

Personal Computer

Canada \$2.75/US \$2.50/FF 8.80/FL 4.00/SFr 7.20/IR £1.12/
BFr 90.00/SKr 12.80/DKr 21.00/Lire 4200

World December 1982 75p

PLUTO
GRAPHICS
BOARD REVIEWED

BRITAIN'S LARGEST SELLING MICRO MAGAZINE

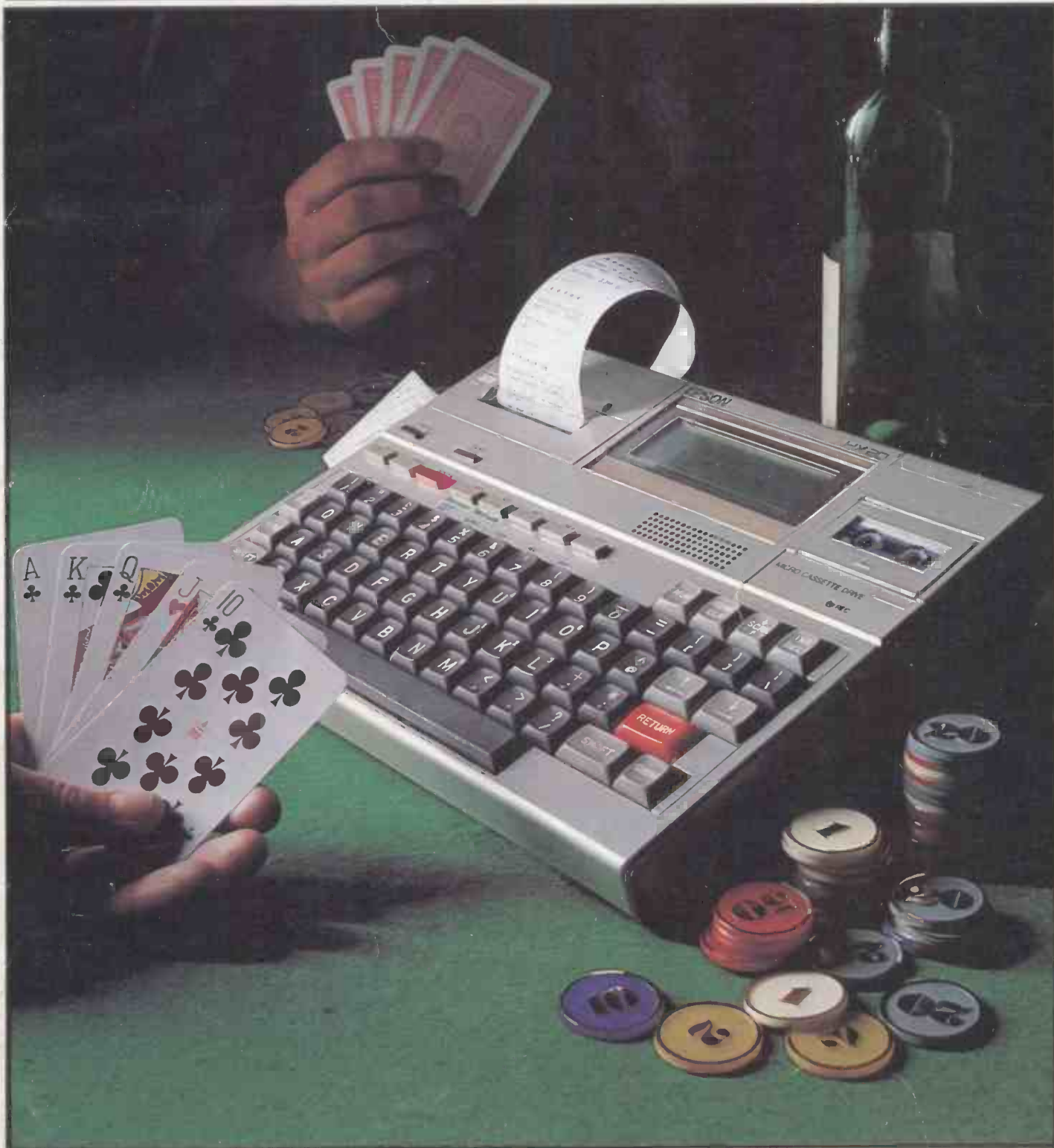

**CAN YOU TAKE AN EPSON ANYWHERE?
PCW Benchtests the HX20**

**NEW
MODEL**

**LOWER
COST**



Cromemco System One

MicroCentre introduce Cromemco's new System One computer, available with an integral 5 megabyte Winchester hard disk, at a new low price.

The System One supports the full range of Cromemco interface cards, including high resolution colour graphics, and software packages. The choice of operating systems includes CDOS, CP/M and CROMIX—Cromemco's answer to Unix.

Call MicroCentre for  Cromemco

MicroCentre Ltd
(Complete Micro Systems)

**Britain's independent
Cromemco importer**

**30 Dundas Street
Edinburgh EH3 6JN
Tel: 031-556 7354**

ANNOUNCING
EVEN NEW COURSES
IN THE 1983 PROGRAMME

KT

MICRO TRAINING FOR COMPUTER USERS

6 Micro courses



Which would you like to attend?

Digitus is running a number of courses to train users and potential users in the basic skills of micro-computing. Conducted at our Central London Workshop, the courses provide hands-on experience of microcomputers, demonstrations of working systems and tutorials on your particular needs.

INTRODUCTION TO MICROCOMPUTERS

One day's concentrated information on microcomputing aimed at the potential user in small and large organisations. A practical course which includes business applications of micros, guidelines on selecting microcomputer systems and an introduction to programming.

FUNDAMENTALS OF PROGRAMMING IN BASIC

A two day course designed to teach the first principals of programming in BASIC. Aimed at those with some understanding of micros who want to learn how to instruct their computer to perform tasks.

IMPROVE YOUR BASIC

A two day course for those who have learned Basic from hands-on experience and want to brush up their BASIC techniques and learn some timesaving software tools.

Training for Computer Professionals
Course in: Micro Technology for Management • Local Area Networks • Micros for Computer Professionals.
Courses are run at the Workshop or on site. Telephone or write for details.

WORDSTAR WORDPROCESSING

A one day course for people who want to learn the fundamentals of wordprocessing. Uses the popular Wordstar wordprocessing package available on most CP/M micros and teaches by hands-on use.

DATASTAR INFORMATION MANAGEMENT

The DataStar data entry, retrieval and management system is a powerful aid which enables the educated user and computer professional to build information systems economically and rapidly.

Micro Technology Workshop Set in 8,500 sq.ft in Central London, the Workshop is a few minutes from Covent Garden, Trafalgar Square, Charing Cross, Embankment and Waterloo stations. Specialist areas include: Personal Computers, Technical Systems, Business Systems, 16 bit and Local Network Systems, Bookstore and Training Rooms.

Booking and Fees Courses 1 to 8 £95 per day plus VAT. Courses 9 to 16 £125 per day plus VAT payable 14 days prior to starting date. YOU SAVE £10 per day BY BOOKING MORE THAN ONE DAYS TRAINING AT ONE TIME

MICRO-PRO SOFTWARE TOOLS

In addition to Wordstar, Micro-Pro Inc have produced a variety of aids to improve productivity in offices and systems departments. This one day course includes: Mail-Merge linked to Wordstar • Supersort sorting utility • CalcStar rows and columns manipulation • DataStar information manager • harnessing the 'Star' products together.

All courses provide access to an extensive range of micro hardware, software and expertise.
Note: Wordstar and DataStar are registered trademarks of Micro-Pro Inc.

INFORMATION FORM (Please complete in BLOCK capitals)
To Digitus Ltd, 10-14 Bedford St, London WC2E 9HE. Tel 01-379 6968

COURSES/Times 9.30-5.30/dates

1 Introduction to Microcomputers	<input type="checkbox"/>	Dec 13	Feb 14	<input type="checkbox"/>
2 Business Systems	<input type="checkbox"/>	Feb 15	Apr 19	<input type="checkbox"/>
3 Information Management	<input type="checkbox"/>	Feb 16	Apr 20	<input type="checkbox"/>
4 Management Aids	<input type="checkbox"/>	Feb 17	Apr 21	<input type="checkbox"/>
5 Fundamentals of BASIC Programming	<input type="checkbox"/>	Dec 14/15	Feb 22/23	<input type="checkbox"/>
6 Improve Your BASIC	<input type="checkbox"/>	Dec 16/17	Feb 24/25	<input type="checkbox"/>
7 WordStar Wordprocessing	<input type="checkbox"/>	Dec 7&10	Jan 18	<input type="checkbox"/>
8 DataStar/SuperSort/MailMerge	<input type="checkbox"/>	Feb 1	March 30	<input type="checkbox"/>
9 Hardware for Software People	<input type="checkbox"/>	March 14	June 13	<input type="checkbox"/>
10 Operating Systems & Languages	<input type="checkbox"/>	March 15	June 14	<input type="checkbox"/>
11 Communications & Networks	<input type="checkbox"/>	March 16	June 15	<input type="checkbox"/>
12 Application Design & Products	<input type="checkbox"/>	March 17	June 16	<input type="checkbox"/>
13 Systems Tools/Program Generators	<input type="checkbox"/>	March 18	June 17	<input type="checkbox"/>
14 Micro Technology & Strategy	<input type="checkbox"/>	Jan 25	May 17	<input type="checkbox"/>
15 Local Area Networks	<input type="checkbox"/>	Jan 26	May 18	<input type="checkbox"/>
16 Micro Database Managers	<input type="checkbox"/>	May 19	Nov 17	<input type="checkbox"/>

Company/address

Name Position

Signature Tel.No. PCW



CONTENTS

Vol 5 No 12 December 1982



Cover photography: John Mason

FEATURES

ADA — A BRIEF ENCOUNTER 118
Mike Parr discusses the Ada programming language.

AN INTELLIGENCE TEST FOR COMPUTERS? 134
Bev Mason introduces an interesting calculus program.



DATABASE COMPARISON 140

Kathy Lang compares notes.

READ ALL ABOUT IT! 154

Steve Mann takes a look at the proliferation of Spectrum books.

PCW MANHUNT 156

The final part of PCW's exhausting competition.

ADVANCE TO THE FORE! 169

A full report on the 3rd European Micro-computer Chess Championship from Anthony Harrington.

GOING UP

With great reluctance we have to announce that as from next month your monthly dose of micro mania will cost you 10p more. That's right — from January, PCW's cover price will be 85p. Considering that we've held the price at 75p for nearly two years now, we hope you'll not be too outraged by this increase, which has been forced on us by rising costs.

Founder Angelo Zgorelec; Managing Editor Dick Pountain; Editor Peter Rodwell; Programs Editor Maggie Burton; Sub Editor Steve Mann; Consultant Editor David Tebbutt; Art Editor Phoebe Creswell-Evans; Design Assistants Rick Gadsby, Safu-Maria Gilbert, Jonathan Sellers; Typesetting Jane Hamnell, Patrick Dineen; Publishing Manager Fiona Collier; Group Advertisement Director John Cade; Advertisement Manager Patrick Dolan; Assistant Advertisement Manager Peter Goldstein; Sales Executive Jan Martin; Micromart Gaye Collins; Advertisement Assistant Priscilla Senior; Advertisement Production Robert Buggs.

BENCHTESTS & REVIEWS

BRIT PRINTER TAKES ON THE JAPS 110
Peter Rodwell reviews the all-British Walters 100 dot-matrix printer.

EPSON HX-20 112
Dick Pountain peeks inside Epson's hand-held computer.



PLUTO POWER! 126
A review of IO Research's powerful graphics board from Joe Whelan.

COMPUTER SCRABBLE 144
Maggie Burton looks at the finer points of Little Genius's Apple Scrabble game.

THE EDUCATIONAL COMPUTER? 148
Mike Curtis tries out Motorola's MC68000 educational board.

REGULARS

NEWSPRINT 94
What's going on in the micro world — and what isn't.

CTUK! NEWS 104
More from the nation's computer literacy project.

BANKS' STATEMENT 107
Martin Banks muses on chip manufacture.



CALCULATOR CORNER 131
A complex arithmetic program for the Sharp PC1211.

COMMUNICATIONS 138
Your chance to moan, whinge, complain — congratulate even!

SCREENPLAY 145
Dick Olney plays games on the TRS-80 Color Computer.

TJ'S WORKSHOP 157
This month's batch of micro tips.

COMPUTER ANSWERS 162
Sheridan Williams and his gang of experts solve your problems.

PCW SUB SET 165
Another collection of useful Assembler routines.

BRAIN DUMP 167
Editor Rodwell reports on his trip to Japan.

SUBSCRIPTIONS 168
This month's reason to buy a subscription to *PCW*.

NEWCOMERS START HERE 174
PCW's intro to computing.

DIRECT ACCESS 175
With In Store, Diary Data, Transaction File, User Group Index, ACC News, Network News and CTUK! Contacts.

PROGRAMS 186
A mixed bag of readers' software.

LEISURE LINES 203
Another teaser to throw your mental processes into total confusion.

BLUDNERS 203
Every magazine makes mistakes — only *PCW* is daft enough to admit them!

BACK ISSUES 204
Your chance to find out what was in last month's *PCW*.

CHIP CHAT 296
More slanderous industry invective.

Subscriptions Manager Stuart Cruickshank; Subscription rates UK: £11.50, Overseas £20.00; Subscription Address 53 Frith Street, London W1A 2HG. © Computing Publications Ltd, 62 Oxford Street, London W1. No material may be reproduced in whole or in part without written consent from the copyright holders. Printed by Chase Web Offset, St Austell, Cornwall. Distributed by Seymour Press, 334 Brixton Road, London SW9. Tel: 01-733 4444.

HOW TO USE YOUR EPSON WITHOUT WASTING COMPUTER TIME

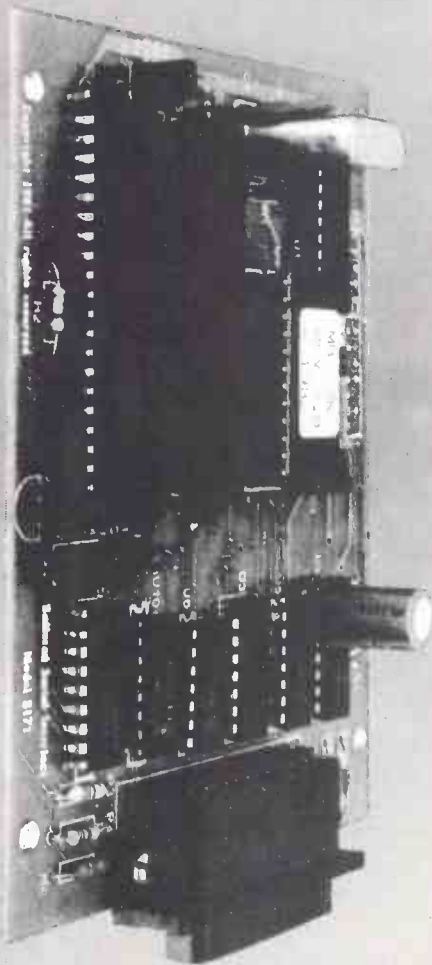

SERIAL 8K
£125 + VAT

Your computer is capable of sending data at thousands of characters per second but the Epson can only print 80/100 characters per second.

This means your computer is forced to wait for the printer to finish one line before it can send the next. A waste of valuable time.

THE NEW MICROBUFFER ACCEPTS DATA AS FAST AS YOUR COMPUTER CAN SEND IT

Microbuffer stores the data in its own memory buffer and then takes control of the printer. This frees your computer for more productive functions.

PARALLEL OR SERIAL

Microbuffer model MBK-16K is a Centronics - compatible parallel interface with 16,384 bytes of on-board RAM for data buffering.

The MBS-8K is a full featured RS232C serial interface with both hardware and software (x-On/X-Off) handshaking, baud rates from 300 to 19,000 and an 8,192 byte RAM buffer.

SIMPLY PLUG IT IN

Either model fits the existing auxiliary interface connector inside the Epson MX80, MX80 F/T or MX100 without modification, and is compatible with standard Epson cables and printer control software.

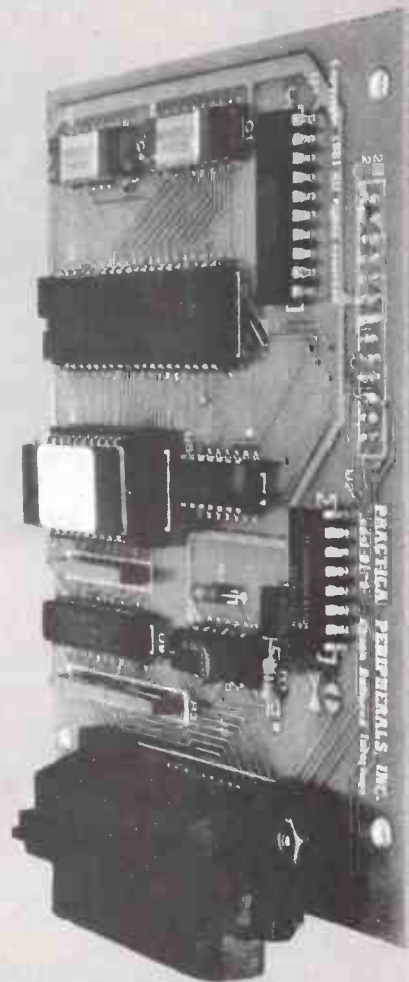

PARALLEL
£125 + VAT

Only available from NORTHAMBER - call your local stockist and get him to order one for you today (he can get 24 hour delivery) - AND GET THE MOST FROM YOUR HOST

NORTHAMBER
The Printer People

3, 4 and 5 DAWES COURT, ESHER, SURREY **LIMITED**
Importers, Distributors and Wholesalers of Computer Products
Tel: ESHER (0372) 66397/62071 Telex: 24123 NAMBEG
(from 01 numbers dial 78-66397 or 78-62071)

Part Exchange Bonanza!

Part Exchange **any** computer/accessorie or calculator
against a **new style** Osborne 1 or an IBM Personal
Computer!

But hurry this offer must close when stocks are exhausted

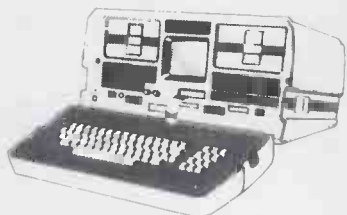

Osborne 1. Recommended
price £1250, plus VAT.



IBM Personal Computer.
Recommended Price £2800
plus VAT

Call us now you never know what we might offer (eg £100
for any calculator, £125 for a ZX81, £200 for a
Spectrum, £??? for an Apple).

OR

An Epson MX80T-3 printer for £99 when you buy an
Osborne 1 or IBM for cash (no part exchange).

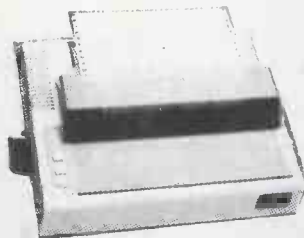

Telephone 01 Computers on 01-228 2207. (6 lines)
Southampton House 192-206 York Road
Battersea London SW11 3SA

ATTENTION... THIS IS YOUR COMPUTER SPEAKING!

Science Fiction has already become a reality. With the DGC TALKER speech synthesizer your computer can now do the talking for itself. By making use of the DGC TALKER developed in The Netherlands an unlimited vocabulary can be composed. The necessary memory space is approx. 10 bytes per second of speech.



Model 01/02

Can be connected directly to the following computer systems: TRS 80 model 1 and III, LNW 80 and Video Genius.
Price £ 120,- plus VAT.

Model 03

The DGC TALKER model 03 can be controlled by any parallel interface. The configuration is standard Centronics compatible. The cable configuration can be connected directly to the following computer systems: Commodore, Vic 20, Pet.
Price £ 110,- plus VAT.

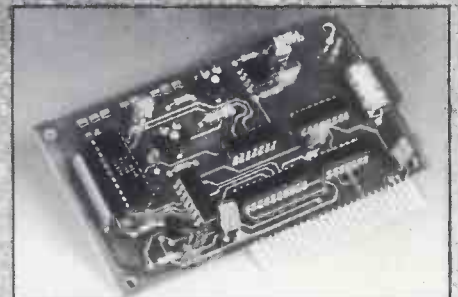

Model 04

The DGC TALKER model 04 is supplied as an insert card, of which the configuration is compatible with Apple expansion slots.

This model can be connected to Apple 2, ITT 20-20 and Pearcom.
Price £ 104,- plus VAT.

The models 01, 02 and 03 have a built-in power supply for 220/240V.

Model 04 uses the power supply of the computer system.

All TALKERS have a built-in LF amplifier and the only item neces-

sary is a loudspeaker.

The DGC TALKER is supplied with V.O.S. (Voice Operating System).

This makes it possible to expand programs written in BASIC

by speech. By using the V.O.S. the application of speech in programs becomes just as simple as the use of the screen.

**Dealers inquires
welcome.**

DGC COMPUTER SYSTEMS

In the U.K.: British Communication Centre.
P.O. Box 149 Oxford OX4 3AB.
Phone 0865 - 72 64 69.
Telex 83147 "for DGC".

In the Netherlands: Dutch head office.
Struytsehoek 1, 3224 HA Hellevoetsluis.
Phone 01833 - 11300.
Telex 26401 "for DGC".

COUPON Send in envelope to:

In the U.K. DGC computer systems
P.O. Box 149 Oxford, OX4 3AB
In the Netherlands: Antwoordnummer 302
3220 WB Hellevoetsluis
Application for more documentation.

Name

Company

Address

City

NEW

ZAND 80/PM MEDICAL PHYSIOLOGICAL MICROCOMPUTER FOR

*** DIAGNOSIS * THERAPY * CONTINUOUS MONITORING * RESEARCH ETC.**



ZAND 80/PM
Medical Physiological Microcomputer

★ Two in one - a professional business Microcomputer plus a Medical Physiological Microcomputer

★ Continuous Real Time display of original signals for ECG, PULSE, FINGER PULSE and RESPIRATION - All four channel display simultaneously for easy comparison

★ Continuous Calculated Mode of display for all four channels above - displays all calculations such as heart beat per minute, pulse transit time, breathing cycles per minute etc.

★ 760K of floppy disc storage for storing the calculated data for later plotting

★ 512 x 512 high resolution graphics and 8 bit A/D converter

★ 96K RAM

★ Quality amplifier with auto gain/offset

★ 15 in. high resolution, long persistent Green Monitor - tiltable & moveable (up-down, side ways)

★ Supplied complete with all hardware inc. ECG electrodes, finger pulse button, radial pulse strap, respiration belt and all software

★ Simple to use - no special training necessary - fully menu driven software

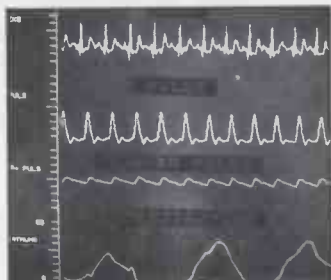

Original Real Time display of ECG, PULSE, FINGER PULSE and RESPIRATION

FAST 100CPS DOT MATRIX PRINTER/PLOTTER FASTER THAN MX801
BETTER GRAPHICS THAN OKI B2A!

The Most Advanced Low Cost Printer Outstanding Graphics, Print Quality & Performance

Recommended Price £399 + VAT

Our price only £292 plus £8 carriage & VAT @ £345 inc.

Stand Alone Serial Interface (to 9,600 baud) with PSU & 4K buffer £80 + VAT = £92 inc.

- Lower case descenders
- Superscript subscript, underlining
- Several character sizes & styles (Pica, elite, proportional, reduced, enlarged, enhanced etc)
- 5 unique alphabets
- Greek and Math symbols
- Adjustable tractors
- Single sheet friction feed
- Powerful programmable paper feed
- Special ribbon cartridge
- Backward carriage return
- 4.5" to 10" paper width
- Original plus 3 copies
- Centronics type parallel interface (standard)
- 2K Buffer

NEC 8023BE-C

**NEW
LOWER
PRICE**

Now only £292
plus £8 carriage plus
VAT @ £345 inc.



- 100CPS print speed
- Bi-directional logic seeking - increment mode
- 80, 136 column
- High resolution dot graphics - 144 x 160 dots/inch
- proportional spacing
- 7 x 9 dot matrix for alphanumerics & symbols
- 8 x 8 dot matrix for character generator graphics
- Output to printer on character by character or dot by dot basis
- Auto reversal (up to down) of ribbon maintains clarity for long period
- ASCII 96 characters - JIS 160 characters - character generator graphics 64 characters - European 14 characters
- Horizontal & vertical tabbing

THE BIGBOARD OEM - INDUSTRIAL - BUSINESS - SCIENTIFIC SINGLE BOARD COMPUTER PCB



Vast user group & bi-monthly Journal "MICROCORNUCOPIA" details sent with documentation.

- 64K RAM
- 2 x RS232
- 24 x 80 characters
- Parallel ASCII Keyboard Port
- Real Time Clock
- 2K System Monitor
- Size: 8 1/2" x 13 1/2" same size as an 8" drive
- Z80 CPU
- Two Port parallel
- Video Port
- Floppy Disk Controller (1771) for up to 4 8" SSSD drives
- Runs CP/M 2.2
- 2K Character Generator (upper & true lower case)
- Requires +5V @ 3A, +12V @ 0.5A

Available ONLY as blank PCB which comes complete with full documentation, the Character Generator ROM, the PFM 3.3 Monitor ROM and a diskette with the Source of BIOS, BOOT, PFM 3.3 Monitor and Printer Routines

£115 + £5 P&P + VAT = Total £138

**UP TO 9600 BAUD
4K BUFFER
ONLY £80 + VAT = £92 INC.**

STAND ALONE multi Board Interface VL-964K

Recommended for NEC 8023BE-C, EPSON and OKI Series of Printers



Suitable for any Printer with centronics Interface and any Computer with serial interface. VL-964K simply plugs into centronics port of the Printer and converts to serial to plug into RS232 port of the Computer.

- 4K Buffer
- Selectable Baud Rates 150 to 9600
- Completely cased
- All IC's socketed
- RS232 Cable (150cm) and Connector
- Self test facility
- Own PSU for 220-240V operation - Mains Cable 200cm ready plugged

VL-964K simply plugs into existing centronics port of the printer and RS232 port of the computer. No installation required! No interference with the Printer Motherboard! Does not invalidate any warranty!



Vincelord Ltd

Suite 2, 26 Charing Cross Road, London WC2
Tel: 01-240 0213/01-240 0217 Telex: 295173 VILORD G

Two new additions to the Microline Family



Whatever your printing needs, one of our Oki printers will fit the bill. Oki Microlines – the only complete printer range.

MICROLINE
80

- 80 column
- 80 cps
- block graphics
- pin, friction or tractor feed

£235

MICROLINE
82A

- 80 column
- 9 x 9 matrix
- 120 cps bi-directional
- multiple interface capability
- pin-addressable or block graphics

£349

MICROLINE
92

- 80 column, bi-directional
- mode 1-160 cps
- mode-2 near letter quality
- high-resolution graphics
- subscript and superscript

£449

MICROLINE
83A

- Full 136 columns
- 9 x 9 matrix
- 120 cps bi-directional
- and all features of 82A

£499

MICROLINE
84

- Full 136 columns
- Mode 1 – 200 cps (400 cps skip)
- Mode 2 – near letter quality
- High-resolution graphics
- Down-line-loadable character set

£799

MICROLINE
93

- full 136-column carriage
- bi-directional
- mode 1-160 cps
- mode-2 near letter quality
- high-resolution graphics
- subscript and superscript

£649

X-DATA

The authorised OKI distributor

X-Data Limited, Equipment Wholesalers.

750-751 Deal Avenue, Slough Trading Estate, Slough, SL1 4SH

Telephone: Slough (0753) 72331; Telex: 847728

SEE US
AT COMPEC '82
STAND
3198/4197



MICROCOMPUTER COMPATIBLE DISK DRIVES

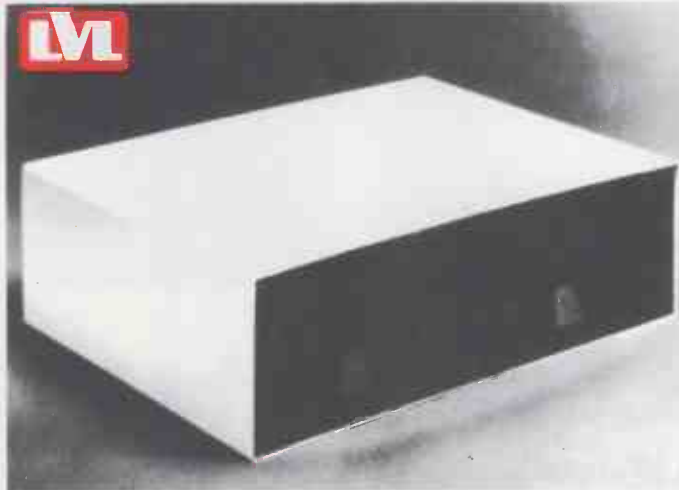

- Dual disk drive unit incorporating 2 x 100K single sided single density disks.
- COMPATIBLE with the BBC single drive unit. Disks are interchangeable with those formatted on the BBC 100K drive.
- Powered from your BBC model B computer. No chance of data corruption from an on-board power supply.
- Operates either from the BBC DOS (available with the unit) or from our optional Z80 card with CP/M.
- Comes complete with all necessary connecting leads, utility disk and full operating manual.

COMING SOON

- Twin 200K drives.
- Twin 400K drives.
- Z80 card with 64K RAM and in-built CP/M.

• Introductory offer: Twin 400K disk drive plus our Z80 card 825 + VAT.

• Many of the above will be available by the time you read this ad!

Call your LVL dealer for a demonstration

The Almaine Company
2 Church St.
Colne Lancs.

W. M. Coupar
8-12 Wellmeadow
Blairgowrie.

D. F. Gibbs Ltd.
555 Foleshill Rd.
Coventry.

Percy Lord & Son
63 Blaby Rd.
Leicester.

Quality Radio & T.V.
790 Alcester Rd. Sth.
Maypole.

B. E. C. Computerworld
66 Lime Street
Liverpool.

Kempson's
26 St Owen St.
Hereford.

S. I. R. Computers
38 Dan-y-Coed Rd.
Cardiff.

Trigon Ltd.
98 Victoria Rd.
London NW. 10.

Cantelec Ltd.
45-46 Moulsham St.
Chelmsford.

Modern Business Techn'y
P. O. Box 87.
Guildford.

Cannonbury Radio
185 Upper St.
Islington N.1.

J.H. Donald Ltd.
6 Riccarton Rd.
Hurlford.

P. R. Hartley Ltd.
20-22 High St.
Ruddington.

R. H. Murcott Ltd.
Gt. Central Rd.
Loughborough.

S. P. Electronics
2 High St.
Hucknall.

Excell of Bembridge
High St.
Bembridge.

Liverpool Computer Ctre.
14-16 Manchester St.
Liverpool.

Computer Shop
18 Mansel St.
Swansea.

A. C. L. Radio Services
1 Northhall
Grays Essex.

Broadway Electronics
1 The Broadway
Bedford.

Video Viewing Centre
Claudeboye Centre
Bangor.

Carvell of Rugby
9 Bank St.
Rugby.

S. Emery & Co.
10 Market Place
Bungay.

Kent Micro Computers
57 Union St.
Maidstone.

P. A. J. Rentals Ltd.
17 Hampden Sq.
London N.14.

The Service Centre
48 Lynedoch St.
Greenock.

F. B. C. Systems Ltd.
10 Main Centre.
Derby.

M. C. E.
79 Ratcliffe Gate
Mansfield.

Commscoi
30 Gordon St.
Glasgow C. 1.

TypeStyle
1 Avondale Court
Onchan.

Vermillion Ltd.
Unit 14
Halesfield 18.

Telford
Salop

The Centre of Sound
120 Notting Hill Gate
London W.11.

H. N. & L. Fisher Ltd.
264 Huthwaite Rd.
Sutton in Ashfield.

J. Lambert Radio Ltd.
107-9 Burnley Rd.
Padiham.

Pratt Bros. Ltd.
9 Lutterworth Rd.
Leicester.

Arthur Yates Ltd.
2 Westgate
Ripon.

Green's Telecom
6 New St.
Barnsley.

Oakleaf Computers Ltd.
121 Dudley Rd.
Grantham.

Off Records
58 Battersea Rise
London SW. 11.

DEALER INQUIRIES INVITED



If you are unable to obtain any of the above products please return the form below.

TO LEASLINK VIEWDATA LTD. SCIENTIFIC HO. 32 BRIDGE ST. SANDIACRE NOTTM. NG10 5BA.

PLEASE SEND ME:

QUANTITY	DESCRIPTION	COST	TOTAL
	TWIN 100K DISK DRIVE	389 00	
	BBC DOS & INTERFACE	95 00	
	POSTAGE & PACKING	6 35	6 35
			TOTAL

I ENCLOSE CHEQUE/PLEASE DEBIT MY ACCESS/BARCLAYCARD TO THE VALUE OF.....
CHEQUE/CARD No. SIGNATURE

NAME.....

ADDRESS.....



LEASLINK VIEWDATA
LIMITED

0602 396976

ACORNS ONLY UK DISTRIBUTOR

DISTRIBUTORS OF:- ACORN ATOM & PERIPHERALS, BBC
MICRO COMPUTER & PERIPHERALS, GEC DATACOM 30,
MICRON VITEC MONITORS, NEWBURY PRINTERS & TORCH COMPUTERS
© CP/M IS A REGISTERED TRADE MARK OF DIGITAL RESEARCH.

COMPAS PASCAL



Fast. Compact. Interactive. COMPAS Pascal for your Z-80 based CP/M micro.

COMPAS is an interactive Pascal system for use on any Z-80 based microcomputer with CP/M*.

COMPAS is incredibly compact - In a single 16K byte program, COMPAS includes a native machine code compiler, an advanced onscreen editor, and all necessary run-time routines! This leaves you more free memory and disk space than any other Pascal system.

COMPAS compiles a large subset of Standard Pascal directly into native Z-80 machine code, at a speed of up to 5000 lines per minute on a 4 MHz system! And a program written in COMPAS is 5 to 25 times faster than the same program in BASIC.

All major features of Pascal are supported by COMPAS, including INTEGERS, REALs with 11.5 significant digits, ARRAYS, RECORDs with variants, FILEs, and recursive PROCEDUREs and FUNCTIONs. Furthermore, many extensions are offered to give increased versatility, for instance STRINGs, random access data files, structured constants, in-line machine code, logical I/O devices, bit/byte manipulation, and program chaining with common variables.



Gemini Microcomputers

UK distributor:

Gemini Microcomputers Ltd.
Oakfield Corner, Sycamore Road
Amersham, Bucks HP6 5EQ
Tel: (02403) 28321 Tx: 837788

PolyData

Overseas distributor:

Poly-Data microcenter ApS
Strandboulevarden 63
DK-2100 Copenhagen O
Tel: 45 * 1 42 07 05

COMPAS is highly interactive. On finding an error during compilation, the compiler automatically invokes the on-screen editor and moves the cursor to the point of error, ready for immediate editing and recompilation.

COMPAS was designed with speed, efficiency, and ease of use in mind. COMPAS brings you the power of Pascal combined with fast compilation, high-speed execution, and easy editing and debugging. Let COMPAS show you the direct course to programming power.

Price £ 120.00 excluding VAT.

Dealer and OEM enquires welcome.

* COMPAS is currently available in Gemini, Superbrain, RML 380Z, Apple II 16-sector (SoftCard), and IBM 3740 8" disk formats. More formats are being implemented.

Please send me details of the COMPAS Pascal package.

Name: _____

Address: _____

Tel.: _____

PCW.11.82

BIRMINGHAM | MANCHESTER | BRISTOL | EDINBURGH
 021-233 1000 | 061-792 2723 | 0272-214572 | 031-225 7446

SILICON VALLEY

01-800 8185

01-802 7186 01-834 9090

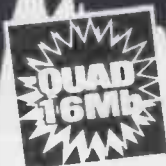

LEASE FROM £11.49 per week



Personal Computer

LEASE FROM £7.99 per week

OSBORNE 1

& **PRAXIS 35**

LEASE FROM £13.40 per week

Logica **VTS**



QUAD DENSITY DRIVES:
 1.6 Mb fitted as standard

ACCESSORIES:

— High quality RAM expansion boards:
 Up to 1 Mb easily installed in your IBM PC

256K £475 512K £775

Full list available on request

— Revolutionary LISTENING and SPEAKING system

SPECIALITY AREAS:

- Main Frame Communications
- Winchester Hard Disks 5 to 40 Mb
- Graphics
- Networking

"MICROPORTABILITY"

OSBORNE 1 + 360K double density disk drives from £6.73 per week

**BETTER DEAL!
 FOR EVERY NEED**

**CASH & CARRY
 or ADVANCED FULL
 SUPPORT**

SPECIAL OFFER

COMPLETE SET OF ACCOUNTING SOFTWARE
 (Invoicing, Stock Control, Sales Ledger,
 Nominal Ledger, Purchase Ledger and Payroll).

AT GIVEAWAY PRICE OF **£299**
 (normal cost £1,500) available with every
 microcomputer purchased.

RAM EXPANSION BOARDS FOR **SINUS 1**
 and VICTOR 9000. In many sizes

— Call in for details and prices.

BRITAIN'S PRIDE
 16-Bit Processor/15" Screen/Keyboard/Dual
 5 1/4" Disk Drives/64K RAM (up to 512K
 available).
 Serial and parallel communication parts,
 CP/M-86 Operating System.

EASY CREDIT TERMS

We have a range of easy credit terms:

LEASING — HP
 — **SHORT TERM RENTALS**
 can be easily arranged.

Call in or FREEPOST your coupon NOW!

THE COMPLETE SERVICE

- * ALL UPGRADING FACILITIES AVAILABLE
- * FULL SOFTWARE SUPPORT
- * MAINTENANCE AND FULL AFTER SALES SERVICE
- * PROFESSIONAL ADVICE IN CHOOSING THE BEST SYSTEM FOR YOUR NEEDS

FREEFONE 2718

PERSONAL CALLERS WELCOME.

MANY OTHER MICROS AVAILABLE!

For more information FREEPOST to
 SILICON VALLEY — Group 18, FREEPOST,
 LONDON N15 6BR.

My interests are:

Please send me further
 details about LEASING

NAME:

POSITION:

COMPANY:

ADDRESS:

..... TEL:



**SILICON
 VALLEY
 COMPUTER
 CENTRE**

Open Monday-Friday 10 am-6 pm

The Silicon Valley Computer Centre
 Group 18 Ltd
 115 Craven Park Road
 LONDON N15

SPECTRUM

**We won't be
be beaten on
price!**

SPECTRUM is a rapidly expanding group of independent retailers who specialise in selling home computers. Our group policy is simple - **WE WON'T BE BEATEN ON PRICE!** - our **BULK BUYING** ensures this. We select and buy the best and pass the savings on to **YOU**, the customer. We **GUARANTEE** that if you find an item currently advertised and in stock at another dealer and at a better price than ours - **WE WILL MATCH THAT PRICE ON THE SPOT.**

**Only trained personnel
at Spectrum!**

We believe that our product 'know-how' is crucial to you the customer. That's why in every one of our centres you'll find fully trained personnel, who have been trained by the importers or distributors themselves - so we know and understand the products we sell and can help every customer even the complete beginner. At SPECTRUM we find the **RIGHT** equipment to suit your needs. Handling over sealed boxes is not our line - our service includes 'hands-on' experience that we pass on to **YOU.**

After Sales care

SPECTRUM service centres will ensure that should your machine 'go-down' we will get it running again as quickly as possible. We also offer extended warranties at reasonable prices too! - ask your SPECTRUM HOME COMPUTER CENTRE for full details.

Shop News!

New Spectrum Centres

BANBURY ● CAMBERLEY
CHELMSFORD ● COVENTRY
DARLINGTON ● DONCASTER
GLOUCESTER ● HULL
HYDE ● LONDON SE1
LONDON N20 ● LONDON W13
NORTHAMPTON
NORTHWICH ● OLDHAM
PEMBROKE ● ST. AUSTELL

COMPUTER DEALERS!

(or prospective Computer Dealers!)

If you would like to know more about becoming a SPECTRUM APPOINTED DEALER on an exclusive area basis, please contact MIKE STERN or ALAN WARREN on (07073) 34761.

Spectrum (U.K.) Ltd.,
Burrowfield,
Welwyn Garden City, Herts.

STOP PRESS

Arriving soon! Very limited quantities of the fabulous

LYNX 48K

£195.65
Ex. VAT

(£225.00 Inc. VAT)

TEXAS TI99/4A

Sensational Value from Spectrum!

Sensational

£50

CASH BACK OFFER!

£50 CASH REBATE WITH EVERY TEXAS TI99-4A PURCHASED

Please ask for full details
Offer expires 31.1.83



REBATE when you return your mailing slip & receipt to Texas Instruments, which in effect brings the price of the TI99/4A down to an unbelievable **£148.95 INC. VAT.** So if you're looking for a top quality micro at a bargain price **HURRY** to your local SPECTRUM dealer and take a look at the **TEXAS TI99/4A.**

- 16K RAM (expandable to 48K)
- Built-in 14K Byte BASIC Interpreter
- 16 Bit Microprocessor
- 16 Colour High Resolution graphics
- Optional programming languages - UCSD PASCAL, TI-LOGO & ASSEMBLER.

■ Extensive range of solid state software command modules available from games to architectural aids.

Spectrum **LOW Price**

£173.00
PRICE INC. VAT £198.95

	EX. VAT	INC. VAT
TEXAS PERIPHERALS		
Speech Synthesizer.....	£40.50	£45.55
Peripheral Exp. System.....	£122.00	£140.30
Disc Cont. Card.....	£124.30	£142.95
Disc Drive.....	£234.74	£269.95
RAM Exp. Card.....	£179.57	£206.50
Matrix printer.....	£347.78	£399.95
Software Entertainment		
TI Invaders.....	£16.48	£18.95
Tombstone City.....	£19.95	£22.95
Attack.....	£19.95	£22.95
Car Wars.....	£23.43	£26.95
Munchman.....	£23.43	£26.95
Adventure & Pirate.....	£31.26	£35.95
Education		
Number Magic.....	£12.13	£13.95
Addition/Subt. 1.....	£23.43	£26.95
Teach yourself beginners		
BASIC.....	£8.26	£9.50
Home Budget Management	£19.96	£22.95

... and many more

Commodore VIC-20

Now a top quality home/business micro for the price of a games machine.

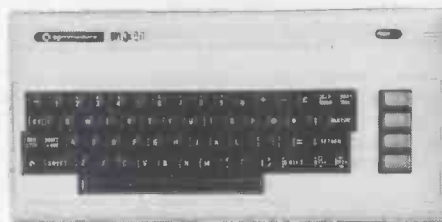

The VIC-20 represents superb value-for-money from SPECTRUM. A truly expandable computer system which can be as simple or as complex as your needs require. Ideal as a home micro with a large number of educational & games cartridges available. Equally, with additional memory expansion, a disc drive and printer, it becomes suitable as a small business system, powerful enough for stock control, book-keeping and payroll generation

- Memory expandable to 32K
- High resolution (full PET type) graphics
- 16 Screen colours & 8 border colours
- Plugs in to your T.V. or monitor
- Add Disk Drive & Printer for impressive 170K Byte system
- Can act as an intelligent terminal for a larger computer.

**Unbelievable
New LOW price** **£127.50**
Ex. VAT (£146.63 Inc. VAT)

	Exc. VAT	Inc. VAT		Exc. VAT	Inc. VAT
VIC C2N cassette unit...	£34.00	£39.10	"Jelly Monsters"	£17.35	£19.95
VIC Printer.....	£185.00	£212.75	"Super Lander"	£17.35	£19.95
VIC Single Floppy disk drive (5 1/4").....	£260.83	£299.95	"Road Race"	£17.35	£19.95
3K RAM.....	£24.00	£27.60	"Rat Race"	£17.35	£19.95
8K RAM.....	£34.00	£39.10	"Super Slot"	£17.35	£19.95
16K RAM exp. cartridge.....	£59.00	£67.85	"Alien"	£17.35	£19.95
Super exp. Hi Res cartridge...	£27.50	£31.63	"Mole Attack"	£17.35	£19.95
Joystick.....	£6.52	£7.50	"Adventure Land"		
Games paddles.....	£11.74	£13.50	"Mission Impossible"	£21.70	£24.95
Programmers			"Voodoo Castle"	£21.70	£24.95
Aid cart.....	£27.50	£31.63	"Blitz" (cass.)	£4.34	£4.95
Machine Code.....	£27.50	£31.63	BOOKS		
Basic (1).....	£13.00	£14.95	Learn Computer Programming with the Commodore VIC	£1.95	No VAT
			VIC Revealed.....	£10.00	No VAT
			VIC 20 Prog. Reference Guide.....	£14.95	No VAT
			VIC Computing Magazine.....	£0.95	No VAT

Super RABBIT Software for VIC-20

	Save 50p on rec. price of the following super quality games.	Inc. VAT
Myriad.....	£9.49	Super Worm..... £4.49
Frogger.....	£9.49	Rabbit Function..... £4.49
Space Storm.....	£6.49	Charset 20..... £4.49
Ski Run.....	£4.49	Rabbit Base..... £14.49
Cosmic Battle.....	£4.49	Rabbit Writer..... £19.49

Not all stores carry every advertised item, please phone before making a journey - Prices correct at time of going to press E. & O.E.

Sensational SCOOP Offer!

LESS THAN WHOLESALE PRICE!

SHARP PC-1211

**Pocket Computer complete with
Cassette/Printer interface**



Here's a tremendous **SCOOP OFFER** from **SPECTRUM** - the **SHARP PC-1211** Pocket Computer, a ready-to-use set up complete with printer and a cassette interface. And **ALL** for an amazing **£95.90 ex. VAT. THAT'S LESS THAN WHOLESALE PRICE!** Complex interest rates, budgets, statistics, or engineering and architectural formulae can be handled quickly and easily. If you're looking for a pocket computer you must take a look at this sensational offer from **SPECTRUM - FIRST!**

- Handy pocket computer employing BASIC language ideal for Mathematics, Statistics, Measurement, Office work, etc.
- Program capacity 1424 steps - 26 memories with memory safeguard.
- Reservable and definable Key Systems.
- Smooth key operation with typewriter key arrangement.
- Cassette Interface allows data and programmes to be saved on tape.
- Connects easily to almost any tape recorder.
- 16 digit dot printer records calculations, programmes, etc. for quick reference.
- Long life battery operation with auto power-off function.
- Plus many more top features.

**Incredible
Value from Spectrum!**

ONLY

£95.90

Ex. VAT
£110.28 Inc. VAT
COMPLETE

SHARP PC-1211

**Pocket computer complete with CE-121
Cassette Interface**



- Ideal for **SCHOOL, OFFICE** or **HOME** use
- High performance functions with easy to understand BASIC language
- Cassette Interface allows easy connection to almost any tape recorder for storage of programmes and data etc.
- 24 Digit alphanumeric dot matrix display
- Plus many more top features.

ONLY

£59.59

Ex. VAT
£68.42 Inc. VAT

HURRY! Limited stock only at these prices!

Plus! We also stock a full range of SHARP accessories including paper rolls, ink ribbons etc.

MORE SPECTRUM LOW PRICES!

Spectrum Computer Centres have no connection whatsoever with the ZX-Spectrum Computer manufactured by Sinclair Research Ltd.

SPECTRUM

ATARI

From household budgets to analysis of bond yields. From foreign languages to spelling or geography. From missile command to PACMAN - ATARI does it all, EXCELLENTLY! See the top selling ATARI range at your nearest SPECTRUM COMPUTER CENTRE - but HURRY! As Christmas approaches stocks are selling fast so make it soon.



ATARI 400
16K RAM
£173.00

(Excluding programmer kit)
Price inc. VAT £198.95



ATARI 800
16K RAM
£434.00

(Includes programmer kit)
Price inc. VAT £499.10



ATARI
THERMAL PRINTER
£173.00

Price inc. VAT £198.95

Additional Equipment	EX. VAT	INC. VAT
Program Recorder	£43.00	£49.45
Disk Drive	£280.00	£299.00
Thermal Printer	£173.00	£198.95
Interface Module	£117.39	£135.00
Accessories		
16K Ram Pack	£56.52	£65.00
Paddles (Pair)	£12.17	£13.99
Joysticks (Pair)	£12.17	£13.99
Printer Cable	£24.78	£28.50
RS232C Cable	£21.74	£25.00
Monitor Cable	£21.74	£25.00
Thermal Paper	£3.48	£4.00
Dos. 2 Master Diskettes	£19.12	£21.99
Books and Manuals		
Wiley Manual	£5.21	£5.99
Basic Reference Manual	£5.21	£5.99
Dos. 2 Manual	£5.21	£5.99
Operating System Listing	£10.43	£11.99
Dos. Utilities Listing	£3.47	£3.99

Atari Home Computer Programs-- Home/Office	EX. VAT	INC. VAT
Graphi	£13.03	£14.89
Statistics 1	£13.03	£14.99
Home Study (Cassette except where stated)		
Inv. to Programming 1	£17.38	£19.99
Inv. to Programming 3	£19.99	£22.99
Conversational French	£34.77	£39.99
Conversational German	£34.77	£39.99
Conversational Italian	£34.77	£39.99
Conversational Spanish	£34.77	£39.99
Hangman	£13.03	£14.99
Scram	£17.38	£19.99
Touch Typing	£17.38	£19.99
Music Composer (Cart.)	£31.30	£35.99
Home Entertainment		
Asteroids	£26.08	£29.99
Basketball	£21.73	£24.99

	EX. VAT	INC. VAT
Blackjack (Cassette)	£13.03	£14.99
Caverns of Mars (Disk)	£26.08	£29.99
Centipede	£26.08	£29.99
Computer Chess	£21.73	£24.99
Missile Command	£26.08	£29.99
Pac Man	£26.08	£29.99
Space Invaders	£26.08	£29.99
Star Raiders	£26.08	£29.99
Super Breakout	£21.73	£24.99
Video Exel	£21.73	£24.99
Programming Languages & Aids		
Assembler Editor	£34.77	£39.99
Pilot (Consumer)	£52.17	£59.99
Pilot (Educator)	£78.25	£89.99
Entertainer kit (Star Raiders, Missile Command and Pair Joysticks)	£60.86	£69.99
Programmer Kit (Basic Cartridge and Manuals)	£43.47	£49.99

SEIKOSHA GP-100A Graphic Printer



Now a top quality graphic printer at a price you can afford. The SEIKOSHA GP-100A - Terrific value at under £200 from SPECTRUM. Standard Centronics compatible interface for easy link-up with most micros. Full graphics capability. Printing speed 30 chars/sec. Double width character output under software control. Graphics, character and double width character can be intermixed on same line. Paper width adjustable up to 10" - tractor feed. Print position addressable by character or dot.

Spectrum LOW price £189.00 Price inc. VAT £217.35

Also Available	EX. VAT	INC. VAT	EX. VAT	INC. VAT
GP-100VC (for VIC-20)	£199.00	£228.85	APPLE SERIAL	£45.00
GP250X 50cps.	£230.00	£264.50	APPLE GRAPHIC	£55.00
Optional Interfaces for GP-100A/GP-100VC			VIDEO GENIE	£36.00
RS232	£70.00	£80.50	Cables for BBC MICRO, ACORN,	
MZ80-A	£60.00	£69.00	DRAGON	£19.09

EPSON PRINTERS

Chosen by SPECTRUM for their reliability, the superb new top quality graphic printers from EPSON. New features include super & subscript, underlining & deletion. If you're looking for an up-market printer at a down-to-earth-price, call in and see the EPSON range at SPECTRUM.

Model	EX. VAT	INC. VAT
MX80-T3	£299.00	£343.85
MX80 F/T Type III	£335.00	£385.25
MX100 Type III	£429.00	£493.35

Please see your SPECTRUM dealer for prices of INTERFACE/CABLE options.

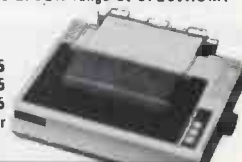

BOOKS

We stock an extensive range of books to help you. Here are just few to whet your appetite.

CP/M Handbook	£11.50
DON'T	£9.65
Programming the Z80	£11.95
Programming the 6502	£10.75
Your First Computer	£7.75
BASIC Handbook (2nd edition)	£14.95
A-Z of Computer Games	£5.60
Atari Basic	£5.95
Basic "BASIC"	£9.95
BASIC Computer Games	£6.95
BASIC Computer Programs for Business (VOL I)	£8.55

NO VAT ON BOOKS

ACCESSORIES

	EX. VAT	INC. VAT
SANYO Slim 3G Cassette Recorder (for use with Nascom and Dragon)	£26.04	£29.95
CTT 3106 14" Colour TV Set	£199.96	£229.95
ACCUTRAK C12 Cassettes	£0.43	£0.50
Single sided, double density disks (for Commodore, Atari, Apple, Tandy etc.)	£1.70	£1.95
Double sided, double density disks (for Sharp and Superbrain)	£2.87	£3.30
Single sided, double density double track disks (for Nascom and Commodore 8050)	£2.30	£2.65
Disk Bank Interlocking cases for diskettes	£3.91	£4.50
Disk head cleaner	£13.00	£14.95
Single part 11" x 9 1/2" printer paper, box of 2200 sheets	£10.39	£11.95

Incredible Value! BMC 12" Green Monitor



18 MHz band width
Green and black display
Spectrum LOW price £69.00 (£79.35 inc. VAT)
Ex VAT Inc. VAT
Prince 12" Monitor £86.00 £98.00
Sanyo 12" SM-12H £84.00 £96.60
Sanyo 14" SCM-14H
Colour £350.00 £402.50

NASCOM Special Edition

SAVE £15 On the BMC 12" Monitor when purchased together with the Nascom Special Edition.

Are you a real computer enthusiast? If you're looking for a machine to take you way beyond the sphere of a normal domestic computer you need go no further than the NASCOM SPECIAL EDITION. To give you some indication of it's scope its already been adopted for many commercial applications including Hotel Booking Systems, blood grouping, weaponry & satellite tracking etc. Now SPECTRUM bring you the opportunity to embark on a remarkable sphere of computing with the infinitely expandable NASCOM. It's a terrific buy! - Trade-In your old machine & trade-up to a NASCOM SPECIAL EDITION - NOW!

■ Programmable in BASIC and machine code ■ 8K Memory expandable easily to 56K with plug-in board ■ Facility for up to 206K onboard memory ■ Super colour graphic facilities ■ Full range of disk drives, printers & various input/output facilities can be added ■ Supplied complete with Mains Lead & Plug, TV, Monitor & Tape Recorder connections.

Spectrum LOW price £429.95 Ex. VAT (£494.44 Inc. VAT)
BMC Monitor illus. Extra
NASCOM Special Edition 48K RAM Board (ready to plug in) £130.00 ex. VAT (£149.50 inc. VAT).



FREE!
£75 WORTH
of software
 with every MZ80A
 purchased

SHARP MZ-80A

Desk top genius! - the all-in-one SHARP MZ-80A. A personal computer designed with the serious user in mind. ready to run the moment you get it home. Built-in keyboard, CRT 9" display and cassette data storage with 48K RAM. The BASIC with extra useful additions, offers quite a powerful micro for the home or business.

■ 4K Byte ROM + 48K Byte RAM + 2K Byte Video RAM ■ ASCII profiled keyboard + numeric pad ■ 2 page Video RAM allows screen to be scrolled up or down. ■ CP/M available.

Spectrum LOW price £475.00 Price Inc. V.A.T. £546.25

MZ Software from KUMA

Pakman (48K)	£8.00
Asteroids	£8.00
Frogger	£8.00
Chess	£14.00
Cribbage	£10.50
Adventure	£10.50
Tombs of Karmak	£8.00
Map of U.K.	£10.50
Music Composer	£10.50
Junior Maths	£5.50
Home Budget	£5.50
Word Pro (Cass)	£39.50
Word Pro (Disk)	£79.95
Data Base (Cass)	£29.50
Data Base (Disk)	£59.50

All KUMA prices excluding V.A.T.

SHARP PERIPHERALS FOR MZ80A	EXC. VAT	INC VAT
Twin-floppy disk unit (inc. 1/0 card, diskette, Manual & Cable)	£689.00	£792.35
Twin Floppy disk unit (5¼") only	£590.00	£678.50
Single floppy disk unit only	£400.00	£460.00
Floppy disk interface card	£100.00	£115.00
Floppy disk cable	£24.00	£27.50
Master diskette and manual	£31.00	£35.66
Expansion unit (disk drive or printer)	£100.00	£115.00
MZ80 P5 Printer	£349.00	£401.30
MZ80 P6 Printer	£409.00	£470.35
MZ80 P4 Printer	£745.00	£856.75
Printer Interface	£30.00	£34.50
P4 Cable	£33.00	£37.95
Universal Interface Card	£45.00	£51.00
Assembler Tapes & Manuals	£42.00	£48.30
FDOS	£85.00	£97.95
MX80K to MZ80A Converter Tape	£10.00	£11.50

... and many more

Fantastic Value for money! DRAGON 32



HURRY!
 Stocks of DRAGON 32 selling fast — few only left at this amazing price

Unbelievable value at only £173.00 from SPECTRUM! British built and designed! It's one of the most impressive micros to appear for quite some time. Extensive facilities include highly advanced colour graphics. Just look at this top specification: Powerful standard 32K RAM (expandable to 64K Bytes) ■ 9 Colour, 5 resolution Display. ■ Extended Microsoft colour BASIC (as standard). ■ Advanced sound with 5 octaves - 255 tones. ■ Professional style editing, e.g. extract line, auto find reinsert. ■ Professional quality keyboard. ■ Centronics Paralled printer interface. ■ Serious programmer/user - the BASIC on this machine is similar to that found on machines costing 3 times the price! ■ Uses almost any cassette recorder. ■ Standard file handling ON TAPE.

Spectrum SENSATIONAL price

£173.00
 PRICE INC. VAT £198.95

SOFTWARE for DRAGON 32	EX. VAT
Joysticks (pair)	£17.35
Cassette lead	£2.35

CASSETTES	EX. VAT
Ghost Attack	£21.70
New! Dragon Mountain	£6.91
New! Typing Tutor	£6.91
New! Flag	£6.91
Computervoice	£6.91
Graphic Animator	£6.91
Quest	£6.91
Madness and the Minotaur	£6.91

EX. VAT	EX. VAT
Selection of Games	£9.01
Selection of Utilities	£6.01
Examples from Dragon Manual	£6.01
Personal Finance	£6.01
Selkosh GPT00A printer for Dragon	£100.00
Printer cable	£10.00
Above prices excluding VAT.	

CARTRIDGES	EX. VAT
New! Cave Hunter	£17.35
New! Starship Chamelon	£17.35
Beserk	£17.35
Cosmic Invaders	£17.35
Meteoroids	£17.35

There's a SPECTRUM CENTRE near you ...

ALFRETON Gordon Harwood, 69/71 High St. 0773 832078	CAMBRIDGE KP Ltd., 12a Kings Parade. 0223 68087	GLOUCESTER The Model Shop, 79-81 Northgate St. (0452) 410893	LONDON N1 ASP Micro Systems, 185 Upper St., Islington. 01-359 9095	NORTHWICH Camera & Computer Centre, 3 Town Sq. (0606) 45629	STAFFORD Computarama, 59 Forgate St. (0785) 41899
ASHFORD Ashford Computer Centre, 2 Station Parade, Clarendon Rd. 07842 44955	CANTERBURY Kent Micro Systems, Conquest House, 17 Palace St. 0227 50200	GUILDFORD The Model Shop, 23 Swan Lane. (07072) 0483 38115	LONDON N.20 Devron, 1291 High Road 01-446 2280	NOTTINGHAM Cameo Computers, 8/9/10 Trinity Walk. 0602 42912	TEDDINGTON "Andrews", 49 Broad St. 01-977 4716
BANBURY Computer Plus, 2 Church Lane. (0295) 55890	CARDIFF Rendall Cox, 18-22 High St. Arcade. 0222 31960	HARROW Camera Arts (Micro Computer Division), 24 St. Ann's Rd. 01-427 5469	LONDON W3 Colomatic Computers, 44 High St., Acton. 01-992 7611	OLDHAM Home & Business Computers Ltd., in store at The Mall, 119 Union St. 061-633 1608	WALLINGTON Surrey Micro Systems Ltd., 53 Woodcote Rd. 01-647 5636
BASILDON Godfrey's, 28-32 East Walk, Town Centre. 0268 289379	CHELMSFORD Maxton Hayman Ltd., 5 Broomfield Rd. (0245) 354595	HATFIELD Microworld, 2 Crawford Rd. (07072) 64137	LONDON W11 Electroleisure, 120 Notting Hill Gate. 01-221 7029	PAIGINTON Devon Computers, 81 Upper Manor Rd. (0803) 526303	WATFORD SRS Microsystems Ltd., 94 The Parade, High St. 0923 26602
BASINGSTOKE Fisher's, 2/3 Market Place. 0256 22079	COVENTRY Coventry Computer Centre, 33 Far Gosford St. (0203) 58942	HULL The Computer Centre (Humber-side) Ltd., 31 Albion St. (0482) 26297 (Just Opening).	MACCLESFIELD Camera & Computer Centre, 118 Mill St. 0625 27468	PEMBROKE Rendall Cox, 19 Main St., 064 668 2876	WEST BROMWICH Bell & Jones, 39 Queens Sq. 021 553 0820
BATH Software Plus, 12 York St. 0225 61676	DARLINGTON McKenna & Brown, 102 Bondgate. (0325) 59744 (Just Opening)	HYDE Page, 213-215 Market St. 061-366 5935	MANCHESTER Lomax Ltd., 8 Exchange St., St. Ann's Sq. 061 832 6167 Mr. Micro Ltd., 69 Partington Lane, Swinton. 061 7282282 open Thurs.-Fri.-Sat. till 8 p.m.	PRESTON Wilding's, 49 Fishergate. 0772 556250	WIDNES Computer City, 78 Victoria Rd. 051 420 3333
BIRMINGHAM Sherwoods, Great Western Arcade. 021 236 7211	DERBY C T Electronics, The Spot. 0332 44760	LEEDS Bass & Bligh, 4 Lower Briggate. 0532 454451	MIDDLESBROUGH McKenna & Brown, 190 Linthorpe Rd. 0842 248345	READING David Saunders Computer Centre, 8 Field Hall Place. 0734 580719	WIGAN Wilding Ltd., 11 Mesnes St. 0942 44382
BRADFORD Photosave, 18 Cheapside. 0274 308598	DONCASTER Briarstar Computer Centre 13 Netherhall Rd. 0302 67135	LEICESTER Youngs, 40-42 Belvoir St. 0533 544774	NEWCASTLE-ON-TYNE Newcastle Camera & Computer Mart, 16 Northumberland Ct. 0632 327461	RUGBY The Rugby Micro Centre, 9-11 Regent St. 0788 70522	WOKING Harpers, 71-73 Commercial Way. 04862 61061
BRIGHTON Capricorn, 1 Queens Rd. 0273 29634	EDINBURGH The Silicon Centre, 6-7 Antigua St. 031 557 4546	LONDON SE1 Vic Odden's, 6 London Bdg. Walk 01-407 6833	NORTHAMPTON Basic Computers & Systems Ltd., 72 Kingshorpe Hollow. 0604 710740	ST. AUSTELL A B & C Computers, 11 Brookstone Rd. (0726) 64463	WORCESTER David Waring Ltd., 1 Marmion House, High St. 0905 27551
CAMBERLEY Camera Arts (Micro Computer Division), 36 High St. (0276) 65848	GLASGOW Victor Morris Ltd., 340 Argyle St. 041 221 8958	LONDON SE9 Square Deal, 375 Footscray Rd., New Eltham. 01-859 1516			Opening soon in: YORK VICTORIA London SW1

COMPUTER DEALERS!
 (or prospective Computer Dealers!)

If you would like to know more about becoming a SPECTRUM APPOINTED DEALER on an exclusive area basis, please contact MIKE STERN or ALAN WARREN on (07073) 34761
 Spectrum (U.K.) Ltd., Burrowfield, Welwyn Garden City, Herts.

MAIL ORDER

When it comes to MAIL ORDER our service is FAST! with SECURICOR DELIVERY to anywhere in the British Isles. - Ask your nearest SPECTRUM dealer for further details at time of ordering.

Up to £1000 INSTANT CREDIT with a SPECTRUM CHARGECARD

With a SPECTRUM CHARGECARD you choose the credit limit to suit YOU. e.g. a monthly payment of £10 gives you £200 credit. Ask your nearest SPECTRUM COMPUTER CENTRE for written details on how to apply for your SPECTRUM CHARGECARD - NOW!
 (Typical APR 30.6%)

V.A.T.

You will see that we quote our prices both including VAT and excluding VAT - no hidden 15% to suddenly up-lift your bill but also making our prices easier to compare with our competitors.

Not all stores carry every advertised item, please phone before making a journey — Prices correct at time of going to press E. & O.E.

Jupiter ACE



The Jupiter Ace personal computer runs in FORTH, an easily understood language, typically four times as compact and ten times as fast as BASIC. Before the Ace all personal computers used BASIC and FORTH was only available to a privileged few.

The Jupiter Ace also features a full-size moving-key keyboard, high-resolution graphics, sound, floating point arithmetic, a fast and reliable cassette interface and 3K of RAM.

If you own a personal computer you will be aware of the limitations of BASIC. You know how slowly your programs run and how quickly your computer's memory gets filled. The Jupiter Ace is your answer.

If you already know FORTH, the Jupiter Ace closely follows the FORTH 79 standard with extensions for floating point, sound and cassette. It has a unique and remarkable editor that allows you to list and alter words that have been previously compiled into the dictionary. This avoids the need to store screens of source, allowing the dictionary itself to be saved on cassette. Comprehensive error checking removes the worry of accidentally crashing your programs.

All inclusive price

For **£89.95** you receive your Jupiter Ace, a mains adaptor, all the leads needed to connect to most cassette recorders and T.V.s (colour or black and white), a software catalogue and a manual.

The manual is a complete introduction to the world of personal computing and a course in FORTH programming on the Ace.

Even if you are a complete newcomer to computers, the manual will guide you step by step from first principles to confident programming.

The price includes postage, packing and V.A.T.

The Jupiter Ace is backed by a full 12 month warranty.

Available soon

Plug-on parallel printer interface.

For around £20.00 this will connect your Jupiter Ace to anything from high-speed dot matrix to letter-quality daisy wheel printers.

Plug-on 16K Memory Expansion

For around £30.00 you will increase the memory of your Jupiter Ace to 19K giving you instant access to enormous amounts of information.

Software

A catalogue will be sent with every machine, and includes, initially, programs for education and entertainment.

FORTH Finishes First!

Speed Comparison Chart showing times in seconds to perform one thousand operations.

Type of Operation	Jupiter Ace	BBC Micro	Vic 20	Spectrum	ZX81
Empty loop	0.12	0.67	1.3	4.2	17.7
Print a number	7.5	13.5	26	19	430
Print a character	0.62	1.3	3.1	7.5	24
Add two numbers	0.45	1.4	5.5	7.5	28
Multiply two numbers	0.9	1.6	6.5	7.5	32

Because of the difficulty in devising exactly equivalent programs, these measurements should only be taken as a guide.

"The Ace is an excellent way of using FORTH"

Popular Computing Weekly

"FORTH is an easy language"

Byte

only £89.95

Designed by Jupiter Cantab

Computer Designers Steven Vickers and Richard Altwasser played a major role in creating the ZX Spectrum and then formed Jupiter Cantab to develop advanced ideas in personal computing. The Ace is the result, another all-British computer to lead the world.

Technical Information

Hardware

Z80A running at 3.25 MHz.
8K bytes ROM
3K bytes RAM

Keyboard

40 Moving-key keyboard with auto repeat on every key and Caps Lock.

Screen

Memory mapped 32 column x 24 line flicker-free display with upper and lower case ascii character set.

Graphics

Chunky graphics (64 x 46 pixels) may be plotted, unplotted or over-plotted (XOR operation). Also, the entire character set (128 characters and their video inverses) may be redefined allowing intricate shapes to be drawn with a resolution equivalent to 256 x 192 pixels.

Control Structures

IF-ELSE-THEN, DO-LOOP, DO-+LOOP, BEGIN-WHILE-REPEAT, BEGIN-UNTIL, all may be mixed and nested to any depth.

Cassette

Programs and data in the compact dictionary format may be saved, verified, loaded and merged. Blocks of memory can be saved, verified, loaded and relocated. All tape files are named. Running at 1500 baud, the Ace will connect to most portable tape recorders.

Expansion Port

Contains D.C. power rails and full Z80 Address, data and control signals. May be used to connect extra memory and other peripherals. IN and OUT words allow port-based peripherals to be addressed.

Data Structures

Integer, Floating point and String data may be held as constants, variables or arrays with multiple dimensions and mixed data types. There are no restrictions on names.

Sound

Internal loudspeaker may be programmed to operate over the entire audio spectrum.

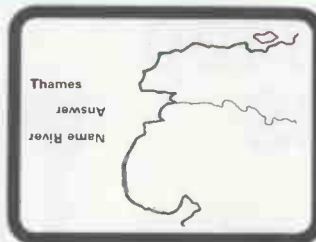

In Schools Teachers already know how quickly children take to computing, and the Jupiter Ace is an ideal introduction. FORTH is an easy and important language to learn and by making learning fun, the Ace can help to teach science, music and many other subjects.

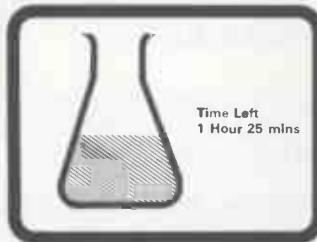

In Laboratories For monitoring and controlling experiments, the Jupiter Ace has many advantages. The language is perfect, even the Jodrell Bank Radio Telescope is controlled in FORTH. The Ace expansion port enables it to be interfaced to almost anything, and the built in quartz timer allows experiments to run all weekend.

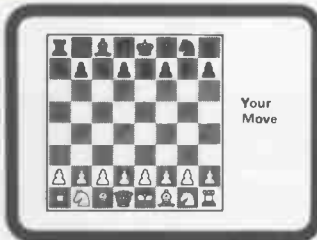

At Home The Jupiter Ace is powerful enough to play games as complex as Chess and with sound and high resolution graphics, action games written in FORTH will stretch your reaction speeds to their limits.



In the Office Stock control, Accounts and Financial forecasts are all possible on the Jupiter Ace. With a printer and extra memory attached you can do word processing as well.

"FORTH is very flexible"

"FORTH is compact"

Electronics and computing

"FORTH is in general very much faster than BASIC"

Computing Today

Programming in FORTH

Programming in FORTH

FORTH programs are constructed without line-numbers, as words which are defined in terms of other words that already exist. Consider the following definition of the word STARS. Comments are in parenthesis and have no action.

```
: STARS      (: starts word definition)
  " *** "    (print 3 asterisks)
  200 100 BEEP (play a note for
              100 mSecs)
;
```

The semi colon at the end finishes the word definition. Now, whenever you say STARS the computer will print out 3 asterisks and sound a short tone. (Notice how the word BEEP comes after the numbers it uses, 200 and 100. This characteristic occurs throughout FORTH so that you write, for instance, 28 76 + instead of 28 + 76.)

The Jupiter Ace already has 140 FORTH words defined in ROM.

The Jupiter Ace is available only by mail order. Please allow up to 28 days for delivery.

Send cheque or postal order with the form to:—
JUPITER CANTAB, 22 FOXHOLLOW, BAR HILL,
CAMBRIDGE CB3 8EP



ORDER NOW!

Please send me:—

JUPITER ACE MICROCOMPUTER(S) @ £89.95.

Name. Mr/ _____
Mrs/Miss _____
Address _____

_____ E

MIDAS S100 SYSTEMS

MIDAS 1 : From £895

MIDAS 2 : From £1,890

MIDAS 3D : From £3,100

MIDAS 86 — 16 Bit : From £3,520



- Our versatile **Z80** Microcomputers are available as standard units or custom configured to your exact specification from a comprehensive range of stocked **S100** boards.
- Disc storage capacity of the **MIDAS 3** can be 2M Bytes, expandable to over 80M Bytes with a Winchester Hard Disc Unit in our **MIDAS 3HD** range.
- **MIDAS** runs **CP/M** and **MP/M**. Other Software includes **M-BASIC**, **C-BASIC**, **FORTRAN**, **COBOL**, **CIS-COBOL**, and **Word Processing**.
A **MIDAS 3D** with 64K RAM and 2M Bytes on two 8" drives with two Serial I/O Ports and **CP/M** only **£3,100**
- Printers, VDUs and other peripherals stocked to give complete package system at kept prices.

BOARDS

We stock over 50 different S100 Boards all from quality manufacturers, such as Godbout, SSM, Micromation, Dual, Ithaca, Vector, S.D. Systems, Morrow, Pickles & Trout, etc.

PROCESSOR

Z80 Starter Kit
Single Board Computers
8085/8088 CPU
Z80A CPU 4MHz (4 types)
8086

EPROM

2716 EPROM (2x16K)
2708/2716/2732 Programmer

VIDEO BOARDS

24x80 I/O Drive
24x80 Memory Mapped

DISK CONTROLLERS

Single Density 5" or 8"
Double Density DMA
Floppy or Hard Controllers

RAM

Static RAM 16-64K 24 Bit addressing
Static RAM 8x64K or 16x32K RAM/
Battery Back-up
Memory Manager

I/O BOARDS

2S/2P or 4S/2P or 3P/1S etc
A/D & D/A or 12 bit
IEEE 488 Interfaces

MISCELLANEOUS

Real Time Clocks
Graphics 512x256 (b/w)
Colour Graphics 312x290
Maths Board AMD 9511
Extender Boards/Logic Probe
Motherboards 7-20 slot

MAINFRAMES

We are the sole distributor for Integrand Mainframes and Disc Enclosures, available in nine models including Desk Top and Rack Mounting, with or without provision for Disc Drives. All units totally enclosed, painted on all external surfaces and complete with power supply etc.

SOFTWARE

CP/M 1&2, MP/M, PL/1, C-Basic 2, M-Basic V5, XYBasic, Fortran 80, Cobol 80, Cis-Cobol, Pascal/Z, Pascal M/T, Forth, MAC, ZSID, Disassembler, Wordstar, Datastar, Wordmaster, Supersoft etc etc.

We are pleased to discuss your requirements and will advise you as to whether your needs can be met with one of our computers.

All of our systems are specials as they are configured to suit your specification, thus ensuring that you get what you want rather than what happens to be available.

Write or phone for a catalogue.

Unit 14, 29 Willow Lane, Mitcham, Surrey
Telephone: 01-640 6931/2/3

ANYTHING IBM CAN DO...

It's 16 BIT. It's IBM PC compatible. And it's here now!

Icarus have a new personal computer manufactured by Columbia Data Systems of the USA complete with its own software and hardware. It will also run all software and hardware produced for the IBM PC.

At first glance, this machine may bear a certain resemblance to its mentor.

That's before you switch it on.

What a performance!

Appearances can be deceptive as a look at the credentials of the Columbia PC machine will tell you.

Operating system software is MS-DOS® or CP/M 86®.

Its 16 BIT 8088 hardware configuration provides 128 K RAM with parity, two RS-232 serial ports, Centronics parallel printer port, DMA controller, eight levels of interrupt, dual floppy disc system with one megabyte storage,

Winchester interface and eight expansion slots.

Not bad for the standard version.

Examine your options

Columbia like to leave your options wide open. So they've included 256K RAM boards, 8087 arithmetic co-processor for high speed math functions, dual RS-232/RS-422 boards, and a Winchester disc based system.

The Columbia PC's expansion capability can easily accommodate just about any imaginable hardware configuration including one megabyte RAM and 10 megabyte disc.

It's here now

And you know the other great thing about the Columbia PC? It's here now. Available off the shelf. And Icarus have a nationwide dealer network waiting to start deliveries.



For further details, or if you would like to become a dealer yourself, contact

ICARUS

Computer Systems Ltd.

Icarus Computer Systems Ltd., Deane House, 27 Greenwood Place, London NW5 1NN.

Tel: 01-485 5574. Telex: 264209

MS-DOS is the trademark of MICROSOFT CP/M is the trademark of Digital Research

For BUSINESS!!!

Telephone 01-9381588

XEROX 820 II

WORDPROCESSING
FORECASTING
BUDGETING
PLANNING



If you're a businessman looking for a superb microcomputer system, come along to Deans and see the new Xerox 820-II.

The revolutionary HX-20



From Epson
Portability for Program
Ability Anywhere £402.00

Olivetti

M20

- ENGINEERING
- BUSINESS
- EDUCATION
- SCIENCE



16 BIT MICRO

Or For PLEASURE!!!

VIC 20

Avenger	£15.95	VIC 20	£129.95
Star Battle	£15.95	Cassette Unit	£39.95
Super Slot	£15.95	VIC 20 Printer	£195.00
Jelly Monster	£15.95	VIC 20 Discdrive	£309.95
Allen	£15.95	3K Add-on RAM	£24.95
Road Race	£15.95	8K Add-on RAM	£36.95
Rat Race	£15.95	16K Add-on RAM	£59.95
Blitz	P.O.A.	Joystick	£6.52
		Paddles	£11.74
		Super Expander	£28.95
		Programming Aid	£28.95
		Machine Code Monitor	

Introduction to Basic
Part 1 £13.00
Part 2 £13.00

commodore 64
£199.95

DRAGON 32
32K Ram
164.95

SHARP

PC 1211	49.95	MZ 80A	417.55
PC 1500	139.95	MZ 80P5	349.95
CE 150 Printer	129.95	MZ 80P6	409.95
CE 155 8K Ram	59.95	MZ 80P4	745.00

Atari 800 with 16K RAM	Atari 400 with 16K RAM
£417.55	£164.95

SINCLAIR ZX81

ZX81	£43.45	Byteing Deeper	£4.95
ZX Printer	£51.95	Gateway Guide	£6.45
16K Ram Pack	£25.95	Getting Acquainted	£5.95
64K Ram Pack	£69.55	Hints & Tips	£4.25
Super Programs 1	£4.30	Mastering Machine Code	
Super Programs 2	£4.30		£7.50
Super Programs 3	£4.30	ROM Part A	£7.00
Super Programs 4	£4.30	English Lit 1	£6.95
BioRhythms	£6.05	English Lit 2	£6.95
Backgammon	£5.17	Geography 1	£6.95
Chess	£6.05	History 1	£6.95
Fantasy Games	£4.13	Maths 1	£6.95
Space Raider	£3.43	Spelling 1	£6.95

LOOK INTO DEANS

for a wide selection of micros, software, printers and books to suit your application

BOOKS: send S.A.E. for complete catalogue

The ZX Spectrum Explored	£ 5.95	Micros - Interfacing Techniques	£13.10
Byteing deeping Into ZX81	£ 4.95	Programming the Z-80	£11.95
Dictionary Of Mini & Micro	£15.00	Programming the 6502	£10.75
Practical Progs/BBC & Acorn	£ 5.95	6502 Applications' Book	£10.25
Apple BASIC: Data File Prog	£ 8.75		
Atari BASIC	£ 7.50	6502 Games	£10.25
Atari Sound & Graphics	£ 6.75	Apple II User's Guide	£11.85
Sharp Software Techniques	£ 5.95	Apple Computer Software	£18.50
BASIC Progs for Business	£ 9.05	Getting Acquainted with VIC20	£ 5.95
		Hints and Tips for ZX81	£ 4.25
		Intro to 8080/8085	£ 5.95
CP/M - The Software Bus	£ 8.50	Assembly Language	
Dictionary of Computing	£ 8.50	6800 Assembly Lang Prog	£12.10
Programming Your ZX Spectrum	£ 6.95	6809 Assembly Lang Prog	£12.10
60 Games/Apps for ZX Spectrum	£ 5.95	8080/Z80 Assembly Lang	£12.10
BBC Micro Revealed	£ 7.95	ZX81 Companion	£ 7.95
Let BBC Teach You to Program	£ 6.45		

INSTANT CREDIT/LEASING

Prices are subject to change without prior notice.

Add 15% VAT, Books 0% VAT
OFFICIAL ORDERS ACCEPTED
Send orders with cheque to
DEANS at
191 Kensington High Street,
London W8.

CARRIAGE: 75p for book/small item £5.00 per large item
Open Mon to Sat 9.30 to 6.30.

Deans
of Kensington

191 Kensington High Street London W8 Tel: 01-937-7896 or 01-938-1588

ON THE ONE HAND A 32BIT PROCESSOR AND 16BIT SYSTEM

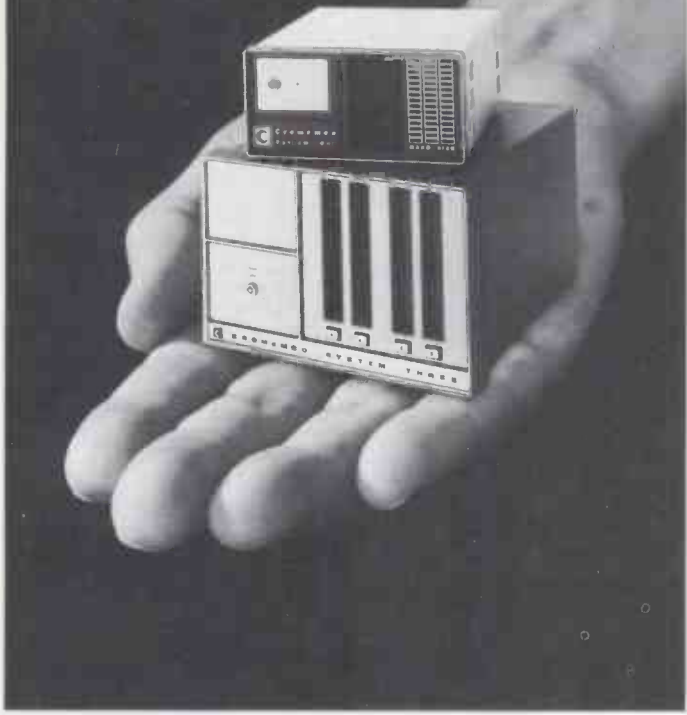

ON THE OTHER FULL 8BIT COMPATIBILITY

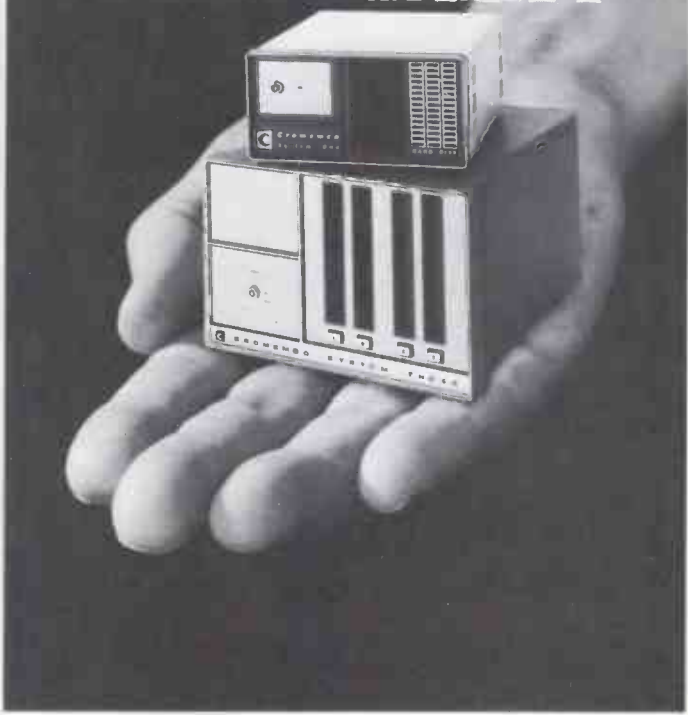

Imagine a microcomputer system which offers all the exciting prospects of full 16 Bit technology to come; but isn't too proud to admit that your existing 8 Bit Software has many years of useful life ahead. So it incorporates the new, high performance MC68000 16 Bit, 8 MHz processor, and an integral software selectable Z80A processor.

And that is the only concession that the new Cromemco 16 Bit System needs to make.

Its use of the MC68000 processor adds new found freedoms to microcomputer systems development. To start with it is fast. Benchmark tests showed it four times as fast as the Z80A, and twice as fast as the PDP11*. It offers superb software performance without having to resort to expensive memory management techniques. The 1000 plus instruction set offers the widest options for producing compact efficient code. Its 32 Bit Architecture offers full 16MByte direct memory addressing. It all adds up to the promise of larger, more efficient software programs, executed in a highly controlled and managed environment.

But it takes Cromemco to put promise on the path to reality. So to support MC68000 processing power there is a new concept in memory cards, full S100 and IEEE 696 compatibility, and a new software library based on 16 Bit Code to optimise the new found processing power.

The Memory Storage comes in single 256K or 512K cards with built in error detection and correction. That gives a full 4MByte of high speed memory in a Cromemco 16Bit System 3, with internal space to spare. The S100 and IEEE 696 compatibility offers the widest possible options in add-on facilities and interface requirements.

The new software library is comprehensive. There is a 16 Bit version of the proven Cromix Multiuser operating system, (now it will support up to 18 users or tasks). There is a new Fortran 77,

designed for creating larger programs in a science/engineering/research environment, and COBOL, PASCAL and 'C', a Structured BASIC, and a 68000 Assembler.

Overall the Cromemco 16 Bit Systems extend the existing boundaries of microcomputer application. In particular, they offer the Scientist and Engineer the opportunity to dramatically reduce the cost of performing the complex mathematical functions required in multi dimensional design, simulation and analytic processes. What was once mainframe capability and became mini is now decidedly Cromemco Microcomputer capability.

But without professional assistance along the way, the path from promise to reality is fraught with obstacles. Comart are Cromemco's longest standing, most experienced distributor in the UK. A five year partnership in this industry, is a lifetime in others.

So with Cromemco's dual processor and Comart support, you won't have to write off the past to step on forward into the future.

comart

SPECIALISTS IN MICROCOMPUTERS

Please send me details of Cromemco's 16 Bit development now and as it evolves.

Name

Position

Company

Address PCW/12

Tel



Cromemco File
Developing through Evolution

*PDP 11 is a trademark of Digital Equipment Corporation
Cromemco and CROMIX are trademarks of Cromemco Incorporated

A member of the  Comart group of companies

Comart Ltd, Little End Road, Eaton Socon, St Neots, Cambs Tel: (0480) 215005 Telex: 32514 ComartG.

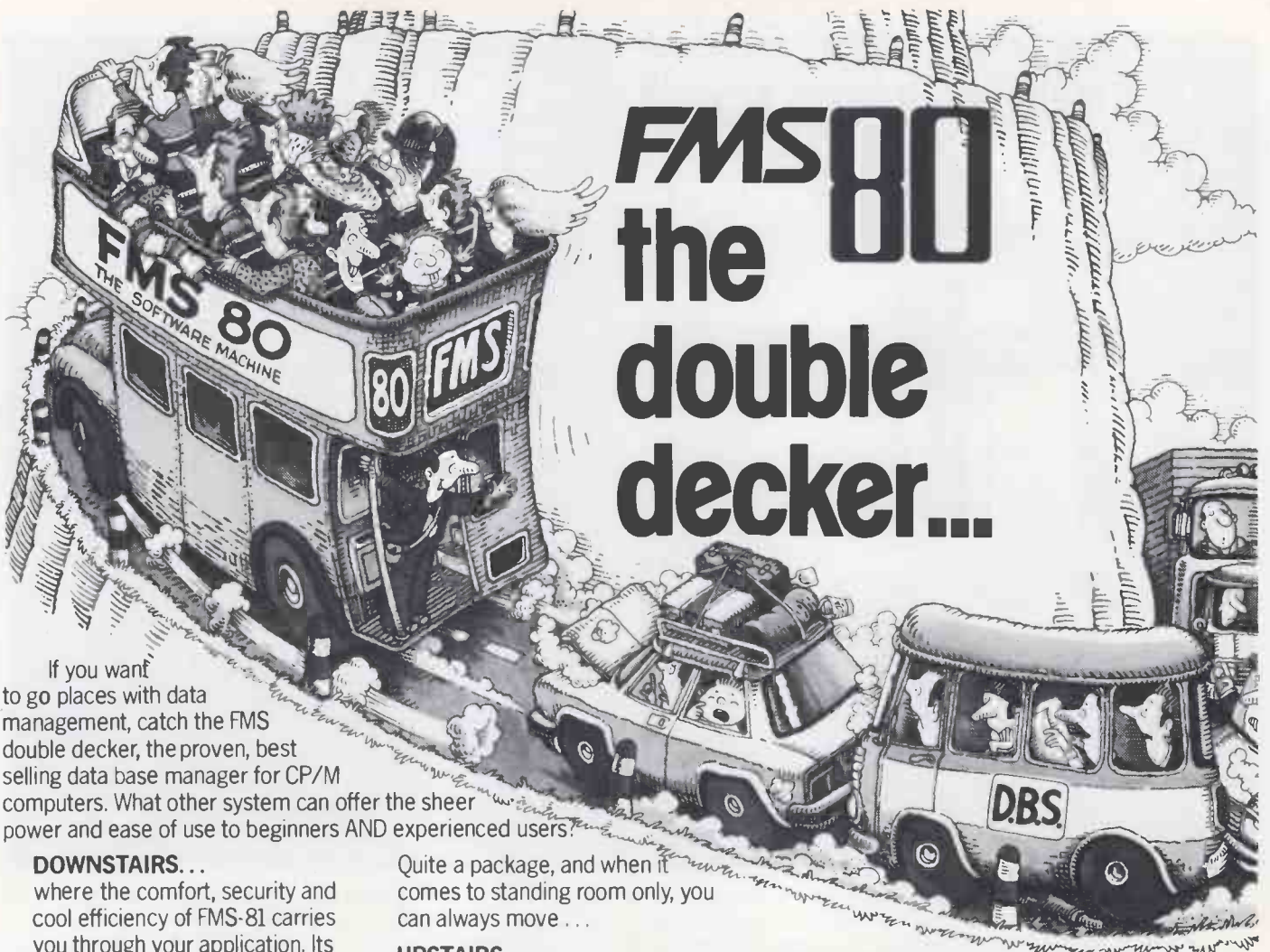

FMS 80 the double decker...

If you want to go places with data management, catch the FMS double decker, the proven, best selling data base manager for CP/M computers. What other system can offer the sheer power and ease of use to beginners AND experienced users:

DOWNSTAIRS...

where the comfort, security and cool efficiency of FMS-81 carries you through your application. Its powerful FMS engine delivers:

- Fully MENU driven, with menu generation
- User defined SCREEN layouts, with multiple pages
- Powerful REPORT generation including totals and averages
- User defined and standard HELP facilities
- Powerful QUERY facility including partial key search
- Up to 255 characters per field; alpha, decimal and variable
- Up to 255 fields per record
- Multiple INDEXes, each up to 250 characters
- Unlimited SORTing and SELECTION criteria including AND/OR definitions.

Quite a package, and when it comes to standing room only, you can always move...

UPSTAIRS...

for a wider view and space to reach out into exciting new applications, FMS-82 provides the top deck other data base systems can't carry. Now, only the sky's the limit with:

- Extended File Maintenance (EFM) programming language enables greater customisation and total flexibility
- Multiple file processing, up to 19 files open at one time
- Direct drive to screen and printer
- Easy generation of data files with access to/from other systems
- Direct access to the SHELL, the FMS engine, enabling full system integration and customisation
- Enhanced REPORT generator with full maths processing

that leaves the other data base systems standing

Don't delay, get a ticket now and leave the others behind - call us now for more details on the FMS HOTLINE. Or, complete and send off the coupon for more information. We know you'll be impressed!

Also now available under CP/M-86 on IBM PC Sirius Victor 9000

SPECIAL INTRODUCTORY OFFER
for a limited period only
FMS 80 £355
FMS 81 £240
FMS 82 £200

Name _____ Company _____
Address _____
Tel No. _____

distributed by:
**INFODATA
SYSTEMS LIMITED**
Chaucer Estate, Easton Lane
Winchester, Hants SO23 7RU
Telephone: 0962 60744/69344
a **djr** product - FMS-8Q, FMS-81, FMS-82™
DJR Associates Inc.

Value - MicroValue - Micro

Computers are our business

As the interest in micro computers increases, magazines like this are attracting an increasing number of readers who are new to the computer market, so we have felt it worthwhile to explain what MicroValue is and who we are.

We do not sell washing machines, cameras, videos or records. Unlike many of our recent competitors, we have been in the computer business for many years and have fully experienced staff, able to give you the advice you need whether you just have an interest in personal computers or whether you wish to buy a relatively sophisticated system for your business needs.

We are all independent enterprises who have grouped together to form MicroValue. This gives us the benefit of increased buying power, which we can in turn pass on to you, our customer. We can also pool our extensive experience in a wide range of computer-related activities, allowing us to give you the best advice.

We are not in business just to sell you the machines and a 13 amp plug. We are prepared to work with you after your purchase to make sure that you obtain the maximum benefit from the marvellous opportunities being offered as micro computers come within the grasp of many small businesses. At the other end of the scale, we are all computer enthusiasts and are delighted to introduce newcomers to the variety of machines under £200 that make an inexpensive, but fascinating, introduction to the world of computers.

So, look through the following pages as a sample of what we have to offer and then visit your local MicroValue Dealer with complete confidence that you will get sympathetic and expert advice.

Computers are our business. Not washing machines, not cameras, not videos; so we depend upon you and we promise you the personal attention that you need.

B.S. Wingfield

BRIAN WINGFIELD

MULTIBOARD

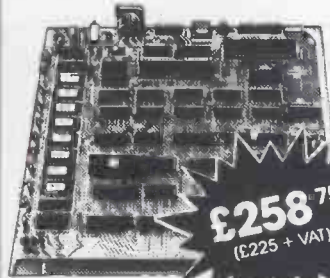

GM813 - CPU/64K RAM Board

- ★ 4 MHz Z80A CPU
- ★ 64K Dynamic RAM
- ★ RS232 Serial Interface
- ★ Two 8-Bit I/O Ports
- ★ 1200 Baud Cassette Interface
- ★ Extended and Page Addressing Modes

£258⁷⁵
(£225 + VAT)

The Gemini GM813 is a new 80-BUS compatible CPU card incorporating 64K dynamic RAM and utilising the powerful Z80A microprocessor running at 4MHz. Extended addressing and page mode facilities allow for future memory expansion up to 2 megabytes. Input and output capabilities include both programmable serial and parallel interfaces - RS232, 1200 baud CUTS cassette interface and the Z80A PIO. When used with the GM812 video card, the GM813's unique RP/M monitor allows the creation of cassette or EPROM based programs or files which are upwards compatible with a disk based CP/M system.

GM811 - CPU Board

- ★ 4MHz Z80A CPU
- ★ Four 'Byte-wide' Memory Sockets
- ★ Two 8-Bit Input/Output Ports
- ★ 8 Bit Input Port
- ★ RS232 Serial Interface
- ★ 1200 Baud CUTS Cassette Interface

£143⁷⁵
(each inc. VAT)

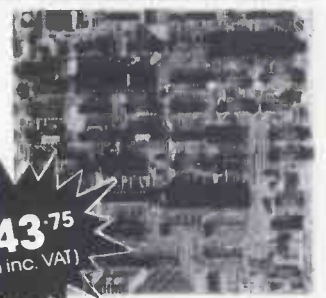

GM812 - IVC Board

- ★ 80x25 Display Format
- ★ On-board Z80A Microprocessor
- ★ Buffered Keyboard Input
- ★ Programmable Character Generator
- ★ 160x75 Pixel Graphics
- ★ Light Pen Input

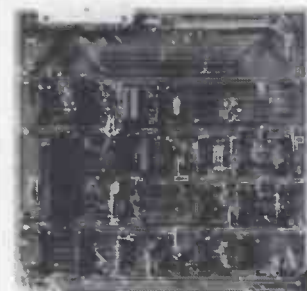
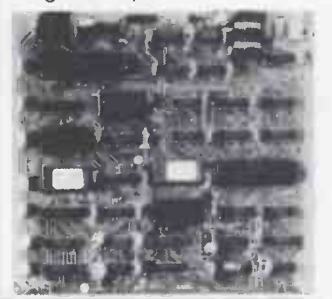

GM809 - FDC Board

- ★ Disk Controller Board
- ★ Single/double density
- ★ Single/double sided
- ★ 8" or 5.25" Drives

Other boards available in the Multiboard range:

GM802	64K Dynamic RAM Board	£143.75 inc. VAT
GM803	EPROM/ROM Board	£ 74.75 inc. VAT
GM816	MULTI-I/O Board	£143.75 inc. VAT
MP826	32K Static RAM Board	£212.75 inc. VAT
PLUTO	Colour Graphics Board	£458.85 inc. VAT

Send for latest catalogue for full details.

MicroValue

REAL value - from the Professionals

Value - MicroValue - Micro

COMPUTERS

New from Gemini

Gemini Galaxy 2

- ★ Twin Z80A Processors
- ★ CP/M 2.2 Operating System
- ★ 64K Dynamic RAM
- ★ 800K Disk Capacity
- ★ 80x25 Video Display
- ★ Serial and parallel printer interfaces
- ★ Cassette and light pen interfaces
- ★ User definable function keys
- ★ Numerical key pad
- ★ 12" Monitor included

£1719^{·25}
(£1495 + VAT)

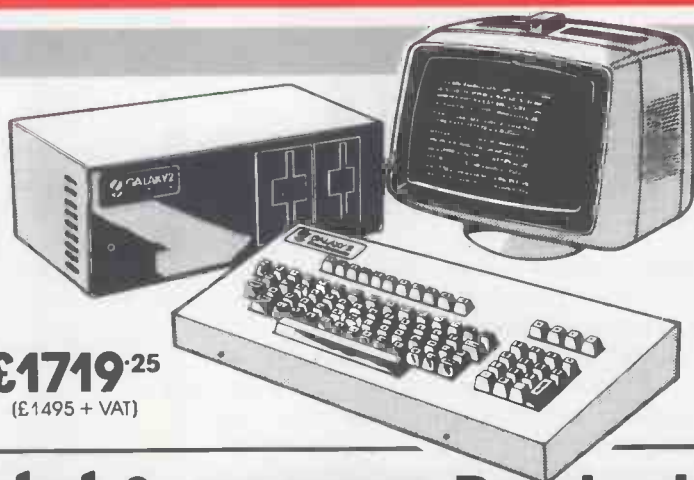

Total support for Gemini & nascom Products

nascom 3 available from MicroValue

Based around the successful Nascom 2 computer, this new system can be built up into a complete disk based system. Supplied built and tested complete with PSU, Nas-Sys 3 and Nas-Gra.

48K System
£631^{·35} (£549 + VAT)

CP/M 2.2
£115 (£100 + VAT)

NASCOM 2 KIT
£258^{·75} (£225 + VAT)

Built & Tested
£327^{·75} (£285 + VAT)

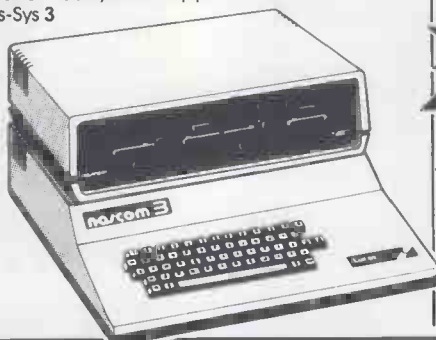

80x25 Video for nascom



Nascom owners can now have a professional 80x25 Video display by using the Gemini G812 Intelligent Video Card with on-board Z80A. This card does not occupy system memory space and provides over 50 user controllable functions including prog character set, fully compatible with Gemini G805 and G815/809 Disk Systems. Software supplied on Gemini system disks. Built and tested.

£143^{·75}
(£125 + VAT)

Nascom 1 Printed Circuit
(inc. parts list)

£28^{·75} (£25 + VAT)

GM802 64K RAM Card
£143^{·75} (£125 + VAT)

GM802K 16K RAM Kit
£92 (£80 + VAT)

Disk System for Gemini & nascom

GM809 - full Nas-Bus floppy disk controller card - drives up to 4 drives - optional 8" expansion - **£143.75 inc. VAT.** **GM815** - Double density disk system.

With a thousand in daily use, the Gemini Disk system is now the standard for Nascom and Gemini Multiboard systems. Single or twin drive configurations are available, giving 350K storage per drive. The CP/M 2.2 package available supports on-screen editing with either the normal Nascom or Gemini IVC screens, parallel or serial printers and auto single-double density selection. An optional alternative to CP/M is available for Nascom owners wishing to support existing software. Called POLYDOS 2, it includes an editor and assembler and extends the Nascom BASIC to include disk commands.

Single drive system
(G809, G815/1)
£517^{·50} (£450 + VAT)

CP/M 2.2 package (G513)
£115^{·00} (£100 + VAT)

Double drive system
(G809, G815/2)
£776^{·25} (£675 + VAT)

POLYDOS 2
£103^{·50} (£90 + VAT)

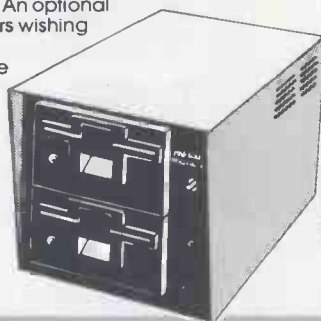

At last - a Winchester Drive for your Gemini / nascom System!

GM835 Winchester Drive Sub-system.

- ★ 5.4 Megabyte Formatted Capacity
- ★ Rodime Drive
- ★ Industry Standard SASI interface
- ★ Integral Controller and power supply

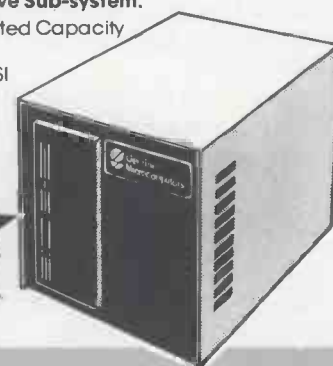

SOFTWARE

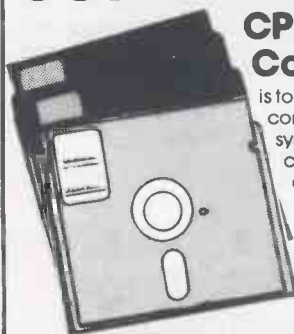

CP/M Software Compas

is totally different from other compiler based Pascal systems, as it allows you to create, edit, run, and debug Pascal programs in a highly interactive manner.

£138^{·00}
(inc. VAT)

'The Last One' is used in conjunction with Microsoft's MBASIC*. No knowledge of BASIC programming is required since all input is performed using question and answer routines written in plain English.

£379^{·50}
(inc. VAT)

*MBASIC - MicroValue Price - **£178.95 inc. VAT**

Gemini Software:

GEM PEN Text Editor **£51.75 inc. VAT**
GEM ZAP Assembler **£51.75 inc. VAT**
GEM DEBUG Debugging Utility **£34.50 inc. VAT**
WORDSTAR Word Processor **£247.25 inc. VAT**
GEM GRAPHIC Links with MBASIC **£40.25 inc. VAT**

VIZ:APL is a high level language system. It can be used to develop small programs faster and large programs in limited memory. The language can be enhanced almost indefinitely and the user's own operators and functions can be built up.

£293^{·25}
(inc. VAT)

A wide range of software for Nascom also available.

When ordering disks, please specify format.

Value - MicroValue - Micro

LOW COST SYSTEMS

Dragon 32

A powerful colour computer for under £200.

- * 32K RAM
- * 6809E Microprocessor
- * Extended Microsoft Colour BASIC
- * 9 Colour, 5 Resolution Display
- * Sound through TV 5 octaves, 255 tones
- * Advanced Graphics

Full range of Dragon software available.

FREE
cassette with
every Dragon
purchased.



£199^{·50}
(£173.47 + VAT)

Sinclair ZX81

Now available through MicroValue — a real computer for less than £50!

- * Sinclair ZX81 Computer
- * Sinclair ZX Printer
- * 16K ZX RAM PACK
- * ZX81 Learning Lab
- * Software for Sinclair

£49.95 (£43.43 + VAT)
£59.95 (£52.13 + VAT)
£29.95 (£26.04 + VAT)
£19.95 (£17.35 + VAT)
from **£3.95 inc VAT**



THE NEW

SHARP MZ80A

Electronic magnificence from Sharp

Z80A C.P.U. · 48K RAM · 4K ROM · Industry standard Qwerty keyboard with numeric pad · 9" GREEN C.R.T. · 1200 baud cassette · Music and sound · Real time clock · Enhanced BASIC · Full editing facilities · Internal expansion.



£546^{·25} (£475 + VAT)

FREE SOFTWARE!

Home budget, bank reconciliation, SPACE INVADERS, STAR TREK, SCRAMBLE, bank loan calculator, mortgage calculator + 7 other games.

Educational — Geography, Maths., Spelling + 4 part BASIC tutorial.

PRINTERS

Epson MX80 Type III **£399.95 inc. VAT**
Epson MX80 FT Type III **£445.95 inc. VAT**
Epson MX 100 Type III **£569.95 inc. VAT**
NEC 8023A **£389.95 inc. VAT**
SEIKOSHA GP100A **£246.95 inc. VAT**

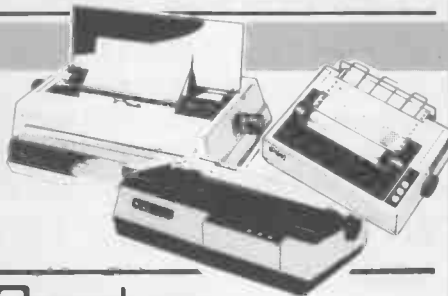

Daisy Wheel Printer:

Smith-Corona TP-1 **£557.75 inc. VAT**

Quantum

HI-COPY FOR MZ80K

This combination of hardware and software not only allows printing of the full Sharp character set, but allows a full High Resolution print of the actual screen if used with the Hi-Res graphics option.

Available in 2 versions —

QUANTUM GP100A HI-COPY

SEIKOSHA GP100A, Interface, ROMS and Screen dump BASIC

£345

(£300 + VAT)

Price includes printer

QUANTUM EPSON HI-COPY

Interface and ROMS and screen dump BASIC suitable for use with any

EPSON PRINTER

£103^{·50}

(£90 + VAT)

Price excluding printer

SPECIAL OFFER

Quantum Hi-Res Only **£80.50 inc. VAT** if purchased with Quantum Hi-Copy. Quantum MZ80K Games Packs 1-5 **£5.75 inc. VAT** each.

Quantum

HI-RES FOR MZ80K

High resolution plotting on your MZ80K down to a resolution of a single dot within a character cell.

A new BASIC is supplied with the following additional commands: LINE, WIPE, G SET, G RESET.



A high quality data display monitor, ideal for all Nascom and Gemini systems. 20MHz resolution. Available in amber or green phosphor.

£126^{·50}
(£110 + VAT)

Phoenix P12 Monitor

Telephone orders welcome



**JOIN THE
COMPUTER
PROFESSIONALS**

MicroValue

REAL value — from the Professionals

MICROVALUE DEALERS:

AMERSHAM, BUCKS

Amersham Computer Centre,
Oakfield Corner,
Sycamore Road.
Tel: (02403) 22307

BIRMINGHAM B5

Skytronics MBM, 80 Bristol Street,
Tel: 021-622 6436

BRISTOL

Target Electronics Ltd., 16 Cherry Lane.
Tel: (0272) 421196

EGHAM, SURREY

Electrovalue Ltd.,
28 St. Judes Road, Englefield Green.
Tel: (07843) 3603

IPSWICH

MDW (Electronics),
47/49 Woodbridge Road East.
Tel: (0473) 78295

LEEDS LS2

Bits and PC's Computer Products Ltd.,
Leeds Computer Centre,
60/62 Merrion Centre.
Tel: (0532) 458877

LONDON W2

Henry's Radio, 404 Edgware Road.
Tel: 01-402 6822

LONDON SW11

OFF Records,
Computer House, 58 Battersea Rise,
Clapham Junction.
Tel: 01-223 7730

MANCHESTER M19

EV Computing, 700 Burnage Lane.
Tel: 061-431 4866

NOTTINGHAM

Computerama, (Skytronics Ltd.)
357 Derby Road.
Tel: (0602) 781742

A FREE 12" MONITOR WITH EVERY

OSBORNE 1

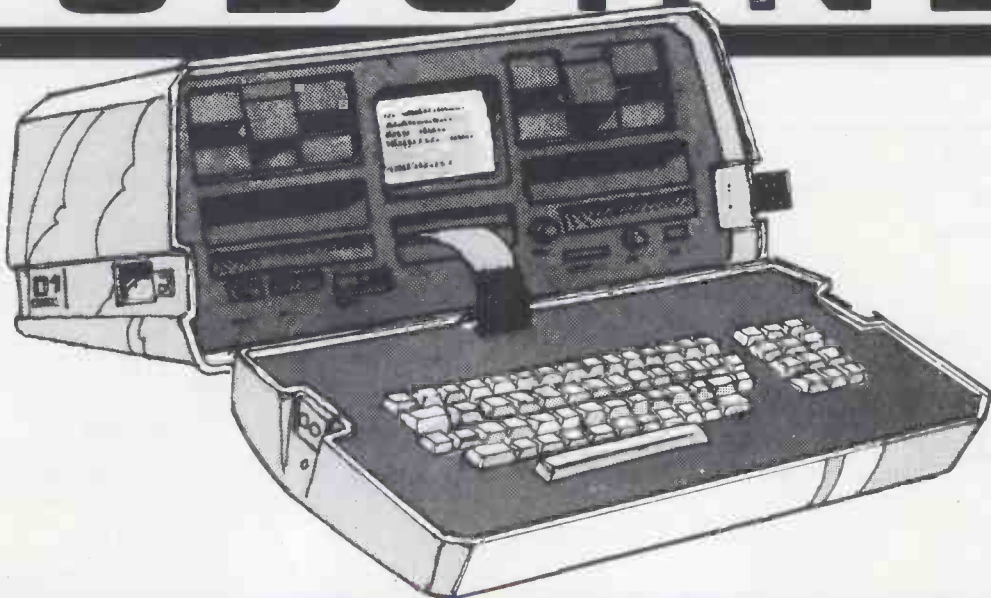

Personal Business Computer!

Available NOW from DATALINK the amazing Osborne 1 is the totally portable 64K personal business computer. An incredible breakthrough for mobile executives, sales personnel, engineers etc., Osborne 1 weighs only 24lb and fits under the standard airline seat!

And just look at DATALINK's special introductory offer
WORTH NEARLY £200! —

— A FREE 12" QUALITY GREEN MONITOR

which Interfaces with the Osborne for home use PLUS A BOX OF HIGH QUALITY BASF DISCS complete with SUPERIOR LIBRARY CASE! FREE!

Datalink's price - £1250+VAT!

The Osborne package also includes as standard: WORDSTAR,[®] SUPERCALC,[™] MAIL MERGE,[®] MBASIC,[®] CBASIC[®] and CPM[®]

Take advantage of this superb offer while it lasts.
Cash with order — Personal buyers welcome. Post FREE in UK!

DATALINK

MICROCOMPUTER SYSTEMS (UK) LIMITED

10 Waring House, Redcliffe Hill, Bristol BS1 6TB Tel: Bristol (0272) 213427 Telex: DATAL G 44807

24 hr answering service

THE Computer SUPERMARKET

£50 "Cash Back" Offer.
 Each person who buys a Texas TI-99/4A before 31st January 1983 can claim a £50 refund and save in excess of 25%.
 Ask for application when ordering your TI-99/4A

Nobody does it like we do
Just order from us once.
We know you'll be back for more.

Texas

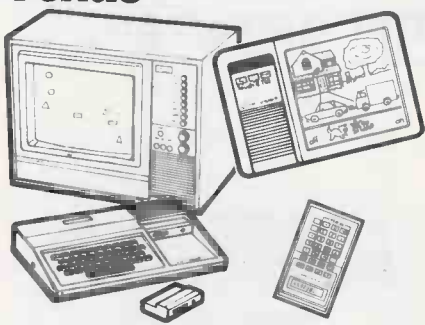

Home Computers

		Price VAT inclusive
TI-99/4A	16K RAM Per. Comp.	199.00
	Peripheral Expansion Unit	149.50
	Disk Drive (Internal)	253.00
	Disk Controller Card	138.00
	32K RAM Expansion (Internal)	149.50
	RS232 Interface (Internal)	114.99
	Dot Matrix Printer	373.75
	Speech Synthesizer	49.95
	Joystick	20.70
	Cassette Cable	9.00

Learning Aids

Little Professor	Over 50,000 problems (5yrs and over)	9.95
Touch & Tell	Pre-School Learning (2/5yrs)	29.95
Speak & Write	Speaking/Spelling Aid	23.95
Speak & Maths	Fascinating Figure Aid	34.95
Speak & Spell	Talking Learning Aid	34.95

Calculators

TI-1006	Light-personal Office Use	7.95
TI-1032	Elementary School Use	6.95
TI-21	Business Use	9.95
TI-30	O and A Level	12.95
TI-40	A Level, Statistics, Physics	16.95
TI-57	O and A Level, Laboratory	24.95
TI-5000	Display and Print-out (hand hold)	25.95
TI-5130	Desk Display and Print-out	53.95
TI Programmer	Full Scientific	49.95
TI-501	Elementary School Use	4.95

Dragon

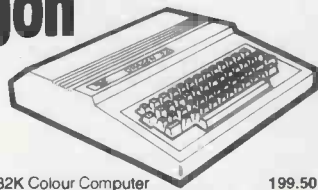

Dragon 32 32K Colour Computer Joysticks (Pair) - available shortly 199.50

Atari

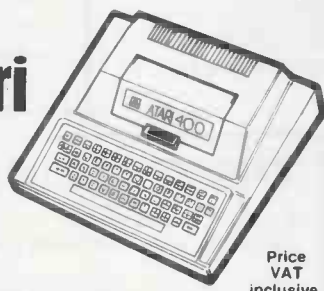

		Price VAT inclusive
Atari 400	16K Computer (inc BASIC cart)	224.95
Atari 400	48K Computer (inc BASIC cart)	344.99
Atari 800	16K Computer (inc BASIC cart)	475.00
Atari 400	16K Computer (exc BASIC cart)	189.95
Atari 410	Cassette Recorder	47.99
Atari 810	Single Disk Drive	299.99
Atari 825	80 col printer	488.75
Atari 853	16K RAM Pack	60.37
Atari CX30	Paddles (Pair)	13.80
Atari CS40	Joysticks (Pair)	13.80

Epson Printers

MX80 T/3	Dot Matrix, Hi-Res Tractor	373.75
MX80 FT/3	Dot Matrix, Hi-Res, Friction - Tractor	431.25
MX82 FT/3	Friction	447.35
MX82 T/3	Dot Matrix	402.00
MX100/3	Dot Matrix 100 CPS 15" Platen	552.00

Epson Interfaces

Apple Interface and Cable	63.25
RS232 Interface	40.25
BBC Micro Cable	23.00
TRS80 Interface and Cable	46.00
IEEE Int. (Ext.)	75.00

Monitors

BM12A	12 inch (Green) 18MHz	103.50
BM1401	12 inch RGB Colour	286.35

Despatch of all items ordered by credit card made within 48 hours of order (subject to stock availability) and is FREE anywhere on mainland UK, or to any BFPO address. (Shipment outside UK, deduct VAT). Shipment can be arranged worldwide, send for Export Price List from Computer Supermarket (Export) Ltd.

Approved Distributor for Commodore, Atari, Texas and Dragon.

All machines are to full UK Standard and are fully tested before despatch. Sold with full manufacturer's warranty and subject to conditions of sale (available on request).

Prices are valid only for the cover date month of this magazine. Telephone for latest prices. All prices are VAT inclusive. Ring or write for full details of credit facilities available. Concessionary price list available for bonafide representatives of government and educational establishments.

All orders will be acknowledged by return post.

Commodore

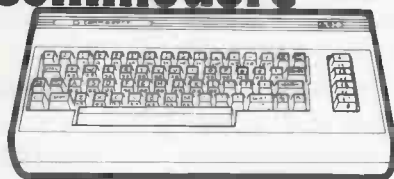

		Price VAT inclusive
VIC 10	(CBM Max) Personal Computer	109.95
VIC 20	Personal Computer	147.50
VIC 64	Personal Computer	343.85
VIC/C2N	Cassette	41.40
VIC 1110	8K RAM Cartridge	41.40
VIC 1111	16K RAM Cartridge	69.00
VIC 1211M	3K RAM (High-Res) Cartridge	32.20
VIC 1212	Programmers Aid	32.20
VIC 1213	Machine Code Monitor	32.20
VIC 1215	Matrix Printer	215.00
VIC 1540	Single Disk Drive	299.00
VIC Joystick		7.50
VIC Paddles (Pair)		12.65
VIC Expansion Unit		89.70

To The Computer Supermarket Ltd.,
 Unit 8, Southfold Road, Oakley Hay Ind. Estate,
 Corby, Northamptonshire.

Please send me

Model No.	Item	Price

Please send me free catalogue

I enclose my cheque for £
 Or debit my Access/Barclaycard/
 Diners/Amex No.

(Cardholders may telephone orders to 0536 744015)

Signature _____ (I am over 18)
 Name _____
 Address _____

PCW (BLOCK CAPITALS PLEASE)
 Your remittance should be made payable to Computer Supermarket Reader's Account, and shall remain your money until the goods have been despatched to you at the address specified. Reg. No. 2646589.
Prestel subscribers may order some products through the Prestel system. Directory No. 400400.
 If the product you have purchased does not meet with your satisfaction, return it in the carton it arrived in, in good condition within seven days and your money and postage will be refunded in full.

THE Computer SUPERMARKET

UNIT 8, SOUTHFOLD ROAD,
 OAKLEY HAY ESTATE, CORBY,
 NORTHAMPTONSHIRE
 ☎ (0536) 744015 Telex COMPUS 341543/4
 Also at Knightsbridge Mall, Arndale Centre,
 Manchester (Retail only)
 ☎ 061 835 1116

OPEN 6 DAYS PER WEEK

INTEREST FREE

On Atari, VIC20, Commodore 64 and

If your order contains over £120 worth of computer hardware apply now for interest free credit by telephoning: Mail-order: (0702) 552911. London Shop: 01-748 0926. Birmingham Shop: 021-356 7292. Southend Shop: 0702 554000 or write to P.O. Box 3, Rayleigh, Essex SS6 8LR.

You pay 10% down, then 10% per month for a further nine months (to nearest penny). Example: VIC20 Colour Computer. Cash Price £169.99. Credit terms: £16.99 down then £17 per month for nine months: Total £169.99. Credit quotations on request.

THE NEW COMMODORE 64

The incredible new computer from Commodore comes with 64K RAM fitted! Plus 16 colours, hi-res graphics, 320 x 200 pixels, 40 columns by 25 lines, Z80 micro processor can be added — that means you can run CP/M software, 8 independently movable Sprites with collision detection, and a sound generator with 3 voices, 4 wave-forms, envelope and filter to rival some dedicated music synthesisers. And all this at the most incredible price ever. (AF56L) Only £339.00

DRAGON 32

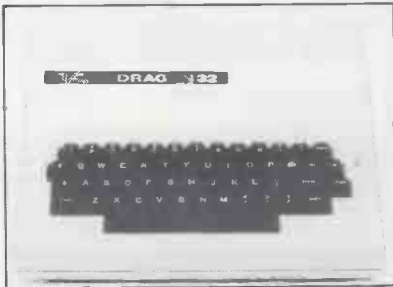

The amazing new British computer with a full-travel standard keyboard, a 16-bit microprocessor, 32K RAM fitted (expandable to 64K and later to 256K!), 9 colours, hi-res graphics and Microsoft extended colour BASIC (the very best BASIC to learn with). It can be used with virtually any ordinary cassette recorder, it has a printer interface (Centronics-type), joysticks are available and it's incredible value for money. (AF57M) Only £199.50

THE AMAZING ATARI COMPUTERS

4 Consoles Available:

- Atari 400 with 16K RAM (AF36P) £249.95
- Atari 400 with 48K RAM (AF37S) £319.00
- Atari 800 with 16K RAM (AF02C) £499.00
- Atari 800 with 48K RAM (AF55K) £590.00

★ All above with BASIC & handbooks

- Other hardware:
- Cassette Recorder (AF28F) £50.00
 - Disk Drive (AF06G) £299.95
 - Thermal Printer (AF04E) £265.00
 - Epson MX80T Mk III (AF38R) £399.95
 - Epson MX80F/T Mk III (AF40T) £447.35
 - Printer Interface for 400 (AF41U) £59.95
 - Printer Interface for 800 (AF42V) £59.95
 - Interface Module (AF29G) £135.00
 - Versawriter (AF43W) £199.95
 - 16K RAM Module (AF08J) £55.00
 - 48K RAM Module for 400 (AF44X) £125.35
 - 48K Upgrade for 400 (AF45Y) £75.00
 - Floppy Disk (YX87U) £2.50
 - Le Stick (AC45Y) £24.95
 - Joystick Controllers (Pair) (AC37S) £13.95
 - Paddle Controllers (Pair) (AC30H) £13.95

For full details ask for our hardware leaflet (XH54.J) SAE appreciated

JOIN THE U.K. ATARI COMPUTER OWNERS' CLUB

An independent users' group. Four issues of the club magazine for only £3.00! Address your subscription to Ron.

Issue 1 of the club magazine featured a tutorial on character set redefinition and contained a collection of demonstration and games programs and lots more. Issue 2 featured a tutorial on player/missile graphics, an article about graphics on computers, a selection of members' contributions to the program library and much more.



THE FINEST SELECTION OF ATARI SOFTWARE

- | | | | | | | | | | | | | | | | | | | | | | | | | | | | | | | | | | | | | | | | | | | | | | | | |
|--------------------------------|---|---|---|---|--|--|---|---|--|---|---|---|---|---------------------------------------|--|--|-----------------------------|------------------------------|--|---|---|--|--|---|---|---------------------------------------|-------------------------------------|--|---|------------------------------------|--------------------------------|--------------------------------------|--|--------------------------------------|---------------------------------|--------------------------------------|---------------------------------------|------------------------------------|---|-------------------------------|---|---|---|---------------------------------|----------------------------|---|----------------------------------|
| Teach-Yourself Programs | Conversational French -5C-16K-YG44X £39.95 | Conversational German -5C-16K-YG45Y £39.95 | Conversational Spanish -5C-16K-YG46A £39.95 | Conversational Italian -5C-16K-YG47B £39.95 | Touch Typing -2C-16K-YG49D £15.95 | States & Capitals -1C-16K-YG56L £9.95 | Euro Countries & Capitals -1C-16K-YG57M £9.95 | Kids 1 (3 Programs) -1C-16K-BG00A £9.95 | Kids 1 (3 Programs) -1D-24K-BG01B £9.95 | Kids 2 (3 Programs) -1C-16K-BG02C £9.95 | Kids 2 (3 Programs) -1D-24K-BG03D £9.95 | | | | | | | | | | | | | | | | | | | | | | | | | | | | | | | | | | | | |
| Learn Programming | Invitation To Programming 1 -1C-8K-YG43W £15.95 | Invitation To Programming 2 -2C-8K-BQ67X £22.95 | Invitation To Programming 3 -2C-8K-BQ68Y £22.95 | Basics Of Animation -1C-16K-BQ57M £11.95 | Basics Of Animation -1D-24K-BQ58N £11.95 | Player Missile Graphics -1C-32K-BQ59P £18.95 | Player Missile Graphics -1D-32K-BQ60Q £18.95 | Display Lists -1C-16K-BQ51F £11.95 | Display Lists -1D-24K-BQ52G £11.95 | Horiz./Vert. Scrolling -1C-16K-BQ53H £11.95 | Horiz./Vert. Scrolling -1D-24K-BQ54J £11.95 | | | | | | | | | | | | | | | | | | | | | | | | | | | | | | | | | | | | |
| Page Flipping | Page Flipping -1C-16K-BQ55K £11.95 | Page Flipping -1D-24K-BQ56L £11.95 | Sounds & Music -1C-16K-BG04E £11.95 | Sounds & Music -1D-24K-BG05F £11.95 | Tricky Tutorials -3C-32K-BG06G £59.95 | Tricky Tutorials -3D-32K-BG07H £59.95 | | | | | | | | | | | | | | | | | | | | | | | | | | | | | | | | | | | | | | | | | |
| Business Programs | Visicalc -1D-32K-YL39N £119.95 | Atari Word Processor -1C&3D-48K-YG42V £99.95 | Text Wizard -1D-32K-BQ99H £69.95 | Mim Word Processor -1C-32K-BG08J £11.95 | Mim Word Processor -1D-32K-BG09K £11.95 | Calculator -1D-24K-YG50E £16.95 | Graph-It -2C-16K-YG51F £13.95 | Statistics -1C-16K-YG52G £13.95 | Personal Financial Management -3D-32K-BQ65V £49.00 | Mortgage & Loan Analysis -1C-16K-BQ66W £13.95 | Bob's Business -1C-32K-BG11M £9.95 | Bob's Business -1D-32K-BG12N £9.95 | | | | | | | | | | | | | | | | | | | | | | | | | | | | | | | | | | | |
| Adventure Games | Galactic Empire -1C-32K-BQ14Q £14.95 | Rescue At Rigel -1C-32K-BQ21X £22.45 | Rescue At Rigel -1D-32K-BQ80B £22.45 | Datestones Of Ryn -1C-32K-BQ22Y £14.95 | Datestones Of Ryn -1D-32K-BQ82D £14.95 | Star Warrior -1C-32K-BQ24B £28.95 | Star Warrior -1D-32K-BQ79L £28.95 | Invasion Orion -1C-24K-BQ23A £18.95 | Invasion Orion -1D-32K-BQ81C £18.95 | Star Trek 3.5 -1C-32K-BQ15R £14.95 | Star Trek 3.5 -1D-40K-BG26D £18.95 | Crush, Crumble & Chomp -1C-32K-BQ83E £22.45 | Crush, Crumble & Chomp -1D-32K-BQ84F £22.45 | Mission Asteroid -1D-40K-BQ91Y £17.19 | Wizard & The Princess -1D-40K-BQ25C £21.79 | Ulysses & The Golden Fleece -2D-40K-BQ92A £20.64 | Zork I -1D-32K-BQ94C £28.95 | Zork II -1D-32K-BQ95D £28.95 | Ali Baba & The 40 Thieves -1D-32K-BQ78K £27.95 | Temple Of Apschal (Part 1) -1C-32K-BQ85G £28.95 | Temple Of Apschal (Part 1) -1D-32K-BQ86T £28.95 | Upper Reaches Of Apschal (Part 2) -1C-32K-BQ87U £14.95 | Upper Reaches Of Apschal (Part 2) -1D-32K-BQ88V £14.95 | Curse Of Ra (Part 3) -1C-32K-BQ89W £14.95 | Curse Of Ra (Part 3) -1D-32K-BQ90X £14.95 | Analog Adventure -1D-32K-BQ33L £16.95 | Adventure Land -1C-24K-BQ00A £14.95 | Pirates Adventure -1C-24K-BQ01B £14.95 | Mission Impossible -1C-24K-BQ02C £14.95 | Voodoo Castle -1C-24K-BQ03D £14.95 | The Count -1C-24K-BQ04E £14.95 | Strange Odyssey -1C-24K-BQ05F £14.95 | Mystery Fun House -1C-24K-BQ06G £14.95 | Pyramid Of Doom -1C-24K-BQ07H £14.95 | Ghost Town -1C-24K-BQ08J £14.95 | Savage Island I -1C-24K-BQ09K £14.95 | Savage Island II -1C-24K-BQ10L £14.95 | Golden Voyage -1C-24K-BQ11M £14.95 | Softporn Adventure -1D-40K-BQ93B £20.64 | Deadline -2D-32K-BQ96E £34.95 | The Shattered Alliance -1D-48K-BQ96G £29.95 | The Battle Of Shiloh -1C-40K-BQ63T £29.95 | The Battle Of Shiloh -1D-40K-BQ97F £29.95 | Energy Czar -1C-16K-YG55K £9.95 | Kingdom -1C-8K-YG55K £9.95 | Space Shuttle Module 1 -1D-32K-BG65V £19.95 | Star Raiders -1E-8K-YG66W £29.95 |

CREDIT

Dragon 32 computer hardware

(Subject to approval which can take up to 48 hours) (APR = 0%)

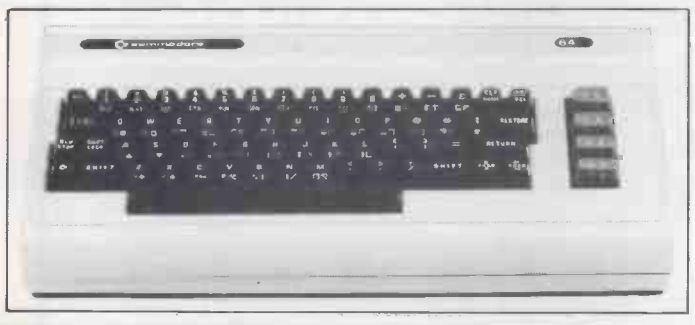

ATARI SOFTWARE continued

- | | | | |
|---------------------------|-------------------------|--|---------------------------|
| Asteroids | -1E-8K-YG60Q £29.95 | Blackjack | -1C-8K-YG62S £9.95 |
| Space Invaders | -1E-8K-YG70M £29.95 | Hangman | -1C-8K-YG54J £9.95 |
| Missile Command | -1E-8K-YG81U £29.95 | Super Cubes & Tilt | -1C-16K-BQ48C £14.95 |
| Caverns of Mars | -1D-16K-BQ89A £24.50 | Humpty Dumpty & Jack & Jill | -1C-16K-BQ36R £19.95 |
| K.Razy Shoot Out | -1E-8K-BQ63T £29.95 | Hickory Dickory Dock & Baa Baa Black Sheep | -1C-16K-BQ39N £19.95 |
| K.Razy Kritters | -1E-8K-BQ61F £29.95 | British Heritage Jigsaw Puzzles | -2C-16K-BQ40T £19.95 |
| K-Star Patrol | -1E-8K-BQ52G £29.95 | European Scene Jigsaw Puzzles | -2C-16K-BQ41U £19.95 |
| Pathfinder | -1D-32K-BG33L £27.95 | Video Easel | -1E-8K-BQ72P £24.50 |
| Crossfire | -1C-16K-BG22Y £20.64 | Micro Painter | -1D-48K-BG56L £29.95 |
| Crossfire | -1D-32K-BG23A £20.64 | Music Programs | |
| Protector | -1C-32K-BG24B £21.80 | Music Composer | -1E-8K-YG48C £35.95 |
| Protector | -1D-32K-BG25C £21.80 | Movie Themes | -1C-8K-BQ34M £9.95 |
| Threshold | -1D-40K-BG18U £27.54 | Computer Languages | |
| Deluxe Invaders | -1D-16K-BG34M £29.95 | Assembler | -1C-16K-YL32K £19.95 |
| Galactic Chase | -1C-16K-BQ62S £16.95 | Assembler Editor | -1E-8K-YG68Y £39.95 |
| Galactic Chase | -1D-16K-BQ61R £19.95 | Macro Assembler | -1D-32K-BQ73Q £59.95 |
| Race In Space | -1C-16K-BQ350 £14.95 | Basic A+ | -1D-48K-BQ31J £49.95 |
| Race In Space | -1D-16K-BG20W £16.95 | Basic A+ & Operating System A+ | -1D-48K-BQ32K £99.50 |
| Space Chase | -1C-16K-BG42V £10.95 | Microsoft Basic | -1D-32K-BQ74R £59.95 |
| Space Chase | -1D-24K-BG43W £12.95 | Pilot (Educator) | -1E & 2C-16K-BQ75S £79.95 |
| Centipede | -1E-16K-BQ70M £29.95 | Pilot (Consumer) | -1E-8K-YG69A £54.00 |
| Angle Worms | -1C-8K-BG50E £10.95 | QS Forth | -1D-24K-YL29G £49.95 |
| Lunar Lander | -1C-24K-BQ16S £10.95 | Tiny-C | -1D-48K-BG62S £64.95 |
| Lunar Lander | -1D-24K-BG49D £14.95 | Inter-Lisp/65 | -1D-48K-BG61R £87.00 |
| Jumbo Jet Lander | Available November | Utilities | |
| Submarine Commander | Available November | Programming Aids Package 1 | -1C-16K-BG60Q £ 9.95 |
| Rasterblaster | -1D-32K-BG35Q £22.95 | 6502 Disassembler | -1C-8K-YL30H £9.95 |
| Shooting Gallery | -1C-16K-BQ36P £14.95 | 6502 Disassembler | -1D-8K-BQ17E £12.95 |
| Shooting Gallery | -1D-16K-BG19V £16.95 | Aiani World | -1D-40K-YL23E £43.95 |
| Shooting Arcade | -1C-16K-BG15R £24.95 | 3D Supergraphics | -1C-40K-BQ29G £29.95 |
| Shooting Arcade | -1D-16K-BG16S £24.95 | 3D Supergraphics | -1D-40K-BQ28F £29.95 |
| Super Breakout | -1E-8K-YG69X £24.50 | FileIt 2 | -1D-48K-BG10L £34.95 |
| Dodge Racer | -1C-16K-BG29Q £19.95 | Filemanager 800 | -1D-40K-BG59P £72.80 |
| Dodge Racer | -1D-24K-BG30H £19.95 | K-DOS | -1D-32K-BQ76H £49.95 |
| Matchracer | -1C-16K-BG31J £23.95 | Disk Manager | -1D-32K-BG58N £21.80 |
| Matchracer | -1D-16K-BG32K £23.95 | Disk Detective | -1D-16K-BG57M £24.95 |
| Mouskattack | -1D-32K-BQ77J £22.95 | Operating System A+ | -1D-32K-BQ30H £49.95 |
| Jawbreaker | -1C-16K-BG17T £20.64 | Telelink | -1E-8K-YG59P £21.50 |
| Jawbreaker | -1D-32K-BQ26D £20.64 | The Next Step | -1D-32K-BG64U £27.54 |
| Ghost Hunter | -1C-16K-BQ64U £19.95 | Books | |
| Pac-Man | -1E-8K-BQ71N £29.95 | Master Memory Map | -XH57M £ 0.00 |
| Pacific Coast Highway | -1C-16K-BG13P £24.95 | De Re Atari | -WG56L £16.95 |
| Pacific Coast Highway | -1D-16K-BG14Q £24.95 | Operating System User's Manual & Hardware Manual | -WA46A £16.95 |
| Chicken | -1C-16K-BG27E £21.80 | Atari Basic-Learning By Using Games For The Atari | -WG55K £8.24 |
| Chicken | -1D-16K-BG28F £21.80 | Atari Basic | -WG47B £4.45 |
| Tumble Bugs | -1D-24K-BG46A £24.95 | Atari Basic | -WG05F £6.80 |
| Bug Attack | -1C-24K-BG36P £23.95 | Atari Sound & Graphics | -WA39N £8.25 |
| Bug Attack | -1D-40K-BG43T £23.95 | Your Atari Computer | -WA40T £13.45 |
| Canyon Climber | -1C-16K-BG44X £24.95 | 6502 Assembly Language Subroutines | -WA05F £12.45 |
| Canyon Climber | -1D-16K-BG45Y £24.95 | Advanced 6502 Interfacing | -WA41U £11.45 |
| Mountain Shoot | -1C-16K-BQ12N £10.95 | Beyond Games (6502) | -WA45Y £13.00 |
| Haunted Hill | -1C-16K-BG38R £16.95 | Computers For People | -WA00A £8.25 |
| Haunted Hill | -1D-16K-BG39N £19.95 | Analog: The Magazine For Atari (6 issues) Annual Subscription | -GG24B £9.00 |
| Time Bomb | -1C-16K-BG40T £10.95 | Send see now for our new software leaflet with details of all the above programs. Order As XH52G - Issue 3. | |
| Time Bomb | -1D-24K-BG41U £12.95 | Key: C = Cassette D = Disk E = Cartridge. | |
| Tank Trap | -1C-16K-YL34M £9.95 | 2C = 2 Cassettes etc. 8K, 16K shows minimum memory requirement. | |
| Tank Trap | -1D-32K-YL35Q £12.95 | | |
| Thunder Island | -1C-16K-BQ37S £10.95 | | |
| Home Game Programs | | | |
| Soram | -1C-16/24K-YG58N £17.50 | | |
| Basketball | -1E-8K-YG61R £24.50 | | |
| Cypher Bowl | -1C-16K-BQ20W £29.50 | | |
| Sunday Golf | -1C-16K-BQ13P £10.95 | | |
| Darts | -1C-16K-BQ42V £19.95 | | |
| Tournament & 8-Ball Pool | -1C-16K-BQ45Y £19.95 | | |
| Snooker & Billiards | -1C-16K-BQ44X £19.95 | | |
| Ricochet | -1C-16K-BG47B £14.95 | | |
| Ricochet | -1D-32K-BG48C £14.95 | | |
| Computer Chess | -1E-8K-YG63T £24.50 | | |
| Fast Gammon | -1C-8K-WL33L £16.95 | | |
| Gomoku | -1C-16K-BQ18U £14.95 | | |
| Gomoku | -1D-16K-BG55K £19.95 | | |
| Reversi | -1C-16K-BQ19V £14.95 | | |
| Reversi | -1D-16K-BG54J £19.95 | | |
| Cribbage & Dominoes | -1C-16K-BQ43W £14.95 | | |
| Poker Solitaire | -1C-16K-BQ17T £10.95 | | |
| Poker Solitaire | -1D-16K-BG53H £14.95 | | |

VIC20 COLOUR COMPUTER

- | | | | |
|---|-----------------|--|----------------|
| Hardware | (AF47B) £169.99 | Simplicast Cassette (+16K) | (AC93B) £19.95 |
| VIC20 Console | (AF48C) £44.95 | VIC Stock Control Cassette (+8K) | (AC94C) £19.95 |
| C2N Cassette Unit | (AF49D) £230.00 | VIC File Disk (+16K) | (AC95D) £24.95 |
| VIC Printer | (AF50E) £386.00 | VIC Writer Disk (+8K) | (AC96E) £24.95 |
| VIC Disk Drive | (AF51F) £29.95 | VIC Writer Cassette (+8K) | (AC97F) £19.95 |
| 3K RAM Cartridge | (AF52G) £44.95 | Education [CSE & GCE 'O' Level Revision] | |
| 8K RAM Cartridge | (AF53H) £74.95 | All cassette based and require at least 8K expansion memory. | |
| 16K RAM Cartridge | | English Language | (AC98G) £9.99 |
| Joysticks and Paddles | | Mathematics 1 | (AC99H) £9.99 |
| Single Joystick | (AC53H) £7.50 | Mathematics 2 | (BC00A) £9.99 |
| Pair of Joysticks | (AC37S) £13.95 | Biology | (BC01B) £9.99 |
| Le Stick | (AC45Y) £24.95 | Chemistry | (BC02C) £9.99 |
| Pair of Paddles | (AC30H) £13.95 | Physics | (BC03D) £9.99 |
| Programming Aid Cartridges | | Computer Studies | (BC04E) £9.99 |
| Super Expander: 3K RAM and Hi-res graphics | (AC54J) £34.95 | Geography | (BC05F) £9.99 |
| Programming Aid: Additional commands, function key programming etc. | (AC55K) £34.95 | History | (BC06G) £9.99 |
| Machine Code Monitor | (AC56L) £34.95 | Arithmetic for 9 to 11 year olds | (BC07H) £9.99 |
| Software (all 3K unless stated) | | Reading for 9 to 11 year olds | (BC08J) £9.99 |
| Introduction to BASIC Cassettes | | General Knowledge for 9 to 11 year olds | (BC09K) £9.99 |
| Part 1 | (AC57M) £14.95 | Spelling for 9 to 11 year olds | (BC10L) £9.99 |
| Part 2 | (AC58N) £14.95 | Home Programs | |
| Game Programs | | All cassette based and require at least 8K expansion memory | |
| Avenger Cartridge | (AC59P) £19.95 | Quizmaster | (BC11M) £9.99 |
| Star Battle Cartridge | (AC60Q) £19.95 | Know Your Own IQ | (BC12N) £9.99 |
| Super Slot Cartridge | (AC61R) £19.95 | Junior IQ | (BC13P) £9.99 |
| Jelly Monsters Cartridge | (AC62S) £19.95 | Know Your Own Personality | (BC14Q) £9.99 |
| Alien Cartridge | (AC63T) £19.95 | The Robert Carter Family Menu Planner | (BC15R) £9.99 |
| Super Lander Cartridge | (AC64U) £19.95 | VIC Money Manager | (BC16S) £9.99 |
| Road Race Cartridge | (AC65V) £19.95 | VIC Road User & Highway Code | (BC17T) £9.99 |
| Rat Race Cartridge | (AC66W) £19.95 | Garden Planner | (BC18U) £9.99 |
| Blitz Cassette | (AC67X) £4.99 | Interior Designer | (BC19V) £9.99 |
| Mole Attack Cartridge | (AC68Y) £24.95 | BBC "Ask The Family" | (BC20W) £9.99 |
| AdventureLand Cartridge | (AC68T) £24.95 | BBC "Mastermind" | (BC21X) £9.99 |
| Pirate Cove Cartridge | (AC68F) £24.95 | "Mastermind" additional General Knowledge | |
| Mission Impossible Cartridge | (AC68U) £24.95 | Data 1 | (BC22Y) £2.50 |
| Voodoo Castle Cartridge | (AC68V) £24.95 | Data 2 | (BC23A) £2.50 |
| The Count Cartridge | (AC68W) £24.95 | Data 3 | (BC24B) £2.50 |
| Sargon 2 Chess Cartridge | (AC67J) £24.95 | Data 4 | (BC25C) £2.50 |
| Orf Cartridge | (AC69X) £24.95 | "Mastermind" additional Specialist Knowledge | |
| Omega Race Cartridge | (AC69Y) £24.95 | Wine & Food | (BC26D) £2.50 |
| Another VIC in The Wall Cassette | (AC69Z) £24.95 | Music | (BC27E) £2.50 |
| VIC Panic Cassette | (AC78K) £7.00 | Sport & Games | (BC28F) £2.50 |
| Cosmids Cassette | (AC79L) £7.00 | Films & TV | (BC29G) £2.50 |
| Backgammon Cassette (+3K) | (AC80B) £7.00 | Books About VIC | |
| VIC-Men Cassette | (AC81C) £7.00 | Learn Programming on the VIC | (WA31J) £2.50 |
| VIC Asteroids Cassette | (AC82D) £7.00 | VIC Revealed | (WA32K) £10.00 |
| VIC Asteroids Cassette | (AC83E) £7.00 | VIC Programmers Reference Guide | (WA33L) £9.95 |
| Business Programs | | VIC Graphics | (WA48C) £10.00 |
| Simplicast Disk (+16K) | (AC92A) £24.95 | | |

MAPLIN

Maplin Electronic Supplies Ltd., P.O. Box 3, Rayleigh, Essex. Tel: Southend (0702) 552911/554155.
 Demonstrations at our shops NOW. See the computers in action at 159-161 King St., Hammersmith W6. Tel: 01-748 0926
 284 London Road, Westcliff-on-Sea, Essex. Tel: (0702) 554000
 Lynton Square, Perry Barr, Birmingham. Tel: (021) 356 7292.

Note: Order codes shown in brackets. Prices correct at time of going to press. (Errors excluded).

OFFICIAL BBC DEALER
MICRO COMPUTER

Model B £399
 (inc. VAT) + £8 carr
 Model A to Model B Upgrade Kit £50
 Fitting charge £15

MEMORY PACK **PRINTER & USER PORTS**
 8 x 4816 AP-3 100ns £21.60
 ICS 69, 70, 71, PL9, 10 £9.50

PRINTER LEAD COMPLETE £13.50

ANALOGUE PORT **F.D PORT**
 IC 72 PL6 £7.30 IC 77-88 PL8 £70

R S423 & R S423 R VDU PORTS
 IC 74, 75 SK3 & 4 £10.80

Full range of Connectors in stock. Floppy Disc Drives now available. Phone or send for our BBC Leaflet.

EP4000 EMULATING PROGRAMMER

This EPROM programmer will accept most single and three rail eproms by simple rotary switch personality selection. Output to TV and monitor. Comprehensive 1/0 Ports - TTL and RS232 mA current Loop, parallel port, cassette 1/0, printer port and DMA. £545 + £8.00 Carr.

P4000 PRODUCTION PROGRAMMER

This unit offers simple and reliable programming of up to 8 EPROMS simultaneously. Self-check - blank check - program and verify sequence built in. £545 + £8.00 Carr. BP4 - TI Bi-polar Prom Programming module for EP4000. This module will program most TI devices and read equivalent devices from other manufacturers enabling copies to be made. £180 + £6.00 Carr.

SOFTY II INTELLIGENT PROGRAMMER

The complete micro processor development system for Engineers and Hobbyists. You can develop programs, debug, verify and commit to EPROMS or use in host computer by using softy as a romulator. Powerful editing facilities permit bytes, blocks of bytes changed, deleted or inserted and memory contents can be observed on ordinary TV. Accepts most +5v Eproms Softy II complete with PSU, TV Lead and Romulator lead £169

NEW LOW PRICES!

PRINTERS

NEC PC 8023 BE C

100CPS, 80 cols
 Logic Seeking, Bidirectional,
 Forward and Reverse Line Feed,
 Proportional Spacing, Auto Underline,
 Hi-Res and Block Graphics, Greek
 Char. Set. Only £325+ £8 carr.

SEIKOSHA GP 100A

80 cols 30 CPS.
 Full ASCII & Graphics.
 10" wide paper.
 Now only
 £175 plus £6 carr.

EPSON MX 80 and 100F/T3

MX 80 80CPS 80 cols
 MX 100 100CPS 136 cols
 Logic Seeking, Bi-directional, Bit Image
 Printing, 9 x 9 Matrix Auto Underling
 MX 80 F/T3 £325; MX 100F/T3
 £430 (£8 carr/printer)

PRINTER ACCESSORIES

2,000 fanfold pages with perforated margins £14.50 + £3.50 carr.
 500 fanfold pagers with perforated margins £4.50 + £1 carr.

RIBBONS FOR PRINTERS

GP 100A £6.50 EPSON MX 80 £7.50.
 NEC PC 8023 £7.50

AMPHENOL CONNECTORS

1EEE 24 way £5.50
 Centronix 36 way £5.50

MICRODOCTOR

This is not a logic analyser or an oscilloscope. It tests a microsystem and gives a printed reprint on RAM. ROM and 1/0 - it will print memory map, search for code, check dataline shorts and operates peripherals and even disassembles the ROM.
 Microdoctor complete with PSU, printer probe cable and two configuration board £295.

UV ERASERS

UV18 up to 6 Eproms £47.50
 UV140 up to 14 Eproms £61.50
 UV1T with Timer £60.00
 UV141 with Timer £78.00
 (Carr £2/eraser)
 All erasers are fitted with mains switches and safety interlocks.

MICROTIMER

6502 Based Programmable clock timer with
 * 224 switching times/week cycle
 * 24 hour 7 day timer
 * 4 independent switch outputs directly interfacing to thyristor/triacs
 * 6 digit 7 seg. display to indicate real time. ON/OFF and Reset times
 * Output to drive day of week switch and status LEDs
 Full details on request. Price for kit £57.00

FLOPPY DISC DRIVES

TEAC FD50A 5 1/4 in. 40 track drive housed in an attractive case with PSU.

Single Drive £190 + £5 carr.
 Double Drive £360 + £7 carr.

Interfaces for Apple II

- * 3.3 DOS CARD £48
- * RGB COLOUR CARD £120
- * 8 BIT A to D CARD £135
- * 8 BIT D to A CARD £135

Apple 11 Drive: This drive can handle data in both 13 and 16 sector formats. 143K can be stored over 25 tracks when using DOS 3.3. Drive complete with cable £270 + £5 carr.

CASSETTE RECORDER

Sanyo Computer Grade Recorder £24.00 + £1.50 carr.
 Cassette Leads £3.50
 Computer Cassette £0.50 each - £4.50 for 10.

RUGBY ATOMIC CLOCK

This Z80 micro controlled clock/calendar receives coded time data from NPL Rugby. The clock never needs to be reset. The facilities include 8 independent alarms and for each alarm there is a choice of melody or alternatively these can be used for electrical switching. A separate timer allows recording of up to 240 lap times without interrupting the count. Expansion facilities provided.
 Complete Kit £120 + £2.00 carr.
 Ready Built Unit £145 + £5.00 carr.
 Reprint of ETI articles at £1.00 + s.a.e.

MONITORS

BMC BM 1401 14" colour monitor RGB input 18MHZ bandwidth £240 plus £8 carr.
 SANYO 12" green monitor. Antiglare screen £99 plus £6 carriage.
 MICROVITEC 1431 M/S 14" Colour monitor RGB Input £269 plus £8 carr. RGB lead for BMC £8. Composite Videolead £3.50.

COMPONENTS MICRO'S * MEMORIES * TTL's * INTERFACE DEVICES

CPUs		SUPPORT DEVICES		Z80 AP10		* SPECIAL OFFER *	
1802CE	650p	6520	280p	Z80AP10	280p	2114L-450	1-24 25-99
2650A	£12	6522	310p	Z80CTC	230p	2532	80p 65p
6502	350p	6522A	530p	Z80AECT	280p	4116-2	350p 335p
6502A	500p	6532	550p	Z80ADART	700p	6116	80p 75p
6800	225p	6551	650p	Z80ADAMA	£10		350p 335p
6802	225p	6821	100p	Z80AS10-0	£9		
68B02	700p	6821	100p	Z80AS10-1	£9		
6809	650p	68B21	220p	Z80AS10-2	£9		
68B09	£12	6854	770p				
6809E	£12	68B54	800p	CRT CONTROLLER			
8035	350p	6875	500p	CRT6545	900p		
8039	300p	8205	225p	CRT 5027	£18		
8080A	250p	8212	110p	CRT 5037	£18		
8085A	450p	8214	350p	EF9365	£48		
INS8060	£11	8216	100p	EF9366	£48		
TMS9980	£20	8224	180p				
TMS9995	£12	8250	850p	INTERFACE ICs			
Z8	£24	8251	250p	MC14411	675p		
Z80	290p	8255	250p	MC14412	750p		
Z80A	320p	8256	£36	COM8116	800p		
Z80B	£12	8279	440p	DAC80	£30		
8088	£18	8288	£11	DP8304	250p		
		Z80P10	250p				

MISC

AY5-2376 700p
 AY 5-3600 600p
 4702B 750p
 RO32513 750p

PLEASE SEND FOR OUR DETAILED PRICE LIST AND COMPREHENSIVE CATALOGUE

TECHNOMATIC LTD

MAIL ORDERS TO: 17 BURNLEY ROAD, LONDON NW10 1ED
 SHOPS AT: 17 BURNLEY ROAD, LONDON NW10
 (Tel: 01-452 1500, 01-450 6597. Telex: 922800)
 305 EDGWARE ROAD, LONDON W2

PLEASE ADD 40p p&p & 15% VAT

(Export: no VAT, p&p at Cost)

Orders from Government Depts. & Colleges etc. welcome.

Detailed Price List on request.

Stock items are normally by return of post.



STARTTECH

Absolutely
the lowest
prices!

computer apple computer apple computer apple com... z computer apple c

**BOLDLY GOING WHERE NO
PRICES HAVE EVER GONE BEFORE!**

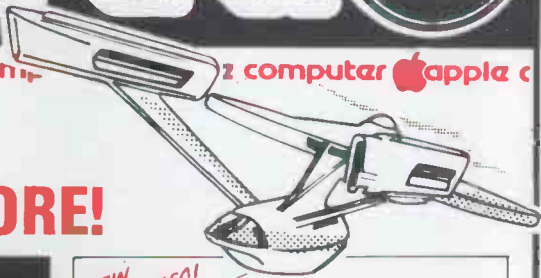

NEW
LOW PRICES!

£5 OFF!
ALL VISI PRICES

	WAS	NOW		WAS	NOW
VISICALC, VISICORP	£105.00	£100.00	VISISCHEDULE, VISICORP	£149.95	£144.95
VISIDEX, VISICORP	£127.95	£122.95	VISITERM, VISICORP	£53.95	£48.95
VISIFACTORY, MICRO	£37.95	£32.95	VISITREND/VISIPLOT, VISICORP	£148.95	£143.95
VISIFILE, VISICORP	£120.95	£115.95	DESK TOP PLAN 11: PERSONAL SOFTWARE	£131.95	£126.95
VISIPILOT, VISICORP	£98.95	£93.95			

NEW
LOW PRICES!

£5 OFF!

16K RAM CARDS
(Pascal CPM: Computer Stop)

WAS ~~£49.95~~ NOW **£44.95**

NEW
LOW PRICES!

**SENSATIONAL
REDUCTION!**

D BASE II
(Relational D Base; Ashton Tate)

WAS ~~£318.95~~ NOW **£299**

NEW
LOW PRICES!

**MAILMERGE
PRICES SLAMMED!**

Mailmerge; Micropro

WAS ~~£47.95~~ NOW **£39.95**

NEW
LOW PRICES!

£5 OFF!

APPLESOFT COMPILERS!

Hayden Applesoft Compiler

WAS ~~£87.95~~ NOW **£82.95**

Tax Applesoft Compiler; Microsoft

WAS ~~£80.95~~ NOW **£75.95**

ADVENTURE

Adventure (Microsoft); Microsoft	£13.95
Ali Baba + 40 Thieves; Quality Software	£17.95
Castle Wolfenstein; Muse	£13.95
Dark Forest; Sirius Software	£15.95
Dalestones of Ryn; Automated Simulations	£10.95
Soft Porn Adventure; On Line	£13.95
Space Adventure; Sierra Software	£14.95
Time Zone; On Line	£40.95
Wizzard + Princess; On Line	£14.95
Zork 2; Infocom	£19.95

BOOK

Beaneath Apple Dos; Quality Software	£9.95
--------------------------------------	-------

BUSINESS

Address Book (List) Muse	£23.95
Data Factory; Micro Lab	£72.95
Data Factory 5.0; Micro Lab	£139.95
OB Master; Stoneware	£104.95
Magic Window (WP); Artsci	£46.95
Personal Filing Sys. (PFS); Software Publishing Corp	£40.95
Personal Report Sys. (PRS); Software Publishing Corp	£40.95

GRAPHICS UTILITY

A2302 Enhancement; Sub Logic	£13.95
A26E1 Graphics; Sub Logic	£32.95
Hi-Res Secrets; Avant Garde	£60.95

HI-RES ACTION

Alien Rain; Broderbund	£13.95
Anti Ballistic Missile; Muse	£12.95
Apple Panic; Broderbund	£14.95
Flight Simulator; Sub Logic	£18.95
Frogger; On Line	£17.95
Gorgon; Sirius Software	£17.95

Snoggle; Broderbund	£17.95
Space Eggs; Sirius Software	£12.95
Space Quarks; Broderbund	£13.95
Swashbuckler; Datamost	£12.95
Hi-Res Soccer; On Line	£13.95

LANGUAGE

Asm Lang; Development Sys; Hayden	£24.95
Expediter 11 Compiler; On Line	£39.95
Fourth 11 (Language); Softape	£31.95
Lisa 2-5 6502 Assembler; On Line	£45.95

STRATEGY GAME

Air Traffic Controller; Avant Garde	£7.95
Robot Wars; Muse	£18.95
Tigers In The Snow; Strategic Simulations	£17.95

UTILITY

Black It Up; Sensible Software	£30.95
Bag of Tricks; Quality Software	£20.95
Deadly Secrets; Broderbund	£17.95
Dossource 3.3 Dos Listing; Lazer	£18.95
Program Line Editor; Synergistic Software	£18.95

HARDWARE

Excel-9 (6809 With "Flex"); ESD Laboratory Co. Ltd	£164.95
23 Key Keypad (Visicalc); Keyboard Company	£101.95
Omnivision 80/24 Video; Computer Stop	£144.95
U Term 80/24 Video Card; U Micros	£151.95
Z80 Softcard; Microsoft	£203.95
10 Meg Hard Disk System; Computer Stop	£1644.95

Z80 CPM (Z80 Softcard Required)

Wordstar; Micropro	£137.95
D Base 11 Manual; Ashton Tate	£33.95
Alds Z80, 8080 Assembler; Microsoft	£57.95
Bstam Micro To Micro; Byrom	£108.95

Please send me:

I enclose cheque/P.O. for

Name:

Address:

Please add V.A.T. to all orders.

Postage paid in U.K. Allow 30 days for
delivery. Access & Barclaycard orders
welcome on 051-256 8244 P.C.W. 1182

STARTTECH

63 Lisburn Lane,
Tuebrook, Liverpool L13 9AF

TRUE 16 bit!



Olivetti M20

The new Olivetti M20 provides everything the modern businessman is likely to need in a desktop computer

- * SPEED: fastest of 62 'Personal Computer World' Benchmark timings. Faster than Sirius and IBM
- * MEMORY EXPANSION: 128k up to 512k RAM
- * DISK STORAGE: Standard 320k or 640k floppies with optional 10MB hard disk (built-in)
- * BUSINESS SOFTWARE: Full Range. Integrated Accounts, Stock control, Payroll, or separate packages. Wordprocessing, Financial planning, Specific packages e.g. Solicitors accounts, Engineering design etc.
- * GRAPHICS: High resolution standard on all versions. About 3 times Apple II resolution for NO loss of user memory. Colour version available.
- * COMMUNICATIONS: Programmable RS232 interface built in plus parallel printer output, IEEE 488 option. Software available for IBM etc protocols, Videotex.
- * CP/M: Not an ideal 16 bit operating system but optionally available. Olivetti's PCOS system is supplied as standard and is faster and more powerful.
- * SERVICING: Direct from Olivetti Service Centres.
- * FINANCE: Lease or Rent through Olivetti Finance.
- * COMPETITIVE PRICING (Includes PCOS and MBasic 5.2):

M20S: 128k RAM, Single disk, monochrome:	£1895
M20D: 160K RAM, Dual disk, monochrome:	£2395
M20C: 160k RAM, Dual disk, 8 colour:	£3262

Brighton Computer Centre

130 Lewes Road, Brighton BN2 3LG
(0273) 688946 Mon-Sat 10am-6pm

Please send me further details of the Olivetti M20

Name.....
Company.....
Address.....
.....Tel.....
Application.....

PCW12

Kuma Computers Limited

11 York Road, Maidenhead, Berks SL6 1SQ
Tel: (0628) 71778 9 Telex: 849462 TELFAC.KUM



PROFESSIONALS IN SOFTWARE APPLICATIONS: INTERFACING

Sirius - 1.

The best price/performance you've ever seen on a personal computer: £2395 + VAT For 128K, 1.2 Mbyte, 16 bit, available software includes:- CP/M86, MSDO, Mbasic, COBOL, PASCAL, FORTRAN. etc.



Osborne - 1: You can take it anywhere. CP/M + 64K RAM, Dual discs interfaces and Wordstar, Super Calc, Mbasic. All for £1250.00 + VAT. Ask us about additional software.



Newbrain:

The only professional micro of this size: Phone us for immediate **FREE delivery + SOFTWARE CATALOGUE** Newbrain AD with onboard display £232.61 + VAT.



SHARP A + B;

Computers and systems with a **Wealth of software applications programs.** "WDPRO" Wordprocessing, Database, Accounts, Mail Lists etc. Phone Now for our new Autumn 170 Program Catalogue.



SHARP ≡ KUMA ≡ SOFTWARE

Printers:

Matrix - from £380.00 + VAT.
Epson Mx 80F/T3 NEC (C.itoh)
Daisywheel - from £476.50 + VAT.
Brother 8300 Tec Star Writer

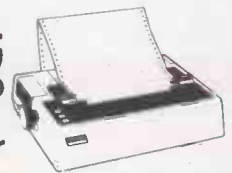

Applications:

Direct experience of office applications, phone us for advice on ledgers, stock control, payroll and word processing.

Software: the established leader for Sharp Computers.

Training: Financial planning, information storage and word processing. One day introductory seminars.

MAIDENHEAD (0628) 71778

Kuma Computers Ltd., 11 York Road, Maidenhead, Berks. SL6 1SQ.

Tel: (0628) 71778/9 Telex: 849462 TELFAC Kum



The background of the advertisement is a soft-focus image of numerous pink cherry blossoms. The flowers are in various stages of bloom, with some showing prominent stamens. The overall color palette is light and airy, with shades of pink and cream.

Peachtree is blossoming...

An open invitation to suppliers of
microcomputer hardware and software



Peachtree
Software™

AN **MSA** COMPANY

Attention dealers and systems suppliers of Altos, Apple, Commodore, IBM, ICL, Intertec, Rair, Sirius, Victor and other leading microcomputers.....

A Peachtree Software Partnership will safeguard your software reputation and improve profitability!



Peachtree software really works! We have established the largest installed user-base in the USA and a unique worldwide distribution and support network. We are the world leader in business management software. Our programs are simple to use. They have professional documentation and are utterly proven!

Team up with Peachtree

It's goodbye to software problems and loss of profit if you become a 'Peachtree Partner.' You will be free to concentrate on the marketing of your complete business solutions, secure in the knowledge that you have the best systems in the world to enhance your reputation.

You will be supported by professionals and all the resources of a world class organisation determined to stay at the top of the tree in micro software.

Now is the time to say 'YES'

This is your opportunity to apply for your Peachtree Partnership. We are spreading our roots, right across the country and deep into your marketplace.

Peachtree is now an established and powerful force in UK software.

We intend to tie in with the leading suppliers in every town. They will be our type of people - professional, experienced and commercially sound. Above all dedicated to success!

Bumper Harvest in '83

In the new year, Peachtree suppliers will see the most spectacular growth in their business. We intend to continue taking the micro business software market by storm. There will be no stopping us or those who choose to join us NOW.

act IMMEDIATELY

Complete the initial application form now. It will be treated in the strictest confidence and places you under no obligation.

Successful initial applications will bring a personal invitation to meet the Peachtree team and to negotiate your Peachtree Software Partnership.

"There's more to Peachtree than just a computer program"

JOHN HALE, MANAGING DIRECTOR OF PEACHTREE SOFTWARE INTERNATIONAL LTD.

"We are part of MSA, the world's largest company specialising in computer software products for large computers.

Together we make an unbeatable combination, guaranteeing you the best in software and support, now and in the future."

Peachtree Proven Programs

Peachtree Basic Accounting Systems

Purchase Ledger, Sales Ledger with Invoicing, Nominal Ledger, Inventory Management, Payroll.

Peachtree Business Management Systems

Purchase Ledger, Sales Ledger with Invoicing, Nominal Ledger, Costing Ledger, Inventory Management with Sales Order Processing, Payroll.

Peachtree Office Productivity Systems

Word Processing, Automatic Spelling Dictionary, Name and Address Management, Financial Modelling, Communications, Colour Graphics.

Peachtree programs run under Digital Research and Microsoft operating systems and they are written in Microsoft BASIC and Micro Focus CIS COBOL.

Peachtree Products are

- ★ Fully integrated. So your client can use all the information his system holds.
- ★ Totally modular. So your client can implement one system at a time.
- ★ Complete with professional documentation. Helping you to help your client.

Peachtree's commitment is to provide software products for the smallest business computers as well as the most powerful 16-bit multi-user micros with hard disk storage.

"Call me with your queries
on 0628 32711"

Ray Todd,
Peachtree Partnership Manager



Praise for Peachtree

"As an accountant and line manager with a wide experience of using systems, I consider Peachtree's product to be the best integrated business package I have found" VICTOR LINGARD

MANAGING DIRECTOR, DAEDALEAN CONSULTANTS

"We have the greatest confidence in Peachtree because Peachtree is continually investing in enhancing products, introducing new packages, providing the best support and backing our sales through its marketing campaigns" MALCOLM CHADWICK

MANAGING DIRECTOR, BUSINESS-LIKE SYSTEMS

"Not only have Peachtree products improved our sales by 25% but we have also developed a very good two-way relationship where we have input to Peachtree's plans for the future" STEVE JOHNSON

MANAGING DIRECTOR, JOHNSON MICROCOMPUTERS

Peachtree Software International Ltd
43/53 Moorbridge Road, Maidenhead, Berks. SL6 8LT
Tel: Maidenhead (0628) 32711

CONFIDENTIAL

Complete this initial application without obligation for a

Peachtree Partnership

My Name _____

My Position _____

My Company _____

Our Address _____

Telephone No. _____

Hardware Dealerships _____

Technical Facilities _____

Software Currently stocked _____

Date Established _____

Number of Employees _____

Marketing Area _____

Experience in mainframes _____

Experience in minis _____

Experience in micros _____

How many people would you
want to attend training sessions _____

Name and address of Bankers _____

Trade Reference 1 _____

Trade Reference 2 _____

Alternatively

Please contact me to discuss our potential before
I make an application

Signature _____

Date _____

PCW

Mail this form today to
Ray Todd at Peachtree Software
International Limited, 43/53
Moorbridge Road, Maidenhead,
Berkshire SL6 8LT
Tel: Maidenhead (0628) 32711



Peachtree Software is also distributed by:
Britannia Computers, Digital Equipment Company,
Logitek (Altos), Memory Computers, The OEM Group,
Rank Xerox, Wilkes Computing (YE Data).

Read this ad

You: "Darling, I've decided to buy a computer."

Her: "***++**??!!***@XX??££**??!!? off!"

You: "Yes, I know we could do with a new washing machine. But the new Dragon 32 Computer is much more important. It's the first computer actually designed for all the family - and it costs under £200!"

Her: "***++??!!@££??! fortune!"

You: "No, I'm not being selfish. Computers are for the whole family - and they're going to play a big part in the children's future."

Her: "Oh?"

From this point on, the conversation should follow more reasonable lines.

Allowing you to fully explain the many advantages of the new Dragon 32 family computer.

32K RAM FOR UNDER £200.*

For a start, the Dragon offers 32K RAM. Your wife may not understand that, so just tell her that the Dragon's capabilities are truly massive - at least twice as powerful as its competitors, with some features you won't find even in more expensive units. The Dragon will give you all the power you're likely to need, and more, to create your own programs - along with

an exciting range of software which can do anything from helping with kids' spelling and arithmetic to creating your own cartoons.

THE FIRST FAMILY COMPUTER.

All of which brings you nicely to the point where you tell your wife just how much fun the kids will have with the Dragon. How it will save her all that

*Television not included in price.

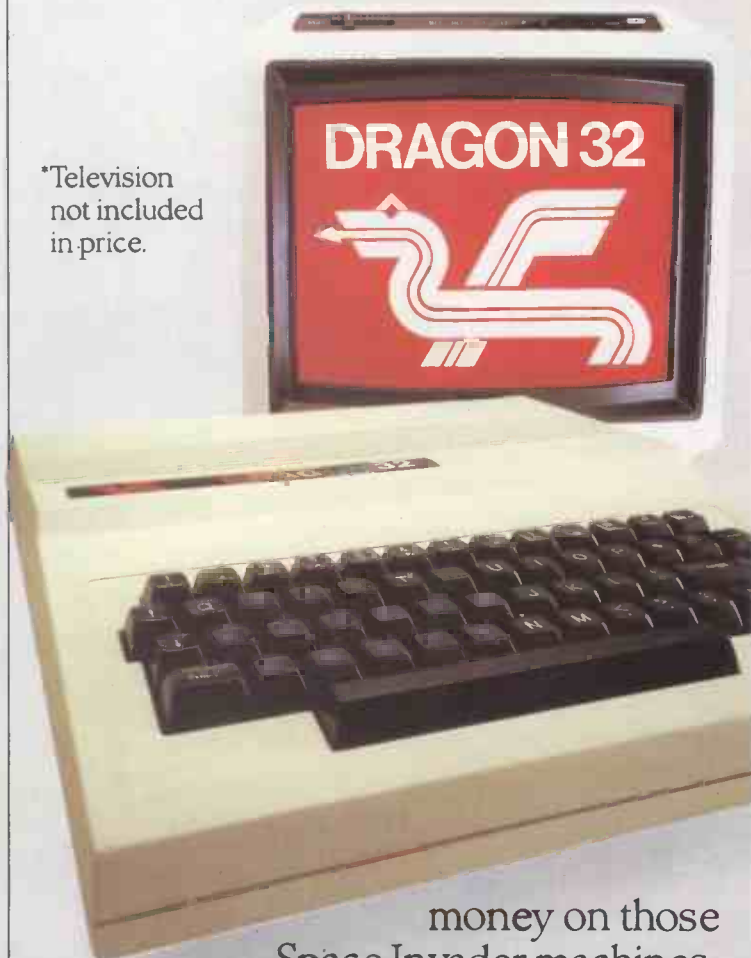

money on those Space Invader machines. How it will magically translate simple typed instructions into beautiful drawings and designs using set, line, circle, draw, scale, rotate and paint features, in up to 9 colours - and play and compose

to your wife.

SPECIFICATIONS

6809E MICROPROCESSOR. Pet, Apple, Atari 400, BBC Micro, and VIC 20 still have the less powerful 6502.

32K RAM (as standard). At least twice the power of similarly priced machines. Expandable to 64K RAM.

EXTENDED MICROSOFT COLOUR BASIC (as standard).
Featuring: ADVANCED GRAPHICS (set, line, circle, paint, print, draw, rotate and print using).
ADVANCED SOUND 5 octaves, 255 tones.
AUTOMATIC CASSETTE RECORDER CONTROL.
FULL EDITING with INSERT and DELETE.

9 COLOUR, 5 RESOLUTION DISPLAY.

USE WITH ANY U.H.F TV and/or separate P.A.L. monitor.

PROFESSIONAL QUALITY KEYBOARD.
Typewriter feel. Guaranteed for 20 million depressions.

PRINTER (Centronics parallel).

JOYSTICK CONTROL PORTS.

with 5 octaves of music. How it will engross your children in mind-boggling adventures in dungeons and caves without even getting their knees dirty. And the Dragon works with any U.H.F. TV

THEY'LL LEARN AS THEY PLAY.

And then you can casually point out that although the kids are having fun, they're also learning. And within a very short space of time, the whole family will be completely at home with programming - with computer language - with every aspect of how computers work. Which can't do their future prospects any harm at all.

BRILLIANTLY SIMPLE INSTRUCTION MANUAL.

The Dragon is made in Britain, designed with the help of British Universities. And it's also worth remembering

that the Dragon's instruction manual is clearer and easier to understand than any other homecomputers.

That its top-quality keyboard is as easy to use as a typewriter, and so well made it's guaranteed for twenty million depressions.

TAKE THE FAMILY DOWN THE HIGH STREET.

And if she still wants to know more, take her to see the Dragon 32. It'll soon be available in most good stores - or you can send the coupon for further details.

And if you're one of our many lady readers, please accept our apologies.

Perhaps you'd like to read this ad to your husband.

DRAGON 32 The first family computer.

To: Jean Webster, Dragon Data Ltd., Queensway, Swansea Industrial Estate, Swansea, Glamorgan SA5 4EH.
Tel: 0792 580651.

Please send me further information about the Dragon 32.

Name _____

Address _____

PCW

SEE US AT THE PERSONAL COMPUTER
WORLD SHOW, HALL A (LOWER) STAND 122.

A member of the Mettoy Group of Companies.



The choice is yours...

Xitan Systems, the South Coast's leading centre for microcomputer hardware and software, offer a choice of over twenty systems from seven major manufacturers.

apple Popular desktop computers for personal and small business use.

comart Communicator range of sophisticated British S100 business systems.

commodore VIC-20, the ideal introduction to computing.

Cromemco Computer range for professional use, with numerous options.

**XITAN
SYSTEMS**
Xitan Systems Limited
23 Cumberland Place
Southampton SO1 2BB
Telephone 0703 38740
Telex 47388 CHACOM G.

NorthStar  The Advantage desktop computer with business graphics.

OSBORNE The briefcase-sized system that took America by storm: a complete business system in a compact, portable package. 

SHARP The elegant MZ80B desktop computer, with a range of options.

XITAN The essential back-up for every system, Xitan offer unrivalled knowhow in commercial, industrial, educational and scientific microcomputer applications. Xitan's services include system development, hardware and software support, and fast and effective service in the field.



High-rise technology at down to earth prices!



DISK DRIVE
4040 £550
8050 £750



PET COMPUTER
4032 £550
8032 £690



MATRIX PRINTER
4022 £340
8023 £775



PERSONAL COMPUTER
VIC 20 £125
CASSETTE DECK £35

We also stock a large range of other Commodore peripherals, programs, games, etc. Please phone for quotation—**Hollywood (02317) 6821/2**. Export enquiries also welcome.

I enclose a cheque/Postal order for £_____.
Delivery free within the UK. Allow 21 days for delivery.
Please add 15% VAT to all prices.

Name _____

Address _____

Irish Computer Centre Limited

4, High Street, Holywood, Co. Down BT18 9AZ, N. Ireland



ORIC-1TM

TIMELESS TECHNOLOGY FROM ORIC PRODUCTS INTERNATIONAL

The Computer Challenge

**16 colours
professional keyboard
full graphics
real sound**

- Superb styling
- Choice of 16K RAM or massive 48K RAM
- Ergonomic keyboard with 57 moving keys
- 28 rows x 40 characters high resolution
- Teletext/viewdata compatible graphics
- 6 octaves of real sound plus Hi-Fi output
- Centronics printer interface and cassette port
- Comprehensive user manual

OPTIONAL MODEM OFFERS COMPUTER PHONE LINK FOR:
● ELECTRONIC MAIL ● TELESOFTWARE ● PRESTEL

COMING SOON, TO COMPLETE YOUR SYSTEM: ORIC MICRO-DRIVE DISCS & SPEED PRINTER

THE REAL
COMPUTER SYSTEM
FOR
£ 99.95
incl VAT

FOR HOME: The ORIC-1 is the professional alternative for home computing. Superbly styled, the 57 key layout is based upon computers costing many times more than the ORIC, and will help the whole family to learn and understand computing, right from day one. The ORIC incorporates an improved version of Microsoft Basic for ease of programming and use. For the enthusiasts the computer has laser zaps, explosions, etc. pre-programmed for games use, with Hi-Fi output for incredible effect. The communications Modem will allow 'Telesoftware', message sending, and Prestel use.

FOR BUSINESS: The ORIC-1 is the answer to many day to day problems. Software is becoming available for payroll, accounts, stock-control, and many more systems to help your day to day business organising and control. In addition, the ORIC COMMUNICATIONS MODEM will allow you to access up to 200,000 pages of Prestel information, to send and receive 'electronic mail', to book hotels, and flights (and pay for them) and to look at the latest stock-market and share indexes. In short the ORIC-1 is a must for all businesses large or small.

HOW TO ORDER YOUR ORIC-1: By phone: Just ring our telesales number Ascot (0990) 27641.

By post: You can pay by cheque, postal order ACCESS - BARCLAYCARD - AMEX - DINERS. (Please allow 28 days for delivery).

Money back if not satisfied.

© Copyright ORIC PRODUCTS INTERNATIONAL 1982

ORIC-1

The Real Computer System

ORIC PRODUCTS INTERNATIONAL LTD
Crowth Park, Wareson, Crowth Park, London Road,
Sunninghill, Ascot, Berks SL5 7SE.

Item	Qty	Price Inc VAT	Total
ORIC-1 16K RAM		£ 99.95	
ORIC-1 48K RAM		£169.95	
Postage and Packing		£ 79	
Please charge my Access Barclaycard			
Amex, Diners Club account no.			
Name			
Address			
TOTAL		£	5.95

* please delete/complete as applicable.
* I enclose a cheque/PO payable to:
ORIC PRODUCTS INTERNATIONAL LIMITED
for £.

If you require a brochure please tick

PCW



See our intelligent li
space conqueror and y
know why he's gree

TIME was when the Mekon had things all his own way. Highly intelligent, small, compact, manoeuvrable, he had no equal on our planet.

Then along came Durango, a reliable multi-tasking, multi-terminal, business system offering extraordinary performance, plus the ability to expand with you as your business grows. Complete with a wide range of business software packages.

Durango is contained in one neat compact, space-saving unit complete with a printer, VDU, processor and 15mb of disk. All of which occupies only fractionally more room than a typewriter and represents terrific value for money.

And, sorry Mekon, Durango also looks prettier. Proving that just because you're hard and ruthlessly efficient, you don't have to look it.



Contact us now
and we'll fire off full details to you.

Computer Ancillaries Ltd, 64 High Street,
Egham, Surrey TW20 9EY.

Telephone: Egham (0784) 36455.

Send to: Computer Ancillaries Ltd, 64 High Street, Egham, Surrey TW20 9EY.
Please send me details of the Durango plus the address of my nearest customer support centre.

NAME

POSITION

COMPANY

ADDRESS

Tel:



ttle
ou'll
n.

THE VERSATILE COMPUTER

with the features you need for
TODAY and TOMORROW

- *Z-80
(8 bit processor)
- *8088
(16 bit processor)
- *128K ram
- *8035 keyboard
processor
- *S-100 slots



- *Green phosphor
high resolution
screen
- *Integrated
floppy & winchester
disc drives
- *Detached
ergonomic
keyboard

The Vector 4 is an advanced
8/16 bit desk top computer.

It allows you to take advantage
of the existing 8 bit CP/M
programs while also providing
16 bit processing power.

The future is built into the Vector 4
with its Z-80 and 8088 processors,

Let ALMARC show you
tomorrow's computers today.

128k of main
memory (expandable to 256k),
3 S-100 expansion slots
and standard software facilities
with high resolution graphics that
are second to none. Floppy disc
and hard disc systems are available.
Nationwide sales and servicing.

Almarc

Almarc Data Systems Ltd,
Great Freeman Street,
Nottingham NG3 1FR.
Tel: (0602) 52657
Telex: 37407 Almarc/G

Almarc Data Systems Ltd,
Ward International Building,
Green Street,
High Wycombe,
Bucks. HP11 2RF.
Tel: (0494) 23804.

DATA SYSTEMS

FOR TOMORROW'S SYSTEMS TODAY



ZX Spectrum

BLUE EDIT	RED CAPS LOCK	MAGENTA TRUE VIDEO	GREEN INV. VIDEO	CYAN	YELLOW	WHITE	BLACK DELETE
1 !	2 @	3 #	4 \$	5 %	6 &	7 ' ,	8 (
DEP-FN	FN	LINE	OPEN #	CLOSE #	MOVE	ERASE	POINT
SIN	COS	TAN	INT	RND	STR\$	CHR\$	CODE
Q ←	W <>	E >=	R <	T >	Y AND RETURN	U OR IF	I AT INPUT
A5N	ACS	ATN	VERIFY	MERGE	[]	IN
READ	RESTORE	DATA	SGN	ABS	SQR	VAL	LEN
A STOP NEW	S NOT SAVE	D STEP DIM	F TO FOR	G THEN GOTO	H ↑ GOSUB	J - LOAD	K + LIST
LN	EXP	LPRINT	LLIST	BIN	CIRCLE	VAL \$	SCREEN \$
Z :	X £	C ?	V /	B BORDER	N NEXT	M PAUSE	L = LET
BEEP	INK	PAPER	FLASH	BRIGHT	OVER	INVERSE	ATTR
CAPS SHIFT	CLEAR	CONT	CLS	BORDER	NEXT	PAUSE	LET
							ENTER
							BREAK SPACE



Sinclair ZX Spectrum

**16K or 48K RAM...
full-size moving-
key keyboard...
colour and sound...
high-resolution
graphics...**

**From only
£125!**

First, there was the world-beating Sinclair ZX80. The first personal computer for under £100.

Then, the ZX81. With up to 16K RAM available, and the ZX Printer. Giving more power and more flexibility. Together, they've sold over 500,000 so far, to make Sinclair world leaders in personal computing. And the ZX81 remains the ideal low-cost introduction to computing.

Now there's the ZX Spectrum! With up to 48K of RAM. A full-size moving-key keyboard. Vivid colour and sound. High-resolution graphics. And a low price that's unrivalled.

Professional power— personal computer price!

The ZX Spectrum incorporates all the proven features of the ZX81. But its new 16K BASIC ROM dramatically increases your computing power.

You have access to a range of 8 colours for foreground, background and border, together with a sound generator and high-resolution graphics.

You have the facility to support separate data files.

You have a choice of storage capacities (governed by the amount of RAM). 16K of RAM (which you can update later to 48K of RAM) or a massive 48K of RAM.

Yet the price of the Spectrum 16K is an amazing £125! Even the popular 48K version costs only £175!

You may decide to begin with the 16K version. If so, you can still return it later for an upgrade. The cost? Around £60.



Ready to use today, easy to expand tomorrow

Your ZX Spectrum comes with a mains adaptor and all the necessary leads to connect to most cassette recorders and TVs (colour or black and white).

Employing Sinclair BASIC (now used in over 500,000 computers worldwide) the ZX Spectrum comes complete with two manuals which together represent a detailed course in BASIC programming. Whether you're a beginner or a competent programmer, you'll find them both of immense help. Depending on your computer experience, you'll quickly be moving into the colourful world of ZX Spectrum professional-level computing.

There's no need to stop there. The ZX Printer—available now—is fully compatible with the ZX Spectrum. And later this year there will be Microdrives for massive amounts of extra on-line storage, plus an RS232/network interface board.



Key features of the Sinclair ZX Spectrum

- Full colour—8 colours each for foreground, background and border, plus flashing and brightness-intensity control.
- Sound—BEEP command with variable pitch and duration.
- Massive RAM—16K or 48K.
- Full-size moving-key keyboard—all keys at normal typewriter pitch, with repeat facility on each key.
- High-resolution—256 dots horizontally x 192 vertically, each individually addressable for true high-resolution graphics.
- ASCII character set—with upper- and lower-case characters.
- Teletext-compatible—user software can generate 40 characters per line or other settings.
- High speed LOAD & SAVE—16K in 100 seconds via cassette, with VERIFY & MERGE for programs and separate data files.
- Sinclair 16K extended BASIC—incorporating unique 'one-touch' keyword entry, syntax check, and report codes.

um



ZX Spectrum software on cassettes – available now

The first 21 software cassettes are now available directly from Sinclair. Produced by ICL and Psion, subjects include games, education, and business/household management. Galactic Invasion... Flight Simulation... Chess... History... Inventions... VU-CALC... VU-3D... 47 programs in all. There's something for everyone, and they all make full use of the Spectrum's colour, sound and graphics capabilities. You'll receive a detailed catalogue with your Spectrum.

RS232/network interface board

This interface, available later this year, will enable you to connect your ZX Spectrum to a whole host of printers, terminals and other computers.

The potential is enormous. And the astonishingly low price of only £20 is possible only because the operating systems are already designed into the ROM.

sinclair

Sinclair Research Ltd, Stanhope Road,
Camberley, Surrey GU15 3PS.
Tel: Camberley (0276) 685311.

The ZX Printer – available now

Designed exclusively for use with the Sinclair ZX range of computers, the printer offers ZX Spectrum owners the full ASCII character set – including lower-case characters and high-resolution graphics.

A special feature is COPY which prints out exactly what is on the whole TV screen without the need for further instructions. Printing speed is 50 characters per second, with 32 characters per line and 9 lines per vertical inch.

The ZX Printer connects to the rear of your ZX Spectrum. A roll of paper (65ft long and 4in wide) is supplied, along with full instructions. Further supplies of paper are available in packs of five rolls.

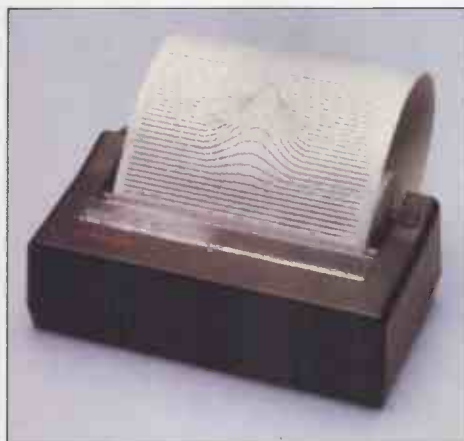

The ZX Microdrive – coming soon

The new Microdrives, designed especially for the ZX Spectrum, are set to change the face of personal computing.

Each Microdrive is capable of holding up to 100K bytes using a single interchangeable microfloppy.

The transfer rate is 16K bytes per second, with average access time of 3.5 seconds. And you'll be able to connect up to 8 ZX Microdrives to your ZX Spectrum.

All the BASIC commands required for the Microdrives are included on the Spectrum.

A remarkable breakthrough at a remarkable price. The Microdrives are available later this year, for around £50.



How to order your ZX Spectrum

BY PHONE – Access, Barclaycard or Trustcard holders can call 01-200 0200 for personal attention 24 hours a day, every day. BY FREEPOST – use the no-stamp needed coupon below. You can pay by cheque, postal order, Barclaycard,

Access or Trustcard.

EITHER WAY – please allow up to 28 days for delivery. And there's a 14-day money-back option, of course. We want you to be satisfied beyond doubt – and we have no doubt that you will be.

To: Sinclair Research, FREEPOST, Camberley, Surrey, GU15 3BR.				Order
Qty	Item	Code	Item Price £	Total £
	Sinclair ZX Spectrum – 16K RAM version	100	125.00	
	Sinclair ZX Spectrum – 48K RAM version	101	175.00	
	Sinclair ZX Printer	27	59.95	
	Printer paper (pack of 5 rolls)	16	11.95	
	Postage and packing: orders under £100	28	2.95	
	orders over £100	29	4.95	
Total £				
Please tick if you require a VAT receipt <input type="checkbox"/>				
*I enclose a cheque/postal order payable to Sinclair Research Ltd for £ _____				
*Please charge to my Access/Barclaycard/Trustcard account no. _____				
*Please delete/complete as applicable _____				
Signature _____				
PLEASE PRINT				
Name: Mr/Mrs/Miss _____				
Address _____				

PCW812				
FREEPOST – no stamp needed. Prices apply to UK only. Export prices on application.				

Sinclair ZX Spectrum—technical data.

Dimensions

Width 233 mm
Depth 144 mm
Height 30 mm

CPU/memory

Z80A microprocessor running at 3.5 MHz.
16K-byte ROM containing BASIC interpreter and operating system.

16K-byte RAM (plus optional 32K-byte RAM on internal expansion board) or 48K-byte RAM.

Keyboard

40-moving-key keyboard with full upper and lower case with capitals lock feature. All BASIC words obtained by single keys, plus 16 graphics characters, 22 colour control codes, and 21 user-definable graphics characters. All keys have auto repeat.

Display

Memory-mapped display of 256 pixels x 192 pixels; plus one attribute byte per character square, defining one of eight foreground colours, one of eight background colours, normal or extra brightness and flashing or steady. Screen border colour also settable to one of eight colours. Will drive a PAL UHF colour TV set, or black and white set (which will give a scale of grey), on channel 36.

Sound

Internal loudspeaker can be operated over more than 10 octaves (actually 130 semitones) via basic BEEP command. Jack sockets at the rear of computer allow connections to external amplifier/speaker.

Graphics

Point, line, circle and arc drawing commands in high-resolution graphics.
16 pre-defined graphics characters plus 21 user-definable graphics characters. Also functions to yield character at a given position, attribute at a given position (colours, brightness and flash) and whether a given pixel is set. Text may be written on the screen on 24 lines of 32 characters. Text and graphics may be freely mixed.

Colours

Foreground and background colours, brightness and flashing are set by BASIC INK, PAPER, BRIGHT and FLASH commands. OVER may also be set, which performs an exclusive-or operation to overwrite any printing or plotting that is already on the screen. INVERSE will give inverse video printing. These six commands may be set globally to cover all further PRINT, PLOT, DRAW or CIRCLE commands, or locally within these commands to cover only the results of that command. They may also be set locally to cover text printed by an INPUT statement. Colour-control codes, which may be accessed from the keyboard, may be inserted into text or program listing, and when displayed will override the globally set colours until another control code is encountered. Brightness and flashing codes may be inserted into program or text, similarly. Colour-control codes in a program listing have no effect on its execution. Border colour is set by a BORDER command. The eight colours available are black, blue, red,

magenta, green, cyan, yellow and white. All eight colours may be present on the screen at once, with some areas flashing and others steady, and any area may be highlighted extra bright.

Screen

The screen is divided into two sections. The top section – normally the first 22 lines – displays the program listing or the results of program or command execution. The bottom section – normally the last 2 lines – shows the command or program line currently being entered, or the program line currently being edited. It also shows the report messages. Full editing facilities of cursor left, cursor right, insert and delete (with auto-repeat facility) are available over this line. The bottom section will expand to accept a current line of up to 22 lines.

Mathematical operations and functions

Arithmetic operations of +, -, X, ÷, and raise to a power. Mathematical functions of sine, cosine, tangent and their inverses; natural logs and exponentials; sign function, absolute value function, and integer function; square root function, random number generator, and pi.

Numbers are stored as five bytes of floating point binary – giving a range of $+3 \times 10^{-39}$ to $+7 \times 10^{38}$ accurate to 9½ decimal digits.

Binary numbers may be entered directly with the BIN function. =, >, <, >=, <= and <> may be used to compare string or arithmetic values or variables to yield 0 (false) or 1 (true). Logical operators AND, OR and NOT yield boolean results but will accept 0 (false) and any number (true).

User-definable functions are defined using DEF FN, and called using FN. They may take up to 26 numeric and 26 string arguments, and may yield string or numeric results.

There is a full DATA mechanism, using the commands READ, DATA and RESTORE.

A real-time clock is obtainable.

String operations and functions

Strings can be concatenated with +. String variables or values may be compared with =, >, <, >=, <=, <> to give boolean results. String functions are VAL, VAL\$, STR\$ and LEN. CHR\$ and CODE convert numbers to characters and vice versa, using the ASCII code.

A very powerful string slicing mechanism exists, using the form a\$(x TO y).

Variable names

Numeric – any string starting with a letter (upper and lower case are not distinguished between, and spaces are ignored).

String – A\$ to Z\$.

FOR-NEXT loops – A-Z.

Numeric arrays – A-Z.

String arrays – A\$ to Z\$.

Simple variables and arrays with the same name are allowed and distinguished between.

Arrays

Arrays may be multi-dimensional, with subscripts starting at 1. String arrays, technically character arrays, may have their last subscript omitted, yielding a string.

Expression evaluator

A full expression evaluator is called during program execution whenever an expression, constant or variable is encountered. This allows the use of expressions as arguments to GOTO, GOSUB, etc.

It also operates on commands allowing the ZX Spectrum to operate as a calculator.

Cassette interface

The ZX Spectrum incorporates an advanced cassette interface. A tone leader is recorded before the information to overcome the automatic recording level fluctuations of some tape recorders, and a Schmitt trigger is used to remove noise on playback.

All saved information is started with a header containing information as to its type, title, length and address information. Program, screens, blocks of memory, string and character arrays may all be saved separately.

Programs, blocks of memory and arrays may be verified after saving to confirm successful saving.

Programs and arrays may be merged from tape to combine them with the existing contents of memory. Where two line numbers or variables names coincide, the old one is overwritten.

Programs may be saved with a line number, where execution will start immediately on loading.

The cassette interface runs at 1500 baud, through two 3.5 mm jack plugs.

Expansion port

This has the full data, address and control buses from the Z80A, and is used to interface to the ZX Printer, the RS232 and NET interfaces and the ZX Microdrives.

IN and OUT commands give the I/O port equivalents of PEEK and POKE.

ZX81 compatibility

ZX81 BASIC is essentially a subset of ZX Spectrum BASIC. The differences are as follows.

FAST and SLOW: the ZX Spectrum operates at the speed of the ZX81 in FAST mode with the steady display of SLOW mode, and does not include these commands.

SCROLL: the ZX Spectrum scrolls automatically, asking the operator "scroll?" every time a screen is filled.

UNPLOT: the ZX Spectrum can unplot a pixel using PLOT OVER, and thus achieves unplot.

Character set: the ZX Spectrum uses the ASCII character set, as opposed to the ZX81 non-standard set.

ZX81 programs may be typed into the ZX Spectrum with very little change, but may of course now be considerably improved. The ZX Spectrum is fully compatible with the ZX Printer, which can now print out a full upper and lower case character set, and the high resolution graphics; using LLIST, LPRINT and COPY. ZX81 software cassettes and the ZX 16K RAM pack will not operate with the ZX Spectrum.

sinclair ZX Spectrum

**Imagine a totally portable computer
that slips into your briefcase, incorporating
an LCD screen, full typewriter keyboard,
printer and microcassette,
and runs on its own power supply for use anywhere.**

We did.

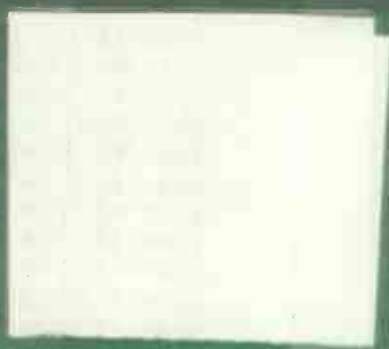

HX-20
PORTABLE COMPUTER

EPSON

Extraordinary product.
Exceptional quality.

Taking the computer a step further.

A computer small enough to fit into a briefcase yet with full size typewriter keyboard, LCD Virtual Screen, printer and microcassette facility actually built in.

Improbable. Until today.

Functions fantastic.

The HX-20 is a real computer, not a gimmicky toy. Or an extension of your calculator. Or just another desk top computer. It is a precision machine with 16k RAM which is optionally expandable to 32k and 32k ROM expandable to 64k, RS-232C and serial interfaces.

The full size ASCII typewriter keyboard and five programmable keys brings ten separate program functions to your fingertips.

The HX-20 can run on its own power supply for over 50 hours which can be easily recharged overnight, and has the ability to retain its memory in RAM even when switched off.

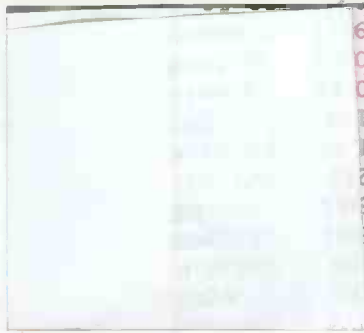

Virtual Screen keeps you in the picture.

The HX-20's LCD Screen is unique, keeping you in the picture by showing any 20 characters by 4 lines at a time. You can,

therefore, carry out word processing or data entry as if you are using a large screen.

Upper and lower case letters, numerals, punctuation marks and graphics are easily read by simply adjusting the viewing angle.



Print out. Built in.

A built-in 24 column dot matrix impact microprinter offers 42 LPM in a crisp, precise 5 x 7 matrix for perfect hard copies on plain paper. Every time.

And there's more. . . Bit addressable graphics allow you to design your own characters for full graphic capability, a cartridge ribbon, full ASCII character set including £ sign and enough international symbols for reproducing most Western languages.



Add-on capability.

Choose from a wide range of peripherals. Barcode readers, audio cassette for loading and saving programs, microcassette and ROM cartridges, and the world famous Epson dot matrix computer printers for quality-output . . . to name just a few.

Via acoustic couplers this superb machine can also be linked through the telephone to other computers:



Software and the hard facts.

The HX-20 uses a full extended version of Microsoft BASIC, with a 24 hour clock, date and alarm, string functions, and music generation. The interface options (with RS-232C and serial interfaces as standard) include a standard cassette, a ROM cartridge, plus a system bus that allows you to expand the RAM and ROM capabilities.

The HX-20.
The most complete portable computer available today.

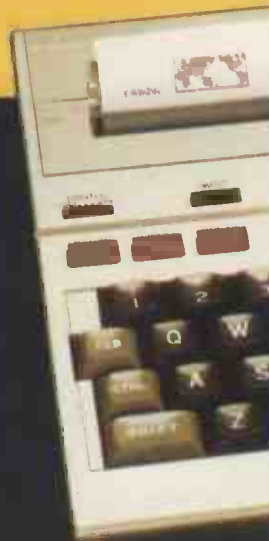

Portability for Programability. Anywhere.

The HX-20 is light and totally portable for writing programs and manipulating data – virtually anywhere. (Just four nickel-cadmium batteries and a low power all-CMOS memory gives you a reliable power source during your travels.)

Back at the office you can dump your data or programs onto a cassette or into your main computer system.

Reliability through Research.

A computer coming from Epson has got to be good. After all we have been responsible for high quality precision manufacture since 1961. Just take a look at our impressive track record with the hugely successful Epson dot matrix printers.

So it follows that you can expect the same quality, the same reliability through our extensive research program prior to launching



any revolutionary new product. Now that product has arrived. The HX-20 is here today. From Epson. But it's got to be seen to be believed.

Clip the coupon below and return it to us – Freepost – no stamp required and we'll send you the complete list of HX-20 stockists by return.

If you would also like further details of how the HX-20 can be suited to your particular requirements simply include your area of business and any other relevant details separately or on the back of the freepost coupon.

To: Epson (UK) Limited,
Freepost, Wembley, Middlesex HA9 6BR

- Please send me your list of HX-20 stockists.
 I would like details of how Epson products can help my particular business. I have included further information separately/overleaf.

Name _____

Address _____

Postal Code _____

Specifications of HX-20

Dimensions and Ambient Conditions

Dimensions and Weight

1. Dimensions: 290mm wide
215.5mm deep
44mm high
2. Weight: Approx. 1.7 kg

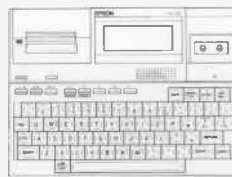

Ambient Conditions

1. Temperature: 5°C to 35°C (operating)
5°C to 35°C (charging)
-5°C to 40°C (data storage) (RAM battery backup)
-20°C to 60°C (non-operating)
2. Relative humidity: 10% to 80% (operating, no condensation)
10% to 80% (non-operating, no condensation)
3. Shock resistance: 1 G for 1 ms maximum (operating)
4. Vibration resistance: 0.25G 55 Hz maximum (operating)

Power Supply (Nicc batteries)

1. Voltage: 4.5V to 6.0V (operating)
4.0V to 6.0V (data storage)
4.5V (low voltage detection)
2. Battery capacity: Approx. 1100 mA/H

AC Adaptor

1. Input voltage: AC 220V/240V ± 10%
2. Power consumption: 8W
3. Insulation resistance: 10Megohms between AC power supply and case
4. Insulation strength: Can withstand 1 kV applied between AC power supply and case for 1 minute or more

Microprinter (M-160)

1. Printing system: Dot impact (4 printing solenoids)
2. Printing format:
 - a. Total number of dots: 144 dots maximum/dot line
 - b. Number of characters per line: 24 maximum
(5 x 7 dots; character-to-character space 1 dot)
(6 characters/printing solenoid)
3. Printing speed:
 - a. 1 dot line: Approx. 150 ms (continuous printing)
 - b. 5 x 7 dot matrix (interline space 3 dots): Approx. 0.7 line/s (continuous printing)
42 lines per minute
4. Character size:
 - a. Dot spacing: 0.33mm horizontal
0.33mm vertical
 - b. 5 x 7 dot matrix: 1.7mm wide, 2.4mm high
5. Recording paper:
 - a. Kind: Plain paper
 - b. Paper width: 57.5 ± 0.5mm
 - c. Outside diameter: 50mm or less
 - d. Thickness: 0.07mm
 - e. Weight: 52.3 g/m² (45 kg/1000 sheets/1091 sheets x 788mm)
6. Paper feed: Automatic feed every dot line; with paper release
7. Inking:
 - a. Ribbon cartridge type: Automatic continuous feed during motor operation
 - b. Colour: Purple/Black
 - c. Dimensions: Approx. 91mm wide, 25mm deep, 7mm high
 - d. Life: Approx. 10,000 lines
 - e. Standard: ERC-09

Liquid Crystal Display

1. Text: Upper and lower case, numerals, symbols, graphic characters and more; 20 characters per line; 4 lines in total (20 x 4 = 80 characters)
2. Graphic: 120 dots (horizontal) x 32 dots (vertical) = 3840 dots
3. View angle adjustment: Adjustable with VIEW ANGLE density control

Keyboard

1. Key switches: Typewriter layout, full size. 68 keys (including 5 function keys and 13 special keys)
2. Others: Power on switch, VIEW ANGLE density control for LCD, and adjusting circuit built in

RS-232C Interface

1. Connector: DIN (8-pin) TCS 4480
2. Input and output levels: RS-232C standard
3. Transfer speed: 110, 150, 300, 600, 1200, 2400, 4800 bps (selectable by operator)

Serial Interface

1. Connector: DIN (5-pin) TCS 4450
2. Input and output levels: RS-232C standard
3. Transfer speed: 38, 150, 400, 600, 4800 bps (selectable by operator)

HX-20
PORTABLE COMPUTER

EPSON

Epson (UK) Limited
Dorland House
388 High Road Wembley
Middlesex HA9 6UH
Telephone: 01-900 0466/9
Telex: 8814169



NEC turns 28 years of computer experience to your personal advantage.

It takes a great computer company to make a great personal computer. And from the start, NEC has been a pioneer in computer technology. In fact, we invented the all-semiconductor computer in 1959. Now, hundreds of innovations later, we've made it personal.

We present the PC-8000, a powerful and friendly business tool that can help you get more done in a day than you ever could before. It combines some of the most reliable hardware on the market with application packages designed to make the most of its unique features. In addition, the PC-8000 accepts popular CP/M® business software, making its possibilities virtually limitless.

The entire PC-8000 system is now available through better computer dealers across the country. And that means more than hardware. It means effective software, the finest documentation and extensive training to help you get the most from your personal computer. So why not turn our system to your personal advantage now.

NEC
Nippon Electric Co., Ltd
Tokyo, Japan

(CP/M is a registered trademark of Digital Research Inc.)

NEC Telecommunications Europe Co. Limited
NEC House, 164/166 Drummond Street,
London N.W.1 3HP UK
Telephone: 01-388-6100 Telex: 261914

Write for more information
about the NEC PC-8000.

NAME _____
COMPANY _____
ADDRESS _____

Attach this coupon to your letterhead and mail it to NEC Telecommunications Europe Co. Limited, NEC House, 164/166 Drummond Street, London N.W.1 3HP, U.K.

See us at
COMPEC
Stand 2164



THE GALAXY 1 COMPUTER

The cost effective solution to
your computer needs for only

£1,450*

The Galaxy 1 desk top computer system can be used in education, small business applications, word processing, stock control and a host of other environments. Our choice of CP/M as the operating system means that our customers can select a suitable application package from the widest possible range.

However, unlike our competitors, we supply not only the hardware but all the essential system software needed to start using the Galaxy 1 as soon as it is installed. We have adopted COMAL-80 as our standard language. This structured basic is rapidly gaining widespread acceptance and popularity especially in the education market, offering much greater flexibility and ease of use than existing Basics. We also supply a very powerful Z80 assembler/editor called GEM ZAP with GEM PEN, a compact but very powerful word processing package. The system software suite is completed with GEM DEBUG, a useful machine code program de-bugging utility.

Modular design means reliability and ease of maintenance. Unlike many other manufacturers Gemini offer a full one year warranty (except Disc heads which are guaranteed for 3 months). Our distributors carry a full range of replacement boards thereby facilitating a quick, efficient and cost effective back up customer service.

Features include:

- Twin Z80 Processors
- 64K Dynamic RAM
- 800 K Disc Based Storage
- 80x25 Screen Format
- Dual Printer Interfaces
- Modular Design
- CP/M 2.2 Operating system
- COMAL-80 - Structured Basic
- Z80 Editor/Assembler
- Text Editor & Formatter
- Program De-Bugging Utility

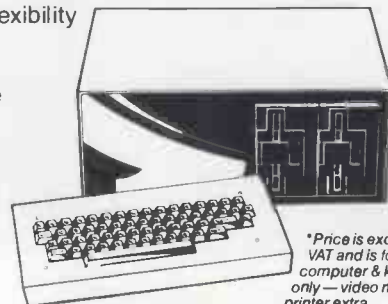

*Price is exclusive of
VAT and is for
computer & keyboard
only - video monitor &
printer extra.

BRITISH MADE



Telephone Amersham 28321 for the name and address of your nearest distributor.
* Dealer enquiries invited.

Gemini Microcomputers Oakfield Corner, Sycamore Road, Amersham, Bucks HP6 5EQ.

MICROCOMPUTER PRODUCTS

MPI

INTERNATIONAL LTD.

ROOM PCW, 8 CAMBRIDGE HOUSE, CAMBRIDGE ROAD, BARKING, ESSEX IG11 8NT, ENGLAND

Telephone: 01-591 6511 Telex: 892395

SOFTWARE FOR CP/M COMPUTERS

Software & Manual		Manual Only	Software & Manual		Manual Only
ANTHONY ASHPITEL TYPING TUTORS					
BASIC VERSION	£50		FORTH	£85	£23
BUSINESS VERSION	£125	£25	PAYROLL	£500	£15
BYROM SOFTWARE					
BSTAM—Utility to link one micro-computer to another also using BSTAM	£112	£7	SALES LEDGER	£200	£15
BSTMS—Utility to link a micro to a mini or mainframe	£112	£13	PURCHASE LEDGER	£200	£15
CP/M USER LIBRARY					
51 Volumes—Price per volume			NOMINAL LEDGER	£200	£15
8" disc (one volume per disc)	£5		INCOMPLETE RECORDS	£1200	£20
5" disc (one volume per 2 discs)	£10		MATHSPACK	£120	
Index		£2	STATSPACK	£120	
DIGITAL RESEARCH					
CBASIC v 2.08	£76	£16	MPI LTD.		
CB-80 1.3	£312	£21	FORTH	£85	£23
PASCAL MT+	£206	£24	PAYROLL	£500	£15
PASCAL MT+ WITH SPP	£297	35	SALES LEDGER	£200	£15
PASCAL MT+ LIB SOURCES	£129		PURCHASE LEDGER	£200	£15
PASCAL MT+ SPP ONLY	£147		NOMINAL LEDGER	£200	£15
MP/M 1.1	£138	£12	INCOMPLETE RECORDS	£1200	£20
MP/M 2.0	£288	£35	MATHSPACK	£120	
CP/M86	£171	£32	STATSPACK	£120	
CP/M 2.2	£103	£24	MICROFOCUS		
CP/NET	£126	£16	CIS COBOL v 4.5	£425	£25
XL786	£94	£8	FORMS 2	£110	£10
SID 1.4	£50	£16	ANIMATOR	£225	£25
ZSID 1.4	£65	£16	FILESHARE	£250	£20
MAC	£62	£16	MICROLOGY		
TEX3.0	£65	£16	FTNUMB (FORTRAN-80 RENUMBER & REFORMATTER)	£50	
DESPOOL	£31	£7	MICROPRO INC.		
PL/1-80	£315	£32	WORD-MASTER 1.7A	£88	£26
BT-80	£165	£24	TEX-WRITER 2.6	£44	£20
ELECTRONIC ACCOUNTING SERVICES					
LINEAR & GOAL PROGRAMMING	£200	£10	WORDSTAR 3.0	£88	£45
FOX & GELLER					
QUICKSCREEN FOR DBASE-II	£103	£14	MAIL MERGE 3.0 (requires Wordstar)	£88	£12
QUICKSCREEN FOR CBASIC/CB-80	£103	£14	SPELLSTAR 1.2 (requires Wordstar)	£147	£12
QUICKSCREEN FOR MBASIC	£103	£14	WORDSTAR TRAINING MANUAL	£59	£21
QUICKCODE FOR DBASE-II	£182	£21	WORDSTAR CUSTOMIZATION NOTES	£147	
GRAM BUSINESS SYSTEMS LTD.					
DISKREV	£65	£13	SUPER-SORT 1.6: Version 1	£147	£26
DISKLENE	£40	£6	DATASAR 1.101	£206	£29
DISKORG	£50	£6	DATASAR CUSTOMIZATION NOTES	£59	
DISKED-2	£65	£8	CALCSTAR 1.2	£176	£29
DISKTOOLS-1 (DISKREV-DISKORG)	£90	£15	APPLE VERSIONS		
DISKTOOLS-2 (DISKTOOLS-1-DISKED-2)	£145	£19	WORDSTAR 3.0	£221	£44
MICRO-AP					
SELECTOR-V 1.6	£324	£29	MAILMERGE 3.0 (requires Wordstar)	£74	£12
ORDER INFORMATION					

SAVE OVER 20% WHEN YOU ORDER ONE OF THESE SUPER ALL STAR PACKS



Retailer and OEM terms available

MAIL ORDER

TELEPHONE

CREDIT CARD ORDER

* VISIT *

FREE

Full descriptive

Catalogue

available

Trade Enquiries Welcome

Software & Manual	Manual Only
MARS	£295 £25

PHOENIX SOFTWARE ASSOCIATES (For Z80 only)

PLINK—Disc to disc link loader	£85	£18
PASM—Macro Assembler	£85	£18
PEDIT—Line editor with Macros	£85	£18
BUG—Very powerful debug	£85	£18
PDEVELOP Package with all the above	£227	£39
PLINK—2 Overlay Link Loader	£218	£18

MICROTECH EXPORTS

REFORMATTER CPM→IBM	£147	£20
REFORMATTER CPM→DEC	£147	£20

MICROSOFT INC.

BASIC-80 5.21	£218	
BASIC Compiler 5.3	£241	
FORTRAN-80 3.44	£306	
COBOL-80 4.60	£447	
M/SORT 1.012	£88	
EDIT-80 2.02	£76	
MACRO-80 3.43	£124	
MULISP 2.12	£124	
MUMATH 2.12	£153	



MEDIA AND FORMATS

Altos	A1	Dec VT 180 SSDD
APPLE CP/M-80 13 Sector	RG	Delia Systems
APPLE CP/M-80 16 Sector	RR	Dynabyte DB8/4
Blackhawk Micropolis Mod II	Q2	Exidy Sorcerer + CP/M-80
British Micros Mimi	RK	Exidy Sorcerer + Exidy CP/M-80*
California Computer Sys 8 In	A1	EXO
CDS Versatile 4	Q2	Gemini Galaxy I
Columbia Data Products 8 In	A1	Health H8 + H47
Comart Communicator CP50	P2	Hewlett-Packard 125.8in
Comart Communicator CP100	P2	IBM PC-DOS SSDD
Comart Communicator CP200	P2	IBM PC-DOS DSDD
Comart Communicator CP500	P2	IBM CP/M-86 SSDD
Compal-80	Q2	IBM CP/M-86 DSDD
CPT 8000	A1	ICL-PC
Cromemco System 3	A1	ICL DRX Series
Cromemco System 2 SD/SS	R6	ICOM 3712

Cromemco System 2 DD/SS	RX	IMSAI VDP-80
CSSN Backup	T1	Industrial Microsystems 5000
Cyber 8"	A1	Industrial Microsystems 8000
Datapoint 1550/2150	A1	Intel MDS SD
Dec VT 180 SSDD	RV	Intertec Superbrain SSDD
Delia Systems	A1	Intertec Superbrain QD
Dynabyte DB8/4	A1	ISC Intercoler 8063/8360/8963
Exidy Sorcerer + CP/M-80	Q2	ITT 3030 DSDD
Exidy Sorcerer + Exidy CP/M-80*	A1	Micromation
EXO	A1	Micropolis Mod II
Gemini Galaxy I	NI	Morrow Discus
Health H8 + H47	A1	Mostek
Hewlett-Packard 125.8in	A1	Multi-Tech 1
IBM PC-DOS SSDD	C1	Multi-Tech 2
IBM PC-DOS DSDD	C2	Micromation
IBM CP/M-86 SSDD	C3	Micropolis Mod II
IBM CP/M-86 DSDD	C4	Morrow Discus
ICL-PC	RE	Mostek
ICL DRX Series	A1	Nascom (Gemini Drives SSDD)
ICOM 3712	A1	Nascom (Gemini Drives DSDD)

Nascom/Lucas	A1	SD Systems 5.25in
NCR 8140/9010	RA	SD Systems 8in
NNC-80	A1	Sharp MZ-80B
NNC-80W	A1	Sharp PC-3201
North Star Advantage	RK	Sharp PC-3201
North Star Horizon SSDD	RS	Shelton Signet
North Star Horizon SSDD	P1	Spacebyte
North Star Horizon QD (MPI CP/M)	P2	Tarbell 8in
North Star Horizon QD	P3	TEI 8in
North Star Horizon QD	A1	Televideo DSDD
North Star Horizon QD	A1	Torch
Nylac Micropolis Mod II	P2	Toshiba T200 DSDD
Osborne-I	Q2	TRS-80 Mod II + Shuffle-board 8in
Pertec PCC 2000	RP	TRS-80 Mod II
Rade 1000 SSDD	A1	Vector MZ
Rade 1000 DSDD	RL	Vector Systems 2800
Rair Black Box	RM	Vector Systems B
Research Machines 5.25in	RE	Vector VIP
Research Machines 8in	RN	Xerox 820 5.25in
Robotron 5"	A1	Xerox 820 8in
Robotron 8"	R7	

SD Systems 5.25in	R3
SD Systems 8in	A1
Sharp MZ-80B	R7
Sharp PC-3201	R8
Sharp PC-3201	RK
Shelton Signet	A1
Spacebyte	A1
Tarbell 8in	A1
TEI 8in	A1
Televideo DSDD	S5
Torch	N2
Toshiba T200 DSDD	SF
TRS-80 Mod II + Shuffle-board 8in	A1
TRS-80 Mod II	A1
Vector MZ	Q2
Vector Systems 2800	A1
Vector Systems B	Q2
Vector VIP	S6
Xerox 820 5.25in	Q2
Xerox 820 8in	A1

Dealers,

Increase your profits with LSI

***Business Opportunities
that cannot be missed!***

EXCELLENT MARGINS
BIG ADVERTISING
SUPPORT
FULL TECHNICAL
BACK-UP

LSI Computers Limited, one of Britain's most progressive and entrepreneurial computer manufacturers whose products have, in a relatively short space of time, captured a significant market share, and whose products have the potential to dominate in the demanding and constantly developing market of small business and personal computers, are expanding their Dealer network.

Through our OEM Division we are looking to appoint Dealers all over the U.K. for some very exceptional and technically advanced microcomputer products.

Massive Success

OEM business is very important to LSI, and we are dedicated to offering our next generation computers through our Dealer network. Using our reputation and financial strength, we are implementing a vigorous programme of research and development to secure the very latest technology and products for our Dealers. In an era of unparalleled growth and keen competition LSI are more than confident of maintaining their justifiable reputation for

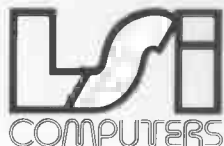

Putting Britain back in front

Copse Road, St. John's, Woking, Surrey GU21 1SX Telex: 859592

Ring

technical innovation and achievement and their ability to provide the market with the right product at the right time and at the right price.

Our Dealer programme offers you the opportunities of higher sales of demanded products at excellent margins. There's an ambitious stock programme, full engineering and technical support facilities, and a substantial and exciting advertising and promotional programme already established - in all a package that we can rightfully predict will bring our Dealers massive success. The 8 bit System M-Three continues it's amazing success and it's complimentary partner, the eagerly awaited 16 bit, High performance micro, System M-Four is soon to be launched. In addition, we are able to offer our dealers attractive arrangements on a range of Daisy Wheel and Matrix printers. **And for the larger OEM, specially configured machines totally badge engineered in your own colour schemes.** All at amazing and highly competitive prices.

And that's not all, our exciting new, high performance, low cost word processing system, still under wraps for now, is to be launched in a very, very big way this Autumn.

Move Now!

Grasp this amazing opportunity to ensure your future prosperity. Act NOW - phone Laurie Bright on Woking (04862) 23411 today to discuss this fantastic offer in more detail - you could be just one phone call away from a long and prosperous partnership.



30 NEW DEALERS
DECIDE LSI
ALREADY!

Laurie Bright

Woking (04862) 23411

DOVNESS

Business

Specialists
in
Data
Bases

DATA BASES for Apple

01 800-8268

Create your own Programs with a database

Visi File	£158.00
DB Master	£129.00
P.F.S. *New Improved	£ 75.00
P.F.S. Report	£ 54.00
d. Base II (CPM)	£350.00

Free
Accutrack
Diskette
With every
Purchase
over £50

HAVE FUN WITH THE INCREDIBLE

OSBORNE 1



Double
Density
Disks

FREE
POSTAGE

THE COMPUTER/SUITCASE

for business/pleasure

With lots of free programs & plus **£1250.00**

We're here
to solve
your problem

*P.S. We've got printers
and monitors as well*

All prices plus VAT at 15%

Box of 10 Accutrack Diskettes (inc. hard case) £18.20

Plain listing paper 11½" x 9½" 2,200 £13.50 (Local deliveries)

Plus lots of others at the best prices. Please phone

DOVNESS

88, Fairview Rd, London N.15 Callers by appointment only.

Tel. 01 800-8268 (24 hours)

comart communicator

PROGRESS REPORT



...now the pedigree really shows

How has Comart's controlled, down to earth development strategy kept Communicator a firm favourite in the UK, and the leading candidate to reverse the tide of microcomputer imports?

New Range Additions The Communicator range has broadened to add a new 20 Megabyte 5" Winchester Hard Disk Drive System to the already well established 5 Megabyte and floppy diskette models. Another new system offers 8" floppy disk drives for compatibility of data transfer. With the associated tape and additional Winchester back up systems that adds up to eight basic models – all in the same neat, stackable, casing – all based on S100 bus construction to keep future options in memory, users, peripherals and interface requirements wide open.

New System Additions Communicator operating systems continue to broaden both in options and facilities. An improved CP/M offers enhanced diagnostics, for example, and auto boot from Hard Disk. These basic improvements are reflected in the now tried and tested Communicator multi-user MP/MI™, which also provides for full CP/M™ compatibility.

New Communications Options Communicator now offers CP/Net™ and RBTE communications protocols. Individual Communicator



Systems can now operate as Intelligent information terminals, integrated with either existing mainframe or mini computer installations, or be part of a shared resource or communications network.

New Range of Terminals Find out more about Comart's new smart VDU. It's a new advanced ergonomically designed unit. It has a 105 keyset detached keyboard, soft green phosphor tilt screen, and a low profile foot. It's a perfect complement to the Communicator in both styling and performance.

Some things don't change Communicator still has Comart's established dealer network and nationwide after sales service back up, supporting thousands of Communicators already at work throughout the UK.

And in the Future? Behind all these innovations are advanced programmes of research and development. Soon Comart will be bringing you 16 bit, multi processor and distributed processing systems. This is your guarantee that Communicator will continue to keep pace as microcomputer technology progresses.

To find out more about Communicator today, call us now on 0480 215005.

Main Dealers

Birmingham The Byteshop 94/96 Hurst Street Tel 021-622 7149
 Dublin Lendac Data Systems 8 Dawson Street Tel 0001 372052
 Glasgow The Byteshop Magnet House 61 Waterloo Street
 Tel 041-221 7409 Leeds Holdens Bray House Leicester Place
 Tel 0532 459459 London The Byteshop 324 Euston Road NW1
 Tel 01-387 0505 Digitus Lading House 10/14 Bedford Street Covent
 Garden WC2 Tel 01-379 6968 Jarogate 197/213 Lyham Road Brixton
 SW2 Tel 01-671 6321 Manchester The Byteshop 11 Gateway House
 Piccadilly Station Approach Tel 061-236 4737 Nottingham
 The Byteshop 92a Upper Parliament Street Tel 0602 40576
 Southampton Xitan Systems 23 Cumberland Place Tel 0703 38740

A member of the Comart Group of Companies

comart
SPECIALISTS IN MICROCOMPUTERS

Comart Limited, Little End Road,
 Eaton Socon, St Neots, Cambs PE19 3JG
 Tel: 0480 215005 Telex: 32514 Comart G

Dealers

Aberdeen MOM Offshore Tel 0224 22863 Bedford Remdex Bradley Tel 93 68581
 Cambridge Cambridge Computer Store Tel 0223 65334 Edinburgh Holdens
 Microsystems Tel 031 557 4060 Glenrothes Computer Services (Scotland) Tel 0592
 773710 Blackpool Western Computers Tel 0253 404676 Manchester NSC Computers
 Tel 061 832 2269 Norwich Anglia Computer Centre Tel 0603 29652 Worthing Ace
 Computing Services Tel 0903 354111 Middlesbrough Aztech Tel 0642 22821 Barking
 Moldava Tel 01-591 8511 Belfast Cardiac Services Co Tel 0232 825566 Wilmsholw
 Holdens Tel 0625 529486 Colchester Eurotec Consultants Tel 0206 72538
 Huntingdon Westcom Tel 0480 217217 Luton M E Marketing Tel 0582 31806
 Middlesex Berks Newbury Data Recording Tel 0784 61141 Sheffield Hallam
 Computer Systems Tel 0742 663125 Watford Lux Computer Services Tel 0923 29513
 Aylesbury J K Wakeford Assoc. Tel 0296 27473

CP/M, MP/MI and CP/Net are all trademarks of Digital Research Inc.

£1,350*

The MIMI 802 is a supreme example of high quality British engineering. It is a truly professional microcomputer that really does meet all the criteria of a sophisticated business machine - at a price you can afford.

Our competitors expect you to make do with the basics and then buy expensive extras in order to fulfil your needs. The MIMI 802 has all the 'extras' as standard - so when you buy a MIMI you really are getting a microcomputer that will do the job from the outset.

The MIMI's operating system OS/M[†] is fully CP/M[‡] compatible so you have access to a very comprehensive range of software, extending from word processing to accounting.

During the next few months we will be announcing the availability of TROJAN - a major software innovation that totally simplifies the learning process and use of micros, and dramatically eases the creation of new applications programs. We are using it and generating applications software in record time - so we can guarantee its performance.

Don't settle for less... contact us or one of our dealers now.

Features include:

- Z80A at 4MHz
- 64K Dynamic RAM
- Integral D/S - D/D 5¼ ins floppy discs - 700Kb.
- Full RS232C and Centronics parallel ports.
- 96 Key ASCII keyboard - colour coded.
- 17 programmed function keys.
- Light pen socket.
- Elegant compact and light - 24 lbs.
- OS/M operating system - fully CP/M compatible.
- Disc format conversion facility.
- Wide range of software, utilities and languages.

And now with:

- Winchester disc option.
- Super high resolution graphics option* (802G-512 x 256 pixels).

NOW ALL OTHER MICROS ARE LESS THAN PERFECT

† OS/M is the trademark of Scifax Microsoftware.

‡ CP/M is the registered trademark of Digital Research Inc.

*Monitor extra, from £132. (Choice of orange or green display)
MIMI 802G (graphics version, as illustrated) £1495.

Some of our dealers

Anita Electronic Services
34 Musters Road West Bridgford Notts
Tel: 0602 813204
Contact: Steve Conroy

Apollo Information Systems Ltd.
13 Southend Road Grays Essex RM17 5NH
Tel: (0375) 33088
Contact: Ronald Burrell

Belmondo Research Ltd
68 Maple Road Horfield Bristol BS7 8RG
Tel: 0272 427428
Contact: Roger Banfield

Broadway Systems (BCSS) Ltd
5-7 Mariner Street Swansea W Glam Wales SA1 5BA
Tel: 0792 462279/474598 01-997 4764/0498
Contact: Phillip Gittoes

Chris Robinson Consultants
Maple Way Kensworth Dunstable Beds
Tel: 0582 872940
Contact: Chris Robinson

City Microsystems Ltd
65 London Wall London EC2
Tel: 01-588 7272
Contact: Anthony Coulson

Computer Graphics Workshop
38 Ullett Road Sefton Park Liverpool 17
Tel: 0507 604271
Contact: Noel Runnels-Moss

Comput-A-Crop
3 Cornmarket Louth Lincolnshire LN11 9PY
Tel: (0507) 604271/2 Telex: 56332
Contact: Jenny Wilson

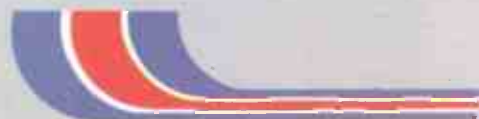

BRITISH MICRO

Penfold Works Imperial Way Watford Herts. WD2 4YY Tel: Watford (0923) 48222/4395



A Hegotron Group Company



Derwent Data Systems
18 Norfolk Street Sunderland Tyne & Wear SR1 1EA
Tel: 0783 652026
Contact: Tom Maxfield

Easabee Computing Ltd
133-135 High Street North East Ham London E6 1HZ
Tel: 01-471 4884
Contact: Computer Sales Director

John Elmer Office Equip
105-107 Church Road Burgess Hill Sussex
Tel: 04446 5670
Contact: John Elmer

Leicester Micro Centre
59 Regent Road Leicester
Tel: 0533 551869
Contact: Ray Beresford

Malvern Micro Systems
Wych Cutting Upper Colwall Malvern Worcestershire
Tel: (06845) 68500
Contact: Barry Lewis

Maystar Micro Systems Ltd
62 Peach Street Wokingham
Tel: 0734 789381
Contact: Simon Hart

Microcosm Research Ltd.
26 Danbury Street London N1 8JU.
Tel: 01-226 9092
Contact: Peter Cheesewright

Synergy Computer Systems
'E'Block University Village
UEA Norwich NR4 7TJ
Tel: (0603) 503015/6/7
Contact: Sonia Kennedy

Telex: 946024 Contact: Gerald Roll

MIMI 802



MS™-DOS gives you the only complete set of software tools for 16-bit systems. Now. From Microsoft.

Systems and Applications. Now. The success of any microcomputer system depends on the amount of software available for it. And, the ease of writing more. Microsoft™ MS-DOS is the only single-user operating system fully supported by Microsoft's 16-bit languages: BASIC Interpreter, BASIC Compiler, COBOL, FORTRAN and Pascal. Plus, the Multi-Tool™ family of applications software... starting with the Multiplan™ electronic worksheet.

More software. Soon. IBM chose MS-DOS as the primary OS for the IBM® Personal Computer. Lifeboat Associates chose MS-DOS as the 16-bit, single-user DOS it will support. And Microsoft will continually introduce new applications and systems software for MS-DOS. The implication is clear: MS-DOS is going to be even better supported. Fast.

Easier conversion. MS-DOS was written to make conversion of CP/M-80® programs simple. Simpler, according to programmers, than conversion to CP/M-86™. Again, the implication is clear.

Better system features. MS-DOS offers features unavailable under either CP/M-80 or CP/M-86: device independent I/O, advanced error recovery, variable length records, and full program relocatability in order to take

MS, Multiplan, Multi-Tool, and Microsoft are trademarks of Microsoft Corporation. CP/M and CP/M-80 are registered trademarks of Digital Research, Inc. CP/M-86 is a trademark of Digital Research, Inc. IBM is a registered trademark of International Business Machines, Corp.



advantage of the extended addressing capabilities of the 8086 and 8088 microprocessors. And MS-DOS' descriptive error messages make it a user-friendly OS.

Leadership in microsystems. Microsoft led the industry into the 8-bit world when we put BASIC on the first microcomputer. Now, we're leading the industry into the 16-bit world with the first complete set of software tools for the 8086 and 8088 microprocessors. The MS-DOS operating system. Languages. Utilities. And, applications software.

Planning an OEM system? Return the coupon below for complete OEM information on MS-DOS and Microsoft's complete set of tools for 8086 systems. Can't wait? Call our OEM Accounts Manager.

MICROSOFT

Microsoft Europe Ltd
Bulbourne House, Gossoms End
Berkhamsted, Herts HP4 3LP

(04427) 75091
TLX: 825888 MICROE G

- Send me information on MS-DOS for OEM's.
 Send me information on applications for MS-DOS.

Name _____
Company _____
Address _____
Town _____ County _____ Postcode _____

In the USA: Microsoft Corporation, 10700 Northup Way, Bellevue WA 98004, U.S.A. Tel: 010.1.(206) 828.8080. Tlx: 328945



A fresh new 48K Apple II will only cost you:

£499

(While stocks last!)



LOWEST U.K. EPSON PRICES!

MX80T (Type 3)£290
MX80F/T (Type 3).....£315
MX100F/T (Type 3).....£420

Other printer prices on application

UNBEATABLE VALUE

VISICALC

ALL LATEST PACKAGING VERSIONS!

Visicalc£98
Visitrend/plot£131
Visidex£126
Visifile£120
Visischedule£150

IEEE 488 Card£241
Z80 System (Microsoft) £184
80 Col System (Videx) ..£199
16K RAM Card£48
32K RAM Card£150
128K RAM Card£350

Disk Drives

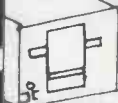

Apple disk drives at these amazing low prices!

With Controller **£270**
Without Controller **£220**

Apple III

At these prices, it must be the top of the crop!

128K 1995
256K 2495

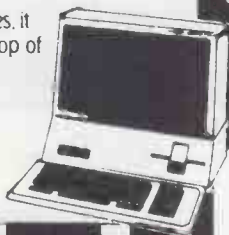

INTERFACES

Parallel Printer Card.....£70
Serial Printer Card.....£105
Pascal Card£105
Eurocolour Card.....£70

Monitors

Haga
Denshi
12" Green
Screen
Monitor.



£90

Apple Take Away

All prices plus 15% VAT

Daisywheel Printers

TEC 40cps£995
TEC 55cps£1295
Ricoh 1600£1195
Ricoh Flowriter£1575
Diablo 630 RO.....£1595

Software

DATABASE

PFS£40
PFS Report£40
DB Master 5£104
DB Utilities£47
Data Factory 5£195
DataStar£99
Supersort£95
dBase II£348
Access£179

Vlasac Orbit Accounting Modules are fully integrated, however, to use this facility, a third disk drive with controller and a pascal card are necessary.

General Ledger£295
Sales Ledger£295
Purchase Ledger£295
Stock Control£295
Payroll£295
Auto Invoicer£150

TABS
MODULES
ON REQUEST

Word Processing

Applewriter£39
Applewriter II£85
Wordstar 3.0£125
Mailmerge£47

Bits'n'Bytes

Numeric Keypad£75
Joystick (TKC)£24
Paddles£15
Cooling Fan£50
Voltage Stabiliser£170
Acoustic Coupler£200
10 BASF 5.25" disks£18
Listing Paper£14
Locking Disk Box£20
Printer RibbonsPOA
DaisywheelsPOA



Mail Order



We accept both Access and Barclaycard, subject to a 5% surcharge. Telephone orders are welcome on

01-278 3838

Mathemagic£46
Graphmagic£46
Mathe/Graphmagic (Pack)£88
Microfinesse£350
Micromodeller£560
Apple Project Manager.....£137
Order Tracking System.....£28
Hand Holding Basic£59
Personal Finance£43
Applesoft Compiler.....£110
Locksmith 4.1£65
DOS Tool Kit£41
Pascal Tutor£60
Pascal Programmer.....£60
Pilot£84

Delivery

Please add 1.5% to your order for UK delivery charge. Securicor delivery by arrangement.

All goods are normally despatched same day.

All goods are normally carried in stock, however, please confirm before collecting.

We are open from 9.30 to 5.00 on Mondays to Saturdays.

ATA SYSTEMS

4 ALBION HOUSE, 1 BACK HILL, LONDON EC1

01-278 3838/01-278 5285

DRAGON 32 — £173
NEWBRAIN A — £199
(MODEL AD — £229)

Full Range of Software and Peripherals in stock: Please phone for list.

MEMOTECH Explores the Excellence of your ZX81

Access Barclaycard Holders
Please Tel. Oxford
(0865) 722102

**MEMOTECH
KEYBOARD**
including separate
buffered interface
only
£43.43
plus VAT

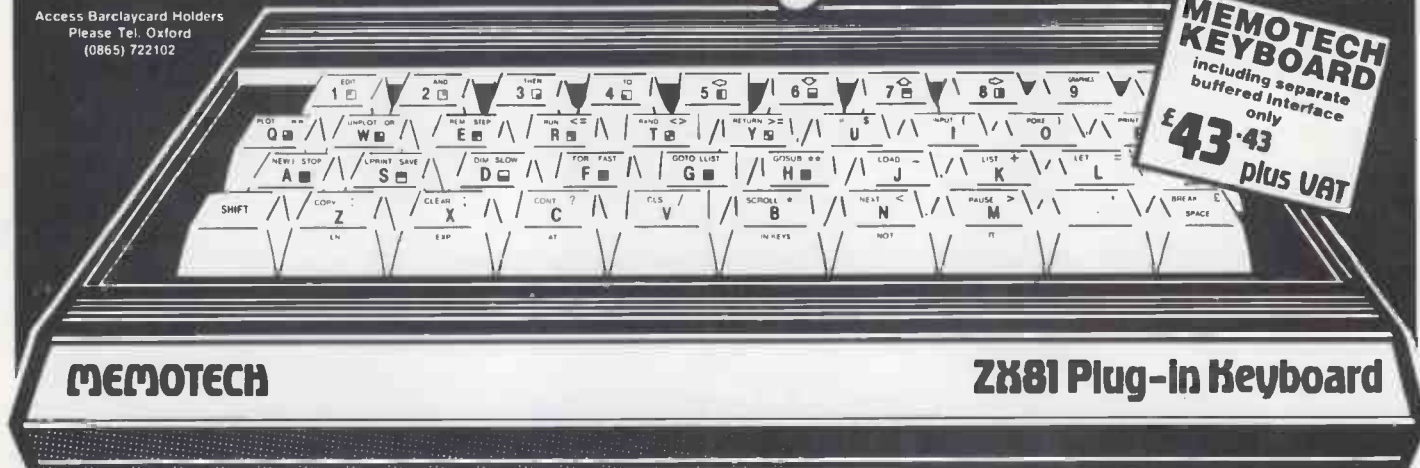

NEW Memotech's Plug-in ZX81 Keyboard

- Plugs directly into the back of your ZX81
- Keys have durable Sinclair legends
- High quality typewriter keys
- Does not inhibit other add-ons
- Automatic hold-down repeat
- Complete with buffered interface
- Fast and easy data entry
- Moveable between configurations

Memotech's Memopak Range

Current Memopaks
16K
32K
64K
HRG
Centronics Interface

MEMOPAK 64K MEMORY EXTENSION
The 64K Memopak extends the memory of the ZX81 by 56K, and with the ZX81 gives 64K, which is neither switched nor paged and is directly addressable. The unit is user transparent and accepts commands such as 10 DIM A(9000).
Breakdown of memory areas...0-8K Sinclair ROM. 8-16K This area can be used to hold machine code for communication between programmes or peripherals. 16-64K A straight 48K for normal Basic use.

MEMOPAK 32K and 16K MEMORY EXTENSIONS
These two packs extend and complete the Memotech RAM range (for the time being!) A notable feature of the 32K pack is that it will run in tandem with the Sinclair 16K memory extension to give 48K RAM total.

MEMOPAK HIGH RES GRAPHICS PACK
HRG Main Features — • Fully programmable Hi-Res (192 x 248 pixels) • Video page is both memory and bit mapped and can be located anywhere in RAM. • Number of Video pages is limited only by RAM size (each takes about 6.2K RAM) • Instant Inverse video on/off gives flashing characters • Video pages can be superimposed • Video page access is similar to Basic plot/unplot commands • Contains 2K EPROM monitor with full range of graphics subroutines controlled by machine code or USR function

MEMOPAK CENTRONICS TYPE PARALLEL PRINTER INTERFACE
Main Features — • Interfaces ZX81 and parallel printers of the Centronics type • Enables use of a range of dot matrix and daisy wheel printers with ZX81 • Compatible with ZX81 Basic, prints from LLIST, LPRINT and COPY • Contains firmware to convert ZX81 characters to ASCII code • Gives lower-case characters from ZX81 inverse character set



Coming Soon...
**RS232
Interface
Digitising
Tablet**

© R. Branton & G.A.C. Boyd 1982

We regret we are as yet unable to accept orders or enquiries concerning the above products, but we'll let you know as soon as they become available.

We want to be sure you are satisfied with your Memopak — so we offer a 14-day money back Guarantee on all our products.
Memotech Limited, 3 Collins Street, Oxford OX4 1XL, England Tel: Oxford (0865) 722102 Telex: 837220 Orchid G

Please make cheques payable to		Please send me		Price	No	Total
Memotech Ltd. Please Debit my Access/Barclaycard* account number _____ *Please delete whichever does not apply		64K RAM	£68.70+£10.30 VAT	£79.00		
		32K RAM	£43.43+£6.52 VAT	£49.95		
		16K RAM	£26.00+£3.90 VAT	£29.90		
		HRG	£52.00+£7.80 VAT	£59.80		
		CENTRONICS I/F	£34.70+£5.20 VAT	£39.90		
		MEMOTECH KEYBOARD	Price £43.43+£6.52 VAT	£49.95		
		Packaging & Postage £2.00 per unit (UK), £3.00 (overseas)				
				TOTAL ENC		
SIGNATURE _____		NAME _____				
ADDRESS _____		DATE _____				

Now Available
at major branches of
WHSMITH

STACK

Computer Services



Microcomputer with 128K Ram,
1-2 Mb S/S Disks including CP/
M 86 MS-DOS Microsoft Basic
86 & Utilities.

Full range of software available including
Pulsar, Supercalc, Micromodeller,
Wordstar etc.

£2395.00



Personal Computer



IBM Personal Computer with 64K
(expandable to 768K) Internal
diskette drives 160K (320K
optional) per diskette. Basic,
Pascal, Cobol, Fortran.

£2850.00

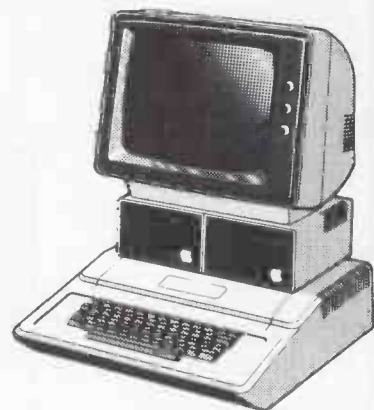

Apple II 48K Processor with twin
170K drives. Full range of Apple
accessories available.

£1252.00



Commodore Business Machines

700 SERIES

4000 Series Pet Range

8000 Series Pet Range

9000 Series Pet Range

Coming Soon!!

CBM 500 Series (256K-896K) at £695

CBM 700 Series (256K-896K) at £995



VIC-20 **CBM 64** and **CBM MAX**

— with full range of peripherals and software.

EPSON

PRINTERS



MX-80T3at £349.00

MX-80FT3at £389.00

MX-82Tat £369.00

MX-82FT3at £409.00

MX-100FT3at £499.00

DP-9501at £1045.00

DP-9500Aat £1150.00

DP-9501Aat £1150.00

DP-9620Aat £1250.00

WP-6000at £1950.00

CONSUMABLES

A full range of **Verbatim** diskettes, paper, printer ribbons etc available P.O.A.

(Trade enquiries welcome. Quantity terms available)

COMING SOON!!

New training premises for courses for the beginner and the expert.

(All prices exclude VAT)

STACK

Sales 051 933 5511

Service 051 933 3355

SPECIAL OFFERS

PETS



CBM 4016 — 16K 12" Screen 40 Col. Computer.
 CBM 4032 — 32K 12" Screen 40 Col. Computer.
 CBM 2031 — 170K Single Drive Floppy Disk.
 CBM 4040 — 340K Twin Floppy Disk Drive.
 CBM 4022 — 80 Col. 65cps Tractor Printer.
 CBM 8032 — 32K 80 Col. 12" Screen Computer.
 CBM 8096 — 96K 80 Col. 12" Screen Computer.
 CBM 8050 — 1 Meg. Twin Floppy Disk Drive.
 CBM 8422 — 22 Meg. Winchester Disk Drive.
 Please phone for latest prices.
 We offer some of the best deals around!

APPLES **apple**

Apple II — 48K Computer.
 Apple III — 128K Computer.
 Video Monitors — Colour and Black & White.
 Disk Drives.
 Silentype Printer.
 All Apple related products available. Please call for prices.

PRINTERS

Epson MX80FT — 80/132 Col. Friction/Tractor.
 Auto Bi-Directional. 9x9 Head True Descenders.
 Ricoh RP1600 — 164 Col. 60cps Daisy Printer.
 Scripta — 17cps Daisy Printer at low prices.
 We will quote for any type or make of printer available.

DEMONSTRATIONS AT YOUR PLACE

We are able to demonstrate complete business systems at your site in our mobile demonstration unit (up to 4 people at a time). Just phone for an appointment anytime.



VIC

VIC20 — Computer. Works with your colour TV.
 VIC1530 — Cassette Unit.
 VIC1540 — Single Floppy Disk Drive.
 VIC1515 — Printer.
 Expansion Memory, Games Cartridges, Programmers' Aids & Tutorials.
 Low price computer. New accessories coming in all the time. Call for latest news and prices.

SOFTWARE

Word-processing Sales Ledger
 Payroll Purchase Ledger
 Incomplete Records Record Keeping
 Book-keeping Financial Packages
 Invoicing Time Recording
 Stock Control Silicon Office



BOOKS

Full range of computer books available from Beginners Guides to Advanced Machine Code Programming.

NEW DRAGON COMPUTER

Nine colours, 32K, full size keyboard, full expansion capabilities £199.50 inc VAT.

SEE THE NEW **SYSTEME**
 Systeime S500

MULTI-USER, MULTI-TASKING 16BIT MICRO. VERY FAST & POWERFUL.



DAVINCI COMPUTER SHOP

65 High Street, Edgware, Middx. HA8 7DD.

Open Mon-Fri 9.00-5.30
 Sat 9.30-5.00

Telephone: 01-952 0526



2'ND HAND

We have a constant changing range of 2'nd hand and ex-demo equipment at considerable savings.

ACCESSORIES

All types of accessories and stationery supplied.

Floppy Disks
 Storage Boxes
 Printer Ribbons
 Tractor Feeds
 Cassettes
 Maintenance

Stationery
 Continuous Labels
 Daisy Wheels
 Auto Sheet Feeders
 Dust Covers
 Installation & Training

BACKUP YOUR WINCHESTER ONTO A FLOPPY

with our CP/M*-based utility program CLIP

- As fast as PIP and simpler to use
- Compresses text or data to less than half size
- Backs up larger files by splitting onto multiple floppies, recreated when copied back

Price £75.00 + vat, post free in U.K.

CP/M Formats include ICL/RAIR, VECTOR, SUPERBRAIN/SIGNET, IMS, XEROX, NORTH STAR/COMART, TELEVIDEO, NEC, Z80-APPLE, OSBORNE, 8" IBM and others.

CLIP is a development of our E40 file compression utility, with many file handling features too. CLIP (Compressed Library Interchange Program) does all that the name implies. It takes care of most of the chores in building an ordered file library, and can make automatic notes of its own operations. For completeness, it handles uncompressed files too, so that the powerful file-handling capacity is available for every task. Use CLIP with all-floppy systems as well. CLIP your files and clip your costs.

*CP/M is a trademark of Digital Research

Write or call for further details



KEELE CODES LTD

University of Keele, Keele, Staffordshire, U.K. Tel: (0782) 629221 Telex: 36113
 24-hour telephone service: Access accepted.



One Expander Card for apple leads to another....

In fact it leads to many others! Joining the amazing success of our PAL Encoder Card, these four new expander cards all featuring the unique 'Digitek Safety Tab' are ready to plug straight into your Apple Computer.

PAL Colour Encoder Card £105 This amazing card with its on-board modulator, displays exceptional colour graphics to your TV.

16k Ramcard £91 Insert the card straight into slot 0, and increase the memory capability of your Apple without having to remove any memory chips.

Z80 Expansion Card £110 Installing the Z80 into your Apple gives you two systems in one, which enables you to run the popular CP/M operating system.

RS232 High Speed Serial Interface £72 The RS232 Interface Card incorporates 13 selectable Baud rates from 75 to 19,200.

Print-master Interface £79 The ultimate parallel interface for Apple to all popular dot matrix printers.

The PRINT-MASTER accepts Apple protocols, 15+ software commands and has on-board graphics dump capability to all popular graphics printers. No need to load clumsy software routines - it's all at your fingertips on the PRINT-MASTER - choice of inverse printing, double size picture, 90° picture rotation, many word processor type text commands, plus many more.

Apple is the trademark of Apple Computers Inc. Digitek and Print-master are the trademarks of Digitek (International) Ltd.



Dealer enquiries welcome

The people who are really into Apples.

DIGITEK

EXPANDER CARD SERIES

Please send me
 Colour Encoder £105
 Ramcard £91 Z80 £110
 RS232 £72 Print-master £79
 Further Information

I enclose my cheque for £
 payable to Digitek International Ltd.
 Add 15% VAT to all prices quoted.
 Post and packaging FREE.
 Telephone orders **0403 66550**

Name.....
 Address.....
 Post Code.....

My card.....
 Number is.....

DIGITEK (INTERNATIONAL) LTD. 37C WEST STREET, HORSHAM, WEST SUSSEX RH12 1PP.

PCW12-82

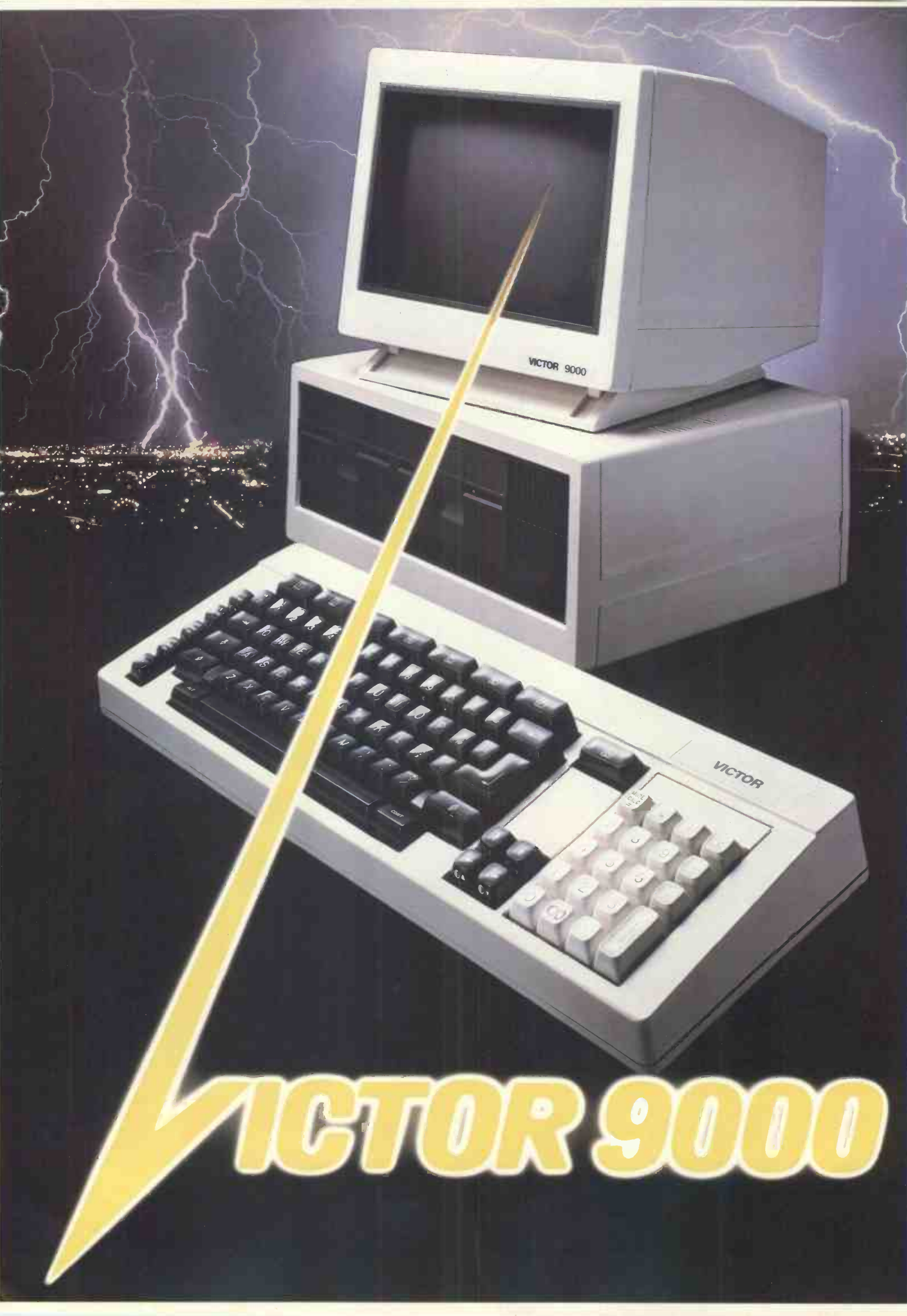

VICTOR 9000

VICTOR

VICTOR 9000

At last here's the real advance; a fully integrated computer that's fast enough, versatile enough and big enough for any business but small enough for a desk. That's the unique Victor 9000.

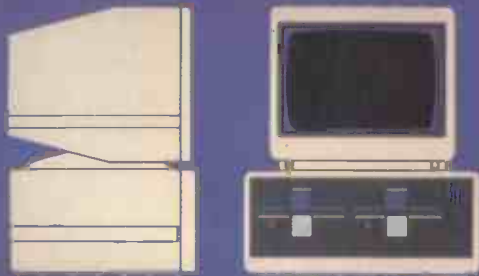

I want to know more about the Victor 9000.
(Clip coupon to letterhead.)

Name _____
Position _____

PCW/12/82

CONQUERING SUCCESS

Designed by Chuck Peddle, the genius behind some of the world's best known microsystems, the Victor 9000 is already a runaway success in the United States and Europe. Now it's in the U.K.

CONQUERING OPERATION

Very simple and made to be operated by non-computer personnel. Menu style step by step procedures and verbal prompts can enable anyone to use the Victor 9000.

CONQUERING PERFORMANCE

All the performance of a minicomputer only at micro size. 16 bit processing starting at 128Kb of RAM expanding up to 896Kb. That means large customer files, instant information, flexibility and integration of functions.



CONQUERING USER SUPPORT

DRG Business Machines, backed by its £600m parent company, are making certain that every Victor 9000 once installed, is fully supported. A nationwide network of the very best distributors means help is never more than a few minutes away.

CONQUERING OBSOLESCENCE

The Victor 9000 is designed to grow. From 1.2Mb to 10Mb. It'll communicate directly with other terminals, even other computers. It will change as your needs change. You'll probably never need to purchase another system.

CONQUERING PRICE

The Victor 9000 starts at around £2395. Or about £12 per week. The performance of a mini-computer at a micro price. There's nothing to beat the Victor 9000. See one in action and you will be conquered too.

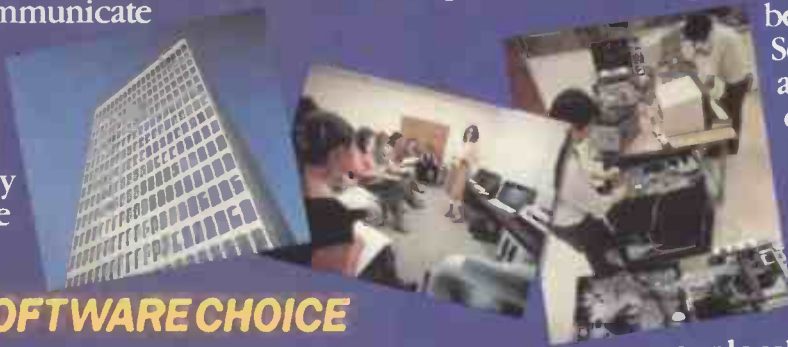

CONQUERING SOFTWARE CHOICE

Four operating systems (two standard) and a wide variety of languages means that the choice and sources of software are almost unlimited – both for business and other purposes. Numerous accounting, specialist and scientific packages are already available including the unique Victorcalc and Victorwriter.

Clip the coupon or telephone (0934) 32525 or 415398 and we'll put you in touch with your local Victor distributor.

DRG
BUSINESS
MACHINES

DRG Business Machines,
Distributors' Division,
Unit 13/14 Lynx Crescent,
Winterstoke Road,
Weston-super-Mare, BS24 9DN.
Tel: 0934 415398 or 32525.

THE ALL CONQUERING BUSINESS SYSTEM.



TI's Home Computer. Unbeatable value. Unrivalled software.

When you choose a TI Home Computer you're choosing a "real" computer. A computer that can grow with you and your family. A computer that lets you play, invent, discover... that lets your imagination soar.

What makes this possible is our wide range of software. You'll find subjects as simple as "Early Reading" and as complex as "TMS 9900 Assembler Editor." Many of our programs are packaged in our unique Solid State Software™ Command Modules. Some have sound. Others have superb colour graphics. Simply plug them in and begin.

When you want to learn to

program for yourself, the TI 99/4A is ready too. TI BASIC is built in. The programming manual is easy to understand, easy to follow every step of the way. You will be amazed

to discover how much fun programming can be.

And when you're ready to expand your system, we're ready too. Our unique Peripheral Expansion System can house up to seven peripherals without extra cables or clutter. There is even a speech synthesiser that gives your computer a voice.

Sound impressive? Try the TI Home Computer for yourself at your nearest dealer. At around £200 you'll look no further.



TEXAS INSTRUMENTS

WHAT THE PROFESSIONALS LOOK FOR IN A HOME COMPUTER

Feature	Texas Instruments TI 99/4A
Microprocessor	TMS 9900 16 BIT
Graphics	16 colour, high resolution
Languages	TI-BASIC (built-in), extended BASIC, UCSD-PASCAL, TI-LOGO, Assembler
Memory	16K RAM standard—expandable to max ROM/RAM of 110K
Keyboard	Full size, standard typewriter style
Software	1000 programs to choose from worldwide
Solid State	Yes
Speech Capability	Yes

VIDEO GENIE and TRS80

THE ROM-VIDEO GENIE & TRS 80 (3 ROM Models)

Are you fed up of loading a lower case drive every time you switch on? — Want your name inside your computer — Better loading (TRS80) — Sick of bouncy keyboards-s!

You need our new ROM—simply remove old—plug in new.

- 1) Firmware driver for lower case
- 2) Security code displays—(your name & post code?)—up to 21 characters
- 3) Improved tape loading
- 4) Alleviates repeating characters (key-bounce)
- 5) Checks for feature ROMS

£14.95 + VAT + P&P (80p)

FEATURE ROMS £18.95 + VAT + P&P (80p)

A series of ROMS starting with FEATURE 'A'

- 1) Single keystroke commands
e.g. Shift A = Auto etc.
- 2) Flashing cursor (can be toggled on/off)
- 3) Repeating characters—with delay—(toggle)

- 4) Machine code monitor and editor
- 5) System load and save for backing up those system Programs —uses no RAM and so can deal with a FULL 16K program

NEW

FEATURE 'B'—extended basic

- 1) Merge—two basic programs to one
- 2) Renumber
- 3) Screen print
- 4) Various basic tools PLUS

Plug on for feature ROMS

Now you can simply plug on the back of your computer, insert ROM and away you go.

VG £29.95 inc. ROM A OR B + VAT + TRS80 £34.50 + VAT + P&P (80p)

48K RAM—internal

TRS80 & VG £43.50 + VAT + P&P (80p)

Plug in our modules. Connect three wires (VG) or five (TRS80). You are not required to piggyback chips. Keep your old RAM (or sell it!). Compatible with expansion.

LOWER CASE HARDWARE (VG & TRS80)

Unplug two IC's, plug in two modules, connect three wires—EASY! £19.00 + VAT + P&P

BOOKS

"Disassembled Handbook for TRS80"—A Self Teach—Series of Books—Written by Bob Richardson of New York. Very well received by U.S. Reviewers, **Essential** Reading for TRS80, Video Genie & Radio Hams.

- Vol. 1 Decoding the ROM & Calls, etc. **£6.45**
Vol. 2 Using Calls, to shorten programs, etc. **£8.75**
Vol. 3 D/A—AD, Spooling, etc. **£10.50**
Vol. 4 Teletype, Morse Techniques **14.50**
Vol. 5 Voice Systems **TBA**

+ Much else in each volume.

Various Books—Lists on application.

+ VG—Expansion—Disk Drives—Printers, etc. Details on application.

EPSON PRINTERS

MX80T Type III

£285 + CARR. + VAT (Cash/Chq. only)

M x 80 FT II

£315 + CARR. + VAT (Cash/Chq. only)

WABASH

5.25 SSSD Floppy Disks

including FREE library case

£16.00 per ten + V.A.T. + 80p P&P



General Northern Microcomputers Ltd.

Unit 8, Whitworth Road, South West Industrial Estate
Peterlee, Co-Durham (0783) 860314



**STEMMOS LTD.
ANNOUNCE**

**THE WORLD'S LEADING AUTOMATIC
PROGRAM GENERATOR**

AUTOCODE I™

Automatic development of dBase II™ program code without any programming

- ★ Automatic Menus and Sub-Menus
- ★ Automatic Data Entry Screens
- ★ Automatic Data Entry Routines
- ★ Automatic Edit/Validation
- ★ String, Numeric, Data and calculated fields
- ★ Automatic Multiple Reports
- ★ Automatic Programs in dBase code with interactive screens
- ★ No prior knowledge of dBase II is needed.

AUTOCODE I £120
dBASE II & AUTOCODE I ... £450
(excluding VAT)

STEMMOS LTD.

World leaders in automatic programming

344 Kensington High Street,
London W14 8NS
Tel. 01 602 6242
Telex 893003 Stemmos G

dBase II™ Ashton-Tate
Autocode I™ Stemmos Ltd.

NAMAL ASSOCIATES

No. 25 GWYDIR STREET, CAMBRIDGE CB1 2LG. UK
Tel. 0223 355404 Telex 817445

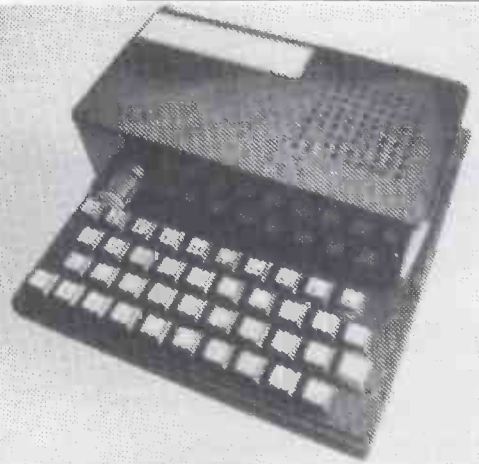

**NAMAL
SUPER
TALKER**
FOR YOUR
COMPUTER

£49.95 ZX81
£59.95 SPECTRUM
£69.95 ANY OTHER
COMPUTER WITH
RS232 INTERFACE

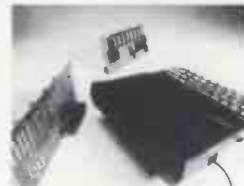

16K MEMORY EXPANSION
for ZX81, £17.00



64K MEMORY EXPANSION PACK
SIMPLY PLUG ONTO YOUR
COMPUTER £59.95

Payments to Namal Associates.
Overseas Orders Welcome. All prices
excluding VAT. Please add £1.00 p & p to
all orders below £15.00. Government
Colleges and Overseas orders welcome.



Transam M

1. GENERAL OFFICE

ATP-80: Redwood Software	£270
Powerful British wordprocessor with exceptional features.	
Cardbox: Caxton Software	£155
A fast, impressive, simple to use card indexing system for computers.	
Datapen: Redwood Software	£150
A database where the forms can be designed using a wordprocessor. The base is used to manipulate data.	
Datastar: Micropro	£175
Excellent package for data entry, retrieval and update for microcomputers.	
Dbase II: Ashton Tate	£395
The most sophisticated database available on micros. Very fast and exceptionally powerful.	
DMS: Comsoft	£400
A fairly sophisticated database designed for the unskilled user. Links simply to Wordstar.	
Documate:	£95
A program for indexing books which have been typed in using Wordstar.	
Fileforce: Brand	£250
A very flexible and powerful British Database with some unique features.	
Indexer: TCL Software	£100
A book indexing program for professional indexers.	
Mail Merge: Micropro	£75
Mailing system and extra facilities for Wordstar.	
Spell: Software Tools Inc.	£45
A powerful proof corrector/spelling program with a virtual dictionary of 40,000. Wordstar can call it.	
Spellbinder: Lexisoft	£275
A powerful and popular wordprocessor, easier to use than Wordstar.	
Spellstar: Micropro	£125
Wordstar's spelling program.	
Wordstar: Micropro	£195
The 'Industry Standard Wordprocessor', includes many powerful text formatting and printing functions.	
Wordstar self instruction disk: MAC	£75
Help at all levels with Wordstar.	

2. BUSINESS AND ACCOUNTING

Purchase Ledger: TABS	£250
Includes Day book, Cashbook, Audit trail, Aged debtors analysis, VAT analysis and Reports. Links to Stock, Nominal and Job Costing.	
Sales Ledger: TABS	£250
Includes Day book, Cashbook, Audit trail, Aged debtors analysis, VAT returns and Reports. Links to Stock and Nominal.	
Nominal Ledger: TABS	£250
For up to 1000 accounts. Day book, analysis, Trial balance, all accounts and subtotals printed. Links to Sales, Purchase, Stock, Payroll and Job costing.	
Payroll: TABS	£250
For up to 1000 employees. Pre tax schemes, payslips, cheques, P45, P11, P60, P35. Analysis. Links to Job costing and Nominal.	
Bill of Materials/Stock: TABS	£250
Parts explosion to 10 levels. Up to 20 char ID for parts. Up	

to 99 parts per level, up to 10000 parts in an assembly. Forecasting Min re-order levels, re-order lead time, batch entry. Integrates with Sales, Purchase, Invoice and Sales Order modules.	
Job Costing: TABS	£250
Stand alone module with Job charging, time sheet input, transfer to/from stock, overhead calculation. Links to Purchase, Stock and Payroll.	
Modeller: TABS	£250
A spreadsheet analysis package which picks up data from your own ledgers.	
Word Processor: TABS	£125
Links to Sales, Purchase ledgers and mailing List.	
Sales Order processing, Management accounts, Invoice Compiler and firmware module: TABS	all £125
Bookkeeper: Mike Lewis	£350
A simple self-contained accounting system. Based on double entry book keeping leading to trial balance. Ideal for company that does not want full computerised ledger accounting.	
Business Software by Peachtree International	
Each Module:	£325
Payroll, Sales, Purchase, General Ledger and Inventory Management.	
Timerec: KSL	£350
Time recording package, originally for accountants. Carries forward transactions from one run to the next.	
Time Recording: Graffcom	£400
Excellent documented package which allows for job cost and analysis reports, update and deletion.	

3. PROFESSIONAL AND SCIENTIFIC

Scientific Subroutines: TCL Software	£495
A major breakthrough in software for micros in engineering and scientific applications. This is a library of Fortran routines which provides the theoretical analyst with a programming capability which embraces statistics, interpretation of functions, solution of systems of linear equations, matrix computation, integration, differentiation, solution of ordinary differential equations, numerical approximation, solution of non linear equations, least square optimisation, Fourier series evaluation and Fast Fourier transform analysis. More like the NAG library than anything else on micros.	
Sam: Software International	£280
A statistics package with all the usual routines, plus facility for handling missing variables	
Calcstar: Micropro	£120
Financial modelling package linked to Wordstar.	
Editroom	£275
Heat loss calculations for architects and engineers.	
Fastplan: Comshare	£395
An easy to use but very sophisticated financial modelling package.	
Microstat: Ecosoft	£180
The statistics package for micros. Powerful statistics plus a Data Management System for further manipulation.	
Microsurvey: Systematica	£1200
Astonishingly powerful package for survey analysis. Editor for cleaning data, checking ranges and logic. Three levels of hierarchy for data structure.	

Mu Simp/Mu Math: Microsoft	£149
Performs sophisticated mathematical functions whilst keeping track of all 611 digits.	
SNAP-Survey Analysis: Mercator	£650
Designed for use by non-computer staff. Includes questionnaire design & printing, data entry validation.	
Statpak: North West Analytical	£295
A statistics package for the analyst to manipulate and handle data in almost every conceivable manner.	
Supercalc: Sorcim	£180
CP/M improved version of Visicalc, the best selling spreadsheet analysis package.	
T/Maker:	£165
Screen-orientated visual calculating tool. Highly sophisticated and well suited to complex applications.	

4. BASIC

TCL DISK BASIC: TCL Software	£55
A compact but powerful 10K interpreter ideal for the beginner because of its ease of use and simple syntax.	
CBasic II: Software Systems	£75
Comprehensive commercially orientated Basic, ideal for business software.	
CB80: Compiler Systems	£315
Compiler for CBasic. Improves Cbasic programs 5 to 10 fold in terms of speed and ability.	
Basic 80: Microsoft	£170
The 'industry standard basic'. A good all purpose Basic with a large vocabulary of statements and functions.	
Basic Compiler: Microsoft	£200
Compiler for Basic 80 which allows run-times which are 3-10 times faster. Allows linking to Fortran and Cobol 80.	
Xbasic: Xitan Systems	£195
A new BASIC with many attractive features: mathematical accuracy, graphics routines for Hi-tech SID1 colour card.	

5. PASCAL

TCL Pascal CP/M: TCL Software	£120
This is a powerful, general purpose language suited both to beginners and experienced users. Ideal teaching tool.	
TCL Pascal Pet: TCL Software	£120
Specially designed for Commodore UK. Versions for 3032, 4032 and 8032 Pets.	

6. OTHER LANGUAGES

C-Compiler: BD Software	£75
This is a powerful, fast, compact, modular implementation and subset of Unix C.	
C-Compiler: Whitesmiths	£470
The ultimate in system software tools. Compiler output in A-Natural source. Supplied with A-Natural.	
C/80: Software Toolworks	£50
New 2.0 release includes full C structures, pointers and arrays all storage classes and data initialisation. One pass. C library.	
CIS Cobol: Microfocus	£425
Two versions available, compact and standard, both based on the ANSI 74 COBOL.	
Cobol 80: Microsoft	£145
Microsoft version of Cobol with relocatable object code.	

CP/M Systems

THE TUSCAN DESK TOP MICROCOMPUTER

"Designed and manufactured in Britain. Built to a high standard, with a proven track record."

SYSTEM CONFIGURATION AND PRICE LIST

All systems are 60K, 80 x 24 display & include CP/M 2.2

DISK BASED

Disk size/Capacity	formatted per Drive	Single Drive	Double Drive
5 1/4 SS/DD	190K	£1544	£1699
5 1/4 DS/DD	380K	£1674	£1959
5 1/4 80T/DD	790K	£1784	£2179
8 SS/DD	450K	£2180	£2605
8 DS/DD	900K	£2310	£2875

WINCHESTER BASED 5 1/4 Mini Winchester & Floppy

3.14 Meg & 5 1/4 80T/DS Drive Back-Up	£3234
6.28 Meg & 5 1/4 80T/DS Drive Back-Up	£3479
12.56 Meg & 5 1/4 80T/DS Drive Back-Up	£3870

Contact us for more information

MICROCOMPUTER PERIPHERALS

We stock a comprehensive range of:

Printers	Video terminals
Video monitors	Disc drives
Stationery	Cables
Connectors	Plotters
Modems	I/O Cards
Memory boards	Discs
Spares	Ribbons
Winchesters	S100 Cards

59/61 Theobald's Road London WC1X 8SF.

crosystems

Comal: Metanic	£145	11. DEVELOPMENT AND UTILITY PROGRAMS	Sid: Digital Research	£55	
A good microcomputer version of this popular language.			8080 Symbolic Instruction Debugger which expands upon the features of the CP/M standard debugger.		
Forth: Laboratory Microsystems	£45/£100	Archive: de Galle	£100	Zsid: Digital Research	£65
A good version of Forth for CP/M machines. Two versions available, interger and floating point.		Compresses files to less than half size for compact disk storage.		Symbolic debugger for Z80 Instructions, with Z80 mnemonics.	
Fortran 80: Microsoft	£220	Compress: Mike Lewis	£29	Z80 Development Package: SD Systems	£55
Microsoft Fortran is comparable to large mainframe packages. Complies with ANSI stand FORTRAN X3.9-1966.		A package to compress Microsoft Basic 80 code. Makes it more compact on disk and reduces run-time.		Assembler plus editor. Produces rel code.	
Fortran: Supersoft	£180	Crash Patch: Elektrokonsult	£70		
Has Complex variable.		Powerful set of CP/M utilities. Includes Ddump and Dtest, Unera (unerase) and Ddup.		12. MISCELLANEOUS SOFTWARE	
Lisp 80: Software Toolworks	£42	UVMAC-Z80: Software Toolworks	£40	CP/M User Group:	
Lisp interpreter, offers over 75 built in functions including trace, file I/O and string operations.		Absolute macro Assembler for Z80.		A range of public domain software, available from TCL Software for disk and copy charge.	
Mu-Lisp:	£119	Text: Software Toolworks	£40	Time Tabling: K. Johnson	£40
Microcomputer implementation of Lisp programming language suitable for artificial intelligence applications.		Takes the output from a cheap editor and gives it the appearance of having passed through an expensive word processor.		Set of programs and a book to perform school timetabling.	
7. EDITORS		Despool:	£50	Typing Tutor: TCL Software	£35
		A utility program to permit simultaneous printing from text files while executing other programs.		Interactive tutor which uses the calculating power of the computer to assess and set exercises.	
Edit 80: Microsoft	£69	Diagnostics II: Supersoft	£65	Authoring: TCL Software	£30
Very fast random access text editor. An ideal product to use as a programming tool.		Utility for disk testing. Routines to check the VDU, printer, disk drives CPU and memory.		A small package designed to help non-programmers to write computer-aided programs.	
Text: Digital Research	£55	Disilog:	£55	Estate Agents: Mike Lewis Consultants	£800
Text formatter to create paginated, page numbered and justified copy from source text files.		Disk based disassembler.		Match and Mail for Estate agents.	
Wordmaster: Micropro	£75	Disk Doctor: Supersoft	£65	NEW PRODUCTS	
Comprehensive screen based text editor for programmers. Has superset of CP/M's ED commands, also similar to Wordstar.		A popular utility for disk repair.		Plink II: Phoenix Software	£195
8. APPLICATION TOOLS		DDump: Elektrokonsult	£35	Two pass link editor which supports arbitrarily complex overlay structures.	
		Dumps file and then reviews by track, sector or block. Possibly the best ever disk editing routine.		PL/1 80:	£325
Pearl III:	£295	Dtest: Elektrokonsult	£35	Application Programming language based on ANSI subset of the full PL/1.	
Produces application programs by allowing user to "converse" with the computer. Early program generator.		Tests and locks out corrupt areas on disk.		Pmate: Phoenix Software	£100
Qsort: Structured Systems	£89	Macro 80: Microsoft	£110	Full screen text editor with some unique features. Easy to learn and easy to use.	
Fast sort/merge for files with fixed record length.		8080/Z80 Macro Assembler, Relocatable, linkable output.		XASM-**: Avocet Systems Inc.	£115
Supersort: Micropro	£125	Forms II: Microfocus	£100	A cross assembler for 8080 and Z80 based micros which generates machine code for the Intel 8048 processor.	
Best commercial sort for fixed & variable length records merges data from several files, multiple keys etc.		IBM/CPM:	£135	XSM 8048	£130
9. OPERATING SYSTEMS		Allows the transfer of data between IBM and CP/M systems.		Accepts source code for 8048 and generates object code for 8048 to allow CP/M micros to be used as development tools.	
		Lynx: Avtek	£250	Ada: RR Software	£350
CP/M 2.2 Tuscan Version: Digital Research	£95	An overlay linker for creating executable programs from the rel files of Microsoft products. Best Fortran overlay.		A subset of the Ada programming language developed by the US Department of Defence.	
A version of this general-purpose operating system available fully configured for Tuscan users.		Mac: Digital Research	£73	Ada: Supersoft	£185
10. COMMUNICATIONS		8080 Macro assembler, with full Intel macro definitions.		Supersofts version of this highly structural language which is a direct descendent of Pascal.	
		RMAC: Digital Research	£120	Keele Codes (E40): Keele Codes Ltd	£100
Bisync-80:	£445	Utility for CB80.		A program which compresses files on disk by 40-50%, thus increasing disk space.	
Synchronous communications with any CPU or device that provides IBM support. Error checking.		Ratfor:	£42.50	Magic Wand: Peachtree	£250
BSTMS:	£125	A preprocessor for Fortran.		A popular, easy to use and highly sophisticated Word Processing package based around single stroke control keys.	
Intelligent terminal program for CP/M systems. Emulates a TTY when hooked up to a host computer.		Reformatter:	£140	Translators for 16 Bit Processors.	
BSTAM:	£125	Allows the transfer of data between CP/M and IBM and CP/M to DEC.		XLT-86	£90
Utility that permits two CP/M micros to communicate by RS232 or modem and telephone line.		Reclaim:	£50	Accepts 8 bit source code and translates it to source code for 8048.	
TTY: Systematica	£180	Helps to prevent loss of valuable data because of defective disk surfaces.		Trans-86	POA
A synchronous communication to other computers. Micro is an intelligent terminal, plus ability to download files.		Restore, Spool, Unspool, Qsub: FBN Software	£45	Similar to XLT-86 but for different machines.	
		A set of utilities with functions indicated by the names.		Act-86	POA
		Smartkey: FBN Software	£45		
		A package that can be used to redefine keys on the keyboard to represent one or a sequence of keys.			
		Smartprint: FBN Software	£45		
		The same as Smartkey but for the printer.			
		Supervyz: Epic Software	£65		
		A package for creating menu driven options, with messages and prompts, to help with CP/M and other software.			

& Software

MULTI-USER SYSTEMS

Our TS100 Series Card Cage system with CP/M or MP/M with up to four users – choice of video terminals and software compatible with TUSCAN. 5" or 8" drives or also available with Winchester. Contact our Sales Department for further details. Prices from £2302.

LONDON'S PORTABLE MICRO CENTRE

A complete range of portable microcomputers

- | | |
|--------------|----------------------|
| Epson HX20 | Hewlett Packard HP75 |
| Sharp PC1500 | Teleram T3000 |
| Newbrain | Kaypro II |
| Osborne 1 | Brother EP20 |

Send for further information or visit our Showroom.

Tel: 01-405 5240/2113

STAR RAIDERS™

NEW GAME. PRIVATE PROPERTY.

'Star Raiders' is the latest of Atari's video games to become available.

Since it is an ATARI® game we have exclusive rights to exercise all copyrights and other rights connected with 'Star Raiders.'

We lead the field in the development of video games. And it's due to our considerable investment of time and resources that our games have become so popular. And due also, of course, to the people who have enjoyed the games.

Unfortunately, however, some companies and individuals have been copying ATARI games, gaining profits at Atari's expense.

We must protect our investment so we can carry on investing in the development of new and better games.

So consider this a warning both to intentional pirates and to individuals unaware of the copyright laws.

Any manufacture, sale or other dealings in games which reproduce any of the copyrights in 'Star Raiders,' or any unlawful use of the name 'Star Raiders' (or imitation of it) is an infringement of Atari's rights.

Atari will protect these rights with vigorous action against all infringers. Regardless of what computer or other apparatus is used in playing infringing games.

We would also appreciate the co-operation of legitimate software developers in the protection of our property.

And if you happen to be selling a software product which performs a game similar to 'Star Raiders' (or any other ATARI game) please contact us immediately.

Write to the attention of: Graham Daubney, Atari International (UK) Inc., 185 Ealing Road, Alperton, Wembley, Middlesex.

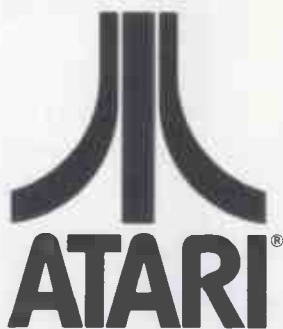

© A Warner Communications Company

© 1982 ATARI INC. ALL RIGHTS RESERVED. ® TM INDICATE TRADEMARKS OF ATARI INC.

ACT

pulsar

INDUSTRY-STANDARD 16-BIT BUSINESS SOFTWARE.

The new PULSAR business software is 16-bit software specially developed for new generation 16-bit personal computers.

It's inherently faster and more powerful than traditional 8-bit software.

The result: More and more business users are choosing PULSAR, making it one of the industry standards on 16-bit personal computers.

Only PULSAR meets the five key requirements for 16-bit business software:

PORTABILITY

PULSAR is primarily written in the BASIC portable language. So your investment in software is protected, regardless of how often you change your system.

PEDIGREE

PULSAR has been developed by ACT's own software engineers as a true 16-bit system. And ACT has more than 15 years experience in business software — computer bureaux using ACT programs produce more than 3 million statements every year and handle business applications

for more than 2000 companies. PULSAR incorporates many facilities that were previously available only on large mainframe computers.

INTEGRATION

ACT supplies integrated business software, linking every aspect of business accounting. Now with PULSAR, this integration is taken a stage further with word processing and business management tools able to share information and files with accounting applications.

USER-FRIENDLY

PULSAR is really easy to use. Documentation is to the highest standards in the industry, taking the operator step by step through the system. A simple question and answer routine on the computer screen prompts the user at every turn.

TOTAL SUPPORT

ACT is used to providing on-going support for its users. Not only is there a "hot-line" to resolve queries, but also a fully equipped training school open to all PULSAR users.

THE PULSAR RANGE...

PULSAR ACCOUNTING

- Pulsar Sales Ledger
- Pulsar Purchase Ledger
- Pulsar Nominal Ledger
- Pulsar Payroll

PULSAR ORDER PROCESSING

- Pulsar Stock Control
- Pulsar Invoicing
- Pulsar Order Handling



PULSAR FINANCIAL MANAGEMENT

- Pulsar Data Analysis
- Pulsar MicroModeller
- Pulsar SuperCalc
- Pulsar MultiPlan

PULSAR OFFICE SYSTEMS

- Pulsar WordStar (word processing)
- Pulsar Mailmerge (mailing)
- Pulsar Select (word processing)

pulsar

16 BIT - SOFTWARE
FOR 16 BIT
PERSONAL COMPUTERS

The ACT octagon encapsulates our philosophy of providing users with a single source for their computing solutions. ACT products include personal computers — network micro-computer systems — turnkey mini computers and a total range of services, including software development, computer field engineering, computer supplies, and a complete range of Bureau services.

The eight specialist ACT companies are each leaders in their field and are wholly owned by Applied Computer Techniques (Holdings) p.l.c., one of Britain's largest and most successful computer companies.

For more information on 16-bit Pulsar Software complete the coupon and post to ACT (Microsoft) Ltd., FREEPOST, Birmingham B16 8BR or phone 021-454 8585

I'm buying a 16-bit personal computer. Tell me more about the new 16-bit PULSAR software.

Name: _____

Position: _____

Company: _____

Address: _____

Telephone: _____

Application: _____





THE 16-BIT PERSONAL COMPUTER

The ACT Sirius 1 is more than the UK's best-selling 16-bit personal computer. It is the only one with such a large choice of 16-bit software — business and scientific programs specially developed to take advantage of the high speed 16-bit Intel 8088 microprocessor at the heart of every Sirius.

Combine this faster and more powerful software with the advanced specifications of the Sirius 1 and you can see why more and more business users are choosing Sirius.

Because Sirius users have both the latest microcomputer technology and the powerful 16-bit software that takes full advantage of it.

Ergonomics plays a vital part in the design of ACT's Sirius 1. The screen tilts and swivels to suit the user and glare is eliminated.

The display is razor sharp, and the brilliance and contrast can be adjusted using keys on the low profile detachable keyboard.

UP TO 896 KBYTES RAM

128 Kbytes of RAM memory as standard easily upgraded to a massive 896 Kbytes ensures plenty of capacity for fully fledged business software and associated record files.

Within the basic system is 1.2 Mbytes of floppy disk storage, with 2.4 Mbytes double sided disks available as an option. More than any other comparable personal computer.

As a result, the Sirius is suitable from the start for large record processing applications. And with 5 and 10 Mbyte Winchester disk drives scheduled for early introduction, the Sirius can easily match your own organisation's growth.

SOFTWARE THAT TALKS BACK

And built into every Sirius is a revolutionary new concept: An audio decoder that can play back verbal messages and prompts under program instruction to assist the non-computer people to get acquainted with the software more quickly.

NEW 16-BIT SOFTWARE

All the big names in applications software are on the Sirius: ACT's Pulsar for accounting, WordStar for word processing, MicroModeller for financial modelling and SuperCalc the "spread sheet" program.

Plus the exciting SELECT, the only word processor that teaches you how to use it in less than 90 minutes.

And more than 100 top software companies are currently developing specialist software for every business and profession from the motor trade to solicitors.



The ACT octagon encapsulates our philosophy of providing users with a single source for their computing solutions.

ACT products include personal computers — network micro-computer systems — turnkey mini computers and a total range of services, including software development, computer field engineering, computer supplies, and a complete range of Bureau services.

The eight specialist ACT companies are each leaders in their field and are wholly owned by Applied Computer Techniques (Holdings) p.l.c., one of Britain's largest and most successful computer companies.



ACT Sirius 1

PERSONAL COMPUTER

Price £2,395



MORE LANGUAGES

The Sirius has more available programming languages than any newly-introduced personal computer. MicroSoft's BASIC 86, interpretative or compiled, CBASIC, a choice of several versions of COBOL, three different PASCAL's and a full scale FORTRAN.

The benefits? Programmers and software houses are making the Sirius their first choice computer for business software development.

Unlike other personal computers, the ACT Sirius 1 is delivered with the two industry standard operating systems at 16-bit level — MS-DOS and CP/M-86. Once again a guarantee now of the widest choice of off-the-shelf 16-bit software.

And further operating systems are under development. The much vaunted UNIX and a new system to support a low cost local area network.

COMMUNICATIONS

The Sirius is the ideal communications system, with two independent RS232 communications ports in addition to parallel and IEEE 488 ports. Available NOW are all the facilities required to communicate directly with large, mainframe computers.

Further backing is available by way of a dedicated Sirius Training Centre, run by ACT and open to all.

To support the product ACT has a truly professional network of systems dealers, hand picked for its knowledge of the business environment, enabling top quality support to always be close at hand.

ACT SIRIUS 1 — THE COMPLETE 16-bit personal computer.

To know more about the 16-bit ACT Sirius 1 and its exciting range of 16-bit software, clip the coupon and return it to: —

ACT (Sirius) Ltd.,

FREEPOST,
Halesowen, West Midlands,
B63 1BR.

Or call for details now on

021-501 2284

Price excludes VAT.

I need to
know more about
the ACT Sirius 1 and the new
16-bit Software.

Name: _____

Position: _____

Company: _____

Address: _____

Telephone: _____

I may qualify for a dealership.
Please send a dealer
application pack

PCW/12/82

VIC-20 and Commodore 64 from Adda

VIC20

£144.95

inc VAT – carriage free

Still unbeatable value at this price with a full size keyboard
Backed by Adda's full one year warranty.

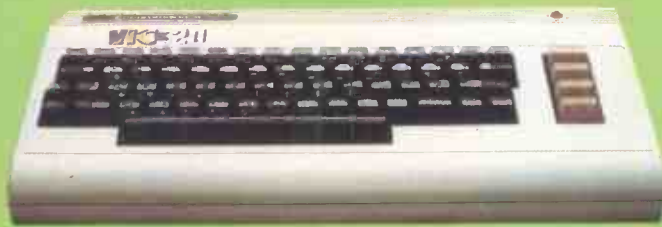

Features include: * 5K RAM expandable up to 29K * 8 border colours, 16 screen colours * 8 screen character colours * 3 audible tone generators, each of 3 octaves * a 'white noise' generator * 88 character program line length * 64 ASCII character set * full PET-type graphics character set generated directly from keyboard * 176 x 158 pixels (27,808 in total) maximum resolution * 8 programmable special functions accessed via 4 special function keys.



COMMODORE 64

£343.85

inc VAT – carriage free

The 64K personal computer that outpaces the rest
Backed by Adda's full one year warranty.

Features include: * 64K built in RAM * 40 column colour display – tv interface * Upper and lower case characters and graphics * Sprite graphics on eight levels * Music synthesiser with three voices and nine octave range * 16 colours available simultaneously * 8 bit parallel user port.

PRINTER

£230

inc VAT – carriage free

The VIC Printer – suitable for the Commodore 64 also – will print programs, letters, business data and graphics. It offers high specifications at a competitive price.

Features include: 80 characters per line. Tractor feed dot matrix. 30 characters per second print speed. Full alphanumerics and graphic printing. Double-size character capability. Price includes all cables. Alternative printer GP100VC with full-size paper feed **£270.25 inc VAT.**



DISK UNIT 1541

£299.95

inc VAT – carriage free

For the VIC-20 and the Commodore 64. A disk unit transforms your computer into a high-speed system ideal for the more serious programmer or small businessman. It enables you to get the best out of your utility programs.



Features include: 170K bytes capacity. Uses soft-sectored standard 5¼" single density floppy disks. Direct interface to computer. Direct compatibility with Printer. Price includes all cables.

MEMORY PACKS FOR THE VIC-20
Special plug-in cartridges are available to expand VIC's memory. 3K, 8K and 16K RAM packs plug directly into computer.
16K RAM Memory Pack **£74.95**,
8K RAM Memory Pack **£44.95**,
3K RAM Memory Pack **£29.95**



How to order
By mail
postage and packing free
send order with
cheque or P.O. to
Adda Computers, FREEPOST,
London W13 9BR no stamp needed

adda

Telephone orders 24 hour service telephone

01-200 0200

with Access/Barclaycard number

FOUR NEW VIC ADD-ONS FROM ADDA

1. Light up with VicRel. VicRel is a control relay that plugs straight into the Vic user port to give simple, programmable switching of electrical apparatus in the home, office or factory. Its six relay outputs can control door locks, lamps, valves, tools, ventilators. And two inputs allow the Vic to read signals from external sources such as thermostats, push buttons or light activated switches. VicRel eliminates black boxes full of wires and represents one of the most exciting, value-for-money, firmware additions to any Vic computer system.



£28.95 INC VAT

2. Plot away with VicGraf. This cartridge allows you to explore the complicated equations and functions of graphs. The menu screen, activated by the Vic's special function keys, will automatically plot a graph, define new functions, calculate accurate values of an intersection, find the maxima and minima of a function. Simple editing allows you to check current functions and to change them. A necessary and attractive addition to any educational situation where graphs need to be explored.

£28.95 INC VAT

3. Crunch & Display with VicStat. A plug in cartridge that undertakes statistical calculations—such as Meanvalues, Standard deviations and Variances—and displays using single commands. Other one word commands allow you to draw vertical and horizontal bar charts,

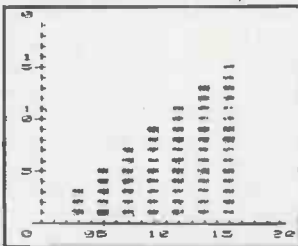

to plot graphs, and to specify the scales and the colours used by these commands. It will also sort numeric and character strings. Finally, all or part of screen displays can be copied to the Vic Printer.

VicStat comes complete with a detailed operating guide.

£28.95 INC VAT

FORTH The VicForth plug-in cartridge, complete with 3K of additional memory, takes programming into new dimensions. As both an operating system and program development aid VicForth can speed up program writing and speed of operation. VicForth is based on fig-Forth and is almost identical to Pet Forth. It does however support the Vic cassette deck—an unusual feature. For those who do much programming a Vic Disk unit is suggested. VicForth provides several hundred one-word commands—listed in the detailed user guide—that can be added to.

£38.95 INC VAT

ADDA COMPUTERS

Contact your local dealer for these VIC products from Adda.

In case of difficulty—or to see demonstrations—call the VIC Centre
154 Victoria Road, London W3. 01-992 9904.

adda

AQUA

COMPUTING LIMITED

dBASE II is the USA's leading data base package, which AQUA can offer at the special price (ex. VAT) of £375.00 while current stocks last. In addition we offer a complete supporting programming service. Get your copy of dBASE II today!

INTRODUCTORY
OFFER

£375
(excl VAT)

dBASE II

dBASE II is a registered trade mark of Ashton Tate.

We supply the latest release inclusive of a 300+ page comprehensive manual and ZIP—the dBASE II screen and print out FORM WRITER. Available for all popular Z80 (* Z80 card required) micros. On 5.25" diskettes for all machines including:

Apple II (*)
Televideo
Superbrain
Sirius I (*)
Xerox 820/822

Osborne I
North Star
Sanyo
IBM PC (*)
Galaxy

Also on SD 8" diskette (IBM format)

dBASE PACKAGES

Support packages customised to your requirements can be provided for the following applications:

- | | |
|-------------------------|------------------------|
| 1 Automatic Invoicing | 6 Stock Control |
| 2 Information Retrieval | 7 Exhibition Enquiry |
| 3 Personnel Records | 8 Mailing List |
| 4 Job Costing | 9 Production Budgeting |
| 5 Equipment Register | 10 File Indexing |

Information sheets are available on these applications. Indicate your area(s) of interest on the coupon below.

FREE - SAVE - £30

With every dBASE II purchased from AQUA before 31.12.82, we are also providing—FREE—a copy of our program—DBFLIST.COM—The easy way of keeping track of all your dBASE II files.

The total cost inclusive of VAT & p & P is £431.25.

<input type="checkbox"/>	<input type="checkbox"/>	<input type="checkbox"/>	<input type="checkbox"/>	<input type="checkbox"/>	<input type="checkbox"/>	<input type="checkbox"/>	<input type="checkbox"/>	<input type="checkbox"/>	<input type="checkbox"/>	<input type="checkbox"/>	<input type="checkbox"/>
--------------------------	--------------------------	--------------------------	--------------------------	--------------------------	--------------------------	--------------------------	--------------------------	--------------------------	--------------------------	--------------------------	--------------------------

* Please debit my Barclaycard/Access account with
I enclose Cheque/P.O. for

* delete as appropriate

£

Name:

Address:

Machine: Sheets:

Send to AQUA Computing Ltd, 10 Barley Mow Passage
London W4 4PH (01-994 6477)

(PCW17)

Why not spend Christmas with the Genie Family!



Our ingenious range of small computers, accessories and software make ideal gifts for 1st time buyers or committed hobbyists!



Genie I

Tried and trusted! - The Genie I is still one of Britain's best-selling small computers, with over 14,000 sold, and it's easy to see why! Software compatibility with Level 2 BASIC means there are literally 1000's of programs on the market ready to run on the Genie, including educational, leisure and small business applications. It's easy to expand, with a vast range of accessories to perform many functions - you only have to read this ad!

Genie I is the ideal computer for the first time buyer, to use at home, at school or at work. The simple BASIC language enables you to write your own programs with ease, and the Microsoft Extended BASIC offers many powerful extra features.

So, if you are not lucky enough to own a Genie I, or if you have a less powerful small computer and want to upgrade, go along to your local Genie dealer, or phone us for advice. It could be your first step into the enthralling world of microcomputers.



Genie II

Equally popular and totally reliable! - The Genie II is a breakthrough for small business computers. Harnessing all the advantages of the Genie I, including its low price, Genie II adapts perfectly to commercial functions with the addition of the following features:

★Numeric Keyboard ★Specific Business Commands ★Four User-Definable Function Keys ★Expandable via the same Genie peripherals ★Extension to BASIC.

Genie II is an ideal, first-entry, computer for the small business. Corner shops, professional practices and small manufacturers can all benefit from a Genie II business system. For further advice, see your local dealer, or contact us direct!

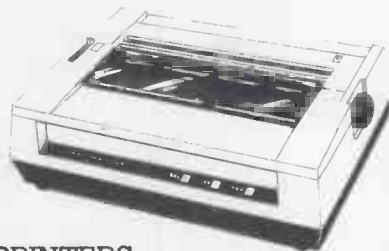

PRINTERS

The EG 3085 is quiet, fast and efficient. Printspeed is 100 characters per second and printing is bi-directional at 80 or 136 characters per line. Suitable for use with other systems, it has three typesstyles, adjustable pin or friction feed and single sheet or roll paper facilities. **£425 plus VAT.**

If you don't want to pay that much for a printer, consider the EG 603. It doesn't match the EG 3085 in certain areas, but you will still get 100 c.p.s. bi-directional, a range of character styles, forward and reverse feed and pin/friction feed, with 96 characters and 64 graphic patterns. **£235 plus VAT.**



BROTHER HR-1 Daisywheel Printer

You can now buy a superior daisywheel printer for a price only previously associated with dot matrix models.

The Brother HR is an enticing addition to your system. It has a print speed of 16 cps, range of 8 typefaces, and a choice of two models with either parallel or RS232 interfaces.

Reliability, durability and attractive appearance make the Brother HR-1 probably the best printer buy this Christmas!

£650 - VAT

EQUIPMENT COVERS

Beat the dirt, coffee spills and sticky fingers when your computer and monitor are not in use with these top quality black leather covers.

Genie CV1 **£5 plus VAT.**
12" monitors CV6 **£6.20 plus VAT.**
9" monitors CV3 **£4.20 plus VAT.**

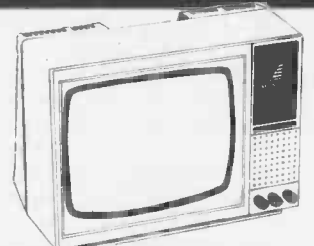

GENIE MONITORS

Two good performance, low priced 12" monitors, either to match your Genie or compatible with a wide range of other systems. Good resolution and band width and, of course, they free your television set for the other type of programmes you like to watch!

The EG 100 12" in black & white costs **£69 plus VAT.**

The EG 101 12" with green phosphor is **£79 plus VAT.**

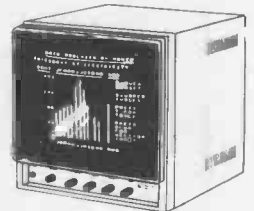

A.V.T. MONITORS

Available in 9" and 12" sizes, with white, green or amber display, Lowe A.V.T. monitors are sturdy, attractive, easy to operate and feature an easy view screen with smoked anti-glare display filter. Compatible with most popular micros on the market. From **£75 plus VAT.**

HIGH RESOLUTION GRAPHICS

Increase graphic resolution capabilities on your Genie seventy-three fold with the LE18 HI-RES unit. It offers bit image graphics of 73,728 points, a resolution of 384 x 192, and uses a separate 16K of video memory to achieve its resolution. Graphics are intermixable with text or existing pixel graphics, and animation, reverse video displays and use of programmable graphic characters are possible. **£86 plus VAT.**

TECHNICAL MANUALS

Full technical details of Genie Hardware (all you ever wanted to know about Genie).

Genie I/II Technical Manual **£10 - No VAT.**
Expander and accessories (EG3014) **£10 - No VAT.**

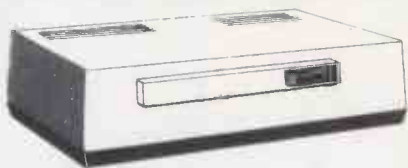

EXPANDER BOX

The updated EG 3014 expander box allows for up to four disk drives with optional double density. It connects to a printer, or RS 232 interface, or S100 cards. Not bad value at **£190 plus VAT (16K version)** or **£200 plus VAT (32K version)**

*The EG 3014 will work with TRS 80 by using the EG 3023 Tandy Adaptor.

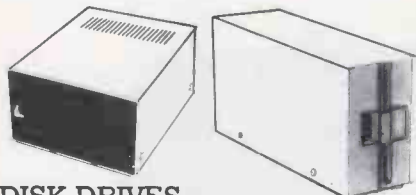

DISK DRIVES

If you want fast, reliable program storage, true random access file handling and access to many computer languages, we can meet your needs. The EG 400T provides storage of up to 184320 bytes per floppy disk and comes complete and tested, in a stylish colour matched cabinet. **£220 plus VAT.**

The EG 401 AT offers dual disk drive with 368640 bytes of useable storage and comes complete with a power supply ready to connect to an expander box. **£365 plus VAT.**

DOUBLE DENSITY ADAPTOR

Allows the use of standard minidisk drives in double density, with virtually double the storage capacity. The EG 3021 is equally at home in the Genie or TRS-80 expander boxes.

A double density disk operating system will be needed, such as smallDOS provides. **£72 plus VAT.**

smallDOS

Powerful, yet reasonably priced, the Genie smallDOS contains 21 library commands, 7 utilities, LBASIC, disk basic and bags of information, including a reference manual and 40 page beginners guide to disk usage. **£35 plus VAT.**

BUSINESS SOFTWARE

Specifically written for the Genie II computer, with disks and a suite of packages from the renowned house TRIDATA. The suite includes SALES LEDGER, PURCHASE LEDGER, PAYROLL and STOCK CONTROL. Each package is a very reasonable **£175 plus VAT.** Full details on request.

LOWE electronics

Chesterfield Rd., Matlock,
Derbyshire DE4 5LE.

Tel: 0629 4995 Telex: 377482 Lowlec G

EG 3203 TANDY-BASHER

If you are a TANDY user, read on! The EG 3203 is bus converted to allow Genie peripherals to be used with Tandy Model I computers. **£18.40 plus VAT.** (Just in case there might be a few strange souls who want to convert in the opposite direction, there is the 50/40 converter which generates a Tandy compatible 40 way bus from a Genie.) **£34 plus VAT.**

FRED MUSIC SYNTHESISER

Beethoven might well roll over at this stereo music synthesiser, it can produce six simultaneous notes over the whole audio range and provide sound effects. FRED comes complete with a software compiler, full instructions and a demo tune. It is simply plugged onto the Genie 50 way bus and has two outputs for an audio amplifier. **£51 plus VAT.**

EG 3016 PARALLEL PRINTER INTERFACE

The EG 3016 is a simpler interface allowing a Centronics parallel compatible printer (EG 603, EG 3085) to be connected directly to the Genie keyboard without the need for an expander box. **£38 plus VAT.**

BUS EXTENDER

A most useful accessory, allows two bus using devices to be connected simultaneously to the Genie - when using the Hi Res and expander for instance. **£21 plus VAT.**

EP1, EP3

Genie I and Genie II have ROMS offering 13.5K BASIC are custom written extensions contained in EPROMs. You can change these as follows:

EP1 Adds all Genie I software facilities to other Genies, lower case driver, machine language monitor, renumber facility, keyboard repeat and screen print.

EP3 Has HI-RES driver software with 10 extra HI-RES commands which prevent need to load HI-RES software from tape. All at **£12 plus VAT.** For Video Genie Systems, the LE-19 connects direct to the Genie bus and allows one of these EPROMs to be fitted externally. **£26.50 plus VAT.**

SYSTEMS DESK

Even a compact modular computer system like the Genie benefits from being used on a custom designed system desk. The SD1 system desk is designed to accommodate a complete Genie System and has a special upper shelf to support the display monitor at the best level. The desk is flat packed for easy delivery and finished in attractive teak and charcoal colours. **£81.40 plus VAT.**

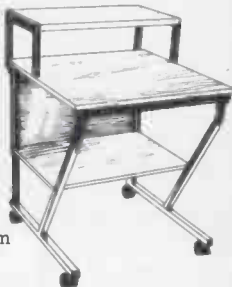

SPECIAL TECHNICAL GENIE

HOT - LINE ON 0629 4995

for all your technical advice and service back up on any aspect of the Genie system direct from the experts!

Please send me details of my nearest Genie dealer OR The following items:



ONLY £199
inc VAT

Colour Genie is the latest piece of personal computer magic from Lowe Electronics. Remarkably compact in design, Colour Genie is a powerful piece of new technology which combines all the best features of the popular Genie I; 16K RAM, 16K BASIC ROM, and full size typewriter keyboard, with the addition of vivid colour, high resolution graphics, 3 channel sound and 40 x 24 screen format - a new dimension in home computing!

Put one in your living room, connect it to a standard colour T.V., and you will be amazed at the worlds that open up for you and your family!

For children and adults, Colour Genie provides an ideal introduction to computer programming. If you fancy a spot of intergalactic travel, or a battle for the planets, Genie will lay on the transport. When you get tired of the lads beating you at Space Invaders, you can always turn their attention to schoolwork. Genie makes that fun too! You can learn typing, a foreign language, or simply keep your household accounts in order.

Of course, Colour Genie is only one of a number of home computers you could consider buying, however, the £199 price tag gets rid of some of the opposition, as do the 64 present and 128 programmable graphic characters! 8 exciting colours leave a few more standing, and four function keys with a built in power supply put Colour Genie way out in front!

ACCESSORIES

Colour Genie can be supplemented by a large range of optional extras. There is an attractive matching cassette recorder on which to store your own programs, or play pre-recorded software. Joysticks are available for popular video games, and a position-detecting light pen to heighten your colour-graphic creations. If you want to put your machine to work in your business, it can be expanded by a 16K RAM card, and connected to a quality matrix printer via the printer interface and cable.

SOFTWARE

Colour Genie uses a Z80 central processing unit, and is fully programmable in Microsoft colour BASIC, the most popular home computer language in the Western World!

MUSIC

Colour Genie contains a FULL MUSIC SYNTHESISER, which will generate a remarkable range of musical sounds through your T.V. speaker, in a variety of pre-settable tempos.

I enclose 30p p & p for Genie Colour Brochure

Name _____

Address _____

Tel: _____



PCW.12.82

The case for consulting professionals



Birmingham

The Byteshop,
94-96 Hurst Street
Tel: 021-622 7149

London

The Byteshop,
324 Euston Road NW1
Tel: 01-387 0505

Nottingham

The Byteshop,
92A Upper Parliament Street
Tel: 0602 40576

Glasgow

The Byteshop, Magnet House
61 Waterloo Street
Tel: 041-221 7409

Manchester

The Byteshop,
11 Gateway House, Piccadilly
Station Approach Tel: 061-236 4737

Southampton

Xitan Systems
23 Cumberland Place
Tel: 0703 38740

Members of the  Comart group of companies

Take a Professional View

of our Personal Computer

The Logica VTS Personal Computer.

The 'vitesse' was designed and produced by professionals for professionals.

The full 16-bit power of the 8086 microprocessor with high quality 15" bronze display and superior ergonomic design, is manufactured and supported by Logica - a European leader in Computing and Communications Technology.

This machine deserves a professional view.

Qualified dealers are invited to contact Adrian Noad, or return the coupon.

logica **VTS**

Logica VTS Limited

64 Newman Street, London W1A 4SE

Telephone 01 637 5171. Telex 27200.



for readicon
no. of charact
MSOLESBUFFER

Feed
SOLESCOUT

1 PRINTSSTRING
Also use this value
index
; Point to first
character of message

I would like to see more of the Logica VTS Personal Computer.
Please include dealer information Position

Name

Company/Address

Tel

Logica VTS Limited
64 Newman St.
London W1

FORTUNE



The Complete 32 Bit **Multi-User** Desktop
each

Minicomputer Performance at a Microcomputer Price

The FORTUNE 32:16 (TM) is the most powerful and unique microcomputer in its price range. This new system combines the power and computing capability of a minicomputer with the ease of use, convenience and price of a microcomputer. The FORTUNE 32:16 desktop microcomputer is designed for versatility and flexibility in the small to medium size business operation from a one person office to the department of a large corporation.

32:16

Compare these Characteristics

The FORTUNE is based on the most advanced microprocessor available – the Motorola MC68000. Its 32-bit architecture provides significantly higher performance than any other microprocessor in its price class.

Features include –

* MEMORY	256K – 1 MBYTE
* DISK CAPACITY	2.0 MB – 80 MB
* PROCESSOR	32 BIT*
* MULTI-USER	16 ADDITIONAL INTELLIGENT WORKSTATIONS
* LOCAL NETWORKING	ETHERNET
* COMMUNICATIONS	MICRO/MINI/MAINFRAME
* OPERATING SYSTEMS	UNIX & CP/M
* MULTI-TASKING	SEVERAL BUSINESS ACTIVITIES PROCESSED SIMULTANEOUSLY
* COLOUR GRAPHICS	HIGH RESOLUTION 1K x 1K

* 32 BIT Internal Address Bus 16 BIT External Data Bus.

Advanced Software

Of course all the features count for nothing if you don't have software and the right level of professional support. It comes with a large range of advanced software with commercial applications tailored to the equipment and allowing the user to learn while using the system rather than referring continuously to manuals to find out what the next instruction to the microcomputer should be. It couldn't be simpler and yet so powerful. No other computer has been launched with more comprehensive software than the FORTUNE 32:16. WE'RE READY FOR BUSINESS.

Designed with the User in Mind

The FORTUNE 32:16 is attractive in design, lightweight and easily portable. Ergonomics were a critical factor in dictating all design features. The anti-glare screen is razor sharp and can be swivelled or tilted for user convenience. Attention to detail is evident with the

keyboard in the choice of overall colour (to reduce eye fatigue), colour coding of various groups of keys (for easy visual identification), and the varying mounting angles of rows of keys (to reduce hand and arm fatigue).

For the Expanding Business

The FORTUNE 32:16 can easily and inexpensively be expanded from a single user to a multi-user operation, or expanded even further into a multi-system local network configuration by using standard ethernet (TM) designed by Xerox. In addition the FORTUNE 32:16 can support advanced data communications to other terminals, minicomputers and large corporate mainframes. The FORTUNE 32:16 is a computer that fits your requirements.

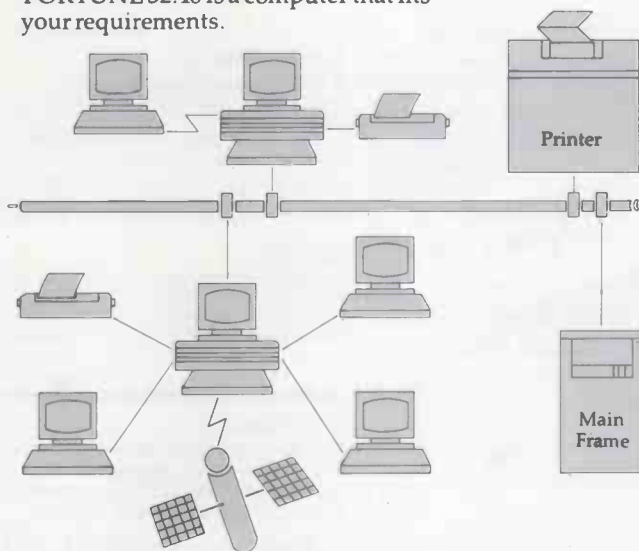

FORTUNE 32:16

The FORTUNE 32:16 is designed for quality and reliability, because downtime is one thing business can least afford. Every major component has been proven in tens of thousands of hours of on-line operation, and each individual unit undergoes comprehensive design, validation and production testing to assure trouble-free performance.

THE FORTUNE 32:16 IS BACKED BY FULL PROFESSIONAL SUPPORT AND TRAINING THROUGHOUT THE COUNTRY.

One Step Beyond

The combination of all these features makes the FORTUNE 32:16 the most unique and most powerful microcomputer available in today's marketplace.

The FORTUNE 32:16 is available now at your nearest authorised dealer.

Send the coupon today for more information, or call Reading (0734) 664111 for the name of your nearest supplier and see a demonstration without delay.

There is nothing to compare with it.

Fortune Systems from

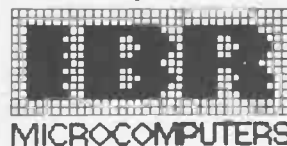

MICROCOMPUTERS

Please send details of the FORTUNE 32:16 and the name of my nearest dealer

I am interested in a dealership. Please send full details and contact me.

Name _____

Position _____

Company _____

Address _____

Telephone No. _____

To: IBR Microcomputers Ltd
Unit 57, Sutton Industrial Park
Earley, Reading, Berks RG6 1AZ

Top System from only £4375
additional workstation £800

THE MOST DIFFICULT THING ABOUT GETTING A COMPUTER IS GETTING THE RIGHT ONE.

COMMODORE VIC 20
Top selling home computer with enough facilities to interest the hobbyist or serious programmer. **130.00 ex. VAT**



COMMODORE VIC

VIC 20 Home Computer	130.00
VIC 20 Starter Pack	215.48
VIC CZN Cassette Unit	39.09
VIC Printer	200.00
VIC Single Floppy Disk Drive	260.00
VIC 3K RAM Cartridge	26.04
VIC 8K RAM Cartridge	39.09
VIC 16K RAM Cartridge	65.17
VIC Programmers Aid Cartridge	30.39
VIC Superexpander High Res. Cartridge	30.39
VIC Machine Code Monitor Cartridge	30.39
VIC Joystick	6.52
VIC Paddles (Pr)	11.74
VIC Games Cartridges from	17.35
VIC Games Tapes from	2.95
Commodore 64 Home Computer	299.00

DRAGON 32

Dragon 32 Family Computer	170.00
Dragon Joysticks (Pr)	19.95
Dragon Printer GP100A	199.00
Dragon Cartridges from	17.35
Dragon Cassettes from	6.91

SINCLAIR

ZX81 Computer	43.43
ZX Printer	52.13
16K RAM Pak	26.04
Learning Lab	17.35
All Sinclair Software available from	3.43

APPLE

Apple II Computer	642.61
Disk Drive C/W Controller (16 sec)	338.26
Disk Drive W/O Controller	251.30
H. R. B/W Monitor 9"	99.00
Monitor Green 12"	120.00
Cable for VM906	9.00
Cable for VM12G	3.75
Epson Card	65.00
Desk Top Plan	115.00
Visicalc 3.3	115.00
Visiplot	105.00
Apple Writer II	89.00
Visifile	165.00

CROMEMCO C-10 PERSONAL COMPUTER

A full feature personal business computer system including software - for the price of a VDU. Also the entry point into the renowned Cromemco range. **4195.00 ex. VAT**



CROMEMCO

C-10 SP Personal Computer Superpak inc. Z80A Processor, 64K Memory, Single 5 1/4" 390K Byte Floppy Disk, 24 x 80 Screen, CKBA Keyboard. CP/M Compatible Operating System, plus Word Processing, Financial Planning & 32K BASIC Software 1195.00
Additional 5 1/4" Floppy Disk Drive 450.00
120 Word/Min Daisy Wheel Printer 675.00

SHARP

PC 1500 Pocket Computer	147.48
CE150 Printer for PC 1500	130.39
MZ 80A Micro Computer	477.39
MZ 80B Micro Computer	899.00

OSBORNE 2

Truly portable personal small computer system housed in a 'snap together' case complete with business programs, so you can start work almost anywhere.

Inc. Monitor **1250.00 ex. VAT**

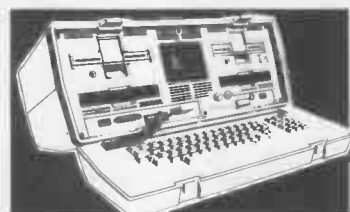

OSBORNE 2

Osborne Portable Computer Inc. Standard Software - Wordstar, Mailmerge, Supercalc, MBASIC, CBASIC, CP/M - Plus Free Monitor 1250.00
Osborne Starter Kit inc. Daisy Wheel Typewriter Printer 1699.00

PRINTERS - IMPACT

Anadex DP9500A 132 Cols., 150CPS Matrix Printer with Graphics. 10, 12, 5, 13, 3, 16.4 Char/In, Low Noise 1150.00
Anadex DP9501A 132 Cols., 150CPS Matrix Printer 10, 12, 15, 16.4 Char/In, Low Noise 1150.00
Anadex DP9620A 200CPS Printer, Low Noise, 10, 12, 15, 16.4 Char/In 100 CPS in Double Pass Enhanced Mode 1250.00
Anadex DP6000 Dual Mode Printer 132 Cols., 150/180CPS Correspondence Quality, 300/330CPS Draft and Graphics Mode. Diablo 630 Protocol Emulation 1950.00
Epson MX801/3 Tractor only 80CPS 349.00
Epson MX801/3 Friction and Tractor 389.00
Epson MX100FT/3 Friction and Tractor 100CPS 499.00
Saikosha GP100A 30CPS, 80 COL 199.00
Interfaces and cables for all popular micros available - contact your nearest shop.

PRINTERS - DAISY WHEEL

Diablo 630RO	1575.00
Crown Ranier - Brother 19CPS	795.00
Brather 8300	458.00

NORTH STAR ADVANTAGE

Advantage Desk-Top System inc. Keyboard, Graphics, Screen (Green), 64K Byte RAM, Z80A Processor, Serial Interface, Dual 350K Byte Diskette Drives and Busigraph Software 2195.00

Advantage Desk-Top System, as above except single 350K Diskette Drive + 5M Byte 5" Winchester Hard Disk 3095.00
Advantage upgrade to Intel 8088 Processor with 64KB Memory @ 320.00

PRICES EXCL. VAT

NORTH STAR ADVANTAGE

Two versatile desk top options to choose from featuring high quality business graphics with either 720Kb floppy or 5Mb hard disk storage.

From 2195.00 ex. VAT

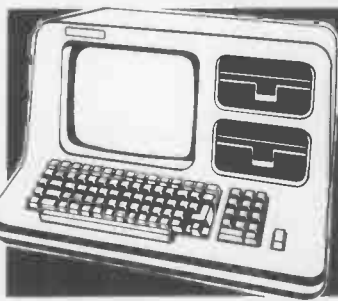

NORTH STAR HORIZON

Horizon S100 Bus. Micro Computer inc. Z80A Processor, 64K Byte Memory, Dual 350K Byte Diskette Drives and DOS/BASIC 1995.00

COMART COMMUNICATOR

Clearly the most price competitive modular computer system on the market with built-in expandability - inside and out. **From 1895.00 ex. VAT**

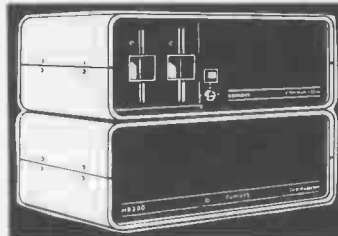

COMART COMMUNICATOR Z80A MODULAR SYSTEMS

Comart CP100 'Communicator' Micro Computer: Z80A Processor, 64K Byte Memory, Dual 5 1/4" Floppy Diskette Drives each storing 390K Bytes of Data. Dual Serial and Parallel Ports. 10 Slot S100 Bus. CP/M Version 2 included 1895.00
Comart CP200 as CP100 except Dual 790K Byte Diskette Drives 2195.00
Comart CP500 as CP100 except one 790K Byte Diskette Drive and one 5" Winchester Drive having 4.8M Bytes of Formatted Data 2995.00
Comart CP520 as CP100 except one 790K Byte Diskette Drive and one 5" Winchester Drive having 19M Bytes of Formatted Data 3995.00

COMART COMMUNICATOR 8086 MODULAR SYSTEMS

Comart CP1100 Communicator Micro Computer: 6MHz 8086 Processor, 128K Byte Memory with Parity, Dual 5 1/4" Floppy Disk Drives each storing 390K Bytes. Dual Serial and Parallel Printer Ports. 10 Slot S100 Bus inc. CP/M86 2295.00
Comart CP1102 CP1100 with 256K Byte Memory 2445.00
Comart CP1200 as CP1100 except Dual 790K Byte Diskette Drives 2595.00
Comart CP1202 CP1200 with 256K Byte Memory 2745.00

PRICES EXCL. VAT

Comart CP1500 as CP1100 except Single 790K Byte Diskette Drive and Single 5" Winchester Hard Disk Drive having 4.8M Bytes of Formatted Data 3395.00

Comart CP1502 CP1500 with 256K Byte Memory 3545.00

Comart CP1520 As CP1500 except 5" Winchester Disk having 19M Bytes of Formatted Data 4395.00

Comart CP1522 CP1520 with 256K Byte Memory 4545.00

COMART MULTI USER CONFIGURATIONS

Comart CP500 / M CP500 Communicator System with 256K Byte Memory and 6 Serial Interfaces. Includes CP/M and MP/M11 3995.00

Comart CP520 / M CP520 Communicator System with 256K Byte Memory and 6 Serial Interfaces. Includes CP/M and MP/M11 4995.00

Comart CP1525M CP1520 Communicator with a total of 512K Byte Memory and 10 Serial Interfaces. Includes CP/M86 and MP/M86 5995.00

COMART SUBSYSTEMS

Comart CB200 Cartridge Tape Back-Up Subsystem for Hard Disk 2495.00
Comart HD200 8" Hard Disk (18M Byte) Subsystem (including HD10 Controller) 3895.00

Comart HD520 5" x 20M Byte Hard Disk Subsystem (requires HDCONT or can be added to a CP520 or CP1520) 1995.00

Comart HD522 Dual 20M Byte Winchester Hard Disk Subsystem (requires HDCONT) 3495.00

Comart HDCONT Winchester Disk Controller for 2, 20M Byte Drives 595.00

Comart FD800 8" Floppy Single Disk Drive Subsystem; Single Sided, Single Density IBM 3740 Compatible (requires C-IFDC) 995.00

Comart FD802 8" Floppy Dual Disk Drive Subsystem 1495.00

Comart MP/MSUB Hardware & Software to Upgrade Communicator to MP/M. Includes MP/M, two 48K Byte CRAM 48 Memory and 4SIO Serial Interface Card 1150.00

S100 BOARDS

Comart CRAM64 64K Byte Dynamic RAM with Bank Select 200.00

Comart CRAM48 48K Byte Dynamic RAM with Bank Select 180.00

Comart CRAM256 256K Byte Dynamic RAM with Parity, 8 and 16 Bit Data. IEEE696 Compatible. Also supports 8 Bit Bank Switching 550.00

Comart CRAM128 128K Dynamic RAM with Parity, 8 and 16 Bit Data, IEEE696 Compatible. Also supports 8 Bit Bank Switching 400.00

Comart C-CPU86 8086 Processor Card, with Dual Serial and Parallel Port. Monitor in 8K EPROM and 4K RAM 300.00

Comart PRESTAIID Viewdata Subsystem including Display Board, Modern and Software 690.00

Comart C-IFDC Intelligent Diskette Drive Controller with Z80A Processor 295.00

Comart C-CPU Z80A system Processor Board incl. 2 Serial/1 Parallel Port 200.00

Comart 4SIO 4 Channel Synch/Asynch Interface Board 250.00

Dual Systems CLK24 Battery Supported Real Time Calendar Disk 295.00

Dual Systems CMEM32 32K CMOS Battery Supported Memory 1195.00

Dual Systems CMEM16 16K CMOS Battery Supported Memory 895.00

CROMEMCO 68000/Z80A SUPER MICRO SYSTEMS

Cromemco CS1D2E System 1 including Dual 390K 5" Floppy Disks, DPU, MCU, 256MSU and 16 FDC Cards in 8 Slot S100 Card, Table Top Enclosure 3620.00

PRICES EXCL. VAT

Cromemco CS1D5E as CS1D2E but with 512 MSU 4280.00
Cromemco CS1HD2E System 1 including Single 390K 5" Floppy Disk, 5.5M Byte 5" Winchester Disk, DPU, MCU, 256MSU, 16FDC, WD12 5595.00
Cromemco CS1HD5E as CS1HD2E but with 512MSU 6255.00
Cromemco CS3D5E System 3 including Dual 1.2M Byte Floppy Disk Drives, 21 Slot Card Cage, DPU, MCU, 512MSU, 16FDC 6585.00
Cromemco CS3HD5E as CS3D5E but with 5" 5.5MB Winchester Disk and WD1 8230.00

CROMEMCO Z80 COMPUTER SYSTEMS

Cromemco CS-1H System One including Z80A Processor, 64K Memory, 390K Byte 5" Floppy, 5.5M Byte 5" Winchester Disk and VDU/Printer Interfaces 4595.00
Cromemco CS-1B Slot S100 Bus. Computer System One, with Z80A Processor, Dual 5" Diskette Drives, 64K Memory, VDU/Printer I/F 2630.00
Cromemco CS-2 21 Slot S100 Bus. Computer System Two, Z80A Processor, Dual 5" Diskette Drives, 64K Memory, VDU/Printer Interfaces (19" Rack Mount) 3095.00
Cromemco CS-3 21 Slot S100 Bus. Computer System Three: Z80A, 64K Memory, Dual High Speed 8" Diskette Drives (1.2M Byte each), VDU/Printer Interfaces (19" Rack Mount) 4495.00
Cromemco Z-2H 12 Slot S100 Bus. Hard Disk Computer System with Z80A Processor, Dual 5" Diskette Drives, 10M Byte Winchester Drive. 64K RAM & VDU/Printer Interfaces 6585.00
Cromemco Z-2H/GS Cromemco Graphics System based on Z-2H, together with additional Dual Ported 96K Byte Video Memory, High Resolution Graphics I/F and Bit Pad Interfaces CDS and SGS Software Included 8560.00

CROMEMCO GRAPHICS OPTION

Cromemco SD1 High Resolution (754 x 482) Colour Graphics Interface Board 595.00
Cromemco 48KTP 48K Byte Dual Port Graphics Memory 755.00

VDU'S & MONITORS

Comart WY100 Visual Display Terminal, Green Display, 24 x 80 and Status Lines. Detached 105 Key Keyboard with Numeric Pad, Function, Cursor and Editing Controls. Swivel and Tilt Display 675.00
Volkerkraig 4404 595.00
Volkerkraig 4404WS 695.00
Cromemco RGB14LP, High Resolution Monitor 1395.00

BUG - BYTE SOFTWARE

All Tapes Available For Acorn, VIC, BBC, ZX81, Spectrum. Call for availability.

BOOKS

Very wide range of computer books stocked at all shops.

DISKETTES

Wabash 5 1/4" Single Sided, Single Density 1.70ea
Wabash 5 1/4" Single Sided, Double Density 2.13ea
Dysan 5 1/4" Double Sided, Double Density 3.90ea
Dysan 8" Double Sided, Double Density 4.40ea
 Full range of 5 1/4" & 8" Diskettes in stock

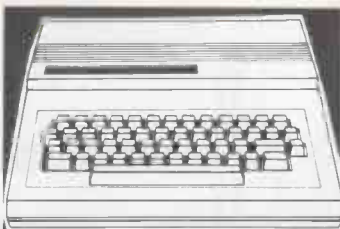

SYSTEM SPOTLIGHT DRAGON 32

Compact home computer designed for family use that nevertheless compares favourably with far more expensive models on the market. Comprehensive features include 32K RAM memory as standard, expandable to 64K, professional keyboard and Microsoft BASIC with advanced graphics using nine colours. Simple operation and wide range of available software and add-on units.

170.00 ex. VAT

CP/M SOFTWARE

PRICES EXCL. VAT

ACCESS MNGR Digital Research Programming Tool 175.00
ANIMAJOR Microfocus Programming Tool 225.00
BASCOM Microsoft Basic Compiler 227.46
BASIC-80 Microsoft Basic Interpreter 205.27
BAZIC Micromikes Basic Language 120.00
BSTAM BYROM Software Communications Package between CP/M based machines. Both machines require BSTAM. 115.00
BSTMS BYROM Software Communications Package. A commercially orientated, TTY Emulation Facility for CP/M Systems 115.00
BT-80 Digital Research Programming Tool 116.00
CALCSTAR Micropro Financial Planning/Budgeting, Electronic Spread Sheet Package 165.00
CARDBOX Caxton Fast Store and Search System 155.00
CB80 Digital Research Basic Compiler 290.00
CBASIC Digital Research Basic Language 87.00
CBASIC/B6 Digital Research Basic Language for 16 BIT Micro's (CP/M) 86) 190.00
CIS COBOL Microfocus COBOL Language 425.00
COBOL TRAIN Microcal Training Package for CIS COBOL 350.00
COBOL-80 Microsoft COBOL Compiler 421.63
CP/M Digital Research Operating System 87.00
CP/M for SBC Digital Research Operating System 116.00
CP/M-86 Digital Research Operating System for 16 Bit Micro's 145.00
CP/M-86 DISPWR Digital Research Operating System 190.00
CP/M-86 + CB86 Digital Research Operating System + Language 350.00
CP/NET Digital Research Networking Operating System 116.00
CPFILT Jarogate Operating System Simulator 55.00
DATASTAR Micropro Database Package 195.00
DATASTAR U/D Micropro Update for DATASTAR 25.00
DBASE II Ashton-Tate Relational Database + ZIP (ZIP is a Screen and Printout Form Writer for DBASE II) 435.00
DISPLAY MNGR Digital Research Programming Tool 235.00
EDIT-80 Microsoft Editor 72.12
EXTEND Jarogate Utility 55.00
FLESHARE Microfocus Utility 250.00
FILESTAR Microsec's Disk Reformatter CP/M to IBM, DEC, Motorola and Intel Formats 195.00
FMS-80 DJR Assoc. Database / FM 650.00
FMS-81 DJR Assoc. Database / FM 350.00
FMS-82 DJR Assoc. Database / FM 350.00
FORMS 2 Microfocus Table Maker. Useful with CIS COBOL 110.00
FORTAN-80 Microsoft FORTRAN Compiler 288.48
GBS Bytesoff General Business System 810.00
ITC CP/M Intelligent Terminals Corporation CP/M Operating System for Cromemco 200.00
KSAM80 EMS Database 350.00
LINK-80 Digital Research Programming Tool 59.00
MAC Digital Research Programming Tool 55.00
MACRO-80 Microsoft Macro Assembler 116.50
MAILMERGE Micropro Wordprocessing Enhancement to link with WORDSTAR 65.00
MAILMERGE UD MAILMERGE Update 15.00
MARS Sophie Business System 400.00
MICROSTAT Ecosoft Statistics Package 195.00
MILESTONE Organic Software Critical Path Package 225.00
MP/M II Digital Research Multi-User Operating System 260.00
MP/M 86 Digital Research Multi-User Operating System for 16 Bit Systems 380.00
MSORT Microsoft Sort Utility Pascal 83.21
PASCAL/MT + & SPP Digital Research Pascal Language with Speed Programming Tool 275.00
PASCAL/MT + Digital Research Pascal Language 205.00
PASCAL/MT + 86 Digital Research Pascal Language for 16 Bit Systems 350.00
PL/I-80 Digital Research Language 290.00
REFORM/DEC Microtech Disk Reformatter CP/M to and from Dec. 110.00
REFORM/IBM Microtech Disk Reformatter CP/M to and from IBM 110.00
RMAC, LINK Digital research Programming Tool 116.00
SID Digital Research Programming Tool 50.00
SID-86 Digital Research Programming Tool 87.00
SIM22 Wheatcroft Hards Operating Systems Simulator CP/M Simulator for CROMIX Version II 55.00
SPELLSTAR Micropro Proofreading Utility to link with WORDSTAR 135.00
SUPERCALC Sorcim Financial Planning/Budgeting Electronic Spread Sheet Package 190.00
SUPERSORT Micropro Sort Utility 125.00
SUPERSORT UD Micropro SUPERSORT Update 25.00
SUPERVYZ Epic Application Control 55.00
T/MAKER II Lifeboat Associates Financial Planning/Budgeting Electronic Spread Sheet Package 195.00
W/S TRAINING Micropro Training Guide for WORDSTAR 17.00
WORDSTAR Micropro Wordprocessing Package 255.00
WORDSTAR U/D Micropro WORDSTAR Update 50.00
WP WORKSHOP MAC Ltd Training Guide for WORDSTAR or MAILMERGE 75.00
X1802 Avocet Cross Assembler 115.00
X3870 Avocet Cross Assembler 115.00
X6502 Avocet Cross Assembler 115.00
X6800 Avocet Cross Assembler 115.00
X8048 Avocet Cross Assembler 115.00
X BASIC Xitan Language 185.00
X COPY Xitan Utility 50.00
X CP/M Xitan DR Operating System 100.00
XI86 Digital Research Programming Tool 87.00
ZSID Digital Research Programming Tool 59.00

CROMEMCO SOFTWARE FOR 68000/Z80A SERIES

Cromemco CRO-D Cromix (Multi-User/Multi Tasking) Unix Based Operating System 395.00
Cromemco FOR-D Fortran 77 395.00
Cromemco PAS-D ISO Pascal 395.00
Cromemco ASM-D 68000 Macro Assembler 395.00
Cromemco STB-D 32K Structured BASIC @ 395.00
Cromemco CCC-D C-Compiler @ 395.00
Cromemco COB-D Cobol Compiler @ 395.00
 Note: All 68000 Languages (Suffix D) require Cromix (CRO-D). All Software is available on 5" or 8" Floppy Disks - Please Specify.
 @ = Availability early '83

CROMEMCO OPERATING SYSTEMS

Cromemco CROMIX Multi User/Multi Tasking Unix Based Operating System (Z80A Systems) 395.00
Cromemco KSAM KSAM File Management for CROMIX (Z80A) 195.00

CROMEMCO LANGUAGES (Z80A)

Cromemco FDB 16K BASIC Interpreter 130.00
Cromemco FDF Fortran IV Compiler 195.00
Cromemco FDC Cobol Compiler 395.00
Cromemco STB 32K Structured BASIC (includes KSAM) 130.00
Cromemco FDR RATFOR - Rational Fortran IV Compiler & Pre-Processor 260.00
Cromemco FDA 280 Macro Assembler 195.00
Cromemco CCC C Compiler (Requires Cromix) 395.00
Cromemco RPG RPGII Report Generator 395.00
Cromemco LSP LISP List Processor 260.00
Cromemco COL Overlay Link Editor 260.00
Cromemco IDS I.O.P. Development Software 395.00
Cromemco CDS Diagnostic Systems Software 130.00
 All software is available on 5" or 8" Diskettes - please specify.

ALL PRICES EXCLUSIVE OF VAT

* Barclaycard Visa & Access cards taken in payment.
 * Shop opening hours 9 - 5.30, check individual shops for details of Saturday opening times.
 * Phone Mail Orders accepted. Please contact nearest shop for P.P. & Delivery Rates. Regret no C.O.D.
 * Some items may be subject to a dollar surcharge if the dollar exchange rate changes more than 5 cents. Prices will be adjusted in line with the rate prevailing at the time of purchase.
 * Prices subject to change without notice E. & O.E.
 * Whilst we carry a vast range of stock, we cannot guarantee that every advertised item will be available in each shop.
 * All goods are new and include factory warranties.
 * No refunds on opened software.
 * Orders from Government Depts. & Colleges etc. welcome.
 * Leasing & HP facilities available - apply for written details.
 * Detailed prices available on request.



There are so many micro computers on the market that choosing the right one is far from easy.

And it isn't made any easier when you find them cheek by jowl with cameras, hi-fi and a host of other electrical equipment.

What you need is someone that is single minded. And that means us.

Byteshops are totally dedicated to micro computers. So not surprisingly, we can offer you a wider range because we sell nothing else.

Our prices are keener too. So are our staff. Each one is an expert who can make sure you get the computer that's exactly right for you - whether it's a £40 home micro or a £20,000 business system.

What's more we'll freely advise you on expanding or upgrading your system as your knowledge or your requirements grow. While our Microserve Centres offers service and maintenance on site at our shops.

After all, we are the UK's longest established microcomputer specialists. Come and see us soon.

THE BYTE SHOP

A member of the Comart group of companies

LONDON
 The Byteshop
 324 Euston Road NW1
 Tel: 01-387 0505

BIRMINGHAM
 The Byteshop
 94-96 Hurst Street
 Tel: 021-622 7149

GLASGOW
 The Byteshop, Magnet House
 61 Waterloo Street
 Tel: 041-221 7409

MANCHESTER
 The Byteshop
 11 Gateway House, Piccadilly,
 Station Approach Tel: 061-236 4737

NOTTINGHAM
 The Byteshop
 92A Upper Parliament Street
 Tel: 0602 40576

SOUTHAMPTON
 Also at **XITAN** Systems
 23 Cumberland Place
 Tel: 0703 38740

SBD

Software

Choose from over 100 titles with the SBD Christmas Collection

ARCADE/ACTION GAMES



001D	Alien Typhoon	£17.00
002D	Bandits	£22.50
003D	Bug Attack	£19.95
004D	Cannonball Blitz	£22.50
005D	Choplifter	£21.50
006D	County Fair	£19.95
007D	Crossfire	£20.50
008D	David's Midnight	£21.50
009D	Falcons	£19.95
010D	Fly Wars	£19.95
011D	Gorgon	£24.95
012D	Horizons V	£21.50
013D	Jawbreaker	£20.50
014D	Kabul Spy	£19.95
015D	Laff Pak	£22.95
016D	Marauder	£22.95
017D	Mouskattack	£22.95
018D	Pegasus II	£21.50
019D	Photar	£19.95
020D	Ribbit	£19.95
021D	Snack Attack	£19.95
022D	Snake Byte	£19.95
023D	Space Eggs	£19.95
024D	Swashbuckler	£21.50
025D	Threshold	£22.95
026D	Track Attack	£19.95
027D	Twerps	£19.95
028D	Zenith	£23.00



029D	Apple Panic	48K £19.95
030D/C	Bug Attack	16K £19.95
031D/C	Chicken	16K £19.95
032D	Choplifter	£22.00
033D/C	Crossfire	32K £20.50
034D/C	Frogger	£22.95
035D	Ghost Hunter	16K £22.95
035C	Ghost Hunter	16K £19.95
036D/C	Jawbreaker	16K £20.50
037D	Maze of Death	24K £14.25
037C	Maze of Death	24K £10.95
038D	Mouskattack	32K £22.95
039D/C	Nautilus	32K £19.95
040D/C	Preppie	£22.00
041D	Raster Blaster	32K £19.95

042D/C	Shamus	£22.50
043D/C	Slime	16K £19.95
044D	Snake Byte	48K £18.50
045D	Space Eggs	48K £18.50
046D	Threshold	40K £26.00

ADVENTURE GAMES



047D	Ali Baba & 40 Thieves	£21.00
048D	Castle Wolfenstein	£19.95
049D	Cranston Manor	£20.50
050D	Escape from Rungistan	£18.50
051D	Knights of Diamond	£22.50
052D	Mission Asteroid	£11.50
053D	Mystery House	£14.95
054D	Odyssey	£20.50
055D	Soft Porn Adventure	£20.50
056D	Terrorist	£19.95
057D	The Wizard & Princess	£20.50
058D	TIME ZONE	£20.50
059D	Ulysees & Gold Fleece	£20.50
060D	Wizardry	£29.90



061D	Ali Baba & 40 Thieves	32K £22.95
062D	Cyclod	48K £18.50
063D/C	Invasion Orion	32K £17.00
064C	Lords of Karma	40K £13.50
065D	Midway Campaign	32K £11.25
066D	Mission Asteroid	40K £17.25
067C	North Atlantic	16K £11.25
068D	Soft Porn Adv.	40K £20.50
069D/C	Temple of Apshai	32K £27.50
070D	Ulysses & Fleece	£27.50
071D	Warlock's Revenge	40K £25.00
072D	Wizard & Princess	40K £21.50

STRATEGY GAMES



073D	Cartels & Cutthroats	£26.00
074D	Computer Air Combat	£45.00

075D	Computer Ambush	£40.00
076D	Computer Bismarck	£40.00
077D	Datestones of Ryn	£13.50
078D	Napoleon's Campaign	£40.00
079D	Pursuit of Graf Spee	£40.00
080D	Road to Gettysburg	£40.00
081D	Shattered Alliance	£40.00
082D	Southern Command	£40.00
083D	Temple of Apshai	£26.00
084D	The Warp Factor	£26.00
085D	Zork I	£26.00
086D	Zork II	£26.00



087D	Tanktics	32K £19.00
087C	Tanktics	24K £16.50
088D/C	The Battle of Shiloh	£26.00
089D/C	Tigers in the Snow	£26.00
090D	Ultima I	£26.00

CARD & SPORTS GAMES



091D	Computer Golf	£19.95
092D	Computer Foosball	£19.95
093D	Cribbage	£14.50
094D	Fastgammon	£17.00
095D	Flight Simulator	£22.50
096D	Olympic Decathlon	£19.95
097D	Pinball	£22.50
098D	Pool 1.5	£22.50
099D	Sargon II Chess	£18.00
100D	Trick Shot	£26.00



101C	Fastgammon	8K £14.50
102D	Poker Solitaire	£17.00
102C	Poker Solitaire	8K £11.00
103D	Pool 1.5	48K £22.50
104D	Reversi	£19.95
104C	Reversi	8K £13.00

C = CASSETTE D = DISK

To SBD Software, FREEPOST, 15 JOCELYN ROAD, RICHMOND, SURREY TW9 1BR. Telephone 01-948 0461 (24 hours)

Please send me the following items of software:

Code	C or D	Qty	Price	Total
Add 75p for Postage & Packing				0.75
<input type="checkbox"/> I enclose cheque/postal order for made payable to SBD Software			Grand Total	£
<input type="checkbox"/> Please debit my Access/Barclaycard (delete as app.)				

Exp Date.....

Name.....

Address.....

A10



FOR ACCESS/BARCLAYCARD ORDERS, PHONE OUR GAMELINE ON

01-948 0461 (24 Hour Service).

NEW!

TRACKBALL JOYSTICK

Available for both Apple and Atari.

Now you can recreate authentic arcade manoeuvres in your own home with the new trackball joystick. 360° movements and fire button at your fingertips.

Code 105H
only £39.95



PERSONAL COMPUTER WORLD

presents the long awaited sequel

THE 1983 MICROCOMPUTER BENCHTEST SPECIAL

Starring in order of appearance

Sinclair ZX Spectrum	Positron 9000
Epson HX20	DEC Rainbow
Hewlett Packard HP125	Texas Instruments TI99/4A
Casio fx9000p	Gemini Multiboard
Mimi	Newbrain
Apple III	ACT Sirius 1
Munroe OC8820	Sharp PC1500
Dragon 32	Exleigh Expert
Sharp MZ80A	Olivetti M20
Hewlett Packard HP75C	Hewlett Packard HP86
Hewlett Packard HP15/16C	Texas Instruments TI88

AND MUCH MUCH MORE!

Please send me copy/copies of the 1983 Benchtest Special. @ £1.95.
Please make all cheques/postal orders payable to:
Computing Publications, and send this form to Computing Publications, 53/55 Frith St, London W1A 2HG
Price includes postage and packing. * Overseas orders requiring airmail postage add £1.00 per copy.
Please allow 28 days for delivery.

Name.....

(block letters)

Address.....

.....

.....

.....

.....

A LOW COST

Purpose-Built *ONLY* £485
+ VAT

Daisywheel
Printer

**SMITH CORONA
TP-1**



- Microprocessor Controller
- Dedicated Computer Printer
- Serial, Parallel or IEEE Interface
- Lowest cost purpose-built Daisywheel

Contact your local dealer — today!

Cambridge Computer Store
1 Emmanuel Street, Cambridge,
Tel: 0223 65334

CWP Computers
108 Rochester Row, London SW1
Tel: 01 630 7444

Chromasonic
48 Junction Road, London N19
Tel: 01 263 9495

A & C Business Computers
1 Beresford Street, St. Helier,
Jersey, Tel: (0534) 35433

Camden Computer Systems Limited
462 Coventry Road, Small Heath, Birmingham,
Tel: 021 771 3636

Peritronic Limited
Lomond House, Almondvale, Livingston, West Lothian,
Tel: 0506 410041

Computer Peripheral Supplies
2/10 Whitchurch Road, Pangbourne, Berkshire,
Tel: 07357 2721/4378

Maystar Micros
62 Peach Street, Wokingham, Berks, Tel: 0734 789381

Interface Components Ltd
Oakfield Corner, Sycamore Road, Amersham, Bucks,
Tel: 02403 22307

Dorling Microsystems
Tockington, Thornbury, Bristol BS12 4PR.
Tel: 0454 418596

Butel-Comco Limited
Garrick Industrial Centre, Garrick Road, London NW9 6AQ,
Tel: 01 202 2277

Computer Services (Scotland) Ltd
89/90 Westlaw Place, Whitehill Industrial Estate, Glenrothes, KY6 2RZ, Tel: (0592) 773710

Technicare Products Ltd
The Lodge, Brick Kiln Street, Evesham, Worcs.,
Tel: (0386) 41484/41587

discom

DISCOM TRADING COMPANY
Dresden House, 51 High Street,
Evesham, Worcestershire WR11 4DA
Telephone: (0386) 3591
SOLE U.K. DISTRIBUTORS

MicroRAPPORT

The Relational Database System for Micro Computers

For more information, purchases or dealership terms contact: Peter Barnes, Database Products Group, Logica Limited, 64 Newman Street, London W1A 4SE Telephone: 01-637 9111

MicroRAPPORT is a proven Relational DBMS for CP/M* based microcomputers. It has an easy to use Interactive Query Language for retrieving data and formatting simple reports, a utility program for loading data and a powerful command interface for use within Fortran programs. It is a derivative of RAPPORT, the popular DBMS for mini and mainframe computers and is ideal for building applications of all kinds.

MicroRAPPORT can handle 16 data-base files holding up to 30 Megabytes of data. It is powerful, very efficient and proven on a wide range of machines. No application should be without it.

Logica

*CP/M is a trademark of Digital Research.

ozwise computers

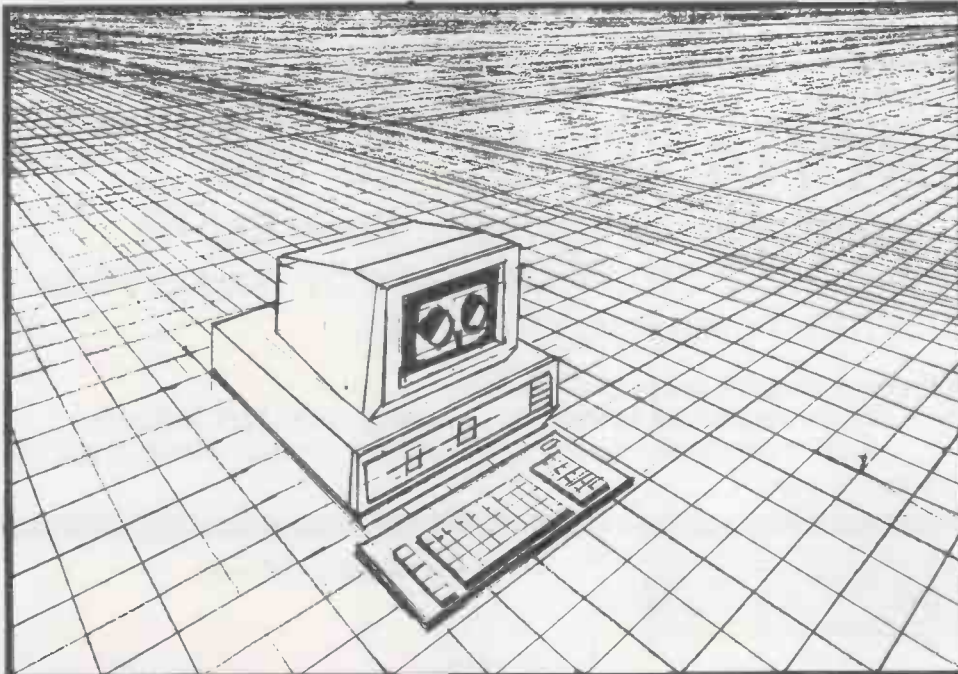

 apple II/III





 ACT
sirius 1



DRAGON 32

PUTTING COMPUTERS INTO PERSPECTIVE

Call now for **free professional advice**, for details of our **computer courses** and latest **special offers**.

236 Imperial Drive, Rayners Lane

Harrow, Middx HA2 7HJ

01-429 1060

INTEREST FREE CREDIT

£485

+ VAT

I.F.C.
ALSO AVAILABLE
ON OSBORNE 1
MICRO AND
EAGLE BUSINESS
SYSTEMS



- LOW COST DAISYWHEEL PRINTER
- MICROPROCESSOR ELECTRONICS
- SERIAL, PARALLEL or IEEE INTERFACE

SMITH-CORONA® TP-1™

This top quality microcomputer daisywheel printer can be yours for an initial payment of £100.75 followed by twelve equal monthly payments. Written details on request.

Accessories are also available at very reasonable prices. Delivery free.

FILM RIBBONS £1.50 each

DAISYWHEELS £7.50 each

DRIVE CARD FOR APPLE £55

CABLE FOR ANY MICRO £20

IEEE CONVERTOR FOR PET £65

INTERFACE FOR SHARP MZ80 £65

Educational discounts. Official orders accepted.

Technicare

Technicare Products Limited

Freepost

Evesham, Worcestershire WR11 4BR

Tel (0386) 41484/41587 Telex 334421



Further information please

Name _____

Address _____

Tel No _____

My Computer is _____

COST CONSCIOUS!

Heralding the beginning of a new age of low cost Word Processing Computer Systems

SMITH CORONA TP-1

- Dedicated Computer Printer
- Microprocessor Controller
- Serial, Parallel or IEEE Interface
- Lowest cost purpose-built Daisywheel

£485
+ VAT



BYTEWRITER

- Keyboard Printer
- Lift off facility
- Built-in self test
- Rigid carrying case

£485
+ VAT



DISCOM TRADING COMPANY
Dresden House, 51 High Street
Evesham, Worcs. WR11 4DA
Telephone (0386) 3591

Further Information Please

Name _____

Address _____

Telephone _____

discom

BBC MICRO INSTANT MACHINE CODE!

Yes, it's true. Instant machine code from a good subset of BBC BASIC. Type your BASIC program into your model B BBC Micro, trigger the compiler, and your program is changed almost instantaneously into superfast machine code. For £34.95 you get: Cassette version of the complete compiler (along with a version of the compiler for use with discs, ready for when you upgrade, the disc version being dubbed on the cassette after the cassette version); complete compiler listing; extensive documentation and instructions. The compiler was written by Jeremy Ruston.

THE BBC MICRO REVEALED

By Jeremy Ruston

'... destined to become the bible of all BBC microcomputer users. ...' (Personal Computing Today). If you've mastered the manual, then this book is for you. Just £7.95

LET YOUR BBC MICRO TEACH YOU TO PROGRAM

By Tim Hartnell

'... takes you further into the cloudy areas of the BBC machine than anything else I've yet seen. ...' (Computer and Video Games). If you're just starting out in the world of programming, then this book is the one for you. Forty complete programs, including Othello/Reversi, Piano and a host of dramatic graphic demos. Just £6.45

Interface, Dept. PCW

44-46 Earls Court Road, London W8 6EJ

Please send me:

INSTANT BBC MACHINE CODE—tape and book—£34.95

THE BBC MICRO REVEALED—Ruston—£7.95

LET YOUR BBC MICRO TEACH YOU TO PROGRAM—Hartnell—£6.45

I enclose £

Name

Address

CITY MICROSYSTEMS LIMITED

65 LONDON WALL, LONDON EC2M 5TU

01-588 7272/3/4

 **ACT
Sirius 1**



The NEW Generation Microcomputer
1Mb Disc Capacity 128K RAM
CP/M-80 compatibility available.

TELEVIDEO



Stand Alone and Multi-User, Multi-Task,
Multi-Processor Systems.
Televideo reliability with complete
expandability, one to sixteen users.

BRITISH MICRO



MINI 802 now available. 700K disk drives,
CP/M operating system
Computer & monitor

COMPLETE BUSINESS ACCOUNTING SYSTEMS WORD PROCESSORS
PROGRAMME PACKAGES FOR MOST APPLICATIONS

ADVICE, TRAINING AND MAINTENANCE

ALL YOUR COMPUTER REQUIREMENT READILY AVAILABLE

IN THE CENTRE OF THE CITY- LONDON EC2

VISITORS TO OUR OFFICES MOST WELCOME

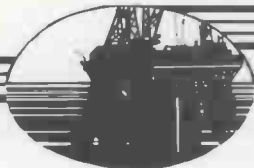

**MOM
SYSTEMS
LTD.**

Aberdeen — London — Singapore

**ADVANCED
MICROCOMPUTER SOFTWARE**

COMMUNICATIONS

- ★ Asynchronous terminal emulator. Allows mainframe/to micro communication. Configurable for a variety of protocols. — £350
- ★ Micro to micro file transfer utilities. Configurable for various reader/punch or port addresses. — from £225

DATABASE

- ★ CONDOR™ relational database CPM or CPM86 (Sole UK Distributors). Multiple data set operations. — £650

ENGINEERING

- ★ **Mechanical** — Superpipe, Superframe & Superrig Structural Analysis program. from £995
- ★ **Chemical** — MINI-DES Process Simulation
Distillation — Pipeline — Column Sizing —
Equilib Calcs — Physical Property Prediction
— Sour Gas — Heat Exchangers P.O.A.

Tel. (0224) 22863 Telex 739740

Tel. (0474) 57746 Telex 965462

EuroMicro™



OLIVETTI L1

M20 Personal Computer

For Business and Professional Users

- Word Processing ● Estate Agents
- Quantity Surveyors ● Wages
- Automated Accounts ● Solicitors

And Many More Businesses Supplied and installed
by local experts in micro-computers

EuroMicro Limited

EuroMicro House, Coleridge Lane, London N8 8ED. England

Telephone: 01-341 2447

The Worlds Most Complete Portable Computer.

EPSON HX-20



**ONLY
£402
PLUS VAT**

FEATURES:

WEIGHT: Less than 4lb
SIZE: Fits in briefcase
POWER: 50 hrs running before recharge
PRINTER: 150 ms/ Dot Line
L.C.D.: 20 chrs x 4 lines
 Scroll up to 255chrs
GRAPHIC: 120 x 32 dots

RS-232C & serial interface
6301 Processor from Hitachi
Five Special Function Keys
Numeric Keypad
PSS FACILITY

OPTIONS

Microcassette Drive (300K)	75.00
Expansion Unit (32K Ram)	80.00
Barcode Reader	82.00
Rom Cartridge	45.00
Serial Cable	15.00
Network Cable	15.00

PROFESSIONAL DATA SYSTEMS

Carne House, Markland Hill,
Bolton. Lancs.

Telephone: 0204 493816

Please rush me my EPSON HX-20
I enclose my cheque/credit card details.

--	--	--	--	--	--	--	--	--	--	--	--

FOR £ _____ +VAT _____

NAME _____

ADDRESS _____

TEL NO _____



micro change ltd

computer systems and equipment

Microchange introduces a database system for the Sharp MZ80B Computer, an exceptional combination of efficiency and reliability. Use the database management system to develop your application software eg —

- *Insurance and assurance
- Estate agents
- Video shop
- *Stock control
- *Personal records
- Student records
- (*Working examples enclosed with package)



Benefit from master and chained records, second level indexing, use of codes, search and extract on up to 30 criterion with print display option, and many more excellent facilities.

RRP for microchange database system £400 excluding VAT

Special offer for complete system includes —
System hardware, CPM. M basic compiler. Plus database management system £2 465 excluding VAT

Individual and dealer enquiries welcome
Tel: Peter Clark or Lesley McGregor on 041 204 1929

micro change ltd

computer systems and equipment

Telfer House, 74/80 Miller Street, Glasgow G1 1DT

SPECIAL CHRISTMAS ZX MICROFAIR!

If you're interested
in exhibiting please
contact Mike Johnston



**Saturday 18th December at the
New Horticultural Hall,
Greycoat Street, London SW1.
One day - 10am to 6pm.**

Thinking of buying your
Christmas computer?
Looking for ZX hardware or software?
Want to meet local user-groups and ZX
enthusiasts?

Or just want an interesting day out?

Then call along on Saturday, 18th December for the **Christmas
Special MICROFAIR!**

It's full of Christmas Cheer — everything for the ZX81, ZX80 and
ZX SPECTRUM under one roof!

Meet a wide range of manufacturers of all types — talk to
interesting people — get advice — buy that last minute present.

There's plenty of room, there's a Bar if you get thirsty and a Buffet
if you're famished!

There's even a bring and buy sale so you'll be able to pick up a
bargain, and of course a complete showguide, available on the day.

Make a note of the date or
write for advanced tickets to
Mike Johnston, 71 Park Lane,
London N17 0HG (enclosing
a S.A.E.).

Admission charges are 75p
for adults or 50p for kids
(under 14). Please make
cheque, P.O. payable to ZX
Microfair.

Do it now and make sure of
a very happy ZX MAS!



SOFTWARE Try before you Buy

If you need software on a trial or short-term basis —
you need ATLANTA RENTALS.

Famous names in our huge library of software include all
Visicorp products, Micromodeller, Desktop/Plan,
Microfinesse, Microplanning, TABS, Padmade, Wordstar,
Cardbox, Format-80, dBase II etc, etc.

We also provide the hardware — Apple II and Apple III
and now the Sirius 1, plus top quality printers, monitors,
hard and floppy disk drives, sheet feeders, line plotters, and
all peripherals to complete the rental picture.

No capital expenditure, no membership nonsense,
and no waiting. Fixed charges, full support and
friendly people.

Rental hotline 01-729 1411

Atlanta Data Systems

350/356 Old Street, London, EC1V 9DT. **01-739 5889**

* Business purposes only

LET YOUR MICRO DO THE WALKING!

Organizations from Europe and America will
exhibit billions and billions of bytes of useful
information available to your micro at the end of
a telephone line.

Now in its 6th year, the *Information Technology
& Electronic Publishing Exhibition* opens an
exciting window to a world of facts and figures
ready to be tapped by your micro.

**INFORMATION TECHNOLOGY &
ELECTRONIC PUBLISHING EXHIBITION**

CUNARD HOTEL, HAMMERSMITH, LONDON

7-9 December 1982

Bring a copy of this advertisement and pay £1 instead of £2 to
enter the exhibition.



Learned Information Ltd., Besselsleigh Road,
Oxford OX13 6LG. Tel: (0865) 730275

PUT AN apple IN YOUR 1982 XMAS!

DEANS OF KENSINGTON XMAS SALE

APPLE II EUROPLUS 48K

£499.95

Regular Price £700 plus
Dean's Xmas Sale Price
You save £200 plus!

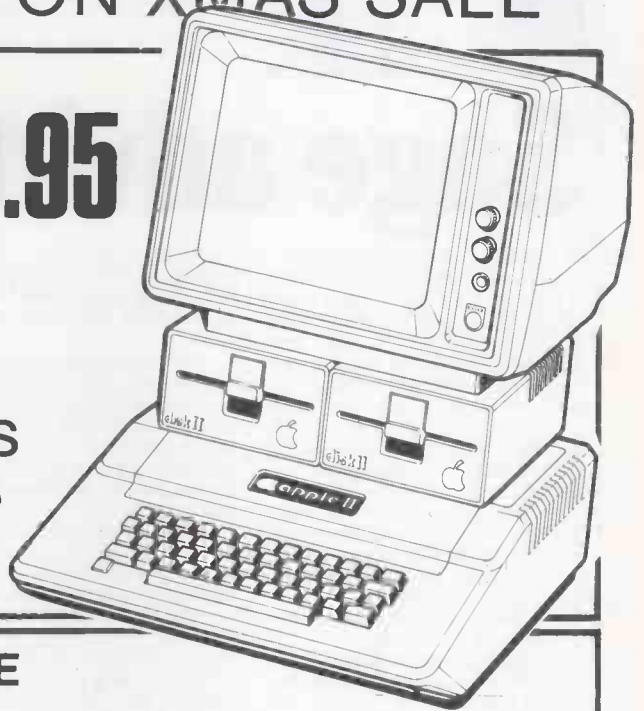

STOCKING STUFFERS FOR THE APPLE OWNER . . .

- DISK DRIVE W/CONTROL £269.95
- DISK DRIVE £219.95
- EUROCOLOUR PAL B CARD £64.95
- CP/M SOFTCARD £179.95
- PLUS!! A COMPLETE SELECTION OF BOOKS FOR APPLE!!**

SAY "MERRY XMAS" TO YOUR BUSINESS. . .

- | | | | |
|--------------------------|---------|--------------------------------------|---------|
| APPLE WRITER 2 | £79.95 | VISICALC | £109.95 |
| GREEN MONITOR | £89.95 | 16K RAM CARD | £69.95 |
| 80 COLUMN CARD | £119.95 | DISC DRIVE W/CONTROLLER | £269.95 |
| APPLE POST | £27.00 | DISC DRIVE W.O./CONTROLLER | £219.95 |

COMPLETE BUSINESS SYSTEMS FROM £859.95!

PRICES EXCLUSIVE OF VAT. CASH ONLY, PLEASE. PRICES SUBJECT TO CHANGE.

WE STOCK APPLE III, ATARI, COMMODORE, DRAGON, OLIVETTI, RANK XEROX, SHARP.

MAIL ORDERS & ENQUIRIES WELCOME, SEND SAE FOR QUOTATIONS.
TELEPHONE ORDERS & ENQUIRIES WELCOMES DURING OPENING HOURS

DEANS *of* Kensington

**OPEN MONDAY-SATURDAY
9.30-5.30
INSTANT CREDIT AVAILABLE
LEASING TERMS AVAILABLE**

191 Kensington High Street, London W8
Tel 01-937 7896



Guy Kewney delivers his monthly package of micronews.

Sage advice

A machine which runs programs 14 times faster than an Apple, costs £2,500, and bases itself on something that really is better than CP/M is the sort of machine which some of my colleagues are understandably excited about.

The makers are even more excited. 'More performance for £2,500 than any computer in history,' they say.

These voices, I would say, are the voices of people who love to write Pascal programs.

The Sage II, however, isn't quite as wonderful as they make it sound because the world, unlike my colleagues and the Sage people, does not (yet) understand the language Pascal, or the associated p-system 'foundation' of the Sage.

The Sage uses the powerful Motorola 68000 chip as its central processor. It runs (Sage says) 14 times as fast as a standard Apple II.

There are a lot of machines with that chip inside now, and they all share the high price tag.

What the Sage actually is a signpost. It shows that a computer doesn't have to be vastly expensive, or an imitation of a minicomputer, just because it has a Motorola 68000 processor inside it.

But what it actually is not is cheap.

The price at £2,500 doesn't include a display or keyboard, or printer, nor any usable software.

It does include the means of producing programs which you could then actually use, because it includes compilers for various languages.

The price of any computer is made up of two things — the purchase price of its components plus a profit margin on the one hand, and an extra amount to cover the costs of developing it on the other.

A Sage II computer consists of (hardware): a floppy disk, a circuit board with some chips on it, and some wires and plugs all in a box. The disk is better than some, and there are more chips inside than in some computers. But that said, the difference between this box and the next, in raw materials, is only a couple of hundred pounds.

For instance, the total cost

(in components) of a Sirius1 is around £500 — including two disks, screen and keyboard (and quite nice ones, too).

The Sage also includes (software): the UCSD p-system (version 4.1), plus the associated Pascal compiler, a Basic compiler, a Fortran compiler, a macro assembler, and a goodly package of utilities.

You could sell this package on the open market for more than £500 without raising an incredulous eyebrow.

But then again, the number of customers who would actually want that shopping bag full is rather limited to specialist programmers. For them, compilers are essential tools.

For the rest of us, compilers are what we expect the software supplier to use in writing 'real' software — accounts receivable, text processing, stock control, and Adventure Invaders.

And by the time you have bought those, you will find your bill for the complete system ending up very much the same as for a Sirius (or, for that matter, an Apple III — which proves something about the Apple III).

That sounds like a lack of enthusiasm: it isn't. It is just emphasising that we are talking about a system (working) which costs £3,500, and that this is not 'cheap'. In the context of a 'not cheap' computer, the software available is less than thin.

For accountants, things are rosy enough — several brands of integrated accounting software run on the p-system background. They include Systematics, Ormbeta and Jarman brands.

There is only one test editor that Sage's UK agent was able to tell us about: something called an ASE editor 'with sprinter text for matter for technical publications' — something sold by Sage's UK agent itself, TDI.

There are one or two Visicalc equivalents, there is a little comms software, and Micro Expert. And there are some database packages.

I suppose you think I'm making rather a fuss, but I'm still smarting from the injus-

tice of being accused (in print) of 'perpetuating the myth of a lack of software for the IBM PC'. And since IBM itself has so far refrained from releasing its micro over here because it happens to believe the same myth, and since the amount of software for the IBM is a veritable gold-mine compared with the stuff for the Sage there are real grounds for vehemence.

Now, a small surprise for you.

I think the Sage is nearly the greatest thing since sliced bratwurst.

The reason I like it is that it is the first reasonably priced machine to offer the incredible power of the 68000 in as single-user package.

What is the point, you may well ask, of having a 68000, which can solve your problem five times faster than any other chip, and then find some clown has stuck it in a box where it has to service four other people, all on the end of their own terminals, at the same time?

The point of doing that is (since you ask) that there are a bunch of ignorant lunatics who will buy such things, because they see multi-user minicomputers costing £15,000, and the multi-user micro at £8,000 looks like a bargain by comparison.

The Sage, however, (if I ever get one) will be mine, all mine, and nobody else can interrupt my processor and start searching through his silly database for a non-existent order just when I'm trying to do a big file-backup in a hurry.

Somebody out there put a sort of SuperWordStar on it. Please. TDI is in Bristol, and can be contacted on (0272) 742796.

UK Vector

The arrival of a UK based home office of American system builder Vector Graphic poses an interesting question: how long can 'mainframe' or S100 based microsystems continue to produce big revenues simply because they are cheaper than minicomputers?

Because its systems are not cheap (prices start at £3000 with virtually no software for office applications) each sale is both big-revenue and big-profit.

So the fact that Vector is now only six years old and is already a \$36 million operation makes it sound as though it is the micro world incarnate — fast-growing, forward-looking, high technology, micro revolution, and so on.

In fact, Vector produces



The reason this box doesn't look like much of a computer is that it isn't much of a computer. It's a bank window. Microperipheral Corporation in Washington State sells it for \$100, so that you can plug it into a television and a phone, and use it to transact business with your bank. It is rather like viewdata systems (Prestel, Telidon and so on) and it only works if your bank has equipment to receive the call.

According to Microperipheral Corporation, the box was presented to the recent 'Instant Teller' conference held by City National Bank in Phoenix, and was very favourably received by 90 banking institutions.

I don't want one myself, but I thought it worth noting, since people still do seem to imagine that our Prestel system somehow gives us a two-year lead over the rest of the world — and clearly, it doesn't.



The Vector 4: see 'UK Vector'

standard equipment (in the eyes of many there is no higher praise) that outperforms others by good engineering. It has added to its range by producing a system that runs 16-bit (IBM style) software.

And it provides 'big' systems by putting a lot of ordinary CP/M machines into one box, and making it look like a multi-user mini — because there are a lot of people out there who will buy such a thing, even if they really want a lot of ordinary CP/M machines.

The new company (Vector in Europe) has a new product (the Vector 4) which uses the same micro which runs the IBM and Sirius and DEC Rainbow machines — the Intel 8088.

It can run CP/M and CP/M-86, if it wants to. It looks good in an office. It is (to my mind) not underpriced, but not astonishingly overpriced, either — and in this world it looks like good value for money by comparison with a lot of systems.

But, the question is: can those other systems stay around for comparison? Can the run-of-the-mill S100 system compete with Rainbow and IBM designs, which are cheaper, more glamorously attractive, and carry the magic labels of their builders?

It's a question which doesn't concern Vector directly, but the other S100 system builders, all facing the same question: what can they offer the 'user with a bigger cheque-book' that can't be got cheaper on systems around £1,000; or how can they keep up with the marketing strengths of the big

IBM and DEC dealers?

My own opinion, for what it's worth, is that the multi-user market (both multi-processor and multi-taking systems) will continue to flourish, despite its obvious lack of fundamental logic, simply because the network world is dragging its feet.

And as long as it does, Vector will shine brightly by comparison.

Eventually, as with the big Vector systems, we can all link the machine of our choice into a chain of identical 'modes' on a network, rather than buying a central processor and attaching terminals to it.

It will be very interesting to see how the 'central box' approach is received in the market when that happens.

Vector in Britain is in Windsor, at Vector House, William Street, Windsor, Berks SL4 1BA; phone (07535 69375).

Prizes, prizes

There is no shortage of people offering prizes for software to do with education, is there?

There are usually only two reasons for doing this — either publicity, or simply the software itself.

In the case of Apple's Young Programmer of the Year contest (closes end January) the unusual prize of an Apple II with colour display is offered to the best program of 500 words (?) or less in length, written by somebody who doesn't turn 20 until 1983.

In the case of Micronet 800, the reason is software — the network wants to supply it to network subscribers

(that was the whole point of the network after all) to encourage them to join.

For Apple, the real prize is to prove that the machine is unusually suitable for educational work. 'Programs will be judged by a panel, looking for strong relevance to education,' says Apple.

It doesn't just want one program, either — there are 300 runner-up prizes, 50 of assorted books and software, plus (a dead giveaway) '250 copies of the book for programmers and users, *An Apple for the Teacher* published by Sigma'. There are 1000 wall posters printed already, 'suitable for educational establishments and shop premises', publicising the competition.

Both these groups are playing it straight: if you submit a program, you keep copyright and can negotiate it for a fee. Not everybody is quite so straightforward, and there have been competitions in the past where the entrants were merely providing the organiser with a mass of free software.

Apple is at the Education Department, Apple, Eastman Way, Hemel Hempstead, Herts HP2 7HQ. Micronet 800 can be contacted on Peterborough 265666.

A likely tale

I know it can't be done — but the idea of turning the Sinclair ZX Spectrum into a 'powerful nine octave electronic organ' so appeals to my sense of humour that I just had to pass it on.

The claim is by PDQ Software of Edenbridge, Kent. The product which performs this miracle is not (as you might suppose) a powerful amplifier, set of synthesisers and other audio hi-fi stuff, but a program.

What the program does is

to pick up your touch on a Spectrum key, and do the hard work of calculating a BEEP statement for you. It then BEEPs that note, displaying a picture of the note and the BEEP number on the screen.

With the program comes a keyboard overlay, so that you can see which note is on which key, and how to change octaves.

But not with the program (at £6, what do you expect?) is anything to make the Spectrum play more than one BEEP at a time, nor anything to guarantee that you will be able to hear the damn thing, anyway.

Spectsound (the name of the program) is worth buying for one thing alone, however: with it you get a BEEP chart. This converts notes to BEEP numbers, and vice versa.

Details by mail only: money or queries to Parsley Rye, Hilders Lane, Edenbridge, Kent TN8 6JU.

Beeb aids

At the moment, there is no program to run on the BBC Computer which helps you draw graphics, edit them, and move them around memory.

There is, in the meantime, a series of paper aids, with graph paper that helps you keep track of odd bits in memory.

There is also a flow-chart pad, symbol design pad, and a series of binders to keep them all in.

Details from Intastor Micro Aids, Freepost, Stroud, Glos GL6 1BR.

CP/M Fair

The idea of a CP/M Fair must be absolutely unique in the history of computing. It is going to happen, nonetheless,



This appalling grey photo shows a 'low cost object recognition system' using a BBC Microcomputer.

It is built by Digithurst, in Royston, near Cambridge, and here it is trying to prove that it can recognise the spanner which the television camera is focussing on, as a spanner.

The system also works with Pet and Apple hardware. Cost including software but excluding the central micro is around £2,000. Details and a better photo from Peter Kruger on Cambridge (0223) 208926.

in January in San Francisco. Previous gatherings of like-minded user groups have always centred on a language or a machine — and, mostly, the languages on one machine have been different enough from those on other machines to keep IBM users from discussing Cobol with Honeywell or ICL people.

CP/M, however, is an operating system which is not native to any one machine more than any other. The problems which CP/M software designers have vary from machine to machine, but still have more in common with each other than they have to distinguish them.

The scope of the show is enormous. Over 200 exhibition stands are planned, and these 'will show the full spectrum of application packages, development aids, microcomputers (how did they get in there?), peripherals, accessories, publications and services available to CP/M users.'

The strength of the show is at the same time its weakness.

The strength lies in the fact that this is an 'official' CP/M show, with Gary Kildall himself (the inventor and boss of Digital Research which sells it) plus people like Tony Gold, founder of the CP/M Users Groups and of Lifeboat Associates, and people like Adam Osborne, who swears by the system and sells a machine which runs it.

In other words, the people who can answer your questions will be there.

But the weakness lies in the fact that the dissidents will not be invited to speak. The organisers will claim that there is no point in having dissidents at workshops, where people are trying to get things done, not question the basis of why they need doing.

The organisers will therefore fail to consider ways of moving CP/M away from its dreadful limitations.

By limitations, I don't mean faults. Digital Research, at press time, was planning to announce a new version of CP/M itself, supposedly eliminating many of its known faults, but those faults aren't the important limitations.

Limitations of CP/M are all derived from paper. CP/M is a standard, and it assumes that you may want to talk to a CP/M machine from a remote teleprinter.

The effect of this is a catastrophe on a comparable level to what would happen to air transport if laws were passed insisting that aircraft should be capable of pulling trains through tunnels.

You can't say this, however, to a CP/M believer. To such a one, the fact that CP/M is a standard is all, and if the standard implies a lowest

common denominator, so be it.

Yet without this assumption, we would have had concurrent screens, because there would be nothing to stop them. We would have global, relational data structures, because you could look at them. We would have flexible screen formatting, we would eliminate dual terminals, we would have screen editors, and we would have soft keyboards and screens.

Anyway, that isn't what you will get at CP/M-83, which is the name of the exhibition and conference.

For what you will get, contact Digital Research, or Northeast Expositions Inc, which is contactable at 824 Boylston Street, Chestnut Hill, Mass 02167. Phone, if you like, (617) 739 2000.

The exhibition runs from January 21 to 23.

Wider VIC

Commodore is now preparing for the day when it stops selling the VIC-20, at £160 or so, and tries to make people buy the Commodore 64 at £300 or so — and of course there will be those who will still carry on wanting the VIC.

However, they will quickly come to realise that 23 characters spread across the width of a television screen are 23 very fat characters, and very hard to read.

Dutch firm Computer World (no relation to an American computer newspaper of the same name) has produced a little plug-in circuit which gives the VIC either 40 characters or 80 characters per line of screen. VIC users will be impressed.

However, since the add-on costs the best part of £150, it is possible that they will eventually come to wish they'd just bought the 64 right away.

Details from Holland at Hilvertsweg 99, 1214 JB Hilversum, phone (035) 12633.

From the horse's mouth

The next fifteen years, thinks Clive Sinclair, inventor of the ZX range of micros, are likely to be a turning point for our civilisation, when computers provide us with the means to real freedom.

Clive Sinclair is not just a rich man who sells cheap computers, but a fully paid-up high octane brain user (being head of British Mensa) and optimist or visionary.

As a consequence, the BBC2 television programme *Futures* felt he was a good person to put on display when they needed somebody to explain why the world might feel warmly welcoming towards microcomputers.

Clive felt that more people should grasp the fact that automation is our friend, and actually went so far as to suggest that a Golden Age might be just round the corner.

Not everybody will instantly recognise his vision as one of the Golden Age — at least, not at first, because the first prediction he made on the programme was that manufacturing jobs in Britain are going to drop still further. And unemployment, he said, will rise to at least seven million.

'Daunting this may be; disastrous, not,' he said. 'We do not need a manufacturing industry to be wealthy. The truth is that Britain is in the wrong part of the world to make conventional goods. I believe any products with a strong creative content can be made here profitably.'

In other words, we must become a nation of designers, and let the low-cost labour nations become producers, he thinks. 'We must turn from the products of the material to products of the mind; books, video-tapes, tv programmes, computer programs, design services, consultancy of all forms.'

In such ways, seven million jobs, creative, enjoyable and rewarding (and highly paid) jobs can be produced by the 1990s, he says.

Behind this (I think) dubious theory lies Clive's unstated belief that if people whose opinions are generally

valued (like himself) go around making encouraging noises, other people will be encouraged to start doing useful things. 'Laugh, and the world laughs with you,' in simple words.

Oddly, perhaps, I agree that things in Britain and Europe will get more golden rather than less (no doubt Clive is delighted to hear me say so) but not because of our creativity, nor the power of infectious giggling.

The vast majority of humanity is bitterly poor, living on the equivalent of a bowl of rice a day — and by comparison, even the poorest Westerner is an immensely rich person.

And while things may get, for a time, marginally worse, then (perhaps) marginally better from decade to decade, there is no obvious way for the poor nations to gain the sort of control over international finances which would give them our relative wealth.

In the end, of course, simple overcrowding can't be avoided, and simple starvation, already widespread, will become the norm, and eventually there will be a plague.

We, in our Golden Age, will send blankets, and will tut-tut over the difficulty of getting reliable sub-contractors to build cars and computers, in their low-wage economies, the way the rich always grumble about the problem of finding reliable

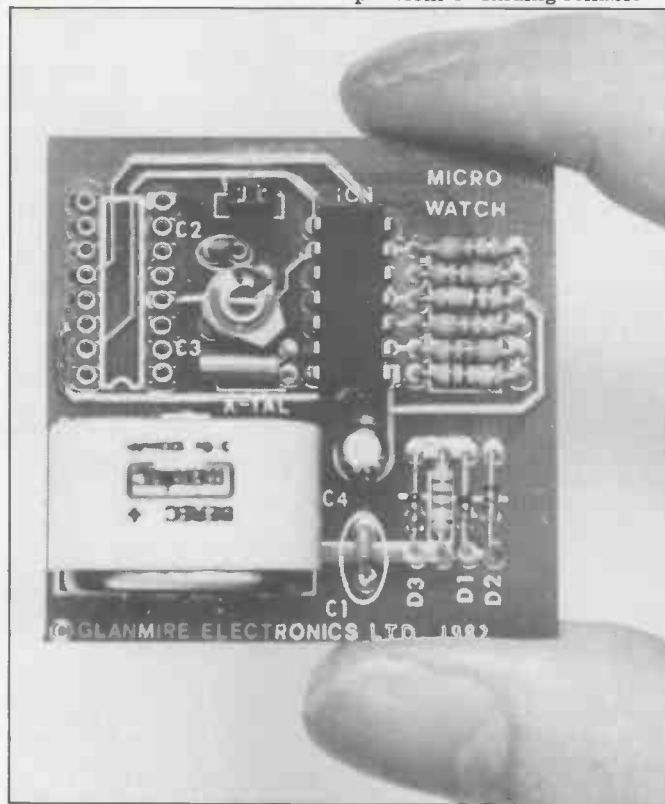

You have a quartz watch — so perhaps your Apple II should have one too. It'll also want the software needed to read the watch. The Micro Watch (a real-time clock card) and an Electronic Diary program which uses it, are both available from Glanmire Electronics, of Cork. Contact them on 128 Oliver Plunkett Street, Cork, or phone (Eire, remember) 021-500418.

Still Need Convincing?

SOFTWARE FACTSHEET

Product: CARDBOX	Type: CardIndex
Retail Price: £155	Machine: CP/M & MP/M
File Size: CP/M 8MB MP/M 16MB	Records: 65,500 maximum
Record Size: 1484 ch maximum	Fields: 26 maximum
Field Size: 1484 ch maximum	Index Limits: None

Notes: Allows complex searching using up to 99 separate criteria.
Widely available from distributors in USA, UK and Australia.

Published by Caxton Software Ltd of London.

The Critics Don't....

"Cardbox is your familiar, tried and trusted card index... with most of the features you have always wanted on your manual card index but couldn't have, because of the limitations of pieces of card."

"Cardbox... succeeds extremely well. Its facilities for indexing and searching are good and very fast... the user image of the screen displays and the documentation are in the main excellent."

Personal Computer World, August 1982

"The interesting thing... is the display... Cardbox enables you to draw a form on the screen complete with headings."

"Cardbox is an excellent database manager... its versatility... and its ease of operation make it a useful program for home or business."

InfoWorld, September 13, 1982

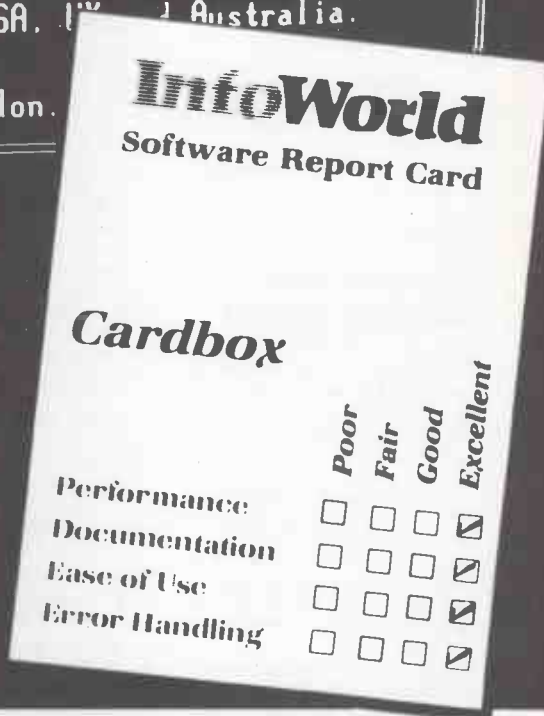

Anyone can use Cardbox. It's a simple yet powerful electronic card indexing system. Easy to learn and easy to use, Cardbox is bringing real computer power to hundreds of new users.

Put yourself in a user's shoes:

- You wouldn't have to change your present working methods or think in computer terms. Cardbox talks to you in plain English.
- If you can do it with a card index you can do it better with Cardbox thanks to its sophisticated automatic cross-indexing.
- Up to 65,500 'cards' can be stored and they can be displayed, printed or passed to other programs in any number of alternative formats.
- Groups of 'cards' can be selected by any word in any field. Your choice can be refined by using up to 99 words in a single search.
- Information is easily added, changed, duplicated or deleted.

These are just a few of the reasons why the top British and American micro journals are convinced Cardbox is the ideal card index for CP/M users.

Cardbox - the ideal card index system for CP/M users

Caxton Software Ltd, 10-14 Bedford St, London WC2E 9HE. Tel: 01-379 6502. Telex: 27950. Ref: 398

Caxton products are available from leading microcomputer suppliers in the UK.

CP/M, MP/M are trademarks of Digital Research Inc.

I am an End User Dealer Distributor/OEM

Please send further information. Business Card attached

Please send _____ copies @ £157 + VAT (includes P+P)

A cheque for _____ is enclosed.



servants.

But the majority of humanity will continue in grinding poverty. The habits of the last three thousand years aren't about to end in a couple of decades just because of the microcomputer.

Unless, of course, it is the microcomputer that presses The Button.

Howzat?

An unusual claim to fame by a software writer: Microchat of Penistone in South Yorkshire is into cricket and rugby, producing the software which drives the Headingley scoreboards.

'We maintain we can write software for any application on virtually any machine,' they say — the scoreboards were controlled by a Hewlett Packard HP-85, and they did a marathon scoring system on an Apple for McEwan's Lager, and an insurance system, and a joinery job costing system.

Getting someone to write your own software is not normally a good idea on a micro, but if you must, I suppose these are unusual enough credentials to warrant a mention.

Microchat is on (0226) 765927.

Saving scrap

Horrible old Teletype printers, for which people used to pay nearly a thousand pounds because they were the cheapest sort of printers you could get, are nowadays sold as scrap.

For users of cheap Sinclair ZX machines, however, those romantic clanking ruins are worth salvaging from the scrap heap, and are usable to record things that the machine produces, on paper.

All that is needed is an interface — something to connect computer to printer.

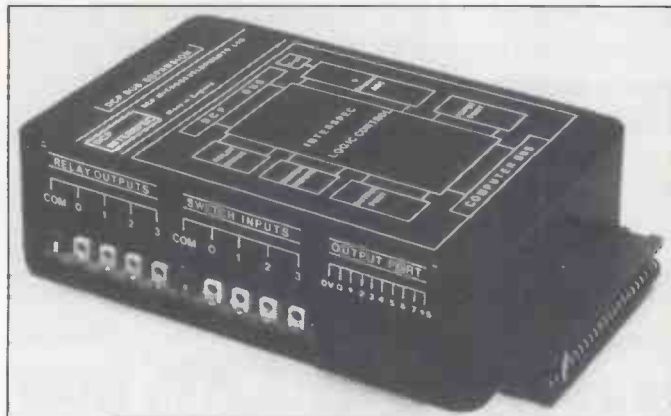

The pattern laid out on the top of this cigarette-box size package is a sort of circuit layout, showing what the box can do for a Sinclair ZX Spectrum. Round the edge are colour-coded sockets into which wires can be wedged. They can be input analogue signals, output relay lines, switch input and output, and two I/O ports.

In other words, the DCP Interspec connects the Spectrum to other electronic equipment from automatic washing machines to pianolas. Details on Norwich (0603) 712482.



For £19.50, plus an additional £2.50 for a bit of software, this is now available from Sofstest, 10 Richmond Lane, Romsey, Hants SO5 8LA.

Market gardening

Despite the fuss that 16-bit machines are causing, software house Peachtree obviously thinks that it is more significant to be able to run its accounting programs on the Apple II for the first time, than on the CP/M-86 family.

At the moment, of course, the programs will probably run on any IBM Personal Computer you can get your hands on, but Peachtree isn't going to say that, for fear of offending IBM.

So the company refers coyly to 'CP/M-86 16-bit machines including the Sirius 1 and Victor 9000' (identical machines).

The programs are all written in Microsoft Basic. Details on Maidenhead (0628) 71011.

Comspeed

To anybody with a Commodore machine, the simple statement that Petspeed is now available on the Com-

This is the sort of picture you normally use a Tektronix screen to generate. Here, it is being done with an IBM Personal Computer on a screen and graphics tablet from Computer Displays Ltd.

It may give you something to do with an IBM PC (all you need is the PC!).

Agent is Riva Terminals: details on Woking (04862) 71001.

modore 64 is all this item has to say.

To the rest of the world, all one needs to add is that Petspeed compiles Basic programs into faster code which can run anything from twice as fast to 40 times as fast as the original code.

Details from Oxford Computer Systems on Woodstock (0993) 812700.

No sex, please

Possibly the idea of a program which plays selections of Robert Carrier's menu recommendations on a VIC 20 is a silly idea, but I don't see why former PCW publisher Felix Dennis had to get quite so hysterical about it.

A less silly idea, I think, is Ivan Berg's latest program for the machine: a transcription of the tests in Hans Eysenck's book *Know Your Own Personality*.

The machine asks all Eysenck's questions, and then plots the personality rating on three ways of reading personality.

Unfortunately, Berg has left out the two really interesting aspects of personality — social/political attitudes, and sexual attitudes.

'We didn't want it to be too long, and wanted to leave something out,' he said. 'Anyway, the sexual one was very explicit, asking questions about orgasms, and so on.'

I think it would make a great party piece, and I hope he brings out part two very soon.

He also does 'Know Your Own IQ' which may not tell you much about your brain, but will certainly make you good at doing IQ tests, if you're thinking of joining Clive in Mensa.

Micro mania

Help is coming to muscular dystrophy sufferers from Tandy in the form of a

national games competition to raise money for research into possible cures for the disease. Every Tandy store has been equipped with a TRS-80 Color running Tandy video pinball games and members of the public can pop into the store, pay 50p and attempt to reach the highest score in their region. All winners will receive a TRS-80 Color Computer as their prize and are invited to a national play-off at the *Which Computer?* Show on 18 January next year. The national winner will be presented with two disk drives and an extended software and memory pack, giving a prize worth over £1000.

Anyone (except, presumably, Tandy's employees) is entitled to have as many tries as they like at the game — the more the merrier, in fact, and all money raised will be donated to the Muscular Dystrophy Group. In addition there'll be well-known personalities promoting the venture throughout the country.

The first games were played at a press launch on 19 October and the competition will close on 8 December. Tandy is the first micro manufacturer to organise any kind of charity-based promotion and the competition is a first for the Muscular Dystrophy Group.

Accounting for taste

Quote: 'Although business software for microcomputers has been available for some time' (true) 'Padmede Computer Services has now developed a new system, which is designed to provide faster operation, more flexibility, and greater integration.'

Padmede said that. The software is accounting software, and the word

'integration' is a magic word when it comes to accounting software.

It runs on CP/M or MS-DOS operating systems.

Apart from that, all you can say is that it is available, and try to find out from a user what it is like, because there is no way of describing it in print. Details on Fleet (02514) 21892.

Quite separately, Mediatech has also announced a range of accounting programs called Accounting Plus, which were originally supplied on the Eagle Computer range.

It is probably the most comprehensive CP/M accounts package available on the UK marketplace,' says Mediatech, adding that modules cost £400 each except for the £600 payroll module.

Again, not much point in adding anything to their claims except the phone number: 01-903 4372.

Apple walker

The baby, the Apple and the teddy bear are all trying to make sure that the baby will be able to walk.

Apparently a few of us (human beings, not teddy bears) are born with dislocated hips. Normally, the only way to tell is to wait until we can't walk a couple of years later, and then wish we'd detected it at the time, because now you're stuck with painful operations, and not much chance of ever getting a normal hip.

The way to tell that you have dislocated hip joints is to listen. Unfortunately, doctors aren't very good at detecting the difference between the sounds made by a normal baby's hip and a dislocated hip.

Apples, however, can do the job.

The one in the photo is at the Musgrave Park Hospital in Ireland, and is produced with extra hardware and software to listen to joints clicking, by Medical and Scientific Computer Services Ltd of Lisburn, County Antrim.



Helping the very young: see 'Apple walker'

According to Robin Jelly, managing director of the company, the software took a few tries to get right.

'Data comes from the transducers attached to the baby, every 100 microseconds,' he says, 'and is analysed by a complex machine code inside the 48 Kbyte Apple.'

'The trouble was that originally the machine code program took 130 microseconds to run. It had to be "tuned" to get it faster. It now runs in 96 microseconds.'

After clinical trials, the equipment will be marketed around the world. Anybody interested should phone (08462) 77533, or write to the company at Altona Road, Lisburn, Co Antrim, N Ireland.

You don't get a free teddy bear, however.

Spreading the word

To the many people who use CP/M machines because they have to (because the software they want to use runs on a CP/M machine) it will seem strange that there are people who use it because they think it is wonderful.

Like all cranky religious sects, these people don't take criticism of their God kindly, and look forward to the spread of his Gospel into the next generation of machines.

These people will be delighted to hear that Euro-micro, a company which makes fairly expensive systems based on the old S100 standard circuit boards, has moved not only CP/M but its multi-user brother, MP/M, into the world of 16-bit processors.

It has produced a processor board which fits into the S100 box, and has two micro chips on it — the Intel 8085, and the 8086 — the 8086 being the full 16-bit chip of which IBM and Sirius use the chopped-down 8088 version.

This system starts at a mere £4000 for a single-user version with disks and display, so it clearly isn't the



Logic analysers made by Thandar enable computer designers to check out new microsystems; one of the customers who used the Thandar 2080 now reckons to have improved its design.

'It had disadvantages,' according to Dataman Designs. 'The output was solely to the screen, not to the printer, so only a small part of the data could be seen.' Also, no disassembler was available to turn the raw octal, hex or binary code into sense.

The system works with either Z80 or 6502 chips. Cost is around £2000. The photograph shows the new menu to control all the new features. Anybody who is not a computer designer, ignore it. Otherwise, contact Dataman on (0300) 20700.

price which makes it interesting.

What makes it interesting is a combination of things: first, the fact that (like the Digital Equipment Rainbow) it has both 8-bit and 16-bit processors together, and can tell which processor to apply to which task; and secondly, that it can actually run 8 and 16-bit programs simultaneously.

The software which makes this possible is a new version of Digital Research's CP/M family, MP/M-86.

There are those (and I agree with them) who say that putting multi-user software on a cheap micro is a silly idea. If you would like the argument in full, read Brain Dump; for now, it is enough to say that it is usually cleverer to get two cheap micros than to buy one expensive one and connect it to two display terminals for two users.

Despite the fact that it is a silly idea, it will continue as long as the minicomputer makers ask £20,000 for the smallest multi-user system they make, and make the smallest system less powerful than the average micro.

It is the recent past, the idea was even sillier, because MP/M was needed to do it, and MP/M could not be trusted.

On this system, however, you don't get MP/M, but its 16-bit relative, MP/M-86.

Euromicro's boss, Jim Wood, says that yes, he accepts that MP/M used to have its flaws, but no, MP/M-86 is a new product, reliable and to be trusted. Wood is actually a very honest man so, at the very

least, we can accept that if there do turn out to be flaws in the software, they are flaws he could not have known about.

The only thing that rather puzzles me is the use of the Intel 8085 chip, rather than the Zilog Z80, as the 8-bit processor.

To be sure, the 8085 chip can run a good deal of CP/M software — but if you are paying this sort of money for a 16-bit system, then surely the only reason for throwing in the 8-bit half is to make sure that the customer can keep any and all of his old CP/M programs. And while the Zilog chip can run most software that the 8085 can run, the opposite is less true, and the Zilog is, today, the better bet.

Euromicro is on 01-341 2447, and past fans will recognise that number as one which used to belong to Ithaca Intersystems. It is the same company, but Olivetti bought the US parent, and the name — they had to change the European name as a result.

Blowing up a storm

Anybody who has written a Basic program longer than 20 lines will have found, one day, that there are two instructions to GOTO 200, and they can't remember where the other one is, or that there are three GOSUB 3000s and one of them is line 450, but what of the other two?

On the Apple these people can now do a simple search for a string, using new soft-

ware called Gale, from MicroSparc.

Gale 'gives Applesoft programmers the ability to perform global searches and replacement of any specified character or characters throughout a program,' says the supplier in Lincoln, Massachusetts. 'Line by line editing allows you to make fast changes without recopying an entire line — you can delete characters, insert characters, compact a line by replacing PRINT statements with the equivalent (a question mark), enter lower case characters, and so on.'

Details on PO Box 325, Lincoln, Mass 01773, or try phoning (617) 259 9710.

Three card tricks

In the nicest possible way, the Director of Fair Trading has warned micro suppliers that a lot of their products look like a three-card trick to the public.

Marvels such as automatic checkout machines, automated shopping and banking, and viewdata catalogues, he says 'have potential benefits to offer'.

But: 'I put forward with some force a caution to the innovators that the new

electronic marvels may fail to gain public acceptance — a nice way of phrasing it — 'unless the shopper can plainly see that his or her interests have been safeguarded, and that the benefits do not accrue solely to the shopkeeper and the bank.'

The Director, Sir Gordon Borrie, offers this advice on what 'user friendliness' really means (not just chummy chat on the screen) in an OFT report on the effects of microelectronics on 'the consumer' — you and me.

The report, 'Microelectronics and Fair Trading', is available from the Distribution Unit, OFT, Room 600, Chancery House, Chancery Lane, London WC2A 1SP.

And nation shall speak unto nation...

Chinese micro users now have a machine which they can program in Basic — which, as the listing here shows, is quite a problem.

The word PRINT makes a lot of sense to English speakers, so it is quite sensible to use it in a programming language.



For the Chinese, however, it is daft. Ask the average Streatham computer club member to use the ideogram showing two waffles on top of a barbecue next to a three legged table with a minus sign floating over it, and it is possible that he would regard Basic as a daft language, too.

條列

```

20 方陣 A(20)
30 註解 ASSIGN A(I)
40 從 I = 1 到 20
50 A(I) = 5 * I + 2
60 下個 I
70 註解 PRINT A(I)
80 從 I = 1 到 20
90 顯示 A(I)
100 下個 I
    
```

The solution has been produced by a Taiwanese company called Multitech, which rather thinks it has an idea with world sales potential — because while a lot of people can write English, most prefer to write something else.

The Multitech micro, like Sinclair ZX machines, uses a single key to tell the computer to perform some Basic function.

But on the key, instead of PRINT, you get two waffles (etc, etc). Or in Italy, the appropriate Italian word. And on the screen, the same word appears in the listing.

The essential hardware for each language remains the same, says Multitech; just a plug-in cartridge changes the native spelling of Basic into the local tongue.

Presumably few people will rush for the Chinese one, but nonetheless, details are available: the address is just a bit more exotic than the run of the mill ones usually printed here. It is Multitech Industrial Corporation, 977 Min Shen E Road, Taipei, 105 Taiwan, ROC.

Soft Sirius

The Sirius is a lovely computer (it says in all the

reviews) because you, the user can change the shape of the letters on the screen. The screen is, they say, 'soft'.

Hands up all users who know how to do it, then?

All the rest of you will want Kuma's new character set editor, obviously. Details on Maidenhead (0628) 71778.

Making space

Programmers who earn their living at programming still include a large number of Cobol writers, who will now be able to buy an even better version of their favourite language for micros.

Micro Focus, the designer of CIS Cobol, has now released a new version which 'makes more user space available'.

The operating software which stays in the machine when it is running compiled CIS Cobol code is smaller, in other words.

It has also put new ribbons on: smaller and lighter manuals. The manuals, says the company, 'stand up independently when in use' which I think actually means they don't fall over (see picture) because they are supported from behind.

Worth every penny of £425. Details on 01 722 8843.

Apology

For some obscure reason, the price of the Oric 1 (page 85, Newsprint November) was printed as £499. It should, of course, have been £99.95 — our apologies to Oric Products and any readers who may have been misled.

Apple revamp

One of the most common phenomena in the micro industry seems to be the use of the Apple II as a base for all sorts of interesting add-ons and upgrades either to fit the Apple for use in a specialised environment or to give the machine state-of-the-art capabilities.

Perhaps the reason for the common use of the Apple as opposed to other machines from its era is that it displays

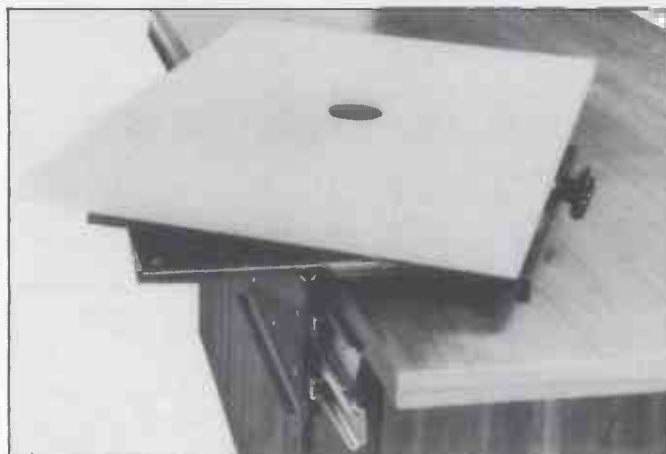
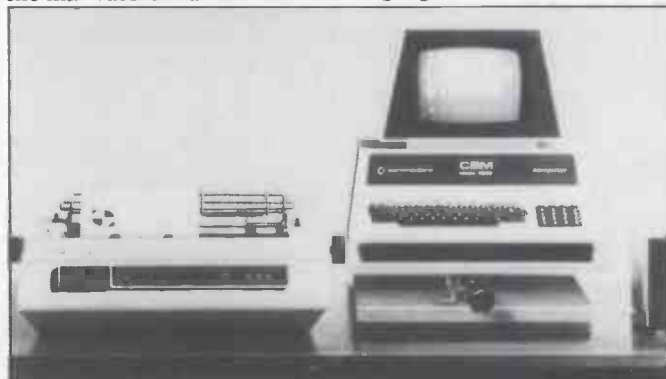

Swivel stands for desks aren't the sort of chip technology you pay to read about in this paper, but for people who have a machine which covers more than half the desk, they may be more important than semiconductor details.

These swivel stands are by Chasmood: they fasten to your desk, and let you slide the computer back and forward, as well as swivel it about.

Chasmood is on (0483) 577161, and they make no guarantees about the stability of your own desk with one of these fastened to the side.

THE OFFICE OF THE FUTURE TODAY

OR LEASE FOR ABOUT
£150 + VAT AND
£52 A MONTH +
VAT FOR 33 MONTHS

1 The heart of this office of the

future is the powerful new Osborne 1 portable computer, with 64k memory, two disc drives and a built-in monitor. The Osborne is linked to an Olivetti Praxis 30 11cps daisy-wheel printer/typewriter for printing your work

superbly. In addition you get a packet of software (sold elsewhere for up to £800) to make your office of the future into a word-processor or a financial planner.

3 The Olivetti Praxis 30 is a new style electronic typewriter with its own memory, automatic erase, and a double

keyboard which gives you 14 extra characters. Use your Praxis on its own as a prestige easy-to-use typewriter,

or plug it into your Osborne and use it as a high quality computer printer.

2 Your Osborne and Praxis are a remarkable combination. The machines are so portable you can carry them both home instead of working late. Plug them together slip the Wordstar/Mailmerge disc into the drive and you have a word-processor as good as costly dedicated systems. Change discs for Supercalc and you have the power of a dozen clerks for your budgets. Then Osborne types your work perfectly on Praxis.

O-COMPUTERS

A member of the C/WP Group
104-106 Rochester Row, London SW1
Telephone: 01-630 7575



This is the Philips Prospect, which Philips describes as a 'budget price start for word processing.'

It isn't a microcomputer, and Philips didn't say what the 'budget price' was. Not encouraging. However, Philips does add that the word processing side has been enhanced, because the system is 'equipped to perform the complex number of information management procedures traditionally associated with the Philips P5000 Series'.

Explain what 'tradition' actually means to someone on 01-636 6561, where you will find the publicity agent who handles business.

both simplicity and versatility. Equally likely as a reason is that many companies (and homes) bought the Apple when it was new and now want the capability of a modern computer without having to shell out for it. The Robocom Bit Stik is one example of this phenomenon.

To add to the legion of gizmos and widgets which stick on the end of an Apple come the XAD1 industrial control card from Xcalibur Computers of Northampton and the Apple with a special power supply from MC Computers of Newbury.

The XAD1 will permit the Apple to be used for measuring analogue or digital signals by providing four channels of 12-bit integrating A/D conversion. It provides a battery packed clock/calendar, contact energisation voltages on board and screw down terminations. There's also the four channels of isolated reed relay contact outputs to add to this list of extras. This card is, of course, designed for the scientific or industrial user as a controller. The real time clock ensures that any measurements are carried out at regular intervals.

This card costs less than £100 (we are not told how much less) and is provided with full documentation providing operation examples. Details from Xcalibur on 0604 21051.

MC Computers' special power supply Apple is a standard machine with a PSU built in which offers the ability to power the Apple from either AC or DC supplies. If both are connected the DC unit is trickled charged from the power

supply. If the AC source fails then the PSU switches to the DC source without interrupting the system at all. Power outputs are short circuit protected.

This special PSU is also being offered as an option within MC's butch repackaged Apple II for industrial use. MC Computers can be reached on 0635 44967.

Maggie Burton

Adventurous games

Influenced, probably, by Kit Williams' Masquerade quest for the golden hare comes a new trend in computer gaming. This is the idea of an adventure game with an ultimate solution leading to a big prize for the first person to crack it. Probably the best known one will by now be Pimania from Automata Cartography. The prize here is the Golden Sundial of Pi — a sculpture in gold and diamonds valued at £6000. Players have to find out where in time and space the sundial is hidden by travelling through a series of gates of Pi and following clues which are very often difficult to find — concealed in music and mixed up with red herrings, for instance. Now Artic Computing has jumped on this new bandwagon with a game called Krakit which carries a prize of at least £10,000 for the first person to solve 12 clues. Pimania will be launched by the time you read this — mid October — and Krakit will be launched on 1 November. Both games will run on the Spectrum and Krakit works on the ZX81 as well. Details of prices and

availability will be advertised shortly.

Artic has also produced a speaking chess game for the Spectrum. This is based on the company's original Chess game, ZXChess which is well known for its strong play. Voice Chess tells you its move, repeats yours and makes sarcastic and ambiguous comments on the state of play. It costs £9.95 and runs on the 48k machine. Maggie Burton

4MHz Sharp

If you'd like your MZ-80K to save and load programs twice as fast, run large programs at a much greater speed and still offer the choice between 2 and 4MHz processing speeds then John Bosco or Steve Oates should have the answer. At £45 their 4MHz board will offer all the above without affecting the MZ-80K's clock or sound. It comes with a red/green LED and switch to indicate which of the two speeds the machine is running at.

Details from John Bosco or Steve Oates on Leeds 520938 or Wakefield 279348. Incidentally, a version is also under development for the MZ-80A. Maggie Burton

Pro Digital

Prospero Software recently announced its decision to

make the Pro Pascal compiler available on the DEC range of personal computers, including the Rainbow. An agreement to this effect has recently been signed which will run initially for five years giving DEC worldwide marketing rights for Pro Pascal on its own computers. Pro Pascal will be included in DEC's classified software directory. Maggie Burton

Festival fun

Here in the bustling capital the GLC has branched out the tentacles of its efforts to promote cultural activity with a computer festival. This is because London is becoming increasingly aware of the micro revolution following the success of such ventures as those organised to mark IT year, the ALCC's annual computer fair and the growing number of computer shops, advice centres, clubs and workshops. The festival will run from 3-17 April next year and is London's first.

The festival will promote and publicise the activities of all relevant organisations offering help 'within the community'. It aims to spread knowledge and awareness of how information technology is used in everyday life and help people get in touch with organisations offering courses, advice and the like.

It will also provide some special events. One of these will be an exhibition from 14-16 April at the Central Hall, Westminster which will include the London Computer Fair. The Festival is being organised by a consortium of the ALCC, the National Computing Centre, City Tech, the North London Poly Computer Centre, ILEA's Computer Centre, the GLC and several London Boroughs.

Anyone who would like to run an event as a part of the festival, be included in its diary of events and promotion or who just wants to know more should contact the Secretary to the Consortium, GLC Central Computer Service, Room 431, County Hall, London SE1 or telephone 01-633 3348. Maggie Burton

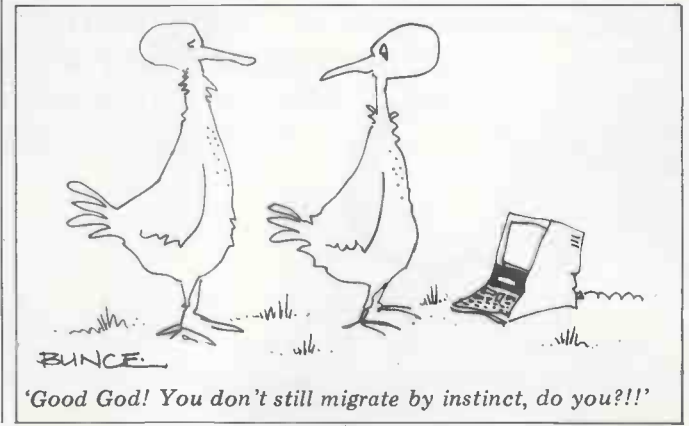

C/WP HAS ITS WAY WITH THE DAISIES

£399 + VAT



If you want good quality print, clean and crisp as a lettuce leaf, you need a daisy wheel printer. But you pay for that quality. Or at least you did, until C/WP, which shrunk Apple prices (yes, still £499 + VAT while stocks last), had its way with the daisies. Now, thanks to C/WP you can afford the smartest print in town.

OLIVETTI PRAXIS 30, baby of our range, not only prints superbly from your computer, but doubles as a portable electric typewriter with automatic erase ribbon and 10

character memory. It's slow (11 character a second or around 5 minutes for an A4 page), but what quality. And what a price – only £399 + VAT. Others advertise the same printer for £480 + VAT.

£499 + VAT

The TEC STARWRITER is an even bigger bargain at just £499 + VAT. It prints bidirectionally and impeccably at 25 characters a second (just over 2 minutes a page) and responds to all the commands Wordstar throws its way. A really professional, heavy duty, thoroughly reliable daisy wheel, which has never been sold at such a low price.



For those who are only satisfied with the best, C/WP offer the QUME SPRINT 5 – the industry standard, normally sold for £1800 or more – for only £1295 + VAT. SPRINT 5 eats up your printing at 45 characters a second (about 75 seconds a page) with unbeatable quality, no fuss and not too

£1295 + VAT

ghastly a noise. Or if you prefer a printer with a keyboard, to use as a typewriter when you want, you can have a QUME SPRINT 9/35 KSR (35 cps) for the same low price, £1045 + VAT.

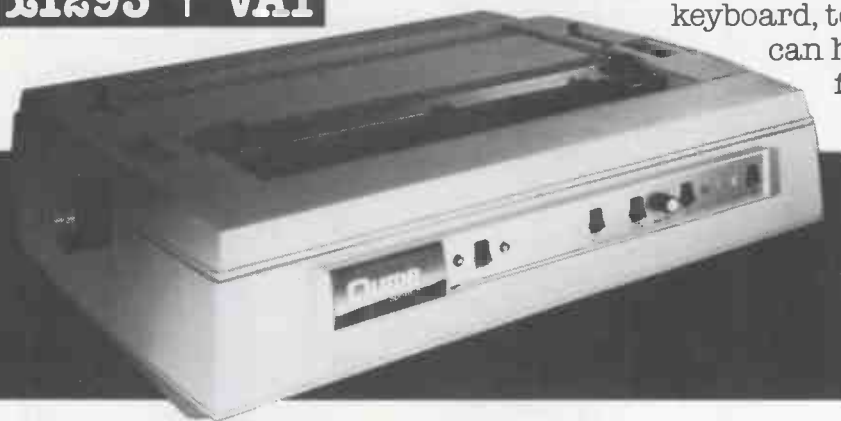

Take your pick of the daisies, and remember ours bloom the whole year long. Most dealers offer you only 90 days warranty on daisy wheel printers. C/WP thinks this unacceptable. All our equipment, including daisy wheel printers has a full year's guarantee covering parts and labour.

C/WP

OUR PRICES TURN OTHERS GREEN

108 Rochester Row,
London SW1.
Telephone: 01-630 7444

Maggie Burton chats about the PCW Show and all the latest news

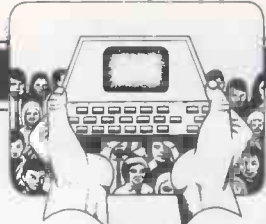

Last month David just managed to slot in a brief mention of what CTUK! managed to do at the PCW Show. Well, thanks to John Bone, I've got quite a bit more to tell you this month. There were two ComputerTown stands this year (an increase of 100 percent on last year) and both were packed throughout the Show — one volunteer said it seemed as if every visitor to the Barbican had dropped by the stands.

Over 8000 leaflets were given out by those intrepid lads and lasses in a big effort to explain what CTUK! is and why it's still getting bigger. Two new 'Towns were promised by visitors to the stands and members of the public had some trouble working out what was actually being sold — a few did not believe that the use of the micros and all that advice was *really* free.

Many youngsters dragged their parents onto the stand to be 'talked around'. John tells me he was unable to beat the Scrabble micros (but so was I) and the signposting in the halls was found to be rather lacking — a few CTUKites did, however, perform the miracle of finding their way to the PCW lounge for a quick drink on the last day — a well-earned one judging by all the hard work that was done.

Some 15 micros were up and running on the stands and I've been asked to add to David's vote of thanks from last month by mentioning Dragon Data and the Newcastle and Notting Dale ITECs for their hardware loans. Several software houses supplied demonstration programs. Thanks also to CTs Romford, Ashford, Croydon, Dorchester and CTNE! (Gateshead), whose members gave up their spare time to man the stands. The ACC is also owed our gratitude as Vernon Quaintance and David Annal were more than helpful in getting the stands booked.

Lastly, but not leastly, for those living in the Thames TV area, the stands were filmed for a short computer series starting in November — watch out for it!

Now onto rather less festive news. Kent County Library has agreed to make space available in all its libraries where possible for CTUK!. Incidentally, you only really need about 12 square feet of floor space to run a small 'Town, so many of them will not be putting too great a demand on Kent's library space.

While still on the subject of libraries, Burton-on-Trent library has, it seems, decided not to allow CT Burton to use the library for nothing. This seems a shame as so much goodwill goes into running a 'Town and it would be nice to think this particular library committee could follow Kent's generous example. The reason for this is, apparently, that granting free use of library facilities would 'set a precedent among other clubs and societies'. What seems to have gone unheeded is that ComputerTown does not request any fees from those who attend, nor does it have any members as such — apart from those who run the 'Towns, whereas the trend among 'other clubs and societies' is to

charge subscriptions or attendance fees.

Chris Woodford of CT Burton is, in spite of the hassle, running a thriving 'Town. He's just started to produce a newsletter in his spare time and other ComputerTown organisers might like to consider this idea. However, there are one or two problems with this. There may be times when one person cannot produce a newsletter alone, for various reasons, and if only one 'Town is producing it money can become a bit of a problem. A syndicate of two, three or four 'Towns could produce a nicely put together newsletter for very little outlay and if it's readable to the absolute beginner it will draw a good response. Copies could be left at libraries or leisure centres or just given out to passers-by in the street. Burton's newsletter is packed with news on micro developments and ComputerTown activities and short articles related to micros — indeed, when you look at the amount crammed into a mere two pages, you wonder if they couldn't perhaps teach PCW a lesson or two on production economy! The letter also includes a quick glossary of all the jargon used within it which, although it's very brief, does introduce the reader to what it's all about.

The letter is, of course, not only applicable to Burton. It's relevant to CTUK! as a whole and contributions are invited for it. If you've got any news on what your 'Town is up to, then you can contact Chris at 31 Hopley Road, Anslow, Burton-on-Trent, Staffs DE13 9PY. If anyone has thought of the idea of producing a national CTUK! newsletter, Chris has thought of it already. He hasn't got the time to do it every month, and if he's to get it going he needs help from one or two others. David and myself would be happy to help in any way we can with production and layout.

Peter Kiff of CT Broadstairs held a special 'education day' on Saturday 10 October in Broadstairs Library for teachers and parents to come along and see how computers can be used in the classroom. This was very popular and fulfilled its purpose of attracting new people to the 'Town. CT Broadstairs is hoping the day will lead to bigger atten-

dance at future ComputerTown meetings. Displays included one of books, and there was a TV screen in the foyer to welcome visitors and tell them where to go. ZX81s, RML 380Zs, a BBC and a PET ran education-oriented software all day.

There have been several successful ComputerDays over the past two years and we'd like to hear about them all in future — in advance and afterwards. Next month we'll have a few ideas on ComputerDays to put forward. Watch this space!

The Prestel index of ComputerTowns has now been moved to another page. The number quoted in the October issue was a temporary page and the new location is page *800803#. Vernon Quaintance of the ACC is the man to contact if you find your 'Town is missing from the index. And a complete list of ComputerTowns will soon be on Rewtel — dial up and take a look if you've a modem or an acoustic coupler. The number is 0277 230959 from 6pm to 9am weekdays and all weekend.

To finish off, I'd like to send our warmest congratulations to Frank Fadipe — the ComputerWeek stalwart — on the birth of his son. We hope he'll grow up happy and healthy and have a bright future.

Computer Town UK! is an ever-growing network of computer literacy centres where members of the public are given free access to micro-computers, courtesy of those willing to volunteer their time and equipment. Computer Towns might be found anywhere — in a church hall, a library or perhaps a school after hours. The aim is to make computers enjoyable and non-threatening and, because Computer Town is entirely non-commercial, any kind of axe-available for those interested in setting up their own 'Towns: Write to CTUK!, 7 Collins Drive, Eastcoke, Middlesex HA4 9EL or 17 St George's Road, London NW11 0LU. Remember to enclose an A4 SAE for your reply. Please don't telephone PCW for information as CTUK! is entirely a spare-time activity.



'The game's up, Clegg! Your user group grassed on you.'

GOODBYE TO FLOPPIES C/WP INTRODUCES A HARD DISC FOR £995.



C/WP have done it again. We proudly announce the C/WP CONTOUR, a range of British-made high technology 5-inch Winchester discs at prices starting below £1000.

Suddenly your micro-computer has come of age. One little box, not much larger than a floppy disc drive, stores up to 21 million characters. That size costs £1995 and stores the equivalent of more than 160 floppy discs, or 35 full-length books. And in a maximum of around a fifth of a second the C/WP CONTOUR finds any piece of information your computer asks for.

C/WP CONTOUR is available now for your APPLE II, Pet, IBM Personal, Sirius, Superbrain and many other CP/M and S100 machines. On APPLE the C/WP CONTOUR supports DOS 3.3, Pascal and CP/M operating systems.

Write or telephone for full details of this great price breakthrough. Now you can afford the luxury of a Winchester.

C/WP CONTOUR PRICE LIST

3Mb (formatted)	£995
6Mb (formatted)	£1195
12Mb (formatted)	£1595
21Mb (formatted)	£1995
Tape streamer back-up (21Mb 4min)	£1495
All prices exclude VAT	

C/WP FOR BIG VALUE IN HARD DISCS

C/WP

C/WP Computers
108 Rochester Row, London SW1P 1JP
Telephone: 01-630 7444

See us at the Compec
Show Stand No 9036.

A NEW BRITISH PRINTER TO BEAT THE WORLD!

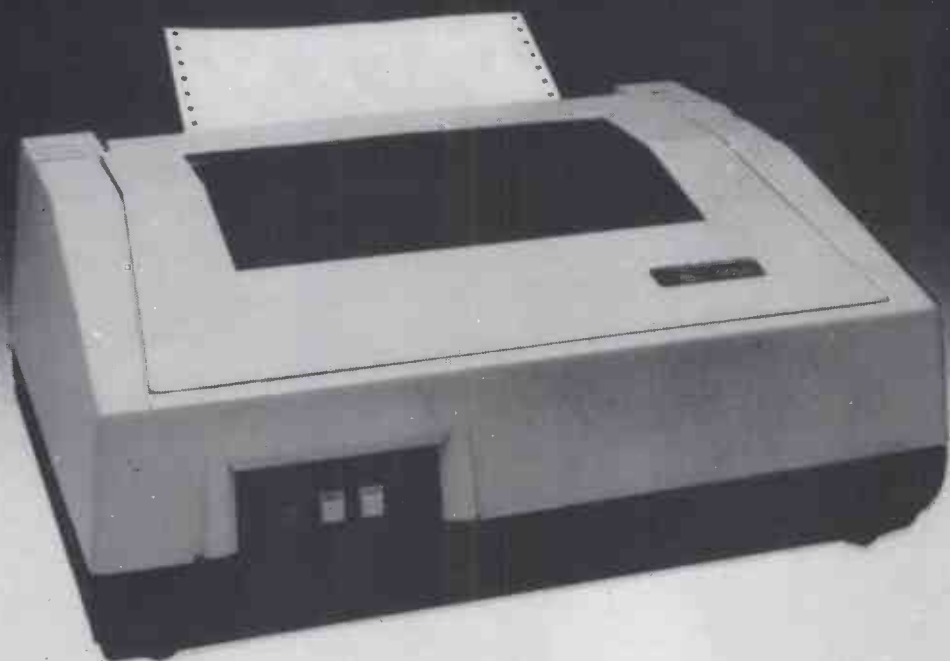

THE NEW

WALTERS 120

UNBEATABLE VALUE!

- 80/132 column dot matrix printer
- 120 characters per second
- 9 wire ballistic, bi-directional logic seeking print head
- Plug-in interfaces:
Centronics Serial V24/RS 232C
20 mA current loop I.E.E.E. 488
- High Resolution and Block Graphics
- and more!

The Walters 120 sets new standards in quality and value for money in the dot matrix printer market.

Just check the specification and you'll find there's never been a better time to buy British!!

And the price -
an amazing

£395.00

(with centronics interface).

(Serial / 20mA current loop £25.00 extra, I.E.E.E. 488 £33.00 extra) All prices quoted exclude VAT

For full details and the name of your nearest dealer contact:

IMPACT DATA

16 Putnoe Lane, Bedford. MK41 9AB Telephone: 0234 62288

1 Chilton Road, Edgware, Middx. HA8 7NJ Telephone: 01-952 7956



BANKS' STATEMENT

Martin Banks provides more punditry on chips and things

CHIPPERY AND RIVALRY

It is some time since I last wrote in any seriousness about chipperiness and things in this august magazine (*Late again, Banks: this is the December issue — Ed*), though it is a subject that is quite dear to my heart. So this month, given that something of interest has occurred in the semiconductor business, I am going to have a go.

In fact, I have in mind two distinct and separate subjects for this month and their only connection is the semiconductor industry, so I'm going to try to stick them together, with only a half-hearted attempt at finding a more cogent link between them.

The first is to do with marketing, and the application of the marketing ploys learned in the semiconductor industry to the personal computer business. The second is to do with the application of the technology of memories, in the form of firmware. No, this is not something that might prove of interest to Mary Whitehouse, but it is to do with the storage of software in hardware form, which to the gizmo-freak means ROMs, PROMs, and EPROMs.

The economies of semiconductor manufacture are those of many high technology, high capital cost products — it costs as much to produce one chip as it does a million of them. As there is more chance of selling a million — because a lower unit cost can be charged — than there is of selling one very expensive chip (the high price being to cover the high capital costs) then the semiconductor industry duly makes millions of them.

The drawback of this is that the chips themselves have to be of a type that users want to buy by the million, so, except in occasional circumstances, there is little profit in the semiconductor companies producing anything too far out of the ordinary.

Indeed, it is a general rule that uniqueness in chip design or manufacture is akin to the kiss of death. No self-respecting systems manufacturer is going to commit a new design to the production line when that product employs a type of chip that comes from just one manufacturer. Should that supplier go delinquent, which is a delightful American way of saying screw up on the supply of chips, then the whole production run, and the investment involved, can go down the Swanee.

So chip customers seek second sources, an alternate source of supply for the same part. The semiconductor companies now go to great lengths to ensure that such second sources are available to the customer, usually by licensing their 'rivals'.

Such 'second sourcing' has now come to the personal computer business, and it has come to Europe, not America. The particular deal in question specifically precludes our

American friends from taking advantage, as will be revealed.

At the beginning of this year, the observant among you would have noticed the arrival of the Sirius 1 system from the drawing board of one Chuck Peddle, father of both the PET and the 6502 microprocessor. The Sirius company was funded in its efforts to develop the machine by a deal in the USA with Victor Business Machines. By way of recompense, Victor took the rights to the US market for the machine, which is manufactured for them by Sirius. Both companies are allowed to sell into the other markets around the world.

Victor declined to call their version of the machine the Sirius. Instead, they called it the Victor 9000. Well, you might ask, what's in a name? — and for European customer that would indeed be true, because the customers are getting real and legal second sourcing.

Yes, the recent introduction into this country of the Victor 9000 means that the customer has the opportunity of making a choice in the purchase of a system. And, if it happens to be the Sirius/Victor system being considered, to go out and shop from alternative sources.

From the user's point of view this can only be a good thing, for it will give greater scope to these all-important subsidiaries — things like service, support, and specialist knowledge, as well as price and delivery — that all dealers should find it important to offer. If a dealer in one type of system seems poor, the chances are there will be a dealer in the other system not too far away.

This could, of course cause a problem for the dealers themselves, and even for the two importing companies: ACT for the Sirius, and DRG for the Victor. The latter is hoping to have 100 dealers

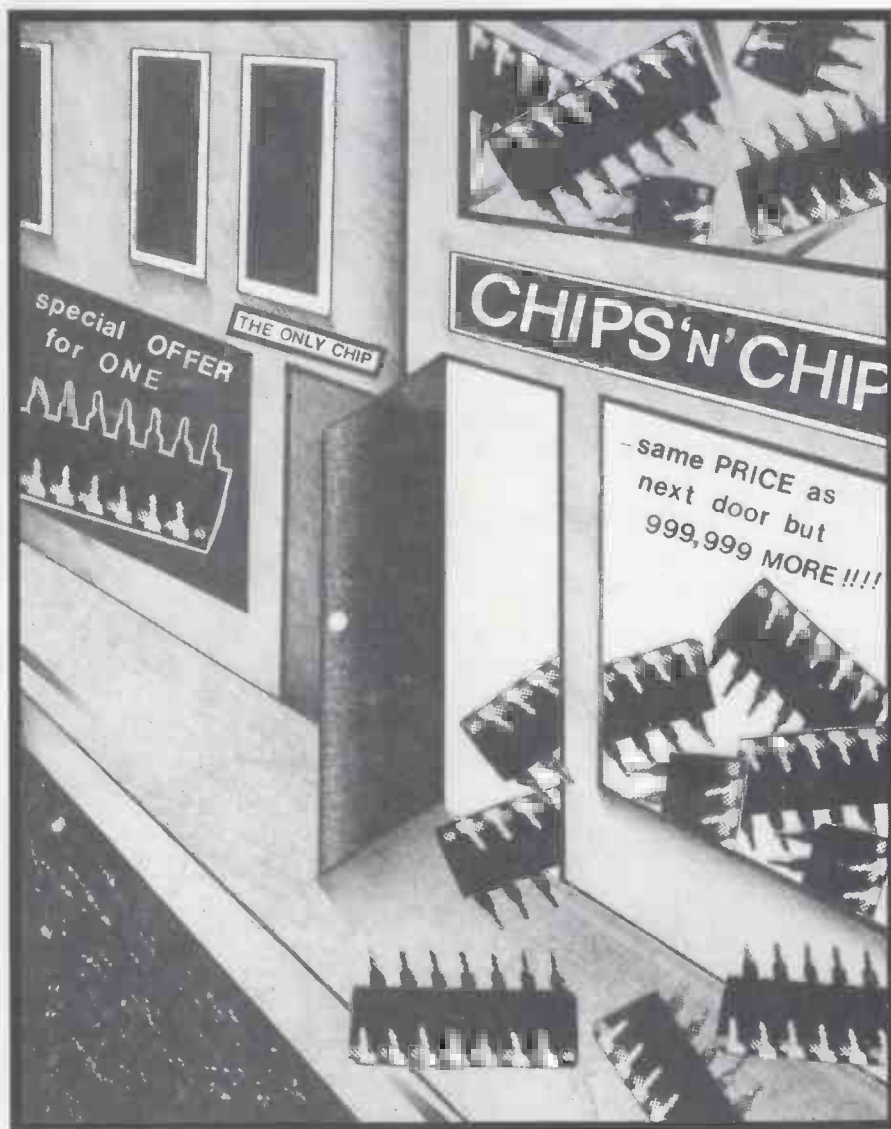

THE 2MB apple FROM



EICON
Research

Now you can boost your apple's on-line capacity up to 2 Mb with the Eicon FD8 8" floppy disk sub-system from ADC.

The FD8 is cost cutting alternative for those companies contemplating the switch to hard disks. Not only is it considerably lower in cost but also it allows almost instant access to 50Mb or more of data and enables disks to be written under DOS 3.3, UCSD Pascal and CP/M.

Its extremely reliable too. By employing digital data separation techniques Eicon have been able to provide double density operation with single density reliability. Thermal drift and periodic adjustments are a thing of the past.

For the complete story on this breakthrough in floppy disk technology contact ADC today, the main U.K. distributor for the Eicon FD8 system.

access data communications ltd.

Eskdale Road, Uxbridge Industrial Estate, Uxbridge, Middlesex. UB8 2RT
Tel: (0895) 59781 (10 lines) Telex: 267336

Northumberland Avenue, Hull, North Humberside, HU2 0LN
Tel: (0276) 75157 Telex: 52269

BANKS' STATEMENT

around the country and, according to them, some 60 percent of the dealers that have made an approach are existing Sirius dealers.

DRG has said that it has a working understanding with ACT, especially on such items as pricing, and is not against appointing dealers that already handle the ACT import. It will be interesting to see whether this understanding stands the test of business practice.

Having two sources for the same machine (the only differences are a slightly different keyboard and a resprayed box), especially when that machine looks like being extremely popular, can only be good for the customer.

And what is good for the customer forms the extremely tenuous link to the second theme for the month, which is all to do with firmware. Now this is the trick of loading commonly used software into a hardware form such as ROM or PROM. It is an idea that has both advantages and disadvantages, though its long-term potential as an aide to systems design, systems configuration, and user choice is considerable.

The reason I mention it this month is because of an announcement by Intel, the company that brought you the 8080 and the 8086 processors. As its 8088/8086 family looks like being the biggie in the 16-bit systems stakes, it being at the heart of the Sirius/Victor and the IBM PC among other machines, it is sensible for the company to look for

other related areas where it can turn an honest dollar.

Now, as already mentioned, the real application of the firmware idea is with commonly used software. This is because of the nature of semiconductor manufacturing, where volume production is king. Only with software that is fully debugged and in great demand does firmware really make sense.

In the 16-bit marketplace, such a target for firmware is an operating system, and it is one of these that Intel has selected. The one it has gone for is CP/M-86 from Digital Research, for which Intel has just taken out a licence.

It is now in the throes of finalising a new chip that will incorporate the operating system in silicon. To be called the 80150, the chip is intended for use with the 8086, 8088 and the latest Intel processor offering, the 80186.

The chip will contain Version 1.1 of CP/M-86, held in 16 kbytes of ROM, which will be accompanied on the chip by some important hardware functions needed by the operating system, such as timers and an interrupt controller.

The obvious market for such a chip is in the vast army of stand-alone systems currently being produced by the likes of Sirius/Victor and IBM. It makes a great deal of sense from everyone's point of view, for by having not only the operating system, but also some of the attendant chippery required for it, resident on a single chip, systems manufacturing costs will be brought down. It will also make the design of any new systems based on the Intel family that much easier, and therefore cheaper(?).

Not surprisingly, it will lock systems manufacturers even more tightly into the grip of Intel (and almost certainly its official second source suppliers), which will no doubt please the company.

For the user, this should mean not only cheaper systems. It should also give (in theory at least) more reliable systems, as the chip should be relatively bug-free, and certainly free from being corrupted as it might be in disk form. It also makes a system more user-friendly as the O/S becomes an integral part of the hardware, with the booting-up procedure totally transparent to the user.

It is also one more step along the road to the appearance of more general software in a firmware form. This could well include some complete applications packages that are popular and 'standardised', such as the 'Calc' programs and the word processing packages. Games packages will be (damn it, are) another target market for firmware. Other applications areas, for example accounting, may well be too complex and variable for such overall treatment, though it is likely that 'tailored' programs may be constructed out of ranges of utility packages and sub-routines that can be linked together.

System configuration could then become easy. The user could actually do it himself. . . perhaps. A system would be a processor, memory, and spare sockets into which the user popped whatever ROMs held the software needed. The ROM'ed O/S would do the rest.

END

HURRY! HURRY! HURRY!

to see the

DRAGON 32

THE NEW FAMILY COMPUTER

- 6809E Processor
- 32K RAM expands to 64K
- Extended Microsoft colour BASIC
- Colour graphics and sound commands



Hurry to
Computer Plus
and see not only
the DRAGON but
APPLE, ACORN, BBC,
COMMODORE, SHARP,
SINCLAIR,
TEXAS INSTRUMENTS, VICTOR 9000.

COMPUTER PLUS, 47 Queens Road, Watford, Herts.
Telephone: WATFORD (0923) 33927

NASCOM

Special Offer from SRS!

We have the last of the makers stocks of the

NASCOM IMP
Serial Printer with Imprint
(Graphics ROM)

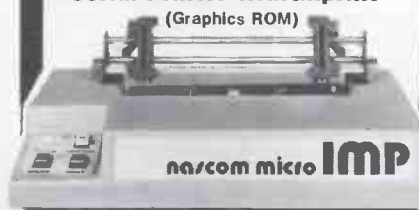

GREAT VALUE!

ONLY
£199.95

EX. VAT

(Previous price before being
discontinued £325 + VAT)

apple C.O.R.P.

Come & see the complete APPLE II system with C.O.R.P. program generator. It's incredible — now anyone can write what they require and C.O.R.P. will work out the program for you — call into our new store at Watford and see it for yourself.

We are pleased to advise our customers that we are members of the SPECTRUM COMPUTER GROUP and can supply all the items featured in SPECTRUM'S ad's in THIS issue.

spectrum



SRS MICROSYSTEMS

94 The Parade, High Street, Watford, Herts.
Telephone (0923) 26602

You'll value our experience, you'll value our prices, free Securicor delivery or post on orders over £50. Access & Barclaycard welcome. Hire purchase and part exchange available E. & O.E.

CHECKOUT

BRIT PRINTER TAKES ON THE JAPS

Peter Rodwell tests a new British low-cost dot matrix printer aimed at a market currently dominated by the Japanese

When the micro scene first began to take off, one company dominated the small, low-cost dot matrix printer market — Centronics. In the last two years, this enviable position has been usurped by the Japanese; specifically Epson, whose printers are found not only with Epson labels on them but in a wide range of colours and cases with other people's tags stuck on.

Now a British company called Walters Microsystems has tackled Epson head on with its Walters 120 printer, with a price slap bang in the Epson range and a specification which, in some respects, is rather better than the best-selling Epson MX-80.

The most striking first impression of the Walters 120 is that it's built like the proverbial 'force-field latrine'. It weighs a hefty 12 kilos and is very solidly constructed — apparently one still functioned perfectly after being dropped down two flights of stairs, although I admit I didn't test this for myself! The machine is also rather larger than the MX-80, at 44 cm wide, 18 cm high and 33.5 cm deep.

The second impression one gets of the Walters is that, despite considerable amounts of soundproofing foam inside the case, it is rather noisier than the Epson, although future models will have even more thorough soundproofing, I'm told.

The Walters 120 has a 9-wire print head which sprints along at a claimed 120 characters per second. The standard typeface is a readable 10 characters per inch/80 chars per line but, by sending control codes to the printer, you can change to double width (40 chars per line) or condensed (132 chars per line).

There is, in fact, quite a range of control codes to do all the usual things like setting tabs and form lengths but Walters has included several less usual but extremely useful ones, including decimal tabbing to align numbers to either the decimal point or — for European uses — to a comma.

By far the most interesting facility, though, is the capability for the user to define up to 10 characters of his own by sending a stream of dot patterns. These are printed by sending another control code plus a letter in the range 'A' to 'J' (or 61H to 6AH) to select the particular character desired. I found this quite an easy operation to perform — both designing and printing, that is — and it's certainly a very useful feature, particularly if you have an application, such as in engineering, maths or science, which requires the use of special symbols. What could be pain, though, is trying to use these symbols from a word processing package.

The Walters 120 also has 64 predefined graphics symbols, activated by another control code, which would enable you to print forms and simple graphics designs. While the text characters are printed on a 9x9 matrix, graphic symbols use an 11x9 matrix, so the result looks quite good.

Setting up the Walters is very easy. The top lid lifts off completely and paper slides in through a slit at the bottom of the rear, keeping it clear of the power and data cables. You then simply push the paper in until it pops up in front of the print head and then pull it through to clip into the two tractor wheels. The lid can then be replaced.



Print head and Facit ribbon cartridge

The printer has four controls — power on/off at the back and three pushbuttons on the front in a small panel, with four LED indicators. These pushbuttons allow you to reset the machine from an error (such as paper out), take the printer off line altogether, and perform line and form feeds. A self-test function is built in but is activated by an internal switch — fiddly but fair enough as you don't need to use it often. One particularly useful feature is the ability to set the top of form position using these front-panel switches — you line feed the paper until it's at the top of a page then press the reset switch. On an Epson, you set the top of form by switching off and on again — top of form is wherever the paper is when you switch on.

The Walters 120 comes with Centronics parallel interface as standard and optional RS232 and IEEE-488 interfaces. You get a properly typeset 30-page manual which clearly explains everything you might ever need to know and even gives you a few blank pages at the back for your own notes. It takes standard Facit ribbon cartridges (life 1.5 million characters) which are easily available from most computer and office equipment suppliers.

On the whole, I felt the Walters 120 was very good value for money. It's solidly built and should withstand very heavy use (the printhead is rated at 400 million characters), although it lacks some of the Epson's features (particularly bold and double-strike printing). In particular, the user-defined characters feature should make it very useful for anyone with specialised applications demanding non-standard characters.

Prices

(excluding VAT and including UK delivery)

Walters 120	
with Centronics interface	£395
with RS232 interface	£420
with IEEE-488 interface	£428
Average ribbon price	£2

The UK distributor for the Walters 100 is Impact Data Ltd, tel: 01-952 7956

This is a sample of normal printing
This is printed in the condensed face
And here's some
double width
Walters 120 print faces



The robust Walters

"If you can buy a business computer package of the same quality at a lower price, I'll buy it for you!"

**Noel C. May, Managing Director
Transtec Computers.**

The Transtec Total Accounting Package costs just £2400 (ex. VAT) and includes . . .

The BC2 Computer

- ★ 800K usable disk storage
- ★ 64K of memory
- ★ 80X25 hi-res. green screen
- ★ CPM 2.2 operating system as standard
- ★ Detachable keyboard with 17 function keys and numeric pad
- ★ In-built facility to expand capacity at any time.

The Printer

An Olivetti DM 5050C heavy duty 80 cols. 100 CPS dot matrix printer with capacity to handle single sheet or continuous sprocket fed paper.

The Software

Complete "Business Desk" set of programs by Paxton incorporating Invoicing, Stock, Sales, Purchase and Nominal Ledgers - a fully integrated accounting software package.

Other financial modelling, word processing and data base packages available

at low all-in costs.

To get the full facts
Contact your local computer dealer or
Transtec direct.

**13 Small Street, Bristol BS1 1DE.
Tel. (0272) 277462**

European Plant
IDA Complex, Macken St., Dublin 2.
USA - Leading Edge Products Inc.,
Canton, Mass.

I'm interested, tell me more.

Name, _____

Address. _____

Company, _____

Trade/User Enquiry (delete as appropriate).



SIMPLY BETTER COMPUTING

BENCHTEST
PERSONAL COMPUTER

EPSON HX20



THE ALL-IN-ONE PORTABLE

Dick Pountain Benchtests a remarkable new portable computer from one of Japan's most famous manufacturers

I said my piece on the future of hand-held computers in last month's review of the Hewlett-Packard HP75C and so will not take up space repeating it here. Suffice it to say that the subject of this review is the second general purpose fully portable microcomputer to reach the UK market; by general purpose I mean that it has the speed, memory and other facilities to take on tasks hitherto

reserved for mains-powered machines and is not limited to mathematically oriented problems.

The HX-20 is also the first computer to be seen here from Epson, the Japanese firm which has achieved a remarkable dominance of the micro printer market in the space of three years. Epson, which is owned by the giant Seiko watch firm, has sold

computers in Japan for some time but this is the first to be exported, and it will be followed soon by a series of desk-top CP/M machines.

Hardware

As delivered, the HX-20 is a self-contained battery-operated computer with 16k of non-volatile memory, a 32k



Side and rear views show various peripheral sockets and controls



Photography by John Mason



Basic in ROM and built in four-line display and printer.

The outward presentation of the HX-20 is very neat and very Japanese. The case is moulded in that metallised silver plastic which has become a trademark of Japanese consumer electrical goods; the moulding is robust and intricate with many embossed legends and removable panels. All the screws which hold the assembly together go into moulded-in brass collets rather than naked plastic.

The case is exactly A4 sized (the size of this page) and the depth tapers from an inch and a half at the front to two inches at the rear. As you will quickly grasp, this is not a pocket-sized machine nor, at 1.6kg, is it even 'hand-held' in the traditional sense; you would need to support it in a crooked arm. Epson is deliberately calling it 'portable' not 'hand-held', but I suspect that 'lap-held' is the way most people will use it in the absence of a table; it will, however, slip into an ordinary briefcase without trouble.

The display is a 20-character by 4-line LCD unit (Epson leads the world

in production of liquid crystal displays) which has no calculator type annunciators; it is treated exactly like a VDU screen of 120x32 dots. This screen is in fact only a 'window' onto a virtual screen whose size is user definable up to 255 characters by 255 lines and so can be scrolled in all four directions. A most unusual feature of the display is that the angle of view may be changed by adjusting a control on the side of the case; you sit in the position in which you want to use the machine and turn the knob until maximum contrast is achieved. Most previous LCDs can only really be viewed from square-on.

The keyboard is of standard ASCII layout and is not just good for a portable computer but good, full-stop. The keys are of low cushion shaped profile with recessed tops and have full-sized typewriter pitch, travel and a satisfying feel and feedback. The keyboard is fully debounced and appears to have a type-ahead buffer, which is useful as liquid crystal displays have a noticeable lag compared to a VDU. All the main keys have auto-repeat. TAB, CTRL and CAPS LOCK

keys are provided, though the latter regrettably has no indicator to show that it's engaged. There is no numeric keypad but a shift key called NUM will turn a block of the main board into one for data entry. Another shift key called GRPH produces block graphics and symbols. Editing keys include CLR/HOME, INS/DEL and four-way cursor movement, but irritatingly the latter is done by two keys, cursor up and down being shifted. Along the top of the main keyboard are five programmable function keys, the PAUSE and BREAK keys and a key called MENU of which more below. In short this is a keyboard, for the first time on a portable, upon which I'd be happy to type all day. My only real criticism is that the keys are mounted directly onto a PCB which bends slightly under pressure (like the early Acorn Atoms); it would feel more robust if more ribs were cast into the case bottom to support it.

To the left of the display sits the built-in miniature dot-matrix printer. This unit uses rolls of plain paper and ribbon cartridges which are perfect

EPSON HX20

Lilliputian copies of the MX-80 ones; the review machine had purple ink in it. The 2¼in paper accommodates 24 characters on a line and it can print the whole HX-20 set including the block graphics characters, as well as performing dot graphics. Operation is either under program control using LPRINT or manual, screen dumps being possible using CTRL and one of the function keys. The printer has its own on/off switch so that

programs which have printer output can be debugged without wasting paper; it also has a manual linefeed button.

Printing speed is not fast at around 40 lines/minute but is comparable to other units of this size, while the print quality is much better than electrostatic 'silver paper' printers. Paper rolls are spindle-less and merely drop into a cavity under a hinged trapdoor, while changing cartridges is a cinch. The plain paper rolls are a standard size and so many office calculator rolls should work. They think of everything.

A third type of output is revealed by

a grille just below the display. This conceals a piezoelectric beeper which is programmable for pitch and duration.

Around the sides of the case are various sockets for connecting peripherals. The back panel holds two RS232C ports which have different DIN-plug connectors. One is for communication with terminals, printers, other computers and modems at up to 4800 baud and has an 8-pin DIN socket. The other is for communicating with a TV or monitor via an adaptor, or to disk drives; it has a 5-pin DIN socket and a maximum transfer rate of 38,400 baud. At the left side is a parallel connector for the expansion RAM box, while at the right are mini-jack sockets for an external cassette recorder with remote control, and a bar-code reader. Finally, a socket next to the RS232 port allows an AC/DC power supply to be plugged in to recharge the NiCad batteries. These have a capacity of around 50 hours (they didn't need charging during this test) and take eight hours to charge; the computer can be used on the mains unit while they are charging but Epson warns not to use it this way once they are recharged as overcharging can shorten their life. I was rather surprised that the HX-20 doesn't auto-power down after a set interval as do most other battery-operated machines; best remember to switch it off.

The on/off switch is at the right hand side, as is the reset button; the latter is required only when a run-away program does not respond to the BREAK key or the on/off switch, which is only likely with machine-code programs. It does not perform a true cold start (which is done through software) and preserves all memory contents.

On a standard HX-20 the area to the right of the display is blank. It contains a dummy module which can be removed (using a very ingenious lever at the back) and replaced by either the optional microcassette drive or by ROM modules containing software. None of the latter were available for the test but the cassette drive was. This is a digital, not audio, device and uses standard microcassettes. It reads and writes at a fast 1300 baud and gets around 50k onto a 30 min tape. Although it has a tape speed of 2.4cm/s, which is the same as most pocket dictaphone recorders, Epson does not recommend swapping tapes between recorders. A really nice feature is the software tape counter which allows fast winding to the exact location of a program before loading; the tape position at any time can be read by a program. Using this feature cuts the time wasted searching tapes enormously and approaches the convenience of disk. The tape drive can be operated manually as well as under program control by pressing CTRL and the first function key. This turns all the function keys into tape deck controls, including one for zeroing the tape counter (which is displayed on the screen in this mode).

The ROM packs are unusual in that that they are accessed by a high-speed serial link and are treated, like other serial mass-storage, as a sequence of files rather than as part of the memory-map. They will be available in sizes from 8 to 32k.

Getting inside the case is quite easy and reveals some surprises. It is no sur-

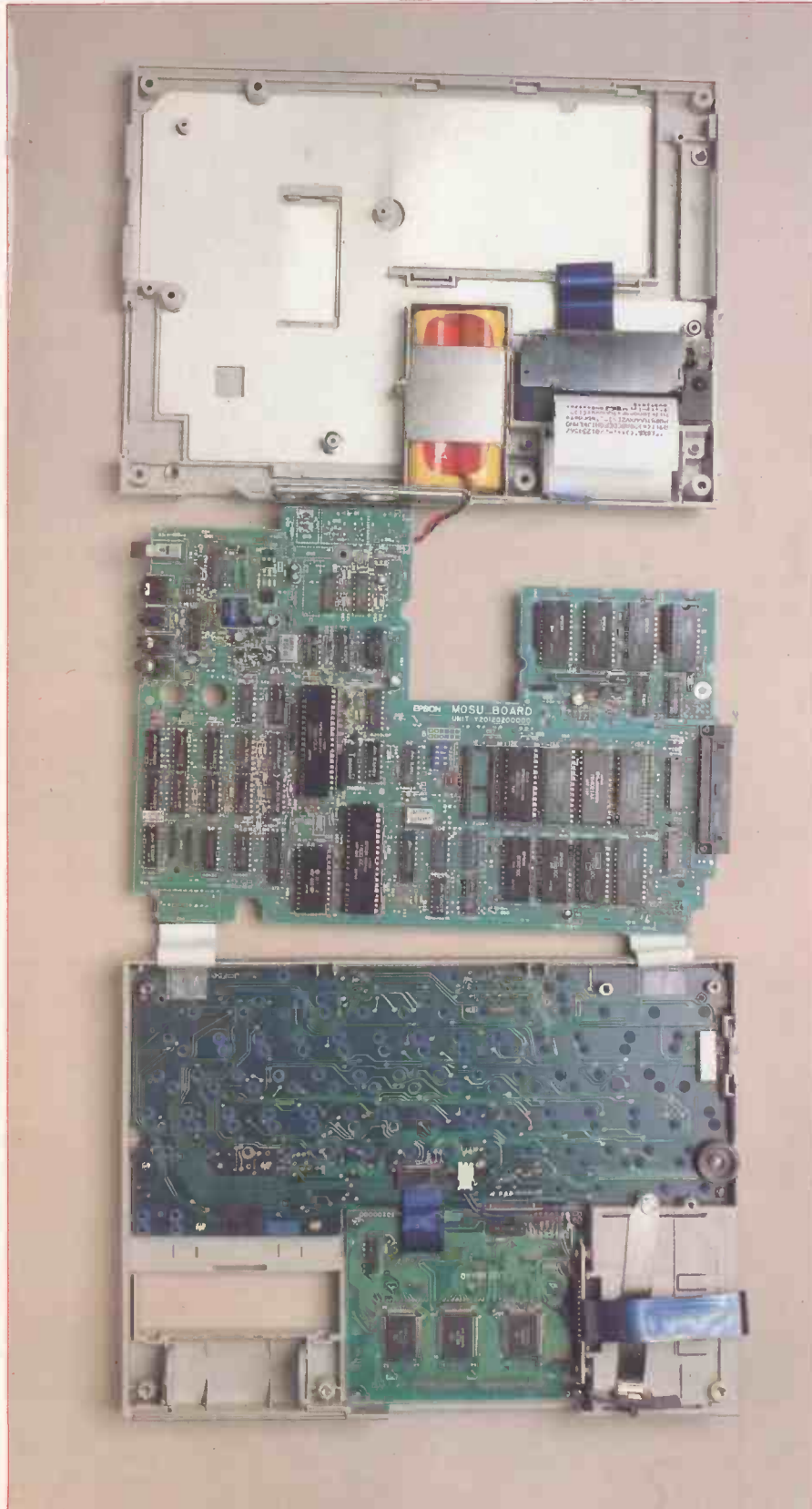

Not sure what the warranty department would think of this treatment!

prise that the manufacturing techniques are 'state-of-the-art'. The design is highly modular (the printer comes away as a sub-unit by undoing two screws) and uses two circuit boards, one for the logic and one for the keyboard switches. These are interleaved with sheets of a curious flexible metallised card which doubles as insulation and RF shielding. All intercard connections are by FCPs (flexible printed connectors) which are held by ingenious sliding grippers rather than those precarious sockets used on the Spectrum; they can be refitted over and again without damage. An interesting little anecdote; after I took the HX-HX-20 to pieces for that 'squashed hedgehog' photograph, I reassembled it and the RAM contents were still intact! The 16k of on-board CMOS memory is in eight 16k chips while the ROM is in four 64kbit chips which are socketed; there is a spare socket for 8k of ROM expansion.

The architecture of the HX-20 is unorthodox, to say the least. It has two CPUs, which are related as master and slave. They are both 6301 CMOS devices of Epson's own manufacture and have 4k of mask ROM and 128 bytes of RAM on the chip; they are reputed to be code-compatible with the Motorola 6800. The master CPU controls memory, keyboard, display, clock and bar-code reader using the external ROM while the slave CPU controls the printer, cassette recorders, RS232 and high-speed serial ports and low-battery power-off function using its on-chip ROM. Most unusually, the two CPUs talk to each other by the 38,400 baud serial link rather than parallel. One consequence of this is that the memory map is, to say the least, complicated.

There are plenty of other oddities which space prevents me from describing; one I must mention is that both processors go into a 'sleep' state to save power when not being used and must be woken up when required. A glance at the Benchmark timings will show that they are by no means fast (50 percent slower than the HP75C) but are no disgrace.

The overall impression given by the HX-20 hardware is that here is a level of professionalism in design and manufacture which would give me nightmares were I an occidental computer manufacturer.

Firmware

The HX-20 operating system sits in ROM along with the Basic. Since all file handling for the cassette drives is done through Basic the operating system has very little to do with the user; it is responsible for the Menu selection function, managing the partitioned memory, cold and warm starting Basic (which includes setting the system clock) and responding to requests for manual control of the printer and cassette drive. Entry of machine code programs is done through a separate monitor which runs under the Menu function.

When you switch on the HX-20 the first response is always to present the menu on the display. The very first time you do it, it reads:
CTRL @ Initialize
1 MONITOR
2 BASIC

What this means is that to perform a cold start (which clears all memory contents and allows setting of the system clock) you must press CTRL @. Cold start also sets default values for user RAM size, amount of RAM file space and assigns 10 Basic keywords to the function keys. If you do this you will be prompted for the time and date; once you've entered these you will be returned to the above menu. You now have a choice of pressing the 2 key to enter Basic or 1 to enter the monitor.

Later on, when you have written some programs, up to five of these may be added to the menu so that they can be run immediately upon switching on the machine. The user RAM is divided into five partitions, called P1-P5, and each one may contain a separate program (or none). The partitioning is totally transparent to the user and you will only know it's happening if the total size of all your programs exceeds the total user RAM.

Unlike the Sharp and HP machines, there is no calculation mode; to perform calculations you must enter Basic and use PRINT 2+2, etc. Time and date can be displayed by pressing SHIFT and function key 1 from Basic but there is as far as I can discover no alarm function nor any of the sophisticated calendar functions of the HP75C; you can of course write your own alarm routine using the beeper.

Basic can be warm-started at any time (you must BREAK out of any running program) by pressing the Menu key; this returns the menu to the screen, and resets the default values for various system parameters such as the size of the screen but doesn't wipe out your programs. When you re-enter Basic, though, it is always into partition P1 no matter what you were in before warm start. In case you're wondering, no, you don't have to warm start to change program areas; that can be done from within Basic or even from within a program by the LOGIN x command which puts you into Px.

The monitor is quite a powerful program which has the ability to set breakpoints and change the contents of processor registers as well as the usual functions of dumping and changing blocks of memory and loading and saving binary files to tape. Coupled with the Basic MEMSET command which allows you to reserve space below Basic for machine code programs (the manual continually refers to them as 'Assembly Language' programs) this would be a very useful facility if only the instruction set were to be found anywhere in the documentation, which it isn't. If it is true that the processors are 6800-compatible this may not be a problem; I didn't have the time or the 6800 experience to find out.

One very neat feature of the monitor I should mention is the K command which lets you set up a 'boot' program which is automatically executed when power is switched on; if you wish it could be Basic itself so that you bypass the menu.

The amount of memory available to the user on the HX-20 is a whole story in itself. It depends not only on the setting of MEMSET but on space allocated for RAM files (see later) for strings, and on the size of the screen which you've defined. Of the 16k stan-

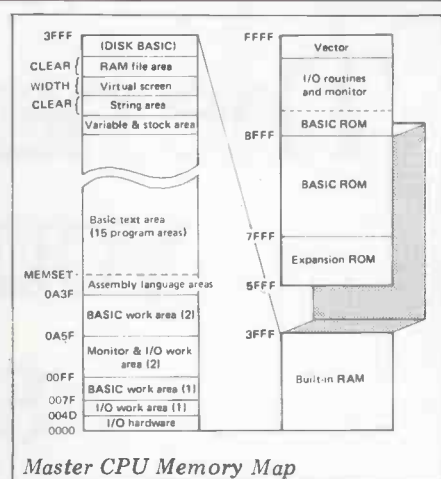

Master CPU Memory Map

dard memory, the bottom 2624 bytes are used by the system (so this is the minimum value for MEMSET) and the most which can be allocated to Basic programs is 13,398 bytes with a 20x4 screen and no string or RAM file space. On warm start the default memory size is 12,891 bytes; adding the expansion memory pack would give 29,275 free bytes so the HX's advantage over the HP785C is not quite so great as it first appears in this respect.

Although the business of controlling screen sizes and graphics modes is done from Basic I propose to deal with it here since the default values are set by the operating system.

There are two different screens available on the HX-20; a text screen and a dot-addressable graphics screen. There are two devices on which these screens can be displayed, namely the built-in LCD and an external TV or monitor. The text screen can be a 'virtual screen' bigger than the device, so that the physical device is a moveable window onto it. On the LCD both screens can be displayed superimposed on one another; on the TV you can show only one or the other but the graphics can be in colour. When you have picked the bones out of that lot you will realise that there is much to learn about the HX-20 screen, and I don't propose to teach you all of it here.

The size of the text screen is set by the WIDTH statement; for the LCD it can be up to 255x255 depending on available memory. For the external TV the limit is 40x37, of which the actual screen shows 32x6 lines. Since the TV adaptor was not available for test I'll concentrate on the LCD. When the cursor reaches the edge of the actual screen it 'drags' the window with it to the edge of the virtual screen. Alternatively you can move the window itself using control characters, in which case the cursor stays where it is. The cursor or the window can be sent to any point on the virtual screen using LOCATE or LOCATES x,y. It is possible to define margins round the actual screen so that that cursor starts to 'drag' the window before it reaches the edge; this makes life much easier as you can see if you're going to overwrite anything so the system defaults to a margin of four characters unless you tamper with it. In practice you soon get used to moving this window in two dimensions over a bigger screen and it becomes second nature. In Basic an excellent full screen editor is provided (with insertion and

The next best thing to your computer speaking Oxford English.

That's you being able to talk to it, easily and fluently, in its own computer language.

And now you can. Fast. Without any hassles.

Because now there's a new range of audio teaching packages that you can use in your own office. At your own speed.

Ideal for inexperienced users or non-programmers, each self-contained, self-teach package is written by ICL training experts.

The packages not only beat any other method for sheer convenience, but are surprisingly inexpensive. And they can be used to master operating and programming skills not just on ICL machines, but on a wide range of hardware.

CP/M 2.2 Introductory Training Package

Contents: Course Guide and 4 Audio Cassettes.

At the end of the course, which is made up of a number of sessions, you will confidently be able to load CP/M 2.2, create text files, look at files on the system, use filenames, Resident and Transient commands and handle most other CP/M facilities.

Microsoft Basic Training Package

Contents: Course Training Manual & Workbook, 2 Audio Cassettes, Floppy Disc (for ICL Personal Computer).

Provides 10 sessions backed by visual

material and exercises, covering Simple Programming, Arithmetic, Decisions & Flowcharts, Loops & Subroutines, Arrays, Data Handling, Graphics, etc.,

CIS COBOL Training Package

Contents: Course Manual, Coding Sheets, Layout Charts, 8 Audio Cassettes, Floppy Disc.

The 16 sessions of the course cover COBOL character set and data names, moving data, structured programming, code layout, initialisation, arithmetic verbs and COPY, and Forms II.

PASCAL Training Package

Contents: Comprehensively Indexed Course Manual and 6 Audio Cassettes.

This package is based on the Jensen and Wirth Report includes sessions covering Declarations and Statements, Typing, Subranges, IF, ELSE, Enumerated Types, Loops & Arrays, Literal Strings, Simplified I/O, Functions and files.

To find out more about ICL's audio training packages telephone Paul Hobbins on Windsor (07535) 51483 or order your package direct from ICL's Packaged Training

Distribution Centre at
Icknield Way, Letchworth.



Packaged Training Distribution Centre, ICL, Training Centre, Icknield Way, Letchworth, Herts, SG6 4AS.

I wish to order _____ CP/M2.2* Training Packages at £42

I wish to order _____ Microsoft BASIC* Training Packages at £83

I wish to order _____ CIS COBOL* Training Packages at £150

ICL Personal Computer DRS Model 20 DRS Model 40/50 Other

I wish to order _____ Pascal Training Packages at £124

(All prices include VAT and p&p. Allow 21 days for delivery. Orders restricted to the UK only).

I enclose a cheque/postal order, made payable to **International Computers Limited** to the value of \$ _____

I do not wish to order at this stage. Please send me more information on _____

Name _____ Position _____

Company Name _____

Address _____

Machine type _____ Telephone _____

* CIS COBOL is a product of Micro Focus Ltd. CP/M is a trademark of Digital Research Inc. Microsoft BASIC is a product of Microsoft Inc.

EPSON HX20

deletion) so if you define a big enough virtual screen you can scroll upward through a listing or re-use commands previously entered. In doing this it pays to be careful that nothing else is lurking on the same line but off the screen!

The graphics screen is 120x32 dots for the LCD and 128x96 mono or 128x64 in four colours for the TV. If you use colour, however, a bizarre addressing mode prevails where there are 64 physical dots vertically but 96 addresses, so that either 0,0 or 0,1 will light the dot at 0,0 but only 0,2 will light 0,2 and so on alternately. Personally I never cared much for colour anyway, sniff. . .

Software

Epson's Basic (originally called MFBasic but now EBasic) is a pretty substantial implementation of the language. It is much more orthodox and Microsoft-like than HP's 75C Basic but lacks the latter's modular programming facilities.

To write a program, select Basic from the menu and then either write it in P1 which comes up automatically or LOGIN to one of the other areas. AUTO line numbering, DELETE and RENUMBER are all provided. To copy a program to another area use PCOPY x. If you wish your program to be added to the menu then TITLE it and it will automatically become the next item; the menu number is not necessarily the same as the P number but making a menu selection puts you into the right partition anyway. A program with a title cannot be NEWed or over-written until you give it a null title with TITLE "", which affords very valuable protection. STAT gives the title and size of a program and STAT ALL gives this for the whole lot and throws in the value of MEMSET and the RAMFILE space; a nice touch for homesick CP/M users. The function keys are easily set up by 'KEY number, "string"' and the assignments can be inspected with KEY LIST or KEY LLIST for hard copy.

Error messages are rather more terse than I would like, but at least they have some mnemonic value and are not mere numbers; eg, SN ERROR (syntax), PP ERROR (protected program). There are over 60 of them including the intriguing 'Unprintable error'!

The HX can handle decimal, hex and, surprisingly, octal integers plus single and double precision (16 digit) reals. Variable names are up to 255 chars with a whacking 16 significant which should be enough even for the purist. Full type conversion functions are provided, type being indicated by the suffixes %, !, # and \$. Arrays may have more than two dimensions.

The Boolean operators are remarkable for the inclusion of IMP(implication) and EQV(equivalence) in addition to the normal AND, OR, NOT and XOR.

Most of the rest is standard Microsoft, a single line DEF FN and IF... THEN... ELSE and the normal string functions including INSTR. INPUT is supplemented by LINE INPUT, which takes 255 characters without delimiters, and the unusual

INPUT\$ which reads a specified number of characters from the keyboard or a file and waits until they're all delivered. A powerful PRINT USING is supported to format numeric output. Error trapping by ON ERROR GOTO/GOSUB is included, too.

File handling is fairly orthodox, with a couple of nice flourishes such as LOF, a function which returns the byte length of an open file. The latest thinking on device independence has been implemented; files have a 'descriptor' in the format 'devicename:filename' (filename optional) and can be directed to another device by changing the name. Recognised devices are keyboard, screen, tapes, ROM packs, RS232 ports, and internal printer; floppy drives are not recognised as a new Disk Basic will be required to run them.

Program files may be saved in two forms — compressed binary or ASCII. All the files so far mentioned are sequential. Random files are supported in the form of RAM files. These sit in memory and can be written and read randomly by a program from any of the partitions as they occupy their own protected area. This area is set aside by issuing a CLEAR statement; as well as clearing numeric variables this can take parameters which set the amount of string and RAM file storage. Once allocated, individual files can be defined in this area using DEFFIL, which sets the record length and the offset in bytes from the beginning of the RAM file area of the first record. Data of any type may be mixed in one record. As RAM files do not have names it's up to you to keep track of what starts where; there are no absolute addresses to remember, only offsets. They are very handy for permanently storing look-up tables of much used constants or conversion factors as a means of passing parameters between programs.

Finally, while on the subject of storage, the cassette control statements are exceptional. TAPCNT is a system variable which keeps the tape counter reading. WIND xxx fast winds the tape to any given place xxx and MOTOR switches on or off an external cassette recorder. FILES will give a directory of the names and types of files on a tape, or any other storage device including a ROM pack.

The graphics commands are confined to PSET to plot a point, PRESET to unplot it and LINE to draw lines, plus a function POINT which tells if a given point is lit.

All considered, this is a very powerful Basic, biased if anything towards

business use. It will be immediately familiar to programmers used to MBASIC, which is no bad thing.

No applications software was supplied with the machine, which was one of the first final production models with export ROMs in this country.

Documentation

I was supplied with a Xeroxed copy of what looks like a fairly finalised user's manual and the technical manual. Both are excellent, somewhat to my disappointment as I have relied for several years on Japanese manuals to inject a little humour into otherwise turgid Benchtests. These really are different. For a start they're in English with only the very occasional hint they've been translated.

The user's manual starts with a straightforward and comprehensible account of the machine's features and how to get it running. This leads on to the main section on EBasic which is laid out in the same format as Microsoft's MBasic manual and is clear and comprehensive. There follows a good chapter on machine code programming (apart from the aforementioned absence of instruction set) and file handling. It ends with numerous appendices of character codes, control codes, error messages and an index by function of the Basic reserved words and functions. There is no alphabetic index to the whole manual, though.

The technical manual is remarkably detailed, going through all the hardware down to the signal and timing level and ending with full maintenance and repair instructions which are intended for the dealer and repair shop. If you're a hardware junkie make sure you get this manual as well as the user one.

To summarise, a quantum leap forward from the stereotype of inscrutable Japanese documentation.

Expansion

There is room for 8k more of ROM on the main board, which may be used for alternative language character sets. An expansion module which fits externally onto the left side of the machine contains 16k of RAM and a further 16k ROM.

ROM modules which fit in the place of the microcassette drive are somewhat different from ordinary ROM in that they are treated as file-oriented read-only mass storage.

A TV/monitor adaptor should be available by the time of the launch in November, and a bar code reader for

GOTO page 200

Technical data

Processors	Twin 6301 (CMOS) 0.6MHz
Dimensions	290mmx215.5mmx44mm
Weight	1.6kg
Power	Rechargeable Ni/Cad cells 4.5-6.0V
RAM	16k CMOS standard. 32k expanded
ROM	32k
Display	20 col x 4 row LCD; 120x32 dot graphics
Keyboard	ASCII standard 68 keys, including 5 programmable function keys
Printer	Micro dot-matrix 24 chars/line, 144 dots/line, 150ms/dot line.
Ports	RS232C up to 4800 baud, High speed serial up to 38,400 baud
Language	EBasic

ADA— A BRIEF ENCOUNTER

The US Department of Defense is interested in Space Invaders of a rather more dangerous variety than we micro folks are used to. It has chosen Ada as the language to implement all future defence software. Mike Parr explains why. . .

Rarely does the design of a new programming language cause emotional discussion, but the introduction of Ada, the language selected by the US Department of Defense (DoD) is the exception. Basic, Forth and Pascal all have their critics, but the Ada debate is at a different level because of the sensitive area of its use — missile control, nuclear power plants, etc. Here I'll present a brief overview of the language, together with the arguments (sorry — discussions) on its value. I will attempt to be neutral!

History

In 1975 the US DoD decided to standardise on its programming language, and put out tenders for a language design to several firms. The winner was eventually called Ada (after Ada Lovelace, who worked with Babbage on an early mechanical computer). The language is based on Pascal, but has important additions to allow for real-time control, and to assist in the production of large software systems by teams of programmers. Because of the area of its use, the handling of errors is also vital — if your Space Invaders game crashes it is merely annoying, but if a fault occurs in a nearby nuclear power station you might be more concerned.

However, before criticising Ada, let's look at some features of the language.

What is Ada?

Fundamentally it is a Pascal-like language with these features:

Strong data typing.

Separately compilable 'modules'.

Facilities for the simultaneous execution of tasks.

(An explanation of this jargon will follow!)

However, Ada is more than just a language — it comes with a set of software tools collectively known as APSE (Ada Programming Support Environment), comprising editor, testing software, etc. In fact, APSE can handle all the paperwork associated with a project. Secondly, as Ada is a higher-level language than Pascal, it can be made use of at the program design stage, where one might have used pseudo-code or flowcharts. Certainly, a detailed study of Ada will affect the way you think about large programs, and the module and pro-

cedure facilities will encourage a 'divide and conquer' approach, making programs easy to read: after all, programs are read many times during development. (Forth fans please note!!)

The Ada attitude

Because Ada is intended for large programs, small examples are not always realistic — however it might be useful to approach the Ada way of thinking (on errors, reliability, etc) by criticising some fragments of MicroSoft Basic. Firstly:

```
10 IF F THEN 30
20 PRINT F * 3.142
```

These two lines have the following drawbacks:

The initial value of F is unclear (in fact it is zero).

F is rather meaningless — we would prefer longer names, eg, FLAG.

In Basic 1 (or -1 in some dialects) means 'true'. When F is zero, line 20 will be obeyed, and the missing line 30 will not produce an error.

In line 20 we multiply a logical (boolean) variable by a real number. What is the meaning of 'false'*3.142?

This brings out several points (bearing in mind that programs may be used in life-or-death situations) — ie, that incomplete programs should not be allowed to run, and that the type of each variable should be specified by the programmer to allow the compiler to reject misconceived operations. This feature, also present in Pascal and Algol 68, is called 'strong typing' and though it sounds like a good idea, is not popular among all programmers.

Now a subroutine to find the average value of the elements of an array:

```
1000 REM AVERAGING ROUTINE
1010 S = 0
1020 FOR I = 1 TO 100
1030 S = S + A(I)
1040 NEXT I
1050 AV = S/100
1060 RETURN
```

Again there are drawbacks:

The routine will only work on an array A, of size 100.

It also affects the value of I and S, which may be in use elsewhere in the program.

We may not want the user to have the power of editing the routine — it may be dangerous in certain environments.

These problems, present in Basic (and to some extent in Pascal) are all

overcome in Ada. Bearing in mind the 'safety first' approach, let's look at some areas of the language.

Control structures

Here at last is a fragment of Ada, illustrating the familiar FOR loop of Basic and Pascal —

```
SUM = 0 -- initial value
FOR INDEX IN 1 .. 100 LOOP
  SUM = SUM + A(INDEX);
END LOOP;
```

Upper or lower case characters can be used for variables or reserved words, but I'll stick to capitals to differentiate programs from commentary. The layout is similar to Pascal but note that comments are preceded by '--', and that a semi-colon must follow each complete statement.

As well as FOR, we have WHILE, as in:

```
WHILE X < 11 LOOP
  any statements
END WHILE;
or even more simply, an infinite loop —
LOOP
  any statements
END LOOP;
```

The idea of WHILE is that one collects together the terminating conditions at the head of the loop, though sometimes it is simpler to break out from the loop body; in recognition of this practical requirement, Ada provides an 'exit' statement as in:

```
LOOP
  EXIT WHEN X < 0.0001;
END LOOP
-- next statement
```

We may also use GOTO in such a situation.

As well as repetition, we need statements for selection, and Ada provides IF and CASE, each being more powerful than their Pascal counterpart. The form of an IF is —

```
IF condition THEN statements
ELSIF condition THEN statements
ELSIF condition THEN statements
etc
ELSE statements
END IF;
```

Note that this is one statement, *not* a series of nested IF's. You *could* choose to nest the statements by writing ELSE IF instead of ELSIF but each IF would need a matching END IF, which becomes clumsy.

The CASE statement at first sight seems similar to the IF, as in
CASE EXAM_MARK IS
WHEN 100 = >

```

200 D$="statestatestatestatestatestatestatestatestate"
210 A$(0)="          "
220 A$(1)="          "
230 A$(2)="          "
240 A$(3)="          "
250 A$(4)="          "
260 A$(5)="          "
270 A$(6)="          "
280 A$(8)="          "
290 A$(9)="          "
300 A$(10)="          "
310 A$(11)="          "
320 A$(12)="          "
330 Z$="8":FORI=1T
340 NEXT Z$:Z$=Z$+"8"
350 IFV.C.2THENA$Q2
360 IFV.C.4THENA$Q8
400 FORI=1TO8:T%CI
410 T%(I,3)=X:NEXT
500 PRINT"Q1":FORI
510 GOSUB7000:FORJ
520 GOSUB7100:PRINT
530 GOSUB7000
540 POKE32849,233:POKE328
550 POKE33689,95:POKE337
560 FORI=0TO10:READJ:PO
600 FORI=65TO82:K$=CHR
610 GOSUB7200:IFV%(A)
620 IFRND(1)<.5THF
630 PRINT"J":K$)
640 PRINT"statestate"
650 B=TI
1000 T=TI
1010 GETK$:IFK$<"B"OR
1020 GOSUB7200:P%CE
1030 PRINTA$(B)
2000 D=T%(I,1)
2010 IF
2020

```



CUANDI... GOTO2000

```

40
45
450
IFK$<" " THEN4500

```

**COMMODORE 700 SERIES
THE BUSINESS
COMPUTER**

80-column display; 128K or 256K user RAM expandable to 896K; tilt and swivel screen. 8088 or Z80 second processor capability giving option of other operating systems such as CP/M. Built-in DMA disk-drives available. IEEE-488 and RS232C interface capabilities.

FROM
£995

EX VAT

*Registered Trademark of Digital Research Inc.



3 great deals.

**COMMODORE 500 SERIES
THE SCIENTIFIC/
PROFESSIONAL COMPUTER**

40-column 16-colour display to monitor or TV. 128K user RAM expandable to 896K. High-resolution graphics and 3-dimensional effect capability. Sound synthesis. Second processor option. Prestel facility available. 8-bit parallel port to interface scientific equipment.

FROM
£695

EX VAT



**COMMODORE 64
THE PERSONAL
COMPUTER**

40-column 16-colour display to monitor or TV. 64K RAM. High-resolution graphics and 3-dimensional effect capability; music synthesiser. Z80 additional processor option.

FROM
£299

EX VAT



WEST COUNTRY

Avon Business Computers Ltd.
(Formerly Calculator Service and Sales (Bristol) Ltd)
192 Wells Road, Bristol, Avon BS4 2AX
Bristol (0272) 779452/3

Currys Micro Systems Ltd.
2 Channons Hill, Fishpond,
Bristol, Avon BS16 2EA
(0272) 650501

Radan Computational Ltd.
19 Belmont, Lansdown Road,
Bath, Avon BA1 5DZ
Bath (0225) 318483

A. C. Systems,
6 Cathedral Lane, Truro,
Cornwall TR1 2QS
Truro (0872) 79727

J. M. Computer Services Ltd.
14-15 Lemon Street, Truro,
Cornwall TR1 2LS
Truro (0872) 71626/70071

A. C. Systems,
53 Magdalen Road, Exeter,
Devon EX2 4TA
Exeter (0392) 211718

A. C. Systems,
75 Mutley Plain, Plymouth,
Devon PL4 7DS
Plymouth (0752) 260861

**J.A.D. Integrated Services
Plymouth Ltd.**
21 Market Avenue, City Centre,
Plymouth, Devon PL1 1PG
Plymouth (0752) 662616

Devon Computers,
The White House, 39 Totnes Road,
Paignton, Devon
(0803) 526303

**South Coast Business
Machines Ltd.**
South Coast House, Wimborne Road,
Ferndown, Bournemouth,
Dorset BH22 9NG
(0202) 893040

Computer Shack Ltd.
14 Pittville Street, Cheltenham,
Glos. GL52 2LJ
Cheltenham (0242) 584343

Milequip Ltd.
7a Hare Lane, Gloucester GL1 2BA
Glos. (0452) 411010

**Somerset Business
Computers,**
25 East Reach,
Taunton, Somerset
(0823) 52149

Computacenter Ltd.
Theatre Square,
Swindon Wiltshire SN1 1QN
Swindon (0793) 612341/2

Whymark Computer Centre,
20 Millford Street, Salisbury,
Wilts. ST1 2AP
(0722) 331269/26688

SOUTH AND SOUTH EAST

Currys Micro Systems Ltd.
(inside Currys) Units 91/93,
Arndale Centre, Luton, Beds LU1 1TB
0582 425079

HB Computers Ltd.
40-50 Collingdon Street, Luton, Beds.
(0582) 454466

MMS Ltd.
Ketwell House, 75-79 Tavistock Street,
Bedford, Bedfordshire MK40 2RR
Bedford (0234) 40601

Adda Computers Ltd.
275 Oxford Road, Reading,
Berks. RG1 7PY
Reading (0734) 585928

Adda Computers Ltd.
120 High Street, Slough, Berks. SL1 1JQ
Slough (0753) 72470/77514

Alphascan Ltd.
22 Hambridge Road, Newbury, Berks.
Newbury (0635) 30880

C.S.E. (Computers),
12 Wokingham Road, Reading,
Berks. RG6 1JG
Reading (0734) 61492

Kingsley Computers Ltd.
132 Desborough Road,
High Wycombe, Bucks. HP11 2PU
(0494) 449749

Amplicon Micro Systems Ltd.
Richmond Road, Brighton,
East Sussex BN2 3RL
Brighton (0273) 608331

South East Computers,
15 Castle Street, Hastings,
East Sussex TN34 3DY
Hastings (0424) 426844

**Alphanumeric Computer
Systems Ltd.**
Mixgate House, 38 Hamlet Court Road,
Westcliff-on-Sea, Essex SS0 7NS
(0702) 43304

Apollo Reprographics,
Unit 15A, West Station Industrial Estate,
Spital Road, Maldon, Essex CM9 6TW
Maldon (0621) 56933

**Computer Sales & Software
Centre Ltd.**
190-192 Cranbrook Road,
Ilford, Essex IG1 4LU 01-554 3344

Dataview Ltd.
Portreeves House, East Bay,
Colchester, Essex CO1 2XB
Colchester (0206) 865835

DDM Direct Data Marketing Ltd.
22 Warley Hill, Brentwood,
Essex CM14 5HA Brentwood (0277)
229379/230480/214168

Stuart R. Dean Ltd.
373 Southchurch Road,
Southend-on-Sea SSI 2PY
(0702) 62707

Business Electronics,
Rownhams House, Rownhams,
Southampton, Hants. SO1 8AH
Southampton (0703) 738248
Currys Micro Systems Ltd,
(inside Currys)
10/11 Bargate, Southampton, Hants.
(0703) 29676
Microchips,
46-48 St. Georges Street, Winchester,
Hants. SO23 8BE
(0962) 68085
Super-Vision,
13 St. James Road, Shirley, Southampton
(0703) 774023
Alpha Business Systems,
Electron House, Church Street
Industrial Estate, Ware, Herts. SG12 9ES
Ware (0920) 68926/7
Brent Computer Systems,
33 Church Street, Rickmansworth,
Herts. WD3 1DH
(09237) 71306/70329/76102
Vance Business Systems Ltd,
Salter House, 109 High Street,
Hemel Hempstead, Herts. HP1 3AH
Hemel Hemp. (0442) 40722
Photo Acoustics Ltd,
255a St. Albans Road,
(entrance in Judge Street),
Watford, Herts. WD2 5BQ
Watford (0923) 40698
South East Computers,
31 Watling Street, Canterbury,
Kent CT1 2UD
(0227) 59917
South East Computers,
29 High Street, Maidstone,
Kent ME14 1JS
(0622) 681263
The Computer Room,
87 High Street, Tonbridge,
Kent TN9 1RX
Tonbridge (0732) 355962
Alphacan Ltd,
Little Bourton House,
Southern Road,
Banbury, Oxon. OX16 7SR
Cropredy (029575) 606/8202
Currys Micro Systems Ltd.,
(inside Bridgers),
31/35 Blagdon Road,
New Malden, Surrey KT3 4BG
01-949 2091
Datalect Computers Ltd,
7 St. Georges Walk,
Croydon, Surrey
01-680 3581
Datalect Computers Ltd,
33-35 Portugal Road, Woking,
Surrey GU21 5JE
Woking (04862) 25995
Micro-Facilities Ltd,
7-9 Church Road, Egham,
Surrey TW20 9QL
Egham (0784) 31333
Wego Computers Ltd,
22A High Street, Caterham,
Surrey CR3 5UA
Caterham (0883) 49235

EAST LONDON
Adda Computers Ltd,
National Electronics Centre,
London World Trade Centre,
Europe House, London E1 9AA
01-488 2400
C.S.S. (Systems) Ltd,
502 Kingsland Road, London E8 4AE
01-254 9293/1674
Healey Management Services Ltd,
442 446 London Fruit Exchange,
Brushfield Street, London E1 6EL
01-247 2858/3149
Merchant Systems Ltd,
5 New Bridge Street, London EC4V 6AB
01-583 6774
Sumlock Bondain Ltd,
263-269 City Road, London EC1V 1JX
01-250 0505
Sumlock Bondain Ltd,
Cannon Street Station, London EC4
01-626 0487

NORTH LONDON
Chromasonic Electronics,
48 Junction Road, London N19 5RD
01-263 9493/9495
Currys Micro Systems Ltd,
23 Hampstead Road,
Euston, London NW1 3JA
01-387 9275
Database,
101 Cricklewood Broadway,
London NW2 3JG
01-4501388
Micro Computation,
8 Station Parade, Southgate,
London N14 5BL
01-882 5104
Missing Link Computers Ltd,
Abacus House, 53-55 Ballards Lane,
Finchley, London N3
01-349 4969/4711

SOUTH LONDON
Cavendish Data Systems,
74 Portland Road, South Norwood,
London SE25 4PQ 01-656 8941
DDM Direct Data Marketing Ltd,
86-87 Wilton Road, London SW1V 1DM
01-834 5016/5096
GMT Computers Ltd,
Newport House, 22 Hatfield Road,
Wimbledon, London SW19 3TD
01-947 7234
Micro Computer Centre,
28 Sheen Lane, East Sheen,
London SW14 8LW 01-878 7044/7

WEST LONDON
Adda Computers Ltd,
Mercury House, Hanger Green,
Ealing, London W5 3BA
01-997 6666
Capital Computer Systems Ltd,
(inside Currys)
32 Windmill Street,
London W1P 1HH
01-636 3863
Database,
30 Wigmore Street,
London W1
01-431 3410

GREATER LONDON/MIDDLESEX
**Advanced Digital Office
Systems Ltd,**
College House,
King Edward's Road, Ruislip,
Middlesex HA4 7AE
(08956) 72661
Cream Computer Shop,
380 Station Road, Harrow,
Middlesex HA1 2DE
01-863 0833
Da Vinci Computers Ltd,
63 High Street, Edgware,
Middlesex HA8 7DD
01-952 0526
L & J Computers,
192 Honeypot Lane, Queensbury,
Stammore, Middlesex HA7 1EE
01-204 7525
Wego Computers Ltd,
3 Wadsworth Road, Perivale,
Greenford, Middlesex UB6 7JP
01-998 9011

EAST ANGLIA
Arden Data Processing,
166 Park Road, Peterborough,
Cams. PE1 2UF
Peterborough (0733) 47767
Consyst Computer Services,
1 Maris Lane, Trumpington,
Cams. (0223) 841997
**Sumlock Bondain
(East Anglia) Ltd,**
32 Prince of Wales Road, Norwich,
Norfolk NR1 1LG
Norwich (0603) 26259/614302

MIDLANDS
Davidson-Richards Ltd,
29 Charnwood Street,
Derby, DE1 2GU
Derby (0332) 683231
Caddis Computer Systems Ltd,
72-74 Trinity Lane, Hinckley,
Leics. LE10 0BH
(0455) 613544
Currys Micro Systems Ltd,
127 Charles Street, Leicester,
Leics. LE1 11R
(0533) 546224
Currys Micro Systems Ltd,
Devonshire House,
Devonshire Lane, Loughborough, Leics.
(0509) 37367
The Computer Supermarket Ltd,
Unit 8, Southfold Road,
Oakley Hay Estate, Corby,
Northants.
(0536) 744015
HB Computers Ltd,
104 St. James' Road,
Northampton, Northants.
(0604) 56544
HB Computers Ltd,
20-22 Station Road, Kettering,
Northants.
(0536) 520910
**A.J.R. Office Equipment
Services Ltd,**
80 Nottingham Road, Arnold,
Notts. NG5 6LF
Nottingham (0602) 206647
Betos (Systems) Ltd,
Bennett House, 155 Mansfield Road,
Nottingham NG1 3FR
Nottingham (0602) 48108
Computer Services Midlands Ltd,
Abbeyfield Road, Lenton Industrial
Estate, Nottingham,
Nottinghamshire
Nottingham (0602) 866366
Currys Micro Systems Ltd,
(inside Currys)
2 Wheeler Gate, Nottingham, Notts:
(0602) 412455
Jentech Services Ltd,
Rosemary Cottage, Nordley, Bridgnorth,
Shropshire WV16 4SU
(07462) 5287
Peach Data Services Ltd,
5 Horninglow Street, Burton-on-
Trent, Staffordshire DE14 1NJ
Burton-on-Trent (0283) 44968
BER Limited,
99 Albert Street, Rugby,
Warks. CV21 2SW
Rugby (0788) 65756
**McDowell, Knaggs &
Associates Ltd,**
Shades House, Meachapean
Street, Worcester WR1 2DQ
Worcester (0905) 28466
Minster Microcomputers Ltd,
12 York Street, Stourport-on-Severn,
Worcestershire
Stourport (02993) 77098/6706

WEST MIDLANDS
BER Limited,
11 Grosvenor House,
Grosvenor Road, Coventry CV1 3FF
Coventry (0203) 20246
Camden Computer Systems Ltd,
462 Coventry Road, Small Heath,
Birmingham B10 0UG
021-771 3636
**CBS Consultants - Computer
Business Systems,**
75 Watery Lane,
Birmingham B9 4HW
021-772 8181
Computer Services Midlands Ltd,
Refuge Assurance House,
Sutton Row Road, Erdington,
Birmingham B23 6QX
021-382 4171
Currys Micro Systems Ltd,
(inside Currys),
5/11 Marineau Way,
Union Street, Birmingham,
West Midlands
021 233 1105
Ibek Systems Ltd,
437 Stony Stanton Road,
Coventry, West Midlands CV6 5EA
(0203) 661162
Micro Associates,
471 Lichfield Road, Aston,
Birmingham B6 7SP
021-328 4574
Micro Business Centre,
Lewis House, Linthouse Lane,
Wednesfield, Wolverhampton,
West Midlands
Wolverhampton (0902) 725687
Microtrading Ltd,
641 Bromford Lane, Ward End,
Birmingham B8 2EP
021-784 0077
Taylor-Wilson Systems Ltd,
Oakfield House,
Station Road, Dorridge, Solihull,
West Midlands B93 8HQ
Knowle (056 45) 6192
Walters Computer Systems Ltd,
57 High Street, Stourbridge,
West Midlands DY8 1DE
Stourbridge (03843) 70811

NORTH WEST
**Automated Business
Equipment Ltd,**
Mersey House, Battersea Road,
Heaton Mersey Industrial Estate,
Stockport, Cheshire SK4 3EA
061-432 0708/4299
**Catlands Information Systems
Ltd,**
8 Charlotte Street West,
Macclesfield, Cheshire SK11 6EF
Macclesfield (0625) 615375
Criffell Micros Cumbria
22 Louthier Street, Carlisle, Cumbria
(0228) 44044
Holdene Ltd,
82a Water Lane, Wilmslow,
Cheshire SK9 5BB (0625) 529486
B & B Computers Ltd,
124 Newport Street, Bolton,
Greater Manchester BL3 6AB
Bolton (0204) 382741/384599
Currys Micro Systems Ltd.,
19 Brown Street,
Manchester M2 0G1-834 0144
Cytek (UK) Ltd,
Sandringham House,
9 Warwick Road, Old Trafford,
Manchester M16 0Q 061-872 4682
D. Kipping Ltd,
Ralli Building, Stanley Street,
Salford, Greater Manchester M3 5FF
061-834 6367/9
**Executive Reprographic &
Business Consultants Ltd,**
2-4 Oxford Road,
Manchester M1 5QA
061-228 1637
POS Computer Systems Ltd,
50 Gidlow Lane, Wigan,
Greater Manchester
Wigan (0942) 31464
Computers & Business Systems,
89 Manchester Road, Nelson,
Lancs. BB9 7HB (0282) 601191
Datel Computing Ltd,
323 Clifton Drive South,
Lytham St. Annes, Lancs. FY8 1HN
(0253) 727051
Microrose Ltd,
Main Street, Bentham,
Lancaster LA2 7JH (0468) 62180
Mipac Services,
St. Leonards House,
St. Leonardsgate, Lancaster,
Lancs. LA1 1NN
Lancaster (0524) 62033
**North West Business
Machines Ltd,**
Curate Street, Great Harwood,
Blackburn, Lancs. BB6 7DB
Blackburn (0254) 888125
Preston Computer Centre,
6 Victoria Buildings, Fishergate,
Preston, Lancs. (0722) 57684/58445
Aughton Microsystems,
29-31 Woodward Road, Kirkby,
Liverpool, Merseyside L33 7UZ
051-548 7788/6060

Rockliff Micro Computers,
2 Rumford Street, Liverpool,
Merseyside L2 8SZ
051-521 5830
Stack Computer Services Ltd,
290-298 Derby Road, Bootle,
Liverpool, Merseyside L20 8LN
051-933 5511
RPL Microsystems,
Goldie House, Upper Church Street,
Douglas, Isle of Man
Douglas (0624) 4247/8

NORTH EAST
Intex Datalog Ltd,
Eaglescliffe Industrial Estate,
Eaglescliffe, Stockton-on-Tees,
Cleveland TS16 0PN
(0642) 781193
Microprocessor Services,
77a Beverley Road, Hull,
North Humberside HU3 1XR
(0482) 23146
Microware Computers Ltd,
Priory House,
1133 Hessle High Road, Hull,
North Humberside HU4 6SB
(0482) 562107
Currie & Maughan,
204-206 Durham Road, Gateshead,
Tyne & Wear NE8 4JR
Gateshead (0632) 774540
Key Computer Services Ltd,
28 Osborne Road,
Newcastle-upon-Tyne NE2 2AJ
Newcastle (0632) 815157
Newcastle Computer Services,
906-908 Shields Road, Walkergate,
Newcastle-upon-Tyne NE6 4QP
(0632) 761168/9
Ackroyd Typewriters Co. Ltd,
Atamco House, 57-59 Leeds Road,
Bradford BD1 5AF
Bradford (0274) 731835
Computer Centre (Sheffield) Ltd,
227 London Road, Sheffield S2 4NF
(0742) 53519/588731
Deans Computer Services Ltd,
Unit 1, Sheepscar House,
Sheepscar Street South,
Leeds LS7 1AD (0532) 452966

Holbrook Business Systems Ltd,
Moss House, High Street,
Mossborough,
Sheffield S19 5AE
Sheffield (0742) 484466
Currys Micro Systems Ltd,
(inside Currys), 57-59 Albion Street,
Leeds, Yorks LS1 5AA
(0532) 446601
Holdene Ltd,
Bray House, Leicester Place,
Leeds LS2 9BH
(0532) 459459
Yorkshire Electronics,
Caxton House,
17 Fountain Street,
Morley, West Yorks. LS27 9AE
Leeds (0532) 522181
Yorkshire Microcomputers Ltd,
28 Ramshill Road, Scarborough,
North Yorkshire YO11 2QF
(0723) 78136

CHANNEL ISLANDS
**Channel Data Processing
(Jersey) Ltd,**
108 Halkett Place, St. Helier,
Jersey, Channel Islands
Jersey (0534) 24333

SCOTLAND
Ayrshire Office Services Ltd,
22 Douglas Street, Kilmarnock,
Strathclyde KA1 1RB
Kilmarnock (0563) 24255
Criffell Micro Business Systems,
Grassford Road, Dumfries DG2 0NY
(0387) 69151/2
Gate Microsystems Ltd,
The Nethergate Centre,
35 Yeaman Shore, Dundee,
Tayside DD1 4BU
Dundee (0382) 28194
Gate Microsystems Ltd,
Abbey House, 10 Bothwell Street,
Glasgow G2 6NU
041-221 9372
Holdene Micro Systems Ltd,
48 Great King Street,
Edinburgh EH5 6QY
031-557 4060
MacMicro Ltd,
Beaufort House, Shore Street,
Beaulieu, Inverness IV4 7BX
(0463) 782774
Microcom,
89 West Campbell Street,
Glasgow G2 6SE
041-204 0812/3
Robox Office Equipment Ltd,
Unit 14, Anderson Shopping Centre,
Argyle Street, Glasgow G2 7PH
041-221 8413/4-5401/2

NORTHERN IRELAND
**Northern Ireland Computer
Centre,**
4 High Street, Holywood,
County Down,
Northern Ireland BT18 9AZ
(02317) 6548

WALES
Computer Supplies (Swansea),
82 Gower Road, Sketty,
Swansea SA2 9BZ
(0792) 290047
**North Wales Computer
Services,**
Alliance House,
16 Penrhyn Road, Colwyn Bay
Colwyn Bay (0492) 33151
Reeves Computers Ltd,
24 Spilman Street, Carmarthen,
Dyfed SA31 1LQ
(0267) 32441
Reeves Computers Ltd,
33 Bridge Street, Newport,
Gwent NP20 4BH
(0633) 212331
Reeves Computers Ltd,
6 Walter Road, Swansea,
West Glamorgan SA1 5NF
(0792) 468103
Rockliff Micro Computers,
Pendre House,
High Street,
Mold
(0352) 59629
Sigma Systems,
Computer Centre,
266 North Road, Cardiff,
South Glamorgan CF4 3BL
Cardiff (0222) 34865/34869

150 great dealers.



For more information, telephone or write to your nearest dealer, or to us at:
The Commodore Information Centre,
 675 Ajax Avenue, Slough, Berks SL1 4BG.
 Telephone: Slough (0753) 79292
 I am particularly interested in (Please tick box)
 Commodore 700 series
 Commodore 500 series.
 Commodore 64

Name _____
 (MR/MRS/MISS)
 Company _____
 Position _____
 Address _____
 Telephone _____

57PCW12/82

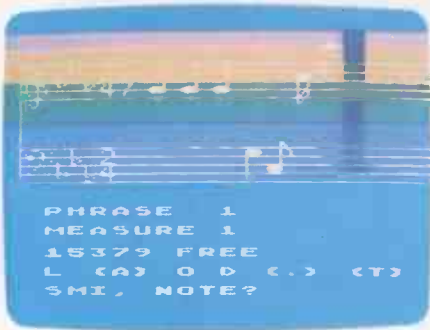

Music Composer

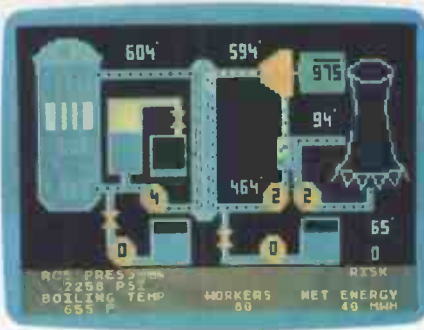

Scram



Graph-it



Intro to BASIC 1



Star Raiders



European Countries



Missile Command



Basketball

3.7 million reasons why the Atari Home Computer is something to see. The display screen used with our computers is composed of 192 horizontal lines, each containing 320 dots. Delivering colour and luminosity instructions to each dot for a second requires 3.7 million cycles...a lot of work for the normal 6502 processor.

That's why the Atari computer has equipped its 6502 with its own electronic assistant. It's called ANTIC, and it handles all the display work, leaving the 6502 free to handle the rest. What this means to you is uncompromisingly spectacular display capabilities without loss of computer power needed to carry out the demands of your program.

That's a quality you just don't find in ordinary home computers. And it's one of the reasons some computer experts say that Atari computers are so far ahead of their time.

There's more...which is what you'd expect from Atari Language. The Atari Home Computer uses several programming languages to give the user maximum control of its extraordinary capabilities. PILOT, Microsoft BASIC and Atari BASIC are understood and spoken by the Atari computer. You'll also find our Assembler Editor cartridge indispensable for machine language programming.

Sound. An Atari computer has four sound generators, or voices, activated by a separate microchip. This leaves the principal micro-processor chips free to perform other tasks. And you can take full advantage of this capability which is designed for easy programming.

Change. Atari Home Computers have been designed to make change and expansion easy. The Atari computer has a modular operating system that can be easily replaced as new technology develops. If you need it, memory expansion requires no more than inserting additional RAM modules.* And the Atari ROM cartridge system also makes it easy to change languages. In short, your Atari computer won't become obsolete by future developments...because it already incorporates the future.

Sharing. To learn more about the amazing capabilities of Atari Home Computers, either visit your local dealer or fill in the coupon below.

THE GRAPHIC DIFFERENCE BETWEEN ATARI® COMPUTERS AND ALL THE OTHERS.

*Atari 800[®] computer only.



Please send me FREE a brochure, price list and the address of my nearest stockist.

Name _____

Address _____

PCW6
Atari International (UK) Inc.
Windsor Hse., 185-195 Ealing
Road, Alperton, Wembley,
Middlesex.

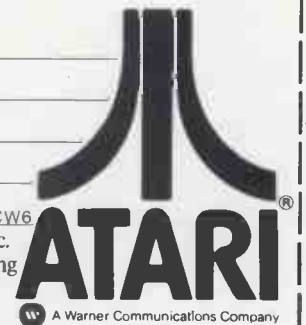

A Warner Communications Company

ADA—A BRIEF ENCOUNTER

```
'write'
WHEN 80 .. 99 =>
  PUT ("GENIUS");
WHEN 60 .. 80 =>
  PUT ("GOOD");
WHEN 35 .. 59 =>
  PUT ("AVERAGE");
WHEN OTHERS => -- ie, default
  PUT ("UNCLASSIFIED");
END CASE;
```

Ada insists that we must cater for every possible value of the selecting item (ie, EXAM_MARK), and also that no two WHEN items include the same values. Moreover, Ada will check this before running the program. In fact, there is an error in my CASE example, because 80 has been specified in two options — the program would produce a compile-time error. You might feel that such a checking facility is impossible, but, to accomplish this, Ada will not allow you to use variables in a WHEN item because variables can be checked only at run-time. The point of all this red tape is a statement which will not inadvertently fall through to the following statement, and whose effect is not altered by re-ordering the WHEN list.

Finally, one overall point on CASE, IF, WHILE, and FOR is that the Pascal BEGIN/END scheme has been rejected in favour of more meaningful terminators — ie, END CASE, END IF and END LOOP.

Data types

This is a major part of Ada, and occupies about 30 pages of the reference manual. Because of this range, I'll examine the more novel features.

Initially, we have built-in types similar to Pascal, eg:

```
COUNT, I: INTEGER;
SUM: FLOAT = 1.0; -- and initialise
A: ARRAY (1 .. 100) OF INTEGER;
```

We may also form 'derived' types as in:

```
TYPE VOLTS IS NEW REAL;
TYPE AMPS IS NEW REAL;
X,Y: VOLTS = 0.0;
A,B: AMPS = 1.0;
and can now write statements such as
X = Y + 6.0;
```

```
A = A + B;
but not
X = A;
because the items are of different types.
```

The declaration of numeric types is worth looking at, as it is a considerable advance on Pascal. We can declare a limited range for an integer as in:

```
TYPE WEEKS IS RANGE 1 .. 52;
X: WEEKS;
```



but the novel point in Ada is to apply this to reals, and specify the range and precision:

```
TYPE FRED IS DIGITS 10
  RANGE -100000 .. 100000;
X,Y: FRED;
```

Here, we have said that, whatever the size of word on our computer, X and Y must be held to at least 10 digits of precision. Though Ada was not specifically aimed at numerical work, it provides better facilities than Basic, Fortran, or Pascal because programs will run on any machine, irrespective of the number of bits per word.

Arrays are defined in a similar manner to Pascal, but the actual size (within certain limits) can be left until run-time. Because array elements can be of any type (eg, character) and the size of arrays is flexible, we automatically have character strings; and because functions can return arrays as results, we can easily write powerful string functions. A simple example of procedure which prints out every element of an array of any size is:

```
PROCEDURE ARRAY_PRINT
(A:ARRAY) IS
FOR I IN A'FIRST .. A'LAST LOOP
  PUT (A(I));
END LOOP
END ARRAY-PRINT;
```

Here we have made use of the reserved words FIRST and LAST, which find out the actual limits of the array index.

Program units

An important requirement in a language is that it allows the programmer

a) to split large programs into smaller manageable chunks (eg, subroutines in Basic);

b) to incorporate standard library packages in a program;

c) to write packages which can be safely used by other programmers.

Most languages do not meet these requirements!

Ada provides us with enhanced Pascal-style procedures and functions, plus two types of module called 'packages' and 'tasks'. As usual, I'll concentrate on the differences from Pascal.

Firstly we can 'overload' (enhance the meaning of) the arithmetic operators. As an example, we could overload the '+' operator to perform matrix addition. Assuming that the type MATRIX has been defined as a two-dimensional array of any size, we can add corresponding elements by:

```
FUNCTION "+" (X,Y:MATRIX)
  RETURN MATRIX IS
SUM:MATRIX;
BEGIN
FOR I IN 1 .. X'LAST(1) LOOP
  FOR J IN X'LAST(2) LOOP
    SUM(I,J) := X(I,J) + Y(I,J);
  END LOOP;
END LOOP;
RETURN SUM; -- ie, the result
END "+";
```

and we may now use '+' to work on matrices.

The package

For safe programming, the Pascal rules on the scope of variables are inadequate

— ideally we want to provide a set of procedures for other users and also prevent the user from interfering with the internal workings. Consider a TV set — it is sealed up to keep out unskilled hands but can be manipulated to a limited extent by a set of controls on the front panel.

We can see why standard Pascal is unsafe by looking at an attempt to provide a set of 'turtle graphics' procedures. The requirement is to control the heading (angle A) of a



point on the screen by two procedures LEFT(N) and RIGHT(N), where N is any angle in degrees. We could try:

```
PROCEDURE LEFT (N:INTEGER);
VAR A:INTEGER
```

```
  Body of LEFT;
PROCEDURE RIGHT(N:INTEGER);
VAR A:INTEGER;
  Body of RIGHT;
```

Here, the programmer attempts to convey that variable A is 'private' to LEFT and RIGHT and must be updated only by these procedures. The problem is that as soon as the program exits from LEFT, all local variables (including A) are lost. In fact, such a variable needs to exist throughout the running of the program, and so must be declared at the outermost global level. Unfortunately, such variables can be accessed by any part of the program.

However, in Ada, we can declare a package, typically consisting of a set of procedures and data items, such that variables within it are inaccessible from outside the package, yet keep their value between procedure calls. For turtle graphics, we could write:

```
PACKAGE TURTLE IS
PROCEDURE LEFT(N:INTEGER);
PROCEDURE RIGHT (N:INTEGER);
END
PACKAGE BODY TURTLE IS
A:INTEGER;
-- followed by the body
-- of LEFT and RIGHT
END TURTLE;
```

Tasks

Many computing applications involve the simultaneous action of several tasks, such as writing to several VDUs at once, controlling a chemical reaction, or animating a Space Invaders game while detecting the player's move. Ada allows several tasks (similar in definition to a package) to be run together by high-level statements, whereas one is accus-

SOFTWARE FOR CP/M®

HIGH QUALITY SOFTWARE – WITH HIGH QUALITY SERVICE

★ **NEW! 16 BIT SOFTWARE** • Wordstar £280 • Mailmerg £150 (£380 with Wordstar)
• CBasic – 86 £195 • Emulator 80/86 £115 • Ascom – 86 £100 • XLT – 86 £90 •

WORDSTAR - Professional word processing software. On-screen formatting, wordwrap, pagination, line and character count on view. Micro-justification on daisy-wheel printer. Search and replace. Block/paragraph manipulation. External file read/write. Background printing during editing etc.	£250	MICROSOFT FORTRAN COMPILER	£225
MAIL-MERGE - Powerful Wordstar enhancement for file merging and document personalisation.	£65	MICROSOFT COBOL	£330
DATASTAR Screen orientated system for Data Entry, Retrieval and Updating.	£175	MAGSAM - Versatile easy to use Keyed File Management System for Microsoft Basic or CBASIC.	£130
SUPERSORT - Sort, merge and selection program.	£125	CIS - COBOL - ANSI' 74 implementation to full-level 1 standard. Supports random, indexed and sequential files, features for conversational working, screen control, interactive debugging, program segmentation etc.	£425
CONFIGURABLE BUSINESS SYSTEM (CBS) - Unique information management system with user definable files, powerful report generator, menu-driven for ease of use. No programming experience necessary!	£225	FORMS-2 - Automatic COBOL code generator for screen formats.	£100
ACCOUNTING PACKAGES by Median - Tec: PAYROLL, SALES, PURCHASE, NOMINAL Specially developed by UK software house to exacting specifications. Written in Microsoft Basic each package may be customised by end user, all are widely used. Ledgers are open item. Payroll caters for weekly and monthly pay.	£500 each	PASCAL-Z	£255
PROJECT COST CONTROL/JOB ACCOUNTING - A comprehensive set of programs to monitor budgets, account for expenditure and project completion etc. Ideally suited for contractors. Written in CBASIC-2.	£150	SUPERCALC FINANCIAL PLANNING SYSTEM	£165
STATISTICS PACKAGE - Over 25 routines including Regression & ANOVA	£100	CBASIC-2 - Extended Disk Basic pseudo compiler and run-time interpreter.	£75
MATHS PACKAGE - Over 40 easily used routines.	£100	THE FORMULA — unique system, report generator and database manager	£330
IBM - CP/M COMPATIBILITY - Powerful utility to transfer data to/from IBM machines in standard disk format.	£110	BSTAM - Telecomms facility for exchanging files between CP/M computers.	£110
MICROSOFT BASIC INTERPRETER	£155	ASCAM - Facility for communicating with other computers.	£95
MICROSOFT BASIC COMPILER	£205	TRANSFER - CP/M to CP/M file exchange - telecomms source code	£95
		MACRO 80 - Macro Assembler	£99
		CP/M 2.2 - Standard Version 8" Single Density.	£99
		Please contact us for availability of other products All orders must be PREPAID. Add £1 per item P & P (Minimum £2.00) and VAT CP/M is trade mark of Digital Research	

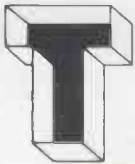

TELESYSTEMS LTD

P.O. Box 12, GREAT MISSENDEN, BUCKS, HP16 9DD

Telephone (02406) 5314

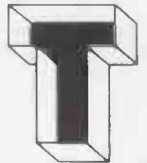

WINNING APPROVAL-



Through their powerful multi-processor operating systems Equinox professional microcomputers will grow and adapt in step with your Company.

Widely used in industry because of their proven power, reliability and expandability, Equinox systems are one of the few Government (CCTA) approved microcomputer systems with both CP/M and MICROCOBOL as standard.

And because they are specifically designed to grow and adapt with you, Equinox microsystems will win your approval, too.

EXPANDABLE

Equinox systems are not just simple desk-top, single-user machines, so they can expand both storage capacity and number of users, and

grow from single-user floppy based (5¼" or 8") to multi-user hard disc systems.

Through the S-100 bus structure, interfacing is possible to a wide range of component boards and interfaces, including PRESTEL/VIEWDATA, mainframe communication processors, floating point hardware, colour graphics cards, A/D and D/A etc. In fact, the large number of component boards manufactured for the S-100 make it the most interesting and versatile bus, around which to build your system.

POWERFUL

All this, plus two powerful multi-processor operating systems – TURBODOS (which will run your CP/M compatible software) and MICROCOBOL BOS/NET – make Equinox the systems for commercial

ADA—A BRIEF ENCOUNTER

tomed to dropping into assembly code to deal with interrupts, etc. In Ada, aside from a minimal amount of assembler which may be needed to address novel peripherals, the interrupt is treated as a low-level device that is hidden from the programmer by the language. Indeed, it is interesting to note that Ada, as well as allowing one processor to switch between several tasks in the conventional manner, will also allow the programming of systems in which each task has its own processor — ie, the program is distributed between several machines. In this area of real-time programming, potentially involving dangerous situations, it is realistic to expect errors, either within the programming system itself (eg, division by zero), or errors in results which can be detected by program. Bearing in mind that an error may be detected deep inside a series of nested procedure calls, Ada allows the programmer to specify an action to be taken when a particular 'exception' occurs, and also to control how many partially completed procedures are skipped before normal processing resumes.

...and

Yes, there's more. Particularly in the area of modules, data types, and input/output (provided by a set of procedures written in Ada), but if you want more detail, try one of the books listed below. However, bear in mind that it

will be some time before you will be able to run Ada on your micro.

The debate

'Coherent'; 'versatile'; 'unwieldy'; 'baroque'; 'almost impossible to implement'; 'unreliable'.

These phrases come from recent Ada articles in the computing press; the anti-Ada faction maintains that it has features grafted together to allow for any possible requirement, making it a very large language, difficult to understand and use. If the language is incomprehensible to most programmers, will the programs they produce be of poor quality? Well, the point about complexity is true — many programmers will find Ada difficult, so perhaps the choice of a Pascal-like subset might be appropriate. On the other hand, real-time systems are complicated in any language, so perhaps one which acknowledges their existence is an improvement. However, one of Ada's strongest opponents, Professor Hoare of Oxford University, says that it must never be used to implement large software systems because it is unreliable in the areas of error-handling and multi-tasking. Bearing in mind that the DoD has had several false alarms in recent years, such criticisms are indeed serious.

Where is Ada?

As Ada compilers are reputed to be six times larger than Pascal compilers, full

Ada is not likely to appear on today's typical micro system. Currently though one can purchase micro Ada subsets from the USA, and for Motorola 68000, DEC, and IBM 370 systems from Telesoft in the UK. York University is also well advanced towards a full Ada compiler.

The future

Will it catch on? Opinions differ, but it will have to overcome Cobol/Fortran inertia from industry — though some firms involved in real-time programming are keen. Ada subsets (eg, without the multi-tasking facilities) will become more widespread, competing with Pascal on CP/M systems.

Perhaps the personal computer language battle will end up being fought between Unix plus 'C', Pascal, Smalltalk, and Ada?

Further reading

The number of Ada books is increasing rapidly, so this is not an exhaustive list.

Programming With Ada by Wegner — published by Prentice Hall.

Ada — An Introduction by Ledgard — published by Springer-Verlag (also includes the Ada reference manual).

Problem Solving With Ada by Mayoh — published by Wiley (uses turtle graphics in many of the examples).

The Ada Programming Language by Pyle — published by Prentice Hall.

END

EQUINOX expandable microsystems.



and industrial applications. TURBOdos supports from one to 16 users and provides single-user response in a multi-user environment; it can also link up to 255 systems — a potential network of over 4,000 users!

FLEXIBLE

What's more, with Equinox you can choose from a wide range of packaged software available: accounting, word processing, financial planning, information (data base) management and many others — or write your own application programs.

And don't worry about hardware support — we can supply nationwide maintenance.

So if your company is in the process of change, growth or expansion, get in touch with Equinox TODAY. You'll find our microcomputers will grow on you.

OEM, SYSTEM HOUSE & DEALER ENQUIRIES INVITED.

Trademarks:

MICROCOBOL; Microproducts Software

TURBOdos; Software 2000 inc.

CP/M; Digital Research



EQUINOX
MULTI-USER MICROSYSTEMS
16 Anning Street, New Inn Yard,
London EC2A 3HB. Tel: 01-739 2387
Telex: 27341

CHECKOUT

PLUTO POWER!

Add more muscle to your colour graphics with IO Research's Pluto board. Joe Whelan investigates.

As the cost of processors and RAM drops, we are likely to see more and more multiprocessor machines to be sold either as rack systems or as add-on units; the BBC machine is a good example of the latter. These multiprocessor machines will also tend to have dedicated processors, for such things as screen control (for example, the review system contains an 'Intelligent Video Controller' card with its own Z80A processor), which will have their own RAM, input/output ports and the ability to perform multi-tasking.

The uses to which these systems can be put are extremely varied and will tend to form a source of extremely powerful, small and yet relatively cheap computers: the new DEC Rainbow is a very good example, with 16-bit and 8-bit processors and running all CP/M software. The really interesting point for most micro users is that machines such as the ACT Sirius and the IBM Personal Computer don't have this nice facility, and so an add-on board must be made to contain the second processor, which means it may also be possible to link these optional boards up to other micros. A second processor would be extremely useful, if not a prerequisite: especially for the Sirius, Galaxy and many others which don't have colour graphics as standard.

The first British company to realise the impact that an add-on, 16-bit processor board dedicated to graphics would make is IO Research Ltd. IO has produced two options of the board — 'Pluto' and 'Baby Pluto', which is cheaper (because it contains less RAM) but is completely upgradable to a full Pluto. Both these cards can be further expanded by the addition of the palette board (see later).

Hardware

The board itself is a well-made 8in x 8in card, and connects to the host computer through an 80 BUS or NAS-BUS edge connector (80 pins). However, the manual gives the data for each of the lines, and so it can be connected

to any host computer which has two 8-bit parallel I/O ports (see Figure 1 for details). Any computer without this facility can be linked to the Pluto by direct connection to the bus: IO Research has at present connected the following machines up to a Pluto: Apple II, Sirius, PET, BBC, Gemini and IBM. The machine used for this review was a Gemini Galaxy 1 (which is based on the Gemini multiboard cards and contained the CPU/RAM/IO card, IVC card and disk controller card) which uses the 80 BUS system and hence allowed the Pluto board to be simply plugged in. The board can also be bought together with a case which will take all future expansions: this is necessary for all those machines which have a design criterion of good looks rather than expandability — such as the Sirius, which has virtually no room left inside the case for expansion. It will also accommodate the power supply, which is not a trivial matter seeing as the Pluto board alone draws a current of around 1.8 amps.

The processor on the board is a 16-bit Intel 8088 running at 6MHz, although there is also a faster 8MHz version which has just become available which gives a 60 percent increase in speed. This was addressing 4k of EPROM (although the board contained socketing for up to 32k of ROM) and 2k of static (8088 work space) plus 192k of dynamic RAM, consisting of three banks of 8x64k RAM chips, all 150 nS cycle time (the 8088 is capable of accessing over 16 megabytes of memory directly). All the chips on earlier versions of the board were socketed (as was the board under review); however, on later versions all chips bar the RAM and the CRT controller are soldered directly to the PCB: something more and more manufacturers seem to be keen on. On the review sample there were some jumper leads between a few of the chips. (I'm not certain of the exact functions of these jumpers but they appear to be used so as to allow for future expansions/options and to configure the

board for different systems.) The connection to the monitor was through a 20-pin plug; the output is for an RGB monitor or composite video signal — note the Pluto can be used on single-colour monitors but only the green plane can be displayed. The CRT controller is a Hitachi 46505SP and there are two oscillators, one of which is the Pluto system clock and the other being, presumably, the oscillator for the CRT controller (IO Research, after many enquiries, is planning to make this oscillator synchronised to an external source — eg, for television studio work). There is also a larger 50-pin connector which was for connection to the palette board which is due for release shortly. The quality of the colour generated is excellent and could only really be appreciated on a high-resolution colour monitor. All the input/output on the board is fully buffered to allow for easier control of the Pluto card by the host processor.

Software

The software is contained in the 4k EPROM, and is generally well thought out, and the commands are comprehensive and powerful, if sometimes complicated. Commands can be sent to the Pluto using any language that allows the addressing of specific output ports — for example, Basic, CBasic and machinecode: with Basic the Pluto will always beat the interpreter for speed and so no checking of the status of the Pluto board is required. However, when writing in machine code (and in CBasic when the command sent previously involved a complicated operation) the status must be checked. The memory is considered as a block which is 640 pixels wide and 800 pixels high. This is divided up into a number of 'partitions', the number of which can be varied by the user, which are 640 pixels wide and of variable height (see Figure 3). These partitions can be used for anything that normal memory is used for, such as data storage or program storage. However, the first two partitions (numbers 1 and 2) are used for the screen display and are predefined to be 640 pixels wide by 288 pixels high: these can be used for super-fast animation as one screen can be displayed while the other is being redrawn. The remaining partitions are capable of containing various symbol tables, eg, character sets, in addition to the predefined ASCII character set for text display which is stored on the onboard ROM: these are defined as an 8x10 matrix which, although good, is not up to the same definition as the Sirius: presumably the characters

1-4	GND
23	WAIT
26	IORQ (kept at 0)
28	WRITE STROBE
29	READ STROBE
30	DATA/STATUS SELECT
31-34	LOGIC 0 TO SELECT PLUTO
35-37	LOGIC 0 TO SELECT PLUTO (depends on set of linkages on board)
50-57	BI-DIRECTIONAL DATA BUS
75-78	+5 Volts

Note: all other signals are 80 BUS specific and are not required by the Pluto board

Fig 1 Interface connections for a non-80 BUS system

are defined in this way so as to make an 80 by 28 screen display.

The actual screen display is defined as a pixel matrix of 640 across by 288 high, with the origin at the top left hand corner. The memory is organised so that one pixel is defined by three bits (giving eight possible bit patterns); this allows the choice of one of eight colours per pixel and there are no restrictions on the arrangements of the various coloured pixels on the screen. In addition, with a small amount of laborious work, these pixels can be grouped to give the impression of other colours.

The commands for control of the screen are very comprehensive: see Figure 4 for the complete list and explanation of the commands. They contain procedures for move, move relative, draw, draw relative, plot point and plot point relative. Each of the relative commands is then subdivided into a long and a short version. The reason for this is that the commands are sent down to the Pluto board as one-byte codes. On receipt of the command code, Pluto will expect a fixed number of data bytes, depending on the command given (one word of warning here; the status port on the Pluto should be checked before sending data to the card as if any information, especially the command and first data bytes, is sent but not read the Pluto will wait for more data or misinterpret any future data). If the command is to move the 'current position pointer' (IO's word for an invisible cursor) relative to its present position, then the move may be either greater or smaller than 127: 127 if the move is positive but 128 if it is negative. If it's greater than 127/-128, two bytes will have to be sent to Pluto for both the X and the Y coordinates. This would mean a total of five bytes to be transmitted, as opposed to only three if the required move is less than 127 pixels in both the X and the Y directions. It may seem a little silly at first

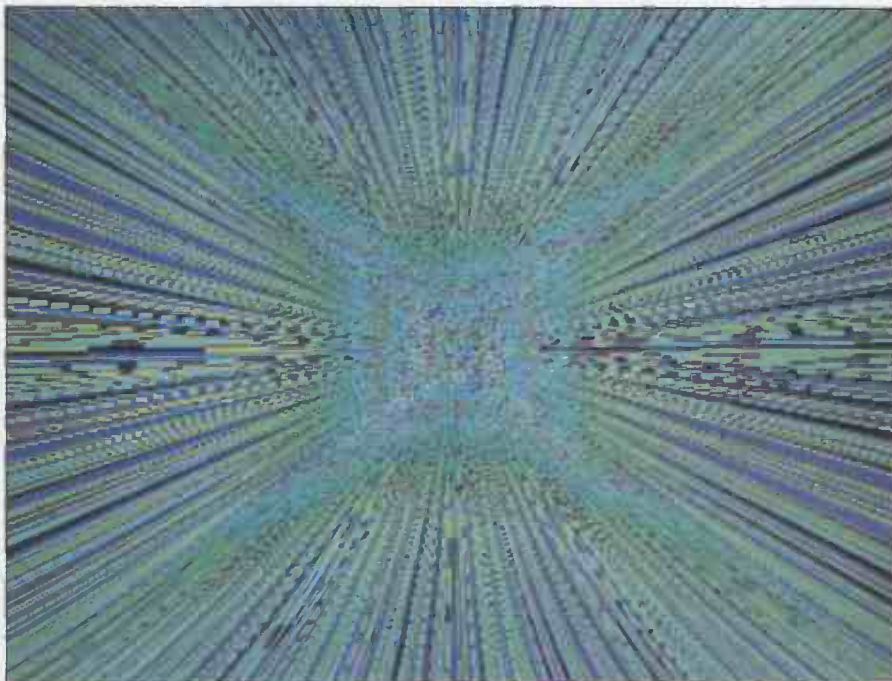

to duplicate these commands, but when you realise that in order to send the data you have to calculate and then send it as two sets of low and high bytes it does save a lot of time using the 'short' instructions: hence it is usually much easier to send two 'move shorts' instead of one move. To tell the truth, I always found it much easier to use only absolute instructions because all the relative instructions, quite logically, require the bytes to be signed. It is possible to lighten the mental load when programming for the Pluto by using lines in your programme such as:

```
1000 N - 166
1010 Y - A * B
1020 OUT N, Y AND 255, Y/255
```

where N is the output port number, line 1010 sets a value for Y, and line 1020 sends low byte followed by high byte.

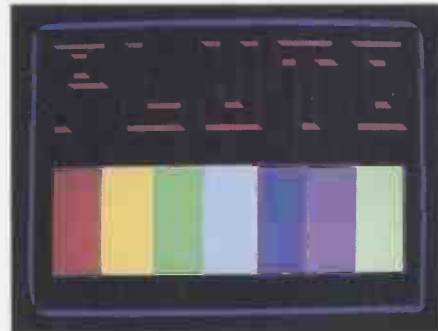
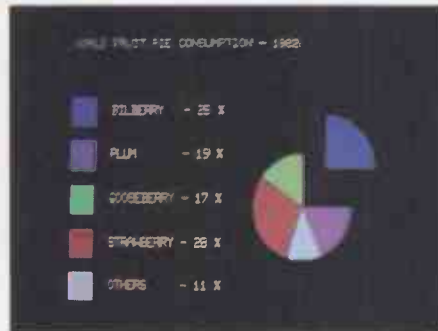

Pluto graphics

The commands for reading the colour value of a pixel are again divided into two and four-byte versions. There are fairly standard commands for colour definition, FCOL, CCOL, BCOL and TCOL. These stand for foreground colour, current colour, background colour and transparent colour respectively. The uses of these commands will be explained in more detail later.

There is a very powerful command for the manipulation of the above commands called 'STYLE'. This, in the simple graphics operations such as draw or plot, decides the method of laying the line, such that you AND, OR, XOR or REPLACE the line in memory: these are fairly standard functions, but none the less necessary. However 'STYLE' allows for various effects to be performed on other operations. The most useful of these 'other operations' is the ability to copy areas of rectangular memory (called Rasters). There are a number of Raster Ops which can be performed such as:

- 1) Set each pixel in the raster to a

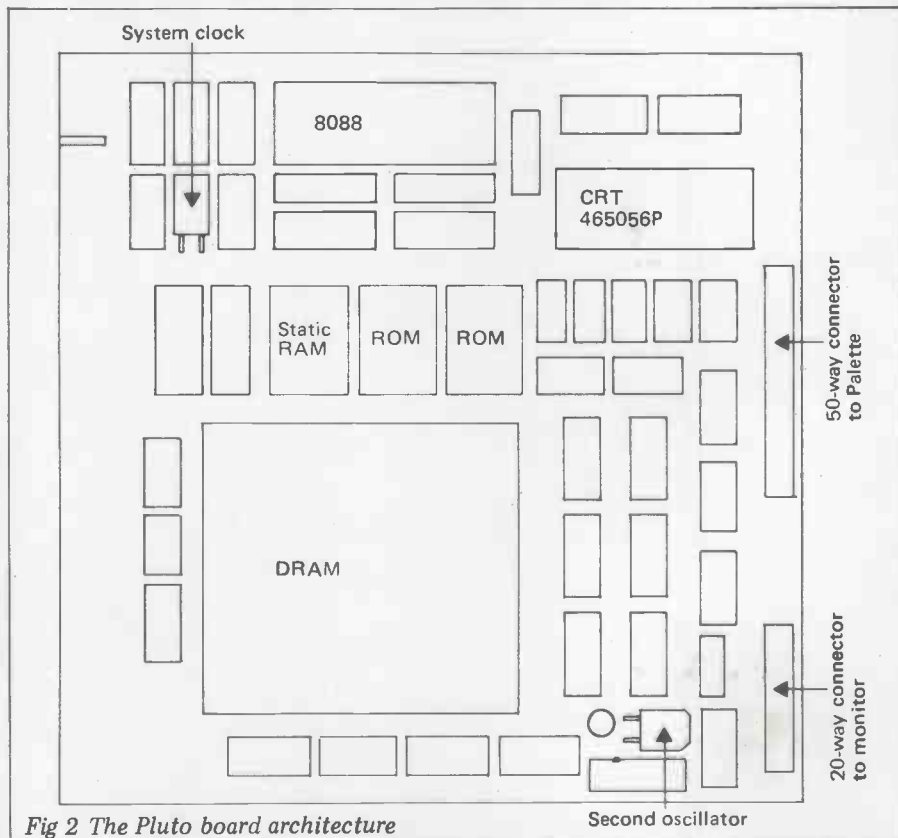
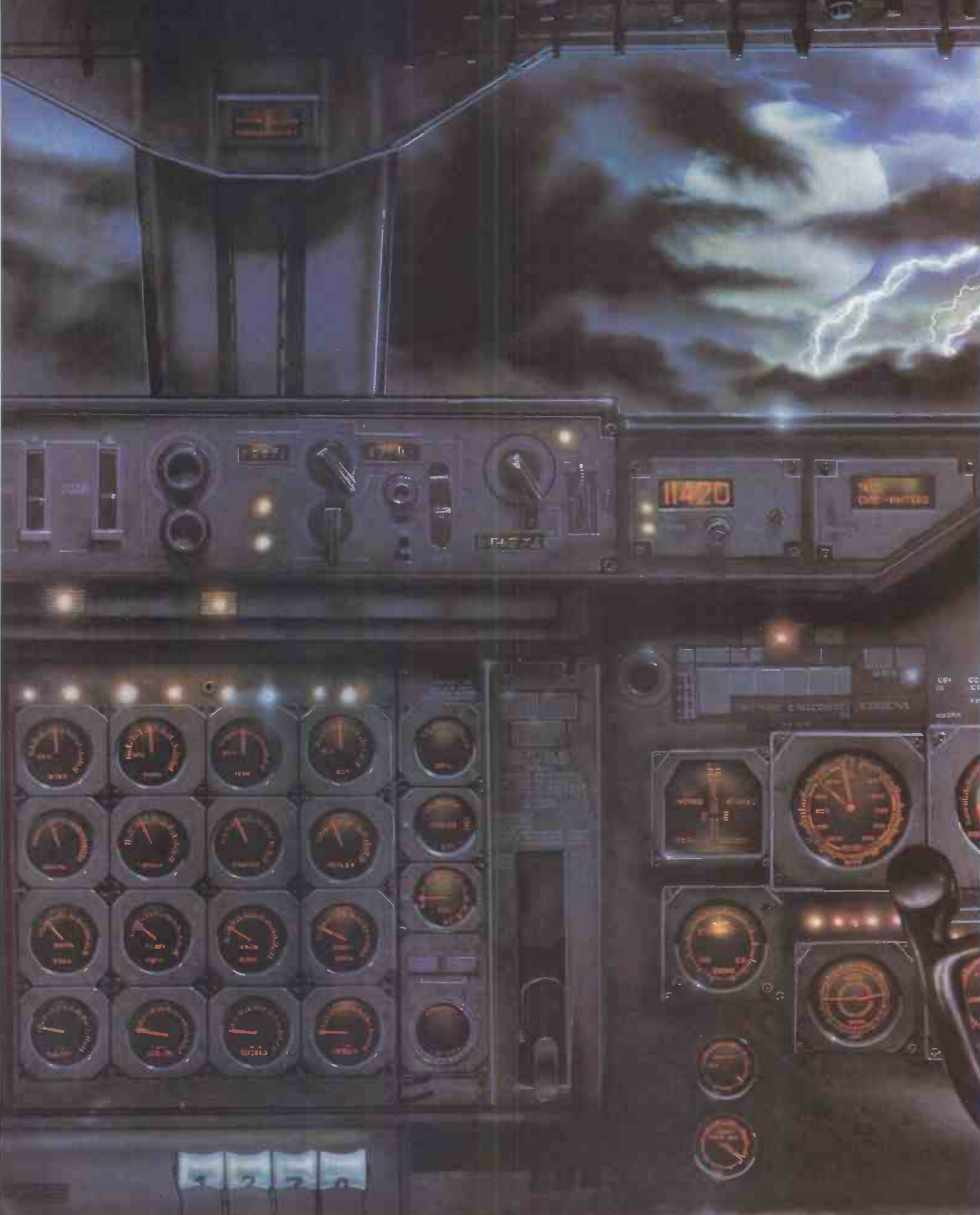
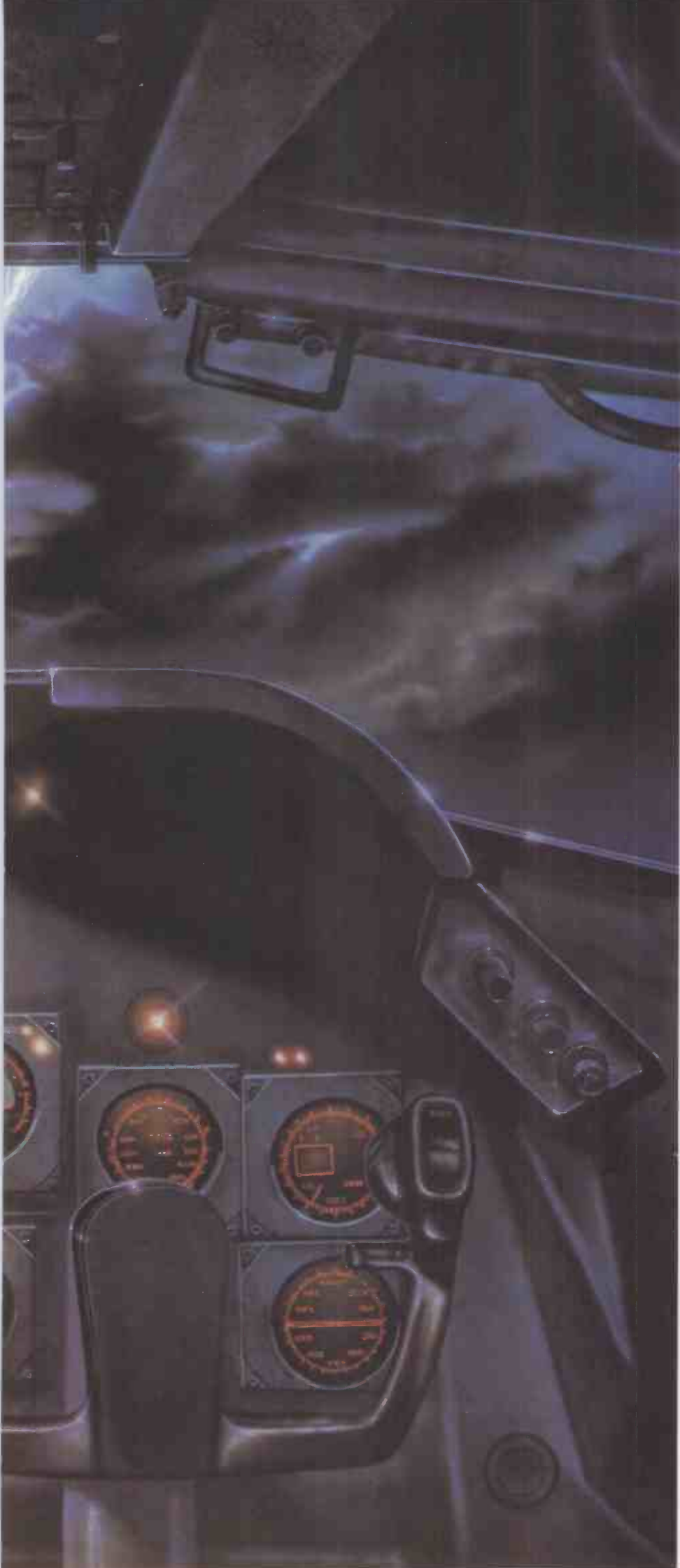

Fig 2 The Pluto board architecture

**“We will be flying at a height of 30,000 feet.
Our air speed will be 500 knots.
And there’s a fair chance we’re going to crash.”**





No smoking. Fasten your seat belt. You're about to take off in a 747. But on this flight you're the pilot.

You could hardly describe THORN EMI's 'Jumbo Jet Pilot' as simply another video game. It's more like a session in a flight simulator with life-like instrumentation and graphics.

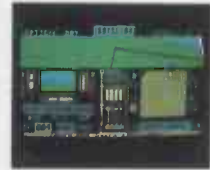

Jumbo Jet Pilot, 16 K ROM, Cartridge.
5 skill levels, Performance rating.
Controls: Throttle, Ailerons, Elevators.
Undercarriage, Brakes, Stall Indicator.
Lights, Fuel, Longitude, Latitude.
Air Speed, Artificial Horizon, Altitude.
Pitch and Roll, Heading, Vertical
Speed, Map Reference and Grid.
Time Elapsed.

To cope you need to be alert. You should expect the unexpected. And you definitely shouldn't lower the undercarriage when your air speed is dropping and the horizon suddenly appears vertical!

On landing, your in-flight computer will assess your skills and give a 'performance rating'. If you manage to land that is.

'Jumbo Jet Pilot' is one of 21 challenging new home computer games from THORN EMI. It's pretty demanding. But our programs aren't all work and no play.

'River Rescue', 'Kickback', and 'Soccer,' are all-action games. 'Pool' and 'Darts' will suit armchair sportsmen.

And whilst budding Beethovens play the 'VIC Music Composer,' would-be Chancellors can work on their budgets with 'Home Financial Management'.



Darts.



Humpty Dumpty.

We also have educational puzzles for children that will puzzle adults at higher skill levels. But there's one simple idea behind all our titles; we've designed them for players who are bored with run-of-the-mill TV games.

Now, is that Heathrow ahead?
Or is it Hyde Park?



The world's greatest TV games



PROGRAMS FOR ATARI 400/800 (Trademark of Atari Inc. except where indicated).
*PROGRAMS FOR COMMODORE VIC 20 (Trademark of Commodore International).

Available from all branches of Laskys (Nationwide), Micro C at Currys, and all other leading Computer software outlets.

PLUTO POWER!

particular colour; used to fill areas of screen with a colour or to clear the screen. This is a standard command called RECTFILL.

2) Copy one raster to another. This is the way Pluto draws characters on the screen, and scrolling must be done by copying one character raster to another raster any number of lines up or down the screen (giving fast or smooth scroll). These functions are done using the COPY command.

3) Invert (complement) the colour of each pixel within the raster — useful for inverting characters on the screen.

4) Copies one raster to another, but at the same time uses another raster to mask the pixels as they are copied, giving the masked pixels in the destination raster one of two colours. This is used for displaying the text, where the character definition is in the mask raster. Those bits set in the mask are set to FCOL in the destination and the remainder set to BCOL (the Pluto's character set is defined using one bit per pixel giving only two colours). Any of the colours can be accessed by use of the STYLE command. However, if desired, the characters can be defined by the user using three bits per pixel giving a character containing all possible eight colours.

5) Paint to a raster using a mask raster



Showing the flag

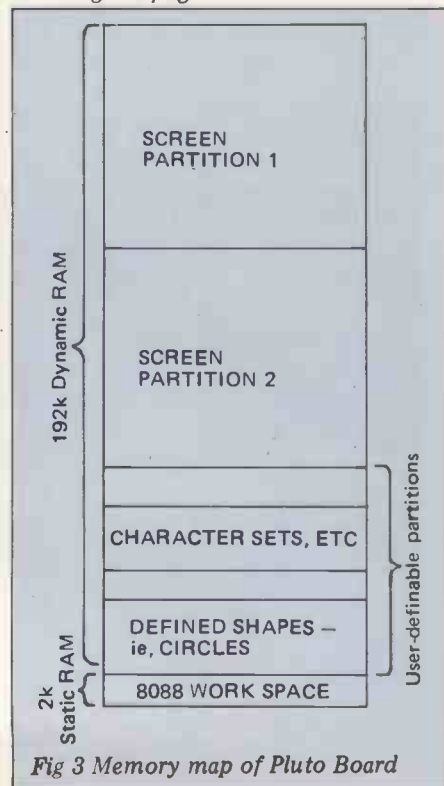

Fig 3 Memory map of Pluto Board

COMMAND (sent as 1 byte)	NUMBER OF PARAMETERS sent	NUMBER OF PARAMETERS received	OPERATION
CopySymbol	0	0	Prints symbol
Allocate partition	5	0	Sets number & size
Copy	14	0	Block copy function
CopyToSymbol	1	0	From block to symbol
Initialise	0	0	Set parameters
InquireBCOL	0	1	Get background colour
InquireCCOL	0	1	Get current colour
InquireCP	0	4	Get cursor position
InquireCDP	0	1	Returns num of screen partition being displayed
InquireSCP	0	1	Returns symbol table number
InquireCWP	0	1	Returns no of screen partition not displayed (current working partition)
InquireFCOL	0	1	Returns foreground colour
InquireSTATUS	0	1	Is Pluto ready?
InquireSTYLE	0	1	See review
InquireTCOL	0	1	Returns transparent colour
InquireWPROT	0	1	No of mask write-protected
LineRel	4	0	Draw line relative
LineRelShort	2	0	
LineTo	4	0	Draw line absolute
LoadMemory	4,*	0	Copy area of memory
LoadSymbol	1,*	0	Defines a symbol number & shape. All defining bytes are sent after command
MoveRel	4	0	Changes abs
MoveRelShort	2	0	Plots point at X,Y
MoveTo	4	0	
PlotAt	4	0	
PlotRel	4	0	
PlotRelShort	2	0	
Polyfill	0	0	Fills area of memory
ReadMemory	4	*	Outputs the byte contents of an area of specified memory
ReadPixel	4	1	Gets colour of pixel at point specified
ReadPixelRel	4	1	
ReadPixelRelShort	2	0	
ReadSymbol	1	*	Outputs bytes which define character
Rectfill	4	0	Fills a rectangular area of memory with colour specified by CCOL and STYLE
SetBCOL	1	0	Sets background colour
SetCCOL	1	0	Sets current colour for line-drawing, etc
SetFCOL	1	0	Sets foreground colour
SetCDP	1	0	(1 or 2) to define current display partition
SetCSP	1	0	Defines the partition which contains the characters in use
SetCWP	1	0	Defines the partition which is being worked on
SetStyle	1	0	Defines the function of this multi-purpose operation
SetTCOL	1	0	Defines the colour of the transparent mask used in COPY
SetWPROT	1	0	Allows for definition of a write-protected mask on any colour during a COPY operation

(*: the number of bytes depends on the amount of data required)

Other commands will be available with the new 8k version of the ROM

Fig 4 Commands available with present Pluto ROM

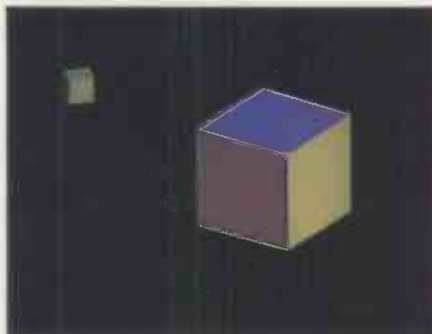

3-D Pluto pic

which defines the colour of the pixels to be changed, while any other pixels are left unchanged. This is where the TCOL function is used, as the transparent colour is the one which is filtered out during the copy.

The above functions are achieved

mainly using the COPY command. This one command requires no less than 14 data bytes to follow it; these include the partition identifiers and conditions for the destination and source rasters.

When using the card for writing text to the screen a number of options are available. Apart from those mentioned above for the alteration of colour and the copying of characters, the size of the actual symbol can be altered by defining your own character set. The size of the character depends only on your patience and the amount of free memory.

There is also a command for the filling in of large or small areas of memory. This is a COMPLEX POLYFILL function which flood-fills the area of memory specified up to a boundary which is assumed to be any colour other than that

GOTO page 201

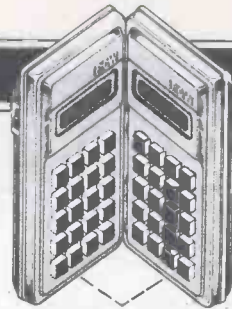

PC-1211 COMPLEX ARITHMETIC

The new HP-15C, reviewed in this column in September, has built-in complex number arithmetic — probably for the first time on a programmable. It is quite possible, however, to program this feature on most machines, and the following is a particularly nice implementation for the Sharp PC1211 by John Kerr of Glasgow.

Dick Pountain

This program converts the 1211 into a calculator operating on complex numbers. It is run in the DEF mode. 'shft Z' creates storage space for up to 18 complex variables, labelled 'A' through 'R'. The assignment statements allowed have the general form

variable name (A...R) shft = operand enter operator enter operand enter operator enter ; ; ; ; operand enter enter

Operands are of two types. A type 1 operand is a variable name, which may be preceded by either or both of the monadic operators '—' and 'C'. These denote complex negation and conjugate respectively; eg, '—CF' represents minus the conjugate of F. A type 2 operand is a numerical input. Examples: $3-j4$ is entered as '3 shft J—4'; $5 \angle -53^\circ$ is entered as '5 shft K—53' (although the latter assumes DEGREE mode, the program will operate in any angle mode). Legal dyadic operators are '+', '—', '*', '/' and '^'. The first four of these represent complex addition, subtraction, multiplication and division. The fifth raises a complex number to a real power; it is followed by a special type of operand (a REAL operand), which is any arithmetic expression. Dyadic operators all have equal priority, and evaluation proceeds from left to right (there is no bracketing facility). Monadic operators have a higher priority and must not be followed by 'enter'.

Several types of prompt are used. These are:

- > Begin entry of calculation
- # For entry of an operand
- ? For entry of an operator, or final 'enter'
- J Rectangular notation; entry of second component
- < Polar notation; entry of second component

The calculation buffer has 32 stages. Type 1 operands and REAL operands occupy one stage; type 2 operands require two, as does the final operand in a calculation, regardless of its type. If the calculation is not terminated (by final 'enter') before this buffer is saturated, the computer automatically suspends input and calculates and displays an intermediate result. To continue the calculation, press 'enter' then input the next operator symbol. This continuation is also permitted when the partial result has been ordered manually.

Memory recall uses the defined program 'L' (for 'look'). For example, 'F shft L' brings the content of memory F to the display. Results are always expressed in rectangular notation, but a result displayed by a memory recall or assignment statement can be converted to polar form by 'shft SPC' (the internal representation of the number is unchanged by this operation). Press 'enter' to return to rectangular form.

Program 'L' also provides the effect of *assignment operators* as found in Algol: 'F shft L enter / enter G enter enter' performs the assignment $F=F/G$ and, in general, 'F shft L enter' is equivalent to 'F shft = F enter'.

Any of the 18 labels A...R may be used in the ordinary way, during calculations, to store REAL numbers. The corresponding complex space will no longer be accessible by its label, but its numerical pointer can be used instead; these pointers are 27 for A, 29 for B, etc. Thus '37 shft L', for example, will bring the value of complex memory F to the display. The calculation register (memories X and Y) is referred to by pointer value 24. On the LHS of an assignment statement it is used to display a calculation result without a destination; while on the RHS it can be used as any other type 1 operand, and has the interpretation 'result so far' — eg, used after '* enter', it squares the current value in the calculation register. NB: memory C should not be used for REAL storage as the operation of complex conjugation would be lost.

Four operations involving REAL storage are:

- Assign the real part of F to R: R=A(F) enter
- Assign the imaginary part to Q: Q=A(F+1) enter
- Assign the modulus of F to M: F shft L shft SPC M = U enter
- Assign the argument of F to A: A = V enter

Lexicon

- Variable names: A, B, C, ... R
27, 29, 31, ... 61
- Complex assignment symbol: shft =
- (Literals) $x + jy$: x shft J y
- $r \angle s$: 2 shft K s
- (Other operands) minus F: —F
- conjugate of F: CF
- conjugate of F: —CF
- (Complex dyadic operators)
- plus: +
- minus: —
- times: *
- divide: /
- power: ^
- Memory recall procedure: shft L
- Rectangular to polar: shft SPC
- Real part of F: A(F)
- Imaginary part of F: A(F+1)
- Modulus of F: U (after 'F shft L shft SPC')
- Argument of F: V (after 'F shft L shft SPC')

Evaluate the polynomial $P = A^4 + (2 + j3)A^3 - 4A^2 - (5 + j6)A + 7 - j8$, for the present value of $A(-1 - j8)$. The expression for P is rewritten in 'nested multiplication' form prior to entering the calculation, since the operators can then be obeyed in the order in which they appear:
 $P = (((A + 2 + j3)A - 4)A - (5 + j6))A + 7 - j8$.
 P shft = A enter + enter 2 shft J 3 enter * enter
 A enter — enter 4 shft J 0 enter * enter

CODE ENTERED	COMMENTS	DISPLAY
(DEF mode) DEGREE enter shft Z	Sets angle mode & pointers	
A shft = —1 shft J —8 enter enter	Assignment: A = —1—j8	—1 —8
B shft = 10 shft K 45 enter enter	Assignment: B = 10 \angle 45°	7.07.. 7.07..
C shft = A enter + enter B enter enter	The sum of A and B is stored in C	6.07..—0.92...
D shft = A enter * enter B enter enter	Product in D	49.49..—63.63..
E shft = A enter / enter B enter enter	This calculation assigns $\sqrt{(A/B+CD)}$ to E; note it has the form	—6.36...E—01 —6.36...E—01 —4.94...E—01
E shft = C enter * D enter + enter E enter ^ enter ½ enter enter	temp = A/B: E = (C*D+temp) ^½	19.18...—11.28...
F shft = —CA enter + enter CC enter * enter 1 shft J 2 enter enter	(—A + C) * (1+j2) where A = conjugate of A, etc, is assigned to F	21.21... 7.07...

Sample calculations

CALCULATOR CORNER

A enter — enter 5 shft J 6 enter * enter

A enter + enter 7 shft J — 8 enter enter

This calculation occupies 12 stages of the buffer: one each for the four occurrences of 'A', and two for each complex constant ('shft J'). The correct answer is $P = 2847 - j493$.

Memory use

A to R Pointers to complex variables
 S to Z Program working space
 A(27) to A(62) Complex variables (storage area)
 A(63) to A(126) 32-stage calculation buffer
 Remaining memory is entirely filled by the 624 steps of program.

Defined programs

shft Z Pointer initialisation routine
 shft = Used as assignment symbol, complex arithmetic
 shft J Numerical input, rectangular notation
 shft K Numerical input, polar notation
 shft L Data recall
 shft SPC Rectangular to polar conversion

NB: Program length is critical; add so much as one colon after a label and it will not work at all. Any addition to the program (such as making the 'complex calculator' program-mable) will entail a reduction in the size of the calculation buffer (reduce 'T=126' at lines 80 and 6). Conversely, T can

```
1: "+" U=-U: V=-V
2: "-" X=X-U: Y=Y-V: RETURN
3: "*" S=1: GOTO 5
4: "/" V=-V: S=UU+VV: IF S=0 BEEP 2: PRINT "DIV. BY ZERO": END
5: T=UY+VX: X=(UX-VY)/S: Y=T/S: RETURN
```

```
6: "=" AREAD Z: S=64: T=126: INPUT "#", A(S): GOTO 10
7: "J" AREAD A(T-1): INPUT "J"; A(T): GOTO 9
8: "K" AREAD U: INPUT "<"; V: A(T-1)=U*COS V: A(T)=U*SIN V
9: A(S)=T-1: T=T-2
10: S=S+2: IF S<T INPUT A(S-1), "#", A(S): GOTO 10
```

```
20: X=#: Y=#
30: FOR W=63 TO 5-3 STEP 2: IF A(W)="A" THEN 90
40: V=A(W+1): S=SGN (200-ABS V): IF -S LET V=V/C
50: U=(ABS V)*SGN V: V=A(ABS V+1)*S*SGN V: GOSUB A(W)
60: NEXT W
70: A(Z)=X: A(Z+1)=Y: BEEP 1
```

```
80: "L" AREAD Z: PRINT A(Z), A(Z+1): S=64: T=126: A(S)=Z: GOTO 10
```

```
90: GOSUB 100: T=A(W+1): U=UAT: X=U*COS TV: Y=U*SIN TV: GOTO 60
```

```
100: U=J(XX+YY): IF X=# LET V=ASN SGN Y: RETURN
110: V=ATN (Y/X): IF -X LET V=V+(SGN Y+(Y=#))*ACS -1
120: RETURN
```

```
150: " " X=A(Z): Y=A(Z+1): GOSUB 100: PRINT U, V: GOTO 80
```

```
200: "Z" FOR W=1 TO 18: A(W)=25+2W: NEXT W: A(63)="+": BEEP 2: END
```

Listing

be increased by two (and the buffer by one stage) for every group of 16 program steps deleted.
 John Kerr

CALCULATION:

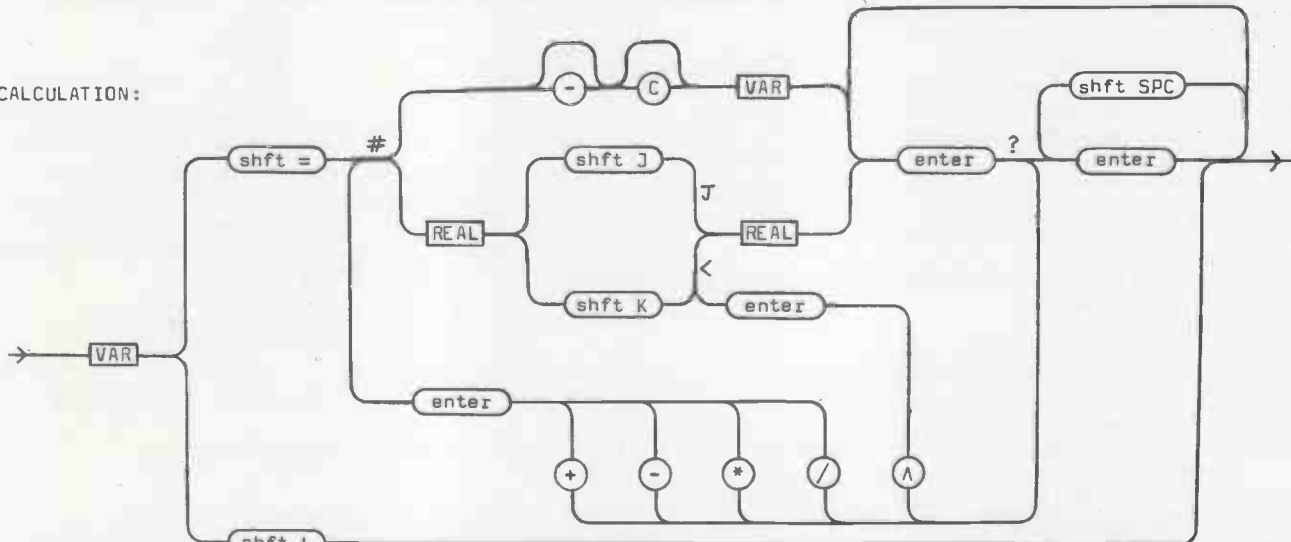

Syntax chart

REAL: any arithmetical expression. VAR: name of a complex variable, A ... R.

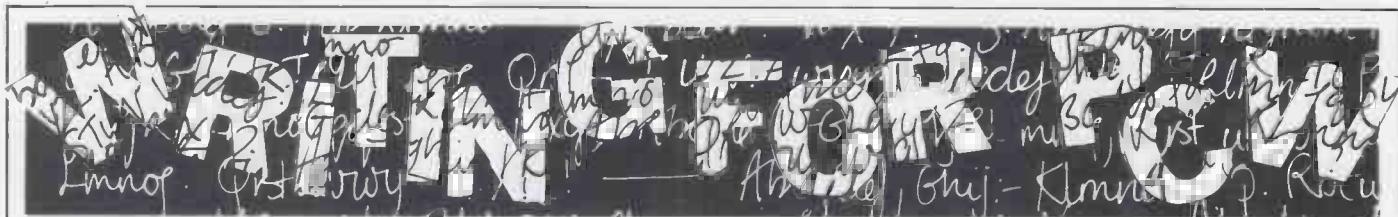

PCW welcomes approaches from would-be writers, even those who may never have appeared in print before. In this game it is often those with practical experience who have important things to say so we don't mind too much if their prose is less than perfect. Providing that submissions have a sensible structure and follow a logical sequence, we can take care of the polishing. Here are some tips:

If the article is already written, simply send it in, making sure that your name, address and 'phone number appear on both the article and the covering letter. If you have submitted the same work to other magazines you

should tell us — it would be embarrassing (to say the least) if the same article appeared in more than one.

If you have an idea for an article or a series, write us a letter outlining your ideas. A one or two page synopsis giving the proposed structure, sequence and content will give us a sound basis for discussion. Please give us a daytime 'phone number if possible.

If you have nothing specific in mind but feel qualified to conduct case studies, Benchtests or whatever then drop us a line saying what you'd like to do and why you think you're qualified to do it. We're not particularly looking for strings of academic qualifications —

experience carries just as much weight.

Dick Pountain is always on the lookout for interesting calculator features and we wouldn't mind seeing one or two readers getting on their soapboxes but remember: even articles such as this need a structure.

Reading PCW will give you a good idea of the style we prefer. You may notice that we try to avoid pomposity at one extreme and flippancy at the other (except in 'Chip Chat', that is).

Finally, have a look through back issue indexes and try not to re-invent any wheels. Oh, we almost forgot — PCW does pay for all published work.

PLANNERCALC MICRO SOFTWARE



Quite simply, PlannerCalc is the best ©CP/M spreadsheet business planner on the market today.

What's more, its nearest rival costs three times as much.

So what exactly, do you get for your £39.00 (plus VAT)?

Well, unlike all other 'Calc' products it allows you to enter calculation rules in English. So it's much easier to use.

It uses the popular 'spreadsheet' approach, with a window that can be rolled in all directions.

Which means you can enter new figures or rules and immediately see their effects on everything else in the model.

It comes with the best manual on the market and it's suitable for most micros with a CP/M2.2 operating system, at least 64K of memory, a screen width of 80 characters and 2 floppy disc drives.

And, as your needs and demands grow you can move on to other more powerful packages like MasterPlanner, the next step up in the Comshare range.

MasterPlanner is totally integrated with

PlannerCalc and you simply carry on where you left off. To order PlannerCalc ask your local dealer or clip the coupon and enclose your cheque or credit details.

COMSHARE
Making the computer make sense.

To: Dept. PCW/12 Comshare Limited, 32/34 Great Peter Street, London SW1P 2DB.

Please send me _____ copies of PlannerCalc at £46.05 inc. VAT and p. & p. per copy, I enclose a cheque/postal order for £ _____ made payable to Comshare Limited.



Please debit my

Access Card No: _____ for £ _____



Barclaycard No: _____ for £ _____

Signature: _____

Name: _____

Address: _____

Tel No: _____

IMPORTANT: Please fill in the following particulars:-

Type of micro _____ Memory size _____ K

Floppy Disc size: 5 1/4" Single Sided Single Density

8" Double Sided Double Density

Please allow 28 days for delivery. VAT No: 238418649 Registered No: 980406

©CP/M is the registered trade mark of Digital Research Inc. Comshare Ltd., 32/34 Great Peter Street, London SW1P 2DB. Telephone 01-222 5665. Comshare reserves the right not to accept any order, any acceptance will be subject to Comshare's Terms and Conditions of Use.

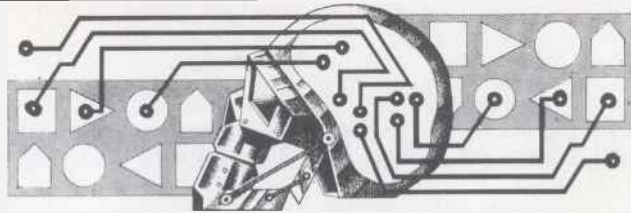

ARTIFICIAL INTELLIGENCE

INTELLIGENCE TESTS FOR COMPUTERS?

Bev Mason explains how computers can tackle a standard intelligence test by using the calculus of finite differences

We are all familiar with the tests used to gauge intelligence, particularly with children, where the subject is asked, among other things, to deduce the next term in a sequence of numbers. For example, the given sequence might be 1, 4, 9, 16, — or 3, 5, 8, 12, —. In the first case the series is obviously a sequence of ascending squares, the next term being 25. In the second case, it is easily seen that the difference between successive terms increases by one at each step, and the next term is 17.

A less obvious sequence is —1, 1, 19, 65, —, where the next term is 151. Even when the answer, the next term, is known the relationship is by no means obvious. In this case, each term is derived by subtracting four times the square of the term *position* from twice the cube of the position and adding one, ie, the *third* term is equal to $2 \cdot 3^3 - 4 \cdot 3^2 + 1 = 19$.

It is interesting to pose the question 'Can a computer be programmed to do these intelligence tests?' When one considers the virtual infinity of relationships which can exist between successive terms of a sequence it would seem that the answer must be in the negative. How can one disassemble the mental processes involved in the 'casting around' for a possible relationship, in order to write a program? Also, if a computer can be programmed to accomplish these tests when computers are undeniably *not* intelligent, do the tests really warrant the name 'intelligence tests'?

Before delving further into these questions, let us say at the outset that a computer *can* be programmed to derive the next term in a sequence, or indeed the *n*th term, forward or backward, and also display the relationship between the terms. The short program at the end of this discussion does just these things. We shall see some further anomalies!

A simple sequence

Let us suppose a child is given the first sequence above, ie, 1, 4, 9, — and is asked to write in the next term. This looks like, and is, a sequence of squares, the next term being 16. So when the child puts a 10 on his paper he gets no marks and is considered to be little better than an idiot — perhaps unjustly, as we shall see.

It is necessary to examine the question more closely. We have become so familiar with this type of test that usually only the minimum is stated. Much has to be inferred or 'understood'.

The fact that the next term in a sequence of terms is requested indicates a count. What is really being stated is

$$y = 1 \ 4 \ 9$$

$$n = 1 \ 2 \ 3 \ 4 \ 5$$

and it is obvious that $y = n^2$ and the term for $n=4$ is 16; that for $n=5$ being 25 and so on. We could have been asked to fill in the *preceding* terms — ie, those corresponding to 0, —1, —2, etc.

$$y = 4 \ 1 \ 0 \ 1 \ 4 \ 9$$

$$n = -2 \ -1 \ 0 \ 1 \ 2 \ 3$$

The series extends to infinity both ways and the relationship $y = n^2$ holds true. However, *n* is nothing more than a count, simply marking the position of each term and there is nothing in the original question regarding the starting point of the count. In the above example *y* has a minimum value of 0 and it is convenient to zero the count at that point. Had the given terms been stated as 9, 16, 25, —, we could have written

$$y = 9 \ 16 \ 25 \ - \ -$$

$$n = 1 \ 2 \ 3 \ 4 \ 5$$

The next terms would still be 36 and 49 but *y* would certainly not equal n^2 . Common sense, or 'intelligence' would have told us to start the count with $n=3$ rather than $n=1$. But suppose that the given sequence had been a series of numbers with no immediately recognisable relationship. The zero point, in the absence of any guidance, would have to be positioned arbitrarily. Let us start a new count 'p' one position further along:

$$y = 1 \ 4 \ 9 \ -$$

$$n = 1 \ 2 \ 3 \ 4$$

$$p = 0 \ 1 \ 2 \ 3$$

Now $n = p + 1$. We can see that $y = n^2$ therefore $y = (p+1)^2$, which simplifies into $y = 1 + 2p + p^2$. This is not as immediately obvious as $y = n^2$ but is just as valid. When $p=3$, $y=16$, which comes as no surprise.

The child in our example, far from being an idiot, is in fact a genius of rare talent. He had spotted that the relationship between *y* and *p* is not only $y = 1 + 2p + p^2$ but also by $y = 1 + 4p^2 - p^3$. In the first case the term for $p=3$ would be 16 while in the second case it would be 10. In the absence of any guidance from the question he plumped

for the 'cleverer' answer and wrote '10'. Had the question sought the preceding term, the child would have written 6 and not 0.

It would seem then that not only can this type of intelligence test be correctly answered by an unintelligent computer, but it can also give a damaging and misleading assessment of a child's intelligence. Perhaps it would be more meaningful if, in addition to requesting the next term, the relationship used in arriving at that term should also be stated.

Before leaving this brilliant, misjudged and probably unbearable child let us not utterly condemn this intelligence test. The computer arrives at the answer by mathematical (arithmetic) means which can, as will be shown, be achieved by humans fairly simply with pencil and paper but not without (except in the easiest or trivial cases). Instead the human uses intuitive mental processes which are undoubtedly facets of intelligence which can be tested.

We shall see, with the aid of our program, that it does not matter in practice where the count is started, whether we count in ones, twos or twenty-threes, or whether the given sequence is three numbers or ten numbers long. It does not even matter if those numbers are generated randomly by our computer! We can still find a relationship between them and state the next (or for that matter the next but sixteenth) number in the sequence.

The 'other' calculus

All of the above is by way of being a lead into a small facet of a fascinating branch of mathematics known as the calculus of finite differences. (The non-mathematical reader need not worry. The remainder of the discussion contains only arithmetic and very elementary algebra.)

The more usual infinitesimal calculus deals with relationships between *continuously varying* quantities. It assumes that one variable changes by an infinitesimal amount and studies the effect on related variables. An elementary application is in the calculation of maxima and minima. Thus, given a relationship such as $y = 81/8x + x/2$, it can be shown that *y* will be at its lowest value when $x=4.5$. However, if *y* represents the number of hours needed for a

job to be done by x men, this method is of no great value. We cannot employ 4.5 men and there is no indication whether 4 men would be more economical than 5. Since we cannot have fractional men, nor negative men, their number x cannot be continuously variable and the methods of the infinitesimal calculus are not strictly applicable. Hence the calculus of finite differences.

Finite differences

In the 'normal' calculus briefly described above, the variable x is assumed to change by an infinitesimal amount

Dx to a value $(x + Dx)$. By subtracting the initial value x from the increased value $(x + Dx)$ we obtain the infinitesimal difference Dx . Since y depends on x it also will change, from y to $(y + Dy)$, and by taking the difference we can arrive at Dy . The calculus then studies the relationship between Dx and Dy or the ratio Dx/Dy , a process known as differentiation. In the same way that the process was applied to x and y , it can be applied to the quantities Dx and Dy and to successive differences: the process is then known as successive differentiation.

When x can assume only integer

values the difference between one value and the next can only be finite, and is invariably taken to be unity. The difference in x is therefore 1 and the corresponding difference in y is designated by the Greek capital letter Delta. We shall use the letter D . The process is known as differencing and, if continued, becomes successive differencing.

A series of cubes

By way of an example, consider the sequence of cubes:-

$$y = 0 \ 1 \ 8 \ 27 \ 64$$

$$x = 0 \ 1 \ 2 \ 3 \ 4$$

To start the process of differencing, set the work out in tabular form:

x	y	D	D^2	D^3	D^4
0	0				
		1			
1	1		6		
		7		6	
2	8		12		0
		19		6	
3	27		18		
		37			
4	64				

The column headed D is obtained by subtracting each value of y from the next higher value. In a similar way, the column headed D^2 (second difference, not $D \cdot D$) is obtained from the D values, and so on. The relationship between x and y is then given by the top figures in each column starting with the y column:

$$y = 0 + 1D + 6D^2 + 6D^3 \quad (A)$$

where

$$D = x/1,$$

$$D^2 = x(x-1)/(1 \cdot 2),$$

$$D^3 = x(x-1)(x-2)/(1 \cdot 2 \cdot 3),$$

$$D^n = x(x-1)(x-2) \dots (x-(n-1))/(1 \cdot 2 \cdot 3 \dots n).$$

Substituting these D values in equation (A) we get

$$y = x + 3x(x-1) + x(x-1)(x-2) \quad (B)$$

By substituting in this equation values of $x=0$ to 4 the original values of y are obtained, as are also those for $x=5$ ($y=125$), and for $x=-2$ ($y=-8$), etc. We know of course that in this example the equation (B) reduces to $y=x^3$.

The theory requires only that x should vary in equal steps. However, differencing is done on the basis that the independent variable varies by unit steps starting at zero. If x does not start at zero, or if it increases or decreases by equal amounts other than unity, it is necessary to introduce a further variable, say p , which does fulfill the necessary conditions. It is a simple matter to establish the relationship between x and p , eg:

y	5	7	12	21
x	13	20	27	34
p	0	1	2	3

y will be obtained as a function of p :
 $y = f(p)$ (C)

where $p = (x-13)/7$. If the value of y is sought for (say) $x=15$ it is only necessary to calculate the value $p=2/7$ and substitute in equation (C).

But what use is it?

Suppose we have obtained experimentally a series of values of y in relation to values of x . If the values of x vary in equal steps we can use the method outlined above to forecast values of y for other values of x . If the values of x are not equally spaced we can plot the points, join them with a smooth curve,

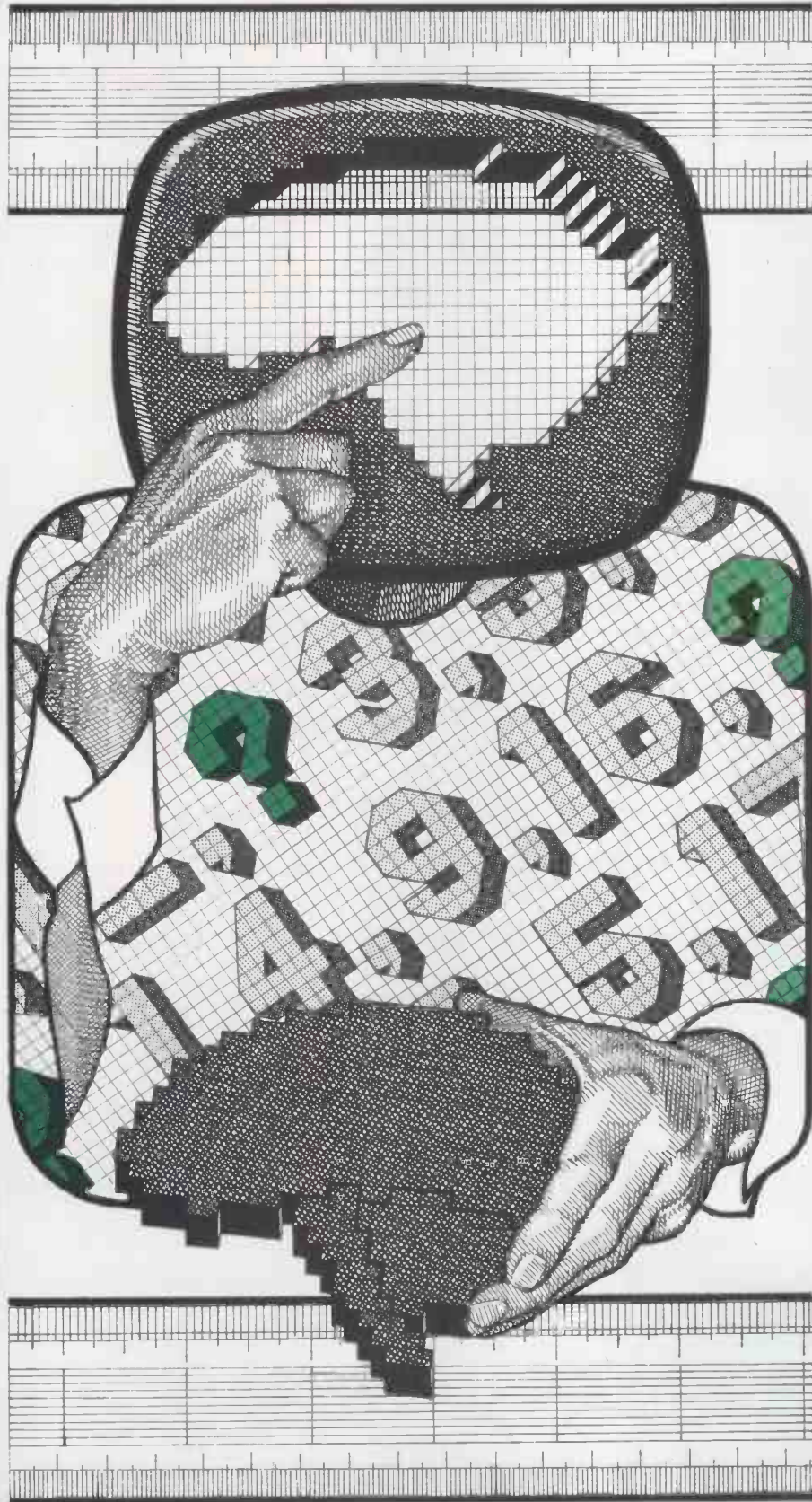

COMPSOFT'S

DMS

The ultimate in
Data Management Systems
for Microcomputers



Compsoft's DMS is everything you ever dreamed possible in computer software. Fast, efficient and reliable, DMS is the only complete integrated system for information management.

DMS needs no programming. Working in conversational English, this ingenious program is designed for Management, Clerical and Secretarial staff to use. You simply create your record layout, then DMS stores the records. It sorts and searches on multiple criteria, calculates, writes letters, and prints lists, reports and self-adhesive labels. As an extra bonus information from the records can be automatically merged with standard letters written by DMS itself or Wordstar.

You can extend your record keeping into a complete selective mailing service.

You can find out more about DMS from our brochures. We also have technical specifications and free guides to DMS dealing with Personnel, Client, Student, Stock or Library, Subscription, Club, Medical, Policy or Property Record, Job Costing, etc., etc.

DMS is available for most micro computers using the CP/M, MP/M, MSDOS or Commodore operating systems with hard or floppy disks. Every version contains the DMS letter writer as standard and costs £400 or less.

THE COMPSOFT HEADQUARTERS AND TRAINING CENTRE, HALLAMS COURT

Brochures, guides and technical information are free on request from:

DATA
MANAGEMENT
SYSTEM



Compsoft Limited
Hallams Court
Shamley Green
Nr Guildford, Surrey
England GU4 8QZ
Telephone: Guildford (0483) 898545
Telex: 859210 CMPSFT

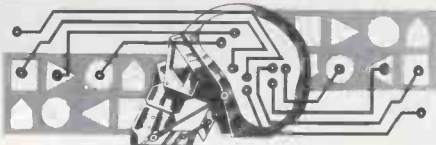

and read off y at standard intervals. The method will then forecast or extrapolate possible y values outside the graph. But remember, we get only a forecast, not a certainty.

Suppose our first four results were 0, 1, 8 and 27 as in the cube series above. If these were RUN in the program, the computer would correctly forecast 64 and 125 for $x=4$ and 5 respectively and print the relationship as $y=x^3$. However, suppose the value of y for $x=4$ were subsequently determined experimentally as 40 and not 64. On feeding the computer the sequence 0,1,8,27,40 it will reply correctly with $y=5$ for $x=5$ instead of $y=125$. The relationship will now be printed as $y=6x-11x^2+7x^3-x^4$. It can easily be seen that the sequence 0,1,8,27 can be followed by an infinity of different numbers of which 64 and 40 are but two.

Our child (I thought we had lost him) could have put any number he liked, positive or negative, after the sequence in his intelligence test, and proved that it was logically related to the earlier numbers.

In the 'conventional' calculus, the

opposite operation to differentiation is integration. One method of finding the integral of a mathematical expression is to plot the graph of the equation and measure, or calculate, the area between the curve and the x axis; Simpson's Rule is a method for calculating irregular areas. It is applied by dividing the area into equally spaced strips, measuring or calculating the length of each strip, and applying a simple formula. It can be programmed into home computers to perform the function of integration. The division of the area into finite steps or strips suggests the calculus of finite differences, and in fact Simpson's Rule and similar methods are derived from that calculus. However, the derivation of Simpson's Rule is too complex to be described here, but its application in computers to calculate definite integrals is simple.

The universe operates in a continuous and smooth fashion — eg, time and planetary motion — and the infinitesimal calculus has been universally applied. However, there are those who maintain that the calculus of finite differences offers a more practical picture since the world operates in a digital manner: a view which should be popular with computer people who can more easily appreciate things operating a 'bit' at a time. It is obvious that the number of men needed to do a job, or

the number of bricks required to build a house, must be integers. It is perhaps not so obvious that the 'smooth' speed of a car is related to the integer number of engine firing strokes per second: one cannot have a fraction of an explosion. Even the classic problem of water running into and out of a bath could be stated in terms of whole numbers of molecules.

When is a random number not?

When I asked my computer to generate four random numbers between 1 and 20 it replied with 8,2,5,17. I set them as a series:

$$y = 8 \ 2 \ 5 \ 17$$

$$x = 0 \ 1 \ 2 \ 3$$

and fed them into the program. The computer showed that the numbers are related to the expression $y = 8 - 10.5x + 4.5x^2$ and that the next number in the 'series' would be 38!

The program

The program is written in Microsoft Basic for use with the Z80 based Video-Genie computer. It occupies about 1.2k of memory, which could be reduced considerably by compression. In the absence of DIMension statements the size of the arrays D(N), E(N), X(N), Y(N) is automatically set to 10 and that of the array C(N,M) to 10*10. The program will therefore accept a sequence of up to ten numbers, as printed, and will require a further 0.8k of memory to RUN. This requirement can be reduced considerably by restricting the sizes of the sequence and of the arrays by including correspondingly suitable DIMension statements.

Lines 10-70 are self-explanatory

Line 80 determines the interval of finite differences between the x values.

Lines 120-170 calculate the differences between the successive y values, setting the differences as a new series of y values and repeating the process. The initial values of y and of the successive difference series are set into the array D(0) — D(N).

Line 180 establishes where x falls on the p scale, zero p falling on the first y value.

Lines 210-270 evaluate the successive terms of the relationship $y=f(x)$ and add them together to give the value of y .

As described above, the program deduces and evaluates expressions such as: $y=x+6x(x-1)/1*2+6x(x-1)(x-2)/(1*2*3)$

This expression is equivalent to the much more convenient and understandable form $y=x^3$. In writing a program to convert from one form to the other it is necessary to overcome the computer's inbuilt tendency to substitute numerical values for algebraic symbols. After all, the computer was designed to do arithmetic and not algebra.

Lines 300-560 are therefore a rather tedious way of reducing the first untidy algebraic forms into ascending power forms, and printing the result. If preferred, these lines could be replaced with a very much shorter version to print the relationship in the original untidy form. Note that Video-Genie language P[3 means P cubed.

```

10 INPUT "HOW MANY VALUES ARE KNOWN":V1:V=V1-1
20 INPUT "LOWEST VALUE OF X":X(0)
30 INPUT "CORRESPONDING VALUE OF Y":Y(0)
40 FOR N = 1 TO V
50 INPUT "NEXT VALUE OF X":X(N)
60 INPUT "NEXT VALUE OF Y":Y(N):NEXT N
70 INPUT "FOR WHICH VALUE OF X IS Y REQUIRED":X
80 DX = X(1) - X(0)
90 IF X(V) <> X(0) + V*DX PRINT "INCORRECT DATA":GOTO 10
100 IF X - INT(X) <> 0 PRINT "INCORRECT DATA":GOTO 10
120 D(0) = Y(0):N = 1
130 IF N = V + 1 GOTO 180
140 FOR N1 = 0 TO V - N
150 Y(N1) = Y(N1 + 1) - Y(N1):NEXT N1
160 D(N) = Y(0)
170 N = N + 1:GOTO 130
180 P = (X - X(0))/DX
210 Y = D(0)
220 N2 = 1
230 Q = 1
240 FOR N1 = 1 TO V
250 N2 = N2*N1
260 Q = Q*(P - N1 + 1)
270 Y = Y + D(N1)*Q/N2:NEXT N1
280 CLS:PRINT:PRINT:PRINT:PRINT "WHEN X="X"Y="Y
290 REM 'EVALUATE ALGEBRAIC RELATIONSHIP'
300 C(1,0) = 0: C(1,1) = 1
310 FOR N = 1 TO V
320 C(N,N+1) = 0:NEXT N
330 FOR N = 2 TO V
340 FOR R = 1 TO N
350 C(N,R) = C(N-1,R-1) - (N-1)*C(N-1,R)
360 NEXT R:NEXT N
370 N2 = 1: E(0) = D(0)
380 FOR N = 1 TO V
390 N3 = N2
400 FOR N1 = N TO V
410 E(N) = E(N) + D(N1)*C(N1,N)/N3
420 N3 = N3*(N1 + 1):NEXT N1
430 N2 = N2*(N + 1):NEXT N
440 PRINT "Y = "
450 IF E(0) = 0 GOTO 470
460 PRINT E(0);
470 IF E(1) < 0 GOTO 500
480 IF E(1) = 0 GOTO 510
490 PRINT "+" E(1) "P":GOTO 510
500 PRINT E(1) "P":GOTO 510
510 FOR N = 2 TO V
520 IF E(N) < 0 GOTO 550
530 IF E(N) = 0 GOTO 560
540 PRINT "+" E(N) "P["N":GOTO 560
550 PRINT E(N) "P["N;
560 NEXT N
570 PRINT:PRINT:PRINT "WHERE P =(X-" X(0)"/)DX

```

Listing

END



COMMUNICATIONS



PCW welcomes correspondence from its readers but we must warn that it tends to be one way! Please be as brief as possible and add 'not for publication' if your letter is to be kept private. Please note that we are unable to give advice about the purchase of computers or other hardware/software — these questions must be addressed to Sheridan Williams (see 'Computer Answers' page). Address letters to: 'Communications', Personal Computer World, 62 Oxford Street, London W1A 2HG

Those factors again

In your May edition, a Mr Hunter asked how he might factor a large number. This drew a 'number' of well-meant but ill-informed replies to the effect that if (as suspected) Mr Hunter was looking for prime factors, it could take him about 10⁹ years.

In fact, recent progress in the application of number theory has increased the rate of testing for primality by a 'factor' of 10⁷. The products of 100-digit primes are no longer thought secure for encryption purposes.

Mr Hunter should contact Dr H W Lenstra (University of Amsterdam, tel 020-5259111), or even design his own method, based on the techniques described on p28 of ZX Computing Vol1 No 2, 1982.

Dr David Fisher, Cardiff

Fix wanted

I would be obliged if you could publish this letter as I am at present unable to obtain any advice locally. I have with me an Osborne 1 and Epson MX80 FT III which I consider to be excellent value for money. However I find that the 'Install' program is unable to make the best of configuring for my printer as Wordstar expects toggles where the Epson has separate control codes for turning on and off certain modes. Does anyone know how to Install for the Epson? Also, as an instructor in electronics I have to produce inserted graphs of sine waves, etc, in my notes. I have a Basic routine that prints them but it is very slow and cannot be patched to Wordstar... any ideas? I have a similar problem with calls in Basic as I don't know the best way to pass variables to the subroutine. What it is to be ignorant!!

It may not be commonly known that location 61281 contains the horizontal screen position during scroll and location 61282 the vertical screen position. It is necessary to divide the horizontal by 2, and there are offsets, but they allow a fantastic 3D space simulation with centralised aiming sights for those who like games. It is also much easier to poke direct to the screen RAM as per other

machines than to use the Osborne routine. Screen memory starts at 61440 as top left of normal screen. (A Basic listing is enclosed... rough and ready but gives a guide.)

Perhaps there is a users club in the UK who can find someone to act as a 'penpal' or should I say keyboardpal, as that is what I need here. I will be here for quite a while longer so the address above will hold good until Christmas at least.

Richard C. Ferryman, 208 Airport Hotel, P.O. Box 2012, Jeddah, Saudi Arabia

You are certainly not the only one with this Osborne/Epson problem Mr Ferryman. The fix is too involved to explain here, however it is documented in issue 1 and 2 of 'Portable Companion', the magazine put out by Osborne for its users. The first issue is free to all Osborne users, and subscriptions are available; Osborne UK will be sending you the relevant issues gratis — Ed'll Fix It.

Dots or brackets...

In response to your challenge (October 1982), I'd like to suggest a way of listing lists of lists of lists for Lisp without brackets. Logicians began using 'Dot Notation' before the inception of set theory. A century on, they are still ranting, enthusing and raving about how convenient and manageable this has turned out to be, and how clever they were to have thought of it.

Let's jump in at the profound end, with Mr Liardet's first example of Lisp data. Using dot notation, it looks something like this:
(SETQ PEOPLE ': BASIL
32 M . CYNTHIA 30 F
JOHN 28 M)

Here, the colon has the job of delimiting the scope of the quote mark — but see how clearly it divides the list assignment into destination and source. Whereas the action of the brackets is to bind elements together, dots act as element separators. They can be compared to ordinary prioritised infix operators: the more dots in a group, the lower the 'priority' of the separator, and the greater its scope (the size of chunk it governs in the list).

For a somewhat dramatic

illustration, consider next the definition of the function LENGTH:
(DE LENGTH . LIST :
COND : : EQ LIST NIL . 0
: : T : PLUS 1 :
LENGTH . CDR LIST)

If you don't think that makes the list structure a lot clearer, did you notice the printer's error in the original? There's an erroneous right parenthesis on the end of the second line.

Now to those lists of lists of lists. The simplest I can think of is a pair of pairs of pairs of atoms. Take your pick — brackets or dots?
(SETQ PAIRS '(((A B)(C D))
(E F)(G H))))
(SETQ PAIRS ':A B . C D :
E F . G H)

John Kerr, Glasgow

...Lisp or logo

Referring to Mr Kerr's letter suggesting that a Lisp interpreter would run faster if reserved words were to be tokenised and brackets removed, it must be made clear that to the interpreter a program, ie, a list, is represented as a set of linked pointers. The brackets are used to delimit lists only in the input/output routines. In Lisp not only are the reserved words tokenised, all words are! If Mr Kerr desires the elegance of Lisp without so many brackets, then I suggest he considers Logo which is Lisp-based and is friendlier in use. This leads me to my second point.

Mr Parr's Logo compiler written in Basic is an interesting program (though lamentably slow) but contains a bug which could confuse a beginner grappling with recursion. If a previously encountered function is again recognised by the compiler, the number of arguments is not fetched and at run time the function is called with wrong values. This occurs in the Branch program in the June 1982 Logo article. It can be fixed by changing line 9730 to read.
IF SY\$=PN\$(W) THEN
N=CP(N); RETURN
Ian A Stewart, Ealing

Spectrum bugs

Spectrum owners beware! There are at least two ROM bugs in my Spectrum, and presumably all others.

LET A\$='ab'+STR\$n+'cd' usually gives the correct

answer — eg, ab 12.3cd, but if 1)n/o the ab prefix is lost eg, 0.12cd.

Pause after INKEY\$ — generally the pause is reduced to zero, unless the pause is repeated (it works the second time).

Both these bugs can be irritating — and I would not be surprised if others crop up after I have used the computer more.

I have written to Sinclair about this, but have not (of course) received any reply. G G R Rutter, Woking

Thank you for your addition to the increasing number of Spectrum bugs, Mr Rutter. This machine certainly seems to have its share of idiosyncrasies — try hitting 'Caps Lock' or both shift keys together when the Spectrum gives a 'Scroll' prompt for a demonstration of one of the stranger bugs—Ed.

Safer downloading

Guy Kewney was right in his article 'Phone Foul-Up' in your October issue that transferring large amounts of data from one computer to another over the telephone lines 100 per cent correctly is a tricky business. There you are, having just transferred 12,000 characters down the line without the operator interrupting, only to find that the 1395th, the 6413th and the 11,999th are corrupted (except that you will never work up the energy to check them all — and doesn't that rather spoil the point anyway?).

That is why the Owl Micro-Communications telesoftware converter doesn't work that way! Prestel fortunately sends you one screen of data at a time. This is about 1000 characters. This is a reasonable number to expect to come down uncorrupted.

If it is corrupted, our program will notice because one of the characters will have a 'parity error'. We then use a useful Prestel command '*00' which asks for a repeat of the screen. Normally this repeat will be okay, but if necessary the program will try again and again until the screen arrives correctly.

We regularly bring down programs of 12,000 bytes reliably with our down-

loader in about five minutes. Perhaps Guy Kewney was using a 300 baud modem for it to take so long?

It seems to us that the CET telesoftware format (which our converter uses) is likely to be successful and appropriate for programs up to 20 kbytes in size, with someone watching the downloading to catch the very occasional snarl-up. For bigger programs or unattended operations, something more sophisticated is really needed.

As a final point, with all this interest in telesoftware, what about using the same system to transfer data? When will we see Visicalc data files on Prestel? There is no need for any technical changes, someone just needs to come along and use it. Mike Gardner, Owl Micro-Communications Ltd, Sawbridgeworth, Herts

Space defender

It is a shame that so much had to be left out of 'Brain Dump' in the October issue. In particular, I wish room could have been found to justify the dangerous use of a space as a mathematical symbol in GSB's arithmetic, since this can, as it does here, involve implicit axioms. It seems that the axioms should include (though one can't be sure):

space space = space
 space } = }
 } space = }
 } } = }
 space } = }
 } } = space

which are isomorphic to

0 or 0 = 0
 0 or 1 = 1
 1 or 0 = 1
 1 or 1 = 1
 NOT 0 = 1
 NOT 1 = 0
 respectively.

If this is so then GSB's arithmetic is nothing more than Boolean algebra and can hardly be said to be more fundamental.

Your article tries to allay the suspicion that *Laws of Form* is a crank book, and to encourage potential readers, but I must regretfully say 'Not convinced'. James Crrok, Cambridge

This is one of several letters from mathematicians who disapprove quite strongly of Spencer-Brown's work. His proof of the four-colour theorem is by no means accepted 'in the trade', and is as far as I know not officially published. Not being a professional mathematician, I do not feel threatened by the unorthodoxy of *Laws of Form*, nor do I feel that PCW readers are likely to come to much harm.

It is indeed a shame that so much had to be left out; I

obviously failed to make clear that 'space' is not a symbol, but precisely the space in which a cross stands. There is only one initial symbol, the cross, which indicates the marked state. The idea is certainly more fundamental than Boolean algebra, to the point where having to write it in ink on paper almost subverts its understanding. It may well be dangerous, but then so are flying and mountaineering. PS: Blackwells of Oxford have informed me that they are importing the book and it will be in stock soon —DP.

A use for VAL\$

Dave Tebbutt, reviewing the Sinclair ZX Spectrum in the June 82 issue of PCW, could not think of a use for VAL\$ — nor could I at the time.

It could be used if a string expression such as A\$ AND Q=0 occurred frequently in a program. The prologue would include LET Q\$= "A\$ AND Q=0" and the body of the program could then use VAL\$ Q\$ whenever the expression was needed. W E Thomson, Aldeburgh

Would be user group?

How's this for a thought? One is aware of the countless thousands awaiting delivery of mail order microcomputers and the need perhaps for some kind of club, whereby recognition of our common plight is secured and where we can air over various experiences.

In the case of the elusive Spectrum I suggest the wearing of a large lapel badge with an updatable number indicating the elapse in weeks since ordering — surrounded by stick-on stars representing the weeks since Sinclair cashed one's money without delivering.

In my own case I will sport a number 20 and seven stars. By the way — is this a record?

H R McCartan, Bracknell.

It might be... unless someone out there knows better? — Ed Rantzen

Dutch treat

Every Sunday evening, the Dutch radio transmits two computer programs in a sort of standardised Basic that can be understood by the operating system in most computers. The programs are sent in the listed form as purely ASCII characters, using 2400/1200 c/s as 1/0 indication, and transmitting 1200 bits per second. The time of the transmission is about 18.40 on MW 747 KHz.

I live five miles south of Copenhagen centre and have had success in receiving the

programs and transferring them to my computer (ABC 80) during the last three Sundays. As the distance from me to the transmitting station is about 400 miles, which is more than the distance to London, I think that this information will be of interest to you and your readers. The programs are in no way only beginners' stuff — programs as long as 10k have been sent.

Dutch radio has issued a booklet containing the protocol for the transmission system and translation programs for some of the most widespread computer types. You can get more information from Hans G Janssen, Hobby-scoop, Postbus 1200, 1200 BE Hilversum, The Netherlands. Frants Liisberg, Hvidovre, Denmark

What's up DOC...

We were interested to read, in your November issue, the letter — under the heading 'Horror DOC' — from Mr Kay of OCLC Europe. Presumably the spelling mistakes are not Mr Kay's fault (*Mea culpa* — *Sub Ed*) although the grammatical errors at the end of para 1 and in lines 2/3 of para 3 could be — 'I could only stand to read... Dear, oh dear! Most people read sitting down!'

However — his complaint is valid enough, even though it is a not unnatural consequence of the appallingly low standard of discipline and education which the Welfare State has managed to produce in the last 30 years or so.

When we started Moffat

Rose, we insisted on speaking and writing plain grammatical English with a minimal use of computer jargon. In writing our own programs, I was given the tedious and boring job of translating the verbiage into grammatical English. As we develop and improve a number of so-called standard programs, I have been appalled at the amount of muddled thought processes which appear in program manuals. Indeed, some of the paragraphs frequently make so little grammatical sense that even our computer staff find it difficult to understand what the author is trying to convey! A major problem is translating what is euphemistically referred to as 'Regional English' into plain, internationally understood English.

Aside from the above chore, we too believe that it is essential to provide a client with a disk-based self-teaching program which he can print if he wishes. In addition, we will modify it to include any points which a client may feel we have taken for granted.

This program is called Roseteach and is included free with systems which we supply. We do not supply hardware manufacturers' manuals, unless requested, as they tend to confuse the first-time or lay user. P Murray Lee, Moffat Rose Ltd



```

10 'SPACE.BAS'
20 REM THIS IS A SPACE SIMULATION ON SCREEN
30 RANDOMIZE 12548:DEFINT A,C-G,I-N,X:B=61440!
   :T=65535!
   :M=4095:VA=61282!:HA=61281!
40 PRINT CHR$(26)
50 FOR I=1 TO 120:X=INT(RND(5)*M):POKE
   (B+X),46:NEXT I
60 FOR I=1 TO 10:X=INT(RND(6)*M):POKE (B+X)
   ,42:NEXT
70 FOR I=1 TO 4
80   X=INT(RND(7)*M):Y=B+X:POKE Y,79
90   IF X=0 THEN Y1=Y+127 ELSE Y1=Y-1
100  POKE Y1,45
110  IF X=T THEN Y2=X-127 ELSE Y2=Y+1
120  POKE Y2,45
130  IF X<128 THEN Y3=Y+3968 ELSE Y3=Y-128
140  POKE Y3,73
150  IF X>3968 THEN Y4=Y-3968 ELSE Y4=Y+128
160  POKE Y4,73
170 NEXT I
180 L=128:BK=4096:POKE VA,0
190 AH=PEEK(HA):AV=PEEK(VA)
200 IF OH=AH AND OV=AV THEN 250
210 V1=(AV+11)*128:IF V1=>BK THEN V1=V1-BK
220 H1=AH\2+34:IF H1=>L THEN H1=H1-L
230 PO=B+H1+V1
240 NC=PEEK(PO):POKE PO,0:POKE OP,SC:SC=NC
250 OH=AH:OV=AV:OP=PO
260 GOTO 190
270 END
    
```

Osborne screen routine: see 'Fix wanted'



DATABASE COMPARISON THE STORY SO FAR

Kathy Lang pauses in her series of database evaluations to bring a comparison of the systems she's tested so far.

In this series so far I've looked at nine packages for managing files of information, ranging in complexity and price from Cardbox, a simple but powerful 'electronic card index' system running under CP/M and costing £155, to FMS-80, a complex and sophisticated system with its own programming language and costing (in its full version) £650. In this article I shall try to put together some of the qualitative information in a way which will make it easier to compare packages and also show the results of some Benchmarks to try and get some feel for comparative speed.

Benchmarks

It is important to remember when looking at the timings that these are only of value in comparing one package with another — they may not give any indication of how quickly a package will run on your system. The machine I used for the tests was a Sirius with 128k of memory and a Z80 processor card; all the tests on CP/M packages were run on the Z80 card under CP/M-80 with the exception of DMS, for which I used the native 8088 processor. I wouldn't expect that to make any significant difference when comparing DMS with the rest, as by far the major limiting factor in data management is disk access time, where the hardware is of course the same for both processors. Silicon Office runs only on the PET so to run those tests I borrowed a 80-column PET with two 500k disk drives.

The tests themselves were conducted using a test file of plain text data created by a Basic program. The purpose of this was to ensure a completely determined set of data identical to all the packages and relatively easy to transport to each system. The data file consisted of 1000 records containing seven fields and 46 characters, which were then imported into a file, where each record contained 21 fields, totalling 152 characters. This arrangement made it possible to test the package's agility at importing information from elsewhere and the efficiency of the storage methods (since part of each of the larger records could either be null or blank, depending on the file organisation). The tests were designed to cover

the major headings I've used in assessing each package. The results of each test are shown in a table under the relevant section, with an attempt at a qualitative assessment of the same facilities alongside. The purpose of the latter is to try to give some impression of the power and ease of use of the particular facility, as well as its speed.

Four of the packages I tried, Cardbox, Silicon Office, DBMSIII, and FMS-80, were able to read my file only if I wrote a special program (in any language, SO own, Basic, EFM respectively) for the purpose. DMS, dBaseII and Condor all had commands or procedures for the purpose, so a program wasn't needed. To import 'stranger' files into Aquila and Pearl requires a special one-off program which can be written only by its originators; apparently for Pearl this can be done only in the US. The Aquila writers agreed to do this for my tests but, unfortunately, neither their data file nor the new version of DBMS from Grama (Winter) arrived in time for this article, so I shall include those timing tests in a later article.

Data models

Most of the packages in this series call themselves 'data base management systems' but, unlike true DBMS, they are all basically single file systems. They thus do not vary tremendously in file organisation and methods of direct access to information. All hold their data either in linear files with indexes, or in relational files with or without indexes. (All that is meant by 'relational' here is that every field in the record is 'related' to every other, without any explicit hierarchy or network arrangement — in fact DBMS does use a kind of network to link records from different files together, but not within a single file.)

Five of the packages (Condor, dBaseII, DBMS, FMS-80 and Pearl) permit the linking of two or more files by keys, although the DBMS approach is rather unusual and requires more human intervention than the others. All the packages except Aquila, Cardbox and Condor use fixed length records and, with very minor exceptions, fixed length fields. Figure 1 shows the limit-

ations each package places on size of file, record, number of fields, number of records, etc.

Input and editing

All the packages require you to decide on at least an initial format for a data file before you can put information into it. I personally find the most satisfactory method of doing this is to 'paint' the format on the screen, in the way that most of the packages now permit (but not Aquila or DBMS). Some are easier to use than others — for instance, I found Silicon Office tricky because the start and end of field markers were very similar, and Cardbox's three-tier naming system I found very confusing. Once designed, and data inserted, the packages vary substantially in the ease with which you can add new fields. In Cardbox this is very easy; in dBaseII and Condor straightforward and in most of the others possible but more difficult and often slow. Figure 2 shows the time taken for each of the packages tested.

Reporting

Only Cardbox uses the same mechanism for designing printed reports and for screen formats. This method of 'painting' the format on the screen is great provided you can keep within the single screen space. The other systems require you to specify row and column positions for each field, heading, etc, with calculations to be performed where this is permitted. dBaseII is rather limited in its ability to display report formats, though whether many users would ever get past the complexity of design to actually use all the features FMS-80 provides I rather doubt.

Selection

It is, of course, very common to want to select records according to particular criteria and display or process them separately. I've used two measures of selection time: one uses two selection criteria and a simple sequential search (ie, no index is used), while the other uses an index and shows indexing as well as access time. Times for both tests

are shown in Figure 4. When comparing indexing time you should bear in mind the difference between dBaseII and Cardbox, which keep their indexes up to date as they go, and the others which only keep the index to the main key field up to date. You should also remember that both FMS-80 and DMS require you to set up a selection file first — you can't just ask for the selection and display in a single statement, and then modify your request in the light of the display. Condor is also rather inflexible, in that it creates a separate data file each time you request selection, even if you only want one or two records. In Silicon Office, you have to write a program for the kind of selection used in the tests (except when selecting on the key field), since the selection command does a sequential search of every field in every record in the file; my tests used a more discriminating method in a program, but it was still very slow.

Sorting

Here the packages vary considerably in whether you can, or need to, sort the whole data file, or whether sorting the indexes is sufficient to enable you to display records in a particular order. DMS probably has the best approach here: the data file is never sorted, but individual indexes may be created and sorted so that the records are displayed in any required order. In FMS-80 you may sort either data files or indexes, but creation and sorting of indexes are two distinct processes. dBaseII allows you to sort the data file if you need to — and you will if you want to select using non-unique keys and then display in key order. Cardbox doesn't have a sort feature, a curious omission in a package so oriented towards bibliographic and free-text applications — surely libraries need their records in author or title order? Figure 5 shows sort times with one 20-character field as the key. The figures shown are for sorting index only, data only, or both, as appropriate.

Adding single records to the file can be done directly — that is by specifying a key value, displaying the record on the screen and editing it there — in all the packages except Condor, which requires the creation of a transaction file which is applied without intervention from the keyboard. This is the approach which is recommended in FMS-80, but not enforced. Personally I think much of the point of an interactive system is lost if you have to think up possible problems in advance rather than being able to check errors as you go. A decent file-handling system should be able to make on-line updating sufficiently secure for the batch process to be unnecessary except in special circumstances. Figures for batch and for on-line updating are shown in Figure 3.

Indexing

Getting all the information in of course begs the question of how to get it out. All the packages (except Condor in its Levels 1 and 2 versions) have some methods of accessing particular records quickly, but they vary a lot in their power and flexibility. Silicon Office, DMS and FMS-80 require you to choose a primary key field and every record is indexed by that field. DMS and FMS-80

Package	Aquila	Cardbox	Condor	dBaseII	DBMSIII	DMS	FMS-80	Pearl	Silicon Office
Max file size	32000 recs †	65500 recs †	32767 recs †	65535 recs †	32000 recs †	26214 recs †	CP/M limit	CP/M limit	3 files per disk
Max size record	472 chars	1404 chars	1023 chars	1000 chars	1400 chars	1024 chars	64k chars	3080 chars	252 chars
Max no fields	20	26	127	32*	20**	60	255	250	no limit
Max field size	38 †† (255)	1404	127	254	70	80	255	80	78
Field	C	C	CDI£	CNL	CN	CN	CDN	CDN	CN

Notes: † = or CP/M limit (8 Mb), whichever greater * = unlimited no subfields
 ** = 200 subfields †† = predefined fields
 Field types: C=Character/D=Date/I=Integer/N=real numbers/£=currency

Fig 1 Constraints

Package	Cardbox	Condor	dBaseII	DMS	FMS-80	Silicon Office
Time for 1000 records to add 1 new field to each	Inst's: just mod definition	6m	10m	58m30s	36m30s	3h27m for 250 records
Star rating	****	***	***	**	*	*

Fig 2 Time to add one new field to each record

Package	Cardbox	Condor	dBaseII	DMS	FMS-80	Silicon Office
Interactive time to add 50 records + Batch	Inst's 35s	NA 25s	Inst's 1m30s	Inst's 1m45s	Inst's 6m30s	3 secs per record NT
Star rating	****	*	***	**	*	**

Notes: + excludes time to key in new data/NA=Not Available/NT=Not Tested

Fig 3 Time to add 50 records

Package	Cardbox	Condor	dBaseII	DMS	FMS-80	Silicon Office
Sequential Time for 1000 records	2m31s	2m + scroll	3m20s total	2m20s total	4m5s + scroll	4h25m for 263 records
Indexed access	8s	NA	Inst's	Inst's	Inst's	NA
Create Index (25 char field)	NA		(14m44s) if needed	4m45s	19m49s	(only one key field)
Star rating	***	***	***	**	**	*

Fig 4 Sequential and indexed read (two criteria, 50 records match)

Package	Cardbox	Condor	dBaseII	DMS	FMS-80	Silicon Office
Time to sort 1000 records on 5-char field	NA	26m30s	35m	5m30s (index only)	NT	1h10m for 250 records
Star rating	NA	***	**	****	NT	**

Fig 5 Sorting 1000 records

also allow you to create other indexes to permit fast access by more than one field but these are not kept up to date when the file is updated — you have to do this for yourself. dBaseII can keep up to seven indexes per file up to date 'on the fly'. These factors should be born in mind when looking at Figure 4, which shows the times for direct searching, since the indexing times are only significant if indexes have to be re-organised explicitly rather than being included as a (very small per record) overhead in the updating process. Cardbox is the most flexible of all in some respects, in that it permits indexing of all or any items (words) within fields

either automatically or on request from the person updating. However, once you have put data into a Cardbox file, if you decide later that you want to index a field which was previously not indexed, then this can be very tedious.

Screen display

Usually you can use the same features for designing a screen format for display and editing. Some packages, notably FMS-80, DMS, Cardbox and the later version of dBaseII, allow you to vary the formats so that some information is not displayed, or shown in different formats for different users. DBMS

Business Blueprint



THE VECTOR 4

From the small business to the large multi-national, Almarc provide one of the largest selections of quality business, scientific and industrial applications software available today, including:

Wordprocessing/Mailing, Financial Modelling, Solicitors Package, Financial & Arable Management, Printers Estimating/Costing, Phototypesetting/Wordprocessing Interface, Data Base Management, Estate Agents Package, Manufacturing Software, Critical Path Analysis, Motor Trade Package, Planning Application Monitoring, Estimating, Data Logging,

Graphics Packages, Business Accounting, Accounts Receivable/Payable, Payroll, Stock Control, Invoicing, Ordering, Purchase Control, Clothing Industry Software, Network & Resource Analysis, Job Costing, Insurance Brokers.

All available on probably the most advanced, 'New Generation', micro-computer system produced today.

The Vector 4, is an advanced 8/16 bit desk top computer. It allows you to take advantage of the existing 8 bit CP/M programs, while also providing 16 bit processing power. The future is built into the Vector 4, with its Z-80 and 8088 processors, 128K of main memory (expandable to 256K), 3 S-100 expansion slots and standard software facilities with high resolution graphics that are second to none. Floppy disc and hard disc systems are available.

At Almarc, we pride ourselves in our systems and our high level of customer support. We can offer back-up and training which is second to none, with 24 hour on site maintenance available in all areas.

Almarc

DATA SYSTEMS

HEAD OFFICE
Almarc Data Systems Ltd,
Great Freeman Street,
Nottingham NG3 1FR.
Tel: (0602) 52657.
Telex: 37407 Almarc/G.

Almarc Data Systems Ltd,
18A Spittal Street,
Marlow,
Bucks. SL7 1DB.
Tel: (06284) 6419.

DATABASE COMPARISON

(version III) allows you to 'tag' fields as protected for security reasons.

Calculations

Since Cardbox and Aquila handle only text data, they can't do calculations. All the others have some calculating facilities. Those in DMS and FMS-80 are quite powerful — except that you can't modify the order of execution of expressions with brackets! In terms of power and flexibility, dBaseII is easily the best of those I've looked at in this area. Figure 6 shows two tests on calculation. The first involves replacing one field in each record with a value derived from a calculation on another field in the same record. The second simply totals three accumulators to give the sum total of each of three variables.

Security

Important features are the ability to prevent unauthorised access to information, and to see what you've actually done in a session if something should go wrong. DMS and FMS-80 provide the most flexible approach to the first question, while DBMSIII has some comparable features. Looking at recovery

from error and detection of possible deliberate fraud, DMS provides a paper audit trail, though I couldn't find a way to store this on disk; dBaseII allows you to record in a file everything which takes place on the screen. Cardbox has an explicit Repair function should the data become corrupted in any way.

Tailoring

All the packages except Silicon Office and DBMS allow you to tailor the terminal interface to your requirements; SO comes already set up for the PET, and DBMS for whatever machine you've specified when ordering. Though some of the packages try to be helpful, this is still a very thorny area for anyone, especially the novice. I'd especially like to see every package make it possible to specify things like cursor movement codes by actually pressing the key concerned, then there's no mistake. Another essential feature is some confirmation that the tailoring has worked — before you leave the terminal definition part of the package. Also, the ability to edit an existing terminal definition, rather than starting from scratch, is another necessity. None of these packages did all these things.

As for tailoring the presentation of the package itself to your needs, this involves a sharp divide between the menu-driven packages and the command-driven systems. With the menu-driven approach, as used by DMS and Cardbox, if your application fits that method of working you're fine, otherwise you just have to fit yourself round the package.

Cardbox, particularly, would be even better if it had the ability to store search sequences for re-use, as Aquila does. In the command-driven packages like Condor, dBaseII and Silicon Office, you can set up files containing sequences of instructions to be executed as a group, including instructions for looping which give you the power of a programming language. You can use these features to construct menus of your own. Of the three, dBaseII is the most flexible, and the ability to call other 'programs' with parameter passing is very valuable.

FMS-80 combines these two approaches by providing menus for the simple things and a crude programming language for the more complex. However, unlike the other command-driven packages, the programming language is quite distinct in its syntax from the commands which execute FMS-80 procedures, and I found it quite difficult to use in anger — especially with the lack of comprehensible error messages. dBaseII is pretty unhelpful with its endless 'syntax error' messages, but FMS-80 often just stops and gives no clue as to why nothing has happened.

Relations with outside

Most packages allow you either to read files written by other programs, or to write files for other programs, or both. To do the Benchmarks I had to read an external file, and Figure 7 shows the timings for reading the file in, restructuring it to match my '21 field' format, and doing any necessary indexing.

Stability and reliability

One of the more cheering features of these reviews has been the level of reliability of most of the packages — there have been occasional glitches, but very few, and I haven't suffered any loss of data or programs during the running of the Benchmarks. In fact my complaints have been more the other way — that once you have started a process going, most packages prevent you from interrupting it in any way — so if you've made a mistake you've had it. FMS-80 takes the sensible line of asking for confirmation that you want to abort.

User image

Here I'm just going to touch on a few principles, because so much of this area is a matter of taste. Firstly, you need to know whether you prefer menu or command driven systems, and, if the former, whether your needs fit sufficiently one of the packages which only has menus, like DMS and Cardbox, or whether to go for a combined approach, like Condor, dBaseII and FMS-80. Whatever you decide, there is little substitute for giving the package a thorough road test yourself before you buy — though if the price is as low as £155, maybe you can afford to experiment anyway.

Consistency is, in my view, the most important element in the user image. You need to be able to generalise the way the package works, so that learning about one part makes it easier to use another. Personally, I found Cardbox,

Package	Cardbox	Condor	dBaseII	DMS	FMS-80	Silicon Office
I calculation on 1 field on each record	NA	4m	6m	12m30s	7m10s	25m for 250 records
Star rating	NA	***	****	**	*	**
Totals of 3 fields over 1000 records	NA	1m30s	1m30s	14m	NT	1 hr for 250 records
Star rating	NA	**	****	**	*	**

Fig 6 Calculations on 1000 records

Package	Cardbox	Condor	dBaseII	DMS	FMS-80	Silicon Office
Importing a file	23m30s	13m	13m	39m17s	16m40s	4h45m for 250 records
Star rating	**	****	****	***	*	*

Fig 7 Importing a file of 1000 records

Package	Aquila	Cardbox	Condor	dBaseII	DBMSIII	DMS	FMS-80	Pearl	Silicon Office
Cost	£310	£155	£195 £375	£425	£295 £575	£400	£350 £650	£200	£790 (floppy version)
Supplier	Kent-Barlow 01-580 7693	Caxton 01-379 6502	MOM 0474 57746	Encotel 01-686 9687	GW (Gramma) 01-636 8210	Comp-Soft 0483 505918	Info-data 0962 69344	Pearl 0202 741275	Bristol Software 0272 277117
Date of PCW review (1982)	Sept	August	Nov	May	June	March	April	Oct	July

Fig 8 Costs, suppliers and date of review

GOTO page 202

COMPUTER SCRABBLE

Maggie Burton takes a look at a new game for the Apple II

Computer Scrabble, from Little Genius, is the first popular board game in the UK to be computerised under licence from its manufacturers, JW Spear & Sons who, naturally, own both copyright and trademark on the game. The package was originally devised by Peter Turcan of Turcan Research Systems Ltd as part of a PhD thesis on word structure and analysis. It runs on an Apple II with disks. Computer Scrabble was launched at the 5th PCW Show this year, with a contest for all-comers who wanted to put their wits against the highest level of the game.

Getting started

You begin by cold booting the Apple as usual and Scrabble loads straight away. The beginning of the program is a rather lengthy display of the name, who wrote it and who markets it — which, to be honest, I found rather annoying (simply because of its length) after loading it up a few times. A Scrabble board is then drawn on the screen along with an empty scoreboard and the computer proceeds to ask you exactly how you want the game played.

Options

The number of options is extensive, to say the least, I almost expected it to ask if I wanted it to sing, but it didn't go quite that far. Instead you can have one to four players in any combination of human and electronic, each one being assigned a name by the user for clarity. You can look at the computer's racks of letters if you want to and, if you couple this with a long delay in placing each letter in a turn, you can get a very good idea of what your electronic Thesaurus is up to.

One very useful provision is the allowance for a monochrome monitor. The game is really meant for use with a

colour TV/Monitor but if you only have black and white you need only specify this and the board changes, offering symbols to indicate the value of each square. Once you've learnt these it makes no difference at all to the game. The colour board is designed to look as much like the real Scrabble game as possible, using all the same colours in the same order.

You can also have sound effects if you want them. These don't make much difference to a game like Scrabble (unless you're the sensitive type and they spoil your game). Those provided here consist of short clicks each time the computer moves the cursor or places a letter. I did feel that the addition of a beep or something when each different turn came around would have made this option more complete.

The game

When you've answered all the questions about your game scenario you are instructed to turn over your disk and press 'Y' to load up the dictionary. I found the use of a double-sided disk rather unusual in a game but it works perfectly well. As soon as the dictionary is loaded up you go straight into play.

The dictionary contains 5000 words taken (with the expert help of Dr Alan Richter, a former British Scrabble champion) from Chambers'. I'm not being funny when I say it includes some very odd words indeed, at the same time rejecting words like 'mania' and 'cover'. It will, however, accept 'igloo', 'amen', 'loch' and 'ding'. I found this somewhat inconsistent ('igloo' contains as many vowels, for instance, as 'mania'), but it's fun all the same and it injects a healthy dose of character into the computer's play.

As an aside, I did discover (very easily) that you can cheat flagrantly without any difficulty at all. When it's

your turn, you type in your word under the board, press return and then use the keys 'I', 'J', 'K' and 'M' (their positions on the keyboard explain which directions they control) to position the cursor where you want the first letter of the word to be. After this, you press 'A' or 'D' for across or down and the computer tells you what the word would score. You then have the option of rejecting it if it's not high enough. You can, if you want, type in your whole rack, place it in a legal position and wait for the computer to challenge it as nonsense. I typed in 'ELIP-QOO' (score 96) and, when challenged, replied with 'ESC Y' which forces the computer to accept your decision as final. This is really only intended for words like 'mania' which are in Chambers' but not in the computer's dictionary. Words like this are not, fortunately, added to the computer's vocabulary.

Another little tip is to make frequent use of the playing option which allows you to juggle your letters around. This can give a great deal of inspiration. The playing options are only available when it is your turn.

Conclusions

As I never normally play Scrabble I thought this game wouldn't be a particularly enjoyable one to review. To be honest, I was wrong. It's thoughtfully put together and fun to play — much more so, in fact, than playing Scrabble with people. The observation must here be made that I've never come across four people playing a game amicably sharing one keyboard — it's not the sort of thing you can pass around between turns. Our old friend the Apple II can play a demonic game and I only managed to beat it once on the hardest level (on which it scores an average of 300 points) although the lowest level of four is a fair challenge to the average adult. It's 'thinking' time is rather long but this only serves to make you feel at home. It takes about as long to make its moves as a talented player would which, coupled with some friendly humming and clicking of disk drives, makes for quite a homely game.

At £24.95 it'll make a fine Christmas present for a brainy son/daughter, although I do feel that the price will put it out of some people's range. Nevertheless, it's worth saving up for as it's the kind of game which lasts years rather than weeks. As it's not directly available from Little Genius their phone number is not included here. The game has been available to Apple dealers since September 9th and there should be several shops stocking it by now. Little Genius has plans to introduce versions of the game to run on other micros. Systems presently under technical review are: ZX Spectrum (which is the most probable second micro for this package), Atari, BBC Computer, TI99/4A, Dragon 32 and the Commodore 64. An 'advanced version' is also planned but details on this are as yet unavailable.

END

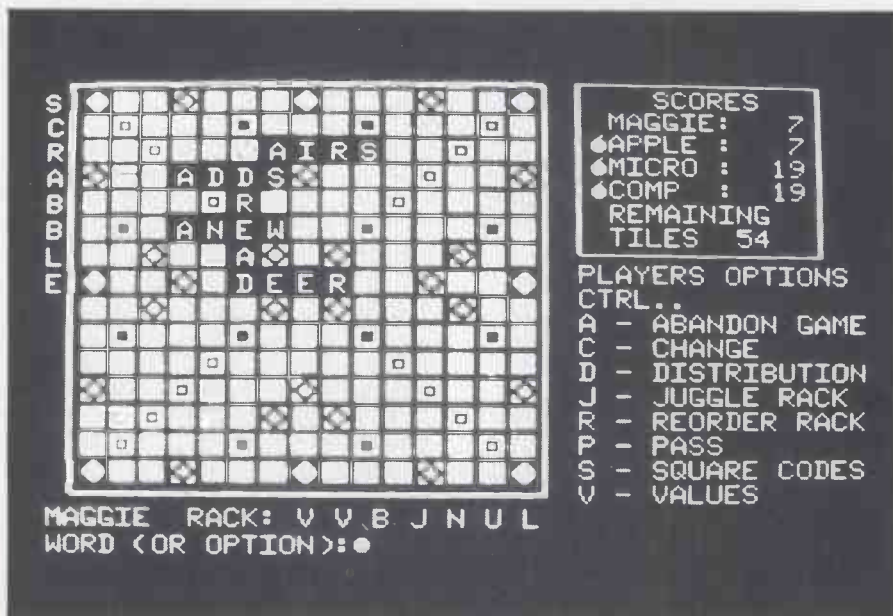

This is what the display looks like in the middle of a game. The board shows the symbols used with a monochrome monitor.

SCREENPLAY

Dick Olney looks at games for

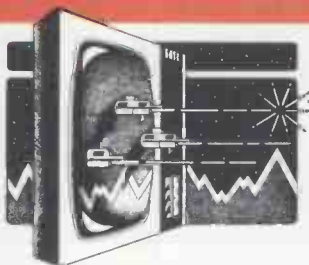

the Tandy Color Computer.

The TRS-80 Color Computer has been around for about a year now — in fact Steve Withers Benchtested one of the first few machines in the country in the September '81 issue of *PCW*. The system I used included 16k RAM and extended Basic (which is essential for all the cassette games); this sells for £369 including VAT. All of Tandy's proprietary games come as plug-in ROM packs, but for all the others you'll need a good cassette deck. In addition many of the games use joysticks, which cost around £20 a pair.

The computer itself is a pleasant looking machine with the standard Radio Shack grey plastic casing. It has a calculator style keyboard whose keys give a reassuring click when depressed. Tandy Extended Colour Basic has four graphics modes and can produce eight different colours. Only four colours can be used at any one time, however, since the two relevant graphics modes operate under either one of two different colour sets. In addition, the highest resolution mode is two-colour only (black/green or black/buff). The powerful 6809 processor is certainly under-utilised in a system of this size, but the Color Computer can be expanded to 32k RAM and will take up to four mini-disk drives (153k each).

The worst aspect of this otherwise attractive set-up was the Japanese joysticks. The fire buttons rely on a thin

metal disk of a shape designed to complete a connection when pressure is applied. This disk is constantly losing its shape and hence its spring, rendering the button permanently active. The problem can be temporarily alleviated by carefully disassembling the whole unit and bending the metal back into an appropriate shape, but it re-occurs with relentless insistence. With a bit of imagination some other small metal object might prove more effective than the disk, but I can't help feeling that Tandy should have come to that conclusion already and acted upon it.

As if this wasn't bad enough, I managed to shear the stick itself away from its screw mounting whilst engrossed in a game of *Berserk* (see review). I admit that it is easy to be inadvertently heavy-handed on such occasions, but I've used a good many different joysticks over the past year and have never broken one before.

Tandy has insisted on retailing the Color Computer itself and, perhaps as a result of this, there are few

sources of external software in this country. This is a pity since Tandy's own selection of games is rather weak on the whole when compared with those I was supplied by Microdeal.

I should mention that I also got to borrow one of Tandy's new four colour plotters, designed to be used with this machine. Using a rotating barrel containing black, blue, red and green pens to produce text or graphics, it can easily be accessed with a Basic program to describe figures and diagrams on hard copy, with the only notable omission being a circle function. This impressive peripheral sells for a very reasonable £150, inc VAT.

On the whole the TRS-80 Color is a well designed machine (with plenty of attention given to minor essentials like a long video lead) although its price brings it in line with machines like the Atari 800, which are rather too pricey for the mainstream home games market. It's a pity that Tandy itself hasn't done more to encourage external software in this country (like stock it in their shops!), especially as I gather there's so much of it available Stateside. The home computer market in this country is changing rapidly, with more and more high street shops stocking popular models and my advice to Tandy is to adjust their marketing approach accordingly.



Game: Galax Attack
Supplier: Spectral Associates
Price: £8.00

This is, of course, yet another version of that infamous arcade game *Galaxian*. Four rows of three different shaped aliens sit above you *Space Invaders* style and swoop down in small groups; like *Berserk*, the titles are in colour and the actual play in black and white. The game is for one player who uses the right joystick for movement and firing. Personally I would have found the keyboard easier and I'm surprised that this isn't given as an option.

There is the opportunity to enter three initials at the outset of each game and the top five scores are displayed at the end. There is no skill level option, but play is fast and smooth and should

present a challenge to the most enthusiastic *Galaxian* freak.

Unfortunately the shoddy Tandy fire button is rather inadequate for a rapid fire game of this type and needs constant adjustment, which is very irritating. Nevertheless this is a reasonable copy of a classic game.

Use of graphics	██████████
Response speed	██████████
Value for money	██████████
Addictive quality	██████████

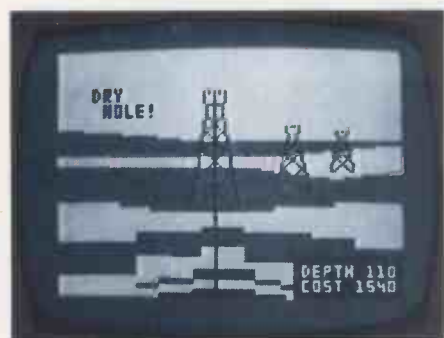

Game: Wildcatting
Supplier: Tandy
Price: £17.95

With Tandy's headquarters being in the heart of Texas, it's not altogether surprising that this new management game is based on the oil business. Up to four players can take part with their names being entered at the outset. As in all good games of this type each turn consists of several phases. First you choose where to drill your well by moving the cursor around a blank dark green screen. Movement can be achieved either by using the joysticks or with the cursor control keys (you specify which at the beginning). Having chosen a likely spot (by pressing the fire button/space bar) you are presented with a surveyor's report, giving you the probability of striking oil, the cost of drilling per

metre and the taxes you will pay each week (ie, turn).

At this point you must balance up the available information to decide whether to drill or not. Even with a high probability, the site may turn out to be a dry hole — and since a well will only produce income greater than its taxes for a limited period of time even a costly successful drilling can easily result in a significant loss. Choosing not to drill costs you nothing, but then you'll not make anything, either.

If you decide to go ahead you are presented with a simple but impressive picture of an oil tower, and a shaft driven into the ground by repeated depression of the fire button. Striking oil

SCREENPLAY

results in a roaring gusher, while failure is rewarded with a deep buzz. In the final phase you are shown a list of all the sites you have investigated with details of their original cost, weekly tax and projected earnings before the next turn. Those mines which you own are marked with a coloured square, and can be sold for one half of their original cost. The idea is to sell each mine before its income falls below the level of tax, and then hopefully end up with a net profit...

Each site which has been investigated

appears on the initial map as a square whose colour represents the oil probability. Since these colours tend to form a concentric pattern the most fruitful areas become more apparent as the game progresses. A game lasts for 13 turns (or weeks), at the end of which the entire map is displayed along with each player's balance sheet.

It is possible to accumulate scores (that is, game profit or loss) after several games, making for quite a lengthy competition. Wildcatting is not as complicated as it sounds though it is well

thought out and could provide hours of entertainment for the right audience; that being children of around seven to ten years old. Most adults would, I feel, tire of it quite quickly since it involves neither coordination nor any real intellectual challenge.

Presentation	▣▣▣▣▣▣▣▣▣▣
Addictive quality	▣▣▣▣▣▣▣▣▣▣
Use of graphics	▣▣▣▣▣▣▣▣▣▣
Value for money	▣▣▣▣▣▣▣▣▣▣

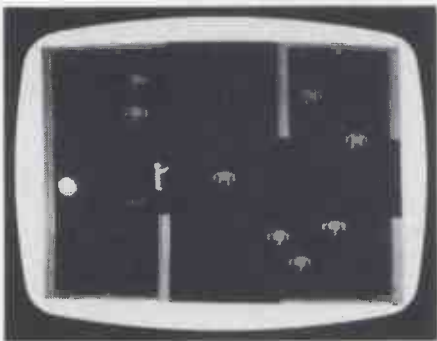

Game: Berserk
Supplier: Mark Data Products
Price: £19.00

A game for one or two players, Berserk is based on an increasingly familiar

scenario. Using the joysticks you control a character who can move and shoot in eight directions; his task is to roam a series of interconnecting rooms destroying hordes of insane and deadly robots. Touching any of the walls or obstacles, or being hit by robot fire, results in the loss of a man (each game consisting of the standard three tries); In addition you are being chased by 'evil Orville', a little smiling face, who can move through walls and will kill everything he touches while remaining impervious to your fire.

The robots become more numerous and deadly as the game progresses, though their shooting is completely random so they frequently destroy each other (for which you are accredited points). Berserk is a good arcade type

game, but is quite difficult to play, being responsible for the demise of the joystick I mentioned in the introduction. The graphics are excellent, though in highest resolution mode and thus black and white only (except the score card and intro which are in bright colours). As with many games for the Tandy, however, it's quite expensive as cassette games go.

Presentation	▣▣▣▣▣▣▣▣▣▣
Addictive quality	▣▣▣▣▣▣▣▣▣▣
Use of graphics	▣▣▣▣▣▣▣▣▣▣
Value for money	▣▣▣▣▣▣▣▣▣▣

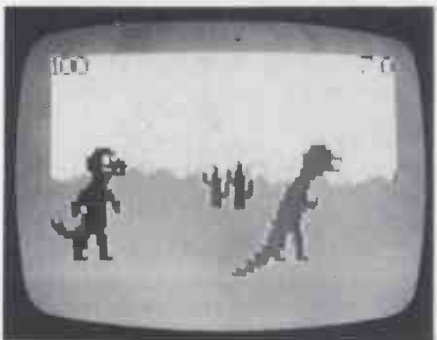

Game: Dino Wars
Supplier: Tandy
Price: £17.95

I couldn't resist reviewing this one, even though it's been around some time now and I'm sure many readers have already seen it at exhibitions, etc, or own a copy if they happen to be

Tandy users. Joysticks are essential for this game, which is for two players. Each controls a dinosaur whose goal is to bite his opponent on the back of the neck. The dinosaurs roam a rather barren landscape with the odd cactus thrown in.

The creatures are brilliantly portrayed, though rather cumbersome to manipulate (added realism?), especially as it takes quite a while to get used to the perspective. When you have steered your dinosaur into a good position to attack, you press the fire button causing the beast's mouth to open (with a loud bloodcurdling roar). A successfully chewed victim falls to the ground with a few whimpers and a not particularly sickening thud.

Each player starts with 100 points and loses 20 for each wound received. Walking into a cactus also knocks five points from your score. The playing area continues off screen

with a wrap-around effect, and it is quite possible to do battle when neither dinosaur is actually visible! The cacti make this manoeuvre dangerous, however, since clearly it is impossible to avoid them.

When a player has no points left, his dinosaur retreats into the distance whimpering pathetically, and the game ends. Dino Wars has good graphics and excellent sound effects. It is hardly the most complex or stimulating of games, but is nevertheless an inspired piece of lunacy which will appeal to anyone with a sense of humour. I'm not sure, however, whether that appeal would be lasting enough to warrant paying out the twenty quid it'll cost you.

Presentation	▣▣▣▣▣▣▣▣▣▣
Use of graphics	▣▣▣▣▣▣▣▣▣▣
Addictive quality	▣▣▣▣▣▣▣▣▣▣
Value for money	▣▣▣▣▣▣▣▣▣▣



Game: Color Scarfman
Supplier: Cornsoft
Price: £11.95

Having been assured that software

copyright laws are much stricter in the States I can't help wondering how this American Pac-Man rip-off slipped through Atari's net. To add insult to injury, Scarfman is actually copyrighted by the Cornsoft Group in Indiana.

The standard maze takes up only two-thirds of the screen, with the score displayed at the bottom — a pity since it restricts the total playing area unnecessarily. There are five energy dots (plus signs in Scarfman) and five pursuers, who look like red laser bases. Either the joysticks or the keyboard can be used to control movement; and the maze remains the same throughout the game. The 'red monsters' remain vulnerable to gobbling for quite a long time in the first few games (they turn blue), giving

you plenty of time to clear areas of dots, but this decreases as the game progresses.

Scarfman is fast moving, giving good responses, but is very straightforward indeed and is probably the most uninspired Pacman copy that I've seen. Still it is the only version I know of for the Tandy Color, so if you want a version of Pacman for your machine I'd suggest you get in touch with Microdeal soon while it's still on the open market!

Use of graphics	▣▣▣▣▣▣▣▣▣▣
Response speeds	▣▣▣▣▣▣▣▣▣▣
Addictive quality	▣▣▣▣▣▣▣▣▣▣
Value for money	▣▣▣▣▣▣▣▣▣▣

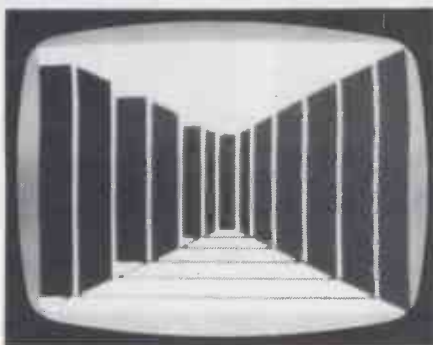

Game: Escape
Supplier: Tandys
Price: £8.00

The blurb about this game describes it as a 3D maze adventure and it is just that. The maze represents the top floor of a building on which you are trapped, and is depicted in classic 3D maze style — remember it's the graphics that are 3D not the maze itself. Colour is used well here to produce the most convincing

maze graphics that I've seen, with movement and turning being dealt with particularly well (the latter executed through the cursor control keys).

The only way to escape from the maze and thus solve the adventure is via an elevator, but attempts to use this without the right key result in you plummeting to certain death. Your task, therefore, is to investigate the various rooms and derive the necessary key from the clues contained therein. Most of these are presented as obscure riddles which should keep you guessing for many a long hour.

I have to admit I was sent the solution, which will shortly be made available to those who feel they would otherwise remain trapped forever. Without giving too much away I would offer a brief clue and a snippet of advice. Firstly remember that Microdeal is merely licensed to distribute this game, which was originally written by Colorsoft in the States. You should try to visit *all* the rooms before giving too much thought to the clues, since several

of them rely on each other for their meaning.

This is in a different format to the usual adventure, with no monsters to kill and no treasure or useful objects to pick up, and is of a type which I can see becoming immensely popular. Though one could hardly describe it as a 'graphics adventure' the incorporation of a maze is an excellent way to present this particular puzzle (it also has a very interesting use of sound). You'll need a bit of patience to find the solution, though there are a few fairly easy clues to quell your frustration. Bear in mind, however, that the game is rendered worthless as soon as you've convinced the elevator to work and thus — as with other adventures — it's difficult to assess the value for money of this game.

Presentation	▨▨▨▨▨▨▨▨▨▨▨▨▨▨▨▨▨▨
Use of graphics	▨▨▨▨▨▨▨▨▨▨▨▨▨▨▨▨▨▨
Complexity	▨▨▨▨▨▨▨▨▨▨▨▨▨▨▨▨▨▨
Value for money	▨▨▨▨▨▨▨▨▨▨▨▨▨▨▨▨▨▨

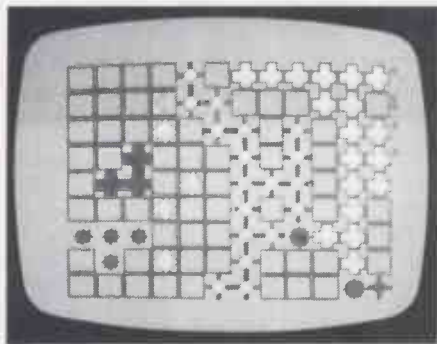

Game: Colour Space Traders
Supplier: Spectral Associates
Price: £8.00

Although this game certainly is in colour the graphics do not play a particularly important part and it seems strange that the fact should be stressed in its title. Up to four players can take part, and the game involves building up intergalactic shipping companies. At the beginning of each turn a nine by twelve grid of squares appears on the screen. Some of these contain stars, indicated by red circles. Five of the squares flash red and blue accompanied by an extremely irritating little tune. A triangular marker can be moved between the squares by pressing the space bar. When the M key is pressed an outpost is set up in the current position of the marker.

The positioning of outposts is a vital part of the game and can have a number of results. If it is in a square adjacent to a star, or another outpost (not diagonally) then a new company is formed, heralded by a noise like a factory hooter and a 'news bulletin'. A player responsible for setting up a company automatically owns five shares in it, which are worth \$100 for each square the company occupies or \$500 for each occupied share adjacent to a star. If an outpost is set up next to an existing company it becomes part of that company and adds to the value of its shares..

When two companies are joined by a new outpost, the one with the highest share value envelopes its neighbour. At

this point the holders of shares in the company which has been taken over are given half as many shares in the new company plus a cash bonus derived from the original share value. Up to five companies can exist at any one time and are denoted on the chart by various coloured symbols (you'll have to remember which symbol is which). In addition, if a company's share value rises above \$3,000 its shares are split two for one — that is, all players' holdings are doubled and the price is halved.

After setting up an outpost players are given the opportunity to buy shares in any of the existing companies, regardless who was responsible for their inception. The cash made available to do this depends on quantity and value of current holdings. Each game lasts for 48 turns and the winner is the player who ends up with the greatest stock value.

I managed to work out the mechanics of the game fairly quickly, but devising a realistic strategy proved rather more difficult. Building up the value of a company in which a reasonable number of shares are held will

increase the cash made available at the beginning of each turn. On the other hand, buying as many shares as possible in a small company while the shares are cheap, and then causing it to be taken over, yields high dividends in both share value and cash.

Space Traders is one of the most interesting games of its type I have played and is thoroughly recommended to anyone who likes this sort of thing. The considerations involved are subtle and complex enough to provide many interesting games, though it does take a while to master. I suggest it would prove rather too obtuse for very young players, and is probably best suited to a teenage or adult audience (compare 'Wildcatting' in this review). At this price, this game is almost certainly the best value for money I've seen on the TRS-80 Color, even though the program itself (written in Extended Basic) is fairly straightforward.

Presentation	▨▨▨▨▨▨▨▨▨▨▨▨▨▨▨▨▨▨
Use of graphics	▨▨▨▨▨▨▨▨▨▨▨▨▨▨▨▨▨▨
Addictive quality	▨▨▨▨▨▨▨▨▨▨▨▨▨▨▨▨▨▨
Value for money	▨▨▨▨▨▨▨▨▨▨▨▨▨▨▨▨▨▨



'It used to be notes up the chimney asking for train sets — now it's all printouts requesting expansion interfaces and floppy disk drives.'

LEARNING THE 68000

Mike Curtis checks out Motorola's powerful new MC68000 'Educational Computer'

Many years ago, more than I care to think about now, my first introduction to the world of microprocessors was a MEKD1 Motorola 6800 development system. It came on a 250 x 150cm board and, along with the 6800 processor, it contained a massive 256 bytes of RAM, 4 parallel ports and one serial port, and the notorious MIKBUG

ROM. Hooked up to a battered old ASR33 teletype it gave hours of enjoyment and education. It is surprising what you can do with 256 bytes! I have been a fan of Motorola processors ever since. The world has moved on a bit since then, and the latest offering from Motorola is the MC68000 Educational Computer; this comes in the form of a

265x165cm board and contains 32 kbytes of RAM, organised as 16k words of 16 bits, one parallel, two serial and one cassette port, and 16 kbytes of ROM containing the Tutor operating system.

It is interesting to note that, despite all the development that has gone on in the time between the introductions of these two products, one important feature remains exactly the same; the combination of the 14411 baud rate generator and 6850 ACIA to provide the serial ports. The 6850 is an excellent chip, though showing its age now, and it was probably included for economy; but a state of the art machine like this should have included a 16-bit component (with combined baud rate generator). The 6850 in fact occupies a full two words in the memory map as opposed to two bytes in an 8-bit system. To make matters even worse, Motorola has actually used Japanese versions of the 6850!

The 68000 itself is an impressive 64-pin chip — this board uses the 4MHz version but there are other variations going up to 12.5MHz. The slower version is used here because this board is not intended as the basis of a full scale computer system, but as a stand-alone educational system for those people and institutions who are interested in using a 68000 system and exploring the capabilities of the chip. The other major components on the board are a 68320 PIA to provide the parallel port (this is a 16-bit component), 16 4116s to provide the RAM and two 64 kbit ROMs. There is a lot of TTL — no ULAs here — and two push buttons; a black Reset, which re-performs system initialisation, and a red Abort, which simply returns control to the operating system leaving registers and memory intact. Connections to the board are by means of four edge connectors for the various ports and four 'banana' sockets for the power supply: ground, +5, +12 and -12 volts. The user must supply his own power supply and RS232 terminal which connects to port #1. There are jumpers provided to set the baud rate individually for the two RS232 ports. The manual makes it clear that the second RS232 port is intended for connection to a host computer on which software can be developed using a cross-assembler or cross-compiler and then downloaded onto the board itself. Cross-assemblers and compilers are available for a number of machines, notably DEC minis and Motorola's own 6800

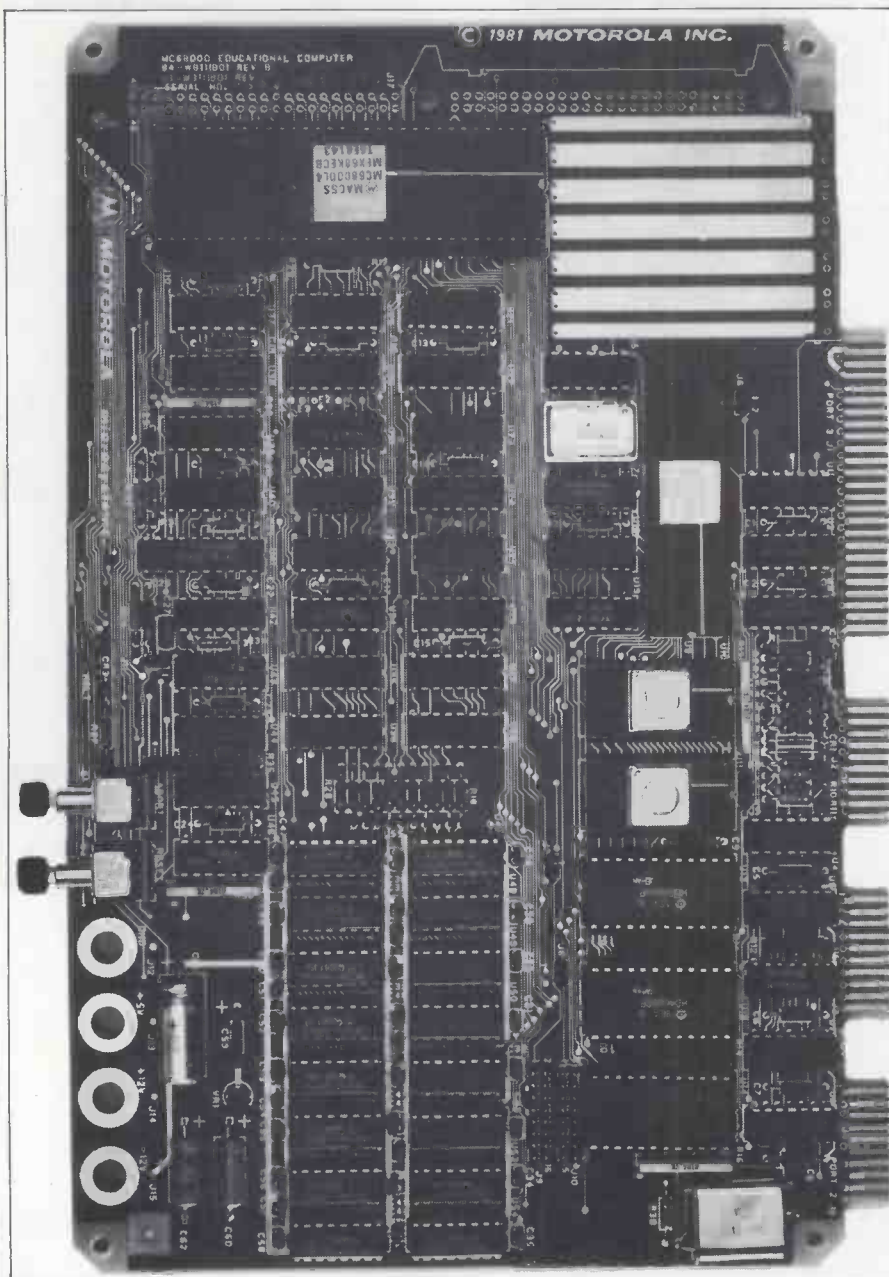

A crowded board — but spotting the processor shouldn't be too difficult!

and 6809 systems. The board is well designed and of the high quality that you would expect from Motorola — it is a three layer board with one set of tracks sandwiched in the middle.

Informed opinion has backed the 68000 as the eventual winner in the 16-bit stakes, though in this country the Intel 8086 seems to have got a head start. We are only just getting the large systems such as the Wicat, which have been available in the States for some time. The 68000 is really a 32-bit processor, though it uses a 16-bit data bus — there is even a version with an 8-bit data bus, which seems to be rather restricting the capabilities of this powerful processor. I understand that there may well be a variant in the future with a full 32-bit data bus; one of those running at 12.5 MHz will be definitely worth at least an arm and a leg.

The 68000 breaks away from the Motorola tradition of accumulator, index registers and stack pointers to give 16 general purpose registers, though these are split into eight data registers, D0-D7, which are perhaps generalisations of the accumulator concept, and eight address registers, A0-A7, which are more like generalised index registers, with A7 and a parallel but normally inaccessible register A7' acting as stack pointers. Most operations can be performed on all 16 registers but, for example, byte operations cannot be performed on address registers, and data registers cannot be used in some forms of address modification. All registers (apart from the 16-bit condition code or status register) are 32-bit. Current versions of the 68000 do not support a 32-bit address bus, though this again may be a future development; however, the 24 bits available do give a possible address space of 16 megabytes, which should satisfy most people. The physical address bus in fact carries only 23 lines; this is because, although the 68000 will address individual bytes, memory access is always done using 16-bit words; the least significant address line A0 only exists internally within the processor and is used to refer to the individual bytes within a word once it is in a register.

Connection of an RS232 terminal is straightforward enough but there always seem to be problems with the supposedly standard interface; the data in and out lines 2 and 3 needed to be interchanged for my terminal to work and this particular interface needed the DTR handshaking signal from the terminal, which neither my own terminal nor the other ones I could obtain provide. It can be tied up to +5 volts, however, and after wasting some time with a jumper to ground the computer eventually sprang to life with the message 'TUTOR 1.2>'.
The Tutor operating system gives a comprehensive set of commands to examine and modify registers and memory, set and remove breakpoints, single step through programs and control the various elements of the system. When examining and modifying memory locations there is an assembler/disassembler option which allows programming directly in assembly language; the 68000 has a very comprehensive instruction set along with a great variety of addressing modes; consequently it is

not really practical to program directly in hex as can be done with most 8-bit processors. The minimum size for an instruction is eight bytes and many instructions need the full eight bytes! This is not a true assembler; it does not allow labels, so branching has to be done to absolute addresses, or the correct offset calculated, and there is only one directive 'DC.W' to set a one word data constant. However, it does make the task of programming much easier.

The assembler is a subset of Motorola's own standard assembler rather than a custom design for this board. This produces a couple of minor niggles: the assembly mnemonic has to be preceded by a space to indicate no label field, even though labels are not

allowed, and the assembler takes decimal as the default number representation with hex values preceded by a \$ sign, whereas the rest of the operating system takes hex as the default and decimal numbers have to be preceded by an & sign. This latter problem is eased somewhat by the provision of a DC (Data Convert) command which converts between decimal and hex, though it can still be irritating to have to quit in the middle of writing or running a program to convert from one to the other before restarting.

There is not sufficient space here to go into the details of the 68000 instruction set but there are a number of noteworthy features:

Most instructions can operate on bytes, words (16 bits) or long words (32

Command	Description
.A0—.A7	These commands without parameters will display the contents of one of the address registers; if a value or numerical expression is given as a parameter then the value is placed in the register.
.D0—.D7	Display or set the data registers.
.R0—.R7	Display or set the Program Counter.
.PC	Display or set the Program Counter.
.SR	Display or set the Status Register.
.SS	Display or set the Supervisor Stack Pointer.
.US	Display or set the User Stack Pointer.
BF a1 a2 w	Block Fill from address a1 to a2 with word w.
BM a1 a2 a3	Block Move the block from a1 to a2 to start at new address a3.
BR a1	Set a breakpoint at address a1. The option ;n will cause the breakpoint to be passed n times before a break occurs.
NOBR	Removes breakpoints.
BS a1 a2 d	Block Search the memory from a1 to a2 for data d, which may be a literal string or a numerical value. A numerical value may be masked by a bit pattern and there are byte, word and long word options (;B ;W or ;L).
BT a1 a2	Block Test of memory between a1 and a2.
DC e	Data Convert a numerical expression e.
DF	Display Formatted registers; this is done automatically when tracing or at breakpoints.
DU a1 a2	Dumps memory from a1 to a2 in Motorola S format. The DU may be followed by a port number — eg, D04 will dump through the cassette port.
GO a1	Executes a program starting at address a1.
GD a1	As GO but ignoring breakpoints.
GT a1	Commences program execution at the address in PC, setting a temporary breakpoint at a1.
HE	Help — gives a list of all commands.
LO	Loads S-formatted records; this may include a port number — eg, LO4 would be used to load a cassette tape, LO2 (the default) to download from a host.
MD a1 c	Memory Display a total of c bytes starting at a1. This will normally give hex and ASCII values but with the ;DI option it will disassemble giving hex and mnemonics.
MM a1	Memory Modify starting at address a1, locations can be left unchanged or modified. Normally as each location is dealt with it will automatically move on to the next; the order may be reversed by entering and the function is terminated by a full stop. The ;DI option may be used to enter data in assembly mnemonics and other options allow data in words and long words as well as odd addresses or even addresses only.
MS a1 d	Memory Set starting from address a1 with data d, which may be hex or an ASCII string.
OF	Displays the contents of the offset registers R0-R7.
PA	Printer Attach, copies all screen output to the Centronics printer port.
NOPA	Displays the printer.
PFn	Display or set characteristics for serial port n (1 or 2) — eg, number of start and stop bits.
RM	General register display and modify.
TM	Transparent mode connects the two serial ports together so the terminal communicates directly with the host.
TR	Trace, single steps through a program starting at the current PC value.
TT a1	Inserts a temporary breakpoint at address a1 and traces to that point.

Table 1



Discover our range of CP/M software.

Although we must admit we have not yet found the cure to the common cold, we have found the solution to a problem that's almost as daunting. The task of choosing and buying your CP/M software.

We hold one of the largest ranges of CP/M software, covering most applications and uses. These are supplied over various formats including: I.C.L. Personal Computer, I.B.M., Rair, Sirius, Superbrain, Apple, etc.

So if you are fed up with suffering, when all you really need is sound advice and off-the-shelf service, then give us a call.

Telephone: 01-387 8832 or 01-388 9927.



Software Limited, Duchess House, 18/19 Warren Street,
London W1P 5DB.

It's rather like finding the remedy to the common cold!

CP/M is the trademark of Digital Research.

Attractive
quantity & dealer
discounts available

LEARNING THE 68000

bits) by the addition of .B, .W or .L to the mnemonic, with word being the default in most cases.

Absolute addresses in instructions which refer to words or long words must (obviously) be even.

The MOVE instruction is a general purpose load and store instruction which takes the form 'MOVE source, destination', where source and destination may be registers or memory locations, or immediate values in the case of the source. Taking into account the different addressing modes this gives a staggering 12,288 different options in this one instruction.

Many of the addressing modes allow auto increment or decrement on an address register by 1, 2 or 4, thus allowing easy access to tables of bytes, words or long words.

The DBcc instruction (cc can be any of the usual conditions LE, LT, GT, etc), which takes the form DBcc Dn, r, will automatically decrement the data register Dn and perform a relative branch to r bytes from the current address where r is a 16-bit quantity. This gives a useful loop primitive.

There is no simple indexed addressing mode — instead there is a BASED mode where a 16-bit offset may be added to a base address in an address register; and a BASED INDEX mode where an 8-bit offset within the instruction may be combined with the contents of any of the 16 registers and the base address in one of the address registers. These give easy access to data structures other than arrays, such as linked lists.

There are MUL and DIV instructions which will multiply two 16-bit quantities to give a 32-bit result and divide a 32-bit quantity by a 16-bit divisor, giving a 16-bit result.

There are two particularly useful variations on the MOVE instruction; MOVEP, which can be used to move values to a peripheral interface, where by virtue of the absence of an A0 address line the registers within the interface chips will be only on even addresses; and MOVEM, which can be used to move multiple registers to a block of memory.

Some instructions have a short (.S) or long (.L) option, depending on

whether the full 24-bit addressing is used or a shortened 16-bit addressing. The use of the shortened form gives a more compact object code, and is especially useful for systems which are only using a maximum 64k address space. Some instructions using a small immediate value (three bits) can use a special form with a Q suffix which places the immediate value in the same word as the opcode — again saving space.

The 68000 chip can operate in two states, user and supervisor; there are some 'privileged' instructions which are effective only in supervisor state. This is to enable the processor to perform memory management functions as the heart of a multiprogramming system. The state is determined by the condition of some of the high order bits in the condition code register.

The 68000 has a comprehensive system of traps whereby most types of errors, such as trying to access non-existent memory, division by zero, or illegal opcodes, cause control to be passed through a number of vectors into the operating system. There is a TRAP instruction which causes a software trap to occur and this, rather than the more usual direct jumps or subroutine calls, is used to communicate between a user program and the operating system. Tutor uses exclusively TRAP #14 for this purpose, and by moving the appropriate function code into D7 calls can be made to a variety of operating system routines — to handle input/output, for example. The following sequence of instructions is necessary to return control to Tutor:

```
MOVE #K228,D7 (moves the immediate value 228 to D7)
TRAP #14
```

Other calls may require additional parameters to be placed in other registers.

The Tutor operating system incorporates eight pseudo registers, R0 to R7. These contain offset values which may be added to any address given in a command; thus assisting the development of position independent code. For example, the command MD 1000+R5 would give a memory dump starting at address hex 1000 plus the contents of R5, so if R5 contained 2000 the dump would start at hex 3000. R7 always

contains 0 and by default R0 is added to every address. If, for example, R0 contained 1000, the command .R0 0 would not set R0 to 0 as you might expect since the current value of R0 would be added on and would hence be unchanged; however, .R0+R7 would have the desired effect.

The Tutor commands shown in Table 1 take the general form: mnemonic <parameters> ; <options>

This comprehensive set of commands makes programming a relatively painless task; the trace and breakpoint functions help debugging, and the ability to single step through code, displaying the contents of registers and memory when appropriate and running quickly through sections of code which do not need to be examined in detail make this an ideal educational machine.

The short program in Figure 1 multiplies two 32-bit numbers by repeated addition, and illustrates some of the features of the language. It is entered after the command MM 1000;DI. The two arguments should be in D0 and D1, and the result will be in D2. The sequence of commands to run the program is;

```
.D0 n1
.D1 n2 (n1 and n2 are the two arguments)
GO 1000
.D2 (to display the results)
```

The documentation supplied with the Educational Computer is quite impressive, despite being a preliminary copy. Motorola's own book on the 68000 processor gives detailed explanations for all instructions and addressing modes as well as the instruction manual for the Educational Computer. It assumes a fair degree of knowledge already, but then this is not a system for absolute beginners. The only real lack was a source listing system, but I understand that copies are available free from Motorola when the user registration card is sent back.

The MC68000 Educational Computer does not set out to be either a stand-alone machine or the basis of a larger system. It sets out to provide, preferably when connected to a host computer, a suitable environment for learning about the 68000 and its instruction set. As such, it does its job admirably. It costs £510, which is not particularly cheap, so I would not expect queues of hobbyists waiting to get hold of the latest technology. There are, however, many companies and educational institutions for whom this will be a cheap and convenient way of educating people in the use of one of the most powerful processors around in preparation for the day when systems using this chip may well be as common as those using the 6502 today. It is also a useful tool for those wishing to learn a modern assembly language.

The MC68000 Educational Computer can be obtained from Thame Components Ltd, Thame Park Road, Thame, Oxon OX9 3XD; telephone 084 421 4561.

Address	Hex code	Assembly
001000	4282	CLR.L D2
001002	2600	MOVE.L D0,D3
001004	670E	BEQ \$1014
001006	D481	ADD.L D1,D2
001008	048300000001	SUB.L #1,D3
00100E	60F4	BRA \$1004
001010	3E3C00E4	MOVE.B #228,D7
001014	4E4E	TRAP #14

Figure 1



WE WISH YOU A MERRY CHRISTMAS. AND

The microcomputer is a Santa Claus machine that will speed up the world's productivity.

And end the recession forever.

Unfortunately, not all the machines on the market are up to this historic task. Fortunately,

there's the iotec 'iona', with 64K of available memory built-in.

It's expandable to an unbeatable 960K. And it has the unique, quick-start 'io' key that makes it easier to use than any other microcomputer.



OFFER YOU A PROSPEROUS NEW YEAR.

The 'iona' is also the only machine in its class to offer colour as standard.

All this intelligence comes gift-wrapped in a professionally-designed metal cabinet. Inside and out, it's the best microcomputer you can buy.

Contact us for the address of your nearest iotec dealer.

And have a very prosperous new year.

IOTECHNOLOGY PLC, 4 PLAYHOUSE YARD, BLACKFRIARS LANE,
LONDON EC4V 5EX. TELEPHONE 01-248 4876.

READ ALL ABOUT IT!

Steve Mann casts an eye over the first batch of Spectrum instruction books

Let me start by saying that I received these items with a fair amount of cynicism. I was certain that there was a bit of bandwagon-jumping going on here. After all, the ZX81 had provided a very good living for all sorts of peripheral manufacturers and publishers and, with the launch of the Spectrum, I'm sure that publishing houses all over the country were calling meetings and saying, 'Look, there's obviously a market crying out for product here. We did okay with the ZX81 — let's tart up some of that material and get it out pronto before someone else cleans up.'

Don't get me wrong — I'm a whole-hearted devotee of the quick buck and, indeed, but for an overwhelming indolence, I would have been tempted to have been out there jostling in the marketplace myself. But, anyway, I was suspicious, and not predisposed to rave about any of the early Spectrum material.

In the event, I was pleasantly surprised. Although there may be nothing here that's astoundingly innovative, the standard, in most cases, is more than adequate. The speed in which these books appeared on the shelves is also indicative of the vast improvement in turn-around times in the publishing industry these days — much of this material has been available for some months now.

I was also impressed with the accuracy shown in the program listings. With very few exceptions, all the programs I tried ran first time, and what mistakes there were — a repeated program line in one instance, a GOTO 25000 instead of 2500 somewhere else — were obvious and easily amended.

So, anyway, let's assume for the sake of argument that you have actually received your Spectrum. You've waded your way through the sometimes incomprehensible, sometimes downright misleading Spectrum manual, and you want more. You want more program listings, and you want more hints and tips on how to get the most out of your new machine. What benefits are you likely to get from the material here?

The Cambridge Colour Collection — 20 Programs for the ZX Spectrum: written and published by Richard Francis Altwasser, £6.95.

First out of the stalls was Richard Altwasser, writer and publisher of *The Cambridge Colour Collection*. It's hardly surprising that Richard had a head start on the rest of the field — as one of the Spectrum designers he would be expected to know a little about the machine.

I must confess that a cursory examination of Richard's book seemed to confirm my worst fears about exploitation. A slim (64 pages), expensive (£6.95) little volume, it hardly seems to break any new ground. The 20 programs concentrate on tried and trusted old favourites like lunar lander

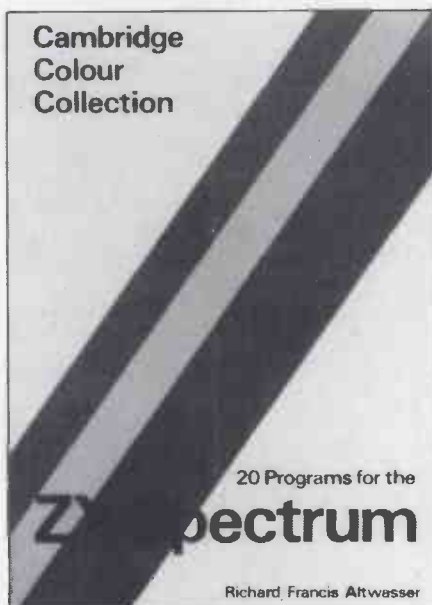

and Android Nim, and my first impressions were unfavourable, to say the least. Apparently there is a companion cassette, costing £2.95, with all the programs ready for immediate loading. I say 'apparently' because, despite two different promises of delivery, I have been conspicuously unsuccessful in getting my hands on one. So, showing remarkable devotion to duty, I spent several evenings and a weekend keying in the listings from the book.

So, at just fivepence under seven quid, what do you get for your money? As mentioned above, the programs do not inspire initial enthusiasm, and the notes to most of them are somewhat sketchy, rarely more than a couple of paragraphs. But, despite this, I feel the book is well worth investigating, especially if you are unsure of the graphics capabilities of your Spectrum. I feel that a large percentage of Spectrum users will be ZX81 freaks who have upgraded, and keying in these listings is a painless way of learning some of the new techniques necessary to get the most from their new toy. Altwasser has compacted his programs very neatly, and, although there are no specific programming hints here, each program illustrates some aspect of the Spectrum's potential. In addition, they're fun. Altwasser's robots in Android Nim squeak and gibber in a most satisfactory manner, then roll their eyes piteously as you wipe them from the screen. The damn program still beats me every time, but the visuals can't be faulted.

On a more serious note, there is a very useful character generator program for user-defined shapes. This differs from the one on Sinclair's free 'Horizons' cassette by giving you a display grid of 25 characters, so you can easily combine several different characters to make a large Space Invader-type graphic.

Also very useful is 'Notebook', which features a neat little machine code search routine and which, slightly

amended, is doing sterling service in the Mann household as a video index.

A bit on the expensive side, then, but if you just want a score of programs that aren't too demanding but will give you an idea of what the Spectrum can do, then this is probably for you.

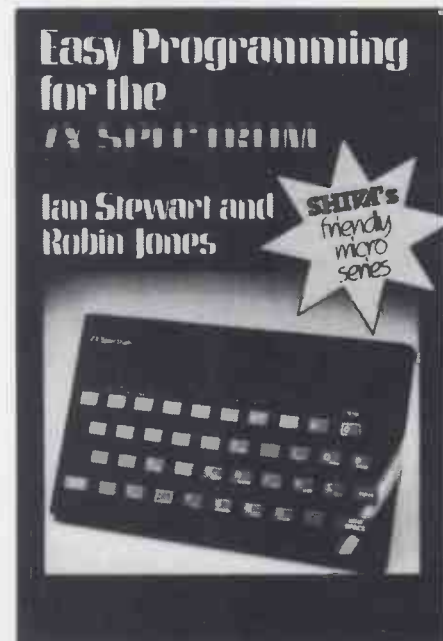

Easy Programming for the ZX Spectrum by Ian Stewart and Robin Jones (Shiva, £5.95)

A strange one, this. Part of 'Shiva's friendly micro series', *Easy Programming* is by Ian Stewart and Robin Jones, authors of the bizarrely titled *PEEK, POKE, Byte and RAM* for the ZX81 — a name they disclaim responsibility for, incidentally, insisting it was 'foisted on us by our publicity man'. The authors describe this as being the Spectrum version of *PEEK, POKE* etc.

The preface says this is 'a gentle guide to Basic programming, programming style, colour, sound, moving graphics, high-resolution graphics, debugging, number-crunching and string-handling. When you've read this, the manual will be easy meat.' Okay, I'll go along with that. Everything's kept short and sweet, and there are indications of a healthily cynical attitude to computer manufacturers' claims — 'This is a feature of the way the Spectrum handles the display. (A bug which can't be fixed is called a "feature" in computing jargon.)'

The debugging sections are excellent; the program notes explain exactly how each program runs and give suggestions for improvements, and the authors are largely successful in their claim that 'lots of computer books give the impression they're trying to prove how clever their authors are. We're not doing that: everything here is very straightforward and basic.'

I was very impressed with the way the book is organised. The chapters are all kept to a sensible length, with

examples liberally scattered throughout and an extended program section, complete with notes, at the back. The sections on debugging are similarly dotted throughout the volume, and I would say the authors have succeeded in their stated aims. That said, I must also add that I found the appearance of the book spoilt by a selection of truly cringe-inducing cartoons — 'De Bugs' — which are distributed liberally throughout. It's probably something that's lacking in my sense of humour, but I found them twee and unfunny in the extreme. What's worse is that, for me at any rate, they detract from what is really a useful and well-put-together book.

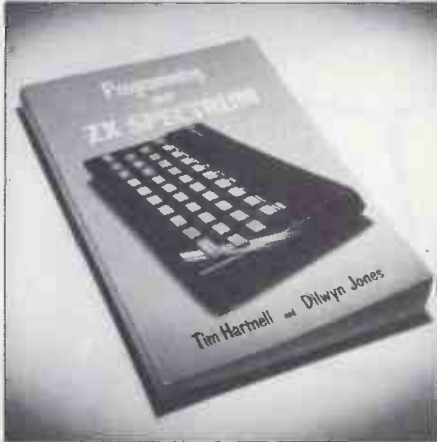

Programming Your ZX Spectrum by Tim Hartnell and Dilwyn Jones (Interface Publications, £5.95)

Never reticent about coming forward, Tim Hartnell — the Barbara Cartland of the micro book industry — was off the mark with almost indecent haste with this weighty tome, written in conjunction with Dilwyn Jones. By 'Barbara Cartland' I don't mean to imply that Tim dresses up like a chocolate-box illustration (I don't know, though. . .), or that he pops thousands of vitamin pills daily, but, my God, is this man prolific! The author of books too numerous to mention here on the ZX81, the VIC-20, the BBC Computer, various guides to buying a computer, etc, this was his first for the Spectrum, although I notice he's come up with another one already — this time with the added attraction of a foreword by Clive Sinclair, which will no doubt add a certain air of authority to the volume.

This is a fat 230-pager, aimed at the beginner, and it progresses at a comfortable pace from basics ('Using the keyboard', 'The PRINT statement') through to some more advanced concepts and useful stuff like using the shifted cursor keys to give diagonal movement (excellent for games). Tim and Dilwyn do a good job of helping the beginner avoid the pitfalls encountered when writing programs, and the writing style is clear and undemanding. As is compulsory these days there's a section on structuring your programs, and — a nice touch, this one — a section on commands in other Basics and advice on how to achieve the same effects in the Sinclair dialect. There's also a collection of handy subroutines, covering things like partial screen clear, left and right scrolling, and aligning columns of numbers to the decimal point.

Along the way there's an exceedingly

naff Pacman-type game, and an astounding cock-up. 'Prime numbers are very easy to determine,' say Hartnell and Jones, then proceed to give a program to generate them and a sample print-out of the first 20. All well and good, but a touch more care in the proof-reading would surely have spotted that the program thinks 9 is prime!

I can't help thinking that the programs themselves do not do justice to the text that surrounds them. They are all the sort of thing that you might key in once to see what each one does, but which you will never return to later on. In an ideal world, the programs in *The Cambridge Collection* would be combined with the instruction given here. As it is, you'll either have to buy them both or use the techniques explained in this book to write your own — which is probably the best way of going about learning how to program, anyway.

A boon to the beginner, then — but don't expect too much from the example programs.

THE ZX SPECTRUM and how to get the most from it



The ZX Spectrum And How To Get The Most From It by Ian Sinclair (Granada, £5.95)

Ian Sinclair (no relation) aims at the same market as the Jones/Hartnell opus, but concentrates less on silly games and more on developing programming technique.

After the 'Introduction' and 'First Steps' chapters, the book is broken down into six main areas: 'Variables', 'Loops, repetitions and arrays', 'Data processing', 'Graphics', 'Sound' and 'Roll Your Own' — a nifty little section on writing your own programs.

I can't get too excited about this book, but then I can't knock it either. It does exactly what it sets out to do, competently if a little uninspiringly, and has some useful tips in its various appendices for aligning your tape recorder correctly, and modifying your recorder leads so that you don't have to unplug one of them when LOADING and SAVEing.

There must be a lot of people out there who don't want to play 'blob-chaser' games, and this book attempts to cater for those who would prefer to find out more about storing and accessing data, or who want to move on as quickly as possible to writing their own

programs. I found it worthy, if a little dull in its approach. My advice? Try before you buy.

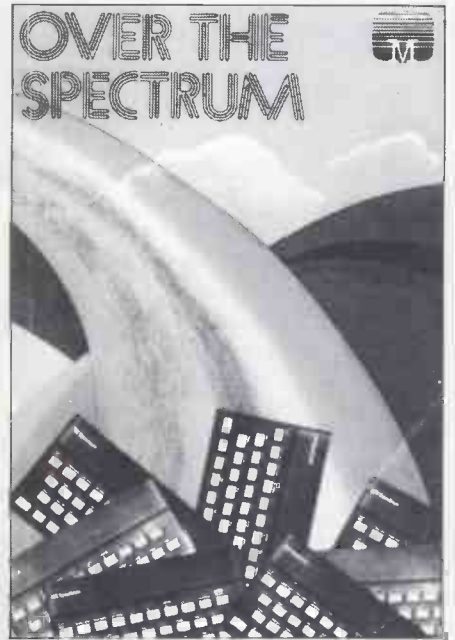

Over The Spectrum — 30 Programs for the ZX Spectrum (Melbourne House, £6.95)

The final entrant in the Spectrum Stakes is Melbourne House's *Over the Spectrum* — and, for me, at least, it runs out the clear winner. Emphatically not a 'teach yourself programming' guide, *Over the Spectrum*, like Richard Altwasser's book, is simply a collection of programs, but unlike the *Cambridge Collection* each program has a detailed breakdown of exactly what happens when, and how it's all achieved.

The listings are not trivial, and care should be taken in keying them in, but the result is well worth the effort. The book is liberally illustrated, in colour, showing the screen display for almost all the programs contained therein — so you know what you are trying to achieve from the outset.

As a demonstration of what can be achieved using the Spectrum's user-defined characters, this book cannot be faulted — several of the programs require 50 or so user-defined characters — and, although it contains no programming hints as such, a diligent reader is going to learn a lot about the Spectrum by working his or her way through it.

Worthy of special mention are probably the slowest fruit machine you'll ever see — but, oh, those graphics! — and a sophisticated character generator which allows you to work on four characters at once, and allows things like mirror-images to be obtained at the touch of a key. There is also a neat little program to turn your Spectrum into an alarm clock, which I find myself using frequently — it would benefit from one of the external amplifiers produced to beef up the Spectrum's sound output, but I find that even the unmodified volume level produces an insistent BEEPing that should rouse you.

No author is credited for the book as a whole, but the bulk of the programs come from Beam Software, Clifford Ramshaw and Neil Streeter. Take a bow, gents — and give us more.

END



THE PCW £5000 MANHUNT

You should be pretty well fed up with looking at Pythagorean triangles by now. If you read the question properly you should have at least five answers to part three of the puzzle (and a lot more if you didn't!). What we neglected to tell you is that you need to find the *smallest* such triangle — ie, the one with the smallest perimeter.

Got it? Okay, you now have six numbers written down: three multi-digit ones and three single-digit ones. Take the multi-digit numbers and write them down one after the other in the order they were obtained. This gives you a nineteen-digit number.

Now cube it (accurately!).

Now you have a rather intimidating 57-digit number.

You also have the following text in enciphered form:

EYOMHDKLZ C20TLY3LDYZM04067E4B8ACA5

which contains the name, rank and phone number you're looking for.

Go to it! The three single-digit answers could help you if you knew how.

By the way, members of the KGB (and their relatives) are not eligible.

When you have it deciphered, ring the number and leave a message for this person on the answering machine (use his/her rank or you may give offence). The message is just the three single-digit numbers (to show you solved the puzzle and didn't get there by any devious dealings).

If you want the prize money, best leave your name and address as well.

Good luck — don't spend it all at once!

J J Clessa

Note: PCW staff will not enter into any telephone or other communication about this problem, so please don't bother them.

TJ's WORKSHOP

Our monthly pot-pourri of hardware and software tips for the popular micros. If you have a favourite tip to pass on, send it to 'TJ's Workshop', PCW, 62 Oxford Street, London W1A 2HG. Please keep your contributions as concise as possible. We will pay £5-£30 for any tips we publish.

SOFTWARE DRIVEN 2MHz/1MHz ATOM

I found A Clements' article on how to modify the Atom to run at 2 MHz extremely interesting.

I eagerly followed his instructions and was delighted to find that the 6502 did indeed run at 2 MHz. However, as pointed out, loading and saving programs necessitated switching the machine back to 1 MHz. A further drawback is that the machine locks up after being switched, thus requiring BREAK followed by OLD to restore the program.

This simple hardware modification uses the spare output line PC3 to switch from one speed to the other.

The modification necessitates cutting two tracks on the Atom circuit board. The first, on side 2, is the track from pin 10 of IC44, as described in Mr Clements' article. The second cut is on side 1 of the board. Locate and cut the link LK5 which connects pin 1 of PL4 output socket to pin 39 of IC31. The Atom board mods are then complete, except for the wire connections to the circuit shown in Figure 1.

The circuit was constructed on a small piece of Vero-board and mounted using two insulating washers on side 1 of the Atom board, just

below IC37/39 and above the keyboard connection for the BREAK key. The siting of the board is not critical and may be left to the constructor's own judgement. A 3/16in hole was drilled in the board in order to pass the insulated wire connections from the Vero circuit on side 1 to the Atom circuit connections on side 2.

Modifications complete, the machine should be switched on and should display 'Acorn Atom' as normal. If this is not the case, check that all connections have been made correctly and that both cuts in the tracks are clean. It will be necessary to carry out the RAM tests indicated by Mr Clements in order to ensure that the correct speed RAM chips have been used.

To switch from 1 MHz to 2 MHz, simply set bit 3 in

location Hex B002 — eg, !#B002=!#B002:FF08. The machine will now be running at 2 MHz and can be checked simply by typing CTRL G. If a high-pitched beep is heard instead of the usual low note, then success. If not, unset bit 3 and try again. If the note is still the same, check all wiring, etc. If it is a high beep, then the default speed at switch on is 2 MHz and you should swap the connections to pins 5 and 11 of the 74LS00 chip to change default speed to 1

MHz. Programs can now automatically control which speed they run at by setting or unsetting bit 3 of Port C, without the machine locking up.

One advantage of this method is that any commands to handle the cassette interface — ie, LOAD, SAVE, CAT — will automatically switch the machine back to 1 MHz. However, it will be necessary to reset the m/c to 2 MHz after saving or loading.

A S Birds

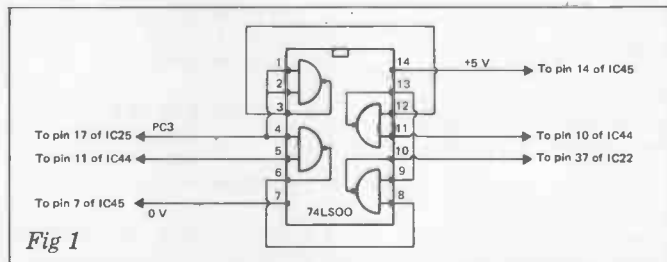

Fig 1

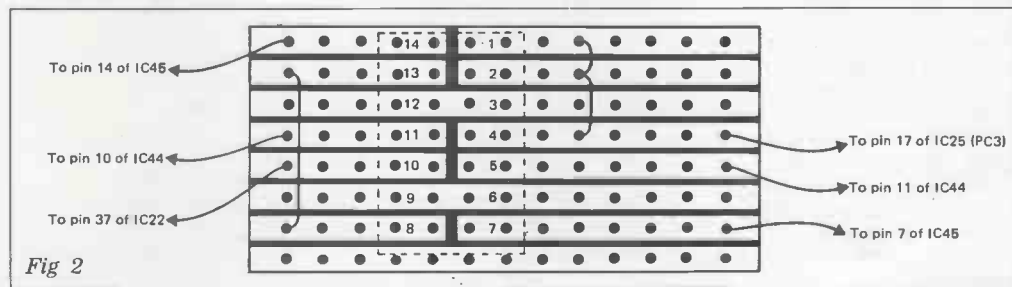

Fig 2

VIC TIP

Here's a useful tip for the Vic-20. Many Vic-20 owners will by now be familiar with the problems of using hi-res graphics with the 8k cartridge. Basic has to be shifted from \$1200 to \$2000 to make room for the user-defined graphics.

This is quite a simple operation if you know how to do it, but for the average user with only the Inane Computer Guide to consult, like myself a few months ago, it can seem like a formidable problem.

Here are the necessary commands:
POKE 32*256,0

POKE 44,32
NEW

The last line is very important as it saves you the bother of changing all the variable pointers just after 44 in the zero page.

Once you have typed in the commands, you will have about 8000 bytes left for Basic programs, which you can type in and save as normal.

Substituting a lower number for 32 in lines 1 and 2 will give you more memory for Basic and less for graphics.

Quentin Gore

UK101 RUBOUT

On the assembler/editor for the UK101, SHIFT/0 has to be used in order to rub out the previous character if a mistake is made when typing in a program. This can become very confusing.

Here is a patch that will allow the RUBOUT key to be used as it is in Basic. To accommodate the extra machine code, the pointer to the start of the source file must be altered by changing \$12C9 to \$B4. The JSR \$FCEA at \$1399 must be changed if a monitor other than NEWMON is being used.

David Hunter.

1311	209113	JSR	1391
1391	AD0302	LDA	1399
1394	F003	BEQ	1399
1396	4CEBFF	JMP	FCEFE8
1399	20EAF8	JSR	FCEA
139C	C91C	CMP	=1C
139E	D013	BNE	1383
13A0	A908	LDA	=08
13A2	20EFFF	JSR	FFEE
13A5	A920	LDA	=20
13A7	20EFFF	JSR	FFEE
13AA	A908	LDA	=08
13AC	20EFFF	JSR	FFEE
13AF	68	PLA	
13B0	68	PLA	
13B1	A95F	LDA	=SF
13B3	60	RTS	
12C9	B4		

ATOM TEXT 'N' GRAPHICS

This program allows text, both upper and lower case, to be mixed with graphics on a graphics screen (Mode 4) — a facility long needed by Atom owners. It makes use of routines contained within the Acornsoft Word Pack word processing ROM which must be in the utilities ROM socket for the program to work.

The program is assembled in #2800 and uses 64 bytes. If floating point variables are to be used by the user program, line 70 must be changed to an alternative assembly address.

It is used as follows:

Once assembled and therefore RUNNING the user program, a LINK #2800 (or as 70 if altered) must be performed. This will clear the screen to mode 4 and a cursor will appear at the top left corner. This can most conveniently be achieved by incorporating the LINK instruction into the start of the user program. CLEAR 4 should not be used in the user program since it will erase the cursor.

The user program is then RUN as usual. When characters are required, a LINK #2809 (or assembly address +9, if line 70 is altered) will cause any character typed to appear on the screen at the current cursor position. Likewise, any character PRINTed by the user program will appear on the screen at the cursor position. Control L will cause an exit from the routine and return control to the rest of the user program.

The program operates as follows: Lines 110 to 140 alter the 'read character' and 'write character' addresses (#20A, #20B, #208, #209) to those required by the word processor.

The rest of the program reads characters typed in by the user and displays them at the current cursor position.

The cursor keys operate in the usual manner.

If 'control L' is typed, the routine will be left, and the user program returned to. If an alternative character is required as the exit command, line 164 should be altered to:
164 CMP @ASCII CODE
FOR DESIRED

CHARACTER.

To prevent the screen from scrolling if the bottom line is passed, the program (lines 180 to 200) continually monitors the contents of location #93, which is where the word processor stores the screen line number. 21 lines of text are possible (0 to #14). When the last line is reached, carriage return and line feed commands are ignored.

The other cause of scrolling is if a character is typed into the rightmost position on the bottom line; lines 300 to 320 watch for this and allow only left cursor, up cursor and delete commands

to be used once this point is reached.

Characters can be inserted anywhere on the screen, but care should be taken that a character does not over-write any required graphics. It should also be remembered that a space is a character and, if typed, will erase a small rectangular area of screen above the cursor.

J J Smith

```

10 REM- ROUTINE TO ALLOW MIXED TEXT
20 REM- AND GRAPHICS IN GRAPHICS MODE 4
30 REM- USES THE ACORN SOFT WORD PACK.
35 REM- COPYRIGHT JERRY SMITH
40 DIM BB4
50 P.*21
60 F.I=0T01
70 P=#2800
80I
110:BB0 LDY @3          } SET UP WORD
120   JSR #ACDE        } PROCESSOR
130   JSR #AC4B        } ADDRESSES
140:BB4 RTS           EXIT
145\
150\* START OF CHARACTER ENTER ROUTINES *
155\
160:BB1 JSR #FFE3      READ A CHAR.
164   CMP @#C          IS IT CNTRL L?
166   BEQ BB4          YES SO EXIT
170   PHA             SAVE IT
180   LDA #93         LAST LINE--
190   CMP @#14        YET?
200   BEQ BB3         YES
210:BB2 PLA           RECOVER CHAR.
220   JSR #FFE9      AND PRINT IT
230   JMP BB1        BACK FOR MORE
240:BB3 PLA           RECOVER CHAR
250   CMP @#D        IS IT CR?
260   BEQ BB1        YES SO IGNORE IT
270   CMP @#A        IS IT LF?
280   BEQ BB1        YES SO IGNORE IT
290   PHA             SAVE CHAR.
300   LDA #E0        POSITION ON LINE
310   CMP @#1F       END OF LINE?
320   BNE BB2        NO
330   PLA             RECOVER CHAR
340   PHA             SAVE CHAR.
350   CMP @#B        IS IT CURSOR UP?
360   BEQ BB2        YES
370   CMP @#8        IS IT CURSOR LEFT?
380   BEQ BB2        YES
390   CMP @#7F       IS IT DELETE?
400   BEQ BB2        YES
405   PLA
410   JMP BB1        IGNORE ANYTHING ELSE
420]
430   NEXT
440   P.*6
450   END

```

SHARP CHARACTERS

The Sharp PC-1500 is pretty remote (ouch) from being a terminal, but it is still good TJ fodder. I have been delving into the inner workings of the machine, and have found a lot of interesting goodies. Here is a program to illustrate one of the most useful.

The Sharp generates displayed characters by software, and so (like the ZX81) the character generator is accessible to programs. It starts at 64672 (&FCA0) with the entry for the space character. Each entry consists of five bytes of dot column image which can be passed to GPRINT. The sixth column is always blank and consequently does not appear in the table.

With a bit of manipulation it is possible to print characters upside-down or back-to-front, but the most useful application of the table is for printing double-width characters, as in this demonstration program.

```

5 REM   DOUBLE WIDTH CHARS
10 WAIT 0
20 INPUT "STRING? ";A$
30 FOR I=1 TO LEN A$
40 A=ASC(MID$(A$,I,1))*5+&FC00
50 FOR J=0 TO 4
60 B=PEEK(A+J)
70 GPRINT B;B;
80 NEXT J
90 GPRINT "    ";
100 NEXT I
110 PAUSE
120 GOTO 20

```

The display annunciators (BUSY, RUN, etc) are memory mapped and appear at &764E and &764F. Sorting out which bit belongs to which symbol is left as an exercise for the reader, but beware — there is a surprise in store!

By the way, does anyone know what the OPN instruction does?

Malcolm Ray

SPECTRUM ERROR

One of the reasons a machine code user may want to display a message on the screen of a ZX Spectrum is that an error has been made somewhere. In many examples one of the Sinclair standard error codes could be used. For instance, in some assembler programs, an attempt to load a single register with a number above 255 could be met by report code 6 - 'Number too big' or report code B - 'Integer out of range', either of which can be followed by a line number and statement number of the programmer's choice.

The trick is to use a ROM subroutine at 0008h. The command RST 8 in a machine code program then gives a

return to Basic. The following byte should contain the number one less than the error code wanted, and addresses 5C45h and 5C46h should contain the low and high bytes of the line number. Address 5C47h contains the statement number.

For example:
LD HL, 1234 21 D2 04
LD (23621),HL 22 45 5C
LD A,5 3E 05
LD (23623),A 32 47 5C
RST 8 CF
18 12

The short program above will give the message: 'J Invalid I/O device 1234:5'.

But if you look in the Sinclair manual, only codes 0-0-9 and A-R are listed. What do other values give? Some very interesting reports. Error

```
1 REM.
10 POKE 23760,207
20 FOR n=0 TO 255
30 POKE 23761, n
40 PRINT USR 23760
50 NEXT n
```

T, for instance, is the Sinclair copyright message. Type in the accompanying six line program, REM statement included, and run it. You get error code 1. Type in NEXT N and press ENTER, and you get error code 2. Repeat this and you work your way through all 256 codes. I hope you can find some useful ones - good luck to your typing finger!

Bill Longley

BEEB STRING SEARCH

Here is a program that will fit in one function key on the BBC Micro. It will search through a Basic program, looking for a specific string (You INPUT it), and will report all line numbers at which it occurs. This is very useful in debugging long programs (eg, Adventures), where you have lost track of where certain procedures and variables are mentioned. NB: the program cannot search for Basic keywords as they are stored as token values. *KEY O"CLS:INPUT"
"Enter string"
N\$:P=PAGE+1:REPEAT:N=256*P?0+P?1:P=P+2:L=P?0:NL=P+L-2:P=P+1:IF INSTR(\$P,N\$) 0 THEN PRINT:N:P=NL:UNTIL P?0-&FF:END:ELSE P=NL:UNTIL P?0-&FF:END:M"

To execute a search press key 'f0' and enter the string you wish to search for when prompted. The program will reply by listing all the line numbers at which the string occurs.

While on the subject, there is a function key bug. The function keys can hold a maximum of only 255 characters (a good reason to use abbreviations for keywords). If you try to enter too many characters you will get a 'Bad key' error. What the computer does is to take the number of characters already in the key, add it to how many more you wish to put in, and if the answer is greater than 255 it reports an error. However, if you are re-defining a key it still adds the number of characters already in the key, even though they will be deleted. This may lead to a 'Bad key' error when in fact there is nothing actually wrong. The best way around this is to type *KEY N"" (where N is the number of the key you wish to define) before defining your key.

Ian C Brodie

BEEB BREAK

Did you know that the Break key on the BBC micro can be defined, just like the other 10 user definable keys?

I find this particularly useful for OLD ;M ;NLIST ;M

Philip Gigg

PET MOVEMENT

Nearly all PET 'movement' games which I have seen published in your magazine in the past two years use a method of movement a great deal slower than the method I use,

which to my knowledge I invented!

This makes use of PEEK (515), which gives the current key pressed and an array and can be adapted for various

types of movement - and no doubt for other machines also.

T H Ley

```
1 PRINT"♥":POKE33333,214
5 G=33333:X=0
10 DIMA(255)
20 A(50)=-40:A(18)=40:A(42)=1:A(41)=-1:R=515
30 REM BASIC)1:A(184)=-40:A(178)=40:A(180)=-1:A(182)=1:R=151
35 REM +++ SET UP THE SCREEN +++
40 FORT=1T040:POKE32767+T,224:POKE33727+T,224:NEXT
50 FORT=0T0960STEP40:POKE32768+T,224:POKE32807+T,224:NEXT
60 REM MOVEMENT
70 X=A(PEEK(R)):IFPEEK(C+X)(<)32THEN70
80 POKEC,32:C=C+X:POKEC,214:GOTO70
```

SPECTRUM SCREENMAP

Owners of the new Sinclair Spectrum may have discovered that the memory map for the screen is arranged in a very unconventional way.

The screen is divided into three sections each of eight character lines by 32 character columns. Each character is eight bytes deep. The first scan of 32 bytes is of the first byte of each character from the lines 0-7; then the second and so on. Which is repeated for lines 8-15 and 16-23... confused? Well, here is a short routine to unscramble the screen map for

conventional screen pokes. Y has the value 0-6143 (0-top right hand corner: 6143-bottom left hand corner). T contains the corresponding location in the screen map.

In return for this, could your readers advise me of a way of constructing a conventional screen map - ie, with the Scans arranged left to right, one line below the other.

(Name omitted! Please contact us.)

```
1000 LET T=INT(Y/2048)*2048
1010 LET Y=Y-INT(Y/2048)*2048
1020 LET T=T+INT(Y/256)*32
1030 LET Y=Y-INT(Y/256)*256
1040 LET T=T+INT(Y/32)*32
1050 LET Y=Y-INT(Y/32)*32
1060 LET T=T+Y+16384
```

BLUDNER

In September's PCW you published a letter from me under the title 'Appendectomy'. The published text contained two omissions which rendered it senseless.

It should have read
1) Load first program
2) PRINT ~ TOP-2 (note ~ sign omitted)
3) Then type *LOAD "second program name" XXXX where XXXX is the address that was printed in 2) [you omitted the XXXX and comment].

R Jewsbury

BEEB TAPE SALVAGE

In answer to many a BBC Micro owner's prayers I offer my own version of a tape salvage program. As many BBCers will know, the 0.1 operating system has two bugs in the cassette filing system. This program attempts to salvage a program which had block 0 corrupted due to one of these bugs. According to Acorn, this bug would corrupt, on average, block 0 of one program in 16.

There is now a well publicised m/c fix for both of these bugs but, alas, these have arrived too late for many users.

My program will attempt to read in as many Basic lines as possible, starting from any block number until the end of the program is reached. Errors in the format of the data coming from the tape

will simply mean a missing line of Basic which the user will have to re-enter but at least he/she will not have to retype 10k of program lost because the first block is unreadable.

The data bytes are detokenised as they are read from tape using the crunch subroutine in the Basic ROM converting single bytes to Basic keywords so that a check can be made of the lines coming in. However, I am detokenising all but the line number and the line length, and consequently characters within quotes and GOTO/GOSUB statements will appear to be incorrect when in fact they are okay.

I suggest that the m/c fixes are chained in before loading this program to ensure when you resave your

salvaged program you do not have to repeat this process unnecessarily.

To use the program type RUN and position your cassette to just before the program to be salvaged. The program will list to the screen as it is found on tape and is stored above this program in memory. When the end of the program is reached or ESCape is pressed the pro-

gram will reset PAGE to start of the salvaged program. Typing LIST will display the salvaged program which can be saved in the usual way.

If you are not satisfied with the salvaged program, type BREAK then OLD <CR> and repeat the process.

Paul Mudditt

UK ERROR LIST

Whilst programs are being written, errors often creep in. I have often wished that the computer would automatically list the incorrect line to speed debugging. This feature is especially useful to CEGMON/WEMON users with a full screen editor, since the editor could be called immediately rather than

after you have had to type LIST xxx.

The program requires alterations to two bytes in order to locate it anywhere in memory.

R Clarke

ADDR	CODE	MNEMONIC
0240	4C 49 53 54 20	; codes for LIST
0245	A9 50	LDA £\$50 ; .0245 G to initialise
0247	A0 02	LDY £\$02
0249	85 04	STA \$04
024B	84 05	STY \$05
024D	4C 00 00	JMP \$0000 ; warm start
0250	C9 92	CMR £\$92 ; check if A/Y=92/A1
0252	F0 03	BEQ \$0257 ; ie, OK message
0254	4C C3 A8	JMP \$A8C3
0257	C0 A1	CPY £\$A1
0259	D0 F9	BNE \$0254
025B	A6 88	LDX \$88 ; we are in command mode
025D	E0 FF	CPX £\$FF
025F	F0 03	BEQ \$0254 ; yes-exit
0261	A2 04	LDX £\$04 ; place 'list' in buffer
0263	BD 40 02	LDA \$0240,X
0266	95 13	STA \$13,X
0268	CA	DEX
0269	10 F8	BPL \$0263
026B	A9 FF	LDA £\$FF ; suspend O/P (CTRL/O)
026D	85 64	STA \$64
026F	20 5A B9	JSR \$B95A ; print line number
0272	E6 64	INC \$64 ; resume O/P
0274	A2 FF	LDX £\$FF
0276	E8	INX
0277	BD 00 01	LDA \$0100,X ; move printed line no
027A	95 18	STA \$18,X ; into buffer
027C	D0 F8	BNE \$0276
027E	A9 12	LDA £\$12 ; PC points to start of
0280	A0 00	LDY £\$00 ; buffer
0282	85 C3	STA \$C3
0284	84 C4	STY \$C4
0286	38	SEC
0287	4C 84 A2	JMP \$A284 ; tokenise & list

```

10 ON ERROR PRINT "REPORT:PRINT" error at line ";EAL:GOTO 310
20 CRUNCH=ABS3A:REM THIS SUBROUTINE DETOKENISES BASIC
   OR PRINTS THE ASCII OF A%
30 REM SELECT SHORT MESSAGES
40 *OPT 1,2
50 REM MAKE COMPUTER IGNORE ALL TAPE ERRORS
60 *OPT 2,0
70 page=(TOP DIV 256)*256+256:REM SELECT NEW PAGE VALUE TO LOAD
   PROGRAM INTO.
80 index=R:REM page OFFSET POINTER
90 X=OPENIN(""):REM LOAD ANYTHING ON THE TAPE
100 REM SELECT NO TAPE MESSAGES FROM NOW ON
110 *OPT 1,0
120
130 REPEAT A%=BGET#X:UNTIL A%=&0D:PRINT:REM WAIT HERE UNTIL WE FIND THE START
   OF A NEWLINE OF BASIC TEXT.
140 PROCPOKE(A%):REM POKE IN &0D 'CR' CHARACTER' TO START PROGRAM STORAGE
150
160 REPEAT Lastnewline=index
170 LnH%=BGET#X:PROCPOKE(LnH%):REM 1st BYTE IS HIGH PART OF LINE NUMBER
180 LnL%=BGET#X:PROCPOKE(LnL%):REM 2nd BYT IS LOW PART OF LINE NUMBER
190 L%=BGET#X:PROCPOKE(L%):REM LENGTH OF BASIC LINE
200 PRINT TAB(20);LnH%*256+LnL%:REM DISPLAY LINE NUMBER
210
220 REM THIS PART LISTS BASIC LINE TO SCREEN AND STORES IT IN MEMORY
230
240 REPEAT
250 A%=BGET#X:PROCPOKE(A%)
260 IF A%<32 OR A%=127 THEN PRINT " "; ELSE CALL CRUNCH
270 UNTIL A%=&0D:PRINT
280
290 UNTIL EOF#X
300
310 CLOSE#X
320 PRINT.
330 index=Lastnewline:PROCPOKE(&FF):REM FINAL BYTE IN ALL BASIC PROGRAMS 'MUST
   BE &FF SO INSERT THIS FOLLOWING LAST RECORDED 'CR'
340 REM RESET DEFAULT MESSAGES
350 *OPT
360 PAGE=page:REM SET PAGE TO START OF SALVAGED PROGRAM
370 END
380
390 DEF PROCPOKE(B%)
400 page?index=B%
410 index=index+1
420 ENDPROC

```



OFFICE EFFICIENCY MACHINES LTD

1 Lochaline Street, London W6 9SJ

Tel. 01-741 7211/2/3/4

SPECIAL PROMOTION DEALS!

IBM
Personal Computer



£2599.00

PLUS! EPSON MX80 PRINTER
WORTH £400.00 FREE!

ACT
SIRIUS 1



£2395.00

PLUS! EPSON MX80 PRINTER
WORTH £400.00 FREE!

NEW!

DRG
VICTOR 9000



£2395.00

PLUS! EPSON MX80 PRINTER
WORTH £400.00 FREE!

OSBORNE 1



PLUS! EPSON MX80 PRINTER
and 12" MONITOR

£1499.00

(Total package worth £1800.00)

includes
WORDSTAR, MAILMERGE,
SUPERCALC, MBASIC + CBASIC
worth £800 FREE!

OR **OSBORNE 1** PLUS 12" (GREEN OR AMBER) MONITOR — **£1250.00**

TO PLACE YOUR ORDER — CALL OUR
HOT LINE — 748 8404

OEM ALSO OFFER SOME OF THE BEST
TRADE PRICES IN THE UK ON IBM PC
AND MOST PRINTERS

To: Office Efficiency Machines

1 Lochaline Street, London W6 9SJ

Telex 263559 Micro G

Please send me information on the

Trade End User

Please ask your sales staff to contact me

re

Name

Company

Address

Telephone

ADVANCE TO THE FORE!

Anthony Harrington reports on the Third

European Microcomputer Chess Tournament



The Third European Microcomputer Chess Tournament, held at the Barbican Centre during the PCW Show, proved once again that computer chess is a thriving force.

Despite the fact that entry forms and invitations to the tournament went out later than usual — a consequence of PCW itself changing hands and of the withdrawal of David Levy from his accustomed role as tournament organiser — the event attracted a very strong field. There were 14 entries in all, though program failure in the case of two entrants meant that the number of programs involved turned out to be the same as last year, with 12 competing programs.

A seven round Swiss tournament is always an exciting affair, with something of a lottery about it. The basic rule is that players with the same number of wins (or losses) play against each other. The point of this is that the more you win, the harder it gets, since you're meeting people (programs in this case) who've done just as well as you have. If you lose, you have the consolation of being able to expect an easier game next round.

The final line-up included four commercial entries (programs or dedicated chess computers actually on sale to the public or which would be available before the end of the year) and four experimental entries from commercial companies. It might have been even stronger, but Fidelity, of Miami, whose Sensory Chess Challenger '9' is one of the strongest chess computers around, decided against entering a week before the start. (According to John Renaldo, Fidelity's marketing manager, the company was considering entering either a commercial model or an experimental entry or both.) The West German company Hegener and Glaser, which makes the Mephisto, also almost entered, but decided at the last moment that they didn't like Swiss tournaments and would concentrate instead on the US World Championships in March 1984.

One has to sympathise with commercial companies. They have a lot at stake as far as potential sales are concerned. And if their machine, for some reason, fails to win one of the top three placings in a tournament it is tempting for their managing directors to feel that the public will take the hint, and buy the machine which did better.

My own feeling here is that they would do better to compete. If they do feel their commercial model is a little delicate, there's no harm in entering an experimental entry. It would give their programmers a chance to test their ideas, and the results wouldn't affect their market share provided the name given to the experimental entry bore no relation to the market model.

Still, if one remembers that the commercial class in the World Championships, held at Lubeck-Travemunde, West Germany in September last year, consisted of only four entries, one of which withdrew after a few rounds, the commercial line up wasn't bad. And the amateur entries were excellent.

It is the amateur entries that make these events. Unburdened by the financial anxieties of the commercial entrants, the amateurs give the tournament its enthusiastic, convivial atmosphere. Whereas commercial competitors have a tendency to get a little grim at the board and to be sharp and short with opponents, the amateurs tone down the seriousness of it all — and are just as willing to laugh at the odd strange move generated by their own program as they are at their opponent's.

In all there were five amateur entries. From Hamburg, Dieter Steinwender, a computer science student, led a team of four German students with an entry called Micromurks, running on an Apple II. Also on an Apple II was White Knight (Mk 10), written by Martin Bryant. This, like Richard Lang's Cyrus II, running on an Osborne, was an improved version of a program entered into last year's PCW tournament. Mark Johnson and Dave Wilson, with Advance 2.4 and Jeff Cooper with Chess '86, also seasoned PCW tournament campaigners, completed the amateur turnout.

In passing, one should probably say that the 'amateur status' of several of these programmers simply means that they are not selling or about to sell their entry programs (though they might, if an offer came along). Johnson, Bryant and Lang are all employed by Intelligent Software, a company set up

by David Levy and Kevin O'Connell to write and market chess programs (and other 'intelligent' games).

In the experimental commercial class (programs which won't go before the public in their present form), there were two entries by SciSys, the Hong Kong based company whose machine, Mark V, won the Travemunde world championships. These were the Mark 5.01 Experimental and the President Turbo Experimental. The Austrian chess programmer Wim Rens, sponsored by the UK firm Microtrend, entered a program called Gambeit '86 and Intelligent Software put in an entry called Philidor.

The commercial section proper consisted of La Regence, a 'sensory-board' chess computer designed by Intelligent Software; another sensory-board machine, called Bogol, by the Hamburg company Omikron (a newcomer to the commercial chess machine market); Spectrum Chess, which runs on the ZX Spectrum, designed by Artic Computing, and an Irish entry, Conchess, another sensory board machine.

On the morning of 9 September the competitors assembled in the playing area in the Barbican Centre, set up their machines and programs and promptly experienced the first (and, thankfully, the last) major delay of the event. Someone had wired up a plug incorrectly and blew the fuse for that entire floor sector of the Barbican exhibition hall.

Bear in mind the fact that the tournament was part of the PCW Show, and hundreds of micro suppliers were putting the finishing touches to their stands while we were hunting for an electrician and you will get a fair picture of the start conditions.

That this was the only electrical problem of the tournament is due in no small part to Gould Electrical Division, Wrexham, who provided power smoothing boxes for every one of the microcomputers in the tournament at the shortest possible notice. The day before the tournament was due to start, the company which had promised to supply power smoothing equipment told us that it was having difficulty with its supplier and wouldn't be able to deliver a single piece of equipment.

We phoned Gould, and the managing director of the branch agreed to provide as much as we needed free of charge and to send a lorryload down in time

MICROCHESS TOURNAMENT REPORT

for the tournament the next day, which he duly did. The equipment did its job marvellously and not a single computer in the event had a moment's trouble from power surges or uneven current. Our thanks to Gould for its prompt action.

Play for the whole of this tournament was at the rate of two minutes a move, with the first time control at 30 moves in the first hour and then 23 moves in 46 minutes. This is a somewhat faster rate than is usual in tournament play, but it was forced on us by the tight closing hours of the exhibition. Doors opened for the players and exhibitors at 9.00am (10.00am for the public), and closed at 7.00pm. In order to get through two games a day, we had to limit each round to approximately 3½ hours.

Players were allowed a maximum of 30 minutes down time to rectify any program crashes, so the possible duration of each round was 4½ hours. Since the theoretical starting time for the morning round was 10.00am, and for the afternoon round 2.30pm, a little mental arithmetic will tell you it was a close squeeze fitting both rounds in. Because of the time pressure, it was decided to adjudicate all unfinished games at move 53. This set the tournament director, Stuart Reuben, some complicated adjudication problems in the course of the four days. Fortunately Stuart is a FIDE recognised arbitrator and has years of experience behind him, having directed events such as the Philips and Drew Tournament, the Lloyds Bank Masters, and many other chess competitions.

He was assisted by Peter Morrish, who also provided all the demonstration boards and chess sets at the tournament and did the draw for each round.

The draw and results for the first round were:

Advance 2.4	½ Philidor	½
Spectrum Chess	0 Cyrus II	1
La Regence	1 Chess '86	0
Gambeit '82	0 President Turbo	1
Conchess	1 Mk 5.01 Exp	0
Micromurks	0 White Knight	1
Bogol	0 (Default)	

This first round was characterised by two events that looked more like absences than things that would shape the tournament's outcome. Advance 2.4, running on a home constructed bit-slice machine, found itself playing the white side of what must be one of the most boring Benoni defences of all time. Philidor, the opposing program, constructed a blocked middle game in which the best either computer could think of doing was to shuffle rooks back and forth. The programmers read the papers while waiting for the inevitable draw by repetition. Fortunately Advance 2.4 went on to win the next five games in a row, in more aggressive fashion.

While this was going on, the Omikron team of Martin Suhl and Gerd Krey were busy missing the first round. Unfamiliar with London traffic, they'd made the mistake of taking a taxi from Oxford Street instead of a tube. Their program, Bogol went on to win four out of the remaining six games, and who knows, a win in this opening round might have seen them draw level for top commercial entry with La

Regence on 5 points.

Second round draw and results:

Cyrus II	(1)	½	Conchess	(1)	0
Pres Turbo	(1)	0	La Regence	(1)	1
White Knight	(1)	0	Advance 2.4	(½)	1
Philidor	(½)	0	Bogol	(0)	1
Mk 5.01 Exp	(0)	½	Micromurks	(0)	½
Chess '86	(0)	0	Gambeit '82	(0)	1
A N Other	(-)	½	Spectrum	(0)	½

As the keen-eyed will have noted, the tournament had 13 entrants at this stage, though it was soon reduced to even figures for most of the tournament. Chess '86 collapsed during its game against Gambeit '82 and Jeff Cooper only managed to rectify it in time for the final round. The day was exceptionally warm and the Barbican Centre was attracting record crowds. Computers don't like heat and several of them began to show their dislike. One of the SciSys entries, President Turbo, overheated in a complex middle game against La Regence. It was a miracle that the President Turbo started the tournament at all, as Andrew Page, the SciSys UK general manager, only received the module late the previous evening airmail from Hong Kong. Ideally, he would have liked a few weeks to test the program before the tournament, and we had to admire the competitive spirit that chose to enter rather than withdraw under such circumstances.

Round three draw and results:

La Regence	(2)	1	Cyrus II	(2)	0
Bogol	(1)	0	Advance 2.4	(1½)	1
Conchess	(1)	0	Pres Turbo	(1)	1
Gambeit '82	(1)	0	White Knight	(1)	1
Spectrum	(½)	0	Mk 5.01 Exp	(½)	1
Micromurks	(½)	0	Philidor	(½)	1

Richard Lang won last year's tournament and his program, Cyrus II, had looked good up to this point. But La Regence proved too strong. Dieter Steinwender and the German team were becoming very disappointed with their program, which was showing definite flaws.

Round four draw and results:

Advance 2.4	(2½)	1	La Regence	(3)	0
Cyrus II	(2)	1	Pres Turbo	(2)	0
White Knight	(2)	½	Mk 5.01 Exp	(1½)	½
Philidor	(1½)	1	Conchess	(1)	0
Bogol	(1)	1	Gambeit '82	(1)	0
Spectrum	(½)	1	Micromurks	(½)	0

This round produced one of the key games of the competition. La Regence put up a dour struggle against Advance 2.4 and the game went to the 53 move adjudication. But Advance 2.4 was two clear connected passed pawns up in a rook ending and Stuart Reuben had no hesitation in awarding it a win. No one knew it at this stage, but Cyrus II won its last game here, beating President Turbo on adjudication. Reuben had his work cut out in this round, for White Knight and the Mk 5.01 also had to be adjudicated. This last was a very complex position, which either computer could have mishandled with ease. A draw seemed the fairest conclusion.

Round five draw and results:

Advance 2.4	(3½)	1	Cyrus II	(3)	0
La Regence	(3)	1	White Knight	(2½)	0
Pres Turbo	(2)	1	Philidor	(2½)	0
Mk 5.01 Exp	(2)	0	Bogol	(2)	1
Gambeit '82	(1)	1	Spectrum	(1½)	0
Micromurks	(½)	½	Conchess	(½)	½

This round saw White Knight and Philidor falter and lose their way, though Mark Bryant with a final score of 3½ was still to finish strongly enough

to take the second amateur placing and a cheque for £50, while Philidor, on 4½, would take third place overall in the tournament.

Round six draw and results:

Pres Turbo	(3)	0	Advance 2.4	(4½)	1
Bogol	(3)	0	La Regence	(4)	1
Cyrus II	(3)	0	Mk 5.01 Exp	(2)	1
Conchess	(1½)	1	White Knight	(2½)	0
Philidor	(2½)	1	Spectrum	(1½)	0
Micromurks	(1)	1	Gambeit '82	(2)	0

The game against Bogol was a stiff test for David Levy's La Regence and it was not without its commercial appeal as well as its chess interest, for both these sensory board machines are due to be marketed before the end of this year.

After this loss, Martin Suhl was undecided whether he was pleased or displeased with his machine's performance. No obvious flaws had been detected and its three wins were very reasonable chess games. In retrospect, the two losses Bogol suffered turned out to be to the machines who came first and second overall, and after picking up another point in the final round, the German team went home smiling.

Philidor had an easy game against Spectrum, but Richard Turner of Artic Computing thought that the ZX program had held its own well against computers that were very much more powerful. It was only the cassette tape module program in the competition and this is one area where one can expect a greater number of entries next year. Advance 2.4 by this stage looked unstoppable, and it duly crushed President Turbo with a fine mating attack.

Round seven draw and results:

Mk 5.01 Exp	(3)	½	Advance 2.4	(5½)	½
La Regence	(5)	0	Philidor	(3½)	1
Bogol	(3)	1	Pres Turbo	(3)	0
Cyrus II	(3)	0	Micromurks	(2)	1
White Knight	(2½)	1	Spectrum	(1½)	0
Gambeit '82	(2)	1	Conchess	(2½)	0

This final round was full of surprises. The Mk 5.01 played a marvellous game against Advance 2.4, won material in the opening and looked set to force mate by move 26. But Advance 2.4 held on and although two rooks down managed to find a position where it could force perpetual check with its queen — the human equivalent of a 'swindle'.

On board two, meanwhile, the Intelligent Software entries finally came up against each other, and much to everyone's surprise, Philidor, which hadn't done much of note till then, chose that moment to play a complex, crafty game against the fancied La Regence and stopped its stable mate from winning 6 out of 7 games. So although the final round had started with the faint possibility of a tie for first place between La Regence and Advance 2.4 (if the former won while the latter lost), the gods decided otherwise and gave us a clean, clear winner.

Mike Johnson and Dave Wilson took away just about every prize on offer. They won the trophy for overall winner of the Third Microcomputer Chess Tournament, the trophy for the best amateur entry and a cheque for £150. La Regence was named as the best commercial entry in the tournament and Martin Bryant, as we said, collected a cheque for £50 for the second highest placed amateur entrant.

OUTGROWN YOUR APPLE ?

HAL Computers Extend The Apple's Capabilities

If your business or scientific application has outgrown your Apple's capability or if you have put off buying an Apple because you thought it couldn't meet your needs — think again.

HAL hard disc systems offer up to 20Mbytes of Winchester storage from as little as £1,750.

Capricorn



A complete subsystem in an attractive space saving cabinet, which holds either one or two drives a combination of standard disk drive and/or Winchester to give a capacity from 5Mbytes up to 20Mbytes formatted.

Capricorn works in conjunction with Apple's standard floppy disc drive for archiving purposes and offers really high capacity computing at an entry level price for cost conscious users.

For:
SUPERBRAIN,
S-100, APPLE II,
HEATH H89,
TRS-80.

Aquarius



As capacity increases with the professional user, so does the importance of a full back up facility. AQUARIUS is HAL's new answer to this problem. It combines a choice of Winchester capacities with a quarterback streaming tape drive which allows a full back-up file copy to cartridge tape in about six minutes with absolutely no user intervention.

The aluminium cabinet is styled to look good alongside Apple in the most professional user applications.

Prices start at £3299, for a ready to run system — the complete business solution to backup problems.

All HAL sub-systems come with a full twelve months parts and labour warranty.

All units are designed and manufactured by HAL in Britain and are complete with all instructions, technical literature and systems discs. The file handling software is written by our own in-house software team — if you need help it is always on hand via your local dealer or direct from the design team that conceived the system.

We use only the disc drives which we distribute exclusively into the U.K. computer industry in massive quantities over 20,000 units per annum sold. Our service department houses a formidable armoury of drive testing computers for pre-test, maintenance and burn in.

For more information and a demonstration contact either your nearest dealer or call us direct on our hot line 0252 517171.

HAL Computers Limited
Invincible Road, Farnborough
Hants. GU14 7QU
Telephone (0252) 517171



PCW SUBSET

Starting this month, David Barrow, a regular contributor to the series, joins Alan Tootill in presenting more useful assembler-language subroutines. This is your chance to help build a library of general purpose routines, documented to the standards we have developed together in this series. You can contribute a Datasheet, improve or develop one already printed, or translate the implementation of a good idea from one processor to another. PCW will pay for those contributions that achieve Datasheet status. Contributions (for any of the popular processors) should be sent to Sub Set, PCW, 62 Oxford Street, London W1A 2HG.

6502 arithmetic

Vincent Fojut's last improvement to the 6502 arithmetic routines deals with SBAD46, the 32-bit binary-to-ASCII decimal conversion. There is only a small change in method from the original, printed in February 1982. To save a transfer of the Y to the X register just before label SBD5, the X register holds the number of digits and the Y register holds the bit count, instead of the other way round.

Remember that in 6502 code Sub Set routines have 16 bytes of zero-page RAM reserved for them, designated M0-MF in the mnemonics and ZZ in the machine code. For this suite of routines, the first accumulator is in M0-M3, the second in M4-M7, and the third in M8-MB. MC-MD points to ASCII strings, ME holds the sign of the product of the second and third accumulators, and MF is available as a temporary store.

```
SBD5:  PLA      ;pop digit off stack      68
      CLC      ;convert it            18
      ADC £$30 ;to ASCII              69 30
      STA (MC),Y ;and put into RAM    91 ZZ
      INY      ;increment RAM point   C8
      DEX      ;get next              CA
      BNE SBD5 ;digit, else          D0 F6
      LDA £13  ;load ASCII carriage return  A9 0D
      STA (MC),Y ;into RAM           91 ZZ
      RTS      ;return                60
```

It was Dennis May of London SE1 who did the original groundwork on these 6502 arithmetic routines. With Vincent's improvements and the accumulators rearranged to make the routines fit together better as a package, as suggested by another reader, we have some useful routines that, given enough zero-page RAM, can easily be adapted to cater for numbers of any size. I intend to use them to handle 72-bit binary numbers.

From one base to another

Dennis May has also sent

routines to convert ASCII encoded numbers in one base to ASCII encoded numbers in any other base from 2 to 36. In bases higher than 10, digits with values 10 to 35 are represented by the letters A to Z. There are three routines. The first, given here in Datasheet XBIN, converts ASCII to unsigned 32-bit binary. The second converts 32-bit binary to ASCII, and the third, using the first two, converts ASCII from one base to another. You might like to have a go yourself at the last two, before Dennis's versions are printed — probably in February. (Read on to see what happens in January.)

Datasheet

```
;=SBAD46 - 32-bit binary to ASCII-decimal conversion
;/CLASS: 2
;/TIME CRITICAL? no
;/DESCRIPTION: Converts a signed 32-bit binary number
to an ASCII-decimal string
;/ACTION Make value absolute.
; if negative put "-" to RAM
; divide number by ten
; put remainder onto stack
; increment number of digits
; repeat until number=0
; pop digit off stack
; convert to ASCII and load into RAM
; decrement number of entries
; repeat until number of entries=0
; put ASCII CR into RAM for terminator
;/SUBR DEPENDENCE: SNEG46
;/INTERFACES: none
;/INPUT: M)-M3 contains the signed 32-bit number for
conversion with the least sig byte atM0 and
the most sig byte at M3
; MC-MD contain the RAM start address of the
result
;/OUTPUT: MC-MD are unchanged. The ASCII string result
is in RAM starting at the address given in
MC-MD
;/REGS USED: M0-M3,MC-MD,MF,A,X,Y,P
;/STACK USE: 10 maximum
;/LENGTH: 71
;/T-STATES: 1096 minimum;11202 maximum
;/PROCESSOR:6502
```

```
SBAD46:LDY £0 ;RAM point A0 00
      BIT M3 ;test sign 24 ZZ
      BPL SBD1 ;skip if positive 10 08
      LDA £$2D ;else put "-" A9 2D
      STA (MC),Y ;to RAM 91 ZZ
      INY ;point of next RAM C8
      JSR SNEG46 ;and negate number 20 XX XX
      STY MF ;save RAM point 84 ZZ
      LDX £0 ;number of digits=0 A2 00
      LDY £32 ;bit count=32 A0 20
      SBD2: LDA £0 ;zeroise accumulator A9 00
      ASL M0 ;shift 06 ZZ
      ROL M1 ;number 26 ZZ
      ROL M2 ;left 26 ZZ
      ROL M3 ;into 26 ZZ
      ROL A ;accumulator 2A
      CMP £10 ;is ACC less than 10? C9 0A
      BCC SBD4 ;skip if so, else 9D 0A
      SBC £10 ;subtract 10 E9 0A
      INC M0 ;and set result bit E6 ZZ
      DEY ;repeat 88
      BNE SBD3 ;32 times D0 EC
      PHA ;save digit 48
      INX ;increment no of digits E8
      LDA M3 ;check A5 ZZ
      ORA M2 ;if number 05 ZZ
      ORA M1 ;is zero 05 ZZ
      ORA M0 ;and 05 ZZ
      BNE SBD2 ;repeat if not D0 DC
      LDY MF ;restore RAM point A4 ZZ
```

Datasheet

```
;=XBIN - convert unsigned base 2-36 number to 32-bit binary
;/CLASS: 2
;/TIME CRITICAL?: no
;/DESCRIPTION: Converts an ASCII base 2-36 number to a
32-bit unsigned binary number
;/ACTION: Clear 32-bit accumulator M0-M3
; fetch next digit; if CR then return with C
; clear.
; Multiply 32-bit accumulator by base no and add
; digit; if overflow, then return with C set
; do next digit
;/SUBR DEPENDENCE: none
;/INTERFACES: none
;/INPUT: an ASCII coded number in RAM terminated by 0DH
(carriage return) with digits of values 10-35
represented by the letters A-Z
; the address of the ASCII coded number in M0(low)
and M5(high),
; the base of the number (between 2 and 36) in M6
;/OUTPUT: for a valid number, CY clear. The 32-bit result
in M0-M3 with the most significant byte in M3
; M4-M6 unchanged
; for overflow: Cy set. M4-M6 unchanged. M0-M3
indeterminate.
;/REGS USED: A,X,Y,P and M0-MC
;/STACK USE: 2
;/LENGTH: 106
;/PROCESSOR: 6502
XBIN: LDX £4 ;byte count A2 04
      LDY £0 ;index counter A0 00
      XBIN1: STY M0-1,X ;clear 94 ZZ
      DEX ;accumulator a CA
      BNE XBIN1 ; D0 FB
      STX MC ;save index counter 86 ZZ
      LDY MC ;load index counter to Y A4 ZZ
      LDA M4,Y ;fetch character B1 ZZ
      CMP £$0D ;if CR C9 0D
      BEQ END ;then end F0 52
      SEC ;convert 38
      SBC £$30 ; E9 30
      CMP £$0A ;to C9 0A
      BCC ASCY ; 90 02
      SBC £7 ;binary E9 07
      ASCY: PHA ;save digit 48
```

PCW SUBSET

```

LDX £4 ;byte count A2 04
LDA £0 ;clear A9 00
XBIN3: STA M6,X ;accumulator 95 ZZ
DEX ; CA
BNE XBIN3 ; DO FB
LDA M6 ;make copy of base A5 ZZ
STA MB ;in MB 85 ZZ
LDY £8 ;bit count A0 08
XBIN4: ASL MB ;get bit into carry 06 ZZ
PHP ;save it on stack 08
ASL M7 ;shift left accumulator b 06 ZZ
ROL M8 ; 26 ZZ
ROL M9 ; 26 ZZ
ROL MA ; 26 ZZ
BCS OVFW1 ;jump if overflow 80 1E
PLP ;pop bit off stack 28
BCC XBIN6 ;skip if bit=0 90 0E
LDX £$FC ;byte pointer A2 FC
CLC ; 18
XBIN5: LDA M4,X ;add acc A to acc B B5 ZZ
ADC MB,X ; 75 ZZ
STA MB,X ;store result in acc B 95 ZZ
INX ; E8
BNE XBIN5 ; DO F7
BCS OVFW2 ;jump if overflow 80 09
INC MC ;increment pointer index E6 ZZ
JMP XBIN2 ;repeat for next digit 4C YY YY
END: CLC ;clear carry for OK 18
RTS ;return 60
OVFW1: PLA ;remove data 68
OVFW2: PLA ;from stack 68
OVFW3: RTS ;and return 60

```

Before any 6502 coders leave us, they might like to look at the Z80 routines that follow, because these are to be given next month in 6502 code. That's what happens in January — or part of it, anyway.

Send three and fourpence

So runs the amusingly illustrative (and, sadly, out of date) example of what can happen to information passed down the line. It is a problem of no mean consequence in computing, where the integrity of stored or transmitted data is of paramount importance and, naturally, there is a multitude of methods designed to deal with it. Some only indicate that an error has occurred while others can identify the error and thus allow for its correction.

John Kerr of Carmyle, Glasgow brings this important subject to the notice of Sub Set for the first time with the routines ECAL8 and EFIX8, which he says are based on the simplest method of data protection. John also sent ECAL6 and EFIX6, which cannot be included this month for

reasons of space, plus an improvement to June's RNDM which saves three bytes and 11 T-states.

ECAL8 produces an error correction byte (ECB) for each data block up to 31 bytes in length. The method could accommodate 32 bytes but, as the ECB is to be appended before transmission or storage, John sensibly sets a limit of 31 data bytes so that the total number of bits of data and ECB is not greater than 256.

The ECB is a parity coding formed by using a parity mask unique to each bit in the data block. The mask is simply the binary number of the position of the bit from bit 0 of the byte following the data. Thus the parity shown in each bit of the ECB is of those data bits which have the corresponding bit set in their position number. For example, bit 5 of the ninth byte from the end would have the position number and parity mask 01001101 where the highest five bits of the mask give the byte number from the end of the block and the lowest three bits give the position of the data bit in that byte. Its parity would be included in bits 0, 2, 3 and 6 of the ECB.

Datasheet

```

;=ECAL8 - calculate error correction byte
;CLASS: 1
;TIME CRITICAL?: no
;DESCRIPTION: calculates a one-bit error-correction byte
; (ecb) to be appended to a data block of 1
; to 31 bytes and subsequently used by the
; error detect/correct routine EFIX8
;ACTION: Abort if no. of bytes=0 or GTAN 31
; initialise mask to 8*(no of bytes)+7
; clear ecb
; for each byte in data block
; for each bit in current byte
; if bit is 1 then ecb←ecb XOR mask
; decrement mask
;SUBr DEPENDENCE: none
;INTERFACES:none
;INPUT: A=no of bytes HL points to 1st byte
;OUTPUT: Cy reset: abort

```

```

; Cy set: A=ecb HL points to block+1
; (ecb can be appended by LD HL,A after the CALL)
;REGS USED: AF,HL
;STACK USE: 4
;LENGTH: 36
;TIME STATES: 103+332 per byte average
;PROCESSOR: Z80
ECALB: AND A ;terminate if A7
RET Z ;no of bytes+0 C8
CP +32 ;or over 31 FE 20
RET NC ; DO
PUSH BC ;save working registers C5
PUSH DE ; D5
RLA ;multiply A by eight 17
RLA ; 17
LD D,+7 ;add 7 for initial mask 16 07
OR D ;using D later as a B2
INC D ;constant for speed 14
LD E,A ;save initial mask 5F
XOR A ;clear ecb AF
NBYTE: LD B,D ;B=8 for bit counter 42
LD C,(HL) ;get byte in C 4E
NXBIT: SLA C ;shift bit into Cy CB 21
JR NC,SKIPX ;and if it is not '1' 30 01
XOR E ;ecb=ecb XOR mask AB
SKIPX: DEC E ;next mask 1D
DJNZ NXBIT ;repeat for all bits in byte 10 FB
INC HL ;point to next byte 23
LD B,A ;temp store ecb while 47
LD A,E ;checking for end of block 7B
CP D ;when mask=7 BA
LD A,B ;get ecb back in A 78
JR NC,NBYTE ;repeat for all bytes in block 30 EF
POP DE ;restore D1
POP BC ;registers C1
RET ; C9

```

The error detection routine EFIX8 uses ECAL8 to mask, or bit position number, included in the parity of one calculate a new ECB for the received or retrieved data and exclusive-ORs this with the appended ECB to produce, a 'correction code' which is the

ECB (because the bit was set to '1') but not in the other (because the bit was reset to '0'). If none of the bits are inverted then the correction code will be zero. If error is indicated EFIX8 uses the code to isolate and re-invert the corrupt bit.

Datasheet

```

;=EFIX8 - detect and correct a one-bit error in data block
;CLASS: 1
;TIME CRITICAL?: no
;DESCRIPTION: examines a 1 to 31 byte data block with
; appended ecb and corrects a single bit error
;ACTION: abort if no of bytes=0 or >31
; calculate ecb of data block
; XOR with stored ecb to show any difference
; if no error then terminate
; else use highest five bits to point at corrupt byte
; terminating if error in stored ecb indicates
; a byte outside data block, use three lowest three
; bits to produce bit inversion mask and invert
; corrupt bit.
;SUBr DEPENDENCE: none
;INTERFACES: none
;INPUT: A=no of bytes excluding stored ecb
; HL points to first byte
;OUTPUT: C=no of bytes in block
; Cy reset: abort
; Cy set: N set: no correction made HL points to
; block + 1
; N reset: correction made A= corrected
; byte HL points to corrected byte
;REGS USED: AF,HL,C
;STACK USE: 4(including CALL ECALB)
;LENGTH: 40
TIME STATES: average 360+332 per byte
;PROCESSOR: Z80
EFIXB: LD C,A ;save no of bytes in block in C 4F
CALL ECALB ;get new ecb of data block CD XX XX
RET NC ;terminate if ECALB aborted DO
XOR (HL) ;compare new and stored ecb AE
CP +8 ;terminating if FE 08
RET C ;no error is indicated D8
PUSH BC ;save B C5
LD B,A ;save correction code 47
RRA ;divide it by eight to get 1F
RRA ;position of 1F
RRA ;corrupt byte 1F
AND 1FH ;from end of block E6 1F
INC C ;test if position greater than 0C
CP C ;no of bytes in block and B9
JR NC,ESCAP ;terminate if error in ecb only 30 11
LD C,A ;move byte position to C 4F
LD A,B ;get three lowest bits of code 78
AND 07H ;to give bit pos in byte into A E6 07
LD B,+0 ;move HL to point 06 00
SBC HL,BC ;at corrupt byte ED 42
LD B,A ;using B as count 47
INC B ;move a '1' into A 04
XOR A ;in the AF
CCF ;same position 3F
SHIFT: RLA ;as the 17
DJNZ SHIFT ;inverted bit 10 FD
XOR (HL) ;re-invert it and AE
LD (HL),A ;restore it to data 77
ESCAP: CCF ;set non-abort flag 3F
POP BC ;restore B C1
RET ; C9

```

John warns that this method can only cope with at most one bit error in the data block and requires that the ECB be received intact. More than one error will not be detected as such and may result in EFIX8 actually inverting a correct bit. Given this limitation, however, the method is fast and is capable of correcting about 95 percent of errors in a system where the probability of bit error is less than 0.4 percent. It also has a very low redundancy figure of 3.125 percent for a 31-byte block.

Flag of convenience

I would like to draw your attention to the use of the N flag in EFIX8 to indicate whether a correction has been made or not. The N result is a consequence of the operation immediately prior to exit, and John obviously noticed this fact and used it for speed and shortness in the routine. But it is difficult to test, unlike Cy and Z, which both have a relative jump conditional on their status. Should a Class 1 routine use any flag for passing information or be limited to the easily tested Cy and Z flags?

Flags are also the subject of a letter from K P Leary of Chislehurst, who would like to see the convention Z = OK, NZ = Error used in Sub Set routines, as is used on the TRS-80. Apparently it makes for easier programming than the other way round. He also offers coding to complement the Z flag:

```
PUSH BC
PUSH AF
POP BC
BIT 6,C
POP BC
and the Sign and Parity flags:
PUSH BC
PUSH AF
POP BC
LD A,80H (LD A,+2
for Parity)
PUSH BC
POP AF
POP BC
```

8048 keyboard

Since we are touching on interfacing, here is a listing of some 8048 assembler code from Jim Chance of Birmingham. It uses port 1 (P1) to read and debounce a 4 x 4 matrix keyboard. Jim says the 8048 processor is much used commercially and can be found in many products; in, for example, the Tandy Quickprinter 1

```
;P1 0-3 = X drivers
;P1 4-7 = Y receivers routine waits for
;character decode table in ROM
;
KEYBRD:MOV R7,#0 ;Read 256 times
MOV A,#11110000B
OUTL P1,A ;Arouse all rows
KEY1: IN A,P1
CPL A ;-ve Logic
ANL A,#11110000B
JNZ KEYBRD ;Start again
DJNZ R7,KEY1
KEY2: IN A,P1
CPL A
ANL A,#11110000B
JZ KEY2 ;Await keypress
MOV A,#0
KEY3: DEC A ;Delay
JNZ KEY3 ;Now read
MOV R7,#16 ; 16 keys
KEY4: MOV A,R7
INC R7
MOV P,A,0A
OUTL P1,A ;Drive row
MOV A,R7
INC R7
MOV P,A,0A
MOV R5,A ;Column test
IN A,P1
CPL A ;-ve Logic
ANL A,#11110000B
XRL A,R5
JNZ KEY5 ;Not found
DEC R6 ;0-15 range
MOV A,R6 ;Answer in R6 and A
RET
KEY5: DJNZ R6,KEY4 ;Illegal
JMP KEYBRD ;List of 16 pairs
;03p drive code, i/p test
; 1st =>0 etc
KEYCODES EQU KEYTABLE-S/256+256
X1 EQU 11110000B
X2 EQU 11111010B
X3 EQU 11111011B
X4 EQU 11110111B ;0/p rows -ve Logic
Y1 EQU 00010000B
Y2 EQU 00100000B
Y3 EQU 01000000B
Y4 EQU 10000000B ;I/p columns +ve Logic
DB X1,Y1,X1,Y2,X1,Y3,X1,Y4
DB X2,Y1,X2,Y2,X2,Y3,X2,Y4
DB X3,Y1,X3,Y2,X3,Y3,X3,Y4
DB X4,Y1,X4,Y2,X4,Y3,X4,Y4
```



BRAIN DUMP



Peter Rodwell reports on some of the lessons the British micro industry could learn from the Japanese

Mention the Japanese to most people in the micro world in this country and you get some interesting reactions: 'Well, they're very good at cameras and hi-fi but they'll never succeed with computers — they can't produce software, you know.' Or, 'If they were going to get serious about micros they'd have swamped us long ago — guess they're just a bit out of their depth.'

Next month I shall be reporting on my visit to the Tokyo Data Show in October and describing some of the vast wave of Japanese products which will be hitting our shores next year. This month, I'd just like to say a few words about the implications to the UK micro industry of the forthcoming invasion — and make no mistake about it, the Japanese are coming, and they're coming with all the professionalism and dedication which they have already applied to the motorcycle, hi-fi, camera and car markets in this country.

The most striking thing about the new Japanese products is their quality. Quite frankly, they make most British products look crude and utterly amateur by comparison. They are all superbly made examples of skilful production engineering, designed to be mass-produced efficiently and to work reliably. Forget the old chestnut about Japanese products being cheap because they're produced by slave labour — they're not; on average, Japanese factory workers seem to enjoy a standard

of living which is at least as high as their British counterparts and frequently higher.

The implications for British (and many American) hardware manufacturers are serious: boys, you'd better pull your socks up fast if you want to stay in this business. The time for good old British complacency is long past; just look at what happened to our hi-fi and motorcycle industries — the same will happen to you if you don't watch out! Even if you can match them on quality, the Japanese are set to fight with prices too — how many British manufacturers are efficient enough to produce a twin-disk, 8086-based, 128k machine with high-resolution graphics, good quality keyboard and a useful amount of applications software for just over £1000 end user price? Or a four-colour A4 plotter at under £90 (yes, ninety pounds) retail? Of course these are the Japanese domestic prices, but even after import duties and freight costs have been added and the price boosted a bit because the British market is traditionally over-priced, there's still a lot of leeway left with which to undercut the market. And don't think that these low domestic prices are gained at the expense of pre- and after-sales backup, either. Even the smallest Japanese computer shop makes the average British equivalent look shamefully pathetic.

Is there any hope at all for the

British micro industry, then, or should we all give up now and start selling (Japanese) video recorders instead? Fortunately, Britain has a hell of a lot to offer the Japanese, mostly in terms of software. Actually, the Japanese are quite good at writing software, but because they plan to hit a wide range of foreign markets virtually simultaneously, the Japanese realise they cannot possibly produce packages tailored to the diverse requirements of each market. They plan instead to commission local software houses to produce suitable packages for each of the various market areas and many of the people I spoke to in Tokyo were well aware of Britain's software expertise. Where we Brits fell down, they told me, was in our reluctance to simply get on a plane and sell our skills abroad — British companies were very noticeably absent from the Data Show.

The coming Japanese invasion will thus be good for our software industry if British software houses act quickly enough — but it has serious implications for our hardware manufacturers unless they can match the Japanese on quality and pricing, and do so very quickly. Regrettably, there will be those who will instead concentrate their efforts on bleating pleas for trade barriers — the barriers won't appear and those who waste time arguing for them instead of getting their acts together are unlikely to last long in this business.

SUBSCRIBE TO PCW

"JUST SKIMMED THE LAST THREE ISSUES AND FOUND THEM FASCINATING..."

Arthur C Clarke



It's amazing what goes on in the basement of *Personal Computer World*. Our erstwhile subscriptions manager, for example, engaging in correspondence with Arthur C Clarke! (For the uninitiated few, ACC is arguably one of the world's most visionary living individuals: a scientist, author of 2001: A SPACE ODYSSEY and 60 or so other works, originator of communications satellites, undersea explorer, etc, etc).

Mr Clarke tells us that he has an Apple II 'languishing in the lab. . . too busy to touch it for weeks'. Busy, apparently, completing SPACE ODYSSEY two ('my latest, last book!') on his Archie word processor (Archives III, 5 megabyte Winchester disk, Wordstar program) with which he is obviously deeply satisfied — 'I could no more imagine going back to a typewriter than to a slide rule. . . '.

We make no bones about our delight that Mr Clarke takes the trouble to write to us from his home in Sri Lanka and comment on *Personal Computer World* so favourably. As a subscriber to PCW, not only will you save a small fortune (see the rates below) but you can count yourself in august company. Remember that Clive Sinclair described PCW a short while ago as 'clearly one of the leading computer journals in the world'.

Well, that's always been our aim. And if it's true that a person is known by the company he keeps, you could do a great deal worse than fill in the coupon on the right hand side of this page. You won't even need to put a stamp on your envelope. . . unless you live in Sri Lanka, that is!

For a limited period only, here are the special offer rates for a subscription to Britain's largest selling microcomputer publication.

1 Year Subscription (U.K. only)	£11.50	(We will send you two free issues at the end of your subscription before reminding you to renew. You get 14 issues for the price of 12 issues if you subscribe now!)
2 Year Subscription (U.K. only)	£19.50	(You receive 24 issues, saving yourself £3.50 off the full current subscription price. Plus you protect yourself against future increases in cover prices and postal rates which will probably amount to a saving of £5.00 over the period.)
3 Year Subscription (U.K. only)	£29.50	(You receive 36 issues, saving yourself £5.00 off the full current subscription price. Plus you protect yourself against future increases in cover prices and postal rates which will probably amount to a saving of £7.00 over the period.)

PLUS

We have now arranged for special 'first-off-the-press' copies to be mailed direct to subscribers which will ensure that they arrive either on the same day or one or two days in advance of national distribution in the U.K.

PLUS

Existing subscribers can take advantage of any of the offers above. Just tick the 'this is an extension subscription' box on the coupon and enclose your payment. The additional copies will be added to your existing subscription automatically. You do not have to wait until it is time to renew (by which time this offer will probably have been withdrawn). Save money by extending your subscription today!

PLUS

We have completely reorganised our Subscriptions Department and any problems, change of address, special requests etc. etc. will be promptly dealt with by an extremely 'user-friendly' human being should you need to write to us.

PLUS

We send subscription copies of PCW in a tough polythene wrapper. It will reach you promptly every month, unfolded and in good condition.

PLUS

You can pay for your subscription to PCW by cheque, postal order or by using Barclaycard (Visa)/American Express or Access. And you don't even need a stamp for your envelope. Use the coupon on the right.

Why do more people read PCW than any other microcomputing magazine in Europe? Subscribe today!!

COMPUTER ANSWERS

Send your queries to: Sheridan Williams, 35 St Julian's Road, St Albans, Herts.
Please note that Sheridan can no longer answer questions on an individual basis, so please don't send an SAE with your query.



What's in a name?

I am considering selling software for my ZX81 but have a query about copyright. If I see a program working on a computer other than the ZX81, and I decide to write a program based on this idea, but using my own programming ideas, is it a breach of copyright if I sell the program?
G Smith, Aberystwyth, Dyfed.

This question is the subject of heated discussion at the moment with the recent threat by Atari to prosecute certain companies who are selling their own representations of Pacman. The question is, can you copyright an idea? If you rewrite a program for the ZX81 then it is very unlikely that it will bear any visual or programming similarity whatsoever, so theoretically you are home and dry. The only point to be careful of is the name, which may be copyrighted. Most companies are very reluctant to allow other companies to benefit from a good name that they have built up.
James Walsh

Forthcoming compiler

I own a 48k RAM ZX81 and have been reading with interest the articles on Forth which have been appearing in various periodicals recently.

I would be very grateful if you could advise me of an address from which I could obtain a Z80 assembly listing of a Forth compiler. I could of course write the I/O routines myself.

Christopher Marriott, Llandudno, Gwynedd

Forth seems to be a particularly popular language among ZX owners, so Artic Computing decided to write and market a Forth compiler. It is available on EPROM (which needs an extension board to plug into) or cassette, which can be LOADED in the normal way.

More details are available from this address: Artic Computing, 396 James Reckitt Avenue, Hull, HU80

OJA.

For the uninitiated, Forth is another programming language much faster than Basic, closer to the machine, and in some ways easier to learn.

It has such statements as DO-LOOP, BEGIN-WHILE-REPEAT and you can compile your own words. The first computer to use this language as standard is the Jupiter ace.

James Walsh

Cramming it in

One of the major uses I have for an Osborne 1 is the production of business letters using Wordstar. Although these letters are usually short (typically four or five lines) I keep running out of disk space, due to the limited (92k formatted) capacity of the Osborne's drives. Is there anything I can do about this, short of altering the hardware, with double density, or external drives?
Name and address supplied

Yes, there's a lot you can do.

1. Make sure you have all 92k available for text files (incidentally, that 92k is quite generous for single density single sided disks — about 70k would be more typical) by leaving all the Wordstar and other programs (such as PIP and STAT) on the disk on drive A, and having a blank (but formatted) disk on drive B: on entering Wordstar use the L option to log onto drive B;

2. Once you are happy with the final version of a text file, delete the corresponding .BAK file created by Wordstar. If you are not doing this already, this simple action will double your usable space.

3. The minimum file size on a CP/M 2.2 system such as the Osborne 1 is 2k. Obviously this will limit you to 46 files per disk, even if, as in your case the files are actually much smaller. (There is a further limitation in that the disk directory can only accept 64 entries, but this would only be significant with double-density disks.)

4. This limitation can be overcome by merging lots of your older text files into one bigger file, using either PIP, or the 'Control KR' function in Wordstar. If you use the latter you can arrange for each letter to start on a separate page, so they can be individually printed. If the start of each page includes the letter's reference you can find them in the file using 'Control QF'.

5. Keele Codes Ltd's utility suite 'E40' (See 'Cramming it in' on page 141 of the September 1982 PCW) compacts textfiles to approximately 40% of their original size, and now include special options to make it compatible with Wordstar. It is available in Osborne 1 disk format, and my copy came without undue delay.

If your letters were of up to 1k size, and you were not already using any of these ideas, you could get 23 letters (and 23 .BAK copies) on a whole disk. Deleting the .BAK copies would increase this to 46. Merging the letters into bigger files would give a capacity of up to 92. Compressing with 'E40' would increase this to some 230 — a tenfold potential increase.

P L McIlmoyle

Adaptable Sinclair?

What are the odds that the Sinclair Microdrives in some way can be adapted to other computers?

Which is the better of the Z80 and 6502 CPUs in terms of speed and execution repertoire?

Approximately how many times faster is a machine code program than one written in interpreted Basic?

What are the drawbacks in using 'pageing' to allow an 8 bit CPU to address more than 64k of memory?
Bo Nordlin, Sweden

Without knowing information that is not yet available, any comments on your first point must be no more than informed speculation. Certainly I would expect some type of 'converter boxes' to appear sooner or later, but whether these will come from Sinclair will depend on many factors, including, I would expect, the size of the potential market for these interfaces. There is a move afoot to standardise such 'microdrives' to ensure compatibility from make to make, but Sinclair has a reputation for producing unique products.

The Z80A micro-processor runs at 4 MHz and is thus definitely faster than the 6502. However, much depends on the design and components of the rest of the computer, and even more on the way languages such as Basic are implemented, so while machines with Z80 CPUs are usually faster than those with 6502s this need not be so. The instruction sets of the Z80 and 6502

each have their own devoted followers, and in many regards it is a question of 'horses for courses'. There is a very strong tendency for the Z80 (and related 8080 and 8085) CPUs to be used for business applications and the 6502/6809 to be used for hobbyist/games applications.

The Intel 8080 instruction set can be used also by the Zilog Z80 and the Intel 8085, thus providing interchangeability between programs on these three machines, so long as the extra Z80 instructions are not used.

It is very difficult to give a useful idea of the relative speeds of machine code compared with Basic, as so much depends on the programs in question, as to the number of loops, the amount of I/O, etc. However, a rough idea can be gained from the fact that a fully compiled 'native code' Basic program may well run some 10 to 20 times faster than an interpreted version. In suitable cases (eg, not much I/O) a skillfully written machine code program could improve on this by up to a further order of magnitude.

There are not many drawbacks to 'pageing', which is a useful and powerful technique. However, special memory boards are likely to be required, and special software to use them. There is inevitably some loss of speed due to the extra switching involved. Another snag is that different computers can use different systems of pageing so that the portability of programs written to run under CP/M may well be lost if they use this technique.

You should note that in microcomputers 'pageing' refers to switching from one 'bank' of RAM memory to another, while with mainframes the same word is often used to refer to a technique of dumping the whole contents of memory to disk, and loading a fresh set from disk. Microcomputer disk operations are not yet fast enough for this to be very useful.

P L McIlmoyle

Even KWICer

In September's 'Computer Answers' we were unable to help with 'KWIC query'. However I have just received a letter from P H Cathedral of Clwyd, N Wales helping somewhat (many thanks by the way). In case you can't find the original question, here it is:

I have seen a book index produced by a KeyWord

In Context (KWIC) program. Each main word was listed as part of the line of text in which it occurred and the whole index was ordered alphabetically.

Do you know of a KWIC program for a micro, or can you offer any hints for writing my own?
B Kat, Newcastle-upon-Tyne

You will find a program to suit your needs in *Software Tools in Pascal* by Kernighan and Planger, Addison-Wesley Publishing Co 1981. ISBN 0-201-10342-7, chapter 4, section 8, page 134 *et seq.*
 SW

NEC's question

I want to buy a micro to serve my university needs in maths and electrical engineering, and am thinking of the NEC PC 8001B. Initially I would buy the console and a 12W monitor. Could you comment on: whether or not the NEC is good enough for my needs; if the console will, with cassette storage, give me high resolution graphics without taking up too much of the 32k RAM; if I should go for NEC's own green monitor, a Hitachi black and white one, or Transtec or BMC green ones.

J Vella, Marsh, Rep of Malta

As always, when choosing between machines for a particular application it is helpful to set out a list of the essential features, and then the desirable ones. Comparison of the machine's specifications with this list will help in ensuring a correct decision.

From what you say in your letter I would expect that your list will include the ability to carry out arithmetic to a fairly high precision, and quite rapidly. Also you require a good graphics capability and the ability to handle text up to 80 characters per line.

The NEC 8001B incorporates a version of Basic which provides for double-precision floating point arithmetic, and the CPU is a Z80 equivalent running at 4 MHz, so both these needs should be met. As far as high resolution graphics is concerned, it all depends on what you mean by this. NEC claims a graphics resolution of 160 by 100 points. This should be just as achievable with cassette storage as with disks.

The question of monitors is partly a question of personal taste, and partly one of performance. Good reports are available of the resolution of up to 80 characters per line using both the NEC and the Hitachi monitors. So here the choice may be one of personal preference for green or black and white. For some

reason that is a mystery to me, my experience is that office staff tend to prefer green, while technical staff tend to prefer black and white. I am afraid I have no information on the other two monitors you mention.
P L McIlmoyle

Non-xray vision

In the October issue of *PCW* I asked if any reader knew the facts concerning the effects on vision of sitting very close to a colour TV/monitor for long periods. I was particularly concerned about X-rays.

I had many replies, and would like to thank the following for their comments: E H Kelly of Chester, A P Searle of Dulwich, Geoff Cox of Gillingham, A Camacho of St Albans and D J Gazely, the General Secretary of The Partially Sighted Society, for their interesting and helpful responses.

I print here with permission from The Partially Sighted Society an extract from their magazine *Oculus* (May/June '82 issue) which was vetted by one of their advisors, Dr Fergus Campbell MD, FRS of the Department of Physiology at Cambridge University.

'Television sets do not give out any sort of "ray" or other emission that can harm the eyes, even if the viewer's sight is defective and the screen is being viewed from close to. *Although some people may experience a heightened sensation of flicker when watching television from close quarters, which may be unpleasant, this can similarly do no actual harm to the eyes. (If the flicker is too unpleasant, it may be reduced by wearing an inexpensive pair of sunglasses.)

'In common with any other visual task, and providing the viewer does not have tunnel vision, moving closer to a television is the simplest of all ways to make the picture easier to see. Moving from ten feet away to a distance of two feet will magnify the picture five times.

'Close viewing like this cannot "strain" or otherwise damage the eyes in any way although the muscles within and around the eyeball, just like any other muscle in the body, may become more quickly tired in these circumstances. If this happens, closing the eyes and resting for a while should relieve any temporary discomfort. (Persistent headaches, or pain in the eye, should of course always receive prompt medical attention.)

*Reference: Terrana T, Merluzzi F and Guidici E 'Electromagnetic radiations

emitted by visual display units,' *Ergonomic Aspects of Visual Display Terminals* (eds: Grandjean E and Vigliani E; London: Taylor and Francis).

Of course, I have no way of checking this, so I publish the extract verbatim.

In return for their article they asked me to ask whether anyone is willing to donate a daisywheel printer compatible with their TRS-80 Level II to the society. If so please contact them on Draycott (03317) 3036.
 SW

Happily ever after?

Once upon a time there was a budding microcomputer enthusiast who bought a ZX81. He learnt how to program in Basic on this and was delighted. His main interest began to centre around games and other programs containing moving graphics and thus his ZX81 was no longer good enough. And so, he sold his ZX81 and looked for a better micro in the £300 - £400 range. 'Egad. . .', he cried as he saw the range to choose from.

As it happens, I have the same problem. I am tempted to buy the Sharp MZ-80K, but would really appreciate some advice on which micro to buy, plus some comments on the MZ-80K.
Mike Swift, Chester-le-Street, Co Durham.

The number of new 'colour/sound micros' in this and the slightly lower price bracket is increasing almost by the day. Probably the two main ones to look at are the Atari 400 at £319 and the BBC Model B Computer at £399. The Atari is available from Maplin and has probably the best range of games software for any micro in the world. For £319 you get 48k RAM, which is probably the most you will ever use. The BBC Model B has 32k RAM and 16 colour graphics. But you must remember that for really good hi-res graphics it

is necessary to use a purpose built monitor rather than a normal colour telly. A colour monitor may set you back another £200 or so. The main problem with the BBC computers is the waiting list, but they have recently been available directly from the address below (among others): Microage Electronics, 135 Hale Lane, Edgware, Middlesex. HA8 9QP. Tel: 01-959 7119.

As far as the MZ-80K is concerned, it doesn't have hi-res graphics or colour and has been overtaken by many of the new computers.
James Walsh

Fuller fun...?

I am the owner of a ZX81 and I am wondering if the Fuller Designs FD system keyboard/case plus a motherboard (so that I can add an interface port as well as the 16k RAM pack), is a good buy, or would I be better off getting a larger computer with 16k+RAM for hobby use?

N Cooney, Hertford, Cheshire

The Fuller FD System is a well made and nice looking keyboard and case for your ZX81, though it is reasonably expensive at £39.95. The motherboard is only £15.95, which is pretty good as far as motherboards go. If you can afford to buy another, more expensive computer then go ahead, but for the sake of a nice keyboard and interface port it does seem like a rather unnecessary expense.

Probably the most suitable computer for expansion in this way within the lower price bracket is the BBC Micro, which is £300 for a model A; quite a jump from £49.95. If your main priority is for a computer which has a better Basic and moderately more expansion possibilities then it is worth taking a look at the multitude of new computers which are emerging for around £200.
James Walsh



Dysan

The Highest Quality Diskettes For Your System.



Dysan diskettes, acknowledged to be the industry leader in quality and data integrity available for all these and other systems from HAL Computers, Dysan's key U.K. distributor.

 **DISC PACKS AND CARTRIDGES ALSO AVAILABLE**

 **TECHNICAL SUPPORT FROM HAL'S ENGINEERING TEAM**

 **QUANTITY DISCOUNTS**

 **FOUR HOUR ORDER TURNROUND**

 **EX STOCK AVAILABILITY**

Please tell me more about the range of Dysan Media for my system.

Name _____

Address _____

Ring the Dysan hot line now on Farnborough 517171 or complete the coupon.

Computer System _____

Telephone No _____

HAL Computers Limited
Invincible Road, Farnborough
Hants. GU14 7QU
Telephone (0252) 517171

PCW/12/82

How to increase the

Anyone with even a limited knowledge of home computers will instantly recognise the very large advantages of owning a Lynx.

And anyone who truly understands the considerable differences between home computers is likely to have spotted The Lynx a mile off.

With 48K of memory to start with, The Lynx far outweighs the majority of home computers on the market.

And it is precisely that size of memory

which makes The Lynx a superior animal in its field.

What's more, 48K of memory is not the end of its capacity, but merely the beginning.

Your Lynx can grow. To 96K, to 128K, or to 192K. All inboard.

All of a sudden your Lynx home computer has assumed the size of memory usually associated with business machines.

Its increased capacity will mean you can have an impressive word processor.



size of your memory.

Disk drives and printers, mono or colour monitors can be added on.

With an RS232 port, your Lynx home computer is compatible with a wide range of other manufacturers' equipment.

And CP/M® compatibility opens the door to a comprehensive selection of business software.

Furthermore, your Lynx home computer has high resolution colour graphics.

In other words, you are free to draw in all 8 colours anywhere on the screen.

For the full story about The Lynx home computer, write to Computers Ltd., 33a Bridge Street, Cambridge CB2 1UW and we'll send you a brochure and the name of your nearest stockist.

®CP/M is the registered trade mark of Digital Research Inc.

CAMPUTERS
LYNX 

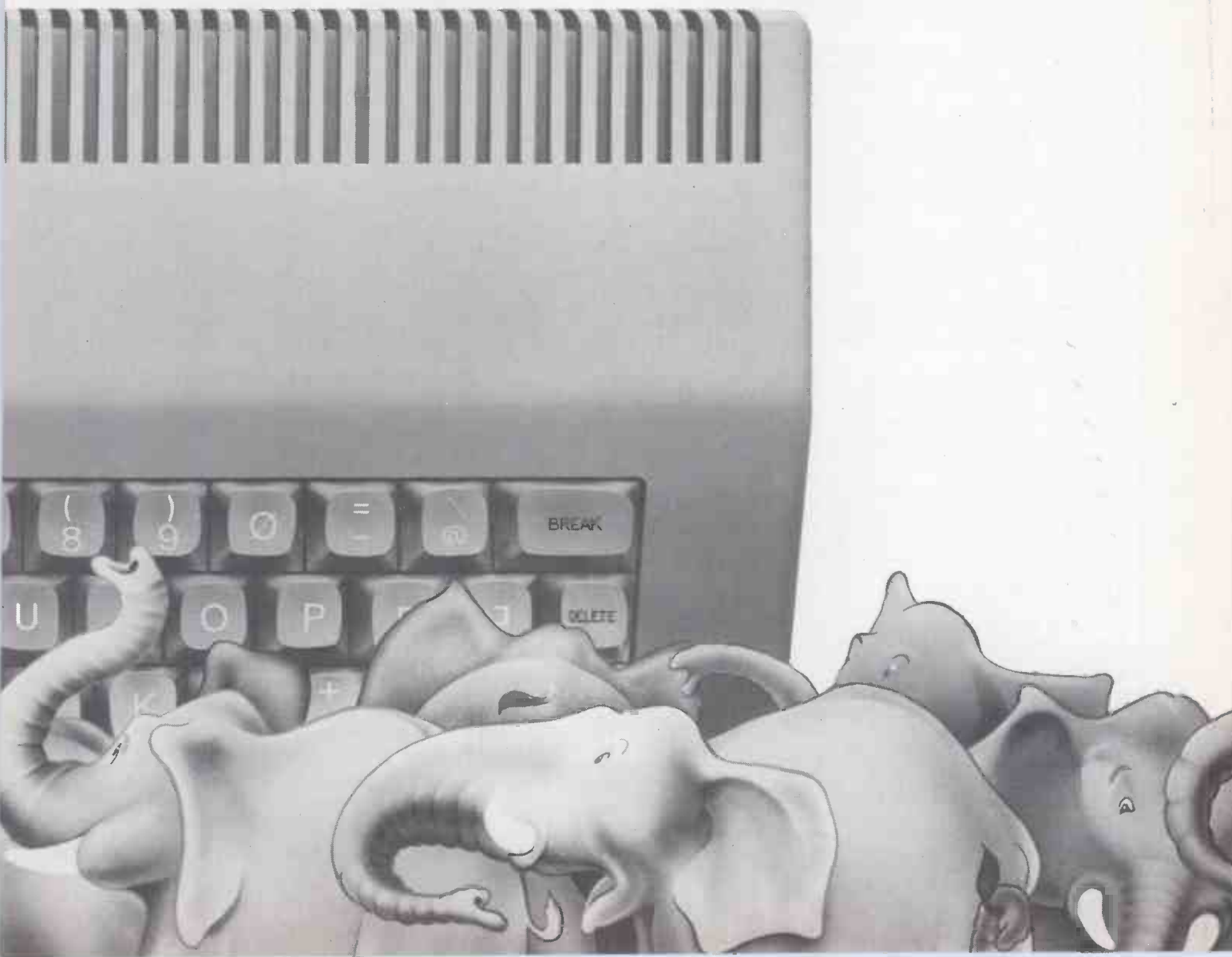

NEWCOMERS START HERE

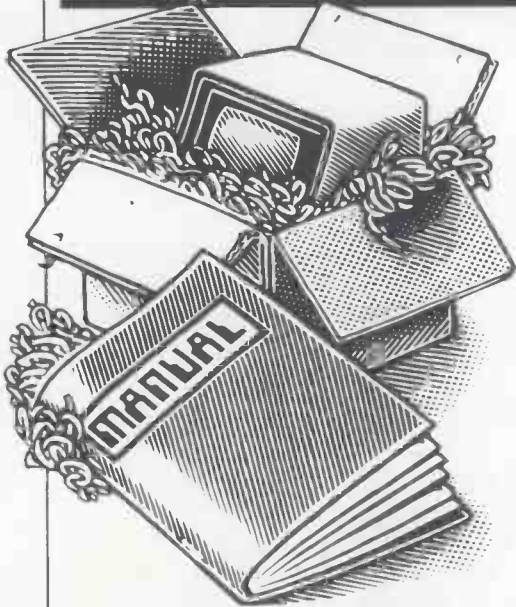

This is our unique quick-reference guide, reprinted every month to help our readers pick their way through the most important pieces of (necessary) jargon found in PCW. While it's in no way totally comprehensive, we trust you'll find it a useful introduction. Happy microcomputing!

Welcome to the confusing world of the microcomputer. First of all, don't be fooled; there's nothing complicated about this business, it's just that we're surrounded by an immense amount of necessary jargon. Imagine if we had to continually say 'numbering system with a radix of 16 in which the letters A to F represent the values ten to 15' when instead we can simply say 'hex'. No doubt soon many of the words and phrases we are about to explain will eventually fall into common English usage. Until that time, **PCW** will be publishing this guide — every month.

We'll start by considering a microcomputer's functions and then examine the physical components necessary to implement these functions.

The microcomputer is capable of receiving information, processing it, storing the results or sending them somewhere else. All this information is called **data** and it comprises numbers, letters and special symbols which can be read by humans. Although the data is accepted and output by the computer in 'human' form, inside it's a different story — it must be held in the form of an electronic code. This code is called **binary** — a system of numbering which uses only 0s and 1s. Thus in most micros each character, number or symbol is represented by eight binary digits or bits as they are called, ranging from 00000000 to 11111111.

To simplify communication between computers, several standard coding systems exist, the most common being **ASCII** (American Standard Code for Information Interchange). As an example of this standard, the number five is represented as 00110101 — complicated for humans, but easy for the computer! This collection of eight bits is called a **byte** and computer freaks who spend a lot of time messing around with bits and bytes use a half-way human representation called **hex**. The hex equivalent of a byte is obtained by giving each half a single character code (0—9, A—F): 0=0000, 1=0001, 2=0010, 3=0011, 4=0100, 5=0101 E=1110 and F=1111. Our example of 5 is therefore 35 in hex. This makes it easier for humans to handle complicated collections of 0s and 1s. The machine detects these 0s and 1s by recognising different voltage levels.

The computer processes data by reshuffling, performing arithmetic on, or by comparing it with other data. It's the latter function that gives a computer its apparent 'intelligence' — the ability to make decisions and to act upon them. It has to be given a set of rules in order to do this and, once again, these rules are stored in **memory** as bytes. The rules are called **programs** and while they can be input in binary

or hex (**machine code programming**), the usual method is to have a special program which translates English or near-English into machine code. This speeds programming considerably; the nearer the programming language is to English, the faster the programming time. On the other hand, program execution speed tends to be slower.

The most common microcomputer language is **Basic**. Program instructions are typed in at the keyboard, to be coded and stored in the computer's memory. To run such a program the computer uses an **interpreter** which picks up each English-type instruction, translates it into machine code and then feeds it into the **processor** for execution. It has to do this each time the same instruction has to be executed.

Two strange words you will hear in connection with Basic are **PEEK** and **POKE**. They give the programmer access to the memory of the machine. It's possible to read (**PEEK**) the contents of a byte in the computer and to modify a byte (**POKE**).

Moving on to **hardware**, this means the physical components of a computer system as opposed to **software** — the programs needed to make the system work.

At the heart of a microcomputer system is the central processing unit (**CPU**), a single microprocessor chip with supporting devices such as **buffers**, which 'amplify' the CPU's signals for use by other components in the system. The packaged chips are either soldered directly to a printed circuit board (**PCB**) or are mounted in sockets.

In some microcomputers, the entire system is mounted on a single, large, PCB; in others a **bus system** is used, comprising a long PCB holding a number of interconnected sockets. Plugged into these are several smaller PCBs, each with a specific function — for instance, one card would hold the CPU and its support chips. The most widely-used bus system is called the **S100**.

The CPU needs memory in which to keep programs and data. Microcomputers generally have two types of memory, **RAM** (Random Access Memory) and **ROM** (Read Only Memory). The CPU can read information stored in RAM — and also put information into RAM. Two types of RAM exist — **static** and **dynamic**; all you really need know is that dynamic RAM uses less power and is less expensive than static, but it requires additional, complex, circuitry to make it work. Both types of RAM lose their contents when power is switched off, whereas ROM retains its contents permanently. Not surprisingly, manufacturers often store interpreters and the like in ROM. The CPU can only read the ROM's contents and cannot alter them in any way. You can buy special ROMs called **PROMs** (Programmable ROMs) and **EPROMs** (Erasable PROMs) which can be programmed using a special device; EPROMs can be erased using ultraviolet light.

Because RAM loses its contents when power is switched off, **cassettes** and **floppy disks** are used to save programs and data for later use. Audio-type tape recorders are often used by converting data to a series of audio tones and recording them; later the computer can listen to these same tones and re-convert them into data. Various methods are used for this, so a cassette recorded by one make of computer

won't necessarily work on another make. It takes a long time to record and play back information and it's difficult to locate one specific item among a whole mass of information on a cassette; therefore, to overcome these problems, **floppy disks** are used on more sophisticated systems.

A floppy disk is made of thin plastic, coated with a magnetic recording surface rather like that used on tape. The disk, in its protective envelope, is placed in a disk drive which rotates it and moves a **read/write head** across the disk's surface. The disk is divided into concentric rings called **tracks**, each of which is in turn subdivided into **sectors**. Using a program called a **disk operating system**, the computer keeps track of exactly where information is on the disk and it can get to any item of data by moving the head to the appropriate track and then waiting for the right sector to come round. Two methods are used to tell the computer where on a track each sector starts: **soft sectoring** where special signals are recorded on the surface and **hard sectoring** where holes are punched through the disk around the central hole, one per sector.

Half-way between cassettes and disks is the **stringy floppy** — a miniature continuous loop tape cartridge, faster than a cassette but cheaper than a disk system. **Hard disk** systems are also available for micro-computers; they store more information than floppy disks, are more reliable and information can be transferred to and from them much more quickly.

You, the user, must be able to communicate with the computer and the generally accepted minimum for this is the visual display unit (**VDU**), which looks like a TV screen with a typewriter-style **keyboard**; sometimes these are built into the system, sometimes they're separate. If you want a written record (**hard copy**) of the computer's output, you'll need a **printer**.

The computer can send out and receive information in two forms — **parallel** and **serial**. Parallel input/output (**I/O**) requires a series of wires to connect the computer to another device, such as a printer, and it sends out data a byte at a time, with a separate wire carrying each bit. Serial I/O involves sending data one bit at a time along a single piece of wire, with extra bits added to tell the receiving device when a byte is about to start and when it has finished. The speed that data is transmitted is referred to as the **baud rate** and, very roughly, the baud rate divided by ten equals the number of bytes being sent per second.

To ensure that both receiver and transmitter link up without any electrical horrors, standards exist for serial interfaces; the most common is **RS232** (or **V24**) while, for parallel interfaces to printers, the **Centronics** standard is popular.

Finally, a **modem** connects a computer, via a serial interface, to the telephone system allowing two computers with modems to exchange information. A modem must be wired into the telephone system and you need British Telecom's permission; instead you could use an **acoustic coupler**, which has two obscene-looking rubber cups into which the handset fits, and which has no electrical connection with the phone system — British Telecom isn't so uppity about the use of these.

PACKAGES

PCW's 'Packages' section is produced bi-monthly, alternating with our 'In Store' hardware guide. We have confined coverage to business packages which are available and supported at national level and which have been in use for at least six months in a minimum of five sites. Producers of packages which fall within these constraints should send details or updates to: Dick Olney, PCW, 14 Rathbone Place, London W1P 1DE.

The layout has been designed to allow you to discover which packages are available for the application you have in mind and to show you which packages are available for your computer if you already have a machine. In either case the code enables you to look up the supplier's name and telephone number in the table below. All details published are the latest made available - some may have changed since this issue went to press.

Code	Company	Telephone
A1	ACT	021-454 8585
A2	Arden Data Processing	0533 22255
A3	ADP Network services	01 388 1912
A4	Alamo Comp. Serv.	0642-310381
B1	B+B Computer Ltd.	0204 26644
B2	Beam Business Centre	061-831-7292
B3	Benchmark Computer Systems	0726 61000
B4	Bristol Software Factory	0272 23430
B5	Byte Soft Systems Ltd	0533 531441
B6	Business Solutions Ltd	01-554-5985
B7	Bromley Computer Consultancy	01 464 8080
C1	CAP-CPP Products Ltd.	01-404 0911
C2	Commodore	01-388 5702
C3	Compsoft	0483 39665
C4	Comput-a-crop	0507-604271
C5	Computastore Ltd.	061-832-4761
C6	Computech	01-794 0202
C7	Compass	Standish 426252
C8	CWP Computers	01-828 3127
C9	C4 Computer Services	0632-664313
C10	Caxton Software	01 3796 502
C11	CBS Consultants	021-722-8181
C12	Comp Prog & Systems Serv	0942-38831
E1	Engineering Sciences	01-437-4894
G1	Graffcom Systems Ltd.	01-727 5561
G2	Gram (W/nter) Ltd.	01-636 8210
G3	Great Northern	0532 589980
G4	Alan Greenhalgh Ltd	01-520-0218
G5	Grade One	Giossop 63819
H1	A. J. Harding	0424 220391
H2	Hartford Software	0606 76265
H3	H.B. Computers	0536 83922
H4	Wordcraft Systems	0332 760127
I1	Intereurope Software Design	0734 786644
I2	Intex Datalog Ltd.	0642 781193
J1	T. V. Johnson	0276 20446
K2	Keen Computers	0602 412777
L1	Lifeboat Associates	01-836 9028
L2	Liveport (Exidy Sorcerer Firmware)	0736 798157
L3	Ludhouse (Computing) Ltd.	01-679 4321
L4	Logic Comp Systems	01-222-1122
M1	Micro Computer Applications Ltd.	0734 470425
M2	Microteck	Orpington 26803
M3	Microsys Ltd	051 426 7271
M4	Microsave	0272 737555
M5	M. A. P. Comp Systems	061-624-5662
O1	Omicron Design	0784 31809
P1	Padmede Computer Services	02514 21892
P2	Personal Computers Ltd.	01-377 1200
P3	Professional Computer Services	061 624 4065
P4	Prestige Computers	021 561 2001
Q1	Quill Computer Systems	061 477 4960
R1	Rockliff	051-521 5830
S1	SMG Micro Computers	0474 55813
S2	The Softwarehouse	01-637 2108
S3	Stage One Software	0202 735656
S4	Systematics International	0440 61121
S5	Sumlock Bondain	01-250 0505
S6	Stemmos	01 602 6242
S7	Software Aids Int	01-904 8139
S8	SD Micros	01 836 9520
T1	Tridata Micros Ltd.	021 622 6085
T2	Templeman Software	0789 66237
T3	The Micro Solution	0608 3256
T4	Terodec Ltd	0734-664343
T5	TABS Ltd	0264-58933
T6	Tip Data Ltd	0375-33910
V1	Vlasak Electronics Ltd.	0494-448633
W1	Wisbech Computer Services	0945 64146
W2	Westfarthing Comp Services	03265-4098
W3	Walters Computer Systems Ltd	04492 70811
X1	Xetal	061 682 7555

Applications

Application	Machine	Price	Code
Analysis ledger	Phillips P2000	£100	P4
Appointments planner	Act Sirius 1	£115	C7
	Challenger	£25	C7
Assembler dev	PET/CBM	£50	L2
Bill of materials	Apple II	£199	T5
	CP/M	£850	B5
	CP/M	£199	T5
	Cromemco	£850	B5
	PET/CBM	£199	T5
Superbrain	£450	T3	
Bookmakers package	CP/M	POR	B7
Budgeting package	Apple II	£125	P2
	Apple II	£125	T2
	CP/M	£95	B5
	Cromemco	£95	B5
	North Star Horizon	£95	B5
Building estimating	Apple II	£570	S8
Bureau de change	PET/CBM	£8	H3

Application	Machine	Price	Code
Cash flow	Apple II	£125	P2
	Apple II	£80	V1
	Apple II	£100	C8
	CP/M	£250	L3
	CP/M	£95	B5
	Cromemco North Star Horizon	£95	B5
Cash register	CP/M	£300	T4
Cheque writer	CBM/8032	£90	P3
	PET/CBM	£90	P3
Company secretary	CP/M	£450	C4
Construction cashflow	Apple II	£75	S8
Construction Expenditure	Apple II	£250	S8
		£350	B3
		£300	W1
		£425	B6
		£500	T4
Construction Financial Control	Apple II	£750	S8
		£400	M5
Construction valuations	Apple II	£500	S8
Container accounting	CP/M	£750	M5
Contract costing	Apple II	£500	P1
	CP/M	£2000	L3
CP/M & utilities	Tandy Model II	£150	M1
Credit control	Apple II	£98	P2
	PET/CBM	£650	B4
Customer file	Famos	£1000	M2
Database management/Information retrieval	ACT800	£225	H4
	Apple II	£150	A2
	Apple II	£150	K2
	Apple II	£60-140	S2
	Apple II	£150	S5
	Apple II	£75	P2
	Apple II	£100	S4
	Apple II	£100	C8
	Apple II	£125	T2
	CP/M	£150-750	C4
	CP/M	£100	G3
	CP/M	£350	B3
	CP/M	£400	C3
	CP/M	£600	G5
Famos	£1500	M2	
North Star Horizon	£150	B3	
	£250	C3	
	£225	H4	
	£75	B1	
	£50/150	C2	
PET/CBM	£150	J1	
PET/CBM	£150	G2	
Superbrain	£300	S6	
Tandy Model 1	£25-80	M1	
Tandy Model 1	£60	S2	
Tandy Model 1	£150	J1	
Tandy Model 1	£32.50	H1	
Tandy Model 111	£270	A4	
8000 Series	POR	C2	
Dental Records	Apple II	£395	M4
CP/M	£500	T4	
Disk operating system	PET/CBM	£150	B1
Double glazing costing	North Star Horizon	£750	W1
Eire payroll system	CP/M	£650	M5
Estate agent	Apple II	£850	A2
	Apple II	£850	S5
	Apple II	£850	K2
	Apple II	£175	P2
	Apple II	£130	C8
	Apple II	£750	S4
	PET/CBM	£30	H3
	CP/M	£750	C4
	CP/M	£700	B5
	PCC 2000	£350	B3
Simplelec Triton 3	£195	W1	
MZ-80K	£600	S6	
Superbrain	£600	S6	
Superbrain	£600	C12	
Equipment lease/rent/HP	CP/M	£400	G1
Expense analysis	Phillips P2000	£150	P4
File Handling	PET/CBM	£225	H4
Financial modelling	Act Sirius 1	£595	A1
	Apple II	£450	P2
	Apple II	£360	C8
	CP/M	£400	G1
	CP/M	£95	B5
	CP/M	£425-535	A1
	CP/M	£400	B6
	Cromemco North Star Horizon	£95	B5
	PET/CBM	£425-535	A1
	RAIR Black Box	POR	A3
Financial planning	Act Sirius 1	£150	A1
	Apple II	£250	S4
General ledger/NL	Apple II	£300	A2
	Apple II	£300	S5
	Apple II	£300	K2

Application	Machine	Price	Code
Apple II	£455	P2	
Apple II	£225	V1	
Apple II	£295	C6	
Apple II	£250P	S4	
Apple II	£400	T2	
Apple II	£470	L4	
Apple II	£179	T5	
CBM/8032	£450	C11	
CP/M	£350	W3	
CP/M	£500	L3	
CP/M	£375	L1	
CP/M	£500	C4	
CP/M	£400	G1	
CP/M	£400	M3	
CP/M	£400	B5	
CP/M	£275	S6	
CP/M	£390	S7	
CP/M	£350	B3	
CP/M	£300	W1	
CP/M	£425	B6	
CP/M	£500	T4	
CP/M	£400	M5	
CP/M	POR	B7	
CP/M	£199	T5	
Cromemco North Star Horizon	£400	B5	
£250	B3		
North Star Horizon	£400	M3	
PCC 2000	£400	B5	
North Star Horizon	£400	B5	
Simplelec Triton 3	£350	B2	
PET/CBM	£200	C2	
PET/CBM	£200	H3	
PET/CBM	£199	T5	
Philips P2000	£100	P4	
Sharp PC3201	£450	P2	
Superbrain	£400	M1	
Superbrain	£400	S6	
Tandy Model 1	£90	M1	
Tandy Model II	£90	M1	
Tandy Model 1	£225	H1	
Tandy Model 1	£225/325	T1	
Tandy Model 11	£425	T1	
Vector	£400	C5	
8080/Z80	£357	L1	
8080/Z80	£275	G3	
General purchase transaction proc.	CBM/8032	£495	S3
Hotel billing	Philips P2000	£500	P4
Hotel management	Apple II	£525	M4
	CP/M	£525	M4
	RAIR Black Box	POR	A3
Incomplete records	Act Sirius 1	£1200	S1
	Apple II	£250	S2
	Apple II	POR	K2
	Apple II	£425	P2
	Apple II	£450	P1
	Apple II	£490	L4
	CBM/8032	£150	W3
	CP/M	£750	M3
	CP/M	£250	B5
	CP/M	£975	B3
CP/M	£750	W1	
CP/M	£1250	M5	
CP/M	£155	C10	
Cromemco North Star Horizon	£250	B5	
£750	M3		
North Star Horizon	£250	B5	
North Star Horizon	£975	B3	
Philips P2000	£150	P4	
Superbrain	£750	M3	
Superbrain	£1200	S1	
Tandy Model 1	£40	M1	
Tandy Model 1	£40	H1	
Industrial cleaning package	CP/M	POR	B7
	CP/M	£360	X1
Industry Factory loading	CP/M	£360	X1
	PET/CBM	£300	X1
Industry work study	Apple II	£990	X1
	CP/M	£990	X1
	PET/CBM	£750	X1
Inn Management	Act Sirius 1	£185	C7
Insurance Broker	Act Sirius 1	£450	C7
Insurance renewals	CBM/8032	£1200	S3
Integrated accts	Act Sirius 1	£795	O1
	Altos (CP/M, MP/M)	£300	B1
	Apple II	£450	P1
	Apple II	£300	P2
	Apple II	£855	V1
	Apple II	£600	T2
	Apple II	£1470	L4
	Apple II	£300	W2
	Apple II	£199	T5
	CBM/8032	£1500	P3
900	£400	C11	
CP/M	£950	L1	
CP/M	£1500	C4	
CP/M	£1100	G1	

PACKAGES

Application	Machine	Price	Code
	CP/M	£990	M3
	CP/M	£690	B5
	CP/M	£900	B5
	CP/M	£1450	B3
	CP/M	£1200	B6
	CP/M	£1199	T5
	CP/M	£690	B5
	Cromemco	£900	B5
	Cromemco	£2000	M2
	Famos	£150	P2
	North Star		
	Horizon	£950	B3
	North Star		
	Horizon	£690	B5
	North Star		
	Horizon	£900	B5
	PET/CBM	£300	B1
	PET/CBM	£800	S3
	PET/CBM	£199	T5
	North Star		
	Horizon	£990	M3
	PET/CBM	£500	C2
	PET/CBM	£650	J1
	PET/CBM	£650	G2
	Philips P2000	£650	P4
	Superbrain	£990	M3
	Superbrain	£1200	S6
	Superbrain	£1000	T3
	Superbrain	£1200	S1
	Tandy Model I	£350	M1
	Tandy Model II	£350	M1
	Tandy Model I	£75	J1
	Tandy Model II	£795	O1
	Tandy Model III	£550	A4
	Vector	£1000	C5
	8000 Series	POR	C2
	8080/Z80	£950	L1
	8080/Z80	£995	G3
Investment portfolio	Tandy Model I	£20	S2
Invoicing	Act Sirius I	£95	C7
	Act Sirius I	£265	O1
	Act Sirius I	£195	A1
	Apple II	£295	S2
	Apple II	£300	P1
	Apple II	£300	P2
	Apple II	£140	V1
	Apple II	£300	T2
	Apple II	£199	T5
	Challenger	£25	C7
	CP/M	£325	L1
	CP/M	£150-350	C4
	CP/M	£250	M3
	CP/M	£250	S7
	CP/M	£100	B5
	CP/M	£200	B3
	CP/M	£300	W1
	CP/M	POR	B7
	CP/M	£199	T5
	Cromemco	£100	B5
	North Star		
	Horizon	£100	B3
	North Star		
	Horizon	£250	M3
	North Star		
	Horizon	£100	B5
	PET/CBM	£350	A1
	PET/CBM	£25-50	B1
	PET/CBM	POR	J1
	PET/CBM	£199	T5
	Philips P2000	£150	P4
	Superbrain	£250	M3
	Superbrain	£150	S6
	Tandy Model I	£90	M1
	Tandy Model II	£90	M1
	Tandy Model I	£25	H1
	Tandy Model I	£75	T1
	Tandy Model II	£125	T1
	Tandy Model II	£265	O1
	Tandy Model III	£280	A4
	8080/Z80	£325	L1
Jewellers System	CP/M	£1000	S7
Job costing	Act Sirius I	£350	C7
	Act Sirius I	£265	O1
	Apple II	£300	P1
	Apple II	£990	X1
	Apple II	£199	T5
	CPM/8032	£1000	C11
	CPM/8032	£350	W3
	CP/M	£700	C4
	CP/M	£350	M3
	CP/M	£990	X1
	CP/M	£500	T4
	CP/M	£650	M5
	CP/M	POR	B7
	CP/M	£199	T5
	CP/M	£1500	T6
	North Star		
	Horizon	£350	M3
	PET/CBM	£750	X1
	PET/CBM	£199	T5
	Philips P2000	£400	P4
	Superbrain	£350	M3
	Tandy Model I	POR	M1
	Tandy Model II	POR	M1
	Tandy Model II	£265	O1
Job order control	8080/Z80	£275	G3
Legal precedents	CP/M	£1100	C4
Letter writer	Apple II	£80	V1
	Apple II	£99	T5
	CP/M	£150	M3
	CP/M	£99	T5
	North Star		
	Horizon	£150	M3
	Superbrain	£150	M3
Local government housing maint	RAIR Black Box	POR	A3
Lotteries	PET/CBM	£45	H2

Application	Machine	Price	Code
Mailing List	Altos (CP/M, MP/M)	£75	B1
	Apple II	£300	A2
	Apple II	£50-150	S2
	Apple II	£300	S5
	Apple II	£300	K2
	Apple II	£40	P2
	Apple II	£100	S4
	CP/M	£50-150	C4
	CP/M	£250	G1
	North Star		
	Horizon	£195	W1
	PET/CBM	£45	H2
	PET/CBM	£15	A1
	PET/CBM	£75	B1
	PET/CBM	£35	H3
	Superbrain	£140	C9
	Tandy Model I	£40	M1
	Tandy Model II	£75	M1
	Tandy Model I	£50-150	S2
	Tandy Model I	£25/38/55	H1
Mail shot	Act Sirius I	£95	A1
	Apple II	£14	S2
	Apple II	£40	P2
	Apple II	£25	T2
	Apple II	£99	T5
	CPM/8032	£350	W3
	Challenger	£25	C7
	CP/M	£200-360	C4
	CP/M	£90	M3
	CP/M	£100	S7
	CP/M	£50/150	G5
	CP/M	£99	T5
	MCZ Zilog	£250	I1
	North Star		
	Horizon	£90	M3
	PCC 2000		
	Simplec Triton 3	£450	B2
	Superbrain	£90	M3
	Tandy Model I	£75	G4
	Tandy Model II	£75	M1
	Tandy Model II	£75+	G4
	Tandy Model III	£160	A4
Membership acting	Apple II	£75	P2
	MCZ Zilog	£250	I1
	PET/CBM	£85	H2
Motor Dealer	Act Sirius I	£345	C7
	CPM/8032	£950+	P3
	Famos	£5000	M2
NEDO price adjustment	Apple II	£200	S8
Order entry/invoicing	Apple II	£99	T5
	CPM/8032	£750	P3
	CP/M	£350	G1
	CP/M	£500	T4
	CP/M	£550	M5
	CP/M	£550	L1
	CP/M	POR	B7
	CP/M	£99	T5
	8080/Z80	£550	L1
Order Processing	Apple II	£99	T5
	CP/M	£99	T5
	Philips P2000	£200	P4
Office admin	Apple II	£100	S4
Pad to plotter systems	Apple II	£250	P2
	Apple II	£180	C8
Payroll	Act Sirius I	£300+	O1
	Act Sirius I	£195	A1
	Apple II	POR	A2
	Apple II	£200	S2
	Apple II	POR	S5
	Apple II	POR	K2
	Apple II	£200	P2
	Apple II	£375	V1
	Apple II	£375	C6
	Apple II	£400	S4
	Apple II	£490	T2
	Apple II	£199	T5
	Apple II	£199	T5
	CPM/8032	£375	P3
	CPM/8032	£350	W3
	Challenger	£24	C7
	CP/M	£450	L3
	CP/M	£475	L1
	CP/M	£495	C4
	CP/M	£500	G1
	CP/M	£390	M3
	CP/M	£500	B5
	CP/M	£450	B3
	CP/M	£425	B6
	CP/M	Lease	W1
	CP/M	£500	T4
	CP/M	£450	M5
	CP/M	POR	B7
	CP/M	£199	T5
	Famos	£1500	M2
	North Star		
	Horizon	£350	B3
	North Star		
	Horizon	£390	M3
	North Star		
	Horizon	Lease	W1
	PET/CBM	£200/350	C5
	PET/CBM	£50/195	I2
	PET/CBM	£150	O2
	PET/CBM	£150	J1
	PET/CBM	£150	C2
	PET/CBM	£10	H3
	PET/CBM	£199	T5
	Philips P2000	£300	P4
	Sorcerer	£250	L2
	Superbrain	£390	M3
	Superbrain	£400	S6
	Superbrain	£250+	T3
	Tandy Model I	£249	M1
	Tandy Model I	£200	H1
	Tandy Model I	£218	T1
	Tandy Model II	£375	T1

Application	Machine	Price	Code
	Tandy Model II	£300+	O1
	8000 Series	£250	C2
	8080/Z80	£475	L1
	8080/Z80	£275	G3
	PET/CBM	£150	G2
	PET/CBM	£150	J1
	PET/CBM	£150	C2
	Sorcerer	£250	L2
	Tandy Model I	£249	M1
	TRS-80	£200	H1
	TRS-80I	£218	K1
	TRS-80I	£218	T1
	TRS-80II	£375	T1
	8000 Series	£250	C2
	8080/Z80	£475	L1
	8080/Z80	£275	G3
Perpetual Inventory	CP/M	£150	B5
	Cromemco	£150	B5
Personnel records	Apple II	£98	P2
	CP/M	£450	C4
	MCZ Zilog	£400	I1
	PET/CBM	£85	H2
Petaid report generator	PET/CBM	£250	S3
Petsoft programs	PET/CBM	£160	J1
Postal advertising response package	Apple II	£350	S2
Price lister	PET/CBM	£112	H3
Product Management	Act Sirius I	£245	C7
Production analysis	Apple II	£75	P2
	CP/M	£700	C4
	PET/CBM	£300	B1
Production control	CPM/8032	£650+	P3
	PET/CBM	£650+	P3
Prof appts groups	8080/Z80	£275	G3
Prof appts individ	8080/Z80	£220	G3
Prof client billing	8080/Z80	£330	G3
Programming aids	Apple II	£40	P2
Property management	CP/M	£450-1000	C4
	CP/M	£400	M3
	CP/M	POR	B7
	North Star Horizon	£400	M3
	Superbrain	£400	M3
Publishers System	CP/M	£1850	S7
Purchase ledger	Act Sirius I	£395	A1
	Apple II	£300	A2
	Apple II	£300	S5
	Apple II	£300	K2
	Apple II	£295	C6
	Apple II	£300	P1
	Apple II	£300	P2
	Apple II	£315	V1
	Apple II	£250P	S4
	Apple II	£300	T2
	Apple II	£490	L4
	Apple II	£199	T5
	Challenger	£25	C7
	CPM/8032	£500	C11
	CPM/8032	£350	W3
	CP/M	£500	C4
	CP/M	£450	G1
	CP/M	£500	L3
	CP/M	£425	L1
	CP/M	£400	M3
	CP/M	£400	M3
	CP/M	£395	S7
	CP/M	£350	S7
	CP/M	£300	W1
	CP/M	£425	B6
	CP/M	£500	T4
	CP/M	£400	M5
	CP/M	POR	B7
	CP/M	£199	T5
	Cromemco	£400	B5
	North Star		
	Horizon	£250	B3
	North Star		
	Horizon	£400	M3
	North Star		
	Horizon	£400	M3
	Superbrain	£400	B5
	Superbrain	£400	M5
	Superbrain	£300	S6
	PCC 2000		
	Simplec Triton 3	£350	B2
	PET/CBM	£300	B4
	PET/CBM	£200	C2
	PET/CBM	POR	J1
	PET/CBM	£350	H3
	PET/CBM	£199	T5
	Philips P2000	£200	P4
	Sharp PC3201	£300	P2
	Tandy Model I	£90	M1
	Tandy Model II	£90	M1
	Tandy Model I	£225	H1
	Tandy Model I	£225	T1
	Tandy Model II	£375	T1
	Vector	£400	C5
	8000 Series	£250	C2
	8080/Z80	£275	G3
	8080/Z80	£425	L1
Quotation estimating	Act Sirius I	£125	C7
	Apple II	£300	P1
	Philips P2000	£400	P4
Recruitment Agency	Act Sirius I	£345	C7
Reinforcement bar schedule	Apple II	£150	S8
Renewals ledger	Philips P2000	P4	
Resource optimiser	Apple II	£295	C10

PACKAGES

Application	Machine	Price	Code
Sales ledger	Act Sirius I	£395	A1
	Apple II	£300	A2
	Apple II	£300	S5
	Apple II	£300	K2
	Apple II	£295	C6
	Apple II	£300	P1
	Apple II	£300	P2
	Apple II	£315	V1
	Apple II	£250P	S4
	Apple II	£300	T2
	Apple II	£490	L4
	Apple II	£199	T5
	CBM/8032	£500	C11
	CBM/8032	£350	W3
	Challenger	£25	C7
	CP/M	£500	C4
	CP/M	£450	G1
	CP/M	£500	L3
	CP/M	£425	L1
	CP/M	£400	M3
	CP/M	£400	B5
	CP/M	£365	S7
	CP/M	£350	B3
	CP/M	£300	W1
	CP/M	£425	B6
	CP/M	£500	T4
	CP/M	£400	M5
	CP/M	POR	B7
	CP/M	£199	T5
	Cromemco	£400	B5
	North Star		
	Horizon	£250	B3
	North Star		
	Horizon	£400	M3
	North Star		
	Horizon	£400	B5
	PCC 2000		
	Simpelec Triton 3	£350	B2
	PET/CBM	£300	B4
	PET/CBM	£800	C1
	PET/CBM	POR	J1
	PET/CBM	£200	C2
	PET/CBM	£350	C5
	PET/CBM	£199	T5
	Philips P2000	£200	P4
Sharp PC 3201	£300	P2	
Superbrain	£400	M3	
Superbrain	£300	S6	
Superbrain	£199	T5	
Tandy Model I	£90	M1	
Tandy Model II	£90	M1	
Tandy Model I	£225	H1	
Tandy Model I	£225	T1	
Tandy Model II	£375	TL	
Vector	£400	C5	
8000 Series	£250	C2	
8080/Z80	£275	G3	
8080/Z80	£425	L1	
S/L, P/L & stock control	Apple II	£900	P2
	Apple II	£1000	T2
	Apple II	£1000	L3
	CP/M	£900	B5
	CP/M	£900	B5
	Cromemco	£900	B5
North Star			
Horizon	£900	B5	
Philips P2000	£950	P4	
Solicitor's complete record accounting	Apple II	£3000	S2
Solicitor's package	Act Sirius I	£1400	S1
	CBM/8032	£1400	S1
	CompuCorp	£2000	Q1
	Superbrain	£1400	S1
	CP/M	£1250	M5
Statistics	Apple II	£150	G3
	Apple II	£100-195	P2
	Apple II	£140	S8
	Tandy Model I	£45	C2
Stock control/recording	Altos (CP/M, MP/M)	£300	B1
	Act Sirius I	£265	O1
	Act Sirius I	£195	A1
	Apple II	POR	A2
	Apple II	POR	K2
	Apple II	POR	S5
	Apple II	£150	G3
	Apple II	£80	S2
	Apple II	£75/300	P2
	Apple II	£285	V1
	Apple II	£300	P1
	Apple II	£500	S4
	Apple II	£490	L4
	Apple II	£199	T5
	CBM/8032	£175	P3
	CBM/8032	£199	T5
	CBM/8032	£350	W3
	Challenger	£25	C7
	CP/M	£325	L1
	CP/M	£500-1500	C4
	CP/M	£350	G1
	CP/M	£900	M3
	CP/M	£700	B5
	CP/M	£550	B5
	CP/M	£550	B3
	CP/M	£300	W1
	CP/M	£500	T4
	CP/M	£550	M5
	CP/M	POR	B7
	CP/M	£199	T5
	Cromemco	£700	B5
	Famos	£1500	M2
	MZ-80K	£150	P2
	North Star		
	Horizon	£450	B3
North Star			
Horizon	£900	M3	
PCC 2000			
Simpelec Triton 3	£350	B2	
PET/CBM	£195	I2	
PET/CBM	£300	B4	
PET/CBM	£15	A2	

Application	Machine	Price	Code	
Sales ledger	PET/CBM	£300	B1	
	PET/CBM	£150	C2	
	PET/CBM	£150	J1	
	PET/CBM	£150	G2	
	PET/CBM	£250	R1	
	PET/CBM	£35/25	H3	
	PET/CBM	£199	T5	
	Philips P2000	£300	P4	
	Sharp PC3201	£300	P2	
	Superbrain	£900	M3	
	Superbrain	£300	S6	
	Superbrain	£450	T3	
	Tandy Model I	£30-50	M1	
	Tandy Model II	£300	M1	
	Tandy Model I	£48	S2	
	Tandy Model I	£200	H1	
	Tandy Model I	£115	J1	
	Tandy Model I	£200	T1	
	Tandy Model I	£375	T1	
	Tandy Model II	£265	O1	
	8080/Z80	£275	G3	
	8080/Z80	£325	L1	
	Surveying	CP/M	£500	T4
	TAP business system	PET/CBM	£125	H2
	Text file librarian	Apple II	£125	S4
	Time/cost recording	Act Sirius I	£800	S1
		Apple II	£450	S2
		Apple II	£300	P1
		CBM/8032	£800	S1
		CP/M	£400	G1
		CP/M	£200	M3
		CP/M	£350	B3
		North Star		
		Horizon	£250	B3
		North Star		
Horizon		£200	M3	
North Star				
Horizon		£450	W1	
PCC 2000				
Simpelec Triton 3		£350	B2	
PET/CBM		£300	B1	
Philips P2000		£300	P4	
Superbrain		£200	M3	
Superbrain		£800	S1	
Tandy Model I		POR	M1	
Tandy Model II	POR	M1		
Travel agency accts	Superbrain	£800	S6	
	Tandy Model I	£225	G4	
	Tandy Model II	£225	G4	
Travel Agents Dairy	Tandy Model I	£100	G4	
	Tandy Model II	£100	G4	
Travel Ticket Sales	Tandy Model I	£225	G4	
	Tandy Model II	£225	G4	
Utilities	Apple II	£40	P2	
	Apple II	£20	C6	
	CP/M	£50	B5	
	ITT 2020	£20	C6	
Utility set	PET/CBM	£78	H3	
Various engineering	Tektronix		E1	
Various thermal insulation industry systems	CP/M	£2000+	T6	
VAT master	PET/CBM	£25	H3	
VAT register	Tandy Model I	£15	H1	
Video hire system	Act Sirius I	£125	C7	
	Tandy Model III	£460	A4	
Video message	Apple	£200	G3	
Warehousing	CBM/8032	POR	S1	
	CBM/8032	£375	P3	
Word processing	ACT 800	£375	H4	
	Act Sirius I	£295-325	A1	
	Act Sirius I	£295+	O1	
	Apple II	£60	S2	
	Apple II	£75	K2	
	Apple II	£75	S5	
	Apple II	£75	A2	
	Apple II	£150-300	P2	
	Apple II	£75	J1	
	Apple II	£120	V1	
	Apple II	£180/95	S4	
	Apple II	£30	C8	
	Apple II	£500	T2	
	Apple II	£99	T5	
	CP/M	£150-260	C4	
	CP/M	£400	G1	
	CP/M	£250	M3	
	CP/M	£250	B6	
	CP/M	POR	B7	
	CP/M	£99	T5	
	Famos	£500	M2	
	North Star			
	Horizon	£250	M3	
	PET	£85/65/40/20	H2	
	PET/CBM	£375	H4	
	PET/CBM	£325	C5	
	PET/CBM	£75/150	C2	
	PET/CBM	£75/150	J1	
	PET/CBM	£75/150	G2	
	PET/CBM	£35	H3	
	Philips P2000	£230	P4	
	Superbrain	£250	M3	
	Tandy Model I	£50/75	M1	
	Tandy Model II	£175-240	M1	
	Tandy Model I	£30/60/90	S2	
Tandy Model I	£45/95	J1		
Tandy Model I	£15	H1		
Tandy Model II	£295+	O1		
Vector	£400	C5		
8000 Series	£250	C2		
Work In Progress	CP/M	£850	B5	

Machines

Machine	Application	Price	Code
ACT 800	Database management/	£225	H4
	Word processing	£375	H4
Act Sirius I	Appointments planner	£115	C7
	Financial modelling	£595	A1
	Financial planning	£150	A1
	Incomplete records	£1200	C1
	Inn Management	£185	S7
	Insurance Broker	£450	C7
	Integrated Accts	£495	A1
	Integrated Accts	£795	O1
	Invoicing	£95	C7
	Invoicing	£265	O1
	Invoicing	£195	A1
	Job Costing	£350	C7
	Job Costing	£265	O1
	Mailing list	£95	A1
	Motor Dealer	£345	C7
	Payroll	£300+	O1
	Payroll	£195	A1
	Project Management	£245	C7
	Purchase ledger	£395	A1
	Quotation Estimating	£125	C7
Recruitment agency	£345	C7	
Sales Ledger	£395	A1	
Solicitors package	£1400	S1	
Stock control/recording	£265	O1	
Stock control/recording	£195	A1	
Time/cost recording	£800	S1	
Video hire system	£125	C7	
Word processing	£295/325	A1	
Word processing	£295+	O1	
Altos (CP/M, MP/M)	Integrated accts	£300	B1
	Mailing list	£75	B1
	Stock control/recording	£300	B1
Apple II	Bill of materials	£199	T5
	Budgeting	£125	T2
	Building estimating	£570	S8
	Cash flow	£80	V1
	Cash flow	£75	P2
	Cash flow	£100	C8
	Construction cashflow	£75	S8
	Construction expenditure	£250	S8
	Construction financial control	£750	S8
	Construction valuations	£500	S8
	Contract costing	£450	P1
	Database management/information retrieval	£150	K2
	Database management/information retrieval	£150	A2
	Database management/information retrieval	£60-140	S2
	Database management/information retrieval	£150	S5
	Database management/information retrieval	£98	P2
	Database management/information retrieval	£100	S4
	Database management	£75	P2
	Database management	£100	C8
	Database management	£125	T2
	Dental records	£395	M4
	Estate agent	£850	S5
	Estate agent	£850	A2
	Estate agent	£850	K2
	Estate agent	£750	S4
Estate agent	£130	C8	
Financial modelling	£360	C8	
Financial planning	£250	S4	
General ledger/NL	£300	K2	
General ledger/NL	£300	A2	
General ledger/NL	£450	P2	
General ledger/NL	£300	S5	
General ledger/NL	£225	V1	
General ledger/NL	£225	C6	
General ledger/NL	£250P	S4	
General ledger/NL	£600	T2	
General ledger/NL	£490	L4	
General ledger/NL	£199	T5	
Hotel management	£525	M4	
Incomplete records	POR	K2	
Incomplete records	£250	S2	
Incomplete records	£450	P1	
Incomplete records	£450	P2	
Incomplete records	£490	L4	
Industry factory loading	£360	X1	
Industry work study	£990	X1	
Integrated accts	£885	V1	
Integrated accts	£450	P1	
Integrated accts	£300	P2	
Integrated accts	£600	T2	
Integrated accts	£300	W2	
Integrated accts	£1470	L4	
Integrated accts	£199	T5	
Invoicing	£295	S2	
Invoicing	£300	P2	
Invoicing	£140	V1	
Invoicing	£300	P1	
Invoicing	£300	T2	
Invoicing	£199	T5	
Job costing	£450	S2	
Job costing	£990	X1	
Job costing	£300	P1	
Job costing	£199	T5	
Letter writer	£99	T5	
Mailing list	£300	K2	
Mailing list	£300	A2	
Mailing list	£40	P2	
Mailing list	£50-150	S2	
Mailing list	£300	S5	
Mailing list	£100	S4	
Mailing List	£25	T2	
Mail shot	£14	S2	
Mail shot	£225	P2	
Mail shot	£99	T5	

BERZERK*

NEW GAME. PRIVATE PROPERTY.

'Berzerk' is the latest of Atari's video games to become available.

Since it is an ATARI® game we have exclusive rights to exercise all copyrights and other rights connected with 'Berzerk.'

We lead the field in the development of video games. And it's due to our considerable investment of time and resources that our games have become so popular. And due also, of course, to the people who have enjoyed the games.

Unfortunately, however, some companies and individuals have been copying ATARI games, gaining profits at Atari's expense.

We must protect our investment so we can carry on investing in the development of new and better games.

So consider this a warning both to intentional pirates and to individuals unaware of the copyright laws.

Any manufacture, sale or other dealings in games which reproduce any of the copyrights in 'Berzerk', or any unlawful use of the name 'Berzerk' (or imitation of it) is an infringement of Atari's rights.

Atari will protect its rights by vigorous action against all infringers. Regardless of what computer or other apparatus is used in playing infringing games.

We would also appreciate the co-operation of legitimate software developers in the protection of our property.

And if you happen to be selling a software product which performs a game similar to 'Berzerk' (or any other ATARI game) please contact us immediately.

Write to the attention of: Graham Daubney, Atari International (UK) Inc., 185 Ealing Road, Alperton, Wembley, Middlesex.

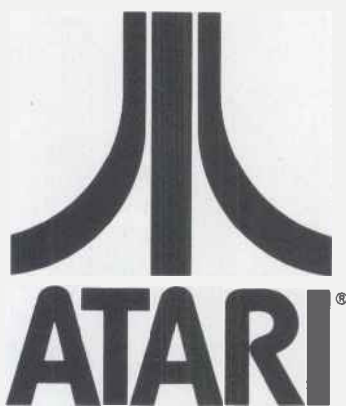

© A Warner Communications Company

*TRADEMARK OF STERN ELECTRONICS INC. ©1982 ATARI, INC. ALL RIGHTS RESERVED. ® INDICATES TRADEMARK OF ATARI INC.

PACKAGES

Machine	Application	Price	Code	Machine	Application	Price	Code	Machine	Application	Price	Code	
	NEDO price adjustment	£200	S8		Cash flow	£250	L3		Purchase ledger	£300	W1	
	Order entry/invoicing	£99	T5		Cash flow	£95	B5		Purchase ledger	£425	B6	
	Order Processing	£99	T5		Cash register	£300	T4		Purchase ledger	£500	T4	
	Pad to plotter system	£250	P2		Company secretary	£450	C4		Purchase ledger	£400	M5	
	Pad to plotter system	£180	C8		Container accounting	£750	M5		Purchase ledger	POR	B7	
	Payroll	POR	S5		Contract costing	£2000	L3		Sales ledger	£500	L3	
	Payroll	POR	K2		Database	£350	B3		Sales ledger	£500	C4	
	Payroll	POR	A2		Database management/ Information retrieval	£150-750	C4		Sales ledger	£450	G1	
	Payroll	£200	S2		Database management/ information retrieval	£100	G1		Sales ledger	£425	L1	
	Payroll	£375	V1		Database management/ information retrieval	£400	C3		Sales ledger	£200	B5	
	Payroll	£200	P2		Database management/ information retrieval	£400	C3		Sales ledger	£275	S7	
	Payroll	£375	C6		Database management/ information retrieval	£600	G5		Sales ledger	£400	M3	
	Payroll	£250P	S4		Dental records	£500	T4		Sales ledger	£300	W1	
	Payroll	£400	T2		Eire payroll system	£650	M5		Sales ledger	£425	B6	
	Payroll	£450	L4		Equipment lease/rent/ HP	£400	G1		Sales ledger	£500	T4	
	Payroll	£199	T5		Estate agent	£750	C4		Sales ledger	£400	M5	
	Payroll	£199	T5		Estate agent	£700	B5		Sales ledger	POR	B7	
	Personal records	£75	P2		Financial modelling	£400	G1		Sales ledger	£199	T5	
	Postal advertising response package	£350	S2		Financial modelling	£95	B5		Solicitors	£1250	M5	
	Production analysis	£75	P2		Financial modelling	£400	B6		S/L, P/L + stock control	£1000	L3	
	Programming aids	£40	P2		General ledger/NL	£500	L3		S/L, P/L + stock control	£900	B5	
	Purchase ledger	£300	K2		General ledger/NL	£500	C4		Stock control/recording	£325	L1	
	Purchase ledger	£300	P2		General ledger/NL	£400	G1		Stock control/recording	£500-1500	C4	
	Purchase ledger	£300	A2		General ledger/NL	£375	L1		Stock control/recording	£350	G1	
	Purchase ledger	£300	S5		General ledger/NL	£200	B5		Stock control/recording	£500	B5	
	Purchase ledger	£315	V1		General ledger/NL	£275	S7		Stock control/recording	£900	M3	
	Purchase ledger	£300	P1		General ledger/NL	£400	M3		Stock control/recording	POR	B7	
	Purchase ledger	£295	C6		General ledger/NL	£350	B5		Stock control	£550	B3	
	Purchase ledger	£250P	S4		General ledger/NL	£300	W1		Stock control	£300	W1	
	Purchase ledger	£300	T2		General ledger/NL	£300	W1		Stock control	£500	T4	
	Purchase ledger	£490	L4		General ledger/NL	£425	B6		Stock control	£550	M5	
	Purchase ledger	£199	T5		General ledger/NL	£500	T4		Stock control	£199	T5	
	Purchase ledger	£199	T5		General ledger/NL	£400	M5		Surveying	£500	T4	
	Quotation estimating	£300	P1		General ledger/NL	POR	B7		Time/cost recording	£400	G1	
	Reinforcement bar schedule	£150	S8		General ledger/NL	£199	T5		Time/cost-recording	£200	M1	
	Resource optimiser	£295	C10		Hotel management	£525	M4		Time ledger	£350	B3	
	Sales ledger	£300	A1		Incomplete Records	£250	B5		Utilities	£50	B5	
	Sales ledger	£300	K2		Incomplete Records	£750	M3		Various thermal insulation industry systems	£2000+	T6	
	Sales ledger	£300	S5		Incomplete Records	£975	B3		Word processing	£400	G1	
	Sales ledger	£300	P2		Incomplete Records	£750	M3		Word processing	£150-260	C4	
	Sales ledger	£315	V1		Incomplete Records	£250	M5		Word processing	£250	M3	
	Sales ledger	£300	P1		Incomplete Records	£155	C10		Word processing	£250	B6	
	Sales ledger	£295	C6		Industrial clean- package	POR	B7		Word processing	POR	B7	
	Sales ledger	£250P	S4		Industry factory loading	£360	X1		Word processing	£99	B5	
	Sales ledger	£300	T2		Industry work study	£990	X1		Work in progress	£850	T5	
	Sales ledger	£490	L4		Insurance brokers	£995	W1					
	Sales ledger	£199	T5		Integrated accts	£1500	C4		Famos	Customer file	£1000	M2
	Sales ledger	£199	T5		Integrated accts	£100	G1			Data base	£1500	M2
	SL, PL stock control	£1000	T2		Integrated accts	£950	L1			Integrated accts	£2000	M2
	Solicitor's complete record accounting	£3000	G2		Integrated accts	£690	B5			Motor dealer	£5000	M2
	Statistics	£150	S3		Integrated accts	£850	S7			Payroll	£1500	M2
	Statistics	£100/195	P2		Integrated accts	£850	S7			Stock control	£1500	M2
	Statistics	£100-195	P2		Integrated accts	£990	B5			Word processing	£500	M2
	Statistics	£140	C8		Integrated accts	£900	M3					
	Stock control/recording	£150	G3		Integrated accts	£1450	B3		MCZ Zilog	Mail shot	£250	I1
	Stock control/recording	POR	K2		Integrated accts	£1200	B6			Membership acting	£250	11
	Stock control/recording	£300	P2		Integrated accts	£199	T5			Personnel records	£400	11
	Stock control/recording	POR	A2		Invoicing	£325	L1					
	Stock control/recording	£80	S2		Invoicing	£150-350	C4		MZ-80K	Estate agent	£195	W1
	Stock control/recording	POR	S5		Invoicing	£200	B3			Integrated accounts	£150	P2
	Stock control/recording	£285	V1		Invoicing	£250	M3			Stock control/recording	£150	P2
	Stock control/recording	£300	P1		Invoicing	£100	B5					
	Stock control/recording	£500	S4		Invoicing	£300	W1		North Star Horizon	Budgeting package	£95	B5
	Stock control/recording	£490	L4		Invoicing	£200	B3			Cash flow	£95	B5
	Stock control/recording	£199	T5		Invoicing	£300	W1			Database management/ information retrieval	£250	B3
	Text file librarian	£125	S4		Invoicing	POR	B7			Double glazing costing	£750	W1
	Time/cost recording	£450	S2		Invoicing	£199	T5			Estate agent	£750	B5
	Time/cost recording	£300	P1		Invoicing	£199	T5			Financial modelling	£95	B5
	Utilities	£20	C6		Jewellers System	£1000	S7			General ledger/NL	£250	B3
	Video message	£200	G3		Job costing	£700	C4			General ledger/NL	£400	M3
	Word processing	£75	K2		Job costing	£990	X1			General ledger/NL	£400	B5
	Word processing	£75	A2		Job costing	£350	M3			Incomplete records	£750	M3
	Word processing	£60	S2		Job costing	£500	T4			Incomplete records	£250	B5
	Word processing	£300	P2		Job costing	£650	M5			Incomplete records	£975	B5
	Word processing	£75	S5		Job costing	POR	B7			Incomplete records	£950	B3
	Word processing	£120	V1		Job costing	£199	T5			Integrated accts	£990	M3
	Word processing	£75	J1		Job costing	£1500	T5			Integrated accts	£690	B5
	Word processing	£180/95	S4		Job costing	£1100	C4			Integrated accts	£900	B5
	Word processing	£30	C8		Legal precedents	£150	M3			Integrated accts	£900	B5
	Word processing	£500	T2		Letter writer	£99	T5			Integrated accts	£100	B3
	Word processing	£99	T5		Letter writer	£50-150	C4			Invoicing	£250	M3
					Mailing list	£250	G1			Invoicing	£100	B5
					Mailing list	£75	S7			Invoicing	£350	M3
					Mailing list	£200-360	G4			Invoicing	£150	M5
					Mail shot	£90	M3			Job costing	£150	M3
					Mail shot	£50/150	G5			Letter writer	£195	W1
					Mail shot	£99	T5			Milling List	£90	M3
					Mail shot	£99	T5			Mail shot	£90	M3
					Order entry/invoicing	£350	G1			Payroll	£350	B7
					Order entry/invoicing	£500	T4			Payroll	£390	M3
					Order entry/invoicing	£550	M5			Payroll	Lease	W1
					Order entry/invoicing	POR	B7			Property Management	£400	M3
					Order entry/invoicing	£99	T5			Purchase ledger	£250	B3
					Order entry/invoicing	£50	L1			Purchase ledger	£400	M3
					Order processing	£99	T5			Purchase ledger	£400	B5
					Order processing	£450	L3			Sales ledger	£250	B3
					Payroll	£495	C4			Sales ledger	£400	M3
					Payroll	£500	G1			Sales ledger	£400	B5
					Payroll	£475	L1			SL, PL + stock control	£900	B5
					Payroll	£500	B5			Stock control/recording	£450	B3
					Payroll	£390	M3			Stock control/recording	£900	M3
					Payroll	£450	B3			Time/cost recording	£250	B3
					Payroll	£425	B6			Time/cost recording	£200	M3
					Payroll	£500	T4			Time/cost recording	£450	W1
					Payroll	£450	M5			Word processing	£250	M3
					Payroll	POR	B7					
					Payroll	£199	T5					
					Perpetual Inventory	£150	B5		PCC 2000	Estate Agent	£350	B2
					Personnel records	£450	C4			General ledger/NL	£350	B2
					Production analysis	£700	C4			Mail Shot	£450	B2
					Property management	£450-1000	C4			Purchase ledger	£350	B2
					Property management	£450	M3			Sales ledger	£350	B2
					Property management	POR	B7			Stock control/recording	£350	B2
					Publishers system	£1850	S7			Time/cost recording	£350	B2
					Purchase ledger	£500	L3					
					Purchase ledger	£450	G1		PET/CBM	Assembler dev	£50	C2
					Purchase ledger	£425	L1			Bill of materials	£199	T5
					Purchase ledger	£450	C4			Bureau de change	£8	H3
					Purchase ledger	£200	B5			Cheque writer	£90	P3
					Purchase ledger	£275	S7			Credit control	£650	B4
					Purchase ledger	£400	M3			Database management/ information retrieval	£75	B1
					Purchase ledger	£350	B3					
CBM/8032	Cheque writer	£90	P3									
	General ledger/NL	£450	C11									
	General ledger/NL	£350	W3									

PACKAGES

Machine	Application	Price	Code	Machine	Application	Price	Code	Machine	Application	Price	Code
	Database management/information retrieval	£50/150	C2	PET/Computink	Stock control/recording	£250	R1		Integrated accts	£350	M1
	Database management/information retrieval	£150	G2	Philips P2000	Analysis ledger	£100	P4		Integrated accts	£550	A4
	Database management/information retrieval	£150	J1		Expense Analysis	£150	P4		Integrated accts	£350	M1
	Database management/information retrieval	POR	C1		General ledger/NL	£100	P4		Integrated accts	£75	J1
	Database management/information retrieval	£225	H4		Hotel billing	£500	P4		Integrated accts	£795	O1
	Database management/information retrieval	£250	C3		Incomplete records	£150	P4		Investment portfolio	£20	S2
	Disk operating system	£150	B1		Integrated accts	£650	P4		Invoicing	£25	H1
	Estate agent	£30	H3		Invoicing	£150	P4		Job costing	POR	M1
	File handling	£225	H4		Job costing	£400	P4		Job costing	POR	M1
	General ledger/NL	£200	C2		Order Processing	£200	P4		Job costing	£265	O1
	General ledger/NL	£1000	C1		Payroll	£300	P4		Mailing list	£40	M1
	General ledger/NL	£200	H3		Purchase ledger	£200	P4		Mailing list	£75	M1
	General ledger/NL	£199	T5		Quotation Estimating	£200	P4		Mailing list	£25/38/55	H1
	Industry factory loading	£300	X1		Renewals ledger	£200	P4		Mailing list	£50-150	S2
	Industry work study	£750	X1		S/L, P/L stock control	£950	P4		Mail shot	£75+	G4
	Integrated accts	£300	B1		Stock control/recording	£300	P4		Mail shot	£75	M1
	Integrated accts	£(50)	C2		Time/cost recording	£300	P4		Mail shot	£75+	G4
	Integrated accts	£650	G2		Word processing	£230	P4		Payroll	£249	M1
	Integrated accts	£650	J1	RAIR Black Box	Financial modelling	POR	A3		Payroll	£200	H1
	Integrated accts	£800	S3		Hotel management	POR	A3		Payroll	£218	T1
	Integrated accts	£199	T5		Local government housing maint.	POR	A3		Payroll	£375	T1
	Invoicing	POR	J1						Payroll	£300+	O1
	Invoicing	£25-50	B1	Sharp PC-3201	General ledger	£450	P2		Purchase ledger	£90	M1
	Invoicing	£400	C1		Sales ledger	£300	P2		Purchase ledger	£90	M1
	Invoicing	£199	T5		Purchase ledger	£300	P2		Purchase ledger	£225	H1
	Job costing	£750	X1		Stock control	£300	P2		Purchase ledger	£375	T1
	Job costing	£199	T5	Sorcerer	Payroll	£250	L2		Purchase ledger	£375	T1
	Lotteries	£45	H2	Superbrain	Bill of materials	£450	T3		Sales ledger	£90	M1
	Mailing list	£75	B1		Database	£300	S6		Sales ledger	£90	M1
	Mailing list	£45	H2		Estate agent	£800	S6		Sales ledger	£225	T1
	Mailing list	£35	H3		Estate agent	£600	C12		Sales ledger	£375	T1
	Membership acting	£85	H2		General ledger	£400	M3		Sales ledger	£225	H1
	Payroll	£150	G2		General ledger	£400	S6		Sales ledger	£225	T1
	Payroll	£150	J1		Incomplete Records	£1200	M3		Statistics	£45	S2
	Payroll	£150	C2		Incomplete Records	£1200	S1		Stock control/recording	£30-50	M1
	Payroll	£50/195			Integrated accts	£1200	S6		Stock control/recording	£300	M1
		195	I2		Integrated accts	£990	M3		Stock control/recording	£200	H1
	Payroll	POR	C1		Integrated accts	£1000	T3		Stock control/recording	£48	S2
	Payroll	£200/350	C5		Integrated accts	£1200	S1		Stock control/recording	£115	J1
	Payroll	£10	H3		Invoicing	£250	M3		Stock control/recording	£200	T1
	Payroll	£199	T5		Invoicing	£150	S6		Stock control/recording	£375	T1
	Personnel records	£85	H2		Job costing	£350	M3		Stock control/recording	£265	O1
	Petsoft programs	£160	J1		Letter writer	£350	M3		Travel Agency Accts	£225	G4
	Petaid report generator	£250	S3		Mailing list	£140	C9		Travel Agency Accts	£225	G4
	Prise lister	£12	H3		Mail shot	£90	M3		Travel Agents Diary	£100	G4
	Production analysis	£300	B1		Payroll	£400	S6		Travel Agents Diary	£100	G4
	Production control	£650+	P3		Payroll	£290	M3		Travel Ticket Sales	£225	G4
	Purchase ledger	£200	C2		Payroll	£250+	T3		Travel Ticket Sales	£225	G4
	Purchase ledger	POR	J1		Property management	£400	M3		Time/cost recording	POR	M1
	Purchase ledger	£1000	C1		Purchase ledger	£300	S6		Time/cost recording	POR	M1
	Purchase ledger	£300	B4		Purchase ledger	£400	M3		VAT register	£15	H1
	Purchase ledger	£350	H3		Sales ledger	£300	S6		Video hire system	£460	A4
	Purchase ledger	£199	T5		Sales ledger	£400	M3		Word processing	£50/75	M1
	Sales ledger	POR	J1		Sales ledger	£199	T5		Word processing	£175-240	M1
	Sales ledger	£200	J1		Solicitors package	£1400	S1		Word processing	£45/95	J1
	Sales ledger	£300	B4		Stock control	£300	S6		Word processing	£15	H1
	Sales ledger	£800	C1		Stock control	£900	M3		Word processing	£30/60/90	S2
	Sales ledger	£350	H3		Stock control	£450	T3		Word processing	£295+	O1
	Sales ledger	£199	T5		Time/cost recording	£800	S1				
	Stock control/recording	£150	C2		Time recording	£200	M3				
	Stock control/recording	£300	B1		Word processing	£250	M3				
	Stock control/recording	£150	G2		Travel agency accts	£800	S6				
	Stock control/recording	£150	J1	Tandy Model I	Database management/information retrieval	£25-80	M1	Vector	General ledger/NL	£400	C5
	Stock control/recording	£195	I2		Database management/information retrieval	£270	A4		Integrated accts	£1000	C5
	Stock control/recording	£15	A2		Database management/information retrieval	£60	S2		Purchase ledger	£400	C5
	Stock control/recording	£300	B4		Database management/information retrieval	£60	S2		Sales ledger	£400	C5
	Stock control/recording	£35/25	H3		Database management/information retrieval	£150	J1		Word processing	£40	C5
	Stock control	£199	T5		General ledger/NL	£90	M1	8000 Series	Database management/information retrieval	POR	C2
	TAP business system	£125	H2		General ledger/NL	£90	M1		Integrated accts	POR	C2
	Time/cost recording	£300	B1		General ledger/NL	£225	H1		Payroll	£250	C2
	Utility set	£78	H3		General ledger/NL	£225/325	T1		Purchase ledger	£250	C2
	VAT master	£25	H3		General ledger/NL	£425	T1		Sales ledger	£250	C2
	Word processing	£75/150	J1		Incomplete records	£40	M1	8080/Z80	General ledger/NL	£275	G3
	Word processing	£75/150	G2		Incomplete records	£40	H1		General ledger/NL	£375	L1
	Word processing	£75/150	C2		Invoicing	£90	M1		Integrated accts	£950	L1
	Word processing	£85/65	H2		Invoicing	£280	A4		Integrated accts	£995	G3
	Word processing	£40/20	H4		Invoicing	£90	M1		Invoicing	£325	L1
	Word processing	£375	H4		Invoicing	£75	T1		Job order control	£257	G3
	Word processing	£325	C5		Invoicing	£125	T1		Order processing	£550	L1
	Word processing	£35	H3		Invoicing	£265	O1		Payroll	£475	L1

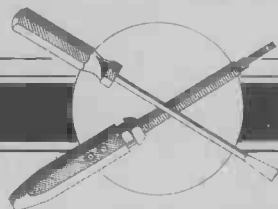

ACC NEWS

Rupert Steele presents his monthly round-up of news from the Amateur Computer Club.

Well, did you enjoy the PCW Show this year? It was of course a great success — there were people every where and lots of exciting new products. Many thanks must go to PCW, as sponsors, and to Montbuild who do all the work, for a really first class job.

As is becoming a regular practice, the exhibition organisers set up a 'Clubs Area', where the computer clubs were given free stands,

administered via the ACC. This was also a great success, though a slight drawing error caused the club area to be smaller than was intended. Nevertheless, the clubs proved to be a major attraction and therefore show how an exhibition can be enhanced by having club stands. The administration of all this was expertly handled by ACC Secretary David Annal, who once again solved all the problems and

smoothed over all the difficulties. Many thanks to you David, and keep it up!

Apart from the various National User Groups, the ACC itself had a stand at the show, and this proved to be quite popular, since there was a PET animated graphics display running. Many thanks to David Annal and his co-authors for writing the 'film' — it was great! Also on that stand was the customary ACC clubs database, which we

used to put people in touch with their local clubs. Unfortunately, due to Peter Whittle, our leader and Chairman, being on holiday, we inadvertently ran an out-of-date copy of the database for the first two days. Sorry — we'll slap Peter's wrist shortly.

Also at the PCW Show was the Electronic Insight Micronet stand. This was the launch of their new Prestel subscription service, which

will be a closed user group, membership of which includes a very simple Prestel adaptor. The 8008 area which was discussed on last month's ACC News will be involved with this, and there seems to be a lot of scope for clubs to put up information on the Prestel system, as well as opportunities for telesoftware. Watch this space (and Electronics Insight, *800#) for more details.

As is becoming customary at the large exhibitions, there was a meeting of the National User groups and part of the ACC committee. I didn't make it myself 'cos I was talked into running the stand but it was apparently very constructive, both in terms of the discussion of the clubs area at this PCW Show and terms of the general policy of the ACC performing a liaison role as the national body for microcomputer enthusiasts. The meeting was felt to be quite useful as a means for the various groups to communicate, as well as the formal consideration of the role that the groups wished the ACC to play.

Anyway, many thanks again to PCW for an excellent show, and to 'Uncle' David Annal for his work.

Exhibition news

On Saturday and Sunday 11/12 December, there will be a Christmas Microfest 82 exhibition at the University of Manchester, Institute of Science and Technology (UMIST). There was a similar exhibition during the summer at UMIST, and this one promises to be even more of a success. The ACC will be there with our now-infamous database running; we are also going to be organising the club stands.

Also on Microfest is an ACC free seminar, 'Your micro on the dog and bone (or how to whistle at 300 baud)'. This will be an elementary discussion of data

communications, using the telephone network. So if Prestel makes you go *+++++* or if mailboxes makes you return to sender, then this talk is for you!

ACC things

ACCumulator now has a new editor. All material for inclusion in **ACCumulator** should be sent to Leon Heller, 8 Morris Walk, Newport Pagnell, Bucks, MK16 8QD. You don't know what **ACCumulator** is all about? Well, write to me and I'll tell you. Let's have lots of contributions flooding in to Leon.

One or two of you out there haven't renewed your ACC subscriptions: I suggest you pay up soon, or the boys will be round to chew your UARTS off. So you say you lost the form... well we have plenty to spare at the head office.

The ACC's new hobby is 'regionalisation'. The rules of the game are that you pick on some group of local computer clubs minding their own business, and you introduce them to each other and form an Association. This association then arranges club stands at exhibitions, joint events, speaker lists, etc, and the various clubs in the association generally help each other. The first regional association was the ALCC, and recently the ACC has set up a North Western group (Manchester area). We now want to extend the idea around the country, and I would be very grateful to hear from anybody running clubs around the country who wants to associate. I am in the process of setting up a 'West of London' association of computer clubs, which would cover the area bounded by London, Milton Keynes, Northampton, Oxford and round to Reading and possibly Guildford. Anyway, please

can we have some feedback on all this.

The ACC is also keen to help those setting up computer clubs, and I have a literature kit that may be of some help to club builders. Please, please make sure that you inform the ACC of the details of the club, as our database is widely recognised as the list of computer clubs, and your club will miss out on a lot of members and information if we don't know about you. It costs absolutely nothing for your group to be entered on the ACC database, apart from the cost of a stamp to write to Peter Whittle, 49 Bartlemas Road, Oxford OX4. Please also tell us about any errors or out-of-date information — quote the reference number on the top of your entry if possible.

Club bits

I have to report that there has been a military coup at OPeCC. A junta led by Major Gen Len Phelps has taken over control of the club while the previous leadership has been variously imprisoned or banished to the ACC committee (which is worse...?). All correspondence to the Chairman of the Revolutionary Council, Len Phelps, Southport Cottage, Sutton Courtenay, Abingdon OX14 4AN.

There is a flourishing computer club in Aylesbury, the Aylesbury Computer Club or ACC for short (I know the ACC is wonderful, but did they really have to name their club after us?). Contact: Ken Knight, 22 Mount Street, Aylesbury.

Also it's about time I gave a plug to the West London Personal Computer Club or WLPC for short. They meet on the first Tuesday of the month — ring Graham Brain on 01-997 8986 for more information.

Also wanting a plug is the Southampton Amateur Computer Club (SACC). It is

now five years old and has a membership of over 100. They are associated with a club in Fareham and Portsmouth. The SACC meets second Wednesday monthly at 7.30pm in the Medical Science Building, Bassett Crescent East, Southampton. More info is available from Paul Blitz, 'Gardenways', Chilworth Tower, Chilworth, Southampton (or phone Soton (0703) 766161).

Also brought to my notice is the 'Community Computing Network'. This is a national association of 'voluntary, community and trade union' computing groups. Their aims are similar to the ACC's, except that they are more interested in the specific area of community/trade union computer clubs, as opposed to the general kind that is the main part of the ACC's interest. In addition they have two aims that are *not* like the ACC's — namely:

- 1) To promote the socially responsible use of the new technology;
 - 2) To provide an education forum for groups interested in the implications of the new technology;
- so I suspect that you would only be welcome if you were ideologically sound. Anyway, if you are interested, contact The Community Computing Network, c/o CODA, 135a Mansfield Road, Nottingham NG1 3FQ.

If you have any queries about any of the information in ACC news, or wish to find out about the ACC, then please contact me: Rupert Steele, ACC Membership Secretary, St John's College, Oxford, OX1 3JP.

NB: You must put my name on the envelope, as the ACC is not associated with St John's College, which is where I happen to live.

TRANSACTION FILE

Readers will be pleased to know that, due to our clever layout ideas, the Transaction File is up-to-date and waiting cut down considerably. Ads are accepted only on the form below for a flat fee of £2.50. Please don't specify issues as we can't oblige. Ads cannot be repeated unless separate forms are sent in. We will only accept entries from non-commercial readers. Thank you for co-operating.



- * 16K ZX81 — PSU, leads, manual and 32 bit i/o board, (for sound, control, etc.) also software; QS DEF, ZXAS, Scramble, + more. Only £85.00 excellent condition, 2, Barton Rise, Chilton Polden, Bridgewater, Som. Tel. (0278) 722588 E/W Ends.
- * TRS80 Level 2 — 16k VDU cassette recorder manuals, dozens of games, adventures, utilities, scripsit, Edtasm, Tasmon, worth £850 accept £350 (includes delivery). Tel. Mr Williamson 0733 63141 ext. 570 during daytime.
- * ZX81 and 16k RAM — Also many m/code games including Asteroids, Defender. Plus book w/ over 40 programs, plus 5 issues of 'Sinclair User'. Will accept £80 ono. Telephone: Worktop 770887.
- * 48k Nascom2 — Gemini 64k/

- EROM cards. Romed, Zeap2.1, Nadsis, Debug, Ext-Basic. Colour. H.R.G. 4k 8 tape. 8Apsu. Vero case. Enormous software library. Eprom prog. £725.00. P. Smith, 23 Sandy Close, Petersfield GU31 4HF. 0730 4059.
- * Video Genie EG3003 — 16k hardly used, condition as new, £180 ono. Tel. 01-440 9498.
- * Knights super machine — code tape, includes free space invaders. (for Sharp MZ-80k) Excellent value the best at only £25 (worth nearly £40). Phone Mr Morris on Wrexham (0978) 365875 after 4pm.
- * PET 3032 — 32k. Toolkit, chip. Cassette recorder. Many program tapes, magazines and Pet manuals. All excellent condition. £400 ono. Near Wolverhampton. Tel. Codsall 2341.

- * UK101 8k RAM — cased with number pad, 300/600 baud switch, many programs, cassette and T.V. £300 ono. Will swap for 8k RAM small keyboard pet. Phone Welwyn Garden City 35949 after 4pm.
- * Apple II — plus single disk manuals, programs including database £925. Also Sharp MZ80k 120 programs. Documentation. Duvostore £325 Tel. Stratford upon Avon 298187 (Weekends).
- * Nascom-2 — 32k kenilworth case, 5 card expansion rack, Basiccomp sound board, software toolkit, Vortex (graphics), Assembler, £400 ono. Phone D. Keeling 051-709 0516 (daytime).
- * Superboard II... — 16k, two monitors, power supply, cased, 6-inch television, all leads, basic 5, Toolkit, enhanced screen, 12k

- Rom, manuals, newsletters, games, including invaders, Assembler Editor. £125 ono. Telephone: 01-897 0620.
- * Acorn Atom — 6k RAM, 8k RO ROM +PSU, Manual, leads, seven programme cassettes (educational and games). Ready to run. Ideal for learner. £90 ono (plus carriage). Nicholls, 01-670 8605 (evenings).
- * Sharp Mz80k — 48k RAM excellent condition £250 reason for sale upgrade Tel 0705 811760.
- * ZX81-1k, Sinc built, inc all leads and adaptor, original packing, manual and PSU. Exc condition. £40 tel: 01-883 0085, after 6pm.
- * Sharp MZ80k — 48k, excellent condition, (boxed) dust cover, £200 worth software inc. chess, adventures, forth and assembler. Green and blue screens £440. St. Albans 65580.

- * Tandy microprinter — electrostatic type. 80 column facility. 3 type sizes — electronics interface. Boxed 1 unused with roll of paper. Need money for discs. £100. Tel. 021-444 4954 evenings/weekends.
- * Apple II+ — 48k autostart ROM disc drive with controller, 9in Hitachi monitor, EPSON FX80/FT Epson interface, Applewriter, Microchess, Toolkit, manuals etc. £1,100 ono. Tel. 0226 297610 after 6pm. Reluctant sale!!
- * MZ-80k — +48k + £350 + £200 worth of games + forth fortran pas Pascal and super 5060 VM. Basic must sell soon: £350 ono (unwanted present). Tel. Frodsham 33978 after 4.00, anytime weekend.
- * MZ-80k Software — Frogger 8k long; 4A. Dcflight 2 player graphics game, 7k long £3.50 48k

TRANSACTION FILE

Adventure 20+ full screen pictures £5, 6k Disassembler £4. Mr G.W. Smith, 7, St Davids Grove, Birmingham B20 1BT.

* UK101 — 8k RAM, new monitor, cased, inc leads, manual and programs. 300/600 Baud, under 1 year old. £150 ono. Tel: 01-529 5325.

* Centronics 308 — Dot matrix printer with manual and some spares suit heavy duty application £320. Tel. Ely (0353) 778446 evenings.

* Seikoshu GP100 — graphic printer, as new £185. Tex Eprompt U.V. Eraser plus 2716 Eproms £20 Tel. Watford 48505 evenings/week ends.

* Atari VCS — inc five cartridges Combat, Space Invaders, Breakout, Lazer Blast, Asteroids, £150. ZX81 plus PSU and Casio FX501P, Library, interpack and master pack £100 ono. 01-556 0395.

* Acorn Atom — 12k Rom 12k Ram 1 I/O ports. Carefully built and maintained by professional engineer. User manual all leads home-made power supply £185. Tel 368 9023 evenings.

* 48k Sorcerer... — with basic Rompack, development Pac and 9" Hitachi Monitor. Various software, Forth, Chess, Asteroids, etc. Also including manuals leads and club magazines. £675 ono. Tel: Brighton 557757.

* TRS80 16k Lower-case — £225. 16k expansion interface unused £200. Aculab floppy tape £125. Buy the lot and get Editasm, Scripsit, Pyramids, Sargon, Monitor3, all for £50. Phone: Chelmsford 329541.

* TRS80 48k monitor — twin disks IBM golfball printer, centronics 779 printer, newdost+, Ldce, sales ledger, Superzap. Many more prog. £750 might split. Tel. 01-637 4135 daytime Lea Valley 714209 (evenings).

* BBC Micro Model B — avoid the queue. Various software: Invaders, space — Warp, Toolkit, etc. Joystick, user Port, etc. £380 ono. Tel: Horley (029-34) 4405.

* HP-41C/V Card Reader — complete with manual and 15 cards. As new. £110. Tel: 66-51462 after 7pm. 5, Lansdowne Avenue, Orpington, Kent. BR6 8JT.

* Tangerine Microtan, Tanex, — 2Kram, Xbug, Basic, Apple Keyboard. Worth £250. £150 ono. includes 8 issues. Tug newsletter. Tel 01-977 9540 after 6.

* Apple software at half price. — 7 original Apple Games Programs for sale at half price. Phone Terry on 0782 564561.

* ZX81 Sinc built — with 16k RAM Manual leads mains adaptor book and cassettes worth £30 including 3D monster maze and asteroids £75 ono. Telephone Great Missenden 5098 evenings and weekends.

* VIC 20 — with commodore cassette unit, mains adaptor, R.F. modulator and about fifteen programs six months old. As new £190. Phone Glenboig 874264 (after 5pm).

* Video Game System — EG3003 with some software £210 ono. Phone 01-251 0959 evenings.

* TRS80-LII 32k — Exp/int. Num/Keypad, single Tandy mini disk drive, Tandy VII printer, Zend/and script sit. Offers! ASR33 ASCII Terminal 110 Baud 20mA tape Punch Reader, Hand-books, stand £130. Worthing 501425.

* Acorn Atom — fully expanded with PSU and VIA chip + invaders and chess programs. £195. Panasonic cassette recorder with leads to work with Atom £20. London SW1 Tel. 01-730 7065.

* TRS80 16k L2 with VDU PSU cassette recorder manuals 1/2 various books on games instructions and 24 cassettes including 'sound' 'Music master' etc. One owner home use as new £380. Tel. Bagshot 71902.

* CBM/PET system 8032 — 8050 950k dual disk drive, 3022 tractor printer, complete with cables, manuals Visicalc. Mint condition (50 hours use only). House purchase forces sale hence cash price £1500. Tel: (01) 452 8020 ext 389. (9-5) R.G.Ormerod.

* PET 3032 — 202 printer Computhink, 400 disk-drive Data-base, many games assembler and toolkit programs. All for £675 ono. Also 2001 series Pet with many games plus second cassette deck — £260 ono or both. £910. Telephone David 01-940 2077.

* Casio FX702P — unwanted present in original box manuals etc £70 ono. Upper Warringham 5737.

* ITT 2020 with 3.3 disc drive many extras including jail-break, type-right, 64k memory and masses of software. £800 or offer. 01-864 3492 evenings and week-ends.

* Commodore 4040 — twin disc drives and 3022 printer. V.G.C. littel used. Includes original packing cables manuals etc. £750 the pair O.V.N.O. phone 202-9630 (work) 953 5900 (home).

* Sharp MZ-80k — 48k, Perfect condition. Cover, software, fourth, and basic. Basic tutor book, subscription to users group, programs inc. The Valley and Space Invaders. Price £310 ono. Tel. Walsall 26201.

* ZX81 and 16k RAM — mains adaptor, leads and manual all £100.00 ono. Andy Field. Day-time 09328-66777 evening 01-570 7724 (Hounslow).

* PET 32k — new ROM, L/keyboard, superchip, toolkit assembler, reset switch, cassette recorder with sound tapecontainer. 20 tapes; asteroids, cosmaids, s/glooper, 3-d Startrek, micro-chess etc. Manuals dust-cover v.g.c. 4495. Tel. Burley (Hants) 2294.

* Video Genie I — EG3003 16k new keyboard and display functions with sound some software books manuals £250. Tel. 01-309 2086 Sidcup Kent even.

* Triton — computer 11k RAM, basic and editor assembler in Eprom, metal case and many extras. Cheam Surrey, Tel. 01-

642 1359, after 6.30 pm, £200 o.n.o.

* TRS80 LII — 16k complete with monitor and CTR80 recorder — As new £350.00 ono. Tel. Birmingham (021) 443 5399.

* Sharp MZ-80K 48K — with £300 worth software including assembler, machine code, Forth, Fortran, Pascal, Invaders, Adventures and many others. Worth over £600. Sell for £350 Phone: (0834) 813021 after 4.

* "WORD PACK" — Rom by Acornsoft Ltd for Acorn ATOM. Fits utility ROM socket. If you have a printer you need this fast wordprocessor. £17. B. Carroll, 42 Manor Rd, Aldershot. GU11 3DG. 0252-22539.

* BBC Model B — unused £395 ono. Tel. Chester 534462 6 weeks old. Why wait for ages when you can buy mine. Reason for selling have bought business system instead.

* UK101 8k — cased Cegmon, MONO2, 600/300 Baud, Fan, Osi, assembler, manuals. Much software one year old: £175 phone Leicester (0530) 32563 after 6pm.

* Wanted Televideo — Terminal service manual model TVI-912. £15.00 paid for good copy or original. Call Rodney on 0705 731478 or write to Rodney 75 St Ronans Road, Southsea, Hnts PO4 0PP.

* TRS80 Model I (Level II) — CPU wanted for spare parts or repair any condition considered. Offers phone Derby (0332) 550408 evenings or weekends.

* Acorn Atom — 12k - RAM 12k - ROM including games e.g. 747 Startrek, etc. Full leads and manuals acorn built £200 5V-5A power supply in case purpose built new £50. Tel. 02404 3071 eve.

* Intellivision super condition — still in box + 12 cassettes; skiing bowling, astromash, boxing, basketball, tennis, etc. Cost £415 — sell £275. Telephone 204 6170 Monday to Friday after six p.m.

* TRS-80 expansion interface — with 32k maximum memory. Only 4 months old, perfect condition £200. R.J. Mottram, 39 Peterdale Drive, Penn, Wolverhampton, West Midlands, Tel. 0902 342254.

* 8k PET 2001 — new ROM, large keyboard, + cassette + superchip + manual + dust cover + 50 programs £4.00 ono. Tel: 052 789 3204.

* Apple II 48k — £400 Monitor £25. Cards — Centronics £80 serial £50, colour/Modulator £50, language £70 disk/controller £250 Software — Visicalc £80, Applewriter £30 Database £20, numerous games £50. Brookwood 6196.

* Sixteen Atari — and three Activision cartridges for sale very good condition. Includes Pac-Man, Missile command, asteroids. Cost owner £500 will accept £250. Phone Norwich 411089 weekdays between 7pm-9pm.

* Sharp MZ-80K 48k Green screen. Languages: Assembler, Machine, Basic, Knight, command

commander, m/c loader, disassembler, +115 programs worth £400. All only £500 o.n.o. Tel. Poole (0202) 678947.

* Video Genie — 16k inc VU Meter etc. Complete with leads, TRS-80 manual plus other books etc. Genuine reason for sale £100 or exchange for reasonable printer. 01-592 3000 ext 2165 day 03756-79533 evenings.

* Atari 400 — 32k (normally £60 extra, also Atari 410 tape recorder, full technical manuals, asteroids, star raiders, galaxians, four joysticks. New £470, only £350. Tel: Shoreham-by-Sea 62296 after 6pm.

* NEC Spinwriter — 55 cps centronics parallel interface. Brand new but perspex front broken, awaiting replacement. £1250 for quick sale. Tel. Great Grandson (07677) 503 (Beds) after 6pm.

* Apple accessories — the following hardly used items are available for sale — DB Master £100, Videx card £140, Digitalizer card £70, Locksmith £35 please ring Harlow (06284) 73776 or 73074.

* PET 32k — Model 3032 complete with commodore cassette deck and manual £350 ono. Phone Glenrothes 771092.

* 8k PET — New ROM 3008 expanded to 32k cassette deck, s/ware, manuals and cover. All for £425 or best offer. Phone Imerio 01-452 4555.

* Video Genie — EG 3003 48k expansion interface TEAC disk drive Newdos TRSDOS, Scripsit (lower case), profile DBMS quality games with sound. Eleven month guarantee £660 printer optional, telephone Hatfield (07072) 65466.

* TRS-80 16k LII — + VDU, cassette recorder, stringy floppy with 10 wafers, quick printer 2 and over £350 of software (including II adventures). Excellent condition. Sell £450 (no offers). Telephone (01) 540 2696 (bargain).

* MZ-80A Sharps — software pack plus forth Pascal and machine code also 100 games and new £20 chess game. £400 the lot. Williams 49 Wye Court, Cwmbran, Gwent. Tel. 06333-64712.

* PC-1500/PC-2 — with plotter, leads & manuals. Only 2 months owned. £300 with my software & printouts. Also Tandy Voxbox: £25 Brand New. Call 01-937 0148 or 01-937 5578 in London for info or offer.

* Atari T.V. game — computer inc. Asteroids, Air, Sea Battle, Space Invaders, Combat, Laser, Blast. Cost over £220. Nearest offer to £175, ask for Stephen on Chester 300 545, after 7pm.

* Epson MX70 — printer with Apple type II interface and manuals £250. Telephone 01-737 2638 (London).

* TRS80 — LII, 16k, numeric keypad, cassette, as new, inc manuals, books, and software (Star Trek) etc. All reasonable offers considered (£260 ono.) Tel. 0634 721672 (evenings).

* Pet 32k, — Basic 4.0. 1 year old, excellent condition with over 200 programs, Hi-res graphics board, cassette unit, soundbox, reset button and some pet books. Only £420. Tel: Wokingham 788024.

* ZX81, 16k RAM, — printer, all sinc built, commercial software, manuals also ZX80/81 upgrade also Rockwell Aim 65 in case. Offers? Owner rationalising. 01-864 1788 evenings.

* Tandy quick printer — £100: Tandy quick printer II £75: Aculab Floppy tape drive £125: Tel: Leicester 700619.

* MZ-80K Sharp — 48k 15 months guarantee left BASIC chess space invaders with extras. Exc. cond. £325 ono. Wakefield 373255 or 368239.

* Seikoshu GP80A printer — and RS232 Interface GP-80010 as new. Hardly used. £200 separated £175 and £40. manuals included. Conta Contact John, 45 Callan Grove, South Ockendon, Essex. 0375 5122 Ext. 26, daytime.

* Texas TI-59 and printer with packets. Excellent condition. Numerous magnetic cards. Skid at £150 o.n.o. Telephone London (01) 850 6737 after 7.30 p.m. (Douglas Vere — Dresser).

* MZ-80K Defender Style — fast m/c game. Thrust, Hyper-space, smart bomb, etc. Hall of fame and bonus lists at every 5000 points. Send £5.00 to P. Ellis, 171 Dyche Road, Sheffield S8 8DR.

* MZ-80k as new — 16 games assembler, monitor listing, 6 books (three sharp), manual, speed basic. £300 boxed. Tel. Wokingham 783999.

* PET 2001 32k — new ROM small keyboard and integral recorder, green screen, dust cover, several games and books £320. Tel. 04895 3846 evenings (Portsmouth/Southampton area).

* Acorn atom — floating point Eprom. £15 utility Eprom £18. Bargain price: £30.00 pair. da Davidson, 109 Highgate Lane, Farnborough, Hants. GU14 8AA.

* A 48k MZ-80k — with 320 x 200 Dot - resolution graphics, fully programmable character set, green screen, sharp assembler, all literature and programs. For only £1350 ono! Ring Marlow (06284) 6136 after 5:00.

* ZX81 sinc built — 16k Ram with mains adaptor, leads, manual & 2 tapes plus 4k graphics Rom giving 1064 graphics. £90 ono. Tel. Crucomey (087382) 528 after 5pm.

* OH10 Superboard — 8k — (not working), cased, W/Stuart colour graphics, PIA board, Cegmon, Codekit, Eprom programmer, lots of software plus documentation original cost over £400, bargain at £100. (Pipe Gate) 063081312.

* 16k ZX81 — PSU, leads, manual and 32 bit i/o board, (for sound, control, etc.) also software; QS DEF, ZXAS, Scramble; + more. Only £85.00 excellent condition, 2, Barton Rise, Chilton Polden, Bridgewater, Som. Tel. (0278) 722588 E/W,Ends.

Transaction File advertisement form

All Transaction File ads must be submitted by readers on this form or a photo-copy of this form. Maximum 30 words. Print one word per box, very clearly. Name, address and/or telephone number must be included in the 30 words. All ads must be accompanied by flat fee of £2.50. Make cheques or POs payable to Sportscene Publishers (PCW) Ltd. Ads accepted from private readers only. Ads cannot be repeated (unless sent in on another form) and we cannot guarantee to print an ad in any specific issue. Please help our typesetter to help you by printing your ad very clearly. Send form to: Transaction File PCW, 62, Oxford Street, London W1A 2HG.

Please find enclosed my cheque/PO for £2.50 for the following Transaction File ad.

TRANSACTION FILE

★ TRS80 Level 2 — 16k VDU cassette recorder manuals, dozens of games, adventures, utilities, scripts, Editasm, Tasmon, worth £850 accept £350 (includes delivery). Tel: Mr Williamson 0733 63141 ext. 570 during daytime.

★ ZX81 and 16k RAM — Also many m/code games including Asteroids, Defender. Plus book with over 400 programs, plus 5 issues of 'Sinclear User'. Will accept £80 ono. Telephone: Workop 770887.

★ 48k Nascom2 — Gemini 64k/ROM cards, Romed, Zeap2.1, Nasdis, Debug, Ext-Basic, Colour. H.R.G. 4k 8 tape, 8APSO, Vero case. Enormous software library. Eprom prog. £725.00. P. Smith, 23 Sandy Close, Petersfield, GU81 4HF. 0730 4059.

★ Video Genie EG3003 — 16k hardly used, condition as new, £180 ono. Tel: 01-440 9498.

★ Knights super machine — code tape, includes free space invaders. (for Sharp MZ-80k) Excellent value the best at only £25 (worth nearly £40). Phone Mr Morris on Wrexham (0978) 365875 after 4p.m.

★ PET 3032 — 32k, Toolkit, chip. Cassette recorder. Many program tapes, magazines and Pet manuals. All excellent condition. £400 ono. Near Wolverhampton. Tel: Codsall 2341.

★ UK101 8k RAM — cased with number pad, 300/600 baud switch, many programs, cassette and T.V. £300 ono. Will swap for 8k RAM small keyboard set. Phone Welwyn Garden City 359 49 after 4pm.

★ Apple II — plus single disk manuals, programs including database £925. Also Sharp MZ80k 120 programs. Documentation. Discover £325 Tel: Stratford upon Avon 298187 (Weekends).

★ Nascom 2 — 32k kenilworth case, 5 card expansion rack, Basiccomp sound board, software toolkit, Vortex (graphics), Assembler, £400 ono. Phone D. Keeling 051-709 0516 (daytime).

★ Superboard II... — 16k, two monitors, power supply, cased, 6-inch television, all leads, basic 5, Toolkit, enhanced screen, 12k ROM, manuals, newsletters, games, including invaders, Assembler Editor. £125 ono. Telephone. 01-897 0620.

★ ZX81 — Sinc built, 16k RAM, inc leads power supply, machine code book and three cassettes inc Galaxies £70 ono. Tel: 01-950 4286.

★ Apple II — Europlus 48k, disk drive. 12" wide bandwidth TV monitor. Epson MX-80/F/T type II 80 column printer (brand new), manuals, diskettes, s/ware etc. Sensible offers. Tel: Tony Bagshot 72762.

★ Video Genie — 16k with extra keys, lowercase, 9in monitor, Seikosha printer. £425 ono. Will consider splitting. N London. Phone 01 340 2318.

★ HP-41CV incorporating Quadram, together with printer, card reader, maths module and handbooks, all complete, as new cond. £500 ono. Tel: 0903 765634 (J A Clegg).

★ Apple II — plus disk drive, colour monitor, silentype printer, music-card, lowercase, paddles, manuals, exc s/ware, Visicalc, Visiplot, SuperText, EZ Draw, Supergraphics and all the best games £990. Delivered 100 miles Portsmouth 020663.

★ Acorn Atom — 8k ROM 12k RAM, power supply and manuals. Acorn built, 6 months old, upgrading soon so collect for £120. Tel: 0303 77314 after 6.

★ Genie I — AVT monitor plus dust covers, manuals, books and home management progs, all brand new and boxed £350 ono. Tel: Longfield, Kent 6054.

★ UK101 — cased, 8k RAM, Cegmon Monitor, 300/1200 baud cassette rate, 1 or 2 MHz, normal or reverse video, games, £145 ono. ASCII keyboard £14. Harding, Reading 67867.

★ Sharp MZ80K — 48k RAM + manuals, Sharp Basic, Xtal basic, Pascal, Forth, Sharp Assembler, Zen Assembler, Sharp machine code, games & business s/ware. Good cond. Cambridge 51795 ext 51 Mr Miles.

★ Sharp MZ-80K — 48k RAM, as new Hi-Res graphics/255 user definable characters. Monitor listing. Many games, assembler, graphics, Basic, Manuals only £310 ono. Tel: Glen Byram, Derby 0332-792185 eve.

★ Nascom 1 — NAS-SYS monitor, 8k Basic, toolkit, Nспен, 32k RAM, boxed with power supply, s/ware inc Zeap Assembler and

Disassembler and Sargon Chess + others. Full manuals £200 ono. Tel: Hailsham 846254.

★ Genie I — 16k green phosphor monitor, lots s/ware inc Assembler and manual, also books inc Zaks £450 ono. Iain Douglas, 2 Ravenhill Crescent, Moreton, Wirral, M'side L46 3RQ, 051-677 6048 after 6.30pm.

★ Challenger — C2 Computer Cegmon monitor, 8k RAM, 8k Basic, sound output, D/A, video, cassette I/O, 64x32/32x32 screen res, in metal fan ventilated case complete with PSU, cost £475 accept £125 obo. Tel: 0272 659278.

★ PET 2001 — 8k, small kboard, with four manuals and 11 games tapes, inc Microchess. £230 ono. Tel: Nottingham 0602 262498.

★ ITT 2020 — Apple System, UHF colour, 48k, Hi/Low res, Palsoft in ROM, with games controllers and some s/ware (inc integer Basic) £350 ono. Tel: Telford (0952) 617106.

★ VIC-20 + cassette deck — 3k RAM pack Super Lander cartridge and other s/ware worth over £350, will accept £220 ono. Tel: Dewsbury (0924) 451321 after 6.

★ PET 16k — 4000 series with cassette unit. 9in screen many progs worth £550 will accept £400 ono. Tel: 01-223 1613 after 6 on w-days.

★ PET 3032 — 3040 disks, 3022 tractor printer, cables, manuals, soundbox, little used exc cond. recently serviced £300 of s/ware inc. Petchess Arcades, Adventures £300. Database. Sale due to upgrade £1800 Cuffley 3507.

★ Gemini — Eprom/ROM board, unused £35. Also, fully working teletype with readers and punch, full service manuals, buyer collects. Tel: Tim, Durham 65591 eve.

★ Apple II — + 48k DOS 3.3 disk drive. Eurocolour card manuals. Lots of s/ware, mostly games and many books. £900 Tel Leicester 546594.

★ BBC Micro Model A — Philips cassette recorder, several cassettes, full guarantee selling due to lack of time. £300. Tel: 577 0323. Ask for Cliff, Houslow.

★ Casio fx501p — program. calculator, hardly used, exc cond. c/w manual and book of progs. Cost £55 accept £27.50. Tel: 07818 2438 (Staffs).

★ UK101 — cased, 8k RAM, new monitor, 300/500 baud, joysticks, programmable sound generator, mini Eprom board, toolkit, manual, s/ware inc Invaders, Supertrk, Assembler, £280 ono. Tel: Bradford 0274 727635 eve.

★ Exchange my SLR camera — Topcon TTL metering, full auto shutter priority and manual, plus matching 135mm telephoto, for your ZX81 plus 16k RAM. Tel: 0532 666487 after 7 or w/ends.

★ Microtan — full Tanex, 16k RAM, system pack, mother board, MPSS supply, ASCII keyboard, ASIMOV word processor, all manuals. List £655. Accept £500 ono, Farnborough (0252) 518549.

★ Commodore VIC20 — with C2N cassette unit only 3 months old, complete with lots of progs. £185 for quick sale. Tel: 01-800 6318 after 6 or 01-357 4453 daytime.

★ Superbrain DD(350K) disks — 64k RAM as new, sell for £1190. Also, Superbrain QD (700k) disks, 64k RAM, as new, sell for £1390. Many s/ware available too. Tel: 01-579 1937 (morning) 01-567 0154 afternoon.

★ Sorcerer — 56K, extended Basic, assembler toolkit, Galaxian, complete with sound plug and all manuals and cables. £450 ono. Tel: 01-390 0936 eve.

★ UK101 — 16k, Mon 2, cased, 5A Sep, power supply, reverse video. Various progs and magazine articles etc. Space on board for 4-Eprom etc. £130 ono. Tel: South Benfleet (Essex) 52847.

★ 16-32K — x16 professionally built RAM card for 9900. Can easily be modified for any 16 Bit M/C. Complete except RAMs, wanted for another project. Diagrams supplied after 6. Phone (0242) 75862.

★ Video Genie I — 16k, sound unit, cover, editor assembler, debugger, adventures: Temple of Apsahl, spider mountain, lost Dutchmans Gold. Any offers of around £130. Considered. Tel: Alan at Billericay 52803.

★ 48k Sorcerer — with business/

games cassettes, manuals etc + Centronics 737 printer. Both mind cond. — offers around £840. Graves, 21 St Pauls Avenue, Witley, Bradford, W Yorks. Tel: Bradford 676194.

★ VIC-20 — nearly new. C2N cassette, super lander, star battle, jelly monsters, cartridges, commodore guarantee. Joystick plus much cassette s/ware. Worth over £300. Tel: 01-777 1678 for details. Eve only.

★ Superbrain — Model QD + s/ware, offers to 01-866 2532. ZX Spectrum — 48k RAM. Only few weeks old (BBC Micro forces sale) £165. Also ZXprinter, little used £45. Will split. Tel: Southend (0702)-75442 after 6.

★ Sharp MZ80K — 48k, with Basic, Sharp Pascal, Hisoft Pascal, Sharp Assembler; Disassembler etc. All booklets inc £330. Tel: Guisborough (0287) 37137.

★ L2 16K — TRS80 Video display, recorder, lower case, Lots of books and s/ware, inc. toolkit, chess, Temple of Apsahl. Upgrading system forces cheap (£280) sale. Phone 01-854 4464 anytime.

★ Video Genie — EG3003 plus over £50 s/ware inc Chess, Startrek, Decathlon £260 complete. Contact Paul Young on Luton 413032 (work) or 413737 (home) or at 5 Mullion Close.

★ Apple II+ — with single disk drive and 14in colour monitor some games disks. £1100. Tel: 01-889 9702. K L Yeap in the eve.

★ Acorn Atom — 12k + 12k with PSU, manual and s/ware (inc games) s/w new £225 ono. Atari TV game complete with two cartridges (combat dodgem) £20. Ono Tel: Hoddesdon 67388 eve.

★ Acorn Atom — 12k+12k, Acorn built, complete working order, PSU, V/A, all leads, manual, magic book, stacks of s/ware inc Invaders, Chess, Asteroids, cost £350, sell £200. Ono. Phone Crayford 528264.

★ VIC20 — Arfon expansion, 19k memory packs, M/C monitor, super expander (inc Hires Graphics), books, manuals, 8 cartridg. games plus lots more s/ware. Must sell at £500 ono. Tel (Eve): Birmingham (021) 382-5283.

★ ZX81 — 32k Sinc built, manual + all leads, 40 games + book. Sinc cassette, games inc Draughts, Zombie, per work order £95 ono. Tel: 041 779 3642 after 5.

★ VIC20 — Arfon expansion chassis fit lid value £107, sell £70 Commodore programmer aid cartridge £20. Vickit programmers aid ROM £10. VIC Revealed £5. Mossley's reference guide £6. Mossley 2080.

★ VIC-20 — Datasette, (6m old and boxed as new) programmers reference guide, Joystick, dust-covers and £40 of s/ware. Over £300 of equipment, selling for just £235. Tel: David on (0602) 201321.

★ Nascom 2 — 32k, NAS-SYS 3, NAS-GRA, HI-RES graphics, (384x224) by I/O systems, PSU, all in Kenilworth case, mother-board with expansion space, manuals, leads: £380. Tel: Welwyn (043871) 4678.

★ Wanted — Acorn Atom; 12k ROM, 12k RAM, FF, colour, sound, H/Res, Cassette Recorder, Joysticks, Manuals, Programs and/or with light pen. Phone 01-840 3610. Give details and price. Thank you.

★ Printer-Nascom Imp — 80 columns upper/lower case at 50 lpm. Friction/tractor feeds 9.5in paper. 1k character buffer, RS232 interface. Little used. Cost £373. Accept £175 ono. Portsmouth 817643.

★ ZX81 — 16k RAM, PSU, manuals, + Q3 mother board and Q3 programmable graphics generator + s/ware (inc Invaders, Chess, ZX81 pocket book). Worth £180, quick sale, £90ono. Phone Banbury (0295) 54896 (eve).

★ Nascom 2 — 8k RAM, Basic, assembler, compact power supply, full documentation, fully working as new cond. Offers around £200. Tel: 01-673 6999 after 6.

★ TRS80 — Line printer Vii and interface cable. Immaculate cond, four months old, plus all documentation and paper — offers above £180. Tel: Airdrie (023 64) 52034.

★ Apple 2 Europlus — 48k, disk drive, controller, 16k language card, Z80 card, CPM, Pascal,

Serial + parallel cards, Visicalc, compiler, Microsoft Adventure, Microchess, Sargon, toolkit + software + others. £1150 ono. Tel: (0203) 415509.

★ ZX81 — 16k RAM Dktronics keyboard, all leads etc. Defender dictator, startrek + more. Four useful books, all for only £85. Tel: Southend (0702) 75442 eve.

★ DA1 — 48k, 16 colour computer with stereo sound, serial and parallel ports. Over 30 progs inc Invaders, Sargon Chess, 8080A assembly package + manual: £500 ono. Phone 802-1280 after 5.

★ PET3032 — 32k, new ROM large keyboard, toolkit latest cassette with counter lots, games progs, manuals, only 9m-old, exc cond. Tel: Winchester 67240 after 6.30 or w/end £475 ono.

★ UK101 — cased, 40k RAM, 10k Basic, Cegmon, interface boards comprising V/A, P/A, PSG, A.D.C, DAC. Many other features, inc s/ware. Sensible offers only please on St Albans (0727) 53946 eve.

★ Acorn Atom — 12k+12k processor ROM cassette recorder monitor (green screen) all leads, s/ware manuals and other book offers. Around £260. Tel: Ingrebourne 75887 night. Romford 41821 day speak to Peter.

★ ZX81 — Sinc built, almost new, all leads PSU manual, + Sinc games tape and Cambridge collection of 1k progs. Only £40. Tel: S Durbun, Maidstone (0622) 45258 (Eve).

★ Microtan 65 — uncased, fully expanded Tanex, ASCII, keyboard & case, Basic, XBug, MPSS, Hi-Res, Graphics plus s/ware in ROM, Motherboard, manuals £400 ono. Seikosha GP80A printer plus paper £150 ono. Tel: Burscough (0704) 893785.

★ 64k — Bigboard, all options, green VDU, keyboard PSU, two Shugart 8in drives. Cased and running CP/M. £1,300 ono. Will split. Tel: Eamonn Cranny 01-623 7511 ext 2043.

★ PET 2001 — 32k Toolkit super-chip. Green screen, new ROMs programs books. £45 ono. Tel: 01-953 7320 Elstree.

★ Atari IV — game with four cartridges, paddle controls, mains adapter £80. Tel: Chesterfield 569423.

★ MZ80K — 48k, immaculate 1yr old. 1yrs guarantee, over 70 of s/ware and books. Service manual. Dust cover £350 ono. Tel: 0273 771031 after 6.

★ TRS80 — LII 16k with numeric keypad, green screen monitor and soundbox. Many books and manuals, offer £100 of s/ware inc Editasm + price £290. Tel: 0942 814597.

★ Hardly used — complete Apple/Tabs business system available exc value for £2300. Ring Marlow (06284) 73776 or 73074.

★ TI59 — program. calculator 960 steps, 100 memories, magnetic cards. Boxed as new inc. everything charger, cards, module, mint. £40 for quick sale. A genuine bargain. Tel: Chris 0632 462306 anytime.

★ TRS80 — 16k LII + 12" TV + recorder + £100 s/ware inc. Defend + LII/II manuals + £45 of books + s/ware catalogue (Molliex) + many extras. Boxed, worth £650. Save £320!! will accept £332. Blackpool (0253) 48018 after 5.

★ HP27 — with adaptor/charger handbook, pouch, still vgc. Offer £35. Ono. Also HP41C four application modules. Home-mgmt. Securities. Aviation statistic offer at £25. Each or £90 all ring. Kang 01-703 4621 eve/w end.

★ ZX80 — with 16k RAM and 8k ROM, modified to give full slow mode moving graphics, all leads, manual and games inc. Quicksilva Defender and Asteroids. £50. Tel: 01-337 3533.

★ Apple II — Europlus 48k DOS 3.3 twin 4 1/2in disk drives, green monitor silentype printer DOS toolkit lots other s/ware, 4 months guarantee remaining. All perfect £1300 ring Grimsby 824238.

★ Video Genie — 48k LII, extra keys, sound, joysticks, manuals, books, magazines, green VDU, Level meter. over £400 s/ware, adventures, toolkits, Arcade, Editasm+, compiler, Pascal. £600 ono. Tel Faversham 533551 eve.

★ Chess Computer — challenger seven. Full size, not a cheap! Every possible function inc 7 levels, charger inc cost £100,

new accept £40. ono. for quick sale. Tel: Chris, 0632 462306.

★ Cheap hardcopy — teleprinter with serial or RS232 interface, 100 baud, uses sheet or roll paper, with circuit diagram and s/ware driver using tape-out on video game. £60. Tel: 01-237 2828

★ Acorn Atom 12K + 12K F.P. ROM. All rear connector. Four books and manuals, including getting acquainted book plus £100 of games cassettes. Perfect condition only £200. Phon+ 061 789 7929 after 6 p.m.

★ UK101, Cegmon, Ohio, G10 expansion board, and single disk unit, 32k RAM, Premier 64x32 screen board, 10 amp, PSU, printer interface, all cased, disk-based software including word processor, £600 ono. R. W. Alderton. Tel: Sheffield 20571.

★ Video Genie EG 3003 32K RAM. Sound, extra keys, Joystick, leads, manuals, £500+ software: Adventures, assembler, Big 5, games, utilities. £100+ books. £350. Moring, The Mount, Hatfield Heath, Essex 0279 730284.

★ UK101 32k cased, Cegmon newmon 32 line 1.2 MHz, 300-600. Baud. Sound, new basic 1, 2, 4, 5, 10kbit, parallel ports. Lots of software and useful documentation. £240. Asher, Tel: Long Eaton (Nottingham) 06076-66593.

★ TRS-80 L II, 48K, UDU, cassette, manual, high res worth £200, software worth £150 including W/P assem, debug, etc. Total worth over £1300 for £800 ono. Tel: 01-542 4624.

★ Video Genie EG3003, 16K, sound, built-in cassette recorder, manuals, loads of software: games, adventures, utilities, music. £280 ono. Tel: Burntwood (054 36) 3729.

★ Casio FX-6020 Alphanumeric programmable calculator 512 steps, 88 memories. Only 3 months old. Microline 80 printer and tractorfeed. Superb condition. Any offers considered. Phone Jeff 01-458 3025 after 7 p.m.

★ Nascom 2 cased 64k CPM DCS-DOS 2 disk disks (160K) Zeap, Nasdis, debug, Xtal. Basic with disk commands ono. Tel: Mike Tumer Stoke-on-Trent (0782) 329248 daytime 324639 evenings.

★ PET 3008 large keyboard, external cassette recorder, dust-cover, manuals, books: "PET/CBM Personal Computer Guide", "6502 Assembly Language Programming", v.g.c. £250. Tel: John Gillham 01-856 3342 (Welling) Eves/Weekends.

★ Microtan 65, Mini Mother Board system Tanex, 8K RAM, Microsoft, Basic, graphics, upper lower case, query keyboard, + numeric +extra, Hex pad, power supply. All cased £240 ono. Tel: 09277 68646.

★ PET 3008 New ROM, with Seikosha GP80 printer. All as new. Games, tapes and manual. Must sell £500 or offer. Tel: 01-567 3547 West London. eve or weekends.

★ Acorn Atom 2k RAM + 82 ROM. Boxed, hardly used, £80. Tel: 051-625 6478.

★ VIC-20 + cassette + super Lander cartridge, Programmers Reference Book. As new, £170 ono. Tel: Leicester (0533) 872168.

★ PET 4032 with cassette. Basic 3.0 and 4.0. £400 ono. Command-o, Arrow, M.L. utilities, assembler/disassembler, and games, Eprom burner, ROM expansion board etc. All worth £400. Will accept offers. Tel: Maldon (0621) 828161 evenings.

★ MZ-8010 (E715). Disk interface plus cable plus master disk and manual for MZ-80K system £75. Parallel interface card for MZ-810 £25. All with full documentation. S. Fielding. Tel: Rochdale 40877.

★ Apple II, 48k Europlus, NEO 8023 printer, two disc drives. Applewriter etc. Virtually new but outgrown! at £1200 complete. Phone 0981 540714 (Hereford) 10 till 5; Tuesday to Saturday. Will post.

★ Apple Software. Visicalc 3.2 £39; Magic window and basic mailer £49. All original disks with manuals in perfect condition. Phone Leeds (0532) 742427 9.30 to 5.30.

★ TRS-80 16K Level 2, green CRT, CI-R-80 deck. Complete with over 100 items. Software including Arcade favourites. Also manuals and books. Sell £395 (worth £500) Tel: 01-600 1893 evenings only.

TRANSACTION FILE

* 6303 CMOS Processor. Fast assembler runs on 32K PET. Disc £15 includes assemblers for 6502 and 6802/03 processors. S.a.e. details. M.J. Tyler, 2 Park View Drive, Cashes Green, Stroud, Glos. GL5 4NQ. 04536-77257.
 * ZX Spectrum, printer, tape recorder, 2 Arcade games, several blank tapes with M/C prog. Why wait. Sinclairs, 10 Weeks when you can get one now. Only £180 inclusive on. Phone Oli on 995 9485.
 * Atari 800. Good condition, Joysticks, Recorder, manuals and many magazines. Games, software worth nearly £300. For good price Phone 997 8597 (01) evenings and weekends only. Urgent. Moving over to Canada soon.
 * Sharp PC-1500 with CE-150. Colour printer/plotter + case. Mint condition. Hardly used. Mint condition. Hardly used.
 * Sharp PC-1500 with CE-150 four colour printer/plotter + case. Mint condition. Hardly used. Lovely machine but no time to use it. £220 ono £320 new. Roger 01-448 2373 evenings/weekends.
 * Acorn Atom one year old. 12K RAM 12K ROM V.I.A. All leads £50+ worth software inc. Invaders Galaxian Manual. Three books £200 D39 (0379) 3273 evenings.
 * TRS-80 Level II 16K. Little used due to exams. All leads and manuals £100+ software including Invaders word processors, Chess etc. £295 ono. TR-80A. Recorder £25. Phone Paul 01-950 9122 after 5 p.m.
 * Sharp MZ-80K microcomputer 48K memory. Basic, green screen and dustcover. Integral VDU + cassette. Many programs, including adventures. One year guarantee. Sacrifice. Excellent condition. Bargain, only £350! Telephone: Manchester (061) 223 4764 - evenings only.
 * Video Genie EG3003 as new with leads, manuals, original box and guarantee includes bomber scramble, books covering 84 programmable games and graphics. Only £200. Tel: Marlow 72107.
 * Nascom 2 48K Ram, Nas-sys 3, Graphics, sound, reliable 4800 Baud cassette, neat cased system (photograph available), Nasdis-Delong, Editor assembler, Basic toolkit, xtal, Basic, many games, full documentation £325. Phone 0935 850416.
 * TRS-80 Level II 16K VDU, cassette recorder, software including Edtasm D-Bug Micro Train, Games books, manuals etc. £290. Tel. Peterborough (0733) 241975.
 * TRS-80 L II 16K V.G.C. Numeric keypad. All leads and manuals, plus books, Pyramid and Microsoft Edtasm. Plus original packing. £275 ono. Tel: Portsmouth 661537.
 * VIC 20 plus cassette unit and seven games. Only two months old. £150. Original packing. Write Mr. Garth, 25 Fellows Place, Millbridge, Plymouth.
 * PET 16K New ROM 2001. Programmers Toolkit fitted in ROM. Large typewriter-style keyboard. External cassette deck. Exc. condition. £450. Includes games and manuals. Tel: 01-554 4470 after 6 p.m.

* Superboard, Cegmon, 24K, Basic's 4, 5 x, Premier screen enhancement (20 screen formats) Eprom-board, ABS case, PSU, Video & TV output, £75. Software value £475 sell £275. Tel: St. Albans 34566.
 * Swap high quality camera and processing equipment for Apple II disk drives and printer plus other peripherals. Tel: Paul Reading (0734) 23931. Cash balancing agreeable.
 * Atari 400/800 Software. Star raiders £20. Air strike £10; Ghost Hunter £12; Protector £13; Canyon Climber £13; Galactic Chase £11; Beta Fighter £8; Supercube £10. Please phone 01-851 5942 after 7 p.m.
 * Nascom-2 64K RAM, boxed with power supply and lots of software (Pascal basic & games) £300. Also Nascom IMP Matrix printer with DOT graphics £200 ono. Tel: 051-487 9586.
 * Sharp MZ-80K-48K 7 months old. Complete with basic manual and games which include Space Invaders and Othello £400. Telephone 0287-23827.
 * Acorn Atom 12K RAM 12K ROM, F.P. PSU, All leads, manuals, Acorn built, software includes getting acquainted with atom, Invaders Flight simulator, Dogfight, ready to run £170. Tel: Garston 74755.
 * Exidy Sorcerer 48K, S100 Expansion unit, 4 x 315K Micropolis drives, IDS printer, monitor, C Basic, M Basic, Word processing pack, CP/M, MDOS and some application packages. £1,600. Tel: 0420 84749.
 * VIC-20 with cassette. Must sell very quick. Buying bike. £125. Ring Kevin on 01-291 0810 SE London.
 * Texas TI99/4 A colour, sound, 16K RAM, unwanted prize, hence very cheap £100 ono. Also cassette £20. Would swap for NASCOM goodies. Phone Dave Sinclair - Copthorne (0342) 712220 weekends.
 * UK101 16K, 12K Basic, Toolkit, Exmon in Eprom. 16/32 screen 1/2MHz. Both switchable. P.C.G., P.S.G., Assembler, HEX Keypad. Cegmon. New Basic 1.3.4. Many programs £185 ono. Phone evenings Mike Salter. 01-529 7858.
 * Sharp MZ80K 48K Sharp printer and interface. Sharp assembler. One year old, one year warranty remaining. As new, little used. Genuine reason for sale. £550 ono. Tel: 031 663 7378.
 * Sharp PC-1211, CE-122 printer, ARC Soft coding pads, 40 paper rolls, programs etc. £110 ono. Toshiba KT-1300 micro-recorder plus 4 cassettes, eraser: £52. Contact Stephen Coates, 105 Freedom Road, Sheffield.
 * Acorn Atom 12K + 12K colour, PSU, printer interface. Software worth £80. All £195. KSR33 Teletype, excellent working condition £75.
 * H. Mardia, Moorfield, Rombalds Lane, Ilkley, Yorks., LS29 8RT.
 * Atari 800 16K 5 weeks old. Still under 2 year guarantee plus 410 program recorder, joysticks, star raiders cartridge and other games on cassette £460. Tel: Symington (Ayrshire) 830176.
 * Atari 400 - 48K RAM Upgrade with basic cartridge, thermal printer, cassette, assembler/editor cartridge.

Complete with all manuals, leads etc. Only few months old. £450 ono. Tel: 304-7529.
 * ITT 2020, 48K, Applesoft ROMS, Visicalc 3.3, Applewriter JC, Pascal, Locksmith 4.1, £425, Seikoshia GP80A, £160, Ikegami 9" monitor, £45, all vgc, Tel: 0272 603252 eve.
 * Sharp MZ 80K - 48K with interfaced Seikoshia GP 100A printer, including dust cover, 4 games cassettes, manuals, printer paper, as new, 8 months guarantee remaining. £600 boxed. Tel. Bristol (0272) 874570.
 * Complete set of PCW's for sale from Vol I No 1 to date. Buyer collects. First reasonable offer secures. Tel: Esher 66442.
 * Texas instruments PC 100B printer cradle for TI 58/59. All leads, instructions, boxed. Mint condition. £45. Mr. Knight Bedworth (0203) 313121.
 * UK101 40K, cased, uprated PSU, Centronics printer interface. Boards and components for PE modules and 4800 BPS cassette interface. Cables, manuals and software. £300. Will deliver. Tel: Luton (0582) 454019.
 * TRS 80 Model 1 Level 2 CPU, Expansion interface, 48K joystick cassette. All manuals and leads. Over 40 programs, mostly games still in original packing £450 ono. Contact C. Knipe, Dalton Hall, Conyngham Road, Manchester.
 * VIC 20 + cassette player + Arfon expansion board, + 8K RAM + 3K RAM + machine code monitor and documentation £320 ono. Tel 037 22 (Ashted) 74282 evenings.
 * ZX81 Sinc built plus 16K RAM (D.K. Tronics). All leads, PSU and manual. 3D Monster maze + adventure programme by Bug-Byte. 2 months old. £65. Tel: Mark + 061 (761) 7617.
 * Acorn Atom, 12K RAM, 12K ROM, including floating point ROM, PSU, Leads, box, manual, 2 books, software including chess. £135 ono. Contact Tim Speight, Fernie Lodge, Husbands Bosworth, Leicestershire. Tel: 0858 880040.
 * TRS 80 Level 2 expanded to 48K with cassette and TV leads. Also some software and manuals. Tel: 01-546 7711 Ext 208 9-5 weekdays. Dave Roberts, £325.
 * Apple II + - Rames 128 card, £230. Rames 16 card, £65, 6522 VIA card £40, or exchange for disk drive or colour card. Ring Beaconsfield 71591 after 6.30 pm, Ask for MAN.
 * Customised PET 4032 features include repeat key, screen print, disc operating system. All ROM based. Reset, VMM sound and other extras. £595 inc 100 + programs. Tel: Chorley (02572) 73263 evenings/weekends.
 * Wanted TRS 80 pocket computer with printer. Will give help with any Maths-type problems if price reasonable. Dr. R. Calver, 6 Albany Road, Bexhill, Sussex.
 * Wanted disk drive(s) and controller, or expansion box for video genie. Will buy separately and will pay a reasonable price. Printer also required. Phone Great Yarmouth (0493) 62101 after 5 p.m.
 * Wanted for TRS 80 Model I: Expansion interface and disk drives. Also back issues of '80

Micro-computing. Tel: David Jackson, 01-304 3991.
 * Wanted Software for Insurance Brokers to run on Act Sirius Computer. Please ring Raja 01-902 5211/2.
 * Wanted VIC 20 + cassettes + "Programmers Reference Guide" for sale £170 cash. 01-802 3946 Peter Brunning.
 * ZX80-16K. Includes many issues of interface, manual, all leads, three books, space invaders and nightmare park cassettes. Ideal for beginner. All for £55. Tel. Stock 840602 Blackburn.
 * BBC Model B as new. Various extras £400. Phone 0256-75717.
 * Video Genie 48K RAM with expansion box, disk and printer interfaces, manuals, leads, m/c, programming book, printer cable, cassette recorder, sound unit. Phone Stevenage (0438) 60056. Selling price £450 ono.
 * TRS 80 Level II 16K with UHF modulator for television. Software includes editor/assembler and many games (including chess, adventures). Tel. Portsmouth (0705) 379411 X302 (day) or Portsmouth 476335 (evening).
 * Microtan 65 10K basic 8K RAM X BUG ASCII keyboard. HEX keypad 19in rack Tanosoft gazette tug. Newsletters ideal system electronics enthusiast. Tel 01 505 3223 eve. £150 ono.
 * Acorn Atom - 13K RAM, 12K ROM, VIA, PSU, all leads, noise-free graphics switch and joystick connector. Also £35 of software and Atom Magic Book £180 ono Phone (0738) 52339.
 * Sharp MZ-80K 48K fitted with reset button. Manuals and software, including games and utilities. £350 carriage paid in Scotland. Bolt 11 High Street, Kiriemuir, Angus, DD8 4EY. 05752-2373.
 * VIC 20 + cassette + 8K expansion + books etc. £200. Denis Yardley, 48 Park Road, Chislehurst, Hants. Phone 4532.
 * Ithaca IA-1010 REV 2-0 S100 CPU board (2 MHz). Tested and working. Full documentation available. £75 ono. Phone John Oxford (STD 0865) 58152.
 * TRS-80 16K LII cassette recorder, manuals, editor/assembler, light usage, £200. R. Hodgson, 23 Atlantic Way, Lowdges, Sheffield S8 7FZ. Tel: 0742 44800 (office hours)
 * VIC-20 and VIC cassette recorder and VIC revealed book. £195 ono. Telephone 01-764 6276 evenings. Hardly used.
 * Atom 12 + 12K still under guarantee! Very good condition. All leads including 5V 3A PSU. Three books + lots of software including Galaxian Puckman Oefender Asteroids Adventures etc only £200 ovo Tel: (01) 254 0742.
 * PET-32K, Basic 4, with cassette £450 8050 disc £700. Also cables, various ROMS, programs etc. for sale. Phone H. Melton, Milton Keynes (0908) 670630.
 * Video Genie for sale. Good condition. Leads, manuals £300 worth of software. £300 the lot. Also 32K Nascom with colour graphics and printer £200 ono. Ring Chris on Tiverton 257 886.
 * MZ-80K Extended basic, cassette and booklet. Keypad, single keystroke entry, auto, renumber, append, delete, find,

show errors, auto-run save, etc. £12, or details s.a.e. 38 South Parade, Bramhall, Stockport.
 * PET 32K new ROM inc cassette sound box. Green screen £150+ software inc invaders asteroids cosmiads + many more £450 ono. Telephone Finmere 7139 evenings.
 * MZ-80K 48K 6 months old. Hardly used with green screen and basic plus. Accounts prog £300. Tel: 943 2410 Teddington.
 * TRS 80 16K L II + cassette recorder + monitor. Lots of software including BIC 5. Edtasm Debut Pascal Ect £275 ono. Also Acualp floppy tape with twelve tapes + software £125 ono. Tel: Tony on Bristol 422373.
 * MZ-80K 48K RAM with 10 months warranty, pascal, M/C + system package, knights forth, fortran, pascal + commander xtal/double/p + disc. Basics plus 100 + programs xtal + Sharp/B £450 ono. 8, Blackdown Avenue, Waterhorpe, Sheffield S19 6NG, S. Yorks.
 * PET 2001 8K Integral cassette deck and VDU. Recently serviced. London area but initially Contact 0227 65948 anytime.
 * Acorn Atom -14K RAM, 12K ROM. 6522 VIA, Bus connector and buffers, external PSU, manuals and software £150. Tel: (0634) 33718 (Medway) evenings.
 * TRS 80 - LII 16K, numeric keypad, PSU, UHF modulator, leads, manuals, etc. Includes: editor/assembler, several books, software (eg. missile command, death maze, crowley manor, etc.) Only £300. Phone: Maidenhead 27854.
 * PET 8K Old ROM. Green screen as new ROM PET's, Integral cassette. Complete with dust cover, manual, 14 games programs. £200. Telephone: South Benfleet (03745) 54633. After 5 p.m.
 * Video Genie - 16K, Boxed with all leads and manuals, plus sound generator worth £35 plus £120 of high quality software. Total worth £480, selling for £245 ono. Tel: 01-340 5414.
 * TRS 80/Genie software edit/ assembler D/Bug space invaders and Zchess. All machine code invaders. Very fast. Worth over £60, will sell £35 ono. Telephone Plymouth (0752) 707962.
 * Video Genie 18 months old. Boxed complete with leads B/White portable TV monitor, manuals, software, joysticks, sound box. £240 ono. Quick sale required. Tel: Faygate 578 (029383) Std Code.
 * Microline 80 Matrix printer with diplomat parallel interface card and disk for printing high-res pictures or graphs on Apple II or IIT. £180. Tel: 01-394 1678 evenings/weekends.
 * Olivetti calculator/computer. Very extensive maths capabilities, printer, magnetic cards storage, 15 digit precision, expansion ports, manuals and accessories £100 ono. H. Suro, C/o Mrs. Walde, 9 Stile Road, Headington, Oxford.
 * Video Genie 16K + sound, extra keys, manuals, leads. Over £150 of software including toolkit and arcade games. Good condition. £250 ono. Tel: (0625) 828549 (Cheshire).

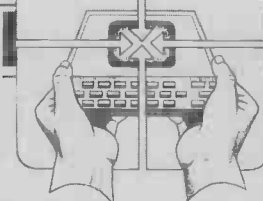

Christopher Bates
 Ashford Main Library
 Church Road
 Ashford Kent

 Derek Knight or Bob Carter
 Rayners Lane Library
 Imperial Drive
 Rayners Lane
 Middx

 Ray Skinner
 62 Central Avenue
 Billingham
 Cleveland TS23 1LN

CTUK! CONTACTS

For further information on ComputerTown UK! see 'CTUK News' or Prestel page *800803 #

- | | | | | | | | | | | | | |
|---|---|---|---|--|---|--|---|---|---|---|---|---|
| Brian Taylor
Tonbridge Area Library
Avebury Avenue
Tonbridge
Kent | Paul Maddison
Gardenways
Chilworth Towers
Chilworth
Southampton SO1 7JH | Peter Jarvis
c/o Health Dept
Corporation of London
Guildhall
London EC2 | Vernon Gifford
111 Selhurst Road
Croydon
London SE25 6LH | Bill Gibbings
3 Longholme Road
Retford
Notts DN22 6TU | Chris Cooper
110 Church Road
Hanwell
London W7 | Lyn Antill
1 Defoe House
Barbican London EC2 | Keith Taylor
Carter Hydraulic Works
Thornbury
Bradford BD3 8HG | Alan Hooley
21 Brammay Drive
Tottington
Bury BL8 3HS | Vernon Quaintance
50 Beatrice Avenue
Norbury
London SW16 4UN | Roger Shears
18 Woodmill Lane
Bitterne Park
Southampton
SO2 4PY | Chris Woodford
31 Hopley Road
Anslow Burton-On-Trent
Staffordshire | Mike Perry, Steve Collas
or Dave Lee
The Library,
Ealing Road,
Weimbley,
Middlesex HA0 4BR |
|---|---|---|---|--|---|--|---|---|---|---|---|---|

CTUK! CONTACTS

J M A Kilburn
(Headmaster)
Shawfield Norden
Community Middle School
Shawfield Lane
Norden
Rochdale
OL12 7QR

Robin Bradbeer
Polytechnic of North London
Holloway Road
London N7

Derrick Daines
18 Cuttings Avenue
Sutton in Ashfield
Notts

Patrick Colley
52 Queensway
Caversham Park Village
Reading
Berks RG4 0SJ

Philip Joy
130 Rush Green Road
Romford
Essex

Pete Shaw
15 St Vincent Road
Clacton-on-Sea
Essex CO15 1NA

Ted Ellerton
25 Beachdale
Winchmore Hill
London N21

Peter J Kiff
52 Stone Road
Broadstairs
Kent CT10 1DZ

Andrew Stoneman
135 Birchdale Avenue
Newcastle-Upon-Tyne
Tyne & Wear

David Sharp
5 Bridgenhall Road
Enfield
Middx

Rex Shipton
17 Woodlands Avenue
Eastcote
Middx

Susan Kelly
Head of Reference
Services
PO Box 4
Civic Centre
Harrow
Middx

Andrew Holyer
10 Masons Road
Mannings Heath
Horsham
Sussex RH13 6JP

Derek Moody
2 Victoria Terrace
Dorchester
Dorset DT1 1LS

Alan Sutcliffe
4 Binfield Road
Wokingham
Berks RG11 1SL

Peter Earthy
46 High Street
Church Stretton
Shropshire
SY6 6BX

Tony Cartmell
54 Foregate Street
Worcester WR1 1DX

R L Saunders
14 St Nicholas Mount
Hemel Hempstead
Herts

Brigitte Gordon
18 Purbright Crescent
New Addington
Croydon CR0 0RT

Richard Powell
22 Downham Court
South Shields
Tyne & Wear

Pam Pollicott
South Ruislip Library
Victoria Road
South Ruislip
Middx

John Stephen Bone
2 Claremont Place
Gateshead
Tyne & Wear
NE8 1TL

USER GROUPS INDEX

are alterations and additions to the complete listing published in the August issue. The next full listing will appear in the February 1983 edition

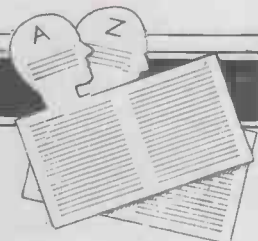

NATIONAL
Irish Amateur Computer Club, recently formed, wishing to hear from anyone interested in computing in Dublin and other parts of Ireland. Contact: Martin Stapleton, 48 Seacourt, Clontarf, Dublin 3. Tel 331304, or send SAE to Brendan Hailgan, 22 Gortmore Ave, Finglas South, Dublin 11.

Sharp Users' mag — for all Sharp computers. Anyone interested? Subscription will be between £4-£6. Contact JP Griffiths, 104 Waterloo Road, Southport, Merseyside PR93AY. This mag will be bi-monthly and is at present only under consideration.

REGIONAL
Dorset — Topic (Tandy Owners Programming & Information Club) for Dorset. Contact: David

Washford, 1, Alexandra Road, Bournemouth, BH6 5JA. Tel: 0202 671122 (day) 0202 423964 (eve).

TOWNS
Bangor & District Microcomputer Users' Group. Meetings fortnightly in Bangor Community Centre, High Street, Bangor. For more details contact: Dilwyn Jones, Fodol Farm, Hafod Lane, Bangor.

Bridgend area. Computer club meets second Saturday monthly at the Pencoed library near Bridgend. Membership £5 pa — £3.50 for OAPs and students. Times are: 3pm-5pm. Contact: Philip Williams on 0656 860307 (after 6pm).

Cambridge Area: MZ-80K User Group. Membership free and if a blank cassette is sent in, programs

from the library can be used. Newsletter also. Contact: Piers Herdrie, 19 Madingley Road, Cambridge CB3 0EG — send SAE for details.

Cambridge — Chesterton Computer Club. Meetings weekly in Chesterton Adult Centre on Fridays at 7.30. Contact: Gillian Turner, 56 Union Lane, Cambridge CB4 1QB. Tel: Cambridge 31201.

Cheltenham Amateur Computer Club. Meets monthly on the 3rd Tuesday of each month (except December). Meetings start 7.30pm at the Prestbury Scout HQ. For further details contact Mike Highes, Cheltenham 75213.

Chiltern Microcomputer Club (South Bucks). Meets first Wednesdays monthly. Contact: Wendy Tibbitts, Chalfont-St-Giles 4906.

Keighley & District Computer Club. Meetings approx every 3 weeks at Keighley Technical College. Subscription £6 per 6 months. Contact Hon Sec Bill Hensman. Tel: Keighley 61681.

LAMS (Loughborough Area Micro Society) meetings held on the 2nd Wednesday monthly at 7.30pm in room N202 of the Haslegrave Building in Loughborough University. Contact: Bob Harding, Human Sciences Dept, LVT. Tel: Loughborough 263171.

Nottingham Microcomputer Club. Please note new secretary: Dr ED Harvey, 68 Roseleigh Avenue, Mapperley, Nottingham. Tel: 0602 608491 (eve) or 0602 48248 ext 2322 (day).

NETWORK NEWS

These are all the European networks of which we're aware. Most are free — but phone them for details.

Forum-80 Hull... (Forum-80 H.Q) Tel: 0482 859169. System operator Frederick Brown. International electronic mail, library for up/down loading software. Forum-80 Users Group, Pet Users section shopping list system hours, 7 days a week midnight to 8.00am, Tues/Thurs 7.00pm to 10.00pm Sat/Sun 1.00pm to 10.00pm.

Forum-80 London... Tel: 01-747 3191. System operator Leon Jay. Electric mail, library for downloading. System hours: Tues/Fri/Sun 7.00pm to 11.00 pm.

Forum-80 Milton... (TRS-80 Users Group 80-Net) Tel: 0908 566660. System Operators: Leon Heller and Brian Pain. Electronic mail, library, newsletter, TRS-80 information system hours: 7 days a week 7.00pm to 10.00 pm.

Forum-80 Holland... Operator: Nico Karssemeyer, tel 01 313 512 533. Facilities: electronic mail, program up/downloading, shopping list. Hours: Tues-Sat 1800-0700 nightly, continuous from 1800 Sat — 0700 Tues.

CBBS London... Operator: Peter Goldman, tel 01-399 2136. Facilities: electronic mail, program downloading. Hours: Wed 0700-0930 & 1900-2200, Fri 1900-2200, Sun 1600-2200.

Mailbox-80 Liverpool... 051-220 9783. System Operator: Peter Tootill. Electronic mail, downloading TRS-80 information.

ACC... members bulletin board, Peter Whittle (0908 44262)

ABC-80... Stockholm, Sweden Tel: 010 468 190522.

University Research Computer... Sweden. Tel: 010-468 23660, guests use password "66,66" for access.

Elfa... Sweden 010 468 7300 706

Tree Tradet... Sweden 010-468 190522.

DIARY DATA

Readers are strongly advised to check details with exhibition organisers before making arrangements to avoid wasted journeys due to cancellations, printer's errors, etc.



Bristol	(Holiday Inn) Business Equip & Services Exbn. Contact: Douglas Temple Design Group, 0202 20533	24-25 Nov
Manchester	(Belle Vue Hotel) Northern Computer Fair. Contact: IPC Exbns Ltd, 01-643 8040	25-27 Nov
Dubai	Gulf Computer Exbn. Contact: Trade Centre Management Co, 01-930 3881	13-16 Dec
Swansea	(Leisure Centre) Microshaw. Contact: Centre for Trade & Industry, 0792 50821	13-15 Jan
USA	(Atlanta, Georgia) Southcon Electronics Show. Contact: ECL (Exhibition Agencies) Ltd, 01-486 1951	18-20 Jan
Birmingham	(NEC) Which Computer Show. Contact: Clapp & Poliak Europe Ltd, 01-747 3131	18-21 Jan

MICROMART

**northern
computers
offer even more**

Apple II Software
Apple III Disk Drive
BBC micro computers Printers
Acorn Atom Second Hand Computers
VIC 20 Tape
Newbrain Recorders
Prestel adaptors Books

**ALL ACCESSORIES SALES
AND SERVICE**

Easy parking off the M56
(Junc. 12)



**northern
computers**

Tel: Frodsham
(0928)
35110

micro computer systems for all applications
Churchfield Rd., Frodsham, Cheshire
WA6 6RD

BBC SOFTWARE

INTRODUCTORY OFFER

GOLF £4.95
**GALACTIC MISSION
£4.95**
BACKGAMMON £6.95
5's AND 3's £5.95
CHANNEL £3.95
BLITZ £3.95

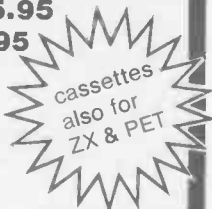

Orders or s.a.e.
for catalogue
to

MICROPLUS SOFTWARE
6 LITTON WAY, LEEDS LS14 2DL

GAMER

VIC 20	£129 plus VAT
DRAGON 32	£173 plus VAT
SHARP MZ80A	£433 plus VAT
ATARI 400 (16K)	£173 plus VAT
ATARI 800 (16K)	£390 plus VAT
EPSOM HX20	£402 plus VAT
VIDEO GENIE (16K)	£299 plus VAT
ATOM (Assembled)	£150 plus VAT

+ software, books, chess computers
+ Intellivision + Ace TV games
+ SF, Fantasy & Wargames

BRIGHTON 24, GLOUCESTER
TEL 0273 698424

PROGRAMS

PCW is interested in programs written in Basic, Pascal, Forth, Logo and Comal — all of which being languages we've covered in previous issues. Please supply your programs on disk or cassette with all necessary documentation (so we've got a good idea what it's about and how much memory it uses) and, if you can, a clear listing on plain white paper.

As all programs in PCW are checked either by a referee or by one of the editorial staff, it can take some time for a program to actually appear. If you don't hear from us within two months or so, it usually means your contribution is in the referee pipeline. It's essential to ensure that your program is fully debugged before you send it in — get a friend to try it out first — and all programs we publish are paid for at a regular rate. Send contributions to: Maggie Burton, PCW Programs, 62 Oxford Street, London W1A 2HG — and please enclose an SAE if you want material returned.

Getting competitive

This should keep you on your toes: to introduce a bit of healthy competition into 'Programs' a prize of £25 will be awarded to the writer of the 'Program of the Month'. This'll be on top of what would normally be paid for a program.

Any contribution sent in for 'Programs' will be eligible, including those I've had in the pipeline up to now. It'll be judged on several criteria — annotation, ideas and their implementation, use of a machine's facilities, user friendliness, originality and innovation.

From the January issue onwards the masterpieces chosen will be specially marked and I'll give an explanation as to why each program is chosen. Length won't matter — unless your program is actually too long to fit in — and all programming languages normally accepted are eligible. So if you've lost interest in that program you've been bashing away at for the past few weeks/months/years, Program of the Month should prove incentive enough to get it finished.

Lastly, I'll here remind readers that no correspondence whatever will be entered into regarding PCW's judgement on programs.

PET Firebird

by Michael Fok

There must be thousands of sticky-fingered, bug-eyed space game addicts who'll find this game keeps them happy over Christmas. It combines many of the dubious qualities of Asteroids, Space Invaders and Phoenix in a series of four little sub-games and it's even got a story behind it. Unfortunately the text in this listing could be improved by some discreet editing, but it's readable and easily absorbed.

The rather comprehensive instructions are entirely optional, as they're a separate program occupying almost 5k. If you don't feel like typing them in you can read them from the listing. The game itself takes up just over 7k. Both programs use machine code which

occupies the second cassette buffer and when the instructions have run the program exits, so to avoid keying-in twice (as you have to type NEW between instructions and game), save the instructions before you run them. Once you've typed NEW, run the game. Pressing key 'N' after running will prevent the 'STOP' key from being disabled — on a 'new ROM' PET.

In the first three stages of the game you can cheat by pressing 'C' (if you're the cheating type), but this won't actually make things much easier as you can't cheat on the fourth stage. Firebird will run on any PET. It was tested using Basic4 and Basic2.

Game

READY.

1 REM	*****
2 REM	***FIREBIRD VERSION 1.1***
3 REM	*****1.FOK -82*****
4 REM	*****
5 REM	

CASES

Protect your computer with a custom built shockproof solidly constructed case to your own special design and size. Ring or write for a quotation.

Cowfold Cases
Redlion Stables, Cowfold,
West Sussex. RH13 8BT
Tel: Cowfold 760

\$100 Memory cards

16 and 32K bank selectable 1EEE standard 250 nS speed, on card power regulation

16K £45 inc. VAT

32K £50 inc. VAT

Postage £1

Send CWO to:

LOWE ELECTRONICS LTD

Chesterfield Road,
Matlock
Derbyshire. DE4 5LE

PROGRAMS

```

6 REM
7 REM
8 FORI=1TO100:GETA#:IFA#="N" THEN30
9 NEXTI
10 IF PEEK(50003)=1 THEN POKE144,49
15 IF PEEK(50003)=160 THEN POKE 144,88
20 IF PEEK(50003)=0 THEN POKE 59458,255
30 ER=515-(364*SGN(PEEK(50003)))
100 REM***FIREBIRD ATTACK***
110 DEF FNA(RX)=32768+RX+RY*40
120 AX=20:AY=21:EX=2:EY=1:F1=0:F2=0:F3=0:DI=1
130 Y#="XXXXXXXXXXXXXXXXXXXXXXXXXXXX"
140 RESTORE:GOSUB8350:GOSUB7000:POKE FNA(RX),1
200 PRINT"R"RIGHT$(Y#,EY);TAB(EX);"
210 IF F1=1 THEN 300
220 EX=EX+DI:IF EX=2 THEN DI=1
230 IF EX=35 THEN DI=-1
240 IF RND(1)>.95 THEN F1=1
250 PRINT"R"RIGHT$(Y#,EY);TAB(EX);
260 IF H=1 THEN H=0:PRINT"R";:GOTO280
270 H=1:PRINT"R";
280 IF RND(1)>.6 THEN PRINT"R"
290 GOTO400
300 G=0+1:IF G=2 THEN G=0:EX=EX+SGN(AX-EX)
310 EY=EY+1:IF EY=22 THEN EY=1:F2=1
320 PRINT"R"RIGHT$(Y#,EY);TAB(EX);
330 IF H=1 THEN H=0:PRINT"R";:GOTO350
340 H=1:PRINT"R";
350 IF F2=1 AND RND(1)>.95 THEN F1=0:F2=0
360 IF RND(1)>.6 THEN PRINT"R"
400 SYS826:IF PEEK(FNA(RX))>01 THEN AP=FNA(RX):GOTO9050
405 POKE FNA(RX),32
410 A=PEEK(ER):IF A=42 THEN AX=AX+(AX>2)
420 IF A=41 THEN AX=AX-(AX<36)
430 IF A=45 AND F3=0 THEN F3=1:LP=FNA(RX)-40
435 IF A=31 THEN 900
440 POKE FNA(RX),1
450 IF F3=0 THEN 200
460 POKE LP,32:FORI=1TO3:LP=LP-40:IF LP<32768 THEN F3=0:GOTO200
470 A=PEEK(LP):IF A=1 OR A=22 THEN S=S+20:GOTO900
480 NEXTI:POKE LP,34:GOTO200
900 AP=FNA(RX):FORI=1TO30:PRINT"R";RIGHT$(Y#,EY);TAB(EX);"R"
910 PRINT"R";RIGHT$(Y#,EY);TAB(EX);"R"
920 NEXTI:PRINT"R";
930 POKE AP,32:AP=AP-40:IF AP<32080 THEN 950
940 POKE AP,1:FORI=1TO50:NEXTI:GOTO930
950 POKE AP,79:FORI=1TO50:NEXTI
960 POKEAP,32:AP=AP+SGN(33198-AP):IF AP=33198 THEN1000
970 POKE AP,60:FORI=1TO50:NEXTI:GOTO960
1000 REM *** ASTEROIDS ATTACK ***
1010 POKE AP,60:FORI=826 TO 980:READA:POKEI,A:NEXTI:POKE768,2:F1=0
1100 PRINT"R"RIGHT$(Y#,EY);TAB(EX);"R";FORI=1TO10:GETA#:NEXTI
1110 POKE768,2:AP=33198:POKE AP,60:MI=32768:F1=0:F2=0:F3=0
1150 PRINT"R"
1160 PRINT"R"
1170 PRINT"R"
1200 FORI=1TO1000:IF RND(1)>.95 THEN POKE32769,87
1210 GOSUB1300:NEXTI
1220 FORI=1TO500:GOSUB1300:PRINT"R"RIGHT$(Y#,EY);TAB(EX);"R";500-I;"R";:NEXTI:S=S+50
1230 FORI=1TO800:POKE 33519,32:GOSUB1300:NEXTI:GOTO1900
1300 IF PEEK(AR)>60 THEN 7500
1305 POKE AP,32
1310 GETA#:IF A#="Q" THEN AP=AP-40:IF AP<MI THEN AP=AP+40
1320 IF A#="A" THEN AP=AP+40:IF AP>33519 THEN AP=AP-40
1325 IFF1=0ANDR#="C" THENI=0:POKEAP,60:PRINT"R"RIGHT$(Y#,EY);TAB(EX);"R";:F1=1:GO
TO1230
1330 POKE AP,60:SYS826:RETURN
1900 FORI=1 TO 8:POKE AP,32:AP=AP+1:POKE AP,60
1910 FORN=1TO50:NEXTN,I
2000 REM *** LASER ATTACK ***
2010 POKE 891,96:E1=32769:MI=32768:MA=33519:F1=0:F2=0:POKE33648,32
2200 SYS840:EX=INT((E1-32768)/40):AX=INT((AP-32768)/40)
2210 POKE E1,32:F1=F1-(F1<10)
2215 IF F1<10 THEN E1=E1-SGN(AX-EX)*40:GOTO2225
2220 E1=E1+SGN(AX-EX)*40
2225 IF E1<32768 THEN E1=E1+40
2226 IF E1>33518 THEN E1=E1-40
2230 IF F1=10 AND ABS(AX-EX)<3 AND RND(1)>.5 THEN F1=0:GOTO2500
2240 POKE E1,62
2300 POKE AP,32:F2=F2-(F2<10)
2310 A=PEEK(ER):IF A=64 THEN AP=AP-40:IF AP<MI THEN AP=AP+40
2320 IF A=48 THEN AP=AP+40:IF AP>MA THEN AP=AP-40
2325 IF A=31 THEN 2900
2330 IF F2=10 AND A=42 THEN F2=0:GOTO2600
2340 POKE AP,60
2345 PRINT"R"RIGHT$(Y#,EY);TAB(EX);"R";F1;"R";F2;"R";
2350 GOTO2200
2500 PRINT"R"RIGHT$(Y#,EX);"R";
2510 IF EX=AR THEN 7500
2520 PRINT"R"RIGHT$(Y#,EX);"R";
2530 GOTO2300
2600 PRINT"R"RIGHT$(Y#,AX);"R";
    
```

ASCII KEYBOARDS

- Parallel 7 bit TTL output
 - 5v Positive Strobe
 - Full ASCII character set
 - 62 keys inc. ESC, CAPS, REP, DEL, TAB etc.
 - Single +5v supply required
 - Circuit diagram supplied
 - New - Unused - Guaranteed
- Cased (685 x 232 x 78mm) £34.50
 Uncased (333 x 175 x 40mm) £32.20
 Inclusive of VAT and Postage (UK only).

Nameworth Limited

31 Barnfield, Hemel Hempstead, Herts, HP3 9QJ (0442-66878/48460).

BBC SOFTWARE & HOLIDAYS

Programs that are guaranteed to run! Save hours of work and worry with these utilities and practical programs.

1. CASHBOOK Double entry accounts DATA or TAPE B. £3.95
2. MAILING 6 options, sort addressing etc B. £3.95
3. PAYROLL A 2 part full weekly PAYE programme B. £11.90
4. STATPACK over 18 different analyses B. £11.90
5. CARDS Beat Bruce Forsyth at his own game A/B £2.95
6. BATTLEFIELD has you on your nerves edge B. £2.50
7. BANNER Print out large characters and graphics A/B £2.95
8. DISTANCES between any 2 places. £2.95
9. SEARCHBAS to search and alter a program £1.95
10. PROCVAR to list all the variables in a program £1.95
11. PROCFLUSH clean memory right round. £1.00
12. DEFCHR Define graphic characters. £2.95
13. SORTM/C I SORTBAS Fast sort routines (listings) each £1.00
14. UTILITY A items 9,10,11,12,13 £4.95

Micro-Aid (P)

All programs guaranteed on tape. Fully documented. EASTER HOLIDAY for computer freaks. Come and enjoy yourselves. Send for lists in more detail or cheque or PO made out to MICRO-AID, 25 Fore St., Praze, Cambourne, Cornwall. Tel: 0209-831274

MICROMART

ELCOMP

For ATARI-PET-OSI-APPLE II-6502-VIC-20-Sinclair-Times

ATARI ATARI ATARI
ATARI BASIC - Learning by Using
 This new book is an "Action" Book. You do more than read it. Learn the intricacy of ATARI-BASIC through the short programs which are provided. The suggestions challenge you to change and write program routines. Yes, it's exciting - Many of the programs are appropriate for beginners as well as experienced computer users. (Screen Drawings, Special Sounds, Keys, Paddles + Joysticks, Specialized Screen Routines, Graphics and Sound, Peeks and Pokes and special stuff).
 Order-No. 164 \$9.95

ATARI Learning by Using - Book + cassette or disk
 This package includes the book No. 164 plus a cassette or disk (please specify) containing a variety of the programs which are listed in the book.
 Order-No. 7220 \$39.95

Games for the ATARI-Computer
 How to program your own games on the ATARI. Complete listings in BASIC and Machine Language of exciting games. Tricks and hints.
 Order-No. 162 \$7.95

GAME PACKAGE for the ATARI
 Book + cassette or disk
 Includes the book No. 162 plus cassette or disk (please specify) containing a variety of the programs listed in the book.
 Order-No. 7221 \$39.95

ATMONA-1
 Machine Language Monitor for the ATARI 400/800.
 This powerful monitor provides you with the firmware support that you need to get the most out of your powerful system, ATMONA-1 comes on a bootable cassette. No cartridges required. Disassemble, Memory Dump HEX + ASCII, Change Memory Locations, Blocktransfer, fill memory block, save and load machine language programs, start mach. Lang. Progr. (Printer optional).
 Comes with introductory article on how to program the ATARI computer in machine language. (Available also in ROM)
 Order-No. 7022 \$19.95

ATMONA-2 Superstepper
 A very powerful Tracer to explore the ATARI ROM/RAM area. Stop at previously selected address. Opcode or operand (cassette).
 Order-No. 7049 \$49.95

EDITOR/ASSEMBLER for ATARI 800, 32K or 48K RAM
 Extremely fast and powerful Editor/Assembler. (BK Sourcecode in about 5 seconds) Includes ATMONA-1.
 Order-No. 7098 \$49.95

MACRO-Assembler for ATARI 800, 48K RAM
 Please specify your system: RAM, disc or cassette.
 Order-No. 7099 \$89.00
 Add \$39.00 for cartridge version

Gunfight - For ATARI 400/800 16K RAM, needs two joysticks, animation and sound. (BK machine language).
 Order-No. 7207 \$19.95

Birth control with the ATARI (Knaus Ogino) Cass. or disk
 Order-No. 7222 \$29.95

Astrology and Biorhythm for ATARI (cass. or disk)
 Order-No. 7223 \$29.95

EPROM Cartridge KIT for ATARI
 Cartridge (bare board) with instructions (holds two 16K or two 32K EPROMs (2716,2532,2732)
 Order-No. 7224 \$19.95
 Order-No. 7043 complete \$29.95

Invoice Writing for small business with ATARI 400/800 16K RAM.
 Order-No. 7022, cass. \$29.95
 Order-No. 7200, disc. \$39.90

Mailing List No. 7213 \$24.95
 Inventory Contr. No.7215 \$24.95

NEW IATEX-1
 This new wordprocessor in machine language (BK) for all ATARI 400/800 computers offers the best price performance ever. 23 editor control commands, 17 formatting commands, dynamic formatting. Vertical and horizontal scrolling (up to 255 char. per line) include command on disk!
 Order-No. 7210 cassette \$29.95
 Order-No. 7211 disk \$39.95
 Order-No. 7212 cartridge \$79.80

Learn FORTH for the ATARI 400/800, cassette or disk
 Order-No. 7053 \$19.95

ELCOMP Publishing, Inc., 53 Redrock Lane
 Pomona, CA 91766, Phone: (714) 623 8314
 Payment: Check, Money Order, VISA, Mastercard, Eurocheck. POSTPAID ON PREPAID IN USA. \$5.00 handling fee for C.O.D. All orders outside USA: Add 15% shipping. CA. add 6.5% sales tax. ATARI is a registered trademark of ATARI Inc. APPLE is a registered trademark of APPLE Inc. PET+VIC-20 is a trademark of Commodore.

Dealers welcome!
BOOKS and SOFTWARE
ELCOMP FORTH - Enhanced GIG-FORTH on disk only.
 Order-No. 7055 \$39.95
How to connect your EPSON-Printer to the ATARI 400/800.
 Construction article with printed circuit board and software. (Screenprint and variable characters per line).
 Order-No. 721n \$19.95

OSI OSI OSI OSI OSI
 The First Book of Ohio Scientific Introduction to OSI computers. Diagrams, hardware and software information not previously available in one compact source, 192 pages.
 Order-No. 157 \$7.95

The Second Book of OHIO
 Order-No. 158 \$7.95

The Third Book of OHIO
 Order-No. 159 \$7.95

The Fourth Book of OHIO
 Order-No. 160 \$9.95

VIP Package - Above book plus a cassette with the programs.
 Order-No. 160A \$19.95

The Fifth Book of OHIO
 Order-No. 161 \$7.95

Invoice Writing Program for OSI.
 C1PMF, CAP, Disk and Cassette, 8K RAM.
 Order-No. 8234 \$29.80

Mailing List for C1PMF or C4PMF 24K RAM
 250 addresses incl. phone number and parameters on one 5 1/4 disk
 Order-No. 8240 \$9.95

8K Microsoft BASIC Ref. Man.
 Order-No. 161 \$9.95

Expansion Handbook for 6502 and 6802
 Order-No. 152 \$9.95

Microcomputer Appl. Notes
 Order-No. 153 \$9.95

Complex Sound Generation
 New revised applications manual for the Texas Instruments SN 76477 Complex Sound Generator.
 Order-No. 154 \$8.95

Small Business Programs
 Complete listings for the business user. Inventory, Invoice Writing, Mailing List and much more. Introduction to Business Applications.
 Order-No. 156 \$14.90

Microcomputer Hardware Handbook (845 pages)
 Descriptions, pinouts and specifications of the most popular microprocessor and support chips. A MUST for the hardware buff.
 Order-No. 29 \$14.95

Care and Feeding of the Commodore PET
 Eight chapters exploring PET hardware. Includes repair and interfacing information. Programming tricks and schematics.
 Order-No. 150 \$9.95

Prototype-Expansion Board for VIC-20 (S-44-Bus).
 Order-No. 4844 \$18.95

Wordprocessor 1. VIC-20, 8K RAM
 Order-No. 4870 \$19.95

Mailing List for VIC-20, 16K RAM
 Order-No. 4883 \$14.95

Tricks for VICs - The Victory Programs, hints and expansion information for VIC-20
 Order-No. 141 \$9.95

TIC TAC VIC
 Order-No. 4880 \$9.95

GAMEPACK 1 (3 Games)
 Order-No. 4881 \$14.95

Dual Joystick Instruction
 Order-No. 4885 \$9.95

INPUT/OUTPUT Programming with your VIC
 Order-No. 4886 \$9.95

16K RAM/ROM board for S44-bus. Any combination of RAM and ROM on one board. (SY2128 or 2716)
 Order-No. 613 \$39.95

Low cost expansion boards for your APPLE II. Bare board comes with extensive description and software.
 6522 VIA-I/O Exp. Order-No. 605 \$39.00
 2716 EPROM-Burner Order-No. 607 \$49.00
 8K EPROM/16K RAM Card Order-No. 609 \$29.00

Software for SINCLAIR ZX-81 and TIMEX 1000
 Machine Language Monitor Order-No. 2399 \$9.95
 Mailing List Order-No. 2398 \$19.95
 Programming in BASIC and machine language with the ZX-81 (82) or TIMEX 1000. Order-No. 140 (book) \$9.95

MICROMART

UK 101 SOFTWARE ON TAPE

from the guy who wrote "Le Passe Temps"

GALACTIC HITCHHIKER (8K). An adventure, all in machine code. A beauty! (£7.00)
SUPERTREK (8K). Sail boldly through the universe, zapping moving Klingons in real time. Superb graphics. (£7.00)
STARTREK (8K). The old favourite, beautifully presented. (£6.00)
LUNAR LANDER. A real challenge. You won't get down in less than 3 hours. (£3.00)
HANGMAN. Excellent graphics, P.E. said so! (£3.00)
BASIC TUTOR (8 x 4K). The only way to learn - at the keyboard. (£12.00)
LE PASSETEMPS. You NEED this, if you haven't already got it. (£3.00)
MAD MONK (8K). It's ready at last! A machine code adventure with some truly remarkable graphics, this programme is in a class by itself. (£9.50)
 These ORIGINAL PROGRAMS are compatible all 2K Monitors and are available for 16 x 48 and 32 x 48 displays (including enhanced Superboards).

HARDWARE

These kits are complete in every way: - Full socketed high quality PCB, all components, switches etc, plus performed cable assembly for easy interconnection to J1, or our...
MOTHERBOARD SYSTEM. Now you can add on all those extras easily. Provides eight, yes EIGHT, fully buffered J1 type sockets. (£19.50)
8K STATIC RAM BOARD (£39.50)
HISPEED CASSETTE INTERFACE. At last, a system that works. COMPLETELY RELIABLE 4000 baud (8000 with reasonable cassette) plus software for named file handling. A delight to use. (£19.50). For software in EPROM, add £6.00
VIDEO ENHANCEMENT. Switch selectable 16 x 48 or 32 x 48 displays without butchering your computer. (£19.50)
Monitor EPROMS re-blown to suit for just £2.50
8K EPROM BOARD (£19.50). A 2K Extended Monitor is available in EPROM for £12.00 plus, coming soon.
TOOLKIT in EPROM and BASIC V.
MONITOR BOARD. Plug into Monitor socket to provide switch selection of up to 4 EPROMS. (£9.50)
AVAILABLE SHORTLY: EPROM Programmer, PIA/ Sound Board, Analogue Board and something rather nice on the graphics side.

All inclusive
 Please add 15% V.A.T.

Write or phone for further details.

MERLIN (MICRO SYSTEMS) LTD.
 93 High St., Eton, Clevaland Tel: (0642) 454883.

nascom

Extension Basic £15 (£30 in ROM)
 Only 4K and adds the following to ROM BASIC: AUTO, BREAK, CALL, CHECK, COPY, DEC, DELAY, DELETE, EDIT, FIND, GET, HEX, IF..ELSE, INKEY, INLIN, LINE, PLOT, PRINT @, PUT, REPEAT..UNTIL, RENUMBER, REDUCE, VDU, SPEED, TEST, TRACE, WHILE..WEND, WRAP, XLIST, XREF.
Compression Assembler £12
 A full Z80 assembler which runs at 3000 lpm and compresses typical source to half the normal size to use less memory and speed up loading/saving. It is 8K and comes with a ZEAP conversion program.
Adventure Quest, Colossal Adventure, Dungeon Adventure
 Three great machine-code adventures, packed with puzzles & each with over 200 detailed locations. 16K version of any adventure: £7.90, 32K: £9.90.
Asteroids: Blast space rocks to smithereens £7.90
Galaxy Invaders: NEW! waves of varied aliens £5.90
Missile Defence: Stop the attacking missiles £7.90
Super Gulp: NEW! Clear mazes of gold (8K) £4.90

P&P / VAT included. Money back if not happy. Full documentation. (Nascom 1s need Nas-Sys/Cottis B.)
 Send order, or SAE for our full catalogue, to:
LEVEL 9 COMPUTING
 229 Hughenden Road, High Wycombe, Bucks. HP13 5PG

* BIG EARS *

SPEECH INPUT FOR ANY COMPUTER



Hugely successful Speech Recognition System, complete with microphone, software and full instructions.

BUILT TESTED & GUARANTEED ONLY £49
 PLEASE STATE COMPUTER: UK101, SUPERBOARD, NASCOM2, ZX80/81, PET, TRS80, M280K, APPLE II

ZX80 ZX81

MUSIC SYNTHESISER + 16 LINE CONTROL PORT

Play 3-part music, sound effects, drums etc. Full control of attack, decay and frequency. Input/Output lines provide control and monitor facility for Home Security, Robot Control, Model Railway, etc. etc. Works with or without 16K RAM.
 Add keyboard to make a live performance polyphonic synthesiser! Full instructions/software included.

AMAZING VALUE AT ONLY £19.50 (KIT)
 £25.00 (BUILT)

COLOUR MODULATOR KIT £12
 RGB in, PAL/LUMF out BUILT £18
 UK101/NASCOM COLOUR GRAPHICS KIT £45
 Inc. Modulator. Still the best selling system! BUILT £60

Please add VAT at 15% to all prices.
 Barclay/Access orders accepted by telephone

WILLIAM STUART SYSTEMS Ltd
 Dower House, Billericay Road, Herongate, Brentwood, Essex CM13 3SD
 Telephone: Brentwood (0277) 610244

PROGRAMS

```

2610 IF EX=AX THEN S=S+30:GOTO2900
2620 PRINT"R"RIGHT$(V$,AX);
2630 GOTO2200
2900 FORI=1TO50:POKE E1,60:POKE E1,170:POKE E1,62:POKE E1,32:NEXTI
2910 GOSUB7000:GOTO4000
4000 REM***PLANET ATTACK***
4010 GOSUB8300:GOSUB8000
4100 AP=33707:MA=33727:MI=33688:FO=40:MP=32768:S1=160:E1=33757:DI=-1
4110 FORN=33728 TO 33767:POKE N,99:NEXTN
4120 F1=0:F2=0:F3=0
4200 POKE AP,32
4210 A=PEEK(ER):IF A=42 THEN AP=AP+(AFO>MI)
4220 IF A=41 THEN AP=AP-(AP<MA)
4225 IF F1=1 THEN 4250
4230 IF A=48 THEN F1=1:LP=AP-FO
4250 POKE AP,1
4260 SYS826
4300 IF F2=0AND ABS(33709-AP)<3 THEN F2=1:EL=33229+INT(RND(1)*5)-2:S1=PEEK(EL)
4310 IF F2=1 THEN GOSUB 4700
4320 IF INT(RND(1)*3)=0 THEN 4440
4400 POKE E1,99:E1=E1+DI:IF E1<33729 THEN E1=33729:DI=1
4410 IF E1>33766 THEN E1=33766:DI=-1
4420 IF INT(RND(1)*10)=0 THEN DI=INT(RND(1)*2):IF DI=0 THEN DI=-1
4430 POKE E1,22
4440 IF INT(RND(1)*6)=0 THEN 4900
4450 IF F1=0 THEN 4200
4500 POKE LP,32:FORI=1TO3
4510 LP=LP-40:IF PEEK(LP)>32 THEN F1=0:GOTO4600
4515 IF LP<MP THEN F1=0:GOTO4200
4520 NEXTI:POKELP,34:GOTO4200
4600 A=PEEK(LP):IF A>128 THEN POKE LP,120:GOTO4200
4610 IF A<99 THEN POKELP,32:GOTO4200
4620 S=S+30:A=LP:S1=80:GOSUB9100:A=LP:S1=32:GOSUB9100:RESTORE:GOTO100
4700 POKE EL,S1
4710 EL=EL+40:IF EL>33687 THEN 4800
4720 S1=PEEK(EL):POKE EL,81:RETURN
4800 FORI=-2 TO 2:POKE EL+I,86:NEXTI
4810 IF ABS(EL-AP)<3 THEN 9050
4820 FORI=-2 TO 2:POKE EL+I,32:NEXTI
4830 F2=0:RETURN
4900 POKE E1-40,30
4910 IF AP=E1-40 THEN 9050
4920 POKE E1-40,32
4940 GOTO4450
7000 REM***DRAW RING***
7010 PRINT"O";FORI=1TO25:PRINT"O*****";
7020 NEXTI:PRINT"O";FORI=1TO25:PRINT"O*****";
7030 NEXTI:RETURN
7500 FORI=1 TO 50:POKE AP,60:POKE AP,170:POKE AP,62:POKE AP,32:NEXTI
7520 P=P+1:IF P<3 THEN RESTORE:GOTO100
7560 PRINT"O";
7570 PRINT"O";
7580 PRINT"O";
7590 PRINT"O";
7600 PRINT"O";
7610 PRINT"O";
7620 PRINT"O";
7630 PRINT"O";
7640 PRINT"O";
7660 A="VERSION 1.1 BY M.FOK-82"
7670 FORI=1TOLEN(A$):PRINT"O";PRINTRIGHT$(A$,I):NEXTI
7680 RESTORE:GOSUB8350:RESTORE
7690 FORI=1 TO 25:SYS826:FORN=1TO20:NEXTN,I
7700 PRINT"O";PRESS"O"FOR A NEW GAME"
7710 PRINT"O";YOUR SCORE IS";S
7715 GETA$:IF A$="O" THEN END
7716 IF A$<"O" THEN 7715
7720 RUN
8000 REM *** DRAW PLANET ***
8100 PRINT"O";
8110 PRINT"O";
8120 PRINT"O";
8130 PRINT"O";
8140 PRINT"O";
8150 PRINT"O";
8160 PRINT"O";
8180 PRINT"O";
8190 PRINT"O";
8200 PRINT"O";
8210 PRINT"O";
8220 PRINT"O";
8230 RETURN
8300 REM *** ROTATE RING ***
8310 FORN=826 TO 843:READ A:POKE N,A:NEXTN
8320 RETURN
8350 REM ***BOMB M.C.***
8360 FORI=826 TO 929
8370 READ A:POKE I,A:NEXTI:RETURN
9000 REM ***U. EXPLOSION***
9010 IF S1=32 THEN S1=32:S2=32:S3=32:S4=32:GOTO9030
9020 S1=77:S2=66:S3=78:S4=64
9030 FORI=1TO10:POKE A-41*I,S1:POKE A-40*I,S2:POKE A-39*I,S3
9040 POKE A-I,S4:POKE A+I,S4:FORN=1TO50:NEXTN,I:RETURN
    
```

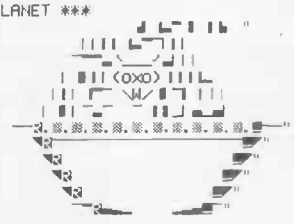

EPSON TYPE III PRINTERS

With Sensational 2yr guarantee

Epson MX80T-3 £345
 Epson MX80 F/T-3 £385
 Epson MX100 F/T-3 £495
 Prices exclude VAT

Data cables made
 Please add £6 carriage but free delivery in Herts

Melmark Microsystems

Mail Order Dept
 8 Kingsfield Rd, Dane End
 Ware, Herts SG12 0LY
 (092 084) 300

The POWER BANK

system compatible sine wave output



Plug your microcomputer, VDU and Printer into the POWER BANK and forget about a disabling break in the electricity supply. This unit will continue to run your system in the event of a mains failure... WITH NO INTERRUPTIONS TO YOUR WORK!

Vital when running business. This unit will of course suppress MAINS SPIKES and SURGES. Batteries included (tested for life) 120 VA. and 250 VA. (output) units available

Power Testing (Sales) Ltd

65a Shenfield Rd, Shenfield, Brentwood, Essex CM15 8HA
 Tel Brentwood (0277) 233188 Telex 24224586

PROGRAMS

```

9050 A=AP: S1=80:GOSUB9000:A=AP: S1=32:GOSUB9000:GOT07520
9100 REM ***F.EXPLOSION***
9110 IF S1=32 THEN S1=32:S2=32:S3=32:S4=32:GOT09130
9120 S1=77:S2=66:S3=78:S4=64
9130 FORI=1TO10:POKE A-41*I,S1:POKE A-40*I,S2:POKE A-39*I,S3:POKE A-38*I,S4
9140 POKE A+41*I,S1:POKE A+40*I,S2:POKE A+39*I,S3:POKE A-1,S4
9150 FORN=1TO30:NEXTN,I:RETURN
9800 REM*** BOMB DATA ***
9805 DATA 162,240,189,255,127,201,81,240,42,202,208,246,162,240,189,239
9810 DATA 131,189,71,131,157,72,131,202,208,247,162,39,172,71,131,140,32,131
9820 DATA 202,208,246,162,240,189,207,130,201,81,240,45,202,208,246,96,0,0,169
9830 DATA 32,157,255,127,169,81,157,99,128,76,67,3,169,32,157,239,128,169,81
9840 DATA 157,23,129,76,79,3,169,32,157,223,129,169,81,157,7,130,76,91,3,169
9850 DATA 32,157,207,130,169,81,157,247,130,76,103,3,255
9860 REM*** SCRAMBLE DATA ***
9870 DATA 172,0,3,136,140,0,3,208,56,160,2,140,0,3,162,39,172,111,131,140,72
9880 DATA 131,189,71,131,157,72,131,202,208,247,162,39,172,71,131,140,32,131
9890 DATA 289,31,131,157,32,131,202,208,247,162,39,172,31,131,140,248,130,189
9900 DATA 247,130,157,248,130,202,208,247,173,247,130,141,0,128,169,32,141,247
9910 DATA 130,162,255,189,255,127,201,87,240,31,202,208,246,162,255,189,254
9920 DATA 128,201,87,240,32,202,208,246,162,249,189,253,129,201,87,240,33,202
9930 DATA 208,246,96,0,0,0,169,32,157,255,127,169,87,157,0,128,76,143,3,169,32
9940 DATA 157,254,128,169,87,157,255,128,76,155,3,169,32,157,253,129,169,87,157
9950 DATA 254,129,76,167,3
11000 DATA162,20,172,174,129,189,154,129,157,155,129,202,208,247,140,155,129,96
    
```

Instructions

READY.

```

1 REM *****
2 REM #FIREBIRD I INSTRUCTIONS#
3 REM ***WORDS BY S. J. MORRIS***
4 REM ***PROGRAM BY M. FOX 1982**
5 REM *****
6 REM
7 REM
8 REM
9 REM
10 Y$=" "
100 FORI=826 TO 931:READA:POKEI,A:NEXTI
110 GOT09500
200 READA$:IF A$="*"THENPRINT:PRINT"PRESS ANY KEY":Y=1:GOSUB8000:PRINT
":READA$
210 IF A$="0" THEN 500
220 FORI=1TO39:PRINTA$;RIGHT$(Y$,Y);RIGHT$(A$,I):NEXTI:Y=Y+1
230 GOT0200
500 PRINT"J"END
510 GETA$:IF A$<"1" OR A$>"0" THEN 510
520 A=VAL(A$):LOAD"FIREBIRD I",A
4000 DATA 162,39,189,199,128,157,200,128,202,208,247,162,39
4010 DATA 189,23,129,157,24,129,202,208,247,162,39,189,103
4020 DATA 129,157,104,129,202,208,247,162,39,189,183,129,157,184
4030 DATA 129,202,208,247,162,0,189,241,128,157,240,128,232,224
4040 DATA 38,208,245,162,0,189,65,129,157,64,129,232,224,38
4050 DATA 208,245,162,0,189,145,129,157,144,129,232,224,38,208
4060 DATA 245,162,0,189,225,129,157,224,129,232,224,38,208,245
4070 DATA 96,0,0,0,255,0,255,0,255,0
5000 DATA""," " INTRODUCTION""," " "
5005 DATA " BACK IN THE 20TH.MAN REALISED THE"
5010 DATA"EARTH IS ON ITS LAST LEG-NO RESOURCES"
5020 DATA"OR SPACES.THEN BEGAN A PHENOMENAR"
5030 DATA"SPACE RESEARCH PROGRAM BEGAN IN A LAST"
5040 DATA"DITCH ATTEMPT TO SURVIVED.IT PROVED"
5050 DATA"FRUITFUL,YIELDING THE EARTH-LIKE "
5060 DATA"PLANET ZOG IN THE ORWELLIAN MAJOR "
5070 DATA"GALAXY.HOWEVER,IT HAS ONE DRAWBACK-"
5080 DATA"THE NEARBY PLANET PLANET OF ARGON."
5090 DATA"THE ARGONITES RESENT THE HUMAN RACE"
5100 DATA"FOR INTRUDING AND PATROL YOUR PLANET."
5110 DATA"ARGONITES HAVE COMMITTED HORRIBLE "
5120 DATA"ATROCITIES ON YOUR PEOPLE.NOW THEIR"
5130 DATA"LEADER ZARGON HAS BUILT A STARBASE"
5140 DATA"FROM WHICH TO ATTACK YOUR PEOPLE.",*
5150 DATA"MANY OF OUR BEST MEN HAVE ALREADY"
5160 DATA"BEEN EXTERMINATED IN AN EFFORT TO "
5170 DATA"ATTACK HIS BASE.ONLY 50 CENTRONS"
5180 DATA"AGO A WHOLE FLEET WAS DESTROYED."YOU"
5190 DATA"ARE OUR LAST RESORT.YOU MUST FIRST "
5200 DATA"SUCCEED TO LIFT OFF IN AN UNPATROLLED"
5210 DATA"AREA AFTER YOU DESTROYED ALL FIREBIRDS"
5220 DATA"IN SIGHT.AFTER TAKING OFF YOU MIGHT"
5230 DATA"GET CAUGHT IN A METEOR STORM WHICH"
5240 DATA"OFTEN OCCURS IN ZOG REGION.ANYTIME"
5250 DATA"DURING THE JOURNEY YOU COULD WELL"
5260 DATA"RUN INTO AN ARGONITE FIGHTER WHICH"
5270 DATA"YOU HAVE TO DESTROY IT BEFORE IT "
5280 DATA"DESTROY YOU.FINALLY THEIR STARBASE"
5290 DATA"IS WELL DEFENDED.GOOD LUCK"
5295 DATA" " " MAJOR GENERAL "
5300 DATA" S. J. MORRIS".*
5310 DATA"MISSION-1"
    
```

MICROMART

RGB COLOUR MONITOR only £99.95 (carr & vat)

We have on offer a limited quantity of 22" Colour Monitors with free isolating Transformers.
The VM22 Colour Monitor Features a 22" Mulard 110 degrees c. CRT and is designed to meet the high reliability and performance standards associated with the Games and Colour Graphics Industries.

For shipping purposes the CRT plus Scancoil assembly are separate from the chassis. The lugs of the CRT allow it to be mounted in a standard 22" Colour TV Cabinet or a unit of your own design. The unit is assembled by plugging the wires from the chassis to the tube, and soldering the input connector, power connector and isolating transformers.

A comprehensive Instruction sheet, and manual with circuit board diagrams will be supplied with each unit.

RAM BARGAINS

Limited Quantity of 22" RGB colour monitors with free isolating transformer. Send or ring for brochure.

	1 OFF	25-99	100
4116-200us.	.80	.75	.68
4116-250us.	.75	.70	.55
2114-300us.	.85	.80	.75
2114-L-200us.	.95	.87	.83
4516-100us-BBC Ram3.10	2.95	2.80	
4164-200us	4.80	4.60	4.20
6116 150us C. Mos	4.20	3.95	3.50
2716 5v-450us.	2.40	2.15	2.00
2716-Tripleram.	6.00		
2732-450us.	3.95	3.75	3.25
2532-450us.	3.95	3.75	3.25

Other IC's available Add 50p p&p + VAT @ 15%.

ATHANA FLOPPIES

Minis with free plastic library case + hob rings.

S/S S/D	£17.95 for 10	8" DISCS	
S/S D/D	£19.95 for 10	S/S S/D	£15.50 for 10
D/S D/D	£23.50 for 10	S/S D/D	£24.50 for 10
S/S T/Track	£26.50 for 10	D/S D/D	£25.50 for 10
S/S 96 Track	£28.50 for 10		

All other discs available. Add 05p P&P + VAT @ 15%.

See us at the Northern Computer Fair, Belle Vue — Manchester — Stand 426. Govt-Educational plus Official orders welcome.

OPUS SUPPLIES

10 BECKENHAM GROVE
SHORTLANDS,
KENT



KENT



01-464 5040 01-464 1598

PET PET PET PET PET PET

*** HI-RESOLUTION GRAPHICS ***
A high resolution graphics board that gives a 64,000 dot (320 x 200) resolution. Versions available for any dynamic ram pet. BASIC 2.3.4, FAT40 & 80 columns. No soldering or track cutting required, supplied complete with fast GRAPHIX software in ROM and full fitting & operating instructions. £149.00

*** SUPER ROM-SELECTOR ***
A high quality printed circuit board giving 64K of utility ROM space, software selectable!!! Allows 16 x 4K ROMs/EPROMs to reside in the expansion area of your PET. One "POKE" enables any two ROMs at a time. Suitable for bank-switched software. £75.00

*** PET UPGRADES ***
WHILE-U-WAIT service! (Dynamic ram pets only.)
Memory expansion:- 8K - 32K. £59.90
16K - 32K. from £48.70
8K - 16K. £38.26

40 column (12" VDU only) to 80 column conversion.
40 to 80 column £89.00
40 to 80 column switchable (two machines in one!) £105.00
Full keyboard functions:- i.e. TAB,ESC,REPEAT,SCROLL up/down, define WINDOW, lower case/graphics mode & DELETE from/tocursor. All available in direct or program mode.

*** REPAIRS AND SERVICING ***
Fast and efficient repairs to all Commodore computers at reasonable prices. WHILE-U-WAIT service whenever possible.

Please add VAT to the prices shown at the current rate.

Telephone Mick Bignell for more details at:-

MICROSERVE
7 Clydesdale Close,
Borehamwood, Herts. WD6 2SD.
Tel: 01-953-8385

NEC PC-8000

OSBORNE 1

IN
THE NORTH

NMR Tel: (0484) 892905
COMPUTERS (Holmfirth)

PRINTER BARGAINS

MX80FT3 £322.00
MX1000 £417.00
NEC PC8023 £284.50
OKI-80 £219.00

MICROS

Gemini Galaxy 1 £1450.00
Dragon 32 £169.95

COMPLETE SYSTEM

Galaxy 1 + Epson + Epson 80
+ Monitor £1765.20
Please add £5 carriage and
15% VAT to all others.

Walthplan

(Computer Systems) Ltd

Priority Court, Priory Rd.
Torquay
0803 38236

MICROMART

HISOFT PASCAL 4 INCREDIBLE SPEED INCREDIBLE PRICE

Hisoft are pleased to announce their latest Pascal compiler, the fastest and most powerful so far, at an amazingly low price. Hisoft Pascal 4 is an almost complete implementation of the Pascal language as given in the Pascal User Manual and Report (Jensen/Wirth) including POINTERS, RECORDS and (for disk systems) FILES. All major Pascal statements and data structures are supported together with many useful additions such as PEEK, POOK, USER, ADDR (returns the memory address of a variable) and, for tape.

The compiler produces Z80 object code directly (ie, no P-codes) and hence the resultant code runs very quickly indeed. Hisoft Pascal 4 requires only a 32K system in which to run (with plenty of room to spare) and can be supplied on cassette tape or 5 1/4" or 8" diskette to run under CP/M. The cassette tape version comes with its own tokenising editor and in a form which is easily adaptable to any Z80 system.

Hisoft Pascal 4 is a powerful and high quality piece of software which can be used for serious program development - we offer it at such a low price because we believe that such software is normally overpriced and out of reach of the individual.

Prices:

Special offer for Spectrum users Hisoft PASCAL 4 on tape	£25
HISOFT PASCAL 4 disk version (Nascom, Superbrain RTML380Z etc)	£40
ZDEV (a Z80 development system for Gemini G805 or G809 disk systems)	£45
NASCOM (a 4k NASCOM monitor)	£25
BAS12K (a 12K BASIC interpreter under NASCOM)	£20
NASGEN (a 3K Z80 assembler under NASCOM)	£15
NASDEM (a 2K Z80 disassembler under NASCOM)	£10

Send for more details from:

HISOFT,
60 Hallam Moor, Liden, SWINDON, SN3 6LS
Tel: (0793) 26616 (24hr telephone).

ESSEX & SUFFOLK

YOUR LOCAL ONE STOP COMPUTER
SHOP. CALL IN AND BROWSE AT
YOUR LOCAL STORE AND SEE:

Acorn from	140.00	Printers from	129.95
Apple	669.00	Disk drives	199.00
Atari	89.00	Cas Recorders	17.40
Dragon	179.00	Monitors	69.50
NEC	599.00	Cassettes	48p
Tandy	78.00	Disks	1.99
TI 99/A	179.00	Software	49p
VIC20	147.99	Avalon Hill war games on cass	9.52
Video Genie	173.50		

We are an authorised service centre for all the above computers. Emprise provides full support so that you get 100% enjoyment from your computer

All our products can be hired on a try-before-you-buy basis and membership of our computer club is free if you buy your computer from EMPRISE.

FREE

All prices are subject to VAT and refer to current stock

EMPRISE
58 EAST STREET
COLCHESTER ESSEX
CO1 2TQ
TEL (0206) 865926
Also branches at
CHELMSFORD TEL (0246) 358834
SUDBURY TEL (0787) 330110
CLACKTON TEL (0254) 437796

CHECK OUR PRICES

- IBM PERSONAL •
- TANDOM FLOPPY DRIVES •
- WINCHESTER DRIVES
SUITABLE FOR APPLE
AND IBM PERSONAL

CALL ALASTAIR DODS
01-467 1985
01-467 8489
THOMAS BUSINESS
SYSTEMS LTD

PROGRAMS

```

5320 DATA"YOUR AIM IS TO DESTROY ANY ATTACKING"
5330 DATA"FIREBIRD(S).BUT WATCH OUT IFIREBIRDS"
5340 DATA"ARE DEADLY SINCE YOU CAN ONLY DESTROY"
5350 DATA"IT BY HITTING ITS SOFT STOMACH"
5360 DATA"ON THE CONTROL BOARD YOU:"," "
5370 DATA"PRESS '4' TO MOVE LEFT"
5380 DATA"PRESS '6' TO MOVE RIGHT"
5390 DATA"PRESS 'A' TO FIRE",*
5400 DATA"MISSION-2"
5410 DATA"YOU MUST AVOID THE ASTEROIDS WHICH "
5420 DATA"APPEAR FROM THE TOP OF THE SCREEN "
5430 DATA"AND MOVE LOWER AND LOWER FOR A SET"
5440 DATA"TIME(TIME IS DISPLAY UNDER THE LAND-"
5450 DATA"SCAPE AFTER THE FIRST ASTEROID REACH"
5460 DATA"THE BOTTOM OF THE SCREEN)."," "
5470 DATA"ON THE CONYROL BOARD YOU:"," "
5480 DATA"PRESS 'Q' TO MOVE UP"
5490 DATA"PRESS 'A' TO MOVE DOWN",*
5500 DATA"MISSION-3"
5510 DATA"YOU MET AN ARGON FIGHTER WHICH WILL"
5520 DATA"ATTEMPT TO ZAP YOU SO YOU MUST ZAP"
5530 DATA"IT BEFORE IT SUCCEED.HOWEVER YOU MAY"
5540 DATA"ONLY FIRE WHEN YOUR ENERGY(LEFT ONE"
5550 DATA"IT BY HITTING ITS SOFT STOMACH"
5560 DATA"ON THE CONTROL BOARD YOU:"," "
5570 DATA"PRESS '4' TO MOVE LEFT"
5580 DATA"PRESS '6' TO MOVE RIGHT"
5590 DATA"PRESS 'A' TO FIRE",*
5600 DATA"MISSION-2"
5610 DATA"YOU MUST AVOID THE ASTEROIDS WHICH "
5620 DATA"APPEAR FROM THE TOP OF THE SCREEN "
5630 DATA"AND MOVE LOWER AND LOWER FOR A SET"
5640 DATA"TIME(TIME IS DISPLAY UNDER THE LAND-"
5650 DATA"SCAPE AFTER THE FIRST ASTEROID REACH"
5660 DATA"THE BOTTOM OF THE SCREEN)."," "
5670 DATA"ON THE CONYROL BOARD YOU:"," "
5680 DATA"PRESS 'Q' TO MOVE UP"
5690 DATA"PRESS 'A' TO MOVE DOWN",*
5700 DATA"MISSION-3"
5710 DATA"YOU MET AN ARGON FIGHTER WHICH WILL"
5720 DATA"ATTEMPT TO ZAP YOU SO YOU MUST ZAP"
5730 DATA"IT BEFORE IT SUCCEED.HOWEVER YOU MAY"
5740 DATA"ONLY FIRE WHEN YOUR ENERGY(LEFT ONE"
5750 DATA"IS FOR ARGONITE FIGHTER WHILE THE"
5760 DATA"RIGHT ONE IS YOURS)IS TEN.", " "
5770 DATA"ON THE CONTROL BOARD YOU:"," "
5780 DATA"PRESS 'Q' TO MOVE UP"
5790 DATA"PRESS 'A' TO MOVE DOWN"
5800 DATA"PRESS '4' TO FIRE",*
5810 DATA"MISSION-4"
5820 DATA"YOU MUST SHOOT THROUGH THE WELL "
5830 DATA"DEFENDED STARBASE AND KILL THEIR"
5840 DATA"LEADER ZARGON.(SINCE NO-ONE HAS GOT"
5850 DATA"THAT FAR YET, THEREFORE THE INFORMATION"
5860 DATA"MIGHT BE WRONG"
5870 DATA"ON THE CONTROL BOARD YOU:"," "
5880 DATA"PRESS '4' TO MOVE LEFT"
5890 DATA"PRESS '6' TO MOVE RIGHT"
5900 DATA"PRESS 'A' TO FIRE"
5910 DATA""," " ,"SPECIAL COMMAND:"
5920 DATA"PRESS 'C' AT ANY MISSION(EXCEPT LAST"
5930 DATA") FOR CHEAT.",*
5940 DATA"
SYMBOLS"
5950 DATA" 'A' ..... FIREBIRD"
5960 DATA" 'O' ..... ASTEROID"
5970 DATA" '>' ..... ARGONITE FIGHTER"
5980 DATA" ' ' "
5990 DATA" (OXO) "
6000 DATA" ' ' ..... ZARGON"
6010 DATA" - " ,*,@
6020 GETB$:IF B$=" " THEN 8000
6030 RETURN
6040 PRINT"
6050 AF(1)=" ..... "
6060 AF(2)=" ..... "
6070 AF(3)=" ..... "
6080 AF(4)=" ..... "
6090 AF(5)=" ..... "
6100 AF(6)=" ..... "
6110 AF(7)=" ..... "
6120 AF(8)=" ..... "
6130 AF=" INSTRUCTION FOR FIREBIRD I BY M.FOK-82"
6140 FORA=1TO37
6150 PRINT"
6160 FORB=1TO7STEP2
6170 PRINT" " ; MID$(A$(B), (38-A), 1)
6180 PRINT" " ; MID$(A$(B+1), A, 1) ; " "
6190 NEXTB
6200 SYS826
6210 NEXTA
6220 PRINT" " ; FORI=1TO8:PRINT" " ; LEFT$(A$(I), 39) ; NEXTI
6230 FORI=1TO39:PRINT" " ; RIGHT$(A$, I) ; NEXTI
6240 FORI=1TO500:NEXTI:GOTO200

```

Put a ZX Printer (£59.95 from Sinclair) on your
PET/VIC using the SOTEX PRINTERFACE
- costing only £19.95 plus £1 p&p.
* Very high-resolution graphics
* Full VIC/PET characters
* 42 column printer with superb formatting
* facilities
* Use as normal PRINT/LIST syntax
Send orders/enquiries to
SOTEX COMPUTERS,
37 Wheaton Road, Bournemouth BH7 6LH
Telephone 0202 422028
Please state exact computer model.

For £79.90 (inc. VAT)
pet/vic printer.

SOFTWARE LIBRARY

for
Sharp MZ80K and SPECTRUM

Low Cost Weekly Hire from
only **50p**. Hire those expensive
GAMES, UTILITIES AND
LANGUAGES
Send stamp for **FREE**
catalogue and details.

KERNOW SOFTWARE
55 Eliot Drive
Saltash Cornwall PL12 5NL

PROGRAMS

Teepee Textpro

by Mike O'Regan

This is the only program anyone's ever sent me for the TI99/4A. It's a word processor which works with the TI Thermal Printer, but if anyone wants to reconfigure it for use with a different printer the relevant lines to change are 1720, 1740 and 2630. Lines 1980, 2190, 2240 and 2630 should all have the '28' changed to suit the line length of any other printer. All the instructions you'll need to process your words of wisdom are contained within the program as a menu.

As listed it will print out 28 columns to match the screen. Control characters for upper case (^) and indent (>) are not included in the characters per line count.

One of its neat features is that it uses the TI99/4A's character redefinition

facilities and the Thermal Printer's ability to mimic the chosen character font. The characters used here are customised, offering lower case with true descenders. These can be obtained directly from the keyboard.

TeepeeTextpro does possess some minor limitations - which were deliberate in the interests of saving RAM. It doesn't offer automatic line wrap-around, block deletion or insertion or line length safeguards on edited lines. However, it does SAVE and LOAD your text to and from cassette at the press of a key.

For users of the TI99/4A this program will be useful as a rough word processor, although I couldn't see it being used for business letters and suchlike unless a more conventional printer were used.

```

100 REM TEEPEETEXPRO
110 REM BY MIKE O'REGAN
120 REM UPDATED 2/09/82
130 REM
140 REM CUSTOM CHAR SET
150 DATA 00101010001
160 DATA 002828
170 DATA 00287C287C28
180 DATA 00382070207C
190 DATA 006468102C4C
200 DATA 00205020545824
210 DATA 00101
220 DATA 000810101008
230 DATA 00201010102
240 DATA 002828
250 DATA 0010107C101
260 DATA 000000060204
270 DATA 0000007C
280 DATA 0000000606
290 DATA 000000060204
300 DATA 00384C546438
310 DATA 001030101038
320 DATA 00384408107C
330 DATA 003844184438
340 DATA 000818287C08
350 DATA 007C403C047C
360 DATA 001020784438
370 DATA 007C0810202
380 DATA 003844384438
390 DATA 0038443C081
400 DATA 00303000303
410 DATA 0030300030302
420 DATA 000204080402
430 DATA 00007C007C
440 DATA 00201008102
450 DATA 00384418001
460 DATA 00384C4C4038
470 DATA 003844447C44
480 DATA 007844784478
490 DATA 003C4440403C
500 DATA 007844444478
510 DATA 007C4078407C
520 DATA 007C4078404
530 DATA 003C44404C3C
540 DATA 0044447C4444
550 DATA 003810101038
560 DATA 000404044438
570 DATA 004448704844
    
```

```

580 DATA 00404040407C
590 DATA 00446C544444
600 DATA 0044645444C44
610 DATA 007C4444447C
620 DATA 00784444784
630 DATA 003844444C3C
640 DATA 00784478504C
650 DATA 003C40380478
660 DATA 007C1010101
670 DATA 004444444438
680 DATA 00444444281
690 DATA 004454545428
700 DATA 004428102844
710 DATA 00442810101
720 DATA 007C0810207C
730 DATA 001810101018
740 DATA 004020100804
750 DATA 00301010103
760 DATA 00102844
770 DATA 00000000007C
780 DATA 001008
790 DATA 00003844443C
800 DATA 004078444478
810 DATA 00003C40403C
820 DATA 00043C44443C
830 DATA 00003844784038
840 DATA 00384070404
850 DATA 00003844443C0478
860 DATA 004078444444
870 DATA 00100010101
880 DATA 00040004044438
890 DATA 004048704844
900 DATA 00301010101
910 DATA 000068545454
920 DATA 000078444444
930 DATA 000038444438
940 DATA 000078444478404
950 DATA 00003C44443C0404
960 DATA 00005864404
970 DATA 00003840380438
980 DATA 002070202038
990 DATA 00004444443C
1000 DATA 00004444281
1010 DATA 000044545428
1020 DATA 000044283844
1030 DATA 00004444443C047C
1040 DATA 00007C08107C
1050 FOR K=33 TO 122
    
```

MICROMART

software for SHARP MZ-80A and MZ-80K

- £5.95 — DUSTCOVERS**
for the A or K and the P6 and P3 printers. Blac. water-proof. A must for every Sharp owner.
- £12.95 — BRIDGE**
Complete 4-handed contract bridge — you against the computer. Full bidding, superb play, this is absolutely outstanding! Ruffs, finesse, slams, Blackwood — they're all there. You can even **WIN** or play a hand again; or define your own hands! Unbeatable value — you'll play this time and time again. Order now — you won't find this program anywhere else!
- £6.95 — FOOTBALL MANAGER**
Join the ranks of the riskiest profession of all! Your mission, to transform a pathetic team into league champions. Your only problems, injured players, insufficient cash, low gates, impatient directors and angry bank managers! Think you can cope? Then try this superb simulation... Before you try it for real!
- £6.95 — COSMIAD**
First Space Invaders, now Cosmiad! Watch out for the aliens peeling off to attack! Excellent.
- £6.50 — HEAD ON**
Basic/machine code arcade game. Gobble up dots, but avoid suicidal robot cars intent on your destruction! Very fast.
- COMPUTER ASSISTED LEARNING**
Whole range of superb programs. Send for details.

MZ-80K only — MOONLANDER £5.50, BIORHYTHM £4.98, BANK ACCOUNT £5.50. Many more

PRICES FULLY INCLUSIVE  Write or phone for full catalogue. Cash with order or ACCESS. Orders despatched by return.

HIGHLIGHT SOFTWARE

3 Nether Court, Halstead, Essex CO9 2HE
Telephone (0787) 475714

PGS

PEDRO COMPUTER SERVICES

- Programming Aids**
- UN-NEW:** If you typed NEW and lost your program without saving, UN-NEW will let you recover it. Price: £10.00
 - DUMP:** You just touch a single key and the entire screen is copied onto the printer. This can happen even while running a program. Price: £10.00
 - DISK UN-NEW 8050:** Recover any scratched program on your 8050. Price: £12.00
 - ASSEMBLER:** for the DR WATSON BOOK OF ASSEMBLY LANGUAGE PROGRAMMING. Price from £7.00
 - TINY BASIC COMPILER:** A true compiler that turns your BASIC programs into fast machine code programs. For old new 8080s. Price: £30.00
 - VIGIL:** Existing, new, game intensive language. Easy to learn with 60+ powerful commands. For all PETA. Also available for VIC. Price £30.00
- Hardware**
- CB2-Sound box:** de luxe Soundbox for Arcade's games with programming manual. Price: £17.50
 - TV Interface:** for both 40 and 80 col. PETA. Video out RF out for connection to home TV. Price: £35.00
 - Telephone Dialer:** use your PET to dial your telephone. Stores 40 names and phone numbers. More than one screen page of names and numbers possible. 40 names and numbers per page. Price: £25.00
 - AD100:** single board analogue to digital converter with on-board supply, 4-bit output port and drive program. Price: £85.00
 - AD200:** Behnert's analogue to digital converter assembled and ready for use. Comes complete with drive program and well documented handbook. Features include 8-bit output port, precision reference voltage, and many others. Price: £55.00
 - PET ROM WRITER:** now you can program DOS and other utilities into 2K and 4K EPROMS. Price £55.00
- Books**
- THE DR. WATSON BOOK OF ASSEMBLY LANGUAGE PROGRAMMING** for all PETA. Price: £10.00
 - THE DR. WATSON BOOK OF ASSEMBLY LANGUAGE PROGRAMMING** for VIC. Includes Assembler Cassette. Price: £17.00
 - PET MACHINE LANGUAGE GUIDE.** Price: £8.00
 - PET REVEALED.** Price: £10.00
 - LIBRARY OF PET SUBROUTINES.** Price: £10.00
 - THE VIC REVEALED.** Price: £10.00
- VIC Programs**
- BIG FISH:** 4 games on one cassette. Price £5.00 (8.5k)
 - STARTRK:** fighting in the galaxy. Price: £5.00 (8k & 8k)
 - DATABASE Retrieval System.** Price: £7.00 (8k & above)
 - HIDDEN CHARACTER GENERATOR.** Price: £7.00 (8k & above)
 - THE CYBER WARS.** Try to destroy them. Price: £7.00 (8.5k) (machine code)
 - VIC DEFENDER.** Destroy fighter ships. Price: £7.00 (3.5k (machine code))
- Prices and 125 VAT (except books) £9.50 p.p. £11.50 hardware only on all orders. Plus add £1.50 if you require Programming Aids on disk. Specify 30x40/40x40 or 80 format.*
- 4 COWCROSS STREET, LONDON EC1.**
TELEPHONE: 01-250 1481

**NEW, QUALITY
COMPUKIT & TANDY
GAMES BUSINESS
SOFTWARE.**

SEND SAE FOR FREE CATALOGUE

IMPEX

Talbot Woods
26 East Avenue
Bournemouth Dorset

MICROCOMPUTERS

Short intensive part time day and evening courses.

01-359 2465
Angel Islington Centre,
69 Upper St.
London N1

MIDLANDS

COMMODORE PET SERVICE CENTRE

Phone Anne on 021-772 8181 about our:

1. Workshop & Field Repairs
2. Business Software
3. Stationery & Supplies



CGS CONSULTANTS

75 Watery Lane, Birmingham B9 4HW.
Telephone: 021-772 8181 (7 Lines)

MICROMART

DISCS . STATIONARY . PRINTERS .

Floppy diskettes in boxes of 10
 5 1/4" s/s/density s/sectored only £15.00
 8" s/s/density s/sectored only £15.00
 (Add £1.00/box P & P + Vat.)

Continuous stationery- 1000 sheets
 9 1/2" x 11" Plain single part only £4.95
 9 1/2" x 11" Plain (with 1/2" margins) only £5.96
 14 1/2" single part only £7.00
 (Includes delivery, excludes Vat.)

Printers from Newbury Labs

Special Introductory Offer
 A free box of 9 1/2" x 11" Stationery with every Newbury Printer purchased

The 8510 (11" carriage) only £480.00
 The 1550 (15" carriage) only £650.00

Printer ribbons
 8510/1550 only £7.50
 Epsom MX80 only £4.56
 Centronic 700 (zip pack) only £3.08

Price - single item but sold in boxes of 5
 (Add £1.00 P & P + Vat.)



CDP Consultants Limited
 Clavering 079985-617

SEARCHING FOR 'BEST PRICE'

FOUND 'BEST PRICE'... GOTO

	RRP
PET	£55
C2N TAPE	£550
4016 16K	£695
4032 32K	£895
8032 32K	£1195
8096 96K	
DISK DRIVES	
2031 170K	£395
4040 343K	£695
8050 1M	£895
8250 2M	£1295
9060 5M	£1995
9090 7.5M	£2495

Our own transport delivers nationwide weekly. All you need is our Best Price Quotation. Contact us Now! For Super Service.

PRINTERS

4022P	80COL	£395
8023	136COL	£895
8300	DAISY	£1395

VAT TO BE ADDED @ 15%
 CARRIAGE - £5 PER ITEM
 IF YOU KNOW WHAT YOU WANT WHY WAIT?

THESE ARE THE PRICES YOU NEED

ORCHARD COMPUTER SERVICES

Orchard House, 21 St Martins St
 Wallingford, Oxon
 Tel: Wallingford (0491) 35529
 Open 6 days per week



UK101 and SUPERBOARD SOFTWARE

UK101 48x16 or 48x32 display:
TAPE 1: Startrek (8k), Robot Chase (4k), Maze (6k), Golf (4k), Space Invaders (4k), Chess board (4k), Graphics (4k), Fourier Series (8k), Best Fit Polynomial (4k), Hangman (8k), Docking and Space Ship (4k).
TAPE 2: Adventure (8k), King (8k), Moon Landing (6k), Simultaneous Equations (4k), Gunfight (4k), Hexapawn (6k), Dogfight (4k), The Tower of Brahma (4k), Nim (4k), Life (8k), Mugwump (4k), Tank Battle (8k), Surround (4k), Integration (8k), Asteroid Shoot (4k), Graphics Aid (4k), Space War (4k), Graphics Aid (4k), Space War (4k), Biorhythm (4k), Breakout (4k), Graph Plotter (6k).
 £7.95 each or all three for £19.95

SUPERBOARD 48x32 display:
TAPE 4: Robot Chase (4k), Golf (4k), Chessboard (4k), Graphics (4k), Fourier Series (8k), Adventure (8k), King (8k), Best Fit Polynomial (4k), Hexapawn (6k), Tower of Brahma (4k), Nim (4k), Mugwump (4k), Graph Plotter (6k), Docking and Space Ship (4k).
 Only £7.95
 Machine Code for UK101 or SUPERBOARD
 PACMAN ASTEROIDS LIFE SPACE INVADERS ASSEMBLER

£3.95 each or all five for £15.95
 (EPROM's erased 50p each plus postage)
Mr M Ward
 9 St Andrews Ave, Chrewe,
 Cheshire CW2 6JJ

PROGRAMS

```

● 1060 READ C$
1070 CALL CHAR(K,C$)
1080 NEXT K
● 1090 CALL CLEAR
1100 GOSUB 5040
1110 PRINT " TEEPEETEXPRO
": : : :
● 1120 PRINT " BY MIKE O'REG
AN"
● 1130 PRINT "FOR THE T.I. THERMAL
PRINTER"
● 1140 PRINT : : : : :
1150 GOSUB 5090
1160 CALL HCHAR(1,1,30,32)
1170 CALL VCHAR(2,1,30,22)
1180 CALL VCHAR(2,32,30,22)
● 1190 CALL HCHAR(24,1,30,32)
1200 GOSUB 4990
1210 CALL CLEAR
● 1220 PRINT "99.4 OWNERS PRESS KE
Y 4"
● 1230 CALL KEY(O,K,S)
1240 IF S=0 THEN 1230
1250 IF K<=52 THEN 1270
● 1260 TT=1
1270 DIM A$(100)
1280 REM - MASTER MENU
● 1290 CALL CLEAR
1300 GOSUB 5040
● 1310 PRINT " ### MENU ###"
: :
● 1320 PRINT TAB(5);"0. WRITE TEX
T"
● 1330 PRINT TAB(5);"1. DRAFT ON
SCREEN"
● 1340 PRINT TAB(5);"2. PRINT FIN
AL DRAFT"
● 1350 PRINT TAB(5);"3. DELETE LI
NE"
● 1360 PRINT TAB(5);"4. INSERT LI
NE"
● 1370 PRINT TAB(5);"5. REPLACE L
INE"
● 1380 PRINT TAB(5);"6. REPLACE W
ORD"
● 1390 PRINT TAB(5);"7. SAVE ON T
APE"
● 1400 PRINT TAB(5);"8. READ FROM
TAPE"
● 1410 PRINT TAB(5);"9. START AGA
IN"
● 1420 PRINT TAB(5);"? . INSTRUCTI
ONS": :
● 1430 PRINT TAB(5);"KEY?"
● 1440 GOSUB 5000
1450 GOSUB 5090
● 1460 CALL KEY(O,K,S)
1470 IF S=0 THEN 1460
1480 CALL CLEAR
● 1490 A=K-48
1500 IF K=48 THEN 2030
1510 IF K=49 THEN 4060
● 1520 IF K=50 THEN 2510
1530 IF (K<=54)*(K>50) THEN 1830
● 1540 IF K=54 THEN 3430
1550 IF K=55 THEN 3890
● 1560 IF K=56 THEN 3970
● 1570 IF K=57 THEN 1760
1580 IF K=63 THEN 4740
● 1590 GOTO 1280
● 1600 GOSUB 5040
1610 PRINT "PICK CHARACTER SET":
: :
● 1620 GOSUB 5000
1630 PRINT TAB(6);"1.PRINTER SET
(LARGE)"
● 1640 PRINT TAB(6);"2.CUSTOM SET
(SMALL)": : :
● 1650 PRINT "IS YOU PRINTER SWITC

```

```

HED ON?": : :
● 1660 GOSUB 5090
1670 CALL KEY(O,KEY,S)
1680 IF S<1 THEN 1670
1690 IF KEY=77 THEN 1290
1700 IF (KEY<49)+(KEY>50) THEN 16
00
● 1710 IF KEY<49 THEN 1740
1720 SET$="TP.E"
1730 IF K=49 THEN 4060 ELSE 2530
1740 SET$="TP.U.E"
● 1750 IF K=49 THEN 4060 ELSE 2530
1760 FOR I=1 TO L
1770 A$(I)=" "
1780 NEXT I
1790 L=0
1800 PRINT "FILE NOW BLANK"
1810 GOSUB 4990
1820 GOTO 1290
1830 INPUT "LINE NUMBER?":B
1840 IF (B<1)+(B>L)=1 THEN 1850
ELSE 1830
1850 PRINT "NON-EXISTENT LINE"
1860 GOSUB 4990
1870 GOTO 1280
1880 PRINT "OLD LINE #":B
1890 PRINT A$(B)
1900 FOR PSE=1 TO 250
1910 NEXT PSE
1920 ON A GOTO 1290,1290,3220,33
00,1930
1930 PRINT "ENTER REPLACEMENT LI
NE:"
1940 INPUT A$(B)
1950 IF SEG$(A$(B),1,2) <> "BB" TH
EN 1930
1960 A$(B)=" "
1970 GOTO 1280
1980 IF LEN(A$(B))>28 THEN 2180
ELSE 1280
1990 REM -- ENTER TEXT
2000 TEMP=L
2010 L=B
2020 GOTO 2350
2030 GOSUB 5040
2040 PRINT "READY FOR TYPING --
STARTING WITH LINE":L+1
2050 IF TT=1 THEN 2050 ELSE 2070
2060 PRINT "A=UPPER CASE"
2070 PRINT "SLASH(DIVIDE SIGN)=C
OMMA STAR(MULTIPLY SIGN)=QUOT
ES DOLLAR SIGN=#
>=INDENT"
2080 PRINT "N.B. # CUSTOM CHARS
ONLY"
2090 PRINT "BB=BLANK LINE": : :
2100 PRINT "KEY-IN ZZ TO FINISH
ENTERINGTEXT": : : : :
● 2110 GOSUB 5090
2120 GOSUB 5000
2130 PRINT L+1
2140 IF L+1<=52 THEN 2160
2150 CALL SOUND(1000,440,2,444,2
,446,2)
2160 INPUT A$(L+1)
2170 LC=LEN(A$(L+1))
2180 LL=LC
2190 IF LC>28 THEN 2200 ELSE 225
0
2200 FOR I=LL TO 1 STEP -1
2210 IF SEG$(A$(L+1),I,1) <> CHR$(
94) THEN 2230
2220 LC=LC-1
2230 NEXT I
2240 IF LC>28 THEN 2310
2250 IF LEN(A$(L+1)) <1 THEN 2130
2260 IF SEG$(A$(L+1),1,2)="ZZ" T
HEN 1290
2270 IF SEG$(A$(L+1),1,2) <> "BB"

```

COMPUTER CORRESPONDENCE COURSE

Learn to program a computer in the comfort of your own home using the latest Dragon micro with 32k of RAM and COLOUR GRAPHICS capability. The computer is yours to keep.

The course extends over a period of 10 weeks taking you from BEGINNERS BASIC to BUSINESS applications and DATABASE handling.

IMMEDIATE ENROLMENT
 Fee: £259« £3.40 p&p All inclusive
 For FURTHER DETAILS write enclosing SAE to:

COMPUTER CORRESPONDENCE COURSES

Churchway, West Ilsley,
 Nr Newbury RG16 0AH
 Berks

PROGRAMS

```

THEN 2230
2280 A$(L+1)=" "
2290 L=L+1
2300 GOTO 2130
2310 REM - SHORTEN LONG LINE
2320 REM BELL
2330 CALL SOUND(100,-5,1)
2340 L=L+1
2350 PRINT "LINE TOO LONG -- SHOR-
TENED AS SHOWN:"
2360 FOR I=28 TO 1 STEP -1
2370 IF SEG$(A$(L),I,1)=" " THEN
2420
2380 NEXT I
2390 A$(L)=" "
2400 L=L-1
2410 GOTO 2430
2420 A$(L)=SEG$(A$(L),I,1)
2430 PRINT A$(L)
2440 IF (TEMP=B)*(TEMP<>0) THEN 2
450 ELSE 2460
2450 L=TEMP
2460 IF A$(L+1)=" " THEN 2130
2470 IF (L>TEMP)*(TEMP=0) THEN 12
90
2480 L=TEMP
2490 GOTO 2160
2500 REM -- PRINT TEXT
2510 C=0
2520 GOTO 1600
2530 GOSUB 5000
2540 PRINT TAB(5);"READY TO PRIN-
T
CHOOSE FORMAT:"
2550 PRINT "0 = NUMBERED
1 = SINGLE SPACED
2 = DOUBLE SPACED"
2560 CALL KEY(O,K,S)
2570 IF S=0 THEN 2560
2580 CALL CLEAR
2590 IF K=77 THEN 1260
2600 B=K-48
2610 IF (K<48)+(K>52) THEN 2540
2620 IF (B<0)+(B>2) THEN 2510
2630 OPEN #1:SET$,OUTPUT
2640 FOR I=1 TO L
2650 P=A$(I)
2660 IF B<>0 THEN 2680
2670 PRINT #1:I;
2680 IF LEN(P)=0 THEN 3070
2690 PRINT #1:TAB(3);"";
2700 FOR K=1 TO LEN(P)
2710 P=ASC(SEG$(P,K,1))
2720 REM -- CONVERT UNSHIFTED LE-
TTERS TO LOWER CASE
2730 IF (P>64)*(P<91) THEN 2740 E-
LSE 2760
2740 P=P+32
2750 GOTO 2950
2760 REM -- CONVERT SHIFTED LET-
TERS TO UPPER CASE
2770 IF (P>96)*(P<123) THEN 2780
ELSE 2800
2780 P=P-32
2790 GOTO 2950
2800 REM -- CONVERT SLASH (/) TO
COMMA (,) - * TO " AND > TO IND
ENT
2810 IF P<>47 THEN 2840
2820 P=44
2830 GOTO 2950
2840 IF P<>42 THEN 2870
2850 P=34
2860 GOTO 2950
2870 IF P<>62 THEN 2900
2880 GOSUB 3110
2890 GOTO 2950
2900 IF P=94 THEN 2910 ELSE 2930
2910 GOSUB 3150
2920 GOTO 2950

```

```

2930 IF P<>95 THEN 2950 ELSE 295
0
2940 GOSUB 3160
2950 PRINT #1:CHR$(P);
2960 REM - TEST FOR BLANK LINE (
BB)
2970 IF (P=66)*(LEN(P$)=2) THEN 3
020
2980 NEXT K
2990 IF B<>2 THEN 3020
3000 PRINT #1
3010 C=C+1
3020 PRINT #1
3030 C=C+1
3040 CALL KEY(O,K,S)
3050 IF S=0 THEN 3070
3060 GOTO 3080
3070 NEXT I
3080 CLOSE #1
3090 CALL SOUND(50,262,0,524,0)
3100 GOTO 1280
3110 PRINT #1:TAB(4);
3120 PRINT TAB(1);
3130 P=32
3140 RETURN
3150 P=ASC(SEG$(P$,K+1,1))
3160 K=K+1
3170 RETURN
3180 PRINT #1:TAB(15);
3190 P=32
3200 RETURN
3210 REM -- DELETE LINE
3220 L=L-1
3230 FOR I=B TO L
3240 A$(I)=A$(I+1)
3250 NEXT I
3260 A$(L+1)=" "
3270 GOTO 1290
3280 REM
3290 REM -- INSERT LINE
3300 L=L+1
3310 FOR I=L TO B+1 STEP -1
3320 A$(I)=A$(I-1)
3330 NEXT I
3340 PRINT "ENTER NEW LINE:"
3350 GOSUB 5000
3360 A$(B)=" "
3370 INPUT A$(B)
3380 IF SEG$(A$(B),1,2)<"BB" TH-
EN 3400
3390 A$(B)=" "
3400 GOTO 1290
3410 REM
3420 REM -- REPLACE WORD
3430 INPUT "WORD TO BE CHANGED:"
:R$
3440 R$=" "&R$&" "
3450 D=LEN(R$)
3460 IF D>2 THEN 3510
3470 PRINT "ERROR"
3480 FOR PSE=1 TO 250
3490 NEXT PSE
3500 GOTO 3430
3510 N=0
3520 INPUT "NEW WORD?":N$
3530 INPUT "FROM LINE (0=ALL)?":
B
3540 IF B<=L THEN 3570
3550 PRINT "NO SUCH LINE"
3560 GOTO 3530
3570 IF B>1 THEN 3610
3580 C=L
3590 B=1
3600 GOTO 3640
3610 INPUT "THROUGH LINE?":C
3620 IF (C<B)+(C>L)<-1 THEN 364
0
3630 C=L
3640 PRINT "SEARCHING"

```

MICROMART

INTRODUCING DATACLONE

The Specialists
in Software Duplication

DataClone is the first company in the UK established specifically for the duplication of data cassettes.

All other duplicating houses are audio orientated - only DataClone has a duplicating system designed from scratch purely to handle computer information.

The result?

Greatly improved reliability in data transfer rates from 300 to beyond 2400 baud - previously unattainable.

All formats catered for. Quantities from 100 to infinity.

Contact us now for brochure.

DataClone - the first specialist service for computer cassettes.

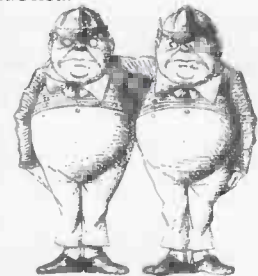

DATACLONE

1-7 Harewood Avenue,
London NW1 6LE
Tel 01-724 3768 Telex 21879

SHARP

C.P.E. are proud to announce *CPE DATABASE* One of the most sophisticated tape based programs currently available and designed specifically for MZ80K/A! Ideal for small business, clubs, personal use. Basic and machine-code give big system performance. FEATURES Alphabetic, Numeric & DATE types, Modify, block Copy/Delete/etc., Sort, Search (1-6 levels), Calculate, Cross-Field Total, flexible user-defined Printer Formats for reports (with headings) mailing lists etc. Loads data files at 10x normal speed! On cassette with 35 page manual £13.80 Manual only, £4 (refunded against program).

BASIC PLUS a popular program for 80K only. Offers Key-Repeat (incl cursor), Numeric-Pad, Syntax errors pinpointed & displayed, Single-Key, List Pause, Auto number, Link. On cassette, with comprehensive manual and printed key labels. Still only

Large SAE for further details. All prices are fully inclusive, please state machine when ordering and send cheques/P.O. to:

C P Electronics,
51 Fairholme Road,
Widlington, Manchester
M20 9SA.



Calling all
hobbyists,
schools, soft-
ware houses
and budding
programmers!

We would like
to hear from program writers who
would like to see their work pub-
lished on Prestel for everyone to
use. We'd like programs for most

micros - Apple, BBC, Commodore,
Tandy, Sinclair - to be included
in our database, 'Aladdin's Cave.

Of course, we are willing to pay for any
that we publish

If you are interested then please
contact us at: Aladdin's Cave,
Prestel Headquarters,
Telephone House, Temple Ave,
London EC4Y 0HL.

Prestel and the Prestel symbol are
trademarks of British Telecommunications.

ZX81

● CASSETTE 3 8 programs for 16K ZX81

STARSHIP 'TROJAN'

Repair your starship before disaster strikes. Hazards include asphyxiation, radiation, escaped biological specimens and plunging into a supernova.

STARTREK

With variable klingon mobility.
PRINCESS OF KRAAL
An adventure game.

BATTLE, KALABRIASZ, CUBE,
SECRET MESSAGES, MARTIAN
CRICKET.

(Martian cricket is 1st m/c game)

● CASSETTE 4 8 games for 16K

ZS-SCRAMBLE (m/c) with 3 stages.

GUNFIGHT (m/c) invaders (m/c)

GALAXY INVADERS (m/c)

Snakebite (m/c)

LIFE (m/c) 3D Tic-Tac-Toe

7 of the 8 games are in machine code for extra speed.

These cassettes cost £5 each.

Please write for Cassette 1&2 details.

On quality cassettes, by first class post

from

Michael Orwin, 26 Brownlow Rd.,

Willesden, London NW10 9QL

SHARPMZ80KUSERS EXTRA MEMORY

No more waiting while your cassettes are loading. Keep all your programs on our 32K EPROM storage board for instant access. Auto load facility allows your program to be up and running after switch on. Add any number of boards to your system. Many other interface boards now available for MZ80K and MZ80A, including Centronics and RS232 printer boards.

Send for details to:

PETERSON ELECTRONICS LTD,
Academy Street
Forfar
Angus DD8 2HA
Telephone Forfar (0307) 62591

ASHFORD COMPUTER CENTRE

All makes of
micros
and accessories
supplied at large
discounts.

Clarendon Road,
ASHFORD Midd'x
Tel: Ashford 44955

OSBORNE 1

Telex Conversion Unit
now available

4B microcentres

North Bar, Banbury, Oxon. OX16 0TF Telephone (0295) 66555

PROGRAMS

```

● 3650 FOR K=B TO C
3660 P$=" "&A$(K)&" "
3670 IF LEN(P$)<D THEN 3740
● 3680 A=LEN(P$)+1-D
3690 FOR I=1 TO A
3700 IF R$<>SEG$(P$,I,D) THEN 373
0
3710 GOSUB 3780
● 3720 P$=SEG$(P$,2,LEN(P$)-1)
3730 NEXT I
3740 NEXT K
● 3750 PRINT N;" CHANGE(S) MADE"
3760 GOSUB 4990
3770 GOTO 1290
● 3780 CPOS=POS(P$,R$,1)
3790 IF CPOS<0 THEN 3810
● 3800 RETURN
3810 T$(1)=SEG$(P$,2,CPOS-1)
3820 T$(2)=SEG$(P$,CPOS+D,LEN(P$
)-1)
● 3830 P$=T$(1)&N$&" "&T$(2)
3840 A$(K)=P$
● 3850 N=N+1
3860 PRINT "LINE #";K
● 3870 PRINT A$(K)
3880 RETURN
3890 PRINT "READY CASSETTE FOR R
ECORDING:"
● 3900 OPEN #1:"CS1",INTERNAL,OUTP
UT,FIXED 192
● 3910 PRINT #1:L
3920 FOR I=1 TO L+5 STEP 6
● 3930 PRINT #1:A$(I),A$(I+1),A$(I
+2),A$(I+3),A$(I+4),A$(I+5)
3940 NEXT I
● 3950 CLOSE #1
3960 GOTO 1290
● 3970 PRINT "READY CASSETTE TO RE
AD"
● 3980 OPEN #1:"CS1",INTERNAL,INPU
T,FIXED 192
3990 INPUT #1:X
4000 FOR I=L+1 TO X+L+5 STEP 6
4010 INPUT #1:A$(I),A$(I+1),A$(I
+2),A$(I+3),A$(I+4),A$(I+5)
● 4020 NEXT I
4030 L=L+X
4040 CLOSE #1
● 4050 GO TO 1290
4060 REM PRINT FINAL TEXT ON SCR
EEN ONLY
● 4070 C=0
4080 PRINT "CHOOSE FORMAT:" : :
● 4090 PRINT TAB(8);"0=NUMBERED"
4100 PRINT TAB(8);"1=SINGLE SPAC
ED"
● 4110 PRINT TAB(8);"2=DOUBLE SPAC
ED" : :
● 4120 GOSUB 5000
4130 CALL KEY(O,K,S)
4140 IF S=0 THEN 4130
● 4150 CALL CLEAR
4160 B=K-48
4170 IF (K>48)+(K<52) THEN 4190 E
LSE 4080
4180 IF (B<0)+(B>2) THEN 4070
4190 FOR I=1 TO L
4200 P$=A$(I)
4210 IF B<0 THEN 4230
● 4220 PRINT I
4230 IF LEN(P$)=0 THEN 4590
4240 PRINT " ";
● 4250 FOR K=1 TO LEN(P$)
4260 P=ASC(SEG$(P$,K,1))
4270 IF (P>64)*(P<91) THEN 4280 E
LSE 4300
4280 P=P+32
4290 GOTO 4440
● 4300 IF (P>96)*(P<123) THEN 4310

```

```

ELSE 4330
4310 P=P-32
4320 GOTO 4440
4330 IF P<>47 THEN 4360
4340 P=44
4350 GOTO 4440
4360 IF P<>62 THEN 4390
4370 GOSUB 4610
4380 GOTO 4440
4390 IF P<>94 THEN 4420
4400 GOSUB 4640
4410 GOTO 4440
4420 IF P<>95 THEN 4440
4430 GOSUB 4670
4440 PRINT CHR$(P);
4450 CALL KEY(O,KE,ST)
4460 IF ST<1 THEN 4480
4470 GOTO 1280
4480 REM TEST FOR BLANK LINE
4490 IF (P=66)*(LEN(P$)=2) THEN 4
540
4500 NEXT K
4510 IF B<>2 THEN 4540
4520 PRINT
4530 C=C+1
4540 PRINT
4550 P=32
4560 C=C+1
4570 IF C<51 THEN 4590
4580 C=0
4590 NEXT I
4600 GOTO 4700
4610 PRINT TAB(1);
4620 P=32
4630 RETURN
4640 P=ASC(SEG$(P$,K+1,1))
4650 K=K+1
4660 RETURN
4670 PRINT TAB(15);
4680 P=32
4690 RETURN
4700 PRINT "
PRESS ANY KEY TO CONTINUE"
4710 CALL KEY(O,K,S)
4720 IF S=0 THEN 4710
4730 GOTO 1210
4740 CALL CLEAR
4750 REM INSTRUCTIONS
4760 PRINT "THIS PROGRAM HANDLES
UP TO 100 LINES OF TEXT" : :
4770 GOSUB 4990
4780 IF TT<>1 THEN 4820
4790 PRINT "IT PRINTS IN LOWER C
ASE (SMALL LETTERS) UNLESS T
OLD OTHERWISE."
4800 GOSUB 4990
4810 PRINT "TO PRODUCE UPPER CAS
E LETTERS, PRESS '^' BEFOR
E EACH LETTER." : :
4820 PRINT "99.4A USERS USE SHIF
T KEY TO PRODUCE UPPER & LOWER CA
SE" : :
4830 GOSUB 4980
4840 PRINT "TO PRODUCE A BLANK L
INE PRESS 'BB', OR AN INDENT
'^'^'"
4850 PRINT "FOLLOWED BY THE APPR
OPRIATE NUMBER OF SPACES" : :
4860 GOSUB 4990
4870 PRINT "IF YOUR TRY TO TYPE
A LINE WHICH IS TOO LONG THEN Y
OU WILL BE TOLD THAT THIS IS TO
O"
4880 PRINT "BE SHORTENED TO THE
NEAREST WHOLE WORD AND THE NEW L
INE IS DISPLAYED. LINES WITH"
4890 PRINT "MORE THAN 28 CONTINU
OUS CHARACTERS(I.E. NO SPACE
S) WILL BE TOTALLY DISCARDED":

```

ZX81 (16k) SPECTRUM STARTREK

Features an 8x8 Galaxy, Klingons and Starbases, short and long range scans, torpedoes and phasers, computer etc. PLUS normal or hyperdrive: choose your speed but watch the energy level. Galaxy Map: keep track of where you have been and whether there are any Starbases or Klingons there. Visual display of Enterprise's position and movement, and of the path of torpedoes. Messages from crew members. A user friendly long range scan. Five levels of play. And much more. Cassette with full instructions.

ZX81 £4.95

SPECTRUM £5.95 (Colour and sound too)

Gemini Software
36 Badminton Road
LEICESTER LE4 7RQ
Tel: 0633 64915

D Tec Digital Technology

Disk and tape based programs
for the Sharp MZ80K

Scrambler IQ test,
general knowledge
quiz, solitaire, poster
prints, roulette, hang-
mans noose, word
square and many,
many more. S.A.E. for
full price lists.

Disk Data-Base,
Accounts/Database,
Stock control, Payroll,
Teledata. A disk-based
telephone and address
book for quick access

Many more programs for business and
games. Please telephone or write to:

D Tec 254 Bridal Road, Eastham,
Wirral Merseyside, L62 8BX
Tel: 051-327 5070

MICROMART

VIC-20

BOMBER RUN — our latest, and it is truly SUPERB! Screensful of scenery flash by beneath your strato-bomber. You must blast out the enemy defences and clear a landing strip enemy defences and clear a landing strip before your fuel expires. But watch out for the enemy suicide fighter pilots, and mind you don't leave an exploded bomb in the runway! Terrific graphics and great arcade action, thanks to machine code. UNEXPANDED VIC, Intro price only £4.95

ALSO AVAILABLE (unexpanded VIC): **ENCOUNTER** — (machine code/basic) — crack the lights and music code to land the giant space ship. £4.95.

BUGBASHER — (machine code) — countless green meanies trying to escape from the rotating maze. On Level 5, it's almost impossible to stop them. £4.95

VICPENDIUM 1 — 4 great games, including machine code INVADERS. £6.95

SPACE TRAVEL — defeat the hordes of deadly space birds. £5.95

PUCMAN — Gobble the dots and avoid the dreaded ghosts. £5.95

OPUS 2 SOFTWARE

525/531 London Road, Westcliff on Sea, Essex

Tel: (0702) 42339

COLOUR and SOUND



'SIMPLY FILE' RECORDS SYSTEM (DBMS). Select by any key. Print alphabetic lists, mailing labels. Calculate, total, average columns. Fast, easy, robust and VERY versatile. DISK ONLY: £65

'SIMPLY WRITE' FAST WORD PROCESSOR. Some £300-£400 programs have no more facilities. Tape or disk, any printer, 40-80 column PET. Needs 16K. TAPE £40, DISK £45

GOTTA PET? ADDA VIC! High resolution graphics, programmable characters, colour and sound on your PET? All this PLUS a complete extra computer using your PET's drives, printer etc? Under £200 including VIC and our super PET-VIC LINK! (Available separately)

PRICES PLUS VAT BUT INCLUDING P&P. SEND FOR DETAILS, MORE UNUSUAL ITEMS. GET OUR FREE 'MICROMAIL' PET NEWSLETTERS.

SIMPLE SOFTWARE LTD.
15 HAVELOCK ROAD
BRIGHTON SUSSEX BN1 6GL
(0273) 504879



OSBORNE 1

Double Density now available

4B microcentres

North Bar, Banbury, Oxon. OX16 0TF Telephone (0295) 66555

PROGRAMS

```

10 INTRO=800:FGND=200:BDR=300:TEXT=400:I
NFO=600:BLINK=700:N16=16
15 GOSUB INTRO
20 GRAPHICS 0:POKE 752,1:POKE 712,148:PO
KE 82,0:POKE 83,40:OPEN #1,4,0,"K:"
23 ? :? " Cntl-Q, Cntl-R 37 times, Cntl-E
"
25 ? " |Number Colour      Number Colour
"
26 ? " |
"
30 ? " | 0      GREY      08      LIGHT-BL
UE " |
35 ? " | 1      GOLD      09      BLUE-GRE
EN " |
40 ? " | 2      ORANGE     10      AQUA
"
45 ? " | 3      RED        11      GREEN-BL
UE " |
50 ? " | 4      PINK       12      GREEN
"
55 ? " | 5      VIOLET     13      YELLOW-G
REEN " |
60 ? " | 6      BLUE-PURPLE 14      ORANGE-G
REEN " |
65 ? " | 7      BLUE        15      ORANGE
"
70 ? " | Cntl-Z, Cntl-R 37 times, Cntl-C
"
75 GOSUB BLINK
80 POSITION 1,16:? "SE.1,0,":POSITION 14
,16:? "SE.2,":POSITION 21,16:? ",":POSIT
ION 27,16:? "SE.4,":POSITION 34,16:? ",
"
85 POSITION 1,18:? "ADDR.709=":POSITION
14,18:? "ADDR.710=":POSITION 27,18:? "AD
DR.712="
90 C1=INT(PEEK(709)/N16):L1=PEEK(709)-C1
*N16
95 C2=INT(PEEK(710)/N16):L2=PEEK(710)-C2
*N16
100 C4=INT(PEEK(712)/N16):L4=PEEK(712)-C
4*N16
110 GOSUB INFO
125 GET #1,CHOICE
130 IF CHOICE=70 THEN 150
135 IF CHOICE=66 THEN 155
140 IF CHOICE=84 THEN 160
145 GOTO 125
150 GOSUB FGND:GOSUB BLINK:GOTO 125
155 GOSUB BDR:GOSUB BLINK:GOTO 125
160 GOSUB TEXT:GOSUB BLINK:GOTO 125
190 REM ***BACKGROUND COLOUR***
200 POSITION 2,20:? "Hit SPACE to alter
BACKGROUND Colour"
205 POSITION 2,21:? "Hit ESCAPE Key to f
reeze parameters "
210 GET #1,K:IF K=32 THEN C2=C2+1:GOTO 2
25
215 IF K=27 THEN POSITION 21,20:? "the B
RIGHTNESS ":GOTO 240
220 GOTO 210
225 IF C2>15 THEN C2=0
    
```

DRAGON 88

with cassette lead, demonstration tape and introduction to basic. £177.06

BMC 12" MONITOR black-green. £79.33

SANYO 12" RECEIVER. £69.19

Software on tape: Full telephone directory (d32 & trs80). £4.50

Data storage/retrieval system, IOO indexed, editable pages (d32). £4.50

Desk-top diary system (d32). £5.00

Please write for printers, monitors, etc.

Add £6 only, for hardware carriage.

TREMORRAN DATA SYSTEMS,

Torr's Park, Ilfracombe, Devon.

SOFTWARE (LEVEL 2)
O' LEVEL FRENCH TUTOR — Pass 'O' level the easy way £10.00
SUPER COPY — copy is virtually all systems (M/C) tapes £6.50
MISSILE COMMAND POST — just like the arcade £7.50
QUICK KEYWORD ENTRY — speed up programme entry £4.50
FALL OUT & GUNFIGHTER — Half price, both for £5.00
HARDWARE
4K — 16K — simply plugs into Keyboard £25.00
16K — 32K — simply plugs into EXP INT £20.00
32K — 48K — simply plugs into EXP INT £20
LOWER CASE — vital for word processing £7
AMPLIFIER — Add sound to your programs £6
All prices include VAT and postage are for level 2 only. Specify disc (add £3.00) or cassette and system configuration. Mail order only cheques and postal orders to:
JD TRONICS, 42 CREDITON HILL, LONDON NW6 1HR

Send SAE for further details on all products

TRS80

PROGRAMS

```

230 SETCOLOR 2,C2,L2:GOSUB INFO:GOTO 210
240 GET #1,K:IF K=32 THEN L2=L2+2:GOTO 255
245 IF K=27 THEN 270
250 GOTO 240
255 IF L2>14 THEN L2=0
260 SETCOLOR 2,C2,L2:GOSUB 600:GOTO 240
270 POSITION 2,20:? CHR$(156):POSITION 2,20:? CHR$(156)
275 RETURN
290 REM ***BORDER COLOUR***
300 POSITION 4,20:? "Hit SPACE to alter BORDER colour"
305 POSITION 4,21:? "Hit ESCAPE to freeze parameters"
310 GET #1,K:IF K=32 THEN C4=C4+1:GOTO 325
315 IF K=27 THEN POSITION 22,20:? " BRIG HTNESS ":GOTO 340
320 GOTO 310
325 IF C4>15 THEN C4=0
330 SETCOLOR 4,C4,L4:GOSUB INFO:GOTO 310
340 GET #1,K:IF K=32 THEN L4=L4+2:GOTO 355
345 IF K=27 THEN 370
350 GOTO 340
355 IF L4>14 THEN L4=0
360 SETCOLOR 4,C4,L4:GOSUB INFO:GOTO 340
370 POSITION 4,20:? CHR$(156):POSITION 4,20:? CHR$(156)
375 RETURN
390 REM ***TEXT BRIGHTNESS***
400 POSITION 3,20:? "Hit SPACE to alter TEXT brightness"
405 POSITION 3,21:? "Hit ESCAPE to freeze parameters"
410 GET #1,K:IF K=32 THEN L1=L1+2:GOTO 425
415 IF K=27 THEN 440
420 GOTO 410
425 IF L1>14 THEN L1=0
430 SETCOLOR 1,L1:GOSUB INFO:GOTO 410
440 POSITION 4,20:? CHR$(156):POSITION 4,20:? CHR$(156)
445 RETURN
590 REM ***DATA UPDATE***
600 POSITION 9,N16:? " ":POSITION 9,N16:? L1:POSITION 19,N16:? " ":POSITION 19,N16:? C2:POSITION 22,N16:? " "
610 POSITION 22,N16:? L2:POSITION 32,N16:? " ":POSITION 32,N16:? C4:POSITION 35,N16:? " ":POSITION 35,N16:? L4
615 POSITION 10,18:? " ":POSITION 10,18:? PEEK(709):POSITION 23,18:? " ":POSITION 23,18:? PEEK(710)
620 POSITION 36,18:? " ":POSITION 36,18:? PEEK(712)
630 RETURN
690 REM ***BLINK INVERSE VIDEO***
700 POSITION 1,14:? "SELECT (T)ext,(F)or eground, or(B)order"
    
```

MICROMART

PET ONLY!

ARCADE GAMES

All run in 8k. All are machine code. Super Gloopier £8, Asteroids £8, Blakatak £8, Tank Zone £8, Invaders Part 2 £6, Cosmic Aliens £8, Cosmic Bandit £6.

ADVENTURES

Hitch-Hikers Guide to the Galaxy (32k) £16, Cracks of Doom (32k) £16, Catacombs (16k disk) £27, Goblin Towers (32k disk) £14, Cornucopia (32k disk) £35

FANTASY GAMES

Halls of Death (16k) £14, Lost Valley (32k) £14, Wizard's Lair (8k) £10.

LOGIC GAMES

Pet Chess (32k) £25, Othello (8k) £8, Gomoku (8k) £8, Hunt the Bismark (32k) £12.

SUPERSOFT

Post free, but please add 15% VAT to prices. Winchester House, Canning Road, Harrow, Middlesex, Tel-01 861 1166



YOU need the PROXIMA GRAPHIC PLANNER

Don't be trapped into designing one graphic at a time on the VDU screen. Work on 2, 4 or up to 48 adjacent units with this quality-printed Graphic Planning Pad. Prepare your designs at home, on the train, at school or the office - anywhere.

£3.50
Introduction Price 80 Pages

- Full instructions
- Over 300 predesigned graphics to use or to spark your imagination
- Space to design over 2000 graphics of your own.
- All column values printed to aid coding
- Sample program to calculate values, POKE to memory and SAVE
- Written for Spectrum but invaluable for any computer with 8x8 user defined graphics
- All in all the best to be had.

Also available: ZX81/Spectrum BASIC coding sheets. Printed blue on quality paper for neat and precise program development. **£2.50 inc p&p per 100 sheets.**

SPECIAL OFFER:
PROXIMA GRAPHIC PLANNER PAD ~~£5.00~~ **£5.00**
PLUS 100 BASIC CODING SHEETS

Remittances to Proxima Centauri Ltd.
Suite A7, 23 Denmark Street,
London WC2H 8NA.
Please specify exact requirements.



32K NASCOM ADVENTURE only £8.95

Now only £8.95 buys you entry to Colossal Cave in our complete full-spec version of the original classic main-frame Adventure. In our opinion, ours is simply the best Adventure for the Nascom -- no one else gives you the full unshortened authentic descriptions and messages, a complete 32k, all the genuine locations, helpful hints in the game, and lots more.

Using English words, explore a vast underground labyrinth of caves, twisty passages, and exotic rooms; outwit fierce enemies, collect all the many treasures, and become a Grand Master!

No one else gives you this -- but don't take our word for it -- buy it and see for yourself!

AMAZING PRICE REDUCTION!

Free P & P in UK. No VAT. Supplied on high quality cassette. Requires 32K RAM and NAS-SYS. Send order, stating tape format, or SAE for further details on this and our other programs, to: SYRATIS SOFTWARE, 23 Quantock Road, Bridgwater, Somerset.

BBC Micro & Car ?

Our new Fuel Monitor program will analyse your fuel consumption on your BBC Micro Model B. Simply note vehicle mileage and fuel added at each fill. Then run Fuel Monitor. Superb graphics give a complete fuel economy history at a glance. This can save £££'s by helping to OPTIMISE SERVICE INTERVALS CHECK ECONOMY MEASURES; FIND FAULTS, ETC.

Send cheque or PO for £9.50 for fully documented program or SAE for further details to:

ORARA consultants
PO Box 179 Sheffield S1 1DZ

PROTOCOL BOOKS

MICRO-COMPUTER LITERACY BEGINS HERE ...

HOT OFF THE PRESS

Power of VISIBLOC/VisualC (Visualc Zone Book)	£10.00
IBM Personal Computer	£12.00
IBM PC Expansion and Software guide	£8.75
Survivors Guide to the IBM PC	£8.75
DPM word Processing	£12.00
Wile II word-processing	£12.00
The Custom Apple II other Mysteries	£17.00

BEST SELLERS

Power of VisiCalc Vols 1 & 2. Power of Supercalc	£9.00
Using BASIC Assembly Language on the Apple	£11.00
Benchmark Apple II DOS	£11.00
Mag of Trivia	£22.00
Includes disk - price inclusive of VAT	£18.00
What's Where in the Apple	£18.00

Postage Free.

For a detailed description of any of the above items and our complete catalogue, please send S.A.E. and indicate the items which interested you.

TRADE ENQUIRIES WELCOMED.

ORARA 114 WIDMORE ROAD
BROMLEY
KENT BR1 3BE
TELEPHONE: 01-460 2080/466 8682

VIDEO GENIE & TRS 80 16K LEVEL II



PACK 1



PACK 2

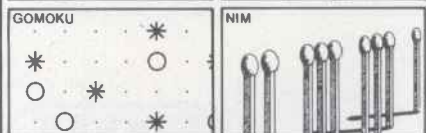
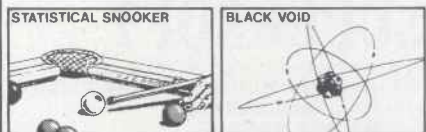

PACK 3

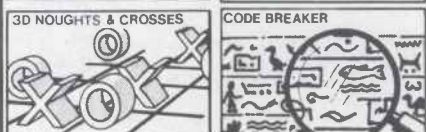
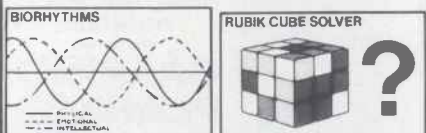

PACK 4

EACH PACK £9.50 ANY TWO PACKS £14.50
 ANY THREE PACKS £18.00 ALL FOUR PACKS £19.50

These four packs (16 games in all) offer the TRS 80 and Video Genie user an enormous variety of excellent games at greatly reduced prices. There are fast, smooth Z80 machine code arcade games like Assault Course, Space Pirates and Space Invaders. There are brain teasers like 3D O's and X's, NIM, Gomoku and a Code Breaker that can even play against you move for move! There are new games as well such as Statistical Snooker, Dracula's Castle and 40-over Cricket.

Promptly delivered and sensibly priced, each tape has a 12 months guarantee. You can't miss this fantastic offer.

WRITE OR PHONE YOUR ORDERS TODAY!

ACCESS ORDERS TAKEN BY PHONE 24 HRS A DAY



24hrs

Dealer enquiries welcome
 Lower North St., Cheddar, Somerset.
 Tel. Cheddar 515265

PROGRAMS

```

710 NORM=PEEK(755)
715 FOR W=0 TO 5
720 FOR DELAY=0 TO 10:NEXT DELAY
725 POKE 755,0:SOUND 1,50,10,10
730 FOR DELAY=0 TO 10:NEXT DELAY
735 POKE 755,2:SOUND 1,0,0,0
740 NEXT W:POKE 755,NORM
745 RETURN
790 REM ***INTRODUCTION***
800 ? "}:":DIM A$(18):POKE 752,1
805 A$="DJL COLOUR UTILITY"
810 FOR J=0 TO 22:POSITION J,J
815 ? A$:POKE 710,J*8:POKE 712,J*4:SOUND
    0,J,10,10:FOR W=0 TO 5:NEXT W:NEXT J
820 SOUND 0,0,0,0:RETURN
    
```

EPSON HX20

Continued from page 117

stock control applications is also promised which will be HP compatible.

The RS232 interface can be used to attach a full-sized printer such as Epson's own MX-100 for which the protocols are built-in (though the interface is programmable to accommodate other devices). An acoustic coupler, the CX-20, will be available at launch, Telecom permitting, which will make the HX-20 into a powerful roving terminal for sales teams and the like.

Floppy disk drives are to be produced; twin 5¼in drives with 328k per drive. They will be controlled by the TV adaptor, but don't expect to see them before 1983.

An obvious question given the excellent keyboard is 'Can I word-process on it?' The answer is that Epson has commissioned a word-processing package called 'Correspondent' and a mailing list program called 'MList', both of which should be available on launch; unfortunately I couldn't get them in time for this test. 'Correspondent' will be distributed in ROM and Epson sounds quite excited about its capabilities. More than that I cannot tell you.

Other software products which Epson has in preparation are a spreadsheet program called 'Epsoncalc', a Sales Order package which takes orders, gives receipts and can communicate to the base computer, and 'Personal Office', which is a calendar/diary/alarm program

with card file style data storage facilities; this should close the gap with the HP75C referred to above.

A very interesting sounding package is 'DIY', which is claimed to allow businessmen to write their own software in plain English. Something along the line of Sord's PIPS perhaps, or maybe a program generator?

Conclusion

I feel rather shell shocked having reviewed the HX-20 so soon after the excellent HP75C. Both machines advance the art of portable computing beyond recognition — if in subtly different directions. The Epson is rather more like a conventional desk-top micro in its functioning than the HP is. It is aimed either at the business user who will buy ready made software on tape or in ROM packs, or at the owner-programmer who will write most of his/her own software. There is not much you can do with the naked machine — unlike the HP which has lots of 'super-calculator' firmware for the busy executive. On the other hand, the Epson is at least the equal of the HP in power and leaves it standing in the quality of its keyboard and the convenience of its built-in printer and tape drive. It is also very substantially cheaper.

When a decent word processing package can be had for it then writing on the train or aeroplane can become an affordable reality at last, even if you do have to take it home to print it. For journalists and for business letters 32k is quite enough memory for away-from-base use to be a practical proposition.

NEW QUALITY SOFTWARE FOR THE BBC MICRO

GALAXIANS (32K) £6.50
 Fast action version of the popular arcade game. 4 types of swooping Galaxians - 6 skill levels.

INVADERS (32K) £6.50
 Superb version of the old classic including 2 types of bomb-dropping spaceships. Increasing difficulty.

SPACE FIGHTER (32K) £6.50
 Game based upon features of *Invaders* and *Scramble*. Fuel dumps, laser cannon, smart bombs, 5 alien types.

CENTIPEDS (32K) £6.50
 Mushrooms, snails, spiders, flies, and the evasive centipedes. Excellent graphics and sound effects.

SUPERIOR SOFTWARE, Dept PCW1 Please add 50p per order P&P.
 69 Leeds Road, Bramhope, Leeds. TEL 0532 842714

SPECIAL OFFER - Deduct £1 per cassette when ordering two or more cassettes!

WANTED

DRAGON & NEWBRAIN ORIGINAL SOFTWARE

Top royalties paid by expanding international software house.

Phone us in confidence.

01-278 3838/5285

TEXAS TI99/4A for only £139 (inc VAT)

Scoop purchase from Texas Instruments. The above include the manufacturer's £50 pay back scheme.

SAE for catalogue. Postage £4.50

COMPASS LTD
 6 MARKET STREET
 STANDISH, LANCS

For tasks such as stock-control, sports result calculations, and sales records as well as general engineering and scientific work it is an excellent tool and an impressively well made one at that. Given Epson's marketing clout (how many computer shops do you know who don't sell Epson printers) I expect to see a lot of them about in 12 months' time and this also bodes well for a supply of third party software; from previous experience of Japanese firms I wouldn't expect a lot of software support from the manufacturer but Epson does seem to be trying to do things differently. The choice of a 6800 look-alike chip is rather unfortunate as it will definitely hinder the conversion of many existing programs but I expect it to open up whole new areas of application where this is not so relevant. I wouldn't mind finding one in my stocking, anyway.

Prices

Epson HX-20 (including battery charger) £402

same but with travelling case	£411
Microcassette Drive	£ 75
Expansion Memory Unit	£ 80
ROM cartridges	£ 45
TV/Monitor Adapter	na
Barcode Reader	£ 82
Acoustic Coupler CX-20	na
Rolls of printer paper	50p
Ribbon cartridge	£2.20

All prices excluding VAT

Benchmark timings

BM1	2.7
BM2	15.3
BM3	33.1
BM4	32.8
BM5	35.3
BM6	59.1
BM7	100.6
BM8*	133.3

All timings in seconds. For a full explanation of Benchmarks see PCW November 1982.

*Note: BM8 now counts 1000 loops.

PLUTO POWER!

Continued from page 130

used to fill in the area. This area can be of any complex shape (hence the name) and is filled in extremely quickly.

Documentation

The manual for the Pluto can only be described as sparse and consists of 17 pages, all printed on a dot matrix printer. It is generally badly written, especially from the point of view of a computer novice, and contains many typing errors. The comment which describes the attitude of the manual is 'Try it and see.' The only demonstration is given by a small sample program at the back which is written in Z80 machine code (and contains some bugs). I can only conclude that the manual was a provisional copy to be replaced later as it in no way matches the standards of the software and hardware.

Future developments

There seems to a very good development programme under way at IO Research which will soon bring out versions of the Pluto card to enable it, with the aid of a new version of the on-board software, to draw arcs, circles (and ellipses to allow for different aspect ratios), do simple polyfills (a very fast way of filling concave shapes), boundary

fill, simple boundary fill, 90-, 180- and 270-degree rotation during copy and a character polyfill.

There is now a function to allow the definition of a two-dimensional mask which is used when filling in a rectangle or complex polygon and allows the existing shape to be filled with the bit pattern in the mask which is smaller than the shape to be filled (ie, it propagates a shape throughout the area of memory). The best use of this function is the definition within the mask of a coloured bit pattern. This will give the visual appearance of a new set of colours/textures, depending on the bit pattern in the mask.

The new software has also been completely rewritten to increase the speed of all the functions dramatically. There will also be a facility to download your own programs to be run by the 16-bit processor on the Pluto board. There is also a simple debugging aid incorporated within the new software to allow you to set breakpoints and single step downloaded programs.

Then there's a version, which has just been released, that has interlace. This means that the beam on the screen performs one scan and then, instead of returning to the original position, does a second scan in between the lines already drawn. This will therefore give twice as much resolution on the screen (640 x 576) as the normal un-interlaced mode. However, in order to have this facility, one screen must be lost, hence losing the ability to have screen swit-

MICROMART

KRAM

Electronics Ltd.

DRAGON 32 £173

Plus free cassette recorder with free cassette leads.

DRAGON SOFTWARE:- Dragonword word processing on the Dragon. £15.95
Hanoi £4.95; Caves of Cronos £5.95.

OLIVETTI PRAXIS 35
ON LINE DAISY WHEEL
KEYBOARD PRINTER

* Centronics standard interface

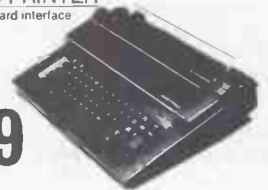

£399

EXPANSION BOX
GENIE
TRS 80 £99

32 Kbytes of RAM Parallel Printer Interface. Disk Controller, for the Video Genie/TRAA-80 (due out mid-October) for more details telephone 0533 27556.

For full details of Products, Software, Books Etc. send large SAE.

All prices are exclusive of VAT. Carriage: Orders over £100 ADD £6. Orders over £10 ADD £3. Orders under £10 ADD 0.50p. P/P on Software 0.50p

Dept MQZ, Kram Electronics, Victoria House, 17 Highcross Street, Leicester, LE1 4PF.

EX-DEMO COMPUTERS with warrantee

CBM 8096 96K Computer	895.00
CBM 8032 32k Computer	695.00
CBM 8050 1 Meg Disk Drive	695.00
CBM 8023 Fast Matrix Printer	695.00
CBM 8027 Daisy Printer	599.00
ESW100KSR Daisy plus keyboard	699.00
FLOWRITER Fast Daisy Printer	1195.00
Apple II 48K Computer	450.00
Disk with controller	250.00
2nd Disk Drive	210.00

All the above equipment are in perfect working order and are in almost new condition.

THESE OFFERS ARE ONLY WHILE STOCKS LAST

We also buy and sell used equipment. Please call for latest.

Please add VAT to above prices.

Call:- DeVincl Computers Ltd.
65 High Street
Edware
Middx, HA8 7DD.
01-952 0526



baby PILOT

An easy-to-use, friendly and very fast version of this important teaching language. All normal PILOT I/O and control commands PLUS integer arithmetic, powerful graphics and formatting commands, "FOR...NEXT" loops, subroutines, automatic marking and other extra features.

Add another language to your TRS-80 or Genie - complete and simple to follow instructions included:
baby PILOT £9.95

WIN THE POOLS?

With the latest version of D S Peckett's well known Pools Prediction Program. Now available for BBC micro (32k) as well as 16k TRS-80 and Video Genie.

Program and Instructions	£4.95
Database tape (optional, but holds data on over 5500 matches)	£13.50
Program and DB together	£17.50

These prices are fully inclusive and are for cassette-based programs only.

DAVANSOFT

1 Delaper Drive,
Haverfordwest,
Dyfed SA61 1HX

We are always looking for high-quality programs for TRS-80, VG and BBC computer, and will pay up to 30% royalties for suitable material. Please contact us with your proposals or for details of our requirements.

NEW FOR THE ZX81

Compose & play your own music - the easy way with the

Music Composer

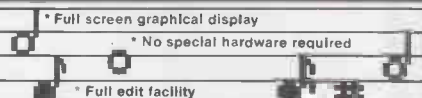

Music composer supplied on cassette £5.95 (inc p&p)

SCREEN-SCENE

144 St Georges Rd, Cheltenham, Glos. Tel (0242) 28979.

★ ADD A NEW DIMENSION TO YOUR PERSONAL COMPUTER WITH: ★

INTELRGRAPH

The NEW intelligent GRAPHICS CARD compatible with ANY computer with a parallel or serial port.

* With the on board processor in command stunning displays can be achieved via a simple data transfer.

- * 28 COMMANDS AT YOUR FINGER TIPS DRW PLOT ARC (circle,ellipse) USER def chars. SCROLLING WINDOWS CURSOR CONTROL CHAR MAGNIFICATION to name only a few.
 - * 512x256 HI-RES GRAPHICS
 - * 80x25 TEXT FREEL MIXED WITH GRAPHICS
 - 2 VIDEO RF OUTPUT
 - * SERIAL V24 TTL 20mA 110-19200 BAUD
 - * PARALLEL TTL INPUT/OUTPUT
 - * SINGLE 5V SUPPLY (0g-12V FOR V24)
 - * VARIOUS OPTIONS £55 - £175
- SEND LARGE SAE FOR DETAILS
Computer Aids 33 Beardsden Cr
Hinckley Leics Tel (0455) 635255

MICROMART

BUSINESS SOFTWARE

INTEGRATED ACCOUNTS

Prepares daybooks, cash books, sales, purchase, nominal ledgers, trial balance, profit and loss accounts. Normal price £1200. SPECIAL OFFER £895.

PAYROLL

All valid PAYE codes are catered for. Facilities for different companies and branches. Cash analysis, payslips, P45 P60 etc. Normal price £500. SPECIAL OFFER £395.

HARDWARE

North Star Horizon and Advantage Superbrain
All hardware and software are under warranty for 12 months.

MICROSYS LTD.

58 High Street, Prescot L34 6HQ
051-426 7271/051-430 6650

OSBORNE 1

Multiple TV Output
now available

4B microcentres

North Bar, Banbury, Oxon. OX16 0TF Telephone (0295) 66555

supercharge your SUPERBRAIN

- * Speed up disk operations by 400%
- * Cut copying time by up to 75%
- * Communicate with other Micros
- * Customise your favourite Word-processor
- * Get BDOS errors under your control
- * Program with Block Graphics
- * Copy screens to memory or printer
- * Chain COM files from BASIC
- * Write unbreakable security routines

SeeDee Software tune-up kits start at £30.00



Full details from:
COMPUTER FACILITY
0734 867855
32 Redlands Road,
READING,
Berks.

"ZX GRAPHICS PROGRAMMING MADE EASY"

Full Colour A4 Manual, 24 pages packed with ZX Graphics Programming techniques and ideas for serious and 'serious' Programs. Written in 'easy to understand' language and illustrated at every stage.

Ideas include:
Information Graphics
Sketch Pads.
Saving your 'Art'.
Making serious programs interesting.
Graphics Stringing.
ZX Printer Graphics

£1-50

(INCLUDING UK POSTAGE)
Print 'n' Plotter Products (UK)
19 Borough High Street,
London SE1 9SE.



ching and therefore rapid animation (the screen partitions are redefined so that partition 1 handles the top half of the screen while 2 handles the bottom half of the screen). If animation is required the interlace can be switched off to return to the normal mode.

The 'Palette Board' will act like a large board into which a various number of RAM chips can be plugged. This means that the full complement of memory will be available to the 8088 and then, while keeping the resolution the same, all 24 bits (from the address line) can be used for the colours all of which can be displayed in any combination of 256 colours (one byte per pixel). However with the palette board you can no longer use a RGB monitor with TTL inputs. To obtain the full colour range you would have to use a RGB monitor equipped with analogue inputs; this is because the variations in colours can be obtained only by altering the input voltages to the individual colour inputs to the monitor through stepped increments of one two-hundred-and-fifty-sixth of the voltage swing (whereas a TTL colour monitor works on a binary input of 0 volts Low and 5 volts High). This requirement for very accurate stepping in voltages to obtain the gradations in colours is why the palette board will once again be available, like the Pluto card, in more than one option — eg, cheaper but fully upgradable systems. To complement the palette board IO is producing a 'frame grabber'. This is a piece of hardware which will enable a standard TV picture to be digitised and displayed from a TV camera or video recorder. This is an option that a lot of TV advertising companies have been after for a long time as it makes image processing very cheap.

Conclusions

The Pluto board seems an exciting development in the area of computer graphics for the micro market, although it can quite easily be used as an intelligent high resolution colour text/

graphics terminal emulating any protocol, such as Tectronix. The Pluto system should appeal to both the hobbyist (because of the system being available in so many upgradable versions and hence not damaging the pocket too much when starting off) and to the professional because of the vast amounts of colours and hardware options: IO Research is willing to do hardware interfaces (or supply details on how to do it), on request, for any machine. Just imagine it, a 16-million-colour high resolution graphics board with a 16-bit processor, all run from a ZX81! (Yes! They will do it.) The most critical comment about the Pluto card is the amount of time and program space taken up through sending all those command and data bytes; though this could not be described as a fault of the Pluto's. This problem can quite easily be overcome by writing a small interpreter program. In fact CCSOFT (the people who brought out the graphics software for the Mimi and the IVC card) are now bringing out a version to communicate to the Pluto board. This software should be able to be linked into a Basic program and hence make graphic operations much simpler.

It is without doubt a very versatile machine which, with all the development being planned, can only do well and is certainly capable of being extended even further.

Prices

Baby Pluto	£299
Pluto	£399
Boxed Pluto + interface	£599
Dble resolution (interlaced) option	£ 50
8 MHz option	£ 50
	(add VAT)

Note: IO Research will perform any of the upgrades free of charge; you need only pay for the parts.

We must extend our warm thanks to GJ Brain of Gradepoll Ltd, formerly Braintech, for loaning the Galaxy 1 and Pluto board.

DATABASE COMPARISON

Continued from page 143

dBaseII and Condor the easiest in that respect. Clarity and 'naturalness' is another important virtue, and another pretty subjective one, but there are some rules. For instance, I found the DMS menu — which for example uses

the letter 'C' as its prompt for Keyed access, and 'K' for another function — very confusing. I also found the Cardbox three-tier naming very confusing in an otherwise highly 'natural' package.

Finally, taking a look at the manual is always a good indicator of what the package is like. Every package should, I think, have a Tutorial Guide for beginners, a Reference Manual for experienced users and a Prompt Card for reminding people about particular command formats. The Cardbox manual is extremely good in all those areas, I

If interested
in advertising
in
Micromart
please call
Gaye Collins on
01-636 6890

NASCOM EXTENSION MONITOR

A 1K M/C EXTENSION TO NAS-SYS 1 OR 3
ADDS 20 EXTRA 'SCALS' TO NAS-SYS INC.
SINGLE/DOUBLE PRECISION SIGNED/UNSIGNED
DIVISION & MULTIPLICATION.
SET, RESET & POINT PIXEL COMMAND
LINE DRAW, SHAPE DRAW & MORE.
SEND S.A.E. FOR FURTHER DETAILS.

£12.50

NMI COMPUTERS
11 Wentworth Court
Ponteland, Newcastle

FULL USER DOCUMENTATION SUPPLIED
NEW PRODUCTS TO BE ANNOUNCED SOON.

thought; personally I also like the dBaseII approach of an initial manual written by an experienced user to complement the reference manual, with lots of examples — another must. The Silicon Office manual is also, I think very good.

Conclusions

I've tried throughout to view each package as having a niche in the market, and to think in terms of 'horses for courses' rather than plumping for just

one or two. I still think that's the right approach, and I hope this article will help you to make up your own mind about what's best for you.

I would like to thank the suppliers of all the packages and systems I've reviewed for their cooperation. I would also like to thank particularly all the staff at Westwood Computers in Birmingham (especially Neil and Wanda Weigel and Sue Alexander), and Keith Frewin and Simon McCarthy of Small Systems Engineering, for considerable help and support.

LEISURE LINES

by J J Clessa

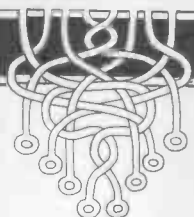

Merry Christmas to all — here are two harder-than usual problems.

Quickie

What is special about the number 8,549,176,320?

No answers — no prizes.

Prize puzzle

A difficult puzzle this month, since it's Christmas and everyone will have extra leisure time to work at their micros.

Every odd number, except two, between 1 and 8999 is either a prime or the sum of a prime and twice a square.

Thus:

$$321 = 19 + 2 \cdot 1^2$$

$$27 = 19 + 2 \cdot 2^2$$

What are the two exceptions?

September prize puzzle

What a lot of coconuts — and what a lot of entries! Well over 300 replies were

received for this puzzle, which is a variation on an old chestnut. Answers received ranged from two coconuts (yes — two) to millions and millions.

The correct answer is 279,931 coconuts, which is the smallest positive solution. Although a solution by micro isn't too difficult, an analytical approach can also be used. Since -5 is clearly a solution, then adding or subtracting multiples of 6⁷ (six men, seven share-outs) to -5 gives all possible answers. Hence the smallest is -5 x 6⁷ which is 279,931.

The winning entry came from S Matcher of Havant. Congratulations, Mr Matcher, your prize will be with you forthwith — if not sooner.

By the way, remember *postcards* (or backs of envelopes) only. All other entries go straight into the bin — you have been warned.

BLUDNERS



In our review of Keele Codes' E40 data compression program in the September issue we gave out a phone number which is no longer appropriate. Keele Codes can be reached on 0782 629221.

A program named 'The Walls' appeared in the November issue with the end of one line missing. The last statement in line 4130 should read 'NEXT A'.

OSBORNE MADNESS

PART EXCHANGE ANY COMPUTER/CALCULATOR
AGAINST A NEW STYLE OSBORNE I

Or phone for latest SPECIAL PRICE
01-228 8860 (4 lines)

LONDON MICRO SYSTEMS

Southampton House
192-206 York Road,
LONDON SW11 3SA

MICROMART

RADEC

ASCII Keyboards



- Upper & Lower Case plus Control
- Low Power Consumption
- Shift & Alpha Lock
- Autorepeat (Model 777)
- Parallel Data Output
- Metal Mounting Frame
- Suitable for Tuscan, Tangerine etc.

Model KB756A	56 key	£39.50
KB710	Numeric Pad	£ 7.50
KB771	72 key	£55.00
KB777	77 key	£62.50

Accessories available include:-

Metal Case	£ 14.95
Edge Connector	£ 1.95
DC to DC Converter	£ 5.00

(for operation off single 5V supply)

High Performance Monitors & VDU's



MONITOR

- 12" Green P31 Phosphor MULLARD C.R.T.
- 80 Character Line Capability
- 24MHz Video Bandwidth
- 240V AC Input
- Toroidal Transformer
- Composite Video Input
- Ideal for Apple, B.B.C., Micro, Gemini, Nascom, Tuscan, Newbrain etc.

NEWBRAIN VDU TERMINAL



- 80/40 Column
- 640/256 Pixel Graphics
- Z80 with 32K RAM
- Printer Port
- Ideal with above Monitor
- Ansi Basic, Graphics and Maths Software onboard for local processing
- Expansion Port for CPM, Floppies, Winchester and up to 2M Bytes RAM.

MODEL A £199.00

U.K. Orders add 15% VAT on order total
Orders under £50 add £2.00 p&p plus VAT
Orders over £50 add £3.50 p&p plus VAT
Overseas orders add £5.00 to cover part cost postage and documentation.

FULL DATA SHEETS ON REQUEST

Citadel Products Ltd

Dept. PCW, 50 High Street, Edgware,
Middlesex, HA8 7EP. Tel: 01-951 1848

BACK ISSUES SERVICE

Here is a complete guide to all available back issues of *PCW*. A quick guide to their contents is shown below. Check the coupon overleaf for the issues you require.

Volume 1 No 1, 1978
The 77-68/Practical hints on kit building/Nascom 1/Charity case study/Flowcharting/Pontoon flowchart.

Volume 1 No 2, 1978
Kit building Basic — first steps/Case study — a software house/PET 2001/Research machines 380Z/School computing/E78 — Europa Bus.

Volume 1 No 3, 1978
More efficient programs/Cosmac 1802/The PDP11 Part 1/Small business computing — an approach/The Z80/EPROM programmer construction.

Volume 1 No 6
October 1978
Pilot/Assembly code programming/Small business case study/PET preening/Time tabling for schools.

Volume 2 No 1
May 1979
Chess programming/Using a small business computer Part 1/Smart 1/In defence of PET/+d Noughts & crosses

Volume 2 No 2
June 1979
Different computer languages/(MSI) 6800/Using a small business computer Part II/Demonstrations using the Apple II Part I.

Volume 2 No 4
Apple medical application/North Star Horizon/Word processing/High speed cassette interface/Sorting/Buying a computer for a small business

Volume 3 No 12
December 1980
Benchmark: Micro writer/Printerfacing: Series — Part 1/Sharp PC-1211 speed-up/Programs: TRS-80 Tarot, PET Cat & Mouse, PET Rebound, MZ-80K Alligator Swamp, PET Connect, UK101 Minefield, PET Simon
Benchmark: Raand SP1

Volume 4 No 1
January 1981
Benchmark: Transam Tuscan/Real-time control using trains — part 1/Recover from a data tape disaster/PET Music Multi-user systems — Part 1/Programs: TRS80 Four in a row, TRS80 Target Practice, PET Convoy, PET Wire, PET Maze Chase, PET Android Attack, PET Anagram

Volume 4 No 3
March 1981
Benchmark: Onyx C8002/Benchmark: Bigboard/Micro music software package/

ALC circuit/Commons report/HP 43C/Programs: TRS80 Show Jumping, PET Grand Prix, PET Aircraft landing, PET Bouncy.



Volume 4 No 5
May 1981
Benchmark: Pascal 640/WP Benchmark: Magic Wand/PET colour/Low-cost digital tape system/Using calculator printers on micros/Apple music-making/Multi-user Benchmark: MVT-Famos/Programs: PET Grand Prix, PET Aircraft Landing, PET Bouncy.



Volume 4 No 6
June 1981
Benchmark: NEC PC-8001/Multi-user Benchmark: MP/M/Benchmark: Sinclair ZX81/West Coast Faire report/Radio Teletype/WP Benchmark: Wordpro 4 plus/Budget tape interface/Further Casio quirks/Programs: UK101 Zor, PET Chords.

Volume 4 No 7
July 1981
Benchmark: Sharp PC-3201/Multi-user Benchmark: Acorn Econet/Case study: Accident investigation on TRS-80/Zilog Z8 family/WP Benchmark: Format-80/Pascal Benchmarks: readers' letters/Quicker Casio com-



putations/Programs: ZX80 Sliding Letters, UK101 Car Rally, TRS-80 Calendar, UK101 m/c code to Basic converter, PET Exam Questions, MZ-80K Designer, ZX91 Sketch Pad.



Volume 4 No 8
August 1981
Benchmark: Tandy Model III/Viewdata update/WP Benchmark: Spellbinder/Printer survey/Micro-holism/Programs: ZX80 Othello; Easter Sunday; Apple Mondrian; MZ-80K Duck Shoot; PET Gomoku; MZ-80K Football.

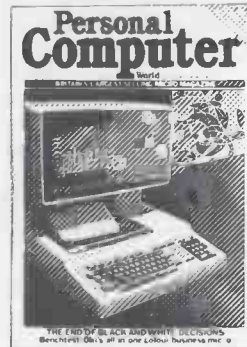

Volume 4 No 9
September 1981
Benchtests: Tandy Color Computer, Commodore VIC/Checkouts: Hi-Tech Speakeasy, Tantal/Multi-user Benchmark: HMSOS/WP Benchmark: Memorite III/Word proc program for PET/Apple dealership run by spastics/Printer facing extra/Calc Corner: Casio fx602p review/Programs: PET Arithmetic test, ZX80 Eldorado, 380Z Memory test.



Volume 4 No 10
October 1981
Benchmark: OKI if-800/Checkouts: Heuristics speech link, Softy 2/Calc Corner: Texas TI51-111/Jeff Taylor on computer literacy projects/Introducing TJ's Workshop/Control your own Substation pt 1/Programs: TRS-80 Sailing.



Volume 4 No 11
November 1981
Benchtests: Osborne 01, IBM Personal Computer, Checkout: Sharp IQ3100 Microtranslator, Calc Corner: Casio fx702p, PCW Show report, Benchmark Summary, Euro Micro Chess Championship report, Programs: TRS-80 Sheepdog trial, ZX81 Sun and Planets.



Vol 4 No 12
December 1981
Benchtests: Sharp MZ-80B Philips P2000/School network/BBC Micro inside story/'Turtle' Graphics for Apple/Forth language/

Curve fitting/Calc corner: HP14C review/Programs: PET Fantasy, ZX81 Battleships and cruisers.



Vol 5 No 1 January 1982
Benchtests: BBC Micro, Xerox 820/Frames of Reference (new series)/ZX81 Printer Checkout/Digital Drummer for PET/Calc Corner: Benchmarks/Programs: MZ-80K Fortune, TRS-80 Reaction Timing, ZX80 Laybrinth, Apple Letters.



Vol 5 No 2 February 1982
Benchtests: Sirius-1, Casio fx-9000p, Gemini Multiboard/Word Processor Benchmark: Scriptit 2.0/Plotter Checkout: Watanabe/Hardware feature: High Density VDU card project/Music system: FREQUOT/Calc Corner: Aerial Navigation/Programs: Pet Haemophilia, Pet Cheese, TRS-80 Extra, Sharp PC1211 Exam, Personality test.



Vol 5 No 3 March 1982
Benchtests: Texas Instruments 99/4A, Hewlett-Packard 125/Choosing a Database/Compsort DMS reviewed/Screenplay (new series)/Calc Corner: Hewlett-Packard Interface Loop/Programs: TRS-80 Solitaire, TRS-80 Ducks, Nascom Business Documents, MZ-80K Race Chase, ZX81 Graphplot.

Volume 5 No 4
April 1982
Benchmark: Monroe OC8820/DB Benchmark: FMS-80/Checkout: Sid 1/

PCW SPECIALS

Benchmark Special £1.80.

All the best of *PCW*'s

Benchtests of popular micros. Desktop computing £2.25. Comprehensive guide to using micros to help you in your Businesses.

BINDERS

Keep your copies in order with these strong, attractive yellow binders. £3.95 each (inc P&P)



Generating screen forms/Comal/Logo/Brain Dump-New series/Calc Corner: Casio FP-10 printer/Programs: TRS-80 Maths & Trig, PET Boot the Cat, ZX81 Resistor & Res code.



Vol 5 no 5 — May 1982
 Benchtests: Apple III, Hitachi Peach/Database Benchtest: dBase II/3D Graphics Made Easy/Equation Solving/Calc Corner: fx 602 quirks/Programs: PET Mini-Animate, MZ-80K Catch, Apple Maze, Atari Sums For Kids, ZX81 Book Index, PET Stockmarket, Microtan 3D Rotation, Extra for MZ-80K, UK101 Crossword Notepad. With free Word Pro-



cessing Supplement containing a summary of all PCW's WP Benchtests.

Vol 5 No 6
 June 1982
 Benchtests: Sharp MZ-80A/ZX Spectrum/Database Benchtest: DBMS2/West Coast Faire Report/Lisp/VIC 20 games/Calc Corner: Sharp PC1500/Programs: RML Altered Basic/VIC-20 Large Characters/BBC Breakout/VIC-20 Trailblazer/MZ-80K Next-to-Last-One/MZ-80K Tarot.



Vol 5 No 7
 July 1982
 Benchtests: Mimi 801/Newbrain/Database Benchtest: Silicon Office/UCSD

p-System/BBC Computer In-Depth/Apple II games/Calc Corner: T188/Programs: ZX81 Hypocycloids/BBC Character Generator/TRS-80 Truth/PET Doc/TRS-80 Screen Dump/UK101 Screen Converter/PET boxes/Atari Earth.



Vol 5 No 8
 August 1982
 Benchtests: Sord M23/Dragon 32/Database Benchtest: Cardbox/Preview: Sony SMC-70/UCSD p-System/RS232 Interface/Sirius graphics/NCC Show report/ZX81 Speech Checkout/Calc Corner: Casio fx602p/Programs: FRS-80 Quadrangle/UK101 Conversion of units/PET Mopup/Apple Lifespan/Apple Trees/Nascom Snail Racing/UK101 Long Multiplication & addition.

grams: Video Genie Extended Basic, ZX81 Alpha-betting, PET File Comparison, BBC Music Player, PET Virus, BBC Radar, PET German Game, TRS-80 Cardshuffler.



Vol 5 No 10
 October 1982
 Benchtests: HP-86; Positron 9000/Database Benchtest; Personal Pearl/3D Graphics for BBC Computer/Hashing Techniques/Designing Your Own Database/CP/M-86 v MSDOS/Clock-Calendar Card for Apple II/Calc corner: hints for Sharp PC122/Programs: ZX81 Star Trek; PET Knockout; PET Trains.



Vol 5 No 11
 November 1982
 Benchtests: Canon CX-1; Hewlett Packard HP75/Database Benchtest: Conдор/Apple II Clock Calendar Card Part — Algebra checking/Benchmarks summary/Bit Stik graphics for Apple/Calc Corner — HP41C, Casio fx 702p programs/PWC Show report/Tiny printing on Centronics 739/Screenplay — Acorn Atom/Programs: Apple Piano; Apple Moon Module; PET Letterwriter; UK101 Logic; Atari Walls; Sharp MZ80K Area-filling; RML 380Z Restore.



Vol 5 No 9
 September 1982
 Benchtest: Olivetti M20/Word Processor Benchtest: Select for NEC/Database Benchtest: Aquila/Checkouts: Microwriter Revisited, E40 Data Compression/Screenplay: ZX81 Pt II/DIY Logo/P for Perfect/Beeb Colour Hi Res/RS232/Calc Corner: HP15 and 16C reviewed/Pro-

BACK ISSUES CENTRE

We have a complete selection of all available PCW back numbers in our flashy new Back Issues Centre in the West End of London, just half a minute's walk from Oxford Street (close to Tottenham Court Road tube station). Of course, you could order them from our excellent mail order service using the coupon below, but by visiting in person you save on postage costs. The Back Issues Centre also often has back numbers of PCW on sale which we cannot offer through the mail order service because of shortage of stock. Our receptionists will also be happy to sell you a set of binders to take your subscription. And there's a range of interesting computer books on sale as well. Drop by next time you're in the West End. We're open Monday to Friday, 10am to 6pm. The address is 14 Rathbone

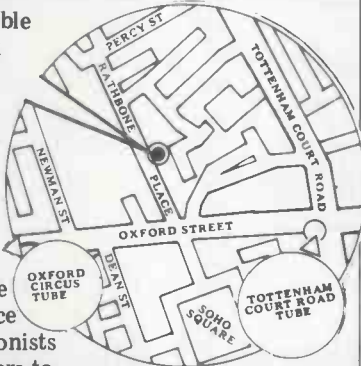

Place, London W1P 1DE.
Come up and see us...
Mon - Fri
10am - 6pm
Saturday
11am - 6pm

CHANGE OF ADDRESS

Readers should note that all mail order subscriptions, binders and back issue enquiries must now be addressed to 55 Frith Street, London W1. However, for personal callers only, a selection of PCW back issues, binders, micro-computing books etc can be purchased from the shop at 14 Rathbone Place, London W1.

Any one issue £1.50; all additional issues £1.00 each. Benchtest special £1.80. Desktop Computing £2.25. Binders £3.95 each. All prices include post and package. *Overseas orders requiring Air Mail postage add £1.00 per copy. Cheques/P.O. payable to Computing Publications Ltd,

53/55 Frith Street, London W1A 2HG Please allow up to 3 weeks for delivery and don't forget to state your name and full address with your order. Please send me the following copies of PCW. I enclose a cheque/P.O. for £. . . Please tick appropriate boxes.

Volume 1	Volume 2	Volume 3	Volume 4	Volume 5	Benchtest Special <input type="checkbox"/>
1 <input type="checkbox"/> 2 <input type="checkbox"/>	1 <input type="checkbox"/> 2 <input type="checkbox"/>	6 <input type="checkbox"/>	1 <input type="checkbox"/> 3 <input type="checkbox"/> 5 <input type="checkbox"/> 6 <input type="checkbox"/> 7 <input type="checkbox"/>	1 <input type="checkbox"/> 2 <input type="checkbox"/> 3 <input type="checkbox"/> 4 <input type="checkbox"/> 5 <input type="checkbox"/>	Desk Top Computing <input type="checkbox"/>
3 <input type="checkbox"/> 6 <input type="checkbox"/>	4 <input type="checkbox"/> 12 <input type="checkbox"/>	8 <input type="checkbox"/> 9 <input type="checkbox"/> 10 <input type="checkbox"/> 11 <input type="checkbox"/> 12 <input type="checkbox"/>	6 <input type="checkbox"/> 7 <input type="checkbox"/> 8 <input type="checkbox"/> 9 <input type="checkbox"/> 10 <input type="checkbox"/> 11 <input type="checkbox"/>		Binder <input type="checkbox"/>

Name _____ Address _____

Books for the microcomputer buyer and user

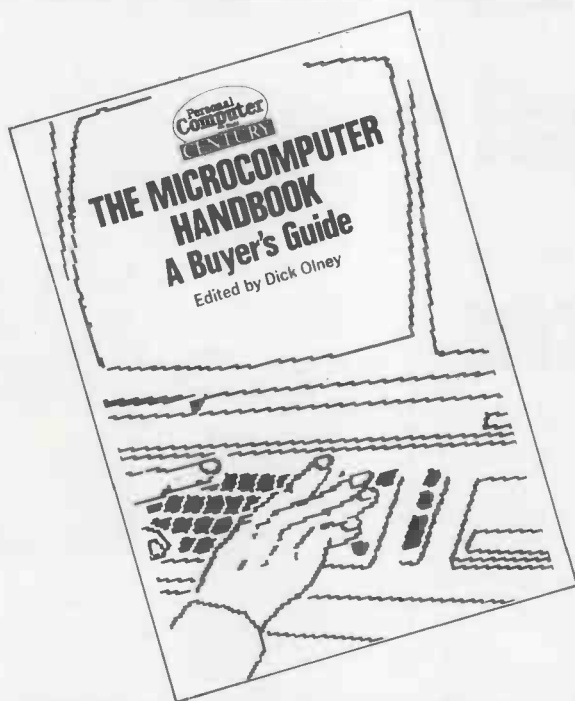

The Microcomputer Handbook A Buyer's Guide

Edited by Dick Olney

In-depth reviews of over thirty leading micros.
An essential reference manual for any prospective microcomputer buyer.

- * reviews by top microcomputer professionals
- * sections on: hardware; software; documentation; potential; prices; technical specifications
- * rapid-access tabulation and listing

£5.95 £8.95 (hardback)

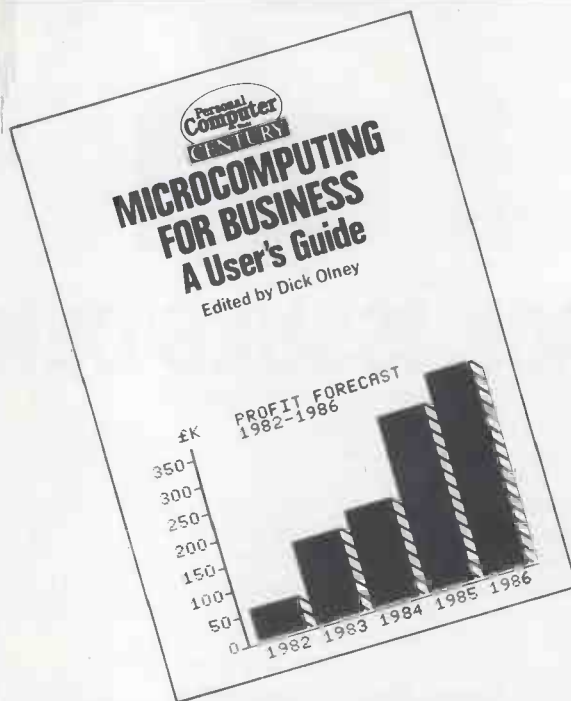

Microcomputing for Business A User's Guide

Edited by Dick Olney

Microcomputing for Business brings together the work of leading authorities in the microcomputer world to present a comprehensive guide for business users.

- * explanation of how to use the techniques of systems analysis
- * advice on word processing
- * extensive real installation studies
- * extensive software buyers' guide

£4.95 £7.95 (hardback)

Available through bookshops everywhere.

Should you experience any difficulty please fill in the order form below.

ORDER FORM

To: Department OIC
George Philip Services Ltd
Arndale Road
Wick, Littlehampton
West Sussex BN17 7EN

Please send me copy/copies of the following titles:
(please fill in the number below)

- MICROCOMPUTER HANDBOOK**
 _____ £6.50 (paperback) post paid
 _____ £9.50 (hardback) post paid
- MICROCOMPUTING FOR BUSINESS**
 _____ £5.50 (paperback) post paid
 _____ £8.50 (hardback) post paid

I enclose my cheque/postal order for £ _____
(please make your cheque/postal order payable to George Philip)

Name _____

Address _____

Please allow 28 days for delivery

A must for anyone who wants to take their Spectrum to the limits – and beyond

The Spectrum Handbook

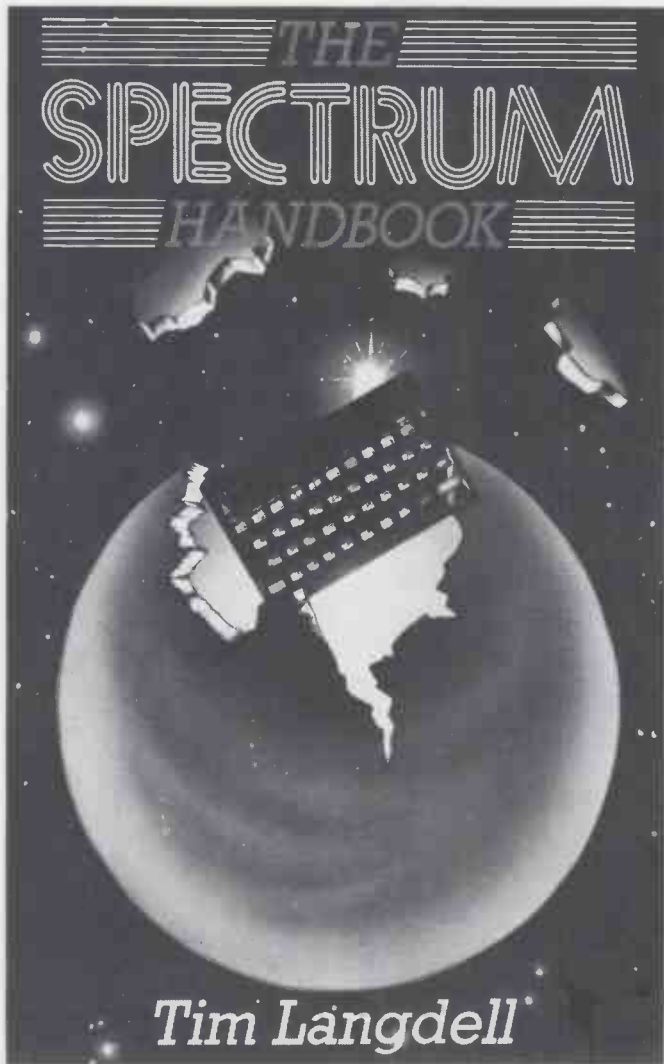

The Spectrum Handbook offers its readers the opportunity of harnessing the power of the most exciting micro of the decade – The ZX Spectrum. Dr Tim Langdell believes that the machine's wide-ranging potential should be available to all Spectrum owners – not just those with previous computing experience. His step-by-step introduction opens the world of the Spectrum to beginners, whilst the wealth of hints and tips, exciting programs and comprehensive machine-code and applications chapters makes the book essential reading for even the experienced programmer.

Contains more than 80 programs
224 pp £4.95 (paperback)

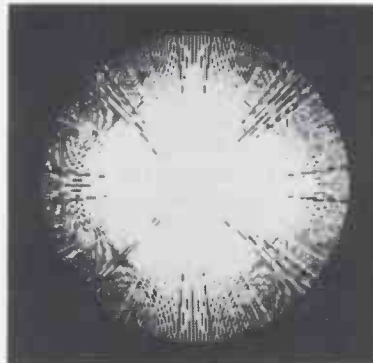

This picture has been produced from a single line of Tim Langdell's *Spectrum Handbook*

Available through bookshops everywhere. Should you experience any difficulty please fill in the order form below.

ORDER FORM

To: Department 01C
George Philip Services Ltd
Arndale Road
Wick, Littlehampton,
West Sussex BN17 7EN

Please send me _____ copy/copies
of **THE SPECTRUM HANDBOOK**
by **TIM LANGDELL**
at £5.45 per copy (post paid)

I enclose my cheque/postal order for £
(Please make your cheque/postal order
payable to George Philip)

Name _____

Address _____

Please allow 28 days for delivery

PERSONAL COMPUTER WORLD

BINDERS



AN EXPANDING BUSINESS!

We heard you!! The size of *Personal Computer World* has been growing at such a rate that our Mark II binders just couldn't keep pace. Twelve issues used to fit very comfortably into a binder, but now it's too much of a squeeze.

Enter our Mark III binder. Bigger and stronger. We've widened the spine to allow twelve issues room to breathe. We've added strength to the back of the binder to carry the additional weight. And we've done it without resorting to the metal rod system of binding magazines . . . a system which causes problems if the rods bend.

PCW Mk. III binders are still attractively bound with the logos of the magazine printed in gold on the front and spine. They keep your back issues of *PCW* in pristine condition and discourage other persons from 'borrowing' your copies. They lie completely flat, even when full, to allow ease of reading and reference. And they come mailed to you in a specially designed protective pack to guard against any over-enthusiasm on the part of the Post Office delivery system.

All in all, they represent exceptional value at £3.95. (A price below that charged by many competing magazines. Indeed, we know of several organisations who keep *all* their back issues of computing magazines in *PCW* binders because of their sturdy construction and their value for money. This is not a practise we can formally condone, but it's flattering nonetheless.) The price covers all postage, VAT and handling. Use the coupon below, or if you do not wish to deface your copy of *PCW*, send your order with remittance clearly written to the address indicated.

BUSINESS!



Please rush me..... PCW Mk III binders at £3.95 each. I enclose a cheque/ PO for £.....

Name.....

Address.....

.....

.....

Cheques should be made payable to *Personal Computer World*. Send this coupon to *Personal Computer World*, 53/55 Frith Street, London W1A 2MG

Reliable hardware alone is not enough

Today's micro-computers are extremely efficient business machines with large information storage capabilities and amazing computing speeds. However, the quality of the output is only as good as the software input. With a Toshiba T-200 micro-computer not only will you have a high quality computer but also you will have a range of software available to you that will meet virtually any business need from single and double entry book-keeping, invoicing, wages and salaries, inventories. Both in our own highly efficient Toshiba business BASIC and in the wealth of software available with CP/M.*

The T-200 has yet more trumps in its hand. It's well styled, manufactured by one of the world's most substantial technology operations with a heavy R and D commitment and a proven success in the home, office and industry.

When you buy a Toshiba T-200 you also get the finest back-up from the largest business equipment retailer in Europe with our own 120 outlets throughout the UK. So wherever you are back-up and help is not far away.

* CP/M is the trademark of Digital Research Inc.

**Toshiba micro computer
T-200 from £ 2400,-**



Office International

International House
Windmill Road, Sunbury
Middlesex, TW 16 7HR
Tel: Sunbury 85666

Send for more details today.

Name

Address

Tel.

TOSHIBA
... in touch with tomorrow

THE **IBM** PC FOR THE PRICE OF A *SIRIUS 1* **£2395*** - HURRY! PRICE GOES UP SOON!!!

NATIONWIDE
 MAINTENANCE

All machines always ex stock

3270 EMULATION
 AVAILABLE NOW!

LOOK!



OFFICE EFFICIENCY MACHINES

Call us at our West London office on 01-741 7211/2/3/4
OEM – THE BEST MICROS AT THE BEST PRICES
 (Volume discounts available)



IBM
 Personal Computer



OSBORNE 1

Includes
 WORDSTAR, MAILMERGE,
 SUPERCALC, MBASIC + CBASIC
 worth £800 FREE!



ACT
 SIRIUS 1

* (Price includes system unit, 64K memory, 2 disk drives (320K), Keyboard & Monitor)

To: Office Efficiency Machines
 1 Lochaline Street, London W6 9SJ

Please send me information on the

Please ask your sales staff to contact me re:

Name _____

Company _____

Address _____

Telephone _____

SPORTING FORECASTS

Professor Frank George, one of the country's leading experts in forecasting techniques, has produced the following microcomputer programs based on his researches.

F4 FOOTBALL FORECAST

A pools forecasting program which uses stored team data to compute the expected result of each fixture.

POOLPERM

Produces full perms according to amount of stake and number of matches required.

H5 HORSE RACE FORECAST

A serious punter's aid to sensible betting. Data is entered from a sporting newspaper and the program produces betting recommendations.

A detailed instruction booklet accompanies each program. Versions are available for:

- APPLE II 32K
- PET 16K or 32K
- SHARP MZ80K
- TRS-80K 32K disk or 16K cassette
- VIDEO GENIE 32K disk or 16K cassette
- NEWBRAIN
- SINCLAIR ZX81 16K
- BBC 'B'
- SPECTRUM

Bureau of Information Science, Commerce House,
 High Street, Chalfont St. Giles, Buckinghamshire

Adding high resolution colour graphics to your Nascom or Gemini system need not cost more than £199.

Introducing the new **Microvector MV256** adding a high Resolution Colour Graphics capability to your **NASCOM** or **GEMINI** computer system.

- ★ High resolution display. 256 x 256 x 4 planes (16 colours).
- ★ High Quality PAL, UHF output with intercarrier sound facility.
- ★ 32k of display memory with flicker-free update (Outside of the host computers memory address space).
- ★ Composite B/W video 75 ohm output (16 grey levels).
- ★ Non-interlaced 50Hz CCIR 625 line display format.
- ★ Red, Blue & Green video 75 ohm outputs (sync. mixed on each) available on MV256B only.
- ★ Audio & light pen inputs.

The **MV256** uses the **Thomson EF365** graphics display processor to provide high level graphics functions in hardware.

- ★ Ultra fast vector and character generation give full animation capability (typ 800 000 pixels/sec, max 1300 000 pixels/sec).
- ★ Rectangle fill, clear screen and scan screen operations.
- ★ Selectable line types (continuous, dotted, dashed, dotted-dashed).
- ★ Host computer access to display memory via registers.
- ★ 96 ASCII character set. Programmable character sizes and orientations.
- ★ Comprehensive display status information.
- ★ Light pen control.
- ★ NMI interrupt generation (on board link option).

MV256A **£199** + VAT

MV256B **£220** + VAT

Both the **MV256A** and **MV256B** are supplied built and tested with comprehensive documentation and programming examples.

Colour Video monitor 12 inch 0.6 mm pitch tube, 9MHz Bandwidth, suitable for use with MV256.

Arfon Light pen, Plug in, compatible with Micro Vector board.

£199 + VAT

£50 + VAT

Cable Accessories available.

For further information and full data information please contact:

CLIMAX COMPUTERS LTD
 17a Broad Street, South Molton, Devon. Tel: (07695) 2314

LONDON COMPUTER CENTRE

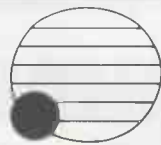

ACT Sirius 1

1.2 Mb Disk Storage £2395
2.4 Mb Disk Storage £2895

Now available
Z 80 CP/M Add-on board
to run all CP/M 8 bit or
16 bit software

NEW

**Sirius
Hard Disk 10 Mb
Available Now!**

Wordstar Magic Wand Spellbinder
Spellstar D Base II T/Maker Calcstar
Milestone Datastar Microstar
Fortran Cobol Pascal or any CP/M
software

TELE-VIDEO SINGLE-USER TO MULTI-USER

NOW UPGRADED NO EXTRA CHARGE

802E 100K EXTRA DISK STORAGE
£2170

Superbrain compatibility
Faster disk access
Green Screen. True descenders
22 Function Keys
802DE 2 Mb Disk Storage **£2295**
802HDE 14 Mb Hard Disk 1
Mb Floppy **£3990**
806 6 User 10 Mb Hard Disk **£4095**
816 16 User 23 Mb Hard Disk **£7385**
800 64K User Station **£1025**

Prices above based on exchange rate \$2 = £

800 64 K user station £1025



Sales



Invoice



Purchasing

806/816

Word Processing

Payroll

Nominal



CP/M Software

Wordstar **£195**
Spellstar **£130**
Grammatik **£65**
Foot Note **£75**
CPM/IBM **£99**
CPM/DEC **£99**
T Maker II **£150**
D Base II **£395**
Autocode **£120**
Milestone **£195**
Task **£195**

NEW

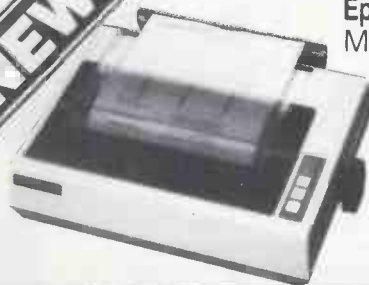

Epson Type 3
MX 80/FT
MX 100

NEW

**New Superbrain 2
from £1595**
Dedicated Wordstar Keypad



AUTO SHEET FEEDER

£580

New! 12" Wide
Automatic
Sheet Feeder
fits all below

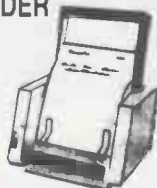

NEW

5Mb Hard Disk Model 111 £995

Model I
48K System
2 Disk Drives
Green Screen
Complete **£995**

Model II
with TRS DOS
and CPM at
no extra charge
from **£1995**

Model III
16K **£599**
48K **£649**
48K with 2 disk
drives **£1395**



DAISY WHEEL PRINTERS LETTER QUALITY PRINTING



- * **FLOWRITER RP 1600. 60 CPS** The most intelligent Daisy. Proportional spacing with Right Justification on WORDSTAR, WORDPRO, APPLE WRITER, SCRIPSIT etc. **£1500.**
- * **TEC 40. 40 CPS** JAPANESE DIABLO 630 uses Diablo Daisy Wheel & Ribbons **£1135.**

HARD DISKS

for Superbrain,
TRS 80 Model II, Apple

Model 6 6 Mb Formatted **£1595**
Model 12 11.5 Mb Formatted **£1895**

- * Specially designed Hybrid heavy duty power supply
- * Data Error Recovery



All prices are Exclusive of VAT and Delivery. Dealer Enquiries invited on all Products.
Large range of CPM Software available. Please phone for Prices.

Demonstrations on all models.

43 GRAFTON WAY, LONDON W1P 5LA (Opposite Maples)
OPENING HOURS: 11-7 MON-FRI 12-4 SAT Tel: 388 6991/2
24 hour answer phone: 01-388 5721

Better trade with Cumana and get the choice of a whole range of Top Quality Disk Drives



A BIG PLUS!
includes
SWITCH UNIT for
80 or 35
track use

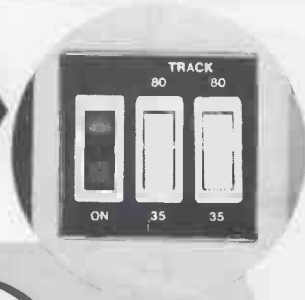

For business systems the 8035. This Unit has the capacity of 4 1/2 Apple drives and can also read all 35 track Apple Software.



A low cost Apple compatible disk drive - quiet and reliable operation.



We offer a wide range of high quality disk drives for Apple, TRS-80 and many other popular computers including the BBC Micro (Model B), NASCOM, Genie and Superbrain. Our continued high reputation depends on supplying professional users with top quality trouble-free products, completely dependable and quiet in operation. And, Cumana make you a promise that when there are better products we will be supplying them; and at prices to keep our Dealers ordering!

DEALER
and OEM
ENQUIRIES
WELCOMED

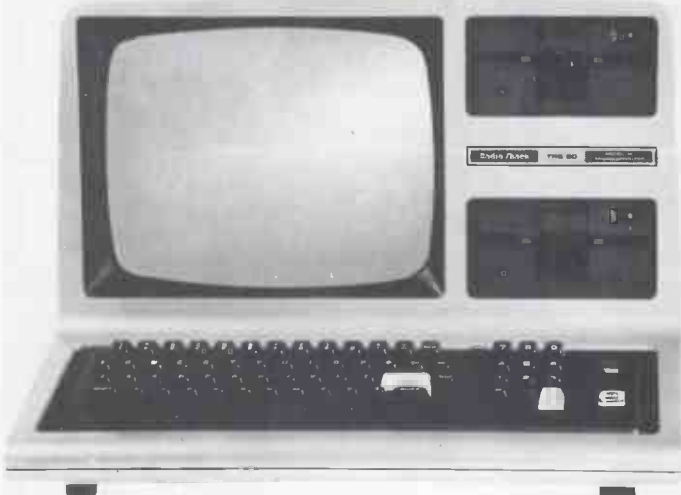

TRIDATA integrated business package now available on Cumana 40 and 80 Track Model III Drives. Contact TRIDATA: Tel. 021 622 6085.

Internal Drive Kits for the TRS 80 Model III 40/80 Track Double Sided

CUMANA LTD

: Unit 1, The Pines Trading Estate, Broad Street, Guildford, Surrey GU33BH.
Telephone: (0483) 503121 Telex: 858306

Apple is the Registered Trade Mark of Apple Inc.

No hassle 12 MONTH WARRANTY

NOT **just another Apple bit copier**

Put Locksmith back on the shelf! SNAPSHOT removes copy protection, and copies most programs that no bit copier can touch – including the bit copiers themselves!

SNAPSHOT will copy any program that runs on a 48K Apple II (except for programs that require a Z-80 card or that repeatedly access their own disc while running.) **For example, SNAPSHOT will copy every bit copier now sold in less time than it takes you to read this paragraph.** SNAPSHOT is a peripheral card that uses your language card* to interrupt a running program and dump the entire contents of 48K and registers to an unprotected backup disc.

Unlike bit copiers, SNAPSHOT requires no complex parameter changes or trial-and-error tedium. SNAPSHOT is also ideal for debugging your own programs or analysing others' programs. And SNAPSHOT can be used to temporarily suspend your work with one program while you use another program. For example, you could interrupt word-processing a letter to look up an address on a database, then resume processing the letter where you left off.

- Repeatedly interrupt and resume any program
- Full monitor capabilities to examine, modify, trace, single-step, or disassemble an interrupted program
- Copies from DOS 3.2 to DOS 3.3
- Faster and easier to use than any bit copier
- Lets you suspend work with one program while you use another
- Makes almost all previously unlistable programs listable.
- Permits transfer of almost all protected programs to hard disc or 8" disc as binary files. Puts several protected programs on one disc.

RAMEX and DIGITEK 16K RAM cards available!

Ring 01-900 0104

PRICE £95.00 from Dark Star Systems

Terms: Add 15% VAT. P&P included. Check with order, please. Postage £1 outside UK, £5 outside Europe. Dealer terms available. * Requires one drive and Apple, Microsoft, Ramex or Digitek language/RAM card. Other brands: specify when ordering.

The logo for Dark Star Systems is presented in a stylized, blocky font. The words "DARK STAR" are on the top line, with a sunburst icon replacing the letter "A" in "STAR". Below this, the word "SYSTEMS" is written in a similar font. The entire logo is contained within a dark, rounded rectangular border.

Dept P. 54 Robin Hood Way, Greenford, Middx, UB6 7QN Tel 01-900 0104

DISKING

FOR THE FINEST DISKS & ACCESSORIES

All disks are factory fresh and individually certified 100% error-free

DISKING INTERNATIONAL FREEPOST LIPHOOK HANTS GU30 7BR UK TEL (0428) 722563

NEW FREE OFFERS

NOW FREE with EVERY TEN-PACK of disks from DISKING

- 1 The genuine EGYLY LIBRARY BOX worth at least £2.00
- 2 The genuine PVC bound DISKING DISK DIRECTORY 'priceless'
- 3 The Ultralite Writing DISKING DISKWRITER worth 45p

... PLUS PERSONALISED PEN SERVICE for 5+ ORDERS ...

When ordering 5-9 Ten-Packs you will also receive a BRUSHED CHROME PAPERMATE PEN and for 10+ Ten-Packs the GOLD PAPERMATE PEN. EITHER PEN may be initialised FREE, please state letter required. The two tone COLD PEN comes in Maroon, Black or Brown, please state colour preference

Datalife

Verbatim

10 Minidis

VERBATIM 'Datalife' are the World's favourite media. Minidis are all double density with hub ring reinforcement.

5.25" DISKS

	EXC VAT
MD525 S/Sided 40 track	£18.95
MD550 D/Sided 40 track	£24.95
MD577 S/Sided 77 track**	£26.95
MD557 D/Sided 77 track**	£34.95
10 & 16 Hard Sector at same prices	

8" DISKS

	EXC VAT
FD34-1000 S/Sided S/Density	£22.95
FD34-9000 S/Sided S/Density*	£28.95
FD34-8000 S/Sided D/Density	£29.45
FD10-4008 D/Sided S/Density	£34.95
DD34-4001 D/Sided D/Density	£34.95
* For Critical applications.	
32 Hard Sector at same prices.	

**96 tpi Certified Media

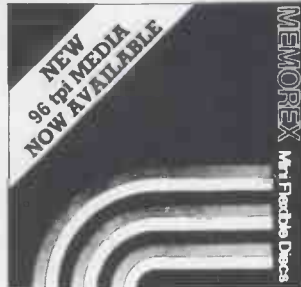

If you have not yet tried the NEW MEMOREX media, you are in for a surprise. Just arrived are their latest formulation diskettes, and customer feedback suggests that they are very conservatively rated! 5.25" all hub ring.

5.25" DISKS

	EXC VAT
3431 S/S S/Density 40 track	£18.45
3481 S/S D/Density 40 track	£21.45
3491 D/S D/Density 40 track	£23.95
3504 S/Sided 77 track**	£26.95
3501 D/Sided 77 track**	£33.95
10 & 16 Hard Sector at same prices	

8" DISKS

	EXC VAT
3064 S/Sided S/Density	£20.95
3090 S/Sided D/Density	£23.95
3101 D/Sided S/Density	£25.95
3102 D/Sided D/Density	£29.95
32 Hard Sector at same prices.	

You tell us



PLASTIC LIBRARY BOXES

The genuine Egly Box that stores and protects your disks in tens - Unbeatable - (FREE with every ten disks ordered).

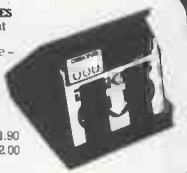

LB5 for Minidisks £1.90
LB8 for 8" disks £2.00

ATTENTION THE TRADE

Please write to us on your letter headed paper, and ask for our special trade prices and offers. If you are selling software OR hardware, you can give your products the ultimate in presentation by offering your personalised disks, disk envelopes, disk & document ring binders and of course a personalised Superluxe Disk Library. Ask for our Vendor Branding leaflet. Your colour PVC, printing and design makes your package professional.



SUPERBRAIN SOFTWARE 'DATAKING'

Here at last, 'DATAKING' is a POWERFUL yet SIMPLE to operate REPORT WRITER, for use with fixed length record files, such as those created by Wordstar & Datastar.

'DATAKING' will 'pull' ANY data from such records, and columnate the way YOU want it, with user defined headings, totals and averages.

'DATAKING' will also generate SELECTIVE REPORTS, by allowing the user to apply numerical limits to ANY data item within that file. FORWARDS, BACKWARDS, RESTART, PRINT, STOP-PRINT, CHANGE MODE & EXIT. DATAKING are only ever ONE or TWO buttons away ANYTIME.

'DATAKING' has no one-way dead-end roads.

'DATAKING' is ONLY available from DISKING INTERNATIONAL and its franchisees. Any other vendor in the U.K. is a pirate, and risks certain litigation.

DATAKING complete package £89.00
DATAKING User Manual only £10.00

DISKING SUPERLUXE DISK LIBRARY



Manufactured exclusively for us to our own design, the SDL keeps your valuable disks flat and dust-free, while at the same time allowing you instant visual selection of any single disk. The standard SDL holds 20 disks, while the SDLX holds 28 disks. The SDL may be updated to an SDLX retrospectively. They come individually boxed complete with instructions and self-adhesive spine labels.

SDL only ... £9.95 . SDLX only ... £11.95
QTY SDL Prices: for SDLX add £2.00.
1-4 5-9 10-19 20-49 50-99 100+
£9.95 £9.45 £8.95 £8.60 £7.90 £7.15.
Upgrading Conversion Kit £2.00



DISK DRIVE HEAD CLEANING KITS

Prevent head crashes and ensure efficient error-free operation. Enough for 26 bi-monthly cleans and a lot cheaper than a service call!

CK5 for 5.25" disk drives £16.50
CK8 for 8" disk drives £17.00

STOP PRESS!

8" Diskettes NOW stocked. Credit Card Surcharges ABOLISHED - REDUCED prices AGAIN! - See our post & package rates - The more you buy, the cheaper it gets.

QUALITY MAINTAINED ALWAYS

U.K. P&P RATES ... EXC VAT

Minidisks 1-2 PACKS each pack	@ 95p
Minidisks 3-5 PACKS each pack	@ 75p
Minidisks 6-9 PACKS each pack	@ 60p
Minidisks 10+ PACKS	*POST FREE*
8" disks 1-2 PACKS each pack	@ £1.30
8" disks 3-5 PACKS each pack	@90p
8" disks 6-9 PACKS each pack	@70p
8" disks 10+ PACKS	*POST FREE*
LB5 5.25" Library Box 1-4 off	each @ 40p
LB5 5.25" Library Box 5-9 off	each @ 30p
LB5 5.25" Library Box 10+	each @ 20p
LB8 8" Library Box 1-4 off	each @ 60p
LB8 8" Library Box 5-9 off	each @ 45p
LB8 8" Library Box 10+	each @ 30p
For CK 5 5.25" Cleaning kit read Minidisk postal rates 10+ POST FREE.	
For CK8 8" Cleaning kit read 8" disks postal rates 10+ POST FREE.	
For SDL or SDLX (5.25" version only) read Minidisk postal rates.	
DATAKING SOFTWARE	post free
DATAKING USER MANUAL	post free

24-HR CREDIT CARD ORDERS

We welcome Access (Master card), Barclaycard (VISA) and Diners Club International, and there is NO credit card surcharge. You may write your c/card No. on your order or telephone the order day or night, 365 days a year. You may speak for as long as you like, and don't forget to give full details of what you wish to purchase, your credit card number, credit card holder's name and address, and delivery or invoice address if different.

NORMAL ORDERS

We accept Armed Forces and all Ministry of Defence Establishments orders over £50.00 in value. All other customers cheques with order please payable to DISKING. If you are a large establishment, and can not raise cheques without an invoice please post or telephone us your order, and we will send a pro-forma invoice by return, for your accounts department to pay against.

URGENT ORDERS

Either post your cheque not forgetting to stamp it FIRST CLASS, or telephone your order with credit card No., mentioning in either instance that your order is URGENT. You may then pay FIRST CLASS POST for your goods, if required.

FIRST CLASS RATES	EXC VAT
First TEN-PACK (Mini or 8")	£1.80
Second & subsequent	£1.30

To: DISKING FREEPOST, Liphook, Hants, GU30 7BR. U.K.

QTY	DESCRIPTION	PRICE EXC VAT
.....	£
.....	£
.....	£
.....	TOTAL GOODS VALUE EXC. VAT	£
.....	TOTAL DELIVERY AND INSURANCE	£
.....	SUB TOTAL EXC. VAT	£
.....	VAT	£
.....	VALUE OF CHEQUE PAYABLE TO DISKING	£

Name:
Address:
Tel No:

Please charge my credit card No:



DINERS CLUB INTERNATIONAL

WELCOME

PCW 10

ZEN MICROCOMPUTERS LTD



Ask YOU



To wait until the new year for our new range, starting with. . . AN EXCITING NEW PERSONAL COMPUTER incorporating

- * Monochrome Display
- * Dual floppy disks
- * Full QWERTY keyboard with function keys

AT A SPECIAL LAUNCH PRICE OF C£1,400*

FEATURES

Microprocessor
Architecture
Speed

RAM Standard/Max
PROM Standard/MAX

Floppy Disks Standard
Storage
Max No. Drives
Hard Disk Option

Monochrome Display
Characters
Graphics
Character Cell

Keyboard No. of Keys
Function Keys
Numeric Keypad

Operating System

Language Standard
Optional

Communications Standard

STANDARD/OPTIONS

iAPX 186/8086
16 Bit
8MHz

128K/896K
64K/128K

2
320KB
4
Yes

12"
80x25
720x350
9x14

88
16
16

MSDOS

Basic
Fortran/Pascal
Cobol

Parallel
RS232-C
V24 & 20mA

Dealer Enquiries Welcome

*Please add 15% VAT

Please write for further details to:

ZEN MICROCOMPUTERS LTD, 5 ENGAINE, ORTON, LONGUEVILLE, PETERBOROUGH PE2 0QA

Name

Company

Address

Tel:

PCW1

INFORMATION DESK SOFTWARE

INFORMATION AT YOUR FINGERTIPS...

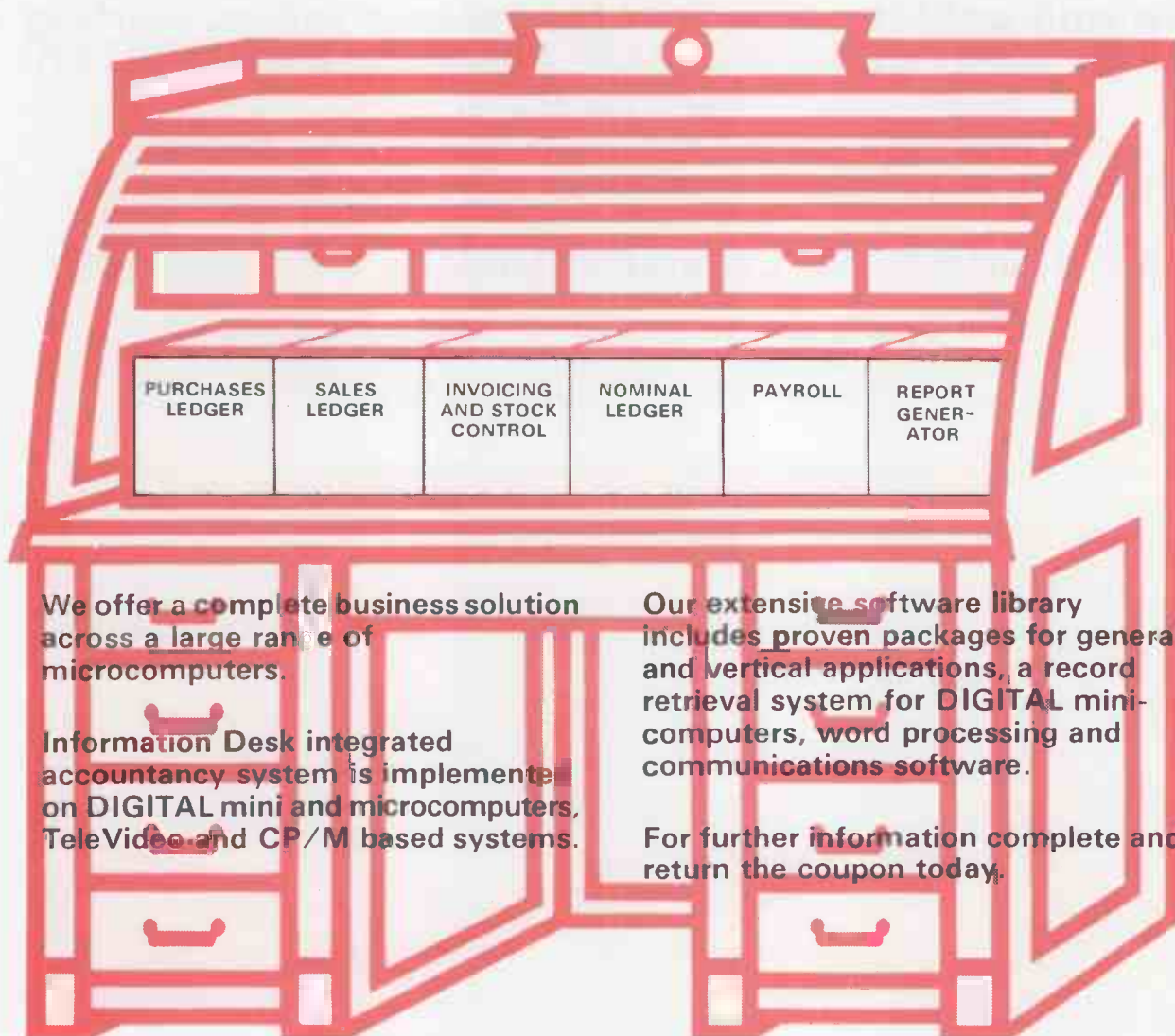

We offer a complete business solution across a large range of microcomputers.

Information Desk integrated accountancy system is implemented on DIGITAL mini and microcomputers, TeleVideo and CP/M based systems.

Our extensive software library includes proven packages for general and vertical applications, a record retrieval system for DIGITAL mini-computers, word processing and communications software.

For further information complete and return the coupon today.

We are looking for dealers to handle our large range of software and hardware. If you feel that your company has the necessary expertise, please contact us for details.

See us at the Ireland stand at Compec.



Information Desk Software
Sandyford Industrial Estate,
Foxrock, Dublin 18.
Tel: 952821
Telex: 30213

- I would like to hear more about your range of products
- Please send me details of your Dealer Plan.

NAME _____

ADDRESS _____

Tel. No. _____

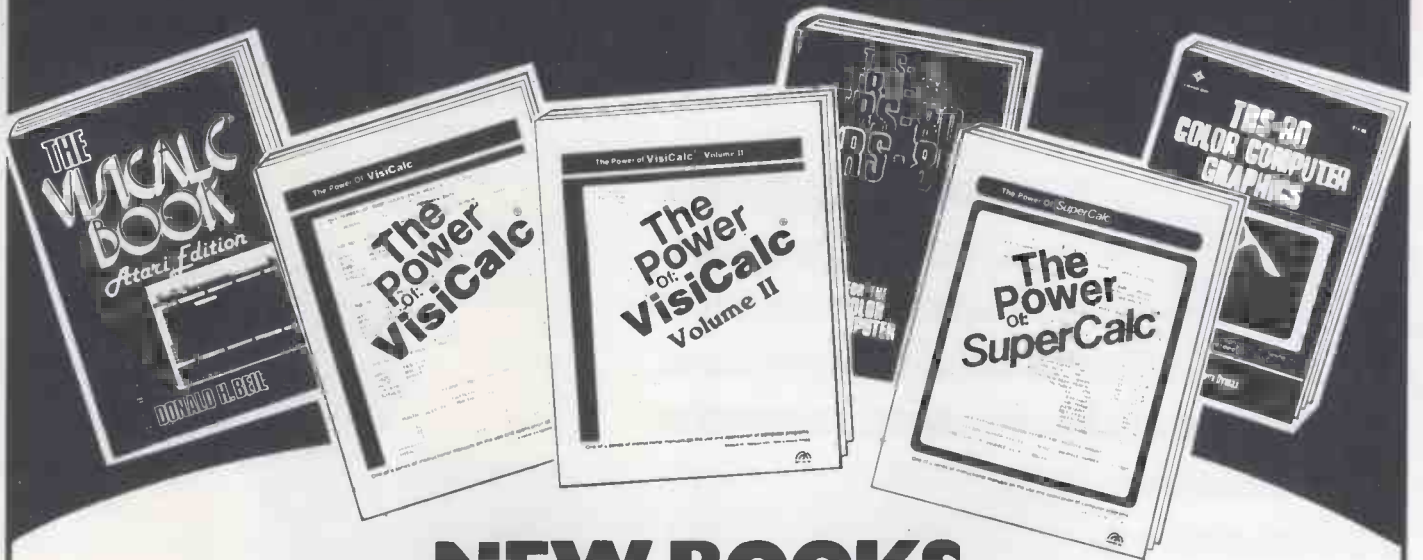

NEW BOOKS from Prentice-Hall International

SuperCalc and VisiCalc books

The Power of SuperCalc

Robert Williams and Bruce Taylor

Seven step-by-step exercises are provided in this book to teach you how to use the broad range of capabilities that make SuperCalc one of the most powerful software programs available for personal computers. The book explains the use of SuperCalc features with specific application examples.

£7.95 120 pages 13-687301-4

The Power of VisiCalc: Volume 1

Robert Williams and Bruce Taylor

This companion volume to the Power of SuperCalc contains seven exercises that show you how to use VisiCalc to solve a wide range of problems. It explains how to take full advantage of VisiCalc commands and functions whatever your application.

£7.95 98 pages 13-687418-5

The Power of VisiCalc: Volume II

Five new exercises are included based on VisiCalc version 3.3. The exercises cover Accounts Payable, Payroll Reports, Sales Reports, Daily Inventory and Financial Forecasting.

£7.95 98 pages 13-687426-6

December publication

The VisiCalc Book: ATARI Edition

Donald Beil

Illustrated with a large number of practice problems, this book shows you how to make the most of VisiCalc on the ATARI. All examples have been prepared on the ATARI 800 using VisiCalc 1.74A. Among the many topics covered are capabilities, commands, built-in functions, recognizing, preventing and correcting errors, creating templates, documentation.

£11.95 312 pages 8359-8393-5

TRS-80 books

TRS-80 Color Computer Graphics

Don Inman with Dymax

Programs and exercises illustrate the detailed instructions given in this practical book. 16K Extended Color BASIC graphics features are covered for low, medium and high resolution graphics as well as the 64-by-32 mode implemented in the 4K Color BASIC machine.

£11.95 308 pages 8359-7864-8

TRS-80 Programs and Applications for the Color Computer

Alfred Baker

Numerous examples and program listings for games, colour, sound and music, educational and financial applications are provided in this introductory book.

£15.15 200 pages 8359-7870-2

Prices are correct at the time of going to press but may be subject to change.

Book Orders

These books can be ordered from your usual bookseller, or in case of difficulty from:

Department 30,
Prentice-Hall International,
66 Wood Lane End, Hemel Hempstead,
Hertfordshire HP2 4RG, England.

Please mark the number of books you wish to order in the boxes beside each title and return the advertisement to the address above.

Name _____

Address _____

I enclose a cheque/P.O. for £ _____
Please add £1.00 per book for postage and packing.
Payment should be made out to INTERNATIONAL BOOK DISTRIBUTORS.
Please allow 28 days for delivery.

Code PCW 12

Prentice/Hall  International

Eat your heart out—

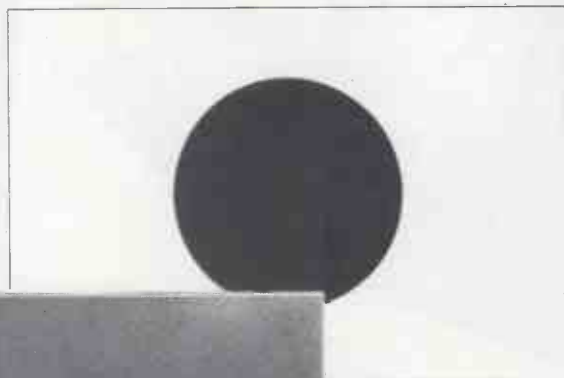

Simulated display.

Torch the new British business micro has:

- Twin processors • 800K floppy disc storage
- Electronic Mail facilities • Local area networking
- Direct access to mainframes
- Hard disc option (10 or 21Mb)
- Private Viewdata/Prestel
- High resolution colour graphics
- Over 20,000 Management Software packages
- Speech synthesis • CP/M* compatibility

And is the only Microcomputer with official British Telecom approval for direct connection to all telephone lines throughout the UK and North America etc.

For full specification, price, and dealer list write or telephone: Torch Computers, Abberley House, Great Shelford, Cambridge, England, (0223) 841000.

*CP/M is the registered trade mark of Digital Research Ltd.

TORCH... Puts the world at your fingertips.

WE CAN PUT YOUR PROGRAM HERE

IF YOU WRITE SOFTWARE THEN READ ON...

15 months ago we had written some excellent Games Software for the ZX-81, but when debugging was finally completed we realised that much of the work remained.

Who could we rely on for the effective marketing and production of our efforts?

Who would give our software the chance it deserved?

No company was really giving ZX Software the professional backup and production it deserved so we created Quicksilva to fulfill this role.

Now Quicksilva has developed a set of specific policies to match our beliefs about how a company of this kind should operate.

CUSTOMERS

The highest priority must be given to customer service — "QS customer relations are the best in this field."

SOFTWARE

A high standard must be maintained for all software — "QS reputation for innovative software is firmly established."

PRESENTATION

Should support and enhance the software — "QS policy is to use full colour reproductions of specially commissioned artworks to match the standards of the programs."

ADVERTISING

Needs to be accurate, informative, enjoyable, eye-catching and effective — See recent magazines.

PRODUCTION

Reliable and efficient duplication of cassettes is essential — "QS cassettes are produced by The Tape Duplicating Company Ltd., who have the expertise and equipment to do just that."

DISTRIBUTION

All avenues appropriate to the Software involved must be explored — "QS has over 200 retail outlets in this country alone and a substantial number in all the major overseas markets."

We now know that Quicksilva will give both of us the professional back-up and expertise our programs deserve. It has taken time and effort, and is very much a continually improving service; always we aim for that indefinable 'quality' that makes all the difference. We feel that now is the time to offer 'You' the same service that Quicksilva gives us.

So if you are a Software Author confronted with the same problems we had 15 months ago, let Quicksilva solve them for you and help you as it helped us.

Yours, Nick Lambert & John Hollis

Quicksilva is interested in quality software for the following personal computers — Spectrum — Atari — VIC 20 — B.B.C. — Atom — ZX81 — Electron — Dragon Quicksilva offers you on acceptance of your program:

25% royalties on all sales; the very best professional quality support for your programs;

full credits in advertising, brochures and on cassette for you as the author;

the opportunities and advantages that working with the leaders in the field offers.

Please contact us immediately to discuss this opportunity at

QUICKSILVA, 92 Northam Road, Southampton, Hants SO2 0PB

or ring our Special Authors' Hotline — Southampton (0703) 20169 Ext. 42 — and we will do our best to give you the answer you are looking for.

MICROAGE ELECTRONICS

BIG value in small printers

At Microage you can now get the very best value in microcomputer printers. We've selected only the best printers available so you can choose confidently, knowing you're getting the best value for money.

Interface Cables and paper supplied with all machines.

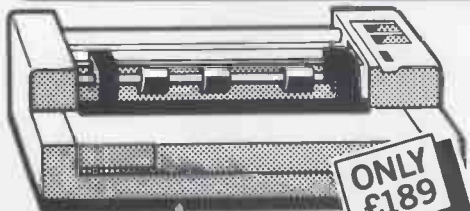

ONLY £189

The Incredible AP80

The AP80 is probably the world's LOWEST COST, compact 80-column graphic dot-matrix printer available.

It can produce single and double width characters and has the ability to produce any pattern through its dot-matrix capability.

The AP80's robust construction and its unique "unihammer" make it an extremely cost effective and efficient printer.

Its features include

80 Cols 30 cps ● Dot Matrix Unihammer action ● 96 ASCII standard characters ● Up to 8" paper width ● Upper and lower case ● Double width printing ● Standard interface: Centronics

The Amazing AP100

Big brother to the AP80 the AP100 is a wider more sophisticated version of the AP80 with a full graphics capability and the ability to take standard width computer stationery, the AP100 is an ideal choice for anyone with a microcomputer.

Its features include:

80 cols 30 cps ● Dot Matrix Unihammer action ● 116 ASCII standard characters ● Full graphics capability ● Up to 10" paper width ● Upper and lower case ● Double width printing ● Centronics interface: ● Friction feed.
Only £215.

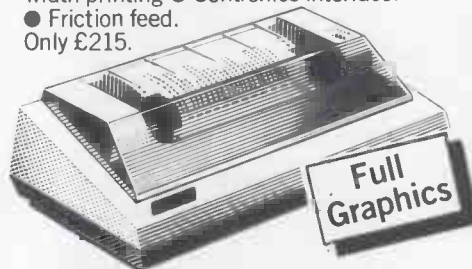

Full Graphics

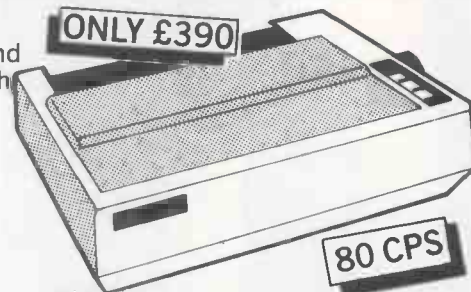

ONLY £390

80 CPS

The Outstanding MX80 FT Type 3

The MX80 is a flexible, high quality and extremely reliable graphic, dot matrix printer.

Its superb performance is due to a number of outstanding features. High resolution graphics, a wide range of type sizes, a quality 9 x 9 dot matrix head and up to 132 chars per line are just some of the exceptional features on this ideal printer for microcomputers. Only £390.

Specifications

132 cols 80 ● Logic-seeking, Bi-directional printing ● 9 x 9 Dot matrix printhead ● 96 ASCII standard chars with descenders ● Full graphics capability ● Several type sizes ● Automatic underlining ● Standard interface Centronics ●

Official Orders Accepted

MICROAGE ELECTRONICS

135 HALE LANE EDWARE MIDDLESEX HA8 9QP TEL: 01-959 7119 TELEX 881 3241

ALL PRICES INCLUDE VAT. FOR FURTHER DETAILS AND MAIL ORDER LIST SEND LARGE S.A.E.

Open Mon - Sat 9am - 6pm. Thurs 9am - 1pm

* NEWBRAIN MODEL A *

ELSTREE COMPUTER CENTRE
£199.50



MODEL A.D.

- 80 CHARACTER DISPLAY PER LINE
- 4 CHARACTER SETS
- VERY FAST: ACCURATE KEYBOARD
- IDEAL FOR BUSINESS USE

* SOFTWARE JUST RELEASED; INVOICE, SALES-LEDGER, DATABASE, INVENTORY, HOME EXPENSES, STOCKCONTROL, ADDRESS BOOK, MAILING LIST, AND MORE ... SEND S.A.E. FOR PROGRAM LIST.

ELSTREE COMPUTER CENTRE
32 DEACONS HILL ROAD
ELSTREE, HERTS, WD63HL
Tel: (01) 953 6921

OFFICE HOURS 9-6 MON-FRI

p&p £2.75
AD £229 plus VAT £263.25
A £199 plus VAT £228.50

★ ATTENTION ZX81 OWNERS!! ★
If you own a ZX81 we will offer you up to £40 against a NewBrain (this is a limited offer)

FOR BBC MICRO

FORTH ROM.....£34.72

Includes fitting instructions, manual for BBC version

Full manual (not necessary if already conversant with Forth).....£6.75

ACOUSTIC
COUPLER£49.72

Send programs and data over your telephone

— works via the cassette interface.

add VAT to the above (not for manual)

— carriage free in UK.

Coming soon!

Fast cos

Modem

Prom Blower

Computer aided learning package

Also: Sales /& Service on the following:

Acorn, BBC, Commodore, Apple, Dragon, SWTPC, Epson, Seikosha, Smith Corona (Daisy Wheel)

Supply:

Chips, paper, tapes, disks, cables, connectors.

H.C.C.S. Associates,
533 Durham Road,
Low Fell, Gateshead,
Tyne & Wear, NE9 5EY
Tel: (0632) 821924

MICROAGE ELECTRONICS

BBC Microcomputers 'B's and expanded 'A' IN STOCK NOW!

BBC Model 'B' wordprocessing pack at a low price of **only £699. Save £44.** Normal price £743. The Pack consists of: BBC Model 'B' GP100 Printer Cables, Cassette Player Word Processing ROM, 1,000 sheets of paper. Then add the GP100A Printer at only £215. The lowest price ever.

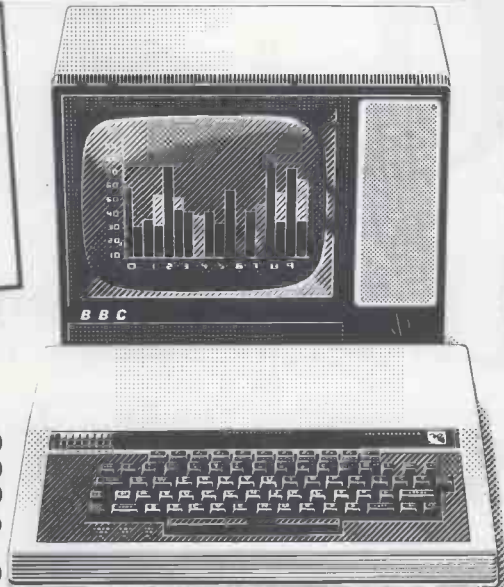

BBC MACHINES

Model A, 32K RAM + 6522 Chip	£329.00
Model B	£399.00
Model B + Disk Interface	£494.00
BBC Dust Covers	£3.95 + £1.00 p&p
BBC Compatible Single Disk Drive (100K)	£235.00
BBC Compatible Dual Disk Drive (200K) Manual utility disk	£389.00
BBC Dual Slimline Disk Drive (Double Sided & Density 800K)	£799.00
Verbatim Single Sided Diskettes 10 for	£22.50
Verbatim Double Sided Diskettes 10 for	£39.99
Let us fit a disk interface in 24hrs	£95.00

BBC MONITORS

14" RGB Microvitec Colour Monitor (as used in the BBC Computer Prog.)	£284.00
RGB Lead for above	£4.95
12" Zenith High Res. Green screen Monitor	£95.00
BNC Cable for above	£4.95

BBC CASSETTE PLAYER

Official Version inc. Leads, tape counter, Battery/Mains etc.	£28.00
Blank Data Cassettes 10 for	+ £2.00 p&p £3.50
DIN to Jack Lead	+ £1.30 p&p £3.50
Official Joysticks per pair	+ £1.00 p&p £13.00
	+ £1.30 p&p

By Courier

Large items such as Computer:—1 item £7.
2 items £10.3 or more £13



Win a £100 or a £50 token!
Free entry into raffle with every order.
For details write or phone Microage.

PRINTERS

Acorn AP-80A now down to	£189.00
Acorn AP-100A now down to	£215.00
AP Ribbons	£4.95
	+ £1.00 p&p
Epson MX-80 F/T 111 (new model, Dot matrix High res. graphics, 80 or 132 chars. per line)	£390.00
Prices include cable & paper	
Epson Dust Cover	£4.95
	+ £1.00 p&p
Parallel printer cable	£15.00

ACORNSOFT FOR BBC

Snapper, Planetoid, Monsters, Rocket Raid, Meteors, Philosophers Quest, Sphinx Adventure, Arcadians, Chess, Lisp Cassette, Forth Cassette, Business Games, Peeko-Computer, Creative Graphics Tape, Graphs & Charts Tape, Desk Diary, Arcade Action, View (on ROM)

All Acornsoft at £9.95 each, except Arcade Action (11.90), Forth & Lisp (16.85 each) and View (£59.95).

THE ACORN ATOM
Large stocks of all Atom kits, machines, disk-packs, ROMs and accessories. Software includes Atomcalc, FORTH, LISP, Adventure etc. Ring or write for list, prices etc.

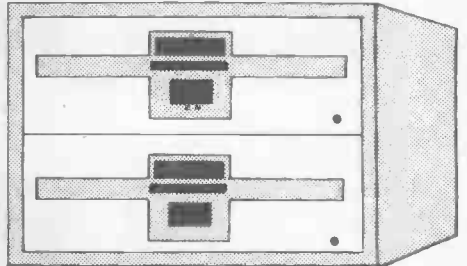

BOOKS

Practical Programs for BBC & Atom	£5.95
BASIC Programming on the BBC Micro	£5.95
Programming the 6502 (Zaks)	£10.75
6502 Assembly Language Programming	£11.95
BBC Micro Revealed	£7.95
Creative Graphics, Graphs & Charts, LISP & FORTH	all at £7.50 each

Postage Rates

Small items such as Ribbon, books & software:— 1 item £1.00, 2 items or more All Dust Covers £1.00 p&p 50p per unit

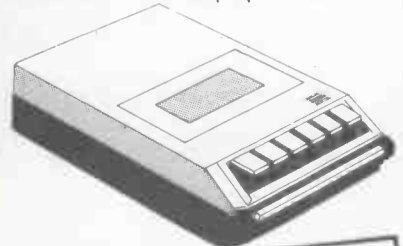

SPECIAL WORD PROCESSING PACK — SAVE £150!!
BBC 'B' with 800k disk drive, word processing ROM and Epson printer — list price £1,752. Our price £1,599.

Barclaycard and Access welcomed All prices include VAT



We accept official orders from educational establishments. We specialise in mail-order, all over the world—send large S.A.E. for lists and info pack.

24hr answerphone for credit-card holders. Phone in for 'express' despatch.

**ALL PRICES INCLUDE VAT. FOR FURTHER
DETAILS AND MAIL ORDER LIST SEND LARGE S.A.E.
Open Mon-Sat 9am-6pm. Thurs 9am-1pm**

MICROAGE ELECTRONICS
135 HALE LANE EDGWARE MIDDLESEX HA8 9QP
TEL: 01-959 7119 TELEX 881 3241

This could be the hardest

£100

you'll

ever earn

At Open Computer Services we're so confident in the quality of our software packages that we throw down this challenge:

For every bug you find in our packages, we will give you £100.

To qualify, just buy any of these packages – payroll, sales ledger, purchase ledger, general accounting/nominal ledger – and if you detect a bug, send a report on the fault together with your name, address and licence number.

Sadly you may well find it difficult to detect any £100 bugs. But at least you can take some consolation from having acquired some very good software indeed.

Software systems for most 8 bit and 16 bit microcomputers including IBM Personal, Sirius and Xerox using CP/M and MS-DOS operating systems.

OPEN COMPUTER SERVICES

Aqua House Old Steine Brighton BN1 1EL Tel. (0273) 672191

Dealer
discounts
available

CHROMASONIC

Business Systems

The 64 from

commodore

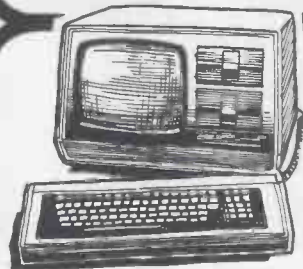

transtec computers

CPIM 2.2 DOS

01-263 9493/5
48 JUNCTION RD, ARCHWAY, LONDON N19 5RD Telex 22568



EPSON
MX-100
MX-80
MATRIX PRINTERS

ACT SIRIUS 1

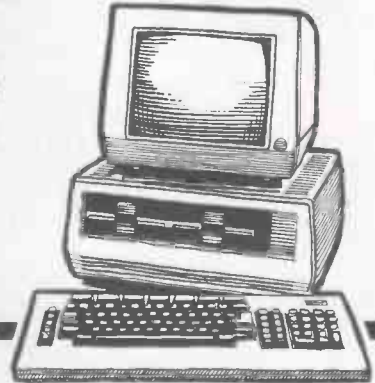

TEC
DAISY WHEEL PRINTERS

SCM SMITH-CORONA



SOFTWARE:

PEGASUS

ACCOUNTS
SALES, PURCHASE &
NOMINAL LEDGERS
INVOICING &
STOCK CONTROL

WORD PROCESSING

SUPERSCRIPT (CBM)
WORDSTAR (TRANSTEC)
SELECT (SIRIUS 1)

VISICALC

FINANCIAL PLANNING

D.M.S.

DATA MANAGEMENT
PACKAGE

SYSTEMS SUPPLIED NATIONWIDE
APPOINTED DEALER FOR
ALL THESE MANUFACTURERS
FULL SUPPORT ON ALL
PRODUCTS!

Leeds Office

'PHONE
FOR ADVICE, PRICE
& DEMONSTRATION

Northern Address: 6 WIGTON GROVE,
LEEDS LS17 7D2 Tel: (0532) 688397

SOFTWARE
HOTLINE:
01-263 7341

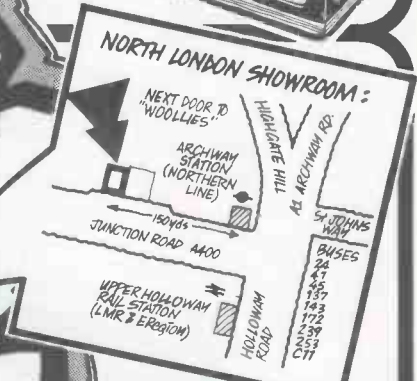

Post to CHROMASONIC Business Systems,
48 Junction Road, Archway, LONDON N19 5RD

Please send me further details about your
business systems. I am particularly interested in:

NAME:

POSITION:

COMPANY:

ADDRESS:

TELEPHONE:

commodore

apple II



TERMS OF BUSINESS: Please add 15% VAT to all prices. Delivery charged at Cost.
Prices valid for cover date of this magazine. Access and Barclaycard orders welcome.

POST YOUR
COUPON NOW!



Home Computer - Starter Packs

AT ROCK BOTTOM PRICES

FREE GAMES
CASSETTE WITH
EVERY
CONSOLE

DRAGON



Cartridges -
Ghost Attack £24.95
Octaves £19.95. Cassettes £6.95
20% off all accessories bought with a Console

- ★ Britain's newest Personal Computer using the latest 6809E processor.
- ★ Full 32K Specification
- ★ Microsoft Basic, Advanced Graphics, Sound, Editing, 9 colour display
- ★ Professional quality keyboard
- ★ Plug-in connection for Joystick, Cassette, Printer, Games.

★ DRAGON 32K - £199★

VIC 20 - £169.00
Cassette Unit - £44.95
Printer - £219.95
Single Floppy - £349.95

VIC 20



VIC 20 + Cassette Unit + Intro to Programming + 10xC12 Cassettes + Blitz Cassette - £215.00
STARTER PACK 1.
VIC 20 + Floppy + Printer - £675.00
STARTER PACK 2.
Full range of Accessories Available.
20% off games cartridges with any starter pack.

ATARI

AM400 - £189.95
A800 - £479.95
Recorder - £49.95



STARTER PACK 1.
16k Computer + Cassette Deck + FREE Intro to Programming + 10 FREE C12 Cassettes - £245.
OR
1/2 price Programmer Kit with every 16k Computer + 10% off most cartridges and cassettes bought with every Console.

ACORN ATOM

FREE power supply with every ATOM
8+2 Kit - £130. 12+12 - £235. Colour Encoder - £45.24
4k Floating Point - £23.30. Convert your ATOM to BBC Basic - £49.95.



BBC

Model B - £399. Upgrade A to B - £95.
Disk Drive - POA.

SINCLAIR



ZX81 - £49.95
Printer - £59.95
16k RAM - £29.95
STARTER PACK 1.
ZX81 + 16k RAM + Printer + 10xC12 Cassettes + 2 Rolls Paper - £139.95
STARTER PACK 2.
ZX81 + 16k RAM + 10xC12 Cassettes - £79.95

ALL PRICES INCLUDE VAT

DISCOUNTS ON ALL TANGERINE ITEMS IN STOCK for Business, Educational and Export. Try us for Rock Bottom Prices!

EXPORT

Single or QUANTITY EXPORT orders welcome. NO VAT.
Experience of exports worldwide full documentation
MONITORS, PRINTERS, SOFTWARE.
Popular prices on all popular Computers.
Send A4 S.A.E. for latest FREE Brochures & Pricelists

CASTLE ELECTRONICS

(0424) 437875

CASTLE ELECTRONICS Dept. PCW
7 CASTLE STREET, HASTINGS, E.SUSSEX

ALF

AD8088 PROCESSOR CARD WITH FTL

FTL is the easy way to speed up your Applesoft programs. You can run all your Applesoft programs with no changes, and without 'compiling' them. Plus, FTL doesn't reduce your available memory. The key is ALF's AD8088 Processor Card, which adds a fast, 16-bit computer to your Apple. FTL, the Formula Transfer Link, sends Applesoft formulas (*), (f, LOG, EXP, COS, SIN, TAN and ATN) to the card for fast processing and is also compatible with most compilers.

FTL is just one use for the powerful AD8088 Processor Card. There's a Multiple Event Timer (MET) for timing critical routines in your programs, with resolution to 50 uS for scientific applications. Coming soon are MS-DOS (the IBM Personal Computer's DOS), CP/M-86, and a fast 3-D high-res graphics card that connects through the AD-8088's versatile expansion port.

£229.00

COOLING SYSTEMS for APPLE...

COOL STACK £89.00
APPLEFAN £68.60
PACT FAN MODULE £49.00

Prevent overheating...
Call Pete & Pam Today....



PLANNER CALC by TARGET FOR APPLE II WITH Z-80

£35.00

UTILITY PROGRAMS

DOS TOOL KIT	41.00
SCRIPT III	64.29
MENU GENERATOR	25.95
MACRO SCREEN EDITOR	32.95
PROGRAMMING AIDS 3.3	49.95
MCAT 2.0	15.95
CRAE 2.0	15.95
ALD SYSTEM II	49.95
ALD SYSTEM FOR APPLE III	49.95
EDIT 6502	69.95
TASC (Applesoft Compiler)	109.00
LISA ASSEM. LANG. DEVEL. SYSTEM	59.00
SPEED-ASM	25.95
EXT. PROG. FACILITY IV	52.95
EXPEDITER II+	75.00
BAG OF TRICKS	25.95
MON+	25.95
SUPER DISK COPY III	19.95
DISK RECOVERY	18.95
DISK ORGANISER II	18.95
MULTI-DISK CATALOG III	15.95
APPLESOFT + STRUCTURED BASIC	15.95
DOS PLUS	15.95
QUICKLOADER	15.95
APPLESOFT PROGRAM OPTIMISER	12.95
APPLE SPELLER	44.95
IMAGE PRINTER	25.95
THE BUG	32.95
BUILD USING	19.95
EDIT SOFT	19.95
ACE (Applesoft Command Editor)	25.95
APPLE DOC	25.95
ASCII EXPRESS	44.95
PROGRAMMERS UTILITIES	13.95
LIST MASTER	25.95
DISK DOCTOR (CP/M D. RECOVERY)	70.00
HIGHER FONTS	11.95
DIRECTORY MANAGER	21.95
PROGRAM LINE EDITOR	25.95
SOFT SEVENTY	32.95
INTEGER BASIC COMPILER	99.95
GLOBAL PROGRAM LINE EDITOR	42.95
PROGRAM LINE EDITOR IN ROM	39.95
KRAM	59.95
SUPER KRAM	89.95
THE MANAGER (Memory MGT. SWRE)	19.95
APPLE EXTENDED EDITOR	44.95
FASTDOS (INC. DOS ACCESS SPEED)	19.95



WIZARD BPO

16K and 32K BUFFERED PARALLEL OUTPUT PRINTER INTERFACE CARD FOR APPLE II and APPLE II PLUS COMPUTERS FOR OKI, EPSON & ANADEX

WIZARD BPO 16K £149.00
WIZARD BPO 32K £169.00

BOOKS

APPLE MACHINE LANGUAGE	11.95
PASCAL PROGRAMMING FOR APPLE	10.45
APPLESOFT LANGUAGE	7.65
INTIMATE INST. IN INTEGER BSC.	5.55
APPLE BASIC FOR BUSINESS	11.20
APPLE PASCAL GAMES	11.45
PROGRAMMING THE 6502	9.70
6502 APPLICATIONS BOOK	10.25
6502 GAMES	10.25
6502 SOFTWARE DESIGN	5.50
6502 APPLICATIONS	9.70
CP/M USER'S GUIDE	4.95
APPLE INTERFACING	7.65
CIRCUIT DES. PROGS FOR APPLE	11.15
APPLE II USERS GUIDE	10.95
VISICALC HOME & OFFICE COMPN.	11.50
THE POWER OF VISICALC VOL.1	6.95
THE POWER OF VISICALC VOL.2	6.95
KIDS AND THE APPLE	13.95
GUIDE TO PROGRAMMING IN ASOFT	11.50
SCIENCE & ENG. PROGRAMS (AII)	11.50
A'SOFT BASIC DATA FILE PROG.	8.95
ASSEMBLY LANG PROGRAMMING	9.50
OSBORNE CP/M USERS GUIDE	3.95

THE MAGAZINE OF THE IBM COMPUTER

Tells you how to put together the best IBM system and how to get the most out of it. Subscribe today.

Name _____
Address _____

6 issues £17.50 12 issues £33.50
 Cheque enclosed VISA Access Card

Card No.

Send to: Pete & Pam Computers,
New Hall Hey Rd.,
Rossendale, Lancs., BB4 6JG

If not fully satisfied return mailing label within 15 days for full refund.

Pete & Pam Computers Golden Promise

WE WILL NOT BE UNDERSOLD SATISFACTION OR MONEY BACK GUARANTEE.

We believe we have the largest range and stock of Apple-related products in the country. From games to business software, floppy disks to interfaces, Apple Computers to Zenith Monitors.



IT'S OFTEN BEEN SAID THAT THE SIMPLEST IDEAS ARE THE BEST - AND JUST LOOK AT THIS ONE FOR PAPER STORAGE.

Pete & Pam Computer's Stilts are four legs which can be installed on to your Epson MX80 in seconds - giving you room for 3 inches of paper. £5.95

stilts

NEW!

DB MASTER

Special Edition for HARD DISK now available from Pete & Pam - Compatible with CORVUS and XCOMP PHD Hard Disk Drives - Allows you to store an incredible number of records.

£299.00

samram

16K MEMORY EXPANSION BOARD FOR APPLE II.

The card that's so good, our Engineer has put his name on it!
Retail Price £65.00

SPECIAL OFFER

VISICORP DESKTOP/PLAN BROWN BINDER EDITION FOR APPLE II.

£79.00



THE WILDCARD

SOFTWARE COPYING SYSTEM £99.00

Function Strip

NEW FROM VIOEX

The Vioex Function Strip™ adds a whole new dimension to your Enhancer III™ Apple II™ Function Keys. Now you can have dedicated keys for your macro definitions. Program often used word processor commands, words or phrases into your Function Strip. Programmers will find it a significant aid to be able to delete often used commands and statements. Vioex™ users can define often used commands and file names for single keystroke ease of use.

The Vioex Function Strip is a low cost, versatile strip of pressure sensitive switches. The Function Strip adheres to the Apple II's lid - just above the keyboard - and connects to the Enhancer III's keyboard connector port. The Function Strip is completely compatible with keyboards connecting to the Apple II motherboard.
Suggested retail price: \$79.00

Function Strip £54.95
Enhancer II £99.00
OR... BOTH FOR A SPECIAL PRICE OF: £149.00

TRIPLE YOUR DISK ACCESS SPEED

No hardware modification required.

FastDOS

Fast Disk operating system for APPLE II computers

Completely compatible with DOS disks
Loads and saves standard DOS files

Completely compatible with all DOS/APPLESOFT programs that access DOS through standard hooks, including FID and MUFFIN

Executes all standard DOS commands

Comparative timings:	DOS	FOOS
Loading integer basic	13 sec	3 sec
Cataloging a 12 file disk	2 sec	1 sec
Saving a 10 sector program	6 sec	2 sec
Saving a 100 sector program	34 sec	7 sec
Loading a 100 sector program	24 sec	7 sec

Requires 48K

Recommended Retail Price £19.95

APPLE CARE MACHINE COVERS

APPLE II	5.95
APPLE & 2 DISKS	7.95
APPLE & 12" MONITOR	7.95
APPLE, 2 DK & 12" MON.	9.50
APPLE, 2 DK & 9" MON.	8.95
SINGLE DISK	3.45
2 STACKED DISK	4.45
9" MONITOR	4.95
EPSON MX80/70	5.45
PAPER TIGER 445/60	7.95
APPLE III INC. MON	12.95
MX100	8.95
QUME 5 W/TRACTOR	10.95
NEC 12" MONITOR	7.50
HITACHI 12" MON.	7.50
DECCA RGB MONITOR	8.95
SIRIUS KEYBOARD	4.45
SIRIUS PROC & MON	12.95

HEAD CLEANING
Clean read/write heads the way leading manufacturers recommend 5/4" disk head cleaning kit. £18.95

DISKS & DISK BOXES
BASF single sided, single density disks.
10 for £17.90 100 for £159 50 for £84.50
Kass-ette storage boxes £2.45

Pete & Pam Computers

Mail Order & Distribution:
New Hall Hey Road,
Rossendale, Lancs., BB4 6JG
Phone: (0706) 227011
Telex: 635740 Petpam G

Norwegian Agent:
The Norwegian Software House
Address: Okernveien 145
Oslo 5

London Retail:
103-5 Blegborough Road,
London, SW16 6DL
Phones: 01-769 1022/3/4

Telephone (02) 22 89 78

Prices do not include VAT please add 15% to your remittance
Postage and Packing FREE



ITS HERE!

The new Commodore 64.
For £299 plus VAT you get
what nobody else can give
you at twice the price.

Even at twice the price you won't find the power of a Commodore 64 in any personal computer. After all the Commodore 64 has 64K of built in memory. And theres more!

Add the graphics; three dimensional objects that move over, under and behind one another. Add the 16 colours and high resolution. And add the 66 keyboard. Add all those things and you'll realise the technological breakthrough that the Commodore 64 represents.

Then check out the cost of CREAM and you'll realise maybe an even greater breakthrough. The price breakthrough.



A computer that's light
years ahead of its competi-
tion should have software
at least a few light years
ahead.

As we all know a computer is only as brilliant as the software you put into it.

That's why **RABBIT** has taken such pains to supply the best and only the best.

RABBIT SOFTWARE famed for its VIC20 software is pleased to announce two business packages for the Commodore 64.

Office Master

Three programs combined in a single package. A database Manager. An electronic calculator and a wordprocessor. All under the control of a simple to use but powerful command language.

Calc Master

Powerful mathematical problem solving planning and analysis tool, a package that allows users to plan budgets, forecasts etc, including "What if" analysis.

Both programs are disk based requiring the 1540, 4040, or 8050 disk drives.

Oh, by the way the Commodore 64 just so happens to be the most brilliant games machine you can buy.

And **RABBIT** are coming in strong here as well with lots of super exciting games that have all the sound resolution that can't be found anywhere else.

RABBIT SOFTWARE

380 STATION ROAD, HARROW, MIDDX
01-863 0833
(Part of Cream Computers)

MICRO'S COMPUTING RESEARCH
BUSINESS ? PLEASURE

The answer's a
commodore
COMPUTER

For **SUPER SERVICE**
 and **BEST DEALS**

L&J COMPUTERS

192 HONEYPOT LANE, QUEENSBURY, STANMORE, MIDDX HA7 1EE. 01-204 7525
 THE "PET" SPECIALISTS

**We specialise in PACKAGE DEALS – from beginners to big users
 you may lose out if you don't contact us before you buy!**

IF YOUR CALL IS URGENT, RING OUR HOT-LINE 01-206 0440

HARDWARE

CBM MICRO-COMPUTERS	16K	4016
	32K	4032
	32K	8032
	96K	8096
	SUPER-PET	9000
DISK DRIVES (5.25")	2M/B	8250
	1M/B	8050
	340K	4040
	170K	2031
HARD DISKS CBM	5 M/B	9060
	7.5M/B	9090
** MATOR	23 M/B	SHARK
** MATOR	30 M/B	SHARK
** MATOR	BACK-UP SHARKIVE	
	(** APPROX 8 WEEK DELIVERY)	
PRINTERS (MATRIX)	CBM	4022
	CBM	8023
	CENTRONIC	150
	CENTRONIC	737
(DAISY WHEEL)	CBM	8300
	NEC	7730
	OUME	SPRINT

NOW IN STOCK: SMITH CORONA DAISY WHEEL PRINTER
 AT £ 485 + VAT
 WITH INTERFACE (£100) - £ 525 + VAT ONLY!!

NEW! NEW!! SWITCH CONTROLLABLE WRITE PROTECT
 + AUDIBLE ERROR WARNING
 ON C.B.M. DISK DRIVES. ONLY £ 15 + VAT

RAM/ROM FOR YOUR CBM AT ONLY £ 39 + VAT.
 REMAINS PROGRAMMED FOR UP TO 7 DAYS
 EVEN WITHOUT USING YOUR MACHINE!

For those with 3032s who want 4032s and those with 4032s
 who sigh for 3032s, all is not lost! HAVE BOTH, at the flick of
 a switch — CHIPSWITCH for £57 + ROMs for £50 (with
 de-glitching facility built-in).

TOOL KITS (BASIC 2 & 4), SUPERCHIPS,
 .. AND ALL SORTS OF OTHER CHIPS...
 UPGRADE YOUR PET EVEN MORE!!

SOFTWARE

**SILICON OFFICE : WORDCRAFT : WORDPRO
 D.M.S.V. : ADMINISTRATOR : DATALEX
 BASIC & SUPERPAY : ACCOUNTS : VISICALC
 ALL IN STOCK**

CASH BOOK
 Enter daily-weekly amounts — printout and totals, weekly/monthly analysis, totals
 and balances.
 3032, 4032 & 8032 versions from £90 to £150
 STOCK TAKING for the licensing trade £240
 Superb new program for 8032 £420
 OUTSIDE SERVICES (For Mini-Cabs, etc.) £220
 New 8032 Version at 3032 price

EDGE CONNECTORS AND COVERS
 RS232 CONNECTORS AND COVERS
 CENTRONIC CONNECTORS AND COVERS
 DUST COVERS FOR MOST PETS & VICS
 ALL SORTS OF RIBBONS
 PAPER (PLAIN & LINED)

WE
 GUARANTEE
 THE
 BEST
 SERVICE
 AND
 WHAT'S
 MORE

WE
 DON'T
 QUIBBLE
 WHEN
 YOU
 HAVE
 A
 WARRANTY
 CLAIM!!

DIRECT MAIL ORDER SYSTEM

Please send me/us the following items:

Cheque/P.O. enclosed (allow for VAT & post)
 Please charge my ACCESS/VISA/BARCLAYCARD
 No. _____

Name _____

Address _____

Postcode _____

Phone No. _____

If you require more information, please tick
 Please send details of
 Please send Software details
 Please send Hardware details

PERSONAL SHOPPERS WELCOME
 Phone & Mail Orders accepted.

ALL GOODS SENT SAME DAY WHEREVER POSSIBLE
 LARGE S.A.E. FOR LISTS ETC.



Buy our
£475*
Electronic Typewriter
and you have a
Daisy Wheel Printer
for your computer
absolutely FREE



The T/Printer 35 is a superb portable typewriter that also doubles as a computer printer. It's the first electronic typewriter that's truly portable (it weighs only 17 pounds and is supplied with an ABS carrying case) and has all the features you'd expect of an electronic office typewriter. Except price.

Features include self-correction, dual function 100 character keyboard, triple pitch (10, 12 and 15 characters per inch), up to 12 in. wide paper—all with excellent print quality. And with Olivetti reliability.

Best of all, when you're finished using it as a typewriter, it's all set to go to work as a word processing quality computer output printer.

That makes the T/Printer 35 about the most versatile and cost effective piece of equipment you can buy. You get all the advantages of having a daisy wheel printer *and* electronic typewriter in a compact unit. And at one low price of £475*, including carrying case.

**The T/Printer 35 costs £475 with Centronics compatible parallel interface. With RS-232C interface it costs £535. Prices listed are exclusive of VAT.*



Datarite Terminals Ltd
Caldare House
144-146 High Road
Chadwell Heath, Essex RM6 6NT
Tel: 01-590 1155

Buy our
£475*
Daisy Wheel Printer
for your computer
and you have an
Electronic Typewriter
absolutely FREE



The T/Printer 35 is the lightest weight and lowest cost daisy wheel printer you can buy for your computer. So it will fit within your budget and you can carry it wherever you take your micro. Yet it is tough enough to give years of reliable service. Interchangeable typefaces (standard Olivetti 100 character daisy wheels), variable pitch, multiple copies—all the features you would expect of more expensive word processing printers.

Yet the T/Printer 35 costs only £475 with parallel interface. Operating speed under computer control is approximately 120 words per minute of letter perfect output. What typist can equal that?

Then when you're finished using it as a computer printer, the T/Printer 35 is ready to go right on working as an electronic typewriter.

That's the dual-purpose T/Printer 35—the versatile computer printer that fits your budget.

Orders are shipped within the UK carriage-free. To order or for more information about the T/Printer 35:



Datarite Terminals Ltd
Caldare House
144-146 High Road
Chadwell Heath, Essex RM6 6NT
Tel: 01-590 1155

YOU ASK THE QUESTIONS...

How do I connect up to a printer



What are the best questions to ask when I'm buying



Is it easy to transfer programs from one machine to another

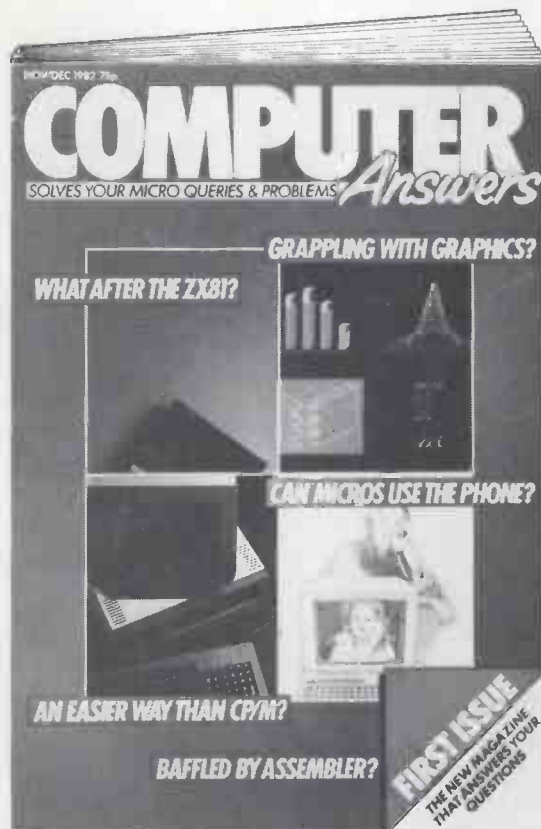

How do I make my Basic programs produce neat screen formats



How can I pick the best software



Is a 16-bit micro twice as powerful as an 8-bit



What is ASCII code for, and what should I know about it



Why do some micros have a problem dividing numbers



FIRST EDITION OUT NOW!

WE'LL FIND THE ANSWERS

PRICE **75p**

COMPUTECH for apple

Authorised dealer, service centre and system consultancy

SPECIALISTS IN SELECTING THE RIGHT SYSTEM AND THE RIGHT SOFTWARE FOR YOUR APPLICATION

COMPEC '82
16-19 NOVEMBER
OLYMPIA

DON'T DELAY
CONTACT COMPUTECH
FOR APPLE II AND APPLE /// SYSTEMS
AND

STAND 1230
GROUND FLOOR
GRAND HALL

COMPUTECH FINANCIAL ACCOUNTING PACKAGES

Payroll	£375
Invoicing and Stock Recording	£295
Sales, Purchases and General Ledgers	each £295

PLUS

COMPUTECH UTILITIES DISK for reliable error checking copying, diskette scan, interpret and patch, etc.	£20
COMPUTECH CHAIN MAIL a mailing merging document processor which may be used with text files, including random files and Applewriter 1.1 binary files.	£45
COMPUTECH GRAPHICS DISK for printing Apple pictures and graphs on Epson and Microline (free with printers purchased from Computech).	£30
COMPUTECH TERMINAL UTILITIES Apple to Apple or Apple to Mainframe.	from £130

ALSO

Visicalc, Applewriter and other Apple Software (Prices on request)

COMPUTECH HARDWARE

DIPLOMAT Video Digitiser - store a frame from a video camera in a fiftieth of a second, process and print images.	£195
DIPLOMAT Parallel Interface	£80
DIPLOMAT High Speed Serial Communications Interface	£85
DIPLOMAT RAM 16 Memory Expansion	£95
DIPLOMAT Clock/Calendar	£80
Lower Case Character Generators including Applewriter enhancements	£50
MICROMUX Data Exchange (Max 16 Ports)	from £850
MAXTRIX Printers, Microline and Epson with graphics and up to 200 cps	from £230
Microline Optional Character Generators	£15
DAISY WHEEL Printers, Olympia, Qume, Ricoh, etc.	from under £1000

Prices exclude VAT, Carriage and Packing. Trade enquiries welcome.

FOR FULL DETAILS PHONE FOR COMPUTECH'S PRODUCTS AND PRICES PACK AND A FREE DEMONSTRATION

Apple National Accounts Dealer

We provide quality service and support to small businesses and to major national and international organizations and government departments.

COMPUTECH SYSTEMS

168, Finchley Road, London NW3 6HP. Tel: 01-794 0202

AGENTS THROUGHOUT THE UK AND OVERSEAS

MEMO
From the Chairmans Office

TO. Wes Powers.

Your design for the McCombo is a winner! Can you let me know what peripherals it will connect to. Can you assure me that it's easy to build up a system based on the McCombo that will suit everyone. Small businessman, office manager, educationalist etc. Remember the McCombo concept is to let the customer choose peripherals that suit his need, building up the system that he needs.

J.S.

With the hard disc option you get all the storage you need for mailing lists etc.

Costs around £1,000

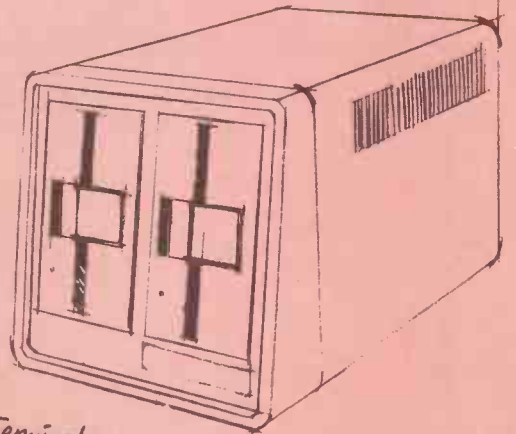

OK Terminals. ADDS, DEC, Hazeltine, Kimtron, Lear Siegler, Televideo, Newbury, Lime etc etc. they're all compatible. The automatic band sensing in the McCombo means you just plug them directly into an RS232 and they will work instantly

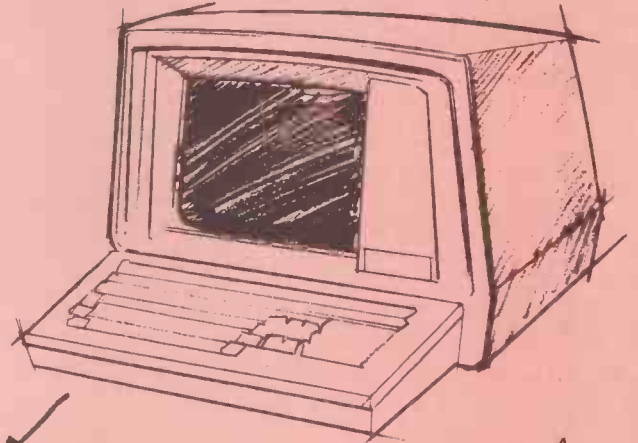
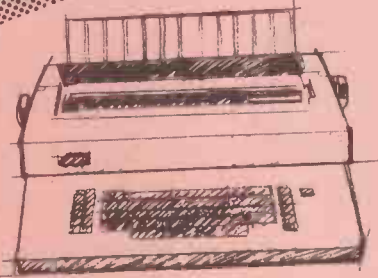

Now. Printers. Anadex, Diablo, Epson, NEC, Okidata etc. etc. They're all centronics or RS232 based. Just plug 'em in. In fact the McCombo can easily run a dot-matrix for invoices etc and a daisy-wheel for word processing. The McCombo will link up with the latest electronic typewriters. Olivetti, Facit, Silver Reed etc for really low cost word processing.

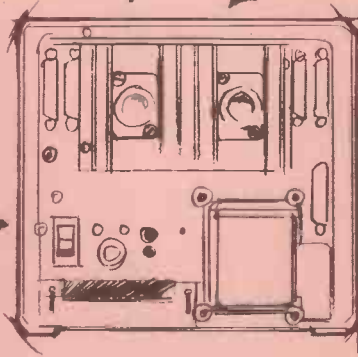
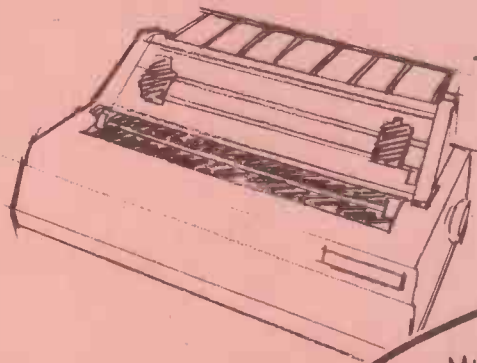

For national and international communications all you need is a British Telecom modem. The McCombo can handle it.



Plotters etc. Again just plug into an RS232

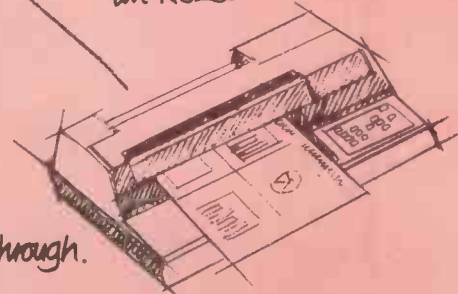

PS. Must remind JJ that a McCombo and terminal can link up to ICL, IBM mainframes etc.

There's still a great deal of tape punches for telex preparation around. They'll connect easily to the McCombo as well.



British through and through.

The **McCombo**
(a Zytex product)
you couldn't plan it better

Zytex International Products Ltd
2 Ganton Street, LONDON W1V 1LJ
Telephone: 01-734 9462

Remember to mention it can run CP/M* the most widespread operating system in the world. All the software anyone can want available, straightaway.



AM ELECTRONICS

"The Power behind the Drives"

Recognising a need for high quality drives at competitive prices, we are pleased to introduce our extensive range of Canon and Denset disc drive units.

Canon 5 1/4" floppy disc drive

A 2/3 height drive, exceptionally quiet, very reliable performance and particularly well engineered, cased and ready to run with PSU and connecting cable

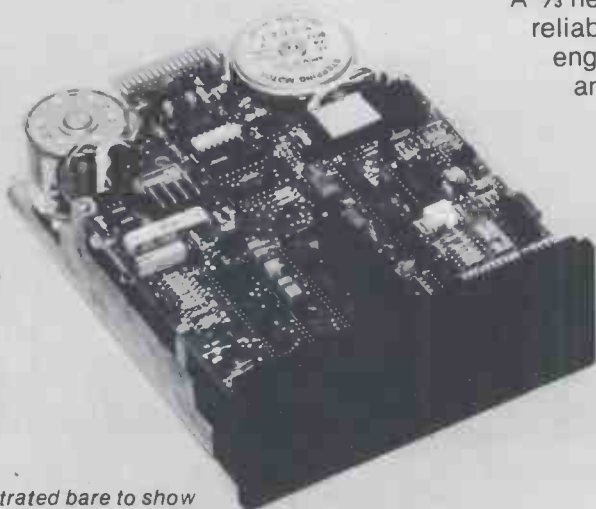

**illustrated bare to show quality of internal circuitry*

48 TPI single sided — 250K capacity

*** £175 — Dual £344**

Double sided — 500K capacity

*** £216 — Dual £418**

96TPI double sided 1 meg. capacity

*** £256 — Dual £506**

** If required bare less case and PSU deduct £26.00*

Denset 6.7 Mbyte 5 1/4" Winchester ready to run

- cased with PSU + controller for Apple II **£1195** with host adaptor and software
- cased with PSU + controller for TRS80 **£1195** with host adaptor and software
- bare **£600**



**illustrated bare to show quality of internal circuitry*

1/2 height drive Apple compatible
48TPI single sided drive, cased with connecting cable

£180 — Dual £370

All prices exclusive VAT — add £8.00 postage (data post)
Delivery approximately 28 days

Office telephone 01-994 6477 9-5 pm
24 hr. Ansaphone Telephone 994 4470.
Access telephone orders gladly accepted

A M Electronics
10 Barley Mow Passage
Chiswick
London W4 4PH

MicroPlan from Bonsai.

The first easy-to-use electronic worksheet that's a true financial planning system.

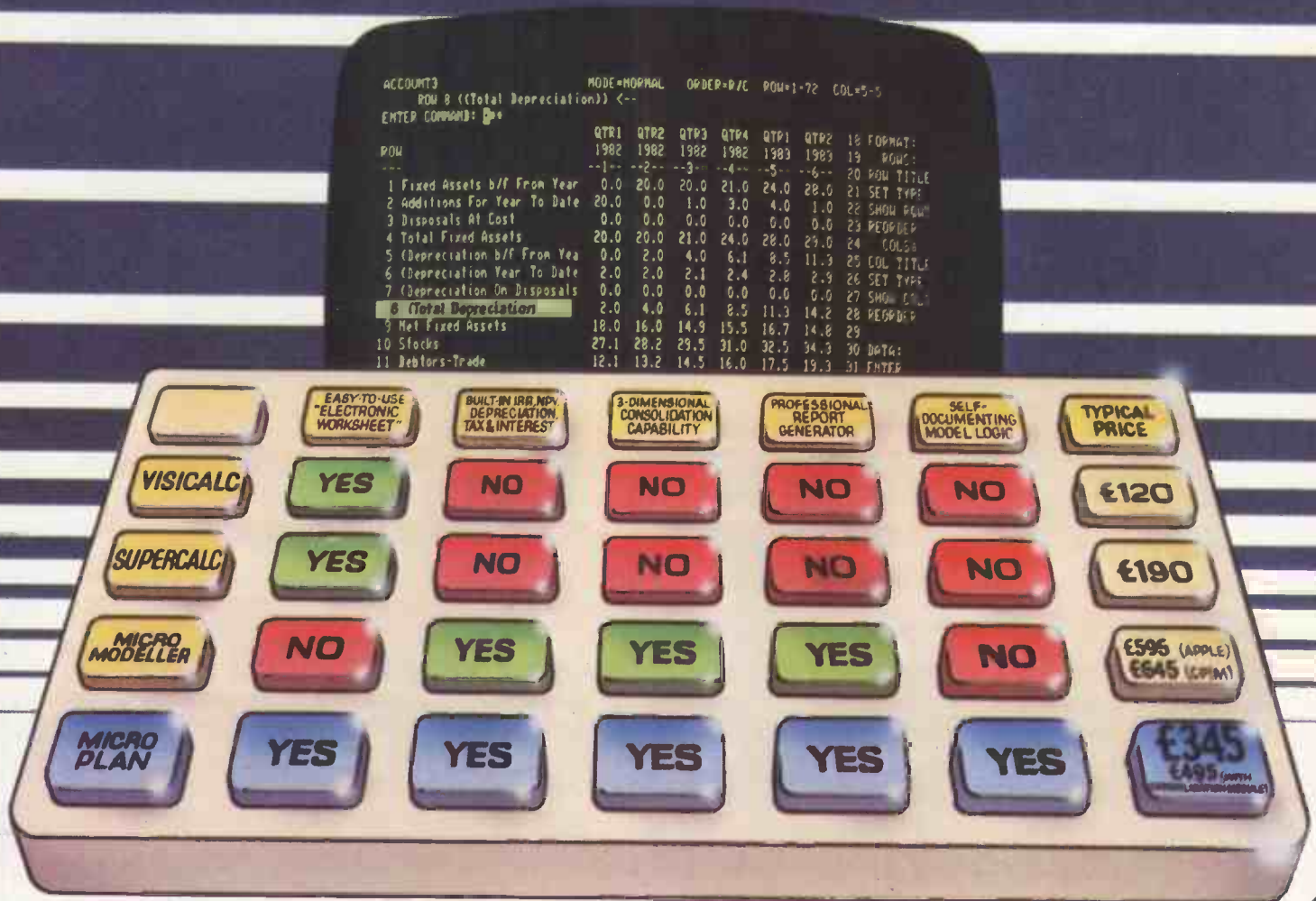

MicroPlan is the most highly developed yet simple financial planning software because it combines real modelling features with an on-screen spreadsheet format.

MicroPlan has everything you need for advanced analysis yet is incredibly easy-to-learn and easy-to-use. You simply enter values into the worksheet and choose any of the powerful financial functions by selecting a number from a "menu" on the screen.

Only MicroPlan will let you calculate depreciation, analyse variances, amortise mortgages and consolidate multi-departmental budgets without the need to learn jargon.

If you need more power than the "calcs" but don't fancy the daunting prospect of a programming-like system, take a look at MicroPlan. MicroPlan can help solve your problems with push-button ease.

To order your copy of MicroPlan or a demo pack - or receive details of our next seminar and our 4-page brochure - give us a ring or return the coupon.

MicroPlan is compatible with Altos, Bonsai SM3000 & MU9000, Caltext, Cromemco, DEC VT-180 & Rainbow 100, Dynabite, HP-125, IBM Displaywriter & IBM Personal Computer, ICL Personal Computer, LSI M2, M3, M-Text & M4, NEC PC8000 & NEC APC, Rair, Sirius, TeleVideo, Vector Graphic, Wangwriter, Xerox 820 & 860 and most other microcomputers running CP/M or CP/M-86. CP/M-86 version requires CBASIC-86 runtime module.



MICROCOMPUTER SYSTEMS FOR PEOPLE IN BUSINESS

112-116 New Oxford St.
London WC1A 1HJ.
Tel: 01-580 0902.

Please send: (please tick as appropriate) MicroPlan standard system @ £345 (+ P&P+VAT = £400), MicroPlan with consolidation module @ £495 (+ P&P+VAT = £570), MicroPlan demo pack @ £37.50 (+ P&P+VAT = £45). 4-page MicroPlan brochure. Details of next MicroPlan seminar.

My Microcomputer is a _____
Please Debit my Access/Visa Account No. _____
Name _____
Company _____
Address _____
Telephone: _____
Signature _____
Position _____
Dealer Enquiries Invited.

You'll be glad you chose a personal computer with power enough to grow with your needs.



The ICL Personal Computer with power to grow as you need it.

Choosing the wrong personal computer can work out very costly, because though they grow to meet your needs, they just don't grow enough.

The new ICL Personal Computer gives you more.

It's a versatile, professional personal computer. It can start with a single Visual Display Unit, naturally, and it has a wide range of functions to meet your increasing requirements. And it can grow larger than most other personal computer systems, because its capacity for additional hardware is greater.

Starting at £2,895 with one VDU

The ICL Personal Computer provides a range of options enabling you to

have a system tailored to meet your changing needs.

For example, by adding a fixed-disc, you can have eight times the original storage capacity, and support up to 4 VDUs. And there is an extensive range of Personal Computer hardware.

Wide range of integrated accounts and other application software available, providing limitless possibilities.

So your secretary can do her word processing, you can do your forecasts, your accountant can do the invoicing, and your programmer can do his own thing, all at the same time.

That's what makes the ICL Personal Computer more than just a personal computer.

And because ICL is Europe's leading computer company, with thousands of satisfied users in over 80 countries worldwide, **we can offer ICL Trader Point service and maintenance back-up that's second to none.**

What more could you ask for, apart from a demonstration?



Johnson microcomputers

Johnson House · 75-79 Park Street · Camberley · Surrey
Telephone 0276 20446

Robophone Answering 24 hrs. Prestel page No. *200632
Mailbox No. 027620448

48 Gloucester Road · Bristol · Telephone 0272 422061
113 Stratford Road · Shirley · Birmingham B90 3AY
Telephone (021) 745 3246

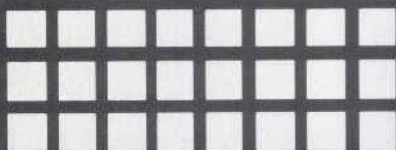

Cambridge Computer Store

Two Great Micros — from Cambridge!

**BBC
Computer**



**IN
STOCK
NOW!**

**Sinclair
ZX81**

Cambridge Computer Store

1 Emmanuel Street, Cambridge CB1 1NE
Phone (0223) 358264/65334

Also in our 'Budget Micros' Dept: Commodore VIC-20

COMPUTER SCRABBLE®

for Apple II 48K with Disk Drive
As exhibited at the Personal Computer World
Show
in September 1982

FIRST TIME IN THIS COUNTRY
Approved by J W Spear and Sons PLC as the
genuine game
Tested by top Scrabble players

EASY TO USE
Board permanently on screen — in colour or
black & white
Dictionary of 8,500 words

FOUR LEVELS OF PLAY
FOUR, THREE, TWO OR ONE CAN PLAY
Level One for beginners and children from about
12 years

Level Four for above average players
R.R.P. £24.95 (incl VAT)

ENQUIRIES, ORDERS
To Turcan Research Systems Ltd
39 Rowallan Gardens, Glasgow, G11 7LH,
Scotland
Telephone: 041-339 9409

SCRABBLE is the Registered Trade Mark of J W Spear & Sons PLC

WRITTEN AND DEvised BY PETER TURCAN.
COPYRIGHT TURCAN RESEARCH SYSTEMS LTD.
PRODUCED BY LITTLE GENIUS LTD.

**SIRIUS-
ADVANTAGE-
COMMUNICATOR-HP-
APPLE-OSBORNE-TRS 80**



Cambridge Computer Store

1 Emmanuel Street
Cambridge CB1 1NE
Telephone (0223) 65334/5
(we close at lunchtime except Saturday)

Our range and stock of micros is backed by an extensive selection of peripherals and media. We also have a 'budget micro' department offering the BBC computer, ZX81, ACORN ATOM and VIC 20 - a unique range of low cost systems.

NASCOM MEANS PERFORMANCE

NASCOM MEANS SOLUTIONS

NASCOM have come a long way since their acquisition by Lucas. With the knowledge of over 30,000 units already in the field you can buy with confidence from NASCOM.

PRODUCTS:

We have kits, built and tested boards, and our fully assembled and tested NASCOM 3 system with a full choice of configuration either cassette or disc based. Alternative operating systems include NAS DOS and CP/M.

Nascom introduce a newsletter. Send SAE for registration form.

NEW SOFTWARE

Nas Dos
 Nas Cal (Financial Modeller) £70.00
 Manor (Data Base Manager) £50.00
 Corplan (Business Modeller) £59.95

CP/M

Calcstar (Financial Modeller) £150.00
 Wordstar (Word Processor) £250.00
 FMS 81 (Data Base Manager) £325.00
 FMS 82 (Enhancement to FMS 81) £325.00
 Finas (Six module fully integrated accounts program suite) £1249.00

NEW HARDWARE

AVC (Hi Res colour graphics) £185.00
 AVC (80 col x 24 lines - CP/M) £185.00
 Single disc (Complete 0.75 Mb system) £599.00
 Dual disc (Complete 1.5 Mb system) £949.00
 Nas Case £64.95
 Card Frame (For use with Nas Case) £49.50
 Printer 1 (GP100A) £215.00

NEW FIRMWARE

Pascal (Compiler included) £75.00
 Poly Sys 4 £35.00

All prices are shown exclusive of P&P and VAT and are subject to change without notice.



£1,493 + VAT
 A typical system as shown, consisting of a Nascom 3 (48K), dual discs, monitor, and printer is available from your dealer now.

To Lucas Logic Ltd, Nascom Microcomputing Division, Welton Road, Wedgcock Industrial Estate, Warwick CV34 5PZ, England.

Please send: Dealership Details
 Literature Full Dealer List Prog. Book Form

Name

Position

Establishment

Address

Tel:

Lucas Logic

PCW 7

authorized stockists



semicomps
NORTHERN LIMITED

Semicomps Northern Ltd.
East Bowmont Street,
Kelso, Roxburghshire. Tel: (0573) 24366



**In the heart of the Nascom country
lies Business & Leisure**

We specialise in tailoring systems to your specific requirements.

16 The Square, Kenilworth, CV8 1EB.
Tel: Kenilworth (0926) 512127

Eley Electronics

Eley Electronics, 100/104 Beatrice Road,
(off Fosse Road North), Leicester. Tel: 0533 871522.

Llandaff Radio & Television

24/26 High Street, Llandaff, CARDIFF
Telephone: 0222 563760
Contact: G. Marshall

MID-SHIRE'S COMPUTER CENTRE

68 Nantwich Road, Crewe, Cheshire.
Tel: (0270) 211086



Stationstraat,
6241 CL,
Bunde (L),
Netherlands.
Tel: 043 641147

MICROCOMPUTER SYSTEMS FOR
HOME BUSINESS & SPECIAL APPLICATIONS
18 Station Road, Lower Parkstone,
Poole, Dorset BH14 8UB.
Tel: Parkstone (0202) 746555



**PARKSTONE
ELECTRICS**

CHRISALID for **nascom**
systems & software *tel 74569*

13 High Street BERKHAMSTED

MicroComms

Amateur radio C.B. radio
Electronics Computers

372-374 George Street, Aberdeen.
Telephone: 0224 633385

MICRO-PRINT LTD

59 Church Street, Stoke-on-Trent, ST4 1DQ.
Tel: (0782) 48348

JPS

9 East Street, Colne,
Nr. Huntingdon, Cambs.
Tel: Ramsey (0487) 840710
Contact Paul Jephcott

Newburn Electronics

Ballycarry Co. Antrim.
Whitehead 78330



SRS MICROSYSTEMS

94 The Parade, Watford, Herts.
Tel: 0923 26602

**Crystal Computers
& Components Ltd.**

209 Union Street, TORQUAY TQ1 4AF
Telephone: 0803 22699 Contact: D. Skinner

58 Battersea Rise,
Clapham Junction,
London SW11 1HH
Tel: 01-223 7730

**OFF
Records**



**The Computer Centre,
Watford, Limited**

150 High Street, Watford, Herts.
Tel: 0923 50123/40601

SKYTRONICS LTD.

357 DERBY ROAD, NOTTINGHAM NG7 2DZ
TELEPHONE: 0602 781742 — Contact: Vernon Skitt
80 BRISTOL STREET, BIRMINGHAM 5
TELEPHONE: 021-622 6436 — Contact: Roger Watson

Electrovalue Ltd.

28 St. Judes Road, Englefield Green
Egham, SURREY TW20 0HB
Telephone: 0784 33603 Contact: D.A. Longland

DYAD Developments

SPECIALISTS IN COLOUR GRAPHIC SYSTEMS
The Priory, Great Milton, Oxford OX9 7PB.
Telephone: Great Milton (08446) 729

E.V. Computing Ltd.

700 Burnage Lane, Burnage, MANCHESTER M19 1NA
Telephone: 061-431 4866
Contact: Bob Hyde

Dealer Enquiries Welcome

PLUTO

INTELLIGENT COLOUR GRAPHICS

Pluto provides YOUR machine with a high quality Colour Graphics Display.

Meet the Family:-

BABY PLUTO... 320(H) x 288(V) x 8 Colour. 96K bytes of memory to provide two full screen buffers.

PLUTO..... 640(H) x 288(V) x 8 Colour. 192K bytes of memory to provide two full screen buffers.

Double resolution option. 640(H) x 576(V) x 8 Colour. Software selectable between 288(V) & 576(V).

Start with Baby and then Upgrade!

Pluto uses the latest technology to provide unprecedented performance and reliability on a single PCB.

Pluto may be readily connected to most Computer Systems or plugged straight into an 80-BUS or NASBUS.

Look at what Pluto offers:-

- 16 bit Intel 8088 microprocessor.
- 192K bytes of dual-ported display memory for fast flicker-free screen updates. (*Outside the host address space*).
- Fast parallel I/O interface usable with ALMOST ANY COMPUTER.
- Operates from a single +5v supply. .

Here are just some of the high level functions that Pluto provides:-

- Fast vector draw – over 100,000 pixels/sec. Lines can be drawn using REPLACE, XOR, AND, OR functions.
- Built-in character set providing an 80 x 28 character display.
- User definable characters or symbols.
- Spare display memory with memory management facilities for allocating symbol storage space or workspace.
- Rectangle Fill and Copy using nine logic functions.
- Fast access to single pixels.
- Write protected memory planes during copy.
- Double buffered screen memory for animated displays.
- Complex polygon colour fill.

Pluto is also available as a boxed unit with integral power supply with cables and connectors and custom interface card for a range of machines:-

PET, APPLE, SIRIUS, NASCOM, GEMINI, RAIR, RML, S100 etc.

Our range of interfaces is being continuously expanded, please ask us for details of others including RS 232.

Pluto is expandable. Available very soon is an expansion board enabling **Pluto** to display 256 colours simultaneously from a very large palette for producing high quality shaded images.

Pluto prices:-

BABY PLUTO £299.00 plus VAT

PLUTO £399.00 plus VAT

BOXED PLUTO AND INTERFACE £599.00 plus VAT

DOUBLE RESOLUTION OPTION £50.00 plus VAT

8MHz PROCESSOR OPTION (40% speed improvement) £50.00 plus VAT

(Carriage £6.00 on boxed **Pluto**)

Dealer and OEM enquiries invited.



iO research Ltd.

6 Laleham Avenue · Mill Hill · London NW7 3HL
Telephone: 01-959 0106

WHEN IT COMES TO MICROCOMPUTER SOFTWARE WE WROTE THE BOOK

How do you stay up-to-the-minute with the rapidly changing world of microcomputer software? Get the Lifeboat Catalogue.

The latest innovations The new Lifeboat Catalogue is packed with the latest state-of-the-art software. And if we publish a new program after the latest catalogue has gone to press, we enclose a flash bulletin in your copy.

The greatest selection

Because Lifeboat is the world's largest publisher of microcomputer software, our catalogue offers you the greatest selection of programs for business, professional and personal use. Our more than 200 programs range from the integrated accounting and professional practice systems to office tools for book-keepers and secretaries to sophisticated tools for programmers. Included are business systems, word processors, programming languages, database management systems, application tools and advanced system utilities.

We specialise in software that runs on most small business computers. Our more than 60 media formats, including floppy disks, data cartridges, magnetic tape and disk cartridges, support well over 100 different types of computer.

Get full service We give the crucial dimension of after-sales service and full support to everything we sell.

That includes:

- An update service for software and documentation.
- Telephone, telex and mail-order services in the London office and at overseas offices in the United States, France, Switzerland, West Germany and Japan.
- Subscriptions to Lifelines™, the monthly magazine that offers comparative reviews, tips, techniques, identified bugs and updates that keep you abreast of change.

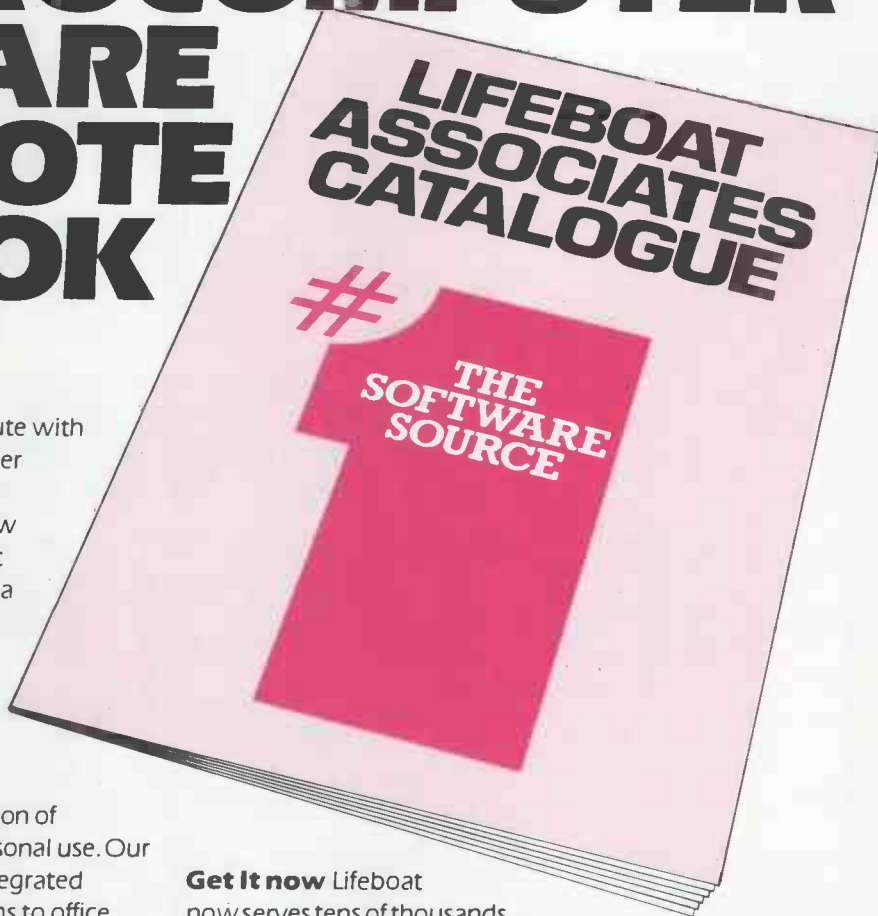

Get It now Lifeboat now serves tens of thousands of satisfied customers with our breadth of up-to-date, fully tested, fully supported and competitively priced software.

You may not need all we offer, but we offer just what you need. After all, we wrote the book.

Lifeboat Associates

World's foremost software source

Mail coupon to: Lifeboat Associates

PO Box 125, London WC2H 9LU or call 01-836 9028

Please send me a free lifeboat catalogue.

Name

Title

Company

Address

Postcode

PCW/12/82

Copyright © 1981, by Lifeboat Associates.

Lifeboat Worldwide offers you the world's largest library of software. Contact your nearest dealer of Lifeboat.

USA Lifeboat Associates 1651 Third Ave. New York NY 10028 Tel (212) 860-0300 Telex 640693 [LBSOFT NYK] TWX 710 581-2524 **JAPAN** Lifeboat Inc. OK Bldg. 5F 1-2-8 Shiba-Daimon Minato-ku Tokyo 105 Japan Tel 03-437-3901 Telex 2423296 [LBJTYO] **ENGLAND** Lifeboat Associates Ltd PO Box 125 London WC2H 9LU England Tel 01-836 9028 Telex 893709 [LBSOFTG] **SWITZERLAND** Lifeboat Associates GmbH Hinterbergstrasse Postfach 251 6330 Cham Switzerland Tel 042-36-8686 Telex 865265 [MICO CH] **WEST GERMANY** Intersoft GmbH Schlossgartenweg 5 D-8045 Ismaning W. Germany Tel 089-966-444 Telex 5213643 [ISOFD] **FRANCE** Lifeboat Associates SARL 10 Grande Rue Charles de Gaulle 92600 Asnieres France Tel 1-733-08-04 Telex 250303 [PUBLIC X PARIS]

Don't let its size fool you.

If anything NewBrain is like the Tardis.

It may look small on the outside, but inside there's an awful lot going on.

It's got the kind of features you'd expect from one of the really big business micros, but at a price of £269.95 including VAT it won't give you any sleepless nights.

However, let the facts speak for themselves.

You get what you don't pay for.

NewBrain comes with 24K ROM and 32K RAM, most competitors expect you to make do with 16K RAM.

What's more you can expand all the way up to 2 Mbytes, a figure that wouldn't look out of place on a machine costing ten times as much.

We've also given you the choice of 256, 320, 512 and 640 x 250 screen resolution, whereas most only offer a maximum of 256 x 192.

Big enough for your business.

Although NewBrain is as easy as ABC to use (and child's-play to learn to use) this doesn't mean it's a toy.

Far from it.

It comes with ENHANCED ANSI BASIC, which should give you plenty to get your teeth into.

And it'll also take CP/M® so it speaks the same language as all the big business micros, and feels perfectly at home with their software.

NO OTHER MICRO HAS THIS MUCH POWER IN THIS MUCH SIZE FOR THIS MUCH MONEY.



So as a business machine it really comes into its own.

The video allows 40 or 80 characters per line with 25 or 30 lines per page, giving a very professional 2000 or 2400 characters display in all on TV and/or monitor. And the keyboard is full-sized so even if you're all fingers and thumbs you'll still be able to get to grips with NewBrain's excellent editing capabilities.

When it comes to business graphics, things couldn't be easier. With software capabilities that can handle graphs, charts and computer drawings you'll soon be up to things that used to be strictly for the big league.

Answers a growing need.

Although NewBrain, with its optional onboard display, is a truly portable micro, that doesn't stop it becoming the basis of a very powerful system.

The Store Expansion Modules come in packages containing 64K, 128K, 256K or 512K of RAM. So, hook up four of the 512K modules to your machine and you've got 2 Mbytes to play with. Another feature that'll come as a surprise are the two onboard V24 interfaces.

With the aid of the multiple V24 module this allows you to run up to 32 machines at once, all on the same peripherals, saving you a fortune on extras.

The range of peripherals on offer include dot matrix and daisy wheel printers, 9" 12" and 24" monitors plus 5 1/4" floppy disk drives (100 Kbytes and 1 Mbyte) and 5 1/4" Winchester drive (6-18 Mbytes).

As we said, this isn't a toy.

It doesn't stop here.

Here are a couple of extras that deserve a special mention.

The first, the Battery Module, means you won't be tied to a 13 amp socket. And, even more importantly, it means you don't have to worry about mains fluctuations wreaking havoc with your programs.

The ROM buffer module gives you a freedom of another sort.

Freedom to expand in a big way. It gives you additional ROM slots, for system software upgrades such as the Z80 Assembler and COMAL, 2 additional V24 ports, analogue ports and parallel ports.

From now on the sky's the limit.

Software that's hard to beat.

A lot of features you'd expect to find on software are actually built into NewBrain so you don't need to worry about screen editing, maths, BASIC and graphics.

However, if you're feeling practical you can always tackle household management, statistics and educational packages. And because NewBrain isn't all work and no play, there's the usual range of mind-bending games to while away spare time.

Waste no more time.

To get hold of NewBrain you need go no further than the coupon at the bottom of the page.

With your order we'll include a hefty instruction manual so you'll know where to start, and a list of peripherals, expansion modules, and software so you'll know where to go next.

© CP/M is the registered trade mark of Digital Research Inc.



Technical Specifications

The NewBrain is a fully specified professional computer built to the highest standards of engineering and reliability. Chosen by leading OEM suppliers. Designed to facilitate easy expansion for use with the CP/M operating system, and the addition of 5 1/4" flexible and Winchester disks, 12 green phosphor professional standard monitor, 80 cps professional quality dot matrix printer with pin addressable graphics.

Z80A cpu and COP 420M input/output microprocessors. 32K RAM expandable to 2 Mbytes. 29K ROM. Dual Cassette Ports. UHF TV port. CCITT Monitor Port Video 40/80 Character x 25/30 lines. 256, 320, 512, 640 x 250 Pixels. Expansion Port. V24 Bi-directional Port. V24 Printer Port. 16-character display (AD only).

Software: Enhanced BASIC (ANSI x 3.2/78) Independent Operating System (12 device drivers). Multi Page Screen Editor (32 Control Commands). Maths (10 Significant Figures). Graphics (Absolute & Relative Plotting, Line & Arc Drawing, Shading, 20 English Language Commands).

NewBrain, Grundy Business Systems Ltd., Grundy House, Somerset Road, Teddington TW11 8TD.

To: NewBrain, Grundy Business Systems Limited, Grundy House, Somerset Road, Teddington TW11 8TD.

Please send me a full-colour leaflet, price list, and name and address of my nearest stockist.

Name _____

Address _____

Postcode _____

Test-drive your software!

Microplanner.....	Rental £99
	RRP £695
Supercalc for IBM.....	Rental £35
	RRP £178
VisiSchedule.....	Rental £38
	RRP £190

Micromodeller.....	Rental £99
	RRP £595
dBase II.....	Rental £79
	RRP £395
microFinesse.....	Rental £70
	RRP £350

£29 Rental		Retail
Supercalc		£175
Omnis		£174
Visifile		£161
Zardax		£160
Wordstar		£145
Datastar		£140
Easywriter (PRO)		£140
DBMaster		£135

£19 Rental		Retail
Calcstar		£120
Visicalc		£113
Visiplot		£111
Word Plus (Speller)		£110
Z-Term (PRO)		£105
Apple-IBM connection		£105
ASCII Express II (PRO)		£100
Complete Graphics Pack		£100

Our unrivalled list of business and technical software also includes accounting systems and expansion cards.

and if you decide to buy- the rental is free

The Software Rental Bank gives you the opportunity to evaluate software on your own machine, with your own data, before committing yourself to a purchase.

The Software Rental Bank offers a unique range of services.

- ★ Short-term rental of software packages and firmware products for 7, 14 or 28 days depending on your class of membership.
- ★ Free rental if you decide to purchase.
- ★ A really wide range of software and advice to help you make the right choice.
- ★ Access to the newest software available — a chance to simply 'taste' some of the latest and most controversial products.
- ★ Speedy service. Rent software by telephone or by mail — all the items on our *Software Asset Listing* are held in stock.
- ★ An advisory 'hot line' in case you have difficulty with a rented package.

The Bank is currently supporting the Apple II, Apple III and IBM-PC — other CP/M machines will be added to the Bank shortly.

Membership of the Bank

- ★ Full Membership costs £70 a year and allows you to rent up to £700 worth of software at any one time for 14 days.
- ★ Members periodically receive our *Software Asset Listing* which gives details of the packages available for rental. Members are encouraged to nominate new items for addition to our stock.
- ★ Larger organisations which may have microcomputers at a number of different locations can opt to join as Corporate Members.

To receive our brochure and software list phone Ruth Oliver on 0525-373440 or clip the coupon below.



I would like to receive the Software Rental Bank brochure.

Name _____

Organisation _____

Address _____

Telephone _____ Machine _____

Send to: The Software Rental Bank Ltd., **PCW Nov. 82**
58 North Street, Leighton Buzzard, Beds LU7 7EN.

100 FREE PROGRAMS

FROM SILICA SHOP — WITH EVERY PURCHASE OF AN

ATARI 400

800



ATARI PRICES REDUCED!

We at Silica Shop are pleased to announce some fantastic reductions in the prices of the Atari 400/800 personal computers. We believe that the Atari at its new price will become the U.K.'s most popular personal computer and have therefore set up the Silica Atari Users Club. This club already has a library of over 500 programs and with your purchase of a 400 or 800 computer we will give you the first 100 free of charge. There are also over 350 professionally written games and utility programs, some are listed below. Complete the reply coupon and we'll send you full details. Alternatively give us a ring on 01-301 1111 or 01-309 1111.

ATARI 400 with 16K **£199**

ATARI 400 with 32K **£248**

ATARI 800 with 16K **£449**

400/800 SOFTWARE & PERIPHERALS

Don't buy a T.V. game! Buy an Atari 400 personal computer and a game cartridge and that's all you'll need. Later on you can buy the Basic Programming cartridge (£35) and try your hand at programming using the easy to learn BASIC language. Or if you are interested in business applications, you can buy the Atari 800 + Disk Drive + Printer together with a selection of business packages.

Silica Shop have put together a full catalogue and price list giving details of all the peripherals as well as the extensive range of software that is now available for the Atari 400/800. The Atari is now one of the best supported personal computers. Send NOW for Silica Shop's catalogue and price list as well as details on our users club.

THE FOLLOWING IS JUST A SMALL SELECTION FROM THE RANGE OF ITEMS AVAILABLE:

ACCESSORIES Cables Cassettes Diskettes Joysticks Joystick La Stick - Joystick Misc Supplies Paddles	Mountain Shoot Rearguard Star Flite Sunday Golf	AUTOMATED SIMULATIONS Crush Crumble Cmp Datesions of Ryn Dragons Eye Invasion Orion Rescue at Rigel Ricochet Star Warrior Temple of Apsai Upper Reaches Aps	BOOKS Basic Ref Manual Compute Atari DOS Compute Bk Atari Compute Magazine Die Re Atari DOS Utilities List DOS2 Manual Misc Atari Books Op System Listing Wiley Manual	Mountain Shoot Rearguard Star Flite Sunday Golf	BUSINESS Calculator Database Managemt Decision Maker Graph-It Invoicing Librarian Mort & Loan Anal Nominal Ledger Payroll Personal Finl Mgmt Purchase Ledger Sales Ledger Statistics 1 Stock Control Teletink 1 VisiCalc Weekly Planner Word Processor	CRYSTALWARE Beneath The Pyram Fantasyland 2041 Galactic Quest House Of Usher Sands Of Mars Waterloo World War III	DYNACOMP Alpha Fighter Chompelo Crystals Forest Fire Intruder Alert Monarch Moonprobe Moving Maze Nominoes Jigsaw Rings of The Emp Space Tilt Space Trap Stud Poker Triple Blockade	EDUCATION from APX Algalcalc Atlas of Canada Cubbyholes Elementary Biology Frogmaster Hickory Dickory Inst Cogpnt Dem Lemonade Letterman Mapware	Maths-Tac-Toe Metric & Prob Solv Mugwump Music Terms/Notatn Musical Computer My First Alphabet Number Blast Polycalc Presidents Of U.S. Quiz Master Starware Stereo 3D Graphics Three R Math Sys Video Math Flash Wordmaker	EDUCATION from ATARI Conv French Conv German Conv Italian Conv Spanish Energy Czar European C & Caps Hangman Invit To Prog 1/2/3 Kingdom Music Composer	Seram States & Capitals Touch Typing	EMI SOFTWARE British Heritage Cribbage/Dominoes Darts European Scene Jig Hickory Dickory Humpty Dumpty Jumbo Jet Lander Snooker & Billiards Submarine Commr Super Cubes & Tilt Tournament Pool	ENTERTAINMENT from APX Alien Egg Anthill Attack Avalanche Babel Blackjack Casino Block Buster Block 'Em Bumper Pool	Castle Centurion Checker King Chinese Puzzle Codecracker Comedy Diskette Dice Poker Dog Daze Dogs Domination Downhill Eastern Front Galahad & Holy Grl Graphics/Sound Jax-O Jukebox Look Ahead Memory Match Midas Touch Minotaur Outlaw/Howitz Preschool Games Pro Bowling Pushover Rabbotz Reversi II Salmon Run 747 Landing Simul Seven Card Stud	Sleazy Adventure Solitaire Space Chase Space Trek Sultans Palace Tact Trek Terry Wizards Gold Wizards Revenge	ENTERTAINMENT from ATARI Asteroids Basketball Blackjack Centipede Chess Entertainment Kit Missile Command Pac Man Space Invaders Star Raiders Super Breakout Video Easel	ON LINE SYSTEMS CrossFire Frogger	Jawbreaker Mission Asterold Mouskattack Threshold Ulysses/Golden Fl Wizard & Princess	PERIPHERALS Centronics Printers Disk Drive Epson Printers Program Recorder RS232 Interface Thermal Printer 16K Memory RAM 32K Memory RAM	PERSONAL INT from APX Adv Music System Banner Generator Blackjack Tutor Going To The Dogs Keyboard Organ Morse Code Tutor Personal Fitness Prg Player Piano Sketchpad	PROGRAMMING AIDS from Atari Assembler Editor Assembler (APX) Microsoft Basic Pascal (APX) Pilot (Consumer) Pilot (Educator) Programming Kit	SANTA CRUZ Basics of Animation Bots Business Display Lists Graphics Machine Kids 1 & 2 Horizontal Scrolling Master Memory Map Mini Word Processor Page Flipping Player Missile Gr Player Piano Sounds Vertical Scrolling	SILICA CLUB Over 500 programs write for details
--	--	---	---	---	---	---	--	--	---	---	--	--	--	---	---	--	--	--	---	--	---	--	--

FOR FREE BROCHURES - TEL: 01-301 1111

For free brochures and reviews on our range of electronic products, please telephone 01 301 1111. To order by telephone, just quote your name, address, credit card number, and order requirements and leave the rest to us. Post and packing is FREE OF CHARGE in the UK. Express 24 hour delivery available at an additional charge.

- SHOP DEMONSTRATION FACILITIES — we provide full facilities at our shop in Sidcup. Monday to Saturday 9am to 5.30pm (closing Thursday 1pm, Friday 4pm).
- MAIL ORDER — we are a specialist mail order company and are able to supply goods direct to your door.
- MONEY BACK UNDERTAKING — if you are totally unsatisfied with your purchase, you may return it to us within 15 days. On receipt of the goods in satisfactory condition we will give you a full refund.
- PART EXCHANGE SECOND HAND MACHINES — we offer a part exchange scheme to trade in many makes of T.V. game for personal computers.
- COMPETITIVE PRICES — our prices, offers and service are very competitive. We are never knowingly under-sold, and will normally match any lower price quoted by our competitors.
- HELPFUL ADVICE — available on the suitability of various computers.
- AFTER SALES SERVICE — available on all computers out of guarantee.
- VAT — all prices quoted above include VAT at 15%.
- CREDIT FACILITIES — we offer credit over 12, 24 or 36 months, please ask for details.

SILICA SHOP LIMITED
Dept PCW 1282, 1-4 The Mews, Hatherley Road, Sidcup, Kent DA14 4DX.
Telephone 01-301 1111 or 01-309 1111.

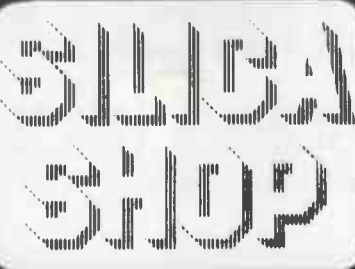

FREE LITERATURE
I am interested in purchasing an Atari 400/800 computer and would like to receive copies of your brochures and test reports as well as your price list covering all of the available Hardware and Software:

Name

Address

Postcode

PCW 1282

INNOVATIVE TRS 80-GENIE SOFTWARE

from the professionals

Penetrator is a superb arcade type space game with excellent graphics, challenging situations, training options — and much more! You will have to cope with radar attack, missiles, enemy paratroopers and other dangers.

You are in a single fighter plane as the sole survivor of a space fighter squadron, whose mission it is to invade enemy defences and to destroy their neutron bomb cache. The mission is highly dangerous and the enemy has installed extremely efficient defences around their neutron bomb stores. These are made up of four defence rings, each with its own special dangers. To get to the neutron bomb store you must penetrate all four. As you knock out defences you are awarded points; 10 for ground missiles, 100 for radar bases, 200 for defending paratroopers and 1000 for the first neutron bomb store. The game supports two players if required.

The game may be customised; a terrain editor is included in the package and in this way, the landscape, number and positions of the missiles and radar bases can be changed by the user. Excellent graphics and, of course, sound. Compatible with all Genies and the Model I and Model III TRS-80.

A fast moving arcade type space game. Full of action and plenty of surprises!

In some ways this is a similar game to Penetrator. We think it is slightly better, but tastes vary. The chief difference is that a "preview" of approaching enemy forces is shown at the top of the screen, rather in the same way as our Defend game. The aim of the game is to penetrate defences to obtain access to a neutron bomb. In order to do this you have to collect some incendiary star shells. This is done by way of a rather tricky manoeuvre, whereby one has to manoeuvre one's ship to sit on the star shell, rather like a hen hatching an egg. When the position is just right the star shell attaches itself to your ship.

To play Strike Force you will need skill, cunning, fast responses and a keen sense of strategy. Most people find it more taxing than Penetrator and the "preview" of advancing forces is certainly one of the key features of the game. It does, of course, have sound. Both Strike Force and Penetrator are published by Melbourne House, an Australian Company. Strike Force is compatible with all Genies and the Model I and Model III TRS-80.

PENETRATOR (Tape) £ 9.95
PENETRATOR (Disk) £12.95

STRIKE FORCE (Tape) £ 9.95
STRIKE FORCE (Disk) £12.95

V.A.T. included. Plus 75p P & P (either or both)

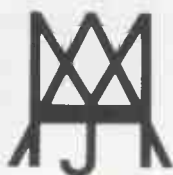

MOLIMERX LTD

A J HARDING (MOLIMERX)

1 BUCKHURST ROAD, TOWN HALL SQUARE, BEXHILL-ON-SEA, EAST SUSSEX.

TEL: [0424] 220391/223636

TELEX 86736 SOTEX G

TRS-80 & VIDEO GENIE SOFTWARE CATALOGUE £1.00 [refundable] plus £1 postage.



INNOVATIVE TRS 80-GENIE SOFTWARE

from the professionals

DATA-WRITER

Data-Writer is, for most microcomputers, a new concept in Database Management. It adapts techniques which have been known and used on mainframe computers for quite a long time. A "normal" microcomputer Database Management program constructs its file in a single plane and is probably more accurately described as a file handling system. All of the data written into each record is filed away on disk in the same place, and it is all recalled and acted upon by the computer as one chunk of data.

Data-Writer approaches Database Management in an entirely different manner in that, subject to one or two requirements, it is not concerned as to how the database came about or the form of it. Indeed, one of the most attractive features of the program is that the data itself can even be written on a word processor — not by Data-Writer at all. So far as we have been able to ascertain, any word processor may be used that writes a plain ASCII file. Certainly AJEDIT and Scripsit are supported. If you do not have a word processor, or do not wish to use it for the manufacture of your database, then there are sections in Data-Writer which in themselves constitute mini word processors and enable the user to manufacture a database very easily.

In the foregoing paragraph we use the words "word processors" in the plural, and this gives a clue to a rather important feature of Data-Writer. The whole concept of the software is that it is a Management program. A number of earlier databases have suffered very seriously from what the author no doubt thought was economic writing, in that if a section of a program (for instance the word processing section) is used by a number of sections, only one is included and is accessed by various sections. At first sight this might indeed appear to be economic writing and we suppose in fact it is, but the result is that the disks are continually thrashing around as access is made to them. Disk access is probably the slowest task that the CPU carries out and if it is done frequently it slows the program down very considerably. Many past Database Management programs have suffered from this deficiency. Data-Writer on the other hand has a mini word processor in each section of the program where it is needed. This has the great advantage of obviating the necessity for the drives to be thrashing around, but almost as importantly means that the format of the mini word processor can be changed for the various sections of the program, so that the best advantage can be made of it in each. Thus every section is entirely separate and gives a very high degree of efficiency and user friendliness.

There are very few restrictions with Data-Writer. The number of records which one can handle in any given database is, essentially, unrestricted although any that span disks would have to have different names. In any event as the Sort section of the program does have a restriction of sorting 4,500 records at a time, this effectively imposes a restriction on the length of the file if one intends to be able to sort it all at one time. The maximum number of fields permitted to a record is 20 and the maximum number of characters per field depends on whether you use the Entry section of Data-Writer to enter your data or whether you use a word processor. In the latter case the maximum number of characters per field is 240. In the former it is 35. The maximum number of characters per field label or title is 20.

Data-Writer has a very powerful mathematical section whereby many complex mathematical functions can be carried out on your data. Up to 20 equations may be defined per run. The section will have available 10 scratch pad memories for use and as the calculations are carried out in double precision they will be carried to 16 decimal places.

Data-Writer also contains a very powerful "Mail Merge" section. Almost any personalisation can be added to a letter or report, and once again the letter or report may be constructed either on the mini word processor provided in Data-Writer or by way of an external one. Indeed we should make it clear that this remark applies to all data manipulation in Data-Writer. In other words, a word processor may be used at any time when its functions would be helpful in Data-Writer. To return to the Mail Merge feature, Data-Writer supports up to 20 different insertions per letter or report and the form letter may be of any length up to 6,000 characters, which we believe is about two and a half A4 sheets.

The Sort is a two level one and supports the extraction of stipulated data from a field. It is what might be called of fair speed. The two key levels make it powerful but as the Select section is so good, the Sort does not get used as often as would be the case in other Databases.

Data-Writer is made up of 10 sections or sub-programs as follows:

Entry	Manage	Maths	Sort	Letters
Edit	Statistics	Select	Labels	Reports

We have already mentioned many of them, others such as Edit are self-explanatory. The Labels section enables you to create pretty well any form of label required, including the ability to have them printed up in a from one to four across format. The Letters section enables you to create a form letter in Data-Writer if you do not wish to use an external word processor. Statistics is a method for searching the database for errors, and as the title suggests, extracting essential statistics from it.

The important sections not yet touched upon are Manage and Select. Taking the latter first, this section enables you to create a sub-set of the database by selecting from the file contents. It is immensely powerful and supports nine equivalency relationships, such as "less than" or "greater than" etc. Furthermore, the two logical relationships AND and OR may be used freely. In this way one can Select from the database to pretty well any specification required. The Management section of the program enables the user to completely re-structure his database without having to Edit it manually. New fields may be added or old ones deleted. They may be re-arranged or even appended one field to another. Indeed, this can be taken even further in that the whole database may be merged or split as required.

The Reports section enables the user to write reports such as inventories, accounts, bibliographies, insurance coverage report, in fact an endless list of applications. Because the Report section contains its own Text Editor, the report contents and format can be controlled at will and literally an infinite number of formats may be adapted.

Data-Writer is one of the most powerful Database Management systems that we have seen available for a microcomputer and certainly is the most powerful that we have seen for the TRS-80 and Video Genie machines. Once the database has been manufactured, either by Data-Writer or a word processor, one has complete and utter control over it and the ability to manipulate any part of it; not only the ones mentioned above, but many others which we have not had the space to list. Data-Writer is compatible with the Model I and Model III Tandy machine, the original Video Genie, together with the Genie I and II. A version for the Model III Genie will be available shortly.

Data-Writer is Compiled Basic, hence its DOS compatibility is dependent upon the compatibility of the Microsoft Compiler. Due to Microsoft's disinterest in supporting any other DOS apart from TRSDOS and the non availability of a Tandy Model III Compiler, we recommend customers to use Data-Writer with TRSDOS or LDOS on the Model I and the proprietary DOS supplied on Data-Writer for the Model III. Other DOS's may well be compatible after patching and as we have said the criteria is whether they are compatible with the Microsoft Compiler.

Data-Writer — All Models . . . £78.00 + V.A.T. = £89.70
P & P . . . £1.25



MOLIMERX LTD

A J HARDING (MOLIMERX)



1 BUCKHURST ROAD, TOWN HALL SQUARE, BEXHILL-ON-SEA, EAST SUSSEX.

TEL: [0424] 220391 / 223636

TELEX 86736 SOTEX G

TRS-80 & VIDEO GENIE SOFTWARE CATALOGUE £1.00 [refundable] plus £1 postage.

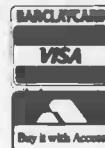

CONVERT YOUR ZX....

FULLER MICRO SYSTEMS ADD STYLE, POWER, VERSATILITY AND FULL TYPEWRITER KEYBOARD OPERATION TO ZX81 AND ZX SPECTRUM!



TURN YOUR ZX81 INTO THIS FOR ONLY...

FULLER FD42 SYSTEM NOW ONLY £29.95

FULLER MEMORY EXPANSION - a massive boost for your ZX81!

The basic ZX81 has only 1K of RAM - now you can add on an enormous 16K with our FD 16K Memory Module. FD 16K to mount on the back of ZX81 or Fuller Case.

£24.95 (plus 80p p & p)

FD 16K to fit inside Fuller Case, complete with RAM

adaptor board. £29.95 (plus 80p p & p)

FD 64K to fit inside case (incl RAM adaptor board) £69.95

FD 64K to mount on back of ZX81 or FULLER CASE £64.95

FULLER SOUND EXPANSION - a superb addition to your ZX Spectrum!

Clear, dynamic sound effects will really enhance your enjoyment of the new, exciting programs available for the sensational ZX Spectrum. Our new sound box comes complete with leads, volume control and loudspeaker. Just plug it into your MIC input, and it fits neatly onto the back of the Spectrum in a tough, plastic case.

JUST £6.95 (plus 80p p & p)

NEW! Programmable Sound Generator - adds exciting new sounds to the Spectrum range.

ONLY £19.95 (plus 80p p & p)

STOP PRESS! 16K Spectrum owners - upgrade to 48K with a Fuller Spectrum Upgrade Pack - complete with full assembly instructions. £34.95 (Inc p & p)

FULLER ZX Spectrum Software

So little software is available for the Spectrum, you could count on Fuller to be one of the first! Startrek, Flight Simulation and Death Star, all in attractively packaged cassette form.

£5.00 (plus 50p p & p)

FULLER FD42 SYSTEM - The ideal Christmas Gift for ZX81 users!

The ZX81 is easily Britain's best selling small computer, and now costs an incredibly low £49.95. To celebrate this event, we are offering our equally popular FD42 system at an even lower price than before! It converts your ZX81 into a sturdy, attractive and professional unit, with full sized typewriter keyboard.

NOW ONLY £29.95
(plus £2.50 p & p)

ITS EVEN CHEAPER IN KIT FORM!

FD42 Keyboard and Case Kit _____ **JUST £24.95**
(plus £2.50 p & p)

FD42 Keyboard Kit _____ **JUST £14.95**
(plus 80p p & p)

OR WHY NOT BUY A COMPLETE SYSTEM!

If you are not lucky enough to already own a ZX81, an FD42 System, including computer, from us, and make an even bigger saving! ZX81, FD42 Keyboard and Case with power supply, reset switch, leads and manual - True Value £79.95.

SPECIAL OFFER £69.95 (plus £2.50 p & p)

FULLER FD SYSTEM for ZX SPECTRUM

COMPLETE £39.95
(plus £2.50 p & p)

Now, the famous FULLER keyboard and case unit has been adapted for Britain's fastest selling colour computer - the amazing ZX Spectrum! It has the same high standard as the ZX81 unit, a tough plastic case encloses the keyboard, Spectrum P.C.B. and power supply. The Keyboard has 42 keys including all the Spectrum graphic characters printed on to them, the full travel key switches have gold plated contacts and guaranteed life of 10⁶ operations.

ITS SO EASY TO INSTALL! You simply unscrew the ZX P.C.B. from its case, screw it to the FD case, and plug in the keyboard. No soldering or technical knowledge required.

COMPLETE UNIT £39.95 (plus £2.50 p & p)

KIT FORM £33.95 (plus £2.50 p & p)

SPECTRUM MOTHERBOARD

Fits inside the Fuller case, allowing expansion to the ZX memory and I/O facilities.

2 SLOTS _____ **£15.95** (plus 80p p & p)

3 SLOTS _____ **£19.95** (plus 80p p & p)

SEPARATE SPECTRUM P.S.U.

9 volts DC at 2 amps.

Mains either 110v or 240v A.C. _____ **£5.95** (plus 80p p & p)

SPECTRUM PLUG PLANNER

A useful combination of 9v @ 2 amp power supply and three 13 amp sockets for computer and peripherals. Complete with 3 metres of cable and power jack

to fit Spectrum or ZX81. _____ **£18.95** (plus £1.00 p & p)

Fuller MICRO SYSTEMS

Mail to: FULLER MICRO SYSTEMS,
The ZX Centre, Sweeting Street, Liverpool 2.
Telephone: 051-236 6109

Please supply the following items:

ITEM	QUANTITY	PRICE	POSTAGE	TOTAL

I enclose cheque/p.o.

Or, please debit my Access/Barclaycard No. _____

Name _____

Address _____

Please send me further details, I enclose S.A.E.

PCW.12.82



JOIN THE 16 BIT SUPER LEAGUE

TEAM MANAGER FMS 86

The World's Leading Data Management System. With Multi-File Access and Ultra Fast Data Entry and Retrieval. Unlimited Records, Single Pass Selection. Automatic Sort and Update, Prints to your own Format. Contains the EFM Program Generation Facility and lots of Other Features which make it the World's No 1. Described as a Rolls Royce at Rover Prices.

Hardware Team

- 1 Sirius 1 with 1.2 Mb disk storage. The U.K.'s biggest selling Business Micro.
 - 2 Sirius 1 with 2.4 Mb disk storage. Its Big Brother, two years early.
 - 3 Sirius 1 with Integral 10Mb Hard Disk. For Powerful Stand Alone or Future Network.
 - 4 IBM PC. In Basic or Upgraded Form. Lots of add-ons available direct from the USA.
 - 5 External Hard Disk. Sirius or Corvus.
 - 6 Printers. A Full Range of Daisy, Matrix Graphics and Colour Printers.
 - 7 Sirius 80 Cards. 4Mh or 6Mh available. Allows 8 or 16 bit programmes to be run.
 - 8 Mainframe Communications. Raven Technical have 100% success record - so far.
 - 9 Memory Expansion. From 128K up to a Massive 1Mb or RAM on the Sirius.
 - 10 Training, Technical Support and National Maintenance available from Raven.
 - 11 Networking, Colour, and Full Graphics on the Leading 16 bit Microcomputers.
- Sub. Slow Small 8 bit Systems.

Software Team

- 1 Pulsar. Full Accounting Software for General and Specialist Business Use.
 - 2 Milestone 86. The World's No 1 Critical Path Analysis Program.
 - 3 Micronet. The New Critical Path Program Written in the U.K. Very Friendly.
 - 4 Wordstar. The New Version of the World's Best Selling Program is Now Available.
 - 5 Datebook. Plan your Appointments and Personal Engagements with this New Package.
 - 6 Pulsar Supercalc. The Easy to Use but Immensely Powerful Spreadsheet System.
 - 7 Pulsar Multiplan. The New Spreadsheet System which has even more than Supercalc.
 - 8 Sirius-Dataflow. The easy to use Data Management System at Budget Prices.
 - 9 Sirius-Mailflow. The Mailing System which integrates with Dataflow for Fast, Easy, Cheap Mailshots.
 - 10 Financial Modelling. Choice of Two Superb Systems. Either Meets The Need of the Professional.
 - 11 Software Maintenance. Constant Update and New Improved Programs. Many Exclusive to Raven.
- Sub. Outdated Slow 8 bit Programs.



Together we're unbeatable.

153 Sunbridge Road
Bradford West Yorks BD1 2NU
Telephone: 0274 306966/309386

GREAT GIFTS COME I



for the
VIC 20



Bug-Byte programs make ideal Christmas stocking fillers! If you have a friend, or member of the family, who already owns a ZX81, Spectrum, VIC, Atom or BBC Micro they will be thrilled by the gift of one of our beautifully packaged, exciting cassettes.

Whats more, Bug-Byte games are the best! Tens of thousands of contented customers testify to that, so do consistently hot reviews in the popular micro-press.

If your game isn't shown, don't worry, we probably have more quality programs for more machines than any other software house, and new ideas are constantly being generated by our young, enthusiastic team of skilled programmers.

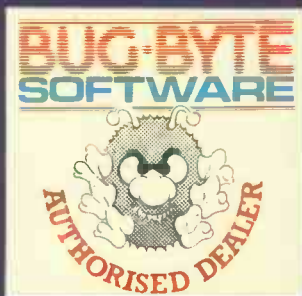
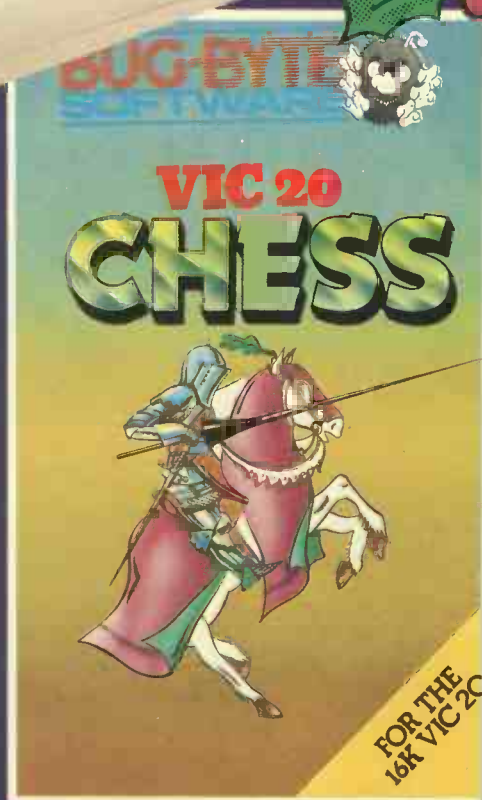

WHERE TO BUY?—

Look for the sign!
Bug-Byte programs are AVAILABLE NOW from:
All Laskys Stores Nationwide.
Large branches of Boots and Curry's Micro-C, plus over 100 independent computer dealers.
If you can't find a Bug-Byte dealer near you – then fill in the coupon opposite and order direct by post – and receive your free copy of our 1983, 16 page, full colour brochure, it's packed with lots of enthralling games for the whole family.

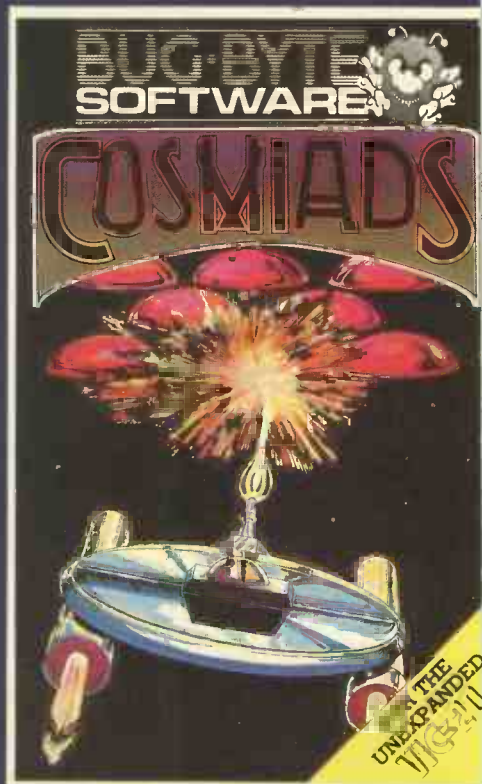
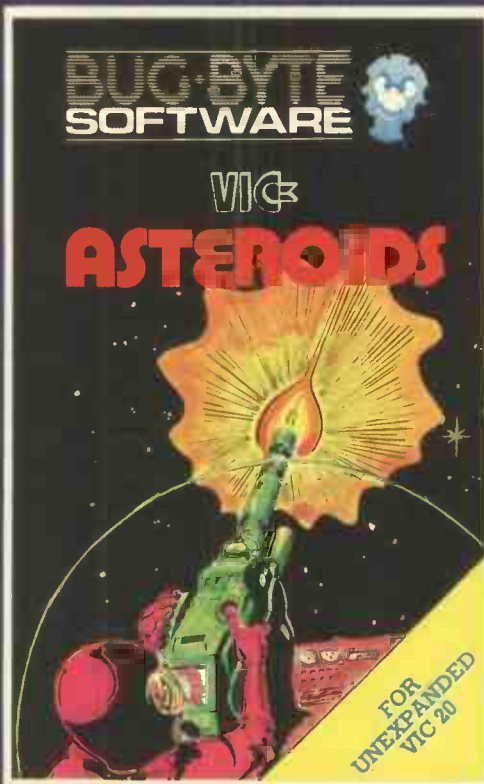

BUG-BYTE SOFTWARE

Also for your VIC:
Backgammon
Another VIC in the Wall

All VIC Programs – £7.00 each
including post and packing

IN SMALL PACKAGES!

for the
SINCLAIR ZX 81
or
ZX SPECTRUM



BBC Micro

We have a large selection of programs for the BBC Micro (A and B models). Our new brochure gives a complete listing, so send for your free copy today! Also see our huge range of software for the ever-popular Acorn Atom!

50^p
VOUCHER
with all orders
of 2 tapes or more

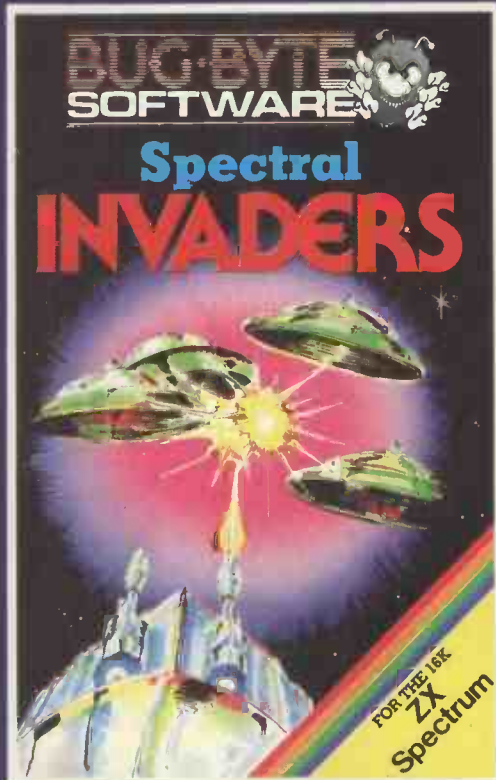
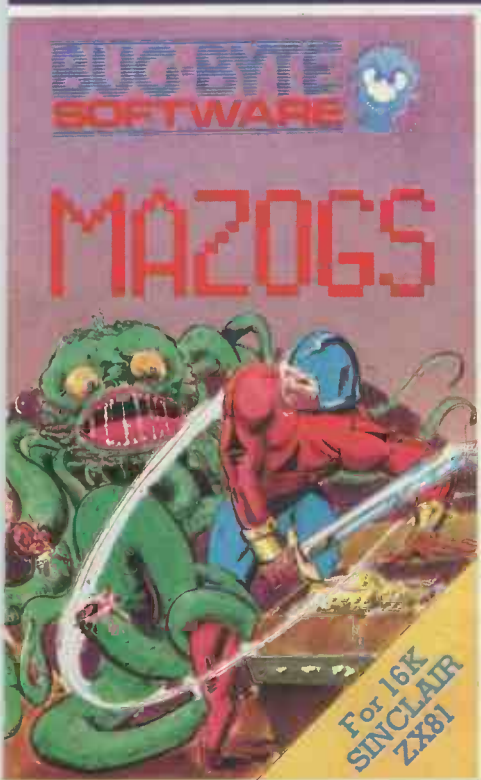

Please send me:

- VIC Panic Spectral Invaders
- VIC Asteroids Spectres
- VIC Chess Mazogs
- VIC Cosmiads ZX AS

OR the following:

I enclose S.A.E. for Catalogue

I enclose cheque/P.O. for _____

OR Please debit my Access 5224 _____

Barclaycard 4929 _____ Expiry Date _____

Name _____

Address _____

Code _____

Dealers Discount Available
ACCESS, BARCLAYCARD ORDERS
WELCOME ON 24hr. ANSWERPHONE
051-227 2642,

or mail to:
BUG-BYTE SOFTWARE,
FREEPOST (No stamp req.)
LIVERPOOL L3 3AB.



X81 Prices: Mazogs - £10.00
XAS Assembler - £5.00
XDB Debugger - £6.50
XTK Tool Kit - £6.00
X Invaders - £4.00

Spectrum Prices:
Spectral Invaders - £5.00
Spectres - £8.00
'Aspect' Assembler - £9.00
All prices include post and packing

BUG-BYTE
SOFTWARE

KEEP YOUR OPTIONS WITH

MIRAGE

A NEW GENERATION OF DATA BASE

MIRAGE has been thought out on a human scale. Design and set-up of a Data Base take less than an hour.

MIRAGE offers just the right number of features to solve your business problems.

MIRAGE uses relational data management techniques to achieve unique flexibility.

MIRAGE can be accessed directly from your programs. Unlimited on-line addition, retrieval and modification of your informations.

MIRAGE has response time which will surprise you.

MIRAGE enables you to use normal, existing files. Its structure is easy to modify interactively.

MIRAGE main specifications and tools :

99 files of 65535 records.

Possibility to have 1 direct access key and 5 chained access keys per file.

Independance of data and pointers.

Multi-users possibility is under development.

For creation :

- DBSCHEMA, design tool
- DBUTIL, preparation tool

For Programming :

- DBPUT, to add a record
- DBGET, to read a record
- DBDELETE, to suppress a record

MIRAGE, is programmed entirely in PASCAL and is independent of any Operating System. Initially available under CP/M at £ 475 excl. VAT. Training and technical support on demand. **MIRAGE** is a product of DATASOFT International.

For additional information, please write to :

DATASOFT INTERNATIONAL 17, CARLISLE STREET, SOHO SQUARE, LONDON, W1V 6 PE

DEALERS AND OEM ENQUERIES WELCOME

MICRO-MADNESS CRAZY PRICES!

All goods sold are brand new and with full manufacturer warranty.

KAGA MONITORS	£	I.D.S	£	ROMwriter	96
High - res. 12" BW inc. Cable	86	Prism 80 Full Option inc. Colour	1031	Copyplus ROM	33
High - res. 12" Green inc. Cable	86	Prism 80 - Graphics/Sprint/Auto Sheet Feed	827	Ramex 128K	245
High - res. 12" Amber inc. Cable	86	Prism 80 - Graphics/Sprint	730	Ramex 16K	64
PRINTERS		Prism 132 Full Option inc. Colour	1186	Analog Output Board 4 Channel	138
EPSON		Prism 132 - Graphics/Sprint/Auto Sheet Feed	973	Analog Output Board 8 Channel	214
MX80 Type III	278	Prism 132 - Graphics/Sprint	879	Digital Interface	173
MX80FT Type III	314	Black Ribbon for Prism	11	Analog Input Board 16 chl. 8 bit	150
MX82	345	4 Colour Process Ribbon for Prism	22	Analog Input Board 16 chl. 12 bit	280
MX82FT	338	4 Colour Primary Ribbon for Prism	22	Videx 80 Column Card	160
MX100 Type III	418	INTEGREX		Omnivision 80-col Display Card	168
RS232 Interface	30	CX80 Colour - Parallel	707	SUP'R Terminal Card	170
RS232 Interface with 2K Buffer	53	CX80 Colour - RS232 Serial	767	APPLEFAN	
Serial Interface Type III	60	CX80 Colour - IEEE	755	Applefan Unit	58
IEEE - 488 Parallel Interface	37	CX80 Colour - RS232 3.7K Buffer	830	Cassette Connector Set	4
Apple Interface (Non-Graphics) + Cable	49	Apple II Interface Card	88	Disc Drive Connector Set	14
Apple Interface (Graphics) + Cable	57	SMITH CORONA		Eurocolour TV Output	4
TRS80 Interface	22	TP1 Daisy Wheel - Parallel	430	Games Connector Set	9
Ribbon for MX80 Series	5	TP1 Daisy Wheel - Serial	430	Monitor 40/80 Char. Display Switch	9
Ribbon for MX100 Series	9	IEEE Interface Box for TP1	67	Mains Output Set	7
CENTRONICS		APPLE INTERFACE CARDS AND ACCESSORIES		Printer Connector Set	14
737 - 2 Parallel	337	CCS Serial Card	100	Graphics Tablet Connector	13
739 - 2 Parallel	433	CPS Multifunction Card	108	DEMONSTRATION/TRANSIT CASE	
150 - 2 Parallel	430	CPS Printer Cable (Please Specify)	10	Apple + 2 Disc Drives	49
152 - 2 Parallel	495	ALF Music Card 9 Voice (MC1)	70	Terms of business: Cash/cheque/P.O.S. with order.	
152 - 4 Serial	558	ALF Music Album A for MC1	5	P&P: Interface cards and ribbons - per unit 50p.	
12 Cartridge Ribbons for 150/152	34	ALF Music Album B for MC1	5	Printers, monitors, and cases - per unit £6.	
12 Zippack Ribbons for 737/739	31	ALF Music Album C for MC1	5	VAT: All prices are exclusive of VAT. Please add 15% to the total cost including P&P.	
ANADEX		ALF Music Card 3 Voice (MC16)	113	Goods damaged in transit will be replaced FOC.	
DP9000A Serial/Parallel (Graphics)	945	ALF Music Album 1 for (MC16)	6		
DP9001 Serial/Parallel	884	ALF Music Album 2 for MC16	6		
DP9001A Serial/Parallel (Graphics)	945	ALF Music Album 0 (Xmas) for MC16	6		
DP9500L Serial/Parallel	838	ALF Ear Training Dis A/Soft MC16	18		
DP9500 Serial/Parallel (Graphics)	905	ALF Ear Training Disc INTG for MC1/16	18		
DP9500A Serial/Parallel (Graphics)	1006	Timing Mode Input Board	8		
DP9501 Serial/Parallel (Graphics)	951	Mountain Computer Expansion Chassis	361		
DP9501A Serial/Parallel (Graphics)	1006	Clock Calendar Card	142		
DP9620A Serial/Parallel (Graphics)	1093	Supertalker	151		
Ribbon for DP9000/9500 Series	10	ROM-Plus Board	84		
Graphics Interface Card	120	RAMplus	99		
WALTERS					
120 - Parallel	377				

Please send me the following goods:

Total (inc. P&P) _____

I enclose 15% VAT _____

cash/cheques/P.O.S. for sum of _____

Name _____

Address _____

PCW1

AIMGRAM

AIMGRAM LTD 31 Roman Gardens, Kings Langley, Herts. WD4 8LG. Tel: Kings Langley (09277) 68211.

DRAGON 32

The ultimate data base

£19.95

Fully inclusive

(ideal Christmas present)

INDISPENSIBLE FOR ALL DRAGON OWNERS

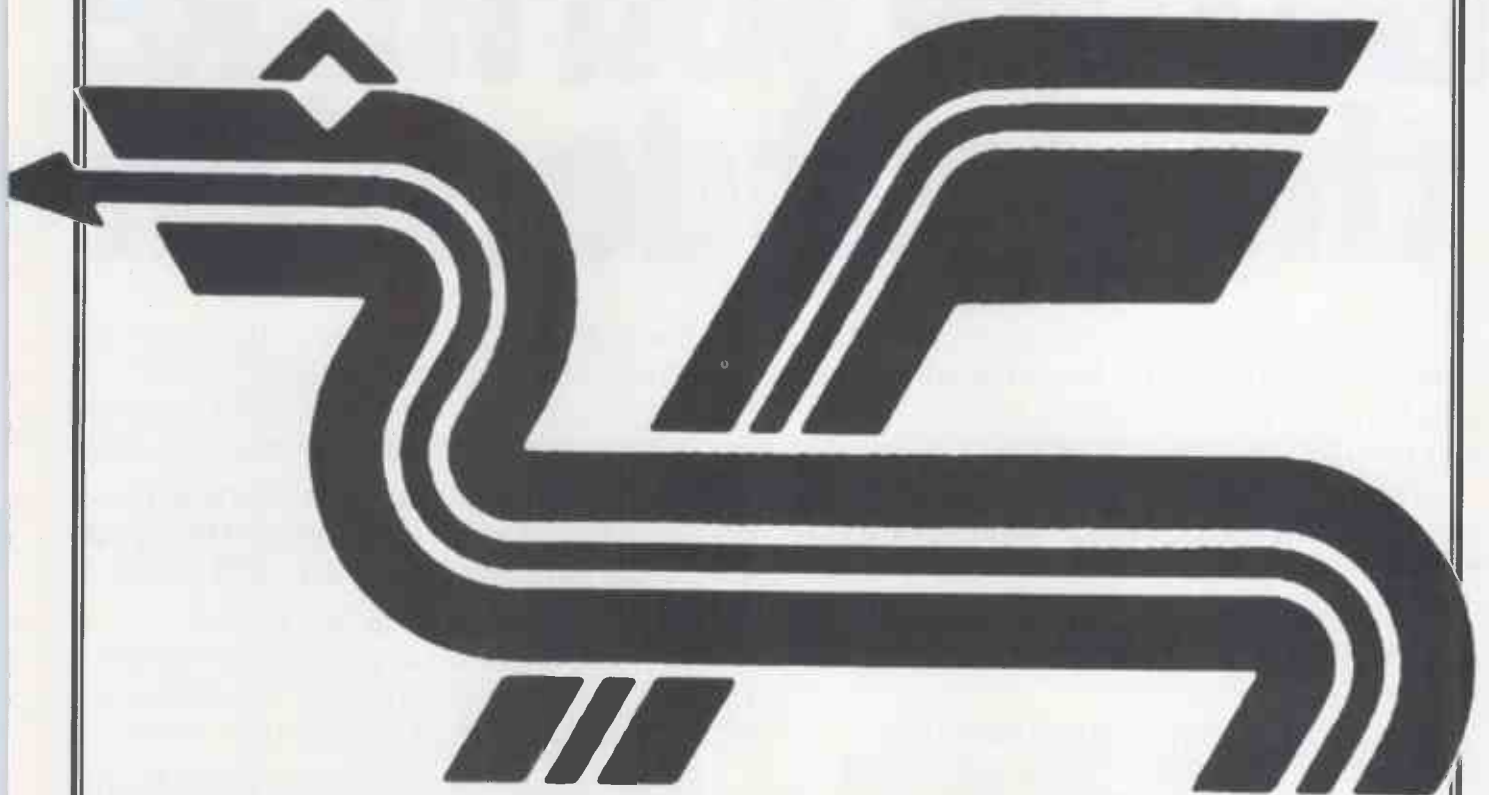

**Extensive file management facilities,
Application:-**

stamp collections
coins

Photos
Price lists

Customer file
Records

Libraries

In fact any application where you would use a card index.

ZX81-16k version £8.95

All programs supplied with exhaustive documentation.

Send cheque or P.O. or Cash (registered) or Credit Card no. to:

Gemini Marketing Ltd

Dept PCW (4) 9 Salterton Road, Exmouth, Devon EX8 2BR

Or telephone us with your credit card order on (03952) 5832

All orders despatched by return – no waiting.

All prices include VAT and post & packing except Hardware. Full range of Sharp peripherals available – please 'phone for quotations.

Please state machine type and memory size when ordering software.



WHICH MICROCOMPUTER?

WHICH PRINTER?

WHICH SOFTWARE?

WHICH SERVICES?

WHICH COMPUTER?

WHICH WORD PROCESSOR?

Be sure you make the right decision

The computer or word processor you install in your business is going to be with you for a long time. So when you're buying a system, the last thing you can afford is a mistake.

The Which Computer? Show is for business people who believe in leaving nothing to chance.

Firstly, the show offers you the widest choice of equipment you'll find under one roof. Over 200 exhibitors will be there.

But then it helps you narrow down that choice until you've found the one system that matches your needs exactly.

At the Which Computer? Show you'll find computer experts who talk your language.

The National Computing Centre will be presenting special video briefings and you get a free NCC Questioner when you send for your tickets to help pinpoint what you're looking for before you leave.

Compare, discuss and get practical experience of the new technology. Then you can make your decision with confidence.

The show takes place at the National Exhibition Centre in Birmingham, easily reached by car or train. Car-parking is free. The dates are 18th-21st January 1983. Open from 10.00 am.

Simply clip out the coupon and send it to us at **Which Computer? Show, 232 Acton Lane, London W4 5DL. Phone: 01-747 3131 during office hours.**

A SPECIAL OFFER FOR VISITORS
Major discount on Which Computer? magazine.
SEE COUPON

THE WHICH? COMPUTER? SHOW

National Exhibition Centre
Birmingham

18-21 January 1983

FREE TICKETS WORTH AT LEAST £3 + INFORMATION PACK

Which Computer? Show, 232 Acton Lane, London W4 5DL

Please send _____ complimentary tickets for me and my colleagues. Also send your free information pack containing the NCC Questioner.

Name _____

Position _____

Company _____

Address _____

Telephone _____

I would like to receive Which Computer? magazine at the 45% discount rate of £9.90 (normal annual subscription £18 - send no money at this stage).

I am interested in exhibiting at the Which Computer? Show.

PCW/1/12

Nobody under the age of 18 will be admitted.

GETTING THE MOST FROM YOUR MICRO?

These days, there seem to be new developments in micros every five minutes. How can you stay in touch? Which Micro & Software Review brings you all the most important news and the most interesting facts every month.

As well as our unique buyers guide to software packages (which is updated every month) we review software in depth. This month we explain how tele-software works and how you can use it with your equipment. There's full details of the new 'Adventure' game to run on Commodore plus two new games for Ataris and Sinclairs. Every month we tell you what's available, what's in the pipeline and what's right for you—over a range of software for home, business and school users.

We don't stint on hardware coverage either. Not only do we publish the most extensive buyers guide available (over 100 micros in detail) but we also publish reviews that really take machines apart. This month we run a giant test of the Lynx vs the Genie, and there's a 20 page pull-out supplement which



reviews the big ten micros in detail: ZX81, Spectrum, BBC A and B, Dragon, VIC, Atari 400 and 800, TI 994A, and the Atom.

Starting this month we're serialising the very funny book "Computer Bluff" which no-one else will be able to read until March next year.

Have you ever thought you could write for a computer magazine? Well, we give you the chance in a unique competition—with cash prizes. And there's another free-to-enter competition this month, from which you can win a new micro for Xmas.

December's a big issue. So make sure you pop into your newsagent—on November 15th and bag your copy.

THE A TO Z OF MICROS

WHICH MICRO? & SOFTWARE REVIEW

MicroShell™ conducts your CP/M™ computer with more power than ever before!

WHAT IS MICROSHELL?

MicroShell is a normal CP/M program which adds a powerful set of commands to all programs running under CP/M. MicroShell remains in your computer, out of the way to continue to process your commands.

WHAT WILL MICROSHELL DO?

All the normal CP/M commands, plus:

- Automatic Disk and User Management - No more copying all your programs to each disk you use and having directories filled with programs. With MicroShell you can work on a nice clean disk or in a separate user area and MicroShell will find your programs from another drive or user number automatically! You'll save time and precious disk space.
- Powerful Redirection Capability - You can send screen output to a file or to the printer. Or send printer output to a file. Or take program input from a file instead of the keyboard.
- Much More: Multiple commands on a line, more powerful and faster "submit" capability, and user-definable prompt.

DEALERS - MICROSHELL GIVES YOU:

- An interface to the computer that can be tailored to the user's level of experience.
- Automatic execution of an application program at startup.
- MicroShell can manage self-running demos to free up your salesmen from demonstrating software packages; have the software package sell itself!

WILL MICROSHELL RUN ON MY COMPUTER?

If your computer runs CP/M 2.2, that's all you need to run MicroShell. Most popular 8 and 5 inch disk formats available. And MicroShell runs on Apple-CP/M, and IBM PC with "Baby Blue"™

CP/M - TM Digital Research UNIX - TM Bell Labs, Wordstar - TM MicroPro, Baby Blue - TM XEDX
Microshell is a trademark of New Generation Systems, Inc.

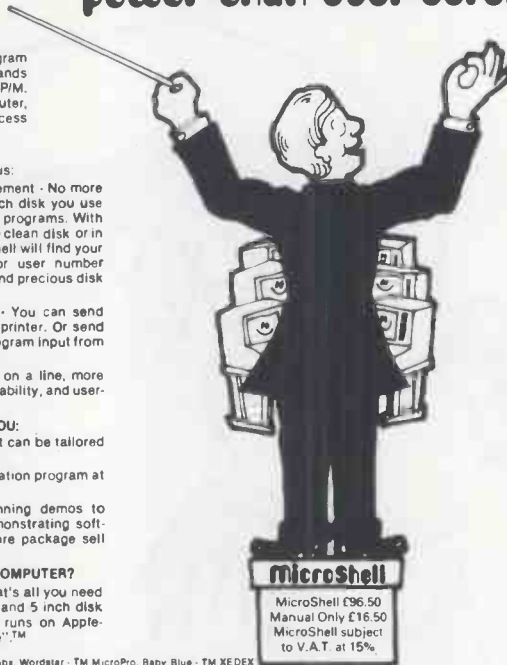

GIVE ME SOME EXAMPLES!

- Run Wordstar™ (or your favorite word processor) from any disk drive or user area: MicroShell will automatically find the programs and overlays as they are needed.
- Wish you could save the screen from some program for later use or to edit in to a report? With MicroShell, you can! Just redirect the output into a file. Have a program that prints a report you want to save but it will only go to the printer? With MicroShell you can direct the printer output into a file.
- Tired of entering the same commands time after time into a program? Put them into a file and have MicroShell supply them to the program from the file.
- Want to do something else while a long program runs? Change MicroShell's prompt to sound the bell on your terminal.

SOFTWARE DEVELOPERS - MICROSHELL GIVES YOU:

- A powerful development environment with many UNIX™ features, and some that even UNIX doesn't have.
- MicroShell eases the part of software development we all dislike: documentation. With MicroShell, you can run your program and collect the output in a file.

CALL OR WRITE TODAY!

asro
INFORMATION
SYSTEMS

P.O. Box 159, Brighton, BN1 3NA

3D COMPUTERS THE ACORN SPECIALISTS

11Z-80A



TEL: 01 337 4317
FOR BEST PRICE POSSIBLE

ATOM & BBC MICROS

- Upgrades • Add-ons • Books
- Peripherals • Software

EX STOCK

**ACORNSOFT BUG-BYTE
PROGRAM POWER**

Available over the counter.

MAIN **BBC** AGENT FOR
WARRANTY REPAIRS & SERVICE

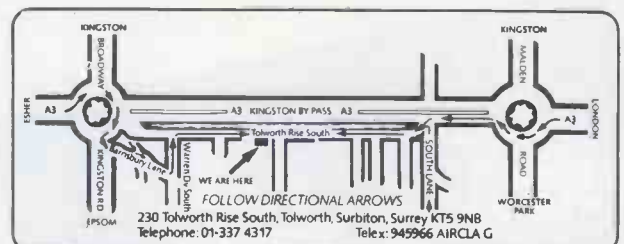

A £550* DAISY WHEEL BARGAIN!!!

At last a daisywheel printer with a professional performance and quality at an affordable price.



- ★ Wide 15 inch carriage.
- ★ Standard print wheels.
- ★ Standard ribbons.
- ★ Fast 25 characters per second.
- ★ Graphics commands.
- ★ Standard **Wordstar** printer.
- ★ Heavy duty mechanism.

★ Price exclude VAT and delivery

For further details contact
JAYMAN ELECTRO DEVICES LTD
15 ASH GROVE,
SPRINGHEAD,
OLDHAM.
GREATER MANCHESTER. OL4 4RP

... beat Sinclair at his own game!

'OLIGOPOLY'

"Oligopoly" is a development of the sort of business simulation game sometimes used in management training. It operates along the same lines but is in several ways more sophisticated and in every way more fun.

Each player runs a company which supplies the home computer market, developing new models, negotiating contracts for their manufacture and for the purchase of special components, buying advertising, engaging in price war and so on. It's all done on borrowed money which has to be paid for out of earnings. The winner is the player whose firm survives and accumulates the most profit.

Two to four players can take part and if you wish one of them can be the computer itself. It can assume the identity of whichever firm you would most like the chance of competing against on level terms — it's not easy to beat the computer but it can be done.

We have been looking out for a game of exceptional interest and originality with which to establish the reputation we mean to sustain as suppliers of a small range of selected quality software. "Oligopoly" had to be the one. It's easy to play and a lot of fun from the first attempt but for those who want to take it seriously there's plenty of scope to improve their performance through experience and by analysis (you can practise by playing alone against the computer). It's just the thing for a wet Christmas/New Year holiday.

"Oligopoly" has too many features to describe here. For full details complete the entries below and send this advertisement (you'll need an envelope but no stamp) to:

Cambridge Software, FREEPOST, 7 Green Street, Cambridge CB2 1BR

For early delivery of "Oligopoly" on cassette indicate which computer you want it for and enclose £5 cheque or PO.

Name _____

Address _____

Please send details of "Oligopoly"
Please send "Oligopoly" cassette
for Spectrum for ZX81(16k)
(£5 encl.)

PCW12/82

A really
absorbing
new game.

Spectrum
ZX81 (16k)

**Cambridge
Software**

LOOK! . . . A NEW NAME IN



apple ACCESSORIES



PA

🍏 All items fully guaranteed for one year
🍏 Free postage and packing on all orders

🍏 Immediate delivery
🍏 Many more items available



BUSINESS SOFTWARE	NET	INC. VAT
Calcstar (CP/M) (80 column spread sheet)	59.00	67.85
dBase II (CP/M)	299.00	343.85
Data Factory 5.0 (many new features)	157.00	180.55
Data Star (CP/M)	122.00	140.30
D.B. Master (version 3.02)	119.00	136.85
D.B. Master statistics	58.00	66.70
D.B. Master utilities (links with visi's)	58.00	66.70
Desk Top Plan II	122.00	140.30
Graphmagic (bar graphs, pie charts, etc)	47.00	54.05
Mathemagic	47.00	54.05
PFS Filing system (new improved)	68.00	78.20
PFS Graph	68.00	78.20
PFS Report	53.00	60.95
Supersort (CP/M)	75.00	86.25
Versaform (form generator in Pascal)	199.00	228.85
Visicalc (new version)	99.00	113.85
Visicalc expander (use with 32K/128K cards)	53.00	60.95
Visicalc utilities	34.00	39.10
Visidex	122.00	140.30
Visifile	115.00	132.25
Visipac (calc/trend/file)	378.00	434.70
Visiplot	93.00	106.95
Visischedule	144.00	165.60
Visiterm	48.00	55.20
Visitrend/plot	143.00	164.45
WORD PROCESSING		
Apple Speller (very fast proof reading)	45.00	51.75
Apple Writer II	72.00	82.80
Form Letter (use with Super Text II)	58.00	66.70
Format 80	275.00	316.25
Letter Perfect	87.00	100.05
Mailmerge (CP/M)	55.00	63.25
Pie Writer (40/80 columns)	78.00	89.70
Screenwriter II (70 col w/out 80 col card)	62.50	71.88
Super Text II	79.00	90.85
Wordstar 3.01 (CP/M) (enhanced features)	135.00	155.25
Zardax	139.00	159.85
GAMES		
Bear Run (Sirius)	16.95	19.49
Cannonball Blitz (Online Systems)	16.95	19.49
Choplifter (Broderbund)	16.95	19.49
Epoch (Sirius)	16.95	19.49
Flight Simulator (Sublogic)	16.95	19.49
Knights of Diamond (use with Wizardry)	18.95	21.79

Laff Pak (Online Systems)	16.95	19.49
Minotaur (Sirius)	16.95	19.49
Pinball (Sublogic)	16.95	19.49
Pool 1.5 (Innovative design)	16.95	19.49
Swashbuckler (Datamost)	16.95	19.49
Tawala's Last Redoubt (broderbund)	16.95	19.49
The Prisoner (Edu-Ware)	14.95	17.19
Threshold (Online Systems)	16.95	19.49
Time Zone (Online Systems)	43.75	50.31
Wizardry (Sir Tech Software)	24.95	28.69
Zork II (Infocom)	21.95	25.24

PRINTERS		
Diablo 630 (R/O)	1375.00	1581.25
Epson MX80T-3 (up to 132 col & hi-res)	299.00	343.85
Epson MX80FT-3 (as above & friction drive)	329.00	378.35
Epson MX82FT (very hi-res graphics)	359.00	412.85
Epson Mx100FT-3 (100 cps & wide carriage)	429.00	493.35
Mannesman Tally MT 120 (160 cps)	365.00	419.75
Nec 8023 (100 cps & prop. spacing)	319.00	366.85
Silentype & interface	159.00	182.85
Smith Corona TP-I (daisywheel printer)	449.00	516.35
Tec Starwriter FP1500 (25 cps)	699.00	803.85

PRINTER INTERFACE CARDS		
CPS Multifunction Card (inc real time clock)	119.00	136.85
Digitek Printmaster (BASIC/CPM/PASCAL)	69.00	79.35
Digitek Printmaster III with memory mang.	159.00	182.85
Grappler graphics (Epson/Anadex/Cen/P.tig)	98.00	112.70
MBP-16K (Epson 16K buffer)	96.00	110.40
Wizard 16K Buffer & graphics interface	149.00	171.35
80 COLUMN CARDS		
Digitek Screenmaster 80	185.00	212.75
Smarterm (very cool running, many features)	182.00	209.30
U-Term (inc shift mod. & font editor)	129.00	148.35
Videx Enhancer II	83.00	95.45
Videx Softswitch (40/80)	19.95	22.94
Videx Utility Disc (inc font editor etc)	24.45	28.12
Videx Videoterm	163.00	187.45
Visicalc preboot disc (80 col with videx)	32.00	36.80
Vision-80	185.00	212.75
MONITORS/COLOUR CARDS		
Digitek Colour Card (excellent colour on TV)	95.00	109.25

Microvitec colour monitor	264.00	303.60
Microvitec colour card (use with above)	35.00	40.25
Sanyo 12" Green Screen	105.00	120.75
Zenith 12" Green Screen (very good value)	89.00	102.35

GRAPHIC UTILITIES & MUSIC		
3-D Supergraphics	23.00	26.45
Arcade Machine (game designer)	21.45	24.67
Artist Designer	33.00	37.95
Digisolve Card (512 x 512 & 64k Ram)	375.00	431.25
E-Z Draw 3.3 (excellent graphic utility)	25.95	29.84
Graforth (fast 3D utility plus music)	43.00	49.45
Graphic package Sublogic (detailed 3D pack)	64.45	74.12
Higher Text II (many diff fonts, sizes, cols)	21.95	25.24
Pascal Animation	34.00	39.10
Pilot Animation Tools	34.00	39.10
Versawriter (graphic digitiser)	165.00	189.75
Zoom Grafix (zoom in on hi-res screen)	23.95	27.54
Alf Music System (9 voice)	85.00	97.75
Electric Duet (creates 2 part music)	18.95	21.79
Music Machine 9 Voice (Vista)	79.00	90.85
Music System (Mountain Computer 16 voice)	211.00	242.65
Mutek Vox Box	61.00	70.15
Zapple Sound Effects & Music Board	56.00	64.40

UTILITIES		
Ace (Applesoft Command Editor)	21.95	25.24
Aplus (Applesoft structured Basic)	18.95	21.79
Assembly lang. Dev. (6502, Z80 or 8080)	75.00	86.25
Bag of Tricks	20.45	23.52
Back It Up II+ (bit copier)	48.00	55.20
B.E.S.T. (Enhanced Software Tool)	23.95	27.54
Build Using (Provides 'print using' command)	23.95	27.54
Dakin 5 (12 utility programs)	47.00	54.05
Disc Library (inc. CP/M & Pascal)	33.95	39.04
Dos 3.3 Tool Kit	39.00	44.85
Edit Soft (powerful macro line editor)	18.95	21.79
Fast DOS	19.45	22.37
Global Program Line Editor (supports 80 col)	34.50	39.68
Image Printer Epson (flexible hi-res dump)	24.95	28.69
Lisa (Assembly lang. dev. system)	55.00	63.25
Lisa (Educational system)	70.00	80.50
List Master (inc. smart renumbering)	23.95	27.54
Locksmith 4.1 (bit copier for most discs)	61.00	70.15
Merlin Macro Assembler (editor & utilities)	42.00	48.30

THREE NEW REVOLUTIONARY CARDS FROM DIGITEK



SCREENMASTER 80

This new 80 column card is the most advanced available with features like: 9x10 matrix, 3 scrolling speeds, shift lock, user definable graphics, supports all Applesoft commands and Applewriter II. Well worth the £185 + VAT.

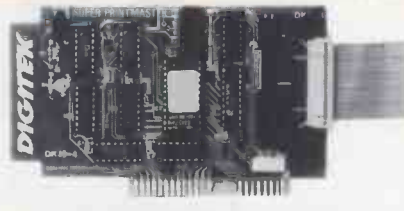

SUPER PRINTMASTER III & BUFFER MANAGEMENT

A totally new concept in printer cards, supporting both colour & B/W printers. It incorporates a unique buffering facility using Ram cards. Up to 16 x normal size graphics dump and pic rotation etc. Prices: £159 (B/W) or £179 (Colour) + VAT.

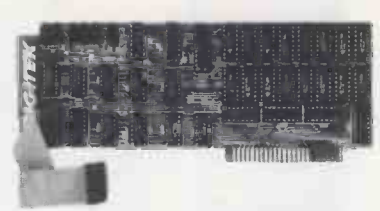

64K & 128K RAM-MASTER

These cards use the latest low power D RAM chips and can be used for high speed disk emulation in Basic, CP/M or Pascal. Visicalc Expand software available, can also be used as printer buffer with Super Printmaster III. PRICES: 64K £213 Or 128K £319+VAT.



SMITH CORONA TP-I DAISY WHEEL PRINTER

A microprocessor controlled high quality printer which delivers fully formed executive print at a speed of 120 words/min. Price £449+VAT.



MICROVITEC 14" COLOUR MONITOR

Besides offering a crystal clear display in either text, hi-res or low-res modes. It also includes the following features, 16 text colours, b/grd colours, 80 column card compatibility. A superb colour monitor for £264.00+VAT.



12" PRINCE MONITOR

Features 24 M/Hz bandwidth, giving a very clear display, and contained in a neat Apple compatible case, available with either Green or Amber screen. Well priced at £105+VAT.

CE

0274 575973

Printographer (supports almost any printer)	27.95	32.14
Quickloader	15.95	18.34
Speed Star (compiles 1200 lines per min)	75.00	86.25
Super Disc Copy III	20.00	23.00
Super Kram	87.00	100.05
Tasc Compiler (handles very large programs) ...	95.00	109.26
The Inspector (disc snooper, needs 18k card). 35.00		40.25
The Routine Machine (mach. lang. routines)	34.50	39.88

SYSTEM EXPANSION

16K Ramcard Digitek (with dos mover)	75.00	86.25
16K Ramcard Ramex	65.00	74.75
16k Ramcard Samram	55.00	63.26
32K Ramcard Saturn	129.00	148.35
128k Ramcard Saturn	299.00	343.85
128K Ramex card	265.00	304.75
Clip on fan (inc separate power switch)	44.00	50.60
Cool stack (holds 2 drives & monitor + fan) 65.00		74.75
DOS upgrade kit (3.2 to 3.3)	36.00	41.40
E-Z Port (game socket extender)	11.45	13.17
Keyplus Numeric Keypad	83.00	95.45
Romplus Card in K/B Filter	119.00	136.85
The Mill 6809 with Pascal speed up	189.00	217.35
VC-Expand-80 (up to 145K Visicalc & 80 col)	65.00	74.75
VC-Expand Ramex (loads 136k visi in 20 sec)	40.00	46.00
Z80 card U-micro (card only)	73.00	83.95
Z80 card Microsoft (CP/M (Mbasic)	179.00	205.85
Z-card (inc CP/M & Supercalc) very good value	179.00	205.85

LANGUAGES

Apple Logo	115.00	132.26
Apple Pascal	145.00	166.75
Apple Pilot	79.00	90.85
Cobol 80 (CP/M)	345.00	396.75
Forth II (Integer only)	39.00	44.85
Fortran 80 (CP/M)	103.00	118.45
Transforth (full floating point Forth)	68.00	78.20

MISCELLANEOUS ITEMS

BASF 5.25 (SS/SD) Pack of 10	17.95	20.64
Disc Drive (Fully Apple Compatible)	199.00	228.85
Disc Drive Controller Card	65.00	74.75
Disc Head Cleaning Kit (2 discs and fluid)	15.95	18.34
Joyport	38.45	44.22
Joystick (Le stick)	22.00	25.30
Joystick (TG Products)	27.95	32.14
Lang Card utility (back up memory to disc)	59.00	67.85
Plastic Disc Box	2.50	2.88

Please make your order by completing the coupon and returning to us - or you can phone **DAVE** or **SHERIDAN** on **0274 575973** and your enquiry will receive a friendly and speedy response.

PACE-SOFTWARE-SUPPLIES

Rose Bank, 130 Clayton Road,
Bradford BD7 2LY, West Yorks.

Please rush me the following items.

£ p

1			
2			
3			
4			
5			
TOTAL			

I enclose my cheque made payable to **PACE SOFTWARE**
(Export licence arranged)

Name _____

Address _____

Town _____

County _____

Postcode _____ Tel. No. _____

PCW/12



PORTABLE ACOUSTIC COUPLERS

TYPICAL APPLICATIONS

- Networking computers
- Linking to electronic mail system (Euronet)
- Converting microcomputer to Viewdata (Prestel) receiver

KEY FEATURES

- Snap-fit acoustic link between standard telephone handset and terminal equipment
- Low cost
- Slimline design
- Lightweight and compact
- Specially designed acoustic chambers need no rubber seals.

PAC-M1: This acoustic modem provides a link between telephone line and Serial Data socket of a microcomputer, thus allowing conversion into a Prestel receiver and facilities for transfer of telesoftware programmes. £135 plus VAT, p&p.

PAC-M2: Specifically for fully interactive data communication at 300/300 Baud rate, this acoustic modem is designed for networking computers and for electronic mail system. It operates in an originate mode to the CCITT V21 standard and connects Serial Data via an RS232 socket. £135 plus VAT, p&p.

PAC-1: Provides an acoustic link between standard telephone handset and all types of Prestel and private Viewdata terminals, TV sets and adaptors. Powered by a single PP3 battery, this acoustic coupler allows Viewdata equipment to be used in office or home without a fixed BT socket. £85 plus VAT, p&p.

TECHNICAL APPROVAL

All products meet the British Telecom Technical Guide for acoustic coupling.

Software available for:

Pet Series, Apple, BBC Micro and many others

O.E Limited,
Industrial Estate,
Appleby in Westmorland
Cumbria CA16 6HX
Tel: 0930 51909 Tele 64157



PLEASE SEND MORE DETAILS OF THE PORTABLE ACOUSTIC COUPLERS. PAC-1 PAC-M1 , PAC-M2 (tick as required)

Name.....

Company.....

Address

Tel: (Ref.PCW12-82)



YOU'VE SEEN THE PICTURES, NOW SEND FOR THE WORDS

BBC Microcomputer or Acorn Atom

Acornsoft is the software division of Acorn Computers, designers and manufacturers, of the BBC Micro and Atom. We know better than anyone the capability of the machines, we know how to get the very best from the hardware. And we have produced a range of exciting games, exacting business and useful household software.

The Biggest Range Available

Acornsoft software ranges from authentic arcade games like Snapper to Algebraic Manipulation to Desk Diary to other languages like FORTH and LISP. Striking colour, amazing sound effects and powerful

graphics are all used to the full. And it does not stop there. There is a complete range of manuals, accessories and plug-in ROMs.

Free Brochures

Just clip the coupon or write to us and we will rush our catalogue absolutely free. Can't wait for the post ring 01-930 1614 now! Don't delay - do it today. Let Acornsoft help you get the best from our machine and open the doors to your imagination.

Acornsoft and Atom are registered trade marks of Acorn Computers Ltd.

ACORNSOFT

4A Market Hill,
CAMBRIDGE CB2 3NJ.



Please rush me my free literature from Acornsoft.

Atom
 BBC Please tick

Name _____

Address _____

Postcode _____

5 1/4" WINCHESTER SUBSYSTEMS FROM ICE

APPLE - SUPERBRAIN - IBM PERSONAL S100 BUS & Z80-BASED MICROS

FROM 3 TO 42 MEGABYTE CONFIGURATIONS WITH TAPE STREAMER BACKUP



RETAIL PRICES FROM £1350. DEALER ENQUIRIES INVITED

ICE 16/18 Littleton Road, Ashford, Middlesex, TW15 1UQ
Telephone: 07842-47271/47171 Telex: 8952042 (DPCUSTG)

Software for CP/MTM

MICROPRO £

WORDSTAR	MICROPRO's comprehensive word processing system	250.00
MAILMERGE	Added power to WORDSTAR for mailing lists, standard letters, etc	60.00
SPELLSTAR	Dictionary on a disk for WORDSTAR spelling checking	120.00
DATASTAR	MICROPRO's data entry, validation and retrieval system	170.00
SUPERSORT I	Sorting, extracting and merging at high speed from MicroPro. Includes Relocatable version for inclusion in your own software	120.00
CALCSTAR	MICROPRO's spread sheet and financial modelling system. Combine with WORDSTAR to get impressive end results.	150.00
WORDMASTER	Video text editor for programmers and simple Word Processing	60.00

MICROSOFT £

BASIC-80	MICROSOFT's popular and powerful BASIC Interpreter (MBASIC)	150.00*
BASIC Compiler	Compile your BASIC-80 programs for speed and protection	190.00*
FORTRAN-80	Fortran compiler to ANSI X3.9 1966 except COMPLEX data	210.00*
COBOL-80	The COBOL compiler for microcomputers. (BASIC, FORTRAN and COBOL compilers include MACRO-80, LINK loader, LIBrary manager and CREF utilities.)	310.00*

MISC £

CBASIC-2	COMPILER SYSTEMS widely used compiler/interpreter for BASIC	94.00
CB-80	CBASIC compatible compiler	310.00
PASCAL/M	SORCIM's PASCAL	120.00
SUPERCALC	SORCIM's spread sheet and modelling system	170.00
MILESTONE	Project Management and Scheduling from Organic Software	160.00
dBASE II	Relational Database Management from Ashton Tate	380.00
dUTIL	Programming aid for dBASE II	50.00
MICROSTAT	Statistical program library from ECOSOFT for (and needs) BASIC-80	150.00
PLI-80	Digital Research PLI Compiler	310.00
BT-80	Record Retrieval for PLI-80	125.00
MAC	Digital Research 8080 Macro Assembler	57.00
SID	8080 Symbolic Debugger	47.00
ZSID	Z80 Symbolic Debugger	63.00
DESPOOL	File Print Spooler for CP/M	31.00
TEX	Tex editor	63.00
SPELLBINDER	Lexisoft's Wordprocessing and Office Management System	275.00
PRO PASCAL	Z80 True Pascal Compiler	190.00

All products are available in 8" SD, SS, Superbrain 5" SS, North Star Horizon QD format except those marked * which are not available in North Star format.

IBM PC SOFTWARE

NOW AVAILABLE - Please ring for full details

All products are supplied complete with full originators documentation.

Please send large s.a.e. for full details. **TRADE ENQUIRIES WELCOME**

Ordering Instructions: Cash with order. Specify disk format. Add £3.00 per item P&P. Add 15% VAT



the soft option (UK) LTD

PO BOX 11 CRANBROOK KENT TN17 2DF Tel. (058 080) 310

PRODUCTS FOR ATARI* 400/800
FROM ELCOMP

HOFACKER

Books
+
Software
for
ATARI
VIC-20
OSI
SINCLAIR
TIMEX

BOOKS:

ATARI BASIC — Learning by Using

An excellent book for the beginner. Many short programs and learning exercises. All important features of the ATARI computers are described (screen drawings, special sounds, keys, paddles, joysticks, specialized screen routines, graphics, sound applications, peeks, pokes, and special stuff). Also suggestions are made that challenge you to change and write program routines.

Order #164 \$7.95

Games for the ATARI Computer

This book describes advanced programming techniques like player-missile-graphics and use of the hardware-registers. Contains many ready to run programs in BASIC and one called GUNFIGHT in machine language.

Order #162 \$7.95



Programming in 6502 Machine Language on your PET-CBM 2 complete Editor/Assemblers (Source code 3 hexdump + description plus a powerful machine language monitor (Hexdump)).

Order #166 \$19.95

How to program your ATARI in 6502 machine language Introduction to machine language for the BASIC programmer

Order #169 \$9.95

SOFTWARE IN BASIC FOR ATARI

Invoice Writing for Small Business

This program makes writing invoices easy. Store your products in DATA statements with order-number, description, and price. The program later retrieves the description and price matching to the entered order-number. The shipping cost and the discount may be calculated automatically depending on the quantity ordered or entered manually. The description to the program tells you how to change the program and adapt it to your own needs. Comes with a couple of invoice forms to write your first invoices on to it.

Order #7201 cassette version \$29.95
Order #7200 disk version \$39.95

Mailing List

This menu driven program allows the small business man to keep track of vendors and customers. You can search for a name or address of a certain town or for an address with a certain note. 50 addresses are put into one file.

Order #7212 cassette version \$19.95
Order #7213 disk version \$24.95

Inventory Control

This program is menu driven. It gives you the following options: read/store data, define items, entry editing, inventory maintenance (incoming-outgoing), reports. The products are stored with inventory number, manufacturer, reorder level, present level, code number, description.

Order #7214 cassette version \$19.95
Order #7215 disk version \$24.95

Programs from Book #164

The programs from book no. 164 on cassette. (Book included)

Order #7100 \$29.00

Game Package

Games on cassette. (Bomber, tennis, smart, cannon fodder, etc.)

Order #7216 \$9.95



Microcomputer Hardware Handbook (845 pages) Descriptions, pinouts and specifications of the most popular microprocessors and support chips. A MUST for the hardware buff.

Order-No. 29
\$14.95

Care and Feeding of the Commodore PET

Eight chapters exploring PET hardware. Includes repair and interfacing information. Programming tricks and schematics.

Order #150 \$9.95

Payment: check, money order, VISA, MASTER-CHARGE, Eurocheck.

Orders from outside* USA: add 15% shipping. CA residents add 6.5% tax

*ATARI is a registered trademark of ATARI Inc.

*VIC-20 is a registered trademark of Commodore

SOFTWARE IN MACHINE LANGUAGE for ATARI

ATMONA-1

This is a machine language monitor that provides you with the most important commands for programming in machine-language. Disassemble, dump (hex and ASCII), change memory location, block transfer, fill memory block, save and load machine-language programs, start programs. Printer option via three different interfaces.

Order #7022 cassette version \$19.95
Order #7023 disk version \$24.95
Order #7024 cartridge version \$59.00

ATMONA-2

This is a tracer (debugger) that lets you explore the ATARI RAM/ROM area. You can stop at previously selected address, opcode, or operand. Also very valuable in understanding the microprocessor. At each stop, all registers of the CPU may be changed. Includes ATMONA-1.

Order #7049 cassette version \$49.95
Order #7050 disk version \$54.00

ATMAS

Macro-Assembler for ATARI-800/48k. One of the most powerful editor assemblers on the market. Versatile editor with scrolling. Up to 17k of source-code. Very fast, translates 5k source-code in about 5 seconds. Source code can be saved on disk or cassette. (Includes ATMONA-1)

Order #7099 disk version \$89.00
Order #7999 cartridge version \$129.00

ATAS

Same as ATMAS but without macro-capability. Cassette-based.

Order #7098 32k RAM \$49.95
Order #7998 48k RAM \$49.95

ATEXT-1

This wordprocessor is an excellent buy for your money. It features screen oriented editing, scrolling, string search (even nested), left and right margin justification. Over 30 commands. Text can be saved on disk or cassette.

Order #7210 cassette version \$29.95
Order #7216 disk version \$34.95
Order #7217 cartridge version \$69.00

GUNFIGHT

This game (8k machine-language) needs two joysticks. Animation and sound. Two cowboys fight against each other. Comes on a bootable cassette.

Order #7207 \$19.95

FORTH for the ATARI

FORTH from Elcomp Publishing, Inc. is an extended Fig-Forth-version, Editor and I/O package included. Utility package includes decompiler, sector copy, Hex-dump (ASCII), ATARI Filehandling, total graphic and sound, joystick program and player missile. Extremely powerful!

Order #7055 disk \$39.95

Floating point package with trigonometric functions (0 - 90°).

Order #7230 disk \$29.95

Learn-FORTH from Elcomp Publishing, Inc.

A subset of Fig-Forth for the beginner. On disk (32k RAM) or on cassette (16k RAM).

Order #7053 \$19.95

Expansion boards for the APPLE II



The Custom Apple + Other Mysteries A complete guide to customizing the Apple Software and Hardware

Order-No. 680 \$24.95

We also stock the boards which are used in the book "The Custom Apple" (bareboards)

6522 I/O Board No. 605 \$39.00

EPROM Burner No. 607 \$49.00

8K EPROM/RAM Board No. 609 \$29.00

Prototyping board for the Apple II No. 604 \$29.00

Slot repeater board for the Apple II No. 606 \$49.00

Order twin boards and get the book free!

COMING SOON I ORDER NOW I

A Look in the future with your ATARI

(Astrology and how to do your own horoscope on the ATARI 800, Order No. 171 \$9.95)

FORTH on the ATARI — Learning by Using

Order No. 170 \$7.95

ELCOMP PUBLISHING, INC

53 Redbrook Lane

Pomona, CA 91766

Phone: (714) 623 8314

Hardware — ADD-ONS for ATARI

PRINTER INTERFACE

This construction article comes with printed circuit board and software. You can use the EPSON printer without the ATARI printer interface. (Works with gameports 3 and 4).

Order #7211 \$19.95

RS-232 Interface for your ATARI 400/800

Software with connector and construction article.

Order #7291 \$19.95

EPROM BURNER for ATARI 400/800

Works with gameports. No additional power supply needed. Comes compl. assembled with software (2716, 2732, 2532).

Order #7042 \$179.00

EPROM BURNER for ATARI 400/800 KIT

Printed circuit board incl. Software and extensive construction article.

Order #7292 \$49.00

EPROM BOARD (CARTRIDGE)

Holds two 4k EPROMs (2532). EPROMs not included.

Order #7043 \$29.95

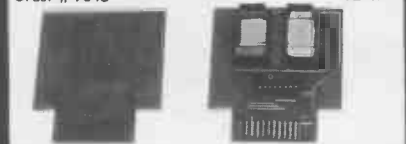

EPROM BOARD KIT

Same as above but bare board only with description.

Order #7224 \$14.95

ATARI, VIC-20, Sinclair, Timex and OSI

New — for your ATARI 400/800

Astrology and Biorythm for ATARI (cass. or disk). Order #7223 \$29.95

Birth control with the ATARI (Knaus Ogino) Order #7222 cass. or disk \$29.95

Books + Software for VIC-20 (requires 3k RAM Exp.)

#4870 Wordprocessor for VIC-20, 8k RAM \$19.95

#4883 Mailing List for VIC-20, 16k RAM \$14.95

#141 Tricks for VICs -The VICstory Progr. \$9.95

#4880 TIC TAC VIC \$9.95

#4881 GAMEPACK I (3 Games) \$14.95

#4885 Dual Joystick Instruction \$9.95

INPUT/OUTPUT Programming with your VIC Order #4886 \$9.95

#4896 Mini-assembler for VIC-20 \$19.95

#4881 Tennis, Squash, Break \$9.95

#4894 Runfill for VIC \$9.95

Universal Experimenter Board for the VIC-20 (Save money with this great board). This board plugs right into the expansion slot of the VIC-20. The board contains a large prototyping area for your own circuit design and expansion. The construction article shows you how to build your own 3k RAM expander and ROM-board.

Order #4844 \$18.95

Software for SINCLAIR ZX-81 and TIMEX 1000

#2399 Machine Language Monitor \$9.95

#2398 Mailing List \$19.95

Programming in BASIC and machine language with the ZX-81 (82) or TIMEX 1000.

Order #140 (book) \$9.95

Books for OSI

#157 The First Book of Ohio \$7.95

#158 The Second Book of Ohio \$7.95

#159 The Third Book of Ohio \$7.95

#160 The Fourth Book of Ohio \$7.95

#161 The Fifth Book of Ohio \$7.95

#151 8K Microsoft BASIC Ref. Man. \$9.95

#152 Expansion Handbook for 6502 and 6802 \$9.95

#153 Microcomputer Appl. Notes \$9.95

Complex Sound Generation

New revised applications manual for the Texas Instruments SN 76477 Complex Sound Generator.

Order #154 \$6.95

Small Business Programs Order #156

Complete listings for the business user. Inventory, Invoice Writing, Mailing List and much more. Introduction to Business Applications. \$14.90

OPUS SUPPLIES

Let you see out 1982 in style on their 12" RGB Colour Monitor

Only a limited quantity available at this price. For use with: BBC Micro; Apple III; Apple II with RGB Colour Gard; IBM Personal Computer Colour Gard; IBM Personal Computer and other computers with RGB Output.

SPECIFICATION

CRT 12v 90deg. Deflection — Slit pitch 0.63mm
Sync input signal. Composite Negative — H/V Separate Negative — H/V Separate positive. (Only for IBM P/C)

Video Input signal RGB Separation 1 Linear/More than 15MHz

Display Area. 214mmx158mm

Horizontal Resolution (At Centre) 380 Dots

Display Formats. 1500 Characters (5x7 Dots)

Power Source — AC 220V — 240v — 240v/50 Hz

Power Consumption 65w

Operation Temperature — 0deg C, 40degC,
Humidity 10deg, 80%
No Dew Forming

Dimension 320(W)x
393(D)x303(H)mm
Weight 12.5kg

Interface Lead for BBC Micro available. Call for details.

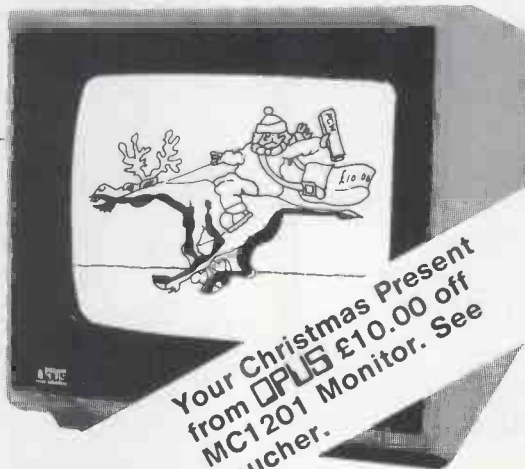

FOR ONLY

£199.95

Excl carriage and Vat

FEATURES

- * High quality 12inch Nectube
 - * Neat, attractive design to complement your Micro.
 - * Solid state circuitry for utmost reliability.
 - * Controls — Brightness
Horizontal hold
Vertical hold
Vertical position on/off switch
Vertical Sync
Horizontal Sync
Horizontal Position
Focus
- * 12 month guarantee

BRIGHTEN UP YOUR LIFE THIS CHRISTMAS

Why sit at home watching dull colours on your TV Set — when you could be watching brilliant colours and precise definition on our MC1201 Colour Monitor. Avoid all those family disputes, Christmas repeats; Channel Four; Terry Wogan; And visits to the Barbican Centre — Have a peaceful Christmas with one of our Colour Monitors.



Your CHRISTMAS GIFT From OPUS SUPPLIES

£10 OFF

OPUS
MC1201
Colour
Monitor

This coupon is redeemable only at OPUS Supplies and valid until 24/12/82. Only one coupon per purchase. Subject to availability.

TEC STARWRITER OPUS DESKS



A Professional Quality Daisywheel Printer For only £499.00 plus Carr plus VAT
A High Quality Daisywheel at a price you can afford
Diablo type mechanism
*** Uses Qume Sprint 5 Instruction codes**

- * Print Speed — 25cps
- * RS232-C Serial Interface
- * Tractor Feed

ATHANA FLOPPY DISCS — Manufactured in the USA
Individually tested and certified 100% error free
Superb quality at a realistic price

* Mini Discs with free plastic library case and Hub Rings*			
S/S S/D	£17.95 for 10	S/S D/D	£19.95 for 10
D/S D/D	£23.50 for 10	S/S 77 Track	£26.50 for 10
S/S 96 Track	£27.50	D/S 96 Track	£28.50 for 10
* 8" Discs			
S/S S/D	£15.50 for 10	S/S D/D	£24.50 for 10
D/S D/D	£25.50 for 10		

Hard sectored and all other discs available.

- * Manufactured by OPUS in the UK.
- * Available nationwide through our Dealer Network
- * Choice of 8 models — Choose within your budget
- * Cream and brown Coordinated design
- * Fully mobile — free castors — two with foot operated brakes
- * Ample space for hardware and peripherals
- * Through shelf for DiscDrives, Paperfeed, Files



* LET OPUS DESKS SUPPORT YOUR SYSTEM *

SEE US AT THE NORTHERN COMPUTER FAIR
BELLE VUE — MANCHESTER NOVEMBER 25-27th
ON STAND 426

HOW TO ORDER

Carriage should be added to prices at the following rates:
Monitor £7.00. Desks £8.00 Discs 85p Printers £6.00.

Please add carriage as applicable and then add VAT at 15% to the total and send cheque/P Order made payable to 'Opus Supplies' to Dept PCW, Opus Supplies 10 Beckenham Grove, Shortlands, Kent, BR2 0JU. Allow up to 28 days for delivery.
Telephone Order Hotline: 01-464 5040 (24 hour service) 01-464 1598

TRADE ACCOUNTS OPERATED — GOVT & EDUCATIONAL ORDERS WELCOME



New, battery operable HP75 personal computer. Desk Top

HP75 is truly portable, measuring only 10" x 5" x 1¼" and weighing as little as 26oz. It's the first personal computer ever to be designed by Hewlett Packard and sold by Sumlock Bondain for both portability and desk top performance. A problem solver that is both inexpensive and easy to use.

On the desk top HP75 ties into a range of HP peripherals including full size printers, graphic plotters and compact 'briefcase peripherals'. Other HP computers too.

And when detached HP75 will function as a completely portable, battery operable computer.

HP75 has a built-in time clock. Plus a magnetic reader, mass storage system, logging up to 1.3k bytes per card.

Also from Sumlock Bondain



The New HP86 personal computer. Offering the fullest set of HP solutions in our lowest priced package.

NOW IN STOCK
HP75 and HP86
 Buy them now



Software available for HP75 and Sumlock Bondain includes general purpose solutions and applications such as investment and finance, statistics and math. With 'software pacs' for specific applications. Sumlock Bondain offers the full range of Hewlett Packard personal, professional computers for business and scientific use. From hand held models to powerful desk top machines.

Plus all compatible Software for communication between them.

For further details of HP75, HP86 or the complete Hewlett Packard range, simply clip the coupon today!

SUMLOCK BONDAIN LTD.

263-269 City Road, London EC1V 1JX. 01-250 0505

Sumlock Bondain Ltd, 263-269 City Road, London EC1V 1JX.

Further information please tick the appropriate box(s) below

HP75 HP86 HP Range

Name _____

Position _____ PCW 12

Company _____

Address _____

Postcode _____



-or portable



Accounting Business Systems

TABS



SOFTWARE.

THE FIRST CHOICE FOR SOLVING YOUR

BUSINESS PROBLEMS.



With intense competition existing between rival hardware companies, TABS software remains the largest selling accounting business software in the UK.

Few business applications are beyond the scope of this immensely popular, fully integrated, modular system which currently comprises: Sales Ledger, Purchase Ledger, Nominal Ledger, Job Costing, Stock Control, Payroll, Fast Data Entry, Sales Order Processing, Management Accounts, Invoice Compiler, Mail List, Word Processor.

Not only is the system designed to help with all the functions of a busy office but it is also designed to run on most micro-computers including the "new generation" 16 bit machines.

With over 2,500 installations and over 14,000 modules being run in the UK and overseas its unparalleled success has been due not only to the proven quality of the software but also to the friendly, unbiased advice that we give our visitors at our regular free seminars and demonstrations held throughout the country.

Further, great care is taken in training our Accredited Dealers and our end users so that when you choose TABS software you are also choosing a product which is fully supported both by your Accredited Dealer and by TABS own personnel.

To find out how the businessman's number one choice would help you and your business phone Andover (0264) 58933 or fill in the coupon.

Free London Demonstrations and Seminars are held at the World Trade Centre within a few minutes walk of Tower Hill tube station.

PARTICIPATING DEALERS: LONDON: Andrew & Co 01 402 6911; Data Management Systems 01 739 8692; Q.E.D. Computers 01 959 7403/8346. AVON: Colston Computer Centre Ltd 0272 276619. BERKSHIRE: Decision Support Systems Ltd 0628 76887; Thames Valley Systems 0734 581829. BUCKINGHAMSHIRE: Cardinal Computers Ltd 06284 73776/73074. CHESHIRE: Desktop Computing 0925 415415. DERBYSHIRE: FBC Systems Ltd 0332 365280. DEVONSHIRE: Keel Data Systems 054 884 3520. GLOUCESTERSHIRE: Computer Shack 0242 584343. KENT: A.E.C. Business Systems 0732 864829; Page One Systems Ltd 0795 53116; The Data Processing Co Ltd 0303 41618. LANCASHIRE: Mipac Services 0524 62033. LINCOLNSHIRE: ZR (Computers) 0522 31621. MANCHESTER: Sumner Jackson & Co Ltd 061 832 8261. NORFOLK: Synergy Computer Systems Ltd 0603 503015/6/7. NOTTINGHAMSHIRE: Micro People Ltd 06076 69117. SOMERSET: Computer Sales & Marketing 06438 3526; The Computer Room 0935 73023. SURREY: Computron 01 943 1113; Interlex Ltd 01 943 0968; Micro-Engineering Ltd 01 930 5678. SUSSEX: Computaccount 08926 5765. TYNE & WEAR: Microcore 0632 846878; Quality Micro Products 0632 614646. WEST MIDLANDS: Beta Computer Services 0676 34664; Datacraft (Computer Systems) 021 705 1906; I.S.L. Ltd 0922 26282; P.J. New Computers Ltd 021 742 6801. WILTSHIRE: Fyne Computing 0722 20323; J.R.M. Software Ltd 02214 65691. WORCESTERSHIRE: Spinks Computer Systems Ltd 0905 29466. NORTHERN IRELAND: FAGS 0662 47618. WALES: DYFED: Aberdara 09745 344. SOUTH GLAMORGAN: Data Plant 0222 40411.

Please complete and return the coupon to TABS Ltd, Sopers House, Chantry Way, Andover, Hants. SP10 1PE.

- 32 page introductory booklet
- User Book (please send £10.00 (inc. P&P))
- Details on Free Seminars and demonstrations
- Dealer plans
- Price List
- Video Training Tapes

Name _____
Address _____
Tel. No. _____
I enclose cheque/postal order for £ _____
Signature _____ **Andover (0264) 58933**

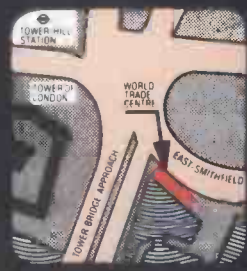

North Star's ADVANTAGE is easy to see.

The best value in microcomputing.

The North Star ADVANTAGE is the perfect low cost micro-computer for business or personal use. With 720Kb of floppy disk storage, or an optional 5Mb Winchester disk, the North Star ADVANTAGE offers the most memory in its price/performance class. And it comes with advanced business graphics software at no extra cost. You can look everywhere, but you won't find a better micro-computer for the money.

High performance computing and high performance software.

The North Star ADVANTAGE system offers high speed computing based on the Zilog Z80A® microprocessor, the most accepted 8-bit microprocessor in the world, plus an Intel 8035 auxiliary processor. 64Kb of RAM main memory delivers fast program execution, with an additional 20Kb of RAM for the graphic display. North Star provides graphics software com-

patible with CP/M® and HDOS operating systems and application packages, and most standard languages. There are thousands of CP/M compatible software programs available throughout the world. Or you can choose any of the North Star application



packages available for word processing, financial analysis, accounting and data base management.

Graphic displays for every need.

The free North Star ADVANTAGE BUSIGRAPH™ package makes it possible to generate line, bar, pie, and 3-dimensional charts, plus complex 3-dimensional forms. Reports can be transformed into impressive hard copy graphic displays in a matter of seconds.

Build a network of ADVANTAGES.

One North Star ADVANTAGE computer can be linked to other North Star ADVANTAGES by twisted pair cable using North Star's new network interface and software package. This allows you to have a low cost network of individual systems sharing the more expensive peripherals. This can be the first step toward fully automating an entire office or department.

Convenient design and service.

The North Star ADVANTAGE is a fully integrated micro-computer in an attractive, integrated enclosure. It provides high reliability and excellent operator comfort, plus straightforward servicing. For more information about the North Star ADVANTAGE, contact... North Star Computers Inc. Arabellastrasse 5/133 c, Postfach 810623, D-8000, Munich 81, Telephone (089) 91 83 58, Telex 521 5772 ibs

FOLLOW THE STAR

NorthStar™

CP/M is a registered trademark of Digital Research, Inc.

North Star Computers Inc.

14440 Catalina Street, San Leandro, CA 94577 USA (415) 357-8500, TWX/Telex (910) 366-7001

Don't spend more than £500 on a Local Area Network until you know about Clearway



Clearway

The best low cost local area networking device

Clearway brings the benefits of Local Area Networking to you **at very low cost**. So if you're thinking about a networking system be sure to find out more about Clearway, the low cost solution that anybody can install.

Available from Johnson Microcomputers, Camberley (0276) 20446, Oxford (0865) 721461, Bristol (0272) 422061

Mail the coupon now for full information

Real Time Developments Limited, Lynchford House, Lynchford Lane, Farnborough, Hampshire GU14 6JA. Telephone: Farnborough (0252) 546213 Telex: 858893 Fietel G

I am interested in Clearway – the low cost Networking System, please send me details

Name

Position

Address

.....

.....

Telephone

Send to: Real Time Developments Limited,
Lynchford House, Lynchford Lane,
Farnborough, Hampshire GU14 6JA
Telephone: Farnborough (0252) 546213
Telex: 858893 Fietel G

8212PCW



When your computer goes down will it be an inconvenience or a disaster?

Microcomputer systems form an indispensable part of our modern working life. Their power and convenience make it easy to forget just how complex they are – until they go wrong!

We hope you will have talked to us long before that happens. In a 'crisis', a fast reliable response is the only type of service you are going to accept.

microserve offers you a complete range of servicing, maintenance and repair plans. With our **microsure** maintenance contract, for example, we'll have a fully trained service engineer on your door step within hours. Other servicing plans include installation, workshop repair and system upgrades.

microserve are specialists in the maintenance and service of Cromemco, North Star and Comart Microcomputer systems.

We operate from service centres throughout the UK, with the technical support of one of the largest microcomputer groups in the country.

For more information, call us today on 0480 215005, or fill in and return the coupon below. It won't inconvenience us, but it might save you from a disaster!

To: microserve, Freepost, Little End Road, Eaton Socon, St Neots, Huntingdon, Cambridgeshire PE19 3BR.

Name

Company

Position

Address

Tel. no.

microserve™

A service of the Comart group of companies
London, Manchester, Birmingham, Glasgow, Nottingham, Southampton, Cambridge.

G.W. COMPUTERS LTD

LONDON'S WEST END - NATIONWIDE OVERNIGHT SERVICE
 NEW FORMAT ADVERTISING - MORE PRODUCT RANGES - LOWER SYSTEM PRICES - BETTER SERVICE

**** THE NEW DBMS III (series III of the world's first 'task-robot-programs') ****
 **** FEATURES ****

MBasic & word-star compatible
 1400 character record sizes
 mathematical scratchpad
 record relational indexes
 translatable to any language
 User-definable reporting
 field protection/classification
 sorts 'alpha or numeric' any window
 either-or.same as.greater.smaller

32000 records per filename
 20 main/200 sub fields per record
 field and record related formulae
 'Jump-to' any of 32000 records per file
 random/binary/key/multiple field search
 'if-then' questioning
 file protection/password entry
 speed of 500 records per 20 seconds
 range match.not match.integer match

12 online file architectures
 240 fields using cross-referencing
 cross-record calculations
 'Jump-to' any record in 12 files
 User-definable files/field words/sizes
 endless 'either-or' matching
 formulate/recall on selection criteria
 12 interrogation question types
 short filing output/audit trails

ONE OF THOUSANDS OF DIFFERENT TASKS ON WHICH THIS PROGRAM MIGHT BE EMPLOYED

DBMS'S MACROS WORK FROM THE MOMENT YOU INSERT THE 'TASK DISK' IN THE COMPUTER'S DRIVE
 Simply design your file, give its fields your words, setup your report mask, and then enter your records. Switch to 'automatic drive' and formulate any task you wish the program to fulfill, the task is stored as

a macro. Take a copy of the program on another 'task disk' and from then on, the task disk will function without a single keystroke. Think of a number of such 'task disks' such as "stock-re-order reports"; "stock-valuation reports"; "sale-mail-shots"; "production-process-analysis"; "patient history analysis"; "research-analysis"; "budgetting"; "purchase/sales-analysis"; "personnel-file-analysis"; "vehicle-location control"; "librarian analysis"; "plus more?"

Last issue we showed an example of 'short-listing' of employees for a prospective job. Here is an example of a garage stock file and two reports it might generate.

The record may look like this
 1- record number (23)
 2- part number (fiat_grill 109)
 3- location (bin 44)
 4- cost price (29.00)
 5- selling price (38.00)
 6- minimum stock (5)
 7- maximum stock (12)
 8- current stock (3)
 9- manufacturer (Fiat motor company)
 10- on order (qty) (<9>)

One report might be: select??
 all records where the current stock is lower than the minimum stock
 When found, subtract current form maximum, and produce a printed list of the manufacturers name; part number; and re-order quantity
 Update the record in field 10 with the quantity ordered.

Another report might be: select??
 all records in the file; calculate the values of current stock multiplied by cost price for each record. Add the values together for every record at location London or Glasgow or Leeds and print a list of all such records showing stock values 'Individual' and for the specific locations

(next issue's example sale ledger)

DBMSII (WITHOUT MACROS) AND DBMS III ARE FULLY IMPLEMENTED UNDER CPM-86 (tm) AND MSDOS (tm) ie: <SIRIUS/VICTOR/IBM> DBMSII IS 395.00 (or 250.00 by mail order ex. training). DBMSIII IS 575.00 (or 295.00 by mail order ex training)

MICRO-COMPUTERS

GWL	- G80 64K/INTFC PORTS/KBOARD	795 00
	- G 80 IVDU	150 00
	- G80 DUAL-D/DRIVES ENCLOSED	550 00
INTERTEC	- SUPERBRAIN 64K RAM/320K DISKS	1695 00
	- SUPERBRAIN 64K RAM/700K DISKS	2195 00
	- SUPERBRAIN 64K RAM/1.5M DISKS	2595 00
	- SUPERBRAIN 64K RAM/10M DISKS	call 00
	- COMPUSTAR 64K RAM/OK DISKS	1495 00
	- COMPUSTAR 64K RAM/320K DISKS	1995 00
	- COMPUSTAR 64K RAM/700K DISKS	2495 00
	- COMPUSTAR 64K RAM/1.5M DISKS	2895 00
NORTH STAR	- ADVANTAGE 64K RAM/700K DISKS	£2095 00
	- ADVANTAGE 64K RAM/5.3M DISKS	£2995 00
	- HORIZON 64K RAM/700K DISKS	1950
	- HORIZON 64K RAM/5.3M DISKS	3595 00
	- HORIZON 64K RAM/18M DISKS	4595 00
TELEVIDEO	- 800 64K RAM/OK DISKS	1195 00
	- 802 64K RAM/700K DISKS	1995 00
	- 802H 64K RAM/7.3M DISKS	3595 00
	- 806 64K RAM/10M DISKS	4595 00
	- 816 256K/750K DISKS	£2950 00
ACT VICTOR	- SIRIUS 1 128K/1.2M DISKS	£2395 00
	- 9000 128K/1.2M DISKS	£2395 00
OSBORNE	- 806 64K RAM/200K DISKS	1250 00
IBM	- PC 64K RAM/64K DISKS	£2695 00
	- PC1 330K/640K DISKS	£2995 00
ATARI	400/830 16K RAM	call 00
EPSON	HX/2D 64K RAM	call 00
PET	8032 32K RAM	695 00
	8050 1 MEG DISKS	695 00
	n4 CBM PERSONAL COMPUTER	call 00
APPLE	II 64K RAM	675 00
	III 128K/143K DISKS	2095 00
ALTOS	ACS800-2 64K RAM/1M DISKS	1995 00
	ACS800-10 208K/10.5MEG DISKS	4995 00
NEC	PC8001/12 64K RAM/350K DISKS	1695 00
	APC 128K RAM/2M DISKS	call 00
CORVUS	CONCEPT 16 BIT PC	call 00
SANYO	G80 64K RAM/320K DISKS	1350 00
	G81 64K RAM NETWORKER	1250 00

All computer prices inc mbasic as standard
 All prices marked £ are 8/16 bit machines

SYSTEM DEALS

Choose any computer & any printer (over 800 pounds)
 add 10% for full 12 month warranty (12.5% maintenance)
 add 150.00 for blank diskettes
 add 175.00 for cables, delivery and installation
 training optional extra 100.00

and get complete ***FREE***
 cpm handbook .50 basic exercises .2000 sheets paper
 DBMS III .magic wand w/proc .magic calc
 mbasic 80 .diagnostics .msort/dsort
 recover .autoload .instant basic
 cbasic .disk/games .library case

total value 1480.00
 Buy a system including a hard disk and get FREE
 the G80/86 software packages value 690.00

PRINTERS

OKI	-MICROLINE 80	295 00
	-MICROLINE 82A	395 00
	-MICROLINE 83A	695 00
	-MICROLINE 84	895 00
EPSON	-MX80 FT-3	375 00
	-MX100 FT-3	495 00
	-DP 9000	895 00
	-DP 9501	1045 00
	-DP 9501(A)	1145 00
	-9 45 P O	1795 00
	-9 55 P O	1495 00
	-9 95 P O	1395 00
NEC	-3510 P O	1795 00
	-7710 P O	1795 00
	-5520 KSR	1295 00
DRE	-8820	1695 00
	-8830	1295 00
TEXAS	-815	1395 00
	-820	1695 00
	-RICOH	1495 00
	-RP1600	995 00
OLYMPIA	-ESW 103	995 00

PERIPHERALS & ACCESSORIES

CORVUS	-6 MEG HARD DISK	1950 00
	-11 MEG HARD DISK	2950 00
	-20 MEG HARD DISK	3950 00
	-MULTIPLXOR 7 STATION	695 00
	-MIRROR BACKUP CARD	695 00
	-PERSONALITY CARD	185 00
INTERTEC	-COMPUSTAR 10 MEG HARD DISK	2950 00
	-CDC 96 MEG HARD DISK	7950 00
NSTAR	-16 BIT U GRADE	325 00
	-18 MEG HARD DISK	2995 00
RODIME	-6 MEG HARD DISK	1495 00
	-12 MEG HARD DISK	1950 00
MORROW	-26 MEG HARD DISK	3295 00
CCC	-5 SIDED FLOPPY DRIVES	150 00
	-D SIDED FLOPPY DRIVES	225 00
	-D SIDED TRACK DRIVES	375 00
MEMOREX	-SOFT HARD S SIDED DISKE 11ES(110)	30 00
	-SOFT HARD S SIDED DISKE 11ES(150)	125 00
	-SOFT HARD S SIDED DISKE 11ES(1100)	200 00
OYSAN	-104 2D DOUBLE SIDED (10)	50 00
	-104 2D DOUBLE SIDED (50)	225 00
	-104 2D DOUBLE SIDED (100)	400 00
SCOTCH	- 104/2D DOUBLE SIDED	225 00
	- 104/2D DOUBLE SIDED	400 00
SS E	-SOFTBOX PET TO CPM	495 00
	- SIRIUS 8/16 BIT 5MHz CARD	365 00

NOTE CORVUS DRIVES WITH MULTIPLEXOR MAY NETWORK
 SIRIUS .SUPERBRAIN .CONCEPT .PET .VICTOR .IBM

SOFTWARE

G.W.L.	- BUS V8.00	575.00
	- DBMS II	£395.00
	- DBMS III	£250.00
	- DBMS III	£575.00
	- DBMS III	£295.00
	-DSORT & MSORT (MBASIC FILES)	£ 75.00
	- SALES LEDGER	£ 95.00
	- PURCHASE LEDGER	£ 95.00
	- NOMINAL LEDGER	£ 95.00
	- STOCK CONTROL	£ 95.00
	- ADDRESS-MAILER	£ 95.00
	- INVOICER	£ 95.00
	- QASORT/QNSORT (500 RECS/14 SECS)	£ 95.00
	- AUTOLOAD & RECOVER	25.00
MICROSOFT	-MBASIC 80	150 00
	-1695 CJ	200 00
	-FORTRAN 80	320 00
	-COBOL 80	190 00
	-BASIC COMPILER	95 00
	-MULISP MUI STAR	195 00
MICROPRO	-WORD-STAR	55 00
	-MAIL-MERGE	100 00
	-SPELSTAR	170 00
	-DATASTAR	120 00
	-SUPER-SORT	350 00
	-W*STAR M MERGE SP-STAR	75 00
BYROM	-BSTAM (COMMUNICATIONS)	85 00
	-BSTMS	30 00
DIGITAL	-DESPOOL	75 00
	-CBASIC	225 00
	-PASCAL MT	95 00
F GELLER	-QUICKSCREEN	195 00
LEXISOFT	-SPELLBINDER	155 00
LIFEBOT	-T MAKER	420 00
MFOCUS	-CIS COBOL	100 00
	-FORMS II	185 00
SORCIM	-SUPER CALC	250 00
	-PASCAL M	195 00
STANDARD	-QUICK EASY	190 00
PEACHTREE	-MAGIC WAND	175 00
	-MAGIC CALC	50 00
S SOFT	-DIAGNOSTICS	250 00
N WEST	-STATPAK	35 00
OASIS	-THE WORD	100 00
ITHACA	-PASCAL Z	100 00

Software formats on all micros in our hardware list
 All prices marked £ are available 8/16 bit formats

TERMS & ETC

G.W. Computers Ltd (Grama (Winter) Ltd.)
 55 Bedford Court Mansions
 Bedford Avenue
 London W.C.1. England.
 Tel: 01-636 8210 01-631 4818 fax: 892031 TWC G
 Boston office tel 94 0890

24 hour answerphones-leave address for infopacks
 We do not operate a reader's reply card: Terms are
 C.W.O. or C.O.D Prices exclude VAT. No dealers
 The above lists are not exhaustive.

Please call only by prior appointment

G80/86 SOFTWARE

Fully implemented on
MS-DOS, CPM 2.2
and CPM 86 (tm)

Works on IBM, Sirius and
Victor 9000

Sale ledger (95 pounds)
Purchase ledger (95 pounds)
Nominal ledger (95 pounds)
Aged analysis (25 pounds)
Stock control-valuation/re-order (95.pounds)
The invoicer (95.pounds)**
The address mailer (95.pounds)
The spread-calc (95.00)
The sales/purchase order-book (95.00)**
Bankbook (95.pounds)**
Qasort/Qnsort (500 records/15 seconds) (95 pounds)

Each module is a set of 'task disks' designed for minimal learning curve. This software derives from modules of 'DBMS III' and runs reports without your secretary having to touch a single key.

Consider the advantages in these features. The user manual is contained in FIVE pages. All reports are generated by robot functions. Reliability tested (benchtest PCW June). Words in a network multi-user environment. Fast easy data entry. Files are re-organised and sorted automatically. Produced by the same people that originated 'BUSINESS', 'DBMS II', 'DB-CALC', 'AUTOLOAD AND RECOVER', 'ETC' and sold successfully over the past five years. Also see our advertisement page, the software above comes free with a system purchase. (excluding items marked ** and DBMS III)

THE G80/86 NETWORKS

Based upon one hard disk and multiplexor module the G80/86 networks feature full network sharing of data resources by adding different stations that may be as various as Sirius/Victor 9000/IBM/Superbrain/Pet/N'star/Sanyo. The low-cost startup of a network could be simply

1 hard-disk of 5 mbytes.	1 multiplexor	1-2 stations
2100.00	695.00	from 795.00

We also have a special 'spooler module' for routing output to either a printer or modem so that a number of terminals may share the resources of one printer, as well as be able to send files over the telephone at any time (day/night) to both store on the hard disk and print out as well.

Imagine a terminal at a remote site, being able to send/receive its files to/from the main network's hard disk/printer overnight to be examined and processed the next day. The commands are literal English. Like: (send file 'ledger' to port 'B' (the modem) at 11.30) only from G.W. Computers (the leaders in database)
call us on 01-636 8210 or 01-631 4818 and leave your address for our standard 'infopacks'
Purchasers of a network (h'disk, micro, printer). Get the system deal and above software list... FREE



Diskwise Ltd. Computer Centres

SOUTH WEST & NORTH WEST

Computer enthusiasts look no further

WE STOCK THE FOLLOWING PRODUCTS:

Dragon 32K	£174
Colour Genie 16K	£174
Vic 20.....	£145
Newbrain 'A'	£199
Newbrain 'AD'	£229
Apple II 48K.....	£730
Apple III.....	£2418
Act Sirius I	£2395
Microline 80 Dot Matrix Printer	£220
Epson MX80 Dot Matrix Printer	£389
Smith Corona Daisy Wheel Printer ...	£485

... AND LOTS MORE ...
Above prices plus VAT

Paper, Discs, Books, Games and the largest range
of APPLE BUSINESS SOFTWARE in the area.

STOCKPORT
68-70 Lower Hillgate
Stockport, Cheshire
Tel: 061 477 5931

PLYMOUTH
Deptford Place
North Hill, Plymouth
Tel: 0752 267000

ZX SPECTRUM HARDWARE 24 line programmable Input/Output Port

This new port has been designed exclusively for the ZX Spectrum and utilises MOS technology to minimise bus loading.

The main features are:

- 3 x 8 bit ports
- Port mapped using IN and OUT commands
- 3 basic modes of operation
- Direct Bit Set/Reset capability
- Outputs capable of sourcing 1mA @ 1.5 volts
- Access via 3 x 16 pin DIL sockets and 28 way edge connector

The port is available fully built together with a set of detailed instructions and suggested control applications. The port can either be used with our new Motherboard thus allowing a further card to be used, or with a stackable connector. Either way, it means that Micro-Drives, Printers etc. will run happily with the port.

ZX Spectrum PPI Port	£16.50
ZX 2 Slot Motherboard	£16.95
ZX Stackable Connector	£5.50

The prices are inclusive of VAT but postage must be added at 70 pence for a single item (100 pence for 2 or more items).

New Spectrum Joystick with controller and driving software. £19.50p inc VAT.

See us at the Northern Computer Fair.

KEMPSTON ELECTRONICS

180A BEDFORD ROAD,
KEMPSTON, BEDFORD.
PHONE:— 0234 852997

ATARI 400 48K

ATARI 400 48K
WITH PROGRAMMERS
KIT



NOW ONLY
£299.99

INC VAT

Available from these specialist micro-computer stores for a limited period only. Offer ends December 25th 1982

Mail order available add £10 p&p.

<p>CALISTO COMPUTERS</p> <p>119 JOHN BRIGHT ST BIRMINGHAM B1 1BE 021-632 6458</p>	<p>LANSDOWNE COMPUTER CENTRE</p> <p>5 HOLDENHURST RD BOURNEMOUTH BH8 8EH 0202 20165</p>	<p>NORMAN AUDIO</p> <p>51 FISHERGATE PRESTON LANCS 0772 53057</p>	<p>SILICON CENTRE</p> <p>7 ANTIGUA ST EDINBURGH EH1 3NH 031-557 4546</p>	<p>VISION STORE</p> <p>3 EDEN WALK PRECINCT KINGSTON-ON- THAMES SURREY 01-546 8974</p>
---	---	---	--	--

Venturesoft

SPECTRUM SOFTWARE SPECIALISTS

ALL OUR PROGRAMS ARE SPECIALLY WRITTEN
FOR THE SINCLAIR SPECTRUM IN MACHINE CODE

INSPECTOR (V2.0)

A MACHINE LANGUAGE MONITOR/UTILITY

- Ultra-fast response
- Full screen memory display and modification — Hex and ASCII with cursor control

- Debugging facilities — breakpoints and register display
- Full search facilities for bytes /words /strings.

- Call and jump to any machine code routine

Plus COMPREHENSIVE
20 PAGE MANUAL

- £6.50 each (inclusive)

SPECTROID STORM

AN ARCADE QUALITY GAME

- Superb quality graphics
- Full colour and sound
- Four different types of asteroid

- Two alien craft
- Two types of saucer
- Left and right rotate, thrust fire and hyperspace

- Full screen wrap around
- Bonus ships, high score table
- £5.50 each (inclusive)

Make cheques/postal orders to:

VENTURESOF
ISALCOT 25/29 TOLLINGTON PARK LONDON N4 3RE

A SPECIAL DEAL for software dealers

cp/m
software

CP/M is the registered trademark of Digital Research Inc.

Top Discounts ... on any quantity

Xitan Systems offer a comprehensive range of software products, with top discounts for registered dealers — regardless of the quantity or value of the order — as well as top-level service and support. Write or phone for our new Software Guide.

DIGITAL RESEARCH

All Digital Research products, including concurrent CP/M-86 for the IBM Personal Computer and CP/M Version 3.0 — the new 'fast as lightning' CP/M.

MicroPro

All MicroPro products, including Wordstar, Spellstar, Mailmerge, Datastar, Supersort, Calcstar etc.

Other Products

Products from most major manufacturers, including Ashton-Tate, Avocet, Bytesoft, Byrom, Ecosoft, MicroCal, Microfocus, Microsec, Sapphire and — of course — Xitan.

Xitan Systems are the systems software house and CP/M distributors of the Comart Group, and Main U.K. Distributors for Digital Research Inc. and MicroPro Inc.

XITAN SYSTEMS

XITAN SYSTEMS LTD
23 CUMBERLAND PLACE
SOUTHAMPTON SO12BB
TEL 0703 38740

Dealers! Visit us at COMPEC U.K. — Stand V12

ASCO BUSINESSES

43 Windmill Way, Reigate, RH2 OJB Rei 48055

ACT
Sirius 1

OLIVETTI
PRAXIS 35



£385

Beautifully designed powerful & versatile 128k RAM. Disc drive of 1.2Mbyte. Superb graphics and a lot more! £2395

- * Daisy Wheel Electronic typewriter/printer
- * Centronics Interface
- * Friction Feed
- * Correction Ribbon
- * Choice of typestyles

OLIVETTI 121 AT A SPECIAL PRICE!

SEIKOSHA

can you take a Dragon home? Catch 32!

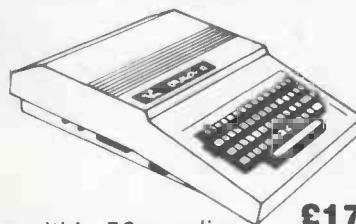

GP100 — £185
VC20 — £210
250X — £240

Add VAT, free delivery within 50m radius.

£173

DIGITAL SOLUTIONS

offers EPSON printers at the lowest prices available.

- * IBM recommended
- * compatible to all microcomputers
- * bi-directional and logic seeking
- * bit image printing

	speed	RRP	Our price	Your saving
MX80 type III	80cps	£349	£275	£74
MX80 type III F/T	80cps	£389	£315	£74
MX82 F/T	80cps	£409	£335	£74
MX100 type III F/T	100cps	£499	£415	£84

Full range of interfaces available at discount rates.

All prices exclusive of VAT and £10 p&p.

Orders to:
DIGITAL SOLUTIONS
28 Rowley Rd
St. Neots
CAMBS.

Enquires:

0480/860549 (office)
0767/40387 (J. Papworth after 6pm)

STOP PRESS: We offer the lowest prices for a large range of micros and peripherals — call us on 0767/40387 before you buy elsewhere and we will tell you within 24 hours whether we can save you money.

CP/M 80 Software for popular micros

LANGUAGES

C COMPILER (Whitesmith's) £455/£25
This compiler conforms to the full UNIX version 7 implementation of the C language, which has more facilities than Pascal or BASIC and produces faster code.

RCC/80/C: CORAL 86 £825/30
The high level programming language designed by RRE for industrial and military command and control systems, implementing the complete CORAL 86 language as defined in BS 5905, except for the rarely used optional Fixed point feature. Comprehensive documentation is provided based on BS 5905. Compiler output is in assembler source form.

BASIC-80 (Microsoft) £175/NA
This is Microsoft Extended BASIC interpreter, version 5. It is a powerful, ANSI compatible disk BASIC with many features not found in PET BASIC, such as WHILE/WEND, chaining, variable length file records, double precision floating point, PRINT USING facility, error trapping, hexadecimal numbers and more.

BASIC COMPILER (Microsoft) £205/NA
This compiler is language compatible with the Microsoft version 5 interpreter but generates 8080/Z80 machine code, so that program execution is typically 3 to 10 times faster.

COBOL-80 (Microsoft) £375/£20
An ANSI 74 COBOL compiler producing relocatable modules compatible with FORTRAN-80 or MACRO-80 output. COBOL-80 has a complete ISAM facility and interactive screen handling.

CIS-COBOL (Microfocus) £425/£30
An ANSI 74 standard COBOL compiler full validated by U.S. Navy tests to ANSI level 1. The compiler also supports many features of level 2 including dynamic loading of COBOL modules and a full indexed sequential (ISAM) file.

FORTRAN-80 (Microsoft) £230/£20
The popular science and engineering language, complying with the ANSI '66 standard (except for the COMPLEX data type), with enhancements such as mixed mode arithmetic.

PASCAL/MT + £375/£20
A Pascal compiler meeting the ISO standard, with many enhancements including full string handling capability and random access files.

PRO PASCAL £190/£19
This Pascal Compiler implements the full proposed standard with improvement extensions such as random access files, strings and program segmentation. Pro Pascal is designed specifically for the Z80 and produces relocatable machine code which is very fast and compact. A linker and cross-reference generator are provided, and Pro Pascal object code may be used in READ only memory.

PL/I-80 (Digital Research) £325/NA
A general purpose application programming language giving mainframe capability for developing large-scale structured programs in a microcomputer environment.

DATA MANAGEMENT SYSTEMS

dBASE II £385.00
An interactive relational database management package with full screen formatting and its own fully structured high level command language. Interactive data entry and validation with WordStar-like commands. Allows you to develop application packages in days rather than months.

PERSONAL PEARL £190/NA
Allows custom application programs to be created using English Language interaction with the system. Includes Report and Help facilities and an independent data base manager. Also includes an interface to Supercalc.

TELECOMMUNICATIONS

BSTAM £115/NA
This telecommunications utility permits any type of CP/M file to be transferred to or from another computer also equipped with BSTAM. Transmission occurs at full speed with CRC error checking and automatic error recovery.

BSTMS £115/NA
An intelligent terminal program permitting communication with a mainframe computer.

WORD PROCESSING

WORDSTAR (MicroPro) £255/35
A powerful screen-oriented word processor designed for non-technical personnel. Text formatting is performed on the screen, so that what you see is what your print-out will look like. WORDSTAR's advanced facilities include justification, pagination, undercores, boldface, subscript and superscript, block movement of text.

MICROSPELL £165/NA
This is a spelling help program which scans through a document file stopping at each dubious word, offering correctly spelt alternatives and allowing you to correct the word with a keystroke.

NUMERIC PROBLEM SOLVING TOOLS

MICRO MODELLER £425/NA
The number one Financial Modelling and forecasting program.

STATPAK £260/£20
A professional statistics and probability package which can rapidly handle large files of data.

SYSTEM TOOLS

CROSS ASSEMBLER £95/£10
XASM 05, 09, 13, 0 48, 65, F8, 65, COPS 400 and 51
Cross assemblers for the Motorola 6505, Motorola 6809, RCA 1802, Intel 8048, Motorola 6800, Fairchild F8, MOS Technology 6502, National Semiconductor 400 and Intel 8051 families.

CP/M 80 for the Sirius

Sirius 80 Card

- Allows all standard CP/M 80 2.2 software to run without modification.
- The card simply plugs into any one of the four internal expansion slots and comes complete with a disk containing all the usual CP/M utilities.
- By typing a single command, the system can alternate between CP/M 80 and CP/M 86. Files generated under either CP/M are identical in structure, providing file compatibility between operating systems.
- The card also has a Corvus hard disk interface allowing the Corvus range of Winchester drives to plug directly into the SIRIUS.
- Z80 4 or 6 MHz with no wait states.
- 64K RAM
- Corvus hard disk interface.
- Multi-user with hard disk-
- Up to 64 Sirii can share 1 hard disk.

Sirius 80 card (4 MHz) £299.00
Sirius 80 card (6 MHz) £335.00

CP/M 80 for the PET

Softbox

Features:-

- CP/M version 2.2 with menu driven system configuration.
- Z80 CPU running at 4MHz with no wait states.
- 64K RAM
- Operates with any 2000, 3000, 4000 and 8000 series Commodore computer.
- Supports up to 8 Commodore 3040, 4040, or 8050 disk drives.
- Supports up to 4 Corvus hard disks of 6, 11, or 20 MBytes.
- RS232 serial interface with software-definable baud rates for use with a printer, modem or terminal.
- Diskette containing operating system with utilities.
- Comprehensive user manual.

A full range of CP/M languages and applications software on Commodore 8050 or 4040 format is available.

Price £495.00

CP/M 80 software is available on formats to suit most popular micros. Dealer enquiries welcomed.

CP/M is a registered trademark of Digital Research Corp.

For a complete list of Small Systems Software and Hardware products please return the coupon.

Name

Address

.....

.....

small systems engineering limited

2-4 Canfield Place, London NW6 3BT. Telephone: 328 7145 Telex 264538

Double Duty... Single Price
 Low Cost, Daisy Wheel Quality Typing & Printing
BEST PRICES AVAILABLE

FEATURES

- **Interchangeable Daisy Wheel**
- **Automatic Correction** (10 Char Memory)
- **Foreign Keyboard Selection**
- **Interchangeable Ribbon Cartridge**
- **11 Inch Printing Line Length**
- **Standard RS-232C Serial Interface**
- **Hardware Handshake & Software Protocols**
- **Selectable Baud Rates** (110, 300, 1200)
- **165 Character Buffer**
- **Approx 12 CPS Printing Speed**
- **UNIVERSAL, SERIAL COMPUTER INTERFACE**
 (adapts to any RS-232C computer port)



OLIVETTI PRAXIS 35

OLIVE-80

Praxis 35 plus Olive 80 £435.
 Olive 80 plus instal kit £145
 All prices plus VAT
 Tel: 045 088 297

YOUR COMPATIBLE COMPANION

olive branch
 Association, Ltd.

SO YOU WANT TO PLAY GAMES

sinclair
ZX Spectrum 16K or 48K model

GROUND FORCE ZERO!!

JUST £5

The ground force has been defeated so the air attack must begin, and you're in control. A super fast, arcade quality, action game for your 16K or 48K Spectrum!



TEXAS INSTRUMENTS TI99/4A

MISSION 99 STANDARD MACHINE JUST £6

Here now is the game every owner of this outstanding machine has been waiting for, Mission 99.

It's sunset in Manhattan when you are sent on a merciless bombing raid. The only way down is to flatten the city. Runs on the standard machine, supplied on cassette. For an unbeatable price!!

VIC-20 GAMES
BUY TWO, GET ONE FREE

MISSILE UNEXPANDED VIC JUST £6
PANIC

Never in the world of computer games has such a game been produced for such a machine. The panic starts when you take delivery. First the panic to unpack, then the panic in play.

You will capture Crossoids and will have to stay clear of the missiles venomous path in the 'Maze of Death'. See it to believe it!!

OTHER VIC SOFTWARE (ALL UNEXPANDED VIC)

ALL £5 EACH

- ROAD RUNNER
- ANDROID ATTACK
- SPACE HOPPER
- SPACE WARS/BATTLE ZONE
- STAR WARS II
- NAVAL ATTACK

FOR FURTHER
 DETAILS ON OUR
 SUPERB VIC RANGE
 SEND S.A.E.



SENSIBLY PRICED ATARI SOFTWARE NOW AVAILABLE FROM TITAN
 400/800

CAVERNS (16K) JUST £6

At last... a totally addictive, arcade quality program that will take a long time to outgrow, and one that does not cost the earth. Navigate your spaceship through rock caverns, past laser fields, through Rock Valley and into the unknown. You will have to see it to believe it!! Supplied on cassette with full instructions.

For immediate delivery send cheques/p.o.s to
 Titan Programs, Titan House, 83 Ashwood Road, Rudloe,
 Corsham, Wiltshire SN13 0LG.

FOR  
 PHONE 24 HR ANSWERPHONE 0225-810132

IMMEDIATE DELIVERY



SIMPLY THE BEST SOFTWARE IN THE WORLD

PORTABLE COMPUTERS

SHARP MEANS BUSINESS



PC-1500 COLOUR COMPUTER

Probably the most powerful pocket computer on earth

THE HARDWARE

The PC-1500 approaches the personal computer in ability, with 16K of ROM extended BASIC language and 3.5K RAM user memory, expandable to 11.5K, all maintained during power off and battery change. Up to 36 separate programs are immediately accessible and there are advanced programming capabilities with PEEK, POKE, CALL etc, 1 and 2 dimensional arrays and variable strings. There is a full range of text manipulation and the QWERTY typewriter-style keyboard offers upper and lower case letters on the 26 character LCD which doubles as a 1,092 point mini-graphic display with BASIC program control. A tone generator and clock, calendar, alarm and stopwatch functions are built in and, under BASIC control, can be incorporated in programs.

The CE-150 is a high resolution (500x200), 4-colour printer/plotter, with 8K bytes Graphics BASIC. The 9 type sizes allow a variable line length from 4 to 36 characters. The CE-150 can print virtually any drawing with full control of up/down, left and right printing. There are two cassette interfaces (for saving/loading) with remote control, allowing bulk storage.

The PC-1500 has a 50 hour battery life, with EA-150 mains adaptor option and the CE-150 has a built-in rechargeable battery and comes with EA-150.

PRICES, including VAT and FREE software voucher.

PC-1500 Computer plus £20 software voucher	£169.95
CE-150 Colour Printer/Interface plus £20 voucher	£149.95
CE-155 8K RAM Expansion module plus £10 voucher	£79.95
CE-159 8K RAM/ROM with battery back-up plus £10 voucher	£89.95
CE-152 Custom Cassette Recorder plus £5 voucher	£39.95
CE-153 140-key Software Board plus £10 voucher	£79.95
CE-158 RS-232C Interface plus £20 voucher	£149.95

Vouchers on request with order only

THE SOFTWARE

Sharp CE-15A Applications Program Tape	£14.95
MICROL 1500 EXECUTIVE OS/1 Ready-to-run, full feature Database, with a wide range of customising features enabling you to create your own business applications programs (eg. stock control, mailing lists) in minutes	£19.95
MICROL 1500 PROCOS Solve all kinds of number-based problems in just minutes, even if you have never programmed a computer before. Handling up to 256 items of data simultaneously. 'Visicalc-type' features help you examine the effects of changes in data, analyse trends and answer 'what if...'	£19.95
MICROL 1500 STATIX Statistics for the 1500. Automatic calculation of mean, standard deviation and linear regression	£9.95
BC SOFTWARE 1500 PROPAC I A set of easy-to-use routines for programs development with: Renumber, Reorganise, Delete, Analyse and Invert Screen	£9.95

Brochure on request

BASIC FOR BEGINNERS



CASIO PB-100
£69.95

Learn as you go

Enter the exciting world of computers with this easy-to-understand system

LEARN with the beginners manual 'An easy-to-follow Introduction to the Personal Computer'. FOLLOW the step by step examples and USE the programs supplied, or develop your own, for business or home use, including exciting games.

QWERTY keyboard, upper and lower case dot matrix display. Up to 544 program steps/94 memories, expandable to 1,568 steps/222 memories, all protected. A truly pocketable 9.8x165x71mm. Weight, 116g. 360 hours battery life. OR-1 1K RAM expansion module £11.95. FA-3 Cassette Interface £22.95

CASIO — THE SCIENTIFIC ANSWER



The future has arrived with the

CASIO FX-801P
£349

High speed computer with integral micro-cassette data control and hard copy printer monitoring

Everything you need, in an area smaller than this page. This truly portable, complete system needs no peripherals on lengths of cable. Batteries last 250 hours (only display), or 5,000 lines (display and printing). Typewriter style QWERTY keyboard, plus all the advanced features of the FX-702P.

MICROL SOFTWARE for your SPECTRUM

USE AND LEARN Vol. 1. 25 BASIC PROGRAMS on cassette plus 100 PAGE BOOK. Professionally written, packed with practical ideas, hints and tips £9.95
USE AND LEARN Vol. 2. 30 MACHINE CODE routines for high speed graphics, games and serious programs. On tape plus 50 PAGE book £9.95
THE DATABASE PRACTICAL, POWERFUL, RELIABLE. Written in machine code and BASIC. Automatic sorting, 'Free Form' with one-key search. Capacity: Inside 48K, 30,000 characters equals 1,000 screen lines equals 45 full screens. With C-90 tape: Over 900 full screens of

information, or over 7,000 names and addresses. Fully MENU DRIVEN with full HELP £9.95
THE SPREADSHEET Visicalc for £10? Not quite — has all the main Visicalc capabilities and some improvements. Available November, 1982 £9.95

Database and Spreadsheet require 48K Spectrums. Add-on options for the Sinclair Microdrive will be available early 1983.

MICROL 14 day money back guarantee

CASIO FX-702P £79.95

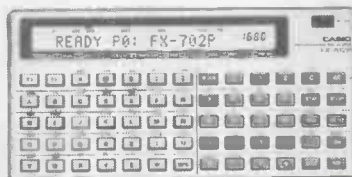

With FREE MICROL Professional Programming Pack worth £9.95 The widest range of math, science and statistics functions (55 in all, including Regression and Correlation). BASIC programming: Up to 1,680 program steps, up to 226 data memories, up to 10 program areas, all protected. Subroutines: Up to 10 levels. FOR/NEXT looping: Up to 8 levels. Edit, Debug and Trace modes. 240 hours battery life. Dims: 17x165x82mm. Wt: 176g.

PERIPHERALS: £19.95
FA-2 Remote control cassette interface/adaptor £44.95
FP-10 Permanent hard copy printer. Mains or battery powered £24.95
Professional computing solutions on tape. Save up to 90% of program-ming time with this electronic equivalent of pen and paper. This 'Visicalc-type' system answers 'what if...' questions and analyses trends £24.95

FREE when you purchase the FX-702P, FA-2 and FP-10 package



CASIO FX-700P
£79.95

Truly pocket size

BASIC programming on a QWERTY typewriter-style keyboard. Up to 10 program areas, up to 1,568 program steps, up to 222 memories, all protected. Upper and lower case dot matrix display. Powerful editing functions. 25 scientific functions. Subroutines: Up to 8 levels. FOR/NEXT loops: Up to 4 levels. Numerical values — 6 levels. Calculation elements — 12 levels. Exclusive character variable stores up to 30 characters. Dims: 9.8x165x71mm. Weight 118g. 300 hour battery life approx.

FA-3 Cassette interface £22.95. FP-12 Printer (December 1982) 49.95

PROGRAMMABLE CALCULATORS CASIO FX-602P

10 program areas, up to 512 program steps, up to 88 memories. Alpha/numeric dot matrix display, 10+ 2 digits. 50 scientific functions, including Standard Deviations and R/P and P/R conversions. 33 parentheses £69.95

CASIO FX-3600P

2 program areas, 38 steps, 7 memories. 10 plus 2 digits. 50 scientific functions, including Integrals and Regression. Standard deviations, R/P and P/R CONVERSIONS, 18 levels of parentheses £22.95

IF YOU SEE A BETTER OFFER WE WILL BEAT IT

TEMPUS

PRICES include VAT, post and packing. SAME DAY DESPATCH, subject to availability. Send cheques, PO, or cash (registered), or telephone your ACCESS/VISA, or BARCLAYCARD number to the Portable Computer Specialists:

Dept PCW
38 Burleigh Street,
Cambridge, CB1 1DG
Tel: 0223 312866

Please supply/send details of _____

Total £ _____ enclosed, or debit my ACCESS/VISA/B/CARD

Number _____

Name _____

Address _____

—pcw

TEMPUS, 38 Burleigh Street, Cambridge CB1 1DG

FANTASTIC VOYAGE

(ZX81 16K ONLY)

This real-time graphics adventure set inside the human body was written by a lecturer in anatomy. You are injected into the blood stream in your miniature submarine. Navigate the arteries, veins and heart to the brain, where a blood clot must be destroyed. Features a real vascular map. You will be attacked by lymphocytes which must be destroyed using arcade game type graphics. Everything you do uses up precious energy. Three display formats — a lateral and frontal body scan plus blood vessel name, a close-up scan and a laser-sight for fighting lymphocytes.

FOILKADE LTD

DEPT PR3
66 LITTLEDEAN
YATE
BRISTOL BS17 4UQ

**ALL GAMES £5.95 EACH,
2 FOR £9.95,
3 FOR £13.95
(ANY MIX) INCLUSIVE**

ZX 16K BBC ZX81 — SPECTRUM — VIDEO GENIE — BBC A/B AWARI

- * The ancient African game of logic. It takes 2 minutes to learn the rules but far longer to master the tactics.
- * Select the 'Goat-herd' level of play and it's an addictive game for children (8plus) that exercises their minds — not their laser fingers.
- * Select the 'Witch-doctor' level and it's a threat to your sanity. We haven't beaten it and we wrote it!

ADVENTURE

- * Over 200 places to explore in this machine code game using advanced data compression techniques.
- * No random elements — you will need skill, cunning and a sense of humour as you explore caves, forest and castles.
- * Evade ruthless pursuers and overcome a host of obstacles.
- * Multiple word commands and single letter abbreviations.
- ** Buy both Awari and Adventure and enter the 'Foilcade Challenge' competition. Details with cassette or send SAE.

£1000 IN PRIZES

Presenting the CONCEPT-09

The new British micro computer system that brings together the processing power of the 6809 micro processor with the renowned FLEX operating system at a price as impressive as the performance.

CONCEPT-09 features:

6809 micro processor. 56k dynamic ram. 2k system rom. 4k user eprom. Dual 5.25 inch disc drives. Serial port for terminal. Centronics compatible printer port. Uncommitted parallel port. FLEX disc operating system.

£995 plus VAT

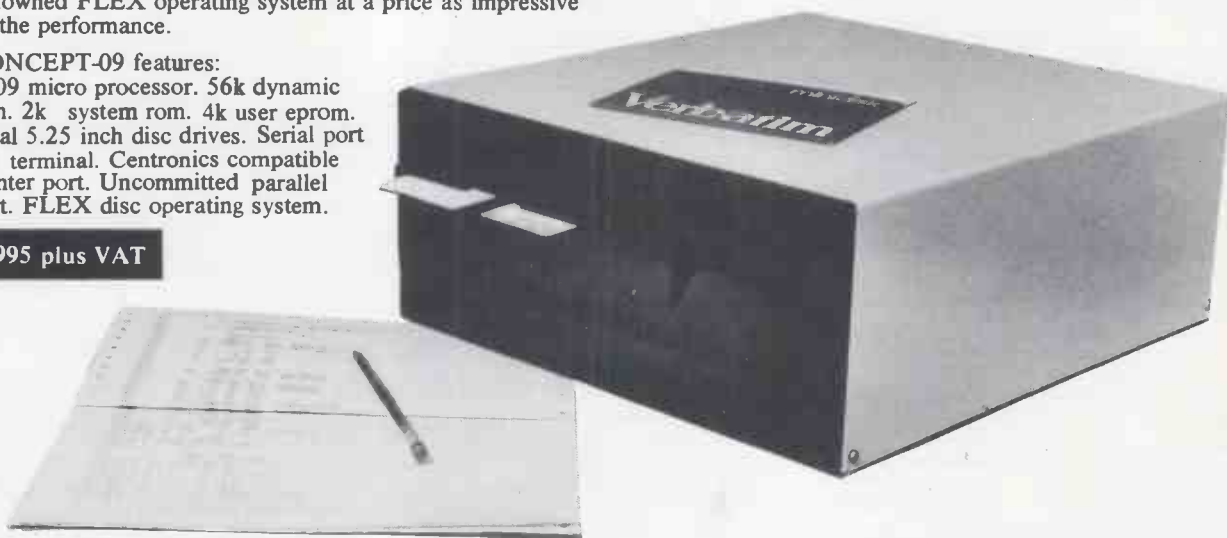

Additional software includes:

Editor. 6809 Macro assembler. Debug. 68000 cross assembler. Pascal compiler. Basic compiler. Forth. Stylograph word processor. Mail merge. Sort merge. Record management system. Dynacalc electronic worksheet.

Micro Concepts

8 SKILLICORNE MEWS · QUEENS ROAD · CHELTENHAM · GLOUCESTERSHIRE GL50 2NJ
Telephone: Cheltenham (0242) 510525

ROMIK SOFTWARE

ROMIK PROMISE A
MINIMUM OF ONE NEW
GAME EVERY MONTH



24 Church Street, Slough, SL1 1PT. Telephone: Slough (STD0753) 71535

Britain's leading games software house are proud to announce our new range of exciting games & other software for the Vic 20. (Games for BBC, Dragon, Spectrum & Atari available soon).

ALL ACTION GAMES CARRY A FREE ENTRY TO NATIONWIDE COMPETITIONS WITH FANTASTIC PRIZES.

MARTIAN RAIDER

FOR UNEXPANDED VIC 20

Skim as close as you dare to the surface of the planet, devastating the Martian cities, destroying ammunition dumps (gaining more time), shooting down the grounds to air missiles and U.F.O.'s dodging or blasting the meteorites.



"A REAL ACTION SHOT OF THE GAME"

A MACHINE CODE ARCADE QUALITY GAME

AIR-SEA ATTACK

For expanded Vic 20 you can use 3K, 8K or 16K RAM

Can you pilot a modern jet fighter? Take off from your aircraft carrier and engage enemy aircraft in battle. Shoot them down and then drop your bombs on the enemy aircraft carrier. Watch out — the enemy fighter is trying to do the same! If he gets past your air defence you are left to defend your own carrier with sea-air missiles. You each have 3 jets.

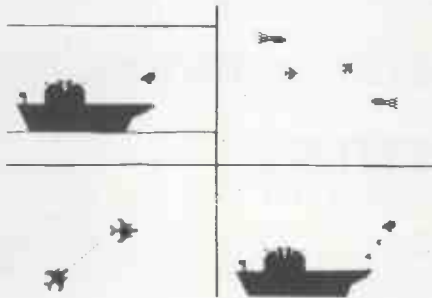

"A REAL ACTION SHOT OF THE GAME"

A MACHINE CODE ARCADE QUALITY GAME.

SHARK ATTACK

FOR THE UNEXPANDED VIC 20

You are in shark infested waters after being thrown overboard from a pirate ship. Your only protection being an atomic net which you trail behind you trying to cover all the visible ocean and ensnare the sharks at the same time. Beware of stopping or covering your tracks for too long, if you do, then the sharks will escape and come after you. Watch out for the ever increasing deadly octopi (sometimes the sharks will eat part or all of one!)

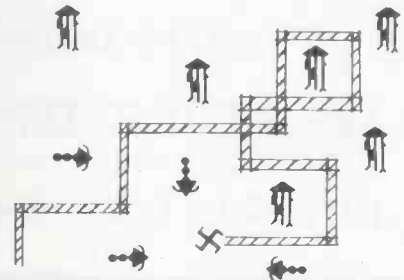

"A REAL ACTION SHOT OF THE GAME"

A MACHINE CODE ARCADE QUALITY GAME.

MIND TWISTERS

For unexpanded Vic 20

Four games to stretch your brain. Blackjack, Decipher, Four Thought and Teaser are our computerised versions of very popular home games and will test your mental agility and skill for many a long hour.

BLACKJACK:
You start with £1,000, the objective being to break the bank, to do this you have to win (including your starting money) £20,000.
Instructions: You have to score nearer (but not over) 21 than the computer does. The computer deals your first card, you then place your bet and hit the return key. The computer then deals your second card. If you want another card hit the "C" key, if not hit the "S" key.
Points: Ace equals 1 or 11, Jack, Queen, King equal 10.
Scoring 21 points with 2 cards — you automatically win.
Draw — the computer wins.
Your kitty is automatically adjusted win or lose. If you lose all your kitty — game over.

DECIPHER:
You have to guess what combination of colours the computer has selected — to enter a colour just hit the colour button on the computer when you have entered your five choices of colour, the computer will display (A) Nothing at all equals None right, (B) Black or White Squares or Both — For every black square you will have a correct colour in the correct position, for every white square you will have a correct colour in the wrong position. If you cannot find the complete combination, it will be displayed when you have had twelve attempts.

FOUR THOUGHT:
You have to make a line of four squares — horizontally, vertically or diagonally BEFORE the computer does, taking turns to take a square (squares can only be placed at the bottom of the grid, or on top of another square). Keys: Hit the number key of the column you want your square dropped in then hit the return key.

TEASER:
The aim of the game is to score "15" BEFORE the computer does, using any combination of 3 boxes. If you cannot score "15" then you must try and stop the computer from doing so and force a draw. Keys: Hit the number key of the box you want (you can only select an empty box).

A MACHINE CODE ARCADE QUALITY GAME.

MULTISOUND SYNTHESIZER

FOR THE UNEXPANDED VIC 20

The Vic Multisound Synthesiser is very flexible and can be played in more ways than can ever be explained here, to create music and special effects. For example, create any tune, up to 255 notes (after following appropriate instructions), then press "F1" or "F3", then key "9" and enjoy the added effect. Now hit "plus", listen to the difference. For a surprise — hit "-" . Now add a melody over the top — hit key "8" then "7" — now play a melody, or experiment. *Have fun!*

A MACHINE CODE ARCADE QUALITY GAME.

SEA INVASION

Fight off the attacking sea creatures for as long as you can. Shoot the whale for a surprise score, watch out for the crabs, starfish and octopi.

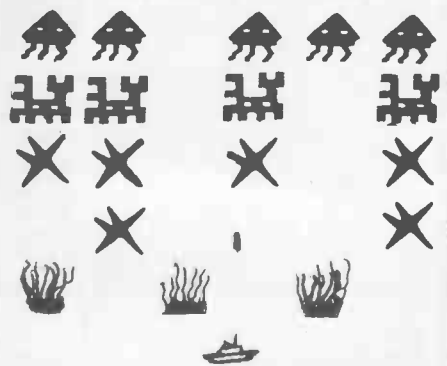

"A REAL ACTION SHOT OF THE GAME"

A MACHINE CODE ARCADE QUALITY GAME.

MOONS OF JUPITER

You are the Commander of a fleet of destroyers looking on from the safety of a mother ship, you send in one destroyer at a time to blast a passage through the MOONS OF JUPITER. **Your destroyers have to dodge, and blast the UFOs. . . Watch out for the Gologs they can smash your destroyers, but you cannot harm them.**

A MACHINE CODE ARCADE QUALITY GAME.

SPACE ATTACK

Is a game of skill you as the pilot of an Inter galactic battleship have to fight your way through wave after wave of various alien spaceships.

A MACHINE CODE ARCADE QUALITY GAME.

Our games are available from all good home computer shops, including:-

LASKYS, MICRO-C, CURRYS, BRIDGERS, CHROMASONIC, MAPLIN, GEMINI, GAMER,

Metclean, 92 Victoria Street, London SW1 01-828 2511. . . (Metclean) 137, The Strand, London WC2 01-240 2321. . . (Metclean) 177 London Road, Croydon 01-686 8626. . . A.C. Systems, Exeter. . . Microtrading, Birmingham. . . Supersoft, Harrow. . . Anirog Computers, Horley, Surrey 346083. . . Ozwise Computers, Harrow 429 1060. . . Cavendish Data Systems, South Norwood 656 8941. . . Software Master, 30 Lincoln Road, Birmingham. . . Tomorrows World, Dublin. . . Algray Software, Barnsley 83199. . . Computer & Business Systems, Nelson, Lancs, 0282 60191. . . Dyad Developments, Oxon 08446 729. . . Leisuretronics/Blackpool Computer Stores 0253 27091. . . Carlow Radio Ltd, Bedford 60447. . . Byte Shop Computerland, Glasgow 221 7409 — Nottingham 40576 — Manchester 236 4737. . . First Byte Computers, Main Centre, Derby 365280. . . Simmons Magee Computers Ltd, Twickenham 891 4477. . . Capital Computer Systems, Ilford 553 3026. . . A.O.M. Business Systems, L.V.E. Building, Leicester 548923. . . Jutea Ltd, Bridge, near Canterbury, Kent 0227 830083. . . Twickenham Computer Centre 01-892 7896. . . Kent Microcomputers, Maidstone 0622 52784. . . J. S. Simmetta Computers Ltd, The Computer Shop, Kingston 01-546 3793. . . Chris Denning Ltd, Poole 0202 761859. . . Yorkshire Micro Computers, Scarborough, Yorks 0723 78136



THE ACT SIRIUS 1 WITH



JARMAN ACCOUNTING SOFTWARE

is available now from Logic Computer Systems

- Sales Ledger with Invoicing
- Purchase Ledger with Costing
- Nominal Ledger with Cash Book and Budgetary Control
- Payroll and Personnel Records
- Stock Control

Jarman high quality intergrated accounting software, already available on other microcomputers, now realises the full potential of the Sirius 1.

For more information call us on (01) 222 1122 or 5492 to-day.

The only serious choice for business

LOGIC COMPUTER SYSTEMS

31 PALMER STREET, LONDON SW1H 0PR
(01) 222 1122 or 5492

LOGIC COMPUTER SYSTEMS specialises in the application of Microcomputers for business. Our services include systems development, installation, training and support. Please call for an appointment to discuss your requirements and to arrange a demonstration.

Micro General

QUALITY PRINTERS

Contact us for advice on printer selection



MICROLINE RANGE

From **£235 + vat**

Microline 80 80 cps £235+vat
Microline 82A 120 cps £349+vat
Microline 83A 120 cps £499+vat
Microline 84 200 cps £799+vat
(The M84 has High Res. Graphics plus Near Letter Quality print)

NEW ADDITIONS TO THE MICROLINE FAMILY

(All with Near Letter Quality printing and High Resolution Graphics)

Microline 92 160 cps £449+vat
(80 cols. at 10 cpi)
Microline 93 160 cps £649+vat
Full Width
(136 cols. at 10 cpi)

EPSON TYPE III

From **£349 + vat**

The Type III printers now have Auto-underline, Super-scripts, Sub-scripts & High Res. Graphics.

MX-80T	Tractor only	£349+vat
MX-80F/T	Friction/Tractor	£389+vat
MX-82T	Tractor only	£369+vat
MX-82F/T	Friction/Tractor	£409+vat
MX-100	100 cps Full Width	£499+vat

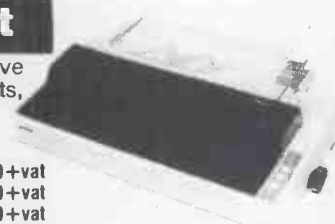

DRAGON 32

ONLY £173 vat

- Professional Keyboard
- Easy to learn & use
- Graphic - colourful - musical
- Sturdily built
- Neat & attractive design



WE ARE PROUD TO ANNOUNCE A BRAND NEW MID-RANGE PRINTER -

THE OKI 2350

From **£1,895 + vat**

Fast 350 cps printing. Skip speed 600 cps. High Resolution Graphics. Two colour printing. Near Letter Quality on the Mod 2 Model. Superb reliability - no routine maintenance.



For all your spooling and interfacing problems, call for details of the SPRI/INTER 32K Buffer/Adaptor Unit. Price from **£249 + vat.**

Always call for the best possible price



FREE CASSETTE RECORDER

RRP £25 + vat when you buy a DRAGON 32 plus printer - Hurry! offer must close shortly.

MICRO GENERAL 6 THE BIRCHWOODS, TILEHURST, READING, RG3 5UH TEL: 0734 25226

TANDY, VIDEO GENIE

NEW!! DRAGON 32 SOFTWARE

THE FAMOUS MICRODEAL JOYSTICK PLAYS THESE GREAT GAMES

SCARFMAN.....£11.95
SPACE CASTLE.....£11.95
ALIEN DEFENSE.....£11.95
FORTRESS.....£11.95

METEOR MISSION.....£5.95
GALAXY INVASION.....£5.95
ROBOT ATTACK.....£5.95
DEFENSE COMMAND ..£5.95

VENTURE.....£11.95
SUPER NOVA.....£ 5.95
ATTACK FORCE.....£ 5.95
PANIK ..**NEW**.....£11.95
DEFIANCE.....£17.50
(48K disc)

All 16K Cassettes

NEW! FROM SSM CATERPILLAR



HIGH SPEED - FAST ACTION FOR ONLY £11.95

Joystick for TANDY MODEL 1 or VIDEO GENIE.

Plugs straight onto Computer £22.50 Model 3 version available soon!



NEW FROM CORNSOFT BOUNCEIDS

The latest and greatest from the makers of SCARFMAN £11.95



THE IDEAL XMAS GIFT

CLOAD CASSETTE

6 to 8 Programs on cassette each month.
Programs include: GAMES, TUTORIALS, ADVENTURES, UTILITIES. Over 4 years of back issues available.
Trial cassette £5.
6 month subscription £28.50
12 month subscription £52.00
Color computer version also available
SEND for our Software Lists, over 500 programs available

TALKING ADVENTURES (48K disc)
Forbidden City £25.00
Forbidden Planet £25.00
MICROCOSM PROGRAM PACKS
Microcosm 1, 2 or 3 £19.50



Microdeal Light Pen cassette recorder or 2nd amplifier. Play Backgammon (included) by just pointing pen at the screen. Comes complete. Tandy Model 1 or 3 Video Genie (requires amp.) £10.95

JOIN OUR MAILING LISTS FOR A

FREE

NEWSLETTER

SEND FOR OUR FREE SOFTWARE LISTS

State which computer you own DRAGON/TANDY/GENIE

ESCAPE 3D Maze Game with full colour life-like graphics.

ALCATRAZ II Avoid the guards and outrun the deadly Minotaur, but do it right or you're doomed.

MANSION ADVENTURE 1 Adventure No. 1 in our series. Search for the diamond in a spooky old mansion.

FLIPPER The ancient game of GO. Inscrutable Oriental strategy.

SPACE MONOPOLY Buy and sell shares in space. Become a Galactic Mega Billionaire.

AVAILABLE ANY DAY

SCARFMAN - Maze chase game
SPACEWAR - Shoot the space castle avoid the meteoroids

DEFENSE - Defend yourself against the missiles

PLANET INVASION - Fly horizontally zapping the enemy

PACER BALL - Steer your ball around the maze

ULTIMATE ADVENTURE No. 2 Gain treasures whilst travelling through deserts, seas & even outer space

ALL PROGRAMS £8
DRAGON LIGHT PEN WITH GAMES CASSETTE £11.95

JOIN OUR DRAGON LISTS

MICRODEAL

DEAL HOUSE, BRIDGES, BODMIN CORNWALL PL30 5EF TEL: 0726 850821 DEALER ENQUIRES WELCOME



VIEWDATA PRESTEL TELETEXT

TXV30 FULL EDITING VIEWDATA 14" COLOUR PORTABLE AND MONITOR

A full or local editing Viewdata terminal or 14" colour or Video Monitor. In Viewdata operation Prestel Teletext and 12 channel infra red remote control UHF/VHF colour receiver. With keyboard or microcomputer operation full or local editing may be made to Viewdata Terminals or with Telesoftware option programs can be directly loaded into the micro other options include cassette, 8 page store, printer. The unit has also RGB or Video to be used as a Professional Monitor. Normal Price £414 but until 1 Jan £360 as a special offer on orders received before this date.



MXV05/2 COMBINED VIEWDATA MICROCOMPUTER ADAPTOR.

An add-on combined Prestel, Teletext Viewdata Adaptor for attachment to UHF set and microcomputer for Viewdata and Telesoftware direct loading. Works with most popular micros via a parallel or RS232 Ports Includes: Full or Local Editing, Teletext with 6 channel TV reception and an optional infra red remote control is available for use without the micro for normal TV Prestel or Teletext operation, other options include cassette, 8 page store and printer. £299

MXV07 UNIVERSAL PRESTEL TANDEM TELESOFTWARE ZX81 ADAPTOR.

An inexpensive intelligent terminal viewdata adaptor for the ZX81 and tandems with most popular micros. The adaptor gives Prestel and Viewdata autodialling facilities to the Sinclair ZX81 which can receive Viewdata Prestel or directly automatically load telesoftware from the databases. With a micro in tandem the micro can have full telesoftware and Viewdata Prestel facilities. £50

BXVB07 ZX81 EPROM ADAPTOR BOARD

The adaptor board uses 2716 or 2732 PROMs for convenient running of programs with the Sinclair ZX81 attaches to the rear edge connector with ports for extra RAM and the MXV07 Prestel Telesoftware Adaptor.

LION VIEWDATA TV

18 Harcourt Terrace, London SW10. (SAE with enquiries please).

PLANNED DATA FURNITURE

Terminal work stations, stands/wing tables turntables

Suppliers to many leading companies

We manufacture many different configurations to suit most requirements

Work stations with disk drive housing built to customers specifications

New PD5000 range of desk work stations designed and manufactured to meet the high standards of strength and finish required by the data processing office and environment

Planned Data Furniture Co. Ltd

Dept E, 134 Chestergate Stockport, Cheshire SK3 0AN Telephone: 061-477 4890/4246

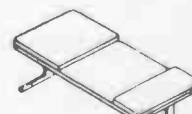
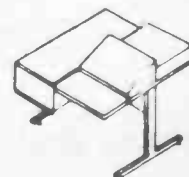

EXPENSES!!

EVERY BUSINESSMAN/WOMAN, ACCOUNTANT,
HOUSEWIFE AND ANYONE WITH EXPENSES **MUST** HAVE ONE!
DON'T WASTE TIME **WRITING** EXPENSES.

BUY...

'THE PERSONAL ACCOUNTANT'

NEW PROGRAM FOR APPLE COMPUTER USERS.

ONLY £65.00 (+VAT)

P

ORDERS BY P.O./CHEQUES ONLY

PAPERLOGIC LTD

12 NOTTINGHAM PLACE
LONDON W1M 3FA
Telephone: 01-935 0480

P

OSBORNE

£995 INC. SOFTWARE

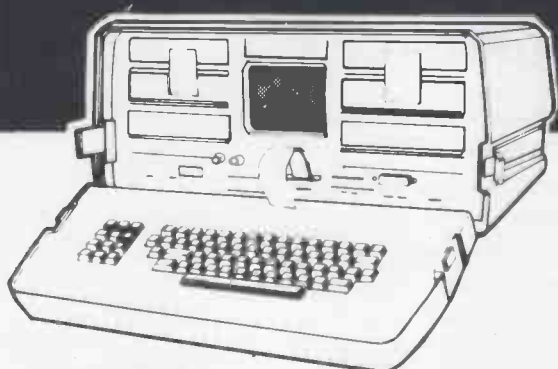

Latest Osborne Mark II

- Z80A 64K CP/M Computer
- Dual 100KB drives (upgradable)
- Typewriter keyboard + numeric pad
- Integral 52 column monitor
- Fully portable – weighs 24 lbs
- RS232/Centronics/IEEE Ports
- **Software** Wordstar/Mailmerge, C Basic – M Basic, Supercalc – CP/M

Also **Sanyo Monitors** £89

Olivetti Daisywheel Printers £455

Epson Dot Matrix Printers £349

Send for list Osborne software and peripherals

All prices exclusive of VAT and delivery. Cheque with order.

Delta Systems Limited

32 Finch Road, Douglas,
Isle of Man. Tel: 0624-27522.

Introducing Orchard Software — formerly Apple Orchard

with quality products for the Apple II and the IBM PC

PROTECT YOUR SOFTWARE INVESTMENT with Copy II Plus

Copy II Plus gives you the power to make back-up copies of most of the "protected" software packages currently available for the Apple II.

INSURANCE

With Copy II Plus you can protect your valuable software investment. Make back-up copies of Visicalc, DB Master, the Apple Special Delivery range, and many more; keep your originals safely locked away from the wear and tear of everyday use.

EASILY PAYS FOR ITSELF

While some software companies offer replacement of expensive damaged diskettes, many do not. With Copy II Plus you eliminate the time, expense, and worry of costly accidental damage to your valuable software.

£50

THE FILER a new Apple Disk Utility

SAVE TIME

Fed up wasting valuable time waiting for disks to copy? With the FILER's fast and accurate copy program you can make completely reliable back-up copies of your disks in 35 seconds. The FILER is ideal for backing-up your data disks, and for copying all unprotected disks.

OTHER FEATURES

The FILER package also contains a disk drive speed check, a disk drive test, and a sophisticated file manager. Options include: Catalog with space on disk, Copy Files, Copy DOS, Delete, Lock and Unlock Files, and Change Booting Program (name and filetype).

£16

SCREENWRITER II

All the features you expect from a good word processor — global search and replace, insert and delete, text move, and complete formatting capabilities, plus:

- Upper and lower case text on screen with no extra hardware
- 70 col. display on screen with no extra hardware
- Form letters and mailing lists as a standard feature
- Handles documents up to 50 pages long
- Complete interface with The General Manager

£79

IBM PC SOFTWARE

As well as a full range of software for the Apple II, we now offer software for the IBM PC, including the Visicorp range, dBase II, Supercalc, the Apple-IBM connector from Alpha software, and many more.

Write for our full list of IBM PC software.

GraFORTH

The Apple Graphics Language

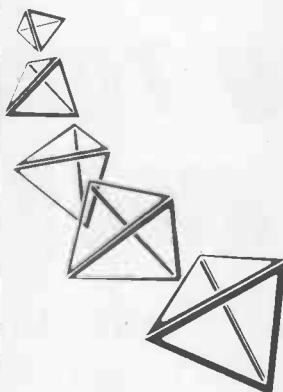

The Apple Graphics language from insoft — specially created to get the most out of the graphics capabilities of your Apple.

- draws 3D images in colour, at rates that make animation easy
- user defined character sets (any size, colour or typeface)
- text and graphics can be mixed on any part of the screen
- music can be included in programs
- excellent manual shows how to use the full capabilities of the system.

Ideal for entertainment software development, scientific and educational uses, and any application where sophisticated graphics are required.

Demo available for £4 (refunded if you buy).

£50

THE GENERAL MANAGER

The latest quality product from On-Line Systems, The General Manager is a true hierarchical database — not just a file manager. Use it for anything from a simple names and addresses file to a complex customer accounts system.

The General Manager offers all the features you expect from a database program, and more:—

- Hierarchical structure gives greater efficiency in data storage and retrieval.
- Retrieve information on several sort criteria, industry and/or searches.
- Full range of calculation abilities, including logical operators.
- The powerful data access commands provided by the Applesoft interface enable you to input or output data to and from Applesoft Files. Information can also be selected and written to text files.
- Data can be spread over 100 disks on 1-4 disk drives.
- Expand or change your database with no loss of data.

A demo disk costing £4 is available, describing these features in more detail.

£79

All featured products require
Apple II 48K, DOS 3.3

Please write for more details of these products, plus our catalogue of Apple II and IBM PC software. Dealer enquiries welcome.

Prices exclude VAT — please add 15%. Send cash with order, or quote your Access or Diners Club number to:—

Orchard Software,
17, Wigmore St.,
London, W1H 9LA.
Tel: 01-580 5816

Top Quality BASF

DISKS

- Individually tested by manufacturer
- 5¼" single sided, single density, soft sectored
- Same day dispatch by first class post

In boxes of 10

£14.95
plus £1 p&p per box (UK)

10 in library case

£16.85
plus £1.50 p&p per box (UK)

Please add 15% VAT to total and send cheque/PO to:

STOCK ELECTRONICS

Plot 3, Forest Vale Road,
Forest Vale Industrial Estate
Cinderford, Glos GL14 2PH

NEW and UNBEATABLE



SMITH CORONA TP-1
Letter quality
for **£485.00**
SERIAL PARALLEL or IEEE
Interface

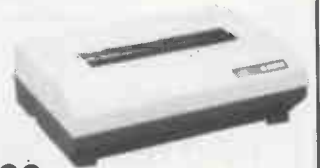

CONTROL DATA 9334

High speed matrix printer
150cps printing Bi-directional

ONLY **£945.00**

SERIAL or PARALLEL Interface.
Xon Xoff. 110-9600 BAUD.6 PRINT DENSITIES
PLUS HIGH QUALITY PRINTING AT 60cps.

HIGH QUALITY DISKETTES

5" Floppies	SINGLE SIDED	£1.75 each boxed in 10s
	DOUBLE SIDED	£2.00 each
8" Floppies	77 Track	£2.95 each
	SINGLE SIDED	£1.82 each boxed in 10s
	DOUBLE SIDED	£2.14 each

EACH ORDER FOR 10 DISKETTES COMES WITH A FREE LIBRARY CASE

PLUS... FULL RANGE OF 5" AND 8" FLOPPY DRIVES FROM THE WORLDS LARGEST INDEPENDENT COMPUTER PERIPHERAL MANUFACTURER AT PRICES YOU WON'T BELIEVE. COMPATIBLE WITH ALL LEADING MAKES OF MICRO COMPUTERS. APPLE TANDY COMMODORE GENIE ETC.

Postage and packing on Diskettes 75p. Carriage paid on Printers and Floppy Drives. Please add VAT to all prices.

Please send orders and payment to:

VAS (Computers Services) Limited
44 Masons Hill, Bromley, Kent, England
Tel: 01-464 5895 Telex: 896559



HAVE YOU TIME TO THROW AWAY?

As a team of experienced Micro Computer Consultants, we can answer your most searching questions on the systems available, and the Software for both MICRO & MAIN FRAME Computer Systems, for the Professional and General Business needs.

Before buying - a telephone call to Impulse Micro Systems Ltd will assist you in your choice.

Impulse
MICRO
SYSTEMS Ltd

6 Central Chambers, Cook's Alley,
Wood Street, Stratford-on-Avon,
Warwickshire. Tel (0789) 295819.



THE FINEST PRINTER/TYPEWRITER MONEY CAN BUY.

THE CROWN RANIER ONLY £795 + VAT



THE CROWN

The ideal home Daisy Printer/Type-writer up to 12 CPS — 6 extra Daisy Wheels available — 14 character correction — carbon ribbon — speed test — all the features you would expect of an electronic portable typewriter/printer. Centronic parallel — IEEE — RS 232

Only £320 + VAT & carriage at cost

FRIENDLY!
The Crown Ranier
is compatible
with
Apple II, III
Sirius
IBM
Superbrain
Televideo
Plus most
other machines

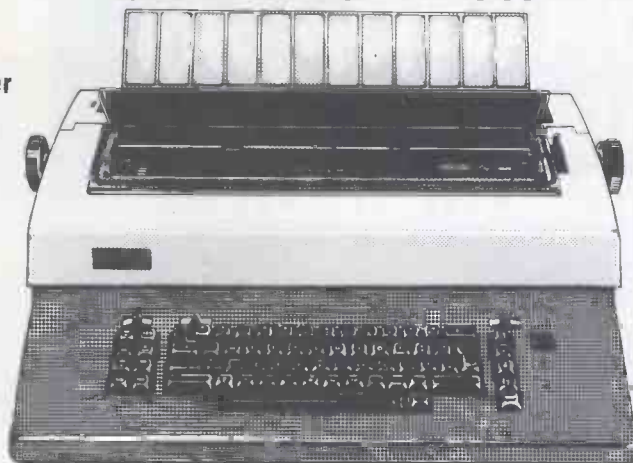

We offer a heavy duty daisy wheel printer/typewriter at the flick of a switch. This machine has the very latest linear motor — no cables or belts to break, stretch or wear. Beware of light weight, low cost machines, these can never give long term reliable service. THIS MACHINE WILL!!

Centronics or IEEE interface. Interchangeable daisy wheels — variable pitch — whole line memory. Easily copes with standard printed forms. Uses standard IBM ribbons and lift off correctors.

Perfection as a typewriter (used by local authorities). Perfection as a printer.

Ask your local computer or office equipment dealer for further information. EXSTOCK DELIVERY.

SOLE UK DISTRIBUTOR. TRADE ENQUIRIES INVITED



CROWN BUSINESS CENTRE

**56-58 SOUTH ST., EASTBOURNE,
SUSSEX. (0323) 639983.**

**SOFTWARE HOUSES,
WHOLESALEERS, DEALERS**

YES. WE MANUFACTURE CASSETTES

DUPLICATING — Need 50 — 50,000
Program Copies within 10 days?

Short-run in-cassette copying, high-speed volume duplicating, with on-cassette body printing, labelling, over-wrapping, blister-carding etc. And YES — we verify our work — methodically.

BLANKS — Need any length blank cassette for copying or re-sale?

We manufacture tapes in bulk, with or without boxes, as well as our own fully-packaged standard length products.

We use high quality batch certified HM-1260 tape, for error-free copies.

Please ring or write to Nigel Boyle today for full details — all enquiries and material treated in the strictest confidence.

Phone
01 223 5955

Write to
BIBI Magnetics
Freepost
London SW11 2BR

BIBI Magnetics Limited,
101/105 Plough Road, London, SW11 2BJ

SOFTWARE BREAKTHROUGH!

THE WORD HANDLER
by SILICON VALLEY SYSTEMS

The ONLY word processor in the world for the Apple II that:

- ★ Gives you full line capability on the screen (66 characters) with no additional boards necessary
- ★ Two character format to choose from at all times!

Runs without any hardware modifications!

All functions shown on the screen
Lower & Upper case

Even & Normal justification
Underlining, super script, bold and unlimited tabs, proportional spacing.

All this at the remarkable low price of £149 plus VAT

plus

THE LIST HANDLER
by SILICON VALLEY SYSTEMS

Stores 3000 names and addresses on one 5¼" floppy disk

Runs on one or two drives — works with any of DIF format and has unlimited sort fields

REMARKABLE PRICE ONLY £65 plus VAT

FOR FURTHER INFORMATION AND
ORDERS (C.W.O.) SEND TODAY TO:

Pinewood Computers

Mail Order Dept. 17 Adelphi Crescent
Hayes Park, Hayes, Middx.

TRADE ENQUIRIES WELCOME
Tel: 01-841 1507 (24 hrs)



let the
DRAGON 32
fire your
imagination . . .



for only £199.50

Plus £5 Post & Packing

*No other computer offers
you all these features
at any price . . .*

- 32K RAM MEMORY
- PROFESSIONAL STANDARD KEYBOARD
- 1 YEAR WARRANTY
- 9 DISPLAY COLOURS
- 5 DISPLAY RESOLUTIONS
- EXCEPTIONAL GRAPHICS CONTROL
- 5 OCTAVE SOUND GENERATOR
- DIRECT MUSIC COMMANDS
- REAL-TIME CLOCK/TIMER
- MICROSOFT EXTENDED COLOUR BASIC
- PLUG-IN CARTRIDGES AVAILABLE
- CENTRONICS PARALLEL PRINTER PORT
- SOCKETS FOR JOYSTICKS
- SOCKETS FOR FULL CASSETTE CONTROL
- EXCELLENT CASSETTE FILE HANDLING
- COMBINED AUDIO/DATA INPUT FACILITY
- AUDIO OUTPUT VIA T.V.
- EXPANDABLE TO 64K RAM
- POWERFUL 6809E MICROPROCESSOR
- FREE 160 PAGE TRAINING MANUAL
- BRITISH MADE

Available now from:

ComServe

98 TAVISTOCK STREET, BEDFORD MK40 2RX.
TELEPHONE: BEDFORD (0234) 216749

Business minded?

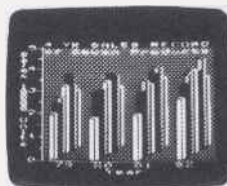

The Apple III helps you mind your own business. Whether you're a doctor, lawyer or business proprietor.

Simply because you don't need to

be a computer expert to put the power of an Apple III to work on your business. So you can do word processing, business planning, forecasting & graphics. On your terms. Without spending time and money coming to terms with a computer service.

Ask for a demonstration and we'll show you why it makes sense to buy an Apple personal computer for your business.

And keep it to yourself.

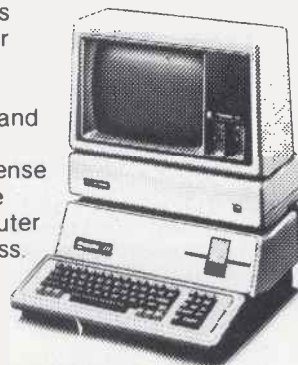

 **apple computer**
Authorized Dealer

LEICESTER
computer centre limited

67 Regent Road, Leicester LE1 6YF. Tel: 0533 556268

Increase your word power

Pound for pound, the Apple III is the most powerful personal computer you can buy.

Combine it with Apple Writer III™ software and you have the most powerful personal word processor you can buy.

Combine all the above with our Mail List Manager™ and you have the final word.

You can make letters, letter perfect. You can target your letters to the right regions and titles. And you can turn out thousands of personalized letters.

All at a price that's less than some dedicated word processors.

Come in for a demonstration.

You'll never be at a loss for words again.

™VisiCalc is a trademark of Personal Software, Inc.



ZX Spectrum

20 Programs £6.95

The ZX Spectrum has brought advanced computing power into your home, The Cambridge Colour Collection, a book of 20 programs, is all you need to make it come alive.

No experience required. Simply enter the programs from the book or load them from tape (£2.95 extra) and run.

Amazing effects. All programs are fully animated using hi-res graphics, colour and sound wherever possible.

Entirely original. None of these programs has ever been published before.

Proven Quality. The author already has 30,000 satisfied purchasers of his book of ZX81 programs.

Hours of entertainment

- **Lunar Landing.** Control the angle of descent and jet thrust to steer the lunar module to a safe landing on the moon's surface.
- **Maze.** Find your way out from the centre of a random maze.
- **Android Nim.** Play the Spectrum at the ancient game of Nim using creatures from outer-space.
- **Biorhythms.** Plot the cycles of your Emotional, Intellectual and Physical activity. Some would say this is not a game at all.

Improve your mind

- **Morse.** A complete morse-code training kit. This program will take a complete beginner to R.A.E. proficiency.
- **Maths.** Adjustable to various levels, this program is an invaluable aid to anyone trying to improve their arithmetic.

Run your life more efficiently

- **Home Accounts.** Keeping track of your finances with this easy-to-use program will enable you to see at a glance where the money goes and plan your spending more effectively.
- **Telephone Address Pad.** Instant access to many pages of information.
- **Calendar.** Displays a 3 month calendar past or future, ideal for planning or tracing past events.

ORDER FORM:

Send Cheque or P.O. with order to:-
Dept. B., Richard Francis Altwasser, 22 Foxhollow, Bar Hill,
Cambridge CB3 8EP

Please send me

- Copies Cambridge Colour Collection Book only £6.95 each.
- Copies Cambridge Colour Collection Book & Cassette £9.90 each

Name: _____

Address: _____

hot stuff!

DRAGON 32



for only £199.50

Plus £5 Post & Packing

I have a burning desire for the
DRAGON 32 — Please send me:

DRAGON 32 COMPUTER - £199.50

DRAGON PLUG-IN SOFTWARE

- Berserk - £19.95
- Meteroids - £19.95
- Cosmic Invaders - £19.95
- Starship Chameleon - £19.95
- Ghost Attack - £24.95
- Cave Hunter - £19.95
- Tube Frenzy - £19.95

DRAGON CASSETTE SOFTWARE

- Special selection 1 - £7.95
- Quest - £7.95
- Computavoice - £7.95
- Madness & Minataur - £7.95
- Examples from manual - £7.95
- Special Selection 2 - £7.95
- Graphic Animator - £7.95
- Mazerace - £7.95

DRAGON PERIPHERALS

- Pair of Joysticks - £19.99
- Cassette Cable - £7.95

(Add £5 Post & Packing for DRAGON 32 — £1 for accessories)

--	--	--	--	--	--	--	--	--	--	--	--	--	--	--

* **Please debit my Barclaycard/Access account with**
I enclose Cheque/P.O. for

£

*Delete as applicable

Name:

Address:

PCW

ComServe

98 TAVISTOCK STREET, BEDFORD MK40 2RX.
TELEPHONE: BEDFORD (0234) 216749

Knights Sharp prices

MZ-80A £419, MZ-80B £747

DEAL A24plus1 £419 SHARP MX-80A with 56k internal memory plus 24 programs including Geography, Spacefighter, Home Budget, Basic Tutorials, Startrek, Invaders, Arithmetic, Scramble, Breakout, Bank Reconciliation, Mortgage etc.

DEAL A36plus2 £429 MZ-80A with BASIC and PASCAL languages plus 36 programs including those detailed above plus 12 in Pascal

DEAL A40plus4 £439 MZ-80A, BASIC, PASCAL, and FORTH plus 40 Programs.

DEAL A40plus4 £449 MZ-80A, BASIC, PASCAL, Forth, 40 programs plus **KNIGHTS EXPERT MACHINE CODE LOADER**

DEAL A113plus4 £475 SHARP MZ-80A with four languages — BASIC, PASCAL, Forth, MACHINE CODE and 112 programs to get you off to a flying start.

DEAL A150plus6 £525 MZ80A, 4 languages, 150 programs, COMMANDER plus **MONITOR PLUS**

DEAL B1plus3 £747 SHARP MZ-80B with 76K internal memory, BASIC plus MACHINE CODE

DEAL B2plus75 £899 MZ-80B with BASIC, MACHINE CODE, KNIGHTS EASY ASSEMBLER, DISASSEMBLER, KNIGHTS DOUBLE PRECISION BASIC and 75 programs.

DEAL P5 £363 SHARP P5 PRINTER SYSTEM for either MZ-80K, A or B

DEAL P6 £418 SHARP P6 PRINTER SYSTEM for either MZ-80K, A or B

DEAL MZ-80FD £657 Dual FLOPPY SYSTEM for MZ-80A or B

DEAL ADS £1575 MZ-80A micro system, dual floppies, printer, expansion etc.

DUAL BDS £1999 MZ-80B micro system, dual floppies, printer, expansion etc

DEAL 400plus 63 £199 ATARI 400, with BASIC and 63 programs

DEAL 800plus63 £429 ATARI 800 with BASIC and 63 programs

DEAL 810plus63 £259 ATARI FLOPPY DISK UNIT and 63 programs

ALL PRICES EXCLUDE VAT BUT INCLUDE SECURICOR DELIVERY

We are now in our 9th year of selling Sharp without ever having charged to repair a Sharp product. Ring or write for our newsletters and software catalogue — we have hundreds of programs for Sharp and Atari

Knights Computers

108 Rosemount Place, Aberdeen Tel: 0224 630526



JOYSTICKS

We are specialist manufacturers and distributors of joystick controls, ranging in price from £3.00 to £1,000. 20 years experience of design and production, and high volume sales on the UK and through 8 overseas distributors allow us to offer, often from stock, or otherwise within 2 to 3 weeks, a range of standard joysticks suitable for almost any application, from a TV game to a control for earthmoving equipment.

We have 3 ranges suitable for Microcomputers

- The J1, economical dual axis carbon track controls, with or without cases, switches, and cables.
 - The JS2, high quality all metal dual controls for any standard potentiometers (and in particular for plastic film potentiometers giving life of several million cycles).
 - The JS4 unique inductively coupled contactless joystick (with life of up to 10 million cycles total noise free outputs and infinite resolution).
- In addition we frequently build 1 off special joysticks such as triple axis with 3 additional knob controls, for underwater vehicle control, or 16 function units for walking talking puppets. We also design and tool plastic or metal cases, and a wide range of accessories of all sorts including weatherproofing gaiters and bezels.

Please contact us for all your joystick requirement — prices, delivery and quality will surprise you.

We regret that we are unable to handle enquiries from individuals — please contact your dealer or write to us to ask for a dealer list.



FLIGHT LINK CONTROL LTD

UNIT 12, THE MALTINGS, TURK STREET
ALTON, HANTS.

Telephone: Alton (0420) 87241 Telex: 858623 Telbur G



GRAPHIC SPACE GAMES

- FORCE FIELD 10.95
- SPACE SEARCH II 12.95
- SPACE DOGFIGHT II 13.95
- SITTING TARGET 9.95
- ORBITTER 9.95
- GALACTIC ATTACK 10.95

ACTION

- CANNONBALL BATTLE 9.95
- GRANDPRIX 9.95
- MOTORWAY 9.95
- BARREL-JUMP 10.95
- SKI-JUMP 11.95
- MAZE EATER 12.95
- CHOPPER RESCUE 11.95

ADVENTURE

- LOST UNDERGROUND 10.95

CHALLENGE

- SNOOKER 9.95
- INTELLIGENT OXO 9.95
- CROSSWORD 9.95
- NIM 5.95
- PONTOON 5.95

BASIC PROGRAM GOSUBS

- SCREEN PRINT 5.95
- STRINGS HANDLER 5.95
- ALPHABETIC SORT 5.95
- PRINTER FORMAT 5.95

MACHINE CODE SUBROUTINES

- DOT PLOT 5.95
- ALPHABETIC SORT 5.95
- SPEAKER TONES 7.95
- SHAPE MOVER 6.95
- BLACK/WHITE SCREEN 5.95



ZX SPECTRUM CASSETTE

- GALACTIC ATTACK RADAR LANDING
 - SPACE MISSION ATTACKER
 - LUNAR LANDER GALACTIC DOGFIGHT
 - PLASMA-BOLT ZION ATTACK
 - STARTREK IVASIVE ACTION
- 10 POPULAR PROGRAMS FOR £9.95

APPLE SUPER - DISK

- SPACE INTRUDER SPACE SEARCH
 - GALACTIC CHALLENGE STARTREK
 - SNOOKER SPACE-SHIP
 - SPACE DOGFIGHT LUNAR LANDER
 - PHASER JET FLIGHT
- ALL FOR JUST £9.95

« « « « « «
THIS MONTH'S SNIPS

Yes, that's less than £1 a program



COLOUR SPACE GAMES

- INFINITE SEARCH 11.95
- GALACTIC ATTACKER 10.95
- ORBITTER 9.95
- SITTING TARGET 9.95
- SPACE DOGFIGHT 12.95

ACTION

- TEN MILE GUNS 9.95
- OVERTAKE 9.95
- GRANDPRIX 11.95
- SKI-JUMPERS 11.95
- MAZE-EATER 12.95

ADVENTURE

- TUNNEL ESCAPE 9.95
- RESCUE MISSION 9.95

CHALLENGE

- INTELLIGENT OXO 5.95
- NIM 4.95
- PONTOON 5.95

GENERAL

- AUTO-VICE 6.95
- ELECTRONIC WORKSHOP 10.95

BUSINESS

- CALCULATOR 15.00
- ALPHABETIC SORT 13.95
- DATABASE 49.95
- ADDRESS FILE 30.00
- CALCULATOR 15.00
- FILING CABINET 30.00
- ALPHABETIC SORT 13.95

POSTAGE FREE TO U.K. ORDER DIRECT TO:

U.T.S.
 P.O. Box 96
 HARROGATE
 NORTH YORKSHIRE
 HG3 2UZ

PLEASE SEND ME

CHEQUE ENCLOSED, VALUE

NAME

ADDRESS

POSTCODE

ZX81 MACHINE CODE ?

ZX.ASZMIC rom transforms ZX81 into an Assembly Language programming unit

o FULL-SCREEN EDITOR

Sixteen shift keys take you into a world with a word processor feel. A blink cursor moves at your command to control insertion, rubout, line or string deletion, auto-scroll & page flip up or down. Text block operations. Ultra-fast editing.

o MULTI-FILE SYSTEM

Declare as many files as you like, with any names you like, & they are automatically handled by the Operating System. Merge them, delete them, print, save & load them, & edit them by name. Superb flexibility with a simple but powerful system.

o TOTAL ASSEMBLER

Full Z80 mnemonics, unlimited length labels, ORG & EQU directives, proper assembly listings with errors flagged on screen or printer. Relocatable object code & options to facilitate cross-assembly. Interpretive immediate execution available.

o POWERFUL DEBUG

All the usual dump, modify, fill & copy commands; plus breakpoints, single stepping, context control, the convenience of interpretive execution mode, full use of the names in your program, Command Macros, autodump, and full operating system interface.

o HI-RES GRAPHICS

255 x 144 resolution under program control to give you truly convincing graphics. With the power & flexibility of assembler you can really use this high definition.

o MUCH, MUCH MORE

Repeat function on all keys. Double height titling on printer. Lots of extras. But more important than all these features, attractive though they are, is the fact that ZX.ASZMIC is an integrated development system in which everything fits together to give you a tool which can satisfy the professional programmer by simplifying all stages of the program development process. It is excellent for those who are taking the first steps into real programming but the more expert you become the better you realise just what ASZMIC can do for you. If you are at all interested in machine code it will be worth your while to find out more.



NEW
 Send for details of under-the-keyboard board for ASZMIC & BASIC.

£ 39.95 total*

Comprocsys limited

I enclose £39.95. Please rush me ZX.ASZMIC + manual

NAME

Address

Sole UK agents: CAPITAL COMPUTERS LTD.
 1 Branch Rd, Park St, St Albans AL1 4BJ.
 Phone: 0727 72917. Cheques payable to Comprocsys ASZMIC a/c.

**The SPECTRUM
Games Companion**
ISBN: 0 907211 02X
PRICE: £5.95
by Bob Maunder

Available NOW!

LINSAC PCW
68 Barker Road,
Middlesbrough TS5 5ES

EXTRAS FOR THE **BBC**

Unique Hardware & Software

> HARDWARE

- > **"MEDPROM-B" EPROM PROGRAMMER**
- With Machine Code software - User Port
Connection - Programs 2516/2716/2532/2732
- Software Eprom Safety Features £79.00

> SOFTWARE

- > **"MEDITOR-B" FREE FORMAT TEXT FILE GEN/EDITOR** - including:
"MEDMAIL-B" MAILSHOT LABEL PRINTER - Professional Word Processor
Features enable Edit, Save, Compose and
Append Text with Single Key Letter
Commands. £9.50
- > **"MEDMON-B" MACHINE CODE MONITOR** - 20 Commands - Disassemble,
Memchange, Break-points, Search,
Relocate, Offset, etc - Invaluable for
Program Development and to reveal the
Machine Operating System. £9.95

**NEW Real time calendar/clock,
battery operated, user port
connection** £29.50

All prices include p & p.



Microtrol Engineering Design Ltd.
640 Melton Rd, Thurmaston,
Leicester LE4 8BB.
Tel.: 0533 704492

SINCLAIR COMPUTERS



UK prices are shown first. The bracketed prices are export prices which include insured air-mail postage to all the countries of Europe including Norway, Sweden, Finland and Denmark. For overseas customers outside EEurope an extra £5 postage per item is charged. zx81 £43.43 (£52). zx printer £52.13 (£61). ZX spectrum 16K £152 (£160). zx spectrum 48K £202 (£210). zx microdrive n/a (n/a). zx rs232 n/a (n/a). 5 printer rolls £10.43 (£16). Ram packs: 16K £26.04 (£28), 32K £39 (£41). 56K £49 (£51).

DRAGON 32 £173

COMMODORE COMPUTERS

Commodore 64 £299. Vic 20 £130. Kit to allow the use of an ordinary cassette recorder £6. Vic20 cassette recorder £36.50. High resolution graphics cartridge £27.95. Vic printer £175. We stock most accessories.

GENIE COMPUTERS

New colour Genie £173.50, 16K ram card £44. Light pen £15. Accessories for Genie 1 and Genie 2: EG3014 32K £189. Disc drives single £199, dual £369. Double density convertor £72. High resolution graphics £82. Printer interface £36.

UK101 and SUPERBOARD

32x48 display expansion kits UK101 £9, Series 1 Superboard £14. 32K memory expansion board £60. Cegmon £22.50. Word processor prog £10. Centronics

interface kit £10. Cased disc drives with DOS single £275, double £415. Stand alone floppy disc controller £85.

PRINTERS

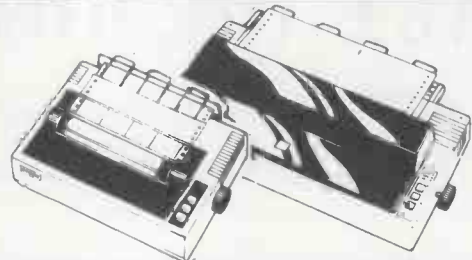

Buy any of the below and get a free interface kit and word processor program for UK101 or Superboard. Epson MX80FT3 £349. Epson MX80T3 £319. Epson MX100/3 £429. Seikoshia GP100A £199. OKI Microline 80 £235. OKI Microline 82A £333. OKI Microline 83A £446. Microline 84 £742.

5V POWER KITS

Fully stabilised 5V computer and TTL power kits. 1.5A £7.83, 3A £12.17, 6A £20.87.

SHARP COMPUTERS

We can supply Epson MX80 and MX100 printers to run direct from the MZ80K (i/o box not needed) for £39 plus printer price. We also specialise in interfacing printers to the MZ80K, MZ80A and MZ80B both with and without the i/o box.

SWANLEY ELECTRONICS

Dept PCW, 32 Goldsel Rd, Swanley, Kent BR8 8EZ
Tel Swanley (0322) 64851

Postage £1 on Sinclair products (UK), £3.50 on other computers, £4.50 on printers and 50p on other orders. Please add VAT to all prices. Official credit and overseas orders welcome.

The '6809' centre

	EX VAT	INC VAT
DRAGON 32-6809 based 32k colour computer	173.48	199.50
DRAGON Joysticks, per pair	17.35	19.95
DRAGON Cassette Interface Lead	2.57	2.95
DRAGON Printer Interface Cable	15.00	17.25

Full range of DRAGON Software in stock.
SOFTWARE—6800 & 6809—on Cassette—300 Baud, CUTS, S1 Format.

6800 Disassembler, with Move function,	10.00	11.50
6800 Text Editor, with Source Listing,	28.00	32.20
6800 Assembler, with Source Listing,	28.00	32.50
6800 Text Processor, with Source Listing,	28.00	32.50
6800 Relocator, with Source Listing,	16.09	18.50
6800 8K Basic Interpreter (V2.3),	15.22	17.50
6809 Text Editor, Cassette to Cassette,	32.61	37.50
6809 Macro Assembler, Memory to Cassette,	32.61	37.50
6809 10.5K Basic Interpreter,	48.70	56.00

The FLEX 9 Operating System for '6809' Based Micro-Computers.

This disk operating system is now the standard single user system for machines using the powerful '6809' micro.

Having many advantages over similar operating systems for other micro-computers, this system can now be run on many different '6809' based machines.

Furthermore, the Configurable Version is available for implementation on custom '6809' computers.

Programs written to run with this operating system are almost completely machine independent, thus allowing the easy transfer of software.

There is a wide range of software available for this system, some of which is listed below. Please send for our full list.

'6809' HARDWARE, RUNNING FLEX 9 OR OS-9.

Convert your APPLE II to FLEX—with the new EXCEL—'6809' board. Complete with FLEX9 on 5 1/4" disk. 181.74 209.00

POSITRON 9000 Multi-user, Multi-tasking System with 64K RAM, 14" Colour Screen. Two 5 1/4" Disk drives with built-in Keyboard with OS-9 Operating System. 2820.00 3243.00

SWT PC S/09, with 64K RAM, 12" intelligent terminal, two 5 1/4" disk drives with 740 Kbyte capacity, with FLEX9 3338.26 3839.00

STIRLING 77—68 KIT, based on 8" x 8" bare PCB's, now with 64K RAM, and Disk Controller for 5 1/4" or 8" Disks.

Send for further details on any of these systems, or their component parts.

FLEX9, 6809 Disk Software, on 5 1/4" or 8" Disks.

Configurable FLEX, with Text Editor & Assembler	120.00	138.00
Sort/Merge Package, with File Editing Facilities	48.70	56.00
Debug Package, a complete 6809 Simulator	48.70	56.00
Disk Utilities, Additional Commands for FLEX	48.70	56.00
Text Processor, for Text Formatting	48.70	56.00
Text Editor & 6800/6809 Macro Assembler	69.57	80.00
Disk & Memory Diagnostics, Further FLEX Commands	48.70	56.00
Extended Basic, Advanced Business Basic for 6809	62.61	72.00
Extended Basic Pre-Compiler, for Extended Basic	32.61	37.50
Pascal, 6809 Machine Code Compiler	130.43	150.00
68000 Cross Assembler, runs on 6809 under FLEX	173.91	200.00
RMS, A Record Management System for 6809	145.22	167.00
Tabula Rasa, Financial Reporting Package	120.00	138.00
Stylograph, The Complete Word-Processing Package	173.04	199.00
Micro-Modeller, Now Available for FLEX9	694.78	799.00
DYNACALC, the Spreadsheet Program for FLEX	140.00	161.00

FULL RANGE OF APPLE II EQUIPMENT ALWAYS IN STOCK, RING FOR PRICES.

- Come and try any of our systems or make use of our mail order service.
- All prices include carriage charges within the mainland UK.
- All prices are correct at time of going to press and subject to availability.
- Send for our latest price list and catalogue covering our vast range.
- Further information is available on all the products listed, send for details.
- Store opening hours 9.30 to 5.30-Monday to Saturday-Access & Visa.
- STIRLING MICROSYSTEMS LTD
- THE '6809' HARDWARE & SOFTWARE STORE.

STIRLING MICROSYSTEMS

241 Baker Street, London NW1 6XE.
 Telephone: 01-486 7671.

ZX81

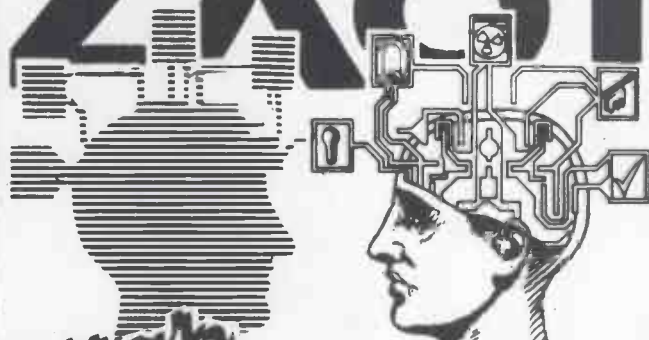

High Resolution Graphics £32

- Stylish case fits neatly between ZX81 and Ram pack of 8K or more.
- 256 x 192 pixels.
- Hi res display file independent of old display file.
- Very fast and powerful graphics commands as extensions of Sinclair basic: SLOW / FAST CLS COPY PRINT PLOT all extended to hi res.
- 114 PLOT modes including:
 - Points and various line types
 - Textured triangle fill
 - Absolute and relative co-ordinates
 - Line drawing to points off screen
- Mixed text and graphics including PRINT at graphics cursor.
- User defined graphics for space invaders etc
- Screen COPY to printer
- Extensive manual, excellent for school and home use, and full guarantee.
- Arcade games available soon!

Post to:- Notting Dale Technology Centre (Ltd)
 T.F.L. (ZX 81)
 189 Freston Road
 London W10 6TH (01-969 8942)

Please send me board(s) @ £32.00 each
 + £4.80 VAT plus 75p P&P

I enclose Cheque/P.O. for
 Or I wish to pay by Access/barclay Card/Visa.

Card Number

Name and Address (PRINT)

Name

Address

Credit card holder's signature.

Scramble for your Spectrum

High-speed arcade game - easily the fastest available. Thrust, altitude, fire and bomb controls. For 16K or 48K Spectrum

Supplied on cassette with library case
ONLY £5.50

from **MIKRO-GEN** the leaders in ZX games



Plus Mikro-Gen games for your ZX81

Space Invaders ★ Breakout ★ Bomber ★ Frog
Paxman ★ Sorcerer's Castle ★ DeBug (Disassembler/Monitor)

All on cassette, with library case **ONLY £3.95 EACH**

Write for full details of the Mikro-Gen range of programs and add-ons, available from local stockists or direct from the manufacturers (please make cheques/PO's payable to Mikro-Gen and add 40p post & packing)

Suppliers of Software to Sinclair

MIKRO-GEN

24 Agar Crescent Bracknell Berks RG12 2BK Tel: Bracknell (0344) 27317

EDUCATIONAL COMPUTING

on the

ZX81

No comparable collection offers so much for so little

Suit children ages 5-11

strongly recommended by educational authorities

Fifty high-quality programs to turn your ZX81 or Spectrum into a powerful educational tool.

And you don't even need to know programming. There are clear instructions and plenty of tips & advice. Designed to go beyond drill & practice to promote learning through interaction & discovery.

Almost all programs work on the **SPECTRUM**

All programs fit 1K

Creative use of graphics

Many innovative ideas

Fully documented

Includes many games

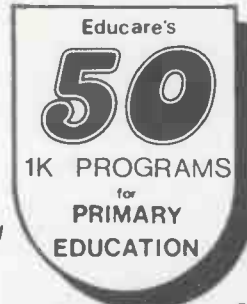

Includes:-

TORTOISE
A simplified version of the famous Turtle programme

CODED MISSILE

Combines the fun of arcade games with learning

£5.95 only
paperback 110 pages plus Spectrum supplement

Graph-plotter ● Histogram ● Simon-spell ● Sketchboard ● Times-table ● Sets Series-quiz ● XY-coordinates ● Count ● Equations ● Areas ● Guess-a-Volume Angles ● Upstairs-Downstairs ● Music-notes ● See-saw ● Wipe-out ● Spell Temperature ● Clock ● Money ● Snake ● Mastermind ● Number-shoot ● +26 more

EDUCARE

To: **EDUCARE**
139a Sloane St.
London
SW1X 9AY

Please send me copies Educare's 50.
I enclose cheque/postal order for £
Name
Address

Let your child benefit early - Send now

ATOM

THE ATOM MAGIC BOOK

By Mike Lord. A wealth of games and other programs; storing speech in your ATOM, converting programs written in other BASICS, and many more useful software & hardware tips. £5.50

GETTING ACQUAINTED WITH YOUR ACORN ATOM

By Tim Hartnell & Trevor Sharples. 80 programs including draughts. £7.95

PRACTICAL PROGRAMS FOR THE BBC COMPUTER & ACORN ATOM

By David Johnson-Davies £5.95

ATOM CASSETTES

We stock a selection of the best; our latest being CAAD: Muncher + Mancala + Target + LIFE 7K. 4 great programs on one cassette for only £6.00

RAM FOR YOUR ATOM (Or other 1MHz 6502/68XX machine)

16 or 32 Bytes; expand your ATOM to 28 or 38K RAM, ideal for Word Processing, Chess programs & Business software. Compatible with other Atom software & hardware including the disc drive. To fit inside the ATOM or Eurocard rack mounting. Some types run from a single +5V supply. S.a.e. for details.

NEW!! ATOM ROAM BOARD M2165 £35.00 inclusive

Allows software switching between up to 3 utility ROMs and also 4K RAM fitted so you can load your own 'utility' programs from tape or disc. Simple plugs into sockets on ATOM board.

All prices inclusive of U.K. P & P & VAT where applicable. Overseas customers please add £1.50 surface mail.

TIMEDATA Ltd. Dept C

57 Swallowdale, Basildon, Essex SS16 5JG
Tel: (0268) 411125 (Mon-Fri)



TIMEDATA

SPELLING CHECKER

The features of PROOF include:-

- Large dictionary of 44,711 words.
- Dictionary contains 1,170 proper names and 659 place names.
- British and American spellings included—either can be selected at run time.
- Plurals of nouns, comparatives of adjectives and all tenses of verbs are included.
- PROOF automatically deals with possessives such as table's, compound words and lines which end with hyphens.
- Alternative spellings, such as civilize and civilise, are included in the dictionary.
- Main dictionary can be extended by adding user created dictionaries.
- Comprehensive 120 page manual.
- PROOF is menu driven.
- Fast interaction by single keystrokes.
- 9 different combinations of input and output plus 4 different operating modes.
- Up to 11 lines of the local context of each spelling mistake may be displayed.
- PROOF can provide the line numbers where spelling mistakes occur.
- PROOF gives a word count.
- PROOF can be used to check individual words typed in at the keyboard.
- Demonstration file included.
- 30 day money back guarantee.

System requirements: 48K Apple][, twin 5 1/4" drives, video monitor, 16 sector DOS. PROOF can accept input from the keyboard or from standard Apple][text or binary files.

Software (2 disks) and manual: £120 + VAT.
Manual: £12 + VAT (credited on purchase of software).

Cambrian Software, Gwynllys, Groeslon, Caernarfon, Gwynedd, LL54 7ST.
Telephone: 0286-831072 (day or night).

Please send me the indicated items. I enclose £.....

Software and manual: £120 + VAT. Manual: £12 + VAT.
 Further details.

Name

Address

Tel. No.

Cambrian Software, Gwynllys, Groeslon, Caernarfon, Gwynedd, LL54 7ST.
Telephone: 0286-831072.

ARBORCRAFT

Micro Computer Mobile Work Stations

High quality 'to glare' melamine finished work surface with post formed long edges. Reinforced polyester coated steel support frames and large twin wheeled castors for ease of movement. Keep your micro off the dining room table and always available.

Choice of 3 models from £98.85 plus VAT. (Access). Money back guarantee. Allow 21 days delivery. Business enquiries welcomed. Phone or send for detailed brochure and order form.



Arborcraft Limited, 137 Watling Street, Radlett, Herts WD7 7NQ
Telephone Radlett (09276) 3126. 24 hour answering service.

Please send me your illustrated brochure and order form for the Arborcraft Micro Computer Mobile Work Stations.

Name _____
Address _____
Post code _____

SPECTRUM BBC

Make the most of your Spectrum or BBC Microcomputer with our proven books.

- () PROGRAMMING YOUR ZX SPECTRUM — Tim Hartnell and Dilwyn Jones. 230 pages, over 100 programs and routines. £6.95.
- () THE SPECTRUM SOFTWARE LIBRARY — 60 Games and Applications listings for the Spectrum — David Harwood. £5.95.
- () LET YOUR BBC MICRO TEACH YOU TO PROGRAM — Tim Hartnell. "Points are well illustrated by programs... quite comprehensive... many of the programs are useful and interesting... will take you further into the cloudy areas of the BBC micro than anything else I have so far read..." (Computer and Video Games). £6.45.
- () THE BBC MICRO REVEALED — Jeremy Ruston. The full inside story, for those who have mastered the manual. £7.95.

Interface, Dept. PCW, 44-46 Earls Court Road, London, W8 6EJ

Please send me the books indicated above. I enclose £ _____.

Name _____
Address _____



CRYSTAL RESEARCH LTD

XTAL BASIC 3

A Z80 based Interpreter. Disc and Cassette versions including CP/M are available now or in the near future.

FEATURES

- 1 Has over 110 Commands and Functions and is user extendable.
- 2 **Xtal BASIC 3** incorporates its own editor that is independent of VDU or terminal being used but appears to have the facilities of the most sophisticated direct screen editing, in brief the editor contains the following:
Lines of 127 characters (can be extended up to 254)
Full on screen editing, up, down, left, right.
Auto insertion of lines.
HOME CURSOR, CLEAR SCREEN, DELETE LEFT, DELETE RIGHT, INSERT CHARACTER, ERASE WHOLELINE, ERASE TO END OF SCREEN, PRINT SCREEN CONTENTS TO PRINTER, and ABANDON LINE. A LINE EDIT MODE IS INCLUDED AS STANDARD.
- 3 Variables can be of any length. First five characters used to distinguish one variable from another. Multi-dim arrays, string arrays and integer arrays.
- 4 Full Tape and Disc file handling.
- 5 32 standard error messages and traps. Ability to trap **BREAK KEYS**. Error table is extendable.
- 6 Possible to run programs larger than memory capacity.
- 7 Special features allow transfers of programs from machine to machine.
- 8 **Xtal BASIC 3** is designed to be compatible with most available BASICS and a program is supplied for many BASIC to BASIC conversions.
- 9 The manual, consisting of over 100 pages, includes full description of the BASIC, sample programs, useful Machine Code Subroutines in Xtal BASIC 3, examples of extra commands and functions.
- 10 **SIZE 12K to 14K** depending on the System.
- 11 Available on **Cassette** and/or **Disc**. Please contact Crystal Research Ltd., for availability on your particular machine.
- 12 On Cassette **£40.00 + VAT** On Disc **£60.00 + VAT**
OEM and Manufacturers are invited to contact Crystal Research Ltd., for licence details.

Open 0930-1200 1300-1730 except Saturday & Sunday
40 Magdalene Road, Torquay,
Devon, England Tel: 0803 27890
Access and Barclaycard



AET LAHST!

PHONETIC SPEECH SYNTHESIS
for ZX81

as well as VIC, PET, ATOM, BBC, NASCOM, etc., etc.

SPEAKEASY

- * INFINITE vocabulary beats pre-programmed words any time!
- * READY TO GO mains powered with smart cabinet and speaker, manual

£69 + VAT + £2.50 post + insurance



ZXPORT

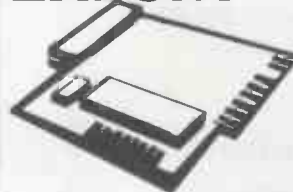

2x8 bit + 2x4 bit ports (memory mapped)
Extends the bus so that extra RAM etc can still be used

£19.50 + VAT + 50p postage

ZXPORT FREE WITH SPEAKEASY
(PRE-WIRED) (WIRED TO ZXPORT)

WIDEBAND PRODUCTS, CAMBRIDGE ROAD, ORWELL, ROYSTON, HERTS. TEL: 0223 208017
(PART OF INTELLIGENT ARTEFACTS LTD)
A subsidiary of Sands-Whiteley Research and Development

CALLING ALL SINCLAIR ZX81 AND ATARI USERS

How about sharing that
program you have written?
Total UK distribution.

25% royalties on all
programs sold.

Programs should be cassette
or disk based complete with
running details.

Forward to:
**STUEBE & WRIGHT
SOFTWARE**

24 Cranbourne Street,
LONDON WC2

Happy Memories

Part type	1 off	25-99	100 up
4116 200ns	.83	.72	.66
4116 200ns	.75	.65	.60
4816 100nms for BBC comp	2.45	2.10	1.95
4164 200ns	4.95	4.45	4.20
2114 200ns Low power	1.15	1.00	.90
2114 450ns Low power	.95	.85	.80
4118 250ns	3.25	2.85	2.65
6116 150ns CMOS	3.70	3.20	2.95
2708 450ns	2.60	2.25	2.10
2716 450ns 5 volt	2.60	2.25	2.10
2716 450ns three rail	5.75	5.00	4.65
2732 450ns Intel type	3.75	3.25	3.00
2532 450ns Texas type	3.75	3.25	3.00

Z80A-CPU £4.35 Z80A-PIO £3.25 Z80A-CTC £3.25
6522 PIA £3.98 7805 reg £0.50 7812 reg £0.50

Low profile IC sockets: Pins 8 14 16 18 20 22 24 28 40
Pence 9 10 11 14 15 18 19 25 33

Soft-sectored floppy discs per 10 in plastic library case:
5 inch SSSD £17.00 5 inch SSDD £19.25 5 inch DSDD £21.00
8 inch SSSD £19.25 8 inch SSDD £23.65 8 inch DSDD £25.50
74LS series TTL, large stocks at low prices with DIY
discounts starting at a mix of just 25 pieces. Write or 'phone
for list

Please add 30p post and packing to orders under £15 and VAT to total
Access and Barclaycard welcome, 24hr service on (054 422) 618
Government and Educational orders welcome, £15 minimum
Trade accounts operated, 'phone or write for details



HAPPY MEMORIES (PCW), Gladestry, Kington,
Herefordshire. HR5 3NY. Tel- (054 422) 618 or 628

Software for SHARP microcomputers

PAYROLLS. All adhere to the INLAND REVENUE regu-
lations, produce payslips on plain paper and a full printout
for record purposes. Fully menu driven, simple to use.

MZ-80K/MZ-80A			MZ-80B increased capacity, higher speed		
Tape	Weekly	£120.00	Tape	Weekly	£120.00
	Monthly	£120.00		Monthly	£120.00
Disk	Weekly	£150.00	Disk	Weekly	£150.00
	Monthly	£150.00		Monthly	£150.00
	Combined	£275.00		Combined	£275.00

MZ-80K	Stock Control	£170.00
	Stock Control and Invoicing	£285.00
MZ80B	Letterwriter	£45.00
	Cashbook	Cassette £65.00
		Disk £95.00
	Revive	£20.00
	Bstam	£90.00

All prices exclude VAT at 15%.

For further details write or ring:

MICROTEK

15 Lower Brook St Ipswich Suffolk IP4 1AQ
tel Ipswich (0473) 50152/52466

where software meets hardware



The only thing we discount is the price.

- CREDIT FACILITIES
- AFTER SALES SERVICE
- MAIL ORDER
- EXPORT

M. O'BRIEN
MICROCOMPUTER DISCOUNTS
01 946 1528/0331

95 High Street
Wimbledon Village
London S.W.19
93 Bus route
Open 9:00 am - 5:30 pm
Tuesday/Saturday
Closed all day Monday
We accept VAT and
offer a 10% discount on
all orders over £100
plus postage and
packing charges.

apple computer

APPLE III £2150

APPLE II 48K £659
DISK II (with controller) £314
DISK II (W/O controller) £285

Prices includes VAT

Computer plus Video Monitor III and
information Analyst Software Package
comprising of: VisiCalc™ III, The
Apple Sophisticated Operating System
(SOS) and Apple Business BASIC
Language.
Additional Disk Drive III £319

TABS

Software
Foundation Module
Sales Ledger
Purchase Ledger Module
Nominal Ledger Module
Stock Control Module

Special
prices
on
request

SOFTWARE

APPLE VISICALC £107
APPLE VISIDEX £107
APPLE VISIPILOT £97
APPLE VISITREND/PLOT £137
APPLE VISITERM £80
APPLE VISIFILE £137
APPLE ESTATE AGENT £345
(inc VAT)
MICRO MANAGEMENT
ACCOUNTS £517 (inc VAT)

VIC-20

VIC 20 £159
VIC C2N £39
VIC PRINTER £299
VIC D.DRIVE £200
VIC 3K RAM £26
VIC 8K RAM £39
VIC 16K RAM £65

GAMES
CARTRIDGES
£17.00

Prices inc VAT.

Printers

CENTRONICS
EPSON MX80
EPSON MX80FT
OKI
MANNESMAN
DIABLO
RICOH
NEC
TEC
STAR
ANADIX
SEIKOSHA

TELEX!

FROM YOUR

OSBORNE 1

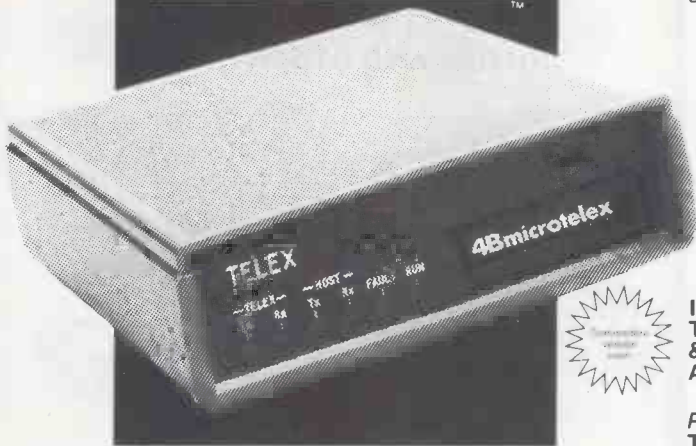

4Bmicrocentres

North Bar, Banbury, Oxon. OX16 0TF Telephone (0295) 66555

- AUTODIALLING
- WORDSTAR ORIGINATE
- STATUS REPORTS PLUS
- MULTIPLE SEND
- CONTINUOUS RECEIVE WITH OSBORNE DISCONNECTED
- BT APPROVED

Manufactured by a leading European Electronics group. Subject to BT Regulations & charges. Eliminates need to pay for separate dedicated Telex terminal. No specialized operator required. Full support available. One year warranty. International Telex interface connections available. Regular telex destination numbers stored in memory.

IF YOU ARE THINKING OF INSTALLING TELEX WHY NOT SELECT AN OSBORNE & MICRO-TELEX AT THE SAME COST AS A B.T. STAND ALONE SYSTEM?

Phone for details!
TRADE & DEALER ENQUIRIES WELCOME

DISKS DISKS DISKS

*** LOWEST PRICES - FAST DELIVERY ***

PRICE PROMISE
We will match any other lower price advertised in this current issue of PCW for single boxes in stock

5.25" DISKS - BOXES OF 10

	£	QTY.	AMOUNT
VERBATIM Single or Double Density			
S-SIDE/SOFT SECTOR (40 TRACK)	16.30		
D-SIDE/SOFT SECTOR (40 TRACK)	23.50		
S-SIDE/SOFT SECTOR (77 TRACK)	23.00		
Add £1.25 for PLASTIC CASE			
MEMOREX			
S-SIDE/S.DENSITY/S.SECTOR	15.50		
D-SIDE/D.DENSITY/S.SECTOR	19.70		
BASF			
S-SIDE/S.DENSITY/S.SECTOR	15.00		
S-SIDE/D.DENSITY/S.SECTOR	18.80		
D-SIDE/D.DENSITY/S.SECTOR	23.00		
HEAD CLEANING KIT	16.30		
LIBRARY BOX	1.90		
POSTAGE/PACKING (UK)			
DISKS/CLEANING KIT	£1 / BOX		
LIBRARY BOX	50p/BOX		
Send to: PINNER WORDPRO,		TOTAL EXC.VAT	
34 CANNONBURY AVE.,		VAT 15%	
PINNER,			
MIDDLESEX, HA5 1TS.		TOTAL PAYABLE	

Name..... Tel No.....

Address.....

My Access/Barclaycard No.....
(Delete as appropriate)

If you do not wish to cut out form send order separately

*** Also supplied at competitive prices ***
HARD SECTOR/OTHER FORMATS MINI-DISKS AND 8" DISKS
PLEASE CONTACT US FOR DETAILS OF QUANTITY DISCOUNTS
(over 4 boxes) AND TRADE ACCOUNTS

TELEPHONE ORDERS ANY TIME - WE DO THE REST

01-868 9548



Pinner Wordpro



For a happy Christmas

make sure you can use the computers you buy!

Your Atari Computer: A Guide to Atari 400/800 Personal Computers.

This is the most comprehensive guide to the Atari available today. It will teach you how to set up the Atari and program in BASIC; covers the sound and graphic capabilities in three detailed chapters, and contains extensive descriptions of the disk drive, printer and other peripherals for the Atari, along with step-by-step instructions for their use. Although written primarily for users with little programming experience, the book contains tables, charts and programming tips that will be very useful to the expert Atari user.

1982 450 pp £10.95

PET Personal Computer Guide (Osborne)

Based on the very popular PET/CBM Personal Computer Guide, this new book contains a wealth of information for the novice or professional alike, from tutorials in PET BASIC, to instructions for using the PET's highly advanced screen editor. Including all the recent PET products it covers all aspects of PET operation from programming and debugging to the use of peripherals. Organised for quick reference it also provides a summary of PET BASIC statements in alphabetical order, a chart of PET character codes, a 36 page memory map and useful references. Practical and easy to use, this book will help you to understand the capabilities of the PET, and be an essential guide for daily use of the machine.

1982 500 pp £11.50

CP/M User's Guide 2/e

No matter what kind of computer or version of CP/M you have, you'll find this brand new edition the most complete, accurate and up-to-date book on CP/M available today. Including a complete section on CP/M 86, it discusses all types of CP/M and their compatibility, provides sample screen displays to explain every operator command and computer response, discusses assembly language utilities, applications passages MP/M and much much more.

1982 284 pp £11.50

Available through all good bookshops, selected computer retailers or direct from the publisher, now!



McGraw-Hill Book Company
(UK) Limited,
Shoppengangers Road, Maidenhead,
Berkshire, SL6 2QL.

NASCOM

BRITISH AND BEST

SYSTEMS

48K NASCOM 3.	£549.00
8K NASCOM Micro Ed.	£399.00
NASCOM Single Drive.	£470.00
NASCOM Dual Drive.	£685.00
NASDOS Disc Operating System.	£60.00
CP/M Disc Operating System.	£125.00
Sanyo Tape Recorder	£25.00
12" Green Screen Plastic Monitor.	£99.00
12" Green Screen Metal Monitor.	£125.00
Epson MX80 F/T2 Printer.	£399.00
TEC 1550 Printer.	£699.00

ADD-ONS

Castle Tape Interface.	£17.50
Milham A/D Converter.	£49.50
Screen Weave Eliminator.	£8.75
Screen Flash Eliminator.	£14.75
Programmer's Aid.	£28.00
Arton Speech Board.	£85.00
W.S. Big Ears.	£45.00
PMG Soundbox.	£40.50
CMOS 2K Ramboard.	£95.00
CMOS 32K Ramboard.	£185.00
I.O. Systems Pluto high res. Graphics Board.	£399.00
Colourgraphics NASCOM AVC On Demonstration Now.	£185.00
RAM B 64K Upgrade	£30.00

All Prices excl. VAT and Postage

TWO MORE BRITISH COMPUTERS

The new Welsh Dragon 32 with colour and sound. High resolution graphics and 32K user memory.

£199 inc VAT

Program tapes, cartridges and joysticks available.

The very popular Sinclair ZX81

£49.50 inc VAT

Printer and program tapes also available.

We will give a generous trade in on a ZX81. Purchased from us if you later wish to upgrade to a Dragon or a Nascom.

Business & Leisure Micro Computers



16, The Square, Kenilworth, Warwickshire CV8 1EB.
Telephone: (0926) 512127.

VISIT OUR GREATLY EXPANDED SHOW ROOM

S.N.P.

"SCOTLAND'S NATIONAL PERIPHERALS"

LET US SURPRISE YOU!

CALL US FIRST FOR DISKS, PRINTERS, MONITORS AND OTHER HARDWARE



WORDSWORTH

6 GRANT ROAD
BANCHORY
AB3 3UR
03302 - 4168



PRINTER BONANZA!

EPSON PRINTERS AT UNBEATABLE PRICES

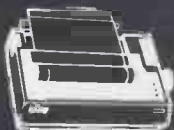

MX80 FT III	£305 + VAT
MX82 FT III	£315 + VAT
MX100 FT III	£415 + VAT

Interfaces to any machine supplied—please ask for price



All printers carry a 1 Year Guarantee and come with paper. Shipment is by Securicor to your door—Please add £7 + VAT carriage.

Payment by Cheque, Access, Visa etc.
All prices Apply to 31st Jan. 1983.

Shipments throughout UK by Securicor.
We can export to most countries in the world.

IMMEDIATE DELIVERY.



Micro-Spares

We cannot and will not be beaten on Price!

19 Roseburn Terrace, Edinburgh EH12
031-337 5611 (24 hrs)

REGISTERED REFERRAL CENTRE FOR THE BBC PROJECT

BEEBUG FOR THE BBC MICRO

INDEPENDENT NATIONAL USER GROUP FOR THE BBC MICRO

MEMBERSHIP NOW EXCEEDS 10,000

10,000 members can't be wrong — BEEBUG provides the best support for the BBC Micro. BEEBUG Magazine — now 36 pages — devoted exclusively to the BBC Micro.

Programs — Hints & Tips — Major Articles — News — Reviews — Commentary. Plus members discount scheme with National Retailers. Plus members Software Library. 10 Magazines a year. First issue April 1982. Reprints of all issues available to members.

April Issue: Program Features: 3D Noughts and Crosses, Moon Lander, Ellipse and 3D Surface. Plus articles on Upgrading to Model B, Making Sounds and Operating System Calls.

May Issue: Program Features: Careers, Bombers, Chords and Spiral. Plus articles on Graphics, Writing games Programs and Using the Assembler.

June Issue: Program Features: Mazetrap, Mini Text Editor, Polygon: Plus articles on upgrading The User Port, TV set and Monitor review Graphics part II. More Assembler Hints, Structuring in BBC Basic, Plus BBC Bugs.

July/August Issue: Program Features: Beeb Invaders Patchwork Program & Screen Dump. Plus Teletext articles on using the mode BBC Cassette, Bugs Fix, Software Review using the User Port II, More on Structuring in Basic, Using User Defined Keys, Input Function and many Hints & Tips.

September Issue: Games Programs! Higher/Lower and Hangman, plus String Search Program, Articles on Debugging Programs, a safe verify, new user guide, Errata, Ideas on Colouring and Shading, Acorns ROM replacement charge, plus much more.

October Issue: Program Features: Alien Attack, Calender Generator, Union Jack, and Memory Display Utility. Plus articles on Debugging, Improving Key Detection. Acorn Press Release on O.S. 1.2 and Issue II Basic, The Tube and Second Processor Options, a New Series for Less Experienced Users and Software Reviews.

MEMBERS SOFTWARE LIBRARY — Growing range of software — around £3.50 per cassette. (Available to members only)

GAMES:
1. STARFIRE (32K) 2. MOONLANDER (16K) 3D NOUGHTS AND CROSSES (32K) 3. SHAPE MATCH (16K) MINDBENDER (16K) 4. MAGIC EEL (32K)
UTILITIES 1. DISASSEMBLER (16K) REDEFINE (16K) MINI TEXT ED (32K)
APPLICATIONS 1. SUPERPLOT (32K) PLUS 3 new cassettes coming soon.



Send £1.00 & SAE for Sample.

Membership:
UK 4.90 for six months
8.90 for one year

Overseas one year only:
Europe £15.00 Middle East £18.00
Americas & Africa £20.00
Other Countries £22.00

Make cheque to BEEBUG and send to:
BEEBUG Dept 374 Wandsworth Rd, London SW3 4TW
Editorial Material to PO Box 50, St Albans, Herts, AL1 1AR





Lion Micro Computers

London's widest range of Computer Books & Computer Magazines

EXTENSIVE RANGE OF SOFTWARE
ACCESSORIES AND PERIPHERALS

For experts and beginners alike

Lion House, 227 Tottenham Court Road, London W1P 0HX
Telephone: 01-580 7383 & 01-637 1601 Telex: 28394 Lion G.

Open 9 to 6 Mon-Sat   
SEND LARGE SAE FOR OUR LISTS 



A FASCINATING INTRODUCTION TO PROGRAMMING

LOGO II MODEL B

The first implementation on the B.B.C. Microcomputer of the graphics language LOGO. This language is now popular in American schools as an ideal educational program. It can graphically demonstrate the ideas of defined procedures, sub-routines, loops and even recursive programming. LOGO II is a much improved version of our original LOGO program and now works in different screen modes and includes the ability to list or delete defined words. These may also be saved on tape. This program will give an excellent introduction to computers and LOGO language.

**£16.00
+vat**

Professional B.B.C. software for homes COMPUTER

CONCEPTS

  **16 Wayside, Chipperfield,
Herts, WD4 9JJ. tel (09277) 69727**

 **Quantity discounts available—ask for details**

Disk Utilities for CP/M

**for
ANY
DISKETTE
FORMAT**

These general disk utilities work on ANY single user CP/M 2.x system, with ANY diskette size and format, and many hard disks. All are menu driven, and easy to use.

DDUMP makes it possible to examine and patch any byte on any sector, addressed by track and logical sector number — or addressed by allocation block number, both in HEX and ASCII format. May be used to study how CP/M allocates disk storage, to examine or repair a damaged disk and to recover lost data.

DTEST tests a disk for bad spots. Bad sectors are locked out from later use by CP/M by automatically collecting them in a -garbage- file. All errors are reported to printer and/or console. Reduces probability of later disk crashes. Indispensable for hard disks, as media cannot be replaced. Use DTEST before disk errors ruin your work!

DUSER enables you to have access from one user area (user number) to programs and/or files stored on other user areas, without having to keep duplicate copies of files on the disk. DUSER makes this possible by copying file entries from one user area to another, thus saving considerable disk storage space.

DDUP duplicates disks. It is independent of disk controller, drive, disk size and format. It only requires that source and destination disks are of the same format and density. It will also replace bad sectors on the source disk with blank sectors on the destination, thus enabling you to automatically recover (what can be recovered from) damaged files.

UNERA recovers accidentally ERASEd files.

Price: Only £19.95 each. All 5 together £69.95.
Complete set of 5 manuals: £12.00.
Specify format: 8" SS/SD, 5" HS Heath/Zenith or 5" Osborne disk. Include £5 per order for handling & shipping. VISA accepted.

Dealers/distributors inquiries invited.

Order from your dealer, **ELEKTROKONSULT AS**
or directly from: Konnerudgaten 3
N-3000 Drammen
NORWAY

CP/M is a trademark of Digital Research.

THE STAR

is pleased to announce that you may now obtain our products direct from the manufacturer.

PRO-DIS

— For the BBC Micro. The superb RAM resident Colour disassembler with Hex/ASCII memory dump, full and easy memory editing on all functions, and memory COPY facilities. Fits ANY BBC Micro. Don't fool around with toy disassemblers from the cowboys. This is from the authors of DISATOM! Please state 16K or 32K. £5.95

DISATOM

— the supremely comprehensive toolkit and disassembler for the ATOM. Look at this:

AULD — targetable OLD
COPY — areas of memory
DELETE — BASIC lines
DIR — directory
EXEC\$ — string in fn or cmdnd
HEADER — freeze top lines
HIGH — 1200 BAUD taping
LOW — 300 BAUD taping
ON ERROR — trap errors
PAGE — new text space
READ — reads DATA statement
RESTORE — reads DATA statement
RESTORE — move data pointer
TAPE — for really bad tapes
ZERO — all variables to zero

AUTO — line numbering
CURSOR — X+Y cursor control
DUMP — value of variables used
ERUN — run with error check
FINL — m/c code, assembler and BASIC
HELP — recover bad tapes
INKEY — a GET command
NUKE — really thorough NEW
OUT — RS232 output from cas socket
PULL — can exit FOR,GOSUB, DO loops
DATA — Data as a list in program
REN — line renumber
TONE — music, and out to tape too

MACHINE LEVEL FUNCTIONS:

Function
DISASSEMBLE — any area of memory, edit/modify directly as desired
HEX DUMP — any part of memory, with direct edit/modify
ASCII DUMP — any memory as its ASCII equivalents, with edit/modify
TRACE — any m/c code routine, setting all registers etc.
M/C DEVELOP — a command for high powered m/c code program writers

These m/c commands make the machine absolutely TRANSPARENT, and it is worth the time of even a novice to learn how to handle them. £19.95

FUSION

— a 17 page, covered manual with demo programs to help you join in the ATOM and DISATOM. £1.00

SOFTSWITCH

— a plug-in (no ribbon cables!) board for the A000 utility socket that allows 4x4K ROMs to be resident, each selectable from Keyboard or Program! Always come up on ROM 0, then you choose. Ideal with DISATOM in socket 0. Mechanically stable, and does not interfere with any other boards in the ATOM. £19.95

PRO-LOG

— An Analogue to Digital converter board for ATOM. 8 Inputs, allows 2 jpyctics with 4 fire buttons, or any other like combinations. Has many built-in software commands. Easy to fit, and gives you real games power. £40.00

Add 15% VAT. Make cheque/PO payable to FOCUSPLAN LTD. Send your orders to PROCYON, 57 Westgate, Cleckheaton, West Yorks, BD19 5HH. Trade Orders welcome.

OPEN FRAME MONITORS AVAILABLE FOR OEM'S

The 'PRINCE' of Monitors

offers better Monitoring.

24MHz Bandwidth - ensures a clear crisp display.

Available with P4 White P31 Green AND L1 ORANGE

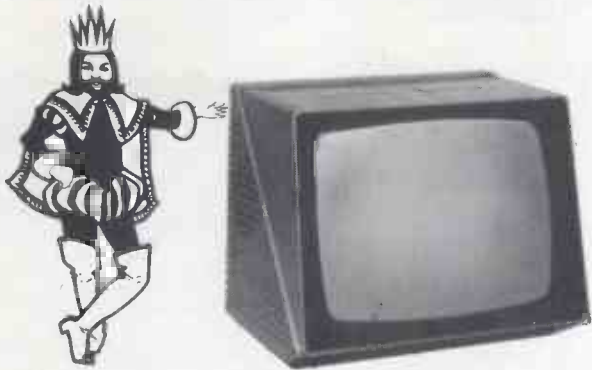

Scan: 625 lines/50 Hz. Deflection: 110°. Active raster: 240x172mm. Bandwidth (3dB): 10 Hz-24 MHz (at 3dB points). Character display: 80 characters x 24 lines. Horizontal frequency: 15625 Hz ± 0.5 KHz. Vertical frequency: 50 Hz. Horizontal linearity: ± 3%. Vertical linearity: ± 2%. Geometric distortion: ± 1.5%. EHT (at zero beam current): 13kV ± 0.5kV. Power drain: 30 Watt approx. Voltage supply: 110V A.C. 50 Hz/220V A.C. - 50 Hz/240V A.C., 50Hz/± 10% upon request. Video input: 2 x BNC - or CINCH - or PL 259, (composite video) negative sync, input 0.5-4V p.p. across 75 Ohms. X-Ray radiation: conforms to I.E.C. Spec. No. 65. Overall dimensions: 320 x 270 x 265 mm. Weight: 7 Kg. approx. Ambient temperature: 0-45°C.

OTHER CROFTON PRODUCTS INCLUDE: Computer peripheral equipment, Frame grabber, Floppy disk drives, Floppy disks, Computer power supplies, C.C.T.V. monitors, Uncased monitors, Monitor P.C.B's., Cathode ray tubes, VHF/UHF modulators, Video switchers, Video distribution amplifiers, Camera housings, Pan and tilt units, Camera lens, Camera tubes, Printed circuit board service.

CROFTON ELECTRONICS LTD

35, Grosvenor Road, Twickenham, Middx, TW1 4AD.
Telephone: 01-891 1923/1513 Telex: 295093 CROFTN G

FOR YOUR MICRO COMPUTER NEEDS

- MICRO COMPUTERS
- ACCESSORIES
- PERIPHERALS
- EXTENSIVE RANGE OF SOFTWARE
- WIDE RANGE OF BOOKS & MAGAZINES
- IN-HOUSE AFTER SALES SERVICE DEPARTMENT

STOCKISTS FOR APPLE, OSBORNE, NEWBRAIN ETC.

Lion Micro Computers

THE SPECIALISTS

Lion House, 227 Tottenham Court Road, London W1P 0HX

Telephone: 01-580 7383 & 01-637 1601

Telex: 28394 Lion G.

Open 9 to 6 Mon-Sat



256Kb RAM CARD FOR NASCOM/GEMINI 80 BUS SYSTEMS

8"x8" Plug in card with memory arranged in four 64k blocks. Buy it now as a standard 64k blocks. Buy it now as a standard 64k ram card and expand it later by simply adding more ram chips.

Versatile page mode options or more extensive memory mapping facilities.

Operation at 4MHz without wait states.

Software support available for CP/M virtual disk - Speed up those programs that access the disk excessively.

NOW AVAILABLE IN KIT FORM

Bare PCB with full instructions £42.50
64k Kit complete £105
64k Card fully built and tested £150
64k Expansion kits POA

All prices are exclusive of VAT
Add £1.50 for carriage and packing

COMING SOON

Low cost 80 column video card for Nascom

MAP 80 SYSTEMS LTD
333 Garret Lane, London SW18
Tel: 01-874 2691

14" COLOUR MONITOR

WITH SOUND
COMPOSITE VIDEO & RGB



**SPECIAL
OFFER**



THE PROFESSIONAL & VERSATILE UNIT FEATURING.

- VERSATILE INPUTS: COMPOSITE VIDEO IV-75 : RGB/SYNC.IV-75_a(TTL COMPATIBLE).
 - BUILT IN AMPLIFIER & SPEAKER
 - CAN DISPLAY ANY TV SIGNAL (UNLIKE OTHERS) EG, VCR's & TV CAMERAS.
 - FULLY ISOLATED SWITCHING POWER SUPPLY.
 - LATEST 'HI-BRI' TUBE FOR ENHANCED PERFORMANCE
 - PROFESSIONAL STRUCTURAL FOAM CABINET
 - STANDARD RESOLUTION, UP TO 1000 CHARACTERS.
 - HIGH RELIABILITY CIRCUIRY.
- COMPATIBLE: DRAGON, ACORN, VIC, APPLE, & OTHERS.

ONLY £249.

INCLUSIVE OF VAT, P&P. TO UK MAINLAND. PLEASE ALLOW 28 DAYS DELIVERY. OFFER ENDS 31/1/83.

**JLC DISPLAY
ELECTRONICS LTD**

**TRIANGLE BUILDINGS,
234R
GREEN LANES, LONDON
N13 5UD 01 882 3531.**

"Our simplified circuitry for quality at low cost."
(OEM & DISTRIBUTOR ENQUIRIES WELCOME)

ADVERTISERS INDEX

Access Data	108	Datarite Terminals Ltd	228	Leaslink Viewdata	9	Prentice Hall International	217
Acomsoft	258	Datasoft	250	Leicester Computer Centre	282	Procyon	293
ACT	71,72&73	DaVinci Computer Shop	62	Lifboat Associates	239	Professional Data Systems	91
ADDA Computers	74&75	Deans of Kensington	20 & 93	Linsac	286	Quicksilva	219
Aimgram	250	Delta Systems	278	Lion Micro Computers	293 & 295	Raven Computers	247
Almarc Data Systems	44&142	Digital Solutions	269	Lion Viewdata	277	Real Time	265
Altwasser	283	Digitek	63	L&J Computers	227	Romk Software	87
AM Electronics	232	Digitus	1	Logica	79 & 275	Satellite Services	270
Apple Orchard	279	Discom	86&89	London Computer Centre	211	SBD Software	84
Apple Takeaway	59	Disking	214	London Micro Systems	5	Silica Shop	243
Aqua Computing	75	Diskwise	267	Low Electronics	76 & 77	Silicon Valley Computer Centre	11
Arborcraft	289	Dovness Business	54	LSI	52 & 53	Sinclair	
Asco	269	Dragon Data Ltd	36&37	Lucas Logic	236 & 237	Research Ltd	45,46,47&48
Asro Information Systems	254	DRG	64&65	Map 80 Systems Ltd	295	Sirton Computer Systems	18
Atari International	70,122&178	Educare	288	Maplin Electronic Supplies Ltd	28 & 29	Small Systems Engineering Ltd	270&271
Atlanta Data Systems	92	Elcomp Publishing	260	McGraw	291	Soft Option	259
Audio Computers	IBC	ElektrokonsORT	293	Microtech	60	Software Ltd	150
Beebug	292	Elstree	220	Microage Electronics	220 & 221	Software Rental Bank	242
BiBi Magnetics	281	Emap	253	Microcentre Ltd	IFC	Spectrum Computer Group	12,13,14&15
Bonsai	233	Equinox Multi-User Microsystems	124&125	Microchange	91	SRS Microsystems	109
Brighton Computer Centre	32	Euromicro	295	Microcomputer Products	51	Stack Computers	61
British Micro	56&57	Flight Link Control	284	Microconcept	274	Startech	31
Bug-Byte Software	248	Folkade	274	Microdeal	277	Stemmos Ltd	67
Bureau of Information Science	210	4B Microcentres	291	Micro-Gen	288	Stirling Microsystems	287
Business & Leisure Micro Computers	292	Fuller Micro systems	246	Micro General	276	Stock Electronics	280
Byteshop	78	Gemini Marketing Ltd	251	Microserve Computers	265	Strebe	290
Calisto Computers	268	Gemini Microcomputers	10 & 50	Microsoft Europe Ltd	58	Sumlock Bondain Ltd	262
Cambrian Software Cambridge	288	General Northern Microcomputers	67	Micro Spares	292	Swanley Electronics	286
Computer Store	234&235	Gramma	266 & 267	Micro Technology	86	Tabs	263
Cambridge Software Computers	255	Grundy Business Systems	240 & 241	Microvalue	23,24&25	Technicare	88
Castle Electronics	172&173	Hal Computers Ltd	164 & 171	Molimex Ltd	244&245	Technomatic Ltd	30
Caxton Software	224	Happy Memories	290	MOM Systems	90	Telesystems Ltd	124
Chromasonic Electronics	97	HCCS Associates	220	Namal Associates Ltd	67	Tempus	273
City Microsystems	223	IBR	80 & 81	Nippon Electric Co	49	Texas Instruments	66
Climax Computers	210	Icarus Computer Systems	19	Northamber	4	Timedata Ltd	288
Comart	21,55,82&83	ICE	258	North Star Computers	264	Titan Programmes	272
Commodore	120&121	ICL	116	Nottingham Technical Centre	287	Thorn EMI	128 & 129
Comprocs	285	Impact Data	106	O'Brien	290	3D Computers	254
Compsoft	136	Impulse	280	OE Ltd	257	Torch Computers	218
Computech Systems	230	Infodata	22	Office Efficiency	161 & 210	Transam Microsystems	68 & 69
Computer Ancillaries	42&43	Information Desk	216	Office International	209	Transtec	111
Computer Concepts	293	Intelligent Artefacts	289	Olive Branch	272	Turcan	234
Computer Plus	109	Interface	289	Open Computer Services	222	VAS (Computer Services)	280
Computer Supermarket	27	Interface Management	89	Opus Supplies	261	Venturesoft	268
Comserve	282&283	IO Research Ltd	238	Oric Products International	40 & 41	Vincelord Ltd	7
Comshare	133	IO Technology	152 & 153	Ozwise Computers	275	Watford Electronics	294
Comshave	226	Irish Computer Centre	39	Pace	256 & 257	Which Computer Show	252
Cream Computers	295	Jayman	255	Paperlogic	278	Wihelmy	285
Crofton Electronics	281	JLC Display Electronics	90	Peachtree	33,34&35	Wordsworth	292
Crown Business Centre	289	Johnson Microcomputers	234	Personal Computers Ltd	OBC	X-Data Ltd	8
Crystal Research	212	Jupiter	16 & 17	Pete & Pam Computers	225	Xitan Systems	38 & 269
Cumana Ltd	212	Keelcodes	62	Pinewood Computers	281	Zen	215
C/WP Computers	101,103&105	Kempston	267	Pinner Wordpro	291	Zytek International Products	231
Dary Star Systems	213	Knights TV & Computers	284	Planned Data Furniture	277	ZX Microfair	219
Datalink Microcomputer Systems	26	Kuma Computers	32				
		Learned Information	92				

CHIP CHAT

The 'state of the art' in micro technology in the USA seems to be getting itself into more and more of a state. For instance, an ad spotted recently in an American micro mag boasts 'Now you can use computer technology to search the Bible on any subject.' You see, some redneck fundamentalist computer freaks have put the King James Bible onto disk and are supplying it with a piece of look-up software called (believe it or not) The Word processor. Going to the other extreme, an outfit calling itself The Software Co is advertising a game (at least, we think it's a game) called 'Sewers of Moscow' — with sound!...

While still on the subject of software trade names, the erstwhile editor of a certain other micro magazine, now a director of a software house, has christened his latest range of software 'Elephant Brand' — we wonder what colour it is (white, maybe?)... While labouring through the Transaction File recently, an anonymous member of PCW's staff

discovered an ad from one W Packman. We presume he's no relation, and would like to warn him that he's making illegal use of a patented trademark... An IT report was dropped onto Editor Rodwell's desk not so long ago, the first item of which was a paragraph about computerised lavatory flushes, of all things. Apparently one of Reckitt & Colman's R&D labs has (quote) 'an international selection of lavatories flushing 24 hours a day at the command of a computer'. These flushes are performed by pneumatic controls which 'compress months of normal household use... into weeks or even days'. No suggestion is given as to why exactly there is a need to wear out all these cosmopolitan khazis, but it could be that Reckitt & Colman will produce a 'superlav' down which micro industry rubbish might be forever flushed at the command of a Cray 1... Caxton directors Tebbutt and Barrow were recently in a certain rather posh London hotel for the

signing of their large deal with Osborne. Once names had been put to paper and all the bigwigs seen onto their plane, the aforementioned gentlemen decided to celebrate their new achievement with the most expensive cocktails on the tariff. They found their way to the bar, ordered their drinks, and then were told that alcohol was at that time not on sale to non-residents. Faced with the choice of waiting 25 minutes for a drink, going home for tea, or sipping fruit juice, they took the final option. Caxton's Card-box deal with Osborne was therefore celebrated with fruit punch — complete with the little umbrellas, mermaids and maraschino cherries... Ever heard of the Apolo II? No? Nor had we, but it's upset Apple Computers. It's like this: Sunrise Computers of Taiwan took it upon itself to manufacture an exact copy of the Apple II — even down to the external design and the contents of the EPROMs — which was, for a while, available through CAB Trading BV

in Holland. CAB Trading is, naturally, now forbidden to sell, exhibit, distribute or otherwise purvey this micro following a hearing in Amsterdam in which CAB's behaviour was held to be 'intolerable' and represented unfair competition to Apple. However, these legal proceedings seem to have gone a little far, as CAB is now also forbidden to use the words 'Apple II compatible' in its brochures and is also forbidden to use the trademark 'Apolo' in any respect as this 'constitutes a direct infringement of "Apple"'. Unfair's unfair, but the connection here seems a little obscure... For worried users of the VIC-20, we've heard from the top that, despite rumours to the contrary, the VIC will not be dropped in the wake of the Commodore 64. So if anyone tells you that the VIC-20 won't be on sale for much longer, you know what to do — tell them to VIC off...

MORE MEMORY FOR MICROS!

look at what we can offer:



RAMPACKS
for SINCLAIR ZX81

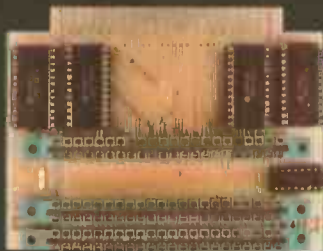

VCS 8K for VIC
8k RAM+3 slots **£44**

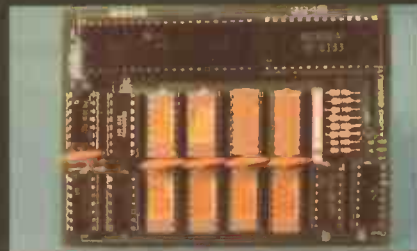

DU01 for ATOM
64k RAM only **£70**



16K - the only upgradable
to 56k on the market -

OUT OF STOCK

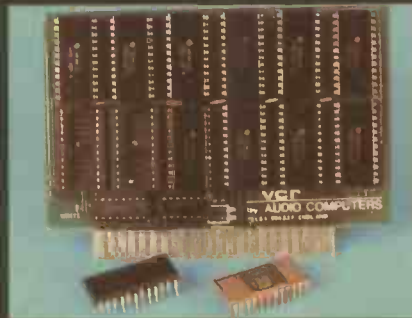

add up to 20k RAM+16k ROM
VCR 20 for VIC
4K-£24, 2k increment-£5

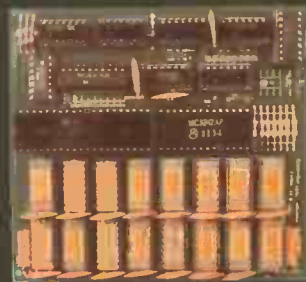

DRC for PET
64K-£80 128K-£130

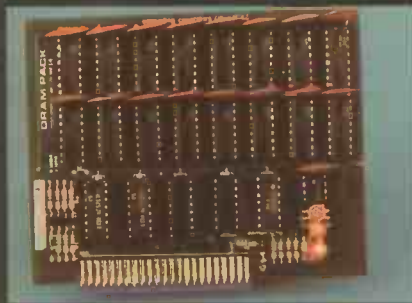

32K bytes - £29

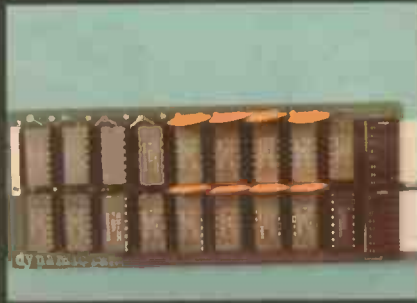

32K add on RAM £46

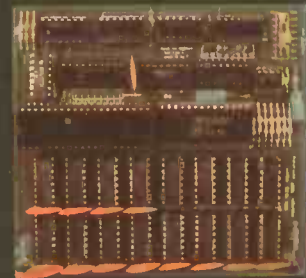

32K add on RAM £69

TRS80-V.GENIE UK101:



56K - exceptional low
power consumption -
£44.90



**64K + Eprom programmer &
user port - only £79**

FOR A FREE BROCHURE, RING LINDA OR
SUE ON SOUTHEND (0702) 613081
FOR CREDIT CARD ORDERS, RING JACKIE
OR PAM ON SOUTHEND (0702) 618144

CHEQUES AND P.O.'s TO:

AUDIO-COMPUTERS

87 BOURNEMOUTH PARK ROAD,
SOUTHEND ON SEA - ESSEX SS5 2JJ

ALL PRICES INCLUDE V.A.T. AND POSTAGE

TELEX 995337 G AUDCOM

A TRADEMARK OF SOLIDISK LTD.

Wise men know where to go this Christmas!



There's something to suit everyone this Christmas at Personal Computers Limited . . . the bright new star in the City!

In our new showrooms, we can demonstrate how best to utilize the Personal Computer in your business, so that you will be able to make the new year more productive and much more profitable!

We can provide and support accounting systems, easy-to-use wordprocessing systems, computerized filing systems, powerful financial modelling tools, commodity and stock price technical analysis systems, foreign exchange dealer support systems, Prestel, private viewdata systems, communications and statistical analysis systems.

AND NEXT DOOR . . .

THE HOME COMPUTER STORE,

where you will be able to explore the personal computer world with demonstrations of the Commodore Vic and the Sinclair . . . together with a huge selection of software and hardware add-ons

Personal Computer

218 & 220-226 Bishopsgate, London EC2M 4JS Tel. 01-377 1200 Telex 8882

So come and buy the present you've been promising yourself all year — you deserve it!

*WE TAKE ACCESS & BARCLAYCARD