

# Personal Computer

HP'S  
LOW-COST  
MICRO TESTED

Canada \$2.75/US \$2.50/FF 8.80/FL 4.00/SFr 7.20/IR £1.11/  
Bfr 90.00/SKr 12.80/DKr 21.00/Lire 4200/DM 5.50

World October 1982 75p

**BRITAIN'S LARGEST SELLING MICRO MAGAZINE**

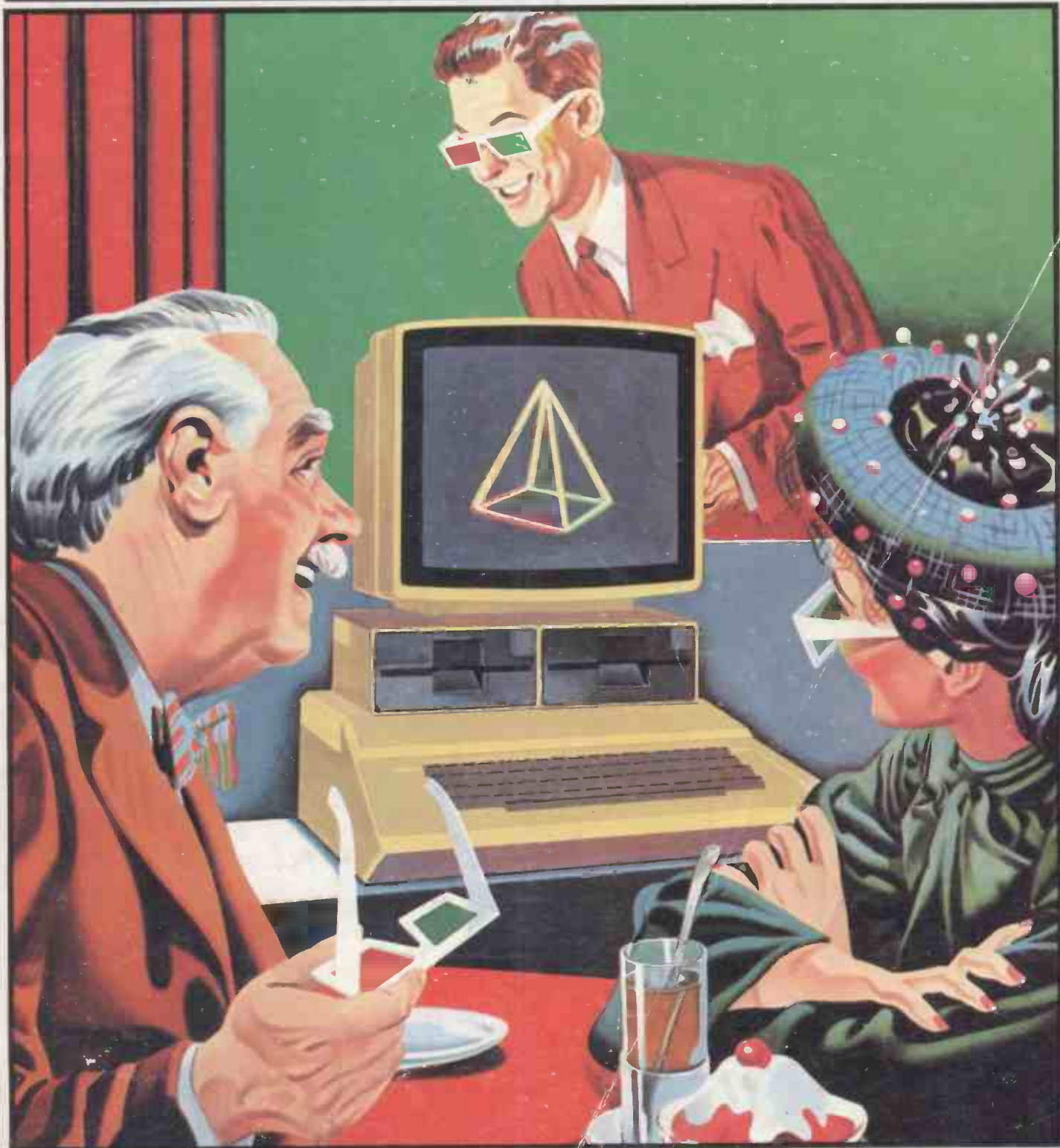

**STEREO MICROSCOPY!**  
Add 3-D to your home computer

PCW OCTOBER 1982

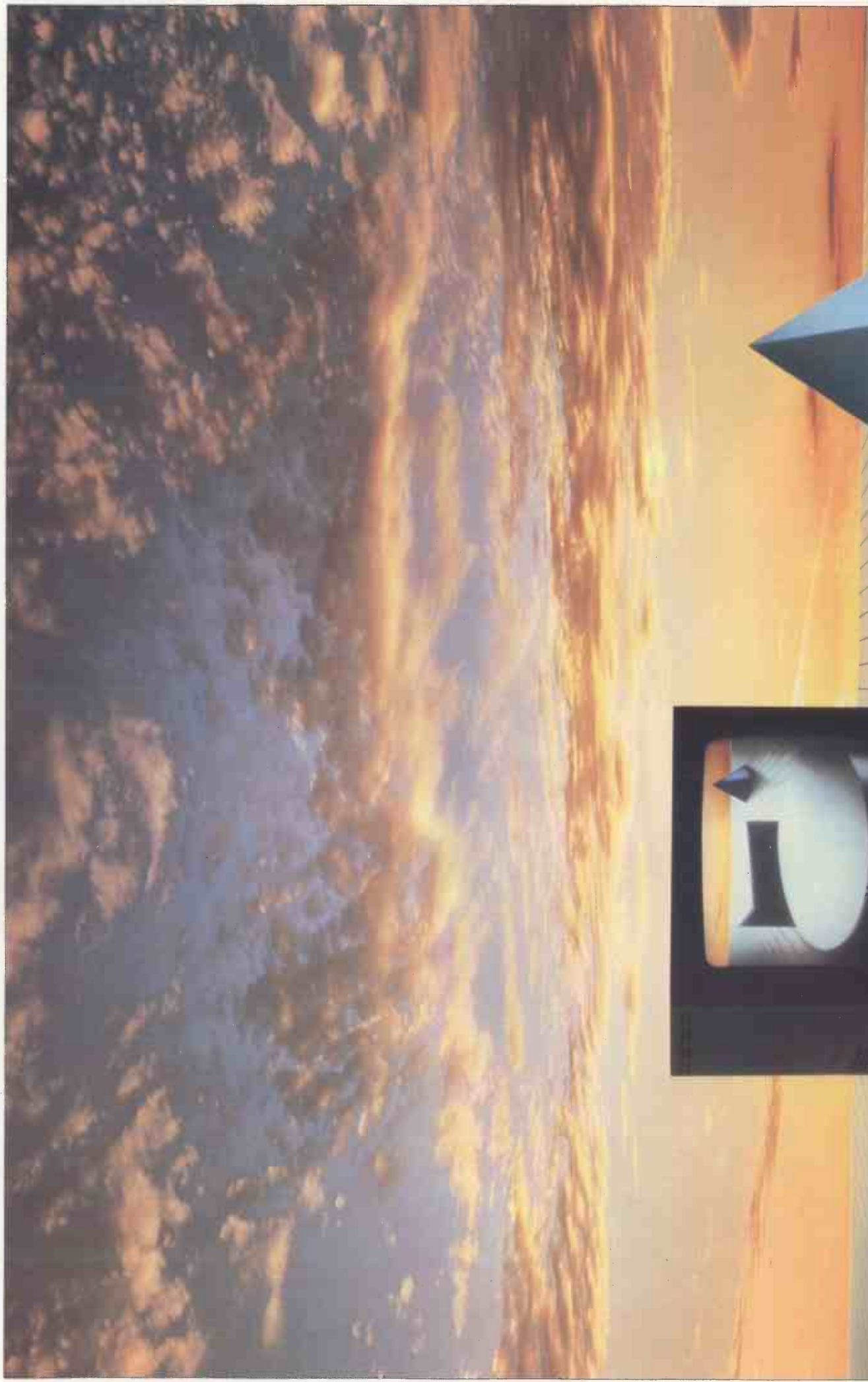



The shape of things to come

# The BBC Microcomputer System

## What the BBC Microcomputer gives you



Amongst the shifting sands of computer technology the BBC Microcomputer is here to stay. "Everything possible seems to have been done to ensure that this is not a "dead-end" machine which you will have to throw away after a year or two when its basic technology is, inevitably, superseded," comments Paul Beverley in the July 1982 edition of *Personal Computer World*.

Teachers on the Department of Education and Science 'Microelectronics Education Programme' are being trained in its use. The Department of Industry has recommended it for both primary and secondary schools so children all over the country will find themselves using the BBC Microcomputer.

It has been chosen as the personal computer for the BBC's own Computer Literacy Project, which includes two series of television programmes on the use and application of computers. It has also been used as the basis for many educational courses, including one offered by the National Extension College.

It all adds up to a massive vote of confidence in a microcomputer designed to grow with the needs of the user and with the advances in technology occurring month by month.

The BBC Microcomputer is a fast, powerful system generating high resolution colour graphics and which can synthesise music and speech using its own internal speaker. The keyboard has a conventional layout and electric typewriter 'feel'. There are two versions - Model A at £299 offers 16K of Random Access Memory (RAM) and Model B at £399 has 32K of RAM.

## The BBC Microcomputer System Plan

Available internally

16K language ROMs  
Pascal, FORTH, LISP

Word processing software ROM

Speech synthesis circuits

Business Planning ROM

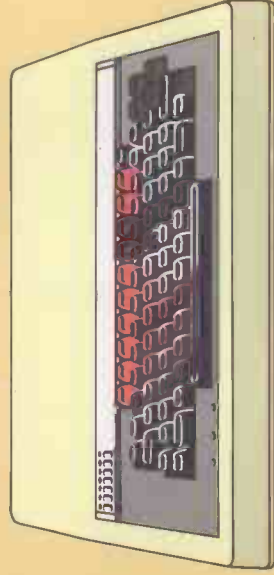

Available externally requiring internal additions

## Software



The Machine Operating System, occupying 16Kbytes, has in-depth facilities for handling all normal requirements, for example keyboard and Visual Display Unit (VDU), which can be your own television, and in addition has many more advanced features such as network handling (linking several computers together), teletext operating system and speech, disc and cassette filing (very similar to the filing which takes place in an office).

The ROM paging system makes it possible to change instantly between high-level languages. A sophisticated version of BASIC has been chosen for the BBC Microcomputer, which incorporates features normally found only in other high-level languages, but you can have up to four different 16Kbyte interpreters inside the machine, allowing access through a simple command to another language - for example, Pascal, FORTH and LISP.

Applications software for the BBC Micro-computer is being developed alongside the hardware, to stringent specifications with wide support from totally independent software houses.

Already a number of packages covering games, educational and business applications are available on cassette.



Versions of many compulsive arcade type games exist; a simulation package called Flight Deck and one to help Rubik Cube addicts are around the corner.

On the educational side creative graphics, graphs and charts, algebraic manipulation and the Peeko-computer pack,

# Room for expansion

The most attractive and exciting feature of the BBC Microcomputer is its enormous potential for expansion. *Which Micro?* May/June 1982.

The diagram opposite shows the numerous options for expansion. Developments will undoubtedly bring more. Model B incorporates interface sockets (RS423, analog inputs, Centronics and User port) to allow you to connect directly to cassette recorder, your own television, video monitors, disc drives, printers (dot matrix and daisy wheel) and paddles for games or laboratory use.

A special interface socket can also be fitted to take plug-in Read Only Memory (ROM) cartridges containing games or specialist application programs. Model A can be adapted to include these facilities.

A feature of the BBC Micro-computer which has attracted widespread interest is the Tube, a design registered by Acorn Computers. The Tube is unique to the BBC Microcomputer and greatly enhances

the expandability of the system by providing, via a high speed data channel, for the addition of a second processor.

The addition of a second 3MHz 6502 processor with 64K of RAM doubles processing speed. A Z80 second processor with 64K of RAM opens the door to a fully CP/M compatible operating system, with all the benefits for business applications. A 16-bit processor with 128K of RAM is now being developed which will give the machine a processing power similar to present day minicomputers.

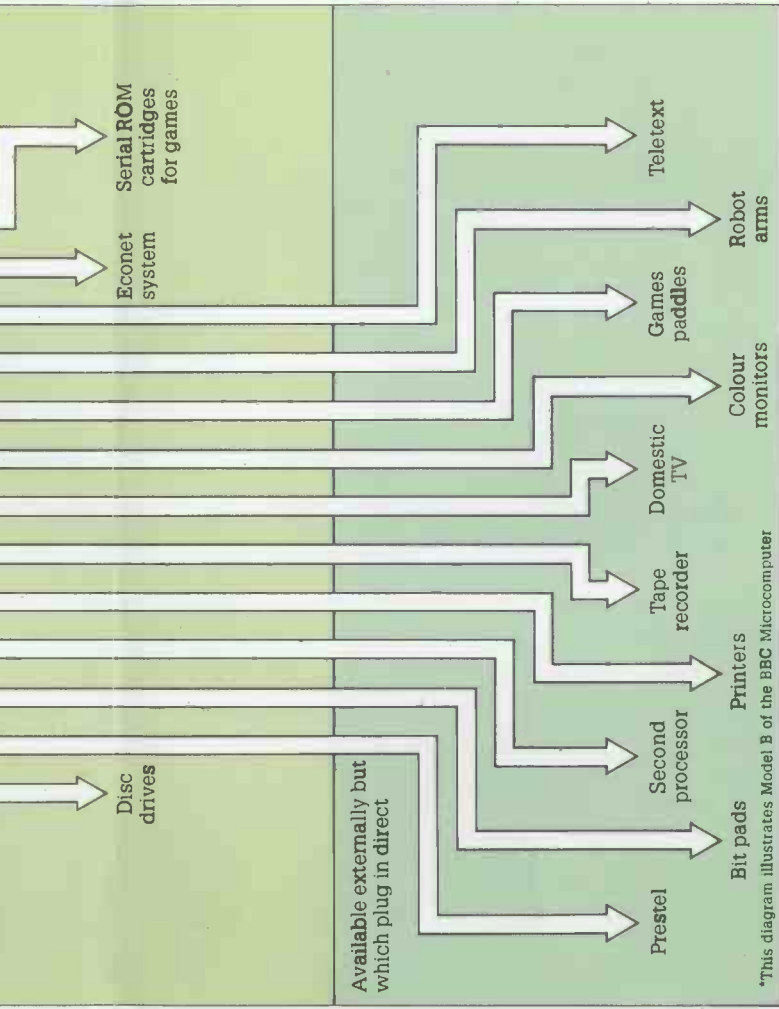
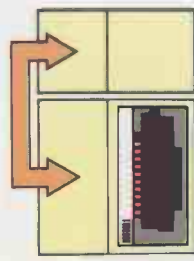

Another first for the BBC

Microcomputer is that it can take information direct from Prestel and Teletext services (telesoftware), using the necessary adaptors and store it for later use.

An expansion facility of immense use to schools, colleges and businesses is the Acorn Econet® - a simple to use yet highly sophisticated system, which by using ordinary 4 core telephone cable links together over 100 computers. A number

of machines can share the use of expensive disc drive and printer facilities.

'Whether your interests lie in business, educational, scientific, control or games applications, this system provides a possibility for expansion which is unparalleled in any other machine available at present,' comments Paul Beverley in the July 1982 edition of *Personal Computer World*.

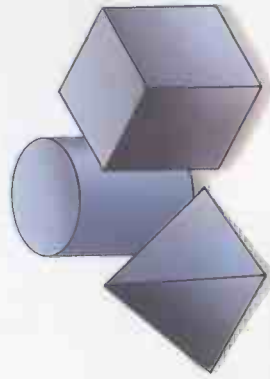

The shape of things to come

which explains the workings of a micro-processor, are available. Other Computer Aided Learning packages are being developed.

For business uses there is a desk diary cassette and nominal ledger, payroll and stock control packages will be available shortly on disc.

ROM based software (fitted inside the machine) includes powerful word processing, business planning and Computer Aided Design packages.

A wide range of software is already on sale at dealers throughout the country and new packages are becoming available almost daily.

## Technical support and after-sales service



Your BBC Microcomputer comes complete with the backing of the BBC itself and one of the most extensive dealer and service networks available. Each approved dealer is able to offer advice and carry out expansion work and repairs. In addition Acorn Computers offers maintenance contracts and has a specialist service centre which undertakes warranty work.

The Government's Microelectronics Education Programme has set up 14 regional information centres in England, Wales and Northern Ireland. These provide technical and educational support for teachers. The Scottish Microelectronics Development Programme offers a similar service as do many local education authorities throughout the United Kingdom.

You can subscribe to a special monthly magazine, *Acorn User*, which carries regular news and features to help you make the best possible use of your machine.

**NEW  
MODEL**

**LOWER  
COST**



## **Cromemco System One**

MicroCentre introduce Cromemco's new System One computer, available with an integral 5 megabyte Winchester hard disk, at a new low price.

The System One supports the full range of Cromemco interface cards, including high resolution colour graphics, and software packages. The choice of operating systems includes CDOS, CP/M and CROMIX—Cromemco's answer to Unix.

**Call MicroCentre for  Cromemco**

**MicroCentre Ltd**  
(Complete Micro Systems)

**Britain's independent  
Cromemco importer**

**30 Dundas Street  
Edinburgh EH3 6JN  
Tel: 031-556 7354**

# MICRO TRAINING FOR COMPUTER USERS

# 6Micro courses



Which would you like to attend?

Digitus is running a number of courses to train users and potential users in the basic skills of micro-computing. Conducted at our Central London Workshop, the courses provide hands-on experience of microcomputers, demonstrations of working systems and tutorials on your particular needs.



**INTRODUCTION TO MICROCOMPUTERS**

One day's concentrated information on microcomputing aimed at the potential user in small and large organisations. A practical course which includes business applications of micros, guidelines on selecting microcomputer systems and an introduction to programming.

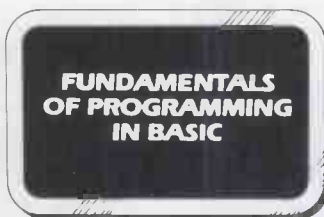

**FUNDAMENTALS OF PROGRAMMING IN BASIC**

A two day course designed to teach the first principals of programming in BASIC. Aimed at those with some understanding of micros who want to learn how to instruct their computer to perform tasks.



**IMPROVE YOUR BASIC**

A two day course for those who have learned Basic from hands-on experience and want to brush up their BASIC techniques and learn some timesaving software tools.



**WORDSTAR WORDPROCESSING**

A one day course for people who want to learn the fundamentals of wordprocessing. Uses the popular Wordstar wordprocessing package available on most CP/M micros and teaches by hands-on use.



**DATASTAR INFORMATION MANAGEMENT**

The DataStar data entry, retrieval and management system is a powerful aid which enables the educated user and computer professional to build information systems economically and rapidly.

**Training for Computer Professionals**  
Course in: Micro Technology for Management • Local Area Networks • Micros for Computer Professionals.  
Courses are run at the Workshop or on site. Telephone or write for details.

**Micro Technology Workshop** Set in 8,500 sq.ft in Central London, the Workshop is a few minutes from Covent Garden, Trafalgar Square, Charing Cross, Embankment and Waterloo stations. Specialist areas include: Personal Computers, Technical Systems, Business Systems, 16 bit and Local Network Systems, Bookstore and Training Rooms.

**Booking and Fees** The fee for all courses is £95 per day plus VAT, payable 14 days prior to starting date.



**MICRO-PRO SOFTWARE TOOLS**

In addition to Wordstar, Micro-Pro Inc have produced a variety of aids to improve productivity in offices and systems departments. This one day course includes: Mail-Merge linked to Wordstar • Supersort sorting utility • CalcStar rows and columns manipulation • DataStar information manager • harnessing the 'Star' products together.

All courses provide access to an extensive range of micro hardware, software and expertise.

Note: Wordstar and DataStar are registered trademarks of Micro-Pro Inc.

**Booking Form** (Please complete in BLOCK capitals)

To Digitus Ltd, 10-14 Bedford Street, London WC2E 9HE. Tel 01-379 6968

Reserve places as follows:

Name of delegate ..... Date .....

Name of delegate ..... Date .....

Name of delegate ..... Date .....

**Courses/dates**

- |                                      |                          |           |
|--------------------------------------|--------------------------|-----------|
| Introduction to Microcomputers       | <input type="checkbox"/> | Oct 11    |
| Fundamentals of Programming in Basic | <input type="checkbox"/> | Oct 12/13 |
| Improve your Basic                   | <input type="checkbox"/> | Oct 14/15 |
| Wordstar Wordprocessing              | <input type="checkbox"/> | Sept 21   |
| DataStar Information Management      | <input type="checkbox"/> | Sept 22   |
| Micro-Pro Software Tools             | <input type="checkbox"/> | Sept 23   |
|                                      | <input type="checkbox"/> | Nov 9     |
|                                      | <input type="checkbox"/> | Nov 10    |
|                                      | <input type="checkbox"/> | Nov 11    |

Company/address .....

Name ..... Position .....

Signature ..... Tel.No .....



PCW/9/82

# INSIDE PCW

## FEATURES

**138** *PCW* MANHUNT  
The second part of *PCW*'s great competition.

**141** THE ULTIMATE TEST?  
Chris Sadler and Sue Eisenbach discuss benchmarking high-level languages.

**142** STEREO GRAPHICS!  
Ideas on how to implement real 3-D graphics on your BBC Computer from Paul Stevenson.



地無  
之各  
始天

**145** MAKING A HASH OF IT  
A useful method of file searching from Paul Overaa.

**155** DATA DABBLING  
J B Leaser discourses on designing your own database.

**165** CP/M-86 vs MS-DOS  
An in-depth look at the relative merits of these two 16-bit disk operating systems from Peter Rodwell.

**178** CLOCK IT TO ME  
A clock/calendar card for the Apple II designed by Bruce Marriott.

## REGULARS

**98** NEWSPRINT  
Man-on-the-spot Guy Kewney keeps us up to date on the micro world.

**108** BRAIN DUMP  
Dick Pountain looks into a rather unusual book.

**111** CTUK! NEWS  
More from the nation's computer literacy project.

**114** BANKS' STATEMENT  
Osborne's sales policy is Martin Banks's theme this month.

**150** COMMUNICATIONS  
Get it off your chest in *PCW*'s letters page.

**193** NEWCOMERS START  
HERE  
If you've never read *PCW* before, GOTO this page!

**194** DIRECT ACCESS  
Including Packages, User Groups, Diary Data, Network News, Transaction File and ACC News.



Founder Angelo Zgorelec; Managing Editor Dick Pountain; Editor Peter Rodwell; Programs Editor Maggie Burton; Sub Editor Steve Mann; Consultant Editor David Tebbutt; Art Editor Phoebe Creswell-Evans; Design Assistants Rick Gadsby, Safu-Maria Gilbert, Sue Tritton; Typesetting Jane Hamnell, Patrick Dineen; Publishing Manager Fiona Collier; Group Advertisement Manager John Cade; Advertisement Manager Patrick Dolan; Assistant Advertisement Manager Claire Fullerton; Sales Executive Peter Goldstein; Micromart Jan Martin; Advertisement Assistant Gaye Collins; Advertisement Production Robert Buggs; Subscription Enquiries Stuart Cruickshank.



Cover illustration: Paul Simmonds

# BENCHTESTS & REVIEWS

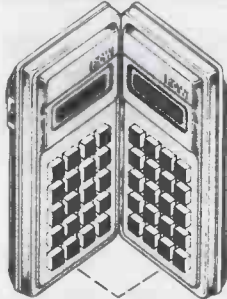

**112 CALCULATOR CORNER**  
Dick Pountain offers some programming hints for Sharp PC-1211 users.

**120 HEWLETT PACKARD HP-86**  
A new low-cost micro from Hewlett Packard, examined by Dick Pountain.



**128 POSITRON 9000**  
Roger Oliver and Chris Sadler look inside this powerful colour computer with multi-user capabilities.

**163 DATABASE BENCHTEST**  
Kathy Lang investigates Personal Pearl.



# ODDS & ENDS

**176 SUBSCRIPTIONS**  
One more reason to send off that coupon somewhere inside your PCW.

**223 LEISURE LINES**  
J J Clessa brings us his latest teaser.

**223 BLUDNERS**  
PCW's monthly confessional.

**224 BACK ISSUES**  
Find out when that Benchtest or article was published and catch up!

**288 CHIP CHAT**  
Slurs, smears, innuendo, cheap jibes and opprobrium from our industry spy.

# TECHNICALLY SPEAKING...

**173 PCW SUB SET**  
More interesting assembler language subroutines for your collection.

**184 TJ'S WORKSHOP**  
PCW's monthly workload for soldering irons and screwdrivers.

**190 COMPUTER ANSWERS**  
Sheridan Williams puts on his Marje Proops hat and solves those pressing micro problems.

**206 PROGRAMS**  
More examples of readers' software.

**CHANGE OF ADDRESS**  
The editorial & business address of  
Personal Computer World is now:  
**PERSONAL COMPUTER WORLD**  
**62 OXFORD STREET**  
**LONDON W1**  
**TEL 01 636 6890**

*This is the new address and telephone number for all communications other than subscription and back issue enquiries.*

# 5MB HARD DISK ACCOUNTING SYSTEM

**INSTALLED and WORKING for £500!**

Balance of £3495 on acceptance within 14 days or by Lease Rental (approximately £18 per week)

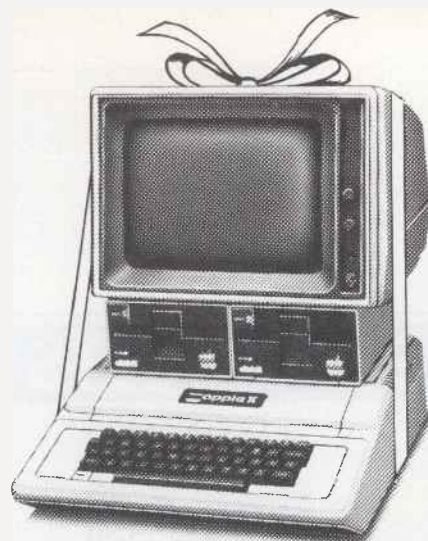

At last the businessman's dream has come true.

Ever since the introduction of the Micro-computer, businessmen have been searching for a complete, powerful and fast Business System ready to run from the moment it is delivered. Now the dream has come true with the VEGA SAS (Super Apple System).

The VEGA Super Apple System is a unique combination of proven hardware and software supplied by a company which specialises in end-user support. This guarantees a price performance ratio superior to any comparable system. Within minutes of the System being delivered, your accounts can be loaded and run and make you money.

For the future, the Super Apple System allows you to take advantage of the wealth of proven Apple software.

The dream is a reality. It's a gift no businessman can afford to refuse.

## SPECIFICATION

- 48K Apple System
- 12" High Resolution Green Screen
- 5 Megabyte Winchester Hard Disk
- 5¼" Floppy Disk Drive
- 120cps Bi-directional Buffered Matrix Printer
- Open-Item Sales Ledger for over 900 Accounts

- Full Audit Trails, Sales Analysis, Age Debts, Controls, Statements, etc
- Complete internal and external security against data loss
- Personalised Software
- All Stationery, Disks and Consumables
- Delivery and on-site instruction

### Optional Extra Software:

- Interactive Invoicing
- Interactive Stock Recording
- Open-Item Purchase Ledger
- Monthly and Weekly Payroll
- General Ledger

### Optional Support:

- 3 months unlimited on-site support
- Comprehensive Maintenance Contract

Please complete the coupon below for a full demonstration.

**Total Package Cost £3995 plus VAT**



# Vega

Computers Limited 10 Essex House George Street Croydon CRO 1PH Tel.01-680 4484 Telex 943763

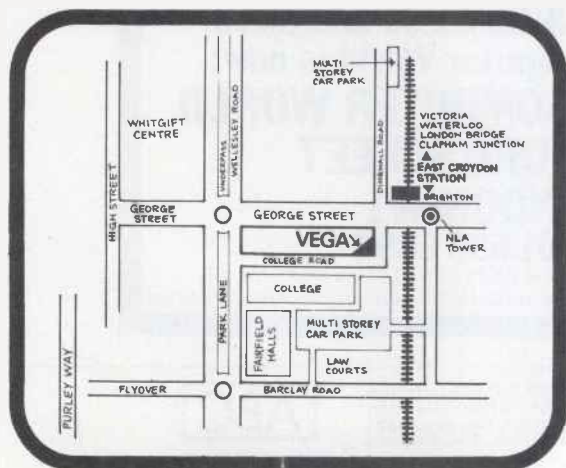

NAME \_\_\_\_\_

POSITION \_\_\_\_\_

COMPANY \_\_\_\_\_

ADDRESS \_\_\_\_\_

\_\_\_\_\_

TELEPHONE \_\_\_\_\_

# ON THE ONE HAND A 32 BIT PROCESSOR AND 16 BIT SYSTEM

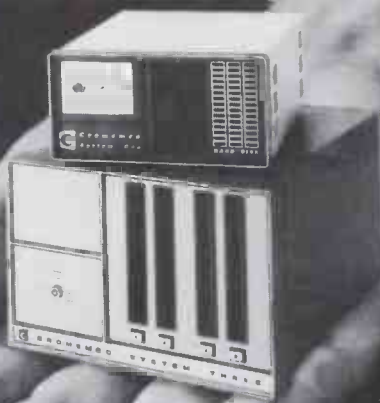

# ON THE OTHER FULL 8 BIT COMPATIBILITY

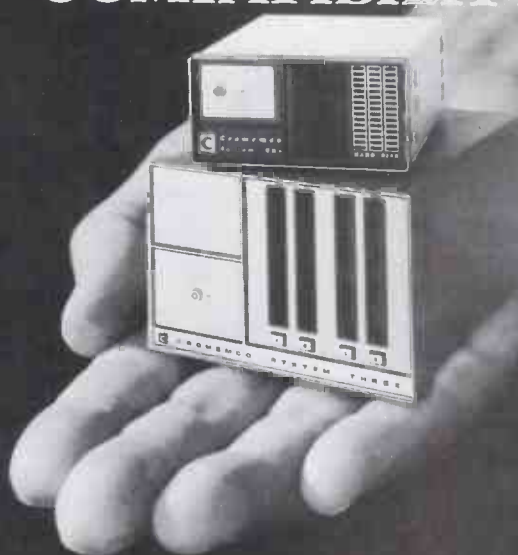

Imagine a microcomputer system which offers all the exciting prospects of full 16 Bit technology to come; but isn't too proud to admit that your existing 8 Bit Software has many years of useful life ahead. So it incorporates the new, high performance MC68000 16 Bit, 8 MHz processor, and an integral software selectable Z80A processor.

And that is the only concession that the new Cromemco 16 Bit System needs to make.

Its use of the MC68000 processor adds new found freedoms to microcomputer systems development. To start with it is fast. Benchmark tests showed it four times as fast as the Z80A, and twice as fast as the PDP11\*. It offers superb software performance without having to resort to expensive memory management techniques. The 1000 plus instruction set offers the widest options for producing compact efficient code. Its 32 Bit Architecture offers full 16MByte direct memory addressing. It all adds up to the promise of larger, more efficient software programs, executed in a highly controlled and managed environment.

But it takes Cromemco to put promise on the path to reality. So to support MC68000 processing power there is a new concept in memory cards, full S100 and IEEE 696 compatibility, and a new software library based on 16 Bit Code to optimise the new found processing power.

The Memory Storage comes in single 256K or 512K cards with built in error detection and correction. That gives a full 4MByte of high speed memory in a Cromemco 16Bit System 3, with internal space to spare. The S100 and IEEE 696 compatibility offers the widest possible options in add-on facilities and interface requirements.

The new software library is comprehensive. There is a 16 Bit version of the proven Cromix Multiuser operating system, (now it will support up to 18 users or tasks). There is a new Fortran 77,

designed for creating larger programs in a science/engineering/research environment, and COBOL, PASCAL and 'C', a Structured BASIC, and a 68000 Assembler.

Overall the Cromemco 16 Bit Systems extend the existing boundaries of microcomputer application. In particular, they offer the Scientist and Engineer the opportunity to dramatically reduce the cost of performing the complex mathematical functions required in multi dimensional design, simulation and analytic processes. What was once mainframe capability and became mini is now decidedly Cromemco Microcomputer capability.

But without professional assistance along the way, the path from promise to reality is fraught with obstacles. Comart are Cromemco's longest standing, most experienced distributor in the UK. A five year partnership in this industry, is a lifetime in others.

So with Cromemco's dual processor and Comart support, you won't have to write off the past to step on forward into the future.

**comart**  
SPECIALISTS IN MICROCOMPUTERS

Please send me details of Cromemco's 16 Bit development now and as it evolves.

Name

Position

Company

Address

Tel.



**Cromemco File**  
Developing through Evolution

\*PDP 11 is a trademark of Digital Equipment Corporation  
Cromemco and CROMIX are trademarks of Cromemco Incorporated

A member of the  Comart group of companies

Comart Ltd, Little End Road, Eaton Socon, St Neots, Cambs Tel: (0480) 215005 Telex: 32514 ComartG.

# ANNOUNCING The BEST Books For Your SPECTRUM



Dr. Ian Logan is the acknowledged leading authority on Sinclair computers. In this book, he gives a complete overview of the way the Spectrum operates, both for BASIC and machine language programming. A special section on the ROM operating system will give you insight into this computer as well as provide you with information on how to use many of the routines present in the ROM. This book is a must if you are serious about programming the Spectrum. Only £7.95.



*Over the Spectrum* is the book where you will find your dreams really do come true. If you want to know how to use the complete facility of the Spectrum, as well as have the full listing for over 30 Spectrum programs, this is the book for you. Fantastic programs such as the incredible *3D-Mazeman*, *Alien Invaders*, just to mention two. Games, utilities, educational and business programs are all in *Over the Spectrum*. Only £6.95.

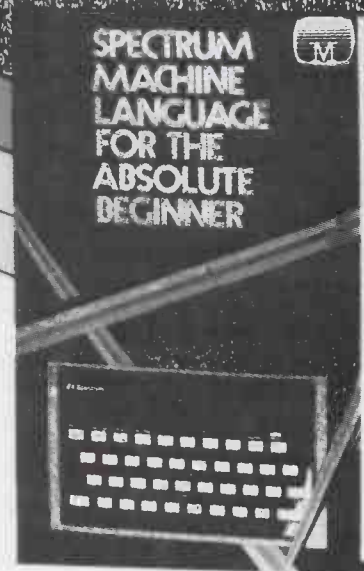

This title speaks for itself, it's everything you need to understand about *Spectrum Machine Language* when you're just starting off. A must for all new Spectrum owners. Only £6.95.

After leading the way in Sinclair ZX81 software, we've produced the highest quality, most exciting Spectrum software available. From the three excellent books depicted above to fast-action games on cassette, we're providing the best choice in Sinclair Spectrum software today.

Whether it's for your new Spectrum or ZX81 Melbourn House has books and programs perfectly suited to your needs.

Send for your Spectrum or ZX81 catalogue today.

CT 10

**Melbourn House Publishers,**  
131 Trafalgar Road, Greenwich, London SE10.

Correspondence to: Glebe Cottage, Station Road,  
Cheddington, Leighton Buzzard, BEDS LU7 7NA.

Please send me your Spectrum/ZX81 catalogue (please specify).

Please send me ..... (please add 80p for post, pack & V.A.T.)

Name .....

Address .....

..... Post Code .....



## MELBOURNE HOUSE PUBLISHERS

# X-DATA

## has the right models at the right price.

Whatever your printing needs, one of our Oki printers will fit the bill. Oki Microlines – the only complete printer range.



### MICROLINE 80

- 80 column
- 80 cps
- block graphics
- pin, friction or tractor feed

**NOW  
£235**



### MICROLINE 83A

- Full 136 columns
- 9 x 9 matrix
- 120 cps bi-directional
- and all features of 82A

**NOW  
£499**



### MICROLINE 82A

- 80 column
- 9 x 9 matrix
- 120 cps bi-directional
- multiple interface capability
- pin-addressable or block graphics
- etc., etc., etc.

**NOW  
£349**

### MICROLINE 84

- Full 136 columns
- Mode 1 – 200 cps (400 cps skip)
- Mode 2 – near letter quality
- High-resolution graphics
- Down-line-loadable character set
- Total flexibility

**NOW  
£949**

Ring Jane for your local stockist  
**X-Data Limited, Equipment Wholesalers.**  
750-751 Deal Avenue, Slough Trading Estate, Slough, SL1 4SH  
Telephone: Slough (0753) 72331; Telex: 847728

See insert for very special  
discount offer – or visit  
us on stand 367  
at the PCW  
Show

# You can't get a Home Computer from Texas Instruments under 16 K RAM.



Make the right move into computing with the Home Computer from Texas Instruments. It gives you a large combined RAM/ROM capacity up to 110 K Byte and the ability to expand with a full range of peripherals and software. So as your knowledge of computers increases the TI Home Computer will grow with you.

Just compare the versatility of the TI Home Computer with its price – you'll find it real value for money that will prove to be a good long term investment.

The TI-99/4A is a sophisticated computer designed not only for the beginner with its ease of operation, but also for the professional with its vast computing power through a 16 bit microprocessor. And it simply plugs into an ordinary household TV set.



With its high resolution graphics with 32 characters over 24 lines in 16 colours (256 x 192 dots), 3 tones in five octaves plus noise, and BASIC as standard equipment and options such as other programming languages – UCSD-PASCAL, TI-LOGO and ASSEMBLER – and speech synthesis, you'll find that the TI 99/4A more than compares with the competition. Especially when the starting price is around £200.

When you want to solve problems there are over 600 software programs available worldwide – including more than 40 on easy-to-use Solid State Software® Modules.

After all, from the inventors of the microprocessor, integrated circuit and microcomputer, it's only natural to expect high technology at a realistic price.



We'll help you do better.

**TEXAS INSTRUMENTS**  
LIMITED

**UNBEATABLE VALUE  
AT AROUND £200**

**NEW!**

# ASPECT

## Assembler



FOR  
**SINCLAIR**  
ZX Spectrum

NOW! unleash the full power of the Z80 micro-processor in your incredible Spectrum, and program for yourself those fast-moving machine code games. Our unique 'Aspect' Assembler has a full screen Editor, and the Assembler can generate code for any address. It has a built-in, foolproof, error-detection system, comes complete with full instruction manual, and will run on 16K and 48K Spectrum.

Just  
**£9**  
inc. post & packaging

# Spectral INVADERS

The original and the best!  
The very first, arcade-quality machine-code game to appear on the market for the sensational ZX Spectrum.

Just  
**£5**  
inc. post & packaging

## IMMEDIATE DELIVERY

Send stamped addressed envelope for details of ZX81 and Atom Software

# BUG-BYTE SOFTWARE

BUG-BYTE SOFTWARE, FREEPOST (No Stamp req) LIVERPOOL L3 3AB.

**NEW!**

# CHESS



Hot on the heels of our quality chess programs for the BBC and Atom Micros, we introduce, for the first time in the U.K., chess on your VIC! (16K expansion). Once again there are 1000 levels of play, plus many options, chess problems, game storage etc. Deals with castling and en passant.

Just  
**£7**  
inc. post & packaging

BBC CHESS \_\_\_\_\_ £11.50  
ATOM CHESS \_\_\_\_\_ £9.00

... also for your



Another VIC in the wall  
VIC Gammon  
VIC Panic  
VIC Cosmiads  
VIC Asteroids

ALL PRICES INCLUDE POSTAGE

Please send me \_\_\_\_\_  
I enclose cheque/P.O. for \_\_\_\_\_  
OR Please debit my Access 5224 \_\_\_\_\_  
BARCLAYCARD 4929 \_\_\_\_\_ Expiry date \_\_\_\_\_  
Name \_\_\_\_\_  
Address \_\_\_\_\_  
Code \_\_\_\_\_

Dealers Discount Available  
ACCESS, BARCLAYCARD ORDERS WELCOME ON 24hr  
ANSAPHONE 051-227 2642, or mail to:  
BUG-BYTE SOFTWARE,  
FREEPOST, (No stamp req.)  
LIVERPOOL L3 3AB.

PCW.10.82

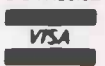

# Home Computer - Starter Packs

## AT ROCK BOTTOM PRICES

FREE GAMES  
CASSETTE WITH  
EVERY  
CONSOLE

### DRAGON

- ★ Britain's newest Personal Computer using the latest 6809E processor.
- ★ Full 32K Specification
- ★ Microsoft Basic, Advanced Graphics, Sound, Editing, 9 colour display
- ★ Professional quality keyboard
- ★ Plug-in connection for Joystick, Cassette, Printer, Games.

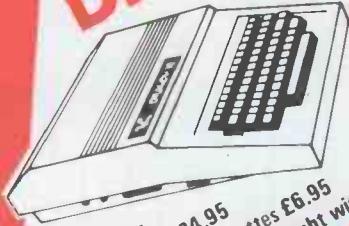

Cartridges —  
Ghost Attack £24.95  
Octaves £19.95. Cassettes £6.95  
20% off all accessories bought with a Console

### VIC 20



VIC 20 — £189.95  
Cassette Unit — £44.95  
Printer — £219.95  
Single Floppy — £349.95

STARTER PACK 1.  
VIC 20 + Cassette Unit + Intro to Programming +  
10xC12 Cassettes + Blitz Cassette — £245

STARTER PACK 2.  
VIC 20 + Floppy + Printer — £699.  
Full range of Accessories Available.  
20% off games cartridges with any starter pack.

### ATARI



AM400 — £189.95  
A800 — £479.95  
Recorder — £49.95

STARTER PACK 1.  
16k Computer + Cassette Deck + FREE Intro to  
Programming + 10 FREE C12 Cassettes — £245.

OR  
½ price Programmer Kit with every 16k Computer + 10%  
off most cartridges and cassettes bought with every Console.

### ACORN ATOM



FREE power supply with every ATOM  
8+2 Kit — £130. 12+12 — £235. Colour Encoder — £45.24  
4k Floating Point — £23.30. Convert your ATOM to  
BBC Basic — £49.95.

### BBC

Model B — £399. Upgrade A to B — £95.  
Disk Drive — POA.

### SINCLAIR



ZX81 — £49.95  
Printer — £59.95  
16k RAM — £29.95  
STARTER PACK 1.  
ZX81 + 16k RAM  
+ Printer + 10xC12  
Cassettes + 2 Rolls  
Paper — £139.95

STARTER PACK 2.  
ZX81 + 16k RAM + 10xC12 Cassettes  
— £79.95

**ALL PRICES INCLUDE VAT**  
10% DISCOUNT ON ALL TANGERINE ITEMS IN STOCK  
DISCOUNTS AVAILABLE ON QUANTITY ORDERS  
for Business, Educational and Export. Try us for Rock Bottom Prices!

### EXPORT

Single or QUANTITY EXPORT orders welcome. NO VAT.  
Experience of exports worldwide-full documentation  
MONITORS, PRINTERS, SOFTWARE.  
Popular prices on all  
popular Computers.  
Send A4 S.A.E. for latest  
FREE Brochures  
& Pricelists



**(0424) 437875**

CASTLE ELECTRONICS Dept. PCW  
7 CASTLE STREET, HASTINGS, E.SUSSEX



# SPECTRUM

**We won't be  
be beaten on  
price!**

SPECTRUM is a rapidly expanding group of independent retailers who specialise in selling home computers. Our group policy is simple - WE WON'T BE BEATEN ON PRICE! - our BULK BUYING ensures this. We select and buy the best and pass the savings on to YOU, the customer. We GUARANTEE that if you find an item currently advertised and in stock at another dealer and at a better price than ours - WE WILL MATCH THAT PRICE ON THE SPOT.

**Only trained personnel  
at Spectrum!**

We believe that our product 'know-how' is crucial to you the customer. That's why in every one of our centres you'll find fully trained personnel, who have been trained by the importers or distributors themselves - so we know and understand the products we sell and can help every customer even the complete beginner. At SPECTRUM we find the RIGHT equipment to suit your needs. Handing over sealed boxes is not our line - our service includes 'hands-on' experience that we pass on to YOU.

**After Sales care**

SPECTRUM service centres will ensure that should your machine 'go-down' we will get it running again as quickly as possible. We also offer extended warranties at reasonable prices too! - ask your SPECTRUM HOME COMPUTER CENTRE for full details.

**New Spectrum  
Computer Centres  
now at:**

**ASHFORD  
(Middx.)  
BATH  
EDINBURGH  
GLASGOW  
HATFIELD  
LEICESTER  
LONDON N.1.  
MANCHESTER  
RUGBY  
WIDNES**

**COMPUTER  
DEALERS!**

(or prospective Computer Dealers!)  
If you would like to know more about becoming a SPECTRUM APPOINTED DEALER on an exclusive area basis, please contact MIKE STERN or ALAN WARREN on (0727) 66646.  
Spectrum (U.K.) Ltd., Unit 6, Marlborough Trading Estate, Lattimore Road, St. Albans, Herts.

**FREE!**  
**CASSETTE**  
**Worth £7.95**

with every DRAGON purchased  
- use your FREE OFFER  
COUPON!  
Offer exp. 30.10.82



**Fantastic Value for money!**  
**DRAGON 32**

Enter the DRAGON! - this really is unbelievable value at only £173 from SPECTRUM! British built and designed, it's one of the most impressive micros to appear for quite some time. Featuring as standard a 32K RAM (expandable to 64K Bytes) plus it offers extensive facilities including highly advanced colour graphics for graphs, cartoon animation etc. It's the Ideal 'Family Computer' and will provide hours of fun and education for YOUR family! - see it at your nearest SPECTRUM COMPUTER CENTRE now. But just one word of warning - at this amazing price they're already selling fast so make it soon, or phone before making a journey.

**Just look at this top specification**

- Powerful standard 32K RAM (expandable to 64K Bytes).
- 9 Colour, 5 resolution Display.
- Extended Microsoft colour BASIC (as standard).
- Advanced sound with 5 octaves - 255 tones.
- Professional style editing, e.g. extract line, auto find reinsert.
- Professional quality keyboard.
- Centronics Paralled printer interface.
- Serious programmer/user - the BASIC on this machine is similar to that found on machines costing 3 times the price!
- Uses almost any cassette recorder.
- Standard file handling ON TAPE.

**Spectrum SENSATIONAL price**

**£173.00**

**PRICE INC. VAT £198-95**

| SOFTWARE for DRAGON 32 | EX. VAT | Graphic Animator         | £6.91 |
|------------------------|---------|--------------------------|-------|
| CARTRIDGES             |         | Quest                    | £6.91 |
| Beserk                 | £17.35  | Madness and the Minotaur | £6.91 |
| Cosmic Invaders        | £17.35  | Selection of Games       | £6.91 |
| Meteoroids             | £17.35  | Selection of Utilities   | £6.91 |
| Ghost Attack           | £21.70  | Examples from Dragon     |       |
| CASSETTES              |         | Manual                   | £6.91 |
| ComputerVoice          | £6.91   | Personal Finance         | £6.91 |

Above prices excluding VAT.

**Great Value from Spectrum!**  
**SEIKOSHA GP-100A**  
**Graphic Printer**

**FREE!**  
**PAPER**  
**Worth £11.95**

with every SEIKOSHA purchased - use your Free Offer Coupon!  
Offer exp. 31.10.82



Now a top quality graphic printer at a price you can afford. The SEIKOSHA GP-100A - Terrific value at under £200 from SPECTRUM. Standard Centronics compatible interface for easy link-up with most micros. Full graphics capability.  
■ Printing speed 30 chars/sec. ■ Double width character output under software control.  
■ Graphics, character and double width character can be intermixed on same line ■ Paper width adjustable up to 10" - tractor feed. ■ Print position addressable by character or dot.

**Spectrum LOW price £189.00** Price Inc. VAT £217.35

Also available:  
SEIKOSHA GP-100VC  
(Built exclusive for VIC-20)  
ONLY £209.50 Ex. VAT  
(£240.93 Inc. VAT)

| Interfaces for GP-100A/GP-100VC            | Ex. VAT | Inc. VAT |
|--|---------|----------|
| APPLE SERIAL                               | £45.00  | £51.75   |
| APPLE GRAPHIC                              | £55.00  | £63.75   |
| VIDEO GENIE                                | £36.00  | £41.40   |
| Cables for BBC MICRO, ACORN, DRAGON, ATARI | £16.00  | £18.40   |

**FREE  
OFFER  
COUPON**

To claim any of the FREE OFFERS featured in our advertisements, present this coupon at time of purchase, and your SPECTRUM dealer will give you the FREE goods relating to the purchase.

Offers expire on 31.10.82 & apply to featured free offers only.



**See next page**

# SPECTRUM

## ATARI

Spectrum's prices now lower than ever - plus super FREE offers too!

From household budgets to analysis of bond yields. From foreign languages to spelling or geography. From missile command to PACMAN - ATARI does it all, EXCELLENTLY! See the top selling ATARI range at your nearest SPECTRUM COMPUTER CENTRE - NOW! and save even more!

**ATARI 400 16K RAM £173.00**  
(excluding programmer kit) Price inc. VAT £198.95

**ATARI 800 16K RAM £434.00**  
(includes programmer kit) Price inc. VAT £499.10

| Additional Equipment                            | EX. VAT | INC. VAT | EX. VAT  | INC. VAT      |
|---|---------|----------|--|---------------|
| Program Recorder                                | £43.00  | £49.45   | Conversational Italian   | £34.77 £39.99 |
| Disk Drive                                      | £260.00 | £299.00  | Conversational Spanish   | £34.77 £39.99 |
| Thermal Printer                                 | £173.00 | £198.95  | Hangman  | £13.03 £14.99 |
| Interface Module                                | £117.39 | £135.00  | Scram  | £17.38 £19.99 |
| <b>Accessories</b>                              |         |          | Touch Typing   | £17.38 £19.99 |
| 16K Ram Pack                                    | £56.52  | £65.00   | Music Composer (Cart.)   | £31.30 £35.99 |
| Paddles (Pair)                                  | £12.17  | £13.99   | <b>Home Entertainment</b>  |               |
| Joysticks (Pair)                                | £12.17  | £13.99   | Asteroids  | £26.08 £29.99 |
| Printer Cable                                   | £24.78  | £26.50   | Basketball   | £21.73 £24.99 |
| RS232C Cable                                    | £21.74  | £26.00   | Blackjack (Cassette)   | £13.03 £14.99 |
| Monitor Cable                                   | £21.74  | £26.00   | Caverns of Mars (Disk)   | £26.08 £29.99 |
| Thermal Paper                                   | £3.48   | £4.00    | Centipede  | £26.08 £29.99 |
| Dos. 2 Master Diskettes                         | £19.12  | £21.99   | Computer Chess   | £21.73 £24.99 |
| <b>Books and Manuals</b>                        |         |          | Missile Command  | £26.08 £29.99 |
| Wiley Manual                                    | £5.21   | £5.99    | Pac Man  | £26.08 £29.99 |
| Basic Reference Manual                          | £5.21   | £5.99    | Space Invaders   | £26.08 £29.99 |
| Dos. 2 Manual                                   | £5.21   | £5.99    | Star Raiders   | £26.08 £29.99 |
| Operating System Listing                        | £10.43  | £11.99   | Super Breakout   | £21.73 £24.99 |
| Dos. Utilities Listing                          | £3.47   | £3.99    | Video Easel  | £21.73 £24.99 |
| <b>Atari Home Computer Programs—Home/Office</b> |         |          | <b>Programming Languages &amp; Aids</b>                            |               |
| Graphit   | £13.03  | £14.99   | Assembler Editor   | £34.77 £39.99 |
| Statistics 1                                    | £13.03  | £14.99   | Pilot (Consumer)   | £52.17 £59.99 |
| <b>Home Study</b>                               |         |          | Pilot (Educator)   | £78.25 £89.99 |
| (Cassette except where stated)                  |         |          | Entertainer Kit (Star Raiders, Missile Command and Pair Joysticks) | £60.86 £69.99 |
| Inv. to Programming 1                           | £17.38  | £19.99   | Programmer Kit (Basic Cartridge and Manuals)                       | £43.47 £49.99 |
| Inv. to Programming 3                           | £19.99  | £22.99   |  |               |
| Conversational French                           | £34.77  | £39.99   |  |               |
| Conversational German                           | £34.77  | £39.99   |  |               |



**FREE!** Cassette WORTH £19.95 with every ATARI 400 purchased - Use your FREE OFFER coupon.



**FREE!** Cassette WORTH £19.95 with every ATARI 800 purchased - Use your FREE OFFER COUPON.



**FREE!** 10 FLOPPY'S WORTH £19.50 with every ATARI DISK DRIVE purchased - Use your FREE OFFER COUPON.



**FREE!** 4 Boxes Thermal PAPER WORTH £16.00 with every ATARI PRINTER purchased - Use your FREE OFFER COUPON.

## VIC-20

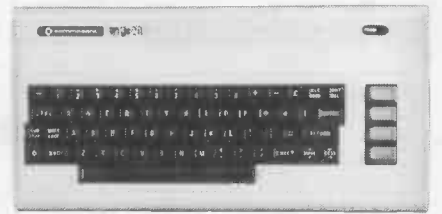

The VIC-20 represents superb value-for-money from SPECTRUM. A truly expandable computer system which can be as simple or as complex as your needs require. Ideal as a home micro with a large number of educational & games cartridges available. Equally, with additional memory expansion, a disc drive and printer, it becomes suitable as a small business system, powerful enough for stock control, book-keeping and payroll generation

- Memory expandable to 32K
- High resolution (full PET type) graphics
- 16 Screen colours & 8 border colours
- Plugs in to your T.V. or monitor
- Add Disk Drive & Printer for impressive 170K Byte system
- Can act as an intelligent terminal for a larger computer.

**Spectrum SENSATIONAL price only**

**£147.50** Ex. VAT  
Price Inc. of VAT £169.63

| VICC2N                                | Exc. VAT | Inc. VAT | GAMES   | Exc. VAT | Inc. VAT |
|---------------------------------------|----------|----------|---|----------|----------|
| cassette unit                         | £35.00   | £40.25   | "Avenger"   | £17.35   | £19.95   |
| VIC Printer                           | £200.00  | £230.00  | "Star Battle"                                     | £17.35   | £19.95   |
| VIC Single floppy disk drive (5 1/4") | £344.35  | £396.00  | "Jelly Monsters"                                  | £17.35   | £19.95   |
| 3K RAM                                | £26.04   | £29.95   | "Super Lander"                                    | £17.35   | £19.95   |
| 8K RAM                                | £39.09   | £44.95   | "Road Race"                                       | £17.35   | £19.95   |
| 16K RAM exp. cartridge                | £65.17   | £74.95   | "Rat Race"  | £17.35   | £19.95   |
| Super exp. Hi Res cartridge           | £30.39   | £34.95   | "Blitz" (cass.)                                   | £4.34    | £4.99    |
| Joystick                              | £6.52    | £7.50    | <b>BOOKS</b>                                      |          |          |
| Games paddles                         | £11.74   | £13.50   | Learn Computer Programming with the Commodore VIC | £1.95    | No VAT   |
| Programmers Aid card                  | £30.39   | £34.95   | VIC Revealed                                      | £10.00   | No VAT   |
| Machine Code Basic (1)                | £13.00   | £14.95   | VIC 20 Prog. Reference Guide                      | £14.95   | No VAT   |
|                                       |          |          | VIC Computing Magazine                            | £0.95    | No VAT   |

**Super RABBIT Software for VIC-20**  
Save 50p on rec. price of the following super quality games.

| Myriad        | £9.49 | Super Worm      | £4.49  |
|---------------|-------|-----------------|--------|
| Frogger       | £9.49 | Rabbit Function | £4.49  |
| Space Storm   | £6.49 | Charset 20      | £4.49  |
| Ski Run       | £4.49 | Rabbit Base     | £14.49 |
| Cosmic Battle | £4.49 | Rabbit Writer   | £19.49 |

## TEXAS T199/4A



**FREE!** INVADER'S CARTRIDGE Worth £18.95 with every TEXAS T199/4 purchased - use your Free Offer Coupon

A very expandable and comprehensive micro from TEXAS INSTRUMENTS - and now available at super LOW prices from SPECTRUM HOME COMPUTER CENTRES.

- 16K RAM (expandable to 48K)
- Built-in 14K Byte BASIC Interpreter
- 16 Bit Microprocessor
- 16 Colour High Resolution graphics
- Extensive range of solid state software command modules available from games to architectural aids.
- Optional programming languages - UCSD PASCAL, TI-LOGO & ASSEMBLER.

**Spectrum LOW Price £173.00** Price inc VAT £198.95

| TEXAS PERIPHERALS      | EX. VAT | INC. VAT | Tombstone City                 | £19.96 | £22.95 |
|------------------------|---------|----------|--------------------------------|--------|--------|
| —just arriving in U.K. |         |          | Attack                         | £18.96 | £22.95 |
| Speech Synthesizer     | £81.70  | £93.95   | Car Wars                       | £23.43 | £26.95 |
| Peripheral Exp. System | £147.78 | £169.95  | Munchman                       | £23.43 | £26.95 |
| Disc Cont. Card        | £124.30 | £142.95  | Education                      | £31.26 | £36.95 |
| Disc Drive             | £234.74 | £269.95  | Adventure & Private            |        |        |
| RAM Exp. Card          | £179.57 | £206.50  | Number Magic                   | £12.13 | £13.95 |
| Matrix printer         | £347.78 | £399.95  | Addition/Subt. 1               | £23.43 | £26.95 |
| Software Entertainment |         |          | Teach yourself beginners BASIC | £8.26  | £9.50  |
| TI Inverters           | £16.48  | £18.95   | Home Budget Management         | £19.96 | £22.95 |

12 PCW

Spectrum Computer Centres have no connection whatsoever with the ZX-Spectrum Computer manufactured by Sinclair Research Ltd.



## BOOKS

We stock an extensive range of books to help you. Here are just few to whet your appetite.

| CP/M Handbook                                | £11.50 |
|--|--------|
| DON'T  | £9.65  |
| Programming the Z80                          | £11.95 |
| Programming the 6502                         | £10.75 |
| Your First Computer                          | £7.75  |
| BASIC Handbook (2nd edition)                 | £14.95 |
| A-Z of Computer Games                        | £5.60  |
| Atari Basic                                  | £5.95  |
| Basic "BASIC"                                | £9.95  |
| BASIC Computer Games                         | £6.95  |
| BASIC Computer Programs for Business (VOL 1) | £8.55  |

NO VAT ON BOOKS

## ACCESSORIES

| SANYO   | Exc.VAT | Inc.VAT |
|---|---------|---------|
| Slim 3G Cassette Recorder (for use with Nascom and Dragon)                      | £26.04  | £29.95  |
| CTT 3106 14" Colour TV Set  | £199.96 | £229.95 |
| <b>ACCUTRAK</b>   |         |         |
| C12 Cassettes   | £0.43   | £0.50   |
| Single sided, double density disks (for Commodore, Atari, Apple, Tandy etc.)    | £1.70   | £1.95   |
| Double sided, double density disks (for Sharp and Superbrain)                   | £2.87   | £3.30   |
| Single sided, double density double track disks (for Nascom and Commodore 8050) | £2.30   | £2.65   |
| Disk Bank Interlocking cases for diskettes                                      | £3.91   | £4.50   |
| Disk head cleaner   | £13.00  | £14.95  |
| Single part 11" x 9 1/2" printer paper, box of 2200 sheets                      | £10.39  | £11.95  |

**Incredible Value!**  
**BMC 12" Green Monitor**

| 18 MHz band width  | Green and black display |
|--------------------|-------------------------|
| Spectrum LOW price | £69.00                  |
| (£79.35 inc. VAT)  |                         |
| Ex VAT             | Inc. VAT                |
| Prince 12" Monitor | £86.00                  |
| Sanyo 12" SM-12H   | £84.00                  |
| Sanyo 14" SCM-14H  | £98.60                  |
| Colour             | £350.00                 |
|                    | £402.50                 |





**FREE!**  
**£75 WORTH**  
**of software**  
 with every MZ80A  
 purchased

# SHARP MZ-80A

Desk top genius! - the all-in-one SHARP MZ-80A. A personal computer designed with the serious user in mind. ready to run the moment you get it home. Built-in keyboard, CRT 9" display and cassette data storage with 48K RAM. The BASIC with extra useful additions, offers quite a powerful micro for the home or business. ■ 4K Byte ROM + 48K Byte RAM + 2K Byte Video RAM ■ ASCII profiled keyboard + numeric pad ■ 2 page Video RAM allows screen to be scrolled up or down. ■ CP/M available.

**Spectrum LOW price £475.00** Price inc. V.A.T. £546.25

## MZ Software from KUMA

| SHARP PERIPHERALS FOR MZ80A                | EXC. VAT | INC. VAT |
|--|----------|----------|
| Twin floppy disk unit (5 $\frac{1}{4}$ " ) | £590.00  | £678.50  |
| Single floppy disk unit                    | £400.00  | £460.00  |
| Floppy disk interface card                 | £100.00  | £115.00  |
| Floppy disk cable                          | £24.00   | £27.50   |
| Master diskette and manual                 | £31.00   | £35.66   |
| Expansion unit (disk drive or printer)     | £100.00  | £115.00  |

## SHARP HAND HELD COMPUTERS

Pocket-sized genius at your command - we sell the well established PC1211 & the new 1500 Models.

|                                    |                 |                    |
|------------------------------------|-----------------|--------------------|
| SHARP PC1211                       | £65.00 Ex. VAT  | (£74.75 inc. VAT)  |
| SHARP PC1500                       | £147.48 Ex. VAT | (£169.95 inc. VAT) |
| PC 1500 Printer/cassette interface | £130.39         | £149.95            |
| PC 1500 4K RAM upgrade             | £43.43          | £49.95             |

# Attention real computer enthusiasts!

# NASCOM Special Edition



**SAVE £15** on the PRINCE 12" Monitor when purchased together with the NASCOM Special Edition.

Are you a real computer enthusiast? If you're looking for a machine to take you way beyond the sphere of a normal domestic computer you need go no further than the NASCOM SPECIAL EDITION. To give you some indication of it's scope its already been adopted for many commercial applications including Hotel Booking Systems, blood grouping, weaponry & satellite tracking etc. Now SPECTRUM bring you the opportunity to embark on a remarkable sphere of computing with the infinitely expandable NASCOM. It's a terrific buy! - Trade-In your old machine & trade-up to a NASCOM SPECIAL EDITION - NOW!

- Programmable in BASIC and machine code
- 8K Memory expandable easily to 56K with plug-in board
- Facility for up to 206K onboard memory
- Super colour graphic facilities
- Full range of disk drives, printers & various input/output facilities can be added
- Supplied complete with Mains Lead & Plug, TV, Monitor & Tape Recorder connections.

**Spectrum LOW price £429.95** Ex. VAT (£494.44 inc. VAT) Prince Monitor illus. extra.  
 NASCOM Special Edition 48K RAM Board (ready to plug in) £130.00 ex. VAT (£149.50 inc. VAT).

## EPSON PRINTERS

**FREE!**  
**PAPER**  
 Worth £11.95 with every EPSON Printer purchased - see your local Office Supplies



Chosen by SPECTRUM for their reliability, the superb new top quality graphic printers from EPSON. New features include super & subscript, underlining & deletion. If you're looking for an up-market printer at a down-to-earth-price, call in and see the EPSON range at SPECTRUM.

| Model             | EX. VAT | INC. VAT |
|-------------------|---------|----------|
| MX80-T3           | £299.00 | £343.85  |
| MX80 F/T Type III | £335.00 | £385.25  |
| MX100 Type III    | £429.00 | £493.35  |

Please see your SPECTRUM dealer for prices of INTERFACE/CABLE options.

## There's a SPECTRUM HOME COMPUTER CENTRE near you...

**ALFRETON**  
 Gordon Harwood  
 69/71 High Street,  
 Alfreton, Derbyshire  
 Tel: 0773 832078

**ASHFORD**  
 Ashford Computer Centre  
 2 Station Parade, Clarendon Rd.  
 Ashford, Middlesex.  
 Tel: 07842 44955

**BASILDON**  
 Godfrey's  
 28-32 East Walk, Town Centre,  
 Basildon, Essex.  
 Tel: 0268 289379

**BASINGSTOKE**  
 Fisher's  
 2/3 Market Place,  
 Basingstoke, Hants.  
 Tel: 0256 22079

**BATH**  
 Software Plus  
 12 York Street, Bath  
 Tel: 0225 61676

**BIRMINGHAM**  
 Sherwoods  
 Great Western Arcade,  
 Birmingham 2.  
 Tel: 021 236 7211

**BRADFORD**  
 Photosave  
 18 Cheapside, Bradford BD1 4JA  
 West Yorkshire.  
 Tel: 0273 308598

**BRIGHTON**  
 Capricorn  
 1 Queens Road, Brighton, Sussex  
 Tel: 0273 29634

**CAMBRIDGE**  
 KP Ltd.,  
 12a Kings Parade, Cambridge.  
 Tel: 0223 68087

**CARDIFF**  
 Randall Cox  
 18-22 High St. Arcade, Cardiff.  
 Tel: 0222 31960

**DERBY**  
 C T Electronics  
 The Spot, Derby.  
 Tel: 0332 44760

**EDINBURGH**  
 The Silicon Centre  
 6-7 Antigua St., Edinburgh,  
 Scotland.  
 Tel: 031 557 4546

**GLASGOW**  
 Victor Morris Ltd.,  
 340 Argyle St., Glasgow G2.  
 Tel: 041 221 8958

**GUILDFORD**  
 The Model Shop  
 23 Swan Lane, Guildford.  
 Surrey GU1 4EQ  
 Tel: 0483 39115

**HARROW**  
 Camera Arts  
 (Micro Computer Division)  
 24 St. Ann's Road, Harrow,  
 Middlesex.  
 Tel: 01-427 5469

**HATFIELD**  
 Microworld  
 2 Crawford Road, Hatfield, Herts.  
 Tel: 82 64137 (Temporary  
 number to be changed)

**LEEDS**  
 Bass & Bilgh  
 4 Lower Briggate, Leeds,  
 W Yorkshire.  
 Tel: 0532 45445

**LEICESTER**  
 Youngs  
 40-42 Belvoir St.,  
 Leicester.  
 Tel: 0533 54774

**LONDON N1**  
 ASP Micro Systems  
 185 Upper Street,  
 Islington.  
 Tel: 01-226 9392

**LONDON SE9**  
 Square Deal  
 375 Footscray Road,  
 New Eltham, London SE9  
 Tel: 01-859 1516

**LONDON W11**  
 Electroleisure  
 120 Notting Hill Gate,  
 London W11  
 Tel: 01-221 7029

**MACCLESFIELD**  
 Camera & Computer Centre  
 118 Mill Street, Macclesfield,  
 Cheshire.  
 Tel: 0625 27468

**MANCHESTER**  
 Lomax Ltd.  
 8 Exchange St., St. Ann's Square,  
 Manchester A2 7HL  
 Tel: 061 832 6167

**MIDDLESBROUGH**  
 McKenna & Brown  
 190 Linthorpe Road,  
 Middlesbrough.  
 Tel: 0642 248345

**NEWCASTLE-ON-TYNE**  
 Turners  
 29-31 High Friars, Eldon Square,  
 Newcastle.  
 Tel: 0632 612901

**NEWCASTLE-ON-TYNE**  
 Newcastle Camera  
 & Computer Mart  
 16 Northumberland, Court,  
 Newcastle-on-Tyne.  
 Tel: 0632 327461

**NOTTINGHAM**  
 Cameo Computers  
 8/9/10 Trinity Walk, Nottingham.  
 Tel: 0602 42912

**READING**  
 David Saunders Computer  
 Centre  
 8 Yield Hall Place, Reading,  
 Berks.  
 Tel: 0734 580719

**RUGBY**  
 The Rugby Micro Centre  
 9-11 Regent Street, Rugby.  
 Tel: 0788 70522

**TEDDINGTON**  
 "Andrews"  
 49 Broad Street, Teddington,  
 Middlesex.  
 Tel: 01-977 4716

**WALLINGTON**  
 Surrey Micro Systems Ltd.  
 53 Woodcote Road, Wallington,  
 Surrey.  
 Tel: 01-647 5636

**WATFORD**  
 SRS Microsystems Ltd.  
 94 The Parade, High Street,  
 Watford, Herts.  
 Tel: 0923 26602

**WEST BROMWICH**  
 Bell & Jones  
 39 Queens Square  
 West Bromwich.  
 Tel: 021 553 0820

**WIDNES**  
 Computer City  
 78 Victoria Rnad,  
 Widnes, Cheshire  
 Tel: 051 424 9999

**WIGAN**  
 Wilding Ltd.  
 11 Mesnes St., Wigan, Lancs.  
 Tel: 0942 44382

**WORKING**  
 Harpers  
 71-73 Commercial Way, Woking,  
 Surrey.  
 Tel: 04862 61061

**WORCESTER**  
 David Waring Ltd.  
 1 Marmion House, High Street,  
 Worcester.  
 Tel: 0905 27551

**COMPUTER DEALERS!**  
 (or prospective Computer Dealers!)  
 If you would like to know more about becoming a SPECTRUM APPOINTED DEALER on an exclusive area basis, please contact MIKE STERN or ALAN WARREN on (0727) 66646  
 Spectrum (U.K.) Ltd. Unit 6, Marlborough Trading Estate, Lattimore Road, St. Albans, Herts.

**MAIL ORDER**  
 When it comes to MAIL ORDER our service is FAST! with SECURICOR DELIVERY to anywhere in the British Isles. - Ask your nearest SPECTRUM dealer for further details at time of ordering.

**Up to £1000 INSTANT CREDIT with a SPECTRUM CHARGECARD**  
 With a SPECTRUM CHARGECARD you choose the credit limit to suit YOU. e.g. a monthly payment of £10 gives you £200 credit. Ask your nearest SPECTRUM COMPUTER CENTRE for written details on how to apply for your SPECTRUM CHARGECARD - NOW!  
 (Typical APR 30.6%)

**V.A.T.**  
 You will see that we quote our prices both including VAT and excluding VAT - no hidden 15% to suddenly up-lift your bill but also making our prices easier to compare with our competitors.

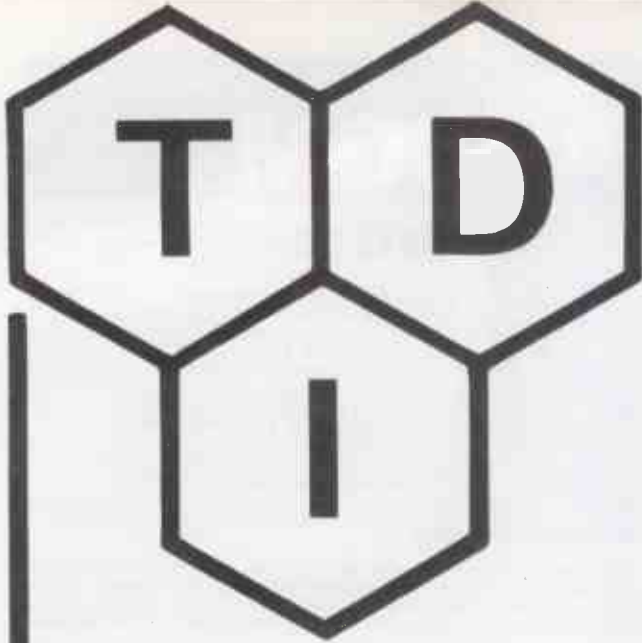

## **DID YOU KNOW THAT.....**

**WITHOUT TOUCHING YOUR  
PROGRAM YOU COULD MOVE IT  
BETWEEN YOUR**

**APPLE, IBM, and now SIRIUS 1...**

You can do it with the UCSD p-System, the fastest growing software development system for microcomputers. Manufacturers, applications developers, and more than 50,000 users have already made the UCSD p-System their choice.

### **The p-System (Version IV) offers: —**

- ★ A complete, portable software development and execution environment.
- ★ Full screen editor with Programming and Text modes.
- ★ Comprehensive file handler, library and utilities (all above for £250 plus VAT)
- ★ Fully compatible and integrated Pascal (£160) FORTRAN and BASIC compilers.
- ★ The same system for most major micros:—  
Apple, IBM, OSBORNE, DEC, TI, all Z80's, 68000'S, and NOW Sirius 1

### **The UCSD adaption now offered by TDI gives the following extra features: —**

- ★ EXTENDED MEMORY allows bigger programs (standard)
- ★ TURTLEGRAPHICS allows the user to exploit the full abilities of the SIRIUS display. (£45)
- ★ NATIVE CODE GENERATOR allows the user to selectively generate native 8088 code giving total control over the 'trade-off' between size and speed. (£80)
- ★ XENOFILe passes CPM files to/from p-System. (£20)

### **APPLICATION SOFTWARE available now or soon includes: —**

- ★ JARMAN accounting systems. Widely recognised on Apple.
- ★ INTERLINK terminal product with full error checking protocol to transmit/receive ALL types of files without corruption.
- ★ ALADIN Relational Database Manager. German authored this product is one of the first truly powerful database systems available on small computers.  
A genuine relational system the product has full screen input and enquiry facilities and even has a Pascal code generating interface.
- ★ Modula 2 Compiler.

Available from: — **TDI LIMITED, 29 ALMA VALE ROAD, BRISTOL BS8 2HL**  
**TEL: 0272-742796**  
(Dealer and educational enquiries welcomed)

# STARTERS

Absolutely  
the lowest  
prices!

Computer apple computer apple computer apple computer apple computer apple

## ADVENTURE

|  |       |
|--|-------|
| Adventure (Microsoft), Microsoft               | 13.95 |
| Adventure In Time: Phoenix Software            | 17.95 |
| Akalabeth: California Pacific                  | 15.95 |
| Ali Baba - 40 Thieves; Quality Software        | 17.95 |
| Alkemstone: Dakin 5                            | 18.95 |
| Beneath Apple Manor: Quality Software          | 10.95 |
| Castle Wolfenstein: Muse                       | 13.95 |
| Castles of Darkness: The Logical Choice        | 17.95 |
| Cosmo Mission: Astar International             | 13.95 |
| Cranston Manor: On Line                        | 12.95 |
| Creature Venture: Highlands Comp Services      | 12.95 |
| Crown Of Arthain; Micro Lab                    | 16.95 |
| Crush Crumble + Chomp; Automated Simulations   | 13.95 |
| Curve Of Ra; Automated Simulations             | 14.95 |
| Cyborg; Sentient Software                      | 15.95 |
| Dark Forest; Sirius Software                   | 15.95 |
| Dates of Ryn; Automated Simulations            | 10.95 |
| Deep Sea Treasure; Avant Garde                 | 7.95  |
| Doom Cavern + Sorcerer; Synergistic Software   | 10.95 |
| Dragon Fire; Dakin 5                           | 21.95 |
| Dragons Eye; Automated Simulations             | 12.95 |
| Dungeon Campaign; Synergistic Software         | 9.95  |
| Empire I World Builders; Edu-Ware              | 16.95 |
| Empire II Stella Sharks; Edu-Ware              | 17.95 |
| Empire III Armageddon; Edu-Ware                | 17.95 |
| Epoch; Sirius Software                         | 15.95 |
| Escape From Arcturus; Synergistic Software     | 18.95 |
| Galactic Empire; Broderbund                    | 11.95 |
| Galactic Revolution; Broderbund                | 11.95 |
| Galactic Trader; Broderbund                    | 11.95 |
| Hellfire Warrior; Automated Simulations        | 18.95 |
| Invasion Orion; Automated Simulations          | 14.95 |
| Jabbertalky; Automated Simulations             | 14.95 |
| Journey; Softape                               | 10.95 |
| Keys Of Acheron; Automated Simulations         | 10.95 |
| Labyrinth; Broderbund                          | 13.95 |
| Mad Venture; Micro Lab                         | 12.95 |
| Missing Ring; Datamost                         | 15.95 |
| Mission Asteroids; On Line                     | 10.95 |
| Mortlocks Tower; Automated Simulations         | 10.95 |
| Mummy's Curse; Highlands Comp Services         | 14.95 |
| Mystery House; On Line                         | 11.95 |
| Odyssey; Synergistic Software                  | 14.95 |
| Oldorf's Revenge; Highlands Comp Services      | 9.95  |
| Palace In Thunderland; Micro Lab               | 12.95 |
| Race For Midnight; Avant Garde                 | 15.95 |
| Rescue At Riget; Automated Simulations         | 14.95 |
| Rings Of Saturn; Dakin 5                       | 18.95 |
| Soft Porn Adventure; On Line                   | 13.95 |
| Sorcerer Of Siva; Automated Simulations        | 14.95 |
| Space Adventure; Siera Software                | 14.95 |
| Survival Adventure; U.S.A                      | 13.95 |
| Tarturian; Highlands Comp Services             | 12.95 |
| Tawalas Last Redoubt; Broderbund               | 17.95 |
| Temple Of Asphal; Automated Simulations        | 18.95 |
| Terrorist; Edu-Ware                            | 14.95 |
| Time Zone; On Line                             | 40.95 |
| Ultima; California Pacific                     | 17.95 |
| Ulysses And Golden Fleece; On Line             | 15.95 |
| Upper Reaches Of Asphai; Automated Simulations | 20.95 |
| Wilderness + Dungeon; Synergistic Software     | 14.95 |
| Wilderness Campaign; Synergistic Software      | 10.95 |
| Wizard + Princess; On Line                     | 14.95 |
| Zork 1; Infocom                                | 19.95 |
| Zork 2; Infocom                                | 19.95 |

## BOARD GAME

|                                      |       |
|--------------------------------------|-------|
| Kabul Spy; Sirius Software           | 17.95 |
| Bishops Square; Datasoft             | 15.95 |
| Casino; Datamost                     | 21.95 |
| Crossword Magic; L & S Computer Ware | 26.95 |
| Gomoku; Softape                      | 10.95 |
| Microchess 2.0; Personal Software    | 12.95 |
| Sargon II (Chess); Hayden            | 19.95 |

## BOOK

|                                      |      |
|--------------------------------------|------|
| Beneath Apple Dogs; Quality Software | 9.95 |
|--------------------------------------|------|

## BUSINESS

|   |        |
|---|--------|
| Address Book (Mail List); Muse                        | 23.95  |
| Apple Bulltin Board; Software Sorcery                 | 43.95  |
| Correspondant; S. W. Data Systems                     | 32.95  |
| Data Dex; Information Unlimited                       | 140.95 |
| Data Disk (Data Factory); Micro Lab                   | 17.95  |
| Data Factory; Micro Lab                               | 72.95  |
| Data Factory 5.0; Micro Lab                           | 139.95 |
| Data Graph; Hayden                                    | 25.95  |
| Data Manager DB + Mail List; Hayden                   | 32.95  |
| Data Plot; Muse                                       | 27.95  |
| DB Master; Stoneware                                  | 104.95 |
| DB Utility Pack II; Stoneware                         | 47.95  |
| DB Utility Pack No. 1; Stoneware                      | 47.95  |
| Desk Top Plan II; Personal Software                   | 131.95 |
| Easy Mailer (Mail List) 40; Information Unlimited     | 33.95  |
| Easy Mailer Pro; 80 Col.; Information Unlimited       | 87.95  |
| Easy Mover; Information Unlimited                     | 27.95  |
| Easywriter (WP) 40 Col.; Information Unlimited        | 47.95  |
| Easywriter Pro; 80 Col.; Information Unlimited        | 115.95 |
| Electronic Price Sheet; Stoneware                     | 41.95  |
| Home Account; Continental Software                    | 36.95  |
| Home Money Minder; Continental Software               | 21.95  |
| Investment Decisions; Mesa Research                   | 54.95  |
| Invoice Factory; Micro Lab                            | 108.95 |
| Letter Perfect; LJK Enterprises                       | 73.95  |
| Magic Window (WP); Artsci                             | 46.95  |
| Magic Words; Artsci                                   | 32.95  |
| Mail Room; Continental Software                       | 17.95  |
| Mailing List; Software Sorcery                        | 32.95  |
| Mailing List/Database Synergistic Software            | 25.95  |
| Micro Information System; Muse                        | 16.95  |
| Micro Memo; Stoneware                                 | 19.95  |
| Modifiable Database II; Synergistic Software          | 43.95  |
| Personal Filing Sys (PFS); Software Publishing Corp.  | 40.95  |
| Personal Report Sys. (PRS); Software Publishing Corp. | 40.95  |
| Store Manager; Hayes Micro Products                   | 130.95 |

|                              |        |
|------------------------------|--------|
| Super Scribble; On Line      | 62.95  |
| Super Text II; Muse          | 68.95  |
| Visiblend; Micro Lab         | 25.95  |
| Visicalc; Visicorp           | 105.00 |
| Visifactory; Visicorp        | 127.95 |
| Visifactory; Micro Lab       | 37.95  |
| Visifile; Visicorp           | 120.95 |
| Visiplot; Visicorp           | 98.95  |
| Visischedule; Visicorp       | 149.95 |
| Visiterm; Visicorp           | 53.95  |
| Visitrend/Visiplot; Visicorp | 148.95 |

## GRAPHICS UTILITY

|  |       |
|--|-------|
| A23D2 Enhancement; Sub Logic                 | 13.95 |
| A26E1 Graphics; Sub Logic                    | 32.95 |
| Apple World; U.S.A.                          | 27.95 |
| Bill Budge 3D Graphics; California Pacific   | 17.95 |
| Combo Enhanced Graphics; Computer Station    | 30.95 |
| Game Animation Package; Synergistic Software | 25.95 |
| Hi-Res Secrets; Avant Garde                  | 60.95 |
| Higher Graphics II; Synergistic Software     | 17.95 |
| Higher Text II; Synergistic Software         | 18.95 |
| Histogram; Hayden                            | 17.95 |
| Painter Power; Micro Lab                     | 20.95 |

## HI RES ACTION

|  |       |
|--|-------|
| Alien Rain; Broderbund                       | 13.95 |
| Amoeba Man; Turnkey Software                 | 18.95 |
| Anti Ballistic Missile; Muse                 | 12.95 |
| Apple Panic; Broderbund                      | 14.95 |
| Apploids; California Pacific                 | 14.95 |
| Arcade Machine; Broderbund                   | 10.95 |
| Asteroid Field; Cavalier Computers           | 12.95 |
| Astroapple; Quality Software                 | 10.95 |
| B. Budge Space Album; California Pacific     | 18.95 |
| Bakers Trilogy; Softape                      | 17.95 |
| Bandits; Sirius Software                     | 17.95 |
| Beer Run; Sirius Software                    | 14.95 |
| Bloody Murder; Stoneware                     | 10.95 |
| Borg; Sirius Software                        | 12.95 |
| Both Barrels; Sirius Software                | 13.95 |
| Bug Attack; Cavalier Computers               | 13.95 |
| Chop Lifter; Broderbund                      | 13.95 |
| Cieling Zero; Turnkey Software               | 16.95 |
| Computer Football; Sirius Software           | 14.95 |
| Cops + Robbers; Sirius Software              | 14.95 |
| County Fair; Datamost                        | 12.95 |
| Cross Country Rally; Continental Software    | 16.95 |
| Cross Fire; On Line                          | 13.95 |
| Cyber Strike; Sirius Software                | 19.95 |
| Cyclod; Sirius Software                      | 15.95 |
| Demon Derby; Broderbund                      | 13.95 |
| Dog Fight II; Micro Lab                      | 9.95  |
| Dung Beetle; Datasoft                        | 15.95 |
| Falcons; Piccadilly                          | 13.95 |
| Fender Bender; California Pacific            | 11.95 |
| Fire Bird; Gebelli                           | 12.95 |
| Fight Simulator; Sub Logic                   | 18.95 |
| Fly Wars; Sirius Software                    | 17.95 |
| Frogger; On Line                             | 17.95 |
| Galaxy Wars; Broderbund                      | 13.95 |
| Gamma Goblins; Sirius Software               | 12.95 |
| Genetic Drift; Broderbund                    | 13.95 |
| Gobblers; On Line                            | 13.95 |
| Gorgon; Sirius Software                      | 17.95 |
| Hadron; Sirius Software                      | 15.95 |
| Hi-Res Golf; Avant Garde                     | 17.95 |
| Hyperspace Wars; Continental Software        | 17.95 |
| International Grand Prix; Riverbank Software | 17.95 |
| Jaw Breaker; On Line                         | 13.95 |
| Jelly Fish; Sirius Software                  | 17.95 |
| Lemmings; Sirius Software                    | 15.95 |
| Meteoroids In Space; Quality Software        | 10.95 |
| Missile Defence; On Line                     | 13.95 |
| Mouskattack; On Line                         | 16.95 |
| Orbitron; Sirius Software                    | 12.95 |
| Outpost; Sirius Software                     | 12.95 |
| Phantoms Five; Sirius Software               | 12.95 |
| Pinball; Sub Logic                           | 17.95 |
| Pool 1.5; Innovative Design S. Ware          | 17.95 |
| Raster Blaster; Budge Co                     | 14.95 |
| Retro Ball; Sierra Software                  | 17.95 |
| Roach Ball; Micro Lab                        | 18.95 |
| Sabotage; On Line                            | 13.95 |
| Shuffle Board; Innovative Design S. Ware     | 13.95 |
| Snake Byte; Sirius Software                  | 12.95 |
| Sneakers; Sirius Software                    | 12.95 |
| Snoggle; Broderbund                          | 17.95 |
| Space Eggs; Sirius Software                  | 12.95 |
| Space Quarks; Broderbund                     | 13.95 |
| Space Warrior; Broderbund                    | 12.95 |
| Star Trek; Cavalier Computers                | 13.95 |
| Suicide; Piccadilly                          | 13.95 |
| Swashbuckler; Datamost                       | 19.95 |
| Thief; Datamost                              | 12.95 |
| Three Mile Island; Muse                      | 19.95 |

|  |       |
|--|-------|
| Threshold; On Line                           | 18.95 |
| Track Attack; Broderbund                     | 13.95 |
| Trick Shot (Pool); Innovative Design S. Ware | 19.95 |
| Twerps; Sirius Software                      | 15.95 |
| Zero Gravity Pinball; Avant Garde            | 15.95 |
| Red Alert; Broderbund                        | 13.95 |
| Hi-Res Soccer; On Line                       | 13.95 |

## LANGUAGE

|                                    |       |
|------------------------------------|-------|
| Asm Lang. Development Sys; Hayden  | 24.95 |
| Expediter II Compiler; On Line     | 39.95 |
| Fourth II (Language); Softape      | 31.95 |
| Hayden Applesoft Compiler; Hayden  | 87.95 |
| Lisa 2 5 6502 Assembler; On Line   | 45.95 |
| Tasc Applesoft Compiler; Microsoft | 80.95 |

## STRATEGY GAME

|   |       |
|---|-------|
| Air Traffic Controller; Avant Garde         | 7.95  |
| Battleship Commander; Quality Software      | 10.95 |
| Cartels + Outthroats; Strategic Simulations | 17.95 |
| Network; Edu-Ware                           | 10.95 |
| Operation Apocalypse; Strategic Simulations | 27.95 |
| Robot Wars; Muse                            | 18.95 |
| Shattered Alliance; Strategic Simulations   | 27.95 |
| Southern Command; Strategic Simulations     | 17.95 |
| Tanktigs; Avalon Hill                       | 14.95 |
| Tigers In The Snow; Strategic Simulations   | 17.95 |
| Torpedo Fire; Strategic Simulations         | 27.95 |
| President Elect; Strategic Simulations      | 17.95 |

## UTILITY

|  |       |
|--|-------|
| Apple Doc (Utility); S. W. Data Systems      | 25.95 |
| Applesoft Prog Optimizers; Sensible Software | 11.95 |
| Appsoft Structured Basic; Sensible Software  | 12.95 |
| Back It Up; Sensible Software                | 30.95 |
| Bag Of Tricks; Quality Software              | 20.95 |
| DDU + Single Disk Copy; Software Sorcery     | 28.95 |
| Deadly Secrets; Broderbund                   | 17.95 |
| Disk Organiser II; Sensible Software         | 13.95 |
| Disk Recover; Sensible Software              | 13.95 |
| Disk Utilities; Softape                      | 13.95 |
| Dos Boss; Beagle Bros                        | 15.95 |
| Dos Plus; Sensible Software                  | 12.95 |
| Dossource 3.3 Dos Listing; Lazer             | 18.95 |
| Linguist; Synergistic Software               | 18.95 |
| Memory Management II; On Line                | 23.95 |
| Multidisk Catalog III; Sensible Software     | 12.95 |
| P.L.T.S. Software Sorcery                    | 30.95 |
| P.U.M.P. Software Sorcery                    | 19.95 |
| Program Line Editor; Synergistic Software    | 18.95 |
| Programmers Utility; S.W. Data Systems       | 9.95  |
| Quick Loader; Sensible Software              | 12.95 |
| Super Disk Copy III; Sensible Software       | 13.95 |
| Text Editor; On Line                         | 43.95 |
| Utility City; Beagle Bros                    | 15.95 |

## HARDWARE

|   |         |
|---|---------|
| Excel-9 (6809 With "Flex"); ESD Laboratory Co. Ltd. | 164.95  |
| Eprom Blaster 2708/16; Apparal Inc.                 | 95.95   |
| Propotyping Board; S.S.M                            | 16.95   |
| 23 Key Keypad (Visicalc); Keyboard Company          | 101.95  |
| A.B.T. 10 Key Keypad; A.B.T.                        | 65.95   |
| Microbuffer Epson (16K); Practical Peripherals      | 86.95   |
| Microbuffer II (16K); Practical Peripherals         | 149.95  |
| Microbuffer II (32K); Practical Peripherals         | 186.95  |
| Ram Card (16K) Pascal CPM; Computer Stop            | 49.95   |
| 10 Meg Hard Disk System; Computer Stop              | 1644.95 |
| Videx 80/24 Video Card; Videx                       | 179.95  |
| Omnivision 80/24 Video; Computer Stop               | 144.95  |
| Videx Inverse Rom; Videx                            | 12.95   |
| Videx Switch Plate; Videx                           | 14.95   |
| Videx Graphics Eprom; Videx                         | 14.95   |
| U Term 80/24 Video Card; U Micro                    | 151.95  |
| Videx Soft Switch Card; Videx                       | 18.95   |
| Z80 Softcard; Microsoft                             | 203.95  |
| U Z80 (Z80 Card); U Micros                          | 72.95   |

## Z80 CPM (Z80 Softcard Required)

|   |        |
|---|--------|
| Calc Star; Micro Pro                      | 73.95  |
| Data Star; Micropro                       | 102.95 |
| DBase II Relational DBase; Ashton Tate    | 318.95 |
| Mailman; Standard Micro                   | 65.95  |
| Mailmerge; Micropro                       | 47.95  |
| Select (WP); Select Information           | 178.95 |
| Select + Superspell; Select Information   | 247.95 |
| Spell Star; Micropro                      | 69.95  |
| Supercalc; Sorcim Corp.                   | 164.95 |
| Wordstar; Micropro                        | 137.95 |
| DBase II Manual; Ashton Tate              | 33.95  |
| Aids Z80; 8080 Assembler; Microsoft       | 57.95  |
| C Basic; Compiler Systems                 | 75.95  |
| Fortran 80; Microsoft                     | 90.95  |
| Mac Macro Assembler; CCS                  | 54.95  |
| Basic Compiler (MBasic); Microsoft        | 172.95 |
| Bstam Micro To Mainframe; Byrom           | 108.95 |
| Bstam Micro To Micro; Byrom               | 108.95 |
| Fabs B Tree File Access; Computer Control | 108.95 |
| Tex (Text) Formatter; Digital Research    | 43.95  |

Please send me:

I enclose cheque/P.O. for

NAME

ADDRESS

Please add VAT at 15% to all orders.

Postage FREE in U.K.

Dealers Discount Available

Access Barclaycard orders Welcome  
on 051-256 8244

BARCLAYCARD



**STARTERS**  
63 Lymburn Lane  
Tuebrook, Liverpool, L13 9AF



# MICROL<sup>©</sup> SPECTRUM

USE  
AND  
LEARN

16/48K CASSETTE SYSTEM

# VOL.1: 25 BASIC PROGRAMS AVAILABLE NOW

## USE

25 PRACTICAL BASIC programs you can put to work immediately—

Programs to demonstrate the wide-ranging potential of your 16 or 48K Spectrum:—

World Atlas — Cassette and Videocassette Index — Music Composer — Computer Term Glossary — Star Maps . . .

Personal Programming Aids to help you write your own programs more effectively:—

Memory Map Monitor — System Diagnostic — Program debugging aids . . . Time-saving routines to use in your own programs:—

Text Editor — Flexible graph drawing routines — Sort and Search routines . . .

Plus much more.

And, of course, original games to entertain and challenge you.

# £9.95

make your games more exciting — How and when to use trees, tables, sorts and searches (do you know the Monkey Puzzle sort?) . . .

Facts at your Fingertips:—

Memory and runtime Benchmarks for every command — Display File Memory Map — Important PEEK and POKE locations you won't find in your Spectrum manual . Program Design Aids:—Screen Designers, for fast graphics and print layouts — Memory Manager, to keep track of every variable and array. PLUS:—All 25 BASIC programs explained line by line — a goldmine of practical hints and tips.



Send today for USE AND LEARN Volume 1—25 BASIC Programs, and we'll also keep you posted with details of further important MiCROL products for your Spectrum. And, of course, USE AND LEARN comes with MiCROL's full 14-day money-back Guarantee.

## LEARN

New ways to get the most from your Spectrum. Over 100 pages packed with —

Powerful programming techniques:— use Structured Programming to save time and make your programs more reliable — Ideas to

To order simply complete the coupon, and FREEPOST with your cheque, made payable to MiCROL (UK Mail Order). Allow 28 days for delivery. Telephone orders—credit card holders can order by telephoning (0223) 312866 from 9-5.30 Monday to Saturday, stating name and address, Card No. Access/Barclaycard/Visa. and item(s) required.

 **MiCROL**  
**SPECTRUM**

**(0223) 312866**

MAIL ORDER DISTRIBUTION EXCLUSIVELY BY TEMPUS OF CAMBRIDGE

38 Burleigh Street, Cambridge CB1 1BR.

Post to:— MiCROL (UK Mail Order) Freepost  
38 Burleigh Street, Cambridge CB1 1BR

Please send me . . . copy/ies of USE and LEARN vol. 1  
I enclose cheque/P.O. for £9.95 plus 50p P&P  
(Total £10.45 each)

Or I wish to pay by Access/Barclaycard/Visa

Card Number . . . . .

Please print name and address

Name . . . . .

Address . . . . .

Credit card holder's signature . . . . .

more for \*\* ATARI

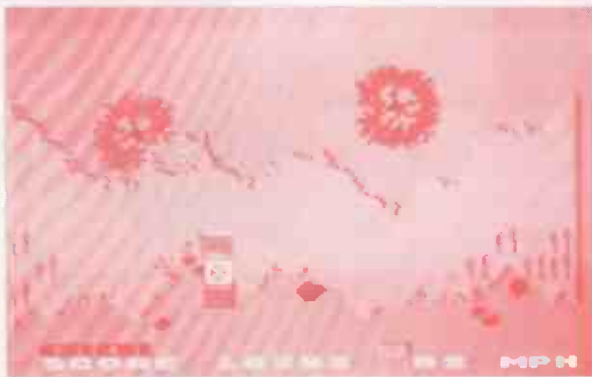

## "HAZARD RUN"

If you've wanted to join those good old country boys and drive the General Lee through Hazard County...

NOWS YOUR CHANCE

In HAZARD RUN, you must make the treacherous run through Crooked Canyon, past Bryan's Pond to the jump at Hazard Creek and safety.

For 24K Atari 400 & 800. Needs a joystick. On cassette.

Also still available BETA FIGHTER. A1 or 2 player game set on a realistic 3D Martian Landscape. For 16K Atari 400/800.

Joysticks required. On cassette at £15.50 (inc VAT).

Available from:

**ALLRIAN** DATA SERVICES

1000a, Uxbridge Road,

Hayes, Middx.

UB4 0RL.

£21.50 (INC VAT)  
P&P Free

AN  
**Artworx**  
PRODUCT

If that Apple  
is just out of Reach...

# Rent One!

Whether your requirement for a microcomputer system is from three days to three years and whether for evaluation, training or just hands-on experience - come to Atlanta Data. We're the experts!

Our terms? The best available, featuring no deposit\*, no capital expenditure, full maintenance & low, low charges.

PLUS the bonus of guaranteed inflation busting - the charge stays the same right through the rental contract!

We know computers & we know renting - for everything Apple - come to the experts!

**Atlanta** Data Systems

350/356 Old Street, London, EC1V 9DT. 01-739 5889

\* Business purposes only

**Kuma Computers Limited**

11 York Road, Maidenhead, Berks SL6 1SQ  
Tel: (0628) 71778 9 Telex: 849462 TELFAC KUM



**PROFESSIONALS IN SOFTWARE APPLICATIONS: INTERFACING**

### Sirius - 1.

The best price/performance you've ever seen on a personal computer: £2395 + VAT For 128K, 1.2 Mbyte, 16 bit, available software includes:- CP/M86, MSDO, Mbasic, COBOL, PASCAL, FORTRAN. etc.



**Osborne - 1:** You can take it anywhere. CP/M + 64K RAM, Dual discs interfaces and Wordstar, Super Calc, Mbasic. All for £1250.00 + VAT. Ask us about additional software.

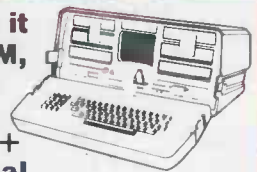

### Newbrain:

The only professional micro of this size: Phone us for immediate **FREE delivery** + **SOFTWARE CATALOGUE** Newbrain AD with onboard display £232.61 + VAT.



### SHARP A + B;

Computers and systems with a **Wealth of software applications programs.** "WDPRO" Wordprocessing, Database, Accounts, Mail Lists etc. Phone Now for our new Autumn 170 Program Catalogue.



**SHARP = KUMA = SOFTWARE**

### Printers:

**Matrix** - from £380.00 + VAT.

**Epson Mx 80F/T3 NEC (C. itoh)**

**Daisywheel** - from £476.50 + VAT.

**Brother 8300 Tec Star Writer**

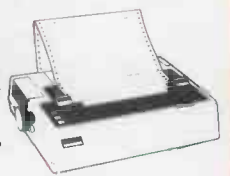

### Applications:

Direct experience of office applications, phone us for advice on ledgers, stock control, payroll and word processing.

**Software:** the established leader for Sharp Computers.

**Training:** Financial planning, information storage and word processing. One day introductory seminars.

**MAIDENHEAD (0628) 71778**

Kuma Computers Ltd., 11 York Road,  
Maidenhead, Berks. SL6 1SQ.

Tel: (0628) 71778/9 Telex: 849462 TELFAC Kum





# UPGRADE YOUR APPLE TO TODAY'S STANDARDS

## 1. SIMON COMPUTERS ARISTOCARD

The Serial Interface has full RS232 protocol and will communicate with any RS232 device. £75.00

The Parallel interface is a general purpose printer card which works with virtually all parallel printers. A lead with a 36 pin amphenol plug wired to the Centronics specification is supplied as standard. £69.00

## 2. SATURN SYSTEMS 128K RAM CARD

High powered memory expansion at a low price offering: \*extensive software support \*simple installation \*less power drain than a 16K language card \*compatibility with existing software & hardware. Can be used as a pseudo disk. £359.00

## 3. RGB COLOUR CARD

Produces vivid and clear colours in graphics giving the standard Apple Lo-Res and Hi-Res colours. £89.00

## 4. TIME KIT

An amazingly compact card - a Micro-Watch and Electronic Diary. Plugs into the game I/O socket. £59.00

## 5. MICROSOFT SOFTCARD

A Z-80 based hardware/software system. SoftCard greatly increases the capabilities of the Apple by letting you run the CP/M operating system. Microsoft BASIC-80 and other CP/M-based software. £189.00

## 6. CCS CALENDAR/CLOCK MODULE

A true real-time clock implementing full interrupt facilities. Can be used on a wide variety of applications. £79.95

## 7. KEYPLUS

The Visicalc compatible keypad with all the extra features: \*backward + forward movement arrows \*plus and minus keys \*space key \*escape key which allows cursor movement for easy editing. £99.00

## 8. VIDEX VIDEOTERM 80 COLUMN CARD

Increases Apple II display to a full capacity 80 columns, and, used with VC Expand 80 and any combination of memory expansion boards. 80 column display and memory expansion for Visicalc models can be achieved. £195.00

## 9. ENHANCER II

The Enhancer II features a typeahead buffer. Your keyboard has upper and lower case, and will auto repeat any key held down. A single keystroke can become a word or an entire sentence. Controlled by a powerful microprocessor. Enhancer II allows you to re-map your keyboard or add specialized features. Changing a chip creates a totally different keyboard. £89.00

## 10. COOL STACK

Offers the features of cabling and efficient organization and storage for Apple II. £69.00



## Pete & Pam Computers



**NEW** SAM RAM  
Pete & Pam's new 16K ram expansion board. £65.00

**Head Office:**  
Waingate Lodge, Waingate Close,  
Rossendale, BB4 7SQ  
Phone: (0706) 227011  
Telex: 635740 Petpam G

**London Office:**  
103-5 Blegborough Road,  
London, SW16 6DL  
Phones: 01-769 1022/3/4  
01-677 2052

**Norwegian Agent:**  
Norwegian Software House  
Okernveien 145  
Oslo 5  
Tel: (02) 22 89 78

Prices do not include VAT please add 15% to your remittance. Postage and Packing FREE

# ingenious!

## Genie I and II accessories

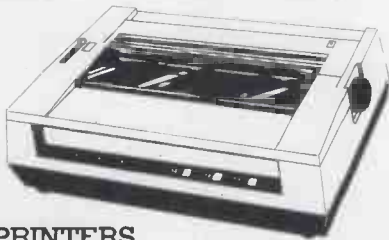

### PRINTERS

The EG 3085 is quiet, fast and efficient. Printspeed is 100 characters per second and printing is bi-directional at 80 or 136 characters per line. Suitable for use with other systems, it has three tpestyles, adjustable pin or friction feed and single sheet or roll paper facilities. **£425 plus VAT.**

If you don't want to pay that much for a printer, consider the EG 603. It doesn't match the EG 3085 in certain areas, but you will still get 100 c.p.s. bi-directional, a range of character styles, forward and reverse feed and pin/friction feed, with 96 characters and 64 graphic patterns. **£235 plus VAT.**

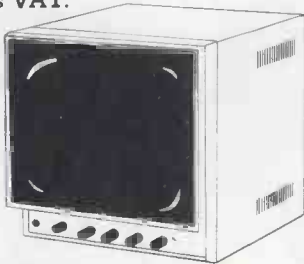

### MONITORS

Available in 9" and 12" sizes, with white, green or amber display, Lowe A.V.T. monitors are sturdy, attractive, easy to operate and feature an easy view screen with smoked anti-glare display filter. Compatible with most popular micros on the market. **From £75 plus VAT.**

### EQUIPMENT COVERS

Beat the dirt, coffee spills and sticky fingers when your computer and monitor are not in use with these top quality black leather covers.

Genie CV1 **£5 plus VAT.**  
12" monitors CV6 **£6.20 plus VAT.**  
9" monitors CV3 **£4.20 plus VAT.**

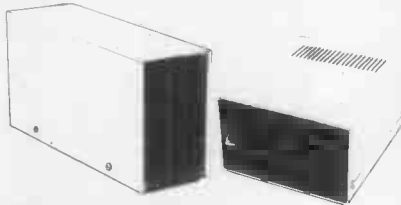

### DISK DRIVES

If you want fast, reliable program storage, true random access file handling and access to many computer languages, we can meet your needs. The EG 400T provides storage of up to 184320 bytes per floppy disk and comes complete and tested, in a stylish colour matched cabinet. **£220 plus VAT.**

The EG 401 AT offers dual disk drive with 368640 bytes of useable storage and comes complete with a power supply ready to connect to an expander box. **£365 plus VAT.**

### DOUBLE DENSITY ADAPTOR

Allows the use of standard minidisk drives in double density, with virtually double the storage capacity. The EG 3021 is equally at home in the Genie or TRS-80 expander boxes.

A double density disk operating system will be needed, such as smallDOS provides. **£72 plus VAT.**

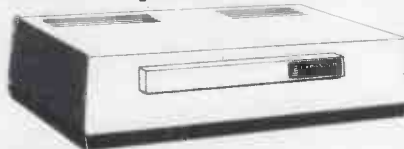

### EXPANDER BOX

The updated EG 3014 expander box allows for up to four disk drives with optional double density. It connects to a printer, or RS 232 interface, or S100 cards. Not bad value at **£190 plus VAT (16K version) or £200 plus VAT (32K version)**

\*The EG 3014 will work with TRS 80 by using the EG 3023 Tandy Adaptor.

### TECHNICAL MANUALS

Full technical details of Genie Hardware (all you ever wanted to know about Genie).

Genie I/II Technical Manual  
**£10 - No VAT.**  
Expander and accessories (EG3014)  
**£10 - No VAT.**

### smallDOS

Powerful, yet reasonably priced, the Genie smallDOS contains 21 library commands, 7 utilities, LBasic, disk basic and bags of information, including a reference manual and 40 page beginners guide to disk usage. **£35 plus VAT.**

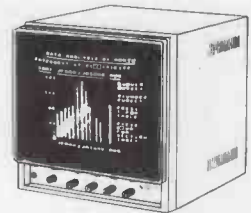

### HIGH RESOLUTION GRAPHICS

Increase graphic resolution capabilities on your Genie seventy-three fold with the LE18 HI-RES unit. It offers bit image graphics of 73,728 points, a resolution of 384 x 192, and uses a separate 16K of video memory to achieve its resolution. Graphics are intermixable with text or existing pixtel graphics, and animation, reverse video displays and use of programmable graphic characters are possible. **£86 plus VAT.**

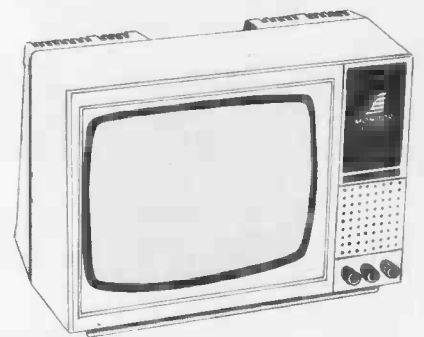

### GENIE MONITORS

Two good performance, low priced 12" monitors, either to match your Genie or compatible with a wide range of other systems. Good resolution and band width and, of course, they free your television set for the other type of programmes you like to watch!

The EG 100 12" in black & white costs **£69 plus VAT.**  
The EG 101 12" with green phosphor is **£79 plus VAT.**

## BUSINESS SOFTWARE

Specifically written for the Genie II computer, with disks and a suite of packages from the renowned house TRIDATA. The suite includes SALES LEDGER, PURCHASE LEDGER, PAYROLL and STOCK CONTROL. Each package is a very reasonable £175 plus VAT. Full details are available on request.



## SYSTEMS DESK

Even a compact modular computer system like the Genie benefits from being used on a custom designed system desk. The SD-1 system desk is designed to accommodate a complete Genie System and has a special upper shelf to support the display monitor at the best level. The desk is flat packed for easy delivery and finished in attractive teak and charcoal colours. £81.40 plus VAT.

## FRED MUSIC SYNTHESISER

Beethoven might well roll over at this stereo music synthesiser. It can produce six simultaneous notes over the whole audio range and provide sound effects. FRED comes complete with a software compiler, full instructions and a demo tune.

It is simply plugged onto the Genie 50 way bus and has two outputs for an audio amplifier. £51 plus VAT.

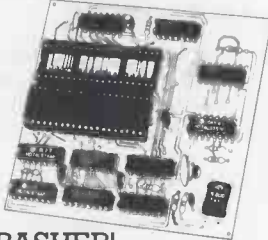

## EG 3203 TANDY-BASHER!

If you are a TANDY user, read on! The EG 3203 is bus converted to allow Genie peripherals to be used with Tandy Model I computers. £18.40 plus VAT.

(Just in case there might be a few strange souls who want to convert in the opposite direction, there is the 50/40 converter which generates a Tandy compatible 40 way bus from a Genie.) £34 plus VAT.

## EG 3016 PARALLEL PRINTER INTERFACE

The EG 3016 is a simpler interface allowing a Centronics parallel compatible printer (EG 603, EG 3085) to be connected directly to the Genie keyboard without the need for an expander box. £38 plus VAT.



## BUS EXTENDER

A most useful accessory, allows two bus using devices to be connected simultaneously to the Genie - when using the Hi Res and expander for instance. £21 plus VAT.

## EP1, EP2, EP3

Genie I and Genie II have ROMS offering 13.5K Microsoft BASIC, of which the final 1.5K BASIC are custom written extensions contained in EPROMs.

You can change these as follows:

### EP1

Adds all Genie I software facilities to other Genies, lower case driver, machine language monitor, renumber facility, keyboard repeat and screen print.

### EP2

Has improved M.L. monitor, can load and save programs. Defined function keys (list, load, save etc.) for Genie II and lower case driver.

### EP3

Has HI-RES driver software with 10 extra HI-RES commands which prevent need to load HI-RES software from tape.

All at £12 plus VAT.

For Video Genie Systems, the LE-19 connects direct to the Genie bus and allows one of these EPROMs to be fitted externally. £26.50 plus VAT.

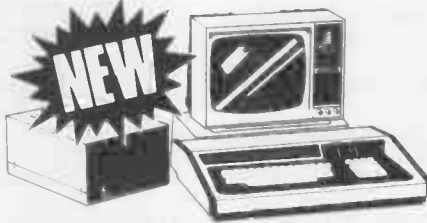

## NEW! A 64K CP/M computer for less than £1,000!

CP/Genie with single disk drive has 64K RAM, 13.5K ROM, comes complete with a 12" monitor, 64 x 16 screen format and operates under CP/M 2.2 supplied with machine. £999 plus VAT.

The dual disk version will cost £1,175 plus VAT.

Both are compatible with existing Genie I software and are supplied with the Genie SmallDOS. A breakthrough for Lowe Electronics customers that should not be missed.

**SPECIAL TECHNICAL GENIE**  
**HOT - LINE ON 0629 4995**  
for all your technical advice and service back-up on any aspect of the Genie system direct from the experts!

# LOWE electronics

Chesterfield Road, Matlock,  
Derbyshire DE4 5LE.  
Tel: 0629 4995.  
Telex: 377482 Lowlec G.

## Available now from your local GENIE dealer

AVON Microstyle, Bath, 0225 334659/319705.  
BEDFORD Conserve, Bedford, 0234 216749.  
BERKSHIRE P.C.P., Reading, 0743 589249.  
Castle Computers (Windsor), 07535 58118.  
BIRMINGHAM Ward Electronics, Birmingham, 021-554 0708. Consultant Electronics, Birmingham, 021-382 7247. A. E. Chapman and Co., Cradley Heath, 0384 66497/8. BUCKINGHAMSHIRE Photo Acoustics, Newport Pagnell, 0908 610625.  
CAMBRIDGESHIRE Cambridge Micro Computers, Cambridge, 0223 314666.  
CHESHIRE Hewat Electronics Macclesfield, 0625 22030. Mid Shires Computer Centre, Crewe, 0270 211086. CORNWALL A B & C Computers, 11 Brockstone Road, St. Austell, Cornwall, St. Austell 64463. CUMBRIA Kendal Computer Centre, Kendal, 0539 22559. DORSET Blandford Computers, Blandford Forum, 0258 53737.  
Parkstone Electronics, Poole, 0202 746555. ESSEX Emprise, Colchester, 0206 865926.  
GLOUCESTERSHIRE HAMPSHIRE Fareham Computer Centre, Fareham, Hampshire, Fareham, 231423. HERTFORDSHIRE Photo Acoustics, Watford, 0923 40698. Q Tek Systems, Stevenage, 0438 65385. Chnasilid Systems and Software, Berkhamsted, 04427 74569. KENT Swanley Electronics, Swanley, 0322 64851.  
LANCASHIRE Harden Microsystems, Blackpool, 0253 27590. Sound Service, Burnley, 0282 38481. Computercat, Leigh, 0942 605730. BEC Computerworld (Liverpool) 051-708 7100.  
LEICESTERSHIRE Kram Electronics, Leicester, 0533 27556. LONDON City Microsystems, EC2, 01-588 7272/4. Wason Microchip, N18, 01-807 1757/2230. Premier Publications, Anerley, SE20, 01-659 7131. NORTH EAST Briers Computer Services, Middlesborough, 0642 242017. General Northern Microcomputers, Peterlee, 0783 860314. HCCS Associates, Gateshead, 0632 821924. NOTTINGHAMSHIRE Midland Microcomputers, Nottingham, 0602 298281. Mansfield Computers, Mansfield, 0623 31202. East Midland Computer Services, Arnold, 0602 267079. Electronic Servicing Co., Lenton, 0602 783938.  
NORFOLK Anglia Computer Centre, Norwich, 0603 29652. Bennetts, Dereham, 0362 2488/9.  
OXFORDSHIRE Micro Business Systems, Whitney, 0993 73145. Pebleglo Ltd. (Thame) 084421 5368. SCOTLAND Esco Computing, Glasgow, 041-427 5497. Edinburgh, 031-557 3937. Computer and Chips Ltd, St. Andrews, 0334 76206. Scotbyte Computers, Edinburgh, 031-343 1055. Victor Morris and Co., Glasgow, 041-221 8958. SHROPSHIRE Tarrant Electronics, Newport 0952 814275. SOUTH WEST Diskwise, Plymouth (0752) 267000. West Devon Electronics, Yelverton, 082 285 3434. Bits and Bytes, Barnstaple, 0271 72789. SUFFOLK Elgelec Ltd., Ipswich, 0473 711164. SURREY Catronics, Wallington, Surrey, 01-669 6700/1. Croydon Computer Centre, Thornton Heath, 01-689 1280. WALES Tryfan Computers, Bangor, 0248 52042. WEST MIDLANDS Allen TV Services, Stoke on Trent, 0782 616929. WILTSHIRE Everyman Computers, Westbury, 0373 823764. B & D Computing (Swindon), 0793 762449. YORKSHIRE Media 5 Ltd., Sowerby Bridge, 0422 33580. Advance TV Services, Bradford, 0274 585333. Huddersfield Computer Centre, Huddersfield, 0484 20774. Comprite, Bradford, 0274 668890. Superior Systems Ltd., Sheffield, 0742 755005. Photo Electronics, Sheffield, 0742 53865. Ebor Computer Services (York) 0904 791595.  
NORTHERN IRELAND Business Electronic Equipment, Belfast, 0232 46161. Britain Laboratories, Belfast 0232 228374.

Please send me further details of the following item(s)

\_\_\_\_\_

\_\_\_\_\_

Name \_\_\_\_\_

Address \_\_\_\_\_

\_\_\_\_\_

Telephone \_\_\_\_\_

\_\_\_\_\_

PCW.10.82



# BBC MICRO COMPUTER

Model A £299

Model B £399

(VAT included: Carriage £6.00)

Model A to Model B Upgrade kit  
£60.00

Single Disk Drive £200 + £4.00 carriage

Dual Disk Drive £335 + £8.00 carriage.

Full Range of Connectors in Stock

Phone or send for our BBC leaflet.

Official BBC Dealer

## EP4000 EMULATING PROGRAMMER

This EPROM programmer will accept most single and three rail eproms by simple rotary switch personality selection. Output to TV and monitor. Comprehensive 1/0 Ports - TTL and RS232 mA current Loop, parallel port, cassette 1/0, printer port and DMA. £545 + £8.00 Carr.

## P4000 PRODUCTION PROGRAMMER

This unit offers simple and reliable programming of up to 8 EPROMS simultaneously. Self-check - blank check - program and verify sequence built in. £545 + £8.00 Carr. BP4 - TI Bi-polar Prom Programming module for EP4000. This module will program most TI devices and read equivalent devices from other manufacturers enabling copies to be made. £180 + £6.00 Carr.

## SOFTY II INTELLIGENT PROGRAMMER

The complete micro processor development system for Engineers and Hobbyists. You can develop programs, debug, verify and commit to EPROMS or use in host computer by using softy as a romulator. Powerful editing facilities permit bytes, blocks of bytes changed, deleted or inserted and memory contents can be observed on ordinary TV. Accepts most +5v Eproms  
Softy II complete with PSU, TV Lead and Romulator lead £169

## MENTA

A sophisticated Z80 development system an and trainer. Powerful keyboard assembler and program debugging facility. Audible feedback on keyboard input. Menta and PS PSU and TV Lead £115.

## NEW LOW PRICES!

### NEC PC 8023 BE - C

100CPS, 80 cols  
Logic Seeking, Bidirectional,  
Forward and Reverse Line Feed,  
Proportional Spacing, Auto Underline,  
Hi-Res and Block Graphics, Greek  
Char. Set. Only £340 + Carr £8.00

### PRINTER ACCESSORIES

2,000 fanfold papers with perforated margins  
£15.00 + £3.50 carriage  
500 fanfold papers with perforated margins  
£15.00 + £1.00 carriage

### FLOPPY DISC DRIVES

TEAC FD50A 5 1/4" 40 track drive housed  
in an attractive case with PSU

\* Unformatted single density capacity  
125K

\* Capable of double density recording

\* Compatible with Shugart SA400 and  
interfaces directly with TRS80 expansi  
expansion box

\* Interfaces with Superbrain, BBC, Atom,  
Nascom

Single Drive £190 + £5.00 carr, Double  
Drive £360 + £7.00 carr.

Apple II Drive: This drive housed in an  
attractive case can handle data in both 13  
& 16 sector formats. 143K can be stored  
over 25 tracks when using DOS 3.3.

Drive complete with cable £270 + £5.00  
carr.

### CASSETTE RECORDER

Sanyo Computer Grade Recorder £24.00  
+ £1.50 carr.

Cassette Leads £3.50

Computer Cassette £0.50 each - £4.50  
for 10.

## MONITORS

BMC BM1401 14" Colour Monitor  
RGB Input 18 MHz Bandwidth  
400 dots at Centre 25 x 40 Char.  
£240 + £8.00 carriage  
SANYO 12" Green Monitor  
Composite Input 18MHz Bandwidth  
£99 + £6.00 carr.

## PRINTERS

### SEIKOSHA GP 100A

80 cols 30 CPS  
Single and Double Width Char.  
Full Graphics, 10" wide paper  
Tractor Feed Standard  
Friction Optional  
Now only £175 + £6 Carr

### RIBBONS FOR PRINTERS

GP100A £6.50 EPSON MX80 £8.00  
NEC PC8035 £9.00

## RUGBY ATOMIC CLOCK

This Z80 micro controlled clock/calendar receives coded  
time data from NPL Rugby. The clock never needs to be  
reset. The facilities include 8 independent alarms and for  
each alarm there is a choice of melody or alternatively  
these can be used for electrical switching. A separate timer  
allows recording of up to 240 lap times without interrupting  
the count. Expansion facilities provided.  
Complete Kit £120 + £2.00 carr.  
Ready Built Unit £145 + £5.00 carr.  
Reprint of ETI articles at £1.00 + s.a.e.

## COMPONENTS MICRO'S \* MEMORIES \* TTL's \* INTERFACE DEVICES

### \* SPECIAL OFFER \*

|            |      |       |          |       |       |         |      |
|------------|------|-------|----------|-------|-------|---------|------|
| 2114L-450  | 1-24 | 25-99 | 2732     | 1-24  | 25-99 |         |      |
| 2114L-200  | 90p  | 85p   | 4116-200 | 375p  | 360p  |         |      |
| 2716 (+5V) | 100p | 95p   | 6116-150 | 100p  | 95p   |         |      |
| 2532       | 250p | 225p  | 6522     | 410p  | 375p  |         |      |
|            | 375p | 360p  |          | 310p  | 300p  |         |      |
| Z8         | £24  | 6800  | 225      | 6502  | 350p  | 6545    | 950p |
| Z80        | 290p | 6802  | 250p     | 6502A | 6847  | 875p    |      |
| Z80A       | 320p | 6809  | 650p     | 2650A | £12   | 9365    | £60  |
| Z80B       | £12  | 6809E | £12      | 6520  | 350p  | 96364   | £8   |
| 8085A      | 350p | 68809 | £12      | 6522  | 310p  | CRT5027 | £18  |
| 8088       | £18  | 8205  | 225p     | 6522A | 550p  | MC14411 | 675p |
| Z80CTC     | 250p | 8212  | 110p     | 6532  | 550p  | COM8116 | £7   |
| Z80ACTC    | 280p | 8216  | 100p     | 6821  | 100p  | 4702B   | 750p |
| Z80DMA     | £10  | 8224  | 110p     | 6854  | 700p  | COM8017 | £3   |
| Z80ADMA    | £1   |       |          |       |       |         |      |
| Z80ADART   | £7   | 8251  | 250p     | 68850 | 220p  | RO32513 | 750p |
| Z80PIO     | 250p | 8255  | 250p     | 6852  | 250p  | AY52376 | 700p |
| Z80APIO    | 280p | 8279  | 440p     | 6875  | 570p  | DAC80   | £30  |
| Z80S10-0/  |      |       |          | 6551  | 650p  | DP8304  | 250p |
| 1/2        | £9   |       |          |       |       |         |      |

Send for our detailed price list.

## ACORN ATOM

8K + 2K Built £135 12K + 12K Expanded £175  
8K + 5K + Colour Card £170 (Carr £3/unit)  
Atom Disc Pack £299 + £6 Carr  
3A 5v Regulated £26 + £2 Carr  
Atom PSU £7.00 + 70p Carr  
Full Range of Atomsoft in stock.

### EPSON MX 80 and 100F/T3

MX 80 80CPS 80 cols  
MX 100 100CPS 136 cols  
Logic Seeking, Bi-directional, Bit Image  
Printing, 9 x 9 Matrix Auto Underling  
MX 80 F/T3 £330 MX 100 F/T3 £430  
(£8 Carr/Printer)

### AMPHENOL CONNECTORS

1EEE 24 way £5.50  
Centromix 36 way £5.50

### UV ERASERS

UV1B up to 6 Eproms £47.50  
UV140 up to 14 Eproms £61.50  
UV1T with Timer £60.00  
UV141 with Timer £78.00

(Carr £2/eraser)

All erasers are fitted with mains  
switches and safety interlocks.

# TECHNOMATIC LTD

MAIL ORDERS TO: 17 BURNLEY ROAD, LONDON NW10 1ED  
SHOPS AT: 17 BURNLEY ROAD, LONDON NW10  
(Tel: 01-452 1500, 01-450 6597. Telex: 922800)  
305 EDGWARE ROAD, LONDON W2

PLEASE ADD 40p p&p & 15% VAT  
(Export: no VAT, p&p at Cost)

Orders from Government Depts. & Colleges etc. welcome.



Detailed Price List on request.

Stock items are normally by return of post.



# BEFORE YOU BUY YOUR MICRO!

COMPUTER, PRINTER, DISC DRIVES & ACCESSORIES

ALMOST EVERY MAKE OF POPULAR COMPUTER STOCKED  
AT PRICES WELL BELOW RECOMMENDED RETAIL

## GIVE US A RING ON 01-441 2922 AND SAVE £££'s WITH THE LOWEST PRICE GUARANTEE

All products carry a 1 year guarantee (parts & labour)

Pay an extra 10% for a 2 year guarantee

Shelves  
of  
Computer  
Books

Spares & repairs on  
all products, even if  
you didn't buy from  
Comp Shop

EXPRESS  
MAIL ORDER  
SERVICE

New  
products  
arriving  
daily

'Phone  
your order  
to  
reserve

Many items  
over stocked  
on Sale Offer

INSTANT CREDIT  
just pay the  
deposit by Credit  
Card and  
take it away

SATISFYING PRICE  
CONCIOUS CUSTOMERS  
FOR NEARLY 5 YEARS

P.S.  
Hopeless  
on-Software

# COMP SHOP

"Europe's Largest Discount  
Personal Computer Stores"

TELEPHONE SALES  
OPEN 24 hrs. 7 days a week  
01-449 6596

MAIL ORDER SHOP

14 Station Road, New Barnet,  
Hertfordshire, EN5 1QW  
(Close to New Barnet BR Station - Moorgate Line)  
Telephone: 01-441 2922 (Sales) 01-449 6596  
Telex: 298755 TELCOM G  
OPEN (BARNET) - 10am - 7pm - Monday to Saturday



BARCLAYCARD  
VISA

AMERICAN EXPRESS

# HOW TO USE YOUR PRINTER WITHOUT WASTING COMPUTER TIME:

Your computer is capable of sending data at many thousands of characters per second but the fastest Epson can only print 100 characters per second and most daisywheel printers are even slower.

This means your computer is forced to wait for the printer to finish one line before it can send the next. A costly waste of time.

THE NEW **SPAJINTER** ACCEPTS DATA AS FAST AS YOUR  
COMPUTER CAN SEND IT.

**SPAJINTER** stores the data in its own memory buffer and then takes control of the printer. This frees your computer for more productive functions.

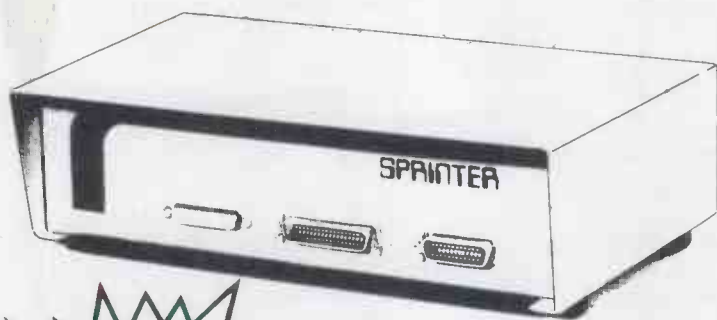

Problem: Connect a 20 character per second Word Processor serial printer to your computer but don't tie the computer up for 20 minutes during a 25,000 character print.

Answer: **SPAJINTER**

Problem: Attach a letter quality serial printer to a parallel output computer for Word Processing.

Answer: **SPAJINTER**

Problem: Save money by attaching a low cost matrix printer to a serial output computer.

Answer: **SPAJINTER**

Problem: (Insert your interfacing problem here)

Answer: **SPAJINTER**

**"SEE US  
ON  
STAND A11"**

**SPAJINTER** COSTS £249.00 including P&P (VAT extra)

SO WHY WASTE ANY MORE TIME?

CALL US NOW FOR YOUR **SPAJINTER** AND LET  
YOUR COMPUTER GET ON WITH SOME REAL COMPUTING.



GB COMPUTER PRODUCTS LIMITED, 14 GREENWOOD GROVE, WINNERSH,  
WOKINGHAM, BERKSHIRE, RG11 5LH  
Telephone 0734 786635 or 791678, Telex 847783 GDB CS G

**SPAJINTER** IS A TRADEMARK OF MUTEK.

THE **IBM** PC FOR THE PRICE OF A *SIRIUS 1*  
**£2395\*** - HURRY! PRICE GOES UP SOON!!!

NATIONWIDE  
 MAINTENANCE

All machines always ex stock

3270 EMULATION  
 AVAILABLE NOW!

**LOOK!**



**OFFICE EFFICIENCY MACHINES**

Call us at our West London office on 01-741 7211/2/3/4  
**OEM – THE BEST MICROS AT THE BEST PRICES**  
 (Volume discounts available)

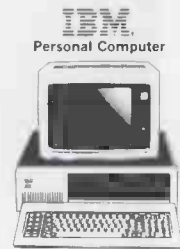

To: Office Efficiency Machines  
 1 Lochaline Street, London W6 9SJ

Please send me information on the .....

Please ask your sales staff to contact me re: .....

Name .....

Company .....

Address .....

Telephone .....

\* (Price includes system unit, 64K memory, 2 disk drives (320K), Keyboard & Monitor)



**RESCUE!**

**THE FINAL SOLUTION**

**THE LATEST ADVANCED DATABASE SYSTEM FOR CP/M™ MICROCOMPUTERS**

**CHECK THESE FEATURES:**

- Suitable for all applications.
- User defined menus.
- Fast data retrieval.
- No programming needed.
- Full maintenance facilities.
- Complete password protection.
- Time saving business calculations.
- User defined screen and report layouts.
- Powerful searching and sorting facilities.
- Sophisticated correspondence processing.
- Data compression makes more of your hardware.

★ **UNIQUE DICTIONARY FIELD**  
 255 ENTRIES OF 60 CHARS.

**SEND NOW FOR OUR FREE BROCHURE WITH FULL SPECIFICATION**

**MANUAL + RESCUE £295 + VAT**  
**EVALUATION DISC + MANUAL £25 + VAT**  
**MANUAL ONLY £20 + VAT**  
**ACCESS: P&P £2/ITEM**

**MBS MICROCOMPUTER BUSINESS SYSTEMS (U.K.) LIMITED**

5 CHARTERHOUSE BLDGS., GOSWELL ROAD, LONDON EC1M 7AN

OEM/DEALER ENQUIRIES INVITED.

**01 253 3998**  
 TELEX 261729

# SPECIAL OFFER.

## MASSIVE DISCOUNTS ON TRENT MATRIX PRINTER RIBBONS.\*



**Data General LP2** ~~£3.00 each~~  
**£9.00** pack of three

**Tally 1000/1612**  
~~£3.00 each~~  
**£10.50** pack of six

**Epson MX80 Commodore**  
~~£4.80 each~~  
**£9.00** pack of three

**OKI 80**  
(approved range)  
~~£1.45 each~~  
**£10.80** pack of twelve

**TI 810/DEC LA30/36**  
PET  
with/without  
eyelets ~~£1.40 each~~  
**£9.60** pack of six  
**£10.80** pack of twelve

P + P free. VAT extra.

Action Computer Supplies launches its second media and supplies catalogue, featuring brand leaders at low, low prices and same day despatch – you order by 5, we despatch by 6.

Catalogue includes:  Flexible diskettes and accessories  Ribbons  Copying products  Paper (continuous and rolls)  Continuous computer labels  Printwheels and accessories  Cleaning products  Data cartridges and cassettes.

To get your free catalogue and take advantage of our special offer ring 01-903 3921 (Access and Visa cards welcome) or send a cheque direct to Action Computer Supplies, FREEPOST, Wembley, Middlesex HA0 1BR.



**ACTION**  
COMPUTER SUPPLIES  
YOU ORDER BY 5 / WE DESPATCH BY 6

\*SORRY only one sale per customer. Offer ends 30 November 1982



# The best value in town is at SILICON VALLEY

## 01-802 7186

278 6783

800 8185

Visit us  
at the  
PCW Show!

Almost all makes of popular business micros available available plus a wide range of software, printers, disc drives & accessories at keenest prices.

## Some of our special offers: The IBM Personal Computer

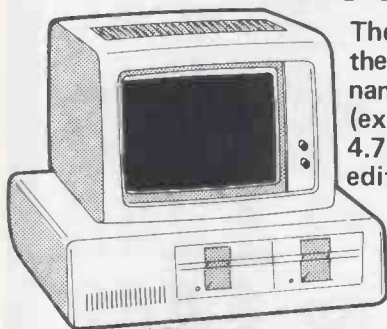

The IBM name means quality and reliability and their new personal computer fully justifies the name. Features include \*40K ROM, \*64K RAM (expandable to 1Mb. \*Intel 8088 processor at 4.77Mhz \*80 or 40 character display \*full screen editor \*BASIC, Pascal, COBOL \*Visicalc, Wordstar, Easywriter. Add these to the latest in 16-bit technology and you have the best micro around. From £2,950 (or lease at £15.50 per week).



**Free!! £700 worth of software**  
We're giving away up to £700 worth of software absolutely FREE with every IBM purchased. Including Wordstar, Mailmerge and Spellstar plus any one of these packages: Visicalc 256K, Desktop plan, Visidex, Visifile, Trendplot or Supercalc.



## apple The Apple II

One of the most widely installed and best supported machines in the world. A powerful low cost solution to so many applications. The vast range of supporting software and hardware add-ons ensure a system that meets your requirements. Only £658 (or lease at £3.67 per week)

Wordstar software pack including Mailmerge absolutely free with every system.

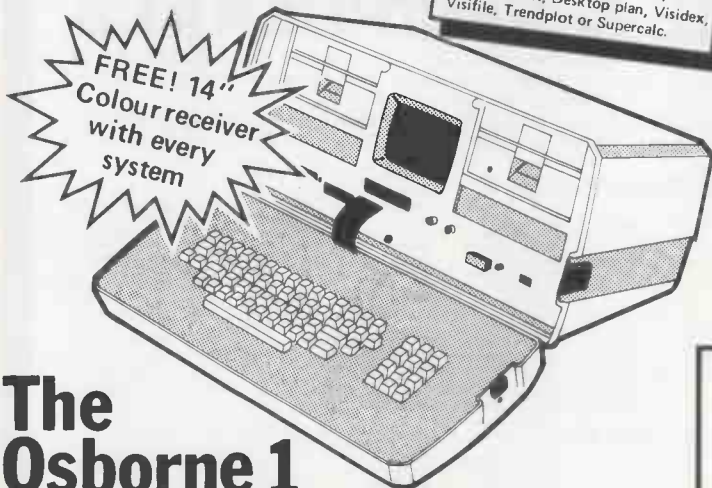

## The Osborne 1

The Osborne is the only truly portable personal computer available. included as standard are five software packages with a retail value of over £800 - CP/M, Wordstar, Supercalc, M BASIC and C BASIC. From £1,250 (or lease at £6.73 per week).

Just in from America! All the latest IBM software now available.

**GAMES**  
DEAD LINE • LOST COLONY • TEMPLE OF ASAKI • GALAXY • MIDWAY CAMPAIGN • VOYAGER • ZORK 10R 2

**IBM BUSINESS SOFTWARE**  
STOCKS AND BONDS • WRITE ON • EASY SPELLER • EASY FILER • EASY WRITER 2 • SUPER CALC • SUPER WRITER • TIM DATA BASE • MAD MAGIC • VERSA COMPUTING HARD COPY GRAPHICS • VERSA COMPUTING WRITER TABLET • WORDSTAR PREMIUM PACK • VISICALC 64K • VISICALC 256K • VISIFILE • VISIDEX • VISITREND/PLOT • DESKTOP PLAN

At low, low prices. Ring for listing and prices.

(open: Mon- Fri 10-6pm) Barclaycard and Access.

**A GOOD DEAL MADE  
A GOOD DEAL BETTER**

The Silicon Valley Computer Centre  
Group 18 Ltd 115 Craven Park Road LONDON N15  
Telephone: 01-802 7186 278 6783 800 8185

SILICON  
VALLEY  
COMPUTER  
CENTRE

# 100 FREE PROGRAMS

FROM SILICA SHOP — WITH EVERY PURCHASE OF AN

# ATARI 400

# 800



**ATARI PRICES REDUCED!**  
 We at Silica Shop are pleased to announce some fantastic reductions in the prices of the Atari 400/800 personal computers. We believe that the Atari at its new price will become the U.K.'s most popular personal computer and have therefore set up the Silica Atari Users Club. This club already has a library of over 500 programs and with your purchase of a 400 or 800 computer we will give you the first 100 free of charge. There are also over 350 professionally written games and utility programs, some are listed below. Complete the reply coupon and we'll send you full details. Alternatively give us a ring on 01-301 1111 or 01-309 1111.

- ATARI 400** with 16K **£199**
- ATARI 400** with 32K **£248**
- ATARI 800** with 16K **£449**

## 400/800 SOFTWARE & PERIPHERALS

Don't buy a T.V. game! Buy an Atari 400 personal computer and a game cartridge and that's all you'll need. Later on you can buy the Basic Programming cartridge (£35) and try your hand at programming using the easy to learn BASIC language. Or if you are interested in business applications, you can buy the Atari 800 + Disk Drive + Printer together with a selection of business packages.

Silica Shop have put together a full catalogue and price list giving details of all the peripherals as well as the extensive range of software that is now available for the Atari 400/800. The Atari is now one of the best supported personal computers. Send NOW for Silica Shop's catalogue and price list as well as details on our users club.

**THE FOLLOWING IS JUST A SMALL SELECTION FROM THE RANGE OF ITEMS AVAILABLE:**

|  |  |   |  |  |  |  |  |  |   |
|--|--|---|--|--|--|--|--|--|---|
| <b>ACCESSORIES</b><br>Cables<br>Cassettes<br>Diskettes<br>Joysticks<br>La Stick - Joystick<br>Misc Supplies<br>Paddles | Mountain Shoot<br>Rearguard<br>Star Fire<br>Sunday Golf<br><br><b>AUTOMATED SIMULATIONS</b><br>Crush Crumble Cmp<br>Dates of Ryn<br>Dragons Eye<br>Invasion Orion<br>Rescue at Rigel<br>Ricochet<br>Star Warrior<br>Temple of Aposhai<br>Upper Reaches Aps | <b>BUSINESS</b><br>Calculator<br>Database Managemt<br>Decision Maker<br>Graph-It<br>Invoicing<br>Librarian<br>Mort & Loan Anal<br>Nominal Ledger<br>Payroll<br>Personal Finl Mgmt<br>Purchase Ledger<br>Sales Ledger<br>Statistics 1<br>Stock Control<br>Telelink 1<br>Visicalc<br>Weekly Planner<br>Word Processor | <b>DYNACOMP</b><br>Alpha Fighter<br>Chompelo<br>Crystals<br>Forest Fire<br>Intruder Alert<br>Monarch<br>Moonprobe<br>Moving Maze<br>Nominoes Jigsaw<br>Rings of The Emp<br>Space Tilt<br>Space Trap<br>Stud Poker<br>Triple Blockade | Maths-Tac-Toe<br>Metric & Prob Solvg<br>Mugwump<br>Music Terms/Notatn<br>Musical Computer<br>My First Alphabet<br>Number Blast<br>Polycalc<br>Presidents Of U.S.<br>Quiz Master<br>Starware<br>Stereo 3D Graphics<br>Three R Math Sys<br>Video Math Flash<br>Wordmaker | Scream<br>States & Capitals<br>Touch Typing<br><br><b>EMI SOFTWARE</b><br>British Heritage<br>Cribbage/Dominoes<br>Darts<br>European Scene Jig<br>Hickory Dickory<br>Humpty Dumpty<br>Jumbo Jet Lander<br>Snooker & Billiards<br>Submarine Commdr<br>Super Cubes & Tilt<br>Tournament Pool | Castle<br>Centurion<br>Checker King<br>Chinese Puzzle<br>Codecracker<br>Comedy Diskette<br>Dice Poker<br>Dog Daze<br>Domination<br>Wizards Revenge<br><br>Eastern Front<br>Galahad & Holy Gr<br>Jax-O<br>Jukebox<br>Lookahead<br>Memory Match<br>Midas Touch<br>Minotaur<br>Outlaw/Howitzner<br>Preschool Games<br>Pro Bowling<br>Pushover<br>Rabbitot<br>Reversi 11<br>Salmon Run<br>747 Landing Simul<br>Seven Card Stud | Sleazy Adventure<br>Solitaire<br>Space Chase<br>Space Trek<br>Sultans Palace<br>Tact Trek<br>Terry<br>Wizards Gold<br>Wizards Revenge<br><br><b>ENTERTAINMENT from ATARI</b><br>Asteroids<br>Basketball<br>Blackjack<br>Centipede<br>Chess<br>Entertainment Kit<br>Missile Command<br>Pac Man<br>Space Invaders<br>Star Raiders<br>Super Breakout<br>Video Easel<br><br><b>ON LINE SYSTEMS</b><br>Crossfire<br>Frogger | Jawbreaker<br>Mission Asteroid<br>Mouskattack<br>Threshold<br>Ulysses/Golden FI<br>Wizard & Princess<br><br><b>PERIPHERALS</b><br>Centronics Printers<br>Disk Drive<br>Epson Printers<br>Program Recorder<br>RS232 Interface<br>Thermal Printer<br>16K Memory RAM<br>32K Memory RAM<br><br><b>PERSONAL INT from APX</b><br>Adv Music System<br>Banner Generator<br>Blackjack Tutor<br>Going To The Dogs<br>Keyboard Organ<br>Morse Code Tutor<br>Personal Fitness Prg<br>Player Piano<br>Sketchpad | <b>PROGRAMMING AIDS from Atari</b><br>Assembler Editor<br>Dumbler (APX)<br>Microsoft Basic<br>Pascal (APX)<br>Pilot (Consumer)<br>Pilot (Educator)<br>Programming Kit<br><br><b>SANTA CRUZ</b><br>Basics of Animation<br>Bobs Business<br>Display Lists<br>Graphics Machine<br>Kids 1 & 2<br>Horizontal Scrolling<br>Master Memory Map<br>Mini Word Processor<br>Page Flipping<br>Player Missile Gr<br>Player Piano<br>Sounds<br>Vertical Scrolling<br><br><b>SILICA CLUB</b><br>Over 500 programs<br>write for details |
|--|--|---|--|--|--|--|--|--|---|

## FOR FREE BROCHURES - TEL: 01-301 1111

For free brochures and reviews on our range of electronic products, please telephone 01-301 1111. To order by telephone, just quote your name, address, credit card number, and order requirements and leave the rest to us. Post and packing is FREE OF CHARGE in the UK, Express 24 hour delivery available at an additional charge.

- **SHOP DEMONSTRATION FACILITIES** — we provide full facilities at our shop in Sidcup, Monday to Saturday 9am to 5.30pm (closing Thursday 1pm, Friday 8pm)
- **MAIL ORDER** — we are a specialist mail order company and are able to supply goods direct to your door
- **MONEY BACK UNDERTAKING** — if you are totally unsatisfied with your purchase, you may return it to us within 15 days. On receipt of the goods in satisfactory condition we will give you a full refund
- **PART EXCHANGE SECOND HAND MACHINES** — we offer a part-exchange scheme to trade in many makes of T.V. games for personal computers
- **COMPETITIVE PRICES** — our prices, offers and service are very competitive. We are never knowingly undersold and will normally match any lower price quoted by our competitors
- **HELPFUL ADVICE** — available on the suitability of various computers
- **AFTER SALES SERVICE** — available on all computers out of guarantee
- **VAT** — all prices quoted above include VAT at 15%
- **CREDIT FACILITIES** — we offer credit over 12, 24 or 36 months, please ask for details

**SILICA SHOP LIMITED**  
 Dept PCW 1082, 1-4 The News, Hatherley Road, Sidcup, Kent DA14 4DX  
 Telephone 01-301 1111 or 01-309 1111.

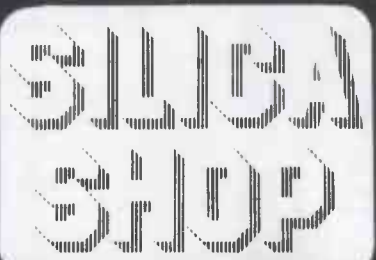

**FREE LITERATURE**

I am interested in purchasing an Atari 400/800 computer and would like to receive copies of your brochures and test reports as well as your price list covering all of the available Hardware and Software:

Name .....

Address .....

Postcode .....

PCW 1082

**Make the Most of your Micro with**

**COMPUTER**  
*Answers*



*The new bi-monthly magazine  
which answers the questions micro  
users will ask*

In each issue you'll find out:

- \* How to get the most out of your system, by understanding how it works
- \* What to do when you want to upgrade
- \* New hardware and software which will prove useful
- \* How to expand your system

*The answers to all these questions  
and many more are in –*

**COMPUTER**  
*Answers*

**First issue at your  
newsagents on Thursday  
October 21. Over 100 pages  
including colour, only 75 pence**

# Outstanding Software from Apple Orchard

Six quality products to help you make the most of your Apple

## PROTECT YOUR SOFTWARE INVESTMENT With Copy II Plus

Copy II Plus gives you the power to make back-up copies of most of the "protected" software packages currently available.

### INSURANCE

With Copy II Plus you can protect your valuable software investment. Make back-up copies of Visicalc, DB Master, the Apple Special Delivery range, and many more; keep your originals safely locked away from the wear and tear of everyday use.

### EASILY PAYS FOR ITSELF

While some software companies offer replacement of expensive damaged diskettes, many do not. With Copy II Plus you eliminate the time, expense, and worry of costly accidental damage to your valuable software.

£50

## THE FILER a new Apple Disk Utility

### SAVE TIME

Fed up wasting valuable time waiting for disks to copy? With the FILER's fast and accurate copy program you can make completely reliable back-up copies of your disks in 35 seconds. The FILER is ideal for backing-up your data disks, and for copying all unprotected disks.

### OTHER FEATURES

The FILER package also contains a disk drive speed check, a disk drive test, and a sophisticated file manager. Options include: Catalog with space on disk, Copy Files, Copy DOS, Delete, Lock and Unlock Files, and Change Booting Program (name and filetype).

£16

*Electric Duet*  
from insoft  
— the only music synthesiser  
for the Apple that plays two part music  
without the need for expensive extra hardware.

£20

## THE HOME ACCOUNTANT

A comprehensive and powerful Personal Financial system.

Runs up to 5 cheque-books, cash, and credit cards • Up to 100 budget categories • Flag taxable items • Graph actuals v. budget • Easy-to-use — less than an hour a month to maintain • Demo available for £4.

£55

## GraFORTH The Apple Graphics Language

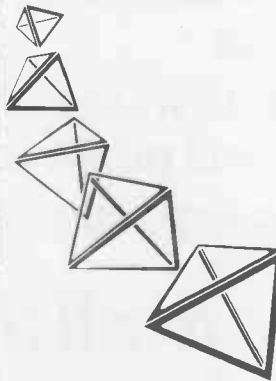

The Apple Graphics language from insoft — specially created to get the most out of the graphics capabilities of your Apple.

- draws 3D images in colour, at rates that make animation easy
- user defined character sets (any size, colour or typeface)
- text and graphics can be mixed on any part of the screen
- music can be included in programs
- excellent manual shows how to use the full capabilities of the system.

Ideal for entertainment software development, scientific and educational uses, and any application where sophisticated graphics are required.

Demo available for £4 (refunded if you buy).

£50

## THE GENERAL MANAGER

The latest quality product from On-Line Systems, The General Manager is a true hierarchical database — not just a file manager. Use it for anything from a simple names and addresses file to a complex customer accounts system.

The General Manager offers all the features you expect from a database program, and more:—

- Hierarchical structure gives greater efficiency in data storage and retrieval.
- Retrieve information on several sort criteria, industry and/or searches.
- Full range of calculation abilities, including logical operators.
- The powerful data access commands provided by the Applesoft interface enable you to input or output data to and from Applesoft Files. Information can also be selected and written to text files.
- Data can be spread over 100 disks on 1-4 disk drives.
- Expand or change your database with no loss of data.

A demo disk costing £4 is available, describing these features in more detail.

£79

All products require Apple II 48K, DOS 3.3

Prices exclude VAT — please add 15%. We accept Access and Diners Club. Dealer enquiries welcome.

Please send cash with order, or phone or write for more details to:—

Apple Orchard Ltd (Dept S)  
17 Wigmore Street  
London W1  
Tel: 01-580 5816



# WHEN IT COMES TO MICROCOMPUTER SOFTWARE WE WROTE THE BOOK

How do you stay up-to-the-minute with the rapidly changing world of microcomputer software? Get the Lifeboat Catalogue.

**The latest innovations** The new Lifeboat Catalogue is packed with the latest state-of-the-art software. And if we publish a new program after the latest catalogue has gone to press, we enclose a flash bulletin in your copy.

#### The greatest selection

Because Lifeboat is the world's largest publisher of microcomputer software, our catalogue offers you the greatest selection of programs for business, professional and personal use. Our more than 200 programs range from the integrated accounting and professional practice systems to office tools for book-keepers and secretaries to sophisticated tools for programmers. Included are business systems, word processors, programming languages, database management systems, application tools and advanced system utilities.

We specialise in software that runs on most small business computers. Our more than 60 media formats, including floppy disks, data cartridges, magnetic tape and disk cartridges, support well over 100 different types of computer.

**Get full service** We give the crucial dimension of after-sales service and full support to everything we sell.

That includes:

- An update service for software and documentation.
- Telephone, telex and mail-order services in the London office and at overseas offices in the United States, France, Switzerland, West Germany and Japan.
- Subscriptions to Lifelines,™ the monthly magazine that offers comparative reviews, tips, techniques, identified bugs and updates that keep you abreast of change.

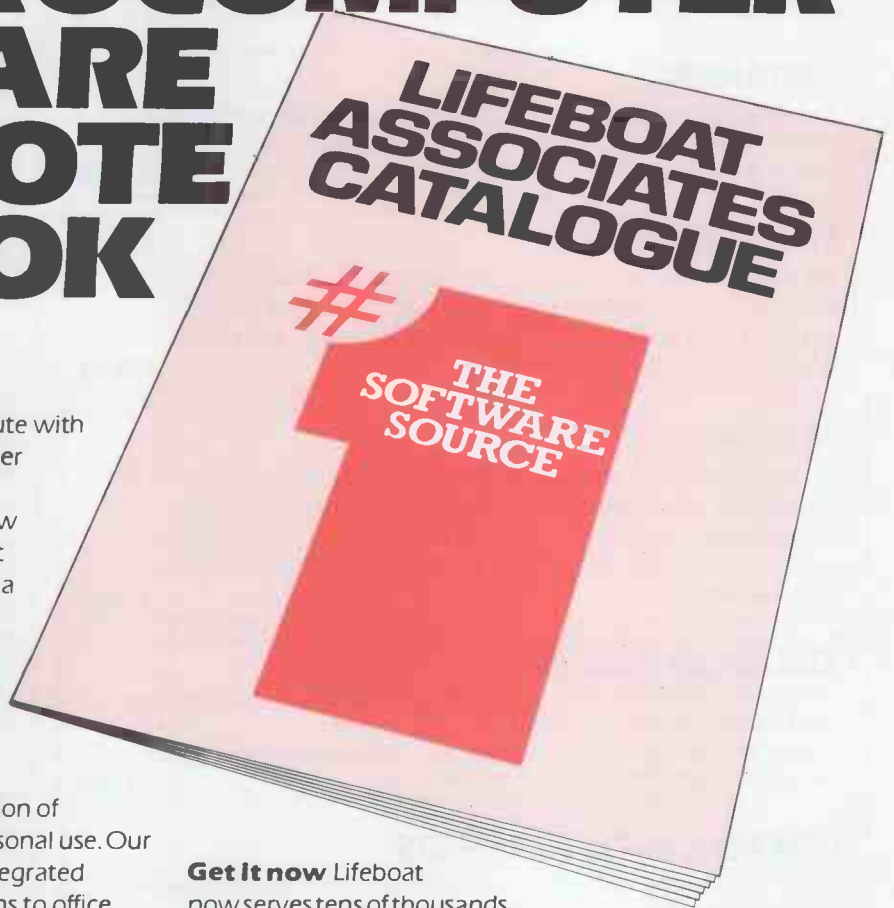

#### Get it now

Lifeboat now serves tens of thousands of satisfied customers with our breadth of up-to-date, fully tested, fully supported and competitively priced software.

You may not need all we offer, but we offer just what you need. After all, we wrote the book.

**Lifeboat Associates**  
World's foremost software source

#### Mail coupon to: Lifeboat Associates

PO Box 125, London WC2H 9LU or call 01-836 9028

Please send me a free lifeboat catalogue.

Name

Title

Company

Address

Postcode

PCW/10/82

Copyright © 1981, by Lifeboat Associates.

**Lifeboat Worldwide** offers you the world's largest library of software. Contact your nearest dealer of Lifeboat.

**USA** Lifeboat Associates 1651 Third Ave. New York NY 10028 Tel (212) 860-0300 Telex 640693 (LBSOFT NYK) **TW** 710 581-2524 **JAPAN** Lifeboat Inc. OK Bldg. 5F 1-2-8 Shiba-Daimon Minato-ku Tokyo 105 Japan Tel 03-437-3901 Telex 2423296 (LBJTYO) **ENGLAND** Lifeboat Associates Ltd PO Box 125 London WC2H 9LU England Tel 01-836 9028 Telex 893709 (LBSOFTG) **SWITZERLAND** Lifeboat Associates GmbH Hinterbergstrasse Postfach 251 6330 Cham Switzerland Tel 042-36-8686 Telex 865265 (MICO CH) **GERMANY** Intersoft GmbH Schlossgartenweg 5 D-8045 Ismaning W. Germany Tel 089-966-444 Telex 5213643 (ISOFD) **FRANCE** Lifeboat Associates SARL 10 Grande Rue Charles de Gaulle 92600 Asnieres France Tel 1-733-08-04 Telex 250303 (PUBLIC X PARIS)

**TI-99/4A \* VIC 16K \* ATARI 400/800 \* SHARP  
MZ-80K/A/B \* BBC MICRO \* SINCLAIR SPECTRUM**

**Functional cassette software by Dale Hubbard**  
**Buy 2 at £19.95 - take 1 at £5.95 FREE!!!**

### DATABASE

The program that everyone needs. Facilities include sort, search, list, delete, change, totals, save file, line print if required, etc. etc. Can be used in place of any card index application.

£19.95

### STOCK CONTROL

All the necessary for keeping a control of stock. Routines include stock set up, user reference no., minimum stock level, financial summary, line print records, quick stock summary, add stock, delete/change record, and more.

£19.95

### MAILING LIST

A superb dedicated database to allow for manipulation of names & addresses & other data, with selective printing to line printer. Features include the facility to find a name or detail when only part of that detail is known. Will print labels in a variety of user-specified formats.

£19.95

### DECISION MAKER

A serious program that enables the computer to make a sound decision for you based on various criteria.

If you want to buy a car, hi-fi, house, etc., or you don't know which woman to marry then you need this one.

£5.95

### INVOICES AND STATEMENTS

Ideal for the small business. A complete suite of programs together with generated customer file for producing crisp and efficient business invoices and monthly statements on your line printer. All calculations including VAT automatic and provision for your own messages on the form produced.

\*Not Spectrum £19.95

### RUBIK SOLVER

It's not our policy to offer games but we make an exception here for a program to solve the cube from ANY position. Shorthand notation makes learning the solution by heart possible for most active brains.

£12.95

### THE CATALOGUER

This dedicated database is ideal for use in any situation where a catalogue could be utilised. E.g. stamp collection, coins, photos, slides, books, records etc.

£19.95

### COMMERCIAL ACCOUNTS

A gem of a program, all for cassette, with the following features:-

|                   |                      |
|-------------------|----------------------|
| Daily Journal     | Sales Ledger         |
| Credit Sales      | Purchase Ledger      |
| Cash Sales        | Bank Account         |
| Credit Purchases  | Year to Date Summary |
| Purchases - other |                      |

A fully interactive program suitable for all businesses. Files can be saved and loaded and totals from one file carried forward to another on cassette. Particularly useful from a cash flow point of view, with an immediate accessibility to totals for debtors and creditors. Bank totally supported with entries for cheque numbers, credits and, of course, running balance.

£19.95

### HOME ACCOUNTS £19.95

Runs a complete home finance package for you with every facility necessary for keeping a track of regular and other expenses, bank account, mortgage, H.P. etc etc etc!! You'll wonder how you ever managed without it.

### CHOPIN - LES ETUDES

Six beautiful studies from Opus 10 and 25 performed for you live by Mr. Computer Spellbinding!!!

\*Not Spectrum £5.95

### MOTOR ACCOUNTANT

Find out exactly what that car is costing you and keep a data file with all your expenses therein!

£5.95

### RECIPE FILE

Let all those computer widows have a bash! The wives will really enjoy the fun of this program designed to keep all her recipes. Will even suggest a menu for the day/week! Excellent value.

£19.95

All programs supplied with exhaustive documentation.  
Send cheque or P.O. or Cash (registered) or Credit Card no. to:

**Gemini Marketing Ltd**

Dept PCW (4) 9 Salterton Road, Exmouth, Devon EX8 2BR

Or telephone us with your credit card order on (03952) 5832

All orders despatched by return - no waiting.

All prices include VAT and post & packing except Hardware. Full range of Sharp peripherals available - please 'phone for quotations.

Please state machine type and memory size when ordering software.

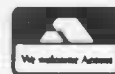

Access Welcome

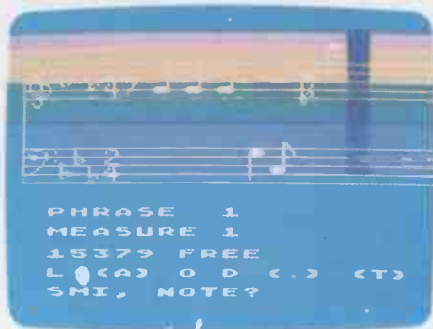

Music Composer

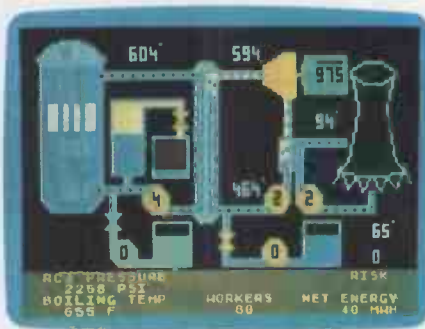

Scram



Graph-it



Intro to BASIC 1

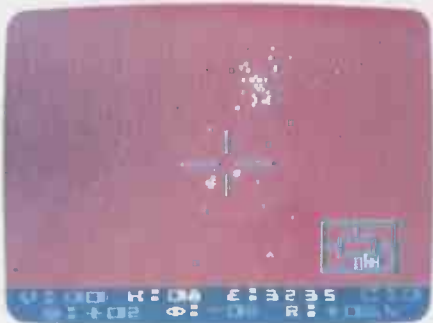

Star Raiders



European Countries

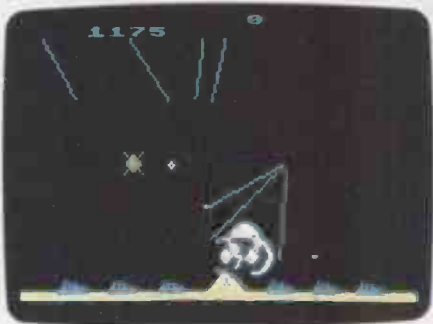

Missile Command



Basketball

3.7 million reasons why the Atari Home Computer is something to see. The display screen used with our computers is composed of 192 horizontal lines, each containing 320 dots. Delivering colour and luminosity instructions to each dot for a second requires 3.7 million cycles...a lot of work for the normal 6502 processor.

That's why the Atari computer has equipped its 6502 with its own electronic assistant. It's called ANTIC, and it handles all the display work, leaving the 6502 free to handle the rest. What this means to you is uncompromisingly spectacular display capabilities without loss of computer power needed to carry out the demands of your program.

That's a quality you just don't find in ordinary home computers. And it's one of the reasons some computer experts say that Atari computers are so far ahead of their time.

There's more...which is what you'd expect from Atari Language. The Atari Home Computer uses several programming languages to give the user maximum control of its extraordinary capabilities. PILOT, Microsoft BASIC and Atari BASIC are understood and spoken by the Atari computer. You'll also find our Assembler Editor cartridge indispensable for machine language programming.

Sound. An Atari computer has four sound generators, or voices, activated by a separate microchip. This leaves the principal micro-processor chips free to perform other tasks. And you can take full advantage of this capability which is designed for easy programming.

Change. Atari Home Computers have been designed to make change and expansion easy. The Atari computer has a modular operating system that can be easily replaced as new technology develops. If you need it, memory expansion requires no more than inserting additional RAM modules.\* And the Atari ROM cartridge system also makes it easy to change languages. In short, your Atari computer won't become obsolete by future developments...because it already incorporates the future.

Sharing. To learn more about the amazing capabilities of Atari Home Computers, either visit your local dealer or fill in the coupon below.

# THE GRAPHIC DIFFERENCE BETWEEN ATARI® COMPUTERS AND ALL THE OTHERS.

\*Atari 800® computer only.



Please send me FREE a brochure, price list and the address of my nearest stockist.

Name \_\_\_\_\_

Address \_\_\_\_\_

PCW4  
Atari International (UK) Inc.  
Windsor Hse., 185-195 Ealing  
Road, Alperton, Wembley,  
Middlesex.

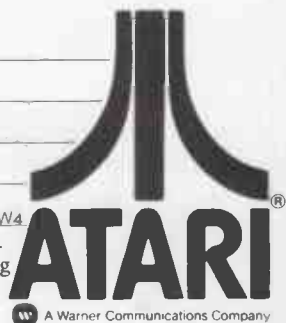

A Warner Communications Company



# The Professional Solution

Logica VTS would like to introduce you to a personal computer well worth meeting.

A powerful 16-bit professional system with the quality, reliability and support you expect from Logica — a European Leader in Computing and Communications Technology.

Together with our successful Word Processor and Local Area Network, meet us on **STAND 703** at the **European Computer Trade Forum**, National Exhibition Centre Birmingham.

**28th September-1st October.**

Qualified dealers interested in the VTS Personal Computer please contact Adrian Noad.

**Logica VTS**

Logica VTS Limited  
64 Newman Street, London W1A 4SE  
Telephone 01 637 5171. Telex 27200.



# OUTGROWN YOUR APPLE ?

## HAL Computers Extend The Apple's Capabilities

If your business or scientific application has outgrown your Apple's capability or if you have put off buying an Apple because you thought it couldn't meet your needs — think again.

HAL hard disc systems offer up to 20Mbytes of Winchester storage from as little as £1,750.

### Capricorn



A complete subsystem in an attractive space saving cabinet, which holds either one or two drives a combination of standard disk drive and/or Winchester to give a capacity from 5Mbytes up to 20Mbytes formatted.

Capricorn works in conjunction with Apple's standard floppy disc drive for archiving purposes and offers really high capacity computing at an entry level price for cost conscious users.

For:  
SUPERBRAIN,  
S-100, APPLE II,  
HEATH H89,  
TRS-80.

### Aquarius



As capacity increases with the professional user, so does the importance of a full back up facility. AQUARIUS is HAL's new answer to this problem. It combines a choice of Winchester capacities with a quarterback streaming tape drive which allows a full back-up file copy to cartridge tape in about six minutes with absolutely no user intervention.

The aluminium cabinet is styled to look good alongside Apple in the most professional user applications.

Prices start at £2995, for a ready to run system — the complete business solution to backup problems.

All HAL sub-systems come with a full twelve months parts and labour warranty.

All units are designed and manufactured by HAL in Britain and are complete with all instructions, technical literature and systems discs. The file handling software is written by our own in-house software team — if you need help it is always on hand via your local dealer or direct from the design team that conceived the system.

We use only the disc drives which we distribute exclusively into the U.K. computer industry in massive quantities over 20,000 units per annum sold. Our service department houses a formidable armoury of drive testing computers for pre-test, maintenance and burn in.

For more information and a demonstration contact either your nearest dealer or call us direct on our hot line 0252 517171.

HAL Computers Limited  
Invincible Road, Farnborough  
Hants. GU14 7QU  
Telephone (0252) 517171

# The comart communicator

RELIABLE BRITISH MADE MICROCOMPUTER SYSTEMS

## from JAROGATE



- EXPANDABLE
- FLEXIBLE
- VERSATILE

#### TYPICAL APPLICATIONS

- ACCOUNTS
- WORD PROCESSING
- COMMUNICATIONS
- COLOUR GRAPHICS
- FINANCIAL PLANNING
- PROCESS CONTROL
- DATA BASE MANAGEMENT
- STOCK CONTROL
- PAYROLL

#### OPTIONAL SUB-SYSTEMS

- HD200 18.7M BYTE 8" WINCHESTER DISK SYSTEM
- CB200 13.4M BYTE CARTRIDGE BACK UP UNIT

#### MODELS

CP100 2 x 390 K BYTE/DRIVE 5¼" FLOPPY DISK  
 CP200 2 x 790 K BYTE/DRIVE 5¼" FLOPPY DISK  
 CP500 1 x 790 K BYTE/DRIVE 5¼" FLOPPY DISK  
 AND 4.8M BYTE 5" WINCHESTER HARD DISK

#### SPECIFICATIONS

Z80A PROCESSOR  
 10 SLOT S100 BUS  
 CP/M and MP/M OPERATING SYSTEMS  
 2 SERIAL PORTS; 1 PARALLEL PORT

JAROGATE LTD. is a Company that specialises in all areas of microcomputer applications. Due to this wide range of expertise, JAROGATE LTD. is swiftly becoming one of the leading names in the microcomputer industry.

**CONSULTANCY** Our services include:— system analysis, software design, programming, hardware design, hardware maintenance and systems integration.

**SALES** As well as distributing a wide range of hardware, software and consumables,

**Also available for multi-user applications — THE JAROGATE MP5 MULTI-PROCESSOR SYSTEM.**

Jarogate Ltd. are main dealers for Comart, Cromemco and North Star ranges of systems and boards.

JAROGATE LTD. also provide technical advice to all users, whether experienced or first time.

**SUPPORT and MAINTENANCE** JAROGATE LTD's team of experienced engineers and programmers are available to give full after-sales support.

JAROGATE LTD. offer nationwide hardware maintenance of all products sold.

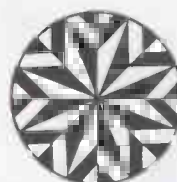

**JAROGATE LTD.**  
 the microprocessor consultants

197-213 Lyham Road, Brixton, London SW2 5PY Telephone 01-671 6321

# Dysan

## The Highest Quality Diskettes For Your System.



Dysan diskettes, acknowledged to be the industry leader in quality and data integrity available for all these and other systems from HAL Computers, Dysan's key U.K. distributor.

 DISC PACKS AND CARTRIDGES ALSO AVAILABLE

 TECHNICAL SUPPORT FROM HAL'S ENGINEERING TEAM

 QUANTITY DISCOUNTS

 FOUR HOUR ORDER TURNROUND

 EX STOCK AVAILABILITY

Please tell me more about the range of Dysan Media for my system.

Name \_\_\_\_\_

Address \_\_\_\_\_

Computer System \_\_\_\_\_

Ring the Dysan hot line now on Farnborough 517171 or complete the coupon.

**HAL Computers Limited**  
Invincible Road, Farnborough  
Hants. GU14 7QU  
Telephone (0252) 517171

# new Sams books

## Apple II Assembly Language

Marvin L. De Jong

For novice programmers with no previous experience with 6502 assembly language, this practical, illustrated book shows you how to use the 3-character, 56-word assembly language vocabulary of Apple's 6502 microprocessor to create powerful programs. Interfacing circuits and programs are included.

£11.95 336 pages 672-21894-1

## Enhancing Your Apple II: Volume I

Don Lancaster

Among the many topics covered in Volume I of this book are how to mix text, LORES and HIRES anywhere on the Apple II's screen, and how to make a one-wire modification to improve 3-D graphics and other special effects.

£11.95 224 pages 672-21846-1

## Don Lancaster's Micro Cookbook: Volume I

Don Lancaster

The first volume of Don Lancaster's Micro Cookbook gives a straightforward introduction to microcomputers and microprocessors, explanations of number systems, hardware and software logic, and practical information on mainstream codes and standards, electronic memory, and microcomputer memory devices and applications.

£11.95 112 pages 672-21828-3

## 8080A Microcomputer Interfacing and Programming: 2nd Edition

Peter R. Rony

With a detailed discussion of the entire 8080 instruction set, this revision of the 8080A Bugbook explains device select pulse generation, clock cycles and timing loops, internal operations of the 8080 chip, microcomputer input and output, and interrupt servicing.

£13.45 506 pages 672-21933-6

## TRS-80 Assembly Language Made Simple

Earles L. McCaul

For TRS-80 users with an understanding of BASIC, this straightforward introduction explains how to plan, write and hand-assemble your own assembly-language programs in memory, using the T-bug and Level II BASIC ROM subroutines.

£9.70 190 pages 672-21851-8

## Using the Z-80 in the TRS-80

Elmer C. Poe

Elmer Poe shows you how to access the powerful Z-80 microprocessor in the TRS-80 Models I and III by means of machine language programming, so that it performs tasks much faster than it will under BASIC.

£10.45 272 pages 672-21839-9

Prices are correct at the time of going to press but may be subject to change.

Prentice/Hall  International

66 Wood Lane End, Hemel Hempstead, Hertfordshire HP2 4RG, England. Exclusive distributors of Howard W. Sams books in the UK and Europe.

APPLE II<sup>®</sup> ASSEMBLY LANGUAGE  
BY MARVIN L. DE JONG

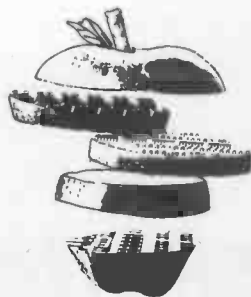

8080A MICROCOMPUTER INTERFACING AND PROGRAMMING  
SECOND EDITION

BY PETER R. RONY

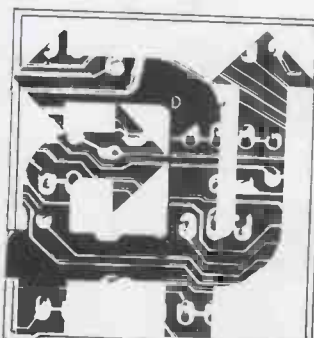

TRS-80<sup>®</sup> ASSEMBLY LANGUAGE MADE SIMPLE

by Earles L. McCaul

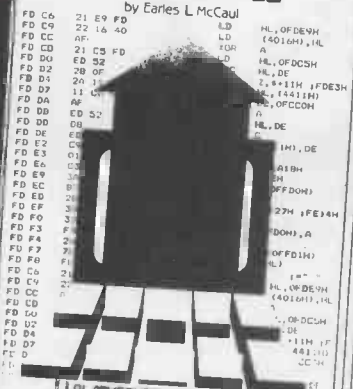

### Available from leading bookshops and these Sams Books stockists:

Aughton Microsystems  
8 Princes Street  
Southport, Merseyside

Business and Electronic Machines  
7 Castle Street, Edinburgh

Byteshop Computerland Ltd.  
P.O. Box 2  
St Neots, Huntingdon.

Cambridge Computer Store  
1 Emmanuel Street, Cambridge

Comprite Ltd.  
Thorite House  
Laisterdyke, Bradford

Datron Micro Centre  
Duckworth Square  
Derby

Datron Micro Centre  
2 Abbeydale Road  
Sheffield 7

Furness Computer Services Ltd.  
87 Dalton Lane  
Barrow-in-Furness, Cumbria

Memo Shop  
32 York Road  
Leeds LS9 8TD

Micro-C  
5-11 Marineau Way  
Union Street, Birmingham

Micro-C  
Unit 2, Channons Hill  
Industrial Estate  
Fishponds, Bristol

Micro-C  
57-59 Albion Street  
Leeds

Micro-C  
127 Charles Street  
Leicester

Micro-C  
Units 91-93  
Arndale Centre  
Luton

Micro-C  
19 Brown Street  
Manchester

Micro-C  
31-35 Blagdon Road  
New Malden, Surrey

Micro-C  
2 Wheeler Gate  
Nottingham

Micro-C  
10-11 Bargate  
Southampton

Micro-Print  
59 Church Street  
Stoke-on-Trent

Mid-Shires Computer Centre  
68 Natwich Road,  
Crewe

Silicon Centre  
Pictural Electronics Ltd.  
21 Comely Bank Road  
Edinburgh 4

Tomorrow's World  
Grafton Arcade  
Grafton Street, Dublin 2  
and  
Unit 68  
ILAC Centre  
Henry Street, Dublin 1

Tryfan Computers  
62 High Street  
Bangor, Gwynedd

Tryfan Computers  
57 Madoc Street, Llandudno

Watford Technical Books  
105 St Albans Road  
Watford

# North Star's ADVANTAGE is easy to see.

## The best value in microcomputing.

The North Star ADVANTAGE is the perfect low cost micro-computer for business or personal use. With 720Kb of floppy disk storage, or an optional 5Mb Winchester disk, the North Star ADVANTAGE offers the most memory in its price/performance class. And it comes with advanced business graphics software at no extra cost. You can look everywhere, but you won't find a better micro-computer for the money.

## High performance computing and high performance software.

The North Star ADVANTAGE system offers high speed computing based on the Zilog Z80A<sup>®</sup> microprocessor, the most accepted 8-bit microprocessor in the world, plus an Intel 8035 auxiliary processor. 64Kb of RAM main memory delivers fast program execution, with an additional 20Kb of RAM for the graphic display. North Star provides graphics software com-

patible with CP/M<sup>®</sup> and HDOS operating systems and application packages, and most standard languages. There are thousands of CP/M compatible software programs available throughout the world. Or you can choose any of the North Star application

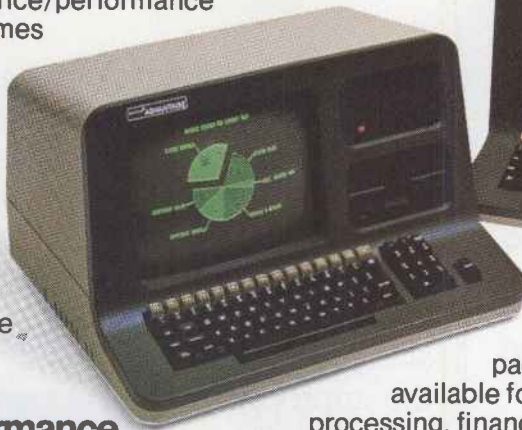

packages available for word processing, financial analysis, accounting and data base management.

## Graphic displays for every need.

The free North Star ADVANTAGE BUSIGRAPH<sup>™</sup> package makes it possible to generate line, bar, pie, and 3-dimensional charts, plus complex 3-dimensional forms. Reports can be transformed into impressive hard copy graphic displays in a matter of seconds.

## Build a network of ADVANTAGES.

One North Star ADVANTAGE computer can be linked to other North Star ADVANTAGES by twisted pair cable using North Star's new network interface and software package. This allows you to have a low cost network of individual systems sharing the more expensive peripherals. This can be the first step toward fully automating an entire office or department.

## Convenient design and service.

The North Star ADVANTAGE is a fully integrated micro-computer in an attractive, integrated enclosure. It provides high reliability and excellent operator comfort, plus straightforward servicing. For more information about the North Star ADVANTAGE, contact...

North Star Computers Inc.  
Arabellastrasse 5/133 c,  
Postfach 810623,  
D-8000, Munich 81,  
Telephone (089) 91 83 58,  
Telex 521 5772 ibs

FOLLOW THE STAR

**NorthStar**<sup>™</sup>

CP/M is a registered trademark of Digital Research, Inc.

North Star Computers Inc.

14440 Catalina Street, San Leandro, CA 94577 USA (415) 357-8500, TWX/Telex (910) 366-7001

# The new Dragon 32. So well designed, you'll even understand this ad.

If you're already a computer expert, may we refer you to the box of technical specifications displayed opposite.

If you're not, may we refer you to the new Dragon 32 Family Computer. A computer so easy to understand, you won't understand why all the others seem so difficult.

And the new Dragon 32 costs under £200.

## 32K RAM FOR UNDER £200?\*

When you're comparing computers, the first thing you need to know is the size of the memory. In plain English, the Dragon has approximately 32 thousand units of Random Access Memory. (32K RAM for those who prefer to be blinded by science.) This means that the Dragon's memory is at least twice as powerful as its competitors'.

With a memory this powerful, the amount of information the Dragon can store is literally vast. But the Dragon doesn't just make it easy to store information. It makes it easy to use, too.

## USER-FRIENDLY?

You may have heard of the term 'user-friendly.' Reverting to plain English once more, this means simply that the computer will go out of its way to understand you, rather than vice-versa.

The Dragon 32 is so user-friendly, it practically licks your hand.

You tap (literally) its vast resources through a beautifully-designed keyboard that's as easy to use as a typewriter.

On this keyboard, you type in a language which is surprisingly close to the English you talk every day. The Dragon 32 will receive your order. Understand it. Send it to the appropriate section of its massive brain. And then display the appropriate information on your screen. All before you can say 'gobbledygook.'



\*TV not included in price.

| SPECIFICATIONS  |
|---|
| 6809E MICROPROCESSOR. Pet, Apple, Atari 400, BBC Micro, and VIC 20 still have the less powerful 6502.   |
| 32K RAM (as standard). At least twice the power of similarly priced machines. Expandable to 64K RAM.  |
| EXTENDED MICROSOFT COLOUR BASIC (as standard).<br>Featuring: ADVANCED GRAPHICS (set, line, circle, paint, print, draw, rotate and print using).<br>ADVANCED SOUND 5 octaves, 255 tones.<br>AUTOMATIC CASSETTE RECORDER CONTROL.<br>FULL EDITING with INSERT and DELETE. |
| 9 COLOUR, 5 RESOLUTION DISPLAY.   |
| USE WITH ANY U.H.F. TV and/or separate P.A.L. monitor.  |
| PROFESSIONAL QUALITY KEYBOARD.<br>Typewriter feel. Guaranteed for 20 million depressions.   |
| PRINTER (Centronics parallel).  |
| JOYSTICK CONTROL PORTS.   |

### FIRE YOUR IMAGINATION.

Learning how to use the Dragon 32 won't cause you to experience any problems. Learning what you can use it for will cause you to experience something entirely different.

Delight. Surprise. Fascination. And challenge.

The Dragon offers a range of some of the most popular computer games in the world. From those celebrated space battles to mind-boggling adventures in seemingly unfathomable dungeons and caves.

As if by magic, a simple typed message will command the Dragon to create your own drawings. Then it will colour and paint them in 9 colours.

And it's clever enough to create virtually any image you want - circles and arcs as well as straight lines.

The Dragon will also play and compose music with you, with a range of 5 octaves. And it works with any UHF TV or PAL monitor.

### LEARNING THROUGH PLAYING.

All of this makes the Dragon the ideal machine to build your children's interest in the world of computers as they become increasingly more vital. School-children already enjoy using computers.

The Dragon is the first computer specifically for the family - so by enjoying yourselves at home, you and your children can soon become expert enough to create your own programs.

| PRODUCT   | DRAGON 32 | SINGULAR SPECTRUM | ACORN ATOM | VIC 20 | TI 99/4A | BBC MICRO-V |
|---|-----------|-------------------|------------|--------|----------|-------------|
| FEATURE   |           |                   |            |        |          |             |
| PRICE   | £199      | £125              | £175       | £190   | £199     | £300        |
| STANDARD RAM SIZE                                   | 32K       | 16K               | 8K         | 5K     | 16K      | 16K         |
| STANDARD AVAILABLE RAM FOR HIGH RESOLUTION GRAPHICS | 26K       | 9K                | N/A        | N/A    | 14K      | 3K          |
| EXTENDED MICROSOFT BASIC AS STANDARD                | YES       | NO                | NO         | NO     | NO       | NO          |
| PROFESSIONAL-TYPE KEYBOARD                          | YES       | NO                | YES        | YES    | YES      | YES         |

### BRILLIANTLY SIMPLE GUIDE.

The Dragon is living proof that you don't have to be an expert in computerspeak to be an expert in computers. It comes with the easiest-to-understand instruction manual ever written for a home computer.

Every step, every explanation, is made clear - even if you're a beginner. In minutes, it will show you how to write a simple program. Within hours, you'll be fascinated. And from then on, you'll continue to be astounded by the new world which the Dragon's power and versatility will open up to you.

See the new Dragon 32 in your High Street. At under £200, it's not just the first family computer. It also has all the features an expert could wish for.

Except perhaps the jargon.

## **DRAGON 32** The first family computer.

To: Jean Webster, Dragon Data Ltd, Queensway, Swansea Industrial Estate, Swansea, Glamorgan SA5 4EH.  
Tel: 0792 580651.

Please send me further information about the Dragon 32.

Name \_\_\_\_\_

Address \_\_\_\_\_  
\_\_\_\_\_  
\_\_\_\_\_

PCW

A member of the Mettoy Group of Companies.

# THE VERSATILE COMPUTER

with the features you need for  
**TODAY and TOMORROW**

\*Z-80  
(8 bit processor)

\*8088  
(16 bit processor)

\*128K ram

\*8035 keyboard  
processor

\*S-100 slots



\*Green phosphor  
high resolution  
screen

\*Integrated  
floppy & winchester  
disc drives

\*Detached  
ergonomic  
keyboard

The Vector 4 is an advanced  
8/16 bit desk top computer.

It allows you to take advantage  
of the existing 8 bit CP/M  
programs while also providing  
16 bit processing power.

The future is built into the Vector 4  
with its Z-80 and 8088 processors,

Let ALMARC show you  
tomorrow's computers today.

128k of main  
memory (expandable to 256k),  
3 S-100 expansion slots  
and standard software facilities  
with high resolution graphics that  
are second to none. Floppy disc  
and hard disc systems are available.  
Nationwide sales and servicing.

## Almarc

Almarc Data Systems Ltd,  
Great Freeman Street,  
Nottingham NG3 1FR.  
Tel: (0602) 52657  
Telex: 37407 Almarc/G

Almarc-Data Systems Ltd,  
Ward International Building,  
Green Street,  
High Wycombe,  
Bucks. HP11 2RF.  
Tel: (0494) 23804.

DATA SYSTEMS

# FOR TOMORROW'S SYSTEMS TODAY



# The programme guide

Stock control, order processing, invoicing, statement production, payroll, general accounting... these are most of the jobs that a business will tackle every day. GRAFFCOM's Integrated Small-Business Software packages - ISBS are designed to get these jobs done better and faster. ISBS can improve your productivity and give you better management control over your business.

For the smaller business user with a twin floppy disk based system, ISBS-F is the ideal starting point. A truly integrated accounting approach, the system offers simplicity of use without trade-offs in facilities. In fact most of the ISBS-F features

can be found in mini and mainframe systems.

Companies with large data volumes and multiuser requirements should look at ISBS-W. The system supports multiple workstations and is designed to take full advantage of the latest hard disk storage based systems. As you would expect, ISBS-F users can easily convert to ISBS-W when the business expands through the System Migration Plan - SMP.

GRAFFCOM's software products have been designed for most CP/M, MP/M based microcomputer systems. All packages are supplied with comprehensive documentation and backed up with technical support, and maintenance to cover legislative changes. In

addition there are products such as accounting guides and graphics programs available to complement and complete our service to the commercial user.

So whether you need professional application software to use or sell, then call us now for further details. (Computer suppliers should ask for information about our Dealer and Superdealer arrangements).

**GRAFFCOM**  
**SYSTEMS GROUP**

102 Portland Road London W114LX 01-727 5561

102

**GRAFFCOM**

## ISBS-W

A totally integrated suite of software designed for microcomputers which use Hard disks or Winchester disks. The user can choose from any combination of modules and add others at a later stage if required.

### 1.0 Business Controller

The business control module acts as a task manager and supervisor for all users and mainfile updates. Operators will feel at ease with the menu prompting when selecting tasks such as order processing, invoicing, accounting modules and word processing. The controller is used to set the system parameters, typically the number of disk units and sizes, number of printers, passwords and authorization codes. You can develop your own application modules for those special jobs and have them incorporated in the business control menu.

### 2.0 Accounting

The system offers a comprehensive range of facilities to meet the most demanding accounting applications. The modules cover tasks such as sales and purchase ledger, payroll and nominal ledger. Management reports including the P/L and Balance sheet can be produced from the data captured by the system. Audit trails are produced for all transactions entered, with batch totals where applicable. In addition to the main accounting reports, pre-printed output includes statements, cheques and remittances, and also payslips and bank giro.

### 3.0 Stock & Order Processing

Stock levels can be checked quickly using the on-line enquiry module, and the operator can also allocate stock if required. Order processing allows orders to be entered and maintained until all items and quantities have been shipped. Invoices and order acknowledgements can be produced on line if required with automatic release of the stock and drawdown from the orders file. Pre-printed invoice stationery can be used and the layout can easily be modified using the built in formatter.



### 4.0 Word Processing

To complete the suite, the word processing module offers one of the most sophisticated systems found on today's microcomputers. It includes all the standard features that you would expect to find in a WP system, such as tabs, justification, margins, global search and replace, proportional spacing etc. In addition there is a merge document option to produce those personalised mailshots and labels, and also a built in spelling checker with a 10,000 word (expandable) dictionary.

## ISBS-F

ISBS-F is a comprehensive system designed for first time users of floppy disk systems. It can be fully integrated or each module can be used individually, adding others at a later date, which makes it an ideal choice for the first time user.

### 1.0 Stock Control

The programme allows fast interrogation of any stock line and produces 11 comprehensive reports to achieve optimum stockholding. Amongst the many features, including stock updates, release and goods inwards, the system has the option to define stock groups allowing for parts explosion.

### 2.0 Order Entry & Invoicing

Invoices can be produced quickly and easily, either by referring to an order already entered, or by entering data at the invoice stage. If necessary, part orders can be sent, as the system can keep track of each order until it is completed. Release of stock and posting of invoices to the Company Sales System is carried out automatically.

### 3.0 Company Sales System

Customers can be set up as open item or balance forward accounts, and statements can be produced easily at anytime. An online enquiry and comprehensive credit control reports allow you to monitor customer credit limits and help maintain a healthy cash flow. The system can handle part payments and unallocated cash, and produces a full audit trail of payments received.

### 4.0 Company Purchases System

Target payment dates can be assigned to each supplier invoice, to plan cash flow and to help speed payment procedure. There are reports to show ageing of invoices and the system also has the facility to print cheques on preprinted stationery or payment advices on Company letterheads.

### 5.0 General Accounting System

The main feature on this programme is the flexibility of the cost code system, which allows you to design final Company reports such as the Profit and Loss Account and Balance sheet. Comprehensive budget reports can be produced, showing any variances between budget and expenditure for your own chosen accounting period.

### 6.0 Payroll

Employees can be paid by cheque, cash or bank giro transfer, on a weekly, monthly or hourly basis, depending on the Company requirements. The system is fully maintained and incorporates all new legislation. Some of the facilities include overtime, holiday pay, coin analysis reports, and production of P11/P60 forms at year end.

### 7.0 Names and Addresses

Names and addresses of customers and suppliers together with any others you may wish to keep a record of, can be stored centrally in this system. Names are retrieved by the programmes for completion of invoices, statements etc., by use of an id code unique to each name. A report generator allows you to design and store your own reports.

**NEWS RELEASE**

**LATEST SYSTEMS FOR ISBS-F**

**IBM Personal Computer**

**Xerox 820**

**NEC PC 8000**

**Hewlett Packard HP 125**

## STEMMOS LTD FOR SUPERBRAIN USERS

1. Has your system run out of storage?
2. Do you have a hardware problem?
3. Is your system under-utilised?
4. Do you need more software?
5. Do you need extra hardware?
6. Do you require a flexible maintenance contract?



### STEMMOS HAS THE ANSWERS

1. STEMMOS can increase the capacity of your Superbrain disk sub-system to 1.5MB or 5/10MB internally.
2. STEMMOS can supply external Winchester disks system with capacity of up to 35MB.
3. STEMMOS repairs and maintains Superbrains and a wide range of peripherals, on site and off site.
4. STEMMOS provides special training courses to suit your requirements and improve the utilisation you get from your machine.
5. STEMMOS supplies a wide range of high standard quality software to run in your system. And we can train your personnel to use it and get the most out of it.
6. STEMMOS customises and designs software to suit your exact requirements.
7. STEMMOS supplies the hardware; Superbrain and peripherals at very competitive prices.

Please contact Stemmos for our excellent services and competitive prices

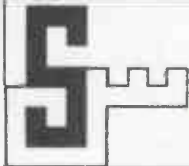

**STEMMOS LTD.**  
344 Kensington High Street  
London W14.  
Tel: 01-602 6242/3/4  
Telex: 893003

### EXPLORING SPECTRUM BASIC

Mike Lord's latest book takes the reader beyond the Sinclair Manual. It contains a wealth of programs and explanations of Spectrum BASIC programming techniques. Topics include writing games programs, personal, business and engineering applications, and utility programs. Worth far more than ..... £4.95

### THE EXPLORERS GUIDE TO THE ZX81

Mike Lord's acclaimed book for the ZX81 enthusiast. Includes games, business, engineering and utility programs for both 1K and 16K machines, an introduction to Machine Language, with a list of useful ROM routines, hints & tips, and hardware notes including RAM and I/O circuits. "of the greatest value" (ZX Computing review) ..... £4.95

### MASTERING MACHINE CODE ON YOUR ZX81

By Toni Baker; 180 pages of immense value to beginner and expert alike. .... £7.50

All prices include U.K. P & P - no VAT on books. Overseas customers add £1.50 carriage per order.

### TIMEDATA Ltd. Dept C

57 Swallowdale, Basildon, Essex SS16 5JG  
Tel: (0268) 411125 (Mon-Fri)



# WINNING APPROVAL-



Through their powerful multi-processor operating systems Equinox professional microcomputers will grow and adapt in step with your Company.

Widely used in industry because of their proven power, reliability and expandability, Equinox systems are one of the few Government (CCTA) approved microcomputer systems with both CP/M and MICROCOBOL as standard.

And because they are specifically designed to grow and adapt with you, Equinox microsystems will win your approval, too.

#### EXPANDABLE

Equinox systems are not just simple desk-top, single-user machines, so they can expand both storage capacity and number of users, and

grow from single-user floppy based (5 1/4" or 8") to multi-user hard disc systems.

Through the S-100 bus structure, interfacing is possible to a wide range of component boards and interfaces, including PRESTEL/VIEWDATA, mainframe communication processors, floating point hardware, colour graphics cards, A/D and D/A etc. In fact, the large number of component boards manufactured for the S-100 make it the most interesting and versatile bus around which to build your system.

#### POWERFUL

All this, plus two powerful multi-processor operating systems - TURBOdos (which will run your CP/M compatible software) and MICROCOBOL BOS/NET - make Equinox the systems for commercial

**NEW MODELS**

# MONOLITH ECR DATA RECORDERS SAVE & LOAD YOUR PROGRAMS EVERY TIME



**£47.50**  
Including VAT.  
complete

## ZX SPECTRUM! Z81! ZX80! BBC MICROCOMPUTER

Enhanced Certified Recorders from MONOLITH are a major advancement in cassette recorder technology which minimises the problems associated with standard audio recorders. The unit is a high reliability program store for microcomputers based on a modified, proven cassette mechanism. The two sections of data recording circuitry automatically ensure precise levels are written onto the tape and that optimised signals are received by the computer.

**MONOLITH ECR'S ARE NOT SUITABLE FOR AUDIO REPRODUCTION  
NO MANUAL VOLUME OR TONE CONTROL ADJUSTMENT PROVIDED**

- Each Monolith ECR comes complete with its own individual certification tape, tested and serial numbered to prove your machine reliability.
- Mains Operation only.
- Mains & DIN connector leads provided.
- Certification of tape head alignment - height and azimuth
- Certified tape tension, torque and speed.
- Fast forward and rewind tape search controls.
- Please allow up to 28 days delivery. ● Monolith ECR's are backed by our 14 day money back options.

**MONOLITH**  
electronic products  
Telephone: Crewkerne 0460 74321 Telex: 46306

To: MONOLITH ELECTRONICS CO. LTD., 5/7 CHURCH STREET, CREWKERNE, SOMERSET

Please supply me with: Monolith ECR Enhanced Certified Recorder(s)

| QTY.  | MODEL                                  | Price            | Total |
|---|--|------------------|-------|
|   | ECR-Spectrum: for Sinclair ZX Spectrum | £47.50<br>(Each) |       |
|   | ECR-81 : For Sinclair ZX80/ZX81        |                  |       |
|   | ECR-BBC : For BBC Microcomputers       |                  |       |
| I also enclose postage & packing per recorder |  | £2.50            |       |

Please print Prices include VAT £

Name: Mr/Mrs/Miss.

Address

# EQUINOX expandable microsystems.

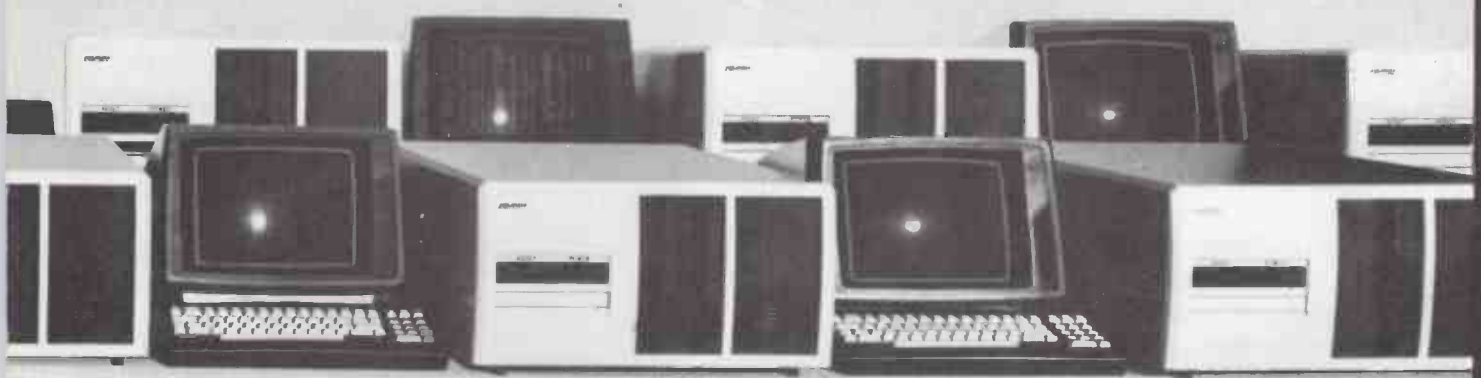

and industrial applications. TURBOdos supports from one to 16 users and provides single-user response in a multi-user environment; it can also link up to 255 systems – a potential network of over 4,000 users!

**FLEXIBLE**  
What's more, with Equinox you can choose from a wide range of packaged software available: accounting, word processing, financial planning, information (data base) management and many others – or write your own application programs.

And don't worry about hardware support – we can supply nationwide maintenance.

So if your company is in the process of change, growth or expansion, get in touch with Equinox TODAY. You'll find our microcomputers will grow on you.

OEM, SYSTEM HOUSE & DEALER ENQUIRIES INVITED.  
Trademarks:  
MICROCOBOL; Microproducts Software  
TURBOdos; Software 2000 inc.  
CP/M; Digital Research

**EQUINOX**  
MULTI-USER MICROSYSTEMS  
Kleeman House, 16 Anning Street, New Inn Yard,  
London EC2A 3HB. Tel: 01-739 2387  
Telex: 27341

THE EUROPEAN

# COMPUTER TRADE FORUM

## Helping you make money, not mistakes

You could be a distributor, a dealer, a software house, a systems integrator, a sales and service company, a retailer—even a DP man about to go into business on your own. You could know the DP/WP business backwards, or you could be coming into the ring for the first time.

But whatever your status, if you owe your livelihood to buying and reselling computers, software or peripherals, you owe it to yourself to visit ECTF at the NEC this Autumn.

### ECTF means business

Because it has been specially created for you, it's the computer industry's own trade show. It has been designed to provide you with a wider range of real business opportunities—together under one roof.

ECTF is there to help you plan the most profitable product line, to get the best hardware and software and to negotiate the most advantageous trade deals. Quite simply, your visit could be crucial to your *future* business success.

### Seeing, hearing...and comparing

Wang, DEC, Sony, Olivetti, ICL, Hewlett-Packard, Toshiba—a host of household names will be there, plus many names you may not know: new companies in the market with new products that could be next year's big money makers.

They all need to meet you. They'll want to talk trade terms, marketing support, dealerships, discounts

—and how their products can mean bigger profits for you.

And you need to meet them to see, discuss and compare the whole spectrum of WP and DP products. In fact that's the key to ECTF. By knowing what's available, you'll be in a better position to make money...and avoid mistakes.

### For trade and trade alone

The general public are not invited to ECTF. The emphasis is on business. And for you it's free.

It takes place at the National Exhibition Centre Birmingham, easily reached by

car or train. It will be open for just four

days—28 September to 1 October. Fill in the coupon and send it to ECTF, 232 Acton Lane, London W4 5DL—or telephone 01-747 3131 and we'll mail you FREE tickets for you and your business colleagues.



PLEASE FILL OUT AND USE CAPITAL LETTERS

Please send me  Free Entrance Tickets for my colleagues and myself.

Name

Company

Address

Telephone  Telex

(No one under 18 will be admitted)

I would like to receive information on exhibiting at ECTF. Phone me on



PCW/10/82

# 5 1/4" WINCHESTER SUBSYSTEMS FROM ICE

APPLE - SUPERBRAIN - IBM PERSONAL  
S100 BUS & Z80-BASED MICROS

FROM 3 TO 42 MEGABYTE CONFIGURATIONS WITH TAPE STREAMER BACKUP



RETAIL PRICES FROM £1350. . . . . DEALER ENQUIRIES INVITED

## ICE

16/18 Littleton Road, Ashford, Middlesex, TW15 1UQ  
Telephone: 07842-47271/47171 Telex: 8952042 (DPCUSTG)



**YOU'VE SEEN THE PICTURES NOW SEND FOR THE BOOKS**

### BBC Microcomputer or Acorn Atom

Acornsoft is the software division of Acorn Computers, designers and manufacturers, of the BBC Micro and Atom. We know better than anyone the capability of the machines, we know how to get the very best from the hardware. And we have produced a range of exciting games, exacting business and useful household software.

### The Biggest Range Available

Acornsoft software ranges from authentic arcade games like Snapper to Algebraic Manipulation to Desk Diary to other languages like FORTH and LISP. Striking colour, amazing sound effects and powerful

graphics are all used to the full. And it does not stop there. There is a complete range of manuals, accessories and plug-in ROMs.

### Free Brochures

Just clip the coupon or write to us and we will rush our catalogue absolutely free. Can't wait for the post ring 01-930 1614 now! Don't delay - do it today. Let Acornsoft help you get the best from our machine and open the doors to your imagination.

Acornsoft and Atom are registered trade marks of Acorn Computers Ltd.

## ACORNSOFT

4A Market Hill,  
CAMBRIDGE CB2 3NJ.

**FREE!**

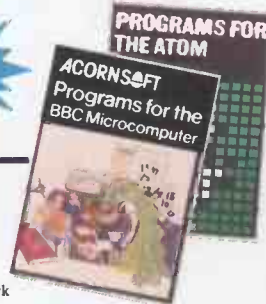

Please rush me my free literature from Acornsoft.

Atom  
 BBC Please tick

Name \_\_\_\_\_

Address \_\_\_\_\_  
\_\_\_\_\_  
\_\_\_\_\_

Postcode \_\_\_\_\_



# Britain can still an extra by

**L**AST year's launch of Caltex proved that an all-British word processor could bite deep into the best of the foreign competition.

This year the bytes are coming thick and fast. Our Great British Word Processors continue.

But now with greater power and an even smaller price tag. On top of that the Caltex Micro has been launched to establish British supremacy for the business personal computer user.

But first things first, what's new about the Caltex



I find  
te.

Word Processor?  
Well, it's got the same easy to use and understand  
function keys that made us welcome in the beginning.  
But now it's also got an in-built Winchester  
Hard Disc. Giving you 8mb of storage and CP/M

software that works across all the proven business packages.  
The cost? Almost £1,000 less than we launched with a year ago. From just over £3,000 to be more precise.  
So what about the new British built Caltex Micro?  
As you'd expect, it's easy to use. With programmable function keys, CP/M and Microcobol software to cover all the business computing requirements.  
But unlike some other micros it has a full communications capability and also an in-built Winchester Hard Disc option of 5mb, 10mb or 15mb.  
For such a powerful micro with immense software and hardware capability you might expect to pay the earth.  
Not so. The Caltex Micro undercuts most micro computers by almost half. With an average starting price of around £1,700.  
We're confident a more efficient British machine could ease a lot of your processing problems.



To find out how, contact us immediately for product information and the address of your nearest customer support centre.  
Let's prove that Britain can still bite back.  
Computer Ancillaries Limited, 64 High Street,  
Egham, Surrey TW20 9EY.  
Telephone: Egham (0784) 36455.

Send to: Computer Ancillaries Ltd, 64 High Street, Egham, Surrey TW20 9EY.  
Please send me details of the Caltex and Caltex Micro plus the address of my nearest customer support centre.

NAME \_\_\_\_\_  
COMPANY \_\_\_\_\_  
POSITION \_\_\_\_\_  
ADDRESS \_\_\_\_\_  
\_\_\_\_\_



# ACT

# pulsar

## INDUSTRY-STANDARD 16-BIT BUSINESS SOFTWARE.

The new PULSAR business software is 16-bit software specially developed for new generation 16-bit personal computers.

It's inherently faster and more powerful than traditional 8-bit software.

The result: More and more business users are choosing PULSAR, making it one of the industry standards on 16-bit personal computers.

Only PULSAR meets the five key requirements for 16-bit business software:

### PORTABILITY

PULSAR is primarily written in the PASCAL portable language. So your investment in software is protected, regardless of how often you change your system.

### PEDIGREE

PULSAR has been developed by ACT's own software engineers as a true 16-bit system. And ACT has more than 15 years experience in business software – computer bureaux using ACT programs produce more than 3 million statements every year and handle business applications

for more than 2000 companies. PULSAR incorporates many facilities that were previously available only on large mainframe computers.

### INTEGRATION

ACT supplies integrated business software, linking every aspect of business accounting. Now with PULSAR, this integration is taken a stage further with word processing and business management tools able to share information and files with accounting applications.

### USER - FRIENDLY

PULSAR is really easy to use. Documentation is to the highest standards in the industry, taking the operator step by step through the system. A simple question and answer routine on the computer screen prompts the user at every turn.

### TOTAL SUPPORT

ACT is used to providing on-going support for its users. Not only is there a "hot-line" to resolve queries, but also a fully equipped training school open to all PULSAR users.

## THE PULSAR RANGE...

### PULSAR ACCOUNTING

Pulsar Sales Ledger  
Pulsar Purchase Ledger  
Pulsar Nominal Ledger  
Pulsar Payroll

### PULSAR ORDER PROCESSING

Pulsar Stock Control  
Pulsar Invoicing  
Pulsar Order Handling



### PULSAR FINANCIAL MANAGEMENT

Pulsar Data Analysis  
Pulsar MicroModeller  
Pulsar SuperCalc  
Pulsar MultiPlan

### PULSAR OFFICE SYSTEMS

Pulsar WordStar  
(word processing)  
Pulsar Mailmerge  
(mailing)  
Pulsar Select  
(word processing)



# pulsar

16 BIT - SOFTWARE  
FOR 16 BIT  
PERSONAL COMPUTERS

The ACT octagon encapsulates our philosophy of providing users with a single source for their computing solutions. ACT products include personal computers – network micro-computer systems – turnkey mini computers and a total range of services, including software development, computer field engineering, computer supplies, and a complete range of Bureau services.

The eight specialist ACT companies are each leaders in their field and are wholly owned by Applied Computer Techniques (Holdings) p.l.c., one of Britain's largest and most successful computer companies.

For more information on 16-bit Pulsar Software complete the coupon and post to ACT (Microsoft) Ltd., FREEPOST, Birmingham B16 8BR or phone 021-454 8585

I'm buying a 16-bit personal computer. Tell me more about the new 16-bit PULSAR software.

Name: \_\_\_\_\_

Position: \_\_\_\_\_

Company: \_\_\_\_\_

Address: \_\_\_\_\_

Telephone: \_\_\_\_\_

Application \_\_\_\_\_



# THE GREATEST BREAKTHROUGH IN COMPUTER HARDWARE.

# THE GREATEST BREAKTHROUGH IN COMPUTER SOFTWARE.

We don't need to tell you what the micro chip has done for computer hardware.

Without it we'd still be in the world of Flash Gordon and mad professors.

Luckily, we have got the micro chip and the computer is now an everyday part of business life.

So, it seems odd that we should have to wait until now for a similar breakthrough in the world of computer software.

Still, it's been worth the wait.

PlannerCalc, the new \*CP/M spreadsheet business planner from Comshare, is the first in a series of powerful packages that are going to put all others in the shade.

And, what's more, at £39.00 (plus VAT and p. & p.) it makes other people's price tags look a little extravagant.

PlannerCalc can handle the kind of business planning applications that fit into the spreadsheet format.

And unlike all other 'calc' products it allows you to enter calculation rules in English.

It uses the popular 'spreadsheet' approach, with a window that can be rolled in all directions.

Which means you can enter new figures or rules and immediately see their effects on everything else in the model.

PlannerCalc also incorporates some very mainframe-like features - for example, you don't need to number the models rows in the correct logical sequence as it can sort the rows itself as it calculates.

It comes with the best manual on the market and it's suitable for most micros with CP/M operating systems, at least 64K of memory and a minimum width screen of 80 characters and 2 floppy disc drives. (It'll even run on the new IBM personal computer.)

But if PlannerCalc is this good, how can we afford to sell it at such a low price?

Simple.

Because we know just how good it is.

And because we know it's going to sell in thousands. (In the U.S.A. we sold 5000 copies in the first month alone.)

£39.00

As your needs and demands grow you can move on to other more powerful packages like MasterPlanner, the next step up in the Comshare range.

Which is good news for both of us.

Because when you do make that move you won't have to reprogram.

Masterplanner is totally integrated with PlannerCalc and you simply carry on where you left off.

But first you'll need to get hold of PlannerCalc.

To order, clip the coupon and enclose your cheque or credit details (but, please, no small change) or ring Teledata on 01-200 0200 and we'll send you PlannerCalc, the manual and list of Comshare's other business software.

## COMSHARE

Making the computer make sense.

\*CP/M is the registered trade mark of Digital Research Inc.  
Comshare Ltd, 32/34 Great Peter Street, London SW1P 2DB. Telephone 01-222 5665.

To: PCW 9 Comshare Limited, 32/34 Great Peter Street,  
London SW1P 2DB.

Please send me \_\_\_\_\_ copies of PlannerCalc at £46.05 inc. VAT and p. & p. per copy, I enclose a cheque/postal order for £\_\_\_\_\_ made payable to Comshare Limited.

Please debit my Access Card No: \_\_\_\_\_ for £\_\_\_\_\_



Barclaycard No: \_\_\_\_\_ for £\_\_\_\_\_

Signature: \_\_\_\_\_

Name: \_\_\_\_\_

Address: \_\_\_\_\_

Tel No: \_\_\_\_\_

IMPORTANT: Please fill in the following particulars:-

Type of micro \_\_\_\_\_ Memory size \_\_\_\_\_ K

Floppy Disc size: 5 1/4"  Single Sided  Single Density

8"  Double Sided  Double Density

Please allow 28 days for delivery. VAT No: 238418649 Registered No: 980406

PCW20/8

Comshare reserves the right not to accept any order, any acceptance will be subject to Comshare's Terms and Conditions of Use.

# INTEREST FREE CREDIT

\* Subject to approval which can take up to 48 hours (APR = 0%)

from **MAPLIN**

## On Atari & VIC computer hardware

If your order contains over £120 worth of computer hardware apply now for interest free credit by telephoning: Mail-order: (0702) 552911  
London Shop: 01-748 0926 Southend Shop: (0702) 554000 or write to P.O. Box 3, Rayleigh, Essex SS6 8LR

You pay 10% down, then 10% per month for a further nine months. (to nearest penny) Example: VIC20 Colour Computer. Cash Price £199.99. Credit terms: £19.99 down then £20 per month for nine months: Total £199.99. Credit quotations on request.

### The VIC20 Colour Computer



could be yours this week for just **£19.99** down.  
Cash price and total credit price **£199.99.**  
Order as **AF47B**

#### VIC 20 ACCESSORIES:

**C2N Cassette Unit** (AF48C) £44.95

**VIC20 Printer:** (AF49D) £230.00  
80 characters per line, 30 characters per second, tractor feed, full alphanumerics and graphics, double size character.

**VIC20 Disk Drive:** (AF50E) £396.00  
170K storage on standard single-density, single-sided, soft-sectored floppy disks.

**Add-on RAM Cartridges:**  
3K RAM (AF51F) £29.95  
8K RAM (AF52G) £44.95  
16K RAM (AF53H) £74.95

**Memory Expansion Board:**  
6 ports for plug-in cartridges (AF54J) £125.95

#### Introduction to BASIC Cassettes

Part 1 (AC57M) £14.95  
Part 2 (AC58N) £14.95

#### Joysticks and Paddles:

Single Joystick (AC53H) £7.50  
Pair of Joysticks (AC37S) £13.95  
Le Stick (AC45Y) £24.95  
Pair of Paddles (AC30H) £13.95

#### Programming Aid Cartridges

Super Expander: 3K RAM and Hi-res graphics (AC54J) £34.95

Programming Aid: Additional commands, function key programming etc. (AC55K) £34.95

Machine Code Monitor (AC56L) £34.95

#### Game Programs:

Avenger Cartridge (AC59P) £19.95  
Star Battle Cartridge (AC60Q) £19.95  
Super Slot Cartridge (AC61R) £19.95  
Jelly Monsters Cartridge (AC62S) £19.95  
Alien Cartridge (AC63T) £19.95  
Super Lander Cartridge (AC64U) £19.95  
Road Race Cartridge (AC65V) £19.95  
Rat Race Cartridge (AC66W) £19.95  
Blitz Cassette (AC67X) £4.99

#### Books About VIC

Learn Programming on the VIC (WA31J) £2.50  
VIC Revealed (WA32K) £11.50  
VIC Programmers Reference Guide (WA33L) £16.50



See us at the  
**Personal  
Computer  
World Show**  
Barbican Centre  
9-12 Sept



**4 Consoles available:**

- Atari 400 with 16K RAM (AF36P) £249.95**
- Atari 400 with 48K RAM (AF37S) £319.00**
- Atari 800 with 16K RAM (AF02C) £499.00**
- Atari 800 with 48K RAM (AF55K) £590.00**

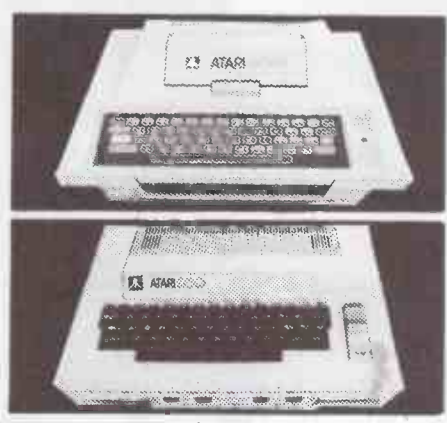

- lots of other hardware:**
- Cassette Recorder (AF28F) £50.00
  - Disk Drive (AF06G) £299.95
  - Thermal Printer (AF04E) £265.00
  - Printer Interface for 400 (AF41U) £59.95
  - Printer Interface for 800 (AF42V) £59.95
  - Interface Module (AF29G) £135.00
  - Typesetter (AF43W) £169.00
  - 16K RAM Module (AF08J) £55.00
  - 48K RAM Module (AF44X) £125.35
  - 48K Upgrade for 400 (AF45Y) £75.00
  - Floppy Disk (YX87U) £2.50
  - Le Stick (AC45Y) £24.95
  - Joystick Controllers (AC37S) £13.95
- For full details ask for our hardware leaflet (XH54J) SAE appreciated

**NOW YOU CAN JOIN THE U.K. ATARI COMPUTER OWNER'S CLUB.** An independent user's group.  
Four issues of the club magazine for only £1.60! Address your subscription to Ron

**THE CHOICEST GEMS OF ATARI SOFTWARE FROM MAPLIN**

|  |   |   |
|--|---|---|
| <p><b>Adventure Games</b></p> <ul style="list-style-type: none"> <li>Star Warrior -C- 32K-(B024B) £28.95</li> <li>Rescue At Rigel -C- 32K-(B021X) £22.45</li> <li>Invasion Orion -C- 32K-(B023A) £18.95</li> <li>Dates of Ryn -C- 32K-(B022Y) £14.95</li> <li>Galactic Empire -C- 24K-(B0140) £14.95</li> <li>Hi-Res Adventure // 2 -D- 48K-(B025C) £24.95</li> <li>Analog Adventure -D- 32K-(B033L) £16.95</li> <li>Adventure Land -C- 24K-(B000A) £14.95</li> <li>Pirates Adventure -C- 24K-(B001B) £14.95</li> <li>Mission Impossible -C- 24K-(B002C) £14.95</li> <li>Voodoo Castle -C- 24K-(B003D) £14.95</li> <li>The Count -C- 24K-(B004E) £14.95</li> <li>Strange Odyssey -C- 24K-(B005F) £14.95</li> <li>Mystery Fun House -C- 24K-(B006G) £14.95</li> <li>Pyramid of Doom -C- 24K-(B007H) £14.95</li> <li>Ghost Town -C- 24K-(B008J) £14.95</li> <li>Savage Island I -C- 24K-(B009K) £14.95</li> <li>Savage Island II -C- 24K-(B010L) £14.95</li> <li>Golden Voyage -C- 24K-(B011M) £14.95</li> <li>Energy Czar -C- 16K-(YG53H) £9.95</li> <li>Kingdom -C- 8K-(YG55K) £9.95</li> </ul> <p><b>Teach-Yourself Programs</b></p> <ul style="list-style-type: none"> <li>Conversational French -5C- 16K-(YG44X) £39.95</li> <li>Conversational German -5C- 16K-(YG45Y) £39.95</li> <li>Conversational Spanish -5C- 16K-(YG46A) £39.95</li> <li>Conversational Italian -5C- 16K-(YG47B) £39.95</li> <li>Touch Typing -2C- 16K-(YG49D) £15.95</li> <li>States &amp; Capitals -C- 24K-(YG56L) £9.95</li> <li>European Countries &amp; Capitals -C- 16K-(YG57M) £9.95</li> </ul> <p><b>Learn Programming</b></p> <ul style="list-style-type: none"> <li>Invitation to Programming -C- 8K-(YG43W) £15.95</li> <li>Basics of Animation -C- 32K-(B057M) £11.95</li> <li>Basics of Animation -D- 32K-(B058N) £11.95</li> <li>Player Missile Graphics -C- 16K-(B059P) £18.95</li> <li>Player Missile Graphics -D- 24K-(B060O) £18.95</li> <li>Display Lists -C- 16K-(B051F) £11.95</li> <li>Display Lists -D- 24K-(B052G) £11.95</li> <li>Horiz/Vertical Scroll -C- 16K-(B053H) £11.95</li> <li>Horiz/Vertical Scroll -D- 24K-(B054J) £11.95</li> </ul> | <p>Page Flipping -C- 16K-(B055K) £11.95</p> <p>Page Flipping -D- 24K-(B056L) £11.95</p> <p>Master Memory Map -Book-(XH57M) £4.00</p> <p><b>Business Programs</b></p> <ul style="list-style-type: none"> <li>Visicalc -D- 32K-(YL39N) £119.95</li> <li>Word Processor -D- 32K-(YG42V) £99.95</li> <li>Calculator -D- 24K-(YG50E) £16.95</li> <li>Graph—H -C- 16K-(YG51F) £13.95</li> <li>Statistics -C- 16K-(YG52G) £13.95</li> </ul> <p><b>Arcade Games</b></p> <ul style="list-style-type: none"> <li>Star Raiders -E- 8K-(YG66W) £29.95</li> <li>Asteroids -E- 8K-(YG60D) £29.95</li> <li>Space Invaders -E- 8K-(YG70M) £29.95</li> <li>Missile Command -E- 8K-(YG64U) £29.95</li> <li>Super Breakout -E- 8K-(YG67X) £24.50</li> <li>Tari Trek -C- 24K-(YL36P) £8.95</li> <li>Tari Trek -D- 32K-(YL37S) £11.95</li> <li>Star Trek 3.5 -C- 32K-(B015R) £14.95</li> <li>Race In Space -C- 16K-(B035O) £14.95</li> <li>Shooting Gallery -C- 16K-(B036P) £14.95</li> <li>Mountain Shoot -C- 16K-(B012N) £10.95</li> <li>Jawbreaker -D- 48K-(B026D) £20.64</li> <li>Basketball -E- 8K-(YG61R) £24.50</li> <li>Tank Trap -C- 16K-(YL34M) £9.95</li> <li>Tank Trap -D- 32K-(YL35D) £12.95</li> </ul> <p><b>Home Game Programs</b></p> <ul style="list-style-type: none"> <li>Scram -C- 16/24K-(YG58N) £17.50</li> <li>Cypher Bowl -C- 32K-(B020W) £29.50</li> <li>Thunder Island -C- 16K-(B037S) £10.95</li> <li>Rotating Tilt -C- 16K-(B048C) £14.95</li> <li>Lunar Lander -C- 16K-(B016S) £10.95</li> <li>Sunday Golf -C- 16K-(B013P) £10.95</li> <li>Darts -C- 16K-(B042V) £19.95</li> <li>Tournament Pool -C- 16K-(B045Y) £19.95</li> <li>Snooker &amp; Billiards -C- 16K-(B044X) £19.95</li> <li>Chess -E- 8K-(YG63T) £24.50</li> <li>Cribbage &amp; Dominoes -C- 16K-(B043W) £14.95</li> <li>Poker Solitaire -C- 16K-(B017T) £10.95</li> <li>Blackjack -C- 8K-(YG62S) £9.95</li> </ul> | <ul style="list-style-type: none"> <li>Fast Gammon -C- 8K-(YL33L) £16.95</li> <li>Reversi (Othello-type) -C- 16K-(B019V) £14.95</li> <li>Gomoko -C- 16K-(B018U) £14.95</li> <li>Hangman -C- 8K-(YG54J) £9.95</li> <li>Humpty Dumpty &amp; Jack &amp; Jill -C- 16K-(B038R) £11.95</li> <li>Hickory Dickory Dock -C- 16K-(B039N) £19.95</li> <li>British Heritage -Jig-Saw Puzzles -C- 16K-(B040T) £19.95</li> <li>European Scene -Jig-Saw Puzzles -C- 16K-(B041U) £19.95</li> <li>Atari Safari (25 Programs) -C- 16K-(B049D) £18.95</li> <li>Atari Safari (25 Programs) -D- 16K-(B050E) £24.95</li> <li>Mind Bogglers (3 Programs) -C- 16K-(YL38R) £11.95</li> </ul> <p><b>Utilities</b></p> <ul style="list-style-type: none"> <li>3D-Super Graphics -D- 48K-(B028F) £29.95</li> <li>3D-Super Graphics -C- 48K-(B029G) £29.95</li> <li>Atari World (Graphics) -D- 48K-(B027E) £43.95</li> <li>Assembler Editor -E- 8K-(YG68Y) £39.95</li> <li>Assembler -C- 16K-(YL32K) £19.95</li> <li>6502 Disassembler -C- 24K-(YL30H) £9.95</li> <li>6502 Disassembler -D- 8K-(YL31J) £12.95</li> <li>Character Generator -C- 16K-(YL27E) £9.97</li> <li>Character Generator -D- 16K-(YL28F) £12.50</li> <li>Teletink -E- 8K-(YG59P) £21.50</li> </ul> <p><b>Music Programs</b></p> <ul style="list-style-type: none"> <li>Music Composer -E- 8K-(YG48C) £35.95</li> <li>Movie Themes (use with Music Composer) -C- 16K-(B034M) £9.95</li> </ul> <p><b>Computer Languages</b></p> <ul style="list-style-type: none"> <li>Operating System A+ -D- 48K-(B030H) £49.95</li> <li>OS Forth -D- 24K-(YL29G) £49.95</li> <li>Pilot (Consumer) -E- 8K-(YG69A) £54.00</li> <li>Basic A+ -D- 48K-(B031J) £49.95</li> <li>Basic A+ &amp; Operating System A+ -D- 48K-(B032K) £99.50</li> </ul> |
|--|---|---|

Key: C = Cassette, D = Disk, E = Cartridge.  
2C = 2 Cassettes etc. 8K, 16K etc. Shows minimum memory requirement.

Send sae now for our new software leaflet with details of all the above programs. Order As XH52G — Issue 2.

Subscribe now to America's leading Atari-only magazine — Analog — 6 issues per year for just £9.00. Order as GG24B.

**New titles this month**

- Learn Programming:**
- Invitation to Programming 2 -C- 16K-(B067X) £22.95
  - Invitation to Programming 3 -C- 16K-(B068Y) £22.95
- Business Programs:**
- Personal Financial Management -D- 32K-(B065V) £49.00
  - Mortgage and Loan -C- 16K-(B066W) £13.95

- Arcade Games:**
- Caverns of Mars -D- 32K-(B069A) £24.50
  - Centipede -E- 16K-(B070M) £29.95
  - Pac-Man -E- 16K-(B071N) £29.95
  - K-Razy Shoot Out -E- 16K-(B063T) £29.95
  - Mous kattack -D- 32K-(B077J) £22.95
  - Ghost Hunter -C- 16K-(B064U) £24.50
  - Galactic Chase -D- 32K-(B061R) £19.95
  - Galactic Chase -C- 16K-(B062S) £16.95

- Home Programs:**
- Video Easel -E- 16K-(B072P) £24.50
- Computer Languages:**
- Microsoft Basic -D- 32K-(B074R) £59.95
  - Pilot (Educator) -E&2C- 16K-(B075S) £79.95
- Utilities:**
- Macro Assembler -D- 32K-(B073Q) £59.95
  - K-DOS (Superior disk operating system) -D- 32K-(B076H) £53.95



**Maplin Electronic Supplies Ltd**  
P.O. Box 3, Rayleigh, Essex.  
Tel: Southend (0702) 552911/554155.

Demonstrations at our shops NOW  
See Atari and Vic in action at  
159-161 King St., Hammersmith W6  
Tel: 01-748 0926  
or at 284 London Road, Westcliff-on-Sea, Essex.  
Tel: (0702) 554000  
Lynton Square, Perry Barr, Birmingham.  
Tel. (021) 356 7292

Note: Order codes shown in brackets. Prices correct at time of going to press. (Errors excluded).

# THE Computer SUPERMARKET

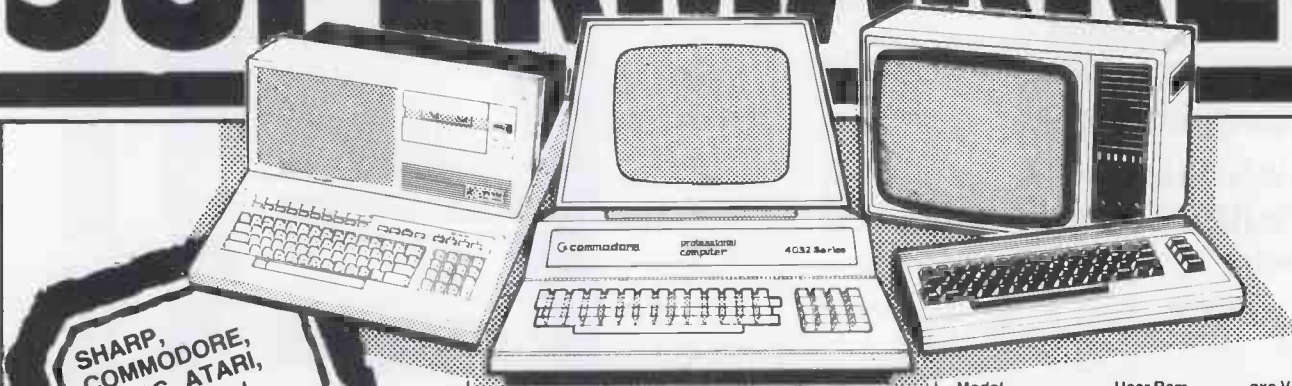

**SHARP, COMMODORE, TEXAS, ATARI, DRAGON and EPSON EQUIPMENT**  
Fully tested before despatch, or collection complete with 13 amp plugs.

### SHARP EQUIPMENT

| Model   | User Ram                         | exc VAT | Inc VAT |
|---------|----------------------------------|---------|---------|
| MZ80A   | 48K Ram                          | 477.39  | 549.00  |
| MZ80B   | 64K Ram                          | 950.00  | 1092.50 |
| MZ80FB  | Dual Floppy Disk Drive           | 525.00  | 603.75  |
| MZ80FBS | Dual Floppy Disk Drive System    | 657.00  | 755.55  |
| MZ80F1  | Floppy Disc I/O Card             | 85.00   | 97.75   |
| MZ80MD  | Master Diskette & Manual         | 26.50   | 30.48   |
| MZ80FC  | Floppy Disk Cable                | 21.00   | 24.15   |
| MZ80P4  | 132 Col Friction/Tractor Printer | 742.00  | 853.30  |
| MZ80P5  | 80 Col Tractor Feed Printer      | 363.50  | 418.03  |
| MZ80P6  | 80 Col Friction/Tractor Printer  | 418.50  | 481.28  |
| MZ80EUA | Expansion Unit (MZ80A)           | 86.96   | 100.00  |
| MZ80EU  | Expansion Unit (MZ80B)           | 43.00   | 49.45   |
| MZ80GMK | Graphics Ram II (MZ80B)          | 120.00  | 138.00  |

Note that the Dual Disk System and the P4, P5, P6 Printers are supplied complete with all cables, manuals, interface cards etc. Please indicate with your order which computer you will be using.

### COMMODORE EQUIPMENT

|           |                        |         |         |
|-----------|------------------------|---------|---------|
| 4016      | 12" 40 Col. 16K Mem    | 445.00  | 511.75  |
| 4032      | 12" 40 Col. 32K Mem    | 560.00  | 644.00  |
| 8032      | 12" 80 Col. 32K Mem    | 755.00  | 868.25  |
| 8096      | 12" 80 Col. 96K Mem    | 1040.00 | 1196.00 |
| SUPERPET  | Micromainframe         | 1299.00 | 1493.85 |
| 2031      | 121K Single Disk       | 350.00  | 402.50  |
| 4040      | 347K Dual Disk         | 560.00  | 644.00  |
| 8050      | 1 Megabyte Disk        | 755.00  | 868.25  |
| 8250      | 2 Megabyte Dual Disk   | 1120.00 | 1288.00 |
| 9060      | 5 Megabyte Hard Disk   | 1995.00 | 2294.25 |
| 9090      | 10 Megabyte Hard Disk  | 2495.00 | 2869.25 |
| 4022      | Matrix Printer         | 350.00  | 402.50  |
| 8023      | High Speed Printer     | 785.00  | 902.75  |
| 8300      | Letter Quality Printer | 1220.00 | 1403.00 |
| PET/IEEE  | Cable                  | 28.00   | 32.20   |
| IEEE/IEEE | Cable                  | 30.00   | 34.50   |
| VIC 10    | Personal Computer      | 152.17  | 175.00  |
| VIC 20    | Personal Computer      | 152.17  | 175.00  |
| VIC 30    | Personal Computer      | 152.17  | 175.00  |
| VIC 40    | Personal Computer      | 152.17  | 175.00  |
| VIC/C2N   | Cassette               | 36.00   | 41.40   |
| VIC 1011A | RS232 Int              | 28.50   | 32.78   |
| VIC 1110  | 8K RAM Cartridge       | 36.00   | 41.40   |
| VIC 1111  | 16K RAM Cartridge      | 60.00   | 69.00   |
| VIC 1112  | IEEE Int               | 44.00   | 50.60   |

**Big name hardware at cash-and-carry prices - and with service you'll find hard to match**

Telephone for Latest Prices

To The Computer Supermarket Ltd., Unit 8, Oakley Hay Ind. Estate, Corby, Northamptonshire.

Please send me

| Model No. | Item | Price | Shipment | Total | Info only |
|-----------|------|-------|----------|-------|-----------|
|           |      |       |          |       |           |
|           |      |       |          |       |           |
|           |      |       |          |       |           |

Please send me free catalogue

I enclose my cheque for £ \_\_\_\_\_

Or debit my Access/Barclaycard/

Diners Card/American Express No. \_\_\_\_\_

\_\_\_\_\_

(Cardholders may telephone orders to 0536 744015)

Signature \_\_\_\_\_

Name \_\_\_\_\_

Address \_\_\_\_\_

\_\_\_\_\_

\_\_\_\_\_

\_\_\_\_\_

\_\_\_\_\_

\_\_\_\_\_

\_\_\_\_\_

\_\_\_\_\_

\_\_\_\_\_

\_\_\_\_\_

\_\_\_\_\_

\_\_\_\_\_

\_\_\_\_\_

\_\_\_\_\_

\_\_\_\_\_

\_\_\_\_\_

\_\_\_\_\_

\_\_\_\_\_

\_\_\_\_\_

\_\_\_\_\_

\_\_\_\_\_

\_\_\_\_\_

\_\_\_\_\_

\_\_\_\_\_

\_\_\_\_\_

\_\_\_\_\_

\_\_\_\_\_

| Model                                | User Ram             | exc VAT | Inc VAT |
|--------------------------------------|----------------------|---------|---------|
| VIC 1210                             | 3K RAM Cartridge     | 25.00   | 28.75   |
| VIC 1211M                            | 3K RAM (Hi-Res) Cart | 28.00   | 32.20   |
| VIC 1212                             | Programmers Aid      | 28.00   | 32.20   |
| VIC 1213                             | Machine Code Mon     | 28.00   | 32.20   |
| VIC 1515                             | Matrix Printer       | 186.96  | 215.00  |
| VIC 1540                             | Single Disk Drive    | 344.35  | 396.00  |
| VIC Joystick                         |                      | 6.52    | 7.50    |
| VIC Paddle (Pair)                    |                      | 11.00   | 12.65   |
| VIC Introduction to BASIC 1          |                      | 13.00   | 14.95   |
| VIC Expansion Unit (Arfon)           |                      | 78.00   | 89.70   |
| Lid for above expansion unit (Arfon) |                      | 6.95    | 7.99    |
| Software Available                   |                      |         |         |

### TEXAS EQUIPMENT

|          |                    |        |        |
|----------|--------------------|--------|--------|
| TI-99/4A | 16K RAM Per. Comp. | 173.04 | 199.00 |
|----------|--------------------|--------|--------|

Full range of peripherals available

### ATARI EQUIPMENT

|   |        |        |
|---|--------|--------|
| Atari 400 16K Computer (Inc BASIC cart) | 195.61 | 224.95 |
| Atari 800 16K Computer (Inc BASIC cart) | 413.04 | 475.00 |
| Atari 400 16K Computer (Exc BASIC cart) | 165.17 | 189.95 |
| Atari 800 16K Computer (Exc BASIC cart) | 378.26 | 435.00 |
| Atari 410 Cassette Recorder             | 41.73  | 47.99  |

Full range of peripherals available

### DRAGON EQUIPMENT

|                               |        |        |
|-------------------------------|--------|--------|
| Dragon 32 32K Colour Computer | 173.48 | 199.50 |
|-------------------------------|--------|--------|

### TANDATA EQUIPMENT

|                              |        |        |
|------------------------------|--------|--------|
| Micro Tantel Prestel Adaptor | 130.00 | 149.50 |
| Alpha Tantel Prestel Adaptor | 182.61 | 210.00 |

Full colour output. Connects to any TV. Full British Telecom approval. Requires British Telecom 96A jack-plug.

### RICOH

|                                    |         |         |
|------------------------------------|---------|---------|
| RP1600 Letter Qual. Printer IEEE   | 1285.00 | 1477.75 |
| RP1600S Letter Qual. Printer Cent. | 1400.00 | 1610.00 |

### EPSON PRINTERS

|  |        |        |
|--|--------|--------|
| MX80 T/3 Dot Matrix. Hi. Res. Super/Subscripts | 325.00 | 373.75 |
| MX80FT/3 Dot Matrix Friction-Tractor           | 375.00 | 431.25 |
| MX82 Dot Matrix Friction-Tractor               | 350.00 | 402.50 |
| MX82FT Friction-Tractor                        | 389.00 | 447.35 |
| MX100/3 Dot Matrix. 100 cps 15" Platen         | 480.00 | 552.00 |

Interfaces available for most popular micros. Prices on request.



Prices quoted are for collection. 24 hour insured shipment arranged anywhere in UK for an additional £17.25 (inc. VAT). VIC, Atari and Texas shipped by insured post F.O.C. Datapost Available.

### EXPORT ARRANGED ANYWHERE IN WORLD.

Write for details to The Computer Supermarket (Export) Ltd. Approved Distributor for Commodore, Sharp, Atari, Texas and Dragon.

All goods sold with full manufacturer's warranty and subject to conditions of sale (available on request).

ALL MACHINES ARE FULL UK STANDARD.

Prices are valid only for the cover date month of this magazine

Credit Facilities Available. Ring or write for full details.

Special price list available for bonafide government and educational establishments.

All orders will be acknowledged by return of post.

## THE COMPUTER SUPERMARKET LIMITED

UNIT 8, SOUTHFOLD ROAD, OAKLEY HAY ESTATE, CORBY, NORTHAMPTONSHIRE  
ALSO OPENING SOON IN MANCHESTER'S ARNDAL CENTRE (TELEPHONE FOR OPENING DATE)

☎ 0536 744015 (3 LINES) TELEX COMPSU 341543/4 PRESTEL No. 400400



ZX Spectrum

|                     |                         |                              |                            |                |                     |                      |                        |
|---------------------|-------------------------|------------------------------|----------------------------|----------------|---------------------|----------------------|------------------------|
| <b>BLUE</b><br>EDIT | <b>RED</b><br>CAPS LOCK | <b>MAGENTA</b><br>TRUE VIDEO | <b>GREEN</b><br>INV. VIDEO | <b>CYAN</b>    | <b>YELLOW</b>       | <b>WHITE</b>         | <b>BLACK</b><br>DELETE |
| 1 !                 | 2 @                     | 3 #                          | 4 \$                       | 5 %            | 6 &                 | 7 ' ,                | 8 ( )                  |
| <b>DEPTH</b>        | <b>LINE</b>             | <b>OPEN #</b>                | <b>MOVE</b>                | <b>CLOSE #</b> | <b>ERASE</b>        | <b>POINT</b>         | <b>FORMAT</b>          |
| <b>SIN</b>          | <b>COS</b>              | <b>TAN</b>                   | <b>INT</b>                 | <b>RND</b>     | <b>STR\$</b>        | <b>CHR\$</b>         | <b>CODE</b>            |
| Q ←                 | W <>                    | E >=                         | R <                        | T >            | Y AND RETURN        | U OR                 | I AT INPUT             |
| <b>ASN</b>          | <b>ACS</b>              | <b>ATH</b>                   | <b>VERIFY</b>              | <b>MERGE</b>   | <b>SQR</b>          | <b>VAL</b>           | <b>LEN</b>             |
| <b>READ</b>         | <b>RESTORE</b>          | <b>DATA</b>                  | <b>SGN</b>                 | <b>ABS</b>     | <b>G THEN GOTO</b>  | <b>H ↑ GOSUB</b>     | <b>K + LIST</b>        |
| A STOP NEW          | S NOT SAVE              | D STEP DIM                   | F TO FOR                   | G              | G                   | J - LOAD             | L = LET                |
| <b>LN</b>           | <b>EXP</b>              | <b>LPRINT</b>                | <b>LLIST</b>               | <b>BIN</b>     | <b>CIRCLE VAL\$</b> | <b>SCREEN → ATTR</b> | <b>USR</b>             |
| Z : COPY            | X £ CLEAR               | C ? C.CNT                    | V / CLS                    | B * BORDER     | <b>IN KEYS</b>      | <b>PI</b>            | <b>ENTER</b>           |
| <b>BEEP</b>         | <b>INK</b>              | <b>PAPER</b>                 | <b>FLASH</b>               | <b>BRIGHT</b>  | <b>OVER</b>         | <b>INVERSE</b>       | <b>BREAK SPACE</b>     |



# Sinclair ZX Spectrum

**16K or 48K RAM...  
full-size moving-  
key keyboard...  
colour and sound...  
high-resolution  
graphics...**

**From only  
£125!**

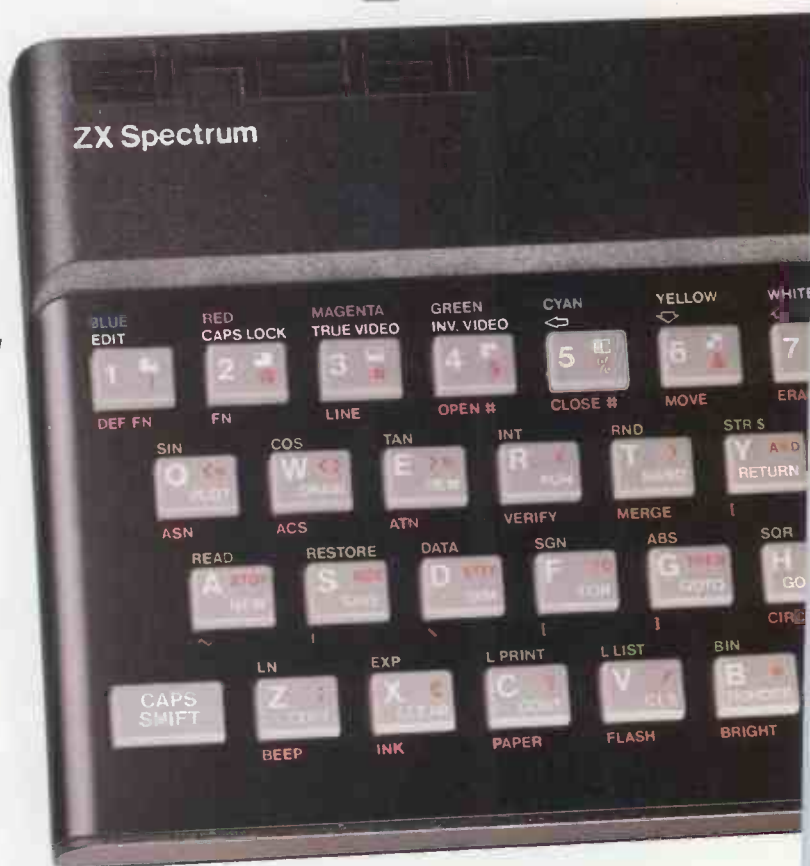

First, there was the world-beating Sinclair ZX80. The first personal computer for under £100.

Then, the ZX81. With up to 16K RAM available, and the ZX Printer. Giving more power and more flexibility. Together, they've sold over 500,000 so far, to make Sinclair world leaders in personal computing. And the ZX81 remains the ideal low-cost introduction to computing.

Now there's the ZX Spectrum! With up to 48K of RAM. A full-size moving-key keyboard. Vivid colour and sound. High-resolution graphics. And a low price that's unrivalled.

## **Professional power— personal computer price!**

The ZX Spectrum incorporates all the proven features of the ZX81. But its new 16K BASIC ROM dramatically increases your computing power.

You have access to a range of 8 colours for foreground, background and border, together with a sound generator and high-resolution graphics.

You have the facility to support separate data files.

You have a choice of storage capacities (governed by the amount of RAM). 16K of RAM (which you can upgrade later to 48K of RAM) or a massive 48K of RAM.

Yet the price of the Spectrum 16K is an amazing £125! Even the popular 48K version costs only £175!

You may decide to begin with the 16K version. If so, you can still return it later for an upgrade. The cost? Around £60.

## **Ready to use today, easy to expand tomorrow**

Your ZX Spectrum comes with a mains adaptor and all the necessary leads to connect to most cassette recorders and TVs (colour or black and white).

Employing Sinclair BASIC (now used in over 500,000 computers worldwide) the ZX Spectrum comes complete with two manuals which together represent a detailed course in BASIC programming. Whether you're a beginner or a competent programmer, you'll find them both of immense help. Depending on your computer experience, you'll quickly be moving into the colourful world of ZX Spectrum professional-level computing.

There's no need to stop there. The ZX Printer—available now—is fully compatible with the ZX Spectrum. And later this year there will be Microdrives for massive amounts of extra on-line storage, plus an RS232/network interface board.



## **Key features of the Sinclair ZX Spectrum**

- Full colour—8 colours each for foreground, background and border, plus flashing and brightness-intensity control.
- Sound—BEEP command with variable pitch and duration.
- Massive RAM—16K or 48K.
- Full-size moving-key keyboard— all keys at normal typewriter pitch, with repeat facility on each key.
- High-resolution—256 dots horizontally x 192 vertically, each individually addressable for true high-resolution graphics.
- ASCII character set—with upper- and lower-case characters.
- Teletext-compatible—user software can generate 40 characters per line or other settings.
- High speed LOAD & SAVE—16K in 100 seconds via cassette, with VERIFY & MERGE for programs and separate data files.
- Sinclair 16K extended BASIC— incorporating unique 'one-touch' keyword entry, syntax check, and report codes.

# um



## The ZX Printer – available now

Designed exclusively for use with the Sinclair ZX range of computers, the printer offers ZX Spectrum owners the full ASCII character set – including lower-case characters and high-resolution graphics.

A special feature is COPY which prints out exactly what is on the whole TV screen without the need for further instructions. Printing speed is 50 characters per second, with 32 characters per line and 9 lines per vertical inch.

The ZX Printer connects to the rear of your ZX Spectrum. A roll of paper (65ft long and 4in wide) is supplied, along with full instructions. Further supplies of paper are available in packs of five rolls.



## The ZX Microdrive – coming soon

The new Microdrives, designed especially for the ZX Spectrum, are set to change the face of personal computing.

Each Microdrive is capable of holding up to 100K bytes using a single interchangeable microflop.

The transfer rate is 16K bytes per second, with average access time of 3.5 seconds. And you'll be able to connect up to 8 ZX Microdrives to your ZX Spectrum.

All the BASIC commands required for the Microdrives are included on the Spectrum.

A remarkable breakthrough at a remarkable price. The Microdrives are available later this year, for around £50.



## RS232 / network interface board

This interface, available later this year, will enable you to connect your ZX Spectrum to a whole host of printers, terminals and other computers.

The potential is enormous. And the astonishingly low price of only £20 is possible only because the operating systems are already designed into the ROM.

# ZX Spectrum

Available only  
by mail order  
and only from

# sinclair

Sinclair Research Ltd,  
Stanhope Road, Camberley,  
Surrey, GU15 3PS.  
Tel: Camberley (0276) 685311.

## How to order your ZX Spectrum

BY PHONE – Access, Barclaycard or Trustcard holders can call 01-200 0200 for personal attention 24 hours a day, every day. BY FREEPOST – use the no-stamp needed coupon below. You can pay by cheque, postal order, Barclaycard,

Access or Trustcard.

EITHER WAY – please allow up to 28 days for delivery. And there's a 14-day money-back option, of course. We want you to be satisfied beyond doubt – and we have no doubt that you will be.

To: Sinclair Research, FREEPOST, Camberley, Surrey, GU15 3BR.

Order

| Qty | Item                                   | Code | Item Price<br>£ | Total<br>£ |
|-----|--|------|-----------------|------------|
|     | Sinclair ZX Spectrum – 16K RAM version | 100  | 125.00          |            |
|     | Sinclair ZX Spectrum – 48K RAM version | 101  | 175.00          |            |
|     | Sinclair ZX Printer                    | 27   | 59.95           |            |
|     | Printer paper (pack of 5 rolls)        | 16   | 11.95           |            |
|     | Postage and packing: orders under £100 | 28   | 2.95            |            |
|     | orders over £100                       | 29   | 4.95            |            |
|     |  |      | Total £         |            |

Please tick if you require a VAT receipt

\*I enclose a cheque/postal order payable to Sinclair Research Ltd for £ \_\_\_\_\_

\*Please charge to my Access/Barclaycard/Trustcard account no. \_\_\_\_\_

\*Please delete/complete as applicable

Signature \_\_\_\_\_

PLEASE PRINT

Name: Mr/Mrs/Miss \_\_\_\_\_

Address \_\_\_\_\_

PCW 810

FREEPOST – no stamp needed. Prices apply to UK only. Export prices on application.

# ZX Spectrum software: how good and how soon?

The ZX Spectrum uses an enhanced version of Sinclair BASIC, fast becoming a world standard, and unlikely to be superseded. Unique features, such as one-touch keyword entry and syntax check and report, are increasingly attracting software originators.

Building the software library is already far advanced, and a complete catalogue will be available in the next few months. Subjects will include sophisticated games, education, 'housekeeping', and business management. The more complex packages can, of course, be used to their best advantage with the full 48K RAM version of the ZX Spectrum.



The Sinclair ZX Spectrum can handle sophisticated games programs with high-resolution colour graphics and sound.



This major advance in computer technology maintains Britain's world-beating position in the field of personal computers.

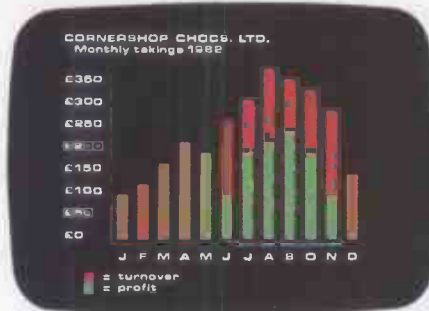

A range of business software will soon be available, covering both specific applications (eg stock-control and payroll) and general business management systems (eg matrix models).



This second generation of Sinclair personal computers demonstrates continuing commitment. Advanced technology made the ZX80/81 family a price breakthrough; advanced technology makes the ZX Spectrum a breakthrough in price and performance.

## Elegant, effective, unique—the ZX Spectrum design.

**'Less than half the price of its nearest competitor – and more powerful.'**

'These two pictures show how it's done. On the right is the PCB from the BBC Model A Microcomputer. On the left is the PCB from the ZX Spectrum.

'It's obvious at a glance that the design of the Spectrum is more elegant.

What may not be so obvious is that it also provides more power.

'The ZX Spectrum has more usable RAM, and higher maximum RAM.

'It offers twice as many colours on the screen at any one time, plus a colour brightness control. It also offers user-definable graphics.

'It has data transfer rate 25% faster,

supported by a VERIFY facility.

'And it employs a dialect of BASIC (Sinclair BASIC) already in use in over 500,000 computers worldwide.

'We believe the BBC make the world's best TV programmes – and that Sinclair make the world's best computers!'

– Clive Sinclair.

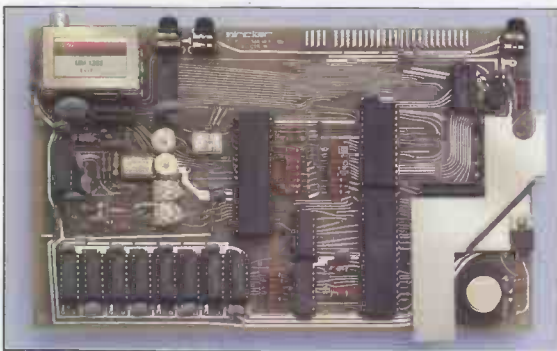

Above left: internal layout of Sinclair ZX Spectrum.

Right: Internal layout of BBC Micro Model A.

The illustrations are to the same scale, and demonstrate the rate of advance in microcomputer design. The ZX Spectrum uses just 14 chips to provide more power and more user-available RAM.

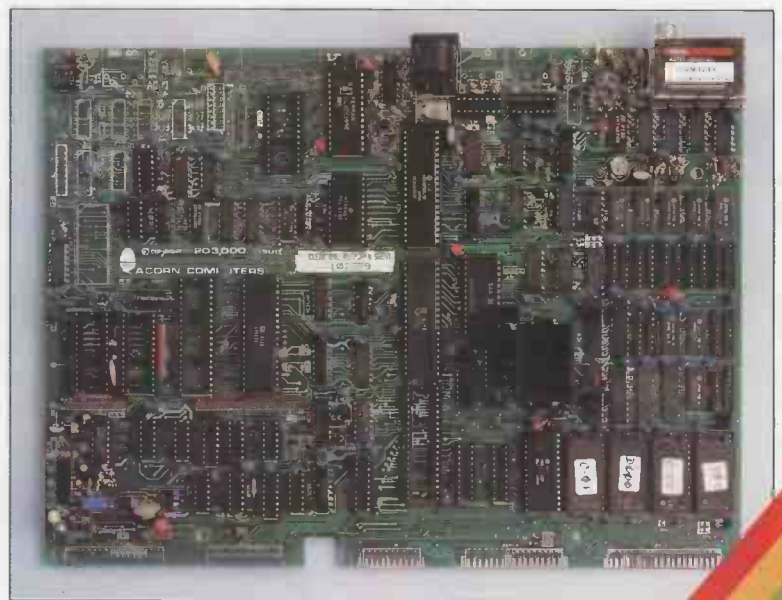

# sinclair ZX Spectrum



# COMPUTECH for apple

## Authorised dealer, service centre and system consultancy

**SPECIALISTS IN SELECTING THE RIGHT SYSTEM AND THE RIGHT SOFTWARE FOR YOUR APPLICATION**

**DON'T DELAY**

**CONTACT COMPUTECH**

**FOR APPLE II AND APPLE /// SYSTEMS**

**AND**

**COMPUTECH FINANCIAL ACCOUNTING PACKAGES**

|                                      |           |
|--------------------------------------|-----------|
| Payroll                              | £375      |
| Invoicing and Stock Recording        | £295      |
| Sales, Purchases and General Ledgers | each £295 |

**PLUS**

**COMPUTECH UTILITIES DISK** £20

for reliable error checking copying, diskette scan, interpret and patch, etc.

**COMPUTECH CHAIN MAIL** £45

a mailing merging document processor which may be used with text files, including random files and Applewriter 1.1 binary files.

**COMPUTECH GRAPHICS DISK** £30

for printing Apple pictures and graphs on Epson and Microline (free with printers purchased from Computech).

**COMPUTECH TERMINAL UTILITIES** from £130

Apple to Apple or Apple to Mainframe.

**ALSO**

Visicalc, Applewriter and other Apple Software (Prices on request)

### COMPUTECH HARDWARE

|   |                  |
|---|------------------|
| DIPLOMAT Video Digitiser - store a frame from a video camera in a fiftieth of a second, process and print images. | £195             |
| DIPLOMAT Parallel Interface   | £80              |
| DIPLOMAT High Speed Serial Communications Interface   | £85              |
| DIPLOMAT RAM 16 Memory Expansion  | £95              |
| DIPLOMAT Clock/Calender   | £80              |
| Lower Case Character Generators including Applewriter enhancements  | £50              |
| MICROMUX Data Exchange (Max 16 Ports)   | from £850        |
| MAXTRIX Printers, Microline and Epson with graphics and up to 200 cps   | from £230        |
| Microline Optional Character Generators   | £15              |
| DAISY WHEEL Printers, Olympia, Qume, Ricoh, etc.  | from under £1000 |

*Prices exclude VAT, Carriage and Packing. Trade enquiries welcome.*

**FOR FULL DETAILS PHONE FOR COMPUTECH'S PRODUCTS AND PRICES PACK AND A FREE DEMONSTRATION**

Apple National Accounts Dealer

We provide quality service and support to small businesses and to major national and international organizations and government departments.

# COMPUTECH SYSTEMS

168, Finchley Road, London NW3 6HP. Tel: 01-794 0202

AGENTS THROUGHOUT THE UK AND OVERSEAS

# MPI MICRO COMPUTER PRODUCTS

INTERNATIONAL LTD.

## SOFTWARE FOR CP/M COMPUTERS

### BYROM SOFTWARE

|  | Software & Manual | Manual Only |
|--|-------------------|-------------|
| BSTAM—Utility to link one micro-computer to another also using BSTAM | £106              | £7          |
| BSTMS—Utility to link a micro to a mini or mainframe                 | £106              | £12         |

### CP/M USER LIBRARY

|                                  |     |    |
|----------------------------------|-----|----|
| 51 Volumes—Price per volume      |     |    |
| 8" disc (one volume per disc)    | £5  |    |
| 5" disc (one volume per 2 discs) | £10 |    |
| Index                            |     | £2 |

### DIGITAL RESEARCH

|               |      |     |
|---------------|------|-----|
| CBASIC v 2.08 | £72  | £15 |
| CB-80 1.3     | £295 | £19 |
| MPM 1.1       | £130 | £20 |
| MPM 2.0       | £273 | £33 |
| CP/M-86       | £161 | £30 |
| CP/M 2.2      | £97  | £22 |
| CP/NET        | £120 | £16 |
| XLT86         | £89  | £7  |
| SID 1.4       | £47  | £16 |
| ZSID 1.4      | £61  | £16 |
| MAC           | £58  | £16 |
| TEX 3.0       | £61  | £16 |
| DESPOOL       | £29  | £7  |
| PL/1-80       | £298 | £30 |
| BT-80         | £156 | £22 |

### FOX & GELLER

|                              |      |     |
|------------------------------|------|-----|
| QUICKSCREEN FOR DBASE-II     | £97  | £13 |
| QUICKSCREEN FOR CBASIC/CB-80 | £97  | £13 |
| QUICKSCREEN FOR MBASIC       | £97  | £13 |
| QUICKCODE FOR DBASE-II       | £172 | £20 |

### INFORMATION UNLIMITED

|                                      |     |  |
|--------------------------------------|-----|--|
| WHATSIT (Database Management System) | £80 |  |
|--------------------------------------|-----|--|

### KLH SYSTEMS

|                              |     |    |
|------------------------------|-----|----|
| Spooler for CPM systems v3.0 | £78 | £7 |
|------------------------------|-----|----|

### MAGIC CIRCLE SOFTWARE

|         |      |  |
|---------|------|--|
| CPM SIM | £133 |  |
|---------|------|--|

### MPI LTD.

|                    |       |     |
|--------------------|-------|-----|
| FORTH              | £80   | £22 |
| PAYROLL            | £500  | £15 |
| SALES LEDGER       | £200  | £15 |
| PURCHASE LEDGER    | £200  | £15 |
| NOMINAL LEDGER     | £200  | £15 |
| INCOMPLETE RECORDS | £1200 | £20 |

### MICRO-AP

|                |      |     |
|----------------|------|-----|
| SELECTOR-V 1.6 | £306 | £28 |
|----------------|------|-----|

### MICROFOCUS

|                       |      |     |
|-----------------------|------|-----|
| CIS COBOL version 4.5 | £425 | £25 |
| FORMS 2               | £110 | £10 |

### MICROLOGY

|  |     |  |
|--|-----|--|
| FTNUMB (FORTRAN-80 RENUMBER & REFORMATTER) | £50 |  |
|--|-----|--|

### MICROPRO INC.

|                                    |      |     |
|------------------------------------|------|-----|
| WORD-MASTER 1.7A                   | £83  | £24 |
| TEX-WRITER 2.6                     | £41  | £19 |
| WORDSTAR 3.0                       | £278 | £42 |
| MAIL MERGE 3.0 (requires Wordstar) | £83  | £11 |
| SPELLSTAR 1.2 (requires Wordstar)  | £139 | £11 |
| WORDSTAR TRAINING MANUAL           |      | £20 |
| WORDSTAR CUSTOMIZATION NOTES       | £56  |     |
| SUPER-SORT 1.6: Version 1          | £139 | £24 |
| DATASTAR 1.101                     | £195 | £28 |
| DATASTAR CUSTOMIZATION NOTES       | £56  |     |
| CALCSTAR 1.2                       | £167 | £28 |

### APPLE VERSIONS

|                                   |      |     |
|-----------------------------------|------|-----|
| WORDSTAR 3.0                      | £209 | £41 |
| MAILMERGE 3.0 (requires Wordstar) | £70  | £11 |
| SPELLSTAR 1.2 (requires Wordstar) | £109 | £11 |
| DATASTAR 1.101                    | £165 | £28 |
| SUPERSORT 1.6                     | £111 | £27 |
| CALCSTAR 1.2                      | £109 | £28 |

### MICROTECH EXPORTS

|             |      |     |
|-------------|------|-----|
| REFORMATTER |      |     |
| CPM ↔ IBM   | £109 | £19 |
| CPM ↔ DEC   | £109 | £19 |

### MICROSOFT INC.

|                    |      |  |
|--------------------|------|--|
| BASIC-80 5.21      | £206 |  |
| BASIC Compiler 5.3 | £228 |  |
| FORTAN-80 3.44     | £289 |  |
| COBOL-80 4.60      | £423 |  |
| M/SORT 1.012       | £83  |  |
| EDIT-80 2.02       | £72  |  |
| MACRO-80 3.43      | £117 |  |
| MULISP 2.12        | £117 |  |
| MUMATH 2.12        | £145 |  |

### MT MICROSYSTEMS

|                                   |      |     |
|-----------------------------------|------|-----|
| PASCAL MT+ 5.5                    | £195 | £28 |
| PASCAL MT+ 5.5 with SPP           | £281 | £56 |
| Library Sources                   | £122 |     |
| Speed Programming Pkge. (Softbus) | £139 | £28 |

### OSBORNE & ASSOCIATES

|  |     |     |
|--|-----|-----|
| ACCOUNTS PAYABLE & ACCOUNTS RECEIVABLE | £50 | £15 |
| GENERAL LEDGER                         | £50 | £15 |

### PHOENIX SOFTWARE ASSOCIATES (For Z80 only)

|                                     |      |     |
|-------------------------------------|------|-----|
| PLINK—Disc to disc link loader      | £80  | £17 |
| PASM—Macro Assembler                | £80  | £17 |
| PEDIT—Line editor with Macros       | £80  | £17 |
| BUG—Very powerful debug             | £80  | £17 |
| PDEVELOP Package with all the above | £215 | £37 |
| PLINK—2 Overlay Link Loader         | £206 | £17 |

### STRUCTURED SYSTEMS (All converted to UK Standard)

|   |      |     |
|---|------|-----|
| SALES LEDGER                            | £350 | £20 |
| PURCHASE LEDGER                         | £350 | £20 |
| NOMINAL LEDGER                          | £350 | £20 |
| STOCK CONTROL                           | £350 | £20 |
| LETTERIGHT                              | £106 | £12 |
| ANALYST                                 |      |     |
| (File management Reporting System)      | £139 | £12 |
| NAD (Name and Address selection system) | £61  | £12 |
| QSORT                                   | £61  | £12 |

### SUPERSOFT INC.

|               |     |     |
|---------------|-----|-----|
| DIAGNOSTICS 1 | £50 | £10 |
| TERM          | £80 | £8  |

### TDL SOFTWARE (Technical Design Labs)

|                           |     |  |
|---------------------------|-----|--|
| BUSINESS BASIC            | £80 |  |
| ZTEL (Text Editing Lang.) | £35 |  |
| LINKER                    | £35 |  |

## NEW PRODUCTS

|                                       |      |     |
|---------------------------------------|------|-----|
| <b>ANTHONY ASHPITEL TYPING TUTORS</b> |      |     |
| BASIC VERSION                         | £150 |     |
| BUSINESS VERSION                      | £125 | £25 |
| <b>SAPPHIRE SYSTEMS</b>               |      |     |
| MARS                                  | £400 | £25 |
| <b>FOX &amp; GELLER QUICKCODE</b>     | £180 | £21 |
| <b>MICROFOCUS LTD.</b>                |      |     |
| ANIMATOR                              | £225 | £10 |
| FILESARE                              | £250 | £20 |
| <b>M.P.I. LTD.</b>                    |      |     |
| MATHS PACK                            | £120 |     |
| STATS PACK                            | £120 |     |
| <b>ELECTRONIC ACCOUNTING SERVICES</b> |      |     |
| LINEAR & GOAL PROGRAMMING             | £200 | £10 |

## ORDER INFORMATION

When ordering CP/M software please specify the format you require. All software items are subject to VAT. Manuals, when purchased separately, are not subject to VAT. Please add £4.00 (including VAT) for postage and packing on each item purchased. For overseas please add £6.50 per item. Most software in this advertisement is available from stock and a 72 hour return service is thereby offered on most orders. These details and prices are all current as of July 1982. Our prices reflect an exchange rate of U.S. \$1.80 to £1.00. All payments must be in Sterling and drawn against a U.K. bank.

MAIL ORDER - TELEPHONE ORDER - VISIT - Send Cash, Cheque, Postal Order, IMO, Access or Barclaycard/Visa number to Microcomputer Products International LTD., Room PCW 8, Cambridge House, Cambridge Road, Barking, Essex IG11 8NT.

## MEDIA AND FORMATS

Altos  
 APPLE CP/M-80 13 Sector  
 APPLE CP/M-80 16 Sector  
 Blackhawk Micropolis Mod II  
 British Micros Mimi  
 California Computer Sys 8 In  
 CDS Versatile 4  
 Columbia Data Products 8 In  
 Comart Communicator CP50  
 Comart Communicator CP100  
 Comart Communicator CP200  
 Comart Communicator CP500  
 Compal-80

CPT 8000  
 Cromemco System 3  
 Cromemco System 2 SD/SS  
 Cromemco System 2 DD/SS  
 CSSN Backup  
 A1 Datapoint 1550/2150  
 RG Dec VT 180 SSDD  
 RR Delta Systems  
 Q2 Dynabyte DB8/4  
 RK Exidy Sorcerer + CP/M-80  
 A1 Exidy Sorcerer + Exidy CP/M-80  
 Q2 EXO  
 A1 Gemini Galaxy I  
 P2 Heath H8 + H47  
 P2 Hewlett-Packard 125.8In  
 P2 ICOM 3712  
 P2 IMSAI VDP-80  
 Q2 Industrial Microsystems 5000

A1 Industrial Microsystems 8000  
 A1 Intel MD5 SD  
 R6 Intertec Superbrain SSDD  
 RX Intertec Superbrain QD  
 T1 ISC Intercolor 8063/8360/8963  
 A1 ITT 3030 DSDD  
 RV Micromation  
 A1 Micropolis Mod II  
 A1 Morrow Discus  
 Q2 Mostek  
 A1 Multi-Tech 1  
 A1 Multi-Tech 2  
 NI Micromation  
 A1 Micropolis Mod II  
 A1 Morrow Discus  
 A1 Mostek  
 A1 Nascom (Gemini Drives SSDD)  
 RA Nascom (Gemini Drives DSDD)

A1 Nascom/Lucas  
 A1 NCR 8140/9010  
 RK NNC-80  
 RS NNC-80W  
 A1 North Star Advantage  
 R1 North Star Horizon SSDD  
 A1 North Star Horizon SSDD  
 Q2 North Star Horizon QD (MPI CP/M)  
 A1 North Star Horizon QD  
 A1 (Other CP/M)  
 Q2 Nylac Micropolis Mod II  
 Q2 Osborne-I  
 A1 Pertec PCC 2000  
 Q2 Rade 1000 SSDD  
 A1 Rade 1000 DSDD  
 A1 Rair, Black Box  
 R3 Research Machines 5.25In  
 R7 Research Machines 8In

N1 SD Systems 5.25In  
 A1 SD Systems 8In  
 A1 Shelton Signet  
 A1 Spacebyte  
 P2 Tarbell 8In  
 P1 TEI 8In  
 P2 Televideo DSDD  
 P3 Toshiba T200 DSDD  
 TRS-80 Modell - Shuffle-  
 board 8In  
 P2 TRS-80 Modell II  
 RP Vector MZ  
 A1 Vector Systems 2800  
 RL Vector Systems B  
 RM Vector VIP  
 RE Xerox 820 5.25In  
 RN Xerox 820 8In  
 A1

# 2

## MORE GOOD REASONS TO RING 01-591 6511

### TYPING TUTOR

by ANTHONY ASHPITEL

A terrific way to learn touch typing! This 'TYPING TUTOR' is an effective teaching tool for correct and speedy typing. Many, many practical exercises which gradually increase in difficulty and speed so the learner builds up his or her skills in a solid and sustained manner.

Can you really bypass this new package? For a demonstration and discussion visit Anthony Ashpitel who will be on our stand at the coming PCW Exhibition.

There are two versions: The BASIC VERSION is a stand alone package. The BUSINESS VERSION includes a fully documented training manual and also incorporates full records of each student's development in relation to his or her own progress and the progress of the rest of the class, so effective comparisons can be made in a useful and helpful way.

BASIC VERSION £ 50  
BUSINESS VERSION £ 125



### MARS

HAVE YOU HAD A CLOSE ENCOUNTER OF THE 4th KIND (Financial Headache)? THEN CONTACT WITH MARS WILL SMOOTH YOUR ACCOUNTING FUTURE. MAY THE MPI FORCE BE WITH YOU!

MAIL ORDER  
TELEPHONE  
CREDIT CARD ORDER  
• VISIT •

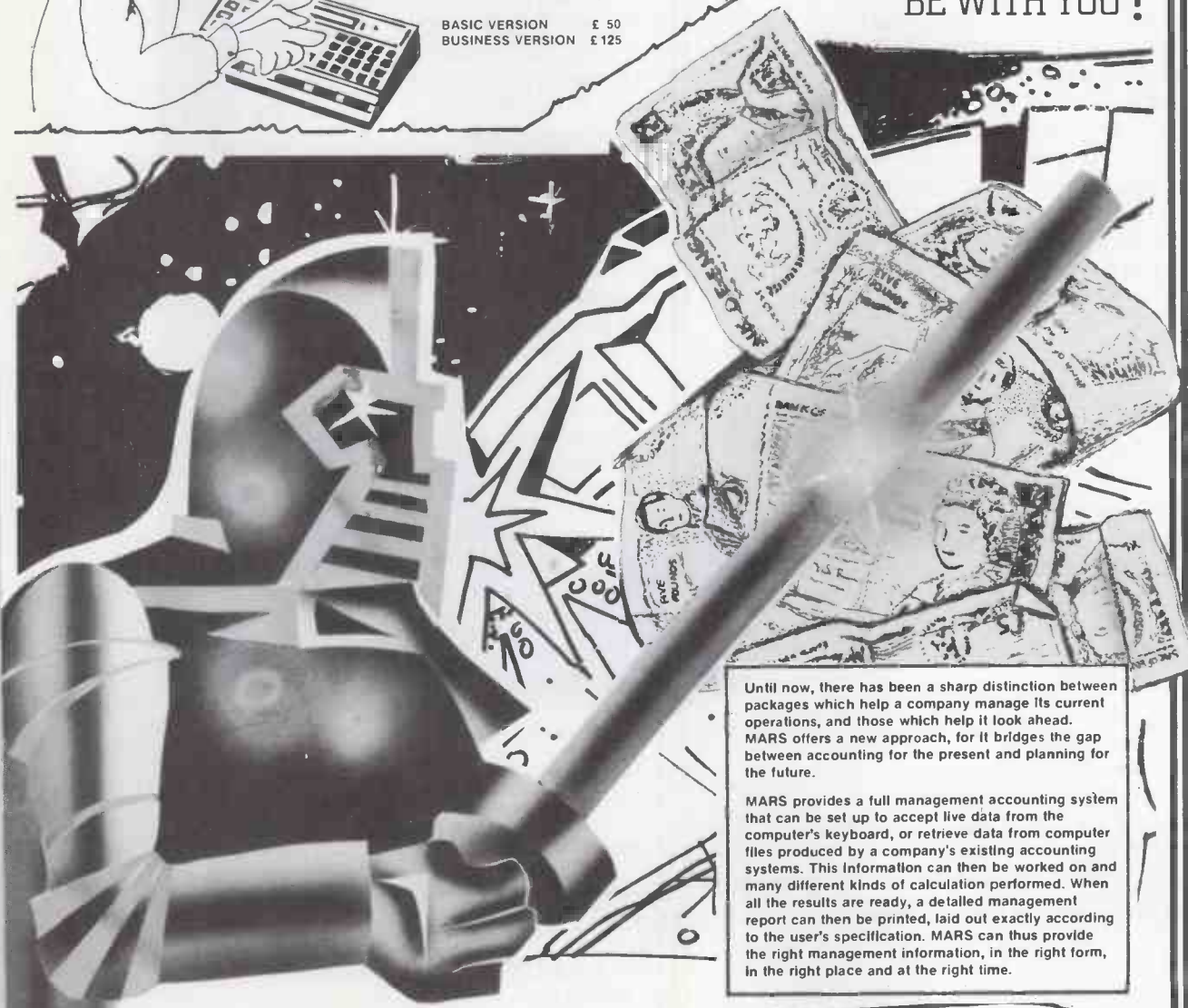

Until now, there has been a sharp distinction between packages which help a company manage its current operations, and those which help it look ahead. MARS offers a new approach, for it bridges the gap between accounting for the present and planning for the future.

MARS provides a full management accounting system that can be set up to accept live data from the computer's keyboard, or retrieve data from computer files produced by a company's existing accounting systems. This information can then be worked on and many different kinds of calculation performed. When all the results are ready, a detailed management report can then be printed, laid out exactly according to the user's specification. MARS can thus provide the right management information, in the right form, in the right place and at the right time.

Trade Enquiries Welcome

# Could Your Business Profit From Another Financial Director?

- Our one works - not only twenty times faster - but doesn't make any mistakes.
- His salary is NIL; doesn't run a car and receives no holiday, sickness or pension contributions.

The role of a financial director covers many areas of financial control, planning and strategy. It also encompasses a vast amount of information preparation - cash flows - projected balance sheets - profit & loss accounts - budgets and plans. This vital information is needed for sound policy and strategic decisions.

The **Financial Director** is a suite of integrated programs which enables those responsible for a company's financial undertakings to see the potential results of their decisions instantly.

Easy to use, the applications of the **Financial Director** are profitable and include:

- The fast production** of Cash Flows, Balance Sheets and Profit and Loss accounts for different eventualities.
- Strategy and Financial Planning** - the ability to see immediately the results and best timing of given financial tactics. e.g. price increases - by item: dropping services or products: fresh capital introduction: effects on loans and interest: tax planning - capital allowances: effects of purchases on pre and after tax profits.
- Anticipate** cash surpluses or short falls.
- New projects** testing their viability and the effect on your business, or part of it.
- Multi-project** - being able to combine and project the results of a number of projects, departments or operating divisions.
- Marketing Tool** - favourably present your business - to Banks - potential partners - at takeover or mergers - the professional presentation and the ease of projecting possible results enhance your bargaining position.

This software program runs on the Commodore Business Micro Computer. A typical complete system which includes software costs less than £4,000.

This very practical tool can be used by any businessman.

The question one most often hears being asked of those having the financial director responsibility is "*What happens to our bottom line when we ...?*"

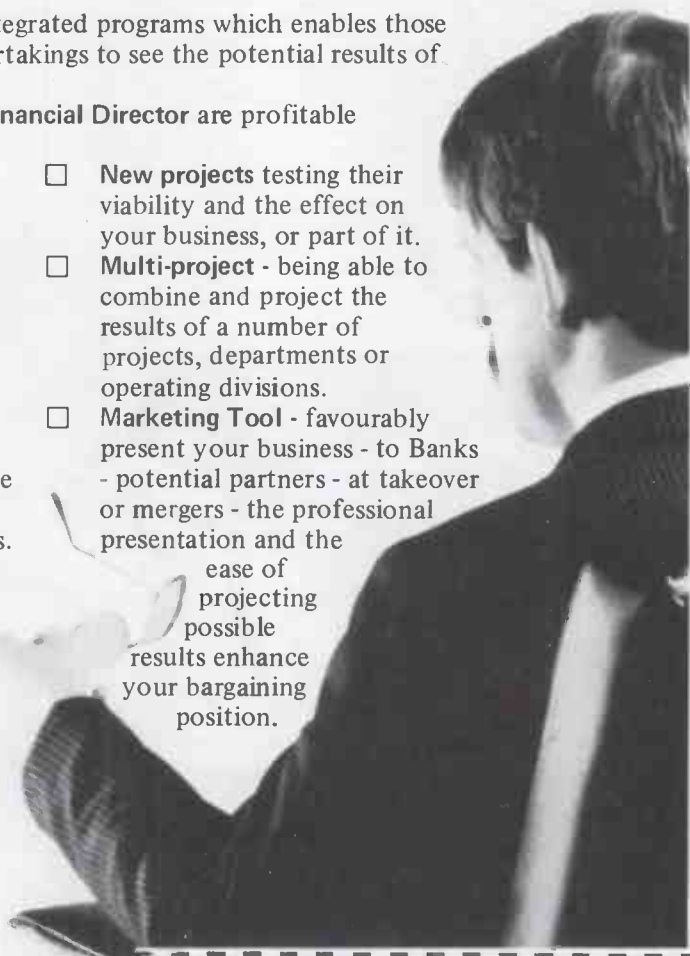

Ring or write to: **Sid Newman**  
 General Manager, Dataview Ltd.,  
 Portreeves House, East Bay,  
 Colchester, Essex. CO1 2XB.  
 Telephone: (0206) 865835 for your nearest stockist.  
 Only available from Approved Dealers

Name \_\_\_\_\_ PCW:3  
 Title \_\_\_\_\_  
 Company \_\_\_\_\_  
 Address \_\_\_\_\_  
 \_\_\_\_\_  
 Tel: \_\_\_\_\_ Telex: \_\_\_\_\_

! We have got a Commodore Micro  
 ! Computer - Yes/No

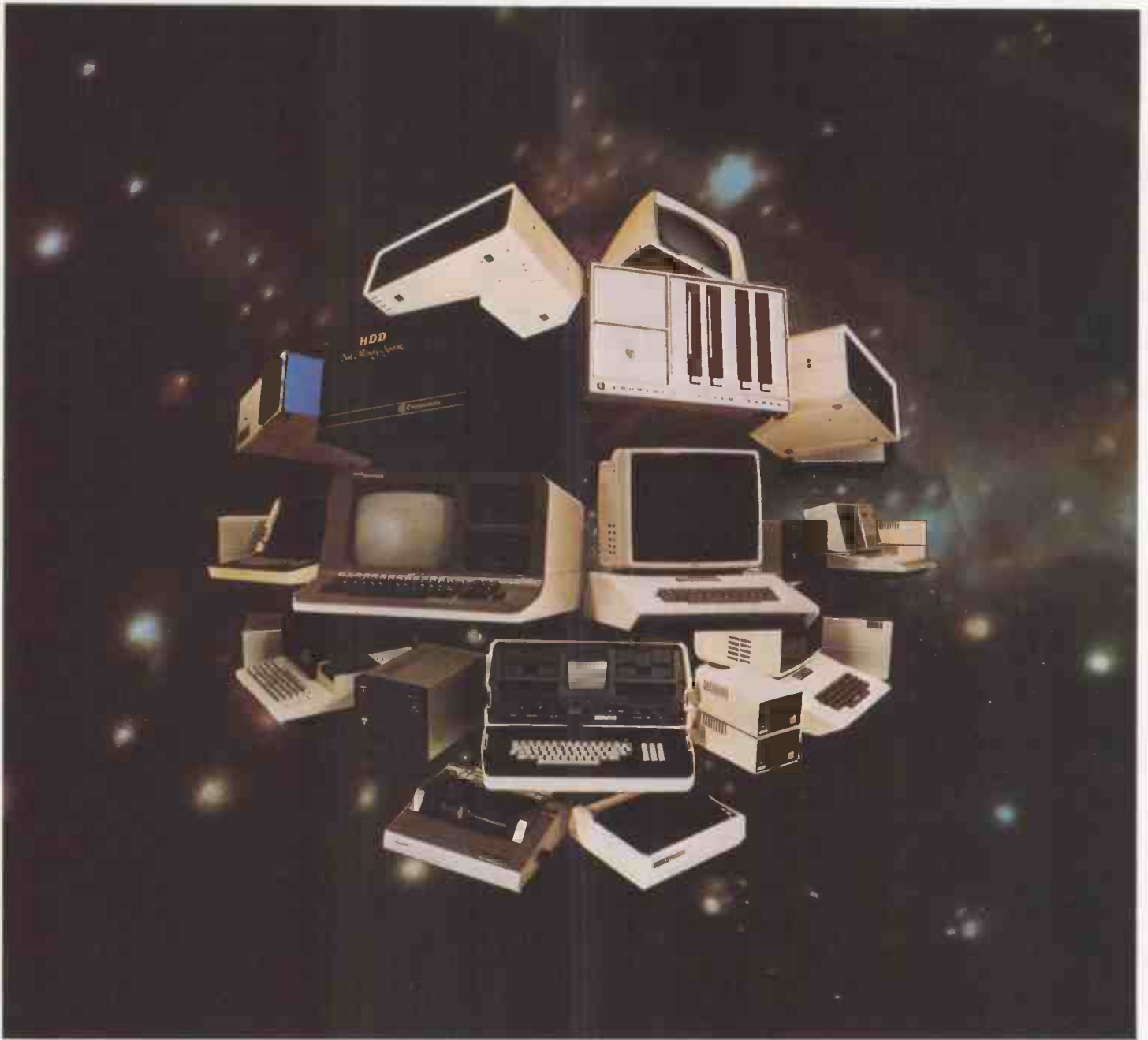

# *The choice is yours...*

Xitan Systems, the South Coast's leading centre for microcomputer hardware and software, offer a choice of over twenty systems from seven major manufacturers.

**apple** Popular desktop computers for personal and small business use.

**comart** Communicator range of sophisticated British S100 business systems.

**commodore** VIC-20, the ideal introduction to computing.

**Cromemco** Computer range for professional use, with numerous options.

## XITAN SYSTEMS

Xitan Systems Limited  
23 Cumberland Place  
Southampton SO1 2BB  
Telephone 0703 38740  
Telex 47388 CHACOM G.

**NorthStar** The Advantage desktop computer with business graphics.

**OSBORNE** The briefcase-sized system that took America by storm: a complete business system in a compact, portable package.

**SHARP** The elegant MZ80B desktop computer, with a range of options.

**XITAN** The essential back-up for every system, Xitan offer unrivalled knowhow in commercial, industrial, educational and scientific microcomputer applications. Xitan's services include system development, hardware and software support, and fast and effective service in the field.

Don't let its size fool you.

If anything NewBrain is like the Tardis.

It may look small on the outside, but inside there's an awful lot going on.

It's got the kind of features you'd expect from one of the really big business micros, but at a price of under £200 excluding VAT it won't give you any sleepless nights.

However, let the facts speak for themselves.

You get what you don't pay for.

NewBrain comes with 24K ROM and 32K RAM, most competitors expect you to make do with 16K RAM.

What's more you can expand all the way up to 2 Mbytes, a figure that wouldn't look out of place on a machine costing ten times as much.

We've also given you the choice of 256, 320, 512 and 640 x 250 screen resolution, whereas most only offer a maximum of 256 x 192.

Big enough for your business.

Although NewBrain is as easy as ABC to use (and child's-play to learn to use) this doesn't mean it's a toy.

Far from it.

It comes with ENHANCED ANSI BASIC, which should give you plenty to get your teeth into.

And it'll also take CP/M® so it speaks the same language as all the big business micros, and feels perfectly at home with their software.

**NO OTHER MICRO  
HAS THIS MUCH  
POWER  
IN THIS MUCH  
SIZE  
FOR THIS MUCH  
MONEY.**



So as a business machine it really comes into its own.

The video allows 40 or 80 characters per line with 25 or 30 lines per page, giving a very professional 2000 or 2400 characters display in all on TV and/or monitor. And the keyboard is full-sized so even if you're all fingers and thumbs you'll still be able to get to grips with NewBrain's excellent editing capabilities.

When it comes to business graphics, things couldn't be easier. With software capabilities that can handle graphs, charts and computer drawings you'll soon be up to things that used to be strictly for the big league.

#### Answers a growing need.

Although NewBrain, with its optional onboard display, is a truly portable micro, that doesn't stop it becoming the basis of a very powerful system.

The Store Expansion Modules come in packages containing 64K, 128K, 256K or 512K of RAM. So, hook up four of the 512K modules to your machine and you've got 2 Mbytes to play with. Another feature that'll come as a surprise are the two onboard V24 interfaces.

With the aid of the multiple V24 module, this allows you to run up to 32 machines at once, all on the same peripherals, saving you a fortune on extras.

The range of peripherals on offer include dot matrix and daisy wheel printers, 9", 12" and 24" monitors plus 5¼" floppy disk drives (100 Kbytes and 1 Mbyte) and 5¼" Winchester drive (6-18 Mbytes).

As we said, this isn't a toy.

#### It doesn't stop here.

Here are a couple of extras that deserve a special mention.

The first, the Battery Module, means you won't be tied to a 13 amp socket. And, even more importantly, it means you don't have to worry about mains fluctuations wreaking havoc with your programs.

The ROM buffer module gives you a freedom of another sort.

Freedom to expand in a big way. It gives you additional ROM slots, for system software upgrades such as the Z80 Assembler and COMAL, 2 additional V24 ports, analogue ports and parallel ports.

From now on the sky's the limit.

#### Software that's hard to beat.

A lot of features you'd expect to find on software are actually built into NewBrain so you don't need to worry about screen editing, maths, BASIC and graphics.

However, if you're feeling practical you can always tackle household management, statistics and educational packages. And because NewBrain isn't all work and no play, there's the usual range of mind-bending games to while away spare time.

#### Waste no more time.

To get hold of NewBrain you need go no further than the coupon at the bottom of the page.

With your order we'll include a hefty instruction manual so you'll know where to start, and a list of peripherals, expansion modules, and software so you'll know where to go next.

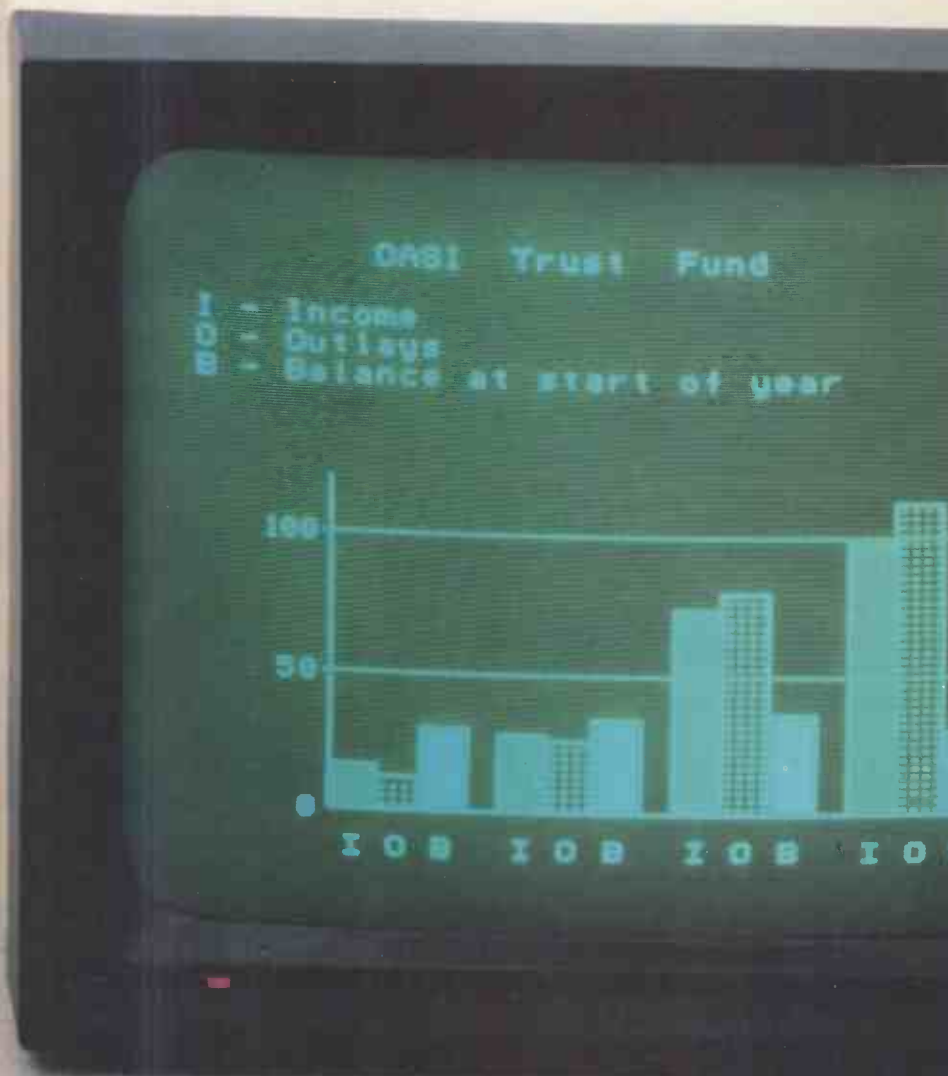

Dealer enquiries invited, please contact:-

NewBrain, Grundy Business Systems Ltd., Grundy House, Somerset Road, Teddington TW11 8TD.

Each NewBrain order will include a FREE comprehensive user manual, a catalogue of expansion modules and peripherals, and a detailed list of available software.

Please send me the following:-

| Quantity | Item   | Price per item<br>(Inc. VAT & p&p) | Total |
|----------|--|------------------------------------|-------|
|          | NewBrain A                                   | £233.00                            |       |
|          | NewBrain AD with onboard single line display | £267.50                            |       |
|          | Printer                                      | £466.00                            |       |
|          | Monitor 12"                                  | £142.50                            |       |
|          |  | Total £                            |       |

I enclose a cheque/Postal Order for £\_\_\_\_\_ payable to Grundy Business Systems Reader Account.  
NewBrain, Grundy Business Systems Ltd., Grundy House, Somerset Road, Teddington TW11 8TD.

Please debit my Access Card No: \_\_\_\_\_ my Barclaycard No: \_\_\_\_\_

Signature \_\_\_\_\_

Name \_\_\_\_\_

Address \_\_\_\_\_

Postcode \_\_\_\_\_ **PCW/10**

Registered Number 1522978  
VAT Number 358661618

# NEWBRAIN

**"If you can buy a business computer package of the same quality at a lower price, I'll buy it for you!"**

**Noel C. May, Managing Director  
Transtec Computers.**

**The Transtec Total Accounting Package costs just £2400 (ex. VAT) and includes . . .**

**The BC2 Computer**

- ★ 800K usable disk storage
- ★ 64K of memory
- ★ 80X25 hi-res. green screen
- ★ CPM 2.2 operating system as standard
- ★ Detachable keyboard with 17 function keys and numeric pad
- ★ In-built facility to expand capacity at any time.

**The Printer**

An Olivetti DM 5050C heavy duty 80 cols. 100 CPS dot matrix printer with capacity to handle single sheet or continuous sprocket fed paper.

**The Software**

Complete "Business Desk" set of programs by Paxton incorporating Invoicing, Stock, Sales, Purchase and Nominal Ledgers - a fully integrated accounting software package.

**Other financial modelling, word processing and data base packages available at low all-in costs.**

To get the full facts  
Contact your local computer dealer or  
Transtec direct.

**13 Small Street, Bristol BS1 1DE.  
Tel. (0272) 277462**

European Plant  
IDA Complex, Macken St., Dublin 2.  
USA - Leading Edge Products Inc.,  
Canton, Mass.

I'm interested, tell me more.

Name,

Address.

Company,



**SIMPLY BETTER COMPUTING**

Trade/USER Enquiry (delete as appropriate)



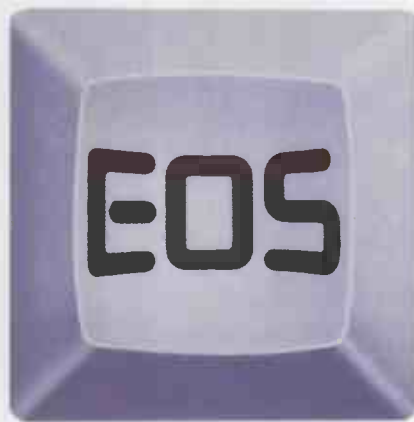

# INFORMATION TECHNOLOGY

# EOS on-line

"What ever is best, wherever it comes from, EOS will try to have it first for the UK." That's the philosophy of Russell Sparkes, Marketing Director of EOS - who turned theory into fact when EOS became the first Distributor to offer UK end users the IBM Personal in quantity.

"The business we are in moves at lightning speed. Every end user knows exactly what is available in various parts of the world... and he wants to get his hands on it today - not at some vague date in the future. My job is to make sure that end users in the UK are not left behind."

Two years ago, Russell Sparkes and his co-director Tony Maclaren moved from a routine office supply business into tomorrow's world of computers. As Dealers in the City of London, they saw how end-users were starved of the latest equipment. In February this year, they made their first buying visit to North America - and in June, signed a contract to bring enough IBM Personals into the UK to meet the immediate demand for this,

---

*"End users want tomorrow's technology in their offices today... EOS aims to get it there."*

---

the world's most up to date micro-computer available.

July 22nd saw the first EOS National Dealer Conference. It was held at The Barbican and attracted more than a hundred would be EOS Dealers and software suppliers.

Within two weeks, more than fifty Dealers nationwide had been accepted into the EOS Dealership Network.

"We look for Dealers with a proven track record and attitudes that show they thoroughly understand the needs of today's businessman. We provide our Dealers with tomorrow's equipment today. We select only the best

---

*"Excellent products... first class dealers... nationwide back-up... that's what EOS is all about."*

---

equipment - and only the most active Dealers."

Sparkes aims to expand his Dealership Network to approximately 100 within the next few months. "We must make sure that every end user in the country has at least an opportunity to test the IBM Personal or any of the other advanced systems we are carrying."



*Russell Sparkes, Marketing Director of EOS.*

In tandem with their Dealership strategy, EOS have chosen General Computer Systems to provide nationwide 24 hours a day servicing and maintenance cover. "In our opinion" says EOS Technical Director Tony Maclaren, GCS offer the best back-up facility available today. They are quick, reliable and up to the second with their knowledge of technology. Added to that, they understand the pressures of today's commerce... so they get the job done."

The EOS Portfolio of hard and software is impressive. Much of it - for example the EOS 7000 three-in-one printer and the newly contracted TIM 111 - is exclusive to EOS.

"All our equipment was on display at the PCW Show at the Barbican"

says Russell Sparkes, "but we wanted to give PCW readers who couldn't get along to the Barbican in early September an opportunity to see something of our product range. In the following pages we have illustrated some of the lines we are offering through our Dealership Network to end users throughout the length and breadth of the country. It is a carefully integrated package of personal computers, memory boards and software... an ever changing Portfolio. We are constantly striving to provide the best, the most reliable and the most up to date.

That's our Company policy. That's the way we intend to continue. Tomorrow's technology today - that's what EOS is really all about."

# Electrohome Colour Monitors



EOS has recently concluded negotiations with Electrohome Limited in Canada to supply their two models of colour monitors with RGB inputs specifically designed for use with personal computers. These are in fact data monitors and are ideal for using with either Apple III or the IBM Personal Computer. There are two models of monitor: the ECM 1302 provides resolution of 370 by 235

pixels and has a 13" screen. With a band width of 6 megahertz it can display 40 characters by 25 lines. The ECM 1302/2 displays 580 by 235 pixels, has a 13" screen and with a 10 megahertz band width can display 80 characters by 25 lines. These monitors provide a very sharp display with vivid colours and no screen distortion. Neatly styled, the new Electrohome colour monitor has an attractive

moulded cabinet and its buff colour ensures that it matches attractively with personal computers such as the IBM and the Apple III. Special leads are supplied to our customers to connect directly to the personal computer of your choice without the need to get involved with awkward wiring problems.

# The small business computer

By Tony Maclaren, Technical Director, EOS

IBM's entry into the personal computer field has been regarded by the industry as one of the most significant developments in the short history of micro computers. To witness the entry of the IBM into the micro computer market place is to witness history being made.

The IBM Personal Computers will have considerable business significance for a whole spectrum of existing and future users of small business computers. The IBM PC is a true 16 bit machine using an Intel 88 microprocessor, offering over twice the memory of traditional 8 bit machines.

I think today, as things are becoming increasingly more complicated in the world of small computers, a buyer will increasingly "buy a company" with all of its reputation, intent and practices. This tendency is part of the excitement about IBM's entry into the market. Buying an IBM in the past, at least for certain products, has been a good investment for many business people. The personal computer industry, like all growing industries, has suffered growing pains. It has come out of an historical hobbies market and one of its chief problems has been the tendency towards putting the low priority items to last, one of which has been documentation for the systems themselves. As the market is becoming more mature and shifting its emphasis towards the business sector, the demand for easy to read professional documentation is becoming increasingly more important.

## Attention to detail.

The fact that IBM's profit before taxes for 1980 was nearly 6 billion dollars - greater than the gross sales of many companies that are recognised as corporate giants - may be in a large measure the reason why IBM's system documentation and tremendous attention to detail is so good in everything connected with the IBM Personal Computer. To the business man the ability to be able to immediately put his new purchase to work for him is extremely important. Time wasted struggling through badly indexed photocopied manuals is simply unacceptable for the modern business professional.

One of the most unusual departures on the part of IBM has been that they have departed from their traditional posture of manufacturing their own components for computers themselves. In the case of the personal computer, IBM went to Tandon for the disk drives, Epson for the printer, Intel for the micro computer chip, Microsoft for the operating system, Information Unlimited Software for the word processing package and VisiCorp for the Visicalc package. This, I feel, to some extent shows how in-

creasingly important it is becoming for standardisation in such things as operating systems and fundamental small computer software packages such as Visicalc. Even the giant IBM has adopted the posture of standardisation which is going to be the key to the survival of all future companies in this highly competitive industry.

## Power

The IBM Personal Computer is now so powerful that in some extents it surpasses the capabilities of main frame computers only a decade ago. For example, the IBM 360 which dominated commercial computing from 1964 through the early 1970's. The 360/40 was used extensively in payroll accounting and stock control applications for companies with several thousand employees. The 360's were housed in huge environ-

mentally controlled rooms, cost \$180,000 for only the 32K model plus \$168 per month maintenance. These machines had a maximum memory of only 262K of RAM compared to 760K on the IBM Personal Computer. The cost of a 262K 360/40 was \$497,000 plus \$383 per month maintenance. The Personal Computer sells for £2,950.

## Speed

As for speed, the CPU of the 360 could access main storage in approximately 2.5 micro seconds compared to the Personal Computer's total storage access and retrieval time of only 600 nanno seconds.

Floppy disk drives for the Personal Computer are up to 200 times faster than the early card readers and punches used on the early 360's. For both pure speed and memory size, the Personal Computer can match one of

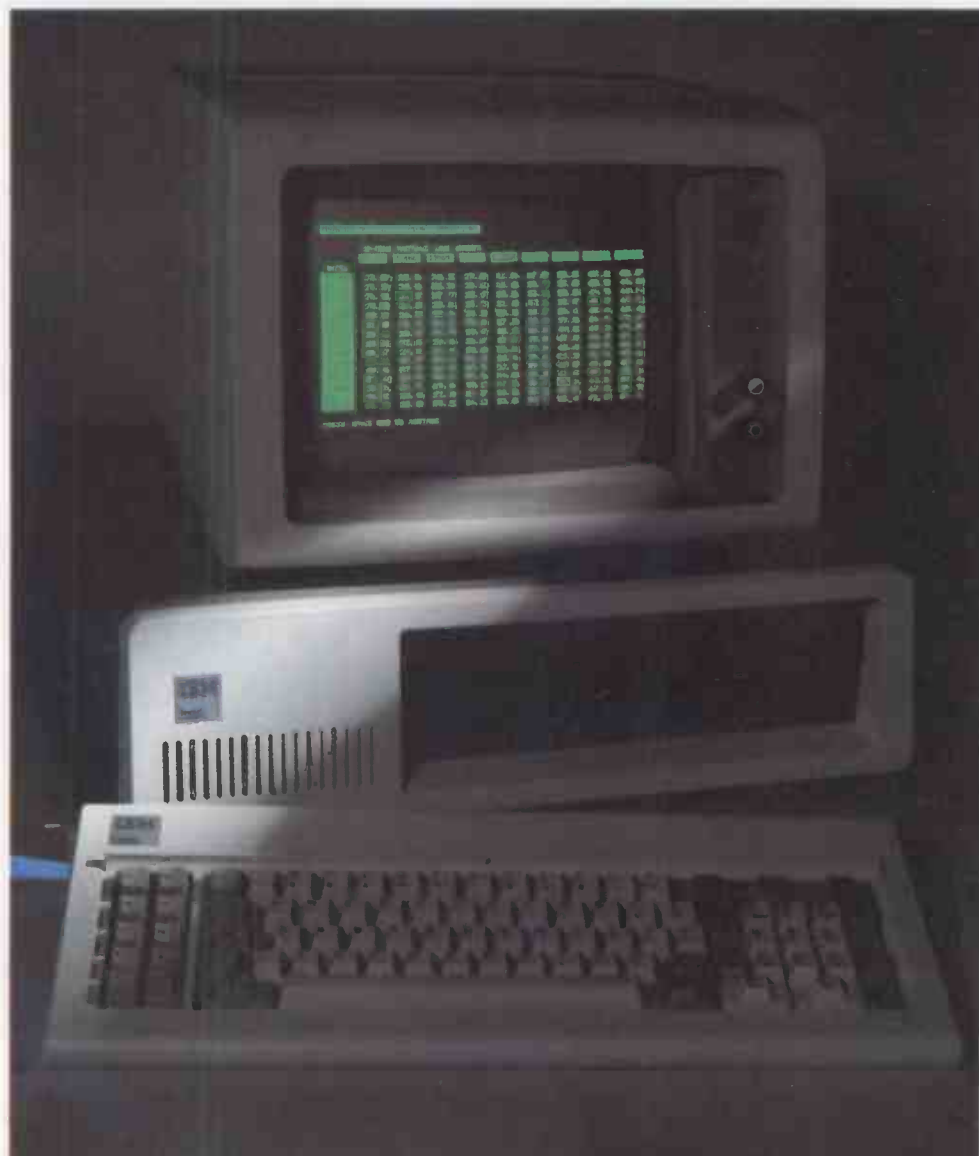

# by the biggest in the business

the most popular and most powerful main-frames of only ten years ago. This is not to say that the Personal Computer's total work capacity is as great as the 360. Actual output is dependent on the speed, number and capacity of peripheral devices such as line printers, hard disks etc. However, even this area has now been challenged by personal computing with the advent of low cost Winchester disk drive technology both increasing in power and decreasing in cost. It seems that no area is safe from the inroads of technology.

## Local work station

In large businesses where there are large amounts of experience with large main-frame computers, the IBM will be used as a local work station for everyday business use in addition to its use as a terminal to the main-frame computer. Even by comparison with very recent 8 bit micro computers, the IBM has made really significant break-throughs in the type of business tasks it can handle. When combined with electronic spread sheet packages such as Supercalc, models of up to 500K can be accommodated and using IBM's colour graphics adaptor and a high resolution RGB monitor such as the Electro-home, it is possible to construct extremely large financial models and get a very high degree of feedback from the system through the clever use of colour display.

Although there is now a small number of 16 bit personal computers coming into the market place, it seems that IBM have given considerable thought to where the next step will come in terms of speed and power requirements. Micro processors can perform thousands of mathematical instructions per second but micro

processors work with only one or two bytes at a time. This limitation restricts the speed at which they can add floating point numbers. Mini computers and main-frames also suffer from this problem. However, they invariably have what is called a floating point processor or a math processor to deal independently with calculating floating point arithmetic. IBM have left an auxiliary socket next to the main processor in their Personal Computer for an Intel 8087 floating point processor to be installed. This will represent a very significant technical advance over even current 16 bit micro computers in that as the tendency becomes more and more for these machines to be used for accounting and business applications, they will be in need for faster arithmetic. For a few hundred pounds an 8087 can be installed which will drastically increase the performance of electronic spread sheets, such as Supercalc, and give a vital performance improvement in many accounting packages, etc., written in high level languages such as BASIC and PASCAL.

## Colour Graphics

Winchester disk drives of the 5¼" size are now so small that they can be fitted inside the IBM PC and this, combined with compiled programs, will give a further increase in speed, performance and capacity. With the colour graphics adaptor IBM have taken an extremely flexible approach. The colour graphics adaptor board can be used not only with a high resolution colour monitor but also with a colour television receiver with a RF modulator and a standard monochrome monitor. The colour graphics adaptor has the same graphics characters as the display printer adaptor but offers two additional

capabilities: coloured characters and individually addressable dots on the video screen (graphics). This board is extremely flexible in that, when used with a colour monitor, it can be used in black and white character mode for packages such as word processing and electronic spread sheets. With the new Supercalc package it can also, of course, be used in colour.

16 colours are possible which are variations on the three primary colours (red, green and blue) and the actual intensity can also be varied. In colour graphics mode 320 dots horizontally by 200 dots vertically is possible. In the high resolution mode-640 by 200.

The IBM is supplied with three operating systems: PC DOS which by any other name is MS DOS by Microsoft, CPM 86 from Digital Research and UCSD/P system from the University of California and San Diego. The IBM is supplied with two basics, standard Microsoft basic and an advanced basic which takes in the special commands for use with IBM's colour graphics adaptor, some of which are extremely useful when creating attractive colour displays. Some of these unique statements are circle, draw, get, paint, put. Under the MS DOS operating system, there are several extremely useful compilers available from Microsoft. These are BASIC, FORTRAN, COBOL AND PASCAL, all of which are two pass compilers producing full machine code. In the short space of time that EOS have been dealing with the IBM Personal Computer, we have seen a really staggering amount of progress in the amount of software available for the machine. New software packages are received in our offices for evaluation at the rate of about two a week.

## Great memories run in our family

Now EOS offers you and your IBM powerful memory-expansion PCBs with up to 512Kb storage per board.

With these versatile add-ons, you can increase your computer's memory to the highest, practical level of current technology - and do it with minimal demands on space and power.

Because only the finest-quality materials and construction go into our multi-layer boards, you are assured of both the lowest signal distortion and the best RFI performance.

Mapping ROM makes set-up fast and easy, with a choice of flexible memory configurations. Our five PCB memories are available

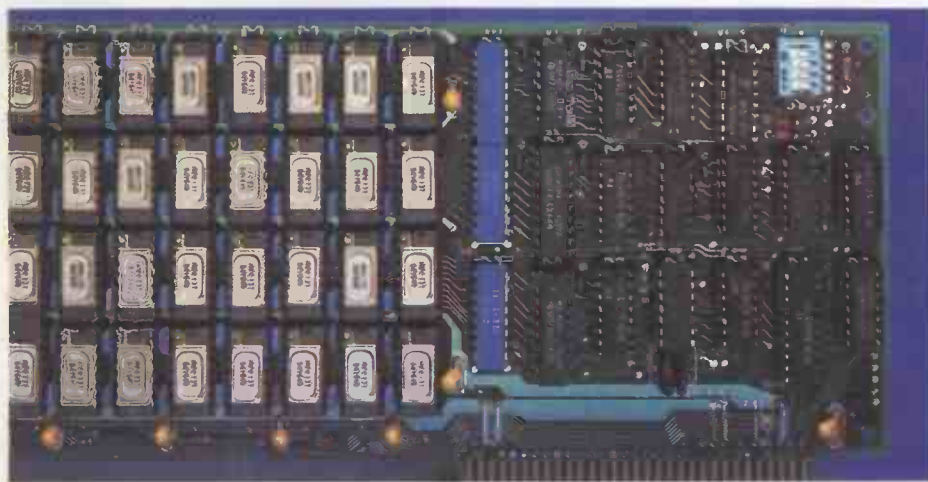

now - in 64, 128, 192, 256 and 512Kb. Each can be obtained in an expandable version.

Whatever your needs may be, you'll find that our "product-family" approach to memory design and

manufacture backs you with total operating-system support - before and after sale.

For complete details on our family's great memories, don't forget to return our coupon.

# Sirius—Britain's best selling 16 bit

The Sirius I is the UK's best selling 16 bit personal computer. It is based on the Intel high speed 8088 microprocessor. The Sirius supports a large range of advanced 16 bit software to take advantage of its unique capabilities.

## Beautifully designed

...the screen tilts and swivels to suit the user and screen glare is eliminated through the use of a special coating. The quality of the display is superb with the ability to display 800 x 400 pixels. Contrast and brightness can be adjusted from the keyboard without the need to reach behind the monitor as was necessary on earlier micros. The best high resolution graphics in the business.

## Massive memory!

Because the Sirius can address directly up to 896K bytes of RAM, plenty of capacity is available for professional business software - the machine is an ideal "data base machine" - EOS offers complete data base solutions from a "user friendly electronic file cabinet" (TIM III) to a full fledged data base management system (MDBS III).

## Larger floppy disks.

Sirius is available as standard with 2 600K disk drives or 2 x 1.2 megabyte drives are available as an option. More than any other comparable personal computer! 5 and 10 megabyte internal Winchester disk drives will be available shortly (probably at PCW). Local area networking is available now from outside suppliers, and ACT plan to announce their own system shortly - more than enough expansion potential as business needs change and develop in the future.

## Sirius speaks.

Sirius offers a revolutionary feature "voice synthesis" using a small microphone messages can be "dictated" to your Sirius, which then stores the message in RAM or on disk for subsequent incorporation into your programs or relayed to another Sirius in another office - or using RS232C coms - anywhere.

## Fabulous software.

Sirius provides a complete range of business software, ACT's PULSAR, TABS, SYSTEMATICS for accounting. Wordstar, Spellstar and Mailmerge for word processing. Supercalc, Multiplan and Micromodeller. There is also SELECT, the only word processor that teaches you how to use it in less than 90 minutes. More than 100 top software companies are

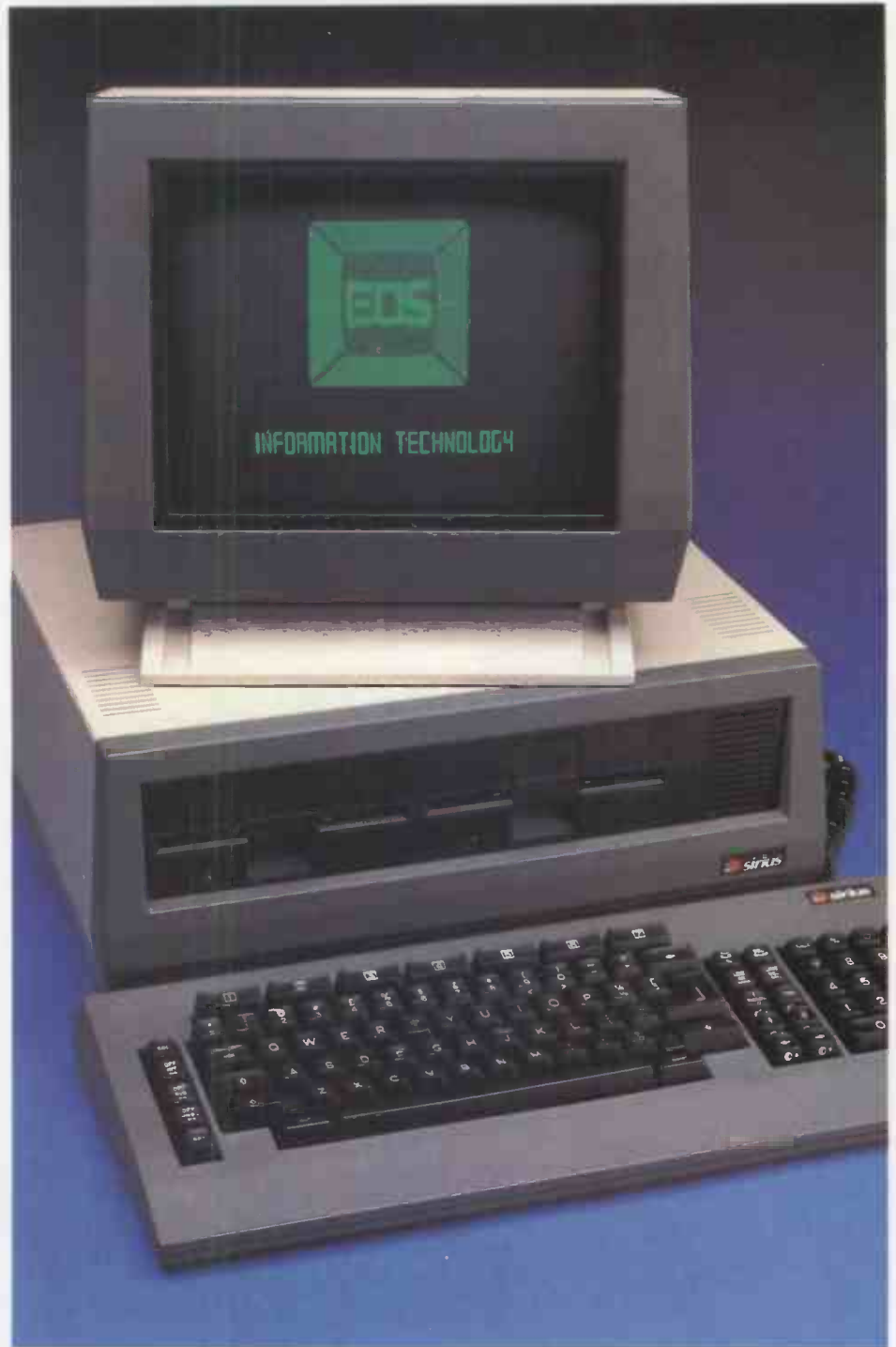

developing specialist software for every business and profession.

## More languages.

The Sirius supports all the new MICROSOFT compilers, BASIC, PASCAL, FORTRAN and COBOL. UCSD PASCAL has also recently been introduced. We have found that this wide variety of BUSINESS languages is why more and more application developers are choosing Sirius.

## Two operating systems as standard.

The Sirius is supplied with two 16 bit operating systems as standard - MS DOS and CP/M 86 with CONCURRENT CP/M 86, the multi-tasking

version, on the way.

## Communications.

Sirius two RS232C ports as standard - both are fully programmable up to 19200 baud. Facilities are also available to communicate with large mainframe computers.

## Peripherals.

EOS can connect the Sirius to almost anything - printers, plotters, digitisers, modems etc. Combined with the EOS 7000 it can dump all the screen graphics out onto the printer. With Supercalc the EOS 7000 can print 272 columns at near letter quality.



# Hello TIM, goodbye filing cabinets

With the exception of spread sheets and financial modelling packages, the area that will undergo the most extensive and rapid development on personal computers will be information management systems. These are also commonly referred to as "data base" packages.

The problem in the past has been that these packages were not "user friendly".

One of the most significant products to appear in this field is TIM III from INNOVATIVE SOFTWARE INC.

## The non-programming approach.

TIM III is a state of the art data base management program, it is written in compiled basic - so it is quick, and because it supports hard disks, it can handle large data bases. Most important of all, TIM III is extremely easy to use. TIM communicates with you on your own terms by using a fully menu driven approach. Just pick what you want from the lists of displayed options. *No programming required.* Help is always available throughout the program, and a clear, well indexed and easy to understand Users Manual is included.

These features combine to make TIM user productive almost immedi-

ately after using the program.

## Word processing interface.

TIM interfaces with Wordstar and Select in both directions, ie TIM files can be put into Wordstar and Wordstar files can be put into TIM.

## A proven system.

Over 3,000 TIM III programs have

been sold on the IBM Personal. TIM is currently available under MS DOS for the Sirius and IBM Personal Computers and all CP/M 2.2 machines.

*Electronic Office Services is the sole distributor for TIM III in the UK.*



Exclusive to EOS, the 7000 3-in-1 Printer is capable of operating in three different modes - fast mode at 180 cps, letter quality at 90 cps and high defini-

tion graphics at 120 dots per inch. The EOS 7000 is available now at the new low price of £1,995.



# CAUSE AND EFFECT

Every day, a new—and frequently unexpected—factor will affect your business...oil, the dollar, the value of sterling, the price of sugar—or copper...whatever your business, something (or someone) will create a situation that calls for a complete recast of targets, budgets and cash flow. Until now, that has meant a lengthy, often labour intensive rethink.

The new version of Supercalc for the IBM Personal Computer represents the latest state of the art of technology in electronic spread sheets, offering up to 512K main memory capability. The largest financial models can be accommodated. The superb colour capability brings a new dimension to electronic spread sheets. Being in the 'red' really does take on a new meaning... if a new figure entered into a cash flow produces a negative cash balance, all these figures appear in red.

One of the new features is the

ability to protect fields so that items which are important are not accidentally erased. Using protective fields enables the author of the spread sheet in question to lay out a mask into which an operator who has no detailed knowledge of the model may input figures for later manipulation.

One of the most useful facilities is the ability to define variable column widths. This enables one to have, for example, a wide column A for inserting titles for the rows, a number of columns for the months of a cash flow at, let us say, 9 characters and a total

column of say 13 characters, allowing complete flexibility. Where the package scores over more well-known products such as Visicalc is the excellent context specific help messages provided.

If the user is unsure when prompted by a selection of mnemonics by the system, he simply types a question mark and immediately receives a more detailed description of the options indicated by the mnemonics. It is also possible to load all or part of a particular work sheet and to output the spread sheet to a disk file which can later be incorporated into a word processing package.

Editing is simplicity itself and it is possible to simply call up a particular entry and insert, delete or modify your entry with a few simple key strokes. Another excellent feature is the ability to insert dotted lines or indeed repeating characters of any type right across the page without the need to replicate cells as was necessary with earlier spread sheet programs.

Tell Supercalc today's price of copper, or how the dollar shifted overnight. It will do the rest for you and keep you totally up to date at the touch of a key.



# WANTED: Top class dealers to join the EOS network

An EOS Dealer has access to tomorrow's technology today. He will be offering his clients the most comprehensive, modern and reliable range of hard and software, much of it exclusive to him through EOS. He can guarantee service and maintenance of the highest order and be assured of full support in terms of advertising and publicity, brochures, posters and mailings. He will also have his own clearly defined geographical territory.

If you wish to be considered for an EOS Dealership, contact:  
Russell Sparkes,  
Marketing Director,  
EOS House,  
29-31 Fleet Lane,  
London EC4M 4YA.  
Telephone: 01-248 6971.

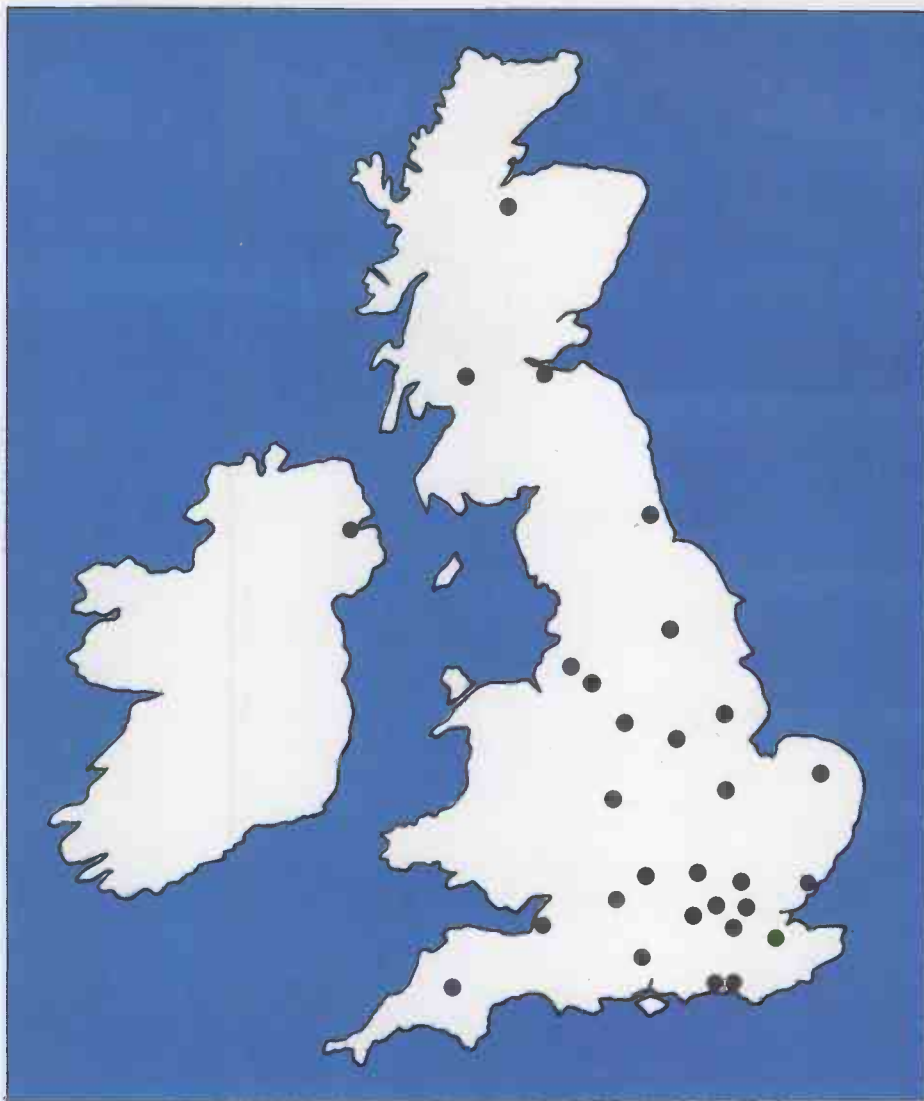

On the previous pages, we have been able to show some of the products from the EOS portfolio of hard and software for today's business applications.

If you would like further information about any of the products shown, please tick the appropriate box(es), and post the coupon to:

EOS, PCW Enquiry, EOS House, 29-31 Fleet Lane, London EC4M 4YA.

Your enquiry will be forwarded to your nearest EOS Dealer.

- Electrohome Colour Monitors  IBM Personal  EOS 7000  
 EOS Memory Boards  ACT Sirius 1  TIM III  Supercalc

NAME \_\_\_\_\_

COMPANY \_\_\_\_\_

ADDRESS \_\_\_\_\_  
\_\_\_\_\_  
\_\_\_\_\_

TELEPHONE \_\_\_\_\_

At £299 it's very little. At 64K it's very large.



## The 64 from Commodore.

This is the new Commodore 64 Personal Computer.

It costs £299. Not bad for a brilliant piece of technology with a 64K memory.

But then, it's a Commodore.

And as one of the world's leading high-performance micro-computer companies, we're not exactly unknown when it comes to outstanding achievements.

The Commodore 64's nearest rival – if that's the word – costs over half as much again.

Here is the specification, a comparison with the Apple II, and a coupon.

The rest is up to you.

1. A total memory capacity of 64K, 38K directly available to BASIC. When not using BASIC a full 54K is available for machine code programs.

2. Interface adaptors will allow the use of a

complete range of hardware peripherals including disk units, plotter, dot matrix and daisy wheel printers, Prestel communications, networking and much, much more.

3. A complete range of business software including word processing, information handling, financial modelling, accounting and many more specific application packages will be available.

4. Other computer languages such as LOGO, UCSD PASCAL, COMAL and ASSEMBLER are being developed. Existing VIC and 40 column PET BASIC programs can be easily converted.

5. The powerful sound chip gives 3 totally independent voices each with a range of 9 octaves. User control over music envelope, pitch and pulse shapes provides the ability to make your Commodore 64 sound like a variety of musical instruments, solo or in harmony.

6. 62 predefined graphic characters plus



business, educational, home and leisure software.

11. A second processor option using the Z80 gives the Commodore 64 the ability to support CP/M®.

### HOW COMMODORE PIPS APPLE.

| FEATURES                                   | COMMODORE          | APPLE II+     |
|--|--------------------|---------------|
| Base Price                                 | £299*              | £499*         |
| <b>ADVANCED FEATURES</b>                   |                    |               |
| Built-in user memory                       | 64K                | 48K           |
| Programmable                               | YES                | YES           |
| Real typewriter keyboard                   | YES (66 keys)      | YES (52 keys) |
| Graphics characters (from keyboard)        | YES                | NO            |
| Upper & lower case letters                 | YES                | NO**          |
| Function keys                              | YES                | NO            |
| Maximum 5¼" floppy disk capacity per drive | 170 K.B. to 1 M.B. | 143 K.B.      |
| <b>AUDIO FEATURES</b>                      |                    |               |
| Sound Generator                            | YES                | YES           |
| Music Synthesizer                          | YES                | NO            |
| Hi-Fi Output                               | YES                | NO            |
| <b>VIDEO OUTPUT</b>                        |                    |               |
| Monitor Output                             | YES                | YES           |
| T.V. Output                                | YES                | EXTRA         |
| <b>INPUT/OUTPUT FEATURES</b>               |                    |               |
| Cassette Port                              | YES                | YES           |
| Intelligent Peripherals                    | YES                | YES           |
| Serial Peripheral Bus                      | YES                | NO            |
| <b>ADDITIONAL SOFTWARE FEATURES</b>        |                    |               |
| CP/M® Option (over 1000 packages)          | YES                | YES           |
| External ROM cartridge slot                | YES                | NO            |

\*EXC. VAT - DETAILS CORRECT AT TIME OF GOING TO PRESS  
 \*\*UPPER ONLY  
 CP/M® IS A REGISTERED TRADEMARK OF DIGITAL RESEARCH, INC.

full alpha numerics with upper and lower case letters, all available directly from the keyboard and displayable in normal or reverse video in any of 16 colours.

7. 40 column by 25 lines colour display. In high resolution graphics mode, a bit mapped screen gives 320 x 200 individually addressable pixels.

8. The dedicated video chip allows the use of high resolution multi-coloured "Sprites" (moveable object blocks). Sprites can be moved pixel by pixel, independently of anything else on the screen.

9. Sprites can also be set up in 8 "layers" giving full 3 dimensional effects with, if required, automatic collision detection between sprites and any other screen object.

10. Machine bus port will accept ROM cartridges for many applications, including



For more information on the powerful new Commodore 64, and the address of your nearest Commodore dealer, telephone or write to us at:

The Commodore Information Centre,  
 675 Ajax Avenue, Slough, Berkshire SL1 4BG.  
 Telephone: Slough (0753) 79292.

NAME \_\_\_\_\_  
 POSITION \_\_\_\_\_  
 COMPANY \_\_\_\_\_  
 ADDRESS \_\_\_\_\_  
 \_\_\_\_\_  
 \_\_\_\_\_

TEL \_\_\_\_\_

# Personal PEARL

## Turns people into programmers.

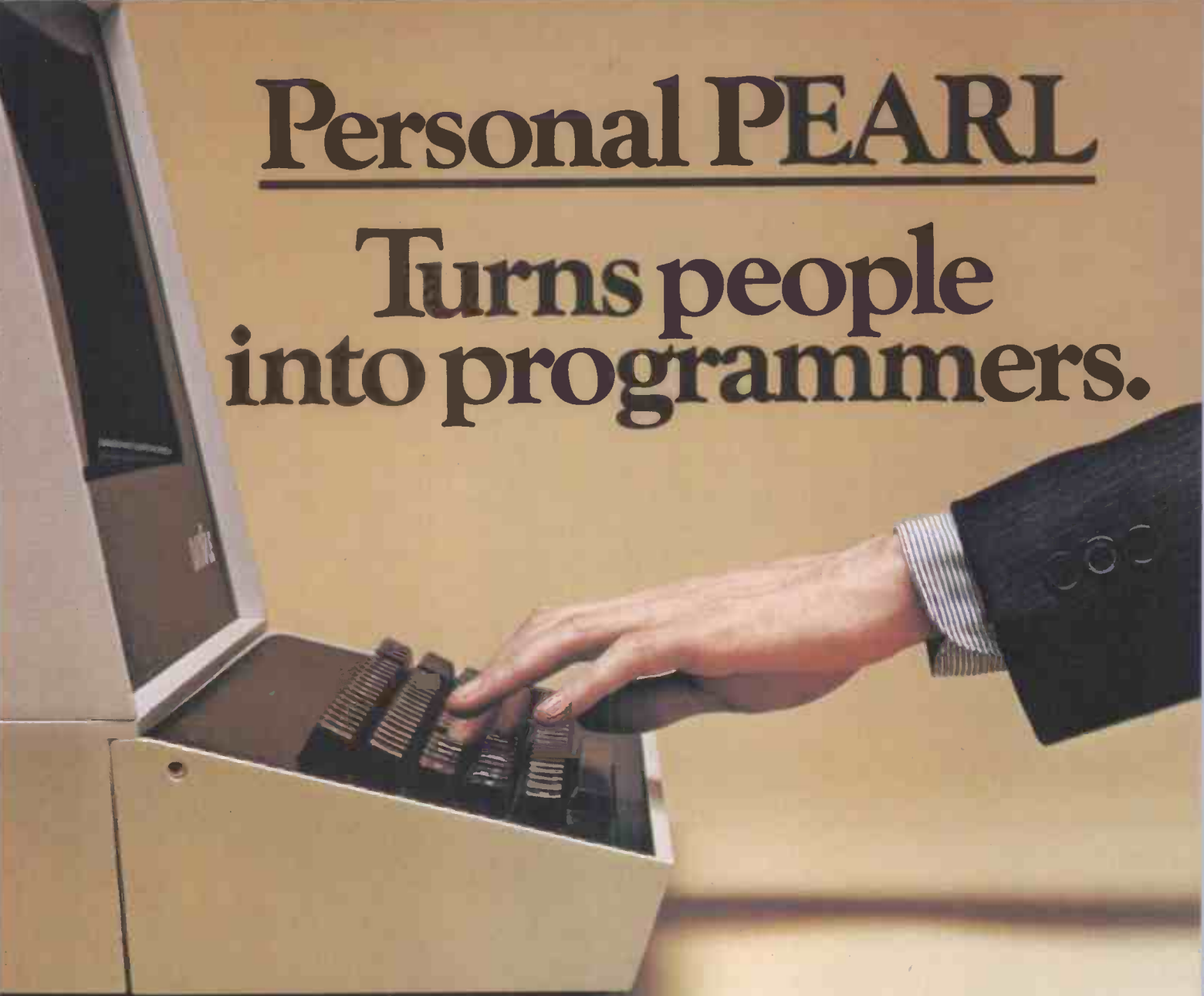

If you could program a computer by simply telling it the result you wanted, without using complex codes or languages, then anyone could become a programming professional. Sounds fantastic?

But now it's possible with Personal PEARL, and all for less than £200. It generates quality Business Programmes, Data Management, Costing, Mailing – in fact you

create your own library of programmes that matches your operation today, and tomorrow.

After all, no-one understands your business better than you. So let Personal PEARL take the technology out of computer programming, and you'll find yourself writing professional business software – at the touch of a button.

Please send more details of Personal PEARL.

Name: \_\_\_\_\_

Company: \_\_\_\_\_

Address: \_\_\_\_\_

Tel: \_\_\_\_\_

Computer Make: \_\_\_\_\_

Disk Size: \_\_\_\_\_ VDU Make: \_\_\_\_\_

Pearl Software International (UK) Limited, PO Box 34, Poole, Dorset, BH14 8AR.  
Tel: Parkstone (0202) 741275

**Pearl Software International (UK) Limited,**  
PO Box 34, Poole, Dorset, BH14 8AR.  
Tel: Parkstone (0202) 741275



# PERSONAL PEARL

## PURPOSE

To provide a natural, easy way for people to create custom application programs through an English language interaction with a personal computer.

## DESCRIPTION

Personal Pearl is the natural, human way to create new computer solutions. Computers are designed to solve general problems at incredible speeds. Application programs are required to operate the computer in order to quickly solve specific human problems. Personal Pearl unlocks the power of the computer so you can resolve your unique business problems.

Personal Pearl asks you for examples of the results you require from the computer. Personal Pearl then produces the application program. Personal Pearl is for the individual who requires custom computer solutions without the cost and time delay of hiring a programmer.

With Personal Pearl, you can create a library of personal programs, each tailored to your individual requirements. Accounting, mailing lists, data files, data management, calculations and reporting. Personal Pearl builds the program library of your choice, for one price.

Why buy several programs designed for the average computer use? Buy Personal Pearl to create an entire library of the highest quality programs designed by you, for your Personal Pearl leads you through the program design. Your answers are used by Personal Pearl to create the new program.

## HIGHLIGHTS

- Interactive English program development. Menu-oriented application description speeds development via formatted screens, input error checking.
- Built in HELP facility.
- Display handling is defined by using Personal Pearl's convenient full-screen facilities to simply type in the display screens exactly the way they are to appear in the new program.
- Report handling is defined in the same way; by simply formatting the display screen to show the layout of the reports required by the new program.
- The application program display screens or reports may be modified at any time, or new displays or reports may be added.
- Calculation edit: arithmetic operations, editing, translation, table look up, and data validation are included.
- Data routine: display-to-display, display-to-printer, and display-to-file facilities are provided.
- Files may be quickly and easily sorted, printed, searched for selected records, reorganised or analysed.
- Display screens, files or reports may be modified to reflect changing program requirements.
- Display screens may be custom designed in any form.
- Reports may be custom designed in any form. Several report formats may be stored for later use.
- Data may be sent to SuperCalc\* or Multiplan\* for forecasting.
- No limitation on number of application programs.
- Maximum file sizes determined only by the maximum capacity of the disk storage medium on the computer.
- Records may be up to several thousand characters long, if needed.
- The number of records that may be stored in a file is determined by the total file size. Records are variable length with record packing, eliminating the wasted space incurred by fixed length schemes.
- Data base support is provided by an independent data base manager.
- File support is provided through indexing and sequential data access.
- Security and Integrity of Data:
  - Data input can be validated against previously defined edit criteria before changes are made to data files.
  - Edit criteria can be modified dynamically.
- Automatic Screen Entry Message:
  - Users of Personal Pearl can establish messages to the program operator in order to direct correct data entry.
- Data File Independence:
  - The descriptions of data files are maintained in an independent description file - the dictionary.
- Multiple Program Integration
  - Several generic programs such as word processing and spread sheet analysis may be integrated through Personal Pearl.

PEARL  
software

**PREREQUISITE PRODUCTS**  
CP/M Operating System  
48K RAM Microcomputer

Manufacture, OEM and dealer enquiries welcome.  
Suggested retail price: under £200\* \*excluding VAT

To: PEARL INTERNATIONAL (UK) LTD, PO BOX 34, POOLE, DORSET, BH14 8AR  
Please send me details of Personal Pearl

Name ..... Firm .....

Address.....

..... Postcode.....

Type of equipment..... Disc size and format.....

Type of VDU .....



# WIN THE EXCITING NEW GENERATION DRG VICTOR 9000

## MICRO COMPUTER

**PLUS 1 YEAR ON-SITE  
MAINTENANCE.**

**PLUS TABS SOFTWARE  
TO SUIT APPLICATION.**

**PLUS FULL TRAINING.**

**PLUS A TEC LETTER  
QUALITY PRINTER.**

**TOTAL VALUE  
£5000**

\*VICTOR 9000 and SIRIUS  
are manufactured  
by the same  
company.

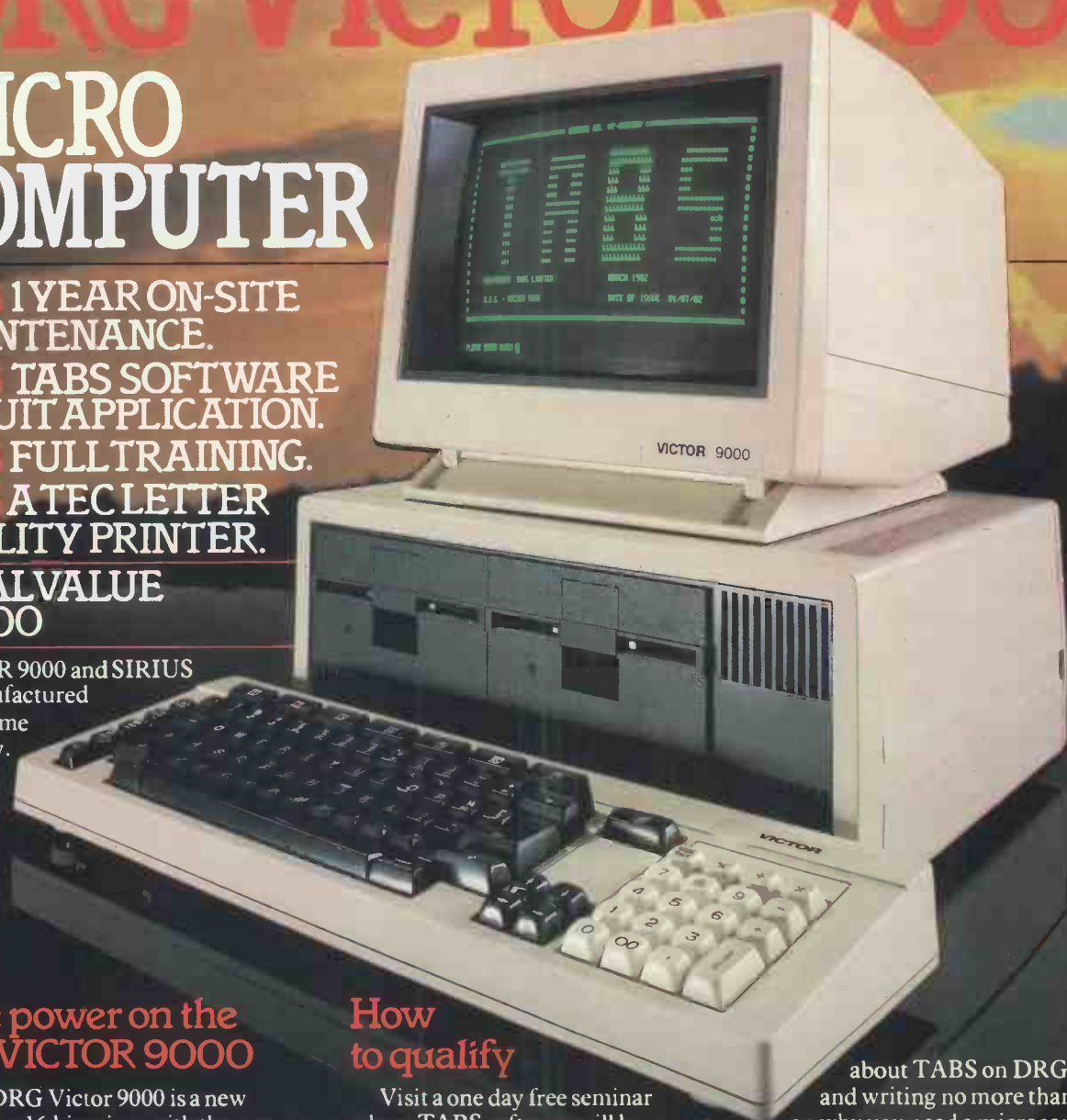

### More power on the DRG VICTOR 9000

The DRG Victor 9000 is a new generation 16 bit micro with the power to rival many minicomputers.

Designed to meet the need for more powerful business applications, its 1.2 MB of floppy disk is expandable to 2.4 MB of floppy disk creating the flexibility to cope easily with longer customer files, company records and word processing.

### How to qualify

Visit a one day free seminar where TABS software will be demonstrated on the DRG Victor 9000 OR Buy the new TABS paperback manual.

### How to enter

Each entrant must complete a competition entry form. This will include answering simple questions

about TABS on DRG Victor 9000 and writing no more than 300 words on why you need a microcomputer accounting system. Competition entry forms are available from any of the participating Accredited Dealers listed below or from TABS at any of the one day seminars also listed below.

Closing date for entries is December 31st. The winner will be announced in the Daily Telegraph by February 1st.

**TABS FREE SEMINARS:** LONDON Great Eastern Hotel 19 Oct. 20 Oct. 16 Nov. NOTTINGHAM George Hotel 6 Oct. 2 Nov. 30 Nov. MANCHESTER Grand Hotel 4 Oct. 4 Nov. BIRMINGHAM Crest Hotel 12 Oct. 9 Nov. EDINBURGH Caledonian Hotel 29 Sept. 27 Oct. 25 Nov. NEWCASTLE Holiday Inn 27 Sept. 26 Oct. 23 Nov. CARDIFF Park Hotel 14 Oct. 11 Nov. BRISTOL Unicorn Hotel 22 Sept. 18 Oct. EXETER Royal Clarence Hotel 8 Nov.

**PARTICIPATING DEALERS:** LONDON: Andrew & Co 01 402 6911; Data Management Systems 01 739 8692; Q.E.D. Computers 01 959 7403/8346. AVON: Colston Computer Centre Ltd 0272 276619. BERKSHIRE: Decision Support Systems Ltd 0628 76887; Thames Valley Systems 0734 581829. BUCKINGHAMSHIRE: Cardinal Computers Ltd 06284 73776/73074. CHESHIRE: Desktop Computing 0925 415415. DERBYSHIRE: FBC Systems Ltd 0332 365280. DEVONSHIRE: Keel Data Systems 054 884 3520. ESSEX: Humac Computer Services Ltd 0708 752005. GLOUCESTERSHIRE: Computer Shack 0242 584343. KENT: A.E.C. Business Systems 0732 864829; Page One Systems Ltd 0279 416808; The Data Processing Co Ltd 0303 41618. LANCASHIRE: Mipac Services 0524 62033. LINCOLNSHIRE: ZR (Computers) 0522 31621. MANCHESTER: Sumner Jackson & Co Ltd 061 832 8261. NOTTINGHAMSHIRE: Micro People Ltd 06076 69117. SOMERSET: Computer Sales & Marketing 06438 3526; The Computer Room 0935 73023. SURREY: Computron 01 943 1113; Interlex Ltd 01 943 0968; Micro-Engineering Ltd 01 397 8137. SUSSEX: Computaccount 08926 5765. TYNE & WEAR: Microcore 0632 846878; Quality Micro Products 0632 614646. WEST MIDLANDS: Beta Computer Services 0676 34664; Datacraft (Computer Systems) 021 705 1906; I.S.L. Ltd 0922 26282; P.J. New Computers Ltd 021 742 6801. WILTSHIRE: Fyne Computing 0722 20323; J.R.M. Software Ltd 02214 65691. WORCESTERSHIRE: Spinks Computer Systems Ltd 0905 29466. NORTHERN IRELAND: FACS 0662 47618. WALES: DYFED: Aberdata 09745 344. SOUTH GLAMORGAN: Data Plant 0222 40411.

For more information about TABS on the DRG Victor 9000 please phone Andover (0264) 58933 or write to TABS Ltd, Sopers House, Chantry Way, Andover, Hants SP10 1PE. or DRG Business Machines, 13/14 Lynx Crescent, Winterstoke Rd., Weston-super-Mare, Avon BS24 9DN.

Please send me \_\_\_\_\_ copy/ies of the new TABS paperback manual @ £10 per copy

Plus \_\_\_\_\_ competition entry forms (1 per manual).

Name \_\_\_\_\_

Company \_\_\_\_\_

Address \_\_\_\_\_

**DRG  
BUSINESS  
MACHINES**

Accounting  
Business Systems

# TABS



# THE GALAXY 1 COMPUTER

The cost effective solution to your computer needs for only

**£1,450\***

Features include:

- Twin Z80 Processors
- 64K Dynamic RAM
- 800 K Disc Based Storage
- 80x25 Screen Format
- Dual Printer Interfaces
- Modular Design
- CP/M 2.2 Operating system
- COMAL-80 - Structured Basic
- Z80 Editor/Assembler
- Text Editor & Formatter
- Program De-Bugging Utility

The Galaxy 1 desk top computer system can be used in education, small business applications, word processing, stock control and a host of other environments. Our choice of CP/M as the operating system means that our customers can select a suitable application package from the widest possible range.

However, unlike our competitors, we supply not only the hardware but all the essential system software needed to start using the Galaxy 1 as soon as it is installed. We have adopted COMAL-80 as our standard language. This structured basic is rapidly gaining widespread acceptance and popularity especially in the education market, offering much greater flexibility and ease of use than existing Basics. We also supply a very powerful Z80 assembler/editor called GEM ZAP with GEM PEN, a compact but very powerful word processing package. The system software suite is completed with GEM DEBUG, a useful machine code program de-bugging utility.

Modular design means reliability and ease of maintenance. Unlike many other manufacturers Gemini offer a full one year warranty (except Disc heads which are guaranteed for 3 months). Our distributors carry a full range of replacement boards thereby facilitating a quick, efficient and cost effective back up customer service.

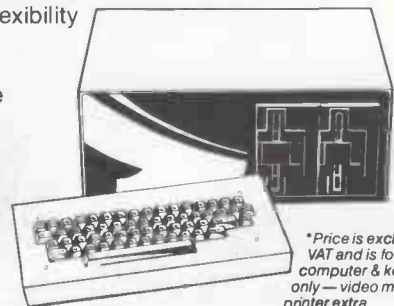

\*Price is exclusive of VAT and is for computer & keyboard only — video monitor & printer extra.

**BRITISH MADE**



Telephone Amersham 28321 for the name and address of your nearest distributor.  
\*Dealer enquiries invited.

**Gemini Microcomputers** Oakfield Corner, Sycamore Road, Amersham, Bucks HP6 5EQ.







The eyes and ears  
of the microcomputing  
community...

# **MicroScope**

Trade only.  
Fortnightly, controlled circulation.  
For more information  
call Stephen England or Neil Fennell  
on 01-631 1433.

**A BRILLIANT MIND  
THAT'S EASILY MANIPULATED**



**The remarkable new Olivetti M20 personal**

ATED.



computer.

Please forgive our boasting but the new Olivetti M20 really does make the current crop of computers look like toys for adults. It's simply the most advanced personal computer in Britain.

The 16-bit central processing unit and 'bus' allow larger more complex programs to be run on larger amounts of data and at far greater speed.

It has two 5¼" mini floppy disk units with a capacity of 320k bytes each that are integral to the system.

(These can be further extended with the addition of a hard disk.)

And it has a minimum internal capacity of 128K bytes.

The result is an extremely powerful computer with interfacing capabilities that allow it to communicate with a wide range of peripherals.

That's proof that it's brainy, but it's also beautiful.

The visual brilliance and clarity of the VDU can be controlled as its position can be swivelled and tilted to suit the operator.

And as well as handling up to two thousand characters, the screen can produce a variety of complex, high resolution graphics.

Naturally, lines, circles, ellipses, bar charts and pie charts are a cinch.

But the screen can actually split itself into sixteen independent windows.

It's all clever stuff but its language is simple.

It uses Microsoft®Basic which has been developed to a new level of professionalism.

In fact, the advanced PCOS\*operating system combined with its programming language make the M20 easier to use than a typewriter.

But if you do manage to get lost there's a 'Help' function to guide you.

The M20 also has the reassuring ability to run through its circuits every morning and if any are faulty it'll tell you.

So Olivetti's national and international network of service engineers can work even faster.

Send off the coupon and find out why the M20 is simply brilliant.

And brilliantly simple.

\*CP/M available.

For more information on the M20 Personal Computer please send this coupon to Valerie Belfer.

British Olivetti Ltd., Olivetti House, PO Box 89,  
86/88 Upper Richmond Road, London SW15 2UR.

Name \_\_\_\_\_

Position \_\_\_\_\_

Company \_\_\_\_\_

Address \_\_\_\_\_

Postcode \_\_\_\_\_

OEM enquiries welcome.

**olivetti**

© Microsoft Basic is a registered trademark of Microsoft Inc

# £1,350\*

The MIMI 802 is a supreme example of high quality British engineering. It is a truly professional microcomputer that really does meet all the criteria of a sophisticated business machine - at a price you can afford.

Our competitors expect you to make do with the basics and then buy expensive extras in order to fulfil your needs. The MIMI 802 has all the 'extras' as standard - so when you buy a MIMI you really are getting a microcomputer that will do the job from the outset.

The MIMI's operating system OS/M<sup>†</sup> is fully CP/M<sup>‡</sup> compatible so you have access to a very comprehensive range of software, extending from word processing to accounting.

During the next few months we will be announcing the availability of TROJAN - a major software innovation that totally simplifies the learning process and use of micros, and dramatically eases the creation of new applications programs. We are using it and generating applications software in record time - so we can guarantee its performance.

**Don't settle for less... contact us or one of our dealers now.**

#### Features include:

- Z80A at 4MHz
- 64K Dynamic RAM
- Integral D/S - D/D 5¼ ins floppy discs - 700Kb.
- Full RS232C and Centronics parallel ports.
- 96 Key ASCII keyboard - colour coded.
- 17 programmed function keys.
- Light pen socket.
- Elegant compact and light - 24 lbs.
- OS/M operating system - fully CP/M compatible.
- Disc format conversion facility.
- Wide range of software, utilities and languages.

#### And now with:

- Winchester disc option.
- Super high resolution graphics option\* (802G-512 x 256 pixels).

# NOW ALL OTHER MICROS ARE LESS THAN PERFECT

† OS/M is the trademark of Scifax Microsoftware.

‡ CP/M is the registered trademark of Digital Research Inc.

\*Monitor extra, from £132. (Choice of orange or green display)  
MIMI 802G (graphics version, as illustrated) £1495.

#### Some of our distributors:

**Anita Electronic Services**  
34 Musters Road West Bridgford Notts  
Tel: 0602 813240  
Contact: Steve Conroy

**Belmondo Research Ltd**  
68 Maple Road Holford Bristol BS7 8RG  
Tel: 0272 427428  
Contact: Roger Banfield

**Broadway Systems (BCSS) Ltd**  
5-7 Mariner Street Swansea W Glam Wales SA1 5BA  
Tel: 0792 462279/474598 01-997 4764/0498  
Contact: Phillip Gittoes

**Chris Robinson Consultants**  
Maple Way Kensworth Dunstable Beds  
Tel: 0582 872940  
Contact: Chris Robinson

**City Microsystems Ltd**  
65 London Wall London EC2  
Tel: 01-588 7272  
Contact: Anthony Coulson

**Computer Graphics Workshop**  
38 Ullett Road Sefton Park Liverpool 17  
Tel: 051 733 9604  
Contact: Mr Noel Runnels-Moss



## BRITISH MICRO

Penfold Works Imperial Way Watford Herts. WD2 4YY Tel: Watford (0923) 48222/43956





A Hegotron Group Company



**Derwent Data Systems**  
18 Norfolk Street Sunderland Tyne & Wear SR1 1EA  
Tel: 0783 652026  
Contact: Tom Maxfield

**Easibee Computing Ltd**  
133-135 High Street North East Ham London E6 1HZ  
Tel: 01-471 4884  
Contact: Computer Sales Director

**John Elmer Office Equip**  
105-107 Church Road Burgess Hill Sussex  
Tel: 04446 5670  
Contact: John Elmer

**Leicester Micro Centre**  
59 Regent Road Leicester  
Tel: 0533 551869  
Contact: Ray Beresford

**Maystar Micro Systems Ltd**  
62 Peach Street Wokingham  
Tel: 0734 789381  
Contact: Simon Hart

**Microcosm Research Ltd**  
26 Danebury Street London N1  
Contact: Peter Cheesewright

**MIMI 802**



NEC PC-8000 Personal Computer.

## NEC turns 27 years of computer experience to your personal advantage.

It takes a great computer company to make a great personal computer. And from the start, NEC has been a pioneer in computer technology. In fact, we invented the all-semiconductor computer in 1959. Now, hundreds of innovations later, we've made it personal.

We present the PC-8000, a powerful and friendly business tool that can help you get more done in a day than you ever could before. It combines some of the most reliable hardware on the market with application packages designed to make the most of its unique features. In addition, the PC-8000 accepts popular CP/M business software, making its possibilities virtually limitless.

The entire PC-8000 system is now available through better computer dealers across the country. And that means more than hardware. It means effective software, the finest documentation and extensive training to help you get the most from your personal computer. So why not turn our system to your personal advantage now.

**NEC**  
Nippon Electric Co. Ltd.  
Tokyo, Japan

See us at the PCW Show  
Stand No. 140

NEC Telecommunications Europe Co. Limited  
NEC House, 164/166 Drummond Street,  
London NW1 3HP UK  
Telephone: 01-388-6100 Telex: 261914

IBR Microcomputers (England/Wales  
Distributor) Sutton Park, London Road,  
Reading, Berkshire  
Telephone: (0734) 664111 Telex: 848215

# THE WORLD OF

# BOS



## BUSINESS OPERATING SOFTWARE

**Choosing the right software...** is the first and most important decision you have to make when choosing a computer.

Choose BOS, and you're choosing the most advanced business software for micro and mini computers available today.

**BOS Reliability...** BOS software has been tried and tested for over four years with 1000's of satisfied users all over the world—small firms, big businesses, DP departments, schools, accountants, doctors, solicitors and government departments. BOS software provides that assurance of maturity and reliability which no new software can hope to match.

**BOS Portability...** Now, for the first time, you can change or upgrade your computer and avoid the costs of software conversion. BOS software is equally at home working in single-user, multi-user or local networking mode and the unique BOS concept allows identical software to run on over 50 different computers including Apple II, Casu, Comart Communicator, DG Enterprise, DEC PDP-11 range, DMS 3/4, Durango, Equinox, IBM Series/1, IBM Personal, ITT 3030, MicroFive, Onyx, Panasonic, Northstar, Pertec, SD, Sharp PC3201, Sirius, Sord 223, Systime 500, Tandy TRS-80, TI model 1/2/4, Transdata, Trivector Triton 4, Triumph Adler 1600 range.

**BOS Quality...** Designed and built in Britain by top software professionals and accountants for use by British business, there is a fully integrated range of BOS software to match all your business needs.

Choose from:—

- BOS Sales Ledger**
- BOS Invoicing**
- BOS Purchase Ledger**
- BOS Nominal Ledger**
- BOS Inventory Control**
- BOS Payroll**
- BOS Fixed Assets**
- BOS AutoWriter**
- BOS AutoIndex**

**BOS Nationwide Support...** BOS software is written by MPSL, a world leader in microcomputer technology, and supplied and supported by over 50 selected independent BOS dealers throughout the country.

Remember, when you choose a computer, what you get out depends on the software you put in. So choose the best—choose BOS.

## THE RIGHT SOFTWARE CHOICE

I'd like to know more about BOS software, BOS dealers and BOS compatible computers.

Name \_\_\_\_\_ Title \_\_\_\_\_

Company \_\_\_\_\_ Address \_\_\_\_\_

Telephone No. \_\_\_\_\_



# You'll be glad you chose a personal computer with power enough to grow with your needs.

## The ICL Personal Computer with power to grow as you need it.

Choosing the wrong personal computer can work out very costly, because though they grow to meet your needs, they just don't grow enough.

The new ICL Personal Computer gives you more.

It's a versatile, professional personal computer. It can start with a single Visual Display Unit, naturally, and it has a wide range of functions to meet your increasing requirements. And it can grow larger than most other personal computer systems, because its capacity for additional hardware is greater.

**Starting at £2,895 with one VDU**

The ICL Personal Computer provides a range of options enabling you to have a system tailored to meet your changing needs.

For example, by adding a fixed-disc, you can have eight times the original storage capacity, and support up to 4 VDUs. And there is an extensive range of Personal Computer hardware.

Wide range of integrated accounts and other application software available, providing limitless possibilities.

So your secretary can do her word processing, you can do your forecasts, your accountant can do the invoicing, and your programmer can do his own thing, all at the same time. That's what makes ICL Personal Computer more than just a personal computer.

And because ICL is Europe's leading computer company, with thousands of satisfied users in over 80 countries worldwide, we can offer **ICL Trader Point service and maintenance back-up that's second to none.**

What more could you ask for, apart from a demonstration?



trader point

To: **Johnson** Johnson House · 75-79 Park Street · Camberley · Surrey  
microcomputers

Please send me further information on the new ICL Personal Computer.

Name  Position

Company Name & Address

Telephone

Type of Business



# Johnson

microcomputers

Johnson House · 75-79 Park Street · Camberley · Surrey  
Telephone 0276 20446

Robophone Answering 24 hrs. Prestel page No. \*200632  
Mailbox No. 027620448

48 Gloucester Road · Bristol · Telephone 0272 422061  
113 Stratford Road · Shirley · Birmingham B90 3AY  
Telephone (021) 745 3246



# ENHANCED MODEL III

## MODEL III HIGH RESOLUTION GRAPHICS

128 user definable characters which effectively give a resolution of 512 x 192.

No external wires or connections, everything is fitted within the case.

Graphic characters optionally software selectable.

Comes complete with demonstration and setup programmes on diskette and cassette.

Fully documented user manual.

Comprehensive fitting instructions (Kit only).

### SPECIAL INTRODUCTORY OFFER 1.

KIT PRICE including PandP, VAT and insurance. **£129.95**

Fully Installed, tested and guaranteed. **£169.95**

Installation includes collection and delivery charges.

The machine language plotting programme "SETXY" is included "FREE" for those people purchasing from this advert.

### SPECIAL INTRODUCTORY OFFER 2.

If you purchase any Model III from us we will install the graphics for you at kit price.

## THE MICROFIRM TURBO MIII

The TRS-80 Model III including:

48K RAM.

14k ROM.

64 x 16 VDU.

4 megahertz clock speed up.

Dual TEAC 80 track disc drives (737,280 bytes total).

RS232C interface.

NEWDOS or LDOS operating system.

MX80 F/T3 lineprinter.

MICROFIRM mailing system (up to 2600 addresses online).

Fully insured, carriage and VAT included. **£2295.95**.

(Note for 6 megahertz clock speed up add. **£80.00**.)

## MODEL III 4 MEGAHERTZ SPEED UP (KIT)

Increase your Model III speed from 2.02 megahertz to 4 megahertz with the MICROFIRM 4 meg module.

Software switchable 2 or 4 meg.

Software switchable to 2 meg disk access for those without appropriate operating system

(ie NEWDOS/LDOS).

Includes full fitting instructions.

Carriage and VAT inclusive. **£69.95**.

## MODEL III 6 MEGAHERTZ CLOCK SPEED UP (KIT)

Increase your Model III speed from 2.02 megahertz to 6 megahertz with the MICROFIRM 6 meg module.

Software switchable 2 or 6 meg.

Software switchable to 2 meg disk access for those without appropriate operating system.

Includes full fitting instructions and 48K of high speed RAM

Carriage and VAT inclusive. **£150.00**.

## MODEL III DISK DRIVES

**CS40** One 40 track single-sided TEAC FD-50A 5.25 inch floppy drive in an alloy frame with switched mode power supply. Disk controller board plus all cables, connectors, screws and mounting instructions. **£481.00**.

**CS80** One 80 track single-sided TEAC FD-50E 5.25 inch floppy drive in an alloy frame with switched mode power supply. Disk controller board plus all cables, connectors, screws and mounting instructions. **£523.00**.

**CD40** Two 40 track single-sided TEAC FD-50A 5.25 inch floppy drive in an alloy frame with switched mode power supply. Disk controller board plus all cables, connectors, screws and mounting instructions. **£678.00**.

**CD80** Two 80 track single-sided TEAC FD-50E 5.25 inch floppy drive in an alloy frame with switched mode power supply. Disk controller board plus all cables, connectors, screws and mounting instructions. **£764.00**.

**FD-50A** Single 40 track disk drive add-on for CS40. **£178.00**.

**FD-50E** Single 80 track disk drive add-on for CD80. **£251.00**.



## MODEL I 32K MEMORY EXPANSION BOX

This unit is designed to sit underneath the video monitor.

It provides:

32K of dynamic memory.

A standard parallel printer port.

A full 40 way bus extension.

It has its own integral power supply needing only a standard 240 volts AC mains connection. All units are fitted with an onboard connector to facilitate disk controller expansion. Up to 4 - 5.25 inch drives can be supported by this expansion.

This unit is ideal for the tape or floppy tape user.

PRICE **£149.95** including VAT.

## FLOPPY DISK CONTROLLER EXTENSION

This unit is available to complement and fit within the 32K expansion box.

External data separation has been provided as standard to increase data transfer reliability. A 25ms heartbeat interrupt provides timing for "clock" facilities supported by most disk operating systems.

PRICE **£99.95** including VAT.

**SAVE MONEY** Purchase the expansion box and FDC extension. **£239.95** including VAT.

**MORE SAVING** either, a further 5% off memory expansion box plus FDC extension if you purchase a single disk drive on the same order, or

a further 10% off memory expansion box plus FDC extension if you purchase a twin disk drive on the same order.

## MODEL I DISK DRIVES AND CABLES

**CS50A** One 40 track single-sided TEAC FD-50A 5.25 inch floppy drive in a cabinet with 220-240 volt mains power supply. **£228.00**.

**CS50E** One 80 track single-sided TEAC FD-50E 5.25 inch floppy drive in a cabinet with 220-240 volt mains power supply. **£304.00**.

**CD50A** Two 40 track single-sided TEAC FD-50A 5.25 inch floppy drive in a cabinet with 220-240 volt mains power supply. **£424.00**.

**CD50E** Two 80 track single-sided TEAC FD-50E 5.25 inch floppy drive in a cabinet with 220-240 volt mains power supply. **£569.00**.

**2 Drive cable** ..... **£17.25**

**4 Drive cable** ..... **£28.50**

## PRINTERS

Epson MX80T Type 3 ..... **£401.00**

Epson MX80F/T Type 3 ..... **£447.00**

Epson MX82 ..... **£424.00**

Epson MX82F/T ..... **£470.00**

Epson MX100 Type 3 ..... **£573.00**

Keyboard printer interface cable ..... **£39.95**

Printer cable ..... **£17.25**

## DISKETTES

Box of 10 5.25 inch SS/SD disks including case **£23.00**

Box of 10 5.25 inch DS/DD disks including case **£28.00**

Box of 10 8 inch SS/DD disks including case **£29.00**

## DISK MAILING SYSTEM

Realise the power of our random access disk mailing system.

Important programme features:

1. Over 2,000,000,000 unique selection codes available.
2. Optional sort on printout by any field.
3. Parameter table for unusual print formats.
4. Blank address lines suppressed on labels print.
5. More than one list may be on the same data disk.
6. Utilises Southern Software Accel 3 compiler for speed.

System configuration:

TRS-80 Model I 48k, 2 disk drives, line printer.

or TRS-80 Model III 48k, 2 disk drives, line printer.

or Video Genie 48k, 2 disk drives, line printer.

(Model II version similar to above specifications available soon).

Price **£49.95** including VAT and postage (UK).

**ALL PRICES ARE INCLUSIVE OF VAT AND CARRIAGE (UK MAINLAND ONLY). SUBJECT TO CHANGE**

TRS-80 is a trademark of Tandy Corporation (UK).

**ENQUIRIES: TELEPHONE BRISTOL (0272) 279560**

**PLEASE SEND ME MORE INFORMATION ON:**

**HIGH RES GRAPHICS**

**HIGH RES MODEL I**

**HIGH RES MODEL III**

**PRINTERS, DISK DRIVES**

**SOFTWARE**

**EXPANSION BOX'S**

**NAME** \_\_\_\_\_

**COMPANY** \_\_\_\_\_

**ADDRESS** \_\_\_\_\_

\_\_\_\_\_

\_\_\_\_\_

**TEL** \_\_\_\_\_

**(PLEASE SEND LARGE SAE)**

Any four colours can be selected at a time from the palette of 255 available.

Automatic character magnification.

Random breakdown in High voltage capacitors

5-Sep-83

Mean

Mean

User-defined shading patterns.

Fast block fill facilities provided.

100 CLEAR 200  
110 DIM H(7)  
120 TEXT  
130 PUT 12  
140 CALL "RESOLUTION", 0, 2  
150 I=5  
160 REM DEFINE COLOURS  
170 CALL "COLOUR", 0, 0, 0, 0  
180 CALL "COLOUR", 1, 5, 0, 0  
190 CALL "COLOUR", 2, 230

Ready:

Enter week number -- 35  
Enter year -- 83  
Enter station number -- 3

Text in 40 character mode with 80 character mode overlaid.

Characters can be oriented in any of four directions.

'Windows' can be defined and scrolled independently.

A picture may be worth a thousand words but it still tells only half the story about graphics on the 380Z.

For a start, our standard graphics functions include point plotting, line drawing, instant block fill, block copying, offsetting, and Exclusive Or Plotting.

Then there is the important fact that our High Resolution Graphics is supported by Basic, Algol and Fortran. And since the Graphics is contained in its own 16K of RAM, every byte of user memory remains available for applications program use.

It is also worth noting that 380Z graphics are equally effective in monochrome — for 'colour' just read 'shades of grey'. Again there are 255 shades available, and there's also a very useful facility for fading up and down throughout the grey scale.

There are also the special effects — such as moving between graphics 'pages' for pseudo-animation, or the

ability to produce 'instant' graphics by drawing them with the colour 'switched' off and then 'switching' on.

Next, not only can 380Z graphics pictures be saved on and retrieved from disc, they can also be output to one of a range of popular dot matrix printers.

Remember, too, that HRG is not a third-party add-on but designed, developed, and supported by Research Machines itself as an integral part of the 380Z.

And finally, we've now implemented GINO. So for the first time this well-established, professional suite of flexible, device-independent graphics software from the CAD Centre is available on a micro.

If you are interested in graphics — for scientific, technical, and industrial research; or in secondary or higher education; or for design, engineering, or control, then you will be interested in the 380Z.

# GRAPHICS MACHINE



**RESEARCH MACHINES**  
MICROCOMPUTER SYSTEMS

RESEARCH MACHINES LTD Mill Street, Oxford OX2 0BW, Tel: (0865) 49866

The RP1600

# FLOWWRITER™

*A Daisywheel Printer that thinks it's a computer !*



*The RICOH FLOWWRITER is the most intelligent Daisy Wheel printer on the world market. Equipped with an internal micro computer and a large memory it will intelligently handle all printing and word processing operations; hence relieving the host computer for simultaneous use.*

*The Flowwriter is fully compatible with software written for any intelligent printer and is plug compatible with all popular hardware.*

## **Standard Features**

- Prints up to 60 characters in 1 second.
- Compatible with QUME SPRINT, DIABLO and NEC Spinwriter standard and enhanced word processing commands including graphics.
- Proportional spacing tables programmed internally.
- Automatic margin justification even with proportional spacing.
- 8K buffer under full program control.
- Auto bidirectional printing.
- Optimised auto logic seeking in both vertical and horizontal directions.
- Graphics capability down to 1/120".
- Three interfaces included internally: Centronics -IEEE 488 - RS232C.
- Detached keyboard option.
- External program mode, allows use of many more printwheels.

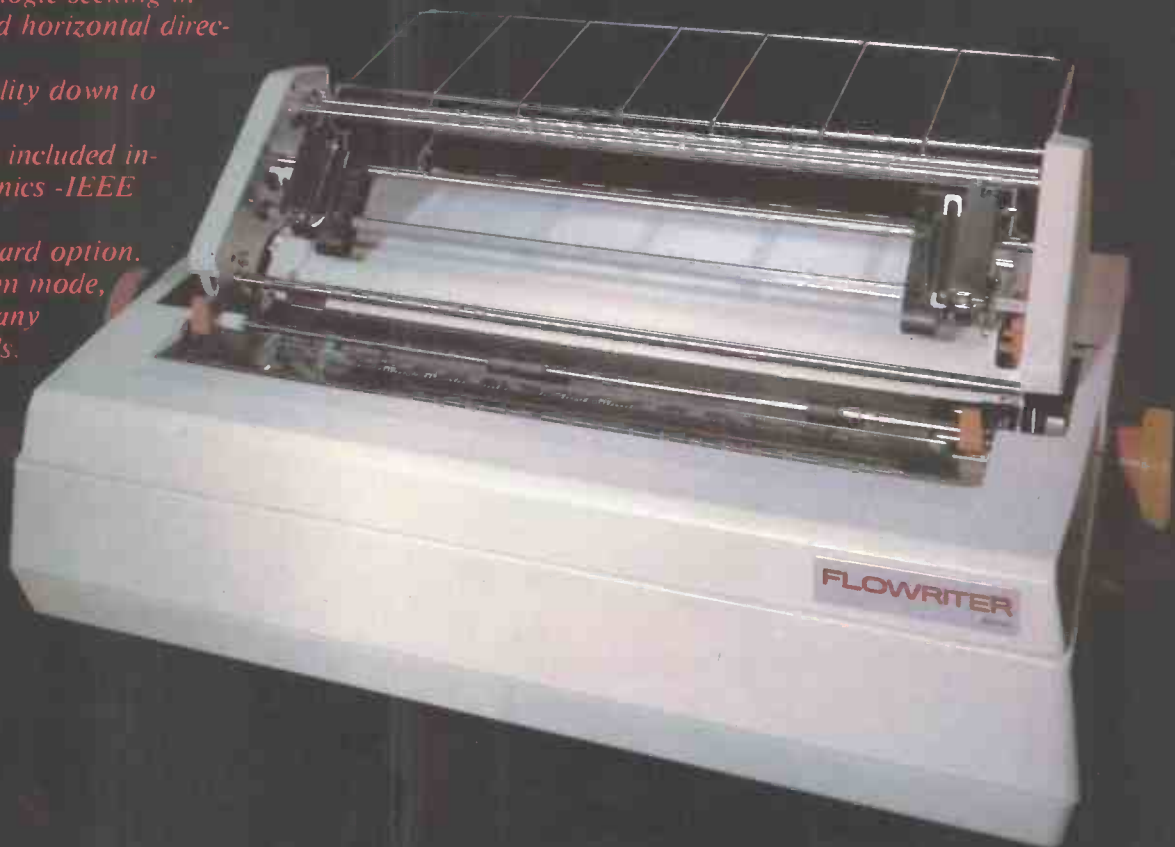

**APT APPROPRIATE TECHNOLOGY LIMITED**



2-4 Canfield Place London NW6 3BT Tel: 01 625 5575/5134 Telex 264538 SSE G

*The RP1600 FLOWWRITER is only supplied by APTEC and their authorised dealers, backed by national and international service networks.  
The FLOWWRITER is designed and manufactured by APTEC UK.*

# Test-drive your software!

|                        |            |
|------------------------|------------|
| Microplanner.....      | Rental £99 |
|                        | RRP £695   |
| Decision Modeller..... | Rental £99 |
|                        | RRP £535   |
| VisiSchedule.....      | Rental £38 |
|                        | RRP £195   |

|                    |            |
|--------------------|------------|
| Micromodeller..... | Rental £99 |
|                    | RRP £595   |
| dBase II.....      | Rental £79 |
|                    | RRP £395   |
| microFinesse.....  | Rental £70 |
|                    | RRP £350   |

| £29 Rental       |  | Retail |
|------------------|--|--------|
| Supercalc        |  | £175   |
| Visitrend/plot   |  | £165   |
| Visifile         |  | £161   |
| Zardax           |  | £160   |
| Wordstar         |  | £145   |
| Datastar         |  | £140   |
| Easywriter (PRO) |  | £140   |
| DBMaster         |  | £135   |

| £19 Rental             |  | Retail |
|------------------------|--|--------|
| Calcstar               |  | £120   |
| Visicalc               |  | £113   |
| Visiplot               |  | £111   |
| Word Plus (Speller)    |  | £110   |
| Time Manager           |  | £105   |
| ASCII Express II       |  | £100   |
| General Manager        |  | £100   |
| Complete Graphics Pack |  | £100   |

Our unrivalled list of business and technical software also includes accounting systems and expansion cards.

## and if you decide to buy- the rental is free

**The Software Rental Bank** gives you the opportunity to evaluate software on your own machine, with your own data, before committing yourself to a purchase.

**The Software Rental Bank offers a unique range of services.**

- ★ Short-term rental of software packages and firmware products for 7, 14 or 28 days depending on your class of membership.
- ★ Free rental if you decide to purchase.
- ★ A really wide range of software and advice to help you make the right choice.
- ★ Access to the newest software available — a chance to simply 'taste' some of the latest and most controversial products.
- ★ Speedy service. Rent software by telephone or by mail — all the items on our *Software Asset Listing* are held in stock.
- ★ An advisory 'hot line' in case you have difficulty with a rented package.

**The Bank is currently supporting the Apple II computer** — including CP/M products for use with the Z80 card. Software for other microcomputers including Apple III, Sirius, IBM and other CP/M machines will be added to the Bank shortly.

#### Membership of the Bank

- ★ Full Membership costs £70 a year and allows you to rent up to £700 worth of software at any one time for 14 days.
- ★ Members periodically receive our *Software Asset Listing* which gives details of the packages available for rental. Members are encouraged to nominate new items for addition to our stock.
- ★ Larger organisations which may have microcomputers at a number of different locations can opt to join as Corporate Members.

To receive our brochure and software list phone Ruth Oliver on 0908-53491 or clip the coupon below.



I would like to receive the Software Rental Bank brochure.

Name \_\_\_\_\_

Organisation \_\_\_\_\_

Address \_\_\_\_\_

Telephone \_\_\_\_\_ Machine \_\_\_\_\_

Send to: The Software Rental Bank Ltd., **PCW Oct 82**  
58 North Street, Leighton Buzzard, Beds LU7 7EN.

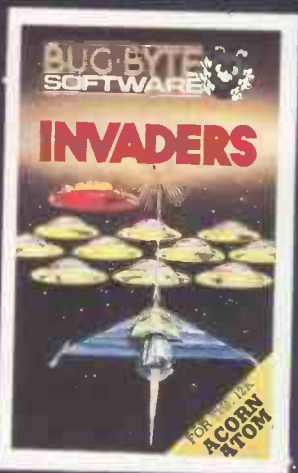
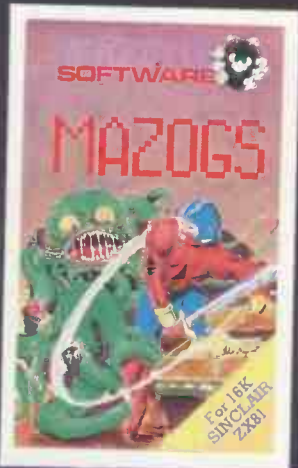

# WHAT'S YOUR GAME?

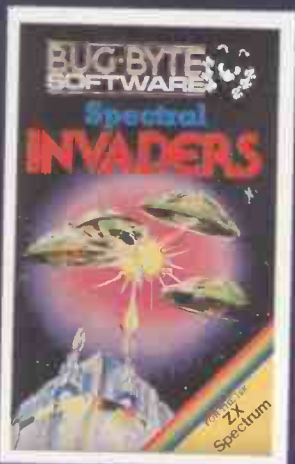
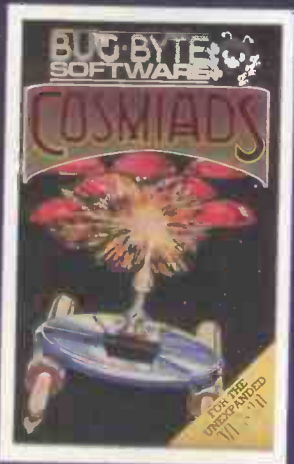

**FOR OWNERS OF ZX81, SPECTRUM, BBC MICRO, ATOM, COLOUR GENE, VIC.**

Bug-Byte games are best sellers. Tens of thousands of contented customers testify to that, so do consistently hot reviews in the popular micro-press. If your game isn't shown, don't worry, we probably have more quality games for more machines than any other software house - we just couldn't fit them all in. Bug-Byte games are available at good computer shops everywhere, or direct from our Liverpool office.

# BUG-BYTE SOFTWARE

FREEPOST (NO STAMP REQUIRED) LIVERPOOL L3 3AB.

PLEASE SEND ME FULL DETAILS, MY COMPUTER IS \_\_\_\_\_  
NAME: \_\_\_\_\_  
ADDRESS: \_\_\_\_\_  
\_\_\_\_\_  
\_\_\_\_\_

PCW-10 82

ATTENTION DEALERS! For special introductory pack send coupon and business card to Mark Butler

**WARNING: Unfiltered power can damage your computer's health.**



**Filter it!**

A POWER INTERNATIONAL COMPUTER HEALTH WARNING.

POWER  INTERNATIONAL

For further information contact:

**Power International Limited**

2A Isambard Brunel Road

Portsmouth Hampshire PO1 2DU

Telephone: Portsmouth (0705) 756715

**VIEWFAX 258**  
**Viewfax**

### **COMPANIES ON 258**

Join companies like Sinclair, Bug Byte and Lowe Electronics by promoting your latest news and information on Prestel's most popular micro database.

Viewfax 258 has around 60,000 accesses per month and users can order goods and further details electronically, using credit cards if they wish.

For a limited period full pages are available from under £15 a year.

Call or write now to take advantage of this new medium.

### **CLUBS ON 258**

Viewfax 258 offers free pages to clubs and groups which you can edit yourselves if you wish. We also offer a free 'transaction file' for secondhand sales and wants.

At no cost to your club, you can keep members informed of the latest news and information. You can even recruit new ones!

If you would like to take advantage of this free offer, call or write to us now.

### **TELESOFTWARE ON 258**

There are already a large number of programs on Prestel that can be 'downloaded' electronically. This saves on cassettes, updates and keyboard bashing!

Viewfax 258 is expanding its telesoftware section and whether you wish to sell software or share it with others free, you can profit from contacting us. Call or write to us now.

**Viewfax Limited, King Edward Building, 205-219 Corporation Street, Birmingham B4 6SE  
Telephone: 021-705 0258**

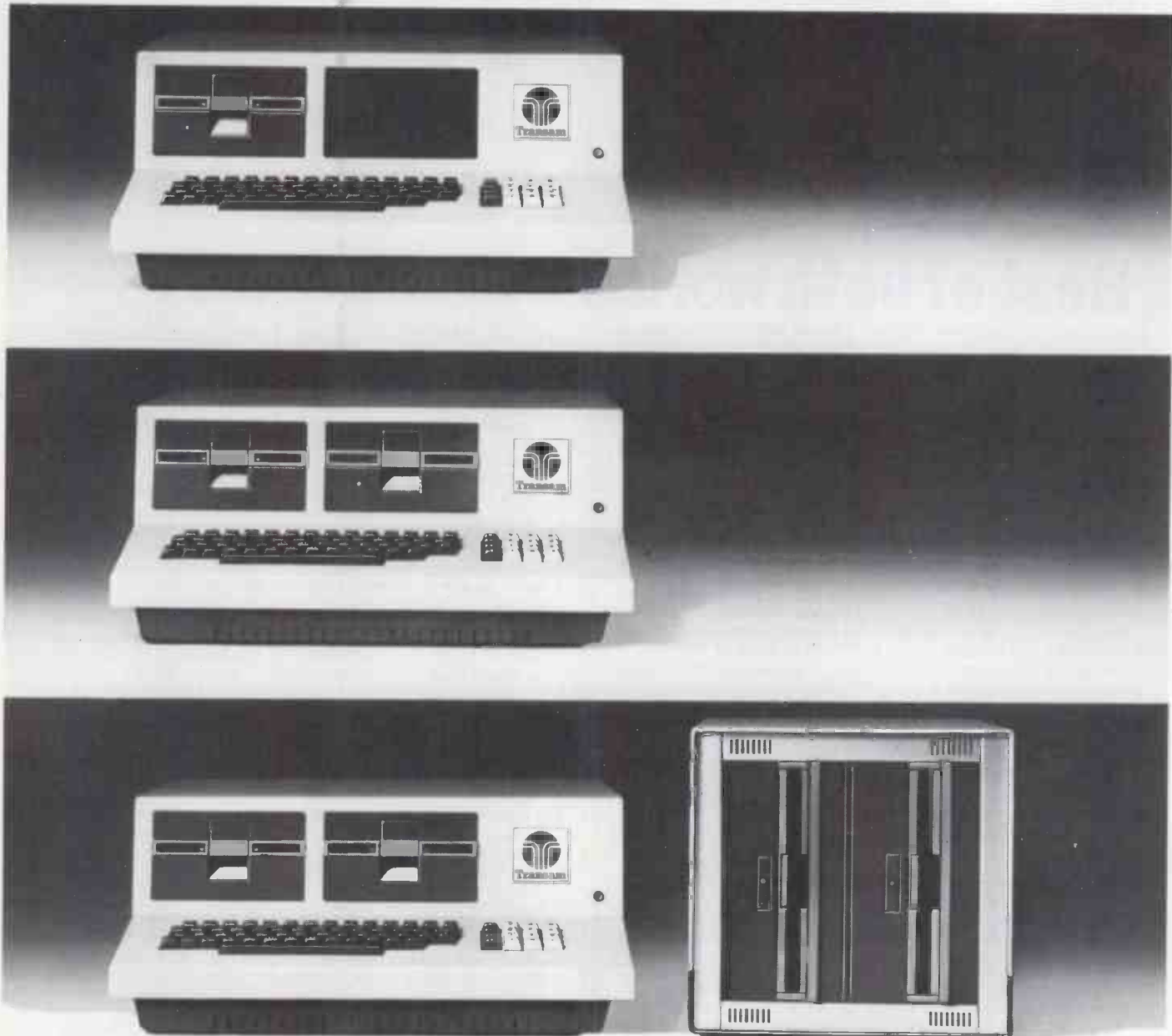

## Designed for expanding minds

The Tuscan S100 can read and write in 18 different disc formats including IBM, RML 380Z, and Superbrain, plus many more CP/M based machines. Now with optional IEEE interface and high definition colour graphics. The versatility of the S100 Bus and CP/M make an investment in Tuscan S100 an investment in the future.

Communication with minis and mainframes? - no problem! With four different communication options, Tuscan S100 looks and feels like an intelligent terminal.

Plotters and colour printers? - no problem! Tuscan S100 is just about the most versatile cost effective micro around. 5 or 8" hard or flexible, disc drives mean power at your fingertips. We go for capacity at low cost plus professional expertise. Send for our prices now - and a list of references. (Just in case you want to check our track record.)

Transam Microsystems Ltd.,  
59/61 Theobalds Road,  
London W.C.1.

Telephone 01-405 5240/2113



**Transam**  
MICROSYSTEMS LIMITED



Guy Kewney delivers his monthly package of micronews.

## Best of both worlds

Way back in May, one of the most significant things to hit the micro industry next year started poking its first shoots tentatively through the soil, when the world's second biggest computer company and biggest minicomputer company, DEC, announced its micro family.

Then, somehow, one of the less significant things of the year happened, and the news of this cataclysm failed to get into PCW. I swear it wasn't my fault.

Nonetheless, Digital Equipment Corporation has obviously got it right, by launching a machine that is both old and new. It is an eight-bit CP/M machine with an ordinary eight-bit Zilog Z80 processor, and it is also a 16-bit machine with a bright new Intel 8088 processor, as used by IBM and Sirius.

On top of that, Digital has backed its own design of minicomputer by launching a micro version of it — something which all minicomputer makers do in order to flatter their own egos. In this case, however, Digital's pride in its mini range is justified by the simple fact that it is the world's best selling mini, and that lots and lots of people really do want to use the wealth of available software that has been generated for it — in marked contrast to those who wish that somebody really would sit down and write a wealth of software for things like the . . . well, the rest of the minis.

The two machines are called Rainbow and Professional, with the Rainbow being the really interesting one that runs CP/M and CP/M-86. It is the only machine in this market which will do this bar some minority interest machines which sell at considerably more than DEC's £2,300 odd.

To everybody else, the choice between established, eight-bit micros (which have lots and lots of software ready to run under CP/M) and exciting, powerful 16-bit micros which will one day have even better software, has been agony. Not to Digital: it has calmly put both eight and sixteen bit processors in the same box.

More: it has ensured that you needn't bother about which micro runs which program.

IBM has been (sort of)

baled out of this problem, by the arrival of a firm called Xedex Corporation, which launched a Zilog Z80 processor, on a board, ready to plug into the IBM Personal Computer and run ordinary CP/M. But you don't have the mindless ease of just shoving in a diskette and pressing the start button, which DEC will give you — because Baby Blue's operating system is either one, or the other.

DEC's operating system is both. It examines the program diskette, and decides which processor is meant to run it. End of hassle.

So far, the only thing known against the DEC micro is the fact that nobody has seen one. It was originally planned to appear in October. This is now to be delayed, and internally executives predict that it will be available in December, but 'better say January to be safe', they say.

Any other computer company would have launched the Rainbow (if at all) with a minimum of fuss, and would have given pride of place in all publicity to a range called the Professional.

The Professional, after all, is the one which gives us all a chance to become PDP-11 users — PDP-11 being the name of DEC's enormously successful range of minicomputers.

The Professional Operating System (P/OS) is derived from base-level RSC, which is Digital's real-time operating system (real-time is what nearly all micros have) of the PDP-11 family.

Digital is as proud of its PDP-11 family, and the design mannerisms which went into it, as its old rival, Data General is of its Nova families. DEC, however, has not restricted itself to offering the Professional the way Data General has restricted itself to Nova lookalikes. Indeed, where DG has, reluctantly and haughtily, condescended at last to offer a non-DG operating system as an option, DEC has put the Rainbow in front of the Professional in its publicity handouts.

And where DG has, inexplicably, refused to allow CP/M to cross its threshold (and has gone for the Business Operating System originally developed by CAP Microproducts, which it describes as a mainline operating

system as though there were tens of thousands of users in the UK alone) DEC has produced not only CP/M, but the new CP/M-86 which IBM has backed.

Strangely, one might have expected things to go the other way. If either company is entitled to a belief that it is right, and the world should follow in its footsteps, it should be DEC, not DG.

There can be no question that a great deal of DEC software is 'superior' — in the sense of being more powerful, avoiding compromises, and being easier to use — than CP/M or MBasic — but you can get both on the Rainbow.

Having praised the company so much, it must then be added that DEC learned its lesson the hard way. It launched a microcomputer two years ago. What! (you say). A DEC Micro, and I never heard of it?

Well, long ago and far away, DEC started out with the PDP-1, and after a while evolved through -2 and -3 until it arrived at the PDP-8. This was a wild success, and the foundation of the company fortunes. It still sells, just because there are things written for the PDP-8 which will run on nothing else — the way people bought Apples when Visicalc would run on nothing else.

A company called Intersil was so impressed that it produced a microcomputer

chip called the 6120, which would do anything a PDP-8 would do.

This failed to become a wild success for esoteric reasons to do with the non-volatility of magnetic core memory and the non-alterable nature of ROM. Digital, suitably flattered, installed this chip in its DECmate micro.

It still failed to become a wild success.

The company has not abandoned DECmate: it has produced DECmate II, which might have sold rather better than it will in the shadow of the Rainbow and Professional. But remember, many another company would have suppressed the Rainbow and Professional on that account — go and have a chat with Texas Instruments, if you don't believe me.

Interesting subsidiary features of the DEC range: they are all equipped to send data direct to ordinary DEC minis and maxis (the Vax is a maxi, because DEC says it isn't a mainframe and I refuse to call anything that big a mini). And they all accept plug-in hard disks without alteration of the operating software. Oh, you thought any micro did? Boy, are you in for a surprise!

Don't bother ringing Digital in Reading on (0734) 868711, because they have already started signing up dealers, and if they aren't talking to you already, you

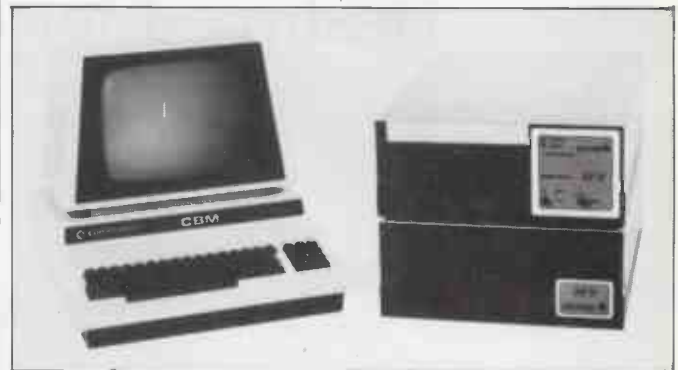

A German-supplied hard disk for Commodore machines, the Adcomp drive, has the unusual feature of being connectable to 16 PETs at once. The system apparently 'understands the CBM 8050 Basic Instruction', a German-language derived phrase which I take to mean that it emulates the 8050 floppy drive and will obey operating system commands normally used for the 8050.

Users can normally have their computers as far as 20 metres away from the disk, and they can even be as much as a kilometre away, providing they use the special long-distance cable driver. The only thing I can't tell you about the system is the price, because I couldn't get through to Mr J Genius (yes, really!) on 089 19 40 19, which is a Munich telephone number. The firm is Adcomp Satensysteme GmbH at Horemansstr 8, D-8000 Munchen 19.





See 'Phone Foul-up'

don't count. And if you just want to buy one, they haven't got any yet.

## Name game

Not to anyone's surprise, I hope, Future Technology Systems has decided that Future Technology Limited is a company name that will not do, and has invoked the Registrar of Companies as authority to stop its rival. Watch this space for further news.

## Turbo PET

It doesn't really matter all that much, usually, how fast your computer is at finding information on a disk. However it starts to matter a lot when 12 computers are using the same disk and you have to wait 12 times as long. Stack, a company which sells a simple method of attaching any PET computer with Basic 4.0 to an 8050 disk shared with several other PETs, also sells a go-faster program to cut the queues for the data. It's called Turbo ROM and it can be installed as an exchange for one of the normal PET chips. Details on 051-933 5511.

## Phone foul-up

Recently, Lion House Micros and I collaborated in an experiment to transmit a 12k byte program down the phone line in hex dump format via a central computer store.

It took well over 80 minutes to transmit — when it worked. The whole first day was wasted because of noise on the line which completely garbled the characters — and the phone kept on ringing up the charges.

It took only around 20 minutes to load, because error checking wasn't available. A pity, because after three separate loadings, it wouldn't run reliably, and obviously had about five characters out of the 12,000 garbled.

These experiences have

deepened my character and I can't blithely accept that the Owltel downloader, which retrieves programs from Prestel for running on the Apple, is really effective on programs much over two or three kbytes in length.

Owl Micro-communications recommends using the package for the 'wide range of educational, games, and utility software now becoming available on Prestel', I recommend sticking to the short ones.

Full details on Bishops Stortford (0279) 723848.

## Virtual virtues

An awful lot of people (for example, those who use the Wordstar word processing program) know that it is possible to run a program that is too big to fit into your computer by 'overlying' bits of it as required — and they are normally very puzzled when firms like Zilog announce 'virtual memory processor units which eliminate the constraints placed on application programs due to main memory size'.

The essential difference between overlay and virtual memory management is that you have to work out the overlaying yourself, but the computer does it for you if it has virtual memory. Neither of these is 'virtual machine' operation, which goes one step further, and overlays the operating system and job control instructions too.

A virtual memory computer programmer sits down and writes code. He (theoretically) doesn't worry how long it is, but hands it over to the compiler, which generates a nice sequence of machine instructions, which it in turn passes to a loader, which feeds it into the computer memory and tells the processor to start at the beginning.

At some stage, the virtual memory management unit notices that the computer is about to access a memory location which doesn't exist. It only goes up to (say) 65535 memory bytes, and is now sending out a request for

the data in byte 78009. Hastily, the virtual manager interrupts, fetches 78009 onwards from the disk, and re-labels it so that it actually starts at number one again.

The drawback is that all too often 78009 contains a quick test which turns out to call for location 25008, which is now location 46999. Processing stops while the new section of program is stored on disk again, and the old lot fetched back out. This can go on and on; it's called 'thrashing' and, in reality, programmers have to watch out that they manage their plans so as to avoid it.

Nonetheless, you don't get omelettes without breaking eggs, and the omelette is a genuine increase in the ability to write programs in languages like Fortran, without worrying how much memory the user will have to have. In other words, to write programs for nearly any machine that can run the compiler.

The chips which Zilog has announced are the Z8003 and Z8004 processors, which will run all software already produced for their predecessors, but will also organise longer programs into segments. The difference is that the Z8003 generates 23-bit addresses organised into 128 segments of up to 64 kbytes each, while the Z8004 generates 16-bit addresses.

The chips will actually start being available around the end of this year. Details on (0628) 39200.

## Advance warning

The exciting thing about the ZX Users' Fair to be held in Pudsey in October is not the fact that it will be in the Pudsey Civic Centre, Stanningley from 10am to 5pm on Saturday 2nd, nor the fact that there will be a free draw and a £50 voucher

to be won. No, it is the simple fact that Northern Premier Exhibitions have told me about it in time to get it in the issue before the Fair happens. You may even have time to book a stand of your own if you've invented something clever for Sinclair computers. Details on (0532) 552854.

## War of the words

The gentle hint of a future war between word processing machines and microcomputers is revealed in a £35 market report from Key Note Publications on the business of processing text.

The report spends much of its time analysing the different types of word processing equipment, all the way from memory typewriters to micros but notes that while micros are starting to sell into the office typing market, there is now some signs of a trend the other way. That is, word processors are starting to handle some computing.

'Many hardware suppliers are now offering additional software to convert their word processors into management information systems, especially accounts, payroll, and financial modelling,' the report notes. 'Some are even offering standard Microsoft Basic so that their word processors can be used as microcomputer emulators.'

However, though word processing machinery is cheaper than it once was, it still isn't down to general purpose micro levels. Some word processor machinery costs 'as little as' £4000, notes the report.

'To become really competitive with general purpose microcomputers, word processors with extended capabilities would have to come down in price by some 50 per cent,' Key Note says. 'At the moment, they only

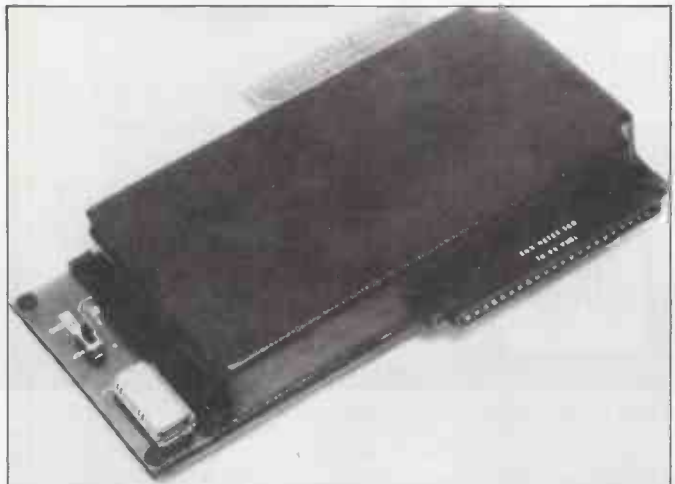

Stack originally released an add-on memory board for the VIC users that gave 3 kbytes for £49 — and promised that one day it would offer more. This is the more. It still costs £49 and now has 8 kbytes plus the ability to expand and room for permanent programs in ROMs.

# One Apple<sup>®</sup> or Commodore Pet and £1,034 can make a lot of pies. And charts. And graphs.

**Introducing the New Personal Computer Plotter from Hewlett-Packard and Laskys.**

Now you can use your Apple or Commodore PET computer to generate your own presentation charts, graphs and pie charts. How? Simply add on the new high quality, low cost HP 7470A Personal Computer Plotter.

The 7470A helps you save time, save money and lets you communicate quickly, accurately and effectively.

### The eye is faster

Data, when visualized graphically, becomes information fast. Charts and bar graphs can make any presentation clearer and more readily understood. But asking your staff to produce the graphics for your next presentation doesn't ensure accuracy or artistic talent. And going to outside suppliers can be costly. Combined with your Apple<sup>®</sup> or Commodore Pet Computer, the new HP 7470A plotter does the communicating for you. Quickly. Logically. And with off-the-shelf software.

### Fast and Pretty

The 7470A gives you high plotting speed with excellent line quality...faster than any competitive small plotter. On top of all that, it comes in an attractive design package that looks nice on your

desk. And it does it for only £1034.

### Count on it

The 7470A is built the Hewlett-Packard Way. To last. Designed and engineered with only a few parts, none of which require adjustment.

And with customized integrated circuits that ensure reliability.

### Pen Pals

The HP 7470A has two single-pen stables. Using different colour pens you can create colour plots using up to ten colours.

### An option you'll want, too.

For only £74.19 you can also get a 17057A Overhead Transparency Kit that turns your plots into transparencies for overhead projectors. For "I need it tomorrow at 9.00am!" meetings, it's a necessity.

### Start plotting your next presentation at Laskys

Stop in at your nearest Laskys Microcomputer Centre today and test-run the HP 7470A. Once you see it demonstrated you'll find a hundred ways to make your own Apple<sup>®</sup> or Commodore PET presentation charts, graphs and pie charts.

Prices include 15% VAT and are correct at time of going to press. All offers subject to availability. All credit offers are subject to acceptance.

▲ Arranged with Lombard Tricity Finance Limited on approval of application. Please ask for written details. APR 36.3%

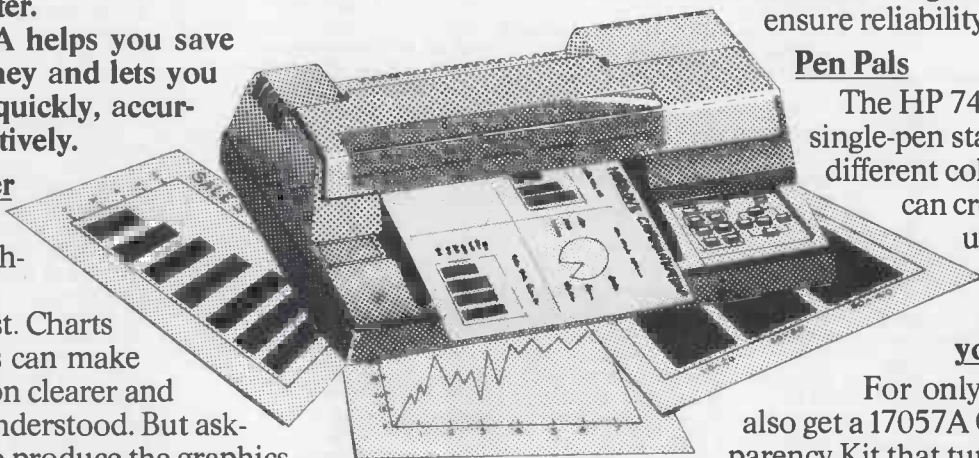

The Retail Division of the Ladbroke Group



**14 DAY  
EXCHANGE**  
ON ALL PURCHASES

**BEFORE & AFTER  
SALES SERVICE**  
ON ALL PURCHASES  
BY OUR OWN ENGINEERS

**▲ UP TO £1000  
INSTANT CREDITS  
3 YEARS TO PAY**

**LONDON & HOME COUNTIES.** 471/473 OXFORD ST, W1 Opening Sept. 1982. 7/9 QUEENSWAY W2, 01-229 6425 (Also open Sun. 12 to 6pm). 42 TOTTENHAM COURT RD., W1 01-636 0845 Reopening Sept. 1982. BROMLEY 22 Market Square, 01-464 7829. KINGSTON Eden St., 01-546 1271. LUTON 192 Arndale Centre, 0582 38302. SLOUGH Queensmere Centre, 0753 24401. WATFORD Charter Place, 0923 47488.  
**SOUTHERN ENGLAND.** BRISTOL 16/20 Penn St., 0272 20421. MAIDSTONE 79/81 Week St., 0622 678165.  
**MIDLANDS & NORTH.** BIRMINGHAM 19/21 Corporation St., 021-632 6303. CHESTER 7 The Forum, Northgate St., 0244 317667. LIVERPOOL 33 Dale St., 051-236 2828. MANCHESTER 12/14 St. Mary's Gate, 061-832 6087. NOTTINGHAM 1/4 Smithy Row, 0602 415150.  
PETERBOROUGH Queensgate Centre, 0733 313513. PRESTON 1/4 Guildhall Arcade, 0772 59264. SHEFFIELD 58 Leopold St., 0742 750971.  
YORK 10a Coney St., 0904 641221.  
**SCOTLAND.** EDINBURGH 4 St. James Centre, 031-556 2914. GLASGOW 22/24 West Nile St., 041-226 3349.



A service provided in association with Unicredit Finance Ltd. Please ask for written details. APR 33.7%. If you pay by Bankers Order (38.5% for other methods of payment).



really attract large organisations seeking standardisation and/or compatibility with existing systems.' What I call people with more money than sense . . . anyway, the report is available from 28-42 Banner Street, London EC1Y 8QU.

## Bubble blowing

Two chip-making companies, Motorola and Intel, are not normally very cooperative so the announcement of an agreement between these two to cooperate on developing Intel's range of bubble memories either proves that the project is very complex and needs heavyweight effort, or that neither side is really too much bothered.

Bubble memory is semiconductor memory that doesn't evaporate when the power is disconnected but it is slow and it hasn't turned out to be as cheap as was first hoped. It was seen as a possible rival to disks when disks were expensive, and nowadays is more realistically viewed as a sophisticated way of producing a disk system that can't get clogged up with dust or that can be bounced around.

The two companies agree that we won't see any of these new bubbles arising from their joint splash until middle of next year at the earliest, from which you can deduce that products with these bubbles in will have to wait even longer. So don't sell your disk company shares just yet.

## Sparky's magic

'The most exciting and novel development in the piano world today,' (says the Cambridge Pianola Company — yes, really), 'is the bringing together of a piano and a home computer.'

The purpose of this exciting and novel development is 'so that they can communicate with each other'.

The idea is enough to make strong fans of Stockhausen quail but I think I have grasped the essentials, and what it means is this: you remember, don't you, the sort of game you play on microcomputers where they have programmable BEEP functions? You randomise the value for the BEEP and do a FOR . . . NEXT loop, and listen to a tiny loud-speaker doing a random walk through the audible spectrum.

Well, now you can do it with a piano instead of the tiny loudspeaker.

'A home computer can invent music,' remarks Cambridge Pianola with breathtaking understatement and oversimplification. 'The piano can play directly from a computer program in Basic, producing an infinite number of variations. It can also be programmed by a musical dunce, to play any score from

Scott Joplin to Mozart.'

If you like this sort of thing, then this is the sort of thing that you will like. Consider: 'piano music can be composed and played without regard for the limitations imposed by the pianist having only human fingers'.

The complete kit will cost £1600 plus VAT. It includes the normal pianola device called a pianocorder, which presses piano keys down, and a Sinclair ZX81 which tells it which keys to press. You can have music without regard for the limitations imposed by humans only having human ears.

For details, contact Thomas Poole on Cambridge (0223) 861348. Better yet, get a time machine and return three years into the past, and blast Uncle Clive before he invents the damn thing.

## Osborne upgrade

The good news from Osborne is that it will supply Pascal/P-System (some say free, but that hasn't been confirmed in the UK) with the upgrade of the Model 1 to a dual-density disk system.

The bad news is that Osborne isn't happy with the dual density controller circuitry, and has postponed its release until January. Apparently too many systems were crashing with CP/M error messages, and there is no better way to infuriate a user than to display a CP/M error message in the middle of his most complex account billing run — because a CP/M error message means 'go back to where you were when you switched on this morning, and start again, because I've just wiped the lot out'.

Details through dealers.

## Here comes Hitachi

Japanese giant Hitachi is all set to launch its 16-bit business micro in the UK early next year. Although billed by some US mags as an 'IBM lookalike', the Hitachi Personal Computer actually has a higher spec than the basic 'baby blue'. Try this for size: 8088 processor, 128k RAM, 192k video RAM (that's 64k each for red, green and blue), 640 x 400 graphics resolution in 16 colours (you can have eight on screen at any one time), 80 x 25 text display, 655k twin minifloppies, MS-DOS, Microsoft Basic and an internal expansion bus which will be compatible with that of the IBM Personal Computer.

Fortran, Pascal, Cobol and Basic compilers will be available, together with an assembler, Multiplan and a

'standard' word processing package. Add-ons and options include 5 and 10 Mbyte winchesters and — probably — Hitachi's 500k 3in micro-floppy disk drives. A large number of applications packages, aimed especially at the business user, are also planned.

As well as setting up a dealer network, Hitachi plans to establish a chain of support centres across the country, where both dealers and end users can be trained and where small businessmen can receive introductory teach-ins.

Peter Rodwell

## IBM clones

While we are all waiting for IBM to find somebody with enough nerve to struggle up the cargo loading bay with its Personal Computer and launch the damn thing in the UK, all is not yet sweetness and light in America.

Two minor niggles have provoked outside manufacturers into trying to compete with (or improve on) IBM's design — one is the keyboard, the other the display.

It is known that IBM's monochrome display is slightly unusual in that it has 'high persistence' — that is, the glowing characters on the video screen fade slowly. If the screen scrolls it is almost impossible to see what is going on because the screen shows the mixed-up overlays of three or four lines together.

Those who have experimented with a short-persistence display, however, report that it may not be an accident that IBM selected the high-persistence phosphor. There is, they say, a decided flicker which seems to be caused by a hardware or software fault in the display.

Other people, less technically experimental, have been known to reject the IBM Personal Computer be-

cause they can have colour or monochrome — but not both.

The display problems are minor niggles, but they have provoked a Michigan company to make the startling announcement that it has 'improved' on the IBM PC by launching the 'Portable IBM Color PC'.

The keyboard is an even smaller niggle but matters more. Simply, the keyboard is nearly unusable by ordinary typists, because the SHIFT and RETURN keys are not where touch-typing fingers expect to find them.

The result is that the very well known keyboard design company Key Tronic in Washington is planning to sell IBM a redesigned keyboard of a more orthodox or up-to-date style.

The really entertaining side of the whole business is that while Key Tronic's venture has attracted much interest, the Michigan Color PC has attracted nothing but derision.

The company, Applied Systems Corporation (ASC), seems to believe that the Intel 8088 chip used in the IBM PC is in fact an IBM 8088 chip. It has also announced that it will put the IBM logo on the front of the box.

That's a suggestion to which IBM has yet to respond, but the company has in the past been known to prosecute people (like British computer company ICL) merely for mentioning the letters IBM in their own advertisements, even when saying merely that something was 'IBM compatible'.

The other rather strange thing that ASC says is that it will use IBM's own keyboard.

It is, perhaps, possible that when IBM switches to the Key Tronics keyboard (if it does), it may have a huge keyboard factory somewhere filled with Mexican workers who want desperately to continue to work, and that in compassion for their plight IBM will sell the useless old-



Ian Dunkley was last year's boss of the Computer Retailers Association. This year, he's gone off with an Osborne 1 to Bombay, where our photographer found him sitting in the market outside Victoria Station, apparently claiming to be negotiating a £150,000 contract for precast moulds by Datron Interform, a company which owns Datron Microcentres, of which Dunkley is the boss. It all sounds very strange to me.

model keyboards to ASC — but it will be the first time IBM has ever done any such thing if it happens.

A healthy scepticism about ASC is therefore probably justified.

Meanwhile, those who like the IBM PC but want a bigger and faster version can look to the announcement of a machine called the Gazelle, just emerging from an American firm called Seattle Computer.

Seattle Computer has a distinct edge over most hardware producers who hope to imitate the IBM computer: it was the company that Microsoft commissioned to write the IBM PC operating system, MS-DOS.

The Gazelle, unlike the IBM PC, uses the full 16-bit implementation of the central processor chip. That is, it uses the Intel 8086, not the sawn-off 8088 version, which makes it bigger and faster but allows it to run exactly the same software. This was always the plan, of course, but perhaps few people expected a direct challenge quite so soon.

In this country, of course, the Gazelle will be old hat — Future Technology Systems has been making a very similar machine, with 8in drives and the 8086, for nearly two years.

Price of the Gazelle in America, including MS-DOS, plus Basic (Microsoft) and a word processor program called Perfect Writer, is \$6000 but that doesn't include a display or keyboard. So it's not likely to sell in its hundreds for quite a while.

## Mock turtle

Yet another version of the Logo language (that's the one that draws pictures by directing an imaginary turtle around the screen with his tail dripping ink) has been launched from New York by Krell Software.

Priced at \$99, this one (like most Logo packages) runs on Apple II and is described as a 'no-frills' version. You get three disks, two containing a 'full authorised MIT copy-righted version of Logo' and the third with 'invaluable MIT applications, including Dynatrack, Rocket, Animals, The Sound Editor, The Shape and the Logo Assembler,' says Krell.

Details from 1320 Stony Brook, NY 11790; tel (516) 751 5139.

## Zilog flood

Around a year ago, we all noticed (didn't we?) a lot of announcements of micro-computers based on the Motorola 6809, plus the beginnings of software support for those machines. Now the fuss has all faded into the background and we will continue to live in the real world of PETAppleTandy and

CP/M as before.

This year we must all try to convince ourselves that the flood of announcements of machines based on the Zilog Z8000, a powerful 16-bit micro, is not a similar silly season hiccup, and that in July next year we will start seeing a small flood of Nat Semi products as a slight intermission to the real world of IBM and Sirius.

Certainly there are some very nice machines based on the chip which won Adam Osborne's White Elephant Award in San Francisco last year (the award was not derogatory but a genuine triumph of tradition over metaphor). Olivetti, Onyx and others are selling, and others will appear.

The good news has been reinforced by Zilog drawing our attention to the fact that its silicon partner AMD has not, after all, backed out of its agreement to make Z8000 devices.

'The unfounded speculation,' said a triumphant Phil Pittman, Zilog UK boss (and ex-Sinclair designer) 'that has been rife concerning a possible rift between Zilog and AMD has now been very firmly squashed.'

He was referring to a new cross-licensing agreement for the whole range of Z8000 processors and support chips.

My own feeling, which isn't much more than opinion, true, nonetheless remains lacking in staunchness of faith, and I still expect the future to be a battle between Intel and Motorola, with Intel eventually winning in 16-bit designs simply by beating everybody over the head with IBM.

One other, small, point which I know Phil Pittman will be grateful for my remarking on: the 'speculation' was not 'unfounded' but 'wrong'. It was founded quite firmly on the news that AMD had signed a deal with Intel, based on the 8086 family of chips — and nobody is pretending that *that* agreement has been ended.

## One-chip modem

There is a big demand for telephone directories and it wouldn't exist without lots and lots of telephones. Similarly, when there are lots and lots of computer-phones (by which I mean modems that connect computers to the phone lines) there will be a big demand for things like Prestel and bulletin boards and useful stuff like that.

One step towards lots of modems is still missing: a cheap modem. Cheap, in this business, means using only a few chips. And I am therefore delighted to observe that Texas Instruments in France is putting together a one-chip modem for computers and Prestel sets.

The chip will not receive ordinary slow (300 bits per second) communications — which is a real shame, because there are quite a few people around who transmit that standard. However, it may not matter. It will receive at either 600 or 1200 bits per second, and it will transmit at 75, or 150, or 600, or 1200 bits.

Frankly, anybody who has ever used a 300 baud communications line will be delighted at the thought that this might become obsolete, because it is painfully slow. If you have a screen of data coming laboriously onto the display at 30 characters per second you can virtually read it as it is printed — and normally we want to read the bottom line first.

What makes the chip really interesting, however, is the fact that it will, according to TI, work with both European and North American standards — which means that modem builders who use this chip can expect a much bigger market than before — which in turn means cheaper modems.

By this time next year, we may see the first early production systems using it, I hope.

## Cash conference

Each year the European Information Providers Association (Euripa) runs a conference, which they call a symposium, and next year they plan to do it again.

This time the subject will

be rather more hardline than the previous rather woolly 'Role of the private and public sector in the information industry', and will concentrate on money.

'How to make money out of Information', then, will run from 17-18 March 1983, and details are available from 79 Great Titchfield Street, London W1P 7FN.

## Movie magic

Someone was asking recently what the point was of all this enormous drive to bigger and better machines.

Is it a plot, he asked, a scheme by the industry to get us to make our nice 8-bit word processing and spreadsheet machines obsolete just so we can chase after new 16-bit and 32-bit stuff? Who needs all the 'extra power' anyway? We can't type fast enough to keep up with the slowest micro today... and so on.

If any designers are reading, then here is a small inspirational idea along those lines. The first order for the world's most powerful computer available for sale is not from the weather forecasters, nor from the big banks, but from an animation outfit. It makes animated films.

No, it doesn't make cartoons. It uses the new super-Cray processor to plot the individual 'grains' of colour film and simulate photographic action. Working flat out, this outfit (Digital Productions Inc) used to be able



This Spectrum is disguised as a Red Indian brave because it wants to understand the IN and OUT commands. The two commands are on the keyboard but they don't make any sense to people who can't find the right pins on the connector at the back to watch them pulse. This Kempston product provides three 8-bit ports, for input and output. 'It's available fully built and tested together with a set of detailed instructions and control applications,' remarks the manager, Mr Pandaal. It costs £16.50.

A £17 motherboard is available, too. Details from Kempston Micro Electronics at 50 Adamson Court, Kempston, Bedford MK42 8QZ.

to churn out one whole frame in a quarter of an hour on its old Cray. On the new one, it will go a lot faster.

Apparently one frame per quarter-hour is around four minutes of film per month, and the new machine can give nearer half an hour's worth of action in that time.

Your average micro can't do this, nor anything like this. The fastest micro likely to be on the market in the next 12 months or so, based on a chip like National Semiconductor's 16032 (a quasi-32-bit design) would be pushed to plot two minutes' worth of movie viewing per year.

The thought, however, is this: drawing pictures is in many ways easier than recognising them. But the power needed to produce two minutes of movie that could be mistaken for camera film could be harnessed to the sort of burglar alarm that could tell the difference between a dog and a human, even if it didn't stand a chance of telling the difference between me and my aunt Maud.

And when Cray machines are priced at the level Sirius machines are today, an awful lot of dreams will suddenly become easy, normal and useful.

Think of the possibilities.

## Wedded bliss?

The word 'marriage' has been used by software writing company MSA to describe the integration of programs for giant mainframes and for individual micros.

What John Imlay, head of MSA, really means by this is complex, but the essence of the idea is that files of data produced by micros should be intelligible to the central computer in any organisation, and, similarly, that data produced by the central computer should be able to be processed by software running on any micros that the group might use.

As Imlay says, his company is 'in a unique position' to offer a range of software that fits this bill. MSA is, whatever rivals may say, probably the biggest specialist software-producing company in the world and it has bought Peachtree, one of the leading micro application producers.

This is not to say that all MSA software and all Peachtree software is automatically interchangeable. It means that one day, with luck, a lot of the newer stuff will be.

Some examples of the applications to be released over the next few months, according to the company's official statement, will include the following.

First, customisation of financial statements produced by MSA's general ledger, to add late changes, footnotes, etc, using Peachtree's word processing system PeachText.

Next, selection of information from big mainframe databases for use on MSA's Visicalc-type program, Peachcalc, 'for budgeting, planning and management analysis'.

Also, integration of the Peachtree Software order entry system will be possible on MSA's accounts receivable mainframe system, so that local orders can be processed centrally all together.

Possibly the most interesting application, however, is that financial and statistical data produced by each of MSA's systems will be transferrable to micros, and turned into full-colour graphics displays with Peachtree's new Business Graphics system.

What I like about the direction this is going is the fact that the micro side of the partnership is intended to enhance, rather than rival, the central DP department's work. It could lead to more co-operation between established and 'pirate' computer users inside corporations and, from that, the new business computing market will be able to draw rich nourishment in ideas, market opportunities and shared resources.

## Genie hi-res

High resolution graphics are now added to the Tandy look-alike Video Genie, for an extra £86.

The new device is the LE18 unit, which uses a separate 16 kbytes of memory to provide a dot matrix of 384 by 192 points, which is some 73,000 points — almost exactly 73 times as many as the Tandy normally has.

New commands in TRS-80 Basic (needed to control this video memory) include PLOT, VECT, FILL, REV, CLR, DISP, HOLD and VIEW. 'In addition, a scratch pad memory allows animation and the use of programmable graphics characters, and the unit can also produce reverse video displays,' says Lowe Electronics.

Lowe is the UK distributor of Video Genie, having sold some 10,000 machines here, but this product is its own design. Details on (0629) 2430.

## 'Allright,' says the Squire

What I like most about a certain part-time director of ACT and general micro entrepreneur (Julian Allason is his name) is his irrepressible optimism. It currently covers the new IBM operating system, MS-DOS.

Allason has released a fervent dose of enthusiasm in conjunction with his associate Christopher Preston on a brand new 'Research Brief' which appears to be the first of a series. It is quite cheering to be told, for instance,

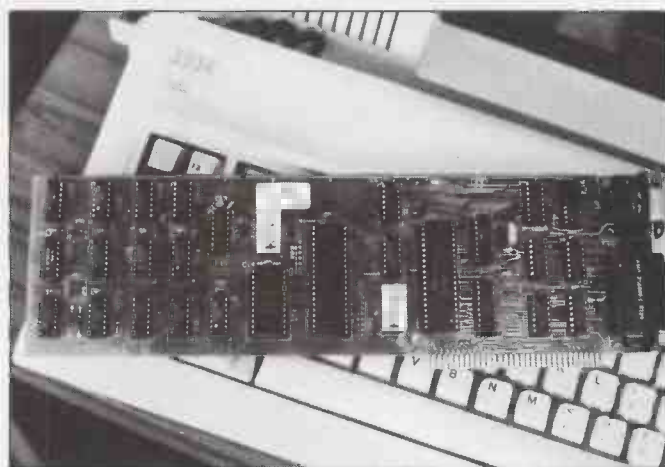

that 'Microsoft claims MS-DOS is almost 100 per cent compatible with CP/M' or that Allason Associates' tests show the new system to be up to three times as fast at reading disks as CP/M-86.

I hope that in future research briefs we will be offered rather more on the differences than on the similarities. CP/M itself differs from CP/M-86 more than MS-DOS appears to here, and I feel there must be more to it, somehow. But it is all very cheerful reading. Contact Allason at PO Box 2, Goring, Reading RG8 9LN for his future plans.

## Tango time

Tango is a dance: it is also the colour, believe it or not, of the paint on ICL computers (hence the fact that people often refer to ICL computers as orange boxes).

A Tango-Lynk, then, is the device which links something to an ICL mainframe. The something is an IBM Personal Computer, and thereby hangs a long tale, mainly about Network Designers and a firm called Telecomputing.

Telecomputing was a software firm which wrote and sold excellent software to allow ICL users to drive their computers from remote terminals. The Telecomputing software was generally agreed to be better than ICL's own software for teleprocessing, and ICL junior operators promptly arranged to do everything in their power to harass the company for showing them up. It ended up with Telecomputing getting close to a million pounds in an out-of-court settlement.

Network Designers is a company with a lot of names at the bottom of the letterhead, which are the same names as used to appear at the bottom of Telecomputing's paper.

What happened was that the company found that they were making a lot of money out of selling their software — but a lot more out of selling an over-engineered, over-priced, and (it turned out) unreliable design of micro made in Australia.

## See 'Tango time'

Having disentangled themselves from that group (not without strife) the directors selected a better micro, and have gone back into selling software which helps you to drive your ICL mainframe through a micro.

The only difference is that this time they have picked the IBM personal micro as the box which you sit at. You plug in the board (illustrated) and run Network's Tango-Lynk software.

Anybody who wants to use a different micro to drive their orange box, contact Network Designers on Oxford (0865) 776888. They will probably prove sympathetic.

## No scrumping

In this country, Bill Unsworth reminds American readers, the verb 'to scrump' means to steal apples. So to unscrump is to prevent them being stolen, hence the name U-NSCRUMP for his software protection device for the Apple II.

Unsworth notes that hardware protection of software is 'more attractive' than disk protection because it allows backup copies to be made of program disks, and also allows the user to run the program on hard disks or on 8in floppies.

U-Microcomputers plugs the device into the expansion bus, not into the games port, which allows the user to have the games port working but clutters up the bus.

The device is now available for evaluation at £28, and at that price, notes Unsworth, 'will be used with the more expensive business, scientific, and professional packages'.

I don't want to spoil his market, but beside the simple fact that I hate these protectives, I really query their value.

Whatever theory you may produce to explain 'lost' revenue due to pirates, you will still be the first person to manage the trick, if you can produce any evidence that software houses which use protectives make any more money than those which don't.

Visicalc has made a mint and is theoretically 'protected'

# WHEN YOU HAVE 637 PROSPECTS TO REMEMBER YOU NEED OUR ELECTRONIC CARD-INDEXING AND RETRIEVAL SYSTEM



Many people know Henry VIII had six wives. But few are aware of his 637 girlfriends. Poor Henry! Is it any wonder he laid about them with an axe. Just imagine trying to remember all those first names, addresses, birthdays, pigeon hole numbers and personal details.

With CARDBOX, Coxton's new electronic card indexing system, keeping and retrieving information is simplicity itself. Not only could Henry have found his ladies but he could have kept tabs on all those barons, bishops and bowmen. (Rent demands would have gone on time, confiscations would have been orderly and executioners would have been selected to suit every occasion.)

And he wouldn't have had to understand a thing about computers. CARDBOX looks like your favourite card index on the screen. You draw the card yourself. You decide where you want lines. You make up your own headings. And you fill in the details. At this point CARDBOX stops behaving

like a flat inflexible card. It becomes multi-dimensional electronic paper. You can change any information you want. You can retrieve portions of information. You can print out all or selected information from your cards.

You talk to CARDBOX in plain English. You search your records on key words or on selected criteria. CARDBOX acts like a sieve, sifting through the records reducing the number until it finds only those that meet your needs. You display records on your screen or print them out in a format of your own design. Label production for mailing is simple. You can also use CARDBOX with some of your favourite wordprocessing packages, eg Wordstar.

CARDBOX works on most popular CP/M machines including those with special screens, eg Osborne. Use the CARDBOX Tutorial to learn all about this simple, fast aid to better record management. Study the detailed Reference Manual to take full advantage of its sophisticated features.

See CARDBOX at your local computer dealer. Or we'll send it to you with a dealer list. Call or return the coupon to us.

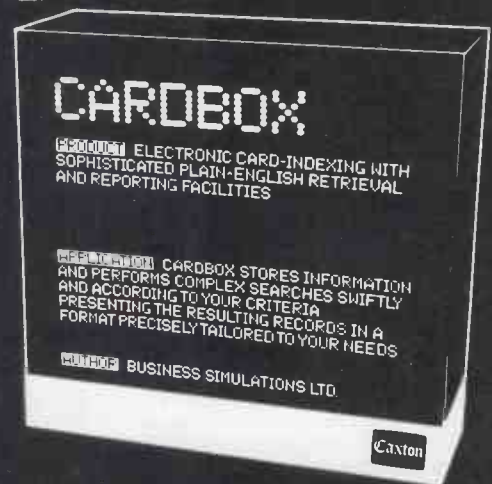

CP/M, Wordstar and Osborne are registered trademarks of Digital Research, MicroPro and Osborne Computer Corporation respectively.

Coxton Software Ltd, 10-14 Bedford Street Covent Garden London WC2E 9HE Telephone (01) 379 6502

I am a  User  Dealer Please send me  Leaflet  Cardbox, I enclose a cheque for £155 (+ VAT at 15% and £2 p & p.)

Name \_\_\_\_\_ Position \_\_\_\_\_ Company \_\_\_\_\_

Address \_\_\_\_\_

Computer \_\_\_\_\_ Disk Format \_\_\_\_\_



and all I can say to that is that it has also made a mint for the bright sparks who sold programs to unprotect it. Wordstar has made a mint, and isn't protected at all from the user.

Anyway, Unsworth is on (0925) 54117/8 in Warrington.

## Not as bad as it sounds

A good indication of the strength of a new product is the list of things that the proud inventor compares it with. The inventor of the Nippon-Univac micro compares it with the IBM Personal Computer (not launched in the UK), with Burroughs' new micro (can't recall hearing about it, can you?) and the enormously successful Apple III, of which so many have said 'when is Apple going to launch the Super II?'

In other words, it's slower than a speeding bullet, can leap over the Empire State Gutter in a single bound, and so on — you deduce. Well, no, it's a bit better than that.

It actually looks to be a reasonable middle-of-the-road sort of beast, capable of selling a thousand or so systems if only it had been launched a couple of years ago. For just under £2000 you get an 8085-based system with CP/M 2.2 and two medium-capacity small disks. That compares reasonably well with the ICL Personal Computer which 'stands out from the crowd' as Martin Banks so caustically observed last month.

Distribution is (sensibly, I would say, in the circumstances) not going to be done on the scale that ACT is pushing the Sirius 1, but will be 'a small distributor network in the UK', according to Peripheral Hardware Ltd, the importing outfit, which can be contacted on 021-745 3033.

## Psychobabble seminars

Computertown USA may have inspired David Tebbutt to start pushing the idea of ComputerTown UK — but the two projects are as unlike as cricket and baseball.

The American version started off as a club in the Menlo Park (in the middle of Silicon Valley) library, for children. It has now become a 'microcomputer literacy project funded by the National Science Foundation' and has announced the selection of its 'official Western US Test Site', in Wenatchee Valley College (in Washington State).

The idea of a Test Site, it seems, is to develop a 'package' which provides 'suggestions for creating

hands-on, public access events, conducting workshops, giving classes, establishing outreach activities, and locating and procuring funding and support,' remarks my handout incomprehensibly.

I wonder if the Americans know what 'quango' means.

The idea of a Test Site, it seems, is to develop a 'package' which provides 'suggestions for creating hands-on, public access events, conducting workshops, giving classes, establishing outreach activities, and locating and procuring funding and support,' remarks my handout incomprehensibly.

I wonder if the Americans know what 'quango' means.

## Cheap but outmoded

Texas Instruments in the US is singularly stubborn about admitting to problems on the basic design of its 99/4A 'home computer' which has received new price cuts here in the UK.

The company says that this year is the beginning of the 'long-awaited' boom in home computers, according to American journal *Electronics*, and is accordingly diverting production resources from the 'soft' terminals market into the 99/4A. The company has already got production economies to the point where it can be sold for \$199 in the US.

Even so, I'll be surprised if that makes it the success of the decade. It's nice that it can talk — but what else can it do that isn't way out of date? Can it play Pac-Man?

Come on Texas, give us a really new design. You can do it, you know you can.

Not surprisingly, the price cuts in the US have been reflected by a drop here, too — to £200.

The company has also announced expansion facilities. You can now buy the illustrated box to plug expansion cards into, plus a floppy disk drive.

## Mega-memory

Two megabytes of disk on a Nascom computer would be something to nod solemnly about, say 'nice' and forget. Two megabytes of silicon chip memory, however, is something else.

The trick has been done by MAP 80 Systems, which has produced a memory board with 64 kbytes of memory chips on it, for £150. That includes all necessary decode circuitry for the expansion of up to eight such cards, which can take a total of 256 kbytes each.

The method that MAP 80 has used is to treat the memory as if it were a very fast floppy disk, which means

that you can abandon your silly dream of writing a single program two megabytes long. And of course you will have to adapt your software to the system to take full advantage of it.

But the trick is now quite widely done, and it is nice to see it performed on the Nascom family, which includes the Gemini and new Galaxy range of machines as well.

Details from 333 Garratt Lane, London SW18; phone 01-785 9721.

## Neat hi-res

A quick trip to the Notting Dale Technology Centre recently revealed, in the middle of a mass of micro bric-a-brac, a rather neat little graphics add-on for the ZX81.

'81 owners who, for varying reasons, would rather keep their old faithful than sell it and fork out for a Spectrum can upgrade the graphics powers of the ZX81 to a higher-than-Spectrum resolution for just £27.50.

The graphics board will allow you to define your own characters using POKE in a rather similar way to the Spectrum's use of BIN and to fill in shapes in varying shades and textures. It adds considerable power to the individual ZX81 graphics commands to enable the use of this extra capability without your having to learn a whole lot of new reserved words.

The only serious limitations it has are that it cannot be used with some of the 64k RAM packs, as these use areas needed by the board.

The board needs at least 8k of RAM but cannot be used with some 64k RAM packs as these use areas of memory required by the board. Also, the G007 (to give it its proper name) makes the ZX81 behave in a rather odd way, compared to its normal habits and this is a little hard to get used to at

first. However, the board comes with full and clear documentation which explains what you can expect to see.

The board was designed by Gary Keall, originally as a hobby project and is now about to go into production at Information Technology Centres throughout the country. It will be on sale from 1 October. For more details contact the Notting Dale Technology Centre on 01-969 0819.

Maggie Burton

## Top of the pops

There are some cynics who feel that the micro business is rapidly becoming a branch of show business, complete with smash hits, cover versions and superstars. What is needed to support this jaundiced view is a hit-parade; a micro Top Ten.

BIS-Pedder have for nine years published an annual Census of Information Systems and in a recent press release they summarise some of the findings of this year's survey. The whole thing makes fascinating reading as it documents the spectacular plunge in mini-computer sales. But the really fun part is a pair of tables which rank the numbers of units shipped in 1981 for general purpose computer systems under £15,000. These have in effect become a hit parade for personal computers as the mini-manufacturers slip out of the top ten.

One difference between records and computers of course is that there isn't a standard price, so you have two top tens; one by units shipped and one by value shipped.

Here then are the top of the pops in 1981:

| % of units shipped |                    |
|--------------------|--------------------|
| 43.3               | Sinclair           |
| 8.8                | Commodore          |
| 6.7                | Acorn              |
| 6.6                | Lucas/Nascom       |
| 5.7                | Apple              |
| 3.6                | Lowe (Video Genie) |
| 4.4                | Sharp              |
| 2.6                | Tangerine          |
| 2.4                | Tandy              |

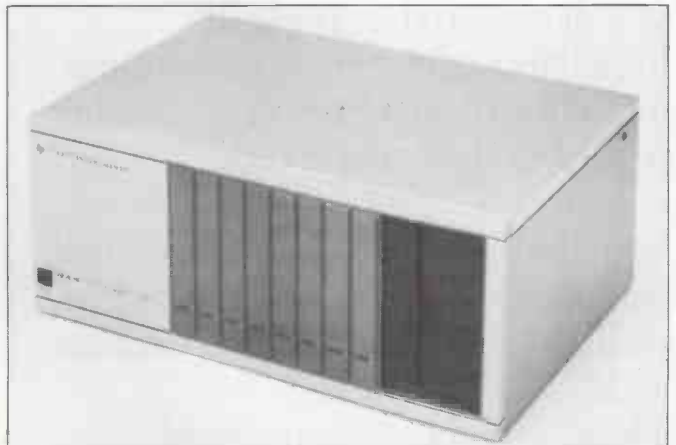

See 'Cheap but outmoded'.

# "Something tells me Sydney's Apple III has solved his accountancy problems."



If you run a small business you need an Apple III.

The Apple III will provide you with an integrated accountancy system, so even in these slippery times you can keep your business feet on solid ground.

Outgoings, incomings, invoicing, VAT: it's all easy to the Apple III.

It will also take care of basic things like stock control, so what's on stock, what you've sold, and what's on order are always on tap.

You'll have access to Apple's essential range of software, such as Apple Writer III, Visicalc III, Mail List Manager and Business Graphics\*.

These small business oriented programs make easy the less ordinary

business functions like sales forecasting, modelling and analysis. So they soon become a lot more ordinary to you than they sound at the moment.

Suddenly you'll see charts and graphics that make complicated business equations simple and easy to consider.

And when key functions like those become easy, small businessmen suddenly have the time and confidence to think about getting bigger, and more profitable.

\*For details of the comprehensive range of Apple III software, write to the Sales Desk, Apple Computer UK Limited, Eastman Way, Hemel Hempstead, Hertfordshire, HP2 4YE. FREEPOST

Name \_\_\_\_\_

Address \_\_\_\_\_

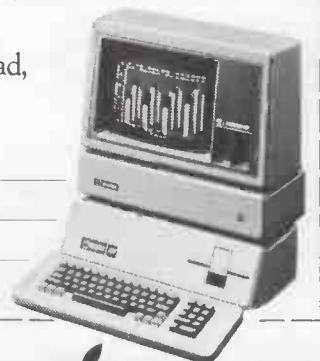

The personal computer.





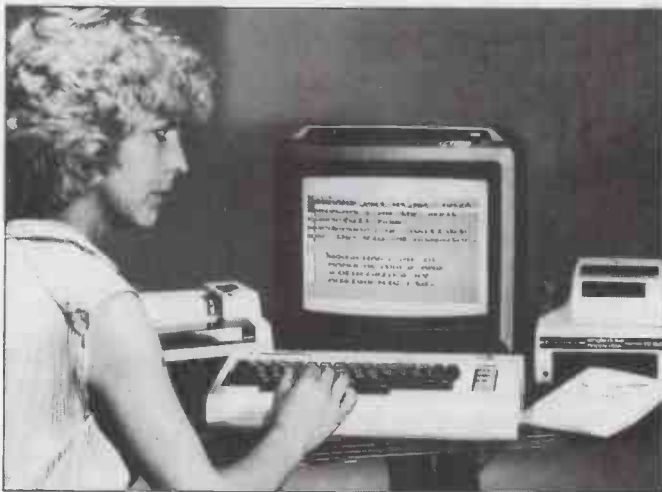

## Bludners extra

There were a couple of bugs in the DIY Logo program printed last month (page 156). Here are the corrections needed.

The QUIT statement mentioned in the article is not in fact implemented in the listing. To make it work add this line:  
 4084 IF SYSS="QUIT"  
 THEN I=0 : GOSUB 9010 :  
 GOSUB 28000 : GOTO 4200

Set K8 in line 10050 to 35 and add this line:  
 10170 R\$(34)="QUIT":  
 R\$(35)="AND"

This also corrects a bug which would have allowed

you to define a procedure called AND despite the fact it is a reserved word.

Finally the RIGHT statement as written in fact moves left on the screen! To alter this change AN-C(S) to AN+C(S) in line 23500.

Some readers have queried the ON...GOTO in line 20130 which has three apparently unresolved line references. These values should never be selected unless there is a typing error somewhere else in the program. If it disturbs you it would be best to write error traps for the three lines involved, 23600, 23700 and 23800.

See 'Not so silly'.

|                       |      |
|-----------------------|------|
| Intertec (Superbrain) | 1.5  |
| % of value shipped    |      |
| Apple                 | 14.2 |
| Commodore             | 9.2  |
| (Olivetti)            | 4.4  |
| (CAI)                 |      |
| Tandy                 | 4.1  |
| Data General          | 3.4  |
| Intertec              | 3.2  |
| Sinclair              | 2.9  |
| ITT                   | 2.3  |
| BCL                   | 2.2  |

These are only figures for new business in 1981 and don't reflect the size of the installed base. If you need more comprehensive information on the state of the micro marketplace get in touch with BIS-Pedder on 01-633 0866 (Philip Hammond or Derek Pedder).

## Not so silly

You have to give Audiogenic some points for candour, in launching the well-known Commodore PET-based word processing package on the 20-characters-per-line VIC. Not everybody in the world would actually display a photo of what the text looks like if it looks like this, would they?

For those who don't have a VIC, however, it is worth saying: it looks sillier than it is. Remember, those who actually do have one will probably want to write notes with it some time, and now they can. The rest of us have been warned.

You buy the software as a plug-in cartridge for £125, including an extra 8 kbytes of memory. Details from Audiogenic at PO Box 88, Reading, Berks; tel 0734 595647.

## A fit of the vapours

We PCW types love good esoteric jargon; we have crazes which last for weeks on particularly barbarous jargon words. Sometimes we go as far as to deliberately introduce them into articles as a sort of private joke or dare, but usually we restrain ourselves and keep them for



office circulation only. A favourite for many months was 'orthogonal' used in such contexts as 'this coffee isn't very orthogonal' or 'that's a rather orthogonal shirt you're wearing'.

'Functionality' enjoyed a considerable vogue, especially when combined into such hybrid horrors as 'just nip out and probe the periphery of the functionality envelope of the coffee machine please'.

We were therefore tickled pink when Chris Buckham of ACT brought us back a real live specimen from the West Coast, namely 'vapourware'. This fascinating concept refers to software which has been announced but doesn't exist yet; there is a lot of it about (or not about, depending on the philosophical school to which one belongs). We don't imagine that Chris heard the word used in connection with any Sirus products of course.

The principle established in an excellent one and we hope to add to the list of 'wares'; for instance 'fogware' could be undocumented software. We leave the definitions of 'rubberware', 'noware', 'someware' and 'edgeware' to the readers.

This picture is a good example of the limitations of providing information on paper, printed in black ink. If PCW was an entirely electronic magazine (and who knows, maybe it will be in 10 years' time), you would be able to appreciate to the full this picture of Rair's latest terminal, the ColorScan 10.

As its name implies, it's a colour terminal and can display up to 256 'unique symbols' per character set, which, says Rair, is 'especially useful in business applications requiring display of forms or bar charts'.

In case you're one of the few people left who seriously think colour computers as strictly for games, let me remind you that colour actually provides an extra information channel - and for that reason we'll be seeing a lot more business computers with colour as standard, soon.

One thing which Rair (phone 01-836 6921) doesn't say about the ColorScan 10 is its price, so you can be sure it ain't cheap!



*'I'm sorry, Mr Harris, but being able to get by in Pidgin-Fortran isn't quite good enough.'*

# NAMER OF THE NAMELESS

*Dick Pountain writes on a little-known mathematical calculus which could have some importance for computing.*

無名天地之始

In 1969 I was a newly graduated biochemist with a keen intellectual interest in maths and philosophy and a keen practical interest in pharmacology. I shared a flat in Notting Hill with several others of like inclination and this flat was filled with many esoteric books of great obscurity. One day I perused a book called *Laws of Form* by G Spencer-Brown. I was unable to understand it on that first reading and decided that it was probably cranky, like most of that mountain of books. It left an impression, though, and I never forgot it; I had a vague feeling that it might in fact have been profound, and felt a certain guilt at not having persevered.

Some eight years later I was flicking through my *New Scientist* when I came across a news piece: the Four Colour Map Theorem had been proved. This famous theorem of topology had resisted proof for more than a century and was a kind of Everest for topologists. It had been proved by one G Spencer-Brown using a fairly short and elegant proof. Around the same time a group of Americans reported a proof by a brute force method using some hundreds of hours on a fast mainframe computer. My mind was forcefully sent back to *Laws of Form* (which had long since disappeared along with several of the people). I scoured Foyles, Dillons and such only to find that it had been out of print since that first edition. Eventually I found a mathematician friend who had a copy which he grudgingly parted with for two weeks. In those two weeks I read it again three times making some progress but still being very far from understanding it.

About this time my involvement with PCW began and I raved somewhat intemperately about the book to David Tebbutt, the new editor, one day. Some weeks later he returned from his first visit to the West Coast Faire and presented me with a brand new copy of *Laws of Form*. It is alive and well and published in paperback by Dutton of New York. According to David it has a certain following among the Artificial Intelligence community in Stanford.

I'm telling you all this to persuade some of you to seek it out and read it because of my faith in the personal computing idea; with so many people out there now possessed of computing power it is just possible that one of you might use the concepts contained in *Laws of Form* to stand computing on its head. I doubt that it will be me, unfortunately.

*Laws of Form* is about logic — sort of. In fact it is about something below or behind logic. Anyone who knows Basic knows something of the algebra

invented by George Boole, though probably not in any rigorous or formal way. Boolean algebra is a notation which allows logical propositions to be expressed as algebraic equations, these being solved by a set of transformation rules to establish the truth value of the original proposition. In Basic it shows up as your AND, OR and NOT and those flag variables which only have the value TRUE (1) or FALSE (0).

Now algebras are abstracted from arithmetics ( $a+b=c$  expresses the form of all such arithmetic sums as  $2+3=5$ ,  $4+5=9$ ). But Boole's algebra was born fully grown as an abstract system to solve problems in logic. The lack of an arithmetic of which Boolean algebra is an abstraction went without notice for 120 years until G Spencer-Brown (aided by his late brother D J) produced this arithmetic. This is the subject of *Laws of Form*.

This arithmetic is non-numeric and is very simple indeed; so simple that it is extremely difficult to understand. That is not just a cheap paradox. Spencer-Brown (GSB from now on, begging his pardon) devotes a preface to warning of the difficulties in store for the reader; these are not due to any mathematical jargon, for the book is written in plain and nicely turned English and doesn't require formal maths training to read. The difficulty will be just as great for mathematicians as non-mathematicians because he is describing concepts which are almost too simple to be expressible in language. The notion of number and counting is formed very early in human beings (some people believe it's innate) and it is an obstacle to understanding concepts which are more primitive than itself. GSB's Primary Arithmetic is easier for amoebae than humans.

The argument starts from the idea of distinction. A distinction 'severs or cleaves' the space in which it is drawn, like the circumference of a circle in a plane. The space is now in distinct parts and one part can only be reached from the other by crossing the boundary drawn by the distinction. This act of crossing is given a symbol  $\sqcap$  which is in fact the only symbol in the arithmetic. It represents the 'marked' state (a distinguished state). The unmarked state is represented by a blank space. I should hasten to point out that GSB develops this rigorously. I'm cutting corners for reasons of space and pace.

Two laws, the law of calling and the law of crossing are taken as axioms and lead to a pair of primitive equations: 2

and  $\sqcap \sqcap = \sqcap$   
and  $\sqcap =$

and the calculus based on direct deri-

# BRAIN DUMP

vations from these equations is the Primary Arithmetic. Expressions made up of any number of these 'crosses' to any depth of nesting can be produced and simplified to give a value which is either  $\top$  or  $\perp$ . An example is

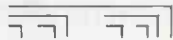

which has the value  $\top$ .

Small wonder that the opening page of *Laws of Form* contains a quotation in Chinese from the Tao Te Ching which goes 'The nameless is the beginning of heaven and earth. The named is the mother of ten thousand things.'

At this point you are probably wondering whether anything concrete can emerge from such a notation. Patience please.

Having proved a number of theorems in the arithmetic, GSB introduces variables or unknowns and so creates the Primary Algebra, which is by no means similar to Boolean algebra though it can be interpreted to give Boolean algebra and more by identifying cross with truth and blank with falsehood.

An expression in the algebra looks like  $\neg a$  where the value of  $a$  is unknown. By deriving a series of nine consequences to which he gives significant names like 'reflexion', 'generation', 'iteration' it is possible to simplify such expressions though they do not always reduce to a known value.

The fireworks now begin. Boolean algebra is based on a set of postulates (ie, unproven assumptions), the exact nature of which set has been the source of much investigation. GSB proceeds to take one such set (Scheffer's Postulates) and prove them all in one page using the algebra. He goes on to demonstrate the interpretation of the algebra for logic. Massively complex syllogisms can be reduced to conclusions with astounding ease when compared to the laborious application of Boolean algebra and de Morgans theorems. At one point it is shown that all of pages 98 to 126 of Whitehead and Russell's 'Principia Mathematica' can be reduced to a single  $\top$ .

But the application to logic is a minor incident on the way. The Calculus of Indications, to give the system its full title, is of much greater generality than any logic.

In a breathtaking final chapter GSB introduces the idea of imaginary values by allowing the creation of re-entrant or recursive expressions. From this in a few short pages he produces expressions which demonstrate oscillating values, and can emit 'waves' which propagate through the space containing the expression. In other words, starting from two simple axioms and a simple notation he has produced expressions which can model the behaviour of the physical world of quantum mechanics.

In fact the calculus provides a general theory of forms which does not merely describe different forms but shows how they all emerge from the original form of distinction. Numbers and counting are derivable as interpretations at quite a low level.

At this point, having indicated just how far one could go with the calculus, he stops with what is perhaps my favourite sentence of all: 'This book is not endless, so we have to break it off somewhere. We do so here with the words

and so on.'

This last chapter contains the key to the solution of Boolean equations of the second and higher degree, which is the method the Spencer-Browns used to prove the Four Colour Theorem and which they put to practical use in designing complex switching networks for British Rail. I cannot pretend that I understand it well enough to either explain it here or to use it myself.

That then is a brief and clumsy account of the importance of *Laws of Form*. Why should PCW readers be interested? For a whole stack of reasons, the first and best of which is that it is a challenging and exciting book, written with an elegance and wit which is almost extinct in modern

science. If you like mental exercise this will stretch you even more than 'Godel, Escher, Bach' and with more immediately usable results.

The first project I thought of connected with microcomputing was the obvious one of writing a parser and evaluator to simplify expressions in the calculus. This is not at all an easy task because the calculus relies so heavily on the cross notation, which is simple and beautiful but highly unsuited to character-oriented micro displays. The trouble I had typing those examples above using Wordstar testifies to that. It's probable that you would have to reduce this notation to something rather like the nested brackets in Lisp to make it work; in fact all kinds of half-formed analogies with Lisp enter my head whenever I read the book.

But the really exciting idea which I can't shake off is that of a language which uses the Calculus of Indications in the place of Boolean algebra. Or, to go the whole hog, a processor with this logic implemented in silicon. I'm in way over my head with this sort of talk but everyone nowadays seems to be talking about non-von Neuman architectures as the next generation of machines; is it possible that higher order Boolean logics may have a role to play too?

At any rate I hope I can stimulate a few readers to find the book (it may well be in print here again by now), read it, assimilate it (which will take about eight readings unless you're a lot smarter than me) and just maybe go on to do something amazing as a consequence. It is not as well known as it ought to be and it's nice to have a platform like this to boost it from.

PS. Professor G Spencer-Brown is alive and as far as I know well and living in Cambridge. Should he by any remote chance read PCW I'd like to apologise here and now for the roughshod way I've trampled among his ideas.

(*Laws of Form* by G Spencer Brown — E.P. Dutton Paperback, New York 1978.)

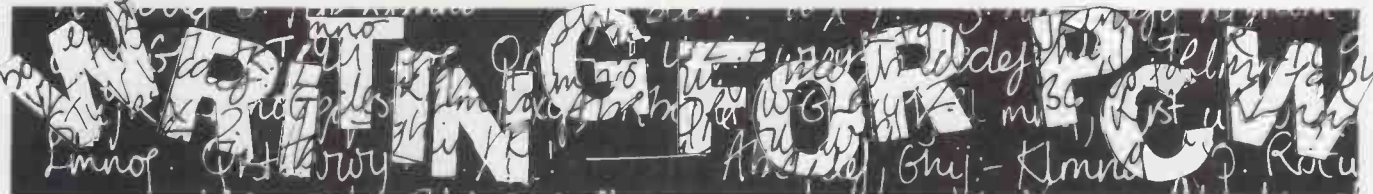

PCW welcomes approaches from would-be writers, even those who may never have appeared in print before. In this game it is often those with practical experience who have important things to say so we don't mind too much if their prose is less than perfect. Providing that submissions have a sensible structure and follow a logical sequence, we can take care of the polishing. Here are some tips:

If the article is already written, simply send it in, making sure that your name, address and phone number appear on both the article and the covering letter. If you have submitted the same work to other magazines you

should tell us — it would be embarrassing (to say the least) if the same article appeared in more than one.

If you have an idea for an article or a series, write us a letter outlining your ideas. A one or two page synopsis giving the proposed structure, sequence and content will give us a sound basis for discussion. Please give us a daytime phone number if possible.

If you have nothing specific in mind but feel qualified to conduct case studies, Benchtests or whatever then drop us a line saying what you'd like to do and why you think you're qualified to do it. We're not particularly looking for strings of academic qualifications —

experience carries just as much weight.

Dick Pountain is always on the lookout for interesting calculator features and we wouldn't mind seeing one or two readers getting on their soapboxes but remember: even articles such as this need a structure.

Reading PCW will give you a good idea of the style we prefer. You may notice that we try to avoid pomposity at one extreme and flippancy at the other (except in 'Chip Chat', that is).

Finally, have a look through back issue indexes and try not to re-invent any wheels. Oh, we almost forgot — PCW does pay for all published work.

**NEW  
FOR ZX81 USERS**

## EVEN MORE MEMORY WITH OUR BYGER BYTE 32K + RAM PACK

Why put aside your 16K RAM PACK when you can use it together with the new BYGER BYTE 32K + RAM PACK, to give you 48K OF MEMORY.

No trailing leads or wires – all you need do is plug the existing 16K RAM PACK into the back of the new BYGER BYTE 32K + RAM PACK and bingo! 48K OF MEMORY.

Uses existing power supply. The new 32K + RAM PACK is tested and guaranteed with the following 16K RAM PACKS: BYG BYTE, Sinclair, Downsway.

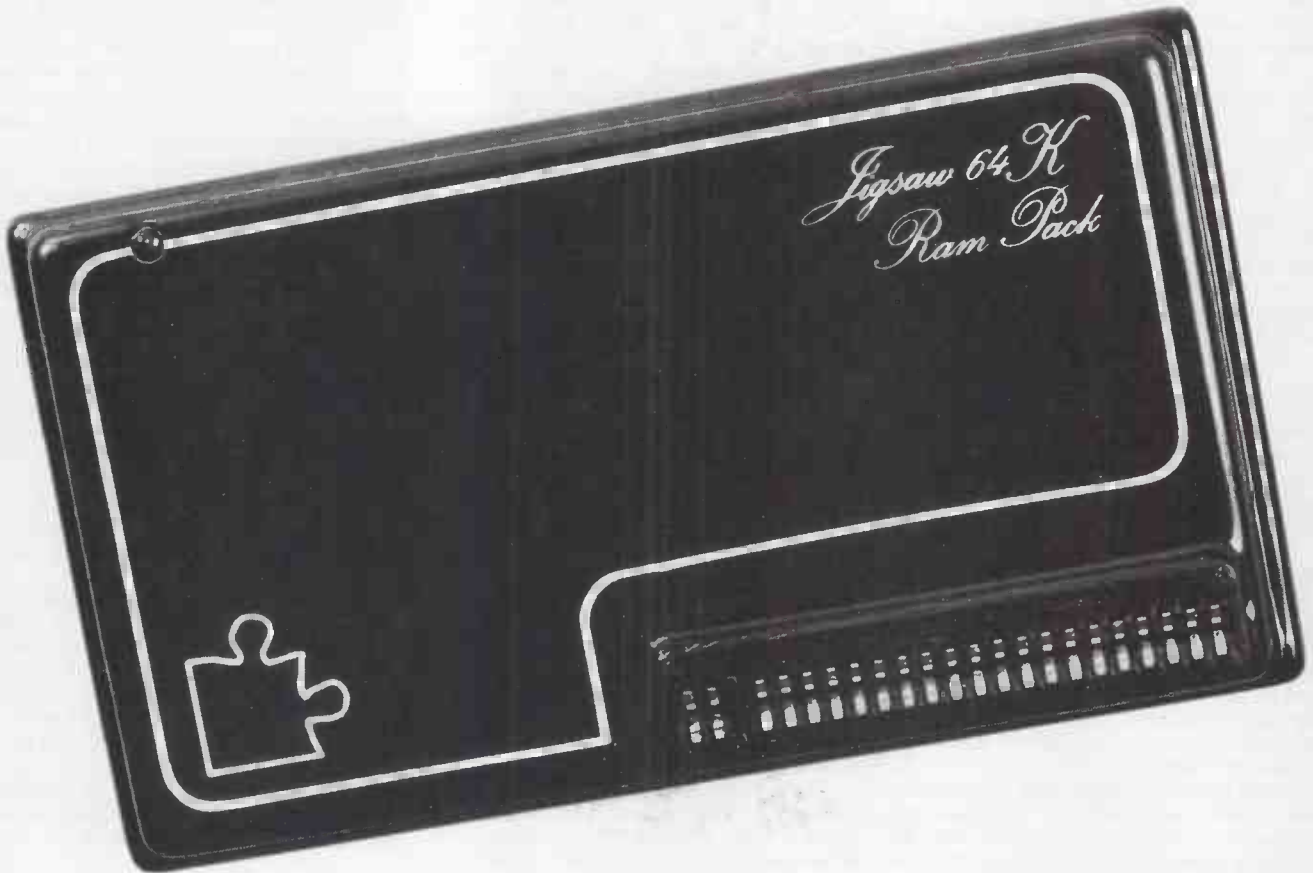

### Also Available

|          |                |        |
|----------|----------------|--------|
|          | 16K RAM PACK   | £22.00 |
| NEW      | 32K + RAM PACK | £39.50 |
| STANDARD | 32K RAM PACK   | £35.00 |
|          | 64K RAM PACK   | £53.95 |

TAPE LOADING INTERFACE. For trouble-free loading of Programs £9.50  
 NEW HIGH QUALITY KEYBOARD WITH BLEEP AND RESET £49.95  
 All prices are inclusive of V.A.T. + FREE postage and packing

### PHOENIX MARKETING SERVICES

Oaklands House, Solartron Road, Farnborough, Hants. GU14 9QL.  
 Tel. (0252) 514990

NAME .....

ADDRESS .....

Make cheques payable to Phoenix Marketing

I enclose my cheque for £.....

Please debit my Access/Barclaycard

|  |  |  |  |  |  |  |  |  |  |  |  |  |  |  |  |  |  |  |  |
|--|--|--|--|--|--|--|--|--|--|--|--|--|--|--|--|--|--|--|--|
|  |  |  |  |  |  |  |  |  |  |  |  |  |  |  |  |  |  |  |  |
|--|--|--|--|--|--|--|--|--|--|--|--|--|--|--|--|--|--|--|--|

Signed.....

Date .....

Please send me

- 16K Ram Pack £22.00
- 32K + Ram Pack £39.50
- 32K Ram Pack £35.00
- 64K Ram Pack £53.95
- Tape Loading Interface £9.50
- Fully Cased Keyboard £49.95

# CTUK!NEWS

by David Tebbutt



You can always tell when summer comes — the number of ComputerTowns starting up drops to zero. Still, we are getting letters from people willing to have a go in the autumn.

Mr Ravinder Bahra writes from Blackheath to say he'd like to be involved in starting a local 'Town. If you live nearby and would like to help, why not write to him at 218 Shooters Hill Road, SE3?

Nottingham looks as if it might be getting its second local ComputerTown — this time in Eastwood. If you're interested in joining in, give Ted Ryan a call on Langley Mill 65011 or write to him at 15 Queens Square, Eastwood, Nottingham NG16 3BJ.

John Davies writes from the Pinner and District Community Association to say that the ComputerTown project looks like a good idea. John can be contacted at 14 Kingsfield Avenue, N Harrow, Middlesex, H42 6AH.

Not far away, in the London Borough of Brent, John Clarke has located four libraries which would like to start their own 'Towns. Staff from the libraries have been in touch with their Harrow and Rayners Lane counterparts and, Presumably, liked what they saw.

If you're with the people at BFPO58, you will find that Cpl DP Morgan would like to hear from you. He's with 3 Squadron, 9 Signal Regiment and, hav-

ing recently started a computer club, he's now thinking of a ComputerTown too.

Now for news from existing 'Towns. First, Alan Waring has sent the names of the secretaries of the three ComputerTowns he helped found. If the PCW system worked this month, they should now be listed under ComputerTown Contacts at the back of the magazine.

By the time you read this, a very brave man called Frank Fadipe will have organised and run a ComputerTown Week(!) with the help and support of the Ruislip library staff. He has managed to persuade all sorts of people to participate, including several local computer firms. Next month I hope to bring you a blow-by-blow account of how things went.

Do you live in Staffordshire? Do you have any influence over decisions of the Library Committee? If the answers are yesses and you think that ComputerTown should be given free space for its meetings could you please whisper in the appropriate ears. At the moment, of course, each meeting costs the organisers money. Since everything about ComputerTowns is voluntary and free, this seems to go against the spirit of the thing.

We're on Prestel! Thanks to the efforts of Vernon Quaintance, Greater London ComputerTowns are being put

on at the moment. If all goes well, Vernon hopes to have the space and information to set up all the ComputerTowns. If you'd like to have a look, the pages start at \*35748111 # for the moment.

Soon, you will be seeing another name associated with this column. Maggie Burton will be sharing ComputerTown work with me on the grounds that I'm not always available when I should be. Maggie has been working on PCW for the last year and is particularly interested in seeing the ComputerTown Project go well. So, if you have anything to say, you can say it to me or Maggie at one of the addresses in the box below.

We both look forward to hearing from you.

For further details of CTUK! write to: CTUK!, 7 Collins Drive, Eastcote, Middlesex HA4 9EL or 17 St George's Road, London NW11 0LU, remembering to enclose a large SAE (A4 would be fine) for your reply. Please don't try to telephone PCW for information because this project is entirely a spare-time activity.

## CITY MICROSYSTEMS LIMITED

### 65 LONDON WALL, LONDON EC2M 5TU

01-588 7272/3/4

**ACT**  
*Sirius 1*



The NEW Generation Microcomputer  
1Mb Disc Capacity 128K RAM  
CP/M-80 compatibility available.

**TELEVIDEO**

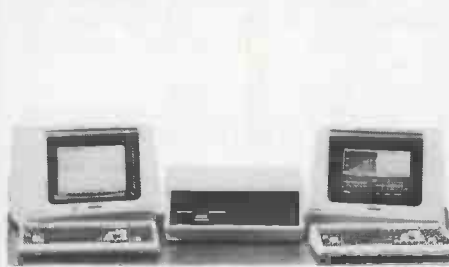

Stand Alone and Multi-User, Multi-Task,  
Multi-Processor Systems.  
Televideo reliability with complete  
expandability, one to sixteen users.

**BRITISH MICRO**



MINI 802 now available, 700K disk drives,  
CP/M operating system  
Computer & monitor £1440 + VAT

COMPLETE BUSINESS ACCOUNTING SYSTEMS FROM £2400 WORD PROCESSORS FROM £2400  
PROGRAMME PACKAGES FOR MOST APPLICATIONS

## ADVICE, TRAINING AND MAINTENANCE

ALL YOUR COMPUTER REQUIREMENT READILY AVAILABLE

## IN THE CENTRE OF THE CITY- LONDON EC2

VISITORS TO OUR OFFICES MOST WELCOME

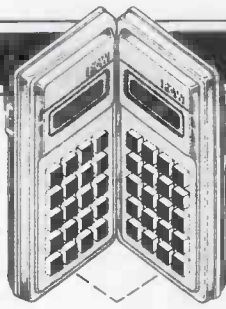

# SHARP TIPS

Some useful programming tips for the Sharp PC1211 or Tandy Pocket Computer

After the hectic Quirkology of the last few months I'm taking a bit of a rest this issue and handing the column over to Simon Maycock of Oldham. Simon has sent in some programming hints for the Sharp PC1211 — or, to be more exact, for the Tandy Pocket Computer, which is what he owns.

Seeing his piece reminded me that I have somewhat neglected this machine in the last year; the introduction of the PC1500 in no way diminishes its interest as there must be an awful lot of units out there in either the Sharp or Tandy guise. The tricks presented here allow proper multi-record data files to be handled and also provide an insight into the way that PC1211 Basic is tokenised in memory.

Dick Pountain

The PC1211 has the useful facility of being able to GOTO a label, eg,  
10 GOTO "L1"

```
20 .....
30 "L1" : .....
```

This may be used advantageously in several situations.

The first arises in the context of performing different actions depending on the value of a string, eg,

```
10 INPUT " INSERT(I),DELETE(D),
   END(E) ?" ; Q$ : GOTO Q$
nn "I" : ..... GOTO x
mm "D" : ..... GOTO y
pp "E" : ..... GOTO z
```

In fact this is similar to the Pascal CASE construct:

```
10 READ (CH) ;
20 CASE CH OF
30 "I" : ..... ;
40 "D" : ..... ;
50 "E" : ..... ;
60 END; (* OF CASE*)
```

providing x, y, z are the same. Note a syntax error will occur if Q\$ is given a value which is not used as a label name.

The second use is similar, ie, to access data embedded in the program body using a named selector. For example, to act as a portable phone or address book.

```
nn "I" : INPUT "NAME?"; N$
   GOTO N$ (alternatively GOSUB N$)
mm "POLICE" : PRINT "999" :
   PRINT " LOCAL = 3278" :
   GOTO "I" (or RETURN)
pp "DOCTOR" : PRINT "456789" :
   GOTO "I"
qq "....."
```

A syntax error will again occur if the name is not catered for; however, with such a limited memory a properly structured program, liberally annotated with comments is only normally attainable at the expense of variable space.

## File handling

The cassette interface allows the computer to CSAVE and CLOAD named pro-

grams, also INPUT# and PRINT# are provided, allowing the memory variables A(1) or A\$(1) up to A(n) to be saved and loaded from tape. n depends on the program size and is typically 130.

An optional part of these instructions is from what memory to start the output, input — eg,  
INPUT# "DATA1" ; A(30)  
will load the internal memory from A(30) upto A(n) with the data file "DATA1" on the tape.

An obvious consequence of the '... up to A(n)...' is that if only a few variables are to be saved then it is not sensible to put them in the low numbered memories, as the rest of the memories will be dumped onto tape as well.

One way round this is to maintain a pointer in the program which is initialised to the top of the variable memory space and as successive variables/data are created the pointer is decreased, then when the memory is dumped onto tape the value of the pointer is specified so that only the required memories are saved.

For example, details of a bank account could be saved in blocks of five memories

```
A(x) = cheque number
A(x+1) = value
A(x+2) = date (dd.mm so that days and
month can be separated using INT)
A$(x+3) = comment1
A$(x+4) = comment2
```

In the following procedures T denotes the top of the memory; its value (a multiple of five) can be determined when the program has been written. P is the pointer, it is initialised to T, and as successive records are created it is decremented by five. All the variables A to Z are preserved.

```
10 T=.....:P=T
20 REM INPUT RECORD
30 "Y" : IF P = 30 PAUSE "NO MORE
   SPACE" : GOTO "DUMP"
40 P=P-5
50 INPUT "CHEQUENUM" ; A(P)
60 INPUT "VALUE" ; A(P+1)
70 INPUT "DATE(DD.MM)" ;
   A(P+2)
80 INPUT "COMM1" ; A$(P+3)
90 INPUT "COM2" ; A$(P+4)
100 INPUT "CONTINUE (Y,N)" ;
   Q$ : GOTO Q$
110 "N" : REM LAST VALUE
   INPUT
120 "DUMP" : PRINT "TAPE ON
   REC"
130 PRINT# "DATA" : A(P)
```

The above 'Dump' routine does not record the value of P; this can be remedied by preceding 'Data' by a definition record, which contains the values of P (and can be extended to contain the date the file was created etc).

```
120 "DUMP" : PRINT "TAPE ON REC"
130 A(T)=P
140 PRINT# "DEFN" ; A(T)
```

150 PRINT# "DATA" ; A(P)

This duplicates A(T) but providing there is no more space after T the "DEFN" will be a very short file.

An appropriate read program could be:-  
10 "READ" : PRINT "DATA TAPE ON  
PLAY"

```
20 INPUT# "DEFN" ; A(T)
30 P=A(T)
40 INPUT# "DATA" ; A(P)
```

Note that these two routines effectively reverse the order of the records in the memory — if the order is important this can be overcome by using the Basic equivalent of a Downto loop in the processing program:  
FOR I=P TO T-5 STEP 5; REM  
PROCESS IN REVERSE ORDER  
FOR I=T-5 TO P STEP -5; REM  
PROCESS IN ORIGINAL ORDER

The above ideas have been successfully used in a series of programs to produce and maintain a record of a current bank account, and calculate balances and trends.

Another interesting point is that when programs are written the memory space for use as variables is gradually reduced. However, if program lines are deleted then these memories become available again. Looking at the contents of these memories reveals that they are full of apparent junk and non-numeric symbols. However, by typing characters into lines of programs, then deleting, and then finding the highest memory available ((A(n)) it can be seen that this 'junk' contains an itemised copy of the line. (Reading from right to left). The character set seems to be in some form of hex, since the following sequence commonly occurs:-

```
0, 1, 2, 3, 4, 5, 6, 7, 8, 9, ., E, %, ¥, $, ,,
the alphabet is itemised as follows:-
A=51, B=52..... I=59, J=5., K=5E,
L=5%
M=5¥ (this symbol produced when shift
Y is entered), N=5$,
O=5π, P=60..... Z=6.
```

All the other symbols have a representation, and Basic commands also have a code — eg:  
PAUSE = ¥.  
PRINT = %1  
GOTO = ¥7

As an example: if NEW is entered, then CLEAR (in PRO mode) A(204) is the highest memory, so if 10:PAUSE A is entered, then 10 is entered (to clear line 10), examining A(204) gives 0.00015.¥01

Since the code for A=51, PAUSE=¥., we can split the line up:  
0.000 15 ¥ 01  
shows these itemised (in reverse order) with the line number at the 'front'.

This is the only explanation I can conceive for this 'junk' and I would appreciate anybody enlightening me further.

# How to make the best home computer in the world even better.

## Peripherals to turn a powerful computer into a super-computer for the professional.

With VIC, you have the finest home computer money can buy. And the more you use it, the more you will ask it to do.

Pretty soon, you'll want to extend VIC's vast potential to the full; and there is a wide range of VIC peripherals to help you do it.

Disk drives, disk-based software, a printer, cassette unit, joysticks, paddles—with these, VIC computing becomes total computing: giving you true professional power and capability.

We describe the major units here.

### VIC PRINTER



The VIC Printer, like all VIC peripherals, offers a very high specification at a very competitive price.

It will print programs, letters, business data, graphic displays and so on.

Its main features include: 80 characters per line • Tractor feed dot matrix • 30 characters per second print speed • Full alphanumerics and graphic printing • Double-size character capability • All cables and leads.

### VIC FLOPPY DISK UNIT

The VIC single-drive Disk Unit provides a fast, accurate and efficient means of storing and retrieving data and programs.

Together with the Printer, it transforms the VIC 20 into the ideal system for the small businessman or serious computer programmer.

Features include: 174,848 bytes capacity • Uses soft-sectored standard 5¼" single density floppy disks • Direct interface to VIC •

Direct compatibility with Printer Intelligent system independent of VIC.

(VIC RAM not required to run it).



### EXPANSION MEMORY CARTRIDGES

Special plug-in cartridges are available to expand VIC's memory. 3K, 8K and 16K RAM packs plug directly into the computer.

A Memory Expansion Board is also available to develop VIC's capabilities to the maximum.

For full details of VIC 20, its peripherals and software, and a list of your local dealers, contact: The Commodore Information Centre, 675 Ajax Avenue, Slough, Berkshire, SL14BG. Tel: Slough 79292.



 **commodore**  
**VIC 20**

**The best home computer in the world.**



# A GROSS OF FRESH SALES STAFF, PLEASE...

*Brushing off the sales talk, Martin muses on micro marketing. . .*

'Hello.' He was tall, angular, and his mohair suit had obviously just come from its third visit to the smoothers.

'Hello.' He repeated his greeting as I sat at my desk wondering what other stunning utterance would spring forth to shatter my concentration. It would come in time; it always did.

'My name is Smith, and I was wondering if you might be interested in some office supplies. You know the type of thing. I have a lovely line in carbon paper, glossy one side, matt finish the other. I have 47 different sizes of typewriter ribbons — they're assorted makes as well, so the customer gets the maximum choice, I have little spray cans of Klenelugs, that's the stuff for cleaning telephone handsets. I have a nice line in personal business computers. Then again there is. . .

'Hold on there, son,' said I. 'I could be interested in a computer. What type is it?'

'Well it's a . . . let me look at the brochure. . . ah, it's a Widget.'

'Is it the 48k version running on CP/M or the original 16k that used that wally operating system that no one ever produced any software for?'

Well, it seemed a fair question for me to ask. After all, I'd read a bit in the magazines about how Widget Computers had completely redesigned its product range so that it could sell some.

He looked perplexed. You can always tell when a sales person is perplexed — his eyes meet in the middle. 'What's software?' he asked. I just asked what the discount was for cash.

Thus ends Scene I, Act I of a play that will almost certainly be performed up and down the country more and more in the future. It is also a precursor to this month's piece and is, for reasons of propriety if nothing else, totally *unconnected* with what follows. What follows is a company's stated intentions. What has already passed is pure fantasy, right?

A few months ago now, Osborne Computers in the UK, the subsidiary of the company that is scaring the financial pants off some others by refusing to roll over and die, held a press conference. At this affair, its management made a significant announcement. It was significant because of the basic idea involved and also because of the numbers being bandied around to flesh the idea out.

Perhaps not surprisingly, there is some tenuous connection between the subject of the press conference and the foregoing scene. Yes, the press conference was called to talk about sales and marketing, and the way that Osborne Computers intended to set about it in this country.

To put this in perspective, there is need for just a little history. The

company, the offspring of Adam Osborne, is less than a year old as a legal entity, with a product that many have defined as 'rubbish' and other 'ong words of a deprecatory nature. The product, the Osborne 1, took run-of-the-mill technology and run-of-the-mill software, put them together in a portable box that had an apparently unusable screen, and sold it at a silly price. The company seems set to exceed \$100 million sales in its first year, which is good going for rubbish.

Unlike earlier successful, and unsuccessful, machines, the Osborne

was tailored for a specific market. With its built-in facilities, its attendant software and its portability, it was a natural for the professional and business market.

Having now dispensed with the history, we move back to the point of the press conference. How will Osborne in the UK move to meet the potential sales demand it expects to find — nay, not only expects but has sales projections to justify the expectation?

The company's objective, as stated at the press conference, is simple. It plans to have about 60 retail outlets around



Illustration by Will Hill



the country by the end of the year(ish). For the type of product the Osborne 1 is — a directly business-oriented machine despite its low cost — the general consensus of opinion suggests that this is a good number of outlets with which to sensibly cover the country.

To this will be added a number of OEM-oriented outfits, the type of company that buys the machine as an engine for its own 'unique' software products..

On top of this there will be a number of freelance sales staff, recruited to hit the major sales accounts. By this the company means the now well-understood market for multiple sales of machines into large companies. OK, so the company is looking for half a dozen such hot sales persons, maybe 10 at the most, certainly to begin with.

Well, no. It plans (or planned, for it will now be in the past tense according to the announcement) to appoint up to 200 by September (and that is the September that has just gone, not the one next year).

It was a great shame that the company felt impelled to put figures to the basic idea, for it made the idea nonsense when in fact it is completely sound. It made it nonsense because one set of figures could be compared with others, as will be seen later.

First of all, the idea. In theory it is just right. A machine like the Osborne 1 is geared specifically for the type of market filled with the managements and executives of the large companies of this world. Such large companies often have central buying policies so that the best prices can be obtained. They are also

normally tough sales nuts to crack. It is an ideal area for professional sales persons that know their way round both the product and the marketplace.

But it is a market that does not need too many of them. Indeed, it is arguable that there are not that many of them to start with. It requires a special blend of skills in — sales, marketing, and the technology of hardware and software to sell micros to such people. It is also a marketplace where sales take time. Months, even years, can go by before the 'big order' comes over the hill.

Now, Osborne want to have appointed 200 by the time you read this. Yet at the same time it is saying it is predicting a UK sales volume of 1,000 units per month by the end of the year. With our calculators at the ready we can see that, on average each person will sell five units a month, which means that with around 30 percent discount, they could expect to gross around £1800-£2000 a month. This is just about enough to run a single person small business with such overheads as a car and money-in-front stock purchasing. It would barely cover the cost of in-depth customer support however.

Ah, yes. Support. Now where would support come from? This according to Osborne, would come from the dealer network.

Oh dear, we had forgotten the dealers, hadn't we, and there will be around 60 of them. That means that each 'outlet' will sell under four units a month, on average, which is hardly enough to make a living. But there is a

grey area here, for why should the dealers provide support for apparent rivals? The answer, according to Osborne, is that the sales people will be selling for the dealers under arrangements that they strike between them.

In essence, what this would surely mean is that the salespersons' operating margin would be less than 30 percent — probably considerably less. Each would have to sell much more to stay in business, even though Osborne's predictions for the market don't indicate it.

The net result of the idea is right — in theory. There is a big market in the large companies, and it is a market that the microcomputer industry is trying to come to terms with. Sales people out on the road is a definite starter as a solution, even if it would have been anathema as an idea just a couple of years ago.

The figures as published by Osborne at its press conference, however, do not seem to indicate the best way to go about it. The purchasers, certainly in the short term, will probably love it. It is a recipe for virtually every form of cut-throat sales tactic that the sales trade has ever invented (for cut-throat the potential purchaser can normally read cut-price) for the sales people will be out to grind each other into the ground to maintain some level of business.

Either that or the 'sales people' will be as outlined in Act I, Scene I. Computers will just be something else they have on the van, along with the carbon paper, used cars, and a night on the tiles with Auntie Vera.

END



# L&J COMPUTERS

192 HONEYPOT LANE, QUEENSBURY, STANMORE, MIDDX HA7 1EE. 01-204 7525

## THE "PET" SPECIALISTS



WE DO NOT GUARANTEE THE MACHINES WE SELL FOR THE STANDARD 90 DAYS.... WE GUARANTEE THEM FOR 1 YEAR & 90 DAYS!!  
NORMAL H.R.P. NO HIDDEN EXTRAS PARTS & LABOUR INCLUSIVE

AVAILABLE EX-STOCK: (EXCEPT FOR ITEMS MARKED\*\*)

|                    |          |        |                                    |
|--------------------|----------|--------|------------------------------------|
| Micro-Computer     | CBM 4016 | £ 550  |                                    |
|                    | CBM 4032 | £ 695  |                                    |
|                    | CBM 8032 | £ 895  |                                    |
|                    | CBM 8096 | £ 1195 |                                    |
|                    | CBM 9000 | £ 1495 |                                    |
| PRINTERS (matrix)  | CBM 4022 | £ 395  | PRICES<br>DO NOT<br>INCLUDE<br>VAT |
| "                  | CBM 8023 | £ 895  |                                    |
| CENTRONIC          | 737      | £ 395  |                                    |
| "                  | 150      | £ 295  |                                    |
| " (daisy wheel)    | CBM 8300 | £ 1395 |                                    |
| "                  | NEC 7730 | £ 1795 |                                    |
| Disk Drives (2 Mb) | CBM 8250 | £ 1195 |                                    |
| (1 Mb)             | CBM 8050 | £ 895  |                                    |
| (340K)             | CBM 4040 | £ 965  |                                    |
| (170K)             | CBM 2031 | £ 395  |                                    |
| Hard Disk (5 Mb)   | CBM 9060 | £ 1950 |                                    |
| (7.5M)             | CBM 9090 | £ 2495 |                                    |
| (23 Mb)            | MATOR**  | £ 3750 |                                    |
| (30 Mb)            | MATOR**  | £ 4495 |                                    |

For those with 3032's who want 4032's and those with 4032's who sigh for 3032's all is not lost! HAVE BOTH, at the flick of a switch — CHIPSWITCH for £57 + ROMs for £50 (with deglitching facility built-in).

TOOL KITS (BASIC 2 & 4), SUPERCHIPS, ... AND ALL SORTS OF OTHER CHIPS ... UPGRADE YOUR PET EVEN MORE!!

PERSONAL SHOPPERS WELCOME  
PHONE & MAIL ORDERS ACCEPTED.

## SOFTWARE

STOCK CONTROL & INVOICING £60  
(Handles up to 500 items — 32K) (180 on 16K). Stock depleted on invoicing, search etc. Cassette, disk (& print option).

### CASH BOOK

Enter daily/weekly amounts — printout and totals, weekly/monthly analysis, totals and balances.

3032, 4032 & 8032 versions from £90 to £150

STOCK TAKING for the licensing trade £240  
Superb new program for 8032 £420

OUTSIDE SERVICES (For Mini-Cabs etc.) £220  
New 8032 Version at 3032 price

See for free software booklet

SILICON OFFICE : WORDCRAFT : WORDPRO  
D.M.S.V. : ADMINISTRATOR : DATALEX  
BASIC & SUPERPAY : ACCOUNTS : VISICALC

# VIC-20 £182!

INC V.A.T.

COMPLETE RANGE OF  
EDUCATIONAL SOFTWARE  
GAMES (CASSETTE & ROM CARTRIDGE)  
ACCESSORIES

S.A.E. FOR LISTS

ALL GOODS SENT SAME DAY WHEREVER POSSIBLE LARGE SAE FOR LISTS ETC.

# INNOVATIVE TRS 80-GENIE SOFTWARE

*from the professionals*

## GRAPHIT

*Visicalc  
compatible*



There are a number of programs which will portray graphs on a Microcomputer. Indeed, we stock two already, Graph Plotter and Plotter. Graphit, however, is the ultimate of such programs. It has been written solely for displaying graphs. It is compatible with Visicalc DIF files. Hence such a file constructed with Visicalc can be fed into Graphit and a graph display obtained. Users may also, however, insert data directly from the keyboard into Graphit. This data may then be fed into Visicalc for further processing.

Every function that we can think of that would be of use to a person requiring a graph has been included in Graphit. Labels may of course be used and these may be transposed from the side to the bottom or vice versa at any time. A great deal of work has been put into manipulation of the display in the sense of magnification, or changing the scale. The program will itself first of all calculate an appropriate scale but thereafter this may be altered in almost any way. Thus a small section of the graph may be made to occupy the whole of the screen. Alternatively a large proportion, or all, of the data may be displayed at once. In other words, the program has complete flexibility of display of the graph.

Scrolling is supported in either a latitudinal or longitudinal direction and by one column or by a complete page. If, for instance, the months for one year are set up along the bottom of the screen with sales figures up the side, the user can move along in either direction from month to month or jump six months at a time and show the whole page — the display facilities are almost endless. And display, when you come to think of it, is what a graph is all about.

The graph as shown on the screen may be printed out to a line printer or the raw data on its own can be printed out. The axis can be changed at any time so that if, as in the example mentioned above, we have the months along the bottom of the screen, by one simple keystroke they can be made to go up the side, and the sales figures along the bottom, with the graph changing accordingly of course.

At any time the zig-zag display can be changed for the step and of course vice versa.

Perhaps the most important feature, has been left until last. Graphit was specifically commissioned and the specification called for ease of use, as the prime requirement. Not only, therefore, is a comprehensive manual supplied, but also at almost any time while using the program the H key can be pressed for help, whereupon all of the available commands are displayed. Graph programs in the past have rather suffered from being included in other software. This one concentrates entirely on drawing graphs and gains a lot thereby. Available on disk only, compatible with the Genie I and II and the original Genie, together with the Tandy Models I and III.

(Visicalc is a Registered Trademark of the Visi Corp.)

Graphit on disk ..... £17.00 + VAT = £19.55  
75p P & P please.



## MOLIMERX LTD

### A J HARDING (MOLIMERX)

1 BUCKHURST ROAD, TOWN HALL SQUARE, BEXHILL-ON-SEA, EAST SUSSEX.

TEL: [0424] 220391/223636

TELEX 86736 SOTEX G

TRS-80 & VIDEO GENIE SOFTWARE CATALOGUE £1.00 [refundable] plus £1 postage.

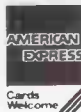

# INNOVATIVE

# TRS 80-GENIE SOFTWARE

*from the professionals*

# QUICKPRO PLUS

Quickpro Plus is a Basic program generator. That is to say you tell it the type of program you want and it writes it for you. The most widely publicised of such program generators is The Last One and it is, therefore, inevitable that Quickpro Plus will be compared with it.

There are two approaches that one can take in writing software like this. Either one can set out with a very broad brush and try and make the generator capable of producing a wide variety of data handling software or one can restrict it to some extent, to simply producing file handling programs. The Last One seeks to go the first route, Quickpro Plus goes the second. There is a great paradox in this software if one thinks about it. Obviously, if a person is at least a semi-skilled programmer then he does not need a program generator. They are really for people who are not skilled in programming and want that chore taken off their hands. The paradox is that programs like The Last One, by being all things to all men are also complex in use and one therefore gets the position of a program aimed at a beginner, but actually requiring some skill to use it.

It was because of this apparent paradox that Quickpro Plus came into being. It is written for somebody with little or no knowledge. You will find no mention of flow-charts and little mention of fields, records and other technicalities. It was written so that a person could sit down in front of his computer, answer a few questions and have a program produced for him, and this is exactly what Quickpro Plus does. The other side of the coin is that it concentrates entirely on producing file handling programs. Within that context the program which you have generated will run on the computer like any other Basic program. You will be able to add file records, in other words items of information in your file. You will be able to search for and locate records, and retrieve these records, as and when you wish; you will be able to up-date and change the records, indeed you can delete them altogether. In the program generation process you will be able to design your own screen layout. Co-ordinates appear on the screen and you simply say where you want questions and statements to be inserted. You will, of course, be able to define whatever part of the record you will wish to use as a search key. These fields may be restricted if you wish to just numeric data and, of course, you may name the data file and indeed the program as you desire.

An added feature is that you may carry out various calculations on any of the numeric fields and if you want to you can change this numeric data. Up to fifty separate computations can be carried out on these fields. The program will report the calculations to you in various arrangements using any of the normal mathematical functions.

Quickpro Plus supports a full print report facility. Indeed within minutes you can design a new report with any column names that you choose, with any calculations that you might want and for many selections of records in your total file. A report will be produced within seconds. This can have been built into the program or you can re-arrange matters so that you get a one time reporting. The same file is thereby manipulated in many different ways. Computations are done and results printed all from the same file which your program has produced.

Quickpro Plus is available for the Model I, Model II and Model III Tandy machines, together with the original Video Genie, the Genie I and Genie II. A version for the Genie III will be available towards the end of 1982. Quickpro Plus is, of course, disk orientated and has no application for cassette users. It is supplied on a protected disk, but Molimerx have masters from which they can repair any damaged disks and hence retain their reputation for support.

The Last One is a Registered Trademark of D.J. A1 SYSTEM LTD.

Quickpro Plus Tandy Model I, III & Genies ... .. £98  
Tandy Model II ... .. £108

Both prices plus V.A.T. Receipted Parcel shipping £1.50.

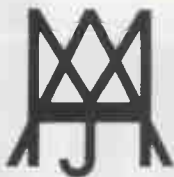

# MOLIMERX LTD

## A J HARDING (MOLIMERX)

1 BUCKHURST ROAD, TOWN HALL SQUARE, BEXHILL-ON-SEA, EAST SUSSEX.

TEL: [0424] 220391 / 223636

TELEX 86736 SOTEX G

TRS-80 & VIDEO GENIE SOFTWARE CATALOGUE £1.00 [refundable] plus £1 postage.



# Expand Your Marketplace

## with the UCSD p-System Version IV

*if you are developing applications packages the UCSD p-System now lets you reach the widest possible marketplace with the minimum investment and the minimum of fuss.*

### The "p-machine"

The p-System was developed at the University of California at San Diego (UCSD) from the concept of an "ideal machine" which can be mimicked by any ordinary microprocessor (in which the machine architecture is dictated by production convenience), and it allows the generation of screen and processor independent software.

### Established at last

The system has a new release, Version IV, and already it's very popular. It's fitted and running on the latest microcomputers being delivered by IBM, Apple, ITT, Texas Instruments, Philips, Xerox, DEC, Tandy, Northstar, Altos, Osborne, Superbrain and others.

### The same friendly face

On each of these machines, the user is presented with the same friendly face, the same easy-to-use operating system, the same p-machine code. So the same programs run without recompilation. And it helps you write very large programs too - with lots of separately constructed pieces, programs can be much larger than the memory of your machine.

### What you get

The UCSD p-System gives you a complete programming development system which lets you write programs in UCSD Pascal. You get a screen editor, a line oriented editor, a compiler for UCSD Pascal, a native code assembler, a linker, a debugger, a linker and a host of utilities - such as disk recovery.

### Other machines

In addition to the systems listed in the coupon below, fully fitted systems can also be obtained on request for the following machines - IBM Personal Computer, TRS80 model II or III, Superbrain, Altos 8000, LSI 11, Xerox 820.

| Qty | Item  | Unit Price | Total |
|-----|---|------------|-------|
|     | UCSD p-System for <b>Northstar Horizon</b> (includes User Manual) Ready to run  | £425       |       |
|     | <b>Z80 Adaptable System</b> (includes User Manual, Installation Guide, Internal Architecture Guide) Requires fitting & disk conversion  | £455       |       |
|     | <b>CPM Adaptable System</b> (includes User Manual, Installation Guide, Internal Architecture Guide) 8" IBM SS SD Disk Sectors 128 bytes | £455       |       |
|     | Version IV User Manual  | £45        |       |
|     | Version IV Installation Guide   | £15        |       |
|     | Version IV Internal Architecture Guide  | £15        |       |

I enclose a cheque/postal order to Microtraffic Systems Ltd for £ \_\_\_\_\_ (total unit price plus 15% VAT) OR

Please charge my credit card account

American Express  Barclaycard  Access

Signature \_\_\_\_\_

Name \_\_\_\_\_

Position \_\_\_\_\_

Company \_\_\_\_\_

Address \_\_\_\_\_

Tel \_\_\_\_\_

Microtraffic Systems Limited  
45/46 Chalk Farm Road, London  
NW1 Tel: 01-485 9190 /  
24 hour service 01-485 3781



UCSD p-System is a trademark of the Regents of the University of California

Be honest. When was the last time you could tear yourself away from the tedium of the office, and fly off to another part of the world to secure a new order, investigate a new business opportunity, or simply enjoy yourself? If you've become your own worst paid executive working all hours on paperwork, book-keeping or general administration, the chances are it's longer than you care to remember.

## COMPLETE SOLUTION

So isn't it time you met the Genie III? A business system specifically designed to meet the requirements of those businesses employing less than 250 people. Anyone from a corner shop keeper to a wholesaler, to an engineer. The Genie III will help them all, and it will help you, providing the complete solution for sale/purchase, sales ledger and nominal ledger. In addition, the system can be expanded to other functions, such as stock control, invoice reminders and word processing. - in fact, generally help you run your business much more effortlessly.

## RELEVANT SOFTWARE

The package consists of a powerful, compact and reliable microcomputer, with a full-size keyboard, built-in screen, 64K of RAM, and dual disk drives as standard. Also included is a quality matrix printer giving a choice of 80 or 136 characters per line, three different type-faces, and the option of using roll paper, single sheets or even multiple copies. Relevant software programmes for the Genie III have been specially produced by TABS, one of Britain's largest suppliers of business software packages, and the complete system is covered by a special one-year maintenance contract... all for around £3,250.

## EXPERT INSTALLATION

If by now all this sounds too good to be true, come and see for yourself. You can meet the Genie III at one of the specially selected SUPERDEALERS, whose technical expertise and experience in the fields of installation, software and maintenance is proven. It could be the first step towards a more successful future for you and your business.

## U.K. SUPERDEALERS

We have a network of superdealers throughout the U.K. (including Northern Ireland). For advice on your nearest stockist, ring our SUPERDEALER MANAGER on 0629 4995.



# Genie

the key to success

# ANOTHER SUCCESSFUL DEAL COMPLETED WHILE GENIE 3 LOOKS AFTER YOUR BUSINESS...



Please send me full details of the Genie III Business System and my nearest Superdealer

Name \_\_\_\_\_

Company \_\_\_\_\_

Position \_\_\_\_\_

Address \_\_\_\_\_

\_\_\_\_\_

Tel. No. \_\_\_\_\_

PCW0.82

Chesterfield Road,  
Matlock,  
Derbyshire DE4 5LE.  
Telephone: 0629 4995.  
Telex: 377482 Lowlec G.

SUPPLIED AS  
STANDARD

Accounting  
Business Systems

TABS

TOWE  
electronics

small business!

# HEWLETT PACKARD HP86

**BENCHTEST**  
PERSONAL COMPUTER



Photography by John Mason

## AFFORDABLE HP!

*Dick Pountain checks out the HP-86, a lower cost addition to HP's 80 series of personal computers.*

There is much excitement in the hi-tech halls of Hewlett Packard about a new product, the HP-86. Not because it represents any great departure in hardware terms from the established 80 series, but because for the first time HP has a personal computer which is priced to

compete in the mainstream of the market place. HP has always been associated with high-priced high-quality products which have been bought largely by the scientific, engineering and other professional communities on reputation rather than cost considerations. The

launch of the HP-125 business/management micro in 1981 broke new ground in using a non-HP produced processor (the Z80) and a non-HP operating system (CP/M) as an acknowledgement that these represent the realities of the current business micro market, but

it is still priced well above the industry average and must sell on reputation and its advanced ergonomic features.

The HP-86 takes a further step toward the deep end. It is nominally part of the 80 series of laboratory and professional microcomputers but it can be expanded with a Z80 module to run CP/M. Most significantly, though, it is priced at a level which competes directly with Apple III and various other machines in the middle range at around £3000 for a 64k, twin disk system with printer. This is still somewhat above the £2000 typical of the keenest CP/M systems, but the 86 does offer graphics facilities which are either unobtainable or extremely costly on such machines. It demonstrates a new commitment by HP to compete in the hurly-burly of the volume micro-market, and to achieve this by up-to-date production engineering techniques. The design features of the 86 are closely based on the HP-87 introduced earlier this year, and the two machines are fully software compatible; the 86 is at least £1000 cheaper for a comparable system due to cost cutting exercises.

## Hardware

The 86 is a 'separates' system, comprising keyboard/processor console, which is a departure from the 80 series philosophy of small integral VDUs.

The computer unit is cased in the traditional HP textured grey ABS plastic. At the rear of this case are three multi-pin connectors for two disk drives and a Centronics parallel printer. Notice I didn't say HP-IB connectors because they're not: the disk ports are dedicated interfaces for special HP peripherals, and HP-IB if required is an optional expansion. Moving across, we come to four edge-connector slots which can house a ROM drawer for certain firmware expansions, extension RAM modules, interface boards (such as HP-IB/IEEE, HP-IL, RS232, BCD or GP-IO) and the Z80 CP/M module. Finally there is a phono-type video socket for a black and white monitor and the power socket, fuse and switch.

Removing the case top reveals the source of cost-cutting: the computer inhabits a single board about 8in square which contains 80k of RAM (in 64k and 16k chips) and 48k of ROM as well as the processor, HP's own 8-bit unit which can address up to 640k via a paging system.

This main board is completely covered by a perforated metal plate to shield R/F emissions, and the interior of the case is metallised for the same reason. There is much evidence of cost-conscious engineering with foil-tape cables and connectors; HP sources say that the board is constructed on a new automatic component insertion line. The keyboard occupies a second PCB and the power supply has a third small

one. The key switches are robust sealed units, but it is slightly worrying that there is no sort of backing plate: you can see the underlying PCB through the gaps between keys and therefore also drop paperclips or coffee right into the works (the PCB is heavily lacquered which is some comfort).

The keyboard has four main areas: a qwerty alphanumeric section, a numeric keypad, a screen control pad and seven programmable function keys with their associated KEY LABEL key. The main keyboard area contains some special keys like RUN, LIST, TRACE/NORMAL, CONT, PAUSE and STEP which are used during editing and will be discussed more under software. The numeric keypad, to my delight, has ALL the arithmetic functions duplicated on it as well as the unshifted ) and ( symbols which makes it into a self-contained, one-handed calculator. It also has a RSLT key which recalls the result of the last performed calculation to the display. Keys are provided to clear the screen, clear to the end or to the beginning of the line, insert and delete characters (BACKSPACE is a destructive backspace while -CHAR removes the character under the cursor; it is good to have both). All keys repeat after a short depression at a brisk rate. There is no TAB key — one or more of the function keys being used for this function if required.

The enter key is called END LINE which I'll grant is a better name than RETURN or CR as this function is not merely carriage return but carriage return/line feed; it's a pity though that everyone can't agree to call it NEW-LINE since between Clive Sinclair and the ANSI standard this seems likely to triumph eventually.

RESET performs a hardware reset without clearing programs in RAM. The CTRL key does not use the normal representation for control characters instead the first 32 ASCII codes appear on the screen as Greek, Scandinavian and assorted graphics characters including the £ sign.

The ROLL key reveals an interesting facility: the 86's screen memory normally holds 54 lines of text by 80 columns, of which either 24 or 16 lines are displayed (selected by the PAGESIZE command). ROLL and its shift allow you to scroll this window up or down through the text eventually returning to the starting point as if the text were written on a cylinder. This means you can, for instance, scroll upwards through a program listing. In fact the screen memory is shared between text and hires graphics. The default condition is 54 lines of text and 400x240 graphics and you can switch manually between text and graphics screens with the A/G key or in a program by the ALPHA and GRAPH statements. If, however, you declare ALPHALL then the whole of

screen memory is given over to text (204 lines); similarly GRAPHALL gives 544x240 pixels of graphics. In GRAPHALL mode though it is not possible to enter any text at all to the screen; you can re-route it to the printer or a disk file if you wish.

I was deeply impressed by the ergonomics and the terminal facilities of this keyboard which are the best of any machine I have used; program entry and editing on it are a pleasure.

The monitor supplied was a 12in green phosphor unit made in Japan for HP. It displays only average sharpness and steadiness, though it is by no means bad; it does not have a green filter over the screen and as a result contrast in well-lit rooms is not as good as it could be. Interestingly it has video and audio inputs and outputs on its backplate, though the 86 makes use only of the video input, having its bleeper in the console section. Many other monitors would be suitable for use with the 86.

The HP 9130A disk drive is specially designed for the 86. It is much smaller than previous HP 5in drives in a neatly styled plastic case rather reminiscent of the Apple III drive. Like the latter it takes its power from the computer so that, thankfully, no extra power cord is needed. The firmware to drive two of these is contained in ROM in the 86 as standard (as is the printer driver for a dot-matrix printer). Each drive holds 270k formatted and (under Basic) has the user selectable skew-factor feature introduced by the HP-125. The disk format is compatible with the HP-87 (as are most features of the 86).

## Software

The HP-86 comes with an extended graphics Basic in ROM. On power up the machine goes through self-test routines and then deposits you in Basic, without any sort of sign on message, merely the square non-flashing cursor. Of the 80k, 16k is used as video memory and a little is pinched by the operating system leaving 61k for the user on switching on — which is twice as much as most disk-based Basics leave you; it is in fact more than you will get on a 128k Sirius or Apple III with Basic loaded. In this state the machine is in calculator mode which is rather more than the usual Basic command mode. Calculations of any complexity can be carried out directly without the need to use PRINT. Variables may be assigned values which are available to programs by using CONT instead of RUN as well as to direct calculations. Because of the rather special way the keyboard works (see later) it is possible to stop a program, perform manual calculations and pass the results to the restarted program.

Arithmetic is to 12 digits with the exceptional dynamic range of 10E±499,

# HEWLETT PACKARD HP86

which should please physicists. The time to run Benchmark 8 is slower than average but bear in mind the above-average precision.

All entries to the computer are via an excellent full-screen editor which allows direct calculations as well as program lines to be edited; using ROLL you can edit and re-enter entries made 50 lines ago. A fine feature is that there is no READY prompt, just the cursor, so you don't get that infuriating syntax error if you CR through the prompt which most full screen editors give. AUTO, RENUM and DELeTe are all provided, plus a fine selection of debugging aids, most of which have their own keys. PAUSE stops execution until CONT is pressed. STEP single steps through a program. TR/NORMAL toggles trace mode, which can display not only line numbers but also selected or all variable values. LIST lists the whole program and displays the number of free bytes at the end. The remarkable thing is that most of the keyboard is active while a program is running; there is no need to hit PAUSE in most cases. You can for instance go straight into TRACE during a program run. Most keys when hit will pause execution; some, like KEY LABEL which displays the function key assignments, leave the program running and just do their thing.

Full syntax checking is performed as a Basic line is entered. Error messages are descriptive, not just numbers, and the cursor is positioned over the error. Programs should normally be initialised with the INIT key before running; this performs semantic checking (eg, FOR without NEXT, GOTO nonexistent line) as well as erasing calculator variables and allocating space for program variables. The latter is valuable if you're in any danger of running out of space and is not performed by RUN.

The editor keeps all spaces inserted between the line number and the first statement so that indentation can be used for readability; it also turns all reserved words into uppercase, however entered.

All considered this editor/terminal combination comes closer to the ideal I outlined in August's Braindump than any I have seen to date, and the speed with which you can write code is significantly improved.

The Basic itself is not Microsoft based but close to the extended ANSI standard. For instance, string manipulation is by substring notation — eg, STRING\$ [n,m] rather than MID\$, LEFT\$ and RIGHT\$ functions. Strings must be dimensioned if longer than the

default length of 18. 31 character variable names, all significant, are recognised and lower and uppercase are distinguished. REAL (12 digit, 12 byte), SHORT (5 digit, 8 byte) and INTEGER (5 digit, 7 byte) can be declared defaulting to REAL.

The set of functions provided is more extensive than most Basics, including MIN, MAX, FLOOR and CEIL, INFINITY and EPSILON (the largest and smallest machine numbers) in addition to the usual trig and logs.

A powerful aid to program readability is the provision of GOTO and GOSUB < label > instead of a line number; the labels follow the rules for variable names so you can say GOSUB Compute-Area or GOTO INPUTROUTINE. Remarks are prefixed with ! and may be added to the end of line; the editor preserves spaces between the last statement and ! so you can line them up nicely. A single line IF... THEN... ELSE and single or multi-line user defined functions are the only offerings made towards structured programs. Nevertheless, the proper use of all these features plus indentation makes for much more readable than average programs.

A powerful PRINT USING (and DISPLAY USING) statement is provided which uses IMAGE strings to control the output format of numbers. Long programs can be segmented and loaded from disk using CHAIN. Any variables which need to be passed between segments are declared as COMMON; the variable names need not be the same, only their order in the declaration list being significant.

Three types of interrupt can be handled by Basic. ON TIMER# allows one of three internal timers to cause program branching. ON KEY# causes programs to branch by pressing one of the function keys; it is also used in command mode to assign strings to these keys. When the computer is switched on they are assigned 14 Basic keywords (seven shifted), and these are not affected by any assignments made by a program, so there are effectively 28 functions. Finally ON ERROR /OFF ERROR permits error recovery. While on this subject, certain maths errors can be trapped by Basic itself — eg, underflow, overflow or division by zero. A default value (eg, INF or 999999999999E+499) is taken, a warning is issued and execution is not halted. This condition can be overridden if required by DEFAULT OFF, in which case a normal error occurs.

The HP-86 graphics deserve a benchmark to themselves. They are lifted straight out of the 9800 series of bench-top 'microminis' and include the most powerful graph-plotting facilities to be found on a personal computer.

Anything which is displayed on the screen can be just as easily sent to a multipen plotter such as the 7049 by declaring PLOTTER IS and its device address.

Characters can be freely mixed with graphics on the high-res screen by incorporating the text into LABEL statements. Such characters can be printed in any size via the CSIZE

statement which can also italicise and condense the letters. Labels can also be printed in any orientation using LDIR < angle >.

Any portion of the physical screen or plotter can be selected for plotting by LIMIT; within this area the LOCATE statement sets up a plotting area and scales it in Graphic Units so that there are always 100 GUs along the horizontal axis. These units can be overridden by User Units using the SCALE statement: eg, if you want to plot x from -200 to 200 and y from 50 to 300 then SCALE - 200, 200, 50, 300 does the trick, automatically converting to graphic units. MSCALE sets up a scale in millimetres for drawing office applications. Axes or grids can be drawn by the machine, marked with appropriate ticks using AXES or GRID. They can even be automatically labelled to the required number of decimal places by LAXES. A selected part of a graph can be cut out using CLIP and then blown up by changing the LOCATE parameters. Making certain LOCATE parameters negative will invert or reflect a plot while leaving the labels right way up.

These plotting commands are much harder to describe than they are to use. Suffice it to say that it is extremely easy to produce a graph with nicely labelled axes (with major and minor ticks) labelled with lettering following the slope of the graph and all automatically scaled so that no crashes occur due to plotting out of limits; and all this with about six lines of code.

Actual plotting of points is performed by PLOT in absolute screen coordinates, by IPLOT relative to the last point plotted or by RPLOT relative to a local origin which is moved by any pen moving command except RPLOT itself. All of these can take an optional para-

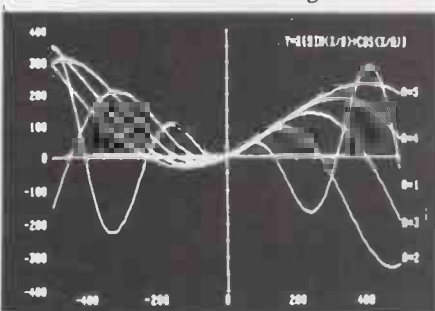

Axes are done automatically

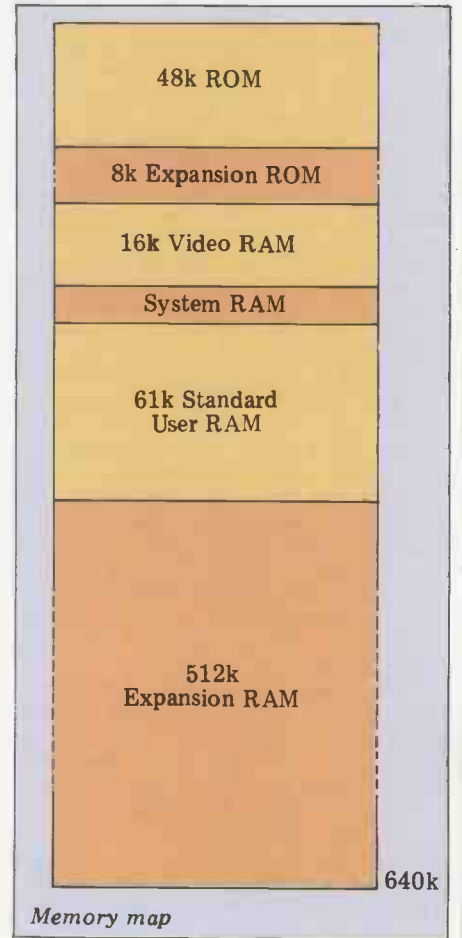



# THE OFFICE OF THE FUTURE TODAY

**1**

The heart of this office of the

future is the powerful new Osborne 1 portable computer, with 64k memory, two disc drives and a built-in monitor. The Osborne is linked to an Olivetti Praxis 30 11cps daisy-wheel printer/typewriter for printing your work

superbly. In addition you get a packet of software (sold elsewhere for up to £800) to make your office of the future into a word-processor or a financial planner.

**3**

The Olivetti Praxis 30 is a new style electronic typewriter with its own memory, automatic erase, and a double keyboard which gives you 14 extra characters. Use your Praxis on its own as a prestige easy-to-use typewriter, or plug it into your Osborne and use it as a high quality computer printer.

OR LEASE FOR ABOUT  
£155 + VAT AND  
£34 A MONTH +  
VAT FOR 33 MONTHS



**2**

Your Osborne and Praxis are a remarkable combination. The machines are so portable you can carry them both home instead of working late. Plug them together slip the Wordstar/Mailmerge disc into the drive and you have a word-processor as good as costly dedicated systems. Change discs for Supercalc and you have the power of a dozen clerks for your budgets. Then Osborne types your work perfectly on Praxis.



## O-COMPUTERS

A member of the C/WP Group  
104-106 Rochester Row, London SW1  
Telephone: 01-630 7575

# HEWLETT PACKARD HP86

meter which controls the raising or lifting of the pen. Lines are produced by DRAW (a relatively weak version which can only take two points as arguments; you can't draw a polygon with one statement) and MOVE, which moves the pen without drawing. WHERE X, Y stores the pen position and status in variables X and Y. If a plotter ROM and plotter are present you can use the plotter in reverse to digitise drawings by the DIGITIZE statement.

User defined graphic shapes can be created with BPLOT, which takes a string as argument and bit maps the shape from the decimal ASCII representation of each byte. The speed of plotting is sufficient for convincing animation to be done by MOVEing the pen between BPLOTS.

It is hardly surprising that the 86 contains 48k of ROM when you consider the amount of matrix arithmetic and such which must be contained in this remarkable graphics package.

If graphics are the strongest point of the 86 then the disk operating system is definitely its weakest. The publicity material describes 'easy I/O' facilities as an advantage; for some applications this may be true but for any data-intensive work it is frankly too simple. Random and sequential files are implemented in a straightforward way using CREATE to allocate disk space (the number and size of

records is specified), ASSIGN# to allocate a file buffer and open the file. Data is transferred by PRINT# and READ#. Data of different types can be mixed in a file and the TYP function will return the type of the next record to be read. The allowed file types are DATA, PROGRAM, BPGM (binary program), and GRAF which contains stored graphics screens. Certain application ROMs can create other file types. When files are deleted using the PURGE command they remain in the directory as file type NULL and periodically you PACK the disk which sweeps away all these NULL files.

The first problem comes when you want to find out how much space is left on a disk. There is no utility equivalent to CP/M's STAT and the information is not given in the directory heading, which merely gives the volume name. To be sure, the directory gives the number of records and bytes per record for each file but I defy anyone to multiply and total these for a disk with 100-odd files. Fortunately DISK FULL is not a fatal error so the procedure is to keep going until you get this message and then change disks; you can format a new disk without affecting the contents of memory thanks to the ROM based operating system (it takes a reasonable two minutes).

This works but it is hardly elegant; so much better to have put the bytes free

in the directory heading.

The next problem is that the command to copy files or whole disks only works with two drives. With only one supplied I couldn't backup any disks as the COPY command doesn't allow you to change disk; it searches for the destination volume and gives an error when it only finds the source. Again it would have been quite easy to have COPY prompt for number of drives and pause if necessary to allow a change. This is a real pity as the drives are not cheap and a single drive system would be very suitable for a lot of lab and workshop applications.

COPY doesn't allow wildcard filenames either; you can only copy single files or whole disks. In the latter case, the files are added to any on the destination disk rather than overwriting them.

The final irritant is that the operating system gives no prompt to signal successful completion of a program LOAD or STORE: the red light on the drive is the only sign that anything has happened; the cursor merely sits blandly on the screen doing nothing.

The operating system works perfectly well and will do most things you require, but in a fairly spartan and unfriendly way which contrasts strongly with the excellent ergonomics and utilities of the other subsystems.

As a final note on software, the 86 like the 87 contains a built-in translator which allows programs written on the 83 and 85 models to be converted and run. Anyone with either



The perforated plate is a Faraday cage to trap RF emissions

# C/WP PUTS APPLE IN THE BIG LEAGUE

C/WP is not simply concerned with selling Apple computers at prices that turn others green. We want you to get the best out of your Apple and are always looking for goodies which make it even more useful.

So we announce with pride that the superb MP/SL Cobol-based accounting systems are now available on Apple II (running BOS-5) exclusively from C/WP.

If you need a really professional large capacity fully integrated accounting system, join the big league with C/WP's BOS-5 Apple II, single or multi-user.

The software is the same as used on IBM System 1 and DEC PDP 11, but the price is true to the tradition of C/WP.

To join the big league at a small price, contact C/WP Computers on 01-630 7444.

# C/WP

C/WP Computers  
108 Rochester Row, London SW1P 1JP  
Telephone: 01-630 7444

## APPLE/BOS OFFER

### HARDWARE

|  |        |
|--|--------|
| Apple 48K Europlus                                   | £ 499* |
| 24 MHz green screen monitor                          | £ 90   |
| Apple disc drive with controller                     | £ 270* |
| 3 MB hard disc                                       | £ 995  |
| 16K RAM card   | £ 70   |
| 80 column card                                       | £ 119  |
| Z80 card   | £ 95   |
| Microline 83A 120 cps matrix printer (15 inch paper) | £ 479* |
| Printer interface                                    | £ 70   |
|  | £2687  |

### SOFTWARE (SINGLE USER)

|                            |       |
|----------------------------|-------|
| BOS 5 + Runtime MICROCOBOL | £ 200 |
| Purchase ledger            | £ 400 |
| Sales ledger               | £ 400 |
| Nominal ledger             | £ 400 |
| Payroll                    | £ 400 |
| Fixed assets               | £ 400 |
| Autoclerk                  | £ 400 |
| Autowrite                  | £ 400 |
| Invoicing                  | £ 200 |
| Inventory                  | £ 200 |
| Autoindex                  | £ 200 |

All prices exclude VAT, delivery and installation. Items available separately at same price. Items marked \* are a special offer of limited duration and subject to availability. Software prices for multi-user on application.

# HEWLETT PACKARD HP86

of these models can thus upgrade without losing the use of their program library. It will not run 85 ROM software however.

## Expansion and potential use

The HP-86 is capable of addressing a prodigious amount of RAM. Expansion modules can be had in 32,64 and 128k sizes and may be combined to a total of 576k user memory.

Similarly the ROM may be expanded by fitting a ROM drawer into one of the rear sockets which can hold six ROMs. The most likely first candidate is the Plotter ROM followed closely by the I/O ROM which adds routines to the Basic to handle instrument and control applications. An assembler is also available in ROM and an EPROM programmer.

A module containing a Z80 can be fitted to allow the 86 to run CP/M. This module totally disconnects the 86 processor and ROM, effectively turning it into a new computer; most of the advanced editing/debugging aids are disabled as are the function keys and the calculator mode. File formats are incompatible so there can be no transfer of data between HP Basic and CP/M. The attraction of CP/M is nevertheless strong for two reasons: Wordstar and Visicalc-PLUS, both of which are offered. One would treat the 86 as two different computers and use CP/M purely for word processing and spreadsheet work. The Visicalc is a greatly enhanced version with extra maths and graphics capability, and with the full RAM expansion it can handle an enormous worksheet.

HP intends to implement the UCSD p-system in the near future and to offer the Pascal and Fortran, though I have no details of how it will be done (ie, will it be under CP/M?)

On the hardware side, an HP-IB module can be had which opens the 86 up to all HP's plotters, printers and instruments as well as to their other disk drives, 5in,8in and winchester. A very large number of these can be accommodated on HP-IB (40 5in drives or five winchesters!) if you can afford them.

The new HP-IL loop interface is also available to link the 86 to HP-41C calculators, tape drives, timers or other series 80 computers for data collection.

Any Centronics-type parallel printer can be used on the dedicated 86 printer port, though HP has simultaneously released a parallel version of its 82905 dot-matrix printer which can do graphics.

A 9in monitor is offered as an alternative to the 12in one tested. The library of ROM software for the 87 and 86 is now quite large though inevitably heavily biased toward scientific, statistical and engineering applications.

Who would use the 86? Despite HP's intention that this should be seen as a general-purpose computer it still has most appeal to the traditional HP customer in the laboratory and design office. The graph-plotting capabilities

are so powerful that any application which doesn't require them is rather a waste of its talents. That's not to say that there aren't many management and educational applications which could benefit from these features. Nevertheless, I suspect that the 86 will mainly go into those regions of the scientific and engineering market which have been invaded by Apple and PET because hitherto HP was considered to be beyond the budget.

Does it make sense as a pure CP/M machine? You could certainly use it as a small business machine but there are plenty of cheaper CP/M machines to be had; moreover not to use the HP Basic would be rather like putting a Steinway in the public bar, — nice but rather extravagant.

In its ROM-based mode the 86 is very much a programmer's machine; everything has been done to make life pleasant for the owner who writes his own medium-sized but complex programs. As a personal computer on the lab bench it represents good value, since a single drive system could be had for around £2300 if you bought a cheaper monitor and an Epson MX-80 printer. It would be nice if they did something about the COPY command to facilitate this kind of use. There is plenty of scope for upward expansion from such a base system too.

It goes without saying that the 86 is not for hobbyists unless they be wealthy amateurs of science.

## Documentation

The manual I was supplied with was for the HP-87 but since the only material difference is the shape of the screen (even the number of dots is the same) it will require only minor alterations. It is a large ring binder which has a first section of owner's information and abbreviated instructions for getting started, a section on HP-IB operations and then the 300-page Operating and Basic Programming Manual. All are written to the customary HP Standard; clear, readable and comprehensive with the exception that as normal there is no hardware information, not even a memory map. HP definitely does not approve of users wandering round through the innards.

The Basic manual has extensive tables at the end of key codes, expanded explanations of the 131 error messages and a list of the functions, commands

and statements with syntax for quick reference. A full index is provided at the end.

As usual it is difficult to fault HP's documentation; maybe it could be done better but nobody does.

## Prices

|                          |          |
|--------------------------|----------|
| HP-86 Console            | £1251.47 |
| Monitor 9"               | £205.67  |
| 12"                      | £226.59  |
| Disk Drive 9130A         | £592.62  |
| Printer 82905B           | £589.13  |
| Expansion RAM 32k        | £205.67  |
| 64k                      | £313.74  |
| 128k                     | £544.27  |
| CP/M Module              | £345.11  |
| ROM Drawer               | £31.00   |
| ROM Module Plotter       | £101.90  |
| I/O                      | £205.67  |
| Assembler                | £205.67  |
| HB-IB Interface or RS232 | £275.39  |

Service contracts are available, price not known.

## Conclusion

Though it is still by no means a budget machine, the HP-86 represents a dramatic saving over the HP-87 and 85. A similarly configured twin disk system will be at least £1200 cheaper while having the same functionality. The disk drives, though much cheaper than previous HP models are still too expensive by half and bump up the system cost. With a bit of shopping around a single disk system could be built for around £2300 with a printer, though backing up data would be inconvenient. At these sort of prices it competes with Apple III, Sirius, IBM, Sharp MZ-80B and the larger Commodores as a laboratory tool. Its plotting facilities and arithmetic are very much more advanced than any of these machines in their standard forms, though it is less flexible in the range of languages available at present. It is nevertheless a welcome sign that HP is ready to do battle in the volume personal computer market and should keep the other manufacturers on their toes.

## Benchmark timings

|     |      |                            |
|-----|------|----------------------------|
| BM1 | 3.0  |                            |
| BM2 | 5.2  |                            |
| BM3 | 19.4 | <i>All timings in</i>      |
| BM4 | 18.8 | <i>seconds. For an</i>     |
| BM5 | 20.4 | <i>explanation of the</i>  |
| BM6 | 36.5 | <i>Benchmark tests see</i> |
| BM7 | 56.5 | <i>PCW Vol 4, No 11,</i>   |
| BM8 | 13.4 | <i>November 1981.</i>      |

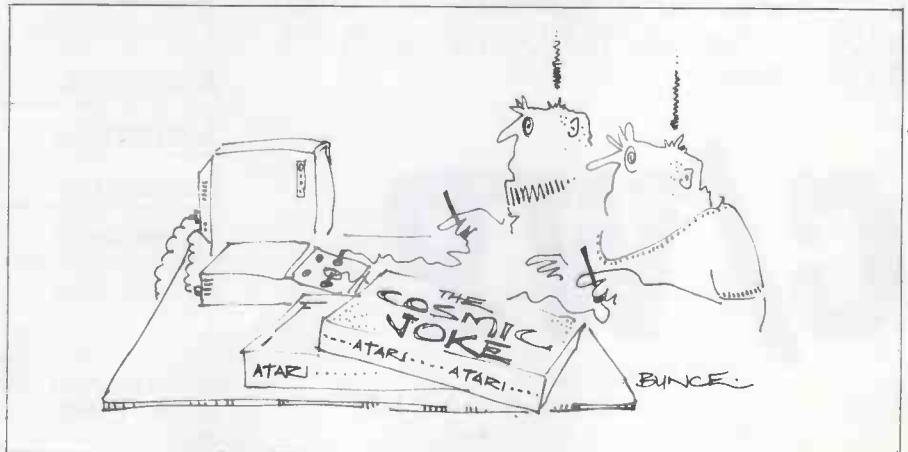

# OUR APPLE PRICES TURN OTHERS GREEN.



C/WP Computers prices are so low we reckon they are the most competitive you'll find. You can buy a standard factory-fresh 48k Apple II Europlus with full 12-month warranty for only £499 + VAT. Or a floppy disc drive (with controller and DOS 3.3) for £270 + VAT. Or a second disc drive for £220 + VAT. And there are hundreds of other Apple bargains at C/WP.

But we're not just clever at keeping prices down: C/WP are experts in Apple and its software.

If you're hungry for an Apple at these mouth watering prices, write or phone for a C/WP price list NOW on 01-630 7444.

Special offer subject to availability.

# C/WP

C/WP Computers  
108 Rochester Row, London SW1P 1JP  
Telephone: 01-630 7444

# POSITRON 9000

The 6809 processor is popular among assembler programmers because of its simplicity and power. It hasn't appeared in many microcomputer systems, though, as its announcement post-dated major software development on other processors (the Z80 and 6502). But it has a loyal following and some high-level software.

Positron is a Manchester-based company which has designed a flexible system (the 9000) around its favourite chip. For software it chose OS-9, a multitasking operating system from American software house Microware.

## Hardware

Picture an Apple-style casing (ie, white plastic with an inclined front section containing the keyboard and a flat top to support the monitor), double the length and breadth to 61 x 58 x 10 cms,

## BENCHTEST

MULTI-USER SYSTEM

*Roger Oliver and Chris Sadler test  
a new British colour micro*

and you've got an idea of the main module of the Positron 9000 review system. The keyboard is grouped into four 'pads' — a 61-key qwerty section, an 8-key 'graphics encoding' pad, a 12-key 'video attributes' pad and a standard numeric keypad. The qwerty keypad is designed for Viewdata rather than ASCII input, which means there are fractions and left and right arrows rather than brackets, braces and the backslash. The non-printing keys (dis-

tinguishable by being a lighter shade of grey) include ESC (end-of-file in OS-9), SHIFT LOCK and CAPS LOCK, REPEAT, DEL and a set of cursor control keys. At present only the back-arrow is decoded (it functions as a BACKSPACE). The other arrows and a red BREAK key are not yet decoded. The keyboard is robust, requiring very firm keystrokes to operate, but the main criticism is that DEL (which deletes the current line) is directly beneath RETURN — which can be a bit disconcerting for the habitual mistypist.

The video attributes keypad has eight colour keys which are used to select the current colour (in alpha or graphics mode) and four which select display attributes — flashing/steady, normal/double height characters, background and graphics status. When in graphics mode, blocks in the Viewdata 2x3 matrix at the current character position can be toggled on or off with the corresponding keys in the 2x3 key matrix on the graphics encoding pad.

At the back of the box there are sockets for a cassette (1200 and 300 baud — remember Kansas City?), four RS232 devices (drivers exist for terminals and printers), an IEEE-488 port, and RGB, composite video and UHF output for the display. The review machine was equipped with a Decca colour monitor providing the more-or-less familiar 40 character by 24 line display. The top of the casing is retained by three screws on either side and, once removed, reveals the keyboard circuitry (supported at an ergonomic angle to the horizontal) beyond which lies the main board and a power supply. The logic supporting the Viewdata functions and 240x 240 pixel 'high resolution' graphics is on the keyboard board. Positron is apparently going to produce a 25x80 screen (and presumably an ASCII board) instead of the Prestel format, although it is also possible to buy the 9000 packaged without keyboard and monitor at all (the case, of course, is differently shaped). A wide ribbon cable connects the keyboard to the processor board.



The main board gives the appearance of a clean design with well-labelled areas, and is well made, with all the pricier chips socketed. The standard configuration provides 64k RAM and 36k ROM, although the review system seemed to have 44k's worth including software (8k). These were all in 4k ROMs but the sockets can optionally take 8k ROMs, and with all the sockets filled there is a potential 128k of ROM. The RAM is expandable (on board) up to 256k. The 6809 (Positron provides a 1 MHz version but will supply a 2 MHz chip with the faster memory required) will address only 64k, but this can be overcome by means of a bank of Motorola memory management units. The review machine was fitted with one of these and there were sockets for another seven. Each can cope with up to four concurrent processes, so it's not difficult to work out what the system is theoretically capable of. An extension board (which stacks above the main board, plugging into a socket similar to that used to connect the keyboard) allows both RAM and ROM to be doubled in size and provides another four RS232 sockets. However, OS-9 level 1 can only address 64k so any extension requires a software upgrade as well.

The four RS232 ports can be configured in two ways. Firstly, by repositioning a pair of chips mounted close to each port, the port can be set up as DTE or DCE. Second, a bank of DIP switches allows each port to be configured for speed (75-4800 baud) and handshaking. On the review machine we had problems getting the ports to work outside the factory settings. DIP switches also exist for configuring the IEEE-488 port and (on the keyboard board) for selecting the video display mode.

The disk drives come in metal cabinets the same width as the main processor box so that they can be stacked on top of it with the monitor perched (actually quite stably) on top of the lot. The review machine had a 5 Mbyte winchester in one cabinet (the Positron 9250) and a pair of 5¼in 380 kbyte floppies in another (the 9151). Drives are daisy-chained together on the IEEE-488 bus, each cabinet containing a controller board with its own processor and PROM to manage the actual drives. A single system is set up to take up to two 9151s



The board is neatly designed.

(D0-D3) and up to four 9250s (D4-D7) where D0-D7 are the device numbers used by OS-9. Positron is also developing the 9300, an adapted disk controller whose PROM performs bus arbitration (instead of disk control) among IEEE devices, enabling a network of up to seven Positrons to share the resources of up to seven other devices (disks and a printer, say).

A fully expanded 9000 then would consist of ½ Mbyte of RAM, 256k of ROM, 12 terminal ports, four floppies and 20 Mbyte of winchester disks. Nobody really expects a single 6809 to be able to cope adequately with all that, but the flexibility of a system should be measured in the extent and number of directions in which expansion is possible. The same remarks probably apply to the fully expanded network.

## Software

OS9 is Unix-like. It is a multi-tasking/multi-user operating system based on a tree-like file structure. System utilities are invoked by issuing a command to the 'shell', a monitor program that, possibly, already has the capability to carry out the requested task, or which,



Double disks can sit on top of console

more usually, calls a separate program to accomplish the task. OS9 deviates from the true Unix philosophy in that programs can be locked into memory so that retrieval of often-needed code from floppy disk drives does not degrade system performance.

OS9 fully supports the Unix concept of any process being able to spawn any number of 'daughter' processes (within the limits of availability of main memory); these are then processed concurrently with all the other processes in the system. New processes can be generated within a program, or by communication with the shell.

# A NEW BRITISH MULTI-USER COMPUTER



# COMPSOFT'S

---

# DMS

---

The ultimate in  
Data Management Systems  
for Microcomputers



Compsoft's DMS is everything you ever dreamed possible in computer software. Fast, efficient and reliable, DMS is the only complete integrated system for information management.

DMS needs no programming. Working in conversational English, this ingenious program is designed for Management, Clerical and Secretarial staff to use. You simply create your record layout, then DMS stores the records. It sorts and searches on multiple criteria, calculates, writes letters, and prints lists, reports and self-adhesive labels. As an extra bonus information from the records can be automatically merged with standard letters written by DMS itself or Wordstar.

You can extend your record keeping into a complete selective mailing service.

You can find out more about DMS from our brochures. We also have technical specifications and free guides to DMS dealing with Personnel, Client, Student, Stock or Library, Subscription, Club, Medical, Policy or Property Record, Job Costing, etc., etc.

DMS is available for most micro computers using the CP/M, MP/M, MSDOS or Commodore operating systems with hard or floppy disks. Every version contains the DMS letter writer as standard and costs £400 or less.

THE COMPSOFT HEADQUARTERS AND TRAINING CENTRE, HALLAMS COURT

Brochures, guides and technical information are free on request from:

DATA  
MANAGEMENT  
SYSTEM



Compsoft Limited  
Hallams Court  
Shamley Green  
Nr Guildford, Surrey  
England GU4 8QZ  
Telephone: Guildford (0483) 898545  
Telex: 859210 COMPSFT



# POSITRON 9000

OS9 supports re-entrant code. When the same program is called by more than one user, only one copy of the code is kept in main memory, and separate data areas are maintained for each use of the program. Each module (program) in main memory has a user count; when it is called the user count is incremented by one, and when the program is no longer required, the user count is decremented by one. When the user count reaches zero, the module is discarded.

In tree-structured file systems it is always necessary to specify the complete route through the tree structure to the individual files; this may be done implicitly or explicitly. If many of the files referenced are from a particular directory file, then it is usual to set that directory as the current directory; thereafter only the file name need be supplied, the rest of the path having been supplied implicitly. OS9 is rather unusual (and un-Unixlike) in that the user is regarded as being 'in' two directories simultaneously; a directory for data files and a directory for programs. These are called the data directory and the execution directory respectively. The supposed advantages of this are not very clear. The picture becomes even more complex when you realise that Basic program files that have been **SAVEd** are regarded as being data files, whereas Basic programs that have been compiled are stored in the execution directory.

Here's a quick rundown of OS9 commands: **ATTR** operates on the attributes of files; these are directory file/data-program file, file shareable between processes or unshareable (see below), owner readable, owner writeable, owner executable, public readable, public writeable, and public executable. An owner is one with the same user number as the originator of the file.

**DCHECK** checks the integrity of the file structure on the specified disk. Sectors on the disk that are allocated to a user but recorded as free in the disk allocation bit-map are detected, and vice versa. Also, the pointers linking the various directories and files are checked.

The **EX** command allows a utility to be called without creating an additional version of the shell; this conserves memory space.

**LOGIN** together with **TSMON** is used to implement a multi-user System. For example, the command **TSMON/T1** sets up a version of the time-sharing system to monitor terminal 1 for activity. Subsequently, any user of terminal 1 has to interact with the **LOGIN** program before being admitted to the system. The **LOGIN** command asks the user for his user name and password and the supplied values are compared with the contents of the password file which details all the permitted users of the system; access is granted only when acceptable values are supplied for user name and password. The password file also specifies a user number (0 to 65535, with user 0 as superuser, with special privileges), the CPU time priority, and the paths for the initial data and execution directories and the initial program for execution (usually the shell).

**PROCS** displays a list of all the pro-

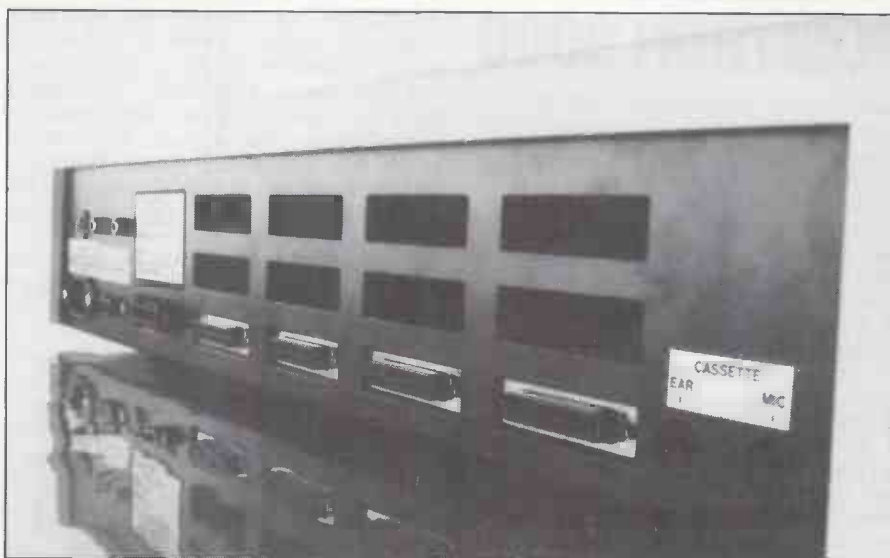

*Plenty of space for more connectors!*

cesses running on the system. The data given on the processes includes the user number, the process number, the priority level, the state (active, waiting for another process to terminate, or sleeping, suspended by self-request for a specified period or until receipt of a signal from another process). OS9 has a unified input/output system in which data transfers to all I/O devices are performed in almost exactly the same manner, regardless of the specific hardware devices involved. Thus, '**DIR >filedata**' lists the contents of the data directory to the file **filedata**, rather than to the screen. Similarly, the command '**DIR >/P**' would direct the output to the printer (parallel interface).

OS9 supports batch or background working. A command file containing the commands that make up the background job can be created with the **BUILD** command. If that file name is then issued to the shell then the commands will be executed. Background working can be ensured by setting the job priority to be low, with the **SETPR** command.

Multi-user access to individual files can be controlled with the shareable bit, set with the **ATTR** command (see above). When this bit is unset, simultaneous access by several processes is allowed. Unpredictable results caused by simultaneous access with **WRITE** rights is prevented with 'lock-out' of other users from the sector last read by a process; setting the shareable bit enables 'lock-out'.

Unfortunately, the **BACKUP** facility only works between disks of the same format; therefore, it cannot be used to backup the winchester onto floppies. There was supposed to be a **DSAVE** command, which scans the 'A' disk and generates a command file to copy all the files of the disk; we could not find **DSAVE** to test it. Since backup is important, and is done so frequently (isn't it?), and is so tedious and time-consuming, and is done when you are tired at the end of a hard session, then it should be easy to do. What is needed is a facility to scan the complete disk file structure, copy across files until the floppy is full, demand attention when this happens and pause for a response when a new floppy has been loaded, etc, until the backup has been done. There should also be a log of where each file has been stored, for later recovery pur-

poses. Alternatively, a tree copy command would have helped; this would copy all the files and sub-directories that came below a specified directory. This would work okay if you could be sure that the selected sub-tree would fit onto a single floppy; otherwise you would have the problem of breaking up the tree structure.

As a multi-user operating system, OS9 has certain defects. For example, the activities of different users are not isolated from each other; it is possible for a process to access memory outside its legitimate address space (using **POKE** in Basic, for example). Thus, a program with bugs in it (and what program of any size is bug free?), can corrupt another's process. Also, it is possible to redirect input/output between user terminals without the other user's permission; this causes some very interesting effects. More seriously, files on disk backing store cannot be considered to be secure. When the '@' character is appended to the reference to a disk drive, then the whole disk is regarded as being a single file. It is possible to completely circumvent the file security system. A malicious individual could overwrite the complete contents of the disk. We should perhaps also mention, that if you set up the password file as suggested in the manual, it has public reading rights!

## Basic 09

A language that can be compiled, has optional line numbers, needs a line editor to change the program, has Pascal-like control structures (plus some more) and variable typing and declarations (in addition to the usual Basic ones) and has Fortran type integer, real and character descriptors in the **PRINT USING** statements cannot sensibly be called Basic.

Basic09 is strongly orientated towards the use of procedures. When one invokes Basic09 one needs to supply the name of a procedure (by means of the **LOAD** command — load a procedure file, or the **E** command — edit a procedure), or the system chooses the exciting name **PROGRAM**. Editing takes place within one procedure, until you exit from that procedure. One can load more than one procedure into the Basic workspace, and can save one or all the procedures into a named file (the

# POSITRON 9000

name of the procedure(s) are distinct from the file name(s), although the default file name is that of the first procedure in the work space).

The Basic editor is entered with the E (procedure name) command, and thereafter can be used for line or string orientated editing. The former is the usual Basic mode, where numbered lines can be entered in any order, a line is replaced by re-entering it, and lines are deleted by entering the line number alone. However, since line numbers can be omitted (indeed you are encouraged to do so, to make the program more compact and faster in execution), standard text editor commands are also provided. These include, insert lines above the current line, delete one or more lines from the current position, search for a specified string of characters, and replace the specified string by another string (either for the first occurrence, or globally throughout the procedure). Lines are parsed, and converted to an internal format immediately on entering, rather than at run-time as is more usual with microcomputer implementations of Basic. An additional benefit of this approach is that reserved words (eg, FOR, NEXT, etc) are printed in upper case, regardless of the case in which they are entered. This aids clarity; unfortunately, it also means that when you use the string search or string change commands, you may have to remember to SHIFT to upper case (very annoying). What is less nice about the editor is that one backtracks a line with the '-' symbol and moves to the top of the procedure with the '-\*' combination; these characters required a SHIFT on the keyboard, and are therefore two-handed operations. One exits from the editor with the Q command; subsequently the interpreter carries out further syntactic checks that could not have been done on a line by line basis (eg, for undeclared arrays).

Once back in SYSTEM mode (as opposed to EDIT mode above), one can issue many of the usual Basic commands: LOAD, SAVE, LIST, RUN, etc. There is room for criticism of the ease of use of some of these commands; for example, in the editor one enters 'I\*' to list the procedure, but LIST is required in SYSTEM mode to list the last used procedure in the Basic workspace. LIST\*, however, causes all the procedures in the workspace to be listed. Where this really matters is with the SAVE command, which saves the last used procedure, and SAVE\*, which saves all the procedures in the workspace; in both cases the default file name is that of the first procedure in the workspace. Thus, if you enter SAVE (or, even, SAVE \*) instead of SAVE\* onto an existing SAVED file, then you lose all the procedures except for the first.

One unusual command is PACK, which compiles the procedure(s) and stores the result in the execution directory (which you may be sharing with many other users, of course!). Also, commands can be issued to the SHELL from SYSTEM mode, by inserting a '\$' character in front of the command.

The atomic data types of Basic09 are BYTE, INTEGER, REAL, STRING and

BOOLEAN. All can be input, operated upon and output. There is a memory saving advantage to using byte values, but no speed advantage. Obviously, there is both a speed and memory advantage to the use of the integer values rather than real values. There are variables capable of holding values of all these types. The default variable types are REAL or STRING (when the name ends in a '\$' character). Other types have to be declared with a Pascal-type construct (eg, DIM a,b,c:INTEGER; n, m: decimal; x,y,z:BOOLEAN — where decimal is a user defined type). User defined types are created with the TYPE statement. Thus, TYPE cust\_record = name, address (3): STRING; balance creates a type consisting of a name string, an address string vector of three elements, and a balance (of type REAL, by default). Therefore, later in the program the declaration DIM trans\_record: cust\_record can be made.

Both sequential and random access files can be accessed from Basic09. There are statements to CREATE, OPEN, CLOSE and DELETE files; one can specify READ, WRITE, UPDATE (both READ and WRITE access), EXEC (open in the execution directory, rather than the data directory) or DIR (open a directory file — can only be used for READ access). Sequential files contain only ASCII data and are accessed with the usual Basic commands of READ <channel> and write <channel>; these carry out any necessary conversions to ASCII format (eg, of numeric values). Random access files contain identical representations to those used in main memory. Thus, the conversion overhead is avoided (although the files are no longer human-readable with the LIST command). One can move to any byte position in the file with the SEEK command. Transfer to and from the file is accomplished with the PUT and GET Statements. These can operate on simple variables, arrays, strings, or complex user-defined structures. The last is very useful, and can be contrasted with the input/output of structures to the standard I/O paths, where each item of the structure has to be handled individually.

Basic09 is very well served for control statements. These are IF <condition> THEN <linenumber>, IF <condition> THEN <blockofstatements> ENDIF, IF <condition> THEN <blockofstatements> ELSE <blockofstatements> ENDIF, two FOR/NEXT (selected by the interpreter/compiler on the basis of the loop variable type — REAL or INTEGER, the latter is faster), WHILE <condition> DO <blockofstatements> ENDWHILE, and a REPEAT <blockofstatements> UNTIL <condition>. Unlike Microsoft-type Basics, <blockofstatements> can be of any length, and the statements are not confined to one line. If that were not enough, there is a LOOP <blockofstatements> ENDLOOP construct which sets up an 'indefinite' loop. Exiting from this loop is accomplished with an EXITIF <condition> THEN <blockofstatements> ENDEXIT construct. When the condition is satisfied, then the block of statements is executed, before control is transferred to the statement below the ENDLOOP statement. Several of these constructs can be included within one loop. This

provides a very nice answer to the situation when one wishes to exit from a loop for one of a variety of reasons and to carry out various tasks depending on the particular condition. Basic09 also provides the more usual GOTO, GOSUB/RETURN, ON... GOTO, ON... GOSUB and ON ERROR GOTO constructs.

Basic09 procedures are completely self-contained as regards variables and line numbers. Values may be passed by reference (by default) or by value. The former is the more common, and means that the address of the memory location is passed to the called procedure; this allows the location to be modified before returning to the calling procedure. In call-by-value, only the value is passed to the called procedure, and hence the value is protected against modification. The method by which call-by-value is selected is rather clumsy; an expression is supplied to provide the required value. If the value is to be extracted from a single variable then an expression must be forced, by adding 0 to the variable, for example. Unusually, if a procedure is to accept values from a calling procedure then the variables in the called procedure are not declared with a DIM statement, but with the PARAM statement; the syntax is identical to the DIM statement. Whereas the DIM statement causes memory space to be set aside, PARAM does not.

Other minor details of Basic09 are: PEEK and POKE are allowed; commands to the shell can be issued with the SHELL command, followed by the actual command in string quotes (eg, SHELL 'copy file1 file2'); TRON and TROFF set the trace flag; one can set whether the storage locations specified in the DIM Statements run from 0 to N-1 or 1 to N with the BASE0 and BASE1 statements respectively (the latter is the default); the usual READ/DATA internal data system is supported.

PRINT USING is very unusual, being based on Fortran-type descriptors. Thus I4 specifies that the integer should be presented to four digits, R8.2 specifies that the real number must be presented with a field width of eight (including provision for the sign and for the decimal point) and with two decimal places; E10.2 specifies that a number should be presented in standard form, with a total width of 10 places (including the six positions for sign, decimal point and exponent), and two decimal places. Descriptors also exist for outputting numbers in hexadecimal form, for strings and for boolean values.

If during program execution any of the following conditions arise then Basic09 enters DEBUG mode:

- i. an error occurs that is not intercepted by an ON ERROR GOTO statement;
- ii. a PAUSE statement is executed; or
- iii. a keyboard interrupt (CONTRL/C) occurs.

In DEBUG mode you can:

- i. send commands to the shell;
- ii. set up break-points;
- iii. CONTINUE program execution;
- iv. list a DIRECTORY;
- v. Quit DEBUG mode;
- vi. assign values to program variables;
- vii. LIST the suspended procedure;
- viii. PRINT values of procedure variables;
- ix. set the trig function mode to RADian or DEGree; and

x call the 'nesting' order of all active procedures.

Access to the 'high resolution' graphics (240x240) of the system is via a procedure LINE. Little documentation was available on how one could exploit the graphics system, although no doubt something could be worked out using LINE and POKE statements. Nevertheless, in comparison with the very much cheaper BBC and Sinclair Spectrum systems, the graphics facilities can only be described as thin. Access to the 'system console', ie, the main keyboard as opposed to additional user VDUs, would be necessary to display graphics: this could pose security problems when used by school pupils, students, etc, in an educational establishment.

One could take one of two opposing views to Basic09. One could say it's a dog's breakfast of features from Basic, Pascal and Fortran; or one could say that it is a sensible attempt to combine the best of the other three languages, although, inevitably, some will dispute whether it does achieve that. A possible criticism of Basic09 is that it is peculiar (ie, unusual), which nullifies one of the supposed advantages of high level languages — their consistency across many computer systems (hollow laugh in the case of Basic). If one regards Basic as what it was originally intended to be, ie, a beginner's language, then Basic09 is easily defended. It introduces programming constructs such as sophisticated control loops, user-defined structures (cf Pascal and Algol 68), procedures (and pass by reference and value), and so on, in a much easier format than, say, Pascal or Algol 68. If Basic is to be regarded as a standard programming language, with some degree of standardisation, then Basic09 offends more against the minimal Basic standards than do most implementations. Nevertheless, in its own right it is a powerful and easy to use language.

## OS-9 Pascal

Microware Systems' Pascal compiler generates p-code objects which can be interpreted by a 'normal' interpreter (PascalN) or a 'swapping' interpreter (PascalS) for large programs. Alternatively, PascalT is a native-code translator which accepts p-code files as input and produces 6809 assembly language source code. The compiler is invoked by means of a fairly complex command line:

```
Pascal (source p/n)list p/n) stats p/n
exec. options: parameters
(where p/n stands for 'pathname'). Of these, only the source pathname is mandatory (unless you want to type the code straight off the keyboard directly into the compiler). Two standard output files are produced by the compiler, PCODEF (the actual codefile) and PROCTAB, the compiler's workfile which is left in the data directory after the compiler exits (rather untidy). The 'parameters' field in the command-line can be used to redirect these files to other pathnames — essential if two or more users are to share the same data directory. In addition there are parameters to specify the format and extent of source and symbol-table listings, inhibit run-time range-checking and suppress the insertion of (diagnostic) source line-numbers into the p-code.
```

Optional range-checking covers array-bounds, memory references via pointers, and boolean and subrange type assignments. Exec-options define stack, heap and swapping buffer sizes together with string justification (leading or trailing blanks), MOD function algorithm, run-time error response and heap control options. Pseudo-comments covering most of the parameter and exec options may alternatively be embedded in the Pascal source. The list and stats pathnames default to the terminal-convenient for the most interactive program development.

The compiler allocates one byte of storage for each character and boolean, two bytes for each integer and five bytes for reals (ie, about nine significant (decimal) digits \* E±38). String constants may extend to 100 bytes and procedures may contain a maximum of 32 kbytes of p-code each while a program may have up to 254 procedures declared within it. The compiler will accept hexadecimal constants, prefixed with a '\$' sign. The keyword OTHERWISE has been added to the CASE construct as a catch-all clause. The compiler accepts subrange specifiers (eg, 'a'..'z') both within CASE definitions and SET membership assignments.

Both p-code interpreters are invoked by a command line of the following form:

```
PASCALx <input p/n >output p/n >>
syserr pcodename exec.options:params
'x' is either 'N' or 'S' depending on interpreter. Input and Output are the standard Pascal I/O files while Syserr is a standard OS-9 device which has been added to the Pascal standard devices. The pathname 'pcodename' is the only mandatory entry, being the actual codefile. Considering its position in the command line, in relation to the sourcefile in a compiler's command line, one can see that the Pascal environment is not especially 'orthogonal'. Params. is a user-defined string which is passed directly to the program once execution begins (so that a user-written program can behave similarly to an OS-9 utility, accepting a 'command line'). This is a nice feature but not as powerful as it might be under version 1 of OS-9 since the command line operators ('<', '>', '&', etc) are not allowed.
```

The swapping interpreter implements a full fixed-page virtual code swapping algorithm whereby a minimum of eight 256-byte pages are maintained in memory and only the code for locked or active procedures need exist in memory at any time. Strings are stored in separate pages so that additional pages (over the eight) need to be allocated for procedures which reference strings and remain active. Obviously, the more pages allocated the more efficiently the program will run, and the manual emphasises that an experimental approach must be adopted in optimising performance.

PascalT is a Pascal program which translates p-code into 6809 assembler language. Up to 36 reduction rules are employed to optimise for speed and space, although, on average, each byte of p-code generates just under two-and-a-half bytes of native code, so care needs to be exercised when translating large programs, especially on a floppy-based system. PascalT runs under the PascalS interpreter and prompts for

input and output filenames. Not all procedures in a program need to be translated into a single output module with a separate file of (external definition) references for subsequent use by the link/load utility PascalE. It is possible to embed the original source line-numbers in the assembly file. If the partial translation is done, the relevant procedures must be removed from the Pascal source-file and replaced with external references. The modified Pascal source-file is then re-compiled before being linked with the assembled native-code module. Native-code modules may not be swapped (which probably explains why PascalT must run under PascalS).

If an entire program is translated it can be invoked by:

```
program <input >output >>
syserr exec.options :parameters
where all terms are as previously described for the interpreters including the parameter string 'parameters'. For true optimisation it is necessary for the user to provide PascalT with information about local and extended stack and heap space — this is prompted for during execution.
```

Apart from the CASE statement extensions mentioned earlier, OS-9 Pascal differs from standard Pascal in that the underscore character is recognised in identifiers; strings are implemented; procedures and functions may not be passed by name; files may not be passed by value (and may be omitted in the PROGRAM statement); DISPOSE, PACK and UNPACK are not implemented and PACKED is ignored (although variable space is allocated on byte boundaries). Character arrays can be indexed (in their right-most dimension) by the form 'p FOR q' where p and q are integers such that p is the index of the first element to be referenced and p+q is the element of the last element referenced. Thus:

```
String [1 FOR 5] := 'ERROR'.
OS-9 distinguishes between 'terminal-like' (SCF) and 'disk-like' (RBF) devices
```

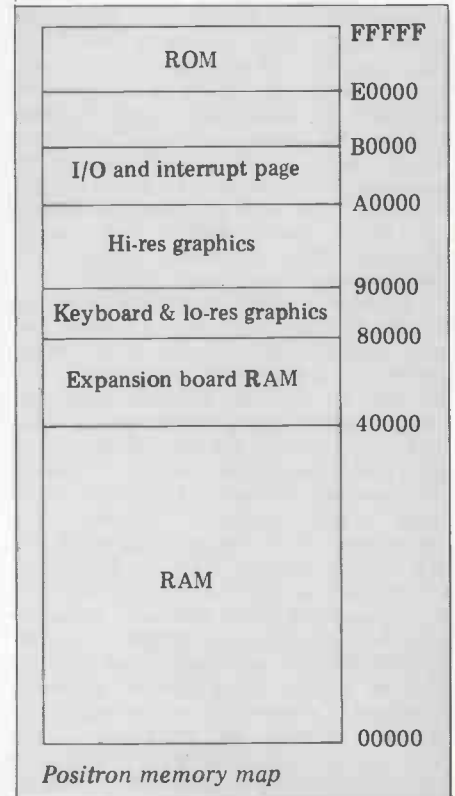

# POSITRON 9000

and this distinction is carried over into the OS-9 Pascal I/O. RBF files follow the proper language specification while SCF files get around the usual Pascal 'interactive' problem by only loading the buffers when they are needed (lazy I/O). This means the EOLN and EOF functions behave slightly differently for the two types of file. The boolean function INTERACTIVE(filename), which returns a value of TRUE whenever 'filename' refers to an SCF-type file, must be employed to provide the customary interactive I/O. A number of 'standard' procedures and functions are provided for file-handling and interacting with OS-9. These include the ability to access the file of error-messages and to suppress non-fatal OS-9 I/O errors. Other procedures and functions allow, among other things, for the trapping of certain arithmetic errors (overflow, range, divide by zero); bit manipulation within integers and forking to the SHELL. There are three run-time support packages, SUPPORT (9k), which contains all routines, SUPPORT1 (7k), which lacks the transcendental functions and SUPPORT2 (5k) which lacks support for any reals and some of the file-handling procedures.

## Other software

Several other software items which, for one reason or another, we were not able to review in much detail include a full implementation of CIS Cobol; a C compiler; an interactive assembler and debugger; a word-processing package, Stylograph; and RMS, a record management system. According to Positron, negotiations are underway to obtain a rather fruity suite of commercial packages which will run on the system via the CIS Cobol implementation.

Stylograph features normal cursor-controlled screen editing with additional block operations and text-formatting functions like filling, centering, headers/footers, etc. The system is designed to interface to individual terminals and printers by means of separate drivers which seem fairly straightforward to construct. It is possible to direct output to disk files and to pass commands to OS-9 from within Stylograph. Positron claim that a new version will incorporate a 'mail-merge' facility.

RMS is a suite of programs which enable the user to create a record format specification (up to 1022 bytes long), to create and maintain a file of (up to 65,536) records according to the record specification and to output a selection of the records according to a pre-defined print-format. A system of secondary records may be associated with each primary record, one (common) field being designated the KEY field (storage is by hash coding). Fields may be alphanumeric, numeric or in 'money' or 'data' format. Validation can be according to length, range or membership of an explicit list. Output can be driven by a file of symbolic commands created by a text editor. It would probably be preferable if the commands were a bit more wordy as a complicated output 'program' would be

quite difficult to debug. Index files (which merely contain a list of KEY values in some significant order) can be used to access the file selectively — but these must be assembled 'by hand' with a text editor and ordered with a SORT/MERGE package (not supplied). Overall, it seems convenient and flexible to use although not particularly powerful or comprehensive.

## Potential

The Positron 9000 is a difficult system to place in the marketplace. It's too different (and a bit too expensive) to compete with any of the standard, single-user CP/M systems with their huge repertoire of software; it certainly isn't a hobbyist machine; yet it offers a multi-tasking operating system (not necessarily even with disks!), a substantial expansion pathway and the potential for multiple users. At the same time there is the Viewdata terminal capability which doesn't really seem to fit in with the rest of the system.

In fact, the machine has been offered for some time to schools but while Basic09 is a very reasonable language with which to learn programming (as is Pascal), we felt that the multi-user aspects of OS-9 (level 1) were not sufficiently robust to provide a stable programming environment for a number of (beginning) users. Keyboard operations are noticeably affected when more than one user is active (hard to expect beginners to take this into account); and we found that the system rejected processes when memory filled up (instead of, perhaps, queuing them), requiring human intervention (hence a supervisor). Perhaps level 2 of the operating system copes better with these problems.

On the other hand, the 6809 is a processor well-known to and much admired by a number of digital designers and any professional who takes the trouble to learn the intricacies of OS-9 (and that includes Unix programmers) should be able to construct themselves a fairly comfortable development environment. The system has a vast capacity for ROM and provides a cheap route to multi-tasking which should mean that, with careful programming, a fairly robust, turnkey delivery system could be built. We would guess that such a system, with its well-

designed boards and expansion capabilities, should appeal to industrial OEMs, especially those expecting to exploit GPIB devices, provided they don't need to push that single little processor too hard. Additionally, a nationwide maintenance service is provided for Positron by Fisons Scientific.

## Documentation

The documentation was of a quality which computer professionals have grown to expect — that is, most of the information was there if one was prepared to persevere. We estimated that about five passes through the manuals would be necessary to resolve all unknown references! They were

## Basic Benchmarks

|     |      |
|-----|------|
| BM1 | 1.1  |
| BM2 | 2.1  |
| BM3 | 5.4  |
| BM4 | 6.8  |
| BM5 | 7.2  |
| BM6 | 14.9 |
| BM7 | 20.2 |
| BM8 | 12.0 |

All timings in seconds. For an explanation and listing of the Benchmark programs, see PCW Vol 4 no 11.

## Pascal Benchmarks

|                |       |
|----------------|-------|
| magnifier      | 5.2   |
| forloop        | 59.3  |
| whileloop      | 73.3  |
| repeatloop     | 67.0  |
| literalassign  | 72.5  |
| memoryaccess   | 73.4  |
| realarithmetic | 61.8  |
| realalgebra    | 48.1  |
| vector         | 172.9 |
| equalif        | 115.1 |
| unequalif      | 110.4 |
| noparameters   | 38.6  |
| value          | 41.2  |
| reference      | 41.9  |
| maths          | 32.9  |

These figures were obtained with the interpreter PascalN. We would have liked to have obtained figures for the native-code (PascalT) version but ran out of time.

## Prices

|               |  |       |
|---------------|--|-------|
| Positron 9000 | basic system with 64k RAM,<br>4 x RS232 and IEEE-488 | £1095 |
| 9000/40       | the review system with Viewdata<br>keyboard          | £1536 |
| 14in          | Viewdata colour monitor                              | £320  |
| 9151          | dual 5¼in, 380k floppy drives                        | £950  |
| 9250          | 5 Mbyte winchester                                   | £2750 |

## Technical data

|           |   |
|-----------|---|
| CPU:      | MC6809 (1 MHz)  |
| Video:    | 24x24 Viewdata colour, 240x240 pixels                 |
| RAM:      | 64k — 512k  |
| ROM:      | 36k — 256k  |
| Comms:    | Cassette (300, 1200 baud), IEEE-488, 4—12 RS232       |
| Keyboard: | 61-key Viewdata, graphics and numeric pads            |
| Bus:      | Positron's own  |
| Disks:    | 2 — 4 5¼in 380k floppies<br>1 — 4 5 Mbyte winchesters |

# MicroPlan from Bonsai.

The first easy-to-use electronic worksheet that's a true financial planning system.

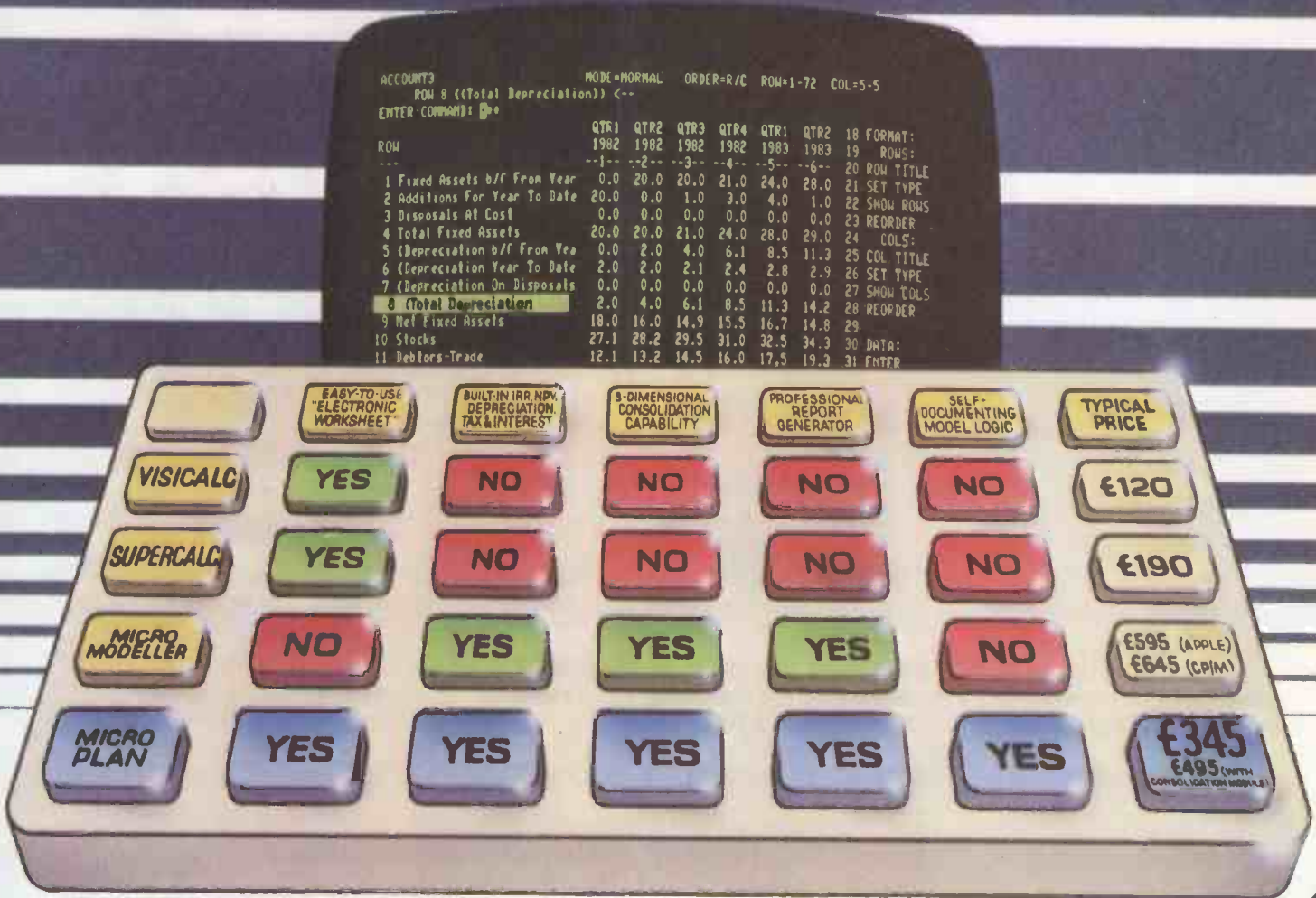

MicroPlan is the most highly developed yet simple financial planning software because it combines real modelling features with an on-screen spreadsheet format.

MicroPlan has everything you need for advanced analysis yet is incredibly easy-to-learn and easy-to-use. You simply enter values into the worksheet and choose any of the powerful financial functions by selecting a number from a "menu" on the screen.

Only MicroPlan will let you calculate depreciation, analyse variances, amortise mortgages and consolidate multi-departmental budgets without the need to learn jargon.

If you need more power than the "calcs" but don't fancy the daunting prospect of a programming-like system, take a look at MicroPlan. MicroPlan can help solve your problems with push-button ease.

To order your copy of MicroPlan or a demo pack - or receive details of our next seminar and our 4-page brochure - give us a ring or return the coupon.

MicroPlan is compatible with Altos, Bonsai SM3000 & MU9000, Caltext, Cromemco, DEC VT-180 & Rainbow 100, Dynabite, HP-125, IBM Displaywriter & IBM Personal Computer, ICL Personal Computer, LSIM2, M3, M-Text & M4, NEC PC8000 & NEC APC, Rair, Sirius, TeleVideo, Vector Graphic, Wangwriter, Xerox 820 & 860 and most other microcomputers running CP/M or CP/M-86. CP/M-86 version requires CBASIC-86 runtime module.

## Bonsai

### MICROCOMPUTER SYSTEMS FOR PEOPLE IN BUSINESS

112-116 New Oxford St.  
London WC1A 1HJ.  
Tel: 01-580 0902.

Please send: (please tick as appropriate)  MicroPlan standard system @ £345 (+P&P+VAT = £400).  
 MicroPlan with consolidation module @ £495 (+P&P+VAT = £570).  MicroPlan demo pack @ £37.50 (+P&P+VAT = £45).  4-page MicroPlan brochure.  Details of next MicroPlan seminar.

My Microcomputer is a \_\_\_\_\_ I enclose cheque for \_\_\_\_\_

Please Debit my Access/Visa Account No. \_\_\_\_\_

Name \_\_\_\_\_ Position \_\_\_\_\_

Company \_\_\_\_\_

Address \_\_\_\_\_

Telephone: \_\_\_\_\_

Signature \_\_\_\_\_

Dealer Enquiries Invited.



# THE 16-BIT PERSONAL COMPUTER

The ACT Sirius 1 is more than the UK's best-selling 16-bit personal computer. It is the only one with such a large choice of 16-bit software — business and scientific programs specially developed to take advantage of the high speed 16-bit Intel 8088 microprocessor at the heart of every Sirius.

Combine this faster and more powerful software with the advanced specifications of the Sirius 1 and you can see why more and more business users are choosing Sirius.

Because Sirius users have both the latest microcomputer technology and the powerful 16-bit software that takes full advantage of it.

Ergonomics plays a vital part in the design of ACT's Sirius 1. The screen tilts and swivels to suit the user and glare is eliminated.

The display is razor sharp, and the brilliance and contrast can be adjusted using keys on the low profile detachable keyboard.

## UP TO 896 KBYTES RAM

128 Kbytes of RAM memory as standard easily upgraded to a massive 896 Kbytes ensures plenty of capacity for fully fledged business software and associated record files.

Within the basic system is 1.2 Mbytes of floppy disk storage, with 2.4 Mbytes double sided disks available as an option. More than any other comparable personal computer.

As a result, the Sirius is suitable from the start for large record processing applications. And with 5 and 10 Mbyte Winchester disk drives scheduled for early introduction, the Sirius can easily match your own organisation's growth.

## SOFTWARE THAT TALKS BACK

And built into every Sirius is a revolutionary new concept: An audio decoder that can play back verbal messages and prompts under program instruction to assist the non-computer people to get acquainted with the software more quickly.

## NEW 16-BIT SOFTWARE

All the big names in applications software are on the Sirius: ACT's Pulsar for accounting, WordStar for word processing, MicroModeller for financial modelling and SuperCalc the "spread sheet" program.

Plus the exciting SELECT, the only word processor that teaches you how to use it in less than 90 minutes.

And more than 100 top software companies are currently developing specialist software for every business and profession from the motor trade to solicitors.



The ACT octagon encapsulates our philosophy of providing users with a single source for their computing solutions.

ACT products include personal computers — network micro-computer systems — turnkey mini computers and a total range of services, including software development, computer field engineering, computer supplies, and a complete range of Bureau services.

The eight specialist ACT companies are each leaders in their field and are wholly owned by Applied Computer Techniques (Holdings) p.l.c., one of Britain's largest and most successful computer companies.

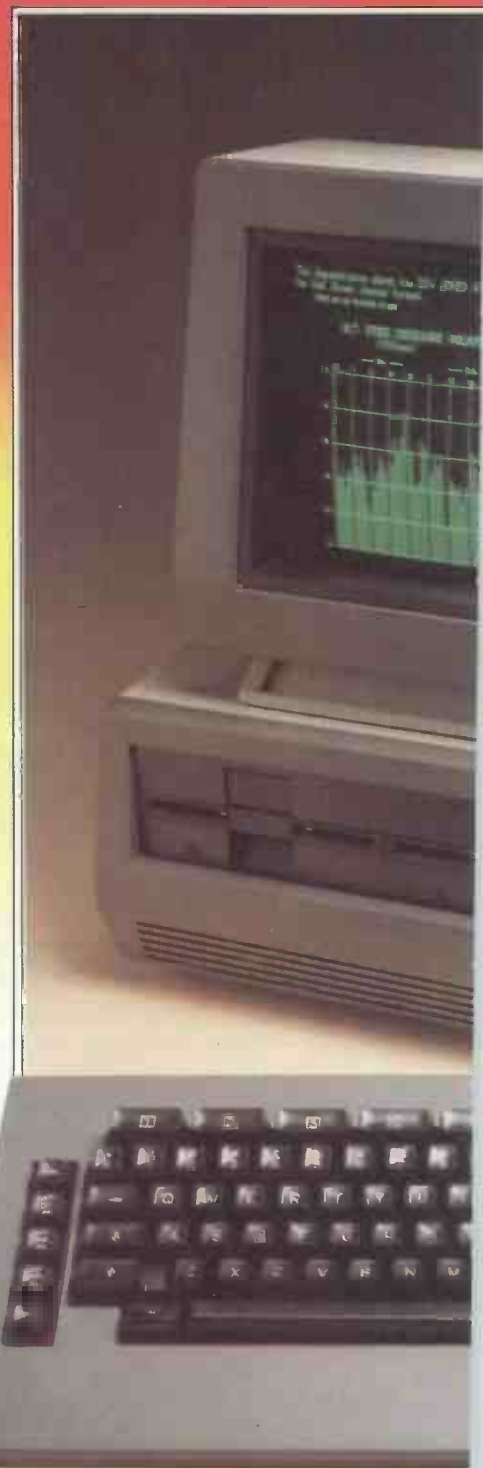

# ACT Sirius 1 PERSONAL COMPUTER Price £2,395

## MORE LANGUAGES

The Sirius has more available programming languages than any newly-introduced personal computer. MicroSoft's BASIC 86, interpretative or compiled, CBASIC, a choice of several versions of COBOL, three different PASCALS and a full scale FORTRAN.

The benefits? Programmers and software houses are making the Sirius their first choice computer for business software development.

Unlike other personal computers, the ACT Sirius 1 is delivered with the two industry standard operating systems at 16-bit level — MS-DOS and CP/M-86. Once again a guarantee now of the widest choice of off-the-shelf 16-bit software.

And further operating systems are under development. The much vaunted UNIX and a new system to support a low cost local area network.

## COMMUNICATIONS

The Sirius is the ideal communications system, with two independent RS232 communications ports in addition to parallel and IEEE 488 ports. Available NOW are all the facilities required to communicate directly with large, mainframe computers.

Further backing is available by way of a dedicated Sirius Training Centre, run by ACT and open to all.

To support the product ACT has a truly professional network of systems dealers, handpicked for its knowledge of the business environment, enabling top quality support to always be close at hand.

**ACT SIRIUS 1 — THE COMPLETE 16-bit personal computer.**

To know more about the 16-bit ACT Sirius 1 and its exciting range of 16-bit software, clip the coupon and return it to:—

**ACT (Sirius) Ltd.,**

FREEPOST,  
Halesowen, West Midlands,  
B63 1BR.

Or call for details now on

**021-501 2284**

*Price excludes VAT.*

I need to  
know more about  
the ACT Sirius 1 and the new  
16-bit Software.

Name: \_\_\_\_\_

Position: \_\_\_\_\_

Company: \_\_\_\_\_

Address: \_\_\_\_\_  
\_\_\_\_\_  
\_\_\_\_\_

Telephone: \_\_\_\_\_

I may qualify for a dealership.  
Please send a dealer  
application pack

PCW/10/82



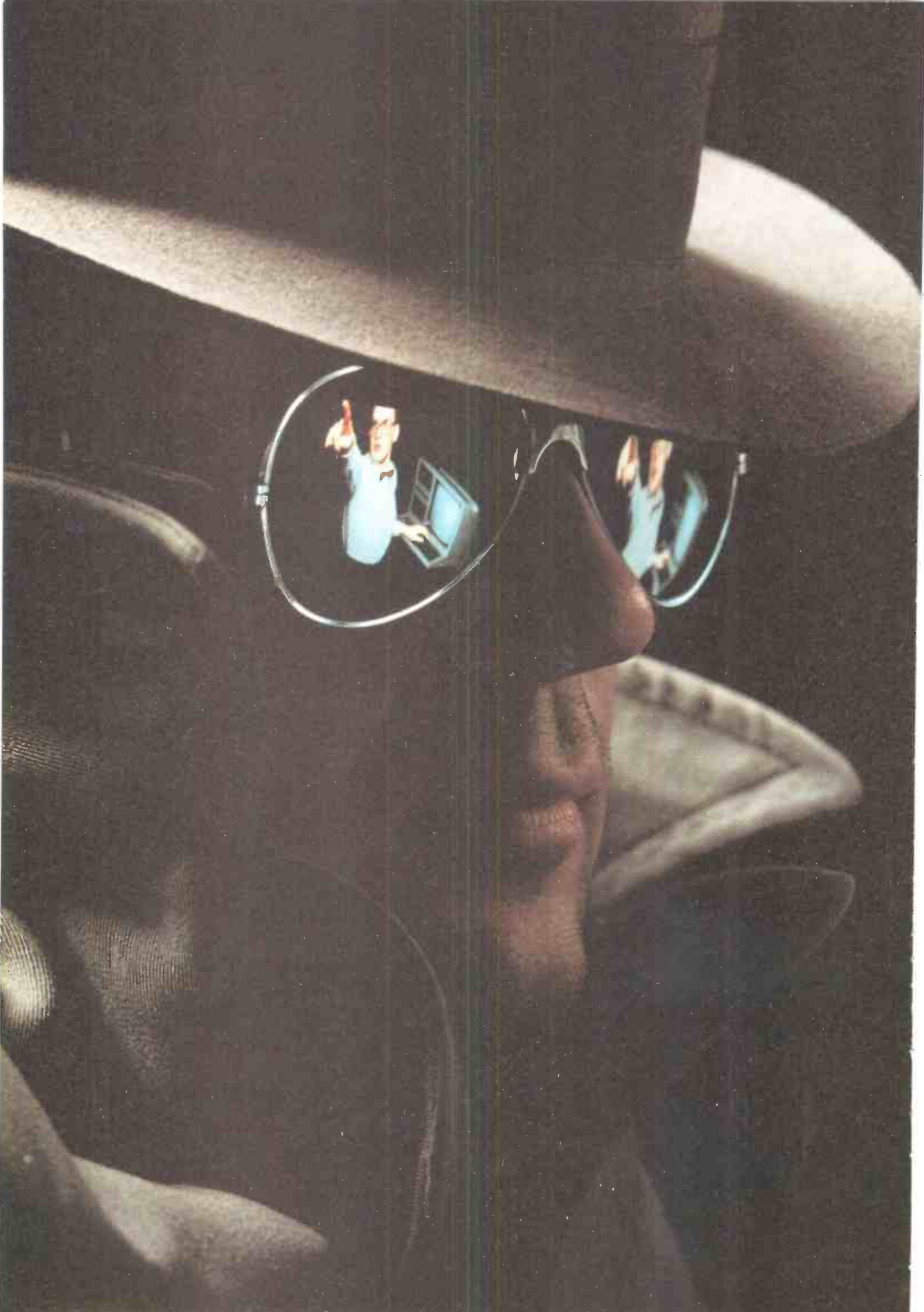





# £50000 MANHUNT

The first puzzle in the PCW Manhunt was an easy one — just to let you limber up a little. This month we'll have something a little harder which will stretch you and your micro rather more.

Using the digits 1 to 9 inclusive, each digit only once, it is possible to generate  $9!$  (factorial nine) different integers — that's 362,880 in all.

If you do this, and then sort them into ascending order of magnitude, you will be able to answer the question 'Which number occupies the 100,000th position? Having found this number write down the digit which occurs halfway along it; you'll need that as well for the final hurdle. Please don't send any answers to us yet; there are still two parts to go!

J J Clessa

# Together we're unbeatable!

**RAVEN**  
COMPUTERS

AN UNRIVALLED RANGE  
OF SOFTWARE & SERVICE

**ACT**  
**SIRIUS 1**  
BRITAIN'S BEST SELLING  
16 BIT COMPUTER

## Raven First Again!

RAVEN COMPUTERS of BRADFORD are pleased to announce their appointment as the **VERY FIRST PULSAR SOFTWARE CENTRE IN THE U.K.** This super new range of software has been produced specifically for 16 bit micros by ACT (Microsoft) Ltd.

It's very-user usable, very fast and very competitively priced.

### Now Available

Full accounting software written in 16 bit mode. Packages include Sales, Purchase and Nominal Ledgers, Invoicing, Data Analysis, Stock control and of course Payroll.

These British written programmes are currently in Sirius Format and will shortly be available for the IBM PC and other leading 16 bit micros.

### \*NEW\*

#### Pulsar Select

The super new word processing package which includes a mailing facility and a spelling dictionary. **Only £295**

#### Pulsar Multiplan

The best spreadsheet system available on the market. Outperforms any other available system. **Only £150**

#### Financial Modelling

Choice of two Super systems. Both systems are well proven and are a must for any accounts forecasting. Prices from: **£400-595**

#### Database

**FMS 80** The world's leading Management System with multi file access and ultra fast data entry and retrieval. Unlimited records, single pass selection Automatic sort and update, prints to your own format. Contains the EFM program generation facility and lots of other features which make it the worlds No. 1. Described as the Rolls Royce at Rover Prices: **£650**

#### Sirius Dataflow

The compact fast data entry and retrieval system which integrates with Sirius Mailflow. It has a powerful report generator and is in full 16 bit mode. **£125**

#### Sirius Mailflow

Mailshots made easy with this powerful mailing system. It allows cut sheet or continuous paper, has default options and even types envelopes. Does mailshots directly from Sirius Dataflow. **£75**

#### Hard Disc Systems.

External hard discs available from 5Mb to 80Mb allowing networking on the Sirius or a powerful stand alone system.

#### Sirius 80 Card.

The CP/M card which allows you to run 8 bit software on the Sirius without diluting any of the Sirius's advanced features. From **£299**

Raven Computers offer only the best hardware and software which is available NOW and at the right price!

Join Us - Together we're Unbeatable.

*If you're*  
**SIRIUS** about  
*getting your*  
**ACT** together  
**1** should try  
**RAVEN**

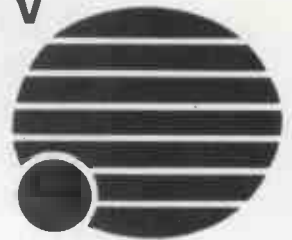

**RAVEN**

**COMPUTERS**

153 Sunbridge Rd  
Bradford BD1 2NU

Tel: 0274 306966/309386



# THE ULTIMATE TEST?

by Chris Sadler and Sue Eisenbach

In the September issue of *Byte* magazine, Jim Gilbreath, head of the Computer Sciences and Simulations Department of the Naval Ocean Systems Centre in San Diego, published a benchmark program which he had translated into 10 different languages and run on dozens of different machines and compilers.

While preparing last month's article

```

10 REM ERATOSTHENES SIEVE PRIME
    NUMBER PROGRAM IN BASIC
20 INTEGER ALL
30 SYZE = 4094
40 DIM FLAG(4095)
50 DISPLAY "ONLY 1 ITERATION"
60 COUNT = 0
70   FOR I = 0 TO SYZE
80     FLAG(I) = 1
90   NEXT I
100  FOR I = 0 TO SYZE
110   IF FLAG(I) = 0 THEN 180
120   PRIME = I+I+3
130   K = I + PRIME
140   IF K>SYZE THEN 170
150   FLAG(K) = 0
160   K = K + PRIME
170   GOTO 130
180   COUNT = COUNT + 1
185   REM DISPLAY PRIME
190   NEXT I
200 DISPLAY COUNT, " PRIMES"
210 END
    
```

on the different language translators available under SofTech's UCSD (version IV) p-System, we decided to use his program to compare the efficiency of the p-code produced by the p-System's Pascal, Fortran 77 and Basic compilers. Frankly, since the p-System is so well-known for its Pascal, we had expected that only lip-service would have been paid to the problem of optimising the p-code statements generated by the other two compilers. The benchmark uses an algorithm based on the Sieve of Eratosthenes to compute the 1899 prime numbers between 3 and 16384.

Once a prime is found, all multiples within range are eliminated, and this information has to be remembered for subsequent processing, so quite a lot of storage is necessary. Unfortunately, SofTech's Basic did not have room in

RAM for the 8k in reals (we decided not to use virtual arrays as we didn't want to compare disk and RAM accessing) required by the *Byte* program and in the end we had to reduce the array to 4k of integers before it would fit in — ie, all primes from 3 to 8181. The programs in Pascal and Fortran are set up to do 10 iterations of the algorithm (as in the original article), although the figures presented below are for a single pass in order to be comparable with the Basic program. The reason Jim Gilbreath built in the different iteration count was to get similar figures for compiled and interpreted code — but since, on the p-System, all the programs are compiled into p-code which is subsequently interpreted, the need for this distinction disappears.

*GOTO page 207*

| Language    | Compile time | 8k primes | 16k primes |
|-------------|--------------|-----------|------------|
| Basic       | 33.6 secs    | 15.7 secs | —          |
| Fortran     | 27.7 secs    | 14.1 secs | 28.6 secs  |
| Pascal      | 28.1 secs    | 13.0 secs | 26.6 secs  |
| UCSD Pascal | 30.6 secs    | 11.0 secs | 20.4 secs  |

Table 1

Program Primer;  
( Eratosthenes Sieve Prime Number Program  
using UCSD Pascal features )

```

Const size = 4094;

Var flags : Array [0..size] of Boolean ;
    i, prime, k, count, iter : Integer ;

Begin
  Writeln ('10 iterations') ;
  For iter := 1 to 10 Do
    Begin
      count := 0 ;
      fillchar(flags, sizeof(flags), true) ;
      For i := 0 to size Do
        If flags[i]
          Then
            Begin
              prime := i+i+3 ;
              k := i + prime ;
              While k <= size Do
                Begin
                  flags[k] := False ;
                  k := k + prime
                End ;
              count := count + 1
            End
          End ;
      Writeln (count, ' primes')
    End .
    
```

```

20   K = I + PRIME
    IF (K .GT. 8190) GOTO 90
    FLAGS(K) = .FALSE.
    K = K + PRIME
    GOTO 20
90   COUNT = COUNT + 1
    WRITE(1, 100) COUNT
91   CONTINUE
92   CONTINUE
    WRITE(1, 200) COUNT
    STOP
100  FORMAT(1X, I6)
200  FORMAT(1X, I6, ' Primes')
    END
    
```

Program Primer;  
( Eratosthenes Sieve Prime Number  
Program in Pascal )

```

Const size = 8190;

Var flags : Array [0..size] of Boolean ;
    i, prime, k, count, iter : Integer ;

Begin
  Writeln ('10 iterations') ;
  For iter := 1 to 10 Do
    Begin
      count := 0 ;
      For i := 0 to size Do flags [i] := True ;
      For i := 0 to size Do
        If flags[i]
          Then
            Begin
              prime := i+i+3 ;
              k := i + prime ;
              While k <= size Do
                Begin
                  flags[k] := False ;
                  k := k + prime
                End ;
              count := count + 1
            End
          End ;
      End ;
      Writeln (count, ' primes')
    End .
    
```

C Eratosthenes Sieve Prime Number Program  
in FORTRAN

```

LOGICAL FLAGS (8191)
INTEGER I, PRIME, K, COUNT, ITER
WRITE (1,50)
50  FORMAT (' 10 Iterations')
DO 92 ITER = 1, 10
  COUNT = 0
DO 10 I = 0, 8190
10  FLAGS(I) = .TRUE.
DO 91 I = 0, 8190
  IF (FLAGS(I) .EQ. .FALSE.) GOTO 91
  PRIME = I + I + 3
    
```

## A high-level language benchmark

# STEREO GRAPHICS!

Paul Stevenson outlines a neat and novel way to get 3-D on a micro

Now that high resolution colour graphics, in various forms, are becoming available in small computers the possibility exists of generating the traditional red/green image pairs necessary to produce a three-dimensional stereoscopic image when viewed through a pair of spectacles with a red filter over one eye and a green over the other.

The geometrical theory behind the positioning in the red and green parts of the image will be given and one example program for the BBC/Acorn computer is included. Finally, possible applications are considered.

Consider first the red and green images which would have to be produced on the page of a book to give the image of a pyramid standing vertically from the page when viewed from 45 degrees. (see Fig 1). This example is chosen because it works particularly well and because the programming is particularly simple when it is later transferred to a VDU screen.

Assume that eye L is to view through a green filter and that eye R looks through a red one. The desired final image is shown in black WXYZA. The eyes are taken as being 6 cm apart. Since a red line on a white ground should not be visible through a red filter and should appear black through a green one and a green line will similarly not be visible through a green filter but will appear black through a red filter, the images of the intended pyramid as seen by each eye separately can be extrapolated back to lines projected onto the horizontal surface as shown. In fact, for simplicity, the only point in the example which needs extrapolating is the apex of the pyramid A, if one assumes that the base of the pyramid lies in the plane of the page. This gives projected points GA and RA as seen by the right and left eyes respectively. Thus all that has to be done to define the green image on the page (screen) is to join GA to the points WXYZ. The red image can then be joined up in a similar manner. In the example the red and green images are symmetrically placed with respect to the centre line but this need not be so for other objects.

Fig 2 shows the final appearance of the images on the screen or page. Note that around the base WXYZ, where both red and green images overlap each other, the line should be plotted in black since it has to be present at both eyes. The final image received by the brain is in monochrome. Both the BBC and RML 380Z machines make provision for making the logical AND function of the plotted red and green colours equate to black and this is a distinct advantage in the programming.

Fig 3 shows the viewing situation for the example program — it was arranged this way because the final pyramid was required 'correct way up'. (There are other ways of achieving this with the VDU arranged conventionally but the geometry is much harder to explain.)

The effect is very powerful if the filters are closely matched to the colours on the screen (more on that later).

Having decided to replace the page with a VDU screen placed horizontally then essentially all that one has to do is to decide on:

- a) the size (centimetres) of the pyramid base;
  - b) the height of the pyramid;
  - c) the viewing distance and angle (50 cms and 45 degrees in this example);
- a) and b) are both variables presented to the program.

What remains is to calculate the screen coordinates of WXY and Z and of the points GA and RA. This involves only simple ratios in similar triangles. At a late stage in the program the position of points GA and RA will have to be converted from centimetres to plottable screen points. This conversion will depend on the resolution of the graphics employed but in the BBC/Acorn machine used this conveniently works out on both axes at about 55 points per centimetre.

The program is listed in Fig 4 and is written in BBC/Acorn Basic but as far as possible it has been kept to a common subset of Basic. For instance, no graphics offset origin or procedure calls been used, both of which would have simplified the code.

## Extensions to the program

The following extensions to this simple program are possible if there is a drive to experiment.

First offset the apex of the pyramid relative to the base. Secondly raise the base itself off the actual screen. The latter task involves calculating the red and green image positions for all four corners of the base as they will not now overlie each other. The pyramid can now be made to appear suspended

above the screen surface (yes it does work) but the height it appears above the screen surface is limited by the screen size you are using — the images start to plot off the top of the screen area if it is raised too high.

A third possibility is to experiment with the viewing angle, but this has not been tried yet. In relation to this, to avoid the silly situation of a VDU monitor lying on its back, a 45 degree viewing angle can be obtained with the VDU in its 'normal' position but with the view standing 45 degrees 'above' the screen. This is more convenient for viewing — the images are plotted 'down the screen' — GA and RA are near the bottom, but the pyramid 'sticks out' towards the keyboard (not so useful for teaching). Talking about teaching use — here is a snag! The effect can only be seen well by one or two people at a time. There appears to be considerable latitude in both viewing distance and angle of view before the effect disappears altogether but at non optimal positions the pyramid is 'distorted'.

## Depth illusions

A program has been experimented with, whereby a framework cube is made to appear suspended in the space between the viewer and the screen (see Fig 5).

With appropriate image placing on the screen, the cube can be made to appear, say, halfway between the viewer and the screen. Using the same type of geometry as before the projections of the cube corners onto the screen from each eye can be calculated and then plotted. The effect works but it is (or appears) more difficult to 'conjure up' as it needs the eyes to be focused on empty space at the halfway point where there is nothing there to start with. The main source of light — the screen — acts as a distractor. If the image is on or near the screen everything appears to work much better.

This program has, as input variables,

|                  |  |
|------------------|--|
| Lines 40 and 50  | fix the pyramid height and base in centimetres.  |
| Line 60          | sets a variable to half the base length. The 55 converts from centimetres to screen units.   |
| Line 100         | selects the appropriate graphics mode (four colours)   |
| Lines 110 to 116 | sets the colours to red and green, with a white background for the graphics.   |
| Line 130         | clears the graphics area to its white background.  |
| Line 140         | calculates the length of GA to 0 (Fig 1) in cms. The 40.11 is the length of OT (one could almost use 40 cms).  |
| Line 150         | calculates the displacement left of the centre line for the point GA in screen units this time.  |
| Line 160         | calculates a similar displacement up the screen.   |
| Line 410         | chooses colour green.  |
| Lines 420 to 510 | draws the green image.   |
| Line 655         | since the green and red images are symmetrical this sets the displacement right of the centre line for RA. (DU is the same as before.)   |
| Line 660         | The clever one! This chooses red to plot unless the colour already there is green in which case it draws black. This will make the red/green overlap areas the correct colour. |
| Lines 670 to 760 | plots the red image.   |
| Line 998         | waits for any key before restarting.   |

Program explanation — see fig 4.

the distance of the desired cube from the eyes, its size, and its angle to the horizontal.

## Images behind the screen

The principle here is the same as in a) but beware — the relative placings of the red and green images are reversed left for right.

Fig 6 should make this clear and illustrates how a frame cube could be made to appear *inside* the VDU tube. Beware of this red/green reversal effect if you have an object which you wish to intersect the screen. The same difficulties about distraction during focusing apply as in a) — the light from the screen has to be ignored as far as possible.

## Selection and rotation of objects

For trial purposes select simple objects. Each corner on an object has to have a projection calculated onto the image plane, and the fewer there are the better. Leave a scale model of the Starship Enterprise till later!

Rotation has been tried with the cube revolving in space between viewer and screen but Basic is too slow to get a nice effect — machine code must be used here.

## Practical points

The matching of the filter material bandpass to the intensity/depth of the colour red or green is important. Through even the best red filter some vestige of the red line will be visible on the screen. Reducing overall screen brightness seems to help here. The relative 'blackness' of each colour when viewed through its opposite colour filter should be the same. If one is black and

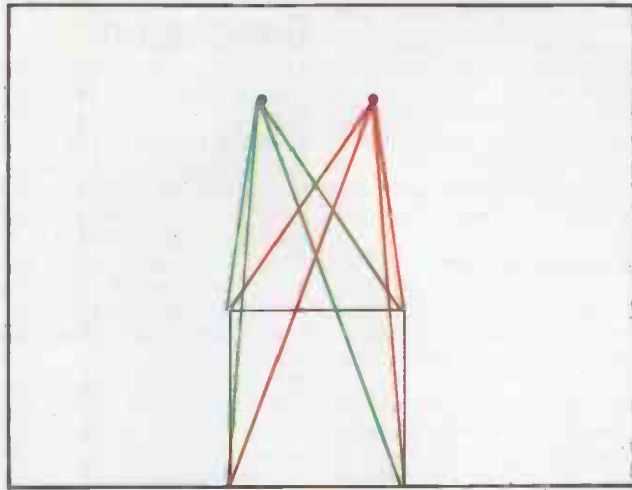

Fig 2. Final images as they appear on the screen or page.

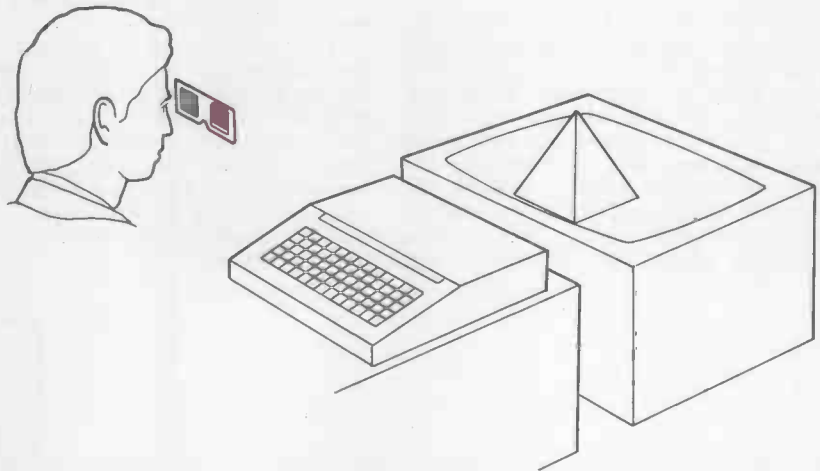

Fig 3. Viewing situation for the example program (put feet on the back of your VDU!!).

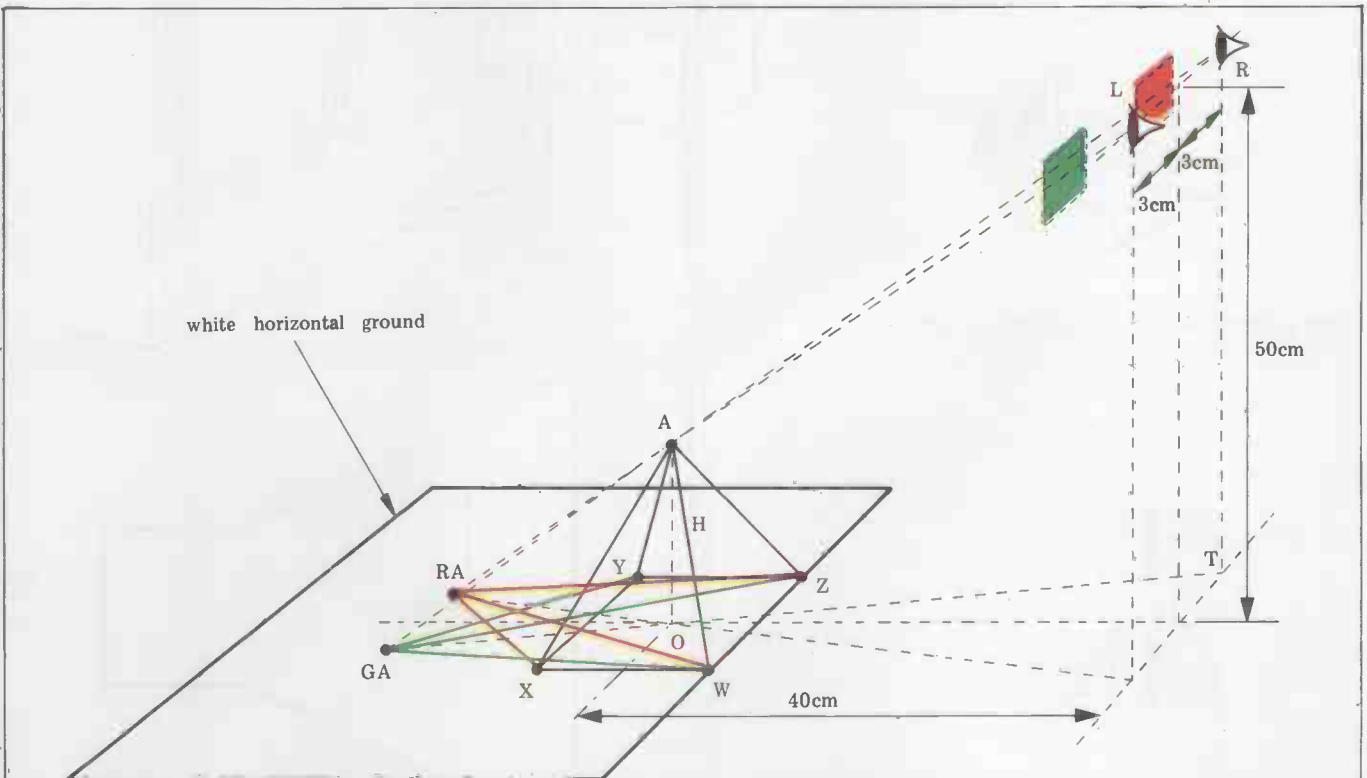

Fig 1. Basic geometry to produce red and green images on a horizontal page or VDU screen.

# STEREO GRAPHICS!

the other a shade of grey the brain will not properly 'pull' the stereo image into the middle and one of the red or green images will dominate.

This is where a facility like the RML 380Z's to 'mix' ones own 'shade' of red or green is very valuable. One then accepts whatever filters one can get hold of and fiddles with the colour mix. This is more elegant.

Wire frame models have been used so far as they do not involve the 'hidden line algorithm'. We now have a need for a hidden line algorithm in three dimensions before real objects can be shown. Who will try?

Although rotation of whole objects is slow it is possible to make a shape 'grow' an extension or 'arm' from a fixed base, and on my first example of the vertical pyramid I have had a small 'character' climb one of the sides 'out' of the screen — hurrah for the BBC's (and the 380Z's) programmable characters!

The ideal to aim for is to have a program which will ask for the coordinates of all corners of an object (or read them from disk if they have been pre-recorded) and a statement about how they are to be joined up and scaled along differing axes if necessary. The program should then request the required position of the object and the viewer and then procede to plot it on the image plane. This is still some way

off as a general package for a wide class of objects.

## Conclusion

The impact of seeing one's first stereo 'object' emerging from the screen is immense. I do encourage you to try. To whet the appetite, how about the following developments for the future?

Computerised chess with graphics-generated 3-D pieces (remember the horizontal screen/board in Fig 1).

'Star Trek' and similar games chasing Klingons 'through' the screen into the distance instead of across it.

'Adventure' type games in genuine 3-D mazes.

Maybe with machine code in a dedicated ROM these are not too far off!

On a more prosaic level, and with more educational content, how about: 'Contour' maps in geography.

Three-dimensional graphs in any setting. Technical drawing projection work — make third angle projection drawings 'come to life'.

Three-dimensional geometry and trigonometry teaching.

This list is probably only scratching the surface but to deflate enthusiasm for the technique a little there is still a need for a convenient or quick way of projecting curved objects onto the screen. Circles are okay, but other curves are more difficult — or are they?

I would like to hear from readers who successfully try these techniques or extend them.,

```

10 REM 3-D PYRAMID P.W. STEVENSON
40 INPUT "PYRAMID HEIGHT (CM)" H
50 INPUT "LENGTH OF BASE (CM)" B
60 D = B*55/2
100 MODE 5
110 VDU 19,2,3,0,0,0
112 VDU 19,131,0,0,0,0
114 VDU 19,128,7,0,0,0
116 VDU 19,130,2,0,0,0
130 CLG
140 X = H * 40.11/(50 - H)
150 DL = 3 * X * 55/40.11
160 DU = 40 * X * 55/40.11
400 REM GREEN IMAGE TO RIGHT EYE
410 GCOL 0,2
420 MOVE 640 - D,0
430 DRAW 640 - D,2 * D
440 DRAW 640 + D,2 * D
450 DRAW 640 + D,0
460 DRAW 640 - D,0
470 DRAW 640 - DL, D + DU
480 DRAW 640 - D,2 * D
490 MOVE 640 + D,0
500 DRAW 640 - DL, D + DU
510 DRAW 640 + D,2 * D
650 REM RED IMAGE TO LEFT EYE
655 DR = DL
660 GCOL 1,1
670 MOVE 640 - D,0
680 DRAW 640 - D,2 * D
690 DRAW 640 + D,2 * D
700 DRAW 640 + D,0
710 DRAW 640 - D,0
720 DRAW 640 + DR, D + DU
730 DRAW 640 - D,2 * D
740 MOVE 640 + D,0
750 DRAW 640 + DR, D + DU
760 DRAW 640 + D,2 * D
998 INPUT T$
999 GOTO 40
    
```

Fig 4.

Reference:- *Descriptive Geometry with 3-D Figures* Imre Pal, Hungarian Technical Publishers 1965. **END**

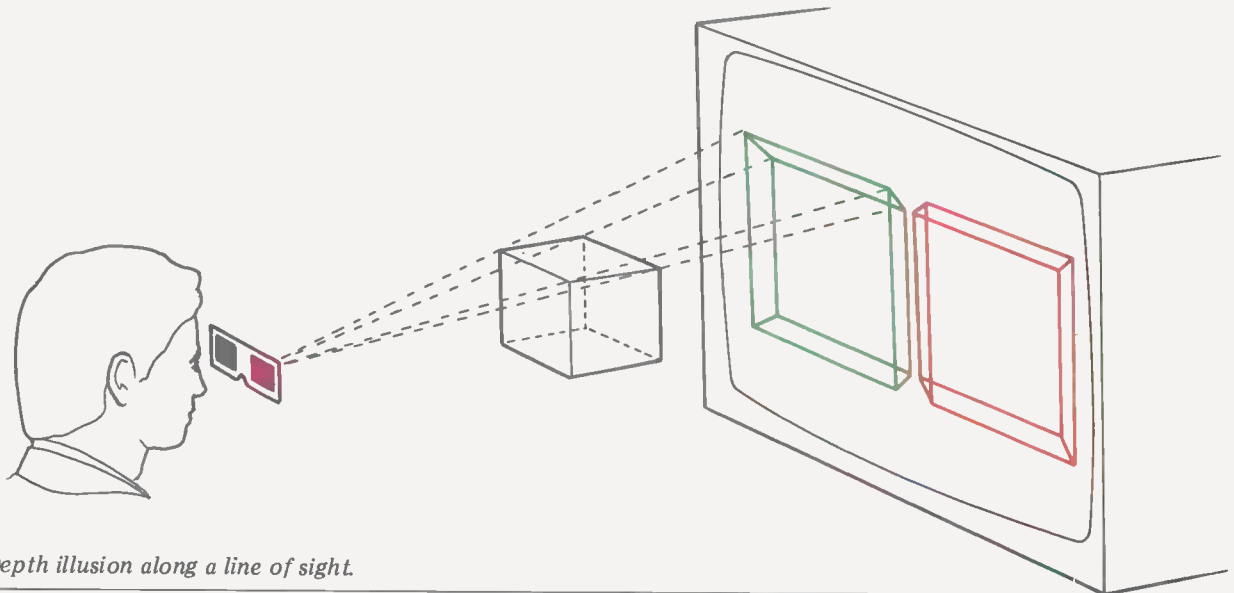

Fig 5. Depth illusion along a line of sight.

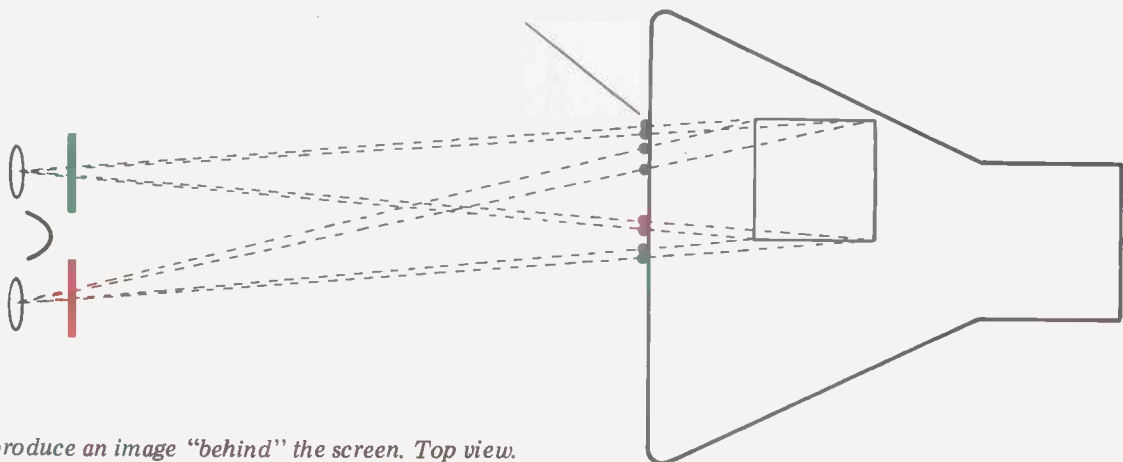

Fig 6. To produce an image "behind" the screen. Top view.

# MAKING A HASH OF IT

Paul Overaa describes hashing, a fast file access method

In many applications it is necessary for sets of data items to be searched in order to rapidly locate an item or items of a specified value. Various approaches exist, including keeping indexes to locate the desired items, but this may require maintaining indexes of the key fields in sorted order so that techniques such as binary searching may be used. Although for some applications this is the best approach there are in many cases alternative solutions. One such alternative is known as 'key to address transformation' or 'hashing' and when used with care (ie, for suitable applications) it is possible to locate records in a fraction of the time that other methods will take.

In a general sense the problem is as follows: you wish to store data in such a way that given particular key fields you could retrieve other data items associated with the keys. As a concrete example, suppose you have a customer file containing records with the following fields or attributes:

CUSTOMER NAME  
CUSTOMER ADDRESS  
INVOICE ADDRESS  
CREDIT STATUS  
CURRENT CREDIT  
DISCOUNT LEVEL

Given the customer name, you would wish to access the particular customer record in order to obtain the remaining details in the customer file. Let us suppose that it would be possible to find some 'rule' or 'function' that would turn the characters of each customer's name into a number each of which was unique and in the range of record numbers you had allotted for your customer file. The existence of such a rule or function would mean that given any customer name you would be able to compute the record number using only the rule. It would therefore be possible to store your records in locations that could subsequently be retrieved without any search at all simply by computing the location of the record from the customer name.

It is fairly obvious that in general no such rules exist, but if we relax the condition that our rules must produce unique numbers and instead be content with a situation where occasionally different keys will produce the same number then we are into the realm of hashing techniques or, as it is often called, key to address transformation techniques. When different keys result in the same hash value being computed then there is going to be a distinct probability that we will attempt to access a record that is not the one we require. Such occurrences are termed 'collisions' and a discussion of how

these are handled is important to the ideas that follow. If the hash function results in a collision then it is necessary to compute a 'second try' and maybe even further tries until the record we require is identified. In the worst possible case all records in the file would be examined before the correct record was located. Such occurrences are extremely unlikely but... because it is possible at all it is necessary to make the following stipulation: any hashing rule used (and we now must include a method for calculating further locations to try in the event of collisions) must in the worst possible case be able to access every possible location available in the file. The frequency of collisions is related to the number of 'used' records in the file. It is a common practice to allocate some 20% more file space than an application requires since this helps to ensure that collisions are kept to an acceptable level.

Addition of data records would use the same rules and would search for the first location that was empty — ie, if the hash function located a record that contained data, then a second try, etc, would be made until an empty record was located. The new data would then be stored at this position in the file.

## Circular files

The concept of a circular file is crucial to the approach I shall use to develop my ideas. I want you to imagine that the computer file is wrapped around a circle with the records of the file spread evenly around the circumference and that possible record numbers range from zero to (N-1).

Those that have studied any modern mathematics will appreciate the connection of my approach with the concept of 'clock arithmetic' — ie, arithmetic modulo N where N is the number of records in our 'Circular File'.

Our problems are as follows:

1. We require a rule that enables a record number to be calculated and a further rule that enables additional 'tries' to be calculated.
2. The rules must in the worst possible cases be able to search the whole of our circular file.
3. The rules must attempt, as far as possible, to distribute the data we store evenly around our circular file otherwise there will be increased chances of collisions which will increase the time required to access a required record.

The most serious immediate problem is 2 — ie, how can we be sure that our circular file will be searched completely

by any rule we could use? We could examine critically every rule that we invent and this approach has been used many times (it frequently results in some quite frightening mathematics) or we can make certain restrictions that will enable us to prove that in the worst cases we are in fact able to search the complete file.

The restrictions that I make are as follows:

1. Our hashing rules must produce two numbers, the first of which lies between zero and (N-1) and the second between 1 and (N-1) where N is the number of record positions in the circular file we are using.

2. The first number is used as the initial attempt value and the second number is used to 'step round' the file using a fixed step-length.

3. The size of the circular file is such that it contains N record positions where N is a prime number, ie, contains no factors other than unity or N itself.

The stipulation of N having to be a prime number enables us to state that any non-zero step length that is less than N will result in every location of the file being examined in the worst possible case. The proof of this is fairly straightforward and has an important corollary... namely that if you do not use a prime number sized file and the 'step-length' calculated has a common factor with your file size N then it will be impossible to search the file completely. To appreciate this image stepping around a file of twelve records using steps of 2,3,4,5,8,9 or 10 all of which have common factors with 12 and all of which will fail to search all of the 12 possible records.

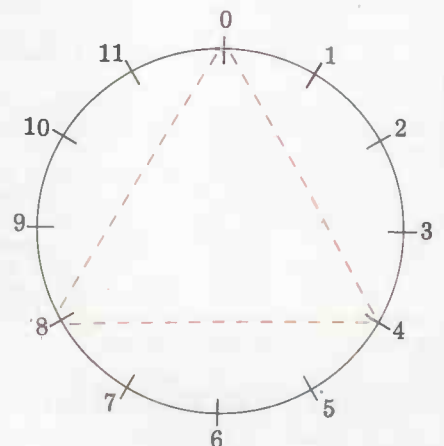

Note: A step length of 4 results in only three records being examined irrespective of how many times we step around the circular file.

# MAKING A HASH OF IT

The calculation of a non zero step-length less than N provides a solution also to the problem of uneven distribution within the file since even if the initial record number produces a collision with another record it would be necessary for the keys to produce identical step lengths as well as before the same path would be followed for more than the first attempt.

At this time a rather important point to be made is that most computer systems do not allow zero as a valid record number. The solution in practice is simply to ensure that computed values are incremented by one, thus avoiding zero values.

Numeric Keys. . . here the problem is relatively straightforward. Suitable functions will depend on the range of values the keys will cover. A single example should indicate a typical method of solution.

The keys are stock numbers ranging from 00100 to 45200. There are approximately 600 different stock items and the wider range of stock numbers is the result of the numbers including check digits, storage area codes and spaces for further stock items.

In this case we could use a file size of say N = 997 and would define variables as follows:

$Q = \text{INT}(\text{STOCK NUMBER}/N)$

$\text{ENTRY POINT} = \text{INT}(\text{STOCK NUMBER} - (N*Q)) + 1$

$\text{STEP LENGTH} = Q \text{ MOD}(N-1) + 1$

Note that our definition of entry point ensures that we will obtain a number between 1 and N similarly the definition of step length ensures a number usually different to the entry point and it will be between 1 and (N-1). (The above type of formula is very common and is able to produce good results in many cases.)

Alphanumeric/alphabetic keys. . . the additional problem is to convert characters into a pure number form before using an approach as for numeric keys. Some methods that may be used are as follows:

1. Convert each character of the key into the ASCII code equivalent then add or multiply them together.
2. Convert to ASCII code as in 1 above but weight each character by a number inversely proportional to its frequency in the language before adding or multiplying.
3. Only convert the consonants in the key to their ASCII equivalents and produce a numeric key from these.

Some procedures will be found to be better than others but in general you may assume that if your key domain is reasonably evenly distributed then most of the procedures will result in a similarly evenly distributed codomain (this is the set of numbers that the hashing function will produce!).

## A typical application

Many simple applications are built around the three basic functions of addition of a record, deletion of a record and searching for a particular record. The example I have chosen was written to illustrate these functions in

```

2 REM -----
3 REM          BEGIN - BLOCK
4 REM -----
5 CLEAR
6 NX=113' IMPORTANT -----> User must set NX to a suitable PRIME NUMBER
10 DIM ADDRESS.LINE$(4),RECORD.LINE$(4),FIELD.NAME$(4),SELECTION$(4)
11 SELECTION$(0)="File full - cannot complete operations";SELECTION$(1)="Addition complete";
   SELECTION$(2)="Retrieval complete";SELECTION$(3)="Record deleted if key existed";
   SELECTION$(4)="All data erased - new file now available"
12 FIELD.NAME$(1)="Name";FIELD.NAME$(2)="First line of address"
13 FIELD.NAME$(3)="Second line of address";FIELD.NAME$(4)="Telephone number"
14 DEF FN CUR$(X,Y)=CHR$(126)+CHR$(17)+CHR$(X+96*INT((SGN(X-30)+1)/2))+CHR$(Y+96)
15 DEF FN CLEARFROM$(X)=CHR$(126)+CHR$(17)+CHR$(96)+CHR$(X+96)+CHR$(126)+CHR$(24)
20 GOSUB 5000'open files
22 REM -----
23 REM          OPTION - SELECTION - BLOCK
24 REM -----
25 WHILE X<5
30 PRINT FN CLEARFROM$(0)
40 PRINT FN CUR$(0,0);"1: Add"
50 PRINT FN CUR$(9,0);"2: Search"
60 PRINT FN CUR$(24,0);"3: Delete"
70 PRINT FN CUR$(38,0);"4: Clear"
75 PRINT FN CUR$(48,0);"5: End"
80 PRINT FN CUR$(60,0);"Which option ";INPUT X
85 ATTEMPTSX=0
90 ON X GOSUB 1000,2000,3000,6000,150
92 PRINT FN CUR$(10,20);"Number of hash attempts required ";ATTEMPTSX
95 PRINT FN CUR$(10,22);SELECTION$(X);" Press RETURN to continue";X$=INPUT$(1)
100 WEND
130 REM -----
140 REM          END - BLOCK
145 REM -----
150 END' -----> This is the logical end of the program
970 REM -----
980 REM          ADDITION - OF - DATA - SUBROUTINE
990 REM -----
1000 PRINT FN CLEARFROM$(0);
1005 GOSUB 4500'input routine
1010 GOSUB 4000'compute initial hash values
1020 WHILE RECORD.LINE$(1)<>STRING$(20,32) AND RECORD.LINE$(1)<>STRING$(20,ASC("*")) AND ATTEMPTSX<NX
1030 GOSUB 4200'compute rehashes until empty record is found
1040 WEND
1050 IF RECORD.LINE$(1)=STRING$(20,32) OR RECORD.LINE$(1)=STRING$(20,ASC("*")) THEN GOSUB 4900
   ELSE X%=0'store data if there is space otherwise prepare to give file full message
1060 RETURN
1970 REM -----
1980 REM          RETRIEVE - DATA - SUBROUTINE
1990 REM -----
2000 PRINT FN CLEARFROM$(0)
2010 GOSUB 4600'input search key subroutine
2015 GOSUB 4000'compute initial hash values
2020 WHILE RECORD.LINE$(1)<>ADDRESS.LINE$(1) AND RECORD.LINE$(1)<>STRING$(20,32) AND ATTEMPTSX<NX
2030 GOSUB 4200'compute rehashes until correct record is found
2040 WEND
2050 IF ADDRESS.LINE$(1)=RECORD.LINE$(1) THEN GOSUB 4800
   ELSE PRINT FN CUR$(10,18);"This record does not exist - request has been ignored"
2060 RETURN
2970 REM -----

```

use is an 'address book' program. The idea being that you create records consisting of a name, two lines of address and a telephone number. The program enables you to locate these details using the name field only. The example is somewhat contrived but it does illustrate the basic ideas involved. Written in Microsoft's Basic 80 using a Rair Black Box/Hazeltine terminal system the program has the following layout:

A 'Begin Block' performs the setting up of variables and opening of a file. Variable N% defines the size of the file and can be altered to suit requirements. Two user defined functions are used: CLEARFROM\$(X) is used to clear the Hazeltine screen from line X downwards. CUR\$(X,Y) is used to position the cursor of the Hazeltine terminal. The cursor co-ordinates are supplied as column X (which may be between 0 and 79) and line Y (which may be between 0 and 23).

An 'Option Select' block enables the

user to add, delete or retrieve data and to initialise the file by writing blank records. This block operates by selecting a subroutine based on the value of the option number selected. Files should be initialised before use since the program identifies unused records as those whose fields contain strings of blank characters.

Two subroutines called 'compute hash values' and 'compute rehash' respectively are used to perform the hashing functions. The name (the key field in this example) is converted to a numeric value which is the sum of the ASCII values of all the characters present. This field is brought to 20 characters in length so that proper comparison may be made with the name field retrieved from the random access file which will be 20 characters in length as defined in the FIELD statement (line 5010). The rehash subroutine increments the last record number calculated by the step length and line 4200 guarantees that we step around our



```

2980 REM      DELETE - DATA - SUBROUTINE
2990 REM -----
3000 GOSUB 2000 'we use the retrieve data option block to locate the record !!
3020 IF ADDRESS.LINE$(1)=RECORD.LINE$(1) THEN ADDRESS.LINE$(1)=STRING$(20,ASC("*")):
      GOSUB 4900 'replace record with asterisks to indicate deletion if record exists
3040 RETURN
3970 REM -----
3980 REM      COMPUTE - HASH - VALUES - SUBROUTINE
3990 REM -----
4090 SUMZ=0:FOR IZ=1 TO 20:SUMZ=SUMZ+ASC(MID$(ADDRESS.LINE$(1),IZ,1)):NEXT IZ
4010 OZ=INT(SUMZ/NZ)
4020 ENTRY.POINTZ=INT(SUMZ-NZ*OZ)+1
4030 STEP.LENGTHZ=OZ MOD(NZ-1)+1
4040 RECORDZ=ENTRY.POINTZ
4045 GET #1,RECORDZ
4047 ATTEMPTSZ=1
4050 RETURN
4090 REM -----
4180 REM      COMPUTE - REHASH - SUBROUTINE
4190 REM -----
4200 RECORDZ=(RECORDZ+STEP.LENGTHZ-1)MOD(NZ)+1 'must keep within file number range !!
4210 GET #1,RECORDZ
4215 ATTEMPTSZ=ATTEMPTSZ+1
4220 RETURN
4480 REM -----
4490 REM      INPUT - SUBROUTINE - A
4495 REM -----
4500 FOR IZ=1 TO 4:PRINT FN CUR$(10,6+2*IZ):FIELD.NAME$(IZ):FN CUR$(40,6+2*IZ):" "":
      ADDRESS.LINE$(IZ)="" :LINE INPUT ADDRESS.LINE$(IZ):PRINT:NEXT IZ
4510 ADDRESS.LINE$(1)=ADDRESS.LINE$(1)+STRING$(20-LEN(ADDRESS.LINE$(1)),32)
4520 RETURN
4550 REM -----
4580 REM      INPUT - SUBROUTINE - B
4590 REM -----
4600 PRINT FN CUR$(10,8):FIELD.NAME$(1):FN CUR$(40,8):" "":ADDRESS.LINE$(1)="" :LINE INPUT ADDRESS.LINE$(1)
4605 ADDRESS.LINE$(1)=ADDRESS.LINE$(1)+STRING$(20-LEN(ADDRESS.LINE$(1)),32)
4610 RETURN
4770 REM -----
4780 REM      DISPLAY - RECORD - DETAILS - SUBROUTINE
4790 REM -----
4800 REM -----
4810 FOR IZ=2 TO 4:PRINT FN CUR$(10,6+2*IZ):FIELD.NAME$(IZ):FN CUR$(40,6+2*IZ)" "":RECORD.LINE$(IZ):NEXT IZ
4820 RETURN
4870 REM -----
4880 REM      STORE - DATA - SUBROUTINE
4890 REM -----
4900 FOR IZ=1 TO 4:LSET RECORD.LINE$(IZ)=ADDRESS.LINE$(IZ):NEXT IZ:PUT #1,RECORDZ:RETURN
4970 REM -----
4980 REM      OPEN - FILES - SUBROUTINE
4990 REM -----
5000 OPEN "R",1,"MASTER"
5010 FIELD #1,20 AS RECORD.LINE$(1),30 AS RECORD.LINE$(2),30 AS RECORD.LINE$(3),18 AS RECORD.LINE$(4)
5020 RETURN
5030 REM -----
5980 REM      CLEAR - FILE - SUBROUTINE
5990 REM -----
6000 FOR IZ=1 TO 4:LSET RECORD.LINE$(IZ)="" :NEXT IZ
6010 FOR IZ=1 TO NZ:PUT #1,IZ:NEXT IZ
6020 RETURN
6030 REM -----

```

'circular file' in uniform steps. The variable ATTEMPTS% keeps track of the number of attempts that have to be made to locate the record and also serves to indicate when the file is full. When the file is full (ie, when the number of attempts equals the file size) the selection variable X% is set to zero to cause a file full message to be printed.

'Addition of data' is accomplished by collecting data with an input subroutine, computing the initial hash values for variables ENTRY.POINT% and STEP.LENGTH% and then stepping around the file using a WHILE/WEND loop until an empty record is found. Option 4 must be used initially to set up the data file by writing blank records. Once an empty record is found (or once all records have been looked at without finding any empty record) the loop is left and if there is available space the new data is stored.

'Retrieval' is performed by collecting the name to be searched for with

the second input routine, computing the initial hash values as before and then performing a 'step-around' search using a WHILE/WEND loop as before. In this case the exit condition is based on three points:

First we may find a key match, ie, we have located required record. Secondly we may reach an empty record, in which case we will have searched all positions where the required record would have been placed. Thirdly we may have looked at all records in the file.

If the record has been located it is displayed by calling a 'Display Record Details' subroutine 4800 otherwise a 'does not exist' message is printed.

'Deletion' is accomplished by setting the name field of the record to a string of asterisks. The effect is to flag the particular record as deleted. Deletion is one of the areas that can provide difficulties since it is not normally appropriate to simply remove the details from the key field. If this were

done then the deleted record would appear to be the 'end of the chain' as it were and the hashing search when reaching such a record would not look any further. This would cause improper searching and so a common solution is to set the key field to some arrangement of characters that can identify the record as being deleted rather than empty. The addition of data routine recognises deleted records by the fact that the key field, ie, the name field, has been set to a string of asterisks.

The remainder of the subroutines used are titled according to their function - eg, 'Open Files', 'Store Data' - and since each one has only two or three lines they should be self-explanatory. You will notice that I keep the individual parts of the program isolated by REM statements which include titles. This helps to split the program up into small units that are more easily understood. I tend also to treat these blocks as subroutines which are called as and when desired. This facilitates alterations, etc, and creates a more readable program. As an example, suppose you wish to change the way the initial hash values are calculated. The subroutine is identified easily by its title 'Compute hash values' and since it has only a few lines of code (which you will note could be written considerably more concisely than I have done for this example) it would only take a short time to understand what the subroutine is doing.

With properly designed screen layouts and the addition of input validation subroutines the program can be used for applications such as a 'computer diary', an 'attribute file', etc, but as a parting thought you may like to consider the following possibility:

An estate agents 'House for sale' file consists of houses that are classified by:

1. Cost Range eg, 10,000-14,999 : 15,000-19,999, etc.
2. Number of bedrooms.

3. Location with geographical areas being coded, say, using the postal code.

If a file was set up that used hash techniques to locate items based on a key produced from the three attributes mentioned and if, instead of storing the data in this file, you regard it as a directory with the file containing pointers to the heads of chains of 'linked' records then we produce what is termed a hashed access multilist directory.

All properties with the same 'attributes' are stored in chained form - ie, each record contains the record number of the next record in the chain. A search for 'all available property in area SS41TD with four bedrooms and in the price range 45,000-49,999' can become virtually instantaneous. The three attributes produce a key that is hashed to rapidly find the 'head' of the chain records with these attributes and then all available property satisfying the criteria given can be retrieved with no further searching required at all.

It is difficult to do justice to any technique in an introductory article of this nature. I have illustrated the approach that I have developed but obviously there are an enormous number of other approaches. Once the basic ideas are understood the transition to more sophisticated applications becomes easier. In the end we are limited only by our own ingenuity.

END

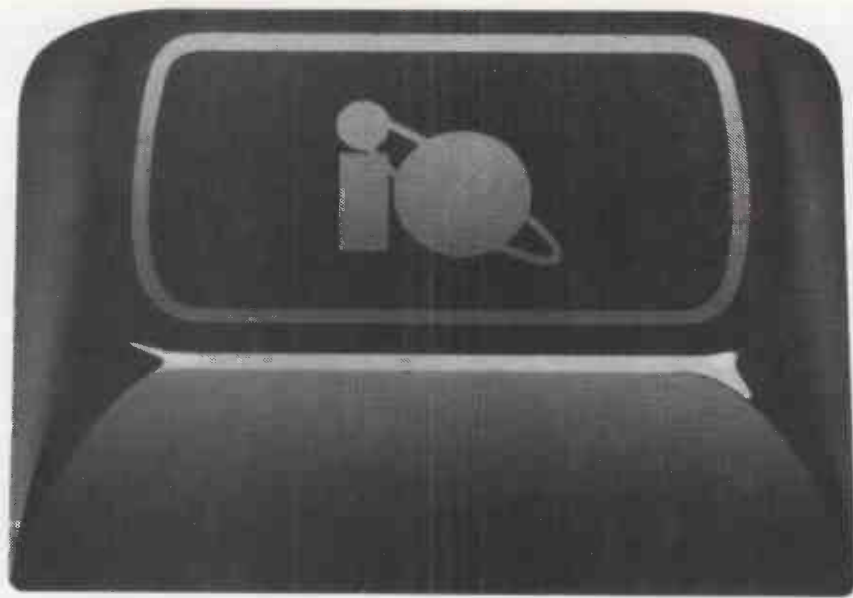

**EVERY  
COMPUTER  
SHOULD  
HAVE  
ONE.**

There are several personal computers big enough to use disk drives.

Only one is easy to start.

If you want to boot RAM on the iotec 'iona' (meaning get the computer ready to accept a program or your business files for the day) all you do is push this button and wait three milliseconds.

Sensible, isn't it?

But one of our major competitor's manuals, which we read when we need a laugh, takes a page and a half explaining how to achieve exactly the same thing.

With a special section on what to do when things go wrong.

The unique 'io' key is just one of the features that make the iona easy to use.

It's also the only personal computer in its class that can be upgraded to 960K of RAM.

It's the only one that gives you colour as standard for under £900.

And, with its professionally-styled black aluminium case, we think it's the only one that looks, feels or works like a serious piece of equipment.

If you think all this is too good to be true, send us your name and address (you'll find ours at the foot of this page).

We'll be proud to send you the details.

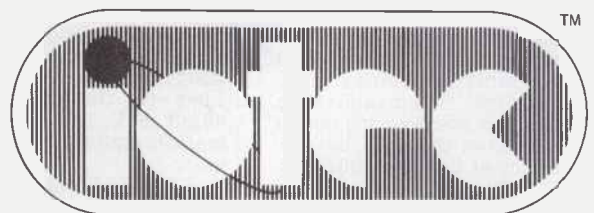

**COMPUTER SYSTEMS**



PCW welcomes correspondence from its readers but we must warn that it tends to be one way! Please be as brief as possible and add 'not for publication' if your letter is to be kept private. Please note that we are unable to give advice about the purchase of computers or other hardware/software — these questions must be addressed to Sheridan Williams (see 'Computer Answers' page). Address letters to: 'Communications', Personal Computer World, 62 Oxford Street, London W1A 2HG

## Beeb characters

I read with interest the article by M Howlett in the July issue on a Character Generator for the BBC Computer, and would like to make some comments. A number of aspects lead me to suspect that the program may have been converted from another micro as some of the more useful features of the BBC machine have not been exploited.

The choice of the non-graphics Mode 6 seems rather strange since a proper 8x8 grid cannot then be drawn. Further, two colours only are available, despite references in the program to COLOUR 0, COLOUR 3 and COLOUR 5. To draw and fill a grid, at least three colours are desirable. The use of a graphics mode, selected by the user, would seem preferable, and this has the added advantage of drawing the character as it looks in that mode — ie, double width in modes 2 or 5, but only half-width in mode 0.

A more important point, since it has a variety of applications, is to note that it is possible to use the cursor control keys in program mode. Typing \*FX 4 1 at the beginning of the program enables the keys (\*FX 4 0 converts the keys back to their usual editing functions). The keys then generate ASCII codes 136 to 139, and GET or INKEY can be used to detect if they have been pressed. These keys, together with DELETE (code 127) and COPY (code 135), give a rather simpler and more natural way of moving around the grid and filling or deleting squares.

It may be of interest to show how to reverse the logic of the program and draw large characters when given the eight bytes required by the VDU 23 command. The memory map given in the user guide shows that the characters 224-255 are stored in memory locations starting at &0C00. This means that the special character with code C is stored in the eight bytes starting at location &0C00 + (C-224)\*8.

A search of the current operating system on my machine (Eprom 0.10, Model B) shows that the VDU codes for keyboard characters are equally accessible. Characters 32 onwards are stored at the

beginning, ie, from &C000. Thus the character with ASCII code C is stored at &C000 + (C-32)\*8. The following program segment uses the VDU codes to draw large characters, and could form the basis of a 'Bigprint' routine. The same variables are used as are given in the article; a free-standing program would need to declare arrays, etc.

```
1000 MODE 4: NUM=1
1010 INPUT "TYPE 1 FOR
A KEYBOARD CHAR-
ACTER OR 2 FOR A
PREVIOUSLY SAVED
SPECIAL CHARAC-
TER "N
1020 IF N=2 THEN INPUT
"CODE" C ELSE IF
N=1 THEN INPUT
"CHARACTER", C$
:C=ASC(C$) ELSE
END
1030 IF C 223 AND C 256
THEN STORE=&0C00
+(C-224)*8-1
ELSE IF C 31 AND
C 127 THEN STORE=
&C000+(C-32)*8-1
ELSE END
1040 FOR A=1 TO 8
1050 C1(NUM,A)=?(STORE
+A)
1060 W=128
1070 FOR B=1 TO 8
1080 IF C1(NUM,A) AND W
THEN PRINT CHR$(
224); ELSE PRINT
" "
1090 W=W/2
1100 NEXT B
1110 PRINT
1120 NEXT A
```

The ? at line 1050 is the BBC Basic for PEEKing the memory location, and the logical AND at line 1080 is used to decide if the particular bit in the byte is 0 or 1.  
P Whitworth, Lewes

See also 'Beeb Character Generator' in this issue's TJ's Workshop — Ed.

## Back-patting dept.

I'd like to thank you for a superbly useful article on the BBC Computer in July's PCW. I bet even the BBC and Acorn won't make this sort of information available to the general user.

I did find one small fault in that the directory address for the first FN is at &04F8,9 and the PROCs at &04F6,7 — not the other way round.

There are far too few articles of this type in the consumer magazines these days

and thumbing through issues of PCW for '78 and '79 the other day I noted the pioneering interest that was created. Keep up the good work.  
Colin Chatfield, Camborne

## One-liner

Here is another of those one-liners for a Tandy or Video Genie: this one is for Bio-rhythm and sine wave freaks!  
0 X=X+.25: FOR Y=1 TO 6: POKE SIN(X/Y)\*32+16288, Y+48: NEXT: PRINT: GOTO

Points to mention are that GOTO without a line number goes to line zero, and that memory location 16288 is the middle of the bottom line of the screen.

B E Newsam, Sheffield

## Out of the frying pan...

With considerable assistance from the Advertising Standards Authority I finally managed to get delivery of a Sinclair Spectrum in a time approximating to the 'up to 28 days for delivery' of the Sinclair ads.

It was faulty. Tuning to a TV (I tried three Sonys) was very critical and colour was lost, at first intermittently then completely, after about ½ - 1 hour's use.

I would have taken a chance and exchanged it for another, but the two weeks quoted for this (in which I have little faith), together with the attitude of the Sinclair staff at Camberley and Cambridge (particularly the 'Customer Relations' manager at Cambridge) have persuaded me to ask for a refund and buy a BBC Computer.

I feel that back-up and customer relations are important, especially when related to complex devices. Perhaps the BBC was wise in not going to Sinclair.  
A Deacock, London W1

Several thousand would-be BBC owners might dispute your last statement, Mr Deacock — Ed.

## Spectrum of woes

After waiting eight weeks to receive a 16k ZX Spectrum I found that when the colour was used the characters

shimmered, making them difficult to read. I phoned Sinclair and they told me to return the computer: this I did.

Two weeks later I had heard nothing, so I phoned to make enquiries. I was asked by the telephone operator at Sinclair if I had received a card from them — to which I replied 'no'. She then told me that she could give me no information until I had received a card.

A few days later the card arrived, and so I phoned Sinclair, quoting the reference number on the card. I was told by the operator that although I had received the card and quoted the reference number she could not find out any information. She assured me that because I had the card my computer was soon to be dealt with, and I should phone back in a few more days; this I did.

My third call was to bear some fruit. After taking my name and reference number, the operator told me that my Spectrum was nearing the top of the pile and would soon be dealt with. I thanked her, breathed a sigh of relief and waited — two more weeks.

It was now five weeks since I had sent my Spectrum back and, feeling a little annoyed, I phoned Sinclair, gave my name and reference number to the operator and waited. I was told very politely that my computer was nearing the top of the pile. I told the operator, also politely, that this was unacceptable and asked to talk to the manager of the service department. I was then put on to someone who said she was the supervisor.

I explained my case to her, only to be told that my computer was working its way to the top of the pile. I then asked for an immediate replacement. She refused this request, saying that because of delays in despatching new machines, and of course the infamous design fault, she had been instructed by management that no immediate replacements would be possible. But she said that she might be able to rush things along in a few weeks.

I then asked to talk to the management who had given her these instructions. She said she had no access to them and, therefore, nor had I. I was forced to ask for a full refund, which she immediately agreed to.

I may now never take up the hobby of home computing because at the moment there is no comparable machine to the Spectrum in price and function. But if Clive Sinclair thinks he can use this fact to keep his customers happy and loyal to his company then he is sadly mistaken, and his company does not deserve to prosper.

As you may have gathered by now, I am not a very happy person. This sort of bad service does not only reflect on Sinclair, which doesn't seem to care anyway, but it also tends to reflect on British companies as a whole as opposed to Japanese companies who have always given me excellent after-sales service — ie, Vivitar UK and Pioneer UK. If this sort of experience is widespread it must also affect the sales of your magazine.

I have sent a copy of this letter to Mr Sinclair in the hope that it may help other customers and in turn Sinclair itself in the future.

Keith Allen, London SE17

*These are just two of many letters on this theme. Below we publish Clive Sinclair's reply. We also have a mountain of BBC Computer complaints which we can't print; it just gets too repetitious. . . Ed.*

## Uncle Clive replies

In response to the many queries which, I understand, PCW has received, I would like to personally explain the current delivery situation for our new ZX Spectrum personal computer.

The general public's response to our new computer has far exceeded our expectations and we have been swamped with orders. This and some small initial production delays have led in turn to considerable delays in delivery.

Regrettably, many of our customers may have to wait up to 12 weeks, from our receipt of their order, for delivery of their Spectrum and we are writing to them all to apologise for the inconvenience and to offer them the chance of an immediate refund.

For those customers who continue to wait, we shall be sending out with each Spectrum, in compensation for the delay, a £10 voucher which can be used in part-payment for a ZX printer or to buy a complete pack of five rolls of printer paper.

We are also providing customers with a new demonstration tape containing:

1. A complete 'keyboard trainer' to introduce the Spectrum.

2. Three major programs — an exciting game, Through the Wall; a drafting program, Draw; and Character Generator, which demonstrates user-defined graphics.

3. A series of illustrative programs — Bubble Sort, Evolution, Life, Monte Carlo, and Waves.

Finally, I would like to assure you and all our customers that the initial problems with the Spectrum have now been completely overcome. Production is running smoothly at 5000 units per week and will rise sharply over the coming months. We are confident that our present backlog will be cleared by the end of September and hope that you will see current delays in the context of our successful delivery of more than 500,000 computers in the last two years.

Clive Sinclair, Sinclair Research Ltd

## DeVALuation

Poring over the August issue of PCW I came across a letter in Communications which commented on the use of VAL for function evaluation. Upon reading the editorial comment, my eyebrows scuttled up over the back of my head. Can I really have owned my Texas 99/4 for two years and missed this use of VAL? I check and, no, I haven't missed a thing. The function of VAL which you ascribe to the Texas does not exist (unless you were thinking of the Equation Calculator, unique to the 99/4, and totally devoid of programmability), neither is it implemented in the new version 110 Extended Basic.

I have often felt the need for VAL on my TI to really represent the counterpart of STR\$, and I have written in the user group newsletter bemoaning this fact. As it appears that some people have bought computers believing them capable of functions of which they are not capable (myself included), in the interests of accuracy can I ask you to correct your misleading comment? It has been bad enough coping with the many inaccurate reviews of the Texas machines without having to explain to disappointed new owners that their latest purchase can't do the things that even some ads claimed they could.

I feel particularly strongly about this as I bought my 99/4 (£1000 in those days) in the mistaken belief that the PLOT and DRAW commands were available (based on an advertisement that claimed you could plot to 192 x 256 individually addressable screen points) and the irritation was compounded, and is still being compounded, by the lack of machine code programming — and buying the Extended Basic won't do you a ha'porth of good as the machine language subprograms function only when the 32k (and there's a story behind that one, too) £300 Expansion Memory is used. Even worse, there is a mini-memory and an assembler/editor module

available; the latter runs only with disks, and it is rumoured that a rewire of the 99/4 may be necessary in order to use either module.

Peter Brooks, Oxford

## Fuller praise

Outraged shouts about British companies are pretty commonplace — here's a nice story for a change!

In March I ordered a keyboard, case and power supply for my ZX81 from Fuller Microsystems of Liverpool. We are not blessed with the best surface mail in the world and so after it hadn't arrived in July I was getting a bit cross. I'll wait for the next boat, I thought, and it did come in August. However, the letter enclosed with it from Bob Rylands made it clear that my order had been mislaid and as mine was an unusual request they had then made up the order especially. They were all very sorry. I'll be dealing with them again! Expatriates often get a raw deal from companies in the UK. When I return I'll be hoping to set up an export agency dealing in systems and peripherals for expats. Fuller Microsystems would be the sort of supplier I would approach.

Needless to say, I'm not connected with them, etc, etc. Ned Abell, Ascension Island, South Atlantic Ocean

## (( Down (with (brackets)))

Many thanks for printing Michael Liardet's excellent article on Lisp. This looks like a really powerful language, quite easy to learn and a lot more fun than Pascal. The only unattractive feature for the micro enthusiast is the extent of the use of nested brackets. These are a hassle to use and a bore to check. But have you noticed? They are also entirely unnecessary! In fact, the notation used by Lisp (prefixed dyadic operators) was invented just to dispense with the need for nested punctuation.

Mr Liardet's first example of Lisp code can be written out, omitting the brackets, like this:

```
COND
OR
EQ
PLUS A B
2
LESSP
TIMES C D
5
SETQ
E
MINUS C D
```

Here indentation is used to show the structure of the conditional, eg, the arguments of 'COND' are 'OR' and 'SETQ'; those of 'OR' are 'EQ' and 'LESSP', etc. This too is dispensable from the compiler/interpreter's standpoint. The whole conditional could be written as a single line of code, and, if the reserved words were 'tokenised', this would slightly decrease execution time compared with the bracket-ridden version.

The ideal solution is: make brackets optional, on input and on listing. The usual restriction on variable names, that they should contain no spaces, is enough to avoid ambiguity.

John M Kerr, Glasgow

*This works fine for dyadic operators, but the brackets in Lisp are primarily intended to delimit lists. How do you show a list of lists of lists without them? — Ed.*

## Video doctor

First of all I want to congratulate you on producing a consistently excellent magazine. I am by no means an expert in microcomputing but it never fails to stimulate my interest and is educational without being taxing.

I am interested in adapting a video-disc system as a medical encyclopaedia for use in doctors' surgeries, and would be very grateful if any of your readers would be able to supply me with information about current developments in this field.

Walter Mrozinski, 28 Lower Park Road, Victoria Park, Manchester 14.



'Case number 3 — Inland Revenue versus Arnold Higginbottom's TRS-80 Accountancy program.'

**AVAILABLE NOW...**  
**COME AND SEE US AT**  
**THE PERSONAL COMPUTER WORLD SHOW,**  
**STAND No. 463**

# B+H

## M 170 Z

- direct plug-in for ZX81
- superb resolution
- green screen 7.5"
- built-in power supply
- accomodates ext. memory, printer and other accessories
- all metal construction

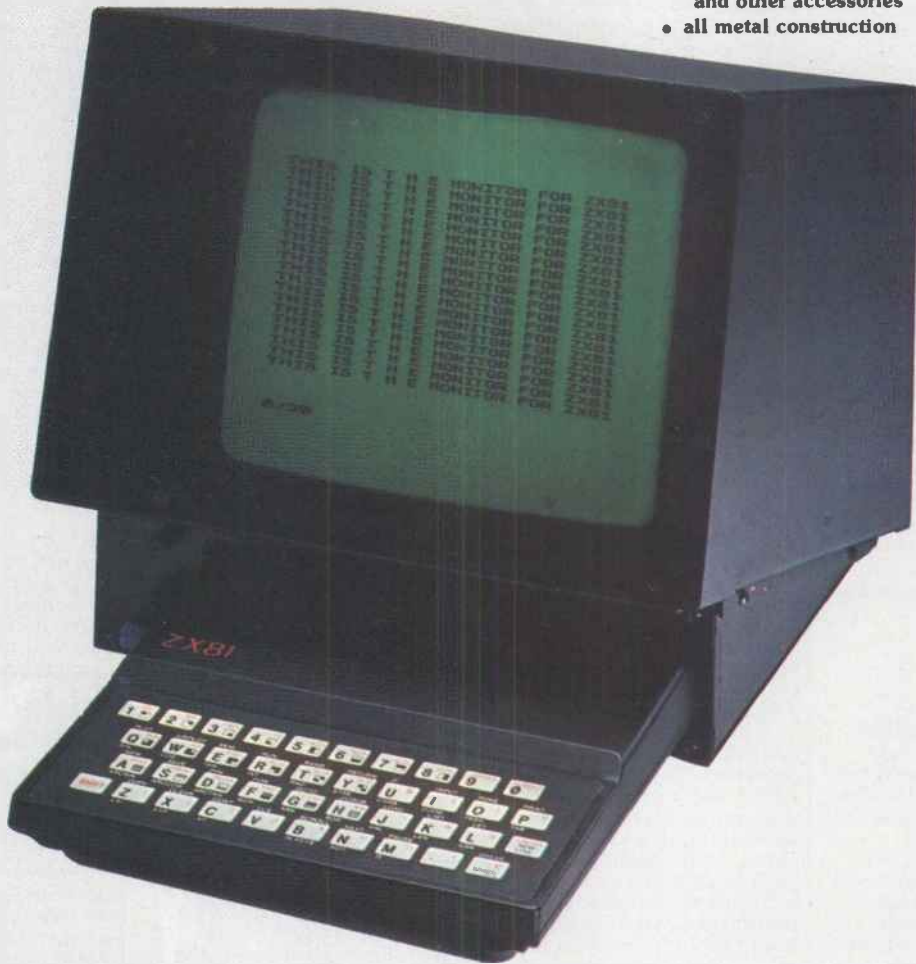

### **B+H Monitor Model 170Z.**

If you are tired of fuzzy pictures from your ZX81, fed up with a multitude of wires dangling around your computer — then try this one, the dedicated monitor for the ZX81.

### **What does it do?**

A lot in fact. Model 170Z lets you plug your unmodified ZX81 into a slot, onto a low-capacitance extension bus and a 3 amp power supply. The extension bus is accessible from the rear allowing all Sinclair and other peripherals to be connected as on the machine itself. The display is a 7½" P-31 CRT, specifically designed for this purpose, and it gives an

unbelievably crisp, clear and steady picture without any adjustments and knob-twiddling. The perspex screen in front of the tube has the same colour temperature as the phosphor enabling you to read characters in direct sunlight.

On the rear... you will find two in/out sockets and a load switch. Here you can connect other computers as signal source for external monitors and thus maintain your comfortable workstation while others can watch your work on a larger screen.

### **Quality**

The printed circuit boards are epoxy

fibreglass. The edge connector is hard gold plated (no more lost programs because of bad connections), the mains transformer is a high quality, double insulated toroid and the cabinet is rugged black anodized aluminium. B+H products are made from the best available industry standard components and you can therefore expect many years of troublefree service.

### **General specifications**

- 7½" green tube, P-31 phosport
- 90° deflection, max 2% geometry error
- resolution min. 1800 lines, 22 MHz
- input/output 75 ohms • CCIR/NAB standard
- 110–240VAC 30W
- Power out 9VDC 3A
- Shipping weight 4.5kg

**Private and trade enquiries welcome:**



**B+H Bergqvist & Hobberstad Eng. A/S, 20-21 Herluf Trolles Gade,  
DK-1052 Copenhagen K, Denmark.  
Phone int. 451 133 188, telex 16031 berhob dk.**

# Do you have a CP/M computer or Sharp PC3201 or MZ80A Wangwriter or Osborne maybe?



WE HAVE A FULL  
RANGE OF CP/M SOFT-  
WARE IN YOUR  
FORMAT LOTS OF  
LOW COST ACCES-  
SORIES TO BUILD  
YOURSELF OR  
PLUG-IN-AND-GO.  
CP/M CONVERSIONS  
FOR PC3201 & MZ80A  
ADD STORAGE WITH  
HIGH-DENSITY  
FLOPPY DRIVES OR  
WINCHESTER HARD  
DISKS.

DOUBLE DENSITY KITS FOR OSBORNE, ADD-ON TERMINALS  
LETTER QUALITY TYPEWRITER/PRINTER

HOT-LINE TECHNICAL SERVICE WITH YEARLY SUBSCRIPTION

MIXED QUANTITY DISCOUNT AVAILABLE TO DISTRIBUTORS



## SYSTEMS OF TOMORROW LTD.

109c HIGH ST, CHESHAM, BUCKS, HP5 1DE.

TEL. (0494) 786989 Tlx. 837854 SOFT G

# MEMOTECH Explores the Excellence of your ZX81

THIS MONTH -  
**2 NEW  
PAKS!**

**MEMOPAK  
CENTRONICS I/F**

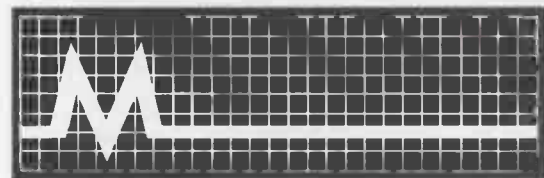

**MEMOPAK 16K**

**MEMOPAK 64K**

**MEMOPAK HRG**

**MEMOPAK 32K**

**MEMOPAK  
32K RAM**  
Operates in tandem  
with Sinclair 16K Ram  
to give a full 48K!

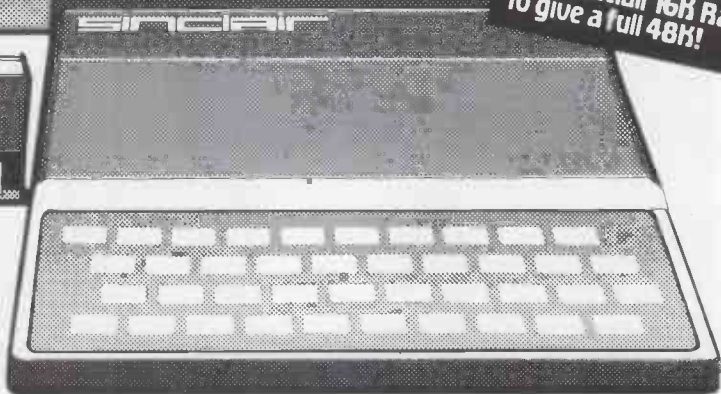

## Memotech's Memopak Range

All five of the currently available Memopaks are housed in elegant black anodised aluminium cases, and are styled to fit wobble-free onto the back of the ZX81, allowing more add-ons (from Memotech or Sinclair) to be connected.

£ **68**<sup>70</sup>

plus VAT

### MEMOPAK 64K MEMORY EXTENSION

The 64K Memopak extends the memory of the ZX81 by 56K, and with the ZX81 gives 64K, which is neither switched nor paged and is directly addressable. The unit is user transparent and accepts commands such as 10 DIM A(9000).

Breakdown of memory areas...0-8K-Sinclair ROM. 8-16K-This area can be used to hold machine code for communication between programmes or peripherals. 16-64K-A straight 48K for normal Basic use.

£ **43**<sup>43</sup> / £ **26**<sup>00</sup>  
32K / 16K  
plus VAT

### MEMOPAK 32K and 16K MEMORY EXTENSIONS

These two packs extend and complete the Memotech RAM range (for the time being!) A notable feature of the 32K pack is that it will run in tandem with the Sinclair 16K memory extension to give 48K RAM total.

£ **52**<sup>00</sup>

plus VAT

### MEMOPAK HIGH RES GRAPHICS PACK

HRG Main Features — • Fully programmable Hi-Res (192 x 248 pixels) • Video page is both memory and bit mapped and can be located anywhere in RAM. • Number of Video pages is limited only by RAM size (each takes about 6.5K RAM) • Instant inverse video on/off gives flashing characters • Video pages can be superimposed • Video page access is similar to Basic plot/unplot commands • Contains 2K EPROM monitor with full range of graphics subroutines controlled by machine code or USR function

£ **34**<sup>70</sup>

plus VAT

### MEMOPAK CENTRONICS TYPE PARALLEL PRINTER INTERFACE

Main Features — • Interfaces ZX81 and parallel printers of the Centronics type • Enables use of a range of dot matrix and daisy wheel printers with ZX81 • Compatible with ZX81 Basic, prints from LLIST, LPRINT and COPY • Contains firmware to convert ZX81 characters to ASCII code • Gives lower-case characters from ZX81 inverse character set

Coming Soon...

MEMOPAK RAM  
HI-RES GRAPHICS  
CENTRONICS I/F

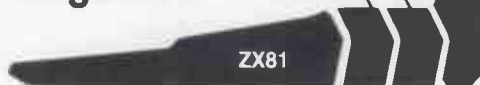

A complete range of ZX81 plug-in peripherals

Digitising Tablet RS232 Interface

We regret we are as yet unable to accept orders or enquiries concerning the above products, but we'll let you know as soon as they become available.

Access/Barclaycard Holders  
Please Tel Oxford  
(0865) 722102  
(24 Hrs)

© R. Branton & G.A.C. Boyd 1982

Please make cheques payable to MEMOTECH Ltd.

Please Debit my Access/Barclaycard account number

\*Please delete whichever does not apply

Please send me

|                     |                     |        |  |  |
|---------------------|---------------------|--------|--|--|
| 64K RAM             | £68.70 + £10.30 VAT | £79.00 |  |  |
| 32K RAM             | £43.43 + £6.52 VAT  | £49.95 |  |  |
| 16K RAM             | £26.00 + £3.90 VAT  | £29.90 |  |  |
| HRG                 | £52.00 + £7.80 VAT  | £59.80 |  |  |
| CENTRONICS I/F      | £34.70 + £5.20 VAT  | £39.90 |  |  |
| Packaging & Postage | £2.00 per unit      |        |  |  |

Price No Total

TOTAL ENC

SIGNATURE

DATE

NAME

ADDRESS

TELEPHONE

We want to be sure you are satisfied with your Memopak - so we offer a 14-day money back Guarantee on all our products. Memotech Limited, 3 Collins Street, Oxford OX4 1XL, England Tel: Oxford (0865) 722102 Telex: 837220 Orchid G



# DATA DABBLING

## A MULTI-FILE DATABASE SYSTEM

*J A B Leeser describes how he wrote his own UCSD Pascal relational database system.*

The idea of writing a type of relational database system for a microcomputer was born just prior to my arrival in Brazil. By this time I felt that I had sufficient mastery of Pascal (UCSD), had done some preliminary studies on tree structures and written a general routine for the binary search of an array — the last two without any specific objective in mind.

My interest in relational databases had been stimulated some three years before by V Nederhof, of UIMC BV, Rotterdam, who had lent me C J Date's *An Introduction to Database Systems*. A time of much travelling and too little home life intervened, but the conviction that the relational approach ought to offer the simplest solution to retrieving information from structured data had stayed with me. Once settled in our new home, I resolved to use what little spare time I had to write the index-driven database system for a micro.

### Overall structure

The decision to use only standard Pascal data structures was made at an early stage. Next, the central database subsystem had to be built on a data file structure, consisting of records with a number of header fields followed by ten general-purpose string fields meant to contain the main data. Clearly, this general structure had to be given a specific form to reflect a particular data file. Thus it had to be associated with a format derived from a format, or Data Dictionary sub-system. On the other hand, data files were to be manipulated by means of indexes. Thus an index subsystem was required, leading into some form of output system to provide results. Connecting these sub-systems by a menu, the overall structure of DABS, as it came to be called, is shown in Fig 1.

This structure turned out to be adequate in the end and is described in more detail below.

### Data dictionary subsystem

The Data Dictionary subsystem consists of three main functions, effectively three programs, which may be represented as in Fig 2.

The first task is to create a format file (when necessary) to insert records carrying file and field names and to delete unwanted records. The second is to create an inverted file listing field names of all records in alphabetic order, giving the appropriate file name. Both these functions use binary tree structures

(B trees) for sorting in main memory. The third function lists either file on the printer.

The file name of the appropriate format record is a prerequisite for operating with a particular data file. The

field names held in the format file define the data file fields. Thus no data file operation can take place unless a format record for that data file exists. The alphabetic list of field names is included as a very simple reference to

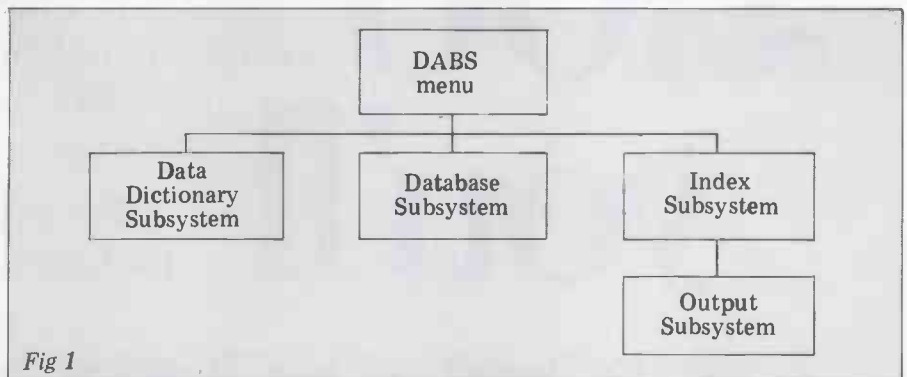

Fig 1

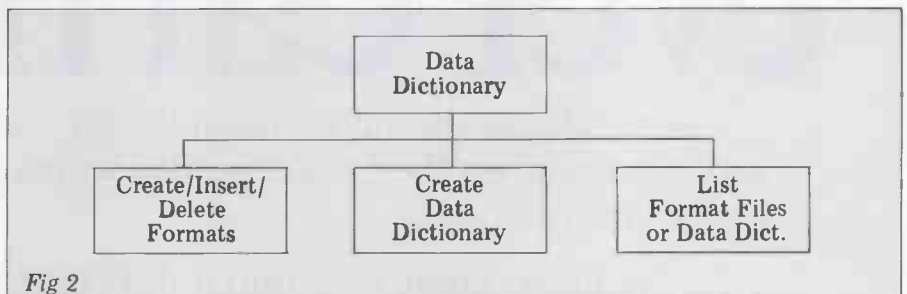

Fig 2

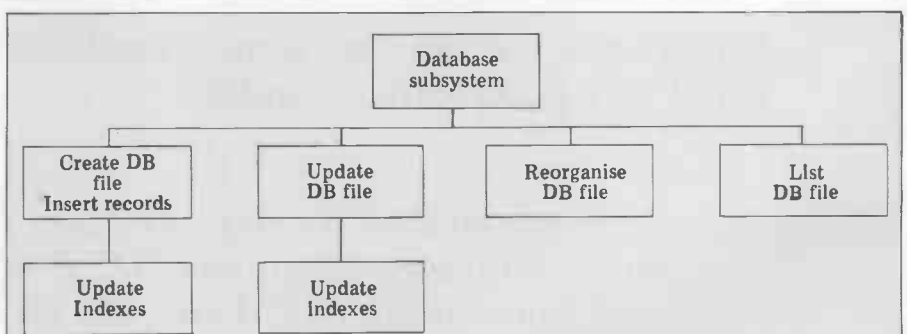

Fig 3

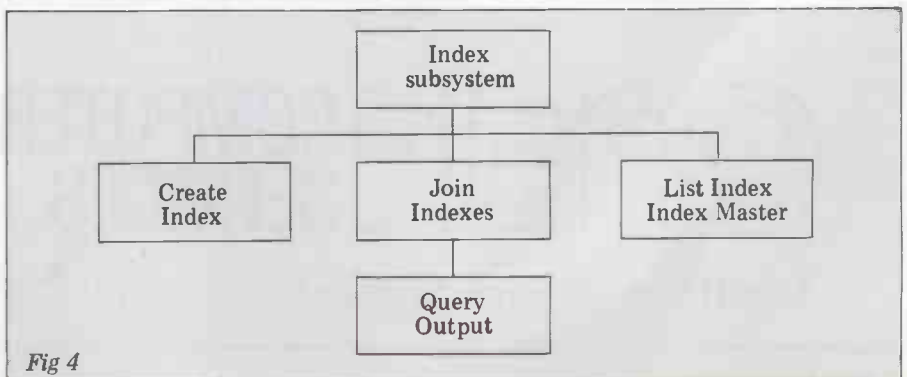

Fig 4

# This could be the hardest £100 you'll ever earn

At Open Computer Services we're so confident in the quality of our software packages that we throw down this challenge:

**For every bug you find in our packages, we will give you £100.**

To qualify, just buy any of these packages – payroll, sales ledger, purchase ledger, general accounting/nominal ledger – and if you detect a bug, send a report on the fault together with your name, address and licence number.

Sadly you may well find it difficult to detect any £100 bugs. But at least you can take some consolation from having acquired some very good software indeed.

*Software systems for most 8 bit and 16 bit microcomputers including IBM Personal, Sirius and Xerox using CP/M and MS-DOS operating systems.*

**OPEN COMPUTER SERVICES**

Aqua House Old Steine Brighton BN1 1EL Tel. (0273) 671666



# DATA DABBING

field names and where they are used, but is of no further importance in the system as a whole.

## Database subsystem

The Database subsystem's functions are: to create files and insert records, to update fields of all or specific records (including deletion of records), to reorganise files and to list them, as depicted in Fig 3.

It will be noted that both the Create/Insert function and the Update function automatically update all indexes related to the data file, at least in all those cases where they exist, having been created in the first place by the Index sub-system (an index is a file holding records or elements of key fields and the relevant data file record numbers, ordered in key field sequence and, optionally, obeying specifiable selection criteria). Thus an index will always reflect the correct state of the data file within the rules relevant to the original definition of that index (its 'scope').

The Update function is itself controlled by an index. It permits changing one or more fields, including the status field, over the scope of the index and offers the choice of a 'global' or a record-by-record update. The status field has either the value L(ive) or the value D(ead). Dead records are intended to be deleted by the Reorganisation function and, pending this final decision, are ignored by the system.

## The index system

Just as the format file record is essential to the creation, etc, of a data file, so is the index (or indexes) for the retrieval of information from that data file. The index specifies which records of the data file are to be used for retrieval of results. As we have seen, indexes are automatically updated by two of the database functions. However, they have to be specified and created in the first place. This is one of the tasks of the Index subsystem, the other being to join two indexes over a given field. The result of this sort of 'join' is, normally, a table formed by concatenating elements from two indexes, such that the elements of each index have the same key-field value. The general scheme of the sub-system is shown in Fig 4.

Index creation offers a number of special facilities:

1. An index may be created, and ordered in ascending sequence, on any data field in the data file record, or on the record number.
2. Selected indexes may be created depending on whether a chosen field is equal to, not equal to, greater than or smaller than a given value or is a member of a user-specified range of values.
3. Use of the 'unique' feature excludes all data file items with the same key field, except the first.
4. A secondary sort of field may be specified for use in cases where a two-key index has to be 'joined' with two other indexes, one having one of the two key fields and one the other.

5. An index will automatically be added to the number of existing indexes, unless specified to replace an existing index.

Details of decisions made in respect of items 1 - 5 are registered in an Index Master File whose primary use is to provide information for automatic updates of indexes, as described above.

The Join function specific to DABS relates two indexes, ordered in the same

sequence, such that, if the key field of an element of the 'argument' index is equal to any key field of an element belonging to the second or 'target' index, the record number of the data file record forming part of the element of the target index is stored in a result table under the data file number to which the target index belongs. Inequality resulting from a particular set of comparisons, that is, absence of a matching element, leaves a zero in the table. A number of such binary 'joins' can be carried out, the current limit being three. The completed table is stored in a temporary file from which

|             |                        |            |           |           |     |     |     |  |
|-------------|------------------------|------------|-----------|-----------|-----|-----|-----|--|
| File 1 :    | SUP (PLIER)/MAT(ERIAL) |            |           |           |     |     |     |  |
| Record no : | 1                      | 2          | 3         | 4         | 5   | 7   | 7   |  |
| Scode :     | 20                     | 10         | 10        | 5         | 15  | 6   | 6   |  |
| Mcode :     | 100                    | 110        | 100       | 120       | 100 | 130 | 140 |  |
| Mprice :    | 1.9                    | 2.7        | 2.0       | 1.9       | 2.4 | 2.1 | 2.2 |  |
| Mquality :  | 4                      | 5          | 5         | 4         | 4   | 5   | 3   |  |
| File 2 :    | SUP(PLIER)             |            |           |           |     |     |     |  |
| Record No : | 1                      | 2          | 3         | 4         |     |     |     |  |
| Scode :     | 5                      | 10         | 15        | 20        |     |     |     |  |
| Sname :     | Ferreira               | Smith      | Perez     | Armando   |     |     |     |  |
| Scity :     | Sao Paulo              | Londres    | Lisboa    | Sao Paulo |     |     |     |  |
| Scountry :  | Brazil                 | Inglaterra | Portugal  | Brazil    |     |     |     |  |
| File 3 :    | MAT(ERIAL)             |            |           |           |     |     |     |  |
| Record no : | 1                      | 2          | 3         | 4         |     |     |     |  |
| Mcode :     | 100                    | 120        | 110       | 130       |     |     |     |  |
| Mname :     | Armchairs              | Chairs     | Cupboards | Tables    |     |     |     |  |
| Mstock :    | 60                     | 36         | 24        | 48        |     |     |     |  |
| Depot :     | Hayden                 | Hayden     | Hayden    | Hayden    |     |     |     |  |

Fig 5

## Example 1

**Task:** Print — Sname, Scity, Scountry from the Sup(plier) file for all records of that file having:  
Scountry < Portugal (lexically) and Scity in the alphabetic range A to M (both inclusive)

### Indexes

The following two indexes are established:

|              | INDEX 8 (Supplier)   | INDEX 9 (Supplier)   |      |        |       |    |    |   |   |   |    |   |   |    |   |   |  |      |      |        |       |    |    |    |   |   |    |   |   |
|--------------|--|--|------|--------|-------|----|----|---|---|---|----|---|---|----|---|---|--|------|------|--------|-------|----|----|----|---|---|----|---|---|
| Instructions | Sortfield : Scode<br>Selec field : Scountry<br>Selec criter : < Portugal   | Sortfield : Scode<br>Selec field : Scity<br>Selec criter : Range A>M |      |        |       |    |    |   |   |   |    |   |   |    |   |   |  |      |      |        |       |    |    |    |   |   |    |   |   |
| Result       | <table border="1"> <thead> <tr> <th>DATA</th> <th>File</th> <th>Record</th> </tr> <tr> <th>Scode</th> <th>no</th> <th>no</th> </tr> </thead> <tbody> <tr> <td>5</td> <td>2</td> <td>1</td> </tr> <tr> <td>10</td> <td>2</td> <td>2</td> </tr> <tr> <td>20</td> <td>2</td> <td>4</td> </tr> </tbody> </table> | DATA   | File | Record | Scode | no | no | 5 | 2 | 1 | 10 | 2 | 2 | 20 | 2 | 4 | <table border="1"> <thead> <tr> <th>DATA</th> <th>File</th> <th>Record</th> </tr> <tr> <th>Scode</th> <th>no</th> <th>no</th> </tr> </thead> <tbody> <tr> <td>10</td> <td>2</td> <td>2</td> </tr> <tr> <td>15</td> <td>2</td> <td>3</td> </tr> </tbody> </table> | DATA | File | Record | Scode | no | no | 10 | 2 | 2 | 15 | 2 | 3 |
| DATA         | File   | Record   |      |        |       |    |    |   |   |   |    |   |   |    |   |   |  |      |      |        |       |    |    |    |   |   |    |   |   |
| Scode        | no   | no   |      |        |       |    |    |   |   |   |    |   |   |    |   |   |  |      |      |        |       |    |    |    |   |   |    |   |   |
| 5            | 2  | 1  |      |        |       |    |    |   |   |   |    |   |   |    |   |   |  |      |      |        |       |    |    |    |   |   |    |   |   |
| 10           | 2  | 2  |      |        |       |    |    |   |   |   |    |   |   |    |   |   |  |      |      |        |       |    |    |    |   |   |    |   |   |
| 20           | 2  | 4  |      |        |       |    |    |   |   |   |    |   |   |    |   |   |  |      |      |        |       |    |    |    |   |   |    |   |   |
| DATA         | File   | Record   |      |        |       |    |    |   |   |   |    |   |   |    |   |   |  |      |      |        |       |    |    |    |   |   |    |   |   |
| Scode        | no   | no   |      |        |       |    |    |   |   |   |    |   |   |    |   |   |  |      |      |        |       |    |    |    |   |   |    |   |   |
| 10           | 2  | 2  |      |        |       |    |    |   |   |   |    |   |   |    |   |   |  |      |      |        |       |    |    |    |   |   |    |   |   |
| 15           | 2  | 3  |      |        |       |    |    |   |   |   |    |   |   |    |   |   |  |      |      |        |       |    |    |    |   |   |    |   |   |

### Join table

When index 8 is joined to index 9 on the sortfield, the following table results:

|       |            |       |       |       |
|-------|------------|-------|-------|-------|
| 0.    | File no.   | 2     | 0     | 0     |
| 1.    | Record row | 0     | 0     | 0     |
| 2.    | Record row | 2     | 0     | 0     |
| 3.    | Record row | 0     | 0     | 0     |
| ..... | .....      | ..... | ..... | ..... |
| n.    | Record row | 0     | 0     | 0     |

### Output

The output program will recognise only the first column and, within that, the row numbered 2. It will seek record 2 of file 2, having first requested identification of fields to be printed. It will then write these details from the record (either on the screen or the printer):

Sname : Smith  
Scity : Londres  
Scountry : Inglaterra

# STOP HERE

APPLE SYSTEMS

## WANT TO BUY AN APPLE II £550 ?

HERE'S HOW!!!  
PURCHASE OUR HARDWARE PACKAGE

### HARDWARE

- ★ 48K APPLE II
- ★ DISK W/CONTROLLER
- ★ DISK W/OUT CONTROLLER
- ★ BMC 12" GREEN SCREEN HI RES MONITOR
- ★ MX80 F/T2 HI RES PRINTER
- ★ PRINTER INTERFACE

### SOFTWARE AVAILABLE

- INVOICING
- PURCHASE/SALES LEDGER
- PAYROLL
- VISICALC
- VISIDEX
- VISITREND/VISIPLLOT
- WORD PROCESSING



**HARDWARE PACKAGE PRICE £1699**

## PET SYSTEMS

**Ideal for: YOUR BUSINESS • EDUCATION • WORD PROCESSING**

- 8032 32K Computer 80 column £755
- 8096 96K Computer 80 column £1040
- 8050 950K Dual Drive £755
- 8023 Tractor Feed Printer £785

*NEW PRODUCTS NOW AVAILABLE*

- 8422 22 Megabyte Winchester Disk POA
- 9000 SuperPet 134K POA
- MULTI LANGUAGE POA

- 4016 16K Computer £445
- 4032 32K Computer £560
- 2031 171K Single Drive £349
- 4040 343K Dual Drive £560
- 4022 Tractor Feed Printer £350



Choice of software packages available, such as:

**WORD PROCESSING, INTEGRATED ACCOUNTS WITH STOCK, INVOICING & FINANCIAL PLANNING, AND MANY OTHER APPLICATIONS**

## LONDON'S MAIN EPSON DISTRIBUTOR

### PRINTERS

TYPE III PRINTERS  
NOW AVAILABLE



#### EPSON MX100 £480

15½" carriage, 254 columns, hi res graphics, true descenders, bi directional.

#### EPSON MX80 £320

Dot-matrix printer Pet and Apple compatible. True bi directional, 80 cps.

#### EP80 MX82 £355

As MX80 plus high resolution graphics, parallel and serial. Interfaces.

#### EPSON MX80 FT/1

£340

Dual single sheet friction and tractor feed, 9 wire head, true descenders.

#### EPSON MX80 FT/2

£380

An FT/1 with high resolution graphics.

#### SEIKOSHA GP100

£189

Dot matrix 5x7, 80 columns, 30 cps graphics, double width characters.

### TERMS

All items carry 1 year guarantee parts and labour. Delivery at cost. All prices exclusive of VAT. Please add 15% VAT. Telex 22568. Official orders welcome. JUST PHONE FOR FURTHER DETAILS



# CHROMASONIC electronics

48 JUNCTION ROAD, ARCHWAY, LONDON N19 5RD TEL 01-263 9493 263 9495 TELEX 22568

100 yards from Archway Station and 9 Bus Routes

# DATA DABBLING

it is picked up by the Output function. The Output function then examines the table horizontally over the columns in which entries were made by the Join operation, starting from the beginning of the table. For any row of data file record numbers, which does not have a zero in it, the corresponding data file

and data file records are accessed and the fields previously stipulated by the user are then written to the screen or to the printer, as required.

Two examples are given of the use of the Index-create, Join and Output functions, based on the data files in Fig 5.

It will be noted that all three files are normalised and that the only connection between them is provided by the Scode and Mcode fields of File 1. Normalisation, while obviously desirable, is however, not a prerequisite of the system as such.

It will be noted that records 6 and 7 of the Supplier/Material data file are excluded. This is because the appropriate records in the other two data files are missing. Note, too, that in order to move index 13 into the table, a unique form of index 13, namely index 15, had to be joined to index 13. Joining index 13 to itself, although perfectly possible, would result in undesirable, additional combinations.

This example indicates the maximum use of the present system — matching three files to provide an answer drawn from all three.

## Example 2

**Task:** Print — Sname from the Sup(plier) file  
Mname from the Mat(erial) file  
Mquality from the Sup(plier)/Mat(erial) file

for all records of the Sup(plier)/Mat(erial) file having Mprice > 1.9

### Indexes

The following indexes are established:

|              |                     |         |           |  |       |         |           |
|--------------|---------------------|---------|-----------|--|-------|---------|-----------|
| Instructions | INDEX 12 (Supplier) |         |           | INDEX 13 (Supplier/Material)   |       |         |           |
|              | Sortfield: Scode    |         |           | Sortfield: Scode<br>2nd Sortfield: Mcode<br>Selection field: Mprice<br>Selec Criterion: >1.9 |       |         |           |
| Result       | DATA                |         |           | DATA   |       |         |           |
|              | Scode               | File no | Record no | Scode  | Mcode | File no | Record no |
|              | 5                   | 2       | 1         | 5  | 140   | 1       | 7         |
|              | 10                  | 2       | 2         | 6  | 130   | 1       | 6         |
|              | 15                  | 2       | 3         | 10   | 100   | 1       | 3         |
|              | 20                  | 2       | 4         | 10   | 110   | 1       | 2         |
|              |                     |         |           | 15   | 100   | 1       | 5         |

|              |                     |         |           |   |         |           |  |
|--------------|---------------------|---------|-----------|---|---------|-----------|--|
| Instructions | INDEX 14 (Material) |         |           | INDEX 15 (Supplier/Material)  |         |           |  |
|              | Sortfield: Mcode    |         |           | Sortfield: Scode<br>Selec field: Mprice<br>Selec Criterion: >1.9<br>Unique: Yes |         |           |  |
| Result       | DATA                |         |           | DATA  |         |           |  |
|              | Mcode               | File no | Record no | Scode   | File no | Record no |  |
|              | 100                 | 3       | 1         | 5   | 1       | 7         |  |
|              | 110                 | 3       | 3         | 6   | 1       | 6         |  |
|              | 120                 | 3       | 2         | 10  | 1       | 2         |  |
|              | 130                 | 3       | 4         | 15  | 1       | 5         |  |

### Join table

Index 13 is joined on Index 12 on Scode }  
Index 13 is joined on Index 14 on Mcode } all in Scode sequence  
Index 15 is joined on Index 13 on Scode }

giving the following table:

|       |            |   |   |   |
|-------|------------|---|---|---|
| 0.    | File no.   | 2 | 3 | 1 |
| 1.    | Record row | 1 | 0 | 7 |
| 2.    | Record row | 0 | 4 | 6 |
| 3.    | Record row | 2 | 1 | 3 |
| 4.    | Record row | 2 | 3 | 2 |
| 5.    | Record row | 3 | 1 | 5 |
| 6.    | Record row | 0 | 0 | 0 |
| ..... |            |   |   |   |
| n.    | Record row | 0 | 0 | 0 |

### Output

The output program recognises all three columns but, of them, only rows 3, 4 and 5, these being the only rows which are completely non-zero. It then seeks the records in each row, first requesting identification of fields to be printed. The results written are as follows:

|          |   |           |           |           |
|----------|---|-----------|-----------|-----------|
| Sname    | : | Smith     | Smith     | Perez     |
| Mname    | : | Armchairs | Cupboards | Armchairs |
| Mquality | : | 5         | 5         | 4         |

## Footnote

Clearly, a multi-file system for a micro has its limitations, primarily of space. DABS, at present, handles 768 records of ten data fields each — not a great deal, but file number, record number and record status are taken care of separately. Given a third disk-drive, somewhere between 900 and 950 records could be handled, after which main memory becomes the restricting factor. A virtue of the system is, however, that it is fast. Sorting, searching and insertion of records (the latter, in some cases only) take place in main memory and access to the main data files is direct, B trees and binary array search methods being used wherever practical.

Two noteworthy points — UCSD Pascal proved entirely adequate for the task, producing code with very few errors. Pascal friends will recognise at once that this is a compliment to the language, rather than to the programmer. Secondly, while an attempt has been made to make DABS as user-friendly as practical, space considerations have made this difficult in at least one case. What can be done to overcome this, remains an interesting exercise for future leisure moments.

END



# How to turn your HP-41 into a handheld computer.

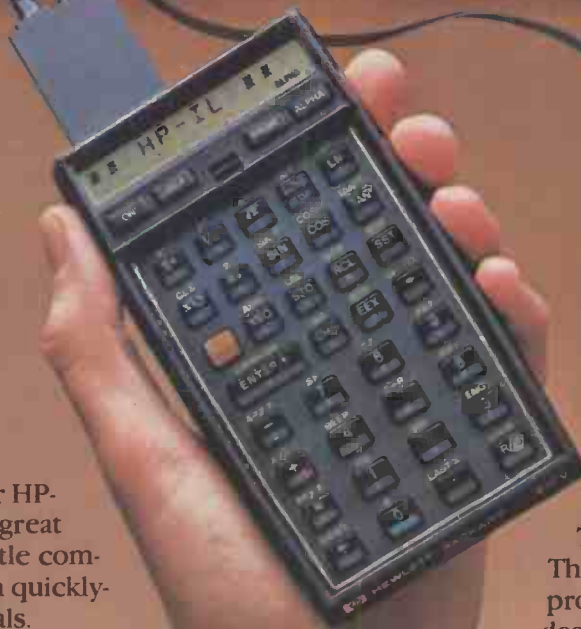

## Introducing the Hewlett-Packard Interface Loop.

Starting today, your HP-41C or HP-41CV can be more than just a great little calculator. It's a great little computer, capable of controlling a quickly-expanding family of peripherals.

The new Hewlett-Packard Interface Loop (HP-IL) makes it all possible. HP-IL is an easy-to-use, low-cost interfacing system, specifically designed for battery-operable devices.

### The Interface Module and Peripherals.

At the heart of the system is the Interface Module, which plugs into any one of four HP-41 ports. You can control up to 30 peripherals, using only one port in your HP-41 calculator.

One of the key HP-IL peripherals is the new Digital Cassette



Drive. This battery-operable device provides an

incredible 131,000 bytes of mass memory.

Another work-saving HP-IL peripheral is the new, battery-operable Thermal Printer/Plotter with enhanced formatting options and graphics.

**This is just the beginning.**

There are many more HP-IL products on the way. And they're all designed to provide the versatility and adaptability you expect from HP. You see, Hewlett-Packard is committed to a very big idea: small devices talking to each other, giving you big system capabilities – at small system prices!

**There's a  
dealer list opposite  
to help you  
get started!**



**HEWLETT  
PACKARD**

See the HP-41C at  
**Comet, Xerox Stores,  
 Sumlock Bondain,  
 Wilding, Landau,  
 Metyclean** or these other  
 Appointed Dealers:

**Aberdeen** Tyseal Office Equipment.  
**Bath** Wilding Office Equipment.  
**Belfast** Cardiac Services Company.  
**Birmingham** John Mabon Associates;  
 Research Micro Systems.  
**Bolton** Wilding Office Equipment.  
**Bournemouth** South Coast Business Machines.  
**Brighton** Office Machinery Engineering Co.  
**Bristol** Decimal Business Machines;  
 Wilding Office Equipment.  
**Bromley** Wilding Office Equipment.  
**Cambridge** W. Heffer & Sons;  
 Wilding Office Equipment.  
**Cardiff** Sigma Systems (Calculators).  
**Carlisle** Thos. Hill International  
**Colchester** Wilding Office Equipment.  
**Croydon** Wilding Office Equipment.  
**Dundee** Tayside Office Equipment.  
**Edinburgh** Holdene; Robox.  
**Glasgow** Robox.  
**Gloucester** Wilding Office Equipment.  
**Halesowen** Research Micro Systems.  
**High Wycombe** Wilding Office Equipment.  
**Hornchurch** Wilding Office Equipment.  
**Ilford** Wilding Office Equipment.  
**Ipswich** Wilding Office Equipment.  
**Kingston-upon-Thames** Wilding Office  
 Equipment.  
**Leeds** Holdene; Wilding Office Equipment.  
**Leicester** A. C. Barratt & Co.; Sumlock Services.  
**Lichfield** Anglo American Office Equipment Ltd.  
**London** City Business Machines - 57 Houndsditch,  
 Bethnal Green Road; Concept Business Systems,  
 Dixons Photographic - 123 Holborn,  
 64 New Bond Street;  
 Landau Calculators - Bourne's Oxford Street,  
 227 Tottenham Court Road; McDonald Stores -  
 78 Oxford Street; Metyclean - 137 The Strand,  
 92 Victoria Street; Mountindene -  
 22 Cowper Street; Sumlock Bondain -  
 263-269 City Road, 360 Euston Road,  
 Cannon Street Station; Wallace-Heaton -  
 127 New Bond Street; Wilding Office Equipment -  
 278 High Holborn,  
 7 The Arcade Hoe Street, 21 Thomas Street,  
 120 The Broadway, Wimbledon;  
 199 Parrock Street, Gravesend; The Xerox  
 Store - Piccadilly, 76 High Holborn, 110 Moorgate.  
**Luton** Wilding Office Equipment.  
**Maidstone** Wilding Office Equipment.  
**Manchester** Automated Business Equipment;  
 Holdene; Wilding Office Equipment.  
**Middlesbrough** Thos. Hill International.  
**Newcastle** Thos. Hill International.  
**Northampton** A. C. Barratt & Co.  
**Norwich** Sumlock Bondain.  
**Nottingham** Bennett's (Typewriter & Office  
 Suppliers).  
**Oxford** Science Studio.  
**Reading** Central Southern Calculators.  
**Romford** Wilding Office Equipment.  
**Royston** Herts Electroplan.  
**Slough** Wilding Office Equipment, The Xerox Store.  
**Southampton** Maths Box.  
**Southend** Wilding Office Equipment.  
**Sunderland** Thos. Hill International.  
**Sutton** Landau Calculators.  
**Swindon** Wilding Office Equipment.  
**Waltham Cross** Wilding Office Equipment.  
**Watford** Automatic & Electronic Calculators;  
 Wilding Office Equipment.  
**Worthing** Office Machinery Engineering Co.  
**CHANNEL ISLANDS:**  
**Guernsey** The Processor centre.  
**Jersey** The Processor centre.  
**EIRE: Dublin:** Abacus Systems.  
 Tomorrow's World,  
 Grafton Street; Henry Street.

All UK Comet branches.

# TRUE 16 bit!

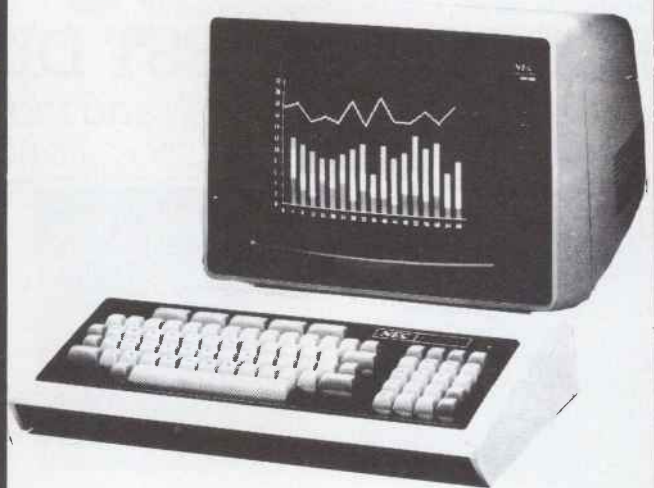

## Olivetti M20

- Q.** When is a 16 bit computer not a 16 bit computer?  
**A.** When it only has an 8 bit data bus. Eg. 8088 cpu.
- Q.** Why buy a 16 bit computer that is not true 16 bit?  
**A.** You tell us! It appears many people are doing just that. But now they have a real choice at a sensible price with the introduction of the new Olivetti M20.
- Q.** High Resolution Graphics?  
**A.** The M20 has 512 x 256 bit-mapped graphics as standard, and they may be mixed with characters. The screen can also be split into up to 16 independent windows for multiple comparisons of data. The colour model provides even more effective graphics.
- Q.** Speed?  
**A.** Substantially faster than the "half" 16 bit micros, inevitably it is also a lot quieter. Z-8001 cpu.
- Q.** Software?  
**A.** A wide range of business, scientific and engineering programs will be available for the official launch. M-Basic 5.2 is supplied as standard.
- Q.** Servicing?  
**A.** Nationwide through Olivetti Engineering.
- Q.** Finance?  
**A.** Leasing and rental through Olivetti Finance.
- Q.** Where can I get one?  
**A.** From us, we can demonstrate right now.

**OLIVETTI M20** - a classic 16 bit microcomputer from the small business computer experts for no more than the price of a Sirius.

|   |       |
|---|-------|
| M20S: 128K RAM, single disk, monochrome | £1895 |
| M20D: 160K RAM, Dual disks, monochrome  | £2395 |
| M20C: 192K RAM, Dual disks, colour      | £3262 |

## Brighton Computer Centre

130 Lewes Road, Brighton BN2 3LG  
 (0273) 688946 Mon-Sat 10am-6pm

Please send me further details of the Olivetti M20.

Name .....  
 Company .....  
 Address .....  
 ..... Tel .....PCW11







# PERSONAL PEARL

Pearl is described by its authors as enabling the user 'to create a library of the highest quality programs designed by you, for your Personal Pearl leads you through the program design'. In use, however, it is very similar to a number of information management packages I've reviewed over recent months. Pearl begins by asking the user to define a record format, including screen layout and indexed fields, goes on to provide facilities for data entry, and then gives options to design report formats for getting information from the database. These functions are made available either through a 'service directory menu', which is shown in Figure 1, or by the user typing the program name for the particular function.

Pearl is closer to being a true database system than many I've seen, as it builds a data dictionary for indexing which is designed to permit extraction of information from one file by reference to fields in another. So, although Pearl is billed as a program generator, from a user's point of view it's much more like a data management system — you would, for instance, have a hard time trying to write production control programs with it. This is especially true as Pearl doesn't allow you to display or modify directly the programs you've 'written', only execute them and therefore it seems of little importance to the user whether particular applications are provided by parameter-driven programs or parameter-written programs. However, bearing those comments in mind, Pearl does compete quite well with some of the other data management packages around.

## Constraints

Pearl files can be as big as the CP/M limit of 8 Mb. Maximum record size is determined by layout: up to three screens' worth is permitted provided you don't exceed 250 fields. Screen displays are limited to 17 lines if you want to preserve the facility for providing HELP information on the bottom of the screen. Fields may not occupy more than one screen line, though if the screen width permits you can go up to 127 characters. Numerical accuracy is to 15 digits. Three types of field are provided: numbers, characters and dates.

One or more fields may be designated as key fields, which may be unique or may contain repeated values. Once the format of the record has been decided, changes may still be made even after the file contains data records, but only changes to and additions of non-key fields are allowed. During form

*Kathy Lang continues her series of database evaluations with a look at Pearl*

design a maximum length for each field is given, but data is actually stored in packed form — so that, for instance, a field which has no value occupies no space.

## Input and validation

The data input process consists of four stages. The first involves designing the layout the record is to have on the screen. This layout will be used for displaying each record when the data is input, edited or deleted. (At present only one format per data file is possible; in later releases Pearl is likely to permit several formats 'overlying' the records in a file.) The layout process involves giving each field a label or caption and showing (for instance by using underline characters) where data will be placed for the field. The placing is at this stage

## Straightforward facilities for the novice user

purely visual, and has no implications for record formats: this comes in the next stage, which involves defining data areas.

Data areas are defined by placing the cursor at the start of an area; Pearl then assumes that the field extends up to the next space (on the same line — fields may not spill over two lines). For each data area you must define an abbreviated name of not more than seven letters, which is the name by which the field will be known for Pearl operations; the label is purely to help the operator, and the two could be quite different if you really wanted to do things the hard way. You then indicate the type of field, whether its presence is mandatory or not, and whether it is to be calculated from other field(s) in the same record. Index or key fields are not indicated at this stage; that is done in stage three.

To allow the user to define key fields, Pearl displays the record format just set up and asks to be told which fields are key fields, and whether each is to contain a unique key or whether more than one record may have the same value. It is not essential to define key fields; if you don't, Pearl will

assume that the first field is the only key, and direct access to individual records will be possible only with that key. The fourth and final step is to establish any links there may be between this file and others set up by Pearl; it is possible to have fields copied from another file, calculated from data in another file, or just brought into the record layout for display purposes.

Once you have designed a format you can use it to enter data. The same section of Pearl is used to enter new data and to edit existing records. Data validation is quite thorough. Dates are checked for plausibility, number fields may only contain numbers, and you aren't allowed to save a record if any of the 'mandatory' fields do not have data in them. (Unfortunately Pearl only tells you about one at a time, so if you miss two you have to go round the save/re-edit cycle twice, but it's very quick.) If you enter a value in a supposedly unique key field which is already present in the file, that error too is flagged.

When retrieving existing records for editing or display, you just put the cursor on the particular key field(s) you want to match and type in the required value. Matching is by identity only while editing, although partial matches are permitted to some extent — for instance, if you are searching a key field containing names, typing 'Hill' will result in Pearl finding a record with 'Hill' in that field if there is one, if not it will find the nearest — 'Hills' for instance. You can scroll through the file by asking for the 'next record', so if there are several people called Hill you will get each one in turn, followed by Hills, etc, if they exist, and then the less closely related values such as Smith. When a record is displayed, you can get a copy of it on the printer.

## Displaying data

Individual records retrieved by key can be displayed or printed as I've already described. This mechanism doesn't allow you to access records matched other than by identity, nor does it let you see them sorted or displayed using some format other than that used for input. For any of these facilities, you must use the Design Report and Produce Report functions, which are primarily provided for printed output but which can also be used to display information on the screen.

## Printed reports

The second option in the Service menu allows the user to design report formats. No reports can be printed without a predefined format, apart from direct copies of the screen display. A report

# PERSONAL PEARL

may display information in exactly the same way as the record is shown on the screen, or you may design appropriate separate layouts, either from scratch or by editing a layout you have used before. The process of designing report formats is very similar to that for screen formats. Reports may be of two kinds: a Fixed report format displays one record per page, while the List report format gives one line per record plus heading information and the ability to display sub-totals and totals. While designing a report format, you can request that the records are produced sorted in a particular order; if the report format requests sub-totals, these are produced when the value of the first sort field (which is the most significant) changes. Fixed format reports can be produced spaced out across the page to allow the printing of address labels. Any report may be sent to the screen, to the printer or to a file; this is decided not when the report format is designed but when the production of the report is requested.

## Selection

When a report is produced, one of the options is to select records which lie within certain ranges. For instance, you might want to find which of your customers had been owing you money for between one and two months; you would then request a report of all records where the 'date due' was more than a month ago but less than two months ago. To match records which are equal to a particular value, you specify the same value for both maximum and minimum. Range comparisons work with all three data types, and you can specify such selections for every field in the record if you really need to. The limitations are that you can only have one selection per field — you can't for instance, select records for people who live either in Birmingham or Wolverhampton — and all the selections are combined together so that a record is displayed only if it matches all the selections, not any one of them or some

other combination. Nor can you select records which contain particular values as part of a field.

## Sorting

Also at the reporting stage, you can have the records sorted on a maximum of five fields, in ascending or descending order. This is requested when the report format is produced, so you can't change it when you actually come to produce (print or display) the information. You can't sort on parts of fields.

## Calculations

Calculations using addition, subtraction, multiplication and division, and parentheses, can be carried out either as part of the data input process or when preparing reports. In both cases, the calculations have to be specified when the display format is set up.

## Security and integrity

There aren't any mechanisms at the moment for securing the data against unauthorised access, other than the crude method of locking up the disks, or allowing people to have only the part of Pearl that permits production of reports. You can't, for instance, allow selective updating by giving someone access only to an 'overlay' which displays names and addresses but not sensitive information like salaries. As to integrity, there is a file maintenance program which will rebuild the data dictionary if there has been some problem during file updating. This program will reset the dictionary to the point before the start of editing session, so that only a few records are likely to have been lost.

As far as file and disk security are concerned, and general housekeeping such as erasing files, the user has to rely upon CP/M commands.

## Tailoring

The only tailoring supplied is the ability to select a particular terminal, and to configure Pearl for different terminals if they meet some fairly specific conditions for cursor control — the system I have previously used to run Benchtests didn't conform, but fortunately we now have a Z80 card and CP/M-80 for our Sirius and I was able to run Pearl successfully on that. Would-be users

would be well advised to see Pearl working on their type of terminal before buying, just in case.

## Use with other programs

Pearl can write data out to ASCII sequential files, so you can use it to create files which Wordstar and other packages can read; you can also create Supercalc files. You can't read 'stranger' files into Pearl at the moment, so I couldn't run my Benchmarks, which rely on the ability to read a data file which is the same for all packages and which contains data stored in a 'predictable' way. My initial reaction is that Pearl in its 'special release' form is rather slow, particularly when loading and formatting — data access by keys was quick on a small file.

## User image

The software is on the whole well designed for naive users, with menus, a pretty straightforward structure and lots of HELP on the screen. I particularly liked the display of special characters available for editing at each stage, though they did take up quite a lot of room — a perennial tradeoff. The user is also protected from him/herself in some quite nice ways, such as not being allowed to save records with duplicate keys where they should be unique. I felt that an expert user might find the menu structure tedious quite quickly. Also I must confess to a strong prejudice against gimmicks — such as the message 'My Pleasure' displayed when you leave Pearl!

The documentation is rather mixed. The tutorial sections displayed a remorseless thoroughness which I found a bit off-putting, but the tutorials did introduce enough features to let the user get off the ground without blinding him with detail. However, because the screens were displayed using ordinary type rather than being typeset, the manual was very bulky for what is basically quite a simple package which is fairly self-explanatory in use. Presumably the next release will remedy this defect, and also make some changes to the reference sections.

The reader was instructed firmly to go through the tutorial sections before reading these, and then given nearly as verbose an explanation of the material already covered all over again, as well as covering the more advanced features. The reference section of my manual covered more than than 40 pages, compared with nine in the pre-release version I had previously which seemed to have virtually all the same features. It did seem to be rather a case of 'never mind the quality feel the width'. I'd much rather have seen some effort put into a decent reference card covering all the options briefly, together with the ability to dispense with screen HELP when one became familiar with the commands and could get by with checking the occasional special key function on the reference card.

## Costs

Pearl costs £150, and needs a CP/M system with at least 48k of memory. It

GOTO page 206

```
*****
(
(          DESIGN          OPERATE          )
(          1:  DESIGN FORMS      3:  ENTER DATA      )
(          2:  DESIGN REPORTS    4:  PRODUCE REPORTS    )
(-----)
(Program Name: PCWBTDI )
(ENTER A SERVICE NUMBER: _ )
(Press RETURN to continue, ? for HELP, or ESC to EXIT )
*****
Fig 1
```

# MS-DOS v CP/M-86

*Peter Rodwell compares the two operating systems which — at the moment at least — are fighting it out for supremacy in the 16-bit market*

Right now the business micro market is dominated by twin disk, 8-bit computers running CP/M as their operating system. In fact it's fair to say that CP/M, more than any other single development, has enabled business microcomputing to develop at the pace it has. By providing a standard environment which is easily adaptable to any machine with a Z80, 8080 or 8085 processor, more than 16 kbytes of RAM and at least one disk drive, it has brought order to what could otherwise quite quickly become a very chaotic situation indeed.

CP/M-80 (as we must call it, now that there's a 16-bit version), enabled programmers to produce standard software packages which could be guaranteed to run on any CP/M-80 micro. Hardware manufacturers have been able to produce machines more easily, confident in the knowledge that there was an 'industry standard' operating system which could be placed on their micro and would immediately allow buyers to choose from a wide selection of packages. The design of a Z80, twin-disk CP/M machine is now so easy that it's possible, with mass-production techniques, to churn them out in large quantities at exceptionally low prices, even with a bundle of standard software thrown in — witness the Osborne 01 at under £1300.

Originally CP/M was written for the Intel 8080 chip, as its creator, Gary Kildall, was closely associated with Intel at the time. By happy chance (well, actually, it was more than chance but I'm sure Kildall didn't predict it), Zilog produced a more powerful microprocessor chip, the Z80, which incorporated the 8080's instruction set as a subset of its own, more powerful set. Thus programs written for the 8080 could run without modification on the Z80, although Z80 programs cannot necessarily run on the 8080 unless they are confined to using only the 8080-compatible instructions and make no use of the Z80's more powerful features.

Kildall wrote CP/M-80 primarily as a software development aid; at that time personal computers were unknown and microprocessors had only just made their appearance. Designs for personal computer systems soon began to appear in American electronics magazines, however, and it was quickly realised that CP/M-80 offered tremendous advantages when used as the operating system for these machines; it meant that pioneer computerists could easily exchange software for a start and, not surprisingly, it didn't take long for people to start producing small business machines, running CP/M-80 and using the standard packages being churned out by the escalating microcomputer software business.

Interestingly, the most successful 'big three' microcomputer manufacturers —

Apple, Tandy and Commodore — earned their success quite independently of CP/M-80. Apple and Commodore had no choice because their machines were based around the 6502 chip, which is totally incompatible with the 8080/Z80 family; they each developed their own (incompatible) operating systems instead. Tandy chose the Z80 for its TRS-80 range but went its own way with its own operating system, which, naturally, was incompatible with anyone else's. The 'Big Three' succeeded because they got into the market quickly with good, well-made systems which were easier to use and cheaper than most of the hobby-based systems.

Since those early micro days, the situation has of course changed. Exact figures are very hard to come by in this business but it's fair to say that the Big Three together have about a 50 percent share of the business market while CP/M-80 machines have taken the other half. The number of software packages available for CP/M-80 systems is staggeringly huge and ranges from system utilities through language compilers and interpreters to all sorts of applications packages.

When 16-bit microprocessors appeared, everyone realised that the industry was heading for a rather awkward situation. A vast user base had been established and a massive range of (mostly) well tried and tested standard software was available. But none of the three important 16-bit chips — the Intel 8086, the Motorola 68000 and the Zilog Z8000 — could run any of this software; not even Zilog had had the consideration to make its new heavyweight code-compatible with its old success, the Z80. So all that standard software, into which a lot of money had been poured and with which hundreds of thousands of users were familiar, wouldn't run on the new machine, and neither would CP/M-80 itself.

Clearly the industry had to come up with a new standard operating system so that software producers could get down to converting their packages and users could get their hands on the new generation of machines. But as the three 16-bit chips all had totally different, incompatible instruction sets, no operating system could be adopted as a standard until it was known which chip was going to lead the field.

At this stage in the game, Digital Research (the company founded by Kildall once he realised he was onto a good thing with CP/M-80) was in a very powerful position. There are operating systems which can be run on any machine and for which programs can be written that are totally transportable. One such is the UCSD p-System (read about it in the last three issues of *PCW*), in which only a small central core needs to be written in the 'native code' of the processor involved; all

programs are written in a high-level language, typically Pascal, and compiled into an intermediate code, p-code, which is translated into native code as the program is run by the central core. But a whole generation of microcomputer programmers have been weaned on CP/M-80 and are familiar with its innards. To convert CP/M-80 packages to a totally alien environment would have been expensive and time-consuming. These people looked to Digital Research to provide as familiar 16-bit environment as possible so that conversion involved a straight translation of assembler source code plus a few other tweaks, rather than the entire restructuring that an alien environment might require.

The difficulty was to know which processor would be the favourite with hardware manufacturers. The Zilog Z8000 was an early front-runner but hardware makers were put off when AMD decided not to second-source the chip (a decision it recently reversed); no manufacturer wants to base a product around a chip coming from a single source because he'll be high and dry if that source disappears — and despite the success of the Z80, Zilog has never managed to run at a profit.

That left the 8086 and the 68000. Chip buffs are unanimous that the 68k is the more powerful of the two but legend has it that when Digital Research went knocking on Motorola's door, asking for 68000 details because they wanted to write the new CP/M for it, they found that nobody at Motorola had even heard of CP/M-80 and they were gently but firmly shown the exit. Whether this is true or not I don't know and neither have I ever been able to find out exactly why Digital opted for the 8086. But go for the '86 they did, and produced CP/M-86, even though nobody seemed too interested in using it in a real system.

One factor which may have tipped the scales was a new microcomputer from a company which, while unknown in the micro world, had been doing quite nicely in the world of big computers. The long-awaited, long-heralded, much-speculated-about IBM Personal Computer turned out to be based on the Intel 8088, a 'sawn-off' version of the 8086. (Internally it's a 16-bit processor but it addresses memory as 8-bit bytes rather than as 16-bit words, which is what the '86 does; it is, however, code-compatible with the 8086.)

Meanwhile, with the sort of arrogance a big company accumulates when it's three-quarters of the way to dominating the world, IBM felt that a CP/M operating system wasn't quite good enough and chose a Microsoft product instead, calling it PC-DOS. But Digital Research produced CP/M-86 for the IBM machine anyway and other

# MS-DOS v CP/M-86

manufacturers, figuring that IBM would be a safe bet to imitate, began work on 8088 and 8086-based computers. Microsoft, too, realised that if PC-DOS was good enough for IBM it should be good enough for the rest of the microworld and released its 16-bit operating system to us all, under the name MS-DOS.

Thus, as more and more 16-bit systems appear, we can detect a distinct leaning towards the 8086/8088 family and towards CP/M-86 and/or MS-DOS. The ACT Sirius 1 is already here, British Micro is about to launch an 8088-based machine and on their way are at least half a dozen Japanese 'IBM lookalikes', lead by Hitachi and using one or both of these operating systems.

Before I look into MS-DOS and CP/M-86 in detail, though, I think a few words on the subject of operating systems as a whole are in order.

## The perfect operating system

There is, of course, no such thing as the perfect operating system. For reasons which totally escape me, operating systems, like programming languages, religion and politics, seem to inspire quite ridiculous degrees of fanaticism, frequently bordering on bigoted blindness, if some of the hate-mail we receive here is anything to go by. (I cannot understand why anyone should get so upset about a subject like operating systems, which, in the global scale of things, are pretty insignificant — but people do.)

Before microcomputers appeared, computers were large, isolated machines tended by highly-trained people — programmers, operators and so on — who, because they were highly trained, were able to make sense of the arcane jargon and terminology which surrounded the machines. It mattered little that the man in the street was totally mystified by the whole business because no ordinary men in the street ever came anywhere near a computer.

Microcomputers have changed all that. Not only are they appearing on desktops in every conceivable kind of business, but they are flooding homes as well, now that anyone with £50 to spare can buy a computer. Most of the people who are now using personal computers in their work places have no computing knowledge or experience and neither do they want to become computerists: the modern business personal computer is a tool, purchased to improve business efficiency and make life easier. Within three years' time, businessmen will walk into their local business equipment shop to buy a computer in much the same way as they now buy a typewriter or photocopier; they will have a business problem of some sort and will be looking for a piece of office equipment which will help solve that problem.

The average businessman simply does not want to have to learn about computers; he wants to know which software will do the job he wants done, which piece of hardware will run that software properly and that's all,

basically. All he wants to do then is to buy the system, plug it in and get down to work with it. Anything which prevents his doing exactly that is an obstruction, an inconvenience and a disincentive for him to get involved with computers at all. After all, if you buy a photocopier, you don't want to have to learn about photocopier technology before you can use the thing.

When he sits down to operate his computer, the businessman has three 'levels' at which he could come across problems. Firstly there's the hardware. These days, it's possible to make this pretty foolproof, with the only specialised knowledge being confined to knowing how to turn the machine on, how to put in a disk and how to look after floppy disks correctly. Then there's the applications package he wants to run. Early business packages for micros were pitifully awful, requiring careful use to avoid crashing, demanding rigid syntax and being accompanied by unreadable documentation. Slowly this situation has changed, as software writers realise that their products are being used by computer-naive people who will never understand phrases like 'default back-up store' or who will always accidentally type a letter of the alphabet when they should be typing a number. Gradually we are seeing packages which isolate the user from the bits-and-bytes end of computing and actually cope with mistakes in a helpful and useful way. Documentation, too, is improving, although horrors still abound — take a look at a Wordstar or a Newbrain manual and you'll see what I mean.

But although considerable steps are being taken to make both applications packages and their documentation user friendly, it's important to realise that operating systems, too, need to be just as friendly and easy to use. When he sits down in front of his computer, the businessman needs the maximum amount of help to achieve his goal; he should not have to wade through pages of instruction manuals in order to understand how to work the machine and he should not be required to learn any special vocabulary before he can make the machine do something sensible. The operating system should enable him to get his application program running as quickly as possible and allow him to carry out whatever 'housekeeping' jobs he has to perform (formatting new disks, taking back-up copies of files, etc) with ease.

Operating systems in the micro world have thus to fulfill two distinct — but by no means mutually exclusive — roles. They must firstly enable software houses and programmers to produce good applications software as quickly — and therefore as cheaply — as possible by providing a useful set of 'interfaces' between the program and the hardware. And — maybe more importantly — they should enable the fast-growing pool of naive users to use their micros as efficiently as possible, with minimal training and/or specialised knowledge.

There are two other, less immediately obvious, qualities that our

## What is CP/M?

In a microcomputer, the operating system is the link between the computer's hardware and the program actually in use. An operating system such as CP/M consists in essence of a series of routines which perform all the boring, mundane but essential tasks involved in computing. This includes things like accepting a character typed at the keyboard, displaying it on the screen, sending characters to the printer and handling the detailed work involved in dealing with disk files. Figure 1 shows how this works on a micro: at the centre is the hardware; between this and whatever programs are being used is the operating system, the program called CP/M (which stands, in case you wondered, for Control Program/Microprocessor). The operating system thus acts as a 'buffer' between the hardware and other software, which could be either applications programs written in assembler language, as

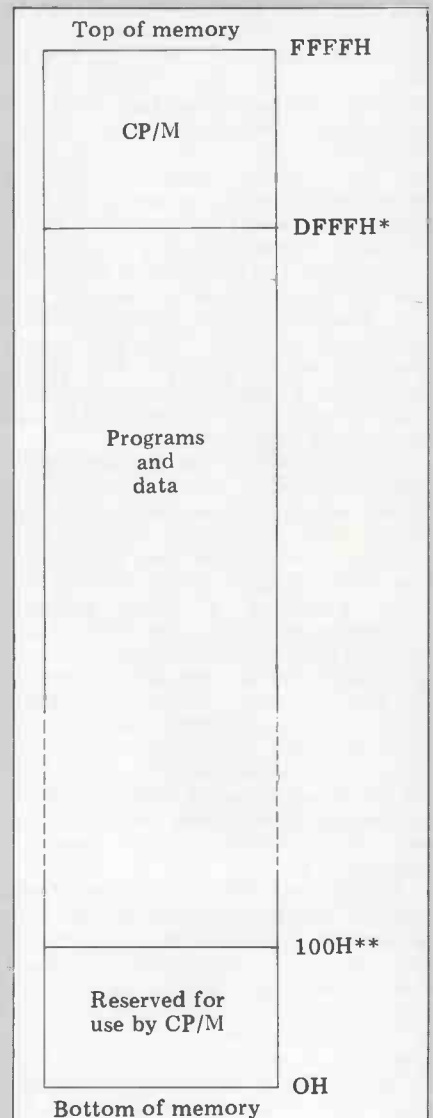

a) A 64k system

\* Approx address - depends on size of BIOS

\*\* Area below 100H not shown to scale!

Fig 2 Memory maps for CP/M systems

shown in the left half of the circle, or a language interpreter which is interpreting an applications program written in a high-level language such as Basic.

## Programming under CP/M

As most programs need at least the ability to accept keyboard input and to display something on the screen, it makes life a lot easier for the programmer if the routines to do this are already available and don't have to be re-written every time a new program is being developed. In addition, the way the computer's hardware is arranged differs from machine to machine, so that while one computer may have Port 0 as its keyboard port, another might use Port 50 for this purpose. A special section of CP/M, called the BIOS (Basic Input/Output Section) contains all the routines which are 'machine specific' (ie, which involve special hardware features which differ between micros) so that, to install CP/M on his product, a manufacturer has only to re-write portions of the BIOS as appropriate.

With the BIOS suitably customised and CP/M successfully installed, any program written for CP/M will then be able to run on it without modification because to perform any of the basic system functions (getting or displaying a character, for instance), the program has merely to execute a subroutine call to an address in a reserved part of memory which is *always* the same, no matter which machine is being used.

As an example of how this works, let's suppose we want to send the character 'A' to the screen. Figure 2a shows the memory map of a typical CP/M computer, from which you will

see that the first 256 bytes of RAM, from locations 0H to 0FFH are reserved for CP/M and that CP/M itself occupies the topmost portion of RAM, typically about 8k or so. In between, starting at location 100H, is the area where programs and data are kept; all CP/M programs must therefore be written to start at 100H. Exactly what CP/M does with all of those 256 bytes needn't concern us here; we're interested in just one location, at 5H. To put the character 'A' on the screen, we must first load it into the processor's E register (remember we're dealing only with the 8080 and Z80 chips), and the *system call* number in the C register. The system call number is simply the number of the operating system routine we wish to execute, obtained from the CP/M documentation which lists all the calls — in this case we want system call 2, so we place the value 2 in C. We now execute a subroutine CALL to location 5. Locations 5, 6 and 7 contain a JUMP instruction to the address inside CP/M up at the top of memory where the routine to work out which function we want and then to execute it lies. The function is executed and CP/M then carries out a RETURN from subroutine instruction to return us to our program.

This may at first sight look a little tedious but in fact it's done for a very good reason. With CP/M you get a utility program to generate a version for any memory size (above 16k); if you want to generate a version of CP/M for a 48k system instead of the standard 64k, you run this program, feed in the relevant details and it produces a new version, which would look something like the memory map in Figure 2b. Notice, though, that this new version still requires those 256 bytes at the bottom; if you were to compare the contents of locations 5, 6 and 7 in the two versions, you'd find they JUMPed to different addresses — the configuration program had so arranged things that, while the addresses of the actual systems calls themselves had changed, a program using them would still work — all that would happen is that when the CALL to location 5 was made, a different address would be JUMPed to automatically, without any modifications being required to the actual program.

CP/M thus frees the programmer of two major headaches: hardware features and memory size. Provided a system has enough memory to contain the program plus whatever extra space the program needs for data storage, it will run on any CP/M machine regardless of the machine's hardware configuration and memory size.

The example I have given is based on the way CP/M-80 works; CP/M-86 and MS-DOS are slightly more complicated but are based on the same principles.

## In use

When the user switches on his machine and inserts the system disk, CP/M is loaded into memory and control is passed to a section of it which displays the 'A>' prompt and waits for something to be typed in at the keyboard.

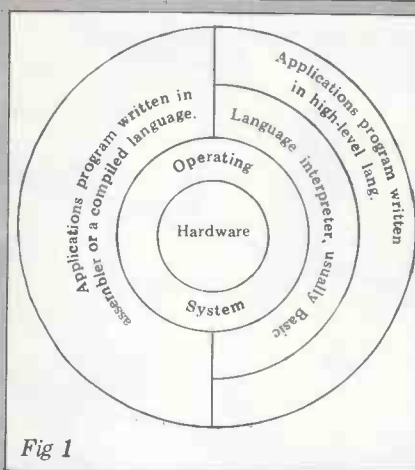

Fig 1

As each letter is typed in, CP/M places it in a reserved area of memory (within that 256-byte lower section) and waits for the next character. It keeps doing this until a carriage return is typed, to signify the end of the command. CP/M then checks first to see whether what has been typed is the name of one of its built-in or *intrinsic* commands, such as DIR, the command to display a disk directory; if it is an intrinsic command, CP/M executes it and goes back to displaying the 'A>' prompt and waiting for the next command.

If the command isn't an intrinsic command, CP/M then searches the disk directory for a program with the same name. If found, the program is loaded into memory from location 100H onwards and control is passed to that program. If there isn't a program with that name on disk, CP/M indicates this fact by the rather crude expedient of re-displaying what you typed followed by a '?' and going back to waiting for another command.

CP/M-80, CP/M-86 and MS-DOS are all single user, single task operating systems. This means that only one person at a time can use the machine to perform only one task at a time. There are operating systems for micros which will allow single user multi-tasking operation, in which one user can have several jobs running at the same time; such a version of CP/M-86, called Concurrent CP/M-86, is promised for the future and it seems logical to assume that a similar version of MS-DOS could also be on its way.

Attempts have been made to produce multi-user operating systems for micros. Trying to do this with an 8-bit system has proved fairly unsuccessful as the poor little processor gets swamped pretty quickly. Even on a 16- or 32-bit micro, the exercise is, frankly, pointless; each user must be provided with a screen and keyboard, both of which are relatively expensive. The processor is made to serve several users by means of a complex (and therefore expensive) operating system yet the processor is the cheapest part of all! It makes far better economic sense to give each user a processor of his/her own — ie, to give them each a micro-computer — and network the micros together to share just the expensive parts such as hard disk drives and daisywheel printers.

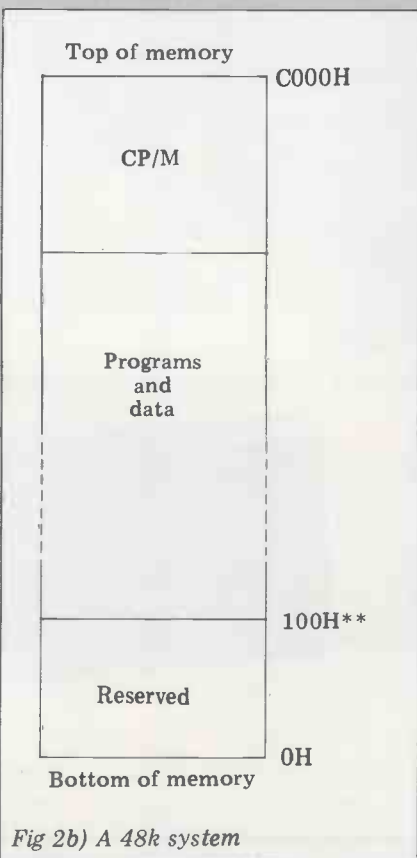

Fig 2b) A 48k system

# THE OFFICE INFORMATION CENTRE

- Word Processing
- Accounting Systems
- Financial Planning

Model II is British  
Telecom Approved for Datel  
200,600 and 2412 Services



**Tandy**  
COMPUTER CENTER

**Availability** - TRS-80™ Computers and accessories available at most of our 300 UK outlets. Some listed below.

**Software** - Tandy because TRS-80 has the biggest computer library of ready-to-run programs. No experience needed.

**Expandability** - Buy your ideal sized computer and never replace it. Simply expand it as your needs grow.



Systems From £2699  
All Prices Include V.A.T.

Training • Classrooms • On-Site Servicing • Leasing

## YOUR NEAREST TANDY COMPUTER CENTRE

**BIRMINGHAM** 021-643-5368/5362  
Edgbaston 021-455-9175  
**BRADFORD** 0274-28431/2  
**BRISTOL** 0272-214721/2  
**CROYDON** 01-680-1852  
**EDINBURGH** 031-225-9337/8854  
**LIVERPOOL** 051-708-0133  
**LONDON**  
Centre Point 01-836-1327

Buckingham Palace Road  
01-828-1423  
Kingsway 01-242-9425  
Bishopsgate 01-626-6688/9  
Seacoal Lane 01-248-5313/4  
**MANCHESTER** 061-236-2122  
Deansgate 061-832-2242/9314  
**ST. HELENS** 0744-30774  
**SOUTHAMPTON** 0703-36492

## TANDY COMPUTER DEALERS

**ABERGELE** 0745-826020  
**ASHFORD** 07842-53024  
**BRIXHAM** 0845-6565  
**CAMBRIDGE** 0223-65334  
**CORK** 22954

**DUBLIN** 0001-730698  
0001-776270  
**LONDON** 01-388-5271  
**RADSTOCK** (Nr. Bath)  
0761-32570  
**WINDSOR** 075-35-58072

Send For Your **FREE 1982**  
**TRS-80™ Computer Catalogue**



Name \_\_\_\_\_  
Address \_\_\_\_\_  
Postcode \_\_\_\_\_ Tel. No. \_\_\_\_\_ PCW 2

**Tandy** Tandy Corporation (UK Branch),  
Tameway Tower, Bridge Street,  
Walsall, West Midlands. WS1 1LA

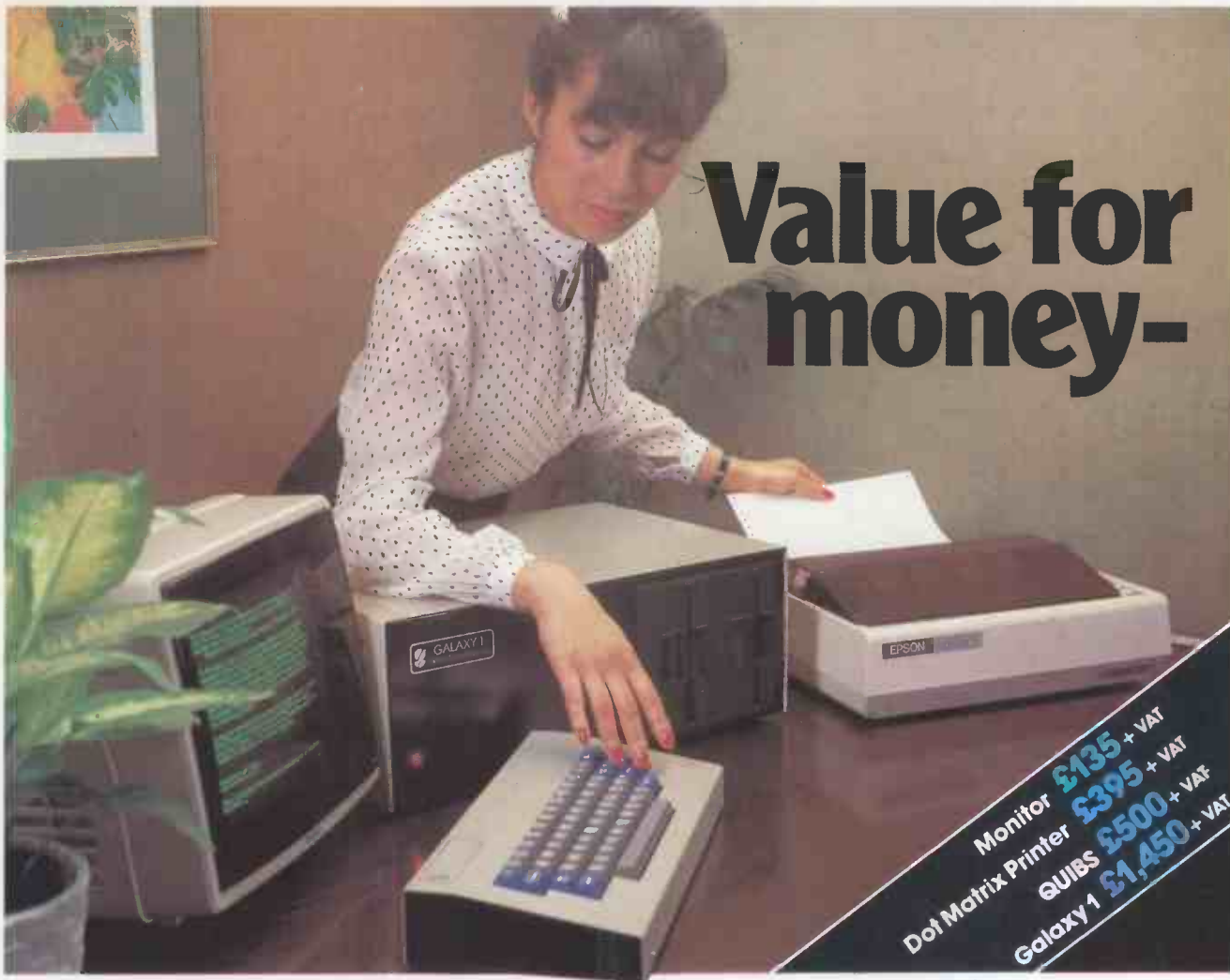

# Value for money-

Monitor £135 + VAT  
 Dot Matrix Printer £395 + VAT  
 QUIBS £500 + VAT  
 Galaxy 1 £1,450 + VAT

## in a word: MicroValue.

The Galaxy 1 computer utilises the widely acclaimed Gemini multiboard modules which make it one of the most reliable 2.2 CP/M computer systems on the market.

Do not be misled by the low price. Galaxy 1 has many standard features which are extra on computers costing twice the price.

Examples of this are: full on-screen editing, keyboard type ahead, serial printer driver, parallel printer driver, graphics both block and programmable, and 64K of user RAM.

Standard software with the Galaxy 1 includes COMAL 80, a high level language; a text editing package; a Z80

assembler; a Z80 disassembler and, of course, industry standard operating system: CP/M 2.2.

QUIBS, the business package offered for the Galaxy 1, has been especially written for the Gemini modules. The extremely low cost of £500 is available because of Gemini's high volume potential. This price is substantially lower than comparable software.

Please call your nearest MicroValue dealer for full information on the system.

Galaxy 1 is an all British product with a 12 month warranty (except Disc heads which are guaranteed for 3 months).

**MicroValue/Galaxy:  
 A complete business  
 system for less than**

**£2,500**

Includes all leads  
 plus 2,000 sheet  
 box of paper

### AMERSHAM, BUCKS.

Amersham Computer Centre Ltd.,  
 (formerly Interface Components Ltd.),  
 Oakfield Corner,  
 Sycamore Road.  
 Tel: (02403) 22307. Tx: 837788

### BRISTOL

Target Electronics,  
 16 Cherry Lane.  
 Tel: (0272) 421196

### BIRMINGHAM

Skytronics/MBM,  
 80 Bristol Street.  
 Tel: 021-622 6436

### EGHAM, SURREY

Electrovalue Ltd.,  
 28 St Judes, Englefield Green.  
 Tel: (0784) 33603. Tx: 264475

### LEEDS

Bits & PC's,  
 Leeds Computer Centre,  
 62 The Balcony,  
 Merrion Centre.  
 Tel: (0532) 458877

### LONDON W2

Henry's Radio,  
 404 Edgware Road.  
 Tel: (01) 402 6822. Tx: 262284  
 (quote ref: 1400)

### MANCHESTER

E.V. Computing,  
 700 Burnage Lane, Burnage.  
 Tel: (061) 431 4866

### NOTTINGHAM

Skytronics,  
 2 North Road, The Park.  
 Tel: (0602) 45053/45215

# MS-DOS v CP/M-86

'perfect' operating system should have: robustness and consistency. Robustness means that if the user does something wrong — say he tries to write to a write-protected disk — the operating system should recognise the error, give the user a useful error message ('That disk is write-protected, nerd!') and allow him

to correct the error quickly and easily. He should be able to recover from the error situation and continue with his applications program unhindered. Consistency means that the command syntax should always follow the same style, so that if he needs to use one of the system's more obscure commands — maybe one he's never used before, or has used very infrequently — he should be able to guess the correct syntax simply by using the same format as is required by all the other commands; there should be no unpleasant, difficult-to-remember exceptions to the command syntax and, as far as our upcoming band of naive users is concerned, the command language should be in something closely resembling English as she is spoke, rather than in terse, arcane abbreviations.

Such a 'perfect' system would have to be a fairly large piece of software, and there was never really any question of developing such a thing for 8-bit micros because they are limited to

64k of memory; there's not enough space to hold a big operating system and leave a sensible amount of room for a business package and its data. But 16-bit micros, with their much larger addressing capacity, do give us the room we need, especially as the price of memory is falling continually. Their increased processing power means that, although there would be a far greater amount of thrashing about to be done, the net result should still provide the end user with faster response times and a quicker-running programs than he currently gets with an 8-bit machine.

I have gone on at some length about the requirements of the naive computer user because, after all, it is he for whom the microcomputer is designed (a fact which seems to escape some hardware and software producers, even now). As I said earlier, nearly all business micros are — and will be in even greater numbers — sold to such users and it's up to the industry as a whole to give them what they need and want, not what some cloistered academic feels they ought to get or what some manufacturer decides is the cheapest and easiest thing to give them.

In the following comparison between MS-DOS and CP/M-86, then, I have very firmly taken the user's side. Although a good operating system should make life easier for the programmer too, to lower software development costs and development times, in the end it's the attractiveness or otherwise of the system to the user that's the most important consideration.

## On the surface

Both operating systems make no secret of their lineage: they both betray strong influences of CP/M-80 to the extent that it's frequently impossible to tell that you're using a 16-bit system. Many of the commands used by both systems are identical to those of CP/M-80, which is a mixed blessing indeed: anyone moving from CP/M-80 to either 16-bit system would find the transition easy but all the boring, awkward things are there too.

When first booted up, CP/M-86 behaves exactly like CP/M-80 and gives you the famous 'A>' prompt. MS-DOS asks for the date and time, for reasons I'll come to in a moment, and then gives the same prompt. This 'A>' prompt can be very confusing, especially in the environment in which I have been running both systems, a Sirius 1 equipped with a Z80 card to allow it to run CP/M-80 as well — three operating systems on one machine, all with the same prompt!

Typing DIR for a directory gives the first major difference. CP/M-86 displays exactly the same directory listing as CP/M-80, a list of file names across the screen and that's all — see Figure 1. MS-DOS is much more helpful, presenting a list of names, the exact size in bytes and the date and time each file was created or last altered, plus the total number of files on the disk — see Figure 2. This finer 'granularity' of MS-DOS is said to indicate that it uses the disk space more efficiently than CP/M-86, in which the minimum recognised file length is a rather hefty 2 kbytes. All this information is extremely useful and I can see no excuse for

|         |     |       |         |        |
|---------|-----|-------|---------|--------|
| COMMAND | COM | 5151  | 5-25-82 | 9:11p  |
| FORMAT  | COM | 16894 | 5-26-82 | 3:40p  |
| DCOPY   | COM | 15719 | 5-26-82 | 3:32p  |
| RDCPM   | COM | 11143 | 5-25-82 | 11:59a |
| MBASIC  | COM | 30720 | 5-20-82 | 2:13p  |
| CHKDSK  | COM | 1976  | 5-26-82 | 2:54a  |
| SETIO   | COM | 935   | 5-20-82 | 12:46a |
| EDLIN   | COM | 2304  | 8-04-81 |        |
| ARCHIVE |     | 0     | 1-01-80 | 12:09a |
| TO      |     | 30720 | 5-20-82 | 2:13p  |
| BASCOM  | COM | 39552 | 5-20-82 | 7:44p  |
| BASCOM  | LIB | 75264 | 5-20-82 | 7:48p  |
| BASRUN  | EXE | 20608 | 5-20-82 | 7:50p  |
| BASRUN  | LIB | 3072  | 5-20-82 | 7:52p  |
| DEMO    | BAS | 512   | 5-07-82 | 12:00a |
| LINK    | EXE | 41216 | 2-04-82 | 1:47p  |
| MP      | COM | 7781  | 5-20-82 | 7:13p  |
| MP      | LDD | 19840 | 5-20-82 | 7:07p  |
| MP      | HLP | 36224 | 5-16-82 | 5:14p  |
| MP      | SYS | 22656 | 5-20-82 | 7:10p  |
| MP      | DAT | 6272  | 5-20-82 | 7:15p  |

Fig 2

|    |          |     |   |          |     |   |          |     |   |         |     |
|----|----------|-----|---|----------|-----|---|----------|-----|---|---------|-----|
| A: | FBASIC66 | CMD | : | MAILMRGE | OVR | : | WS       | CMD | : | SUBMIT  | CMD |
| A: | FORMAT   | CMD | : | WSM565   | OVR | : | FIXLABEL | CMD | : | DDT86   | CMD |
| A: | WS       | KEY | : | FRED     | KB  | : | TIME     | CMD | : | WSQVLY1 | OVR |
| A: | code     | BAS | : | EDIT     | SUB | : | PRINT    | SUB | : | SET     | CMD |
| A: | DIAB66   | CMD | : | CARDBOX  | COM | : | EDIT     | BAK | : | FRED    | KEY |
| A: | DCOPY    | CMD | : | STAT     | CMD | : | BOOTCOPY | CMD | : | ERIC    | KEY |
| A: | ERIC     | KB  | : | PIP      | CMD | : | ASMB6    | CMD | : | GENCMD  | CMD |
| A: | ALLOC    | CMD | : | 1320     | CMD | : | UDCCALC  | CMD | : | BASIC   | CMD |
| A: | SETKEY   | CDE | : | TEMP     | BAS | : | KEY      | BAS | : | KEYGEN  | BAS |
| A: | CEDIT    | BAS | : | SETKEY   | BAS | : | NEWSYS   | COM | : | B6      | COM |
| A: | STAT     | COM | : | PIP      | COM | : | ASM      | COM | : | DDT     | COM |

Fig 1

|                                |   |
|--------------------------------|---|
| dir                            | Display directory of disk in default drive                                    |
| dir d:                         | Display directory of disk in named drive                                      |
| dir filename.ext               | Search for named file on disk in default drive                                |
| dir d: filename.ext            | Search for named file on disk in named drive                                  |
| dir *.ext                      | Search for files with named extension on default drive                        |
| dir filename.*                 | Search for all named files with any extension on default drive                |
| dir x????????.*                | Search for all filenames beginning with x with any extension on default drive |
| era filename.ext               | Erase named file on default drive   |
| era d: filename.ext            | Erase named file on named drive   |
| era *.*                        | Erase all files on default drive  |
| era *.ext                      | Erase all files with named extension on default drive                         |
| era filename.*                 | Erase all named files with any extension on default drive                     |
| ren newname.ext=oldname.ext    | Rename file on default drive  |
| ren d: newname.ext=oldname.ext | Rename file on named drive  |
| type filename.ext              | Display the named file on default drive                                       |
| type d:filename.ext            | Display named file on named drive   |

Fig 3 CP/M-86 intrinsic commands

|          |   |
|----------|---|
| bootcopy | Copies the operating system from the system sectors of one disk to those of another   |
| dcopy    | Copies entire contents of disk in one drive to disk in another, simultaneously formatting the second disk if necessary  |
| format   | Formats disk  |
| pip      | Similar to CP/M-80's PIP but more powerful than MS-DOS's intrinsic copy command as it can copy files to the console or other peripheral device as well as having concatenation capabilities                                       |
| stat     | Also similar to corresponding CP/M-80 command — displays information about files on a disk and space remaining but also allows different devices to be configured to the computer, eg, a serial printer instead of a parallel one |
| submit   | Batch processor which takes a list of commands in a prepared file and executes them sequentially  |

Fig 4 CP/M-86 utilities



Digital Research's failure to provide a similar facility in CP/M-86; it would be even nicer if MS-DOS also indicated how much disk space was occupied and how much was left free. Typing 'DIR/P' with MS-DOS gives a paged version of the directory — the listing stops when a screenful has been presented and prompts you to press any key to list the next screenful when you're ready.

Both systems have wildcard capabilities in the DIR command: typing 'DIR \*.BAS' will display only those files with the '.BAS' extension in both systems. And both allow the use of '?' to match any character in a filename, so that DIR BANK???.\* will display all files beginning with BANK and having three other letters in their names, such as BANKERS, BANKING, etc.

Programs which are executable directly from the operating system (ie, those which have been written in assembler language or compiled) are fired up merely by typing their name. Under CP/M-86 these programs have the extension '.CMD' while MS-DOS sticks to the original CP/M convention of '.COM'.

An interesting and demi-useful feature of MS-DOS is its 'template'. When a command (such as a program name) is typed in at the keyboard and the return key is pressed, the command is copied into an area of memory called the template. A series of editing commands is available, actioned by pressing the escape key followed by a letter, which allows you to insert or delete characters within the template and to copy the template back into the command line. This means that a complicated command such as COPY A:PROGNAME.BAS B: PROGNAME.BAS can be altered to COPY A: PROGNAME.COM B: PROGNAME.COM without the whole line having to be re-typed, although, personally, I found the sequence of commands to do this just a little tedious. The sequence ESC U copies the entire template into the command line, allowing you to repeat a command with just two keystrokes. A rather pointless limitation with the template facility is that the letter following the ESC must be typed in upper case; this is particularly silly as MS-DOS accepts commands in either upper or lower case and is annoying on the Sirius as its keyboard is always in lower case when the system is first fired up.

Both systems allow you to 'edit' the command line itself, although, frankly, neither are particularly easy to use and I generally find myself using only the CTRL-X feature, found on both, which simply deletes the entire line and allows you to try again. Typing a non-existent program name produces a 'Bad command or file name' error message from MS-DOS, while CP/M-86 merely repeats what you typed (translated into upper case if you had typed in lower) followed by a '?' and the prompt.

A major source of irritation (to me, at least) with CP/M-80 is the requirement to type CTRL-C whenever a new disk is inserted. This is done because the operating system maintains a 'map' of the disk in memory and, if a new disk is inserted without CTRL-C being typed to tell it what's happened, the system gets horribly confused when it tries to access the new disk and finds

|                               |   |
|-------------------------------|---|
| Copy fs                       | Copy file onto default drive  |
| copy fs1 fs2                  | Copy first file onto second file  |
| copy fs1+fs2 fs3              | Copy first and second files onto third file                                     |
| copy/b fs1+fs2                | Copy first and second binary files onto first file                              |
| copy fs1/b+fs2/a fs3/b        | Copy first binary and second ASCII files onto third binary file                 |
| copy fs1/a fs2                | Copy first file up to first embedded CTRL-Z onto second file                    |
| copy *.ext fs                 | Copy first file group onto second file  |
| copy *.ext1 *.ext2            | Copy files with extensions matching first onto second file group                |
| date                          | Display date  |
| date mm-dd-yy                 | Set new date  |
| del fs                        | Delete named file   |
| del *.ext                     | Delete all files with matching extensions                                       |
| del d:filename.*              | Delete all files on named drive with matching name regardless of extension      |
| dir                           | Display directory of disk in default drive                                      |
| dir d:                        | Display directory of disk in named drive  |
| dir fs                        | Display directory entry for named file  |
| dir x??????.*                 | Display directory entries for all files starting with x regardless of extension |
| pause                         | Suspend execution of batch file   |
| pause (comment)               | Suspend batch file execution and display comment                                |
| rem (comment)                 | Display comment during batch file execution                                     |
| ren oldname.ext newname.ext   | Rename file on default drive  |
| ren d:oldname.ext newname.ext | Rename file on named drive  |
| ren d:*.ext1 *.ext 2          | Change extensions of all the files with ext1 on named drive to ext2             |
| time                          | Display time  |
| time hh:mm                    | Set time — hour and minute  |
| time hh:mm:ss                 | Set time — hour, minute and second  |
| type fs                       | Display named file  |

Note: fs = file specifier, made up of optional drive name, a file name of up to eight characters and an optional extension

Fig 5 MS-DOS intrinsic commands

|        |   |
|--------|---|
| chkdsk | Gives details of disk and system memory status — how much used, how much remaining  |
| dcopy  | Copies entire disk onto another, formatting second disk if necessary  |
| format | Formats a disk, with option soft error reporting and optional automatic creation of system on second disk   |
| rdcpm  | Transfer a CP/M file from a CP/M disk onto an MS-DOS disk. Of course this is for data files only — it doesn't automatically translate a CP/M-86 program into an MS-DOS program! |

Fig 6 MS-DOS utilities

its contents don't match the 'map'. Very regrettably, CP/M-86 also demands new disks to be logged in with CTRL-C. MS-DOS, on the other hand, is rather more clever: it detects the opening of a disk drive door and automatically logs on the new disk, so there's no need for the user to bother about telling the system what he's done.

It's of paramount importance to make back-up copies of everything you keep on a disk and an operating system should provide a quick and easy way to do this. These two go about it in different ways. CP/M-86 adheres to CP/M-80 practice by providing a utility program called PIP (Peripheral Interchange Program). Calling this program with a command such as PIP A:filename=B:filename will copy a file from the disk in drive B to the one in drive A. Wildcard characters can be introduced, as described in the DIR command above, so that PIP B:=A:\*.BAS will copy all files with the '.BAS' extension from drive A to drive B. Files can also be renamed as they are transferred: PIP B:newname=A:oldname.

PIP is in fact much more than just a file-copying utility, for files can be transferred to other devices, such as the screen or printer, by inserting the appropriate device names instead of destina-

tion files, such as PIP LST:=B:filename, which would send the file to the printer. Additionally, there's a whole host of parameters which can be tagged onto the end of the command line to do things such as verifying after transfer (for disk transfers only), converting ASCII files from lower to upper case, stripping out form feeds and inserting them after a specified number of lines have been sent.

MS-DOS has no direct equivalent of PIP and approaches the back-up facility in a different way. A command called COPY is built into MS-DOS (rather than being a separate program, as is PIP) but is far less versatile than PIP, although its syntax is rather friendlier. COPY A:filename B:filename transfers the file from the A drive to the B drive — note that the syntax is exactly the opposite to that of PIP! Files can be renamed and concatenated and Cromemco's similar XFER function, for a renamed and concatenated as they are transferred. Having used PIP on CP/M-80 machines, and Cromemco's similar XFER function, for a long time, I found COPY a little awkward to get used to, mainly because of the source-destination reversal in its syntax; other users with no previous CP/M convictions have found it far

# MS-DOS v CP/M-86

easier to use than PIP and certainly the word 'copy' makes a lot more sense to the naive user than 'PIP'.

Syntax reversal also takes place with the command to rename (without transferring) files: REN B:oldname newname for MS-DOS, REN B:newname=oldname for CP/M-86 to change the name of a file on drive B. File deletion is carried out with DEL filename for MS-DOS and ERA filename with CP/M-86; both renaming and deletion can be used with wildcards on both systems. Wildcards can be rather dangerous when deleting files so both operating systems trap any attempt to delete everything on a file using DEL \*.\* or ERA \*.\*. CP/M-86 rather tersely asks 'ALL (Y/N?)' while MS-DOS produces a genteel 'Are you sure (Y/N)?' In both cases, typing 'n' aborts the command, leaving your files intact.

While on the subject of messages, I should mention what happens when you try to write to a write-protected disk. True to its ancestry, CP/M-86 gives an expanded — but just as useless — version of the now-infamous 'BDOS err on B: Bad sector' message. MS-DOS is slightly better, with 'Disk error writing drive B Abort, retry ignore'. Neither matches my Cromemco's 'Diskette in drive B is write-protected' message under the same circumstances.

Both operating systems have a TYPE filename command which simply throws the contents of an ASCII file onto the screen and, optionally, to the printer too.

MS-DOS has two additional built-in commands for which there are no CP/M-86 equivalents, TIME and DATE. These display the time and date respectively and offer you the chance to update them if required. You can set both as part of the command line by typing, for example, DATE MM-DD-YY; note the American date format which, irritatingly, is compulsory.

## Other utilities

Both operating systems come with very comprehensive utilities to configure the operating system to your particular needs, such as catering for parallel or serial printers and — for the Sirius — defining character sets and keyboard layouts. Additionally, both systems have a number of other utility programs for performing various 'house-keeping' functions.

Both have a FORMAT program to format new disks and in both cases this can optionally display a report of any faults encountered during the formatting process. The MS-DOS FORMAT program will also, if the option is selected, place a copy of the operating system on the newly-formatted disk. CP/M-86 has a separate program called BOOTCOPY to do this.

Both also have a program called DCOPY which will copy the entire contents of a disk from one drive to another, including the systems tracks, and both will format the destination disk automatically if necessary. This provides a very hand and quick method of taking a backup copy and in both cases you have the choice of

typing DCOPY A: to B: to do it automatically or just DCOPY, which will load the program and prompt you for source and destination drives, giving you the chance to insert a fresh source disk to be copied if required.

The powerful STAT program has been transferred from CP/M-80 to CP/M-86. This allows you to check the amount of space left on a disk, to list the files on a disk alphabetically with a report on their lengths and to change certain features of the operating system; the latter facility allows you to, for example, change the default system printer from a parallel to a serial unit with STAT LST:=LPT:. STAT is a little like PIP in terms of its power and extent and once again there isn't a direct equivalent in MS-DOS. There is a CHKDSK command to give a summary of a disk's space allocation and, of course, file sizes are shown in the DIRectory listing.

Both systems allow you to set up batches of jobs to be done. A text file is written with a word processor or line editor, containing a list of programs to be executed in the order in which they are to be run. To be recognised as a batch file, this must have the extension '.BAT' for MS-DOS and '.SUB' for CP/M-86.

CP/M-86 requires a special program called SUBMIT to run a batch file; you simply type 'SUBMITfilename' and the commands are executed in sequence. However, the disk containing SUBMIT must not be write-protected as SUBMIT creates a temporary file on disk while it's working. Batch processing is much simpler under MS-DOS: the batch processing software is built into the operating system and one merely types the name of the batch file for it to be executed. If the disk contains a file called AUTOEXEC.BAT, this will be executed automatically on boot-up, over-riding the automatic requests for time and date.

## Performance

As both operating systems are single-user, single-tasking systems, there isn't a great deal to say about their performance, except in the area of disk handling. Here, MS-DOS seems to be noticeably quicker than CP/M-86 although lack of time has prevented my running a series of benchmark programs to show just how much faster it is. I did, however, time the loading of Microsoft's Basic 5 interpreter under both systems, in each case from a disk which was otherwise empty. Under CP/M-86 this took an average 4.8 seconds while MS-DOS took 2.1 seconds. Using a variety of other packages, such as Wordstar under CP/M-86 and Multiplan under MS-DOS, I certainly seemed to spend less time waiting around for disk access with MS-DOS than with '86, although until Wordstar becomes available under MS-DOS, I won't be able to quantify this different, either.

## Documentation

As I was using both systems on a Sirius, I had the Sirius manuals to both systems.

These were user's guides and explained all the facilities of each system thoroughly, with examples, and with excellent use of typography to clarify things.

I have seen very early versions of the CP/M-86 programming guide and these seemed slightly better than Digital Research's previous attempts at documentation. Despite a couple of letters and phone calls to Microsoft, I have not yet managed to get my hands on any 'official' MS-DOS documentation and therefore cannot comment on it.

Programmers will certainly need further information on both systems before they can get to grips with them. I understand the documentation is now ready in its final form for CP/M-86 and full programming aids including an assembler and debugger — in fact precisely the same tools as are provided with CP/M-80 — are now available for CP/M-86. Curiously, Microsoft seems to have taken its time to produce an MS-DOS assembler but I'm told this has now been done and will be available very shortly. Several companies are already offering high-level language compilers for both systems — Microsoft has produced a Basic compiler for MS-DOS and there are Pascal, Cobol and C compilers out now for both systems.

## Conclusions

My main aim in investigating these two operating systems has been to see how closely or otherwise they approach the 'perfect' operating system outlined earlier. I must state now that neither come anywhere near this standard but that's not too surprising, given their ancestry and the current newness of 16-bit microcomputers. It will take a while for somebody to develop the 'perfect' system and even longer for it to become recognised as such and adopted as a standard, by which time of course we'll be ankle-deep in 32-bit machines and gigabytes of RAM!

For users graduating from CP/M-80 micros, CP/M-86 will of course be the more familiar of the two. This means that the simplicity of CP/M-80 has been retained but so also have its bad points, especially its very unhelpful user interface. A 'Help' facility is supposed to be on its way to supplement CP/M-86 in some way, but I'm not sure at the moment whether this will be integrated into a new version of the system or supplied as a separated, but linked, text file; I suspect the latter.

MS-DOS is certainly friendlier than CP/M-86 and definitely gives faster disk handling. It incorporates sensible error messages (well, much more sensible than CP/M-86) and generally feels a lot more robust and easier to use.

Of the two, then, I found MS-DOS the nicer to use. At present there seems to be less in the way of applications software available to run under it than is currently up and running under CP/M-86 — but I expect this situation to change pretty quickly as more and more software for the IBM Personal Computer becomes available on this side of the Atlantic and, of course, as more machines running MS-DOS appear.

END



INDEPENDENT NATIONAL USER  
GROUP FOR THE BBC MICRO



REGISTERED REFERRAL CENTRE  
FOR THE BBC PROJECT

DEVOTED EXCLUSIVELY  
TO THE BBC  
MICROCOMPUTER

# BEEBUG FOR THE BBC MICRO

CURRENT MEMBERSHIP  
EXCEEDS 9000

BRITAIN'S LARGEST SELLING SINGLE-MICRO USER GROUP

IF YOU OWN A BBC MACHINE, OR HAVE ORDERED ONE,  
OR ARE JUST THINKING ABOUT GETTING ONE, THEN YOU  
NEED BEEBUG.

BEEBUG runs a regular magazine devoted exclusively to the BBC  
Micro (10 issues per year).

Latest News on the BBC project.

What you should know before you order a machine.

New program listings, regular advice clinic, and hints and tips pages  
in each issue.

**April Issue:** 3D Noughts and Crosses, Moon Lander, Ellipse and 3D  
Surface.

Plus articles on Upgrading to Model B, Making Sounds, and  
Operating System Calls.

**May Issue:** Careers, Bomber, Chords, Spiral and more. Plus articles  
on Graphics, Writing Games Programs, and Using the Assembler.

**June Issue:** Mazetrap, Mini Text Editor, Polygon; plus articles on  
upgrading, The User Port, TV set and Monitor review, Graphics part II,  
More Assembler Hints, Structuring in BBC Basic, plus BBC Bugs.

**July Issue:** Beeb Invaders and other programs plus articles on  
mode 7 graphics, BBC cassette bugs fix, software review, Using  
user defined keys, More on Structuring in Basic, Using the user  
port, and many hints and tips.

PLUS Members discount scheme on books and hardware. AND Members Software library - Low price programs including:  
Starfire, Splat the Rat, Mindbender, Shape match, Moon lander, disassembler, character define graphics aid, Magic worm, Superplot.

Membership: Send SAE for information or;  
6 months - £4.90 Send £1.00 and A4 SAE for sample.  
1 year - £8.90 Europe 1 year £15.00

Make cheque to BEEBUG and send to:  
BEEBUG, Dept 6 374 Wandsworth Road.  
London SW3 4TE

For editorial material send to: The Editor, BEEBUG, P.O. Box 50, St. Albans, Herts AL1 1AR

# Turn to Computer Plus

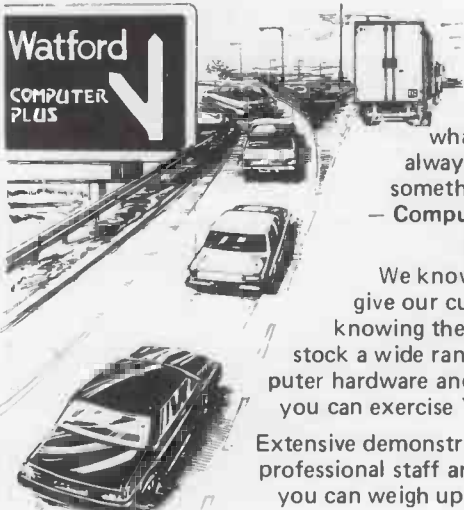

If you're used  
to the kind of  
dealer who  
rarely has exactly  
what you need, but is  
always ready to sell you  
something nearly as good  
- Computer Plus will make  
a pleasant change.

We know our business and  
give our customers credit for  
knowing theirs. That's why we  
stock a wide range of leading computer  
hardware and software, so that  
you can exercise YOUR judgement.

Extensive demonstration facilities and  
professional staff are on hand, so that  
you can weigh up specifications and  
make comparisons.

We have excellent sales back up service and credit  
facilities for our customers.

When you turn to Computer Plus you can be sure you have  
taken a turn in the right direction.

COMPUTER PLUS, 47 QUEENS ROAD, WATFORD  
TELEPHONE: WATFORD 33927

The only thing we discount is the price.

- CREDIT FACILITIES (SAME DAY POSSIBLE)
- AFTER SALES SERVICE
- MAIL ORDER
- EXPORT

**M. O'BRIEN**  
MICROCOMPUTER DISCOUNTS  
01 946 1528/0331

95 High Street  
Wimbledon Village  
London S.W.19  
93 BUS ROUTE  
Open 9.00 am - 5.30 pm  
Tuesday/Saturday  
Closed all day Monday  
Free postage V.A.T. and  
insurance. They are  
responsible for damaged  
goods. Insurance.

## Apple computer

APPLE II 48K £669  
DISK II (WITH CONTROLLER) £314  
DISK II (W/O CONTROLLER) £285

## APPLE III £2150

Computer plus Video Monitor III and  
information Analyst Software Package  
comprising of: VisiCalc™ III, The  
Apple Sophisticated Operating System  
(SOS) and Apple Business BASIC  
Language.  
Additional Disk Drive III £1319

## TABS

Software  
Foundation Module £82  
Sales Ledger £165  
Purchase Ledger Module £165  
Nominal Ledger Module £165  
Stock Control Module £165

## PERSONAL SOFTWARE

APPLE VISICALC £107  
APPLE VISIDEX £107  
APPLE VISIPILOT £97  
APPLE VISITREND/PLOT £137  
APPLE VISITERM £80  
APPLE VISIFILE £137

## VIC-20

ONE FREE GAMES  
CARTRIDGE  
WITH EVERY  
VIC-20 CPU

|                         |         |                               |        |                                |        |
|-------------------------|---------|-------------------------------|--------|--------------------------------|--------|
| VIC 20 CPU              | £173.90 | VIC 8K RAM Cartridge          | £39.09 | 'Super Slot' ROM Cartridge     | £17.35 |
| VIC C2M Cassette Unit   | £39.09  | VIC 16K RAM Cartridge         | £65.17 | 'Jelly Monsters' ROM Cartridge | £17.35 |
| VIC Printer             | £200.00 | VIC Programmers Aid Cartridge | £30.39 | 'Alien' ROM Cartridge          | £17.35 |
| VIC Single Drive Floppy | £344.35 | 'Avenger' ROM Cartridge       | £17.35 | 'Super Lander' ROM Cartridge   | £17.35 |
| VIC 3K RAM Cartridge    | £26.04  | 'Star Battle' ROM Cartridge   | £17.35 | 'Road Race' ROM Cartridge      | £17.35 |

ALL PRICES EXCLUSIVE OF VAT

# PCW SUBSET

```

VECT: EQU X ;Location of interrupt vector in
; RAM (2 bytes)
RTIM: EQU X ;Location of 4-byte time storage
CTCO: EQU X ;CTC port on channel 0
CTCN: EQU X ;CTC port free
ON: PUSH HL ;Save registers E5
PUSH AF ; F5
IM 2 ;280 vector mode ED 5E
LD A,VECT/256 ;Initialise I with 3E XX
LD I,A ; top byte of vector ED 47
LD HL,ISR ;Initialise vector with 21 YY YY
LD (VECT),HL ; address of ISR 22 XX XX
LD A,VECT ;Send low byte of 3E XX
OUT (CTCO),A ; vector to CTC D3 XX
LD A,85H ;Initialise CTC 3E 85
OUT (CTCN),A ; in timer mode D3 XX
LD A,250 ;For 4 MHz sys or 125 3E FA
; for 2 MHz sys
OUT (CTCN),A ; D3 XX
POP AF ;Restore registers
POP HL ;
RET ; C9
;
ISR: EI ;Re-enable interrupts FB
; interrupt response
PUSH HL ;Save registers E5
PUSH AF ; F5
LD HL,RTIM ;Start (LSD) of time 21 XX XX
INC (HL) ;Incr time 34
INC HL ;Point to next digit 23
JR Z,LOOP ;Incr next digit if carry 28 FC
POP AF ;Restore registers F1
POP HL ; E1
RETI ;Return from interrupt ED 4D
;
OFF: PUSH AF ;Save AF F5
LD A,+3 ;To internally reset CTC 3E 03
DI ;Prevent spurious ints F3
OUT (CTCN),A ; D3 XX
EI ;Re-enable interrupts FB
POP AF ; F1
RET ; C9
;
CLEAR: PUSH HL ; E5
LD HL,+0 ;Zero RAM 21 00 00
LD (RTIM),HL ; 22 XX XX
LD (RTIM+2),HL ; 22 XX XX
POP HL ; E1
RET ; C9
;
READ: DI ;Prevent time changing F3
; while being read
LD HL,(RTIM) ;Get low word 2A XX XX
LD DE,(RTIM+2) ;Get high word ED 5B XX XX
EI ;Re-enable FB
RET ; C9

```

## 6502 arithmetic

Continuing Vincent Fojut's improvements to the 6502 arithmetic routines, we have ABS4, to get the absolute values for 32-bit numbers and SMUL46, the 32-bit multiplication.

Before looking at these, I remind you that, for 6502 code, Sub Set routines have 16 bytes of zero-page RAM reserved for them, designated M0 - MF in the mnemonics and ZZ in the machine code. For this suite of routines, the first accumulator is in M0 - M3, the second in M4 - M7 and the third in M8 - MB. MC - MD points to ASCII strings, ME holds the sign of the product of the second and third accumulators and MF is available as a temporary store.

The original ABS4 (April '82) got the absolute values

of the second and third accumulators, after moving them into the first accumulator. Vincent restructures this into two subroutines; a lower level one, ABSNEG, to deal with a 32-bit value without moving it, and the controlling one, ABS4. While functionally the same as the original, the new routines save 20 bytes and 242 T-states as well as a zero page storage location but make use of the Y register, which the original left untouched.

To save space, I have put ABS4 and ABSNEG together but, outside the magazine publishing world, they should be held and documented separately, since ABSNEG has wider application than its use by ABS4.

```

;/INTERFACES: None
;/INPUT: Multiplicand in M8-MB, multiplier in M4-M7 with the
;/ mostly significant bytes in MB & M7
;/OUTPUT: No error: product in M0-M3; M4-M7=zero; M8-MB
;/ contains the absolute multiplicand; carry is reset
;/ Overflow: carry set; all 3 accs indeterminate
;/REGS USED: A,X,Y,P,M0-MB,ME
;/STACK USE: 4
;/LENGTH: 63
;/T-STATES: Min 1756, max 4134
;/PROCESSOR: 6502
;
SMUL46:JSR ABS4 ;Get abs values & product 20 XX XX
STX M0 ; sign, zeroise 86 ZZ
STX M1 ; accumulator 86 ZZ
STX M2 ; withX 86 ZZ
STX M3 ; = 0 86 ZZ
LDY £+32 ;Bit count A0 20
SML1: ASL M0 ;Shift 06 ZZ
ROL M1 ; left 26 ZZ
ROL M2 ; accumulator 26 ZZ
ROL M3 ; 26 ZZ
BMI OVFW3 ;Jump if 30 26
BCS OVFW3 ; overflow 80 24
ASL M4 ;Get next 06 ZZ
ROL M5 ; bit of 26 ZZ
ROL M6 ; multiplier 26 ZZ
ROL M7 ; into carry 26 ZZ
BCC SML3 ;Skip if bit is a 0 90 0E
LDX £-4 ;Using negative A2 FC
CLC ; indexing 18
SML2: LDA M0+4,X ; add byte in acc B5 ZZ
ADC M8+4,X ; to multiplicand 75 ZZ
STA M0+4,X ; & store in acc 95 ZZ
INX ; E8
BMI SML2 ;Continue if X = 0 30 F7
BVS OVFW3 ;Jump if overflow 70 0C
SML3: DEY ;Repeat 88
BNE SML1 ; 32 times 00 09
BIT ME ;Test product sign 24 ZZ
BPL SML4 ;Skip if positive 10 03
JSR SNEG46 ; else negate 20 XX XX
SML4: CLC ;Clear carry to show OK 18
RTS ; 60
OVFW3: SEC ;Set carry to show error 38
RTS ; 60

```

In the multiplication, storage location and, in the negative indexing at SML2, worst possible case, 1013 T-states saves eight bytes, a zero page

## Datasheet

```

;=ABS4 - Get absolute values of two 4-byte numbers
;/CLASS: 2
;/TIME CRITICAL? No
;/DESCRIPTION: Gets abs value of two 32-bit accumulators
;/ in page zero of RAM, leaving X=0 & the sign of
;/ product of the accumulators in ME
;/ACTION: Exclusive OR the most sig bytes of the accs & store
;/ in ME. Point to each acc in turn & call ABSNEG to
;/ negate if necessary
;/SUBR DEPENDENCE: Local ABSNEG
;/INTERFACES: None
;/INPUT: 2nd (M4-M7) & 3rd accs, which are 32-bit signed numbers
;/ with their most sig bytes in M7 & MB
;/OUTPUT: 2nd & 3rd accs contain their absolute values; X=0;
;/ ME has sign of the product of the 2nd & 3rd accs
;/REGS USED: A,X,Y,P,M4-M7,M8-MB,ME
;/STACK USE: 2
;/LENGTH: 37
;/TIME STATES: 33+2*ABSNEG t-states (83 when a number neg,
;/ 13 when positive
;/PROCESSOR: 6502
;
ABS4: LDA M7 ;Get 2nd acc sign & A5 ZZ
EOR MB ; XOR with 3rd acc sign 45 ZZ
STA ME ;Store in ME 85 ZZ
LDX £M4 ;Set pointer to 2nd acc & A2 ZZ
JSR ABSNEG ; negate if necc 20 YY YY
LDX £M8 ;Set up pointer to 3rd acc A2 ZZ
JSR ABSNEG ; & negate if necc 20 YY YY
LDX £+0 ;Zeroise X A2 00
RTS ; 60
;
ABSNEG: LDA O3,X ;Get msb of acc B5 03
BPL EXIT ;Exit if positive 10 00
LDY £+4 ;Initialise counter A0 04
SEC ;Prepare to subtract with no 38
ABNG1: LDA £+0 ; borrow. Subtract A9 00
SBC O0,X ; accumulator F5 00
STA O0,X ; from 95 00
INX ; zero E8
DEY ;Decr counter 88
BNE ABNG1 ;Continue if not = 0 00 F6
EXIT: RTS ; 60

```

## Datasheet

```

;=SMUL46 - 32-bit signed integer multiply
;/CLASS: 2
;/TIME CRITICAL? No
;/DESCRIPTION: Multiplies two 32-bit signed integers in M4-M7
;/ & MB-MB
;/ACTION: Get product sign & absolute values of arguments
;/ Clear accumulator
;/ Multiply accumulator by 2 & check for overflow
;/ Get next bit & if it's 1 add multiplicand to acc &
;/ check for overflow
;/ Repeat 32 times
;/ Negate if product sign minus

```

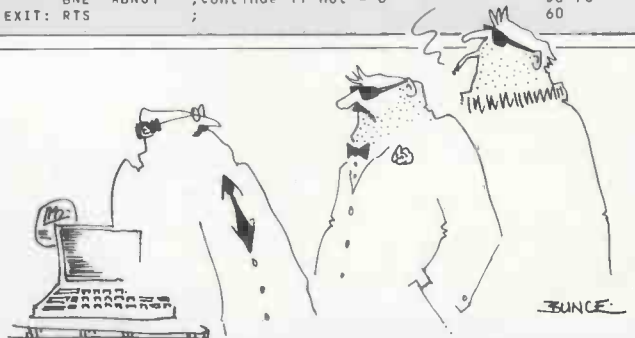

'Afternoon, John. We're looking for a display screen capable of producing three-dimensional trajectories based on the architectural ground plans of, say... any Midland Bank.'

**SUBSCRIBE TO PCW**

# "JUST SKIMMED THE LAST THREE ISSUES AND FOUND THEM FASCINATING..."

Arthur C Clarke



It's amazing what goes on in the basement of *Personal Computer World*. Our erstwhile subscriptions manager, for example, engaging in correspondence with Arthur C Clarke! (For the uninitiated few, ACC is arguably one of the world's most visionary living individuals: a scientist, author of 2001: A SPACE ODYSSEY and 60 or so other works, originator of communications satellites, undersea explorer, etc, etc).

Mr Clarke tells us that he has an Apple II 'languishing in the lab. . . too busy to touch it for weeks'. Busy, apparently, completing SPACE ODYSSEY two ('my latest, last book!') on his Archie word processor (Archives III, 5 megabyte Winchester disk, Wordstar program) with which he is obviously deeply satisfied — 'I could no more imagine going back to a typewriter than to a slide rule. . .'.

We make no bones about our delight that Mr Clarke takes the trouble to write to us from his home in Sri Lanka and comment on *Personal Computer World* so favourably. As a subscriber to PCW, not only will you save a small fortune (see the rates below) but you can count yourself in august company. Remember that Clive Sinclair described PCW a short while ago as 'clearly one of the leading computer journals in the world'.

Well, that's always been our aim. And if it's true that a person is known by the company he keeps, you could do a great deal worse than fill in the coupon on the right hand side of this page. You won't even need to put a stamp on your envelope. . . unless you live in Sri Lanka, that is!

**For a limited period only, here are the special offer rates for a subscription to Britain's largest selling microcomputer publication.**

|   |        |  |
|---|--------|--|
| <b>1</b> Year Subscription<br>(U.K. only) | £11.50 | (We will send you two free issues at the end of your subscription before reminding you to renew. You get 14 issues for the price of 12 issues if you subscribe now!)   |
| <b>2</b> Year Subscription<br>(U.K. only) | £19.50 | (You receive 24 issues, saving yourself £3.50 off the full current subscription price. Plus you protect yourself against future increases in cover prices and postal rates which will probably amount to a saving of £5.00 over the period.) |
| <b>3</b> Year Subscription<br>(U.K. only) | £29.50 | (You receive 36 issues, saving yourself £5.00 off the full current subscription price. Plus you protect yourself against future increases in cover prices and postal rates which will probably amount to a saving of £7.00 over the period.) |

#### PLUS

We have now arranged for special 'first-off-the-press' copies to be mailed direct to subscribers which will ensure that they arrive either on the same day or one or two days in advance of national distribution in the U.K.

#### PLUS

Existing subscribers can take advantage of any of the offers above. Just tick the 'this is an extension subscription' box on the coupon and enclose your payment. The additional copies will be added to your existing subscription automatically. You do not have to wait until it is time to renew (by which time this offer will probably have been withdrawn). Save money by extending your subscription today!

#### PLUS

We have completely reorganised our Subscriptions Department and any problems, change of address, special requests etc. etc. will be promptly dealt with by an extremely 'user-friendly' human being should you need to write to us.

#### PLUS

We send subscription copies of PCW in a tough polythene wrapper. It will reach you promptly every month, unfolded and in good condition.

#### PLUS

You can pay for your subscription to PCW by cheque, postal order or by using Barclaycard (Visa)/American Express or Access. And you don't even need a stamp for your envelope. Use the coupon on the right.

## Why do more people read PCW than any other microcomputing magazine in Europe? Subscribe today!!

# PREMIER BUSINESS SYSTEMS

## PREMIER WORD PROCESSOR PACKAGES

Premier offer a wide range of WP packages for the hobbyist, school user and small businessman, starting from as little as £370. All are based on our phenomenally successful WORD4WORD word processor which was our top-selling business program in 1981 and has had even more facilities added for 1982! Some of the packages use the EPSON MX80 F/T, the world's best-selling and most reliable dot-matrix printer we have ever sold.

WP6 uses a top quality, highly versatile daisywheel printer which gives a superb quality output and, using a special version of WORD4WORD PLUS, also gives true proportional spacing, right justification, bold print, underlining etc. This package has been developed especially for the small businessman/school user and breaks new boundaries in price/performance. It uses WORD4WORD SUPER PLUS, which features all the facilities of W4W, plus extensive file building and retrieval routines. The system is on permanent display in our showrooms.

The WORD4WORD supplied makes full use of the above features, and gives true proportional justification, whether the text is a letter or a series of columns. All disc-based packages are supplied with DOSPLUS and comprehensive file-handling.

|   |          |
|---|----------|
| WP1 W4W PLUS, GENIE II with numeric keypad                    | £369.95  |
| WP2 W4W PLUS, GENIE II EPSON MX80F/T2 PRINTER all cables      | £759.95  |
| WP3 W4W PLUS, 48K GENIE 40 track disc drive DOSPLUS MX80 F/T2 | £1245.00 |
| WP6 W4W PLUS, GENIE II, disc drive and a daisywheel printer   | £2282.75 |



### MAIN GENIE DEALER

Premier Publications now offer the FULL range of Genie equipment, including expander boxes, disc drives and video monitors for the Genie and TRS-80 I/III range. Sample prices .....

|                               |             |
|-------------------------------|-------------|
| GENIE I with FREE TOOLKIT II  | £319.95 inc |
| GENIE II with FREE TOOLKIT II | £342.95 inc |
| 40 track disc drive (EG400)   | £229.95 inc |
| Twin 40 track drives          | £379.95 inc |
| 32K Expander Box (EG3014)     | £224.95 inc |
| 12 inch black & white monitor | £69.95 inc  |
| 9 inch high quality monitor   | £92.00 inc  |
| Parallel Printer Interface    | £37.95 inc  |

### WORD4WORD PLUS

STUNNING NEW TRS-80/IVG WORD PROCESSOR

WORD4WORD PLUS comfortably outperforms Word Processors costing many times its price. Some of its long list of features are:

- Full screen editing & two way scrolling
- Full text insert/delete on screen
- Global Search & Amend
- Text formatting to screen or printer
- Cassette/disc storage of text
- Vision load of stored cassette text
- Standard letter & multiple copies routines
- Type ahead buffer
- Overtyping correction
- Page layout & numbering
- Total printer control
- Text highlighting for u/l recognition
- Text block manipulation
- Comprehensive tab & table generation
- Printer spooler

## DRAGON 32

MAJOR STOCKISTS AND SERVICE AGENTS

32K, 6809 256 x 192 HIGH RES, 9 COLOURS, FULL KEYBOARD

FOR UNDER

£200 !!

- Single keyword deletion
- Four numbering systems
- Word and phrase counters
- Double & multiple spaced printing

W4W PLUS needs only 6K of memory space, yet gives facilities not found in many programs TWICE its size!

Its cursor can be driven all over the text in any direction, with auto-scrolling an integral and extremely useful feature.

W4W PLUS is comparable to most purpose-built systems. Commissioned and developed by PREMIER with the hobbyist and school user in mind. Please state machine type and printer when ordering.

W4W PLUS can cope with the Centronics 737/9 and Tandy proportional spacing modes.

CASSETTE £39.95 DISC £43.95 FLOPPY TAPE £45.95.

#### POSTAGE & PACKING

- Software 75p per order
- EPROMS/DISCS 95p per order
- HARDWARE £1.75 per item. Maximum £5.00.

ALL PRICES INCLUDE V.A.T.

### UK101/OHIO SCIENTIFIC SUPPORT

Premier Publications, a main OSI dealer, can provide a wide range of add-ons for UK101 and OHIO owners, from manuals to full disc systems. Below is a small part of our range. A full catalogue is available on receipt of an A5 SAE.

| Product   | Price inc VAT |
|---|---------------|
| SCREEN ENHANCEMENT KIT — 32 x 64, + 19 other screen sizes, all software selectable! | £55.95        |
| BASIC 4 EPROM — cassette filenames, verify, crash recovery etc                      | £13.95        |
| BASIC 5 EPROM — 17 new BASIC words inc. PRINTUSING, PRINTAT, GETKEY, HLIN, VLIN     | £19.95        |
| BASIC X EPROM — tape data handling, sound, printer, IF..THEN..ELSE, REPEAT..UNTIL   | £19.95        |
| CODEKIT EPROM — Assembler/disassembler. Address transparent                         | £19.95        |
| TOOLKIT II EPROM — renumber, find, delete, view, controlled list, replace, etc      | £19.95        |
| WORD WIZARD EPROM, disc or tape — multi-featured Word Processor                     | POA           |
| CEGMON — our standard upgrade monitor   | £17.25        |
| MINI EPROM BOARD — used to fit any of our EPROMS (kit)                              | £15.95        |
| FLOPPY DISC CARD — takes up to four 5.25in drives, OSI compatible (kit)             | £49.95        |
| JI Buffer Board — provides essential buffering for expansion (kit)                  | £19.95        |
| 32K DYNAMIC RAM CARD — superb value (built only)                                    | £69.00        |
| Motherboard — gives 8 slot expansion capability, 5a PSU, (kit)                      | £29.95        |
| TEAC Disc Drive — cased with PSU  | £229.95       |
| Dual TEAC Drives — enclosed in single case with PSU                                 | £379.95       |
| ROM-DOS — DOS using BASIC-IN-ROM for fast, economical results (2 disc set)          | £19.95        |
| LINK 65 — vital routines for 65D users, DUMP, CREATE, etc                           | £19.95        |
| OS65D V3.3 — latest, much improved OSI DOS — SIX disc set                           | POA           |
| SOUND/VIA Board — includes sound chip and 2 VIA chips!                              | £53.95        |
| Daisywheel printers — RS232, superb print quality                                   | £885.00       |
| Steel case for UK101/OHIO computers   | POA           |
| SOFTWARE — many programs available  | POA           |
| FORTH — disc or EPROM versions  | POA           |



**PREMIER PUBLICATIONS**  
208 CROYDON I D., ANERLEY, LONDON SE20 7YX. TEL 01-659 7131



# CLOCK IT TO ME

In the first instalment of a two-part article, Bruce Marriott describes a real-time clock/calendar card for the Apple II

Many programs require time and date information: either directly, as in tagging output for later identification, or for generating or measuring accurate intervals of time — as, for instance, in scientific data logging.

In the former case, the user can be asked to input the time and date but this is irksome and error-prone since it has to be done at least once for every program run. For generating or measuring time intervals, recourse is often made to assembler or Basic timing loops, the programming of which is complex and hard to modify. Since computers are used to increase efficiency, an automatic (and cheap!) solution to such routine requirements would be particularly useful: this is what led to this design for a clock/calendar card.

This month I shall cover the hardware design of the real-time card; next month I shall go on to describe suitable driving software. Depending on which system is being used, and the chosen construction method, the cost of the card varies between £15 and £35. As usual with such articles, complete details are only given for one machine, in this case the Apple II. Don't let this dissuade you from reading on if you own another micro — the hardware itself is not complex and some information on implementing the design for other machines is given.

The Apple II uses the 6502 processor, so the design will be easiest to adapt to other 6502-based machines; owners of 8080/Z80 machines will have to work a little harder — but again, the comparative simplicity of the hardware cannot be overemphasised.

## Background

There are several methods for implementing a real-time clock on a micro. The easiest is to generate regular interrupts (at least once a second) and have an operating system which counts the interrupts into time (and possibly date) registers in a reserved area of memory. This system — used in several micros — is fine until the power is turned off; the clock has to be reset every time you turn the machine on.

Until two or three years ago the only other practical method was to implement a design totally in discrete hardware using a crystal timebase and a host of TTL chips, with power supplied by rechargeable batteries. This method is used in the Mountain Computer clock/calendar card for the Apple II and suffers from two drawbacks: cost (£149) and excessive power consumption, requiring an AC charger which has to be left permanently on, more or less.

The most satisfactory solution came with low-power CMOS clock/calendar chips specifically designed to interface to micro buses. These chips typically use a 32768 Hz crystal as a timebase and will continue to operate on about

20 microAmps at 2.2 volts, supplied by battery backup which should last for months. Access to the time and date registers is usually through 4-bit address and data lines.

One of the first of these chips was the National Semiconductor MM58174A, which has been described for use in a number of articles. Unfortunately it suffers from a serious flaw: it has no year register, which seems ludicrous. You either have to design a circuit with CMOS RAM to hold the year, or modify the disk operating system to store the year on all disks. Otherwise the user of an applications program is, rather perplexingly, asked to enter just the year instead of the full date. NatSemi has recently produced a rather more sophisticated chip, the MM58167A, but this too lacks a year register!

Casting around for a better device to use for this design produced the Oki MSM5832RS. This chip has no serious drawbacks and, surprisingly, has been available for two years, though it would seem to be used only in professional circles. After opting for the Oki chip, I have heard of a Motorola device, the MC146818, and this might be worth checking out as it has a very advanced specification. It is, however, rather expensive — about £15 one-off.

## MSM5832 anatomy

Figure 1 shows the functional block diagram and pin-out of the 5832. The chip interface breaks down into three broad areas: supply requirements, control systems, and data and address lines.

The supply requirements are a 3276 Hz crystal across XT and XT and +5 volts at Vcc when being accessed, or a minimum of 2.2 volts when on standby (ie, when supplied from a battery).

The major control signals are HOLD, READ, WRITE and CS (chip select). The CS input is rather unusual in that it is not normally connected to the micro bus or tied to a power rail through a resistor but is connected directly to the +5 V supply. With +5 V applied, CS enables all inputs and outputs but when the power is removed (but battery backup is working) CS goes low, disables all the control lines and effectively isolates the chip. The HOLD line is effectively the chip enable (or select) signal and while high suspends updating of registers so that stable conditions exist for reading from or writing to the chip. The READ line goes high to enable reading data from the chip and WRITE goes high to enable writing data.

Two other control signals exist, neither of which is normally used. The ±30 ADJ input, when briefly taken high, resets the seconds register to zero and if there were more than 30 seconds, the number of minutes is increased by one, otherwise the minutes are left unchanged. The TEST input, as its name implies, is used for testing; with CS high, pulsing high signals on this pin will directly clock certain registers depending on the addressing used.

The last group of signals comprises the address and data lines, which follow normal practice with the address lines selecting a specific register within the 5832 and the data lines actually passing the contents. Figure 2 shows the register

| HEX | ADDRESS INPUTS |    |    |    | INTERNAL COUNTER | DATA I/O |    |    |    | DATA LIMITS | NOTES   |
|-----|----------------|----|----|----|------------------|----------|----|----|----|-------------|---|
|     | A3             | A2 | A1 | A0 |                  | D0       | D1 | D2 | D3 |             |   |
| 0   | 0              | 0  | 0  | 0  | S                | *        | *  | *  | *  | 0~9         | S1 or S10 are reset to zero irrespective of input data D0~D3 when write instruction is executed with address selection. |
| 1   | 0              | 0  | 0  | 1  | S 10             | *        | *  | *  | *  | 0~5         |   |
| 2   | 0              | 0  | 1  | 0  | MI 1             | *        | *  | *  | *  | 0~9         |   |
| 3   | 0              | 0  | 1  | 1  | MI 10            | *        | *  | *  | *  | 0~5         |   |
| 4   | 0              | 1  | 0  | 0  | H 1              | *        | *  | *  | *  | 0~9         | D2 = "1" for PM<br>D2 = "0" for AM<br>D3 = "1" for 24 hour format<br>D3 = "0" for 12 hour format<br>(Day of the week)   |
| 5   | 0              | 1  | 0  | 1  | H 10             | *        | *  | †  | †  | 0~1<br>0~2  |   |
| 6   | 0              | 1  | 1  | 0  | W                | *        | *  | *  | *  | 0~6         |   |
| 7   | 0              | 1  | 1  | 1  | D 1              | *        | *  | *  | *  | 0~9         |   |
| 8   | 1              | 0  | 0  | 0  | D 10             | *        | *  | †  | †  | 0~3         |   |
| 9   | 1              | 0  | 0  | 1  | MO 1             | *        | *  | *  | *  | 0~9         |   |
| A   | 1              | 0  | 1  | 0  | MO 10            | *        | *  | *  | *  | 0 1         |   |
| B   | 1              | 0  | 1  | 1  | Y 1              | *        | *  | *  | *  | 0~9         |   |
| C   | 1              | 1  | 0  | 0  | Y 10             | *        | *  | *  | *  | 0~9         |   |

- (1) \*data valid as "0" or "1".  
Blank does not exist (unrecognized during a write and held at "0" during a read)  
† databits used for AM/PM, 12/24 HOUR and leap year.
- (2) If D2 previously set to "1" upon completion of month 2 day 29, D2 will be internally reset to "0".

Fig 2 MSM5832 register addressing



addresses; note that two registers (tens of hours and tens of days) not only hold time and date digits but also use some bits for control of time format and leap years.

One facility of the 5832 which is not apparent from the pinout is the chip's ability to generate interrupts. These appear on the data lines under specific

control and address line conditions, as shown in Figure 3.

## Interfacing

The easiest way to interface the 5832 to most popular systems is to use a 6821 PIA (Peripheral Interface Adaptor) for 6800/6502 systems or the equivalent

8255 PPI (Programmable Peripheral Interface) for 8080/Z80 based systems. The Oki data sheet shows the way with a 'typical application' based on the 8255.

An advantage with using a PIA/PPI is that the normally critical timing constraints involved with discrete logic interfacing are no longer a problem as timing moves from the microsecond

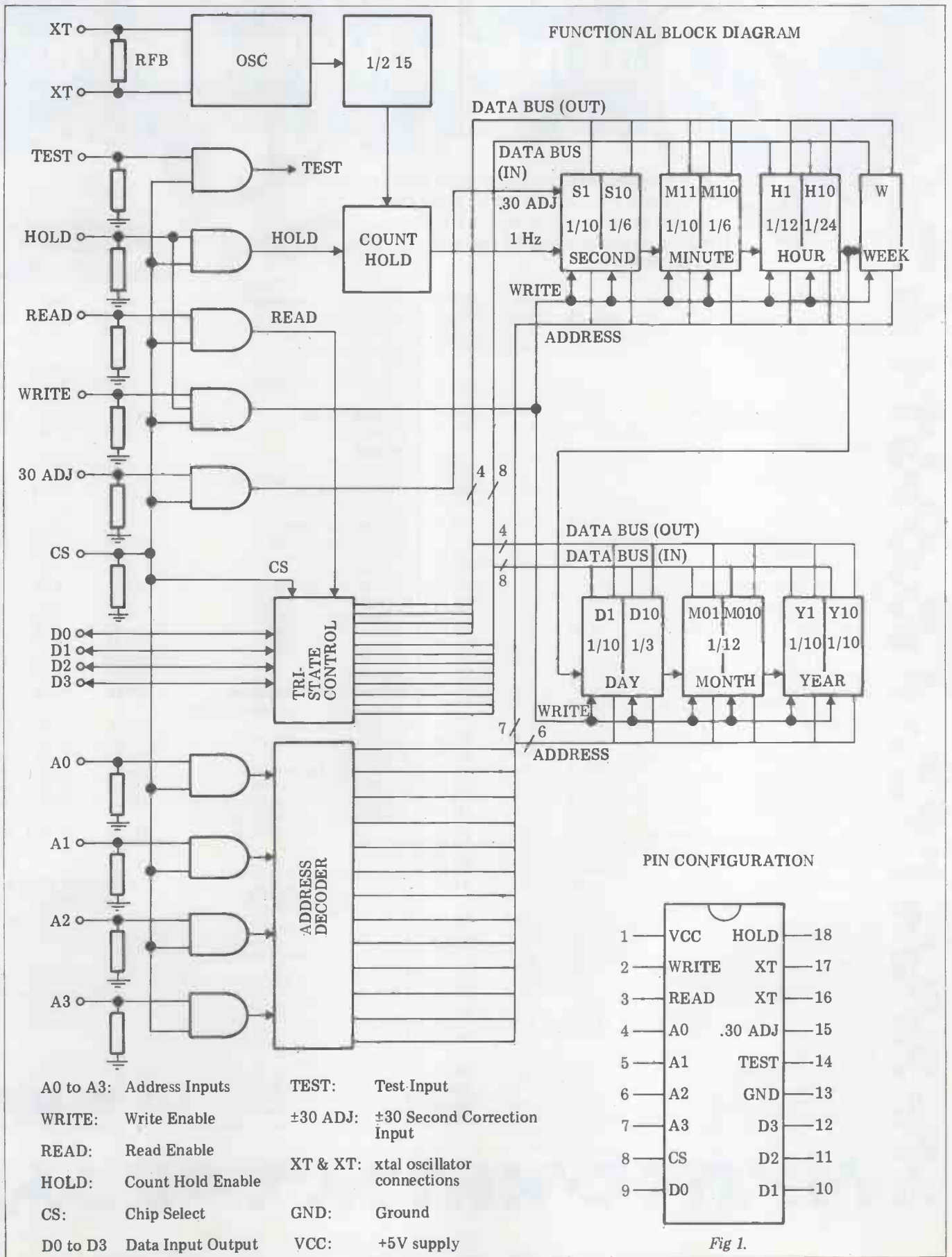

Fig 1.



# Apple, Atari and NEC at hard-checked prices\*

\*Hardware or software, you don't have to shop around. We continually check all our prices and we're certain they are as competitive as you will find anywhere.



Apple VDU Disk Drives and Processor



Atari 800.

|                                     | NET     | VAT    | TOTAL   |
|-------------------------------------|---------|--------|---------|
| <b>PACKAGE SYSTEMS</b>              |         |        |         |
| Apple Executive System              | 1899.00 | 284.85 | 2183.85 |
| Apple Top Secretary System          | 2099.00 | 314.85 | 2413.85 |
| Apple Education System              | 1399.00 | 209.85 | 1608.85 |
| <b>APPLE HARDWARE</b>               |         |        |         |
| Apple II 48K                        | 599.00  | 89.85  | 688.85  |
| 16K Add on                          | 45.00   | 6.75   | 51.75   |
| Disk Drive with Controller (16 sec) | 345.00  | 51.75  | 396.75  |
| Disk Drive without Controller       | 275.99  | 41.25  | 316.25  |
| <b>ACCESSORIES</b>                  |         |        |         |
| Programmers Aid I                   | 25.00   | 3.90   | 29.90   |
| Auto Start ROM Pack                 | 33.00   | 4.95   | 37.95   |
| Graphics Tablet                     | 399.00  | 59.85  | 458.85  |
| Appletel System                     | 525.00  | 78.75  | 603.75  |
| TV Modulator                        | 14.00   | 2.10   | 16.10   |
| <b>INTERFACE CARDS</b>              |         |        |         |
| Prototype/Hobby Card                | 12.00   | 1.80   | 13.80   |
| Parallel Printer Card               | 79.00   | 11.85  | 90.85   |
| Communications Card                 | 100.00  | 15.00  | 115.00  |
| High Speed Serial Card              | 90.00   | 13.50  | 103.50  |
| Centronics Card                     | 100.00  | 15.00  | 115.00  |
| Integer Card                        | 90.00   | 13.50  | 103.50  |
| Language Card                       | 95.00   | 14.25  | 109.25  |
| Controller Card                     | 95.00   | 14.25  | 109.25  |
| Eurocolour Card                     | 65.00   | 9.75   | 74.75   |
| IEEE - 48 Card                      | 200.00  | 30.00  | 230.00  |
| 16K RAM Card (48K to 64K)           | 60.00   | 9.00   | 69.00   |
| <b>SOFTWARE</b>                     |         |        |         |
| Disk Utility Pack                   | 12.00   | 1.80   | 13.80   |
| Apple Post Program                  | 27.00   | 4.05   | 31.05   |
| The Shell Games                     | 15.00   | 2.25   | 17.25   |
| Elementary My Dear Apple            | 16.00   | 2.40   | 18.40   |
| Apple Bowl Diskette                 | 13.00   | 1.95   | 14.95   |
| 3.3 Operating System                | 34.00   | 5.10   | 39.10   |
| DOS 3.3 Tool Kit                    | 41.00   | 6.15   | 47.15   |
| Apple Writer 1.1                    | 34.00   | 5.10   | 39.10   |
| Stellar Invader                     | 13.00   | 1.95   | 14.95   |
| Apple Plot                          | 34.00   | 5.10   | 39.10   |
| Apple Adventure                     | 19.00   | 2.85   | 21.85   |
| <b>APPLE DISTRIBUTED SOFTWARE</b>   |         |        |         |
| The Go Between (Centronics)         | 26.50   | 3.98   | 30.48   |
| Micro Modeller                      | 375.00  | 56.25  | 431.25  |
| Visicalc 3.3                        | 100.00  | 15.00  | 115.00  |
| VisiFile                            | 135.00  | 20.25  | 155.25  |
| VisiPilot                           | 90.00   | 13.50  | 103.50  |
| VisiTrend/VisiPilot                 | 130.00  | 19.50  | 149.50  |
| VisiTerm                            | 78.00   | 11.70  | 89.70   |
| VisiDex                             | 100.00  | 15.00  | 115.00  |
| Desktop Plan II                     | 100.00  | 15.00  | 115.00  |
| <b>LANGUAGES</b>                    |         |        |         |
| Pascal Language System              | 225.00  | 33.75  | 258.75  |
| Apple Pilot                         | 75.00   | 11.25  | 86.25   |
| Apple Fortran                       | 95.00   | 14.25  | 109.25  |
| CIS Cobol with Forms -2             | 410.00  | 61.50  | 471.50  |

## PRINTER & ACCESSORIES

|                        | NET    | VAT   | TOTAL  |
|------------------------|--------|-------|--------|
| Silentype Printer      | 170.00 | 25.50 | 195.50 |
| 10 Rolls Thermal Paper | 28.00  | 4.20  | 32.20  |

## VIDEO MONITORS

|                          | NET    | VAT   | TOTAL  |
|--------------------------|--------|-------|--------|
| BMC 12" Green Screen     | 120.00 | 18.00 | 138.00 |
| 9" Black & White Monitor | 100.00 | 15.00 | 115.00 |
| Cables                   | 5.00   | 0.75  | 5.75   |

## OTHER ITEMS

|              | NET    | VAT   | TOTAL  |
|--------------|--------|-------|--------|
| Z80 Softcard | 170.00 | 25.50 | 195.50 |

## ATARI

|                               |              |              |              |
|-------------------------------|--------------|--------------|--------------|
| 400 16K Computer              | 173.87       | 26.08        | 199.95       |
| 400 16K Computer (with BASIC) | 217.30       | 32.60        | 249.90       |
| 800 16K Computer              | 391.26       | 58.69        | 449.95       |
| 800 16K Computer (with BASIC) | 434.70       | 65.20        | 499.90       |
| 822 Thermal Printer           | 195.00       | 29.25        | 224.25       |
| 825 80 Column Printer         | 375.00       | 56.25        | 431.25       |
| 850 RS 232 Interface          | 110.00       | 16.50        | 126.50       |
| 16K Ram Upgrade               | 52.13        | 7.82         | 59.95        |
| Conversational French         | 28.26        | 4.24         | 32.50        |
| Conversational German         | 28.26        | 4.24         | 32.50        |
| Conversational Spanish        | 28.26        | 4.24         | 32.50        |
| Conversational Italian        | 28.26        | 4.24         | 32.50        |
| Assembler Editor Rom          | 30.39        | 4.56         | 34.95        |
| Visicalc                      | 105.00       | 15.75        | 120.75       |
| Word Processor                | 78.22        | 11.73        | 89.95        |
| <b>Video Computer System</b>  | <b>69.56</b> | <b>10.43</b> | <b>79.99</b> |

## NEW - N.E.C. PC 8000 SERIES

|  |        |       |        |
|--|--------|-------|--------|
| PC 8001 Keyboard                               | 500.00 | 75.00 | 575.00 |
| PC 8011 Expansion Unit                         | 407.83 | 61.17 | 469.00 |
| PC 8012 1/0 Unit                               | 346.96 | 52.04 | 399.00 |
| PC 8023 Dot Matrix Printer                     | 326.08 | 48.91 | 375.00 |
| PC 8031 Floppy Disc Drive                      | 543.48 | 81.52 | 625.00 |
| PC 8041 12" Green or Amber Monitor             | 129.57 | 19.43 | 149.00 |
| PC 8043 12" High Resolution CRT Colour Monitor | 477.39 | 71.61 | 549.00 |

## HARDWARE GUARANTEE

All advertised products are guaranteed one year from date of purchase against defects in materials and workmanship.

During the guarantee period, Metrotech will repair or replace, at no extra charge, components that prove defective - providing that the product is returned, shipping or postage prepaid, stating when bought and enclosing proof of purchase.

This guarantee does not apply if, in the opinion of the Company, the product has been damaged by accident, misuse or misapplication.

## CONDITIONS OF BUSINESS.

We accept cheques or Access, Barclaycard, American Express and Diners Club Cards. All prices, specifications and terms are subject to change without notice at the discretion of the management. All offers subject to availability.

Prices correct at time of going to press. E. & O.E.

Hardware Post and packaging subject to confirmation.



# New CP/M software at hard to beat prices



## DIGITAL RESEARCH

C BASIC II  
Commercial Disk Extended Basic **£75/£30**

**NEW CB 80.** Ultra fast Basic compiler. All the features of C Basic plus the speed and versatility of a compiler. 32K Byte strings, external multiple line functions, run time error trapping and extended file handling capabilities. **£275/£30**

**NEW PL/I-80.** A standard structured commercial applications programming language. Saves design time. Minimises debugging and maintenance problems. Designs high quality output with picture specifications. Includes the compiler, run-time library, lineage editor and relocating macro-assembler. **£275/£30**

## MICROPRO INC.

**WORDSTAR 3XX.** New features: column move capabilities, horizontal scrolling up to 240 columns and even clearer menus. **£195/£30**

**MAILMERGE 3XX** (optional) **£55/£10**

**DATASAR** Powerful data entry, retrieval and up-date system. **£150/£30**

**SUPERSORT 1.** Combines high performance and operational flexibility to perform sorting, merging and record selection functions. **£105/£20**

**WORDMASTER Superior** text editor. **£105/£20**

**NEW CALCSTAR.** This sophisticated but easy to use calculating and planning tool is Micropro's new spread sheet and financial modelling program. **£120/£30**

## COMPSOFT

**NEW COMPSOFT DMS.** Ideal for office records. Personnel, stock, client's and account's records are more easily stored and updated. Features include: Comprehensive calculation • Full sorting facilities • Record selection on updates and reports • Wordstar interface for selective mailing. **£345/£25**

## POINTS TO REMEMBER

- All software is Ex-Stock and available on standard 8" disks or 5" disks for Vector MZ, Superbrain, Dynabyte and NEC PC 8000.
- Prices shown as Software with manual/manual only.
- tmi WORD-STAR is a trademark of Micropro.

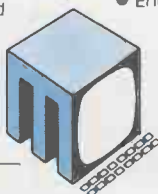

## MICROSOFT INC.

BASIC 80 Interpreter **£155/£25**

BASIC 80 Compiler **£195/£25**

FORTRAN 80 **£215/£25**

COBOL 80 **£315/£25**

## MICROPLAN

**NEW MICROPLAN.** A program designed to cope easily with advanced financial analysis. Microplan helps you to perform all the calculations you presently solve with pen, paper and calculator. Microplan will perform most types of calculations working on rows and columns. **£245/£20**

## SUPERCALC

**NEW SUPERCALC.** Accountants, Planners, Engineers, and Business owners have found Supercalc invaluable for day to day "what if?" and "what now?" questions. Answers for the time when the unexpected occurs. Simple to use advanced financial planning. **£190**

## BCPL

**NEW BCPL.** BCPL CINTCODE is a full and extended implementation of the popular systems' programming language. BCPL CINTCODE gives a dramatic reduction in programme storage space, requiring about one third of a fully compiled Z80 code. **£250/£35**

## DATA MANAGEMENT

**SELECTOR III—C2.** An easy to use information management system, requires C Basic II. **£185/£30**

**SELECTOR IV.** An advanced information management system requires C Basic II. **£275/£35**

**S. BASIC VERSION 5.4.** A high level language that combines the flexibility of Basic with the power of advanced structured techniques. A compiling language that is hard to match. **£175/£30**

## METROTECH

**MET/TWAM.** An index sequential file access in C Basic II designed to increase the flexibility of C Basic. **£55/£20**

## HOW TO ORDER

- State disk type and size • Add 15% VAT
- Include £2 per Software item for Postage and Packing
- Enclose cheque/PO's payable to METROTECH

## CAXTON SOFTWARE

**NEW OPTIMISER.** A linear programming system for finding the best practical solution to resource allocation and planning problems. Easy to learn. Easy to use. Immediately available. Please ring for more details. **£295**

**NEW CARDBOX.** Described simply, Cardbox is an electronic card index system. Choose your own format for cards, and categorise the information to your own specification. Cardbox provides an immensely powerful method of handling large amounts of information. **£155**

## COMMUNICATIONS

BISYNC-80/3780 and BISYNC-80/3270 are full function IBM 2780, 3780 and 3270 emulators for micro computers. BISYNC-80/3780 gives you a Remote Job Entry terminal for the price of a micro! BISYNC-80/3270 combines the local processing power of a micro with a sophisticated screen capability. Make your dumb terminal smart! MET/TTY will connect your micro to a Timesharing service in simple teletype emulation.

BISYNC-80/3780 **£445/£20**  
BISYNC-80/3270 **£445/£20**  
MET/TTY **£145/£20**

## FINANCIAL REPORTING

**REPORT WRITER** You input the values. Report Writer will perform your calculations and produce a report with your headings, totals and summaries. **£70/£10**

**GLECTOR** General Ledger option in Selector III, requires Selector III and C BASIC II. **£125/£30**

## NEWLY RELEASED SOFTWARE

INFO STAR from MICROPRO **TBA**

Mail to METROTECH MAIL ORDER, WATERLOO ROAD, UXBRIDGE, MIDDLESEX UB8 2YW

**CREDIT CARDS-** Telephone orders welcome: Tel: UXBRIDGE (0895) 57048/9

**TRADE ENQUIRIES WELCOMED**

# METROTECH

A MEMBER OF THE GRAND METROPOLITAN GROUP

domain to the processor's clock and instruction times, which are much longer. For instance, to write to the 5832 using a direct design would need HOLD to go high for 150 microseconds before the address and data with the actual WRITE pulse following within a minimum of 0.5 microseconds and lasting at least 1 microsecond. With a PIA/PPI, everything is slowed down to the speed that instructions can be given and these in all cases will be longer than the minimum times given.

Another advantage of a PIA/PPI is that this is the most popular addition to a system (with the exception of memory chips) and hence for most readers will be a known entity. With a 6821 device, as used here, the interrupt inputs are available, allowing the 5832's interrupt capabilities to be exploited under software control rather than by jumper leads.

Figure 4 shows the 'typical application' design from the 5832 data sheet. I haven't tried this so I can't guarantee its correct operation, but it should give a good start for 8080/Z80 users.

## PIA design

For 6800/6502 systems, the 6821 PIA is the easiest chip to use. Figure 5 shows the complete circuit diagram for the Apple II. The heart of the system has been heavily outlined and is usable on any system, so I'll talk about this first. I assume that you know how to interface a 6821 to your particular system; if not, then get a book on your processor or, even better, one on interfacing to your particular computer system.

Connection between the two 8-bit PIA ports and the 5832 requires some consideration because the ports are not identical and this can affect the 5832 when the 6831 PIA is reset. The critical line is HOLD which, when taken high, stops the 5832 updating its registers. When a 6821 PIA is reset, both A and B ports become inputs but the A port has internal pullup resistors while the B side doesn't. The net effect of this is that should the HOLD line be connected to the A side of the PIA resetting the system will take HOLD high and stop the clock. Hence the control lines shown in Figure 5 have been connected to the PIA's B side.

As discussed earlier, the four data lines have a dual function: moving actual register contents and acting as constant interrupt sources (Figure 3). For data flow handling they are connected to port B but, in addition, the lines are also connected to the four interrupt ports (CA1, CA2, CB1, CB2) through which their interrupt signals can be software controlled.

Power-off operation comes from a 3.5 V 100 mAh Nicad battery which is automatically trickle-charged during normal use. Precise setting of the required clock frequency is achieved with a variable capacitor. Two switches are used in this design: one allows the use of the  $\pm 30$  second adjust mentioned earlier while the other write-protects the 5832.

## Apple extension

The ports outside the heavily lined area in Figure 5 are specific to the Apple II.

The Apple has a unique I/O structure which, considering the age of the design, is quite exemplary. At the back of the Apple are eight slots for peripheral cards. Slots 0 and 7 are unique and have specialist uses but the other six can generally be used by any Apple-compatible card. Each slot has 16 locations for general I/O and a 256-byte page of memory which is normally used to hold the card's driving program. The 256-byte page is corrected to Basic via the IN# (slot number) command which, when processed, means that the peripheral card in that slot will respond to subsequent INPUT statements instead of the keyboard. It's clearly much neater to use INPUT TIME\$, DATE\$ rather than resorting to the usual PEEKs and POKEs, so the circuitry to do this has been included.

The driving program is housed in a single rail 2716 EPROM which is both cheap and relatively easy to program. This is a 2k device, so eight 256-byte driving programs could be contained within it. As I don't think anyone will need that many, the highest 2716

address line (A10) has been permanently connected to ground, so only four spaces are available, and are conveniently decoded by switches 1 and 2.

Output enable for the EPROM comes from the Apple-supplied I/O SEL line which is fully decoded for each of the slots. The 6821 PIA is mapped into four of the 16 general I/O locations which have an equivalent chip select signal called DEVSEL.

Most signals available at each slot in the Apple are capable of driving several LSTTL loads with the exception of the data lines which can drive only one such load. Although the design would probably work without buffering, I decided to play safe and an LS245 tri-state buffer has been incorporated. Chip select for this device (G) is derived from an LS08 (AND gate) and the two Apple lines DEVSEL and I/O SEL. All other connections are standard.

## Construction

The circuit can either be constructed on an Apple-compatible prototyping board

| CONDITIONS  | OUTPUT | FREQUENCY | PULSE WIDTH   |
|-------------|--------|-----------|---------------|
| HOLD = L    | D0 (1) | 1024 Hz   | duty 50%      |
| READ = H    | D1     | 1 Hz      | 122.1 $\mu$ S |
| C.S. = H    | D2     | 1/60 Hz   | 122.1 $\mu$ S |
| A0 ~ A3 = H | D3     | 1/3600 Hz | 122.1 $\mu$ S |

(1) 1024 Hz signal at D0 not dependent on HOLD input level

Fig 3 Control of MSM5832 interrupt facility.

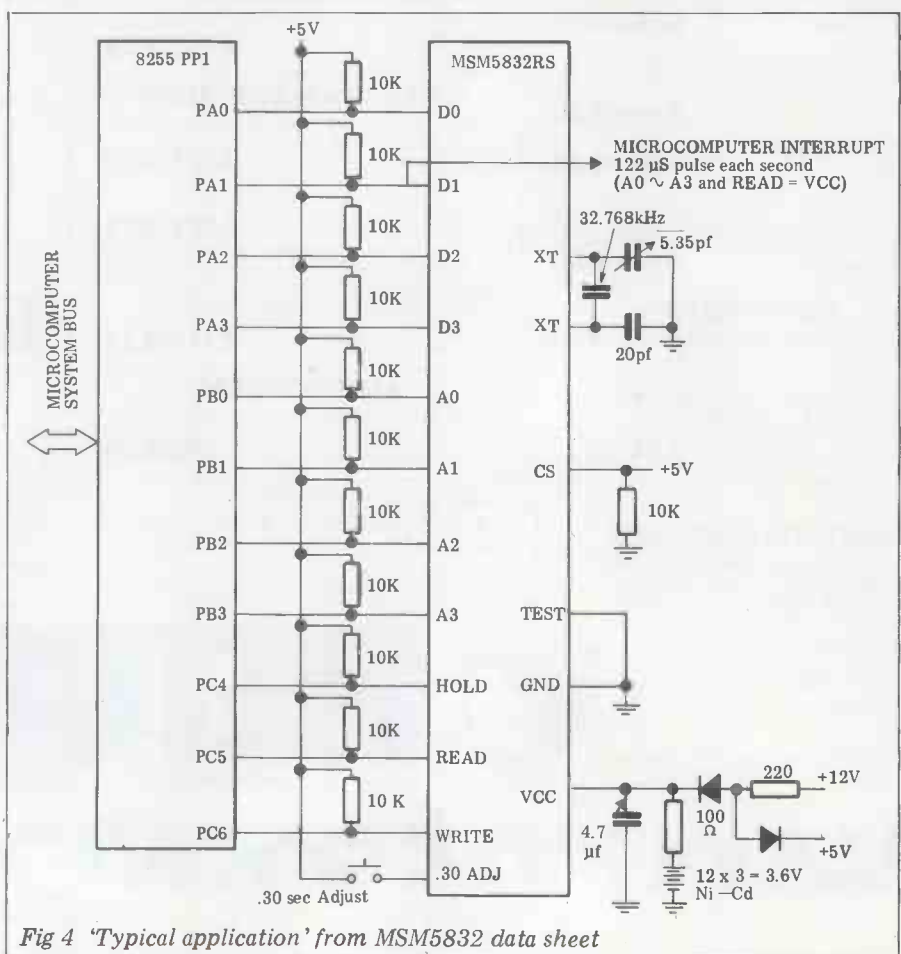

Fig 4 'Typical application' from MSM5832 data sheet



# TJ's WORKSHOP

Our monthly pot-pourri of hardware and software tips for the popular micros. If you have a favourite tip to pass on, send it to: 'TJ's Workshop', PCW, 62, Oxford Street, London W1A 2HG. Please keep your contributions as concise as possible. We will pay £5-£30 for any tips we publish.

## PET CAMERA TESTER

A microcomputer system is ideal for testing the shutter speed of a camera, the main requirement of which is to measure short periods of time, down to 1/2000 second, with a high degree of accuracy.

First, some sort of sensor is necessary to detect the shutter's opening. The obvious way to do this is by light, with a fairly powerful lamp shining into the open lens mount (it's better to remove the lens, if possible) and the sensor held as closely as is safely possible behind the rear of the shutter blind.

The sensor must be a photo-transistor with no connection to its base. A photoresistor will definitely not do as its response times are far too slow. I used an old OC45 from my junk box. Other photo-transistors may be used, but the value of R1 in the circuit diagram may need altering. If you use an NPN photo-transistor you must of course connect the emitter and collector the opposite way round.

A word about the lamp: don't make it too powerful and don't put it too close to

the camera. When I put a photoflood right up next to my Yashica, I was horrified to see the plastic nameplate partially melting! That cost me £5 to fix.

The software consists of a machine-level program resident in the second cassette buffer (which would need re-locating on machines other than the PET) and a Basic program to control it and tabulate the results.

The machine code timer program is shown in Listing 1. The loop at \$033B - \$033E waits until the phototransistor is exposed to light. Once the phototransistor registers, the BC108 turns on and PA0 is grounded so the micro drops through this loop and starts counting. The counter is a simple two-byte counter, clocking continuously until the shutter closes. The complication is to make the routine take exactly the same time and exactly the same number of instruction cycles per loop whether or not the branch to increment the high order byte, \$02, is taken. A bit of roundabout program-

ming has neatly overcome this problem: 25 cycles (25 us with a 1 MHz 6502, 12.5 us with a 2 MHz chip) are taken in each case.

The number of loops made will be given by the Basic code  $PEEK(1)+256*PEEK(2)$ . With only two bytes to hold the count, the system will clock round to 0 after 1.6384 seconds (half this with a 2 MHz clock) so times longer than that will read low by the same amount.

The rest of the Basic program should be self-explanatory. Dividing the figure obtained by the above expression by 40 (because each cycle takes 1/40000 second) gives a reading in milliseconds, and inverting that gives the nearest practical fraction.

I have used the system to measure speeds of both a Yashica FR and a Leica M3. I took 10 successive measurements and averaged them out, as is done by a leading photographic weekly. The results, although too long to publish in full here, make interesting reading. The Leica, the 'Rolls-Royce' of cameras, was less accurate by a factor of 2½ than the electronically timed Yashica. What is more surprising is that a camera a quarter of a century old should hold its own so well against a camera with technology so much newer and still provide a highly commendable set of figures, only 10 per cent out on average, even though it has never been serviced. That's why a Leica costs three times as much as a 'comparable' Japanese product!

The circuit and timer program should be easily adaptable to any other 6502-based machine; other processors will require a simple rewrite. And with different circuitry attached, the timer program must have a thousand other applications.

Kevin Jones

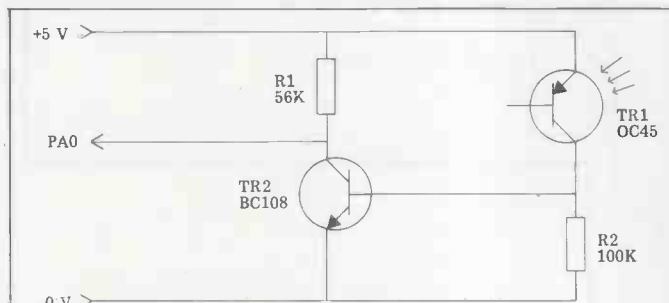

NB: PA1-7 inclusive must also be grounded, as the program will only count when all lines are grounded.

Fig 1 The Circuit

|     |      |     |        |          |                                |
|-----|------|-----|--------|----------|--------------------------------|
|     | 033A | SEI |        | 78       |                                |
|     | 033B | LDA | \$E84F | AD 4F E8 |                                |
|     | 033E | BNE | \$033B | DO FB    | ; Wait for shutter to open     |
| 4   | 0340 | LDA | \$E84F | AD 4F E8 |                                |
| 3   | 0343 | BEQ | \$0347 | FO 02    |                                |
|     | 0345 | CLI |        | 58       |                                |
|     | 0346 | RTS |        | 60       |                                |
| 5   | 0347 | INC | \$01   | E6 01    | ; Increment low order byte     |
| 2/3 | 0349 | BEQ | \$0351 | FO 06    | ; Branch through if low byte   |
| 3   | 034B | JMP | \$034E | 4C 4E 03 | ; clocked round                |
| 3   | 034E | JMP | \$0353 | 4C 53 03 | ; These jumps are a time delay |
| 5   | 0351 | INC | \$02   | E6 02    | ; and must not be delayed      |
| 2   | 0353 | NOP |        | EA       | ; Time delay - must be kept    |
| 3   | 0354 | JMP | \$0340 | 4C 40 03 | ; Back to beginning of loop    |

Fig 2 The machine code program

```

10 POKE 49459,0 : REM Set user port to all inputs
20 POKE 1,0 : POKE 2,0 : REM Set counters to zero
30 PRINT "Ready to start"
40 SYS 826
50 T=(PEEK(1)+256*PEEK(2))/40 : REM Div by 80 if 2 MHz clk
60 PRINT "Time taken = ";T;" milliseconds"
70 PRINT "= 1/";INT(1000/T+.5);" second"
80 GOTO 20

```

Fig 3 Basic program

## UK101 QUIRKS

Has anyone else noticed these quirks on the UK101's new monitor (UK02)?

Clear the screen so that the cursor is in the top right-hand corner. Press Cursor Up (Ctrl-K) a number of times and the machine will allow you to backspace for that same number, wrapping around the bottom of the screen (up to a maximum of 72). With the cursor in this position, press Cursor Up again and a ' ' will appear, replacing the Cursor Up character. This will also cursor up, resulting in a diagonal line of these characters wrapping round the top of the screen. After 72 of these the 'Maximum Line Length' character will appear. After 48 of these characters the whole screen will start moving upwards. When this is done the computer will do some processing and the cursor will appear on the top line of the

screen. Press any key and the machine will perform many carriage returns, leaving the cursor on the top line again in the left-hand corner. If Return is pressed there is a noticeable delay while the computer processes the lines.

Some variations on the theme are to press Return while in the diagonal line stage. Doing this many times will result in the cursor wrapping round the bottom of the screen. Try pressing Return, then enter a program line with Cursor Ups at the end of it. Now try listing it. If keys are pressed while the screen is moving upwards, when the cursor reaches the bottom of the screen Ctrl-K will make the cursor move upwards and wrap over the screen.

Matthew Phillips

## REDUNDANT RESET

Here is a method for ascertaining filenames of Tangerine Microtan programs without having to use RESET.

If the program is saved at fast speed, type

```
0 POKE 14,0 : POKE 22,2 :
  INPUT F$: PRINT F$
RUN
```

and press PLAY on the tape recorder. The computer will display the filename followed by the suffix .B and some garbage.

If the program is saved at slow speed, then alter the line to read

```
0 POKE 14,1 : . . . . .
and proceed as above.
```

This cannot be done in command mode, as this will produce a 'syntax error' message for some reason.

On very short programs the filename will not be given first time around; in this case do not press BREAK, but rewind the tape and press PLAY again.

Jon Strutt

## BEEB CHARACTERS

I read Malcolm Howlett's BBC Character Generator program (July '82) with interest and, I must admit, a little irritation as he had beaten me to getting a similar program published. I typed in the program and ran it, finding it to be a very use-

ful addition.

I suggest that to make it easier to operate the cursor the following modifications could be made:

- 1) Add line 22960 to read 22960\*FX 4,1
- 2) Change lines 23100 to 23400 to read  
23100 IF ASC(C\$)=139  
THEN Y=Y-1  
23200 IF ASC(C\$)=138  
THEN Y=Y+1  
23300 IF ASC(C\$)=136  
THEN X=X-1  
23400 IF ASC(C\$)=137  
THEN X=X+1
- 3) Add line 23405 to read 23405\*FX 4,0
- 4) Delete lines 31120 and 31125.
- 5) Delete the A and D characters from line 31122.

These modifications disable the editing cursor keys and make them return an ASCII code. Line 23405 restores them to normal operation.

P Clayton

## TRS-80 COMPUTED RESTORE

It is often useful to start READING data from a particular point rather than from the start of the DATA lists. This can be done by using RESTORE and then skipping over the unwanted data with a FOR-NEXT loop, but this is slow; if more data is added the numbers need to be changed.

This program allows you to specify a line number and, next time the READ command is used, the data assigned will be from that line (or the first line after it that has DATA). It is in machine code: to enter it simply type the three-line Basic subroutine shown in Listing 1 at the end of your program, and GOSUB 65520 at the start.

Then, to RESTORE at a line number, use the command DU=USR(X) where X is a line number and DU a dummy variable. X can, of course, be a constant, a variable or an expression, allowing the user to RESTORE at different line numbers depending on the value of the expression.

There are two limitations:  
1) The line number cannot be greater than 32767; if it is this

will result in an OV error.  
2) If text entered in response to an INPUT command is over 205 characters long it will destroy part of the machine code program. It is very rare that such long inputs are needed: if they are simply add GOSUB 65520 after the INPUT command in your Basic program.

Briefly, the Basic program is scanned until:

- a) the correct line is found;
- b) the correct line is not

found, so the next line after it is used;  
c) the end of the Basic program is reached.

The data pointer (locations 16639 LSB/16640 MSB) is then set to the end of the previous line.

An assembly listing is provided which shows how it works in detail.

Steve Goldman

```

RESTOR  ORG 17080 ;End of direct command RAM
        CALL 2687 ;Get argument (line no)...
        EX DE,HL ;...into DE
        LD BC,17129 ;Start of Basic program
LINE    PUSH BC ;Store program pointer
        POP IX ; in IX
        LD L,(IX+2) ;Get current
        LD H,(IX+3) ; line number
        OR A ;Reset carry
        SBC HL,DE ;Comp current line no to
        ; that wanted
        JP P,COMP ;If correct, go to adjust
        ; routine
        LD C,(IX) ;Get next
        LD B,(IX+1) ; line pointer
        LD A,B ;If it isn't zero
        OR C ; Loop to check
        JR NZ,LINE ; next line
COMP    DEC IX ;Point to end of last line
        LD (16639),IX ;Adjust data pointer
        RET ;Back to Basic
        END

```

Listing 2 Assembler listing

```

65520 DATA 205,127,10,235,1,233,66,197,221,225,221,110,2,221,
        102,3,183,237,82,242,216,66,221,78,0,221,70,1,120,177,
        32,231,221,43,221,34,255,64,201
65521 FOR L=0 TO 38:READ DA:POKE 17080+L,DA:NEXT
65522 POKE 16526,184:POKE 16527,66:RETURN

```

Listing 1 Basic subroutine to load machine code

## POKE SUBSTITUTE

To anyone mourning the lack of a standard PEEK and POKE on the BBC Computer, I suggest they include the following declarations in their programs:

```
DEFPROCPOKE(A,B)?A=B:
  ENDPROC
DEFNPEEK(A)=?A
```

One can POKE by saying PROCPOKE (address, data) and PEEK by saying data = FNPEEK (address).

At least these look vaguely like the familiar forms. Naturally, getting the hang of the ! and ? operators is better in the long term.

Andrew Civil

## BBC ASSEMBLER AIDS

The assembler built in to BBC Basic does not appear to offer the pseudo operations used in stand-alone assemblers for declaring strings or byte data without the assembled within the assembled code. Although bytes can be initialised, it is necessary to leave the assembler and POKE the values, using the assembly pointer P%, and then correctly adjust the pointer before resuming assembly. This can make construction of large assembler programs rather cumbersome.

The two functions presented here can be used as rough equivalents of pseudo operations, to initialise strings and sequences of data bytes simply.

Function "defstring" initialises a section of memory to hold a string. The function has two parameters: the first is the string itself, and the second is a number specifying the format in which it is to be stored. The routine provides four possibilities:

format=0 stores the string and adds a RETURN (&0D) byte at the end.

format=1 stores the string and adds a zero byte at the end.

format=2 stores the string after a byte containing the length of the string.

format=3 stores the string without embellishment.

The value returned by the function is the address of the first byte it plants, so that text = FNdefstring("Here is a message",0) will store the text, followed by an &0D

byte, and adjust P% to point to the next byte to be used by the assembler. The variable "text" will contain the address of the leading "H" character.

Function "defbytes" initialises one or more bytes to numeric values. The caller passes a list of the values as a string (Basic does not permit a function to have a variable number of parameters, so the numbers have to be set as a string and unpacked by the routine). Each element can be any numeric expression: the 1s byte will be stored. Assembler labels (which are Basic variables) can be used, but forward references can't be handled, so labels thus used should be given (arbitrary) values before the assembly begins. After pass one they will have their correct values. Again, the value returned by the routine is the address of the first byte planted. So numbers = FNdefbytes

("3,&27,&FF,1") will initialise four consecutive bytes, and the variable "numbers" will contain the address of the first of them.

The example program presents the listing of the two functions and an example of their use. The program will clear the screen and move the text cursor to (10,15) by the equivalent of the Basic statements

```
VDU 12
VDU 31,10,15
which involves writing the successive bytes to the OSWRCH routine at &FFEE.
```

The program then prints 'Assembler Rules OK' and stops.

The functions themselves are quite simple and need little explanation. In defstring, the work is done in one IF statement at line 10030. The caller's string is copied to a 'fixed string' starting at the byte pointed by P% (specified by the \$P% construction). This adds a &0D to the string and so no more is done for format 0. For format 1, the string has a CHR\$0 concatenated with it before it is assigned to a fixed string,

and the &0D is subsequently removed. The value of P% is adjusted to point to the byte after the string, allowing for any byte following.

Function defbytes consists of two nested REPEAT loops. The inner loop slices the string into the numeric elements, and the outer pokes the values obtained and increments P% each time.

Alan Phillips

```
100 DIM code 100
120 FOR IZ = 0 TO 3 STEP 3
140 PZ=code ; REM set assembler ptr
160 [OPT IZ
180 .doit
200 LDY #0 \ ptr to list of bytes
220 .nextvdu
240 LDA vdubbytes,Y \ set next byte
260 JSR &FFEE \ send it to vdu driver
280 INY \ step the pointer
300 CPY #4 \ stop when Y=4
320 BNE nextvdu
340 LDY #0 \ now set text ptr
360 .nextchar
370 LDA text,Y
380 JSR &FFEE3 \ output it with osascii
400 CMP #&0D \ was it RETURN?
420 BEQ end \ finish if it was
440 INY \ else move pointer on
460 JMP nextchar \ and carry on
480 .end
500 RTS \ finished
520 ]
540 REM
560 REM DEFINE BYTES AND TEXT - INSIDE
580 REM THE TWO PASS LOOP SO THE ADDRESSES
600 REM ARE KNOWN BY PASS 2 TIME
620 REM
640 vdubbytes=FNdefbytes("12,31,10,15")
660 text=FNdefstrings("Assembler Rules OK",0)
680 REM
700 REM AND DO PASS 2
720 REM
740 NEXT
800 REM
810 REM NOW CALL THE M/C CODE ROUTINE
820 REM
830 CALL doit
840 REM
850 REM AND FINISH
860 REM
870 END
9000 REM
9010 REM FUNCTION defstrings
9020 REM =====
9030 REM
10000 DEF FNdefstrings(string$,format%)
10010 LOCAL address%
10020 address%=P% ; REM note start address of string
10030 IF format%=0 THEN $P%=string$ ELSE IF format%=1 THEN
$P%=string$+CHR$0 ELSE I
F format%=2 THEN $P%=CHR$(LEN(string$))+string$
ELSE $P%=string$:PZ=PZ-1
10040 PZ=PZ+LEN(string$)+1
10050 =address%
11000 REM
11010 REM FUNCTION defbytes
11020 REM =====
11030 REM
12000 DEF FNdefbytes(list$)
12010 LOCAL AZ,BZ,address%
12020 address%=P% ; REM note address of first byte
12030 AZ=1
12040 BZ=1
12050 REPEAT
12060 REPEAT
12070 BZ=BZ+1
12080 UNTIL MID$(list$,BZ,1)="" OR BZ>LEN(list$)
12090 ?PZ=EVAL(MID$(list$,AZ,BZ-AZ))
12100 PZ=PZ+1
12110 AZ=BZ+1
12120 UNTIL BZ>=LEN(list$)
12130 =address%
```

## BBC HAND RESET

Pressing the BREAK key on the BBC Computer returns the system to Mode 7, and deletes any program from memory. The message BBC Computer BASIC

> appears on the screen. However, this does not reset the clock or clear the definitions of the user-defined keys. This is what the User Guide calls a 'soft reset'.

According to the User Guide a 'hard reset' (clock reset and user-defined keys reset) can be obtained in operating system version 1.0 by pressing BREAK and CTRL keys together. However, my Model B machine does not do this, neither has it anything in the hole marked 'reset' at the rear of the case.

Users with similar machines may like to know that it is possible to obtain a hard reset by pressing the BREAK key twice in quick succession. This causes the CHR\$(7) 'bell' to be printed and the message

BBC Computer 32K BASIC

> to appear. The variable TIME will be set to 0 and the ten user-defined keys will be cleared.

Ian Simpson



## NEW ATOM COMMANDS

This assembler routine enables you to create new Basic commands for your Atom. The program sets the error-handling routine pointers (in #202, #203) to the start of an assembler routine. When the new command is encountered, an error occurs and control is passed to this routine.

The routine is illustrated using a simple command ' ' which clears the screen (ie, it issues a CTRL-L). Any new Basic command(s) could be entered between lines 100 and 150.

The assembler routine is essentially in two parts. The

first, lines 55 to 180, checks the error to see if it is the new command (in this case ' '); if it isn't control is passed to the usual error-handling routine. If it is the new command, the command is executed by lines 130-140 and control is passed to the second half of the routine. This part searches for the start of the next statement or line to be interpreted; when located, the statement pointers are updated by lines 260-310 and Basic execution is resumed.

John Hearn

```

10 DIM LL(5)
20 P.$21
30 FOR I=1 TO 2
40 DIMP(-1);A=P;REM Starting address=A
50 I
55 LDY @#1
60 :LL0 LDA (#5),Y #5,#6 point to statement being interp'd
70 CMP @#3B #3B=;
80 BEQ LL2
90 CMP @#0D #0D=return
100 BEQ LL2
110 CMP @#5E #5E=^ (new command)
120 BNE LL1
130 LDA @#0C Print $12, clear screen
140 JSR #FFF4 Print routine
150 JMP LL3 Return to Basic
160 :LL1 INY
170 JMP LL0
180 :LL2 JMP #C9DB Normal error routine
190 :LL3 LDA (#5),Y Look for next statement
200 CMP @#3B
210 BEQ LL4
220 CMP @#0D
230 BEQ LL4
240 INY Continue search for ; or return
250 JMP LL3
260 :LL4 CLC
270 TYA Update statement pointer in #5,#6
280 ADC #5
290 STA #5
300 BCC LL5
310 INC #6
320 :LL5 JMP #C2F2 Return to Basic
330 I
350 N.;P.$6
360 ?#202=AZ256;?#203=A/256;REM#202, #203 point to brk routine
370 ^;REM New command to clear screen
380 E.

```

## BETTER RANDOMISATION

Here is a means of avoiding the prompt RANDOMIZE and its input response required by Microsoft Basic and some other Basics, while still providing fresh randomisation each time the game is run.

A sequential file is opened at the beginning of the program, from which an integer is retrieved, incremented and used as the seed before being rewritten to file. In Microsoft Basic-80 a suitable routine would be

```

10 OPEN "I", #1, "SEED"
20 INPUT #1, N
30 CLOSE #1
40 N=N+1
50 M=N
60 RANDOMIZE M
70 OPEN "O", #1, "SEED"
80 PRINT #1, N
90 CLOSE #1

```

...rest of program  
The file "SEED" is initialised with the largest negative number that the system will support; in my case, -32767.

Theoretically, one should perhaps provide for re-initialisation when N overflows at +32768, but I doubt whether the average punter will live to see it.

If a disk contains more than one game you can incorporate this routine into the menu, so that all games share a common series of randomisation seeds and disk activity is reduced.

Simon Holmes

## ATOM AUTO REPEAT

One of the disadvantages of the Atom keyboard is that the keys do not automatically repeat when they are held down.

This short routine replaces the normal character input routine to provide auto-repeat on all of the keys that are available to Basic programs.

The delay between the time that the key is pressed and the start of the repeat sequence is set on line 150. The number 35 gives a delay of just over half a second.

The subroutine call at line 270 causes a delay of 0.1 seconds. This could be replaced by a delay loop in order to change the repeat speed.

To use the auto-repeat routine the character input vector must be changed to point to the new routine. This can be done in Basic as follows:  
?522=0; ?523=40.

This must also be done if the break key is pressed.  
N P Capper

```

10REM ATOM AUTO-REPEAT ROUTINE
20REM BY N.P. CAPPER
30 DIM LL(3)
40 P.$21 ;REM turn display off
50 F.I=0 TO 1 ;REM do two passes
60 P=#2800 ;REM store at #2800
70I
80:LL0 PHP save flag reg
90 CLD set binary mode
100 STX #E4 save x
110 STY #E5 save y
120 JSR #FE71 scan keyboard
130 BCC LL2 key pressed
140
150:LL1 LDX @35 put repeat delay
160 STX #80 into #80 and get
170 JMP #FEA4 ascii code
180
190:LL2 DEC #80 delay loop
200 BEQ LL3
210 JSR #FE66 wait 1/60 sec
220 JSR #FE71 scan keyboard
230 BCS LL1 key released
240 BCC LL2 key still pressed
250
260:LL3 INC #80 set delay to 1
270 JSR #FB8A wait 1/10 sec
280 JMP #FEB1 get ascii code
290
300I
310 N. ;REM do next pass
320 P.$6 :REM turn display on
330 END

```

# WARNING!

In last month's TJ's we published a method to speed up the display on the PET ('Faster PET Screen', page 174). We have since been advised that on certain models this can cause serious damage to the video circuitry. Unfortunately there is no easy

way to tell whether your PET is one of these models other than by trying the POKEs mentioned and switching off immediately if the screen display collapses. To be safe, we advise readers not to use this method of speeding up the display.

# HOW TO USE YOUR EPSON WITHOUT WASTING COMPUTER TIME

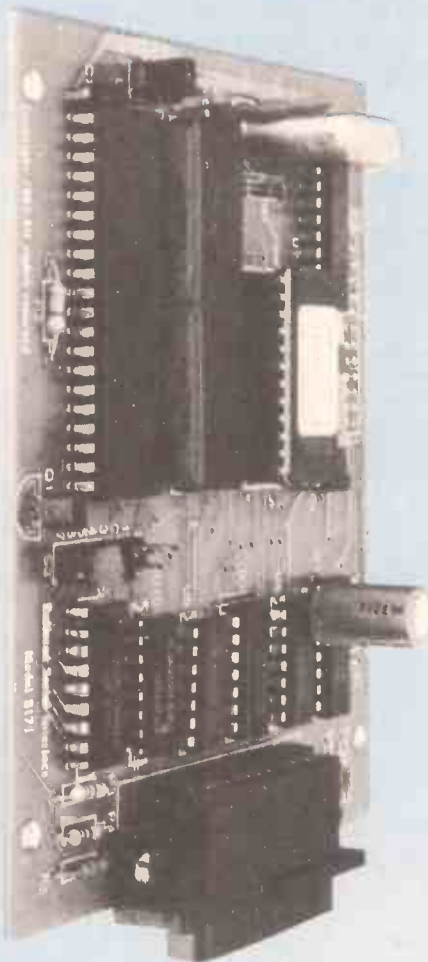

SERIAL 8K  
£125 + VAT

Your computer is capable of sending data at thousands of characters per second but the Epson can only print 80/100 characters per second.

This means your computer is forced to wait for the printer to finish one line before it can send the next. A waste of valuable time.

## THE NEW MICROBUFFER ACCEPTS DATA AS FAST AS YOUR COMPUTER CAN SEND IT

Microbuffer stores the data in its own memory buffer and then takes control of the printer. This frees your computer for more productive functions.

### PARALLEL OR SERIAL

Microbuffer model MBK-16K is a Centronics - compatible parallel interface with 16,384 bytes of on-board RAM for data buffering.

The MBS-8K is a full featured RS232C serial interface with both hardware and software (x-On/X-Off) handshaking, baud rates from 300 to 19,000 and an 8,192 byte RAM buffer.

### SIMPLY PLUG IT IN

Either model fits the existing auxillary interface connector inside the Epson MX80, MX80 F/T or MX100 without modification, and is compatible with standard Epson cables and printer control software.

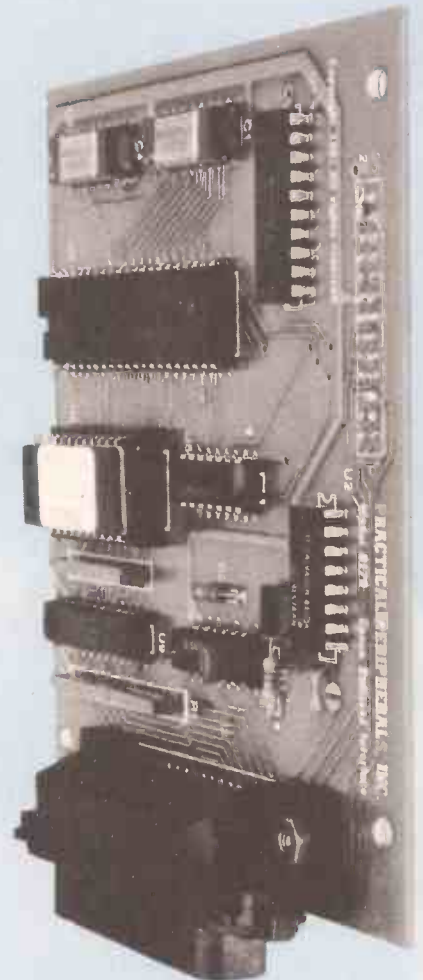

PARALLEL  
£125 + VAT

**Only available from NORTHAMBER - call your local stockist and get him to order one for you today (he can get 24 hour delivery) - AND GET THE MOST FROM YOUR HOST**

**NORTHAMBER**  
**The Printer People**

3, 4 and 5 DAWES COURT, ESHER, SURREY **LIMITED**  
*Importers, Distributors and Wholesalers of Computer Products*

Tel: ESHER (0372) 66397/62071 Telex: 24123 NAMBEG  
(from 01 numbers dial 78-66397 or 78-62071)

# A FREE 12" MONITOR WITH EVERY

# OSBORNE 1

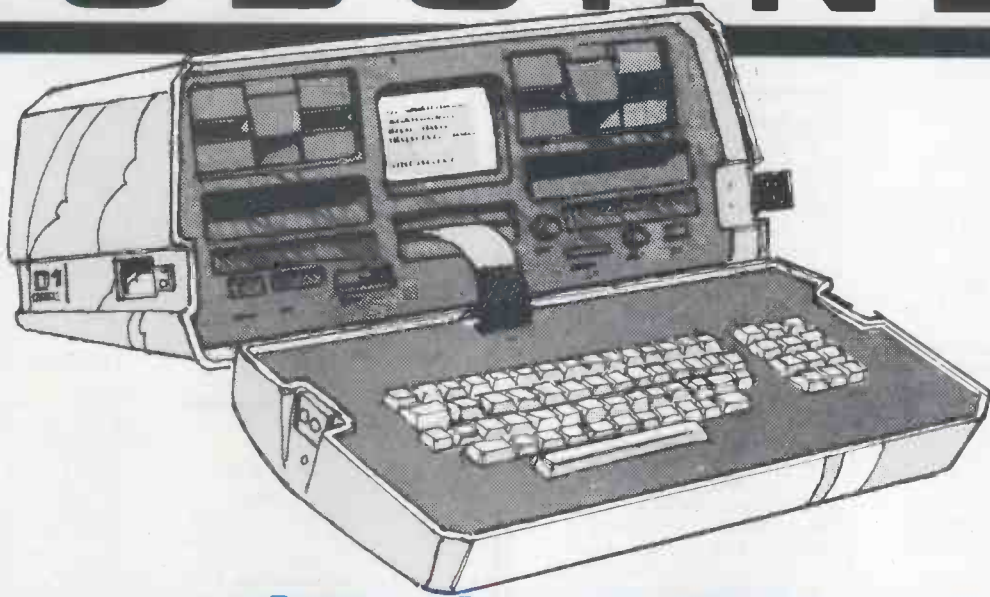

## Personal Business Computer!

Available NOW from DATALINK the amazing Osborne 1 is the totally portable 64K personal business computer. An incredible breakthrough for mobile executives, sales personnel, engineers etc., Osborne 1 weighs only 24lb and fits under the standard airline seat!

And just look at DATALINK's special introductory offer  
**WORTH NEARLY £200! —**

**— A FREE 12" QUALITY GREEN MONITOR**

which Interfaces with the Osborne for home use PLUS A BOX OF HIGH QUALITY BASF DISCS complete with SUPERIOR LIBRARY CASE! FREE!

**Datalink's price - £1250 + VAT!**

The Osborne package also includes as standard: WORDSTAR,<sup>®</sup> SUPERCALC,<sup>™</sup> MAIL MERGE,<sup>®</sup> MBASIC,<sup>®</sup> CBASIC<sup>®</sup> and CPM<sup>®</sup>

Take advantage of this superb offer while it lasts.  
Cash with order - Personal buyers welcome. Post FREE in UK!

# DATALINK

MICROCOMPUTER SYSTEMS (UK) LIMITED

10 Waring House, Redcliffe Hill, Bristol BS1 6TB Tel: Bristol (0272) 213427 Telex: DATAL G 44807

24 hr answering service

# COMPUTER ANSWERS

Send your queries to: Sheridan Williams, 35 St Julian's Road, St Albans, Herts.  
Please note that Sheridan can no longer answer questions on an individual basis, so please don't send an SAE with your query.



## TRS-80 troubles

Could you please tell me where I could get some advice about my TRS-80 micro-computer?

*Martin Pearce, Castleford*

I own a TRS-80 which I have attempted to upgrade myself. Unfortunately I cannot get the upgrade to work, so where can I get advice?

*J Harrison, Burton-on-Trent*

I believe very strongly in self-help. This can be achieved by joining a local club, or user group. There you will find others who have surmounted similar problems. This applies to any computer system, not just to the TRS-80. Look through PCW's user group index and join one straight away.

SW

## VIC follow-up

The following letter from I Wright of Sheffield refers to the query 'VIC Interface' in the June issue of PCW. The original question was: 'Here in Athens the VIC cassette is £90 — is there a way of using an ordinary cassette recorder on the VIC?'

Mr Wright has the following advice:

The solution is a single pole, single throw switch used to ground the 'switch' connection on the cassette output port. Precise details are:

- 1) Ignore the 5V and 9V lines on the output port.
- 2) Connect the 'data out' and 'data in' lines to the centre conductors of two lengths of microphone cable, the screens of which go to the 'ground' (0V) line.
- 3) Connect the other ends of these to 3.5mm jack plugs as normal and insert these into the mic and earphone sockets of the recorder (beware of DIN sockets as there are often unwanted resistors lurking behind these). Remember that the IN and OUT designations of these lines refer to the computer and *not* the recorder.
- 4) Finally, wire a switch between the 'switch' line and 'ground'. If you're not unduly worried about guarantees, etc, the best place to secure this is probably the main computer case.

To operate, type SAVE"" and press RETURN as normal. The VIC will reply with

'PRESS RECORD AND PLAY BUTTONS'; turn on the tape recorder, wait for the leader to pass, then turn on the 'magic switch' and the program will be saved as normal. When complete, turn off the switch, followed by the recorder. Loading is just as simple.

SW

## Space problem

I have an RML 380Z with 5¼in disks and want to store data on 10,000 stock items. I want to know the most efficient (least storage), fastest access method of doing this. I need to be able to access any item by part number, description or drawing number.

*J F Cain, Redhill, Surrey*

The 380Z is far from being the ideal machine for the purpose on three counts: disk access speed, disk capacity and systems software. The 5¼in disks are only single density (70k per side) and have a very slow transfer rate. You are also hampered by the lack of direct access file handling capability in RML Basic, though you can obtain this from a company called Software Production Associates. I suggest that you use Cobol as this supports index sequential files. You will have to code your data substantially as with 10,000 items each needs only to be seven characters in length and your 70k is gone. In fact you will certainly need to split the file across several disks and sides.

You really need a system with large-capacity disks — 8in or even a hard disk.

SW

## Musical micro

I have heard that there is available a micro that can not only play a tune but can also print out the music onto manuscript paper. Can you please tell me more about it?

*A P Hawkins, Camberley, Surrey*

The system you have heard about might well be the Apple II computer fitted with an Alf Products MC16 or MC1 Music Synthesizer board. This provides facilities for composing music on the screen and displaying it in full musical notation. The resultant music can then be played through the user's external audio system. By using a high-resolution graphics printer like the Epson MX100 it should also be possible to print out the music score, screen by screen. Details of the Alf

synthesiser boards are in PCW vol 4, number 5, May 1981.

*P L McIlmoyle*

## Stop it!

How can I stop the computer responding to control characters when using Basic's INPUT\$(1) command?

*D Salkeid, Weymouth*

Simply test after the input — for example:

```
100 CH$=INPUT$(1):
    CH=ASC(CH$)
110 IF CH<32 OR CH>122
    THEN 100
120 PRINT CH$;
```

Using this technique you can restrict the input to only the numeric keys, for instance.

SW

## '81 RAM

I own a ZX81 and wish to extend the memory. My theory of computer internals is low, so I do not understand how you could add 16, 32 or 64k RAM. How does the CPU know how much memory it has?

Also, can you recommend Audio Computers of Southend and its 32k RAM pack?

Finally, how easy would it be to assemble from kit?

*David Pye*

The Z80 is capable of directly addressing up to 64k RAM. So if you subtract 8k for the Sinclair ROM, then the ZX81 is capable of having 56k RAM.

The simplest way for the Z80 to check how much memory it has is by loading each location with 02 (or any other number) and then reading them back — if the result is 02 then there is RAM there; if the answer is 00 then there isn't.

The Audio Computers RAM pack looks very good value. I myself tried to obtain one a few months ago. After sending the money I was repeatedly told that it would arrive within the week. After two months I gave up and asked for my money back, which I got.

If you decide to build any kit involving ICs, it's important to have a good fine soldering iron, which isn't too powerful, and some experience of soldering.

*James Walsh*

I should be grateful for your answers on three ZX81 questions:

- 1) Is there a larger RAM than 16k?
- 2) Is it possible to determine what portion of memory space remains at any stage of program development?

3) Is there any programmable way of deleting 50 or 60 program instructions?

*C Payne*

Starting with the first question first:

1) Yes, it is possible to expand the ZX81 up to 56k RAM. These types of memory expansion are available from JRS Software and Hewson Consultants, to name but two.

2) Yes, by implementing this short machine code routine:  
LD HL,0000  
ADD HL,SP  
LD DE,(16412)  
AND A  
SBC HL,DE  
LD B,H  
LD C,L  
RET

The simplest way of doing this is:

```
10 REM 123456789012
20 FOR X=16514 TO 16526
30 INPUT A
40 POKE X,A
50 NEXT A
60 PRINT USR 16514
```

Then enter these numbers on input prompt:  
33,0,0,57,237,91,28,64,107,  
238,66,68,77,201.

You can now delete lines 20-60.

Any time you want to know the remaining memory, just type PRINT USR 16514.

3) Again the answer is yes. This function is available on the Picturesque ScreenKit.

*James Walsh*

I own a ZX81 and have read many adverts on books to explain how to use the ZX81 'monitor'. What is the monitor and what can I do with it?

Also, I am on my seventh 16k RAM Pack and it works all the time but now and then when I press SHIFT plus another character the memory wipes itself. I have sent away so many times to Sinclair and waited so long that I don't know whether to send away for a replacement or my money back.

*John Hogg*

The monitor is a set of routines within the ZX81 ROM which deals with the operations which the CPU cannot handle on its own. For example, printing on the screen and expanding the display file at the same time and doing the mathematical functions. The best way to find out about the monitor and what you can do with it is to read Ian Logan's book

*Understanding Your ZX81 ROM.*

If I had as much trouble with my Sinclair RAM Pack then I would be inclined to ask for a refund and buy one of the independently manufactured RAM Packs which are on the market. These

don't suffer from most of the problems of the Sinclair model.

James Walsh

I have recently bought one of the machine code programming books advised in the ZX81 Basic Manual. The book doesn't tell you how to get into machine code but just what to do when you are there. I've tried USR routines but they don't seem to work, it's probably that I am doing something wrong. Please can you help?

Jonathan Menmuir

The simplest way of entering machine code on the ZX81 is to put a large REM statement as the first line of the program, and POKE the decimal value of the desired instruction into address 16514 onwards. For example:

```
10 REM 1234567890
20 LET X=16514
30 INPUT A
40 IF A=999 THEN STOP
50 POKE X, A
60 PRINT A; " ";
70 GOTO 20
```

The REM statement must be able to hold the same number of characters as your machine code routine is long. If you type '999' (there is no such m/c instruction) then the program will stop, so that you can execute your routine. To execute type RAND USR 16514.

James Walsh

## The sole of a new machine

I read your Benchtest of the ZX Spectrum and am very interested to see such a cheap and efficient personal computer.

Would you tell me if the Spectrum would serve me in the following area: I sell shoes in a large boutique and want to check my stocks, thus enabling me to serve customers faster. I keep 40 types of shoe in each of four colours and five sizes. I sell 15 pairs a day and serve about 20 customers.

Mehmet Muderrisoglu,  
Istanbul

You should remember that computers need to be fed with information in order to be kept up to date. This will entail entering the transactions as they take place, or in batches at the end of the day, say. If your requirement is really as simple as you state, then the Spectrum would cope, because you could code the model, colour and size as single characters; this would need only around 800 bytes of data storage. This could be loaded from cassette at the start of the day and dumped out at the end (barring power failures, etc). My advice would be to go for a system with a proper keyboard which also has good dealer backup in Istanbul. Once you require the system to handle accounts, sales statistics, etc,

you should certainly look for a more up-market business system.

SW

## Newbrain v Spectrum

I am considering a computer in the £200 range for some medical and financial applications. So far I have narrowed the choice down to the Newbrain Model A and the Sinclair Spectrum (48k).

The Newbrain offers greater memory expansion (to 512k), higher resolution graphics with an 80-column display option (for word processing) and interfaces which would allow disks and CP/M to be used. The Spectrum offers colour and sound and the likelihood of cheaper disks but seems to have limited expansion potential. How would you compare these for my application? Also, how does the Newbrain ANSI compare with the Sinclair Basic?

A Wetter, London N1

As with so many questions it is, as you imply, very much a matter of selecting the right machine for your particular application, rather than one being 'better' than another in some general way. In your case the Newbrain seems to me to have a number of attractions.

Firstly, it is generally about twice as fast as the ZX Spectrum in most benchmarks. Assuming that your medical work calls for searching databases of some type, this could be quite significant. Secondly, the Newbrain has what is essentially a standard typewriter keyboard. If you, or anyone entering data on your behalf, can touch-type, this is a very great advantage over the Spectrum, which does not have such a good keyboard. If you are a novice programmer the Spectrum's multi-function keys can be a great help, but with more experience they can become rather frustrating (which is only to say that the Spectrum is just right for its intended market!).

Again, if you want to use commonly available professional software, the ability of the Newbrain to support standard size disk drives and to run the 'industry standard' CP/M operating system is of great advantage.

On the other hand, the Spectrum offers a cheaper route to a system complete with disk drives and a printer (once the special micro floppy drives become available) and does provide colour graphics, if that is significant for your applications. Doubtless somebody will put CP/M onto the Spectrum soon, too!

As regards the two versions of Basic, both strike me as being above average. The I/O handling on the New-

brain is a little complex, but very powerful, while the Sinclair Basic offers a much better method of handling sub-strings than does the more usual Microsoft Basic.

P L McIlmoyle

## Mono Dragon

In the August issue of PCW Mike Curtis reviewed the Dragon 32, saying that the computer plugs into the back of a colour television. I only have black and white, so will I be able to use the Dragon? T Caddies, Newcastle-on-Tyne

Any colour computer that sends out a colour signal can be used on a b&w set. However, you will have difficulties seeing some of the colours: light blue, for instance, can often only be seen on a b&w set if the brightness is turned right up.

SW

## X-ray vision

I have a question for my own 'Answers' page. I hope some readers may be able to answer it.

Colour TV sets give off X-rays. It has been assumed that this causes no problems when watching at home because of the usual viewing distance from the set. However, it worries me to think that I am being saturated by X-rays when using the colour TV attached to a computer, because I sit less than one metre from the screen. I have no desire to die of these effects on PCW's behalf, so could someone reassure me and readers that the effect is not worth worrying about?

Sheridan Williams

## Which monitor?

I am interested in the Microvitec LCCD colour monitor and intend to use it with my BBC Computer. I notice that it has a bandwidth of 7 MHz and a resolution of 452(H) by 585(V) elements. Can it be used with 80-column text? W H Kwan, Durham

We have reviewed b&w and colour TVs and monitors in the June issue of the Beebug magazine. It was apparent that no colour set (not even RGB) gave a picture quality on 80 columns that was comfortable to read for long periods.

The Microvitec is available in three models — Standard, 1V Linear and high resolution. The bandwidths are 6, 7 and 12 MHz respectively and the horizontal resolutions are 452, 452 and 895 elements respectively. They all have the same (585 elements) vertically. For serious word processing use it is essential to use a black and white monitor

and even the cheapest of these seem adequate. Prices of the three Microvitec sets (14in) are £274, £295 and £499 respectively. For more details write to Microvitec Ltd, PO Box 188, Futures Way, Bradford, BD4 7TU (tel 0274 390011).

SW

## Osborne rub-out

I have recently started to use an Osborne 1 and am generally impressed by it. The keyboard is not as solid-feeling as I would like, but must obviously be light for portability. However, there is one curious and awkward omission, which is the lack of a DEL (or RUBOut) key. This is particularly frustrating when using Wordstar, as deleting the character just typed then needs Control-S to backspace, followed by Control-G to delete the character the cursor is then on, rather than just pressing DEL. Is there any way to provide a DEL function on this machine?

(Name and address withheld by request)

There are in fact at least two ways to overcome this problem. The first is to make use of the ability to program the numeric pad keys to generate the ASCII code for DEL (127 decimal).

Alternatively, and much simpler, pressing Control together with the minus sign key will generate DEL.

P L McIlmoyle

## C sought

I wish to download software I have developed on the Onyx C8002 to a Superbrain for testing under CP/M. I am a little unsure of how to write the driver software in C to handle the communication between the two machines' IEEE ports. I would be grateful if you could recommend any books I could read to help me solve the problem.

H Frost, Shepperton, Middx

For the C language used for the driver program I would recommend *C Programming Language* by Brian Kernighan and Dennis Ritchie, obtainable from Lifeboat Associates, PO Box 105, London WC2H 9LU. One of the best books on CP/M that I know is the *CP/M User's Guide*, published by McGraw-Hill/Osborne. *The CP/M Handbook* by Rodney Zaks (published by Sybex) is also excellent, although it does not go into the inner workings of CP/M to the same extent. The Digital Research CP/M handbooks are also essential for your project, but I expect you are familiar with these.

P L McIlmoyle

## MIDAS S100 SYSTEMS

**MIDAS 1: From £835**

**MIDAS 2: From £1,790**

**MIDAS 3: From £2,450**

**MIDAS 3HD: From £5,495**

**ITHACA-DPS 1: From £1,494**



- Our versatile **Z80** Microcomputers are available as standard units or custom configured to your exact specification from a comprehensive range of stocked **S100** boards.
- Disc storage capacity of the **MIDAS 3** can be 2M Bytes, expandable to over 80M Bytes with a Winchester Hard Disc Unit in our **MIDAS 3HD** range.
- **MIDAS** runs **CP/M** and **MP/M**. Other Software includes **M-BASIC**, **C-BASIC**, **FORTRAN**, **COBOL**, **CIS-COBOL**, **PASCAL** and Word Processing.
- A **MIDAS 3D** with 64K RAM and 2M Bytes storage on two 8" drives with two Serial I/O Ports and **CP/M** only **£3,100**.
- Printers, VDUs and other peripherals stocked to give complete package system at keen prices.

## BOARDS

We stock over 50 different S100 Boards all from quality manufacturers, such as Godbout, SSM, Micromation, Dual, Ithaca, Vector, S.D. Systems, Morrow, Pickles & Trout, etc.

### PROCESSOR

|                         |           |
|-------------------------|-----------|
| Z80 Starter Kit         | £251      |
| SBC 100                 | £215      |
| 8085/88 CPU             | £190      |
| Z80A CPU 4MHz (4 Types) | From £157 |
| 8086                    | (tba)     |

### EPROM

|                           |           |
|---------------------------|-----------|
| 2716 EPROM (2 x 16K)      | £95       |
| 2768/2716/2732 Programmer | From £143 |

### VIDEO BOARDS

|                       |      |
|-----------------------|------|
| 24 x 80 I/O Drive     | £240 |
| 24 x 80 Memory Mapped | £240 |

### DISK CONTROLLERS

|                         |           |
|-------------------------|-----------|
| Single Density 5" or 8" | From £150 |
| Disc 1 D/D DMA          | £282      |
| Double D/D + Serial I/O | £336      |

### RAM

|                               |           |
|-------------------------------|-----------|
| Static RAM 16-64K 24 Bit add. | From £175 |
| Dynamic RAM 64K 8/16 Bit      | £683      |
| Memory Manager                | £60       |

### I/O BOARDS

|                             |           |
|-----------------------------|-----------|
| 2s/2p or 4s/2p or 3p/1s etc | From £120 |
| A/D & D/A 8 or 12 Bit       | From £220 |
| IEE 488 interface           | £360      |

### MISCELLANEOUS

|                             |           |
|-----------------------------|-----------|
| Real Time Clocks (2 Types)  | From £120 |
| Graphics 256 & 512 x 256    | £280      |
| Maths Board AMD 9511        | £345      |
| Extender Boards/Logic Probe | £45       |
| Mother Boards 8-20 Way      | From £32  |

### MAINFRAMES

We are the sole UK Distributor for Integrand Mainframes and Disc Enclosures, available in nine models including Desk Top and Rack Mounting, with or without provision for Disc Drives. All units totally enclosed, painted on all external surfaces and complete with power supply etc.

### SOFTWARE

CP/M 1 & 2, MP/M, PL/1, C-BASIC 2, M-BASIC V5, XYBASIC, FORTRAN 80, COBOL 80, CIS-COBOL, PASCAL/Z, PASCAL M/T, Forth, MAC, ZSID, Disassembler, Wordstar, Datarstar, Wordmaster, Supersoft etc etc.

Prices exclusive of VAT

We are pleased to discuss your requirements and will advise you as to whether your needs can be met with one of our computers.

All of our systems are specials as they are configured to suit your specification, thus ensuring that you get what you want rather than what happens to be available.

Write or phone for a catalogue.

**Unit 14, 29 Willow Lane, Mitcham, Surrey**  
**Telephone: 01-640 6931/2/3**

# NEWCOMERS START HERE

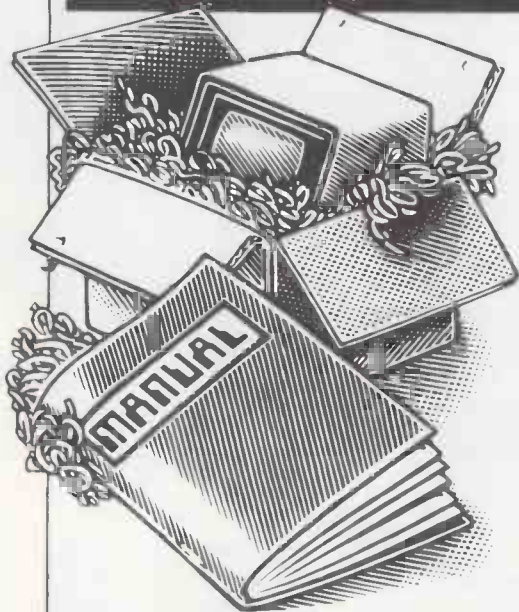

*This is our unique quick-reference guide, reprinted every month to help our readers pick their way through the most important pieces of (necessary) jargon found in PCW. While it's in no way totally comprehensive, we trust you'll find it a useful introduction. Happy microcomputing!*

Welcome to the confusing world of the microcomputer. First of all, don't be fooled; there's nothing complicated about this business, it's just that we're surrounded by an immense amount of necessary jargon. Imagine if we had to continually say 'numbering system with a radix of 16 in which the letters A to F represent the values ten to 15' when instead we can simply say 'hex'. No doubt soon many of the words and phrases we are about to explain will eventually fall into common English usage. Until that time, **PCW** will be publishing this guide — every month.

We'll start by considering a microcomputer's functions and then examine the physical components necessary to implement these functions.

The microcomputer is capable of receiving information, **processing** it, storing the results or sending them somewhere else. All this information is called **data** and it comprises numbers, letters and special symbols which can be read by humans. Although the data is accepted and output by the computer in 'human' form, inside it's a different story — it must be held in the form of an electronic code. This code is called **binary** — a system of numbering which uses only 0s and 1s. Thus in most micros each character, number or symbol is represented by eight binary digits or **bits** as they are called, ranging from 00000000 to 11111111.

To simplify communication between computers, several standard coding systems exist, the most common being **ASCII** (American Standard Code for Information Interchange). As an example of this standard, the number five is represented as 00110101 — complicated for humans, but easy for the computer! This collection of eight bits is called a **byte** and computer freaks who spend a lot of time messing around with bits and bytes use a half-way human representation called **hex**. The hex equivalent of a byte is obtained by giving each half a single character code (0-9, A-F): 0=0000, 1=0001, 2=0010, 3=0011, 4=0100, 5=0101 . . . . E=1110 and F=1111. Our example of 5 is therefore 35 in hex. This makes it easier for humans to handle complicated collections of 0s and 1s. The machine detects these 0s and 1s by recognising different voltage levels.

The computer processes data by reshuffling, performing arithmetic on, or by comparing it with other data. It's the latter function that gives a computer its apparent 'intelligence' — the ability to make decisions and to act upon them. It has to be given a set of rules in order to do this and, once again, these rules are stored in **memory** as bytes. The rules are called **programs** and while they can be input in binary

or hex (**machine code programming**), the usual method is to have a special program which translates English or near-English into machine code. This speeds programming considerably; the nearer the programming language is to English, the faster the programming time. On the other hand, program execution speed tends to be slower.

The most common microcomputer language is **Basic**. Program instructions are typed in at the keyboard, to be coded and stored in the computer's memory. To run such a program the computer uses an **interpreter** which picks up each English-type instruction, translates it into machine code and then feeds it into the **processor** for execution. It has to do this each time the same instruction has to be executed.

Two strange words you will hear in connection with Basic are **PEEK** and **POKE**. They give the programmer access to the memory of the machine. It's possible to read (**PEEK**) the contents of a byte in the computer and to modify a byte (**POKE**).

Moving on to **hardware**, this means the physical components of a computer system as opposed to **software** — the programs needed to make the system work.

At the heart of a microcomputer system is the central processing unit (**CPU**), a single microprocessor chip with supporting devices such as **buffers**, which 'amplify' the CPU's signals for use by other components in the system. The packaged chips are either soldered directly to a printed circuit board (**PCB**) or are mounted in sockets.

In some microcomputers, the entire system is mounted on a single, large, PCB; in others a **bus system** is used, comprising a long PCB holding a number of interconnected sockets. Plugged into these are several smaller PCBs, each with a specific function — for instance, one card would hold the CPU and its support chips. The most widely-used bus system is called the **S100**.

The CPU needs memory in which to keep programs and data. Microcomputers generally have two types of memory, **RAM** (Random Access Memory) and **ROM** (Read Only Memory). The CPU can read information stored in RAM — and also put information into RAM. Two types of RAM exist — **static** and **dynamic**; all you really need know is that dynamic RAM uses less power and is less expensive than static, but it requires additional, complex, circuitry to make it work. Both types of RAM lose their contents when power is switched off, whereas ROM retains its contents permanently. Not surprisingly, manufacturers often store interpreters and the like in ROM. The CPU can only read the ROM's contents and cannot alter them in any way. You can buy special ROMs called **PROMs** (Programmable ROMs) and **EPROMs** (Erasable PROMs) which can be programmed using a special device; EPROMs can be erased using ultraviolet light.

Because RAM loses its contents when power is switched off, **cassettes** and **floppy disks** are used to save programs and data for later use. Audio-type tape recorders are often used by converting data to a series of audio tones and recording them; later the computer can listen to these same tones and re-convert them into data. Various methods are used for this, so a cassette recorded by one make of computer

won't necessarily work on another make. It takes a long time to record and play back information and it's difficult to locate one specific item among a whole mass of information on a cassette; therefore, to overcome these problems, **floppy disks** are used on more sophisticated systems.

A floppy disk is made of thin plastic, coated with a magnetic recording surface rather like that used on tape. The disk, in its protective envelope, is placed in a disk drive which rotates it and moves a **read/write head** across the disk's surface. The disk is divided into concentric rings called **tracks**, each of which is in turn subdivided into **sectors**. Using a program called a **disk operating system**, the computer keeps track of exactly where information is on the disk and it can get to any item of data by moving the head to the appropriate track and then waiting for the right sector to come round. Two methods are used to tell the computer where on a track each sector starts: **soft sectoring** where special signals are recorded on the surface and **hard sectoring** where holes are punched through the disk around the central hole, one per sector.

Half-way between cassettes and disks is the **stringy floppy** — a miniature continuous loop tape cartridge, faster than a cassette but cheaper than a disk system. **Hard disk** systems are also available for micro-computers; they store more information than floppy disks, are more reliable and information can be transferred to and from them much more quickly.

You, the user, must be able to communicate with the computer and the generally accepted minimum for this is the visual display unit (**VDU**), which looks like a TV screen with a typewriter-style **keyboard**; sometimes these are built into the system, sometimes they're separate. If you want a written record (**hard copy**) of the computer's output, you'll need a **printer**.

The computer can send out and receive information in two forms — **parallel** and **serial**. Parallel input/output (**I/O**) requires a series of wires to connect the computer to another device, such as a printer, and it sends out data a byte at a time, with a separate wire carrying each bit. Serial I/O involves sending data one bit at a time along a single piece of wire, with extra bits added to tell the receiving device when a byte is about to start and when it has finished. The speed that data is transmitted is referred to as the **baud rate** and, very roughly, the baud rate divided by ten equals the number of bytes being sent per second.

To ensure that both receiver and transmitter link up without any electrical horrors, standards exist for serial interfaces; the most common is **RS232** (or **V24**) while, for parallel interfaces to printers, the **Centronics** standard is popular.

Finally, a **modem** connects a computer, via a serial interface, to the telephone system allowing two computers with modems to exchange information. A modem must be wired into the telephone system and you need British Telecom's permission; instead you could use an **acoustic coupler**, which has two obscene-looking rubber cups into which the handset fits, and which has no electrical connection with the phone system — British Telecom isn't so uppity about the use of these.

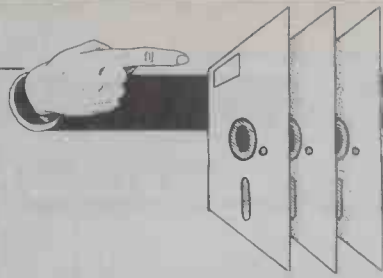

# PACKAGES

PCW's 'Packages' section is produced bi-monthly, alternating with our 'In Store' hardware guide. We have confined coverage to business packages which are available and supported at national level and which have been in use for at least six months in a minimum of five sites. Producers of packages which fall within these constraints should send details or updates to: Dick Olney, PCW, 14 Rathbone Place, London W1P 1DE.

The layout has been designed to allow you to discover which packages are available for the application you have in mind and to show you which packages are available for your computer if you already have a machine. In either case the code enables you to look up the supplier's name and telephone number in the table below. All details published are the latest made available — some may have changed since this issue went to press.

| Code | Company                            | Telephone       |
|------|------------------------------------|-----------------|
| A1   | ACT/Petsoft                        | 021-454 8585    |
| A2   | Arden Data Processing              | 0533 22255      |
| A3   | ADP Network services               | 01 388 1912     |
| A4   | Alamo Comp. Serv.                  | 0642-310381     |
| B1   | B + B Computer Ltd.                | 0204 26644      |
| B2   | Beam Business Centre               | 061-831-7292    |
| B3   | Benchmark Computer Systems         | 0726 61000      |
| B4   | Bristol Software Factory           | 0272.23430      |
| B5   | Byte Soft Systems Ltd              | 0533 531441     |
| B6   | Business Solutions Ltd             | 01-554-5985     |
| B7   | Bromley Computer Consultancy       | 01 464 8080     |
| C1   | CAP-CPP Products Ltd.              | 01-404 0911     |
| C2   | Commodore                          | 01-388 5702     |
| C3   | Comsoft                            | 0483 39665      |
| C4   | Comput-a-crop                      | 0507-604271     |
| C5   | Computastore Ltd.                  | 061-832-4761    |
| C6   | Computech                          | 01-794 0202     |
| C7   | Compass                            | Standish 426252 |
| C8   | CWP Computers                      | 01-828 3127     |
| C9   | C4 Computer Services               | 0632-664313     |
| C10  | Caxton Software                    | 01 379 6502     |
| C11  | CBS Consultants                    | 021-722-8181    |
| C12  | Comp Prog & Systems Serv           | 0942-38831      |
| E1   | Engineering Sciences               | 01-437-4894     |
| G1   | Graffcom Systems Ltd.              | 01-727 5561     |
| G2   | Grama (Winter) Ltd.                | 01-636 8210     |
| G3   | Great Northern                     | 0532 589980     |
| G4   | Alan Greenhalgh Ltd                | 01-520-0218     |
| G5   | Grade One                          | Glossop 63819   |
| H1   | A. J. Harding                      | 0424 220391     |
| H2   | Hartford Software                  | 0606 76265      |
| H3   | H. B. Computers                    | 0536 83922      |
| H4   | Wordcraft Systems                  | 0332 760127     |
| I1   | Intereurope Software Design        | 0734 786644     |
| I2   | Intex Datalog Ltd                  | 0642 781193     |
| J1   | T. V. Johnson                      | 0276 20446      |
| K2   | Keen Computers                     | 0602 412777     |
| L1   | Lifeboat Associates                | 01-836 9028     |
| L2   | Liveport (Exidy Sorcerer Firmware) | 0736 798157     |
| L3   | Ludhouse (Computing) Ltd.          | 01-679 4321     |
| L4   | Logic Comp Systems                 | 01-222-1122     |
| M1   | Micro Computer Applications Ltd.   | 0734 470425     |
| M2   | Microtech.                         | Orpington 26803 |
| M3   | Microsys Ltd                       | 051 426 7271    |
| M4   | Microsave                          | 0272 737555     |
| M5   | M. A. P. Comp Systems              | 061-624-5662    |
| P1   | Padmede Computer Services          | 02514 21892     |
| P2   | Personal Computers Ltd.            | 01-377 1200     |
| P3   | Professional Computer Services     | 061 624 4065    |
| Q1   | Quill Computer Systems.            | 061 477 4960    |
| R1   | Rockliff                           | 051-521 5830    |
| S1   | SMG Micro Computers                | 0474 55813      |
| S2   | The Softwarehouse                  | 01-637 2108     |
| S3   | Stage One Software                 | 0202 735656     |
| S4   | Systematics International          | 0440 61121      |
| S5   | Sumlock Bondain                    | 01-250 0505     |
| S6   | Stemmos                            | 01 602 6242     |
| S7   | Software Aids Int                  | 01-904 8139     |
| T1   | Tridata Micros Ltd.                | 021 622 6085    |
| T2   | Templeman Software                 | 0789 66237      |
| T3   | The Micro Solution                 | 0608 3256       |
| T4   | Terodec Ltd                        | 0734-664343     |
| T5   | TABS Ltd                           | 0264-58933      |
| T6   | Tip Data Ltd                       | 0375-33910      |
| V1   | Vlasak Electronics Ltd.            | 0494-448633     |
| W1   | Wisbech Computer Services          | 0945 64146      |
| W2   | Westfarthing Comp Services         | 03265-4098      |
| X1   | Xetal                              | 061 682 7555    |

## Applications

|                    |              |      |    |
|--------------------|--------------|------|----|
| Appointments       | Act Sirius 1 | £115 | C7 |
| planner            | Challenger   | £25  | C7 |
| Assembler dev      | PET/CBM      | £50  | L2 |
| Bill of materials  | Apple II     | £199 | T5 |
|                    | CP/M         | £850 | B5 |
|                    | CP/M         | £199 | T5 |
|                    | Cromemco     | £850 | B5 |
|                    | PET/CBM      | £199 | T5 |
|                    | Superbrain   | £450 | T3 |
| Bookmakers package | CP/M         | POR  | B7 |
| Budgeting package  | Apple II     | £125 | P2 |
|                    | Apple II     | £125 | T2 |
|                    | CP/M         | £95  | B5 |
|                    | Cromemco     | £95  | B5 |
|                    | North Star   |      |    |
|                    | Horizon      | £95  | B5 |
| Bureau de change   | PET/CBM      | £8   | H3 |
| Cash flow          | Apple II     | £125 | P2 |
|                    | Apple II     | £80  | V1 |
|                    | Apple II     | £100 | C8 |
|                    | CP/M         | £250 | L3 |

|   |                  |          |     |
|---|------------------|----------|-----|
|   | CP/M             | £95      | B5  |
|   | Cromemco         | £95      | B5  |
|   | North Star       |          |     |
|   | Horizon          | £95      | B5  |
|   | PET/CBM          | £8       | A1  |
| Cash register                             | CP/M             | £300     | T4  |
| Cheque writer                             | CBM/8032         | £90      | P3  |
|   | PET/CBM          | £90      | P3  |
| Company secretary                         | CP/M             | £450     | C4  |
| Container accounting                      | CP/M             | £750     | M5  |
| Contract costing                          | Apple II         | £500     | P1  |
|   | CP/M             | £2000    | L3  |
| CP/M & utilities                          | Tandy Model II   | £150     | M1  |
| Credit control                            | Apple II         | £98      | P2  |
|   | PET/CBM          | £650     | B4  |
| Customer file                             | Famos            | £1000    | M2  |
| Database management/Information retrieval | ACT800           | £225     | H4  |
|   | Apple II         | £150     | A2  |
|   | Apple II         | £150     | K2  |
|   | Apple II         | £60-140  | S2  |
|   | Apple II         | £150     | S5  |
|   | Apple II         | £75      | P2  |
|   | Apple II         | £100     | H4  |
|   | Apple II         | £100     | C8  |
|   | Apple II         | £125     | T2  |
|   | CP/M             | £150-750 | C4  |
|   | CP/M             | £100     | C3  |
|   | CP/M             | £350     | B3  |
|   | CP/M             | £400     | C3  |
|   | CP/M             | £600     | G5  |
|   | Famos            | £1500    | M2  |
|   | North Star       |          |     |
|   | Horizon          | £250     | B3  |
|   | PET/CBM          | £250     | C3  |
|   | PET/CBM          | £325     | A1  |
|   | PET/CBM          | £225     | H4  |
|   | PET/CBM          | £75      | B1  |
|   | PET/CBM          | £50/T10  | C2  |
|   | PET/CBM          | £150     | J1  |
|   | PET/CBM          | £150     | G2  |
|   | Superbrain       | £300     | S6  |
|   | Tandy Model I    | £25-80   | M1  |
|   | Tandy Model I    | £60      | S2  |
|   | Tandy Model I    | £150     | J1  |
|   | Tandy Model I    | £32.50   | H1  |
|   | Tandy Model 111  | £270     | A4  |
|   | 8000 Series      | POR      | C2  |
| Dental Records                            | Apple II         | £395     | M4  |
|   | CP/M             | £500     | T4  |
| Disk operating system                     | PET/CBM          | £150     | B1  |
| Double glazing costing                    | North Star       |          |     |
|   | Horizon          | £750     | W1  |
| Eire payroll system                       | CP/M             | £650     | M5  |
| Estate agent                              | Apple II         | £850     | A2  |
|   | Apple II         | £850     | S5  |
|   | Apple II         | £850     | K2  |
|   | Apple II         | £175     | P2  |
|   | Apple II         | £130     | C8  |
|   | Apple II         | £750     | S4  |
|   | PET/CBM          | £30      | H3  |
|   | CP/M             | £750     | C4  |
|   | CP/M             | £700     | B5  |
|   | PCC 2000         |          |     |
|   | Simplec Triton 3 | £350     | B3  |
|   | MZ-80K           | £195     | W1  |
|   | PET/CBM          | £25      | A1  |
|   | Superbrain       | £600     | S6  |
|   | Superbrain       | £600     | C12 |
| Equipment lease/rent/HP                   | CP/M             | £400     | G1  |
| File Handling                             | PET/CBM          | £225     | H4  |
| Financial modelling                       | Act Sirius 1     | £595     | A1  |
| Apple II                                  | £450             | P2       |     |
|   | Apple II         | £424-535 | A1  |
|   | Apple II         | £360     | C8  |
|   | CP/M             | £400     | G1  |
|   | CP/M             | £95      | B5  |
|   | CP/M             | £425-535 | A1  |
|   | CP/M             | £400     | B6  |
|   | Cromemco         | £95      | B5  |
|   | North Star       |          |     |
|   | Horizon          | £95      | B5  |
|   | PET/CBM          | £425-535 | A1  |
|   | RAIR Black Box   | POR      | A3  |
| Financial planning                        | Act Sirius 1     | £150     | A1  |
|   | Apple II         | £250     | S4  |
|   | Apple II         | £125     | A1  |
|   | CP/M             | £125     | A1  |
|   | PET/CBM          | £125     | A1  |
| General ledger/NL                         | Apple II         | £300     | A2  |
|   | Apple II         | £300     | S5  |
|   | Apple II         | £300     | K2  |
|   | Apple II         | £455     | P2  |
|   | Apple II         | £225     | V1  |
|   | Apple II         | £295     | C6  |
|   | Apple II         | £250P    | S4  |
|   | Apple II         | £600     | T2  |
|   | Apple II         | £490     | L4  |
|   | Apple II         | £199     | T5  |

|                                    |                    |          |     |
|------------------------------------|--------------------|----------|-----|
|                                    | CBM/8032           | £450     | C11 |
|                                    | CP/M               | £500     | L3  |
|                                    | CP/M               | £375     | L1  |
|                                    | CP/M               | £500     | C4  |
|                                    | CP/M               | £400     | G1  |
|                                    | CP/M               | £400     | M3  |
|                                    | CP/M               | £400     | B5  |
|                                    | CP/M               | £275     | S6  |
|                                    | CP/M               | £275     | S7  |
|                                    | CP/M               | £350     | B3  |
|                                    | CP/M               | £300     | W1  |
|                                    | CP/M               | £425     | B6  |
|                                    | CP/M               | £500     | T4  |
|                                    | CP/M               | £400     | M5  |
|                                    | CP/M               | POR      | B7  |
|                                    | CP/M               | £199     | T5  |
|                                    | Cromemco           | £400     | B5  |
|                                    | North Star         |          |     |
|                                    | Horizon            | £250     | B3  |
|                                    | North Star         |          |     |
|                                    | Horizon            | £400     | M3  |
|                                    | PCC 2000           |          |     |
|                                    | North Star         |          |     |
|                                    | Horion             | £400     | B5  |
|                                    | PCC 2000           |          |     |
|                                    | Simplec Triton 3   | £350     | B2  |
|                                    | PET/CBM            | £200     | C2  |
|                                    | PET/CBM            | POR      | H3  |
|                                    | PET/CBM            | £199     | T5  |
|                                    | Sharp PC3201       | £450     | P2  |
|                                    | Superbrain         | £400     | M3  |
|                                    | Superbrain         | £400     | S6  |
|                                    | Tandy Model I      | £90      | M1  |
|                                    | Tandy Model II     | £90      | M1  |
|                                    | Tandy Model I      | £225     | H1  |
|                                    | Tandy Model I      | £225/325 | T1  |
|                                    | Tandy Model 11     | £425     | T1  |
|                                    | Vector             | £400     | C5  |
|                                    | 8080/Z80           | £357     | L1  |
|                                    | 8080/Z80           | £275     | G3  |
| General purchase transaction proc. | CBM/8032           | £495     | S3  |
| Hotel management                   | Apple II           | £525     | M4  |
|                                    | CP/M               | £525     | M4  |
|                                    | RAIR Black Box     | POR      | A3  |
| Incomplete records                 | Act Sirius 1       | £1200    | S1  |
|                                    | Apple II           | £280     | S2  |
|                                    | Apple II           | POR      | K2  |
|                                    | Apple II           | £425     | P2  |
|                                    | Apple II           | £450     | P1  |
|                                    | Apple II           | £490     | L4  |
|                                    | CP/M               | £750     | M3  |
|                                    | CP/M               | £250     | B5  |
|                                    | CP/M               | £975     | B3  |
|                                    | CP/M               | £750     | W1  |
|                                    | CP/M               | £1250    | M5  |
|                                    | Cromemco           | £250     | B5  |
|                                    | North Star         |          |     |
|                                    | Horizon            | £750     | M3  |
|                                    | North Star         |          |     |
|                                    | Horizon            | £250     | B5  |
|                                    | North Star         |          |     |
|                                    | Horizon            | £975     | H3  |
|                                    | Superbrain         | £750     | M3  |
|                                    | Superbrain         | £1200    | S1  |
|                                    | Tandy Model I      | £40      | M1  |
|                                    | Tandy Model I      | £40      | H1  |
| Industrial cleaning package        | CP/M               | POR      | B7  |
| Industry Factory loading           | Apple II           | £360     | X1  |
|                                    | CP/M               | £360     | X1  |
|                                    | PET/CBM            | £300     | X1  |
| Industry work study                | Apple II           | £990     | X1  |
|                                    | CP/M               | £990     | X1  |
|                                    | PET/CBM            | £750     | X1  |
| Inn Management                     | Act Sirius 1       | £185     | C7  |
| Insurance Broker                   | Act Sirius 1       | £450     | C7  |
| Insurance renewals                 | CBM/8032           | £1200    | S3  |
| Integrated accts                   | Act Sirius 1       | £495     | A1  |
|                                    | Altos (CP/M, MP/M) | £300     | B1  |
|                                    | Apple II           | £450     | P1  |
|                                    | Apple II           | £300     | P2  |
|                                    | Apple II           | £855     | V1  |
|                                    | Apple II           | £600     | T2  |
|                                    | Apple II           | £1470    | L4  |
|                                    | Apple II           | £300     | W2  |
|                                    | Apple II           | £199     | T5  |
|                                    | CBM/8032           | £1500    | P3  |
|                                    | CBM/8032           | 900      | C11 |
|                                    | CP/M               | £950     | L1  |
|                                    | CP/M               | £1500    | C4  |
|                                    | CP/M               | £1100    | G1  |
|                                    | CP/M               | £990     | M3  |
|                                    | CP/M               | £690     | B5  |
|                                    | CP/M               | £850     | S7  |
|                                    | CP/M               | £900     | B5  |
|                                    | CP/M               | £1450    | B3  |
|                                    | CP/M               | £1200    | B6  |
|                                    | CP/M               | £199     | T5  |
|                                    | Cromemco           | £690     | B5  |
|                                    | Cromemco           | £900     | B5  |
|                                    | Famos              | £2000    | M2  |
|                                    | MZ-80K             | £150     | P2  |
|                                    | North Star Horizon | £950     | B3  |



# PACKAGES

|                                       |                       |            |           |
|---------------------------------------|-----------------------|------------|-----------|
| North Star                            |                       |            |           |
| Horizon                               | £690                  | B5         |           |
| North Star                            |                       |            |           |
| Horizon                               | £900                  | B1         |           |
| PET/CBM                               | £300                  | B1         |           |
| PET/CBM                               | £800                  | B3         |           |
| PET/CBM                               | £199                  | B5         |           |
| North Star                            |                       |            |           |
| Horizon                               | £990                  | M3         |           |
| PET/CBM                               | (£50)                 | C          |           |
| PET/CBM                               | £650                  | J1         |           |
| PET/CBM                               | £650                  | G2         |           |
| Superbrain                            | £990                  | M3         |           |
| Superbrain                            | £1200                 | S6         |           |
| Superbrain                            | £1000                 | T3         |           |
| Superbrain                            | £1200                 | S1         |           |
| Tandy Model I                         | £350                  | M1         |           |
| Tandy Model II                        | £350                  | M1         |           |
| Tandy Model I                         | £75                   | J1         |           |
| Tandy Model III                       | £550                  | A4         |           |
| Vector                                | £1000                 | C5         |           |
| 8000 Series                           | POR                   | C2         |           |
| 8080/Z80                              | £950                  | L1         |           |
| 8080/Z80                              | £995                  | G3         |           |
| <b>Investment portfolio</b>           | <b>Tandy Model I</b>  | <b>£20</b> | <b>S2</b> |
| <b>Invoicing</b>                      | Act Sirius I          | £95        | C7        |
|                                       | Apple II              | £295       | S2        |
|                                       | Apple II              | £300       | P1        |
|                                       | Apple II              | £300       | P2        |
|                                       | Apple II              | £140       | V1        |
|                                       | Apple II              | £300       | T2        |
|                                       | Apple II              | £199       | T5        |
|                                       | Challenger            | £25        | C7        |
|                                       | CP/M                  | £325       | L1        |
|                                       | CP/M                  | £150-350   | C4        |
|                                       | CP/M                  | £250       | M3        |
|                                       | CP/M                  | £150       | S7        |
|                                       | CP/M                  | £100       | B5        |
|                                       | CP/M                  | £200       | B3        |
|                                       | CP/M                  | £300       | W1        |
|                                       | CP/M                  | POR        | B7        |
|                                       | CP/M                  | £199       | T5        |
|                                       | Cromemco              | £100       | B5        |
|                                       | North Star            |            |           |
|                                       | Horizon               | £100       | B3        |
|                                       | North Star            |            |           |
|                                       | Horizon               | £250       | M3        |
|                                       | North Star            |            |           |
|                                       | Horizon               | £100       | B5        |
|                                       | PET/CBM               | £350       | A1        |
|                                       | PET/CBM               | £25-50     | B1        |
|                                       | PET/CBM               | POR        | J1        |
|                                       | PET/CBM               | £199       | T5        |
|                                       | Superbrain            | £250       | M3        |
|                                       | Superbrain            | £150       | S6        |
|                                       | Tandy Model I         | £90        | M1        |
|                                       | Tandy Model II        | £90        | M1        |
|                                       | Tandy Model I         | £25        | H1        |
|                                       | Tandy Model I         | £75        | T1        |
|                                       | Tandy Model II        | £125       | T1        |
|                                       | Tandy Model III       | £280       | A4        |
|                                       | 8080/Z80              | £325       | L1        |
| <b>Job costing</b>                    | Act Sirius I          | £350       | C7        |
|                                       | Apple II              | £300       | P1        |
|                                       | Apple II              | £990       | X1        |
|                                       | Apple II              | £199       | T5        |
|                                       | CBM/8032              | £1000      | C11       |
|                                       | CP/M                  | £700       | C4        |
|                                       | CP/M                  | £350       | M3        |
|                                       | CP/M                  | £990       | X1        |
|                                       | CP/M                  | £500       | T4        |
|                                       | CP/M                  | £650       | M5        |
|                                       | CP/M                  | POR        | B7        |
|                                       | CP/M                  | £199       | T5        |
|                                       | CP/M                  | £1500      | T6        |
|                                       | North Star            |            |           |
|                                       | Horizon               | £350       | M3        |
|                                       | PET/CBM               | £750       | X1        |
|                                       | PET/CBM               | £199       | T5        |
|                                       | Superbrain            | £350       | M3        |
|                                       | Tandy Model I         | POR        | M1        |
|                                       | Tandy Model II        | POR        | M1        |
| <b>Job order control</b>              | 8080/Z80              | £275       | G3        |
| <b>Legal precedents</b>               | CP/M                  | £1100      | C4        |
| <b>Letter writer</b>                  | Apple II              | £80        | V1        |
|                                       | Apple II              | £99        | T5        |
|                                       | CP/M                  | £150       | M3        |
|                                       | CP/M                  | £99        | T5        |
|                                       | North Star            |            |           |
|                                       | Horizon               | £150       | M3        |
|                                       | Superbrain            | £150       | M3        |
| <b>Local government housing maint</b> | <b>RAIR Black Box</b> | <b>POR</b> | <b>A3</b> |
| <b>Lotteries Mailing List</b>         | PET/CBM               | £45        | H2        |
|                                       | Altos (CP/M, MP/M)    | £75        | B1        |
|                                       | Apple II              | £300       | A2        |
|                                       | Apple II              | £50-150    | S2        |
|                                       | Apple II              | £300       | S5        |
|                                       | Apple II              | £300       | K2        |
|                                       | Apple II              | £40        | P2        |
|                                       | Apple II              | £100       | S4        |
|                                       | CP/M                  | £50-150    | C4        |
|                                       | CP/M                  | £250       | G1        |
|                                       | North Star            |            |           |
|                                       | Horizon               | £195       | W1        |
|                                       | PET/CBM               | £45        | H2        |
|                                       | PET/CBM               | £15        | A1        |
|                                       | PET/CBM               | £75        | B1        |
|                                       | PET/CBM               | £35        | H3        |
|                                       | Superbrain            | £140       | C9        |
|                                       | Tandy Model I         | £40        | M1        |
|                                       | Tandy Model II        | £75        | M1        |
|                                       | Tandy Model I         | £50-150    | S2        |
|                                       | Tandy Model I         | £25/38/55  | H1        |
| <b>Mail shot</b>                      | Apple II              | £14        | S2        |

|                                |                |             |    |
|--------------------------------|----------------|-------------|----|
| Apple II                       | £40            | P2          |    |
| Apple II                       | £25            | T2          |    |
| Apple II                       | £99            | T5          |    |
| Challenger                     | £25            | C7          |    |
| CP/M                           | £200-360       | C4          |    |
| CP/M                           | £90            | M3          |    |
| CP/M                           | £75            | S7          |    |
| CP/M                           | £50/150        | G5          |    |
| CP/M                           | £99            | T5          |    |
| MCZ Zilog                      | £250           | I1          |    |
| North Star                     |                |             |    |
| Horizon                        | £90            | M3          |    |
| PCC 2000                       |                |             |    |
| Simplec Triton 3               | £450           | B2          |    |
| Superbrain                     | £90            | M3          |    |
| Tandy Model I                  | £75 +          | G4          |    |
| Tandy Model II                 | £75            | M1          |    |
| Tandy Model II                 | £75 +          | G4          |    |
| Tandy Model III                | £160           | A4          |    |
| <b>Membership acting</b>       | Apple II       | £75         | P2 |
|                                | MCZ Zilog      | £250        | I1 |
|                                | PET/CBM        | £85         | H2 |
| <b>Motor Dealer</b>            | Act Sirius I   | £345        | C7 |
|                                | CBM/8032       | £950 +      | P3 |
|                                | Famos          | £5000       | M2 |
| <b>Order entry/invoicing</b>   | Apple II       | £99         | T5 |
|                                | CBM/8023       | £750        | P3 |
|                                | CP/M           | £350        | G1 |
|                                | CP/M           | £500        | T4 |
|                                | CP/M           | £550        | M5 |
|                                | CP/M           | £550        | L1 |
|                                | CP/M           | POR         | B7 |
|                                | CP/M           | £99         | T5 |
|                                | 8080/Z80       | £550        | L1 |
| <b>Order Processing</b>        | Apple II       | £99         | T5 |
|                                | CP/M           | £99         | T5 |
| <b>Office admin</b>            | Apple II       | £100        | S4 |
| <b>Pad to plotter systems</b>  | Apple II       | £250        | P2 |
|                                | Apple II       | £180        | C8 |
| <b>Payroll</b>                 | Apple II       | POR         | A2 |
|                                | Apple II       | £200        | S2 |
|                                | Apple II       | POR         | S5 |
|                                | Apple II       | POR         | K2 |
|                                | Apple II       | £200        | P2 |
|                                | Apple II       | £375        | V1 |
|                                | Apple II       | £375        | C6 |
|                                | Apple II       | £250P       | S4 |
|                                | Apple II       | £400        | T2 |
|                                | Apple II       | £490        | L4 |
|                                | Apple II       | £199        | T5 |
|                                | CBM/8032       | £375        | P3 |
|                                | Challenger     | £24         | C7 |
|                                | CP/M           | £450        | L3 |
|                                | CP/M           | £475        | L1 |
|                                | CP/M           | £495        | C4 |
|                                | CP/M           | £500        | G1 |
|                                | CP/M           | £390        | M3 |
|                                | CP/M           | £500        | B5 |
|                                | CP/M           | £450        | B3 |
|                                | CP/M           | £425        | B6 |
|                                | CP/M           | Lease       | W1 |
|                                | CP/M           | £500        | T4 |
|                                | CP/M           | £450        | M5 |
|                                | CP/M           | POR         | B7 |
|                                | CP/M           | £199        | T5 |
|                                | CP/M           | £1500       | M2 |
|                                | Famos          |             |    |
|                                | North Star     |             |    |
|                                | Horizon        | £350        | B3 |
|                                | North Star     |             |    |
|                                | Horizon        | £390        | M3 |
|                                | North Star     |             |    |
|                                | Horizon        | Lease       | W1 |
|                                | PET/CBM        | £200/350    | C5 |
|                                | PET/CBM        | £200/25/195 | A1 |
|                                | PET/CBM        | £50/195     | I2 |
|                                | PET/CBM        | £150        | G2 |
|                                | PET/CBM        | £150        | J1 |
|                                | PET/CBM        | £150        | C2 |
|                                | PET/CBM        | £10         | H3 |
|                                | PET/CBM        | £199        | T5 |
|                                | Scotcher       | £250        | L2 |
|                                | Superbrain     | £390        | M3 |
|                                | Superbrain     | £400        | S6 |
|                                | Superbrain     | £250 +      | T3 |
|                                | Tandy Model I  | £249        | M1 |
|                                | Tandy Model I  | £200        | H1 |
|                                | Tandy Model I  | £218        | T1 |
|                                | Tandy Model II | £375        | T1 |
|                                | 8000 Series    | £250        | C2 |
|                                | 8080/Z80       | £475        | L1 |
|                                | 8080/Z80       | £275        | G3 |
|                                | PET/CBM        | £150        | G2 |
|                                | PET/CBM        | £150        | J1 |
|                                | PET/CBM        | £150        | C2 |
|                                | PET/CBM        | £150        | C1 |
|                                | Scotcher       | £250        | L2 |
|                                | Tandy Model I  | £249        | M1 |
|                                | TRS-80         | £200        | H1 |
|                                | TRS-80I        | £218        | K1 |
|                                | TRS-80I        | £218        | T1 |
|                                | TRS-80II       | £375        | T1 |
|                                | 8000 Series    | £250        | C2 |
|                                | 8080/Z80       | £475        | L1 |
|                                | 8080/Z80       | £275        | G3 |
| <b>Perpetual Inventory</b>     | CP/M           | £150        | B5 |
|                                | Cromemco       | £150        | B5 |
| <b>Personnel records</b>       | Apple II       | £98         | P2 |
|                                | CP/M           | £450        | C4 |
|                                | MCZ Zilog      | £400        | I1 |
|                                | PET/CBM        | £85         | H2 |
| <b>Petaid report generator</b> | PET/CBM        | £250        | S3 |
| <b>Petsoft programs</b>        | PET/CBM        | £160        | J1 |

|                                     |                  |             |     |
|-------------------------------------|------------------|-------------|-----|
| Postal advertising response package | Apple II         | £350        | S2  |
| Price lister                        | PET/CBM          | £12         | H3  |
| Product Management                  | Act Sirius I     | £245        | C7  |
| Production analysis                 | Apple II         | £75         | P2  |
|                                     | CP/M             | £700        | C4  |
|                                     | PET/CBM          | £300        | B1  |
| Production control                  | CBM/8032         | £650 +      | P3  |
|                                     | PET/CBM          | £650 +      | P3  |
| Prof appts groups                   | 8080/Z80         | £275        | G3  |
| Prof appts individ                  | 8080/Z80         | £220        | G3  |
| Prof client billing                 | 8080/Z80         | £330        | G3  |
| Programming aids                    | Apple II         | £40         | P2  |
| Property management                 | CP/M             | £450-1000   | C4  |
|                                     | CP/M             | £400        | M3  |
|                                     | CP/M             | POR         | B7  |
|                                     | North Star       | £400        | M3  |
|                                     | Superbrain       | £400        | M3  |
| Purchase ledger                     | Apple II         | £300        | A2  |
|                                     | Apple II         | £300        | S5  |
|                                     | Apple II         | £300        | K2  |
|                                     | Apple II         | £295        | C6  |
|                                     | Apple II         | £300        | P1  |
|                                     | Apple II         | £300        | P2  |
|                                     | Apple II         | £315        | V1  |
|                                     | Apple II         | £250P       | S4  |
|                                     | Apple II         | £300        | T2  |
|                                     | Apple II         | £490        | L4  |
|                                     | Apple II         | £199        | T5  |
|                                     | Challenger       | £25         | C7  |
|                                     | CBM/8032         | £500        | C11 |
|                                     | CP/M             | £500        | C4  |
|                                     | CP/M             | £450        | G1  |
|                                     | CP/M             | £500        | L3  |
|                                     | CP/M             | £425        | L1  |
|                                     | CP/M             | £400        | M3  |
|                                     | CP/M             | £400        | B5  |
|                                     | CP/M             | £275        | S7  |
|                                     | CP/M             | 350         | B3  |
|                                     | CP/M             | £300        | W1  |
|                                     | CP/M             | £425        | B6  |
|                                     | CP/M             | £500        | T4  |
|                                     | CP/M             | £400        | M5  |
|                                     | CP/M             | POR         | B7  |
|                                     | CP/M             | £199        | T5  |
|                                     | Cromemco         | £400        | B5  |
|                                     | North Star       |             |     |
|                                     | Horizon          | £250        | B3  |
|                                     | North Star       |             |     |
|                                     | Horizon          | £400        | M3  |
|                                     | North Star       |             |     |
|                                     | Horizon          | £400        | B5  |
|                                     | Superbrain       | £400        | M3  |
|                                     | Superbrain       | £300        | S6  |
|                                     | PCC 2000         |             |     |
|                                     | Simplec Triton 3 | £350        | B2  |
|                                     | PET/CBM          | £300        | B4  |
|                                     | PET/CBM          | £95/120/350 | A1  |
|                                     | PET/CBM          | £200        | C2  |
|                                     | PET/CBM          | POR         | J1  |
|                                     | PET/CBM          | £350        | H3  |
|                                     | PET/CBM          | £199        | T5  |
|                                     | Sharp PC3201     | £300        | P2  |
|                                     | Tandy Model I    | £90         | M1  |
|                                     | Tandy Model II   | £90         | M1  |
|                                     | Tandy Model I    | £225        | H1  |
|                                     | Tandy Model I    | £225        | T1  |
|                                     | Tandy Model II   | £375        | T1  |
|                                     | Vector           | £400        | C5  |
|                                     | 8000 Series      | £250        | C2  |
|                                     | 8080/Z80         | £275        | G3  |
|                                     | 8080/Z80         | £425        | L1  |
| Quotation estimating                | Act Sirius I     | £125        | C7  |
|                                     | Apple II         | £300        | P1  |
| Recruitment Agency                  | Act Sirius I     | £345        | C7  |
| Resource optimiser                  | Apple II         | £295        | C10 |
| Sales ledger                        | Apple II         | £300        | A2  |
|                                     | Apple II         | £300        | S5  |
|                                     | Apple II         | £300        | K2  |
|                                     | Apple II         | £295        | C6  |
|                                     | Apple II         | £300        | P1  |
|                                     | Apple II         | £300        | P2  |
|                                     | Apple II         | £315        | V1  |
|                                     | Apple II         | £250P       | S4  |
|                                     | Apple II         | £300        | T2  |
|                                     | Apple II         | £490        | L4  |
|                                     | Apple II         | £199        | T5  |
| CBM/8032                            | £500             | C11         |     |
|                                     | Challenger       | £25         | C7  |
|                                     | CP/M             | £500        | C4  |
|                                     | CP/M             | £450        | G1  |
|                                     | CP/M             | £500        | L3  |
|                                     | CP/M             | £425        | L1  |
|                                     | CP/M             | £400        | M3  |
|                                     | CP/M             | £400        | B5  |

# A LOW COST

Purpose-Built *ONLY* £485  
Daisywheel  
Printer

+VAT

**SMITH CORONA  
TP-1**

- Microprocessor Controller
- Dedicated Computer Printer
- Serial, Parallel or IEEE Interface
- Lowest cost purpose-built Daisywheel



*Contact your local dealer — today!*

**Cambridge Computer Store**  
1 Emmanuel Street, Cambridge,  
Tel: 0223 65334

**CWP Computers**  
108 Rochester Row, London SW1,  
Tel: 01 630 7444

**Camden Computer Systems  
Limited**  
462 Coventry Road, Small Heath,  
Birmingham, Tel: 021 771 3636

**Peritronic Limited**  
Lomond House, Almondvale,  
Livingston, West Lothian,  
Tel: 0506 410041

**Computer Peripheral Supplies**  
2/10 Whitchurch Road,  
Pangbourne, Berkshire,  
Tel: 07357 2721/4378

**Maystar Micros**  
62 Peach Street, Wokingham,  
Berks, Tel: 0734 789381

**Interface Components Limited**  
Oakfield Corner, Sycamore Road,  
Amersham, Bucks,  
Tel: 02403 22307

**Dorling Microsystems**  
Sheepcombe Break,  
The Inner Down, Old Down,  
Tuckington, Bristol,  
Tel: 0454 418596

**discom**

**DISCOM TRADING COMPANY**  
Dresden House, 51 High Street,  
Evesham, Worcestershire WR11 4DA  
Telephone: (0386) 3591  
SOLE U.K. DISTRIBUTORS

# ANYTHING IBM CAN DO...

It's 16 BIT. It's IBM PC compatible. And it's here now!

Icarus have a new personal computer manufactured by Columbia Data Systems of the USA complete with its own software and hardware. It will also run all software and hardware produced for the IBM PC.

At first glance, this machine may bear a certain resemblance to its mentor.

That's before you switch it on.

## What a performance!

Appearances can be deceptive as a look at the credentials of the Columbia PC machine will tell you.

Operating system software is MS-DOS® or CP/M 86®.

Its 16 BIT 8088 hardware configuration provides 128 K RAM with parity, two RS-232 serial ports, Centronics parallel printer port, DMA controller, eight levels of interrupt, dual floppy disc system with one megabyte storage,

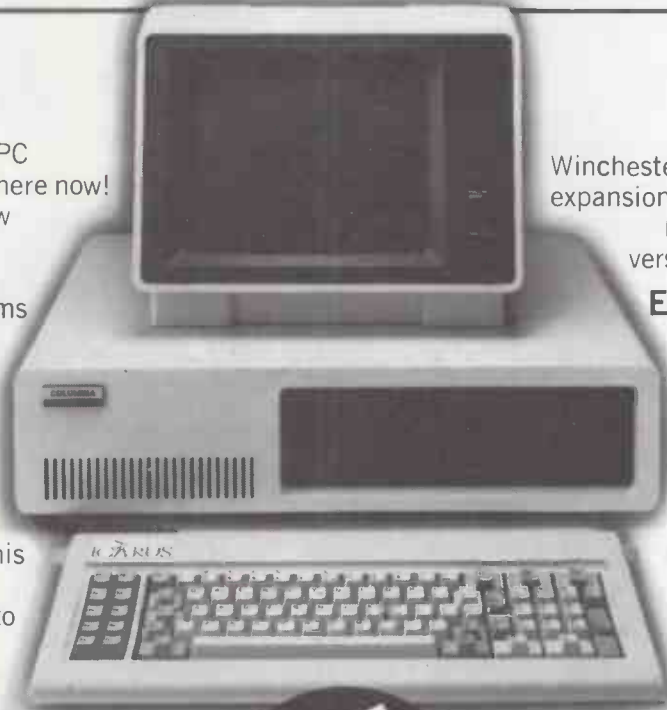

Winchester interface and eight expansion slots.

Not bad for the standard version.

## Examine your options

Columbia like to leave your options wide open. So they've included 256K RAM boards, 8087 arithmetic co-processor for high speed math functions, dual RS-232/RS-422 boards, and a Winchester disc based system.

The Columbia PC's expansion capability can easily accommodate just about any imaginable hardware configuration including one megabyte RAM and 10 megabyte disc.

## It's here now

And you know the other great thing about the Columbia PC? It's here now. Available off the shelf. And Icarus have a nationwide dealer network waiting to start deliveries.



*For further details, or if you would like to become a dealer yourself, contact*

  
Computer Systems Ltd.

Icarus Computer Systems Ltd., Deane House, 27 Greenwood Place, London NW5 1NN.  
Tel: 01-485 5574. Telex: 264209

MS-DOS is the trademark of MICROSOFT CP/M is the trademark of Digital Research

SEE IT ON STAND NO.  
**401**  
AT THE PCW SHOW

# PACKAGES

|  |                    |            |    |
|--|--------------------|------------|----|
|  | PCC 2000           |            |    |
|  | Simplec Triton 3   | £350       | B2 |
|  | PET/CBM            | £300       | B4 |
|  | PET/CBM            | £800       | C1 |
|  | PET/CBM            | £95/350    | A1 |
|  | PET/CBM            | POR        | J1 |
|  | PET/CBM            | £200       | C2 |
|  | PET/CBM            | £350       | C7 |
|  | PET/CBM            | £199       | T5 |
|  | Sharp PC 3201      | £300       | P2 |
|  | Superbrain         | £400       | M3 |
|  | Superbrain         | £300       | S6 |
|  | Superbrain         | £199       | T5 |
|  | Tandy Model I      | £90        | M1 |
|  | Tandy Model II     | £90        | M1 |
|  | Tandy Model I      | £225       | H1 |
|  | Tandy Model I      | £225       | T1 |
|  | Tandy Model II     | £375       | T5 |
|  | Vector             | £400       | C5 |
|  | 8000 Series        | £250       | C2 |
|  | 8080/Z80           | £275       | G3 |
|  | 8080/Z80           | £425       | L1 |
| S/L, P/L & stock control               | Apple II           | £900       | P2 |
|  | Apple II           | £1000      | T2 |
|  | CP/M               | £1000      | L3 |
|  | CP/M               | £900       | B5 |
|  | Cromemco           | £900       | B5 |
|  | North Star         |            |    |
|  | Horizon            | £900       | B5 |
| Solicitor's complete record accounting | Apple II           | £3000      | S2 |
| Solicitor's package                    | Act Sirius I       | £1400      | S1 |
|  | CBM/8032           | £1400      | S1 |
|  | CompuCorp          | £2000      | Q1 |
|  | Superbrain         | £1400      | S1 |
|  | CP/M               | £1250      | M5 |
| Statistics                             | Apple II           | £150       | G3 |
|  | Apple II           | £100-195   | P2 |
|  | Apple II           | £140       | C8 |
|  | Tandy Model I      | £45        | S2 |
| Stock control/recording                | Altos (CP/M, MP/M) | £300       | B1 |
|  | Apple II           | POR        | A2 |
|  | Apple II           | POR        | K2 |
|  | Apple II           | POR        | S5 |
|  | Apple II           | £150       | G3 |
|  | Apple II           | £80        | S2 |
|  | Apple II           | £75/300    | P2 |
|  | Apple II           | £285       | V1 |
|  | Apple II           | £300       | P1 |
|  | Apple II           | £500       | S4 |
|  | Apple II           | £490       | L4 |
|  | Apple II           | £199       | T5 |
|  | CBM/8032           | £175       | P3 |
|  | CBM/8032           | £199       | T5 |
|  | Challenger         | £25        | C7 |
|  | CP/M               | £325       | L1 |
|  | CP/M               | £500-1500  | C4 |
|  | CP/M               | £350       | G1 |
|  | CP/M               | £900       | M3 |
|  | CP/M               | £700       | B5 |
|  | CP/M               | £550       | B5 |
|  | CP/M               | £550       | B3 |
|  | CP/M               | £300       | W1 |
|  | CP/M               | £500       | T4 |
|  | CP/M               | £550       | M5 |
|  | CP/M               | POR        | B7 |
|  | CP/M               | £199       | T5 |
|  | Cromemco           | £700       | B5 |
|  | Famos              | £1500      | M2 |
|  | MZ-80K             | £150       | P2 |
|  | North Star         |            |    |
|  | Horizon            | £450       | B3 |
|  | North Star         |            |    |
|  | Horizon            | £900       | M3 |
|  | PCC 2000           |            |    |
|  | Simplec Triton 3   | £350       | B2 |
|  | PET/CBM            | £12/25/350 | A1 |
|  | PET/CBM            | £195       | I2 |
|  | PET/CBM            | £300       | B4 |
|  | PET/CBM            | £15        | A2 |
|  | PET/CBM            | £300       | B1 |
|  | PET/CBM            | £150       | C2 |
|  | PET/CBM            | £150       | J1 |
|  | PET/CBM            | £150       | G2 |
|  | PET/CBM            | £250       | H3 |
|  | PET/CBM            | £35/25     | R1 |
|  | PET/CBM            | £199       | T5 |
|  | Sharp PC3201       | £300       | P2 |
|  | Superbrain         | £900       | M3 |
|  | Superbrain         | £300       | S6 |
|  | Superbrain         | £450       | T3 |
|  | Tandy Model I      | £30-50     | M1 |
|  | Tandy Model II     | £300       | M1 |
|  | Tandy Model I      | £48        | S2 |
|  | Tandy Model I      | £200       | H1 |
|  | Tandy Model I      | £115       | J1 |
|  | Tandy Model I      | £200       | T1 |
|  | Tandy Model I      | £375       | T1 |
|  | 8080/Z80           | £275       | G3 |
|  | 8080/Z80           | £325       | L1 |
| Surveying                              | CP/M               | £500       | T4 |
| TAP business system                    | PET/CBM            | £125       | H2 |
| Text file librarian                    | Apple II           | £125       | S4 |
| Time/cost recording                    | Act Sirius I       | £800       | S1 |
|  | Apple II           | £450       | S2 |
|  | Apple II           | £300       | P1 |
|  | CBM/8032           | £800       | S1 |
|  | CP/M               | £400       | G1 |
|  | CP/M               | £200       | M3 |
|  | CP/M               | £350       | B3 |
|  | North Star         |            |    |
|  | Horizon            | £250       | B3 |
|  | North Star         |            |    |
|  | Horizon            | £200       | M3 |

|   |                  |              |    |
|---|------------------|--------------|----|
|   | North Star       |              |    |
|   | Horizon          | £450         | W1 |
|   | PCC 2000         |              |    |
|   | Simplec Triton 3 | £350         | B2 |
|   | PET/CBM          | £300         | B1 |
|   | Superbrain       | £200         | M3 |
|   | Superbrain       | £800         | S1 |
|   | Tandy Model I    | POR          | M1 |
|   | Tandy Model II   | POR          | M1 |
| Travel agency accts                         | Superbrain       | £800         | S6 |
|   | Tandy Model I    | £225         | G4 |
|   | Tandy Model II   | £225         | G4 |
| Travel Agents Dairy                         | Tandy Model I    | £100         | G4 |
|   | Tandy Model II   | £100         | G4 |
| Travel Ticket Sales                         | Tandy Model I    | £225         | G4 |
|   | Tandy Model II   | £225         | G4 |
| Utilities                                   | Apple II         | £40          | P2 |
|   | Apple II         | £20          | C6 |
|   | CP/M             | £50          | B5 |
|   | ITT 2020         | £20          | C6 |
| Utility set                                 | PET/CBM          | £78          | H3 |
| Various engineering                         | Tektronix        |              | E1 |
| Various thermal insulation industry systems | CP/M             | £2000+       | T6 |
| VAT   | PET/CBM          | £17.50       | A1 |
| VAT master                                  | PET/CBM          | £25          | H3 |
| VAT register                                | Tandy Model I    | £15          | H1 |
| Video hire system                           | Act Sirius I     | £125         | C7 |
|   | Tandy Model III  | £460         | A4 |
| Video message                               | Apple            | £200         | G3 |
| Warehousing                                 | CBM/8032         | POR          | S1 |
|   | CBM/8032         | £375         | P3 |
| Word processing                             | ACT 800          | £375         | H4 |
|   | Act Sirius I     | £295-325     | A1 |
|   | Apple II         | £60          | S2 |
|   | Apple II         | £75          | K2 |
|   | Apple II         | £75          | S5 |
|   | Apple II         | £75          | A2 |
|   | Apple II         | £150-300     | P2 |
|   | Apple II         | £75          | J1 |
|   | Apple II         | £120         | V1 |
|   | Apple II         | £180/95      | S4 |
|   | Apple II         | £30          | C8 |
|   | Apple II         | £500         | T2 |
|   | Apple II         | £99          | T5 |
|   | CP/M             | £150-260     | C4 |
|   | CP/M             | £400         | G1 |
|   | CP/M             | £250         | M3 |
|   | CP/M             | £250         | B6 |
|   | CP/M             | POR          | B7 |
|   | CP/M             | £99          | T5 |
|   | Famos            | £500         | M2 |
|   | North Star       |              |    |
|   | Horizon          | £250         | M3 |
|   | PET              | £85/65/40/20 | H2 |
|   | PET/CBM          | £375         | H4 |
|   | PET/CBM          | £225/325     | A1 |
|   | PET/CBM          | £325         | C5 |
|   | PET/CBM          | £75/150      | C2 |
|   | PET/CBM          | £75/150      | J1 |
|   | PET/CBM          | £75/150      | G2 |
|   | PET/CBM          | £35          | H3 |
|   | Superbrain       | £250         | M3 |
|   | Tandy Model I    | £50/75       | M1 |
|   | Tandy Model II   | £175-240     | M1 |
|   | Tandy Model I    | £30/60/90    | S2 |
|   | Tandy Model I    | £45/95       | J1 |
|   | Tandy Model I    | £15          | H1 |
|   | Vector           | £400         | C5 |
|   | 8000 Series      | £250         | C2 |
| Work In Progress                            | CP/M             | £850         | B5 |

## Machines

|                    |   |          |    |
|--------------------|---|----------|----|
| ACT 800            | Database management/Word processing       | £225     | H4 |
|                    |   | £375     | H4 |
| Act Sirius I       | Appointments planner                      | £115     | C7 |
|                    | Financial modelling                       | £595     | A1 |
|                    | Financial planning                        | £150     |    |
|                    | Incomplete records                        | £1200    | S1 |
|                    | Inn Management                            | £185     | C7 |
|                    | Insurance Broker                          | £450     | A1 |
|                    | Integrated Accts                          | £495     | C7 |
|                    | Invoicing                                 | £95      | C7 |
|                    | Job Costing                               | £350     | C7 |
|                    | Motor Dealer                              | £345     | C7 |
|                    | Project Management                        | £245     | C7 |
|                    | Quotation Estimating                      | £125     | C7 |
|                    | Recruitment agency                        | £345     | C7 |
|                    | Solicitors package                        | £1400    | S1 |
|                    | Time/cost recording                       | £800     | S1 |
|                    | Video hire system                         | £125     | C7 |
|                    | Word processing                           | £295/325 | A1 |
| Altos (CP/M, MP/M) | Integrated accts                          | £300     | B1 |
|                    | Mailing list                              | £75      | B1 |
|                    | Stock control/recording                   | £300     | B1 |
| Apple II           | Bill of materials                         | £199     | T5 |
| Budgeting          | £125                                      |          |    |
|                    | Cash flow                                 | £80      | V1 |
|                    | Cash flow                                 | £75      | P2 |
|                    | Cash flow                                 | £100     | C8 |
|                    | Contract costing                          | £450     | P1 |
|                    | Database management/information retrieval | £150     | K2 |

|   |          |     |
|---|----------|-----|
| Database management/information retrieval | £150     | A2  |
| Database management/information retrieval | £60-140  | S2  |
| Database management/information retrieval | £150     | S5  |
| Database management/information retrieval | £98      | P2  |
| Database management/information retrieval | £100     | S4  |
| Database management                       | £75      | P2  |
| Database management                       | £100     | C8  |
| Database management                       | £125     | T2  |
| Dental records                            | £395     | M4  |
| Estate agent                              | £850     | S5  |
| Estate agent                              | £850     | A2  |
| Estate agent                              | £850     | K2  |
| Estate agent                              | £750     | S4  |
| Estate agent                              | £130     | C8  |
| Financial modelling                       | £360     | C8  |
| Financial modelling                       | £425-535 | A1  |
| Financial planning                        | £250     | S4  |
| Financial planning                        | £125     | A1  |
| General ledger/NL                         | £300     | K2  |
| General ledger/NL                         | £300     | A2  |
| General ledger/NL                         | £450     | P2  |
| General ledger/NL                         | £300     | S5  |
| General ledger/NL                         | £225     | V1  |
| General ledger/NL                         | £295     | C8  |
| General ledger/NL                         | £250P    | S4  |
| General ledger/NL                         | £600     | T2  |
| General ledger/NL                         | £490     | L4  |
| General ledger/NL                         | £199     | T5  |
| Hotel management                          | £525     | M4  |
| Incomplete records                        | POR      | K2  |
| Incomplete records                        | £250     | S2  |
| Incomplete records                        | £450     | P1  |
| Incomplete records                        | £450     | P2  |
| Incomplete records                        | £490     | L4  |
| Industry factory loading                  | £360     | X1  |
| Industry work study                       | £990     | X1  |
| Integrated accts                          | £885     | V1  |
| Integrated accts                          | £450     | P1  |
| Integrated accts                          | £300     | P1  |
| Integrated accts                          | £600     | T2  |
| Integrated accts                          | £300     | W2  |
| Integrated accts                          | £1470    | L4  |
| Integrated accts                          | £199     | T5  |
| Invoicing                                 | £295     | S2  |
| Invoicing                                 | £300     | P2  |
| Invoicing                                 | £140     | V1  |
| Invoicing                                 | £300     | P1  |
| Invoicing                                 | £300     | T2  |
| Invoicing                                 | £199     | T5  |
| Job costing                               | £450     | S2  |
| Job costing                               | £990     | X1  |
| Job costing                               | £300     | P1  |
| Job costing                               | £199     | T5  |
| Job costing                               | £99      | T5  |
| Letter writer                             | £300     | K2  |
| Mailing list                              | £300     | A2  |
| Mailing list                              | £300     | A2  |
| Mailing list                              | £40      | P2  |
| Mailing list                              | £50-150  | S2  |
| Mailing list                              | £300     | S5  |
| Mailing list                              | £100     | S4  |
| Mailing List                              | £25      | T2  |
| Mail shot                                 | £14      | S2  |
| Mail shot                                 | £225     | P1  |
| Mail shot                                 | £99      | T5  |
| Order entry/invoicing                     | £99      | T5  |
| Order Processing                          | £99      | T5  |
| Pad to plotter system                     | £250     | P2  |
| Pad to plotter system                     | £180     | C8  |
| Payroll                                   | POR      | S5  |
| Payroll                                   | POR      | K2  |
| Payroll                                   | POR      | A2  |
| Payroll                                   | £200     | S2  |
| Payroll                                   | £375     | V1  |
| Payroll                                   | £200     | P2  |
| Payroll                                   | £375     | C6  |
| Payroll                                   | £250P    | S4  |
| Payroll                                   | £400     | T2  |
| Payroll                                   | £490     | L4  |
| Payroll                                   | £199     | T5  |
| Personal records                          | £75      | P2  |
| Postal advertising response package       | £350     | S2  |
| Production analysis                       | £75      | P2  |
| Programming aids                          | £40      | P2  |
| Purchase ledger                           | £300     | K2  |
| Purchase ledger                           | £300     | P2  |
| Purchase ledger                           | £300     | A2  |
| Purchase ledger                           | £300     | S5  |
| Purchase ledger                           | £315     | V1  |
| Purchase ledger                           | £300     | P1  |
| Purchase ledger                           | £295     | C6  |
| Purchase ledger                           | £250P    | S4  |
| Purchase ledger                           | £300     | T2  |
| Purchase ledger                           | £490     | L4  |
| Purchase ledger                           | £199     | T5  |
| Quotation estimating                      | £300     | P1  |
| Resource optimiser                        | £295     | C10 |
| Sales ledger                              | £300     | A2  |
| Sales ledger                              | £300     | K2  |
| Sales ledger                              | £300     | S5  |
| Sales ledger                              | £300     | P2  |
| Sales ledger                              | £315     | V1  |
| Sales ledger                              | £300     | P1  |
| Sales ledger                              | £295     | C6  |
| Sales ledger                              | £250P    | S4  |
| Sales ledger                              | £300     | T2  |
| Sales ledger                              | £490     | L4  |
| Sales ledger                              | £199     | T5  |
| SL, PL stock control                      | £1000    | T2  |
| Solicitor's complete record accounting    | £3000    | S2  |
| Statistics                                | £150     | G3  |
| Statistics                                | £100/195 | P2  |
| Statistics                                | £100-195 | P2  |
| Statistics                                | £140     | C8  |
| Stock control/recording                   | £150     | G3  |

# PACKAGES

|                         |         |    |
|-------------------------|---------|----|
| Stock control/recording | POR     | K2 |
| Stock control/recording | P2      | P2 |
| Stock control/recording | POR     | A2 |
| Stock control/recording | S2      | S2 |
| Stock control/recording | POR     | S5 |
| Stock control/recording | £285    | V1 |
| Stock control/recording | £300    | P1 |
| Stock control/recording | £500    | S4 |
| Stock control/recording | £490    | L4 |
| Stock control/recor-    |         |    |
| din                     | £199    | T5 |
| Text file librarian     | £125    | S4 |
| Time/cost recording     | £450    | S2 |
| Time/cost recording     | £300    | P1 |
| Utilities               | £20     | C6 |
| Video message           | £200    | G3 |
| Word processing         | £75     | K2 |
| Word processing         | £75     | A2 |
| Word processing         | £60     | S2 |
| Word processing         | £300    | P2 |
| Word processing         | £75     | S5 |
| Word processing         | £120    | V1 |
| Word processing         | £75     | J1 |
| Word processing         | £180/95 | S4 |
| Word processing         | £30     | C8 |
| Word processing         | £500    | T2 |
| Word processing         | £99     | T5 |

|          |                         |       |     |
|----------|-------------------------|-------|-----|
| CBM/8032 | Cheque writer           | £90   | P3  |
|          | General ledger/NL       | £450  | C11 |
|          | General purpose trans-  |       |     |
|          | action proc.            | £495  | S3  |
|          | Insurance renewals      | £1200 | S3  |
|          | Integrated accts        | £1500 | P3  |
|          | Integrated accts        | £900  | C11 |
|          | Job costing             | £1000 | C11 |
|          | Motor trader            | £950+ | P3  |
|          | Order entry/invoicing   | £750  | P3  |
|          | Payroll                 | £375  | P3  |
|          | Production control      | £650+ | P3  |
|          | Purchase ledger         | £500  | C11 |
|          | Sales ledger            | £500  | C11 |
|          | Solicitors package      | £140  | S1  |
|          | Stock control/recording | £175  | P3  |
|          | Stock control/recording | £250  | C11 |
|          | Time/cost recording     | £800  | S1  |
|          | Warehousing             | £375  | P3  |

|            |                     |       |    |
|------------|---------------------|-------|----|
| Compucorp  | Solicitors package  | £2000 | Q1 |
| Challenger | Appointment Planner | £25   | C7 |
|            | Invoicing           | £25   | C7 |
|            | Mail Shot           | £25   | C7 |
|            | Payroll             | £25   | C7 |
|            | Purchase Ledger     | £25   | C7 |
|            | Sales Ledger        | £25   | C7 |
|            | Stock Control       | £25   | C7 |

|      |                       |          |    |
|------|-----------------------|----------|----|
| CP/M | Bill of materials     | £500     | B5 |
|      | Bill of materials     | £199     | T5 |
|      | Bookmakers package    | POR      | B7 |
|      | Budgeting package     | £95      | B5 |
|      | Cash flow             | £250     | L3 |
|      | Cash flow             | £95      | B5 |
|      | Cash register         | £30      | T4 |
|      | Company secretary     | £450     | C4 |
|      | Container accounting  | £750     | M5 |
|      | Contract costing      | £2000    | L3 |
|      | Database              | £350     | B3 |
|      | Database management/  |          |    |
|      | information retrieval | £150-750 | C4 |
|      | Database management/  |          |    |
|      | information retrieval | £100     | G3 |
|      | Database management/  |          |    |
|      | information retrieval | £400     | C3 |
|      | Database management/  |          |    |
|      | information retrieval | £600     | G5 |
|      | Dental records        | £500     | T4 |
|      | Bire payroll system   | £650     | M5 |
|      | Equipment lease/rent/ |          |    |
|      | HP                    | £400     | G1 |
|      | Estate agents         | £750     | C4 |
|      | Estate agent          | £700     | B5 |
|      | Financial modelling   | £400     | G1 |
|      | Financial modelling   | £95      | B5 |
|      | Financial modelling   | £425/535 | A1 |
|      | Financial modelling   | £400     | B6 |
|      | Financial planning    | £125     | A1 |
|      | General ledger/NL     | £500     | L3 |
|      | General ledger/NL     | £500     | C4 |
|      | General ledger/NL     | £400     | G1 |
|      | General ledger/NL     | £375     | B7 |
|      | General ledger/NL     | £200     | B7 |
|      | General ledger/NL     | £275     | S7 |
|      | General ledger/NL     | £400     | M3 |
|      | General ledger/NL     | £350     | B3 |
|      | General ledger/NL     | £300     | W1 |
|      | General ledger/NL     | £425     | B6 |
|      | General ledger/NL     | £500     | T4 |
|      | General ledger/NL     | £400     | M5 |
|      | General ledger/NL     | POR      | B7 |
|      | General ledger/NL     | £199     | T5 |
|      | Hotel management      | £525     | M4 |
|      | Incomplete Records    | £250     | B5 |
|      | Incomplete Records    | £750     | M3 |
|      | Incomplete Records    | £975     | B3 |
|      | Incomplete Records    | £750     | W1 |
|      | Incomplete Records    | £1250    | M5 |
|      | Industrial cleaner    |          |    |
|      | package               | POR      | B7 |
|      | Industry factory      |          |    |
|      | loading               | £360     | X1 |
|      | Industry work study   | £990     | X1 |
|      | Insurance brokers     | £995     | W1 |
|      | Integrated accts      | £1500    | C4 |
|      | Integrated accts      | £1100    | G1 |
|      | Integrated accts      | £950     | L1 |
|      | Integrated accts      | £690     | B5 |
|      | Integrated accts      | £850     | S7 |
|      | Integrated accts      | £990     | M3 |
|      | Integrated accts      | £900     | B5 |
|      | Integrated accts      | £1450    | B3 |
|      | Integrated accts      | £1200    | B6 |
|      | Integrated accts      | £199     | T5 |

|                         |           |    |
|-------------------------|-----------|----|
| Invoicing               | £325      | L1 |
| Invoicing               | £150-350  | C4 |
| Invoicing               | £150      | S7 |
| Invoicing               | £250      | M3 |
| Invoicing               | £100      | B5 |
| Invoicing               | £200      | B3 |
| Invoicing               | £300      | W1 |
| Invoicing               | POR       | B7 |
| Invoicing               | £199      | T5 |
| Job costing             | £700      | C4 |
| Job costing             | £990      | X1 |
| Job costing             | £350      | M3 |
| Job costing             | £500      | T4 |
| Job costing             | £650      | M5 |
| Job costing             | POR       | B7 |
| Job costing             | £199      | T5 |
| Job costing             | £1500     | T5 |
| Legal precedents        | £1100     | C4 |
| Letter writer           | £150      | M3 |
| Letter writer           | £99       | T5 |
| Mailing list            | £50-150   | C4 |
| Mailing list            | £250      | G1 |
| Mailing list            | £75       | S7 |
| Mail shot               | £200-360  | G4 |
| Mail shot               | £90       | M3 |
| Mail shot               | £50/150   | G5 |
| Mail shot               | £99       | T5 |
| Order entry/invoicing   | £350      | G1 |
| Order entry/invoicing   | £500      | T4 |
| Order entry/invoicing   | £550      | M5 |
| Order entry/invoicing   | POR       | B7 |
| Order entry/invoicing   | £99       | T5 |
| Order processing        | £550      | L1 |
| Order processing        | £99       | T5 |
| Payroll                 | £450      | L3 |
| Payroll                 | £495      | C4 |
| Payroll                 | £500      | G1 |
| Payroll                 | £475      | B5 |
| Payroll                 | £500      | M5 |
| Payroll                 | £390      | B3 |
| Payroll                 | £450      | B3 |
| Payroll                 | Lease     | W1 |
| Payroll                 | £425      | B6 |
| Payroll                 | £500      | T4 |
| Payroll                 | £450      | M5 |
| Payroll                 | POR       | B7 |
| Payroll                 | £199      | T5 |
| Payroll                 | £150      | B5 |
| Perpetual Inventory     | £450      | C4 |
| Personnel records       | £700      | C4 |
| Production analysis     | £450-1000 | C4 |
| Property management     | £400      | M3 |
| Property management/    |           |    |
| Property management     | POR       | B7 |
| Purchase ledger         | £500      | L3 |
| Purchase ledger         | £450      | G1 |
| Purchase ledger         | £425      | L1 |
| Purchase ledger         | £500      | C4 |
| Purchase ledger         | £200      | B5 |
| Purchase ledger         | £275      | S7 |
| Purchase ledger         | £400      | M3 |
| Purchase ledger         | £350      | B3 |
| Purchase ledger         | £300      | W1 |
| Purchase ledger         | £425      | B6 |
| Purchase ledger         | £500      | T4 |
| Purchase ledger         | £400      | M5 |
| Purchase ledger         | POR       | B7 |
| Sales ledger            | £500      | L3 |
| Sales ledger            | £500      | C4 |
| Sales ledger            | £450      | G1 |
| Sales ledger            | £425      | L1 |
| Sales ledger            | £200      | B5 |
| Sales ledger            | £275      | S7 |
| Sales ledger            | £400      | M3 |
| Sales ledger            | £350      | B3 |
| Sales ledger            | £300      | W1 |
| Sales ledger            | £425      | B6 |
| Sales ledger            | £500      | T4 |
| Sales ledger            | £400      | M5 |
| Sales ledger            | POR       | B7 |
| Sales ledger            | £199      | T5 |
| Solicitors              | £1250     | M5 |
| S/L, P/L + stock        |           |    |
| control                 | £1000     | L3 |
| S/L, P/L + stock        |           |    |
| control                 | £900      | B5 |
| Stock control/recording | £325      | L1 |
| Stock control/recording | £500-1500 | C4 |
| Stock control/recording | £350      | G1 |
| Stock control/recording | £500      | B5 |
| Stock control/recording | £900      | M3 |
| Stock control/recording | POR       | B7 |
| Stock control           | £550      | B3 |
| Stock control           | £300      | W1 |
| Stock control           | £500      | T4 |
| Stock control           | £550      | M5 |
| Stock control           | £199      | T5 |
| Surveying               | £500      | T4 |
| Time/cost recording     | £400      | G1 |
| Time/cost recording     | £200      | M3 |
| Time ledger             | £350      | B3 |
| Utilities               | £50       | B5 |
| Various thermal in-     |           |    |
| sulation industry       |           |    |
| systems                 | £2000+    | T6 |
| Word processing         | £400      | G1 |
| Word processing         | £150-260  | B1 |
| Word processing         | £250      | M3 |
| Word processing         | £250      | B6 |
| Word processing         | POR       | B7 |
| Word processing         | £99       | T5 |
| Word processing         | £850      | B5 |
| Work in progress        |           |    |

|       |                  |       |    |
|-------|------------------|-------|----|
| Famos | Customer file    | £1000 | M2 |
|       | Data base        | £1500 | M2 |
|       | Integrated accts | £2000 | M2 |
|       | Motor dealer     | £5000 | M2 |
|       | Payroll          | £1500 | M2 |
|       | Stock control    | £1500 | M2 |
|       | Word processing  | £500  | M2 |

|           |                   |      |    |
|-----------|-------------------|------|----|
| MCZ Zilog | Mail shot         | £250 | I1 |
|           | Membership acting | £250 | I1 |

|        |                         |      |    |
|--------|-------------------------|------|----|
|        | Personnel records       | £400 | I1 |
| MZ-80K | Estate agent            | £195 | W1 |
|        | Integrated accounts     | £150 | P2 |
|        | Stock control/recording | £150 | P2 |

|            |                         |       |    |
|------------|-------------------------|-------|----|
| North Star | Budgeting package       | £95   | B5 |
| Horizon    | Cash flow               | £95   | B5 |
|            | Database management/    |       |    |
|            | information retrieval   | £250  | B3 |
|            | Double glazing costing  | £750  | W1 |
|            | Estate agent            | £750  | B5 |
|            | Financial modelling     | £95   | B5 |
|            | General ledger/NL       | £250  | B3 |
|            | General ledger/NL       | £400  | M3 |
|            | General ledger/NL       | £400  | B5 |
|            | Incomplete records      | £750  | M3 |
|            | Incomplete records      | £250  | B5 |
|            | Incomplete records      | £975  | B3 |
|            | Integrated accts        | £950  | B3 |
|            | Integrated accts        | £990  | M3 |
|            | Integrated accts        | £690  | B5 |
|            | Integrated accts        | £900  | B5 |
|            | Invoicing               | £100  | B3 |
|            | Invoicing               | £250  | M3 |
|            | Invoicing               | £100  | B5 |
|            | Job costing             | £350  | M3 |
|            | Letter writer           | £150  | M3 |
|            | Miling List             | £195  | W1 |
|            | Mail shot               | £90   | M3 |
|            | Payroll                 | £350  | B3 |
|            | Payroll                 | £390  | M3 |
|            | Payroll                 | Lease | W1 |
|            | Property Management     | £400  | M5 |
|            | Purchase ledger         | £250  | B3 |
|            | Purchase ledger         | £400  | M3 |
|            | Purchase ledger         | £400  | B5 |
|            | Sales ledger            | £250  | B3 |
|            | Sales ledger            | £400  | M3 |
|            | Sales ledger            | £400  | B5 |
|            | SL, PL + stock          |       |    |
|            | control                 | £900  | B5 |
|            | Stock control/recording | £450  | B3 |
|            | Stock control/recording | £900  | M3 |
|            | Time/cost recording     | £250  | B3 |
|            | Time/cost recording     | £200  | M3 |
|            | Time/cost recording     | £450  | W1 |
|            | Word processing         | £250  | M3 |

|          |                         |      |    |
|----------|-------------------------|------|----|
| PCC 2000 | Estate Agent            | £350 | B2 |
| Simplec  | General ledger/NL       | £700 | B2 |
| Triton 3 | Mail Shot               | £450 | B2 |
|          | Purchase ledger         | £350 | B2 |
|          | Sales ledger            | £350 | B2 |
|          | Stock control/recording | £500 | B2 |
|          | Time/cost recording     | £350 | B2 |

|         |                       |          |    |
|---------|-----------------------|----------|----|
| PET/CPM | Assembler dev         | £50      | C2 |
|         | Bill of materials     | £199     | T5 |
|         | Bureau de change      | £8       | H3 |
|         | Cash flow             | £8       | A1 |
|         | Cheque writer         | £90      | P3 |
|         | Credit control        | £650     | B4 |
|         | Database management/  |          |    |
|         | information retrieval | £75      | B1 |
|         | Database management/  |          |    |
|         | information retrieval | £50/150  | C2 |
|         | Database management/  |          |    |
|         | information retrieval | £150     | G2 |
|         | Database management/  |          |    |
|         | information retrieval | £150     | J1 |
|         | Database management/  |          |    |
|         | information retrieval | POR      | C1 |
|         | Database management/  |          |    |
|         | information retrieval | £325     | A1 |
|         | Database management/  |          |    |
|         | information retrieval | £225     | H4 |
|         | Database management/  |          |    |
|         | information retrieval | £250     | C3 |
|         | Disk operating system | £150     | B1 |
|         | Estate agent          | £25      | A1 |
|         | Estate agent          | £30      | H3 |
|         | File handling         | £225     | H4 |
|         | Financial modelling   | £425-535 | A1 |
|         | Financial planning    | £125     | A1 |
|         | General ledger/NL     | £200     | C2 |
|         | General ledger/NL     | £1000    | L1 |
|         | General ledger/NL     | £200     | H3 |
|         | General ledger/NL     | £199     | T5 |
|         | Industry factory      |          |    |
|         | loading               | £300     | X1 |
|         | Industry work study   | £750     | X1 |
|         | Integrated accts      | £300     | B1 |
|         | Integrated accts      | £500     | C2 |
|         | Integrated accts      | £650     | G2 |
|         | Integrated accts      | £650     | J1 |
|         | Integrated accts      | £800     | S3 |
|         | Integrated accts      | £199     | T5 |
|         | Invoicing             | POR      | J1 |
|         | Invoicing             | £25-50   | B1 |
|         | Invoicing             | £350     | A1 |
|         | Invoicing             | £400     | C1 |
|         | Invoicing             | £199     | T5 |
|         | Job costing           | £750     | X1 |
|         | Job costing           | £199     | T5 |
|         | Lotteries             | £45      | H2 |
|         | Mailing list          | £75      | B1 |
|         | Mailing list          | £15      | A1 |
|         | Mailing list          | £45      | H2 |
|         | Mailing list          | £35      | H3 |
|         | Mailing list          | £85      | H2 |
|         | Membership acting     | £150     | G2 |
|         | Payroll               | £150     | J1 |
|         | Payroll               | £150     | C2 |
|         | Payroll               | £50/195  | I2 |
|         | Payroll               | £50/25/  | A1 |
|         | Payroll               | £195     | A1 |
|         | Payroll               | POR      | C1 |
|         | Payroll               | £200/350 | C5 |
|         | Payroll               | £10      | H3 |
|         | Payroll               | £199     | T5 |
|         | Personnel records     | £85      | H2 |

# PLUTO

## INTELLIGENT COLOUR GRAPHICS

*Pluto provides YOUR machine with a high quality Colour Graphics Display.*

*Meet the Family:-*

**BABY PLUTO**... 320(H) x 288(V) x 8 Colour. 96K bytes of memory to provide two full screen buffers.  
**PLUTO**..... 640(H) x 288(V) x 8 Colour. 192K bytes of memory to provide two full screen buffers.  
Double resolution option. .... 640(H) x 576(V) x 8 Colour. Software selectable between 288(V) & 576(V).  
Start with Baby and then Upgrade!

**Pluto** uses the latest technology to provide unprecedented performance and reliability on a single PCB.  
**Pluto** may be readily connected to most Computer Systems or plugged straight into an 80-BUS or NASBUS.

*Look at what Pluto offers:-*

- 16 bit Intel 8088 microprocessor.
- 192K bytes of dual-ported display memory for fast flicker-free screen updates. (*Outside the host address space*).
- Fast parallel I/O interface usable with ALMOST ANY COMPUTER.
- Operates from a single +5v supply. .

*Here are just some of the high level functions that Pluto provides:-*

- Fast vector draw – over 100,000 pixels/sec. Lines can be drawn using REPLACE, XOR, AND, OR functions.
- Built-in character set providing an 80 x 28 character display.
- User definable characters or symbols.
- Spare display memory with memory management facilities for allocating symbol storage space or workspace.
- Rectangle Fill and Copy using nine logic functions.
- Fast access to single pixels.
- Write protected memory planes during copy.
- Double buffered screen memory for animated displays.
- Complex polygon colour fill.

**Pluto** is also available as a boxed unit with integral power supply with cables and connectors and custom interface card for a range of machines:-

**PET, APPLE, SIRIUS, NASCOM, GEMINI, RAIR, RML, S100 etc.**

*Our range of interfaces is being continuously expanded, please ask us for details of others including RS 232. Pluto is expandable. Available very soon is an expansion board enabling Pluto to display 256 colours simultaneously from a very large palette for producing high quality shaded images.*

**Pluto prices:-**

|   |                  |
|---|------------------|
| BABY PLUTO .....                                    | £299.00 plus VAT |
| PLUTO .....   | £399.00 plus VAT |
| BOXED PLUTO AND INTERFACE .....                     | £599.00 plus VAT |
| DOUBLE RESOLUTION OPTION .....                      | £50.00 plus VAT  |
| 8MHz PROCESSOR OPTION (40% speed improvement) ..... | £50.00 plus VAT  |

(Carriage £6.00 on boxed Pluto)

Dealer and OEM enquiries invited.

 **iO research Ltd.**

6 Laleham Avenue · Mill Hill · London NW7 3HL  
Telephone: 01-959 0106

# PACKAGES

|                         |                                 |          |
|-------------------------|---------------------------------|----------|
| Petsoft programs        | £160                            | J1       |
| Petaid report generator | £250                            | S3       |
| Prise lister            | £12                             | H3       |
| Production analysis     | £300                            | B1       |
| Production control      | £650+                           | P3       |
| Purchase ledger         | £200                            | C2       |
| Purchase ledger         | POR                             | J1       |
| Purchase ledger         | £95/120                         |          |
| 350                     | A1                              |          |
| Purchase ledger         | £1000                           | C1       |
| Purchase ledger         | £300                            | B4       |
| Purchase ledger         | £350                            | H3       |
| Purchase ledger         | £199                            | T5       |
| Sales ledger            | POR                             | J1       |
| Sales ledger            | £200                            | J1       |
| Sales ledger            | £300                            | B4       |
| Sales ledger            | £800                            | C1       |
| Sales ledger            | £95/350                         | A1       |
| Sales ledger            | £350                            | H3       |
| Sales ledger            | £199                            | T5       |
| Stock control/recording | £150                            | C2       |
| Stock control/recording | £300                            | B1       |
| Stock control/recording | £150                            | G2       |
| Stock control/recording | £150                            | J1       |
| Stock control/recording | £195                            | I2       |
| Stock control/recording | £12/25/350                      | A1       |
| Stock control/recording | £15                             | A2       |
| Stock control/recording | £300                            | B4       |
| Stock control/recording | £35/25                          | H3       |
| Stock control           | £199                            | T5       |
| TAP business system     | £125                            | H2       |
| Time/cost recording     | £300                            | B1       |
| Utility set             | £78                             | H3       |
| VAT                     | £17.50                          | A1       |
| VAT master              | £25                             | H3       |
| Word processing         | £75/150                         | J1       |
| Word processing         | £75/150                         | G2       |
| Word processing         | £75/150                         | C2       |
| Word processing         | £85/65                          |          |
| Word processing         | £40/20                          | H2       |
| Word processing         | £375                            | H4       |
| Word processing         | £25/325                         | A1       |
| Word processing         | £325                            | C5       |
| Word processing         | £35                             | H3       |
| PET/Computhink          | Stock control/recording         | £250 R1  |
| RAIR Black Box          | Financial modelling             | POR A3   |
|                         | Hotel management                | POR A3   |
|                         | Local government housing maint. | POR A3   |
| Sharp PC-3201           | General ledger                  | £450 P2  |
|                         | Sales ledger                    | £300 P2  |
|                         | Purchase ledger                 | £300 P2  |
|                         | Stock control                   | £300 P2  |
| Sorcerer                | Payroll                         | £250 L2  |
| Superbrain              | Bill of materials               | £450 T3  |
|                         | Database                        | £300 S6  |
|                         | Estate agent                    | £800 S6  |
|                         | Estate agent                    | £600 M2  |
|                         | General ledger                  | £400 M3  |
|                         | General ledger                  | £400 S6  |
|                         | Incomplete Records              | £750 M3  |
|                         | Incomplete Records              | £1200 S1 |
|                         | Integrated accts                | £1200 S6 |
|                         | Integrated accts                | £990 M3  |
|                         | Integrated accts                | £1000 T3 |

|                     |   |             |
|---------------------|---|-------------|
| Integrated accts    | £1200                                     | S1          |
| Invoicing           | £250                                      | M3          |
| Invoicing           | £150                                      | S6          |
| Job costing         | £350                                      | M3          |
| Letter writer       | £150                                      | M3          |
| Mailing list        | £140                                      | C9          |
| Mail shot           | £90                                       | M3          |
| Payroll             | £400                                      | S6          |
| Payroll             | £390                                      | M3          |
| Payroll             | £250+                                     | T3          |
| Property management | £400                                      | M1          |
| Purchase ledger     | £300                                      | S6          |
| Purchase ledger     | £400                                      | M3          |
| Sales ledger        | £300                                      | S6          |
| Sales ledger        | £400                                      | M3          |
| Sales ledger        | £199                                      | T5          |
| Solicitors package  | £1400                                     | S1          |
| Stock control       | £300                                      | S6          |
| Stock control       | £900                                      | M3          |
| Stock control       | £450                                      | I3          |
| Time/cost recording | £800                                      | S1          |
| Time recording      | £200                                      | M3          |
| Word processing     | £250                                      | M3          |
| Travel agency accts | £800                                      | S6          |
| Tandy Model 1       | Database management/information retrieval | £25-80 M1   |
|                     | Database management/information retrieval | £270 A4     |
|                     | Database management/information retrieval | £60 S2      |
|                     | Database management/information retrieval | £32.50 H1   |
|                     | Database management/information retrieval | £150 J1     |
|                     | General ledger/NL                         | £90 M1      |
|                     | General ledger/NL                         | £90 M1      |
|                     | General ledger/NL                         | £225 H1     |
|                     | General ledger/NL                         | £225/325 T1 |
|                     | General ledger/NL                         | £425 T      |
|                     | Incomplete records                        | £40 M1      |
|                     | Incomplete records                        | £40 H1      |
|                     | Invoicing                                 | £90 M1      |
|                     | Invoicing                                 | £280 A4     |
|                     | Invoicing                                 | £90 M1      |
|                     | Invoicing                                 | £75 T1      |
|                     | Invoicing                                 | £125 T1     |
|                     | Integrated accts                          | £350 M1     |
|                     | Integrated accts                          | £550 A4     |
|                     | Integrated accts                          | £100 M1     |
|                     | Integrated accts                          | £75 J1      |
|                     | Investment portfolio                      | £20 S2      |
|                     | Invoicing                                 | £25 H1      |
|                     | Job costing                               | POR M1      |
|                     | Job costing                               | POR M1      |
|                     | Mailing list                              | £40 M1      |
|                     | Mailing list                              | £75 M1      |
|                     | Mailing list                              | £25/38 M1   |
|                     | Mailing list                              | £5 M1       |
|                     | Mailing list                              | £50-150 S2  |
|                     | Mail shot                                 | £75+ G4     |
|                     | Mail shot                                 | £160 A1     |
|                     | Mail shot                                 | £75 M1      |
|                     | Mail shot                                 | £75+ G4     |
|                     | Payroll                                   | £249 M1     |
|                     | Payroll                                   | £200 H1     |
|                     | Payroll                                   | £218 T1     |
|                     | Payroll                                   | £371 T1     |
|                     | Purchase ledger                           | £90 M1      |
|                     | Purchase ledger                           | £90 M1      |
|                     | Purchase ledger                           | £225 H1     |
|                     | Purchase ledger                           | £375 T1     |

|                         |   |          |
|-------------------------|---|----------|
| Purchase ledger         | £375                                      | T1       |
| Sales ledger            | £90                                       | M1       |
| Sales ledger            | £90                                       | M1       |
| Sales ledger            | £235                                      | H1       |
| Sales ledger            | £225                                      | T1       |
| Sales ledger            | £375                                      | T1       |
| Statistics              | £45                                       | S2       |
| Stock control/recording | £30-50                                    | M1       |
| Stock control/recording | £300                                      | M1       |
| Stock control/recording | £200                                      | H1       |
| Stock control/recording | £48                                       | S2       |
| Stock control/recording | £115                                      | J1       |
| Stock control/recording | £200                                      | T1       |
| Stock control/recording | £375                                      | T1       |
| Travel Agency Accts     | £225                                      | G4       |
| Travel Agency Accts     | £225                                      | G4       |
| Travel Agents Dairy     | £100                                      | G4       |
| Travel Agents Dairy     | £100                                      | G4       |
| Travel Ticket Sales     | £225                                      | G4       |
| Travel Ticket Sales     | £225                                      | G4       |
| Time/cost recording     | POR                                       | M1       |
| Time/cost recording     | POR                                       | M1       |
| VAT register            | £15                                       | H1       |
| Video hire system       | £460                                      | A4       |
| Word processing         | £50/75                                    | M1       |
| Word processing         | £175-240                                  | M1       |
| Word processing         | £45-95                                    | J1       |
| Word processing         | £100                                      | H1       |
| Word processing         | £30/60/90                                 | S2       |
| Vector                  | General ledger/NL                         | £400 C5  |
|                         | Integrated accts                          | £1000 C5 |
|                         | Purchase ledger                           | £400 C5  |
|                         | Sales ledger                              | £400 C5  |
|                         | Word processing                           | £40 C5   |
| 8000 Series             | Database management/information retrieval | POR C2   |
|                         | Integrated accts                          | POR C2   |
|                         | Payroll                                   | £251 C2  |
|                         | Purchase ledger                           | £250 C2  |
|                         | Sales ledger                              | £250 C2  |
|                         | Word processing                           | £250 C2  |
| 8080/Z80                | General ledger/NL                         | £275 G3  |
|                         | General ledger/NL                         | £375 L1  |
|                         | Integrated accts                          | £350 L1  |
|                         | Integrated accts                          | £995 G3  |
|                         | Invoicing                                 | £325 L1  |
|                         | Job order control                         | £257 G3  |
|                         | Order processing                          | £550 L1  |
|                         | Payroll                                   | £475 L1  |
|                         | Payroll                                   | £275 G3  |
|                         | Prof appts groups                         | £275 G3  |
|                         | Prof appts individ                        | £220 G3  |
|                         | Prof client billing                       | £330 G3  |
|                         | Purchase ledger                           | £425 L1  |
|                         | Purchase ledger                           | £275 G3  |
|                         | Sales ledger                              | £275 G3  |
|                         | Sales ledger                              | £425 L1  |
|                         | Stock control/recording                   | £325 L1  |
|                         | Stock control/recording                   | £275 G3  |

# TRANSACTION FILE

Readers will be pleased to know that, due to our clever marketing ideas, the Transaction File is up-to-date and waiting cut down considerably. Ads are accepted only on the form below for a flat fee of £2.50. Please don't specify issues as we can't oblige. Ads cannot be repeated unless separate forms are sent in.

We will only accept entries from non-commercial readers. Thank you for co-operating.

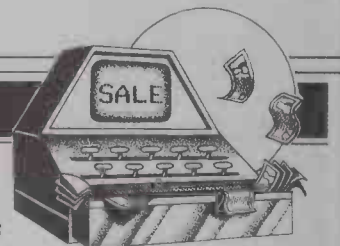

★ Wanted 32-64k 80 column microcomputer/word processor. Part package capable of modification considered. Also required vg quality electric typewriter/printer especially if interfacable. Cash paid. Tel: 01-527 0511 anytime (evenings preferred).  
 ★ ZX81 - + 16k RAM. Sinclair complete: leads, manual, etc. £87.50 (inc postage). ZX printer £49.50 (inc postage). Write to: Rod Postans, 300 Amhurst Rd, Stoke Newington, London N16.  
 ★ Sharp MZ80K - 48k five months old still under guarantee. Still in packing, plenty of software, also manual. Must sell £365. Tel: Russell (0792) 794816.  
 ★ Sharp PC1211 - + cassette interface. Still in box, all manuals etc. £70. Tel: 01-527 3572.  
 ★ ZX81 - Sinclair built inc 16k RAM. As new, perf cond., hardly used, in box with leads, adaptor & manual. Genuine reason for sale. Tel: Nottingham 285010.

★ Acorn Atom - 12k RAM, FP ROM, leads, psu, manuals, magic book, Galaxian, Invaders & other software £150 ono also 3k RAM (6 x 2114) £5. Tel: Sedgfield 20403 after 5pm.  
 ★ Acorn Atom - 12k + 12k. 6522 VIA chip, printer plug, psu, manuals, also £50 plus of software £225, or would consider ZX81 + cash. Tel: Sheffield 0742 339147.  
 ★ ZX81 - mounted in Fuller case with keyboard 16k RAM all vgc, manual, all leads 2 games £100. Tel: Farnham (0252) 711162 after 4pm or weekends.  
 ★ Atom - 12k + 12k lots of software/books. Factory assembled £200 ono. Potts, 4 Littleway, Dunsford Hill, Exeter, Devon.  
 ★ ZX81 16k RAM all Sinc built original box leads & manual exc cond. quick sale wanted £60 ono. Tel: 01-398 2750 (Esher).  
 ★ ZX81 - with 16k RAM & games tape, Sinclair built, £80. Tel: 021 354 6438 eve.

★ TI 994/A - complete. Little used, cost £300 will accept £160 ono. Features good T.I. maths, sound and graphics. Tel: Harrogate (0423) 58588.  
 ★ SWTP - 69A, SS50 Bus, 6809 40k Statis RAM + 16k socketed card. 2 serial ports, 20 amp supply. Full data, easily modified to a S/09 £600 ono. Tel: 01-422-4724.  
 ★ Video Genie 16k - keyboard/lower case/sound mode. Acculab Floppy tape. Over £150 in software inc Basic 4, books + manual £500 R. Beattie. Lincoln 730421 ext 423 (daytime).  
 ★ PCW's - all issues from vol 1. no 1 except 4, £25. Tel: Biggin Hill 74089.  
 ★ BBC Computer - Model B. As new, with games software, leads, mnuual & cassette recorder, £350 ono. Tel: Guildford 71255 ext. 3099, office hours only.  
 ★ PET 2001 - 32k small keyboard plus 4022 printer for sale,

together price £600. Consider P/lex for printer & interface for computar M30/40. Tel: 0135 39441 daytime, Cooden 3194 eve.  
 ★ ZX81 - + 16k RAM Sinc built. Housed in matching console with power switch. Software, tapes, books + cassette player. Bargain at £80 ono. Tel: 01-950 6365 after 6pm.  
 ★ Disk system - twin 8in single-sided drives with PS's in cabinets, double-density controller for S-100 bus, cables £650, can sell separately. Tel: John Gaeth 01-861 8798.  
 ★ ZX81 - 16k RAM, PSU, Sinc built still under guarantee + manual, leads, games, business education & chess cassettes £95. Tel: 0742 364834.  
 ★ ZX81 - + 16k RAM Sinclair built, for £90. All leads, manual etc. Five software tapes '30 programs for the ZX81', five months warranty remaining worth over £130. Tel: 01-808 0620.





# TRANSACTION FILE

Asteroids, Adventures, utilities worth £850. Selling for £450 ono. Phone 0742 302665.

★ ZX81 — manual, leads, also inc 3 of the popular ZX81 games books plus cassette of 6 games inc golf and sub-attack £49. Phone (0628) 72629 eve.

★ VIC20 — C2N cassette and Teach Yourself to Programme, ie manual with 2 cassettes, as new. Cost £250 — £185 ono. Tel: Cramlington (Northumberland) 0670 716196.

★ ENM parallel printer. (Licensed Centronics copy) 5x7 Dot Matrix. Width adjustable to 132 characters. TTL logic. Tractor feed. Heavy duty construction cables. Ink ribbons £75 ono. Tel: 0553 86 618 Steve.

★ ZX81 — +16k RAM, Sinc built, manual, leads, 2 games cassettes, 1 game & 2 m/c books all for £85. vgc. Contact Mark, 173 Mayfield Gardens, Brentwood, Essex. Tel: (0277) 232439.

★ Centronics 101A — £75. LX180 with stand £175. Thermal printer £45. Petivid £35. ASCII keyboard £20. Nascom2 copy, Zeap, Naspen, Debug etc. £245, 073477 5438 Wokingham, Berks.

★ Atari VCS — & cartridges, Asteroids, M/Command, S/Invaders, Adventure Superman, Skydiver, Combat Air/Sea Battle. Tel: Earidoms 318 Salisbury Wilts. £180 ono.

★ PET — 32k large keyboard with Basic 4.0 upgrade & cassette deck. Command-0 ROM. More than 100 programs incl in price £525 ono. Tel: 0235 831449.

★ ZX81 — complete with powerpack, 16k (Sinclair), leads, manual, book. Many large taped programs, Defenders, Nightmare Park, Zombies, Galactic Wars, CUBE, Tank & many more £65 ono. Tel: Capel Bangor (097084) 411.

★ PAL — T199/4 home computer, colour graphics + sound, 16k RAM + software as new £230 ono. Also Microtan 65 with damaged but working keypad £40. Tel: Headley Down 713012 weekends or after 6pm.

★ MZ80k games — 16k, six games incl Lunar Rescue, Breakout, Star Fighter, all fast graphical games £6.95. Send cheque or p/o to Paul Grant, 81 Frenchwood Ave, Preston, Lancs.

★ Teletype — Datadynamics 390 with paper tape reader & punch, vgc quiet operation 20mA current loop-interface £150 ono. Tel: 01-360 5354.

★ Tandy Model III — business system (48k twin disk RS232), line printer vi, all bought from Tandy software. Scripsit, 12

Adventures, Edtasm & more.

Owner going CP/M! Tel: Bracknell 24277 or Knowle 78218.

★ Superboard III — 8k RAM, 10k ROM, rosewood case, Basic 5 new Basic 4, 8k Eprom board, psu & manual. Exc condition. Tel: (0222) 831246.

★ BBC Microcomputer Model B 32K. Mint unopened and guaranteed with games paddles. To the first enthusiast fed up with waiting £420. Tel: 01-445 2114 day; 01-349 9370 eve & weekends.

★ UK101 — 8k RAM cased, separate psu. 300/600 baud case Mon01, Mon02, WEMON. Extensive documentation: manuals, programs cassettes, games & practical. £155 Tel: (0723) 68786 work, 78421 home.

★ ZX81 — 16k RAM Sinc built as new, 2 Sinc games cassettes. Asteroids, golf, Breakout, leads, manual. 10 months old £99 ono. Tel: Whitburn (West Lothian) 0501-40469

★ MK14 — RAM I/O extra RAM, revised monitor, replacement keyboard, boxed, manuals etc £40 ono. Tel: 0367 (Faringdon) 21631 eve.

★ Acorn Atom — 12k RAM 12k ROM psu, only 5 months old, hardly used, manual & leaflets £185. Contact Wayne Davis, The Archer Arms, Lewannick, Launceston, Cornwall PL15 7QD.

★ Acorn Atom — 2k RAM + 8k ROM with leads, manuals & software (incl 2 Acornsoft packs) £120 ono. 164 Alexandra Rd South, Manchester M212RB. Tel: 061-881 5641.

★ KSR 33 RO — Printers, stands as new £100, older £60. 4k x 1 Dram (MCM 6605) with circuit 32/£4. ET1 System 68 Microsystem, CUTS, TTY, VDÚ, RAM, D/A, NCU, PSU, card frame, working £70. Tel: 01-289 7415.

★ Texas T159 — & PC100C both little used & as new. With Master Library, magnetic cards, programming pads, printing paper & many programs, £175. Tel: Keith Basingstoke 881586.

★ ZX81 — + 16k Sinc built. Fuller keyboard, software books & cassettes incl 3d Monster Maze, leads, power, supply, manual £110. Tel: Harpenden 60701 John Clamp.

★ Video Genie — EG3003 hardly used. Still under warranty. £230 o.n.o. Deliver within 50 miles of Newbury else collect. Tel 063 527 587.

★ TRS80 Level 2 16K — as new. All leads and manuals. Over £100 software inc. microchess, asylum, invaders, level 4 basic, scripsit, editor assembler and lots more £300 o.n.o. Tel Little Haywood 881 468

★ VIC20 — 8K RAM cassette unit, joystic, etc; still under guarantee plus cartridge and cassette games, books etc. All worth over £400. Will accept £300 o.n.o. Phone 021 360 1736 after 6pm.

★ ATARI — television game with 13 games cartridges including space invaders, chess, superman, missile command, pele soccer etc. Everything in excellent condition. £220 Phone Sunderland 841194 evenings only.

★ VIC20 — cassette unit several cartridges & books including Vic revealed and book on assembly language programming. £50 of programs worth £450 + will accept £350 o.n.o. Tel 0656 50696 evenings.

★ APPLE 2+ — 64K, disc drive DOS 3.3, eurocolour card, serial/parallel interface, joystick. Works perfectly. Boxed. Best offer or £1250. Phone Bethersden (Kent) 316 after 8pm. Uncased monitor £45. Kaga £110.

★ WordPro — 4+ and Visicalc for sale. I have decided to save up for Silicon office and must reluctantly part with these excellent programmes. 1st come 1st served. Redhill 60986 24-hrs.

★ TermiNet 1200 — Printer, 1200 baud, RS232 interface, vgc, £115, CASE200 monitor £20. Tel: UXbridge 30617 evening.

★ PETITE 32K — add on memory for PET. Complete in case with PUS. Hardly used. Perfect condition. £100 o.n.o. Tels: 0604 412785 evenings. Buyer collects. ★ CBM/PET — 4032-32K plus cassette, tapes, books, £500. Also 4022 printer complete with cable and paper £400, or both for £850 o.n.o. hardly used. Ring Wimbrough Green (0403) 700777 evenings.

★ APPLE II — 48K Europlus, two disc drives plus controller virtually unused, boxed. New unwanted gifts £1150 (might split) Phone Hatfield 71524 after 6.00pm.

★ ZX81 — Sinc built, 1K, one cassette lead, TV lead, manual, mains adaptor + plug. £45.00. Casio — VL-tone perfect condition + case, 100 note memory synthesiser, rhythms. £29.95 Tel: Robert (061) 902 0980

★ ZX81 — + 16K RAM Sinclair built PSU leads manual plus three Sinclair cassettes (2 games 1 business) £80. Oxford (0865) 779257

★ 48K Sorcerer — £350 o.n.o., tapes (inc word processor, toolkit machine code tutorial, galaxians, cadas, ESC games tape) manuals cables and all back copies of ESC. Taylor 01-272 5896 after 6.00.

★ Acorn Atom — 8K ROM 9K RAM PSU TV & tape leads all manuals some software Acorn

assembled. Excellent condition, hardly used, ready to run. £155 Mr C. Dineen, Grove House, Fermoy, Cork, Ireland.

★ ATARI CX2600 video computer system with combat, video olympics casino cartridges. Plus extra pair of paddles for 4-player games. Cost £150, accept £85 for quick sale. Tel: Billericay (02774) 55850.

★ ATARI 800 — 48K, 410 program recorder, joysticks, etc. As new condition. Over £200 games software. Swap for Apple II Europlus in similar condition, or sell for first £450. Tel: 031 331 3651.

★ Two Casio 502p's — with 256 program steps and 21 non volatile memories £40 each, also one FA-1 cassette interface £10. All excellent condition, ask for Paul 01-736 3596 after 7pm.

★ Video Genie — Sound box, extra keys, manuals + leads. Over £300 software incl. editor/ass, T-Bug, Mon 3 and many arcade games. £350 o.n.o. Tel Disley (06632) 3271.

★ ZX81 + 16K RAM — Sinclair built, manual, transformer, leads, software, (inc. 'Monster Maze', Bug-byte M/code assembler + disassembler), 'Mastering machine code' book. Perfect condition. £85 o.n.o. Tel: 0243 785560. W. Young.

★ Apple — Pascal language system. B/W modulator. Desktop plan. Circuit analysis. GoodsPell. Visicalc. Typing tutor. Offers: Wanted — Apple disk drive. Tel: 0205 750365 Mitchell.

★ ZX81 — Sinc built + 16K RAM, power supply, Sinclair cassettes, Startrek, ZXBUG, etc in original boxes and in excellent condition. £110 o.n.o. Telephone Castleton (N. Yorks) 667.

★ Genie 1 48K — colour sound. Joy sticks, monitor, centronics 739 printer, many progs. Complete ready to go. £1250. Seikosha GP80A printer £130. All approx 6 months old. Tunbridge Wells (0892) 23206.

★ VIC-20 Cassette unit — software programs, and Joystick, six months old, price £230 o.n.o. Contact Chris on Merthyr Tydfil 77173.

★ Genie I — 48K on board. Full keyboard, lower case, sound, and prog. sound, plus ACULAB floppy tape, 20 wafers, keypad and joystick. Extensive software £230 o.n.o. for quick sale. Leicester (0533) 898850.

★ PET 3032 — with EPSON TX-80 printer and cassette deck. Games, utilities, cassettes, paper. All in perfect condition. Bargain at £575 George Sobala, 90 Old Road, Headington, Oxford.

★ VIC 20 — as new, original packaging. plus cassette unit. Offers above £200. Tel: Bracknell (0344) 25179.

## ACC NEWS

Rupert Steele presents his monthly round-up of news from the Amateur Computer Club

Yes, personal computing *does* exist outside London On 24-25 July this year 'Microfest '82' was held at UMIST (that's in Manchester for those who have never ventured north of Watford). This was a combination of exhibition and seminars, and was a great success. Needless to say, the ACC was there with our club database, which was in great demand as we put hundreds of people in touch with their local clubs.

Of course, we didn't know where *all* the clubs in the North-West area; while we may be truly wonderful, the ACC aren't telepathic, and if you don't bother to tell us of your existence, then we can't tell anybody else about it. So hurry along there and send the details of your club to Peter Whittle, 49 Bartlemas Road, Oxford, OX4.

Peter was there with me, and frequently deserted me on the stand to visit the

various talks that were going on. Steve Adams gave a thorough discussion of the internals of the Sinclair Spectrum with a talk 'Inside the Spectrum' and, among others, there was a talk on telesoftware, for which Peter got roped in to helping (hinder?) the presentation.

As a result of the various discussions that went on during the show, it looks as if there is going to be an Association of North-Western

Computer Clubs, along the lines of the ALCC, for the Manchester area. Several of this, and the business is being coordinated by David Wade of the Manchester Computer Club: his address is 28 Hazel Road, Altrincham, Cheshire; 061 941 2486.

The general atmosphere at Microfest was very positive and friendly; the emphasis was strongly on the hobbyist sector rather than the expensive business machines, and

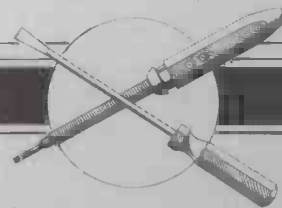

# ACC NEWS

there was a lot of educational work going on; not only were some of the seminars on Computers in Schools, but there were a lot of teachers visiting the show. The Sinclair Spectrum was the machine of the show; they were everywhere. (But where was the Beeb machine? Its keepers Acorn were nowhere to be seen.)

The organisers were so pleased with the show that they are planning a repeat performance at UMIST on 11-12 December. They have asked the ACC to organise the club stands (there was a problem at Microfest in that many clubs who might have gone didn't know about it), so any club wanting to go should contact David Annal, the ACC's exhibition man, at 142 Windermere Road, London, SW16 5HE. We'll mention this in our next club circular (but then this only goes to clubs who have told us of their existence).

The ACC's AGM is coming up soon, so it's not long before the membership gets its annual chance to be really nasty to the committee (it's the other way round for the rest of the time). It will be at 2pm at the Polytechnic of North London, Holloway Road on 16 October 1982. Rumour has it that somebody even more important than our chairman, Peter Whittle, will address the meeting.

The next PCW Show is coming up soon. The ACC is organising the clubs area in the new, expanded, improved Show. See you there, either around the club stands or on the ACC stand itself.

A few people gave me information at Microfest, and one or two have written to me. A Mr Ian Thornton-Bayer of 25 Southfield Drive, West Bradford, Clitheroe, Lancs BB7 4ZU; tel (0200) 25933, wants to set up a local club and is interested in communicating with like-minded individuals locally. So is Mr G M Flanagan, of 11 Sundown Close, New Mills, Stockport,

Cheshire, SK12 3DH; tel (0663) 44051. Also David Webb of 4 Ashfield, Dewsbury, West Yorks.

While we are up north, Mr King of the Holmes Chapel Computer Club, 3 Jodrell Close, Holmes Chapel, Crewe, Cheshire CW4 8BU would be glad to hear from anybody in the area thinking of joining. Going across the country to the North-East, I hear that Harrogate Junior Chamber is running a competition called 'MAC '82', the results of which will be announced at a Computer Fair in the Royal Bath Assembly Rooms, Harrogate, on 6 November 1982. For more information, write to Robert Hopkins, 54 Crimble Meadows, Parral, Harrogate, North Yorks HG3 1EN.

Prestel... there is going to be an official club area on Prestel at the PCW Show for the Computer Clubs to publicise themselves and to set up telesoftware for other people to download. This area will be numbered 8008 and will be administered by the ACC. For more details about what is proposed contact Peter Whittle. The ACC's pages, starting at 292500, should indicate when 8008 is going, and you should be able to request 8008 information by use of a response frame. Prestel still rather too expensive for you? Watch this space... like calls Europe, Prestel might cost less than you think.

I am now in a position to describe more fully Peter's attempts to communicate via modems with some people in Rome. The idea was to make a demonstration for a high technology festival in Rome, which was part of an arts festival that was on there. The people were very interested in what was going on in personal computing in the UK and said that there was no Italian home computer user movement, as there seems to be in this country. They were also very interested in Prestel and general datacomms, so

the following was done:

They were running an Apple with a 300 baud acoustic coupler, while Peter was running a 380Z with a GPO modem. After a fair amount of setting up (described below), the 380Z was set up to emulate a dumb terminal down the modem line, and the Apple was set to remote mode. Therefore the Apple in Rome was run from the 380Z in Oxford, over the phone system. The it was run the other way round, and the Apple was used to run the 380Z over the phone. In the live demonstration, a chess program was run on the 380Z and played in Rome.

It is absolutely essential to have carrier detect lights on the modems, and it is convenient to have the use of two phone lines. Otherwise, it is impossible to talk to the operator at the other end to ask how things are going. Therefore, each user watches the carrier detect light on his modem coupler; if this goes out, it usually means that the guy at the other end wants to talk.

Most of the lines to the States are simplex, with voice detection turn-around, which is not possible for data. However, within Europe most of the lines are duplex and therefore suitable for data use. One thing that has to be done is to switch off the echo suppressors on the line by sending a 2.1 KHz tone for three seconds at the start of the call.

Setting up is easily done in originate mode; after making telephone contact, the originator should listen for the whistle from the answer modem; this should be detected by the originate modem (when you connect it), which then should light the carrier detect. If it doesn't, check the positions of the originate/answer switches on both modems (one should be orig, the other answer; the orig and answer data are modulated on different frequencies, so it

is essential that the modems are listening to each other's frequencies, rather than both talking on one frequency, both listening on the other). If this doesn't identify the fault, make sure that your modems are the right system, namely CCITT V21 standard; the American Bell 103 system is not compatible with the CCITT international standards, so beware acoustic couplers from the States or Japan.

At this point, the answer end should detect the originate end's carrier, and the link should work. The easiest test is to short the send and receive RS232 connections at one end (but see RS232 handshakes below!) and type away at the other to see if anything appears on the screen (computer set up to emulate terminal). This technique is known as using a loop-back.

If there are problems, it is advisable to check that the RS232 handshakes are correct for both the modem and the computer. The following should occur:

1. Set DTR true (Data Terminal Ready - pin 20). This tells the modem to connect to the line.
2. Set RTS true (Request To Send - pin 4) This tells the modem to turn its carrier on.
3. DCD (Data Carrier Detect - pin 8) should go true.
4. DSR (Data Set Ready - pin 6) also goes true.
5. CTS (Clear To Send - pin 5) goes true. When CTS is true, the system thinks that everything is okay and is ready to go.

Note that if your computer RS232 interface doesn't have modem control you will need to set DTR and RTS yourself. Another tip; if CTS is true but nothing is happening, try all possible combinations of swapping connections of pins 2 and 3 at both ends since it is quite likely that these (data send and receive) have got connected the wrong way round at one end or the other.

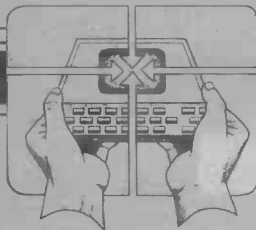

## CTUK! CONTACTS

For further information on ComputerTown UK! see 'CTUK News' or Prestel page 3574831

David Sharp  
5 Bridgenhall Road  
Enfield  
Middx

Andrew Stoneman  
135 Birchdale Avenue  
Newcastle-Upon-Tyne  
Tyne & Wear

J M A Kilburn  
(Headmaster)  
Shawfield Norden  
Community Middle School  
Shawfield Lane  
Norden  
Rochdale  
OL12 7QR

Brigitte Gordon  
18 Purbright Crescent  
New Addington  
Croydon CR0 0RT

Richard Powell  
22 Downham Court  
South Shields  
Tyne & Wear

Pam Pollicott  
South Ruislip Library  
Victoria Road  
South Ruislip  
Middx

Ted Ellerton  
25 Beachdale  
Winchmore Hill  
London N21

Vernon Gifford  
111 Selhurst Road  
Croydon  
London SE25 6LH

John Stephen Bone  
2 Claremont Place  
Gateshead  
Tyne & Wear  
NE8 1TL

Alan Hooley  
21 Brammay Drive  
Tottington  
Bury BL8 3HS

Vernon Quaintance  
50 Beatrice Avenue  
Norbury  
London SW16 4UN

Keith Taylor  
Carter Hydraulic Works  
Thornbury  
Bradford BD3 8HG

Derek Moody  
2 Victoria Terrace  
Dorchester  
Dorset DT1 1LS

Derek Knight or Bob Carter  
Rayners Lane Library  
Imperial Drive  
Rayners Lane  
Middx

Peter Earchy  
46 High Street  
Church Stretton  
Shropshire  
SY6 6BX

Tony Cartmell  
54 Foregate Street  
Worcester WR1 1DX

R L Saunders  
14 St Nicholas Mount  
Hemel Hempstead  
Herts

Christopher Bates  
Ashford Main Library  
Church Road  
Ashford  
Kent

Ray Skinner  
62 Central Avenue  
Billingham  
Cleveland  
TS23 1LN

# CTUK! CONTACTS

Andrew Holyer  
10 Masons Road  
Mannings Heath  
Horsham  
Sussex RH13 6JP

Roger Shears  
18 Woodmill Lane  
Bltterne Park  
Southampton  
SO2 4PY

Bill Gibbings  
3 Longholme Road  
Retford  
Notts DN22 6TU

Chris Cooper  
110 Church Road  
Hanwell  
London W7

Ted Broadhead  
27 Cardinal Road  
Leeds LS11 8EY

Paul Maddison  
Gardenways  
Chilworth Towers  
Chilworth  
Southampton  
SO1 7JH

Lyn Antill  
1 Defoe House  
Barbican  
London EC2

Chris Woodford  
11 Hopley Road  
Anslow  
Burton-On-Trent  
Staffordshire

Peter Jarvis  
c/o Health Dept  
Corporation of London  
Guildhall  
London EC2

Robin Bradbeer  
Polytechnic of North London  
Holloway Road  
London N7

Brian Taylor  
Tonbridge Area Library  
Avebury Avenue  
Tonbridge  
Kent

Peter J Kiff  
52 Stone Road  
Broadstairs  
Kent CT10 1DZ

Patrick Colley  
52 Queensway  
Caversham Park Village  
Reading  
Berks RG4 0SJ

Pete Shaw  
15 St Vincent Road  
Clacton-on-Sea  
Essex CO15 1NA

Phillip Joy  
130 Rush Green Road  
Romford  
Essex

Derrick Daines  
18 Cuttings Avenue  
Sutton in Ashfield  
Notts

BJ Candy  
9 Oakwood Drive  
Gloucester GL3 3JF

Susan Kelly  
Head of Reference  
Services  
PO Box 4  
Civic Centre  
Harrow  
Middx

Alan Sutcliffe  
4 Binfield Road  
Wokingham  
Berks RG11 1SL

Rex Shipton  
17 Woodlands Avenue  
Eastcote  
Middx

## USER GROUPS INDEX

*These are alterations and additions to the complete listing published in the August issue. The next full listing will appear in the February 1983 edition*

### International

Laserbug-user group for the BBC Micro. Originally based in London but due to countrywide enquiries is now operating nationally. Monthly magazine, local and larger meetings to be held. Membership £12pa or send £1 for a sample copy of the magazine to: Laserbug, 4, Station Bridge, Woodgrange Road, Forest Gate, London E7 0NF.

'68 Micro user Group. Newly formed. Newsletter planned, regular meetings. Contact: Jim Anderson, 41, Pebworth Road, Harrow, Middx HA1 3UD.

International Electronic Spreadsheet User Group, for all interested in Visicalc, Supercalc and other spreadsheet packages. Information exchange. Membership £15.00 including subscription to Spreadsheet newsletter, published bi-monthly. Details from: InterCalc (UK), Alpha House (7th Floor), Rowlandsway, Manchester M22 5RG.

National Atom User Group: Contact Peter Frost, 18, Frankwell Drive, Potters Green, Coventry CV2 2FB. Quarterly newsletter, software library. Membership £4pa.

### Towns

Basildon Computer Club. Meetings 1st & 3rd Fridays monthly. Contact: Pete Silver, 24, Havengore, Pitsea, Essex SS13 1JT. Tel: Basildon 726141

Bournemouth TRS-80/Video Genie User Group. Meetings twice monthly. Contact: D Washford, 1, Alexandra Road, Bournemouth BH6 5JA. Tel: 0202 761122 (day), 0202 423064 (evening).

Is anyone interested in forming a computer club in Caerphilly/Cardiff? If so, please contact me, Nigel, on Caerphilly 884315 after 5pm.

Fife Computer User's Club. Contact: Murray Simpson, 31, Tom Stewart Lane, St Andrews, Fife, KY16 8YB.

Leeds Microcomputer Group-Secretary's new address, 27, Richmond Road, Leeds LS6. Venue for meetings: British Telecom House, Leeds.

Southgate Technical College Computer Club. Meetings, talks and demonstrations welcome, beginner or guru. Contact: Kevin Pretorius, 01-882 2282 (after 6pm) for details.

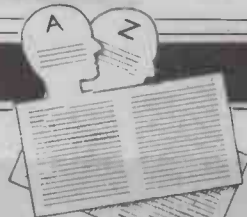

## NETWORK NEWS

*These are all the European networks of which we're aware. Most are free — but phone them for details.*

Forum-80 Hull... (Forum-80 H.Q.) Tel: 0482 859169, System operator Frederick Brown. International electronic mail, library for up/down loading software. Forum-80 Users Group, Pet Users section shopping list system hours, 7 days a week midnight to 8.00am, Tues/Thurs 7.00pm to 10.00pm Sat/Sun 1.00pm to 10.00pm.

Forum-80 London... Tel: 01-747 3191. System operator Leon Jay. Electric mail, library for downloading. System hours: Tues/Fri/Sun 7.00pm to 11.00 pm.

Forum-80 Milton... (TRS-80 Users Group 80-Net) Tel: 0908 566660. System Operators: Leon Heller and Brian Pain. Electronic mail, library, newsletter, TRS-80 information system hours: 7 days a week 7.00pm to 10.00 pm.

Forum-80 Holland... Operator: Nico Karssemeyer, tel 01 313 512 533. Facilities: electronic mail, program up/downloading, shopping list. Hours: Tues-Sat 1800-0700 nightly, continuous from 1800 Sat — 0700 Tues.

CBBS London... Operator: Peter Goldman, tel 01-399 2136. Facilities: electronic mail, program downloading. Hours: Wed 0700-0930 & 1900-2200, Fri 1900-2200, Sun 1600-2200.

Mailbox-80 Liverpool... 051-220 9733. System Operator: Peter Tootill, Electronic mail, downloading TRS-80 information.

ACC... members bulletin board, Peter Whittle (0908 44262)

ABC-80... Stockholm, Sweden Tel: 010 468 190522.

University Research Computer... Sweden. Tel: 010-468 23660, guests use password "66,66" for access.

Elfa... Sweden 010 468 7300 706

Tree Tradet... Sweden 010-468 190522.

## DIARY DATA

*Readers are strongly advised to check details with exhibition organisers before making arrangements to avoid wasted journeys due to cancellations, printer's errors, etc.*

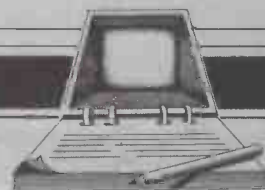

|            |  |           |
|------------|--|-----------|
| Leeds      | (Exbn Centre) Yorkshire Business to Business Exbn. Contact: Solent Exbns Ltd, Bournemouth 20327  | 2-4 Nov   |
| London     | (Wembley Conf Centre) Software Expo. Contact: Interco Business Consultants, Ltd. 01-948 3111   | 8-10 Nov  |
| Romania    | (Bucharest) Electronic Component, Computing & Telecommunications Equip Exbn (ELTRON). Contact: Publicom Publicity Agency, Bd N, Balescu 22, Bucharest. | 9-12 Nov  |
| Dublin     | Irish Electronics Exbn (ITRON). Contact: SDL Exbns Ltd, Dublin 763871  | 23-25 Nov |
| Birmingham | (Albany Hotel) Computer Open Day Exbn Contact: Couchmead Communications Ltd, 01-778 1102   | 24 Nov    |
| Harrogate  | (Exbn Centre) North of England Electronics Exbn. Contact: Exbns For Industry Ltd, Oxted 4371   | 7-9 Dec   |
| Dubai      | Golf Computer Exbn. Contact: Trade Centre Management Co, 01-930 3881   | 13-16 Dec |

## RADEC

### ASCII Keyboards

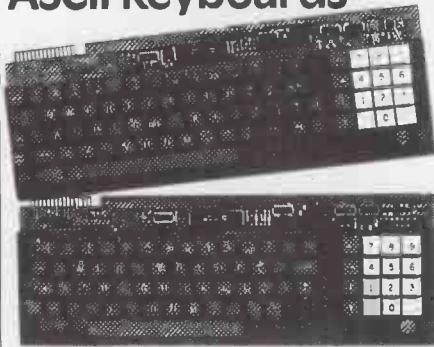

- Upper & Lower Case plus Control
- Low Power Consumption
- Shift & Alpha Lock
- Autorepeat (Model 777)
- Parallel Data Output
- Metal Mounting Frame
- Suitable for Tuscan, Tangerine etc.

|              |             |        |
|--------------|-------------|--------|
| Model KB756A | 56 key      | £39.50 |
| KB710        | Numeric Pad | £ 7.50 |
| KB771        | 72 key      | £55.00 |
| KB777        | 77 key      | £62.50 |

#### Accessories available include:-

|                    |         |
|--------------------|---------|
| Metal Case         | £ 14.95 |
| Edge Connector     | £ 1.95  |
| DC to DC Converter | £ 5.00  |

(for operation off single 5V supply)

### High Resolution Computer Monitor

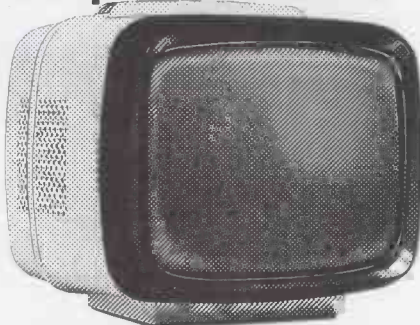

- 12" Green P31 Phosphor
- MULLARD C.R.T.
- 80 Character Line Capability
- 22 MHz Video Bandwidth
- 240V AC Input
- Toroidal Transformer
- Composite Video Input
- Ideal for Apple, B.B.C. Micro, Gemini, Nascom, Tuscan etc.
- MODEL 101

£95.00 + £9.50 Carriage

U.K. Orders add 15% VAT on order total  
Orders under £15 add £1.50 p&p. plus VAT  
Overseas orders add £2.50 p&p

FULL DATA SHEETS ON REQUEST

### Citadel Products Ltd

Dept. PCW 50 High Street Edgware  
Middlesex HA8 7EP Tel: 01-951 1848

### MATHS FOR BBC, PET, APPLE & ZX81

PARENTS, give your children a head-start in life. Make sure they understand and enjoy Maths now, so when the dreaded but necessary O-Level Maths comes along they pass well.

TEACHERS, at last a complete CAL software package is available that lasts years, not just 1 lesson. It includes class-demonstration programs. For example:

SUITE 110. (Factorisation (Algebra), Simple and Compound Interest, Statistics and Trigonometry) only costs from £4.50  
MICRO MATHS. 24 programs from £19.50  
MASTER MATHS. 50 programs on 6 discs for £90

All software uses Colour Graphics and Sound, where appropriate. They are well-tested and reliable and sell worldwide. Phone or send for a free catalogue to:

G. Ludinski B.Sc (Hons) AMBCS  
LCL,  
26 Avondale Ave., Staines, Middx.  
Tel: (0784) 58771



## PROGRAMS

PCW is interested in Basic or Pascal programs for any popular micro — please tell us which one you wrote your program on and how much memory it uses.

Make sure your programs are fully debugged before you send them in on cassette (although we will accept disks) with a clear listing on plain paper. Documentation would be welcome, and if you want it returned please label everything with your name and address and include an SAE.

Send contributions to Maggie Burton, PCW Programs,  
62 Oxford Street, London W1A 2HG

### ZX81 Star Trek

This game is rather like the standard 'Star Trek' to play and is very well written, using as it does machine code and the INKEY\$ function. The use of INKEY\$ unfortunately means that it cannot be run on the ZX80 without changing the program by using INPUT instead. A lot of POKES to the screen are used also which adds further conversion difficulties.

The machine code inverts a window in the middle of the screen which is used as the scenario for the game. This would be of use in other ZX81 programs especially if one knew machine code and could alter the screen parameters. The use of machine code also means that the program should be saved before it is run.

Instructions are included in the program and these are very complicated — not at all easy to take in at one reading. It is helpful to remember that although you are allowed to input numbers with a decimal point for warp factor, this will spoil the display and make it harder to read. The basic idea is, of course, to blow up as many Klingon ships as possible before running out of energy — which you can replenish by calling at starbases. The program can be made more difficult or easier by changing the distance between bases (line 3510), changing the frequency of Klingon attack (line 3410) or changing the amount of energy available (lines 1050 and 5300).

```

10 REM .....
20 DIM Q$(56)
21 LET Q$="2A0C40060AC50620237EFE7F3804DE80
1802C6807710F123C110EAC9"
22 LET X=16514
23 FOR I=1 TO 28
24 LET N=16*(CODE(Q$(I))-28)
25 LET N=N+CODE(Q$(2))-28
26 POKE X,N
27 LET Q$=Q$(3 TO )
28 LET X=X+1
29 NEXT I
30 RAND
100 DIM C$(6)
110 DIM P$(5)
120 DIM T$(5)
130 DIM S$(4)
140 DIM R$(3)
150 DIM H$(17)
200 LET H$="S T A R T R E K" (inverse video)
210 PRINT AT 5,8;" "
220 PRINT TAB 12;" "
    
```

### THE PERSONAL COMPUTER BOOK

by Robin Bradbeer. New ed. just published.

Buying your own micro? Then you need Robin Bradbeer's Personal Computer Book. It includes an illustrated up-to-date survey of 60 micros available in the UK. Contains information on what you can do with micros, details of your nearest computer club and a survey of books and magazines. **Only £5.95.**

Available from W.H. Smith and leading booksellers, or direct from the publishers by sending £6.95 (including p&p) to Virginia Ayers, Dept. PCW, Gower Publishing Co Ltd, Gower House, Croft Road, Aldershot, Hants., GU11 3HR.

### BBC SOFTWARE

Programs that are guaranteed to run! Save hours of work and worry with these utilities and practical programs.

1. CASHBOOK3 Double entry Cashbook ..... £3.95
  2. MAILING Database for mailing list ..... £3.95
  3. CARDS Beat Bruce Forsyth at his own game. .... £2.95
  4. SEARCHBAS PROC to search a BASIC program and alter it ..... £1.95
  5. PROCVAR Attach to any program and list all the variables used ..... £1.95
  6. FLUSH PROC to clean out memory right round the bend! ..... £1.00
  7. DEFCHR Define graphic characters. .... £2.95
  8. DISTANCES Distance between any 2 places in the world. .... £2.95
  9. SORTMC Machine Code sort routine to handle up to 250 items in under one second. .... £1.00
  10. SORTBAS Fastest short sort routines for bulk data ..... £1.00
  11. BANNER Print out large graphic text ..... £2.95
  12. UTILITY Items 4,5,6,7,9 & 10 ..... £4.95
- All programs guaranteed on tape. Fully documented. EASTER HOLIDAY for computer freaks. Come and enjoy yourselves.  
Send for lists in more detail or cheque or PO made out to MICRO-AID, 25 Fore St., Praze, Cambourne, Cornwall.  
Tel: 0209-831274

Micro-Aid

## PROGRAMS

```

230 PRINT TAB 13;" "
240 PRINT TAB 13;" "
250 PRINT AT 13,7;
260 FOR I=1 TO 17
270 PRINT H$(I);
280 NEXT I
290 PRINT AT 18,0;"DO YOU WANT INSTRUCTIONS?"
300 INPUT A$
310 IF A$="YES" OR A$="Y" THEN GOSUB 98000
500 REM *DISPLAY*
510 CLS
520 PRINT "thirty two graphics H characters"
530 FOR I=1 TO 9
540 PRINT "graphic H, thirty black squares, graphic H"
550 NEXT I
560 PRINT "nine graphic H, USS ENTERPRISE (inverse video),
    nine graphic H"
570 PRINT " STARDATE 1000";TAB 21;"ENERGY 5000"
580 PRINT "CONDITION GREEN";TAB 21;"SHIELD DOWN"
590 PRINT "WARP 1 VECTOR 1 SENSORS OFF"
600 PRINT "PHASERS READY";TAB 21;"TORPEDOS 10"
610 PRINT "DAMAGE 0";TAB 21;"SCORE 0"
999 REM*INITIALISE*
1000 LET S$="DOWN"
1010 LET C$="GREEN"
1020 LET T$="READY"
1030 LET R$="OFF"
1040 LET P$=T$
1050 LET E=50000
1060 LET W=1
1070 LET D=0
1080 LET DATE=10000
1090 LET E$="thirty two spaces"
1100 LET S=PEEK 16396 +256*PEEK 16397 +35
1110 LET ST1=S
1120 LET ST2=S
1130 LET SS=0
1140 LET SCORE=0
1150 GOSUB 34000
1160 LET SH=0
1180 LET Z$="five spaces"
1190 LET DOCKED=0
1200 LET WB=1
1210 LET WMAX=9
1220 LET NT=10
1230 LET P=1
1240 LET V=1
1250 GOSUB 35000
1260 LET U$="eleven black squares"
2000 REM ** MAIN LOOP **
2010 LET DATE=DATE+1
2020 LET E=E-W*W-SH*10-SS*5-15*(D>0) -5
    
```

## CENTRONICS

Qualified dealers  
**LOW PRICE PRINTERS**  
 Model 737 Letter Quality Printer  
 Parallel £339 RS232 £389  
 Model 739 plus high res graphics  
 (74x72 dots per inch)  
 Parallel £439 RS232 £485  
 Add £7 carriage & 15% VAT  
 SAE for data sheets

## SCREEN-SCENE

144 St George's Road, Cheltenham  
 Glos, Phone (0242) 28979

Access/Visa orders accepted

## CALLING ALL SINCLAIR ZX81 AND ATARI USERS

How about sharing that program you  
 have written? Total UK distribution.  
 25% royalties on all programs sold.

Programs should be cassette or disk  
 based complete with running details.

Forward to:  
**STUEBE & WRIGHT SOFTWARE**  
 24 Cranbourne Street LONDON WC2

## MICROMART

## VETS FOR PETS

Anita Electronic Services (London) Ltd.  
 are specialists in the repair and service of  
 Commodore Pets.

We offer a fast on-site service, or alter-  
 natively repairs can be carried out at our  
 workshops should you wish to bring in  
 your Pet.

Pet maintenance contracts are available  
 at very competitive prices. Trade inquiries  
 welcomed.

For further information, tel or write to:

John Meade  
 Anita Electronic Services  
 15 Clerkenwell Close, London EC1  
 01-253 2444

We also specialise in the repair of all  
 makes of office equipment.

### UK 101 SOFTWARE ON TAPE

from the guy who wrote "Le Passe Temps"  
**GALACTIC HITCHHIKER** (8K). An adventure, all in  
 machine code. A beauty! (£7.00)  
**SUPERTREK** (8K). Sail boldly through the universe,  
 zapping moving Klingons in real time. Superb graphics.  
 (£7.00)  
**STARTREK** (8K). The old favourite, beautifully presented.  
 (£6.00)  
**LUNAR LANDER**. A real challenge. You won't get down in  
 less than 3 hours. (£3.00)  
**HANGMAN**. Excellent graphics, P.E. said so! (£3.00)  
**BASIC TUTOR** (8 x 4K). The only way to learn - at the  
 keyboard. (£12.00)  
**LE PASSE-TEMPS**. You NEED this, if you haven't already  
 got it. (£3.00)  
**MAD MONK** (8K). It's ready at last! A machine code  
 adventure with some truly remarkable graphics. This  
 programme is in a class by itself. (£9.50)  
 These ORIGINAL PROGRAMS are compatible all 2K  
 Monitors, and are available for 16 x 48 and 32 x 48 displays  
 (including enhanced Superboards).

### HARDWARE

These kits are complete in every way: - Full socketed high  
 quality PCB, all components, switches etc, plus performed  
 cable assembly for easy interconnection to J1, or our...  
**MOTHERBOARD SYSTEM**. Now you can add on all  
 those extras easily. Provides eight, yes EIGHT, fully buffered  
 J1 type sockets. (£19.50)  
**8K STATIC RAM BOARD** (£39.50)  
**HISPEED CASSETTE INTERFACE**. At last, a system  
 that works. COMPLETELY RELIABLE 4000 baud (8000 with  
 reasonable cassette) plus software for named file handling.  
 A delight to use. (£19.50). For software in EPROM, add  
 £6.00  
**VIDEO ENHANCEMENT**. Switch selectable 16 x 48 or  
 32 x 48 displays without butchering your computer.  
 (£19.50)  
 Monitor EPROMS re-blown to suit for just £2.50  
**8K EPROM BOARD** (£19.50). A 2K Extended Monitor is  
 available in EPROM for £12.00 plus, coming soon,  
**TODOLKIT** in EPROM and BASIC V.  
**MONITOR BOARD**. Plug Into Monitor socket to provide  
 switch selection of up to 4 EPROMS. (£9.50)  
**AVAILABLE SHORTLY:** EPROM Programmer, PIA/  
 Sound Board, Analogue Board and something rather nice  
 on the graphics side.

All inclusive  
 Please add 15% V.A.T.  
 Write or phone for further details.  
**MERLIN (MICRO SYSTEMS) LTD.**  
 93 High St.,  
 Eton,  
 Cleveland  
 Tel: (0642) 454883.

## MICROPLUS SOFTWARE

### PET SOFTWARE

- 5 program on each cassette
1. Compendium of Games
2. Space Encounters
3. Home Finance
4. Battle Zones
5. Junior Education

**ONLY  
 £4.95**

Cassettes also available for  
 BBC ZX 81 SPECTRUM

Orders or s.a.e. for catalogue.

to  
**MICROPLUS SOFTWARE**  
 6 LITTON WAY, LEEDS LS14 2DL

## ELCOMP BOOKS and SOFTWARE

For ATARI-PET-OSI-APPLE II-6502-VIC-20-Sinclair-Timex

Dealers welcome!

**ATARI ATARI ATARI ATARI**

**ATARI BASIC** - Learning by Using  
This new book is an "Action" Book. You do more than read it. Learn the intricacy of ATARI-BASIC through the short programs which are provided. The suggestions challenge you to change and write program routines. Yes, it's exciting - Many of the programs are appropriate for beginners as well as experienced computer users. (Screen Drawings, Special Sounds, Keys, Paddles + Joysticks, Specialized Screen Routines, Graphics and Sound, Peeks and Pokes and special stuff.)  
Order-No. 164 \$9.95

**ATARI Learning by Using** - Book + cassette or disk  
This package includes the book No. 164 plus a cassette or disk (please specify) containing a variety of the programs which are listed in the book.  
Order No.: 7220 \$39.95

**Games for the ATARI-Computer**  
How to program your own games on the ATARI. Complete listings in BASIC and Machine Language of exciting games. Tricks and hints.  
Order-No. 162 \$7.95

**GAME PACKAGE for the ATARI**  
Book + cassette or disk  
Includes the book No. 162 plus cassette or disk (please specify) containing a variety of the programs listed in the book.  
Order No. 7221 \$39.95

**ATMONA-1**  
Machine Language Monitor for the ATARI 400/800.  
This powerful monitor provides you with the firmware support that you need to get the most out of your powerful system. ATMONA-1 comes on a bootable cassette. No cartridges required. Disassemble, Memory Dump HEX + ASCII, (Change Memory Locations, Blocktransfer, fill memory block, save and load machine language programs, start mach. Lang. Progr. (Printer optional).  
Comes with introductory article on how to program the ATARI computer in machine language. (Available also in ROM)  
Order-No. 7022 \$19.95

**ATMONA-2 Superstepper**  
A very powerful Tracer to explore the ATARI ROM/RAM area. Stop at previously selected address. Opcode or operand (cassette).  
Order-No. 7049 \$49.95

**EDITOR/ASSEMBLER for ATARI 800, 32K or 48K RAM**  
Extremely fast and powerful Editor/Assembler. (8K Source-code in about 5 seconds) Includes ATMONA-1.  
Order-No. 7098 \$49.95

**MACRO-Assembler**  
for ATARI 800, 48K RAM  
Please specify your system: RAM, disc or cassette.  
Order-No. 7099 \$89.00  
Add \$39.00 for cartridge version

**Gunfight** - For ATARI 400/800 16K RAM, needs two joysticks, animation and sound. (8K machine language).  
Order-No. 7207 \$19.95

**Birth control with the ATARI** (Knaus Ogin) Cass. or disk  
Order-No. 7222 \$29.95

**Astrology and Biorhythm for ATARI** (cass. or disk)  
Order-No. 7223 \$29.95

**EPROM Cartridge KIT for ATARI**  
Cartridge (bare board) with instructions (holds two 16K or two 32K EPROMs (2716,2532,2732)  
Order No. 7224 \$19.95  
Order No. 7043 complete \$29.95

**Invoice Writing** for small business with ATARI 400/800 16K RAM.  
Order-No. 7022, cass. \$29.85  
Order-No. 7200, disc. \$39.99

**Mailing-List** No. 7213 \$24.95  
**Inventory Contr.** No. 7215 \$24.95

**NEW IATEX-1**  
This new wordprocessor in machine language (8K) for all ATARI 400/800 computers offers the best price performance ever. 23 editor control commands, 17 formatting commands, dynamic formatting. Vertical and horizontal scrolling (up to 255 char. per line) Include command on disk!  
Order No. 7210 cassette \$29.95  
Order No. 7211 disk \$39.95  
Order No. 7212 cartridge \$79.80

**Learn FORTH for the ATARI**  
400/800, cassette or disk  
Order No. 7053 \$19.95

**ELCOMP Publishing, Inc., 53 Redrock Lane**  
Pomona, CA 91766, Phone: (714) 623 8314  
Payment: Check, Money Order, VISA, MasterCard, Eurocheck, POSTPAID or PREPAID in USA. \$5.00 handling fee for C.O.D. All orders outside USA: Add 15% shipping. CA add 6.5% sales tax. ATARI is a registered trademark of ATARI Inc. APPLE is a registered trademark of APPLE Inc. PET-VIC-20 is a trademark of Commodore.

**ELCOMP FORTH** - Enhanced FIG-FORTH on disk only.  
Order No. 7055 \$39.95

**How to connect your EPSON-Printer to the ATARI 400/800.**  
Construction article with printed circuit board and software. Screenprint and variable characters per line.  
Order-No. 7210 \$19.95

**OSI OSI OSI OSI OSI**

**The First Book of Ohio Scientific**  
Introduction to OSI computers. Diagrams, hardware and software information not previously available in one compact source. 132 pages.  
Order-No. 157 \$7.95

**The Second Book of OHIO**  
Order-No. 158 \$7.95

**The Third Book of OHIO**  
Order No. 159 \$7.95

**The Fourth Book of OHIO**  
Order-No. 160 \$9.95

**VIP Package** - Above book plus a cassette with the programs.  
Order-No. 160A \$19.95

**The Fifth Book of OHIO**  
Order-No. 161 \$7.95

**Invoice Writing Program for OSI-**  
CIPMF, C4P. Disk and Cassette, 8K RAM.  
Order-No. 8234 \$29.80

**Mailing List for CIPMF or CIPMF 24K RAM**  
250 addresses incl. phone number and parameters on one 5 1/4 disk)  
Order-No. 8240 \$29.80

**8K Microsoft BASIC Ref. Man.**  
Order-No. 151 \$9.95

**Expansion Handbook for 6502 and 6802**  
Order-No. 152 \$9.95

**Microcomputer Appl. Notes**  
Order-No. 153 \$9.95

**Complex Sound Generation**  
New revised applications manual for the Texas Instruments SN 76477 Complex Sound Generator.  
Order-No. 154 \$6.95

**Small Business Programs**  
Complete listings for the business user. Inventory, Invoice Writing, Mailing List and much more. Introduction to Business Applications.  
Order-No. 156 \$14.90

**Microcomputer Hardware Handbook** (845 pages)  
Descriptions, pinouts and specifications of the most popular microprocessor and support chips. A MUST for the hardware buff.  
Order-No. 28 \$14.95

**Care and Feeding of the Commodore PET**  
Eight chapters exploring PET hardware. Includes repair and interfacing information. Programming tricks and schematics.  
Order-No. 150 \$9.95

**Prototype Expansion Board for VIC-20 (S-44 Bus).**  
Order No. 4844 \$18.98

**Wordprocessor I, VIC-20, 8K RAM**  
Order No. 4870 \$19.95

**Mailing List for VIC-20, 16K RAM**  
Order No. 4883 \$14.95

**Tricks for VICs - The Victory Programs**, hints and expansion information for VIC-20  
Order No. 141 \$9.95

**TIC TAC VIC**  
Order No. 4880 \$9.95

**GAMEPACK I (3 Games)**  
Order No. 4881 \$14.95

**Dual Joystick Instruction**  
Order No. 4885 \$9.95

**INPUT/OUTPUT Programming with your VIC**  
Order No. 4886 \$9.95

**16K RAM/ROM board for S44-bus.** Any combination of RAM and ROM on one board. (SY2128 or 2716)  
Order-No. 613 \$39.95

**Low cost expansion boards for your APPLE II.** Bare board comes with extensive description and software.  
6522 VIA-I/O Exp. \$39.00  
Order No. 605  
2716 EPROM-Burner \$49.00  
Order No. 607  
8K EPROM/RAM Card \$29.00  
Order No. 609

**Software for SINCLAIR ZX-81 and TIMEX 1000**  
Machine Language Monitor  
Order No. 2399 \$9.95  
Mailing List  
Order No. 2398 \$19.95  
Programming in BASIC and machine language with the ZX-81(82) or TIMEX 1000.  
Order No. 140 (book) \$9.95

```

2030 IF E<=0 THEN LET E=0.
2040 PRINT AT 11,10;DATE;TAB 28;"four spaces";
      AT 1.1,28;E
2050 IF E=0 THEN GOTO 3200
2100 IF W=0 THEN GOTO 2250
2110 POKE ST1,128
2120 POKE ST2,128
2130 LET ST1=S+INT (RND*9)*33+RND*10
2140 LET ST2=S+INT (RND*9)*33+(RND*10+18)
2150 POKE ST1,151
2160 POKE ST2,151
2170 LET BD=BD+W
2180 IF BV=V THEN LET BD=BD-W*2
2200 IF W<8 OR KV<>V THEN GOTO 2300
2205 IF DK>3 THEN GOTO 2210
2206 LET DK=2
2207 GOSUB 5600
2210 LET DK=DK+2+(W=9)
2220 IF DK>20 THEN GOSUB 3400
2300 LET DK=DK-(DK>0)
2310 IF BD<1 AND NOT DOCKED THEN GOSUB 5000
2400 IF SS AND (DK<3) THEN GOSUB 8200
2500 IF NOT DK THEN GOSUB 9000
2600 IF D=0 THEN GOTO 2700
2610 IF DK THEN LET D=D-1
2620 IF D<1 THEN GOSUB 4030
2630 PRINT AT 15,7;Z$;AT 15,7;D
2700 GOSUB 3000
2800 IF (D>40) AND RND<(W*W/2000+.001) THEN GOSUB 5500
2900 GOTO 2000
2999 REM *****
3000 LET A$=INKEY$
3010 IF A$="" THEN RETURN
3020 IF A$="W" THEN GOSUB 8000
3030 IF A$="S" THEN GOSUB 8100
3040 IF A$="P" THEN GOSUB 7000
3050 IF A$="Z" THEN GOSUB 8500
3060 IF A$="B" THEN GOSUB 8600
3070 IF A$="V" THEN GOSUB 8800
3080 IF A$="T" THEN GOSUB 4100
3090 IF A$="E" THEN GOSUB 4000
3100 RETURN
3200 REM **OUT OF ENERGY**
3210 PRINT AT 19,0;"OUT OF ENERGY.MISSION TERMINATED" (inverse)
3220 LET A$="AN ABSOLUTE DISASTER"
3230 IF SCORE>5 THEN LET A$="TERRIBLE"
3240 IF SCORE>20 THEN LET A$="QUITE GOOD"
3250 IF SCORE>40 THEN LET A$="VERY GOOD"
3260 IF SCORE>60 THEN LET A$="EXCELLENT"
3270 IF SCORE>100 THEN LET A$="KLINGON ZAPPER SUPREME"
3280 PRINT "YOUR PERFORMANCE IS RATED AS"
3290 PRINT A$
    
```

**DAI SOFTWARE FROM IQ SERVICES**  
**8080A ASSEMBLER/EDITOR IN BASIC**

A two pass assembler allowing up to 255 lines of code to be assembled, edited, linked etc. Global and local symbols are allowed as is a special table facility.  
 Also included but available separately @ £3.50 each:

- \* DISSASSEMBLER
- \* TEXT EDITOR
- \* DATA STATEMENT WRITER

Full Package £15. Prices include VAT & P&P. Full instructions supplied with each cassette.  
**CANAL WORKS, ADRISHAIG, ARGYLL. TEL 0456 3212**

**MICRO SERVICING AND REPAIRS**  
 APPLE · PET · VIC · BBC · IIT · and other makes

Micro Malfunction? Send or drop your micro in to us. We'll repair it in our workshops and return it. Our staff are fully qualified and we are Main Dealers and Software Specialists for most leading makes.

**ALSO FULL MICRO SERVICE CONTRACTS IN LONDON AND EAST ANGLIA**

**MICROSTORE · MICRO MANAGEMENT**  
 327 King's Rd. LONDON 32 Princes St. IPSWICH SW3. Tel: 01 352 9291 Suffolk. Tel: 0473 57871

# PROGRAMS

```

3295 STOP
3400 REM **RESET KLINGONS**
3410 LET DK=INT (RND*10+10)
3420 LET NK=INT (RND*3+1)
3430 LET KV=INT (RND*8+1)
3440 LET C$="GREEN"
3445 PRINT AT 12,10;C$
3450 IF SS THEN PRINT AT 17,0;E$;AT 17,0;"NO
    KLINGONS IN SENSOR RANGE"
3460 RETURN
3500 REM **RESET STARBASE**
3510 LET BD=INT (RND*2000+2000)
3520 LET BV=INT (RND*8+1)
3530 RETURN
3600 REM*PAUSE ROUTINE*
3610 FOR T=1 TO 25
3620 NEXT T
3630 RETURN
3700 REM*CLEAR LINES 20,21**
3710 GOSUB 3600
3720 PRINT AT 20,0;E$;AT 21,0;E$
3730 RETURN
3800 REM *LEAVE STARBASE*
3810 LET DOCKED=0
3820 GOSUB 3500
3830 PRINT AT 2,12;U$;AT 3,13;U$;AT 4,10;U$;
    AT 5,11,U$
3840 RETURN
4000 REM *EMERGENCY REPAIRS*
4005 IF E>D+350 THEN GOTO 4025
4010 PRINT AT 20,0;"NOT ENOUGH ENERGY FOR REPAIRS"
4015 GOSUB 3700
4020 RETURN
4025 LET E=E-350
4030 REM *GENERAL REPAIRS*
4035 IF WMAX=9 THEN GOTO 4060
4040 LET WMAX=9
4045 PRINT AT 18,0;"WARP ENGINES REPAIRED.MAX WARP=9"
4050 GOSUB 3600
4055 PRINT AT 18,0;E$
4060 LET WE=1
4065 LET P=1
4070 LET P$="READY"
4075 LET D=0
4080 IF R$="OUT" THEN LET R$="OFF" (nb. "OUT" is inverse)
4082 IF S$<>"OUT" THEN GOTO 4090 " "
4084 LET S$="DOWN"
4086 LET SH=0
4090 PRINT AT 11,28;"four spaces";AT 11,28;E;AT 13,29;R$;
    AT 14,8;"four spaces";AT 14,8;P$;AT 15,7;" "
4092 PRINT AT 12,28;S$;AT 16,0;E$
    
```

## EDUCATIONAL PROGRAMS BBC MICRO

GEOGRAPHY — Italy — colour map displays, regions, cities, mountains, rivers — text and testing £5  
 MATHS — Translations — colour diagrams, explanations, tests £5

SUITABLE 9-15 yr. olds

Please state whether 16k or 32k

**CORONA(software)**  
 21 Tennyson Ave  
 London E.11 2QN

## SOFTWARE STUDIOS

*Small studios on City  
 of London border E1  
 in attractively converted  
 granery. Monthly  
 licences. Ideal for  
 start-ups.*

Tele: 01-236 2675/6/7  
 or 01-377 1226

# MICROMART

## RGB COLOUR MONITOR—only £99.95 (carr & vat)

Limited Quantity of 22" RGB colour monitors  
 — with free isolating transformer. Send or ring  
 for brochure.

### RAM BARGAINS

Limited Quantity of 22" RGB colour monitors  
 — with free isolating transformer. Send or ring  
 for brochure.

|                        | 1 OFF | 25-99 | 100  |
|------------------------|-------|-------|------|
| 4116-200us.            | .80   | .75   | .68  |
| 4116-250us.            | .75   | .70   | .65  |
| 2114-300us.            | .85   | .80   | .75  |
| 2114-L-200us.          | .95   | .87   | .83  |
| 4516-100us-BBC Ram3,10 | 2.95  | 2.80  |      |
| 4164-200us             | 4.80  | 4.60  | 4.20 |
| 6116-150us C. Mos      | 4.20  | 3.95  | 3.50 |
| 2716-5v-450us.         | 2.40  | 2.15  | 2.00 |
| 2716-Tripleram.        | 6.00  | —     | —    |
| 2732-450us.            | 3.95  | 3.75  | 3.25 |
| 2532-450us.            | 3.95  | 3.75  | 3.25 |

Other IC's available Add 50p p&p + VAT @ 15%.

### ATHANA FLOPPIES

Minis with free plastic library case + hob rings.

|              |               |          |               |
|--------------|---------------|----------|---------------|
| S/S S/D      | £17.95 for 10 | 8" DISCS |               |
| S/S D/D      | £19.95 for 10 | S/S S/D  | £15.50 for 10 |
| D/S D/D      | £23.50 for 10 | S/S D/D  | £24.50 for 10 |
| S/S T/Track  | £26.50 for 10 | D/S D/D  | £25.50 for 10 |
| S/S 96 Track | £28.50 for 10 |          |               |

All other discs available. Add 85p P&P + VAT @ 15%.

### OPUS DESKING

AT LAST COMPUTER  
 FURNITURE MADE  
 BY A COMPUTER  
 COMPANY



Full range  
 available at  
 competitive prices.  
 Dealer enquiries invited.

SEE US AT THE PCW SHOW 9-12 SEPTEMBER  
 STAND 255

24-HOUR TELEPHONE SERVICE  
 FOR CREDIT CARD USERS  
 QUANTITY DISCOUNTS AVAILABLE —  
 OFFICIAL ORDERS WELCOME

## OPUS SUPPLIES

10 BECKENHAM GROVE,  
 SHORTLANDS, KENT.

01-464 5040

## SEARCHING FOR 'BEST PRICE'

FOUND 'BEST PRICE'... GOTO

| PET                |        | RRP   |  |
|--------------------|--------|-------|--|
| C2N                | TAPE   | £55   |  |
| 4016               | 16K    | £550  |  |
| 4032               | 32K    | £695  |  |
| 8032               | 32K    | £895  |  |
| 8096               | 96K    | £1195 |  |
| <b>DISK DRIVES</b> |        |       |  |
| 2031               | 170K   | £395  |  |
| 4040               | 343K   | £695  |  |
| 8050               | 1M     | £895  |  |
| 8250               | 2M     | £1295 |  |
| 9060               | 5M     | £1995 |  |
| 9090               | 7.5M   | £2495 |  |
| <b>PRINTERS</b>    |        |       |  |
| 4022P              | 80COL  | £395  |  |
| 8023               | 136COL | £895  |  |
| 8300               | DAISY  | £1395 |  |

VAT TO BE ADDED @ 15%  
 CARRIAGE — £5 PER ITEM  
 IF YOU KNOW WHAT YOU WANT WHY  
 WAIT?  
 THESE ARE THE PRICES YOU NEED

## ORCHARD COMPUTER SERVICES

Orchard House, 21 St Martins St  
 Wallingford, Oxon  
 Tel: Wallingford (0491) 35529  
 Open 6 days per week



# MICROMART

## micro-PROLOG the fifth generation language for micros

- micro-PROLOG is PROLOG for CP/M 2.xx Z80's.
- PROLOG is the European Artificial Intelligence language chosen by Japan as the core language for their Fifth Generation Computers.
- A PROLOG program comprises a set of facts and rules about one or more relations. It unifies:
  - concepts from relational data bases,
  - powerful list processing,
  - pattern directed rule based programming,
  - within a single framework of logic programming.
- Current applications: Expert Systems, Natural Language Understanding, Intelligent Data Bases.
- It is used to teach school children the logic of programming. Teaching material is available.
- micro-PROLOG is a full implementation of PROLOG with with significant extensions:-
  - interactive editor, modules, random access files.

| Current Distribution                               | Prices                                      |
|--|---|
| 8" SS/SD IBM 3740                                  | Software with £185                          |
| 5" format for:                                     | Manual & Primer                             |
| North Star   |   |
| RML 380Z (under CP/M 1.4)                          | Manual £8.50                                |
| Zenith Z89   | Primer £7.00                                |
| Apple II with Z80 card + full lower case key-board | Prices include p&p. Multi-computer licences |

Need more info?  
Sample the language by ordering the 130 page Primer. Price can be set against software.



CP/M™ Data Research, Inc.

Z801M ZiLog Corporation

## BUSINESS SOFTWARE

### INTEGRATED ACCOUNTS

Prepares daybooks, cash books, sales, purchase, nominal ledgers, trail balance, profit and loss accounts. Normal price £1200. **SPECIAL OFFER £895.**

### PAYROLL

All valid PAYE codes are catered for. Facilities for different companies and branches. Cash analysis, payslips, P45 P60 etc. Normal price £500. **SPECIAL OFFER £395.**

### HARDWARE

North Star Horizon and Advantage Superbrain  
All hardware and software Are under warranty for 12 months.

### MICROSYS LTD.,

58 High Street, Prescot L34 6HQ  
051-426 7271/051-430 6650

|                  |                             |                         |                                  |
|------------------|-----------------------------|-------------------------|----------------------------------|
| pet set 1 plus £ | pet set 2 plus £            | greek alphabet math set | electronic symbols and games set |
| french set       | german set                  | russian set             | hebrew set                       |
| apl set          | medium density plotting set | printer matching sets   | BBC RM380Z teletext keymatch set |

**4 DIFFERENT SETS OF CHARACTERS ON SCREEN TOGETHER**  
FOR 2-3-4-8000 PET/CBM COMPUTERS

**ALPHA PLUS**

**Avon Computer Rentals**

FREEPOST 23 THORNBURY BRISTOL BS12 1BR  
TELEPHONE (0454) 415460

# PROGRAMS

- 4095 RETURN
- 4100 REM \*PHOTON TORPEDOS\*
- 4110 IF NT THEN GOTO 4140
- 4120 PRINT AT 20,0;"NO TORPEDOS"
- 4125 GOSUB 3700
- 4130 RETURN
- 4140 IF DK=0 THEN GOTO 4162
- 4150 PRINT AT 20,0;"TARGET OUT OF RANGE"
- 4155 GOSUB 3700
- 4160 RETURN
- 4162 IF SGC<>"UP " THEN GOTO 4170 (nb 2 spaces in string)
- 4164 PRINT AT 20,0;"SHIELD MUST BE DOWN TO FIRE"
- 4165 PRINT "TORPEDOS"
- 4166 GOSUB 3700
- 4168 RETURN
- 4170 PRINT AT 3,16;"+";AT 5,13;"=";AT 5,19;"=";  
AT 7,16;"-" (nb all symbols in inverse video)
- 4175 PRINT AT 20,0;"TORPEDO SYSTEM ACTIVE"
- 4180 LET K=S+3
- 4190 FOR I=1 TO 5
- 4200 POKE K,147
- 4210 POKE K+1,146
- 4220 POKE K,128
- 4230 POKE K+1,128
- 4240 LET K=K+36
- 4250 NEXT I
- 4260 FOR I=1 TO 4
- 4261 LET UU=USR 16514
- 4262 FOR J=1 TO 1
- 4263 NEXT J
- 4264 NEXT I
- 4270 LET NT=NT-1
- 4280 LET NK=NK-1
- 4281 LET SCORE=SCORE+1
- 4282 PRINT AT 15,28;SCORE
- 4290 IF NT AND NK THEN GOTO 4180
- 4300 PRINT AT 3,16;"■";AT 5,13;"■";AT 5,19;"■";  
AT 7,16;"■"
- 4310 PRINT AT 14,30;" ";AT 14,30;NT
- 4320 IF NK THEN GOTO 4400
- 4330 GOSUB 3400
- 4370 GOSUB 3700
- 4380 RETURN
- 4400 GOSUB 3700
- 4410 PRINT AT 20,0;"TORPEDOS OUT";AT 21,0;NK;  
"KLINGONS LEFT"
- 4415 GOSUB 3700
- 4420 RETURN
- 5000 REM \*\*STAREASE\*\*
- 5010 LET W=0
- 5015 PRINT AT 13,5;W
- 5020 PRINT AT 2,12;"████████"

## Protect your favourite asset

— No more dirty keys  
— Fit a dust cover. Strong  
British made in smart black PVC  
£2.45 each (inc VAT). Post free

Send cheque/P.O. to:-

(Ref PCW)  
C.T. Osborne (Chossy) Ltd.,  
168, East Street,  
Epsom, Surrey KT1M 1ET

## SERIOUS SOFTWARE FOR THE ATARI 400 800

— The ATARI 400/800 are the best games computers  
— They can be superb business machines — given the right software

Ixian Technology provide the tools, eg;

- IXISAM database software 32k £50
- IXTERM intelligent terminal/file transfer system 32k £25
- IXFORM turns your screen into a block mode VDU £20
- IXFILL intelligent fill of circles, triangles etc with one CALL £10

Please send large SAE for details





# PROGRAMS

```

5030 PRINT AT 3,13;" "
5040 PRINT AT 4,10;">= "
5050 PRINT AT 5,11;" "
5060 IF DK>2 THEN GOTO 5300
5070 PRINT AT 20,0;"DANGER. KLINGON ATTACK"
5080 PRINT AT 2,12;US;AT 3,13;US;AT 4,10;US;AT 5,11;US
5090 LETZ=S+147
5100 LET Z1=Z-36
5110 LET Z2=Z-30
5120 LET Z3=Z+30
5130 LET Z4=Z+36
5140 FOR I=1 TO 4
5150 POKE Z1,151
5160 POKE Z2,8
5170 POKE Z3,6
5180 POKE Z4,0
5190 POKE Z1,128
5200 POKE Z2,128
5210 POKE Z3,128
5220 POKE Z4,128
5230 LET Z1=Z1-36
5240 LET Z2=Z2-30
5250 LET Z3=Z3+30
5260 LET Z4=Z4+36
5270 NEXT I
5275 LET DOCKED=0
5280 GOSUB 3500
5285 PRINT AT 20,0;ES
5290 RETURN
5300 LET E=5000
5305 LET DOCKED=1
5310 LET NT=NT+2*(NT<8)+(NT=9)
5315 PRINT AT 14,30;NT
5320 GOSUB 4030
5325 LET BD=0
5330 RETURN
5500 REM *METEORITE SHOWER*
5510 LET TV=INT (RND*(WMAX/2)+1).
5520 LET WMAX=WMAX-TV
5525 IF WMAX<1 THEN LET WMAX=1
5530 PRINT AT 18,0;"METEORITE SHOWER. DAMAGE TO WARP
    ENGINES. MAX WARP = ";WMAX
5540 GOSUB 3000
5550 PRINT AT 18,0;ES;AT 19,0;ES
5560 IF W<WMAX THEN RETURN
5570 LET W=WMAX
5580 PRINT AT 13,5;W
5590 RETURN
5600 REM *ESCAPED KLINGONS*
5610 LET CG="GREEN"
5620 PRINT AT 12,10;CS
    
```

# MICROMART

## HISOFT PASCAL 4 INCREDIBLE SPEED INCREDIBLE PRICE

Hisoft are pleased to announce their latest Pascal compiler, the fastest and most powerful so far, at an amazingly low price. Hisoft Pascal 4 is an almost complete implementation of the Pascal language as given in the Pascal User Manual and Report (Jensen/Wirth) including POINTERS, RECORDS and (for disk systems) FILES. All major Pascal statements and data structures are supported together with many useful additions such as PEEK, POKE, USER, ADDR (returns the memory address of a variable) and, for tape, The compiler produces Z80 object code directly (ie, no P-codes) and hence the resultant code runs very quickly indeed. Hisoft Pascal 4 requires only a 32K system in which to run (with plenty of room to spare) and can be supplied on cassette tape or on 5 1/4" or 8" diskette to run under CP/M. The cassette tape version comes with its own tokenising editor and in a form which is easily adaptable to any Z80 system. Hisoft Pascal 4 is a powerful and high quality piece of software which can be used for serious program development — we offer it at such a low price because we believe that such software is normally overpriced and out of reach of the individual.

Prices:

|   |     |
|---|-----|
| HISOFT PASCAL 4 tape version<br>(NASCOM, SPECTRUM etc)                  | £35 |
| HISOFT PASCAL 4 disk version<br>(NASOM, SUPERBRAIN, RML 380Z etc)       | £40 |
| ZDEV (a Z80 development system for Gemini<br>G805 or G809 disk systems) | £45 |
| NASMON (a 4k NASCOM monitor)  | £25 |
| BAS12K (a 12K BASIC interpreter under NASMON)                           | £20 |
| NASGEN (a 3K Z80 assembler under NASMON)                                | £15 |
| NASMEM (a 2K Z80 disassembler under NASMON)                             | £10 |

Send for more details from:

HISOFT,  
60 Hallam Moor, Liden, SWINDON, SN3 6LS  
Tel: (07931) 26616 (24hr telephone).

## MICROCOMPUTER INSURANCE

Comprehensive cover at a reasonable premium:-

- All Risks Cover (incl. Transit)  
— up to £10,000 for £20
- Increased Cost of Working  
— to reinstate lost data
- Breakdown and Derangement  
— alternative to maintenance agreement

Write with details of equipment to:

**Geoffrey Hoodless & Associates**  
Freepost (no stamp required)  
Woking, Surrey GU21 3BR

Tel: Woking (04862) 61082

Answering Service

## PET and VIC Southampton

HIRE Commodore equipment by the week, all including manuals, cassette deck, media etc.  
16K £20, 32K £25, Disk or Printer £25  
VIC 20 £9

Ex-hire equipment with guarantee usually available; 32K from £355  
VIC 20 £125.

Commodore Business Systems — free demonstrations.

RAM circuit boards to fit in ROM sockets

2K £25

4K £45

6550 RAMs £10

Range of software, books and peripherals stocked. All prices are cash-and-carry and exclude VAT

OFFICIAL COMMODORE DEALER

## SUPER-VISION

13 St James Road, Shirley,  
Southampton  
Telephone (0703) 774023  
After hours (0703) 554488

## BBC MICRO NEW

**LANDFALL**  
A powerful decent simulator with full cockpit display, including graphic and digital instruments. Very challenging and not for faint-hearted!

### SERPANT

Can you snatch the golden eggs from the maze before the savage serpents devour you? Becomes more as the game progresses. Fast and totally addictive!

Cheques & PO's to: GT Software, 8 Bull ST, Pottton, Sandy, Beds.

## : GO FORTH &\*;

Complete DIY FORTH kit  
Installation manual ..... £10  
How to do it + model + definitions + editor  
Source code listing for one processor ..... £10  
6502, 6800, 6809, 8080/Z80, 8086/8088,  
9900, 1802  
Manual + one listing ..... £19  
Ready to run  
Lab Microsystems Z80 FORTH FOR CP/M  
..... £45 + VAT  
includes editors, assemblers, utilities, and  
games; good documentation; 8" or 5" formats  
FORTH on disc for most machines inc. PET,  
TRS80, FLEX, CP/M, IBM, and more  
..... from £50



MicroProcessor Engineering Ltd  
21 Hanley Road Shirley  
Southampton SO1 5AP  
Tel: Southampton 775482

## VIC-20

2 GREAT NEW GAMES FOR THE UNEXPANDED VIC!

**BUGBASHER** — little green meanies just keep on pouring out from the centre of the rotating maze. Use your hammer to stop them escaping. 5 levels of play. **FAST** (BASIC-loaded machine code — no monitor required) and **GREAT FUN!** £4.95 inc.

**ENCOUNTER** — crack the lights and music code to land the giant space ship. 5 levels of play — super graphics and sound effects. £4.95 or both above for £9.00 only, inc.

**VICPENDIUM 1**  
4 GREAT GAMES FOR THE UNEXPANDED VIC — all on one cassette

**DIGITMAN, OTHELLO, INVADERS, and GORGON'S TOMB** — a micro maze adventure. Collect the treasure and escape the maze before the evil Serpent catches you.

**ONLY £6.95 — SUPER VALUE FOR MONEY!**

**SPECIAL OFFER — VICPENDIUM 1, plus either BUGBASHER or ENCOUNTER for only £10.50 inc.**

525/531 London Road  
Westcliffe on Sea, Essex.  
Tel: (0702) 42339

## OPUS II SOFTWARE

### "ZX GRAPHICS PROGRAMMING MADE EASY"

Full Colour A4 Manual, 24 pages packed with ZX Graphics Programming techniques and ideas for games and 'serious' Programs. Written in 'easy to understand' language and illustrated at every stage.

Ideas include:  
Information Graphics  
Sketch Pads.  
Saving your 'Art'.  
Making serious programs interesting.  
Graphics Stringing.  
ZX Printer Graphics

**£1-50**

(INCLUDING UK POSTAGE)

Print 'n' Plotter Products (w) 19 Borough High Street, London SE1 9SE.



## PROTEK HP DESKTOP SPECIALISTS

- High density Memory for HP9845 and HP9826
- 5MByte Winchester discs for HP Series 80, 125, 250, 1000L, 9826/36 and HP9845
- Low cost-Immediate delivery

- Utility Software
- Security Systems
- Language enhancements
- Software Consultancy

22 Sussex Street, London SW1V 4RW  
Tel: 01-834 3602

## PROGRAMS

- 8625 IF SS THEN PRINT AT 17,0;E0;AT 17,0;"NO KLINGONS IN SENSOR RANGE"
- 5630 RETURN
- 6000 REM \*PHASER ROUTINE\*
- 6010 FOR I=1 TO 10
- 6020 NEXT I
- 6030 LET K=S+23
- 6040 FOR I=1 TO 8
- 6050 POKE K,147
- 6060 POKE K+1,146
- 6070 IF INKEY<>" " AND E>50 THEN GOTO 6190
- 6080 POKE K,128
- 6090 POKE K+1,128
- 6100 LET K=K+31
- 6110 NEXT I
- 6120 RETURN
- 6190 LET E=E-50
- 6191 LET UU=USR 16514
- 6192 FOR J=1 TO 2
- 6193 NEXT J
- 6194 LET UU=USR 16514
- 6195 IF K=S+147 THEN GOTO 6300
- 6210 GOTO 6080
- 6301 POKE K,128
- 6302 POKE K+1,128
- 6305 LET NK=NK-1
- 6306 LET SCORE=SCORE+1
- 6307 PRINT AT 15,28;SCORE
- 6310 RETURN
- 7000 REM \*\*PHASERS\*\*
- 7010 IF P THEN GOTO 7040
- 7020 PRINT AT 20,0;"PHASERS ARE OUT"
- 7025 GOSUB 3700
- 7030 RETURN
- 7040 IF NOT DK THEN GOTO 7070
- 7050 PRINT AT 20,0;"TARGET OUT OF PHASER RANGE"
- 7055 GOSUB 3700
- 7060 RETURN
- 7070 IF E>50 THEN GOTO 7100
- 7080 PRINT AT 20,0;"NO ENERGY FOR PHASERS"
- 7085 GOSUB 3700
- 7090 RETURN
- 7100 PRINT AT 3,16;"+";AT 5,13;"=";AT 5,19;"=";  
AT 7,16;"-" (nb inverse video)
- 7105 PRINT AT 14,8;"ARMED";AT 20,0;"PHASERS ARMED AND READY" " "
- 7110 GOSUB 6000
- 7115 PRINT AT 11,28;"four spaces";AT 11,28;E
- 7120 IF E<50 THEN GOTO 7200
- 7130 IF NK=0 THEN GOTO 7150
- 7140 GOTO 7110
- 7150 GOSUB 3400

## ATOM BBC

DESIGNER

Can your ATOM manipulate high resolution character graphics?  
Can your BBC handle FULL COLOUR character graphics?

Let DESIGNER do the work:  
It will produce, test and edit your graphics.  
Then finally write your graphics routine for your  
Cassette CB

Or; Send £1 for introductory game cassette and Catalogue.

QUODLIBET,  
2, Victoria Tce.,  
Dorchester,  
DORSET. DT1 1LS

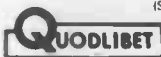

(State which machine!)

## FREE PROGRAM

For TRS-80/V.G.  
(Well almost)

Shooting Gallery £5.95

To introduce the quality of our programs to you, we are making this extra special offer: Send for this fast action machine code program with sound, 4 different scenarios, high score table etc. at the pre-dealer price of £5.95, and you will receive vouchers to the value of £5.95 and our new catalogue. Even if you don't feel like using the vouchers you will still have a superb program at an extremely reasonable price.

Send to: FREEPOST, Algray, 33 Bradbury Street, Barnsley, South Yorkshire S70 6BR

Full money back if not satisfied.

## PROGRAMS

```

7160 PRINT AT 14,8;"READY"
7180 PRINT AT 3,16;"■";AT 5,13;"■";AT 5,19;"■";
    AT 7,16;"■"
7185 PRINT AT 20,0;E0
7190 RETURN
7200 PRINT AT 20,0;E0;AT 20,0;"ENERGY BANKS DRAINED"
7210 PRINT NK;" KLINGONS LEFT";AT 14,8;"OUT " (nb OUT is inverse)
7215 GOSUB 3700
7220 GOTO 7180
8000 REM *CHANGE WARP*
8005 IF W THEN GOTO 8025
8010 PRINT AT 20,0;"WARP DRIVE OUT OF ACTION"
8015 GOSUB 3700
8020 RETURN
8025 LET OW=W
8030 PRINT AT 20,0;"NEW WARP FACTOR?"
8035 INPUT W
8040 IF W>WMAX THEN GOTO 8070
8045 PRINT AT 13,5;W;AT 20,0;E0
8050 IF OW=0 AND DOCKED THEN GOSUB 3800
8060 RETURN
8070 PRINT AT 20,0;"THE ENGINES WONT TAKE THAT CAP"
8075 GOSUB 3700
8080 GOTO 8030
8100 REM *SHIELD*
8105 IF S0="OUT " THEN GOTO 8170 (nb OUT is inverse)
8110 LET SH=NOT SH
8130 LET S0="DOWN"
8140 IF SH THEN LET S0="UP"
8150 PRINT AT 12,28;S0
8160 RETURN
8170 PRINT AT 20,0;"SHIELD IS OUT OF ACTION"
8180 GOSUB 3700
8190 RETURN
8200 REM *SENSORS DETECT KLINGON
8205 IF DK<>2 THEN GOTO 8230
8210 LET C0="ORANGE"
8220 PRINT AT 12,10;C0
8230 LET TV=KV+4
8240 IF TV>8 THEN LET TV=TV-8
8250 PRINT AT 17,0;NK;" UFOS, ";DK;" LIGHT YEARS,VECTOR ";TV
8260 RETURN
8500 REM **SENSORS**
8510 IF R0<>"OUT" THEN GOTO 8540 (OUT is inverse video)
8520 PRINT AT 20,0;"SENSORS OUT OF ACTION"
8525 GOSUB 3700
8530 RETURN
8540 LET SS=NOT SS
8550 LET R0="OFF"
8560 IF SS THEN LET R0="ON"
8570 PRINT AT 13,29;R0;AT 17,0;E0
8580 IF SS THEN PRINT AT 17,0;"NO KLINGONS IN SENSOR RANGE"
8590 RETURN
    
```

## ASCII KEYBOARDS

- o Parallel 7 bit TTL output
  - o 5v Positive Strobe
  - o Full ASCII character set
  - o 62 keys inc. ESC, CAPS, REP, DEL, TAB etc.
  - o Single +5v supply required
  - o Circuit diagram supplied
  - o New — Unused — Guaranteed
- Cased (685 x 232 x 78mm) £34.50  
 Uncased (333 x 175 x 40mm) £32.20  
 Inclusive of VAT and Postage (UK only).

*Namerworth Limited*  
 31 Barnfield, Hemel Hempstead, Herts,  
 HP3 9QJ (0442-66878/48460).

## UK101 SCRAMBLE

A new full speed machine code implementation of the famous game for the 32 x 48 (8k any monitor) UK101. Bomb the ground installations while navigating the tricky terrain and dodging or shooting the enemy fighters. Look out also for the rockets shot at you and the Ack-Ack fire. Destroy fuel dump to reserve fuel for the treacherous castle section.

Send £5.00 or an SAE for full details to:

## ADVENTURE 10

43 Barleycroft Road,  
 WELWYN GARDEN CITY,  
 Hertfordshire, AL8 6JX

## MICROMART

### PET HI-RES!

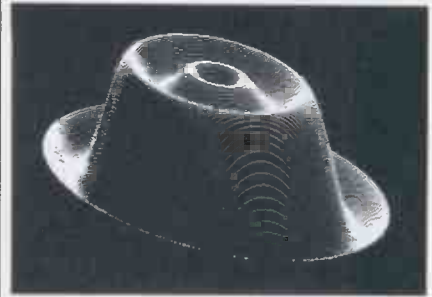

£149 plus VAT brings you 320 by 200 dot resolution on your PET/IBM screen. No soldering is necessary - SUPERSOFT graphics boards just plug in!

Three models are available: for 80 column machines specify the HR80 board; large screen 40 column machines need the HR40B board; for other machines (except very early PETs with no Rom sockets) order the HR40 board. All three boards add 8k of RAM and include GRAPHIX machine code utility software in EPROM. Over 500 boards have been installed in the UK - by schools, colleges, hospitals, research establishments, even home users - and hundreds more are being exported worldwide.

SUPERSOFT are Commodore specialists. We have a large range of software, accessories, and supplies for existing COMMODORE machines and will be supporting new machines as they are launched. Our 20 page catalogue is free to owners and users of PET/IBM machines - but here's a selection of products to whet your appetite! Add 15% VAT to all prices.

|                 |        |                 |        |
|-----------------|--------|-----------------|--------|
| VISICALC        | £148   | VISICALC 96     | £170   |
| SIMPLICALC TAPE | £26    | SIMPLICALC DISK | £32    |
| COMMAND-O CHIP  | £59.95 | MICROSCRIPT     | £425   |
| PAPERMATE PLUS  | £45    | DTL COMPILER    | £99.50 |

## SUPERSOFT

Winchester House, Canning Road, Wealdstone, Harrow Middlesex, HA3 7SJ, England, Telephone 01-861 1166

## A.I.M. Research

**Special offer: 10% off prepaid orders received by 31 October (except dBase 5% and FinalWord 0%).**

### Forth

%Forth is our highly praised implementation of the Forth-79 international standard. It is fast, extensible and fully CP/M compatible, with many enhancements. Used by professionals, but at prices for everyone. From £48.

### Word Processing

by Mark of the Unicorn: available for CP/M, Unix and many other operating systems. Screen editor Mince Unix and many other operating systems. Screen editor Mince £105\*. Paginator Word Processing,

### Word Processing

by Mark of the Unicorn: available for CP/M, Unix and many other operating systems. Screen editor Mince £105\*. Paginator Scribble £105\*. Both £195\*. Mince demo disc & manual £25 (£15 refundable against order).

**The Final Word** - word processing that goes beyond the Stars! Similar features to Mince and Scribble, in a single package, plus features like recovery from hardware crashes. £195\*

### Spelling Checker

The Word - best by far, yet cheapest. See Byte review. £49\*

### Database

dBase II. 30 day trial period! £370

### Accounts

Exact Business Systems - complete accounting package, including payroll. £500

Prices marked \* assume £1 = \$1.80. All prices are subject to availability and for North Star DD discs. For Superbrain, 8", Apple CP/M, and Torch formats and £5 each to xForth, Mince and Scribble and £10 to Finalword.

Add £3 p&p to all orders and 15% VAT.

Dealer enquiries welcomed.

20 Montague Road,  
 Cambridge CB4 1BX  
 Tel: (0223) 353985

# MICROMART

## CBM/PET "IEEE BUS" ROM

Available now — the RHOMBUS B.O.S 4K ROM with 125 page MANUAL. B.O.S. adds 56 commands to BASIC making PET a versatile bus controller. Uses no PET "IEEE Bus" routines. Gives an on-screen data-bus MONITOR. Allows binary, hex, BCD and ASCII data. String variable input of full 255 bytes, including the null byte. Polling, SRQ and all Bus COMMANDS implemented. Bus data transfers from/to memory blocks and no "time-outs".

Available for 2000 to 8000 series PETs with "large keyboard". Price £83 (incl p&p). 10% CWO Discount. Delivery normally Ex-stock. State value of PRINT PEEK (50000) if ordering or send 9x4 SAE for detailed B.O.S. Data SHEET.

### RHOMBUS(CW)

87 BOURNE WAY, HAYES,  
KENT, BR2 7EX

## supercharge your SUPERBRAIN

- Speed up disk operations by 400%
- Cut copying time by up to 75%
- Communicate with other Micros
- Customise your favourite Word-processor
- Get BDOS errors under your control
- Program with Block Graphics
- Copy screens to memory or printer
- Chain COM files from BASIC
- Write unbreakable security routines

SeeDee Software tune-up kits start at £30.00



Full details from:  
**COMPUTER FACILITY**  
0734 867855  
32 Redlands Road,  
READING,  
Berks.

# nascom

Compression Assembler ..... NEW ..... £12  
The best of its kind for the Nascom, this full Z80 assembler compresses source to half the normal size. Thus bigger programs fit in memory & loading/saving is twice as fast. As a bonus it assembles 3000 lpm! It is 6K and includes a ZEEP conversion utility.

Extension Basic .... 200 sold ..... £15 (£25 in ROM)  
Adds these keywords to ROM BASIC: IF..ELSE, REPEAT...UNTIL, WHILE, WEND, AUTO, BREAK, CALL, CHECK, COPY, DEC, DELAY, DELETE, EDIT, FIND, GET, HEX, INKEY, INLIN, LINE, PLOT, PRINT @, PUT, REMEMBER, REDUCE, SPEED, TEST, TRACE, VDU, WRAP, XLIST & XREF. And you can add more yourself. EB is only 4K.

Adventure Quest: see our ½ page ad... 16K=£8, 32K=£10  
Colossal Adventure: see ¼ page ad... 16K=£8, 32K=£10  
Asteroids: fast action in space. Must be played! £8  
Bomber: flatten your least favorite cities .... £5  
Missile Defence: fast action nuclear defence ... £8  
Nightmare PORK: battle the pigs and the puns ... £5

FREE P&P. NO VAT. Money back if not happy. Fully documented. (Nascom is need Nas-Sys/Cottis B.)  
Send order, or request for full details to:  
**LEVEL 9 COMPUTING**  
229 Hughenden Road, High Wycombe, Bucks. HP13 5PG

# PROGRAMS

- 8600 REM \*NEXT STARBASE\*
- 8620 PRINT AT 20,0;"NEAREST STARBASE ";BD;" LIGHT"
- 8625 PRINT "YEARS AT VECTOR ";EV
- 8630 GOSUB 3700
- 8650 RETURN
- 8800 REM\*CHANGE VECTOR\*
- 8810 PRINT AT 20,0;"NEW VECTOR?"
- 8820 INPUT V
- 8825 LET V=INT V
- 8830 IF V>0 AND V<9 THEN GOTO 8850
- 8840 GOTO 8820
- 8850 PRINT AT 13,16;V;AT 20,0;E0
- 8860 RETURN
- 9000 REM \*\*KLINGON ATTACK
- 9010 LET C0="RED" (inverse video)
- 9020 PRINT AT 12,10;C0
- 9025 IF DOCKED THEN GOSUB 5000
- 9030 LET K=S+21
- 9040 FOR I=1 TO 5
- 9050 POKE K,147
- 9060 POKE K+1,146
- 9070 POKE K,128
- 9080 POKE K+1,128
- 9090 LET K=K+64
- 9100 NEXT I
- 9110 FOR I=1 TO NK\*2
- 9120 LET UU=USR 16514
- 9130 FOR J=1 TO 2
- 9140 NEXT J
- 9150 NEXT I
- 9160 GOSUB 9200
- 9170 RETURN
- 9200 REM\*CALCULATE DAMAGE\*
- 9210 LET D=D+NK\*(20+20\*(NOT SH))
- 9215 PRINT AT 15,7;D
- 9220 IF D>=400 THEN GOTO 9300
- 9230 LET TV=INT (D/100)
- 9240 GOTO 9700-100\*TV
- 9300 LET W=0
- 9310 LET W=0
- 9320 PRINT AT 13,5;W;AT 16,0;"WARP ENGINES OUT" (OUT is inverse)
- 9400 LET P=0
- 9410 LET P0="OUT" (inverse)
- 9420 PRINT AT 14,8;P0
- 9500 LET S0="OUT" (inverse)
- 9510 LET SH=0
- 9520 PRINT AT 12,28;S0
- 9600 LET SS=0
- 9610 LET R0="OUT" (inverse)
- 9620 PRINT AT 13,29;R0;AT 17,0;E0
- 9700 RETURN
- 9750 REM \*NEXT PAGE\*

### AIM 65 users..

Would you like to develop 6800/6802 programmes on your AIM?

- 6800 micro assembler, disassembler and ICE communication programmes on cassette, approx 2K.
- 6802 based ICE module for hardware development, RS232 linked, 62K available to user.

More AIM software, phone or send for details.

## Custom Micro Services

2 Upper Holway Rd, TAUNTON, Somerset TA1 2HD  
Tel: 0823 52536.

## SHARP MZ80K ASTRO BLASTER

Fast, exciting, original game. Steer your ship through an unfolding cosmic corridor colliding with aliens and avoiding asteroids. Dock with mother ship for extra bonuses. The game becomes progressively more difficult and retains top 5 scores with name entry. Excellent graphics and sound.

£5 inclusive. Send cheques/PO's to  
P S Laing, Digidata, 34 Salehurst Road,  
IPSWICH, Suffolk IP3 8RY

## PROGRAMS

```

9760 PRINT AT 21,Ø;"PRESS ANY KEY TO CONTINUE." (inverse)
9770 IF INKEYØ="" THEN GOTO 977Ø
9780 CLS
9790 RETURN
9800 REM *INSTRUCTIONS*
9802 CLS
9804 PRINT "YOU ARE IN COMMAND OF STARSHIP"
9806 PRINT "ENTERPRISE. YOUR MISSION IS TO"
9808 PRINT "DESTROY KLINGON BATTLE CRUISERS"
9810 PRINT "IN THIS QUADRANT OF THE GALAXY."
9812 PRINT "YOU ARE ARMED WITH PHASERS AND"
9814 PRINT "PHOTON TORPEDOS. TORPEDOS CAN"
9816 PRINT "ONLY BE FIRED IF YOUR SHIELD IS"
9818 PRINT "DOWN, AND YOU HAVE A LIMITED"
9820 PRINT "SUPPLY, BUT THEY NEVER MISS."
9822 PRINT "PHASERS ARE FIRED BY YOU, AND"
9824 PRINT "SOMETIMES MISS.THEY USE 50 UNITS"
9826 PRINT "OF ENERGY PER SHOT. IF YOU RUN"
9828 PRINT "OUT OF ENERGY THE MISSION ENDS."
9830 PRINT "ENERGY DRAINS ARE LIFE SUPPORT"
9832 PRINT"(CANNOT BE SWITCHED OFF), WARP"
9834 PRINT "DRIVE (HIGH SPEED USES MORE"
9836 PRINT "ENERGY), SENSORS (IF ON), SHIELD"
9838 PRINT "(IF ON), AND DAMAGE REPAIR."
9840 PRINT "DAMAGE IS SUSTAINED AS A RESULT"
9842 PRINT "OF KLINGON ATTACK AND IS WORSE"
9844 PRINT "IF UNSHIELDED.IF MORE THAN 100"
9846 GOSUB 975Ø
9848 PRINT "UNITS, SENSORS ARE LOST;>200 -"
9850 PRINT "SHIELD IS LOST; >300 - PHASERS"
9852 PRINT "ARE LOST;>400 - WARP DRIVE LOST."
9854 PRINT "FUNCTIONS ARE NOT RESTORED UNTIL"
9856 PRINT "DAMAGE IS <10 UNITS, OR UNLESS"
9858 PRINT "YOU REQUEST EMERGENCY REPAIR"
9860 PRINT "(USES A LOT OF ENERGY), OR UNTIL"
9862 PRINT "YOU DOCK AT A STARBASE. EACH"
9864 PRINT "STARBASE CAN REFUEL ONLY ONE"
9866 PRINT "SHIP, SO YOU WILL NEED TO CALL"
9868 PRINT "AT SEVERAL DURING A LONG"
9870 PRINT "MISSION, BUT DO NOT LEAD THE"
9872 PRINT "KLINGONS THERE OR THE BASE WILL"
9874 PRINT "BE DESTROYED."
9876 PRINT "COMMANDS ARE GIVEN BY PRESSING"
9878 PRINT "A CERTAIN KEY (YOU MAY HAVE TO"
9880 PRINT "WAIT A FEW SECONDS BEFORE THE"
9882 PRINT "SHIPS COMPUTER OBEYS)."
```

```

9884 PRINT "OPTIONS ARE :-"
9886 GOSUB 975Ø
9888 PRINT "S CHANGE SHIELD STATUS"
9890 PRINT "Z CHANGE SENSOR STATUS"
9892 PRINT "W CHANGE WARP FACTOR (Ø TO 9)"
9894 PRINT "V CHANGE VECTOR(DIRECTION 1-8)"

```

## MICROMART

### SWEET SIXTEEN!

Turn two ROM sockets into SIXTEEN with the latest expansion board from SUPERSOFT. Suitable for all PET/CBM models, the SUPER-PAGER enables you to select any one chip from eight sharing the UD12 UD3 socket, and one from eight sharing the UD11 (or UD4) socket. Because the SUPER PAGER is software selectable (with a simple POKE command) you can switch from within a program. May be used with the SUPERSOFT range of graphics boards. At just £75 plus VAT the SUPER PAGER is a long-term solution to a peripheral problem!

### DO-IT-YOURSELF

With the EP.1 you could program your own 2 and 4k EPROMs to fit into your spare Rom sockets (or your SUPER PAGER board!). It plugs directly onto the User Port and Cassette Port leaving the IEEE free, and is supplied with machine code software which includes the SUPERMON extended monitor. Price £75 plus VAT.

### PET/CBM GAMES

There is a lighter side to our range. At £8 we've got COSMIC ALIENS, ASTEROIDS, METEORITES, SPACE DEBRIS, SPACE RESCUE, SUPER GLOOPER and TANKS - all in fast machine code with with sound. Adventure games for 32k machines include HITCH-HIKERS GUIDE and CRACKS OF DOOM at £16; other top selling games are PET CHESS (£25), HALLS OF DEATH (£14), and OHELLO (£8), add VAT to all these prices - and ask for our free catalogue when you order.

## SUPERSOFT

Winchester House, Canning Rd, Wealdstone, Harrow, Middlesex HA3 7SJ, England Telephone: 01-861 1166

## SHARP

**CURSED CHAMBERS** - MZ-80K, A or B- Search and explore up to 4000 rooms using Magic wares, Precious stones, Elixirs and your weapons and armour to protect you from the evil that lurks in many of the rooms. Find and kill the Guardians of the Almighty Sphere, take it and escape, but beware of the most deadly monster at the exit.

**QUEST**-MZ-80K, A or B-Travel through over 120 well described locations using the artefacts found to reveal the 4 Eyes of Morpheus. These will then lead you to the treasure.

**ARCADE PACK**-MZ-80K only - Alien Attack (in M/C for fast action with full sound and graphic effects), Escape Force, Blockstop and Madness.

Buy Quest and Cursed Chambers and get Arcade Pack, a 12K adventure and a Graph Plotter - FREE (MZ-80B and A owners do not get Arcade Pack)

All programs supplied on cassette for 48K RAM machines upwards. All prices are fully inclusive. Please state computer when ordering and send to J. Wolstencroft, Sagar Fold, Bleasdale, Preston, Lancs. For more details send an SAE or phone Chipping (09956) 327 after 5.30pm.

## MZ80 SERIES

### baby PILOT

An easy-to-use, friendly and very fast version of this important teaching language. All normal PILOT I/O and control commands PLUS integer arithmetic, powerful graphics and formatting commands, "FOR...NEXT" loops, subroutines, automatic marking and other extra features.

Add another language to your TRS-80 or Genie - complete and simple to follow instructions included: £9.95 baby PILOT

### WIN THE POOLS?

With the latest version of D S Peckett's well-known Pools Prediction program. Now available for BBC Micro as well as TRS-80 (LII) and Genie:

|   |        |
|---|--------|
| Program and Instructions                                      | £4.95  |
| Database tape (optional, but holds data on over 5500 matches) | £13.50 |
| Program and DB together                                       | £17.50 |

These prices are fully inclusive and are for cassette-based programs only.

## DAVANSOFT

1 Delapoe Drive,  
Haverfordwest,  
Dyfed SA61 1HX

We are always looking for high-quality programs for TRS-80, VG and BBC computer, and will pay up to 30% royalties for suitable material. Please contact us with your proposals or for details of our requirements.

Special Offer  
Special Offer  
Special Offer

MEMOREX SS/SD 5¼" Disks  
£16.75 per box of 10 + VAT  
MEMOREX DS/DD 5¼" Disks  
£22.75 per box of 10 + VAT

Special Offer  
Special Offer  
Special Offer

We can also supply BASF, VERBATIM Disks, continuous stationery printer ribbons, etc. | APPLE' SUPERRAIN, PET, CORVUS Products also supplied and maintained;

POSTAGE & PACKING FREE

Discomp Supplies Ltd.

3a High Street, Epsom, Surrey KT19 8DA Tel Enquiries: 0908 566948

# MICROMART

## COLOUR and SOUND



'SIMPLY FILE' RECORDS SYSTEM (DBMS). Select by any key. Print alphabetic lists, mailing labels. Calculate, total, average columns. Fast, easy, robust and VERY versatile. DISK ONLY: £65

'SIMPLY WRITE' FAST WORD PROCESSOR. Some £300-£400 programs have no more facilities. Tape or disk, any printer, 40-80 column PET. Needs 16K. TAPE £40, DISK £45

GOTTA PET? ADDA VIC! High resolution graphics, programmable characters, colour and sound on your PET? All this PLUS a complete extra computer using your PET's drives, printer etc? Under £200 including VIC and our super PET-VIC LINK! (Available separately)

PRICES PLUS VAT BUT INCLUDING P&P. SEND FOR DETAILS, MORE UNUSUAL ITEMS. GET OUR FREE 'MICROMAIL' PET NEWSLETTERS.

SIMPLE SOFTWARE LTD.  
15 HAVELOCK ROAD  
BRIGHTON SUSSEX BN1 6GL  
(0273) 504879



### CRYSTAL RESEARCH LTD

FOR YOUR SHARP MZ80K CP/M 2.21 (XTAL)

BASIC CP/M FACILITIES INCLUDE

- Dynamic file management • General purpose editor
- Fast assembler • Advanced debugging utility

**YOUR SHARP CP/M 2.21 (XTAL) PACKAGE INCLUDES**

- Hardware modification (if fitted by a SHARP dealer does NOT break the guarantee) • SHARP CP/M 2.21 (latest version) on disc • XTAL Monitor and Operating System
- 7 Digital Research manuals • 12 months guarantee and up-dates (on all our products)

**CP/M 2.21 (XTAL) FROM £150 + VAT**

Ask your SHARP dealer for further details or contact

CRYSTAL RESEARCH LTD CP/M SOFTWARE HOUSES - XTAL  
CAN HELP YOU ESTABLISH YOUR SOFTWARE ON THE SHARP

**XTAL BASIC (SHARP) for MZ80 (A, B & K)**

Takes 5K less memory, has all the features of SHARP BASIC PLUS Multi dim strings, error trapping, logical operators, machine code monitor, more flexible peripheral handling, improved screen control, increased list control, auto run, if...then...else - and it doesn't stop there - it grows. You can extend the commands and functions at will - 10K, 12K, 16K, BASIC? SHARP TO XTAL BASIC conversion program is included. **£40 plus VAT.**

Bi-directional serial board for your SHARP RS232 compatible <150 Baud to >2400 Baud adjustable, 5.6, 7, 8 Bit words, plugs into MZ801/0 £99.50 plus VAT. Includes software for bi-directional use in XTAL BASIC software for using SHARP BASIC with serial printer and self-diagnostic software for testing Baud rate etc.

Open 0930-1200 1300-1730 except Saturday & Sunday  
40 Magdalene Road, Torquay, Devon, England  
Tel: 0803 22699 0803 27850  
Access and Barclaycard

## SHARP MZ80K USERS EXTRA MEMORY

No more waiting while your cassettes are loading. Keep all your programs on our 32K EPROM storage board for instant access. Auto load facility allows your program to be up and running after switch on. Add any number of boards to your system. Many other interface boards now available for MZ80K and MZ80A, including Centronics and RS232 printer boards.

Send for details to:  
**PETERSON ELECTRONICS LTD,**  
Academy Street  
Forfar  
Angus DD8 2HA  
Telephone Forfar (0307) 62591

## PROGRAMS

- 9886 GOSUB 975Ø
- 9888 PRINT "S CHANGE SHIELD STATUS"
- 9890 PRINT "Z CHANGE SENSOR STATUS"
- 9892 PRINT "W CHANGE WARP FACTOR (Ø TO 9)"
- 9894 PRINT "V CHANGE VECTOR(DIRECTION 1-8)"
- 9896 PRINT "E DO EMERGENCY REPAIRS"
- 9898 PRINT "T FIRE PHOTON TORPEDOS"
- 9896 PRINT "E DO EMERGENCY REPAIRS"
- 9898 PRINT "T FIRE PHOTON TORPEDOS"
- 9900 PRINT "P ARM PHASERS. YOU THEN FIRE BY"
- 9902 PRINT " PRESSING ANY KEY (HOLD DOWN"
- 9904 PRINT " FOR CONTINUOUS FIRE."
- 9906 PRINT "B GIVES DISTANCE AND DIRECTION"
- 9908 PRINT " OF NEXT STARBASE."
- 9910 PRINT "VECTORS ARE :-"
- 9912 PRINT " 1"
- 9914 PRINT " 8 2"
- 9916 PRINT " 7 3"
- 9918 PRINT " 6 4"
- 9920 PRINT " 5"
- 9922 PRINT "AT WARP 8 OR 9 YOU CAN OTRUN"
- 9924 PRINT "KLINGONS FROM THE OPOSITE"
- 9926 PRINT "DIRECTION. EG. IF THEY COME FROM"
- 9928 PRINT "VECTOR 2, YOU MUST TAKE VECTOR 6"
- 9930 GOSUB 975Ø
- 9932 PRINT "THE DISPLAY SHOWS THE MAIN"
- 9934 PRINT "SCREEN AND INSTRUMENT PANEL OF"
- 9936 PRINT "THE ENTERPRISE. YOU MUST KEEP"
- 9938 PRINT "ALERT FOR ATTACKS BY KLINGONS"
- 9940 PRINT "(WHO LOOK LIKE <>) AND TRY TO"
- 9942 PRINT " CONSERVE ENERGY SO AS TO REACH"
- 9944 PRINT "THE NEXT STARBASE."
- 9946 PRINT "IF SENSORS ARE ON, YOU GET A"
- 9948 PRINT "WARNING OF KLINGONS NEARBY"
- 9950 PRINT
- 9952 PRINT
- 9954 PRINT "GOOD LUCK CAPTAIN."
- 9956 GOSUB 975Ø
- 9958 RETURN

## PET Knockout

by Paul Bradshaw

This is an application program which will organise and control a knockout tournament for any number of players. The author tells me that it was written for an Egg-Jarping contest at Easter but readers will have to use their imagination on what exactly this involves, as no further explanation was offered!

Players are entered either through

the keyboard or from a previous record on tape. The ability to save competitors' names on tape is useful if several tournaments are being held using the same players. A printed list of competitors can also be obtained.

When all the players' names have been entered, the computer will allocate matches at random. The user is asked to

**OSBORNE 1**  
IN NORTHAMPTONSHIRE™

DOUBLE DENSITY  
AVAILABLE NOW

0295.66555

4B

COMPUTER SERVICES

*Choose your time — day or evening  
Learn at your own pace o Apple,  
Pet or CP/m Computers BASIC  
programming and Business packages  
including  
Trial course £ 15 — 4 hours  
computing practise*

Brochure from:  
**MICROCOMPUTER ADVISORY  
CENTRE**  
Polytechnic of South Bank,  
Borough Road  
London SE1 0AA  
Tel 01- 928 8989 ext. 2468

## PROGRAMS.

input all the results and the winner is eventually decided.

This program will run on any PET—it was developed on the 3.0 ROM. Some POKEs will have to be added to the

tape file routines for 'old ROM' PETs and these are detailed in the latest manual.

Listing courtesy of Mr S Warner.

```

100 A=RND(0)
110 PRINT"J"TAB(16)"KNOCKOUT
120 PRINTTAB(16)"
130 PRINT"PLEASE CHOOSE YOUR OPTION:
140 PRINT"
150 PRINT"01. INPUT COMPETITORS FROM KEYBOARD
160 PRINT"02. INPUT COMPETITORS FROM CASSETTE
170 PRINT"03. STORE COMPETITORS ON CASSETTE
180 PRINT"04. PRINT OUT LIST OF COMPETITORS
190 PRINT"05. CARRY OUT KNOCKOUT COMPETITION
200 PRINT"06. EXIT TO BASIC
210 PRINT"WHICH ONE DO YOU WANT?
220 GETH$:H=VAL(H$):IFH<10RH>6THEN220
230 IFH=6THENPRINT"J";END
240 ONHGO SUB260,390,550,660,810
250 GOTO110
260 REM *** ENTER COMPETITORS FROM KEYBOARD ***
270 CLR
280 PRINT"HOW MANY COMPETITORS? ";
290 GOSUB1420:NC=A
300 IFNC<2THEN280
310 DIMC$(NC),X$(NC),Y$(NC/2+1),B$(SGR(NC)+1),F(NC)
320 PRINT"J";
330 FORJ=1TONC
340 PRINT"TYPE NAME OF COMPETITOR"J":
350 GOSUB1420:C$(J)=A$
360 FORK=1TOJ-1:IFC$(K)<>A$THENNEXT
370 IFK<JTHENPRINT"SAME NAME ENTERED TWICE!":GOTO340
380 NEXTJ:GOTO110
390 REM *** INPUT COMPETITORS FROM CASSETTE ***
400 GOSUB1460
410 PRINT"TYPE FILE NAME OR * TO USE
420 PRINT"FIRST FILE FOUND: ":GOSUB1420
430 IFLEN(A$)>10THENPRINT"MAXIMUM LENGTH
IS 10 CHARACTERS!J":GOTO410
440 F$="K:"+CHR$(1):IFA$<>"*"THENF$=F$+A$
450 PRINT:OPEN1,1,0,F$
460 PRINT"THE FILE HAS BEEN FOUND.
470 INPUT#1,NC:CLOSE1
480 POKE16,INT(NC/256):POKE15,NC-256*PEEK(16)
490 CLR
500 NC=PEEK(15)+256*PEEK(16)
510 DIMC$(NC),X$(NC),Y$(NC/2+1),B$(SGR(NC)+1),F(NC)
520 OPEN1
530 FORJ=1TONC:INPUT#1,C$(J):NEXT
540 CLOSE1:GOTO110
550 REM *** STORE COMPETITORS ON CASSETTE ***
560 IFNC=0THENRETURN
570 GOSUB1460
580 PRINT"TYPE FILE NAME: ":GOSUB1420
590 IFLEN(A$)>10THENPRINT"MAXIMUM LENGTH
IS 10 CHARACTERS!J":GOTO580
600 F$="K:"+CHR$(1)+A$
610 PRINT:OPEN1,1,1,F$
620 PRINT#1,NC
630 CLOSE1:OPEN1,1,1
630 CLOSE1:OPEN1,1,1
640 FORJ=1TONC:PRINT#1,C$(J):NEXT

```

## MICROMART

### MINI DISCS- BIG SAVINGS

VERBATIM DATALIFE 5 1/4"

|                         |        |
|-------------------------|--------|
| MD 525 S/Sided 40 Track | £16.45 |
| MD 550 D/Sided 40 Track | £22.45 |
| MD 577 S/Sided 77 Track | £24.45 |
| MD 557 D/Sided 77 Track | £32.45 |

Prices are per ten pack, excluding VAT  
All disks are factory fresh, soft-sectored, hub reinforced and certified 100% error-free.

Please include UK P&P at 95p per pack, then add 15% VAT to total.

Send cheque / P.O. now to:

**DATATECH LTD.**  
Dept. PCW, Freepost, Altrincham,  
Cheshire, WA15 0BR

## ASCO BUSINESSES

### PROPECT<sup>2</sup>

HELPS YOU MAKE BETTER BUSINESS DECISIONS



**THE BUSINESSMAN'S COMPUTER  
DESIGNED BY BUSINESSMEN**  
(AT A BUSINESS-LIKE PRICE)

For a demonstration, or further information please contact:  
**ASCO BUSINESSES**  
43 Windmill Way  
REIGATE  
Surrey RH2 0JB  
Tel: Reigate 48055

## BBC COMPUTER HI-LO GAME

Exciting numbers game based on popular arcade video and TV show. Specially written for the BBC micro Model A or B. Supplied on high quality cassette with good sound and full colour.  
ONLY £2.99 inc. P&P

**D. B. Hewitt (Software)**

527 Whitworth Road  
Rochdale OL12 6EZ

**OSBORNE 1**  
IN OXFORDSHIRE

DOUBLE DENSITY  
AVAILABLE NOW

0295.66555

**4B**  
COMPUTER SERVICES

## 32K NASCOM ADVENTURE

The REAL Adventure begins here, with this full-spec 32K version of the original classic mainframe Adventure, at last available for your Nascom in fast efficient Z80 code. No discs, no graphics needed -- just 32K RAM and NAS-SYS.

Somewhere nearby is Colossal Cave, where others have found fortunes in treasure, though some who enter are never seen again... Explore a vast underground labyrinth of caves, twisty passages and exotic rooms; outwit fierce enemies; collect all the many treasures and become a Grand Master!

Using the most advanced text compression techniques the authentic mainframe messages have been squeezed into 32K.

Supplied on high-quality C60 cassette with full instructions. Only £20 or a large gold nugget! Add 55p post and packing. Discount for Advie 16K owners. Send cheque or PO stating tape format (N1, 300), or SAE for further details on this and other software, to:

\* SYRTIS SOFTWARE \*

23, QUANTOCK Rd, BRIDGWATER, Som.

## PCS

### PEDRO COMPUTER SERVICES

#### Programming Aids

**UN-NEW:** If you typed NEW and lost your program without saving. UN-NEW will let you recover it. Price: £10.00  
**DEMOS:** You just touch a single key and the entire screen is copied onto the printer. This can happen even while running a program. Price: £10.00  
**DISK UN-NEW 8050:** Recover any scratched program on your 8050. Price: £12.00  
**ASSEMBLER:** for the DR. WATSON BOOK OF ASSEMBLY LANGUAGE PROGRAMMING. Price from £7.00  
**TINY BASIC COMPILER:** A true compiler that turns your BASIC programs into fast machine code programs. For old/new 8.0 Rom's. Price: £30.00  
**VIGIL:** Fixing new games into active language. Easy to learn with 60+ powerful commands. For all PET's. Also available for VIC. Price: £30.00

#### Hardware

**CG22Soundbox:** deluxe Soundbox for Arcade games with programming manual. Price: £17.50  
**TV Interface:** for both 40 and 80 col. PET's. Video out RF out for connection to home TV. Price: £28.00  
**Telephone Dialler:** use your PET to dial your telephone. Stores 40 names and phone numbers. More than one screen page of names and numbers possible. 40 names and numbers per page. Price: £23.00  
**A13100:** single board analo-digital converter with on-board supply, 4-bit output port and drive program. Price: £38.00  
**A13200:** 8-channel analogue to digital converter assembled and ready for use. Comes complete with drive program and well documented handbook. Features include 8-bit output port, precision reference voltage, and many others. Price: £55.00  
**PET ROM WRITER:** now you can program D1S and other utilities into 2K and 4K EPROM's. Price: £58.00

#### Books

**THE DR. WATSON BOOK OF ASSEMBLY LANGUAGE PROGRAMMING** for all PET's. Price: £10.00  
**THE DR. WATSON BOOK OF ASSEMBLY LANGUAGE PROGRAMMING** for VIC. Includes Assembler Cassette. Price: £17.00  
**PET MACHINE LANGUAGE GUIDE.** Price: £8.00  
**PET REVEALED.** Price: £10.00  
**LIBRARY OF PET SUBROUTINES.** Price: £10.00  
**THE VIC REVEALED.** Price: £10.00

#### VIC Programs

**WET POUND:** 4 games on one cassette. Price: £5.00 (3K & 8K)  
**STARTERKIT:** fighting in the galaxy. Price: £5.00 (3K & 8K)  
**DATABASE:** Retrieval System. Price: £7.00 (8K & above)  
**HURON CHOKORCHIE GRENKATON.** Price: £7.00 (8K & above)  
**THE CYBER MEN.** Try to destroy them. Price: £7.00 (3.5K) (machine code)  
**VIC FRIENDLY:** Invasive fighter ship. Price: £7.00 (3.5K) (machine code)

Please add £1.30 if you require Programming Aids on disk. Specify 3040/4040 or 80 format.  
 We also stock floppy disks, printer ribbons & cassettes. Send s.a.e. for catalogue.

4 COWCROSS STREET, LONDON EC1.

TELEPHONE: 01-250 1481

# GAMER

|                   |            |
|-------------------|------------|
| VIC 20            | £152 + VAT |
| SHARP MZ80K (48K) | £327 + VAT |
| SHARP MZ80A       | P.O. A.    |
| ATARI 400 (16K)   | £173 + VAT |
| ATARI 800 (16K)   | £390 + VAT |
| TEXAS T199/4      | £173 + VAT |
| VIDEO GENIE (16K) | £299 + VAT |
| ATOM (assembled)  | £150 + VAT |

- + software, books, chess computers
- + Intellivision + Ace TV games
- + SF, Fantasy & Wargames

**BRIGHTON** 24, GLOUCESTER  
 TEL 0273 698424

## PET PET PET PET PET PET

#### \*\*\*\* HI-RESOLUTION GRAPHICS \*\*\*\*

A high resolution graphics board that gives a 64,000 dot (320 x 200) resolution. Versions available for any dynamic ram Pet, BASIC 2,3,4, FAT40 & 80 columns. No soldering or track cutting required, supplied complete with fast GRAPHIX software in ROM and full fitting & operating instructions. £149.00

#### \*\*\*\* SUPER ROM-SELECTOR \*\*\*\*

A high quality printed circuit board giving 64K of utility ROM space, software selectable!! Allows 16 x 4K ROMs/EPROMs to reside in the expansion area of your PET. One 'POKE' enables any two ROMs at a time. Suitable for bank-switched software. £75.00

#### \*\*\*\* PET UPGRADES \*\*\*\*

WHILE-U-WAIT service! (Dynamic ram pets only.)  
 Memory expansion:- 8K - 32K . . . . . £59.90  
 16K - 32K . . . . . from £48.70  
 8K - 16K . . . . . £38.26

40 column (12" VDU only) to 80 column conversion. £89.00  
 40 to 80 column switchable (two machines in one!) £105.00  
 Full keyboard Functions:- i.e. TAB, ESC, REPEAT, SCROLL up/down, define WINDOW, lower case/graphics mode & DELETE from/tocursor. All available in direct or program mode.

#### \*\*\*\* REPAIRS AND SERVICING \*\*\*\*

Fast and efficient repairs to all Commodore computers at reasonable prices. WHILE-U-WAIT service whenever possible.

Please add VAT to the prices shown at the current rate.

Telephone Mick Bignell for more details at:-

MICROSERVE  
 7 Clydesdale Close,  
 Borehamwood, Herts. WD6 2SD.  
 Tel: 01-953-8385

# PROGRAMS

```

650 CLOSE1:RETURN
660 REM *** PRINT LIST OF COMPETITORS ***
670 IFNC=@THENRETURN
680 PRINT"OPRESS 'SPACE' TO CONTINUE AFTER EACH
690 PRINT"OSCREENFUL OF NAMES.
700 PRINT"OPRESS 'SPACE' FOR LISTING...
710 GETH$:IFH#<>" THEN710
720 PRINT"J"
730 FORJ=1TONC
740 PRINT"Q"J":TAB(6)C$(J)
750 IFJ/11>INT(J/11)THEN770
760 GETH$:IFH#<>" THEN760
770 NEXT
780 PRINT"OPRESS 'SPACE' TO CONTINUE...
790 GETH$:IFH#<>" THEN790
800 RETURN
810 REM *** CARRY OUT COMPETITION ***
820 IFNC=@THENRETURN
830 PRINT"QWHEN THE MATCHES ARE BEING PRINTED OUT,
840 PRINT"OPRESS 'SPACE' TO CONTINUE AFTER EACH
850 PRINT"OSCREENFUL OF INFORMATION.
860 PRINT"QWHEN ENTERING THE WINNERS OF EACH MATCH,
870 PRINT"PRESS 31 OR 32 TO INDICATE WHICH
880 PRINT"OCOMPETITOR WON.
890 PRINT"OPRESS 'SPACE' TO CONTINUE...
900 GETH$:IFH#<>" THEN900
910 PRINT"J"
920 BP=0
930 FORJ=1TONC:X$(J)=C$(J):NEXT
940 N=NC:B=0:R=1
950 FORJ=1TON:P(J)=0:NEXT:B=0
960 PRINT"ROUND"R"MATCHES":P=POS(0):PRINT
970 FORJ=1TOP:PRINT" ":NEXT:PRINT
980 IFN/2=INT(N/2)THEN1040
990 B=INT(RND(1)*N)+1:IFBP=@THEN1020
1000 FORJ=@TOBP-1:IFB$(J)=X$(B)THEN990
1010 NEXT
1020 B=X$(B):B$(BP)=B$:BP=BP+1
1030 P(B)--1
1040 FORJ=1TON/2
1050 X=INT(RND(1)*N)+1:IFP(X)=@THEN1050
1060 Y=INT(RND(1)*N)+1:IFX=YORP(Y)=@THEN1060
1070 P(X)--1:P(Y)--1
1080 IFX<YTHENP(X)=Y
1090 IFY<XTHENP(Y)=X
1100 NEXT
1110 CN=0:P=1:FORJ=1TON/2
1120 IFP(P)--1THENP=P+1:GOTO1120
1130 X=X$(P):Y=X$(P(P)):P=P+1
1140 PRINT"Q"TAB(16-LEN(X$))X$  QVERSUS  "Y$:CN=CN+1
1150 IFCN/10>INT(CN/10)THEN1170
1160 GETH$:IFH#<>" THEN1160
1170 NEXT
1180 BB$=B$+" HAS A BYE"
1190 IFB>@THENPRINT"Q"TAB((40-LEN(BB$))/2+1)BB$
1200 PRINTTAB(6)"OPRESS 'SPACE' TO CONTINUE...
1210 GETH$:IFH#<>" THEN1210
1220 PRINT"CENTER WINNERS OF ROUND"R":P=POS(0)-1
1230 PRINT"FORJ=1TOP:PRINT" ":NEXT
1240 PRINT
1250 P=1:FORJ=1TON/2
1260 IFP(P)--1THENP=P+1:GOTO1260
1270 X=X$(P):Y=X$(P(P))
    
```

### S 100 Memory Cards

16 and 32K bank selectable 1EEE  
 standard 250 nS speed, on card power  
 regulation

16K £45 inc. VAT

32K £50 inc. VAT

Postage £1

Send CWO to:

**LOWE ELECTRONICS LTD**

Chesterfield Road,

Matlock

Derbyshire, DE4 5LE

### Superbrain- ABSOLUTE BACK-UP

*Copies & verifies disks 5 tracks  
 at a time. Takes 57 sec to copy a  
 side. Faster than PIP for multi-  
 file backup with less head  
 changing.*

£23 or SAE for details

**FJS Software, 4 Oakfield Rd.  
 Bristol BS8 2AL (0272-739662)**



## PROGRAMS

```

1280 FRINT"Q#1# "X#" OR Q# "Y#TAB(35)
1290 GETH#:IFH#<>"1"ANDH#<>"2"THEN1290
1300 FRINTH#
1310 IFH#="1"THENY#(J)=X#(P)
1320 IFH#="2"THENY#(J)=X#(P<P))
1330 P=P+1:NEXT
1340 IFB>0THENY#(J)=B#
1350 N=INT(N/2+.5)
1360 FORJ=1TON:X#(J)=Y#(J):NEXT
1370 IFN>1THENR=R+1:GOTO950
1380 PRINT"THE WINNER IS:"X#(1)
1390 PRINT"PRESS 'SPACE' TO CONTINUE..."
1400 GETH#:IFH#<>" "THEN1400
1410 RETURN
1420 REM *** INPUT SUBROUTINE ***
1430 OPEN1,0:INPUT#1,A#:PRINT:CLOSE1
1440 A=VAL(A#)
1450 RETURN
1460 REM *** CASSETTE POSITIONING ROUTINE ***
1470 PRINT"INSERT AND CORRECTLY POSITION CASSETTE
1480 PRINT"AND BE USED, THEN PRESS ANY KEY."
1490 GETH#:IFH#=""THEN1490
1500 IFPEEK(59411)=61THENRETURN
1510 PRINT"PRESS 'STOP' ON THE CASSETTE DECK."
1520 IFPEEK(59411)<61THEN1520
1530 RETURN
READY.

```

## PET Trains

by Jeff Aughton

Trains is great fun to play, and not just for children. A grid on the screen defines a track on which run an increasing number of trains. The player's job is to control these little trains and stop them hitting either each other or the buffers. Just to make things interesting, random

closures of junctions have been thrown in as well. It is by no means an easy game to play, and it's unlikely that readers who key in this game will ever last longer than four minutes or so. As a program it is easy and clear to follow. It was tested on a 3022 PET.

```

100 DIMA$(12),PX(18),TX(8,3)
150 GOSUB9000
160 F=0:M=1:U=1:X=160:Y=160:Z=32768
200 I#=""
210 A$(0)=""
220 A$(1)=""
230 A$(2)=""
240 A$(3)=""
250 A$(4)=""
260 A$(5)=""
270 A$(6)=""
280 A$(8)=""
290 A$(9)=""
300 A$(10)=""
310 A$(11)=""
320 A$(12)=""
330 Z#="0":FORI=1TO39:Z#=Z#+1"
340 NEXT Z#:Z#=Z#+1"
350 IFV<.2THENA$(2)=""
360 IFV<.4THENA$(8)=""
400 FORI=1TO8:TX(I,1)=200:TX(I,2)=-1
410 TX(I,3)=X:NEXT
500 PRINT"Q#":FORI=1TO3
510 GOSUB7000:FORJ=1TO6

```

## MICROMART

### EPSON TYPE 3 PRINTERS

Epson's superb Type 3 series replaces the Type 2 and offers:

- \* IMPROVED PERFORMANCE
- \* MANY NEW FEATURES
- \* LOWER PRICES

For free brochure and special Epson offer write, stating your computer, to:

Datatech Ltd, Dept PCW, FREE-POST, Altrincham, Cheshire, WA15 0BR

## ASCO BUSINESSES

43, Windmill Way, Reigate, Surrey RH2 0JB. Tel: (073 72) 48055

LATEST PRINTERS  
UNBEATABLE PRICES

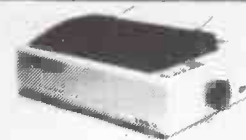

EPSON Mk 111  
MX-80 F/T. £380  
MX-100 £480

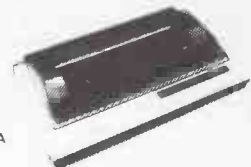

SEIKOSHA GP100A  
£185



OLIVETTI PRAXIS 35  
DAISY WHEEL TYPEWRITER  
STANDARD CENTRONICS  
INTERFACE  
FRICTION FEED  
CORRECTION RIBBON  
£385

SAME DAY, FREE DELIVERY WITHIN 50 MILES RADIUS

## COMPUTERS Bought & Sold.

Contact the UK Specialist in  
Second user systems.

**London Micro Systems**  
10 Victoria Crescent, London SW19  
TEL: 01-228 8860

PLEASE NOTE NEW NUMBER

TO ADVERTISE IN  
MICROMART  
RING JAN MARTIN  
ON 01-636-6890  
ALL CORRESPONDANCE  
TO PCW, EVELYN HOUSE  
62 OXFORD STREET  
LONDON W1

## B B C UPGRADES

LOW PRICES  
16K RAM <£30  
Dealers Welcome

Avon Computer Rentals  
FREEPOST 22 THORNBURY BRISTOL BS12 1BR  
TELEPHONE (0454) 415460

# MICROMART

## DISCS . STATIONARY . PRINTERS .

Floppy diskettes in boxes of 10  
 5 1/4" s/s density s/sectored only £15.00  
 8" s/s density s/sectored only £15.00  
 (Add £1.00/box P & P + Vat.)

Continuous stationery - 1000 sheets  
 9 1/2" x 11" Plain single part only £4.95  
 9 1/2" x 11" Plain (with 1/2" margins) only £5.96  
 14 1/2" single part only £7.00  
 (Includes delivery, excludes Vat.)

### Printers from Newbury Labs

Special Introductory Offer  
 A free box of 9 1/2" x 11" Stationery with every  
 Newbury Printer purchased

The 8510 (11" carriage) only £480.00  
 The 1550 (15" carriage) only £650.00

Printer ribbons  
 8510/1550 only £7.50  
 Epsom MX80 only £4.56  
 Centronic 700 (zip pack) only £3.08

Price - single item but sold in boxes of 5  
 (Add £1.00 P & P + Vat.)



**CDP Consultants Limited**  
 Clavering 079985-617

## INTEGRATED ACCOUNTING SOFTWARE CUSTOM DESIGNED

Cost accounting purchase and sales ledgers  
 invoice, statements etc. cash posting discounts  
 aged debtors due for payment report payroll  
 cost analysis stock control nominal ledger  
 journal entries trial balance profit and loss

Don't let the computer dictate how you run  
 your business! Get an integrated system  
 designed to your particular needs.

### Electronic Aids (Tewkesbury) Ltd

Mythe Crest, The Mythes, Tewkesbury,  
 Glos. GL20 6EB

Telephone (0386) 831020 Or (0684) 294003

## BBC Software

AMERICAN TRADER ... £8.00  
 (Fully inclusive)

American Trader is a game/simulation incor-  
 porating real time (mode 5) graphics for the  
 model B or model A with 32k memory. You  
 are a truck driver in America with a big debt  
 looming over you.

Can you make enough profit on the open  
 and black market to pay off your debt?  
 Can you swindle J.R. or beat th Cincinnati Kid  
 at poker? It's you to you when you try your  
 skill at American Trader.

Supplied on high quality C60 cassettes.

Send cheques/PO's to:

R. Steggles  
 29 Glenlyon Road, Eltham, London SE9

## PLEASE NOTE NEW NUMBER

TO ADVERTISE IN  
 MICROMART  
 RING JAN MARTIN  
 ON 01-636-6890

## PROGRAMS

```

520 GOSUB7100:PRINT"Q " :NEXTJ,I
530 GOSUB7000
540 POKE32849,233:POKE32885,223
550 POKE33689,95:POKE33725,105
560 FORI=0TO10:READJ:POKE2+J,96:NEXT
580 FORI=65TO82:K#=CHR#(I)
610 GOSUB7200:IFP%(A)=5THENNEXT
620 IFRND(1)<.5THENP%(A)=12-P%(A)
630 PRINT"Q";K#;"*";A#(P%(A)):NEXT
640 PRINT"*****"
650 B=TI
1000 T=TI
1010 GETK#:IFK#<"A"OR"K">"R"THEN2000
1020 GOSUB7200:P%(A)=12-P%(A)
1030 PRINTA#(P%(A))
2000 I=T%(U,2):P=2+T%(U,1):K=T%(U,3)
2010 IFK#>THEN2050
2020 IFK#>YORK=1700RK=32THEN6000
2040 D=40/D:IFKAND32THEND=-D
2050 T%(U,2)=D:POKEP,T%(U,3)
2060 IFPEEK(P+D)=96THENT%(U,2)=SGN((UAND1)
-.5)*40/D:GOTO2000
2070 P=P+D:T%(U,3)=PEEK(P):POKEP,Y
2080 T%(U,1)=T%(U,1)+D
2090 FORI=1TO100/M-7*M:NEXT
2100 U=U+1:IFU>MTHENU=1
2110 IFTI-T<800*(1+RND(1))THEN1010
2115 IFTI-B>14400THEN6300
2120 IFFTHEN5200
2130 IFRND(1)<.5VTHENGOSUB5000
2140 M=M-(M/2):GOTO1000
4000 FORI=0TO12:PRINT"Q";TAB(I)K#
4010 FORJ=1TO110:NEXTJ,I
4020 PRINT:RETURN
4500 GETK#:IFK#<">" THEN4500
4510 PRINT"Q":RETURN
5000 Q=6-5*(RND(1)<.5)+INT(3*RND(1))
5010 K#=CHR#(Q+64):P=1
5020 PRINTZ#:" POINTS AT ";K#:" CLOSING DOWN SOON!!!"
5030 PRINT"*****"
5040 GOSUB7200:PRINT"Q";K#:RETURN
5200 PRINTZ# : IFF=2THEN5400
5210 A=Q:GOSUB7205:PRINTA#(6)
5220 P%(A)=6:F=2:GOTO1000
5400 F=0:A=Q:P%(A)=0
5410 PRINT"POINTS NOW CLEAR"
5420 GOSUB7205:PRINTA#(0):GOTO1000
6000 B=INT((TI-B)/60)
6010 PRINTZ#:"CRAAAASH!!!!"
6020 S=37:FORI=0TO9:RESTORE:FORJ=1TO9
6030 READC:POKEP+C,S+I:NEXTJ,I
6040 FORI=1TO1000:NEXT
6050 PRINT"YOU SURVIVED FOR";B;"SECONDS"
6060 PRINT"YOUR SCORE IS";INT(100*(B/240)+(1-V))%"Z"
6070 PRINT"PLAY AGAIN (Y/N)?"
6080 GETK#:IFK#="N"THENEND
6090 IFK#<"Y"THEN6000
6100 RESTORE:GOSUB9500:GOTO160
6300 FORI=0TO2000:NEXT
6310 PRINT"YOU LASTED OVER FOUR MINUTES!!!!!!!"
6320 PRINT"DO BRITISH RAIL KNOW ABOUT YOU ?"
6330 GOTO6070
7000 PRINT"!!";FORJ=1TO37
7010 PRINT"Q " :NEXT:PRINT:RETURN
    
```

### SPECTRUM - High Resolution Colour Graphics and Sound

- 1) Multicoloured meannies: The meannies come at you vertically. From them charcoal black before they reach you.
- 2) Ski slope: Ski down the slope avoiding flags and trees, then try it through a forest.
- 3) Germs: The germs are spreading: Try to gobble more squares than they do, but don't cross your own path or an infected square.
- 4) Alien city: Zap the aliens before they zap you.
- 5) Moving maze: Blast your way out with explosive charges. Warning - the maze changes while you are playing.
- 6) AA gun: Helicopters biplanes and jets. Try to stop them bombing your city.

All games are keyboard controlled, and use high resolution colour graphics and sound. Full instructions included. Send £6.95 (All inclusive) to:

## Action Software

1 Lombard Street, Lichfield, Staffs, WS13 6DP.  
 Please make cheques and P.O.s to ACTION SOFTWARE.

## \*CASES\*

Protect your computer with  
 a custom built shockproof  
 solidly constructed case to  
 your own special design and size.  
 Ring or write for a quotation.

Cowfold Cases  
 Redlion Stables, Cowfold,  
 West Sussex. RH13 8BT  
 Tel: Cowfold 760

# PROGRAMS

READY

```

7020 S=36:FORI=0T09:RESTORE:FORJ=1T09
7030 READC:POKEP+C,S:NEXTJ
7040 S=79-S:NEXTI
7100 PRINT"||||":FORK=1T04
7110 PRINT"||||":NEXT:RETURN
7200 A=ASC(K#)-64
7205 R=INT(A/5):C=9*(A-5*R)
7210 PRINTLEFT$(D#,2+7*R):SPC(C):
7220 RETURN
8000 DATA -41,-40,-39,1,41,40,39,-1,0
8100 DATA 1,1,5,5,5,0,0,0,5
8110 DATA 2,5,0,5,3,5,4,5,4
8200 DATA 1,1,1,5,5,0,5,0,3
8210 DATA 2,0,0,5,5,5,5,4,4
8300 DATA 1,1,1,5,2,0,0,0,3
8310 DATA 2,0,0,0,3,5,4,4,4,0
8400 DATA 50,59,68,200,360,398
8410 DATA 640,678,970,979,988
9000 PRINT"|||||
9010 K#=" TRAINS":GOSUB4000
9020 K#=" " :GOSUB4000:PRINT
9030 K#=" BY J.AUGHTON":GOSUB4000
9040 PRINT"|||||ALWAYS PRESS THE SPACE BAR WHENEVER YOU"
9050 PRINT"|||||ARE READY TO PROCEED TO THE NEXT PAGE"
9060 GOSUB4500
9310 PRINT"TRY TO CONTROL THE TRAINS(##) AS THEY GO"
9320 PRINT"ROUND THE SYSTEM . EACH OF THE POINTS"
9330 PRINT"IS LABELLED WITH A LETTER A-R.YOU CAN"
9340 PRINT"SWITCH THE POINTS BY PRESSING THE KEY"
9350 PRINT"HAVING THE SAME LETTER.KEEP THEM MOVING"
9360 PRINT"AS LONG AS YOU CAN!!"
9370 PRINT"IN THE EVENT OF ANY ACCIDENTS,THE GAME"
9380 PRINT"STOPS AND YOUR SCORE IS GIVEN"
9390 PRINT"AT IRREGULAR INTERVALS SOME POINTS MAY"
9400 PRINT"CLOSE FOR A WHILE FOR REPAIRS.KEEP AN"
9410 PRINT"EYE ON THE TOP OF THE SCREEN FOR DETAILS"
9420 GOSUB4500
9500 PRINT"|||CHOOSE DIFFICULTY LEVEL 1,2 OR 3"
9505 PRINT"1=EASY...3=HARD-YOUR CHOICE":
9510 INPUT"|||. ||||":K#:V=ASC(K#)-48
9520 IFV<1ORV>3THEN9505
9530 FORI=1T09+18*(V-1):READS:NEXT
9540 FORI=1T018:READP%(I):NEXT
9550 FORI=0T018*(3-V):READS:NEXT
9560 N=2+2*V:V=V/7:RETURN
    
```

## POSITRON 9000

Continued from page 134

good in places, obscure in others and occasionally out of date elsewhere. As with much technical documentation, a fairly creative approach should be adopted to its interpretation, although a first-time user would have a bit of trouble dealing with some of the terms which were introduced without much

explanation (eg, recursion).

The manuals covered the following major topics : OS-9, Basic09, Pascal, CIS Cobol, the interactive assembler and debugger, the text editor, Stylographic and system programming.

## Multi-user Benchmarks

We had a certain amount of trouble with the multi-user Benchmarks owing

Exclusive U.K. Distributors — Dealer Enquiries Invited  
**COMPUSENSE THE 6800/6809 SPECIALISTS**



At last — an electronic spreadsheet especially for FLEX and UNIFLEX. Dynacalc does everything you would expect of a 'CALC' program, but it includes row and column sorts and an extensive 'Help' feature which

makes it child's play to handle even the most arduous problems.  
 Flex Version — £140.00 excl. VAT  
 Uniflex Version — £330.00 excl. VAT

We can demonstrate almost every 6800/9 Software item on the market for FLEX. Callers by Appointment.  
 P.O. BOX 169 LONDON N13 4HT Tel: 01-882 0681



# MICROMART

## software for SHARP MZ-80A and MZ-80K

£5.95 — DUSTCOVERS for the A or K and the P6 and P3 printers. Blac, water-proof. A must for every Sharp owner.

£12.95 — BRIDGE. Complete 4-handed contract bridge — you against the computer. Full bidding, superb play, this is absolutely outstanding! Ruffs, finesse, slams, Blackwood — they're all there. You can even bid or play a hand again, or define your own hands! Unbeatable value — you'll play this time and time again. Order now — you won't find this program anywhere else!

£6.95 — FOOTBALL MANAGER. Join the ranks of the riskiest profession of all! Your mission, to transform a pathetic team into league champions. Your only problems, injured players, insufficient cash, low gates, impatient directors and angry bank managers! Think you can cope? Then try this superb simulation... Before you try it for real!

£6.95 — COSMIAD. First Space Invaders, now Cosmiad! Watch out for the aliens peeling off to attack! Excellent.

£6.50 — HEAD ON. Basic/machine code arcade game. Gobble up dots, but avoid suicidal robot cars intent on your destruction! Very fast.

COMPUTER ASSISTED LEARNING. Whole range of superb programs. Send for details.

MZ-80K only — MOONLANDER £5.50, BIORHYTHM £4.95, BANK ACCOUNT £5.50. Many more.

PRICES FULLY INCLUSIVE



Write or phone for full catalogue  
 Cash with order or ACCESS  
 Orders despatched by return

**HIGHLIGHT SOFTWARE**  
 3 Nether Court, Halstead, Essex CO9 2HE  
 Telephone (0787) 475714

northern computers offer even more

Software  
 Disk Drive  
 Printers  
 Second Hand Computers  
 Tape  
 Recorders  
 Books  
 ALL ACCESSORIES SALES AND SERVICE

Easy parking off the M56 (Junc. 12)



northern computers

Tel: Frodsham (0928) 35110

Churchfield Rd., Frodsham, Cheshire WA6 6RD

ASHFORD COMPUTER CENTRE  
 many makes of Micros and Accessories supplied

Courses in Computer Programming for the Complete Novice  
 Ring for Prices...  
**BIG ADS DON'T ALWAYS MEAN BIG SAVINGS**  
 VIC 20 £180.00

Clarendon Road, ASHFORD, Midd'x.  
 Tel: ASHFORD 44955

# ZX81

● CASSETTE 3 8 programs for 16K ZX81

STARSHIP 'TROJAN'

Repair your starship before disaster strikes. Hazards include asphyxiation, radiation, escaped biological specimens and plunging into a supernova.

STARTREK

With variable Klingon mobility.

PRINCESS OF KRAAL

An adventure game.

BATTLE, KALABRIASZ, CUBE, SECRET MESSAGES, MARTIAN CRICKET,

(Martial cricket is 1st m/c game)

● CASSETTE 4 8 games for 16K

ZS-SCRAMBLE (m/c) with 3 stages.

GUNFIGHT (m/c) invaders (m/c)

GALAXY INVADERS (m/c)

Snakebite (m/c)

LIFE (m/c)

3D Tic-Tac-Toe

7 of the 8 games are in machine code for extra speed.

These cassettes cost £5 each.

Please write for Cassette 1&2 details.

On quality cassettes, by first class post from

Michael Orwin, 26 Brownlow Rd., Willesden, London NW10 9QL

# POSITRON 9000

Continued from previous page

to the restriction of four concurrent processes per memory management unit. Regular PCW readers will remember these tests, introduced in February 1981. They include a processor test (actually Basic BM7 above) and two disk access tests which write and read 100 128-byte records to and from the disk, in the first case opening and closing the file after each read/write; in the second using only a single open and close for all writes and reads. These are designed to look at filing system overheads and record locking schemes. Finally the I/O test lists the printable ASCII subset 100 times. The disk tests utilised the winchester disk.

In the event, it was not possible to observe any degradation in performance although equally we were disappointed not to be able to run more than two tasks simultaneously on the review system (with an additional terminal attached).

The timings appear below:

|                   | 1 User | 2 Users |
|-------------------|--------|---------|
| Processor         | 19.0   | 36.4    |
| Disk (single R/W) | 67.7   | 134.4   |
| Disk (100 R/W)    | 8.4    | —       |
| I/O               | 56.0   | 102.1   |

Attempts to get more processes running resulted in a memory full error which is a pity since we wouldn't have

mindful waiting if the tasks could have been queued.

## Conclusions

The Positron 9000 is a flexible, well-built multi-user system that runs a Unix-influenced operating system, OS-9. It has an unconventional but powerful Basic compiler, a Pascal compiler and CIS Cobol. There is a word-processing package and the promise of a record management system, a suite of accounting software and a C compiler. It can take up to 512 kbytes of RAM and 256 kbytes of ROM, has up to 12 RS232 ports, an IEEE-488 bus, floppy and hard disks, and a network.

However, we believe it is based on a faulty design philosophy: in the days of cheap processors, a lot of hardware and software has been made dependent on a single, slow 8-bit processor. The basic system is more expensive than its competitors because it has so much built-in potential for expansion, yet for many applications requiring the extra resources the processor is likely to run out of power. Nevertheless, applications which may not be processor bound and which can exploit the low-cost multi-tasking software, perhaps in the field of process and industrial control, could find the Positron has few real competitors.

END

## MIDLANDS

COMMODORE PET SERVICE CENTRE

Phone Anne on 021-772 8181 about our:

1. Workshop & Field Repairs
2. Business Software
3. Stationery & Supplies

**CBS**  
CONSULTANTS

75 Watery Lane, Birmingham B9 4HW.  
Telephone: 021-772 8181 (7 Lines)

### COMPUTER CASSETTES

High quality, screw assembled cassettes with library boxes. Any lengths available.

C5 - 35p    C10 - 37p    C12 - 38p  
C15 - 39p    C20 - 41p    C25 - 45p  
C30 - 44p



PRICES plus P. & P. (10% or min. £1-50)

SUBSTANTIAL TRADE DISCOUNTS

data-assette®

Dept. PCW6  
44 SHROTON STREET  
LONDON NW1 6UG.  
Tel: 01-258 0409

# PERSONAL PEARL

Continued from page 164

would be clumsy to use on a system with small disks — even on a system with ½ Mb disks I couldn't get all the programs on one disk. My review copy was supplied by Pearl Software International (UK) of Poole, the UK importer — the software originates in the USA.

## Conclusions

Considered as a data management system Pearl has several advantages. It provides quite straightforward facilities for novice users, and should enable them to design and implement a simple file management system fairly easily. Accessing information in related files is well catered for and much less limited in its scope than in some of Pearl's competitors. The methods of data storage should be quite economical in that Pearl does not need to reserve the maximum

permitted field length for every field in a record, and stores only the data which is actually there.

On the other hand, the way the data dictionary which permits these goodies has been implemented means that the user cannot decide, after the data file is set up, to index on extra fields. The selection facilities are rather restricted, and the one-to-one connection between screen display (for data entry and updating) and data file could be a serious drawback in many applications.

Finally — you either like menu-driven systems or you don't; I prefer them to command-driven systems only if they permit the user who has gained some experience to override the menu options completely, so I think people might get irritated with this aspect of the Pearl user image as they get experienced with the package.

**OSBORNE 1**  
IN BUCKINGHAMSHIRE™

DOUBLE DENSITY AVAILABLE NOW

**4B**  
COMPUTER SERVICES

0295.66555

**Printer Stand PSS**

Handsome crafted in 6mm tinted Perspex

PSS model for Microline 80/82/83, Epson MX-80, Sheiksha GP100 etc.

£15.95+VAT

PSL for Microline 84, Epson MX82 etc. £17.95+VAT

APPLE PADDLE

Male connector to Apple slot with 12" colour coded cables for proto boards, external units etc. £5.95 incl.

**CAMBRIDGE MICROELECTRONICS LTD**  
One Milton road Cambridge CB4 1UJ  
(0223) 314 814

# THE ULTIMATE TEST?

Continued from page 141

Finally, the Pascal program published in *Byte* is, in fact, a UCSD Pascal version, utilising FILLCHAR and the function SIZEOF to initialise the Boolean array. Gilbreath regarded as legitimate the use of such implementation-dependent features for his comparisons but we have produced a 'plain' Pascal program to compare with the Fortran and Basic ones. Nevertheless, it is interesting to note that the LSI-11 timing quoted in the articles (for a Terak running UCSD Version II) at

317 sec is 156 per cent slower than our system. Table 1 shows the timings of the programs. The benchmark programs are also listed.

As expected, the UCSD Pascal version runs faster but takes longer to compile (probably due to the need to reference the library more extensively). True to its reputation, the Fortran compiler is fast, but its code does not run quite so quickly as the Pascal versions.

## LEISURE LINES

by J J Clessa

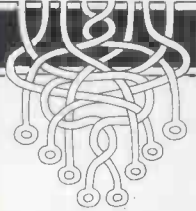

We received 160 entries to the July Puzzle. Quite a few got the answer wrong, although again many people complained that it was too easy. There's no satisfying some folks!

The answer was 5000 since  $300^3 - 2 \text{ million} = 5000^2$

The winner, chosen at random, was Mr Stephen Bennington of Clifton, Bedfordshire. Congratulations, Mr B your prize will be on its way forthwith — if not sooner.

## Quickie

No answers, no prizes. If it takes four men eight days to dig four holes, how

long does it take one man to dig half a hole? The answer is not four days.

## Prize puzzle

This should test your micros! A certain number, greater than 5000 but less than 50,000, when divided by four gives a remainder of three; when divided by five gives a remainder of one; when divided by seven gives a remainder of two; when divided by 11 gives a remainder of 2 and when divided by 17 gives a remainder of 12. What is that number?

Answers, on postcards only, please to: October Prize Puzzle, *PCW*, 62, Oxford Street, London W1A 2HG to arrive not later than 31 October 1982.

## BLUDNERS

Readers will remember the article 'Pouring Quarts Into Pint Pots' which we published in June *PCW*. We have to admit that we made rather a dog's dinner of it and, in fact, left the piece out of the contents page altogether. It was, actually, on page 149. Adding insult to injury, the author's name did not appear beneath the title (or anywhere else on the page!) and so we'll apologise here instead to Erwin Schneider for this mistake.

There were also three little slip-ups in the text and these are as follows: At the end of paragraph four the number

195,000 should read 105,000; in the fourth paragraph from the end the text refers to 'altering the value of 1' the '1' should be 'I' and finally in the program listing (line 330) the first character before the '=' should be a 'k'.



## CAMEL MICROS

33a Commercial Road, Weymouth, Dorset

## TRS 80

software supplies

SPECIAL OFFER... 15% off all software prices below for orders received before 30/10/82.

MATCAL. £12.50 (Manual 2.50)  
(A matrix calculator) PCWINDEX. £10.50 (Mod. 1 disc only)  
Full Personal Comp. World index

ELECTRONIC WORKSHOP £6.90  
20 electronic circuit calcs. See previous adverts for details of the above, or send SAE.

—NEW PROGRAMS THIS MONTH—

DISCOPT. £9.90

This program was developed to speed up disc-bound programs and get fast loads/saves on Model 1 systems. File-structured disc access is not needed for many applications, but just slows things down. DISCOPT adds over 10 extra BASIC commands (in Disc or Level 2 Basic) for accessing discs by track, sector and byte, giving total control. DOS files can co-exist on the same disc, and single disc users can use 100% of disc for user data/programs if desired (no DOS files needed). Example — Program load under TRSDOS 30+ secs, under DISCOPT under 8 secs.!

INVESTMENT MONITOR £4.90

For Aculab floppy tape users, intended for flexible plotting and management of unit trust or Stocks/Shares.

MEMTEST £5.60

No user should be without a memory tester. This tests ROM and RAM on Model 1 only at present.

\*PRINTERS\*

Low prices  
MX80 T/3 £363  
MX100FT/3 £478  
MX80 FT/3 £393

Let us quote you for Mannesmann Tally, Smith Corona, Prince VDU's, etc.

## STEMMOS LTD ANNOUNCES AUTOCODE

Automatic development of dBASE-II programs Code without any Programming.

- \* Automatic menus
- \* Automatic data entry screens
- \* Automatic data entry routines
- \* Automatic EDIT/Validation
- \* String, numeric, data and calculated fields
- \* Automatic multiple reports
- \* Automatic programs in dBASE code with interactive screens

Autocode I £120 00

dBASE-II & Autocode I £450.00

**STEMMOS LTD.**

344 Kensington High Street,  
London W14.

Tel: 01-602 6242



Calling all  
hobbyists,  
schools, soft-  
ware houses  
and budding  
programmers!

We would like  
to hear from program writers who  
would like to see their work pub-  
lished on Prestel for everyone to  
use. We'd like programs for most

micros — Apple, BBC, Commodore,  
Tandy, Sinclair — to be included  
in our database, 'Aladdin's Cave.'

Of course, we are willing to pay for any  
that we publish

If you are interested then please  
contact us at: Aladdin's Cave,  
Prestel Headquarters,  
Telephone House, Temple Ave,  
London EC4Y OHL.

Prestel and the Prestel symbol are  
trademarks of British Telecommunications.

TO ADVERTISE IN  
MICROMART  
RING JAN MARTIN  
ON 01-636-6890

# BACK ISSUES SERVICE

Here is a complete guide to all available back issues of *PCW*. A quick guide to their contents is shown below. Check the coupon overleaf for the issues you require.

**Volume 1 No 1, 1978**  
The 77-68/Practical hints on kit building/Nascom 1/Charity case study/Flowcharting/Pontoon flowchart.

**Volume 1 No 2, 1978**  
Kit building Basic — first steps/Case study — a software house/PET 2001/Research machines 380Z/School computing/E78 — Europa Bus.

**Volume 1 No 3, 1978**  
More efficient programs/Cosmac 1802/The PDP11 Part 1/Small business computing — an approach/The Z80/EPROM programmer construction.

**Volume 1 No 6**  
October 1978  
Pilot/Assembly code programming/Small business case study/PET preening/Time tabling for schools.

**Volume 2 No 1**  
May 1979  
Chess programming/Using a small business computer Part 1/Smart 1/In defence of PET/+d Noughts & crosses

**Volume 2 No 2**  
June 1979  
Different computer languages/(MSI) 6800/Using a small business computer Part II/Demonstrations using the Apple II Part I.

**Volume 2 No 4**  
Apple medical application/North Star Horizon/Word processing/High speed cassette interface/Sorting/Buying a computer for a small business

**Volume 3 No 12**  
December 1980  
Benchmark: Microwriter/Printerfac: Series — Part 1/Sharp PC-1211 speed-up/Programs: TRS-80 Tarot, PET Cat &

Mouse, PET Rebound, MZ-80K Alligator Swamp, PET Connect, UK101 Minefield, PET Simon Benchmark: Raand SP1

**Volume 4 No 1**  
January 1981  
Benchmark: Transam Tuscan/Real-time control using trains — part 1/Recover from a data tape disaster/PET Music Multi-user systems — part 1/Programs: TRS80 Four in a row, TRS80 Target Practice, PET Convoy, PET Wire, PET Maze Chase, PET Android Attack, PET Anagram



**Volume 4 No 3**  
March 1981  
Benchmark: Onyx C8002/Multi-user Benchmark: MP/M/Benchmark: Sinclair ZX81/West Coast Faire report/Radio Teletype/WP Benchmark: Wordpro 4 plus/Budget tape interface/Further Casio quirks/Programs: UK101 Zor, PET Chords.

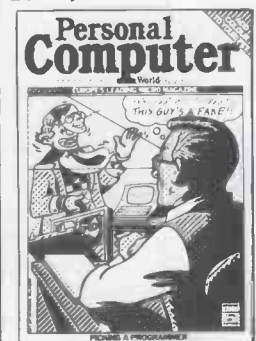

**Volume 4 No 5**  
May 1981  
Benchmark: Pascal 640/WP Benchmark: Magic Wand/PET colour/Low-cost digital tape system/Using calculator printers

on micros/Apple music-making/Multi-user Benchmark: MVT-Famos/Programs: PET Grand Prix, PET Aircraft Landing, PET Bouncy.



**Volume 4 No 6**  
June 1981  
Benchmark: NEC PC-8001/Multi-user Benchmark: MP/M/Benchmark: Sinclair ZX81/West Coast Faire report/Radio Teletype/WP Benchmark: Wordpro 4 plus/Budget tape interface/Further Casio quirks/Programs: UK101 Zor, PET Chords.



**Volume 4 No 7**  
July 1981  
Benchmark: Sharp PC-3201/Multi-user Benchmark: Acorn Econet/Case study: Accident investigation on TRS-80/Zilog Z8 family/WP Benchmark: Format-80/Pascal Benchmarks: readers' letters/Quicker Casio computations/Programs: ZX80 Sliding Letters, UK101 Car Rally, TRS-80 Calendar, UK101 m/c code to Basic converter, PET Exam Questions, MZ-80K Designer, ZX91 Sketch Pad.

**Volume 4 No 8**  
August 1981

Benchmark: Tandy Model III/Viewdata update/WP Benchmark: Spellbinder/Printer survey/Micro-holism/Programs: ZX80 Othello; Easter Sunday; Apple Mondrian; MZ-80K Duck Shoot; PET Gomoku; MZ-80K Foot ball.



**Volume 4 No 9**  
September 1981  
Benchmarks: Tandy Color Computer, Commodore VIC/Checkouts: Hi-Tech Speakeasy, Tanelt/Multi-user Benchmark: HMSOS/



WP Benchmark: Memorite III/Word proc program for PET/Apple dealership run by spastics/Printer facing extra/Calc Corner: Casio fx602p review/Programs: PET Arithmetic test, ZX80 Eldorado, 380Z Memory test.



**Volume 4 No 10**  
October 1981  
Benchmark: OKI if-800/Checkouts: Heuristics speech link, Softy 2/Calc Corner: Texas TI51-111/Jeff Taylor on computer literacy projects/Introducing TJ's Workshop/Control your own Substation pt 1/Programs: TRS-80 Sailing.

**Volume 4 No 11**  
November 1981  
Benchmarks: Osborne 01, IBM Personal Computer. Checkout: Sharp IQ3100 Microtranslator, Calc Corner: Casio fx702p.



PCW Show report, Benchmark Summary, Euro Micro Chess Championship report, Programs: TRS-80 Sheepdog trial, ZX81 Sun and Planets.



**Vol 4 No 12**  
December 1981  
Benchmarks: Sharp MZ-80B Philips P2000/School network/ BBC Micro inside story/ 'Turtle' Graphics for Apple/ Forth language/ Curve fitting/ Calc corner: HP14C review/ Programs: PET Fantasy, ZX81 Battleships and cruisers.



**Vol 5 No 1** January 1982  
Benchmarks: BBC Micro, Xerox 820/Frames of Reference (new series)/ ZX81 Printer Checkout/ Digital Drummer for PET/ Calc Corner: Benchmarks/ Programs: MZ-80K Fortune, TRS-80 Reaction Timing, ZX80 Laybrinth, Apple Letters.

**Vol 5 No 2** February 1982  
Benchmarks: Sirius-I, Casio fx-9000p, Gemini Multiboard/Word Processor Benchmark: Scripsit 2.0/ Plotter Checkout: Watanabe/Hardware feature: High Density VDU card project/Music system: FREQUOT/Calc Corner: Aerial Navigation/Programs: Pet Haemophilia, Pet Cheese, TRS-80 Extra, Sharp PC1211 Exam, Personality test.

## PCW SPECIALS

Benchmark Special £1.80.

All the best of *PCW*'s Benchmarks of popular micros. Desktop computing £2.25. Comprehensive guide to using micros to help you in your Businesses.

## BINDERS

Keep your copies in order with these strong, attractive yellow binders. £3.95 each (inc P&P)

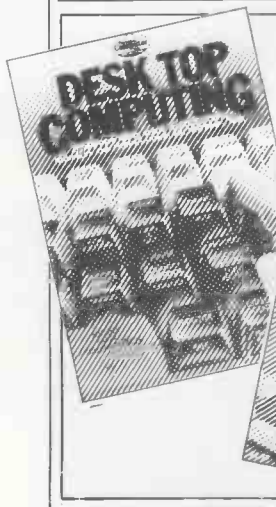



Vol 5 No 3 March 1982  
 Benchtests: Texas Instruments 99/4A, Hewlett-Packard 125/Choosing a Database/Comsoft DMS reviewed/Screenplay (new series)/Calc Corner: Hewlett-Packard Interface Loop/Programs: TRS-80 Solitaire, TRS-80 Ducks, Nascom Business Documents, MZ-80K Race Chase, ZX81 Graphplot.



Volume 5 No 4  
 April 1982  
 Benchtest: Monroe OC8820/DB Benchtest: FMS-80/Checkout: Sid 1/Generating screen forms/Comal/Logo/Brain Dump-New series/Calc Corner:

Casio FP-10 printer/Programs: TRS-80 Maths & Trig, PET Boot the Cat, ZX81 Resistor & Res code.



Vol 5 no 5 - May 1982  
 Benchtests: Apple III, Hitachi Peach/Database Benchtest: dBase II/3D Graphics Made Easy/Equation Solving/Calc Corner: fx 602 quirks/Programs: PET Mini-Animate, MZ-80K Catch, Apple Maze, Atari Sums For Kids, ZX81 Book Index, PET Stockmarket, Microtan 3D Rotation, Extra for MZ-80K, UK101 Crossword Notepad. With free Word Pro-

cessing Supplement containing a summary of all PCW's WP Benchtests.

Vol 5 No 6.  
 June 1982  
 Benchtests: Sharp MZ-80A/ZX Spectrum/Database Benchtest: DBMS2/West Coast Faire Report/Lisp/VIC 20 games/Calc Corner: Sharp PC1500/



Programs: RML Altered Basic/VIC-20 Large Characters/BBC Breakout/VIC-20 Trailblazer/MZ-80K Next-to-Last-One/MZ-80K Tarot.



Vol 5 No 7  
 July 1982  
 Benchtests: Mimi 801/Newbrain/Database Benchtest: Silicon Office/UCSD p-System/BBC Computer In-Depth/Apple II games/Calc Corner: TI88/Programs: ZX81 Hypocycloids/BBC Character Generator/TRS-80 Truth/PET Doc/TRS-80 Screen Dump/UK101 Screen Converter/PET boxes/Atari Earth.

Vol 5 No 8  
 August 1982  
 Benchtests: Sord M23/



Dragon 32/Database Benchtest: Cardbox/Preview: Sony SMC-70/UCSD p-System/R/S232 Interface/Sirius graphics/NGC Show report/ZX81 Speech Checkout/Calc Corner: Casio fx602p/Programs: TRS-80 Quadrangle/UK101 Conversion of units/PET Mopup/Apple Lifespan/Apple Trees/Nascom Snail Racing/UK101 Long Multiplication & addition.

Vol 5 No 9  
 September 1982  
 Benchtest: Olivetti M20/Word Processor Benchtest: Select for NEC/Database Benchtest: Aquila/Checkouts: Microwriter Revisited, E40 Data Compression/Screenplay: ZX81 Pt II/DIY Logo/P for Perfect/Beeb Colour Hi Res/Beeb Colour Hi Res/RS232/Calc Corner: HP15 and 16C reviewed/Programs: Video Genie Extended Basic, ZX81 Alphabetising, PET File Comparison, BBC Music Player, PET Virus, BBC Radar, PET German Game, TRS-80 Cardshuffler.



# BACK ISSUES CENTRE

We have a complete selection of all available PCW back numbers in our flashy new Back Issues Centre in the West End of London, just half a minute's walk from Oxford Street (close to Tottenham Court Road tube station). Of course, you could order them from our excellent mail order service using the coupon below, but by visiting in person you save on postage costs. The Back Issues Centre also often has back numbers of PCW on sale which we cannot offer through the mail order service because of shortage of stock. Our receptionists will also be happy to sell you a set of binders to take your subscription. And there's a range of interesting computer books on sale as well. Drop by next time you're in the West End. We're open Monday to Friday, 10am to 6pm. The address is 14 Rathbone

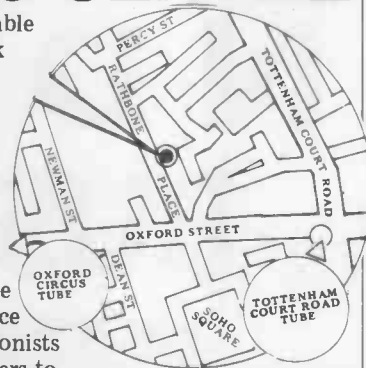

Place, London W1P 1DE.

**Come up and see us...**  
**Mon - Fri**  
**10am - 6pm**  
**Saturday**  
**11am - 6pm**

## CHANGE OF ADDRESS

Readers should note that all mail order subscriptions, binders and back issue enquiries must now be addressed to 55 Frith Street, London W1.

However, for personal callers only, a selection of PCW back issues, binders, micro-computing books etc can be purchased from the shop at 14 Rathbone Place, London W1.

Any one issue £1.50; all additional issues £1.00 each.  
 Benchtest special £1.80. Desktop Computing £2.25.  
 Binders £3.95 each. All prices include post and package.  
 \*Overseas orders requiring Air Mail postage add £1.00 per copy. Cheques/P.O. payable to Computing Publications Ltd,

53/55 Frith Street, London W1A 2HG Please allow up to 3 weeks for delivery and don't forget to state your name and full address with your order. Please send me the following copies of PCW. I enclose a cheque/P.O. for £. . . Please tick appropriate boxes.

| Volume 1  | Volume 2  | Volume 3                    | Volume 4  | Volume 5  | Benchtest Special                           |
|---|---|-----------------------------|---|---|---|
| 1 <input type="checkbox"/> 2 <input type="checkbox"/> | 1 <input type="checkbox"/> 2 <input type="checkbox"/> | 6 <input type="checkbox"/>  | 1 <input type="checkbox"/> 3 <input type="checkbox"/> 5 <input type="checkbox"/> 6 <input type="checkbox"/> 7 <input type="checkbox"/>    | 1 <input type="checkbox"/> 2 <input type="checkbox"/> 3 <input type="checkbox"/> 7 <input type="checkbox"/> | <input type="checkbox"/>                    |
| 3 <input type="checkbox"/> 6 <input type="checkbox"/> | 4 <input type="checkbox"/>                            | 12 <input type="checkbox"/> | 8 <input type="checkbox"/> 9 <input type="checkbox"/> 10 <input type="checkbox"/> 11 <input type="checkbox"/> 12 <input type="checkbox"/> | 4 <input type="checkbox"/> 5 <input type="checkbox"/> 6 <input type="checkbox"/> 8 <input type="checkbox"/> | Desk Top Computing <input type="checkbox"/> |
|   |   |                             |   |   | Binder <input type="checkbox"/>             |

Name \_\_\_\_\_ Address \_\_\_\_\_

# PERSONAL COMPUTER WORLD

# BINDERS



# AN EXPANDING BUSINESS!

We heard you!! The size of *Personal Computer World* has been growing at such a rate that our Mark II binders just couldn't keep pace. Twelve issues used to fit very comfortably into a binder, but now it's too much of a squeeze.

Enter our Mark III binder. Bigger and stronger. We've widened the spine to allow twelve issues room to breathe. We've added strength to the back of the binder to carry the additional weight. And we've done it without resorting to the metal rod system of binding magazines . . . a system which causes problems if the rods bend.

PCW Mk. III binders are still attractively bound with the logos of the magazine printed in gold on the front and spine. They keep your back issues of *PCW* in pristine condition and discourage other persons from 'borrowing' your copies. They lie completely flat, even when full, to allow ease of reading and reference. And they come mailed to you in a specially designed protective pack to guard against any over-enthusiasm on the part of the Post Office delivery system.

All in all, they represent exceptional value at £3.95. (A price below that charged by many competing magazines. Indeed, we know of several organisations who keep *all* their back issues of computing magazines in *PCW* binders because of their sturdy construction and their value for money. This is not a practise we can formally condone, but it's flattering nonetheless.) The price covers all postage, VAT and handling. Use the coupon below, or if you do not wish to deface your copy of *PCW*, send your order with remittance clearly written to the address indicated.



Please rush me..... PCW Mk III binders at £3.95 each. I enclose a cheque/ PO for £.....

Name.....

Address.....

.....

.....

Cheques should be made payable to *Personal Computer World*. Send this coupon to *Personal Computer World*, 53/55 Frith Street, London W1A 2MG



Buy our  
**£475\***

**Electronic Typewriter  
and you have a  
Daisy Wheel Printer  
for your computer  
absolutely FREE**



The T/Printer 35 is a superb portable typewriter that also doubles as a computer printer. It's the first electronic typewriter that's truly portable (it weighs only 17 pounds and is supplied with an ABS carrying case) and has all the features you'd expect of an electronic office typewriter. Except price.

Features include self-correction, dual function 100 character keyboard, triple pitch (10, 12 and 15 characters per inch), up to 12 in. wide paper—all with excellent print quality. And with Olivetti reliability.

Best of all, when you're finished using it as a typewriter, it's all set to go to work as a word processing quality computer output printer.

That makes the T/Printer 35 about the most versatile and cost effective piece of equipment you can buy. You get all the advantages of having a daisy wheel printer *and* electronic typewriter in a compact unit. And at one low price of £475\*, including carrying case.

*\*The T/Printer 35 costs £475 with Centronics compatible parallel interface. With RS-232C interface it costs £535. Prices listed are exclusive of VAT.*

**DATARITE**

Datarite Terminals Ltd  
Caldare House  
144-146 High Road  
Chadwell Heath, Essex RM6 6NT  
Tel: 01-590 1155

Buy our  
**£475\***

**Daisy Wheel Printer  
for your computer  
and you have an  
Electronic Typewriter  
absolutely FREE**



The T/Printer 35 is the lightest weight and lowest cost daisy wheel printer you can buy for your computer. So it will fit within your budget and you can carry it wherever you take your micro. Yet it is tough enough to give years of reliable service. Interchangeable typefaces (standard Olivetti 100 character daisy wheels), variable pitch, multiple copies—all the features you would expect of more expensive word processing printers.

Yet the T/Printer 35 costs only £475 with parallel interface. Operating speed under computer control is approximately 120 words per minute of letter perfect output. What typist can equal that?

Then when you're finished using it as a computer printer, the T/Printer 35 is ready to go right on working as an electronic typewriter.

That's the dual-purpose T/Printer 35—the versatile computer printer that fits your budget.

Orders are shipped within the UK carriage-free. To order or for more information about the T/Printer 35:

**DATARITE**

Datarite Terminals Ltd  
Caldare House  
144-146 High Road  
Chadwell Heath, Essex RM6 6NT  
Tel: 01-590 1155

# I<sup>2</sup>L ANDROMEDA

new  
from

# KRAM ELECTRONICS

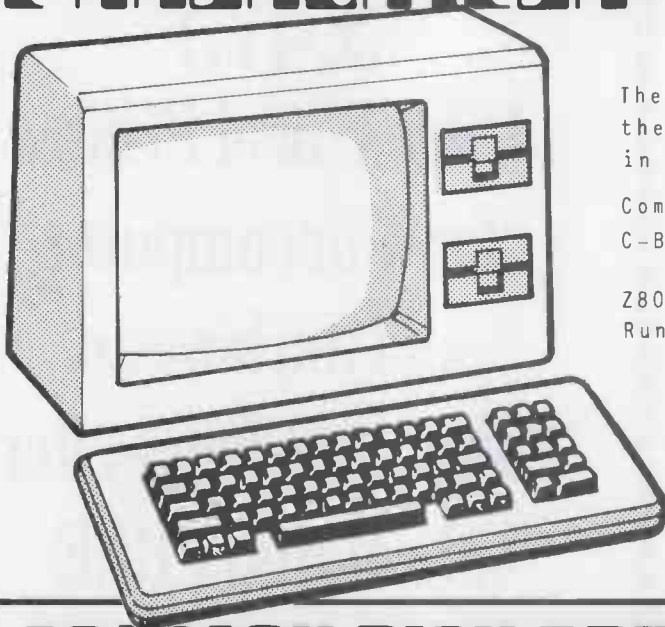

The I<sup>2</sup>L Andromeda has been designed for the Business User by Kram and is built in Leicester by Interactive Instruments.

Complete with CP/M and C-BASIC.

Z80 based. 64 K-byte R.A.M.  
Runs CP/M

Light Pen Facility  
Twin Disk Drives.

Dealer enquiries welcome

## £1299

### CONTINUOUS PAPER

8" for GP80A  
2000 sheets

## £12

9½" for EPSON  
& GP100A  
2000 sheets

## £12

## 40 TRACK DISK DRIVES

The latest  
**OLIVETTI**  
Disk Drives  
fully cased and  
complete with  
Toroidal power supply

*(Perhaps not  
the cheapest but  
we think these  
are the  
BEST)*

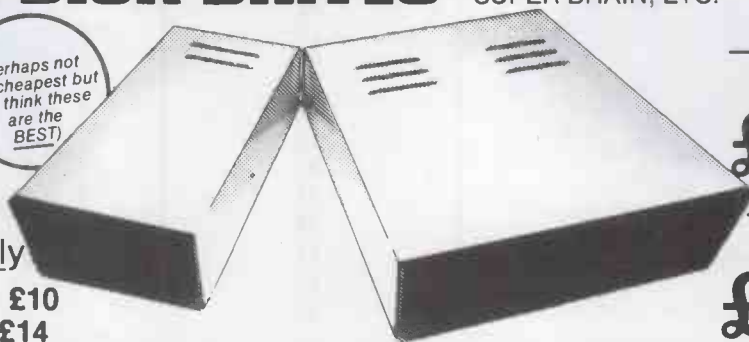

**DISK DRIVE** Single drive £10  
**CABLES** Dual drive £14

COMPATIBLE WITH TANDY,  
GENIE, NASCOM, GEMINI,  
SUPER BRAIN, ETC.

— SINGLE —

## £179

— DUAL —

## £349

## OLIVETTI PRAXIS 35 ON LINE DAISY WHEEL KEYBOARD PRINTER

- ★ Centronics standard interface
- ★ Friction feed
- ★ Correcting ribbon
- ★ Large selection of type faces
- ★ 12 characters per second

## £399



## LATEST SEIKOSHA GP 100A



189

## £199

## EPSON MX 80 F/T

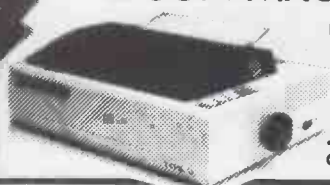

TYPE II  
349

## £359

**CARRIAGE:** Orders over £100 ADD £6. Orders over £10 ADD £3.  
Orders under £10 ADD .50p. On paper £2.50 per box

**ACCESS:** Access orders may be telephoned day or night, give full description of items, card number, name and address.

**TERMS:** Terms available for suitable applicants.  
Please write for details.

Delivery Please allow 28 days.

Showroom open to public  
10 am to 4 pm Monday to Friday.  
10 am to 3 pm Saturday.

Name: .....  
Address: .....

PLEASE SEND:

| QTY | ITEM | PRICE | VAT @ 15% | TOTAL |
|-----|------|-------|-----------|-------|
|     |      |       |           |       |
|     |      |       |           |       |

TOTAL INC. VAT £  
PLUS CARRIAGE £

I ENCLOSE CHEQUE FOR TOTAL £

Access Number: .....  
Post to: (or Tel: (0533) 27556) KRAM Electronics, Ltd. FREEPOST, Leicester.

# KRAM ELECTRONICS

## NEW STC II

# £850

YOU KNOW THE CASE!

YOU KNOW THE SOFTWARE!

WHAT YOU DON'T KNOW IS THE PRICE!

COMPLETE WITH MONOCHROME MONITOR.

DISK DRIVE & controller

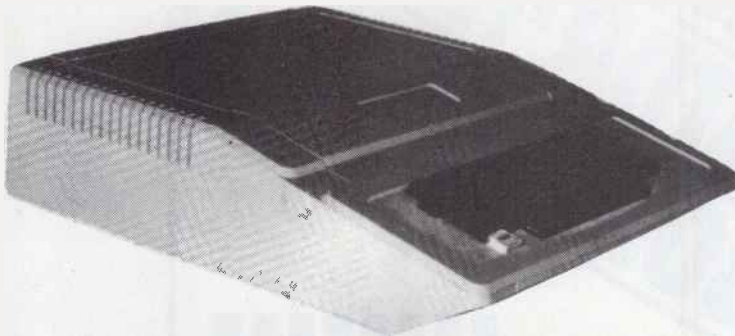

The S.T.C.II gives you all this:-

High Resolution Graphics, 280 by 192 arrays, total 53750 dots, 6 colours selectable. Low Resolution Graphics 40 by 48 arrays, total 1920 blocks, 16 colours selectable. The STC II has the full set Character Modes of Normal, Inverse and Flashing. Complete with 48K R.A.M. and FREE UHF Modulator.

PHONE US TODAY AND ORDER YOUR STC II. Don't ask for an \* \* \* \* \* ask for a GOLDEN DELICIOUS!

# SHARP MZ-80A

Personal Computer

# £477

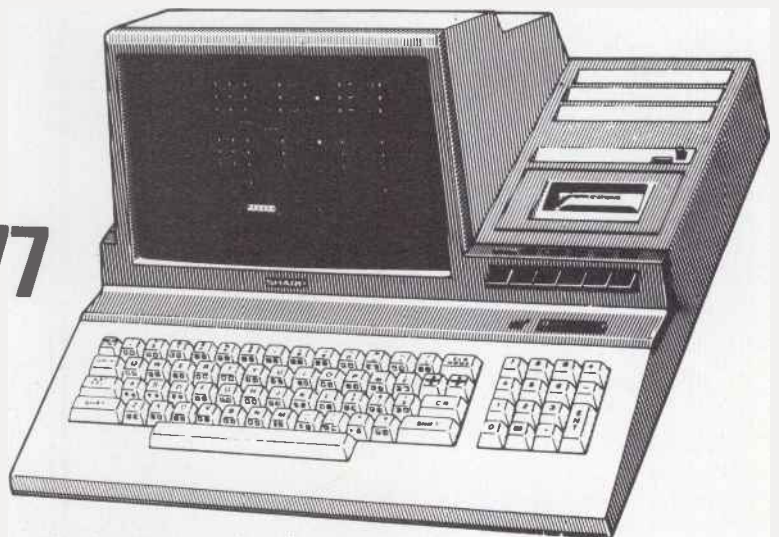

Practical, compact size designed for any environment Always ready to run. The Sharp MZ-80A is a Flexible system with a wide variety of program applications. 48K-byte dynamic RAM. Employs BASIC in tape mode.

PASCAL software system also available, simply by replacing tapes. 9 inch, high-focus monochromatic display - 25 lines by 40 characters wide. Advanced functions include a scrolling display, rolling and screen editing. Typewriter keyboard arrangement - with numeric keypad to make data entry smooth and operation simple. Built-in clock circuit. Complete with £75 worth of Sharp Software.

PLUS SPECIAL FREE OFFER A COPY OF THE BASIC HANDBOOK.



# £169

SHARP PC-1500 Pocket Computer, with a 8-bit C-MOS CPU for high-speed computation with reduced power consumption. Huge memory capacity with 16K-byte ROM and 3.5K-byte RAM. 7 x 156 dot display with graphics. Six user-programmable keys. Ideal for Business, engineering and Hobbies. The CE-150 Colour graphic printer/cassette interface offers you for the first time in a pocket computer a four-colour graphic function.

CE - 150 **£149**

**SIRIUS-  
ADVANTAGE-  
COMMUNICATOR-HP-  
APPLE-OSBORNE-TRS 80**

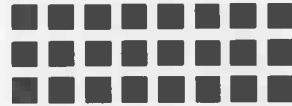

**Cambridge Computer Store**

1 Emmanuel Street  
Cambridge CB1 1NE  
Telephone (0223) 65334/5  
(we close at lunchtime except Saturday)

Our range and stock of micros is backed by an extensive selection of peripherals and media. We also have a 'budget micro' department offering the BBC computer, ZX81, ACORN ATOM and VIC 20 – a unique range of low cost systems.

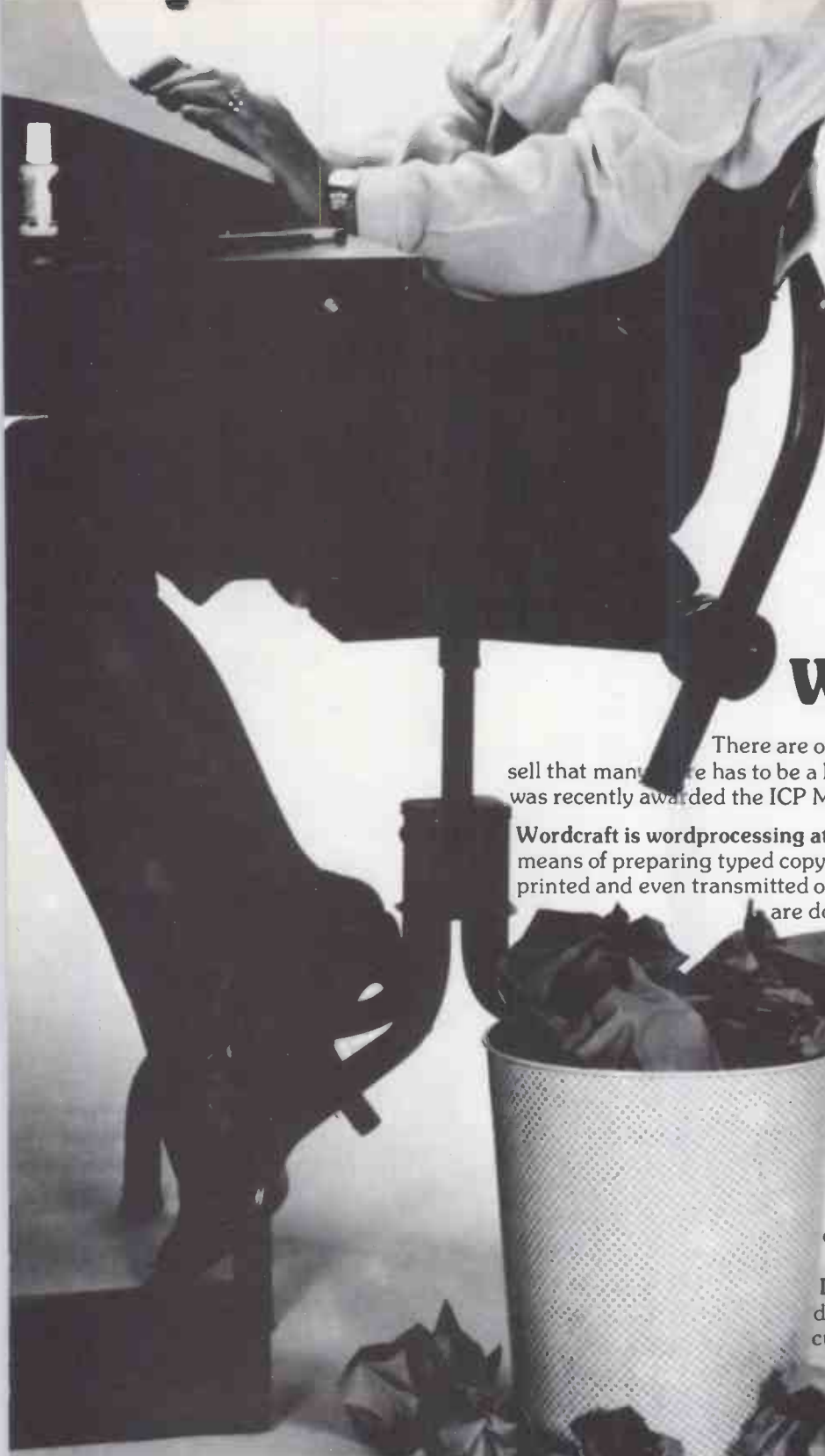

# Increase your productivity and your secretary's skill with

# WORD CRAFT

## Wordprocessing

There are over 9,000 customers of this system. When you sell that many, there has to be a lot of good reasons. **Wordcraft** - a British product - was recently awarded the ICP Million Dollar Award for record sales. This is why:-

**Wordcraft is wordprocessing at its best.** That means a fast, efficient and simple means of preparing typed copy. It allows text to be typed, modified, rearranged, printed and even transmitted over telephone lines with ease. All modifications are done on the screen. The perfect copy is then printed.

Both the secretary and boss benefit from this system because of the ease of operation and time it saves. The result is better quality typed material at low cost.

**Designed and written** by Peter Dowson specifically to enhance secretarial skill and published by Dataview Ltd. **Wordcraft** is packed with features secretaries prefer, some not even found on so called "dedicated" word processors. Bosses appreciate it because it costs well under £4,000 and is a complete microprocessor system able to run other business programs too.

**Dealers & Service** - there are over 300 Dataview dealers. Their well trained engineers know what customer engineering means - fast, effective service - when you need it.

### Wordcraft runs on Commodore:

The most successful micro-computer manufacturer in the country with a highly developed range of software products for business applications - that really work. Over 40,000 installations in the U.K. alone. With over 20 years of electronic manufacturing experience - they even supply some of the competition with parts.

Try our Information Department on 0206 865835 and get in touch with us for your nearest stockist.

Call us for your free copy of:  
**Wordcraft - A History of Word Processing**

Ring or write to our  
**Marketing Department**  
**Dataview Ltd.**  
**Portreeves House**  
**East Bay,**  
**Colchester, CO1 2XB.**  
**Tel: 0206 865835**

Please send me details of **Wordcraft PCW 1**

Name: .....

Position:.....

Company: .....

Address: .....

Telephone No: .....

We have got a Commodore micro-computer Yes  No

# Superior Systems Ltd.

178 West St, Sheffield S1 4ET. Tel.(0742)755005

## SOFTWARE

|                         |             |                            |             |
|-------------------------|-------------|----------------------------|-------------|
| <b>ACORN</b>            |             | <b>Soft VDU</b>            | 11.50A      |
| Atom Games Packs 1-11   | 11.50A each | Peeko Computer             | 11.50A      |
| Word Pack ROM           | 29.95A      | Maths Pack I & II          | 11.50A each |
| Forth                   | 11.50A      | Word Tutor                 | 11.50A      |
| Forth Theory & Practice | 6.95A       | Adventures                 | 11.50A      |
| Business                | 11.50A      | Atom Chess                 | 11.50A      |
| Business Book           | 6.95A       | Floating Point ROM         | 23.00A      |
| Synthesiser             | 11.50A      | BBC ROM Pack               | 49.95A      |
| Life Package            | 11.50A      | Magic Book                 | 7.95A       |
| Desk Diary              | 11.50A      | BBC Basic Programming Book | 5.95A       |
| Database                | 11.50A      | Acom Atom Dust Cover       | 4.60A       |
| Utility Pack I          | 11.50A      |                            |             |

|                             |       |                            |        |
|-----------------------------|-------|----------------------------|--------|
| <b>BBC</b>                  |       | <b>Peeko Computer Pack</b> | 9.95A  |
| BBC Dust Cover              | 4.55A | (in manual)                |        |
| Desk Diary                  | 9.95A | Forth Book                 | 7.50A  |
| Creative Graphics Book      | 7.50A | Forth Pack                 | 16.85A |
| Creative Graphics Pack      | 9.95A | Lisp Book                  | 7.50A  |
| Graphs & Charts Book        | 7.50A | Lisp Pack                  | 16.85Q |
| Graphs & Charts Pack        | 9.95A |                            |        |
| Algebraic Manipulation Pack | 9.95A |                            |        |

|                    |       |                 |       |
|--------------------|-------|-----------------|-------|
| <b>GAMES</b>       |       | <b>Monsters</b> | 9.95A |
| Philosophers Quest | 9.95A | Snapper         | 9.95A |
| Defenders          | 9.95A |                 |       |

|                       |        |                               |        |
|-----------------------|--------|-------------------------------|--------|
| <b>MZ80A SOFTWARE</b> |        | <b>Reactor</b>                | 6.32A  |
| Star Trek             | 6.32A  | Wordpro Word Processor (tape) | 45.43B |
| Cassette Database     | 33.93A | Packman                       | 9.20A  |
| Forth                 | 40.20B | Apollo Word Processor (tape)  | 28.70B |
| Zed Editor Assembler  | 22.43B |                               |        |

|                                 |        |                  |        |
|---------------------------------|--------|------------------|--------|
| <b>MZ80K SOFTWARE</b>           |        | <b>Chess</b>     | 16.67A |
| Wordpro Word Processor (tape)   | 45.43B | Tankwarp         | 6.32A  |
| Wordpro Word Processor (disk)   | 91.74B | Space Invaders   | 6.32A  |
| Apollo Word Processor (atape)   | 28.69B | Head On          | 6.32A  |
| Database (cassette based)       | 33.93B | Racing           | 6.32A  |
| MZ80 Calc II                    | 39.68B | Showjumping      | 6.32A  |
| Zen Editor Assembler            | 22.43B | Fireballs        | 6.32A  |
| Zen Mod (modifies Zen)          | 12.08B | Monkey Climb     | 6.32A  |
| Zen Dos (Editor Assembler Disk) | 43.13B | Football Manager | 5.75A  |
| Zen Disassembler                | 12.08B | Combat           | 5.75A  |
| Program Filing Index            | 6.32A  | Composer         | 5.75A  |
| Lunar Lander                    | 6.32A  | Bank Account     | 4.60A  |
| Map of England                  | 6.32A  |                  |        |

|                             |            |                           |        |
|-----------------------------|------------|---------------------------|--------|
| <b>VIDEO GENIE SOFTWARE</b> |            | <b>Alien Armada</b>       | 10.06A |
| Acquire Business Game       | 12.96C     | Android Nim               | 10.06A |
| B1 Nuclear Bomber Pilot     | 10.96C     | Asteroids                 | 10.06A |
| Conflict 2500               | 10.96C     | Battle of Britain         | 15.53A |
| Midway Campaign             | 10.96C     | Copypis Program Copier    | 12.94A |
| North Atlantic Convoy       | 10.96C     | Cube Hunt                 | 10.35A |
| Nukewar                     | 10.96C     | Database                  | 28.75A |
| Planet Miners               | 10.96C     | Duel-N-Droids             | 10.93A |
| Tanktics                    | 15.97C     | Editor Assembler Plus     | 24.95A |
| Adventures (various titles) | 13.77 each | Invaders                  | 14.95A |
| Adventure Sampler           | 10.06A     | Dust Cover for Genie I/II | 5.75A  |

|                                    |        |                             |        |
|------------------------------------|--------|-----------------------------|--------|
| <b>VIC 20</b>                      |        | <b>VIC Programmers Rer</b>  | 14.95B |
| Programmers Aid Cartridge          | 34.95B | VIC Programmers Reference   | 14.95C |
| Machine Code Cartridge             | 34.95B | Guide                       | 19.95B |
| 3K RAM Cartridge                   | 29.95B | VIC Avenger ROM Pack        | 19.95B |
| 8K RAM Cartridge                   | 44.95B | VIC Star Battle ROM Pack    | 19.95P |
| 16K RAM Cartridge                  | 74.95B | VIC Super Slot ROM Pack     | 19.95B |
| Joystick                           | 7.50B  | VIC Jelly Monsters ROM Pack | 19.95B |
| Paddles                            | 13.50B | VIC Alien ROM Pack          | 19.95B |
| Intro to Basic Part I              | 14.95B | VIC Road Race ROM Pack      | 19.95B |
| VIC Revealed                       | 10.00B | VIC 20 Dust Cover           | 6.50A  |
| Getting Acquainted with the VIC 20 | 7.95B  |                             |        |

## CASSETTE SOFTWARE

|                           |       |                            |       |
|---------------------------|-------|----------------------------|-------|
| Packman (high resolution) | 6.50A | Mole Attack                | 6.50A |
| Submarine                 | 6.50A | Balloon Number             | 6.50A |
| Gunman (high resolution)  | 6.50A | Skier                      | 6.50A |
| Naval Battle              | 6.50A | Treasure Carrying          | 6.50A |
| Space Invaders            | 6.50A | Super Moon Lander          | 6.50A |
| Fire Trek                 | 6.50A | Slot Machine               | 6.50A |
| Alien Wars                | 6.50A | Am! Raiders                | 7.50A |
| Head On                   | 6.50A | Missile Command/Sub Hunt   | 7.50A |
| VIC Cube                  | 6.50A | Six Programmers for VIC 20 | 7.50A |
| Crazy Balloon             | 6.50A | Fly Snatcher               | 7.50A |

## BUG BYTE SOFTWARE

|                       |       |                  |        |
|-----------------------|-------|------------------|--------|
| <b>ACORN</b>          |       | <b>Labyrinth</b> | 7.00A  |
| Galaxian              | 8.00A | Lunar Lander     | 5.50A  |
| 747 Flight Simulation | 8.00A | Golf             | 5.00A  |
| Chess                 | 9.00A | Backgammon       | 7.00A  |
| Atom Invaders         | 8.00A | 2K Programs 1    | 4.50A  |
| Pinball               | 4.50A | 2K Programs 2    | 4.50A  |
| Atom Breakout         | 4.00A | 2K Programs 3    | 4.50A  |
| Fruit Machine         | 4.00A | Statistics       | 20.00B |
| UFO Bomber            | 4.00A | Typist           | 4.00A  |
| Star Trek             | 5.00A |                  |        |
| Disassembler          | 4.00A |                  |        |

|            |        |                  |        |
|------------|--------|------------------|--------|
| <b>BBC</b> |        | <b>Multifile</b> | 25.00B |
| Space War  | 11.50A | Chess            | 11.50A |
| Golf       | 7.00A  |                  |        |
| Backgammon | 8.00A  |                  |        |

|               |       |                      |       |
|---------------|-------|----------------------|-------|
| <b>VIC 20</b> |       | <b>VIC Asteroids</b> | 7.00A |
| VIC Men       | 7.00A | VIC Gammon           | 7.00A |
| VIC Breakout  | 7.00A |                      |       |

## BOOKS

|                                   |        |                               |        |
|-----------------------------------|--------|-------------------------------|--------|
| Apple Pascal Games                | 11.45C | Apple Basic Data File Progs.  | 8.95B  |
| CP/M Handbook                     | 11.50C | Applesoft Language            | 7.65C  |
| DO-N'T (how to look after micros) | 9.65C  | Basic Basic                   | 9.95B  |
| Intro to Word Processing          | 11.45C | Basic Computer Games          | 6.95B  |
| Pascal Handbook                   | 13.95C | Book of Apple Software        | 10.50C |
| Programming 280                   | 11.95C | CP/M Primer                   | 10.45B |
| Programming 6502                  | 10.75C | CP/M Users Guide              | 11.30C |
| 6502 Games                        | 10.25C | Microsoft Basic               | 8.95B  |
| A-Z Computer Games                | 5.60B  | Sharp Software Secrets        | 5.95B  |
| Apple II Users Guide              | 11.85C | Peeking & Poking on the MZ80K | 5.00B  |

## COMPUTERS

|  |          |                            |                      |
|--|----------|----------------------------|----------------------|
| Acorn Atom 8k rom, 5K ram, PSU & Colour Board                                | 179.95E  | NEC PC 8001 Computer       | PHONE 2754.25        |
| Adler P2 Computer System with wor processor & daisy wheel typewriter/printer | 3335.00E | Sirius One Computer System | PHONE FOR BEST PRICE |
| Apple II 48K Computer  | 770.00E  | Sharp MZ80A (48K)          | 79.95D               |
| VIC 20 Computer  | 179.95E  | Sharp MZ80B (64K)          | 169.00D              |
| CIV Cassette Deck  | 44.95D   | PC 1211 Pocket Computer    | 295.00E              |
|  |          | PC1500 Pocket Computer     | 179.95D              |
|  |          | Genie I Computer           | 295.00E              |
|  |          | Genie II Computer          | 295.00E              |

## DISK DRIVES

|                                       |         |                                |         |
|---------------------------------------|---------|--------------------------------|---------|
| Atom Disc Pack, 96K Single Disk Drive | 343.85E | Genie Single Disk Unit         | 228.85E |
| VIC 20 Single Disk Drive              | 632.50E | Apple Drive with Controller    | 329.00E |
| Sharp Dual Disk Drive                 | 228.85E | Apple Drive without Controller | 279.00E |

## MONITORS

|                                   |         |                                       |         |
|-----------------------------------|---------|---------------------------------------|---------|
| 9" AVT Black & White Monitor      | 103.50E | 12" Green Screen Monitor High Quality | 182.85E |
| 9" AVT Green Screen Monitor       | 112.12E | 12" NEC Green Screen                  | 182.85E |
| 9" avt amber Screen Monitor       | 117.30E | 12" NEC High Res Colour Monitor       | 554.35E |
| 12" BMC Green Monitor             | 90.85E  | 14" Decca RGB Colour Monitor          | 269.00E |
| 12" BMC Green Monitor with Filter | 113.85E | 14" JVC Video Monitor                 | 299.00E |

### Postage Rates

a.75p b.1.00 c.1.50 d.2.50 e.5.00

ALL PRICES EXCLUDE VAT

### MAIL ORDER

Please Supply \_\_\_\_\_

£ \_\_\_\_\_

Name \_\_\_\_\_

£ \_\_\_\_\_

Address \_\_\_\_\_

£ \_\_\_\_\_

£ \_\_\_\_\_

£ \_\_\_\_\_

£ \_\_\_\_\_

£ \_\_\_\_\_

Access/Barclay/Cheque Card No. \_\_\_\_\_

P&P+VAT Total \_\_\_\_\_

Code \_\_\_\_\_

Tel \_\_\_\_\_

# MICROAGE ELECTRONICS

**BBC Microcomputer System A's in stock now!**

**It's a Winner!**

**LOOK**



**We've got the BBC  
Microcomputer Model A's in stock  
— ready for immediate sale. Call in, try them out.  
Official orders taken for Local Authorities, Schools and Businesses**

## BBC Machines

|  |                              |
|--|------------------------------|
| Model 'A'  | <b>£299</b>                  |
| 16K RAM 32K ROM. Full colour, high-resolution graphics         | <b>(+£7 p+p)</b>             |
| Model 'B' 32K RAM 32K ROM                                      | <b>£399</b>                  |
| 16 Colour graphics   | <b>(+£7 p+p)</b>             |
| BBC Disk Interface   | <b>£69*</b>                  |
| BBC 'B' Upgrade kit  | <b>£130*</b>                 |
| BBC Compatible Single Disk Drive 100K bytes                    | <b>£235</b>                  |
|  | <b>(+£2.50 p+p)</b>          |
| BBC Compatible Dual Disk Drive 200K bytes                      | <b>£389</b>                  |
|  | <b>(+£2.50 p+p)</b>          |
| 14" RGB Colour Monitor (as used in the BBC Computer programme) | <b>£279</b>                  |
|  | <b>(+£9.50 courier)</b>      |
| 12" Green Monitor  | <b>£95</b>                   |
|  | <b>(+£6.50 courier)</b>      |
| Cassette Player. Includes DIN to DIN lead                      | <b>£28</b>                   |
| Battery mains option   | <b>(+£2 p+p)</b>             |
| BBC Joystick   | <b>£13 p. pair (+£1 p+p)</b> |

\*These prices include fitting — send or bring in your machine for upgrading.

## BBC Software

The first of the software from Acornsoft. Snapper, Defender, Monster, Creative Graphics. Come and review it!

## Printers

|  |                     |
|--|---------------------|
| Acorn GP 80A Printer   | <b>£199</b>         |
| Lowest ever price!   | <b>(+£4.50 p+p)</b> |
| Acorn GP100A Printer   | <b>£228</b>         |
|  | <b>(+£4.50 p+p)</b> |
| Epson MX80 FT111 Printer New model, dot matrix, high res. graphics 80 or 132 char's per line | <b>£431</b>         |
|  | <b>(+£4.50 p+p)</b> |

All with free interface cable

## Atoms

|                                    |                     |
|------------------------------------|---------------------|
| Atom kit                           | <b>£135</b>         |
|                                    | <b>(+£3.50 p+p)</b> |
| Colour Atom                        | <b>£199</b>         |
| Complete with 4 software cassettes | <b>(+£3 p+p)</b>    |
| Atom Disk Pack                     | <b>£335</b>         |
|                                    | <b>(+£2.50 p+p)</b> |

## Atom Software

All the latest Acornsoft software in stock. Atomcalc, electronic spread sheet. FORTH, LISP, Adventure etc.

## Accessories for BBC

|                                      |                          |
|--------------------------------------|--------------------------|
| <b>Computers</b>                     |                          |
| Listing paper, 2000 sheets           | <b>£14</b>               |
|                                      | <b>(+ £4 p+p)</b>        |
| Cassettes per 10                     | <b>£4 (+ £1 p+p)</b>     |
| Disks, Dysan, top quality 5¼" per 10 | <b>£28.75 (+ £1 p+p)</b> |
| GP80 and GP100 ribbon                | <b>£4.75</b>             |
|                                      | <b>(+ £1 p+p)</b>        |
| Printer Cable (parallel)             | <b>£15</b>               |
|                                      | <b>(+ £1 p+p)</b>        |
| 6522 buffers                         | <b>£4.75 (+ £1 p+p)</b>  |
| DIN to DIN cassette leads            | <b>£3.50</b>             |
|                                      | <b>(+ £1 p+p)</b>        |
| BBC Machine dust covers              | <b>£5.75</b>             |
|                                      | <b>(+ £1 p+p)</b>        |

## Books

|                                    |                         |
|------------------------------------|-------------------------|
| BBC 30 hour BASIC                  | <b>£5.50</b>            |
|                                    | <b>(+£1 p+p)</b>        |
| Practical Programs for Atom & BBC  | <b>£5.95 (+ £1 p+p)</b> |
| BASIC Programming on the BBC Micro | <b>£5.95 (+ £1 p+p)</b> |
| Programming the 6502               | <b>£11.75</b>           |
|                                    | <b>(+ £1 p+p)</b>       |

**All the products are the official versions, beware of imitations, they will invalidate your guarantee.**

**ALL PRICES INCLUDE VAT. FOR FURTHER  
DETAILS AND MAIL ORDER LIST SEND LARGE S.A.E.  
Open Mon - Sat 9am - 6pm. Thurs 9am - 1pm**

**MICROAGE ELECTRONICS**  
135 HALE LANE EDWARE MIDDLESEX HA8 9QP  
TEL: 01-959 7119 TELEX 881 3241

# ADDA ADDS UP TO A GREAT DEAL. MORE



Adda is the number one choice for business systems using Commodore's powerful 32K or 96K microcomputer with 1 megabyte disk storage (even more with new hard disks!) Our top four software packages will meet most business needs, at prices you can afford. In every case we will help you select the most cost effective software systems backed with Adda's training and servicing skills.

We have a continuous programme of Open Days at all four sales offices where you can look at our packages without feeling harassed.

**adda**

**CITY**  
National Electronics Centre,  
London World Trade Centre,  
Europe House, London E1 9AA.  
**01-488 2400**

**WEST LONDON**  
Mercury House, Hanger Green,  
Park Royal, London W5 3BA.  
**01-997 6666**

**SLOUGH**  
120 High Street,  
Slough, Berks.  
**0753 72470**

**READING**  
275 Oxford Road,  
Reading, Berks.  
**0734 585928**

## PEGASUS

SYSTEMS FROM £4000  
accounting for sales, purchase and nominal ledger,  
invoicing and stock control

## WORDCRAFT

SYSTEMS FROM £3640  
full wordprocessing facilities with high-quality printer

## SILICON OFFICE

SYSTEMS FROM £3640  
for powerful data management reporting

## VISICALC

SYSTEMS FROM £2900  
financial planning with the world's top selling program

**DIAL A  
DEMO  
01-  
997  
6666**



You can also see our top four systems demonstrated in your own office!  
Just call 'Dial a Demo' on 01-997 6666 and we'll fix a time.

Give us a call. We know the Adda deal adds up to a great deal more.



Total adaptability  
and expandability



the new Hewlett Packard HP-86  
personal computer from Crellon.

Unrivalled price/performance market leader, the HP-86 is designed with a wide range of prospective users in mind, from commercial and manufacturing industries, through to advanced engineering and scientific applications. The HP-86 meets *your* individual needs.

Part of the Series 80 range, the new HP-86 is available with any of the Series 80 software packages, such as statistics, finance and electrical engineering.

64K bytes of user memory are standard, expandable up to 576K. It's also fully software compatible with the HP-87. At least one external disc drive is needed to load and store programs and data, and the HP 9130A drive is designed specifically for this system. The lowest-cost drive in the Series 80 line-up, it is quiet in operation as it needs no cooling fan.

Your HP-86 will also grow with your increasing requirements. Four extension slots are designed to allow you to add interfaces or enhancements. An HP-IB interface gives access to Winchester discs, plotters, instruments or other HP-IB peripherals. Serial, HP-IL, BCD and GP-10 interfaces are also available.

HP-86. The big  
microsystem from Crellon.



**Crellon Microsystems**

More experience in micros

380 Bath Road, Slough, Berks Tel: Burnham (06286) 4434

# THE COMMODORE 64

## THE PERSONAL COMPUTER

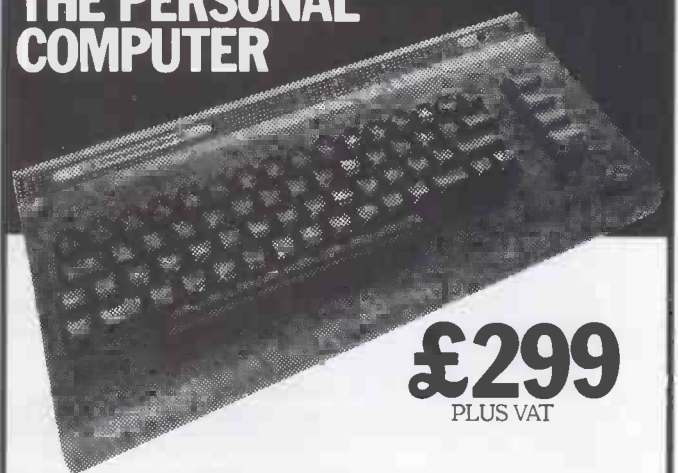

**£299**  
PLUS VAT

- 64k built in RAM
- 40 column colour display—  
tv interface
- Upper and lower case characters  
and graphics
- Sprite graphics on eight levels
- Music synthesiser with three  
voices and nine octave range

---

Business and home utility  
programs available soon. Can use  
VIC-20 printer and disk (with rom  
upgrade). Supports other languages  
including Comal and Pascal—has  
CP/M option.

---

From Adda Computers  
Telephone: 01-992 9904  
for credit card orders or call at  
the VIC Centre, 154 Victoria Road,  
London W3 (near Acton North tube)

adda

FOR PERSONAL AND BUSINESS  
COMPUTING THAT ALWAYS ADDS UP  
TO A GREAT DEAL MORE.

# THESE SHARP COMPUTERS

## MZ80B

CP/M, the world's most widely used operating system is available as an option to run on the Sharp MZ-80B, making it, arguably, the best scientific micro on the market. With high resolution graphics as standard and hard disks, MP/M and CP/NET available, the MZ-80B is now a superbly flexible machine, equally at home in commercial and technical environments.

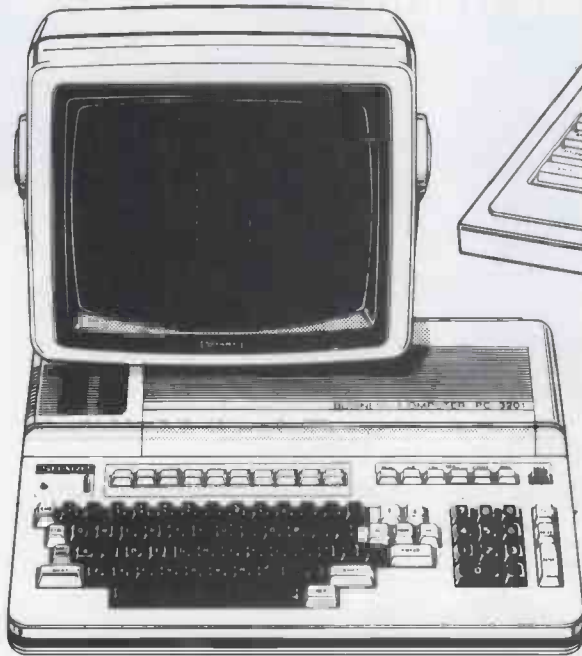

## PC3201

CP/M is also available as an option on the Sharp PC 3201. It is available in two forms. The first is a relocated CP/M giving you 46.5K of user memory, all you need do is insert a disk and off you go. This version will only run the products marked # in our price list. The second provides you with a second Z80A processor on a card which plugs in to the I/O interface card chassis and runs standard CP/M, 64K memory, with access to the whole library of products in our price list. This together with the PC 3201's large screen and keyboard makes the PC 3201 a superb business machine.

CP/M for both these machines is available from your local Sharp dealer, or in case of difficulty, please call us on (0892) 32116.

# RUN ALL THIS CP/M BASED SOFTWARE

**WORDSTAR** # Powerful word-processing package, made easy to use by full function key support on the MZ-80B. **£242**

**MAILMERGE** Add on to WORDSTAR, provides mail-shot and text inclusion. **£73**

**SPELLSTAR** Add on to WORDSTAR, for spelling checking. **£121**

**DATASCREEN** Screen oriented form definition and data entry tool. **£171**

**SUPERSORT I** Powerful disk based sort package. Stand alone program and MICROSOFT\* compatible CALLING SEQUENCE RELOCATABLE ROUTINES. **£122**

**SUPERSORT II** As SUPERSORT I, but only the stand alone program. **£97**

**WORDMASTER** Superb screen based text editor, all functions driven off MZ-80B function keys. **£73**

**CALCSTAR** The new financial planning package from the MICROPRO stable. **£144**

**EASYFILER** Flexible data definition, data entry, data update and report generator. **£150**

**GENISYS** General insurance system for office admin and accounting of general insurance broker. **£1000**

**EMIS** Estate agent management information system. Designed by estate agents for estate agents. **£795**

**COMAL-80** The revolutionary structured programming languages, easy to use as BASIC. Recommended for education and teaching environment. **£130**

**BASIC-80** # Accepted standard Microprocessor based BASIC interpreter. **£209**

**BASIC COMPILER** # BASIC-80 compatible compiler, makes BASIC programs run many times faster. **£236**

**FORTRAN-80** # ANSI standard FORTRAN, except for COMPLEX numbers. **£296**

**COBOL-80** # 1974 ANSI standard COBOL, with large program chaining and screen DISPLAY/ACCEPT. **£448**

**M/SORT** Powerful sorting facility for use primarily with COBOL-80. **£75**

**Mu-MATH & MuSIMP** Symbolic math package, allows computation on to 611 arithmetic digits. Superb for scientific and engineering applications. **£149**

**Mu-LISP & Mu-STAR** Extended LISP 1.5. Includes screen based LISP environment editor. **£119**

**EDIT-80 & FILCOM** Line oriented random access text editor. Includes source and binary file compare program. **£71**

**MACRO-80** # Assembler with Z80\* mnemonics. Includes linking loader, library manager and cross referencer. **£119**

**CIS COBOL** ANSI 74 standard COBOL to full level 1 standard. **£425**

**FORMS-2** For use with CIS COBOL, provides superb screen handling capability for CIS COBOL programs. **£100**

**PROSPERO PRO PASCAL** Fastest Z80\* PASCAL we know. **£190**

**PL/1-80** ANSI standard subset G based PL/1 producing direct object code for fast execution. **£298**

**BT-80** Record retrieval system or use with PL/1-80, to give data base management facilities. **£119**

**MAC** Upward compatible assembler from ASM, provides MACROS and Z80\* assembly support. **£53**

**ZSID** Super symbolic debugger, with full Z80\* mnemonic support. Works well with MACRO-80. **£59**

**TEX** Text for matter ideal for producing manuals and similar documents. Note this is not screen based. **£59**

**DESPPOOL** Allows listing of files at same time as other processing. **£29**

**CBASIC** # Commercial BASIC, used extensively for business packages. **£65**

**CB80** Full compiler for CBASIC. **£298**

**MINI MODEL** # Very powerful professional financial modelling package. **£399**

**MAGSAM** # Indexed sequential access routines, for use with CBASIC. **£110**

**BASKAM** # Basic keyed access routines for use with BASIC-80. **£95**

**DATAFLOW** # Easy use data file entry tool. For reports, labels or MICROPRO\* MAILMERGE compatible files. **£99**

**PADMEDE/MICRO TECHNOLOGY** A full range of business software converted by us from the highly reliable PADMEDE originals to run under CP/M. **£249**

**SALES LEDGER SYSTEM** Fully integrated, secure, parameterisable with full report facilities. **£249**

**PURCHASE LEDGER SYSTEM** All the same flexibility as the sales ledger system. **£249**

**SALES INVOICING SYSTEM** Automatic product description access, audit trail, instantly updatable product file (even while creating an invoice). Integrates with sales ledger system if required. **£249**

**NOMINAL LEDGER SYSTEM** Integrates all the sales and purchase side of your business. Trial balances can be produced for incomplete records accounting. **£249**

**STOCK CONTROL SYSTEM** Full stock control system with minimum stock levels and re-order levels. Integration to sales invoicing system provided. **£249**

**MICRO TECHNOLOGY MICROTTEXT** Easy to learn and easy to use text processor with far more friendly user interface than WORDSTAR. If you wish to use it, then far more power is available to you, including calculator, column and row labelling and macro-text functions. **£270**

**MICROMERGE** Integrate and merge facility for use with MICROTTEXT. Use for mailshots and simple database retrieval and reporting. **£70**

**EXPAND** Library routines for use with MICROSOFT\* calling sequence products. Gives MZ-80B graphics, cassette and music handling. **£65**

Free with any MICROSOFT product purchased at the same time from us.

# All these products now available for the PC3201.

Please state for which machine/version of CP/M the product is intended.

**COMAL-80** The structured BASIC like language that has been given so many favourable reviews in the computer press is now available. **£130**

Dealer enquiries welcomed.

## Micro Technology LIMITED

Royal Sussex Assembly Rooms, The Pantiles, Tunbridge Wells, Kent.  
Telephone: (0892) 32116. Telex: 95441. Micro G.



# G. W. COMPUTERS LTD — LONDON'S WEST END — NATIONWIDE OVERNIGHT SERVICE NEW FORMAT ADVERTISING — MORE PRODUCT RANGES — LOWER SYSTEM PRICES — BETTER SERVICE

\*\*\*\*\*THE NEW DBMS III (series III of the world's first robotic type program)\*\*\*\*\*

### \*\*\*SOME FEATURES\*\*\*

Mbasic & word-star compatible.  
32000 records per file-name.  
12 on-line file architectures.  
1400 character record sizes.  
20 main fields/200 sub-fields.  
mathematical scratchpad.  
field related formulae.  
scratchpad to field updating.  
record relational indexing.  
cross file relational indexing.  
parameter driven dictionary.  
translateable to any language.  
cross file relating 240 fields.  
random-binary-sequence search.  
user defineable reporting.  
user createable files.  
callable selection criteria.  
if 'then' questioning  
12 question types per field:  
endless 'either/or' matching  
either/or, one/all fields.  
same string/same number.  
greater/smaller than.  
number range matching.  
not equal strings.  
greater/smaller related flds.  
'not' identical fields.  
selected record shortfiling.  
history filing (audit trail).  
field protection.  
field classification.  
file passwords.  
PASSWORD password.  
scratchpad totalling.  
scratch' collation totalling.  
alpha/numeric sort any charctr.  
many other subtleties unlistable.

### \*\*\*SOME POSSIBILITIES\*\*\*

This program is the first of its type world-wide.  
Once you have designed your file, your report, and stored your records you will be able to 'clone copy' from the master database disk, a task disk whose life purpose will be to produce specific reports without your user-interaction. The task you have specified, begins itself at precisely the moment you have inserted the diskettes in their drives, and closed the doors; you don't have to touch a key or select from a menu.  
Imagine building a small library of such 'task' disks from suggestions outlined here, or others you may have around you.  
Nominal analysis, stock re-order reporting, stock valuation, sale — analysis, purchase analysis, address mailing, text writing, employees analysis, patient analysis, research analysis, simulations, bureaux personnel analysis, time recording, librarian analysis, budgetting, to name a few.  
Here's an arbitrary example to indicate the power of DBMS III.  
You have set up a filing system of 20,000 records concerning employees and wish to short-list those who meet certain criteria, then write to them. The records in the file have fifteen fields that look like this.

|              |                          |
|--------------|--------------------------|
| 1-Record     | (33)                     |
| 2-Name       | (John Smith (Sir))       |
| 3-Addr       | (55 Bedford Cr. London.) |
| 4-Age        | (40)                     |
| 5-Sex        | (M)                      |
| 6-C.V.       | (5-0 levels, 6-a levels) |
| 6-Exp        | (3 yrs)                  |
| 8-Sal        | (12,000)                 |
| 9-Loen       | (London/South)           |
| 10-Type      | (Computer analyst)       |
| 11-Sport     | (Tennis/golf/riding)     |
| 12-Langu     | (English/French/German)  |
| 13-Pr/emp    | (Local government)       |
| 14-status    | (married/2 children)     |
| 15-code[ c ] | (classified information) |

Just one of a thousand selection criteria might take the form:

"Find all persons that are not Esq, who live in London or Surrey or Croydon, in the age range of 30-45 Male, with 6-a levels, experience less than 5 yrs, prepared for work in London or the South, at computer analysis, whose interests are golf or tennis, speaks German or French has worked in Local government and is married. Finally matches our own classified code [grade 5]".  
Output the short list to a second file for a mail shot.

SEE NEXT ISSUE FOR AN EXAMPLE OF A GARAGE STOCK RE-ORDER REPORT  
The leader in database management software — G. W. Computers — DBMS III

DBMS II (395.00 OR 250.00 BY MAIL ORDER): DBMS III (575.00 OR 295.00 BY MAIL ORDER)  
TELEPHONES: 01-636 8210 01-631 4818 TELEX: 892031 TWC G BOSTON U.S.A. TELEX: 94-0890

## MICRO-COMPUTERS

|           |             |               |       |         |
|-----------|-------------|---------------|-------|---------|
| INTERTEC  | -SUPERBRAIN | 64K.RAM/320K  | DISKS | 1695.00 |
|           | -SUPERBRAIN | 64K.RAM/700K  | DISKS | 2195.00 |
|           | -SUPERBRAIN | 64K.RAM/1.5M  | DISKS | 2595.00 |
|           | -SUPERBRAIN | 64K.RAM/10M   | DISKS | 7777.00 |
|           | -COMPUSTAR  | 64K.RAM/OK    | DISKS | 1495.00 |
|           | -COMPUSTAR  | 64K.RAM/320K  | DISKS | 1995.00 |
|           | -COMPUSTAR  | 64K.RAM/700K  | DISKS | 2495.00 |
|           | -COMPUSTAR  | 64K.RAM/1.5M  | DISKS | 2895.00 |
| NORTHSTAR | -ADVANTAGE  | 64K.RAM/700K  | DISKS | 2095.00 |
|           | -ADVANTAGE  | 64K.RAM/5.3M  | DISKS | 2995.00 |
|           | -HORIZON    | 64K.RAM/700K  | DISKS | 1950.00 |
|           | -HORIZON    | 64K.RAM/6.3M  | DISKS | 3595.00 |
|           | -HORIZON    | 64K.RAM/18M   | DISKS | 4595.00 |
| TELEVIDEO | -800        | 64K.RAM/OK    | DISKS | 1195.00 |
|           | -802        | 64K.RAM/700K  | DISKS | 2195.00 |
|           | -802H       | 64K.RAM/5.3M  | DISKS | 3950.00 |
|           | -806        | 64K.RAM/10M   | DISKS | 4595.00 |
| ACT       | -SIRIUS 1   | 128K/1.2M     | DISKS | 2395.00 |
| OSBORNE   | -1          | 64K.RAM/200K  | DISKS | 1250.00 |
| IBM       | -PC         | 64K.RAM/64K   | DISKS | 2995.00 |
|           | -PC1        | 330K/640K     | DISKS | 3495.00 |
| ATARI     | -400        | 16K.RAM       |       | 210.00  |
|           | -800        | 16K.RAM       |       | 425.00  |
| PET       | -8032       | 32K.RAM       |       | 695.00  |
|           | -8050       | 1.MEG         | DISKS | 695.00  |
|           | -720        | 16.BIT        |       | 7777.00 |
| APPLE     | -II         | 64K.RAM       |       | 675.00  |
|           | -III        | 128K/143K     | DISKS | 2095.00 |
| ALTOS     | -ACS8000-2  | 64K.RAM/1M    | DISKS | 1995.00 |
|           | -ACS8000-10 | 208K/10.5.MEG | DISKS | 4995.00 |
| NEC       | -PC8001/12  | 64K.RAM/350K  | DISKS | 1695.00 |
| CORVUS    | -CONCEPT    | 16.BIT.PC     |       | 7777.00 |

All computer prices include Mbasic as standard

## PRINTERS

|         |                |         |
|---------|----------------|---------|
| OKI     | -MICROLINE 80  | 295.00  |
|         | -MICROLINE 82A | 395.00  |
|         | -MICROLINE 83A | 695.00  |
|         | -MICROLINE 84  | 895.00  |
| EPSON   | -MX80/FT-3     | 375.00  |
|         | -MX100/FT-3    | 495.00  |
| ANADEX  | -DP 9000       | 895.00  |
|         | -DP 9501       | 1045.00 |
|         | -DP 9501 (A)   | 1145.00 |
| QUME    | -9/45 R/O      | 1695.00 |
|         | -9/55 R/O      | 1795.00 |
|         | -9/35 R/O      | 1495.00 |
| NEC     | -3510 R/O      | 1395.00 |
|         | -7710 R/O      | 2250.00 |
|         | -5520 KSR      | 1295.00 |
| DRE     | -8830          | 1695.00 |
| TEXAS   | -810           | 1295.00 |
|         | -825           | 1395.00 |
| DIABLO  | -630           | 1695.00 |
| RICOH   | -RP1600        | 1495.00 |
| OLYMPIA | -ESW 103       | 795.00  |

## SOFTWARE

|           |                                    |        |
|-----------|------------------------------------|--------|
| G.W.L.    | -BUS V8.0 (ACCOUNTS)               | 575.00 |
|           | -DBMS II (DATABASE INC SORTS)      | 395.00 |
|           | -DBMS II (MAIL ORDER NO TRAINING)  | 250.00 |
|           | -DBMS III (DATABASE INC SORTS)     | 575.00 |
|           | -DBMS III (MAIL ORDER NO TRAINING) | 295.00 |
|           | -DSORT & MSORT (MBASIC FILES)      | 75.00  |
|           | -AUToload & RECOVER                | 25.00  |
| MICROSOFT | -MBASIC 80                         | 150.00 |
|           | -FORTRAN 80                        | 200.00 |
|           | -COBOL 80                          | 320.00 |
|           | -BASIC COMPILER                    | 190.00 |
|           | -MU LISP/MU STAR                   | 95.00  |
| MICROPRO  | -WORD-STAR                         | 250.00 |
|           | -MAIL-MERGE                        | 55.00  |
|           | -SPELSTAR                          | 100.00 |
|           | -DATASTAR                          | 170.00 |
|           | -SUPER-SORT                        | 120.00 |
|           | -W-STAR/M-MERGE/SP-STAR            | 350.00 |
| BYROM     | -BSTAM (COMMUNICATIONS)            | 75.00  |
|           | -BSTMS                             | 85.00  |
| DIGITAL   | -DESPOOL                           | 30.00  |
|           | -CBASIC                            | 75.00  |
|           | -PASCAL MT                         | 225.00 |
| F. GELLER | -QUICKSCREEN                       | 95.00  |
| LEXISOFT  | -SPELLBINDER                       | 195.00 |
| LIFEBOT   | -TMAKER                            | 155.00 |
| M'FOCUS   | -CIS COBOL                         | 420.00 |
|           | -FORMS II                          | 100.00 |
| SORCIM    | -SUPER CALC                        | 185.00 |
|           | -PASCAL M                          | 250.00 |
| STANDARD  | -QUIC-N-EASY                       | 195.00 |
| PEACHTREE | -MAGIC WAND                        | 190.00 |
|           | -MAGIC CALC                        | 175.00 |
| S'SOFT    | -DIAGNOSTICS                       | 50.00  |
| N'WEST    | -STATPAK                           | 250.00 |
| OASIS     | -THE WORD                          | 35.00  |
| ITHACA    | -PASCAL Z                          | 100.00 |

Software formats on all micros in our hardware list.

## PERIPHERALS & ACCESSORIES

|          |                                    |         |
|----------|------------------------------------|---------|
| CORVUS   | -6 MEG HARD DISK                   | 1950.00 |
|          | -11 MEG HARD DISK                  | 2950.00 |
|          | -20 MEG HARD DISK                  | 3950.00 |
|          | -MULTIPLEXOR 7 STATION             | 695.00  |
|          | -MIRROR BACKUP CARD                | 695.00  |
|          | -PERSONALITY CARD                  | 185.00  |
| INTERTEC | -COMPUSTAR 10 MEG HARD DISK        | 2950.00 |
|          | -CDC 96 MEG HARD DISK              | 7950.00 |
| N'STAR   | -16 BIT U/GRADE                    | 325.00  |
|          | -18 MEG HARD DISK                  | 2995.00 |
| RODIME   | -6 MEG HARD DISK                   | 1495.00 |
|          | -12 MEG HARD DISK                  | 1950.00 |
| MORROW   | -26 MEG HARD DISK                  | 3295.00 |
| CDC      | -S/SIDED FLOPPY DRIVES             | 150.00  |
|          | -D/SIDED FLOPPY DRIVES             | 225.00  |
|          | -D/SIDED D/TRACK DRIVES            | 375.00  |
| MEMOREX  | -SOFT/HARD S/SIDED DISKETTES (10)  | 30.00   |
|          | -SOFT/HARD S/SIDED DISKETTES (50)  | 125.00  |
|          | -SOFT/HARD S/SIDED DISKETTES (100) | 200.00  |
| DYSAN    | -104/2D DOUBLE SIDED (10)          | 50.00   |
|          | -104/2D DOUBLE SIDED (50)          | 225.00  |
|          | -104/2D DOUBLE SIDED (100)         | 400.00  |
| S.S.E.   | -SOFTBOX PET TO CPM                | 495.00  |
|          | -IEEE TO RS232 B/DIR INTFCE        | 185.00  |
|          | -SIRIUS 8 BIT CARD                 | 335.00  |

## SYSTEM DEALS

Choose any computer & any printer over 800 pounds  
add 10% for 12 month warranty (12.5% full maintenance)  
add 150.00 for blank diskettes  
add 175.00 for cables, delivery & installation  
\*\*\*training optional extra 100.00\*\*\*

and get **FREE**\*\*\*\*  
CPM HANDBOOK-50 BASIC EXERCISES-2000 SHEETS PAPER  
DBMS III DATABASE-MAGIC WAND WORD PROCESSOR-  
MAGIC CALC MODELLING-MBASIC 80 INTERPRETER-  
DIAGNOSTICS-MSORT & DSORT-RECOVER & AUTOLOAD-  
INSTANT BASIC BOOK-DISKFULL OF GAMES-CBASIC  
\*\*\*\*TOTAL VALUE 1480.00\*\*\*\*

## TERMS & ETC

G.W. Computers Ltd (Grama (Winter) Ltd.)  
55 Bedford Court Mansions  
Bedford Avenue  
London W.C.1. England.  
Tel: 01-636 8210 01-631 4818 tlx: 892031 TWC G  
Boston office tlx 94-0890  
24 hour answerphones-leave address for 'infopacks'  
We do not operate a reader's reply card: Terms are  
C.W.O. or C.O.D. Prices exclude VAT. No dealers.  
The above lists are not exhaustive.  
Please call only by prior appointment

# New From Fuller

## FD System for the

# ZX SPECTRUM

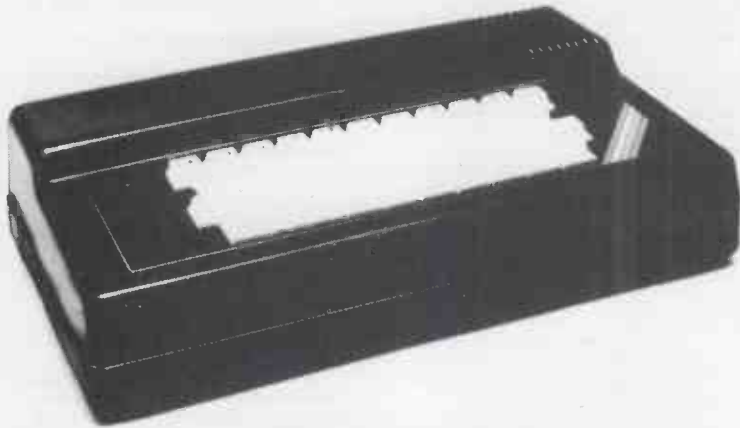

**£39.95**

+ £2.50 p & p.

### Professional Keyboard & Case —

This unit has the same high standard as our ZX81 unit. Tough A.B.S. Plastic case encloses our Keyboard, the Spectrum Printed Circuit Board and the Power Supply.

Our own Power supply is available:- 9 volts DC at 2 amps. Mains either 110v or 240v AC at £5.95 + 80p. p & p.

**The Keyboard** has 42 keys with all the spectrum functions printed onto them, the full travel key switches have gold plated contacts and a guaranteed life of 10<sup>6</sup> operations.

**INSTALLATION** - Simply unscrew the ZX printed circuit board from its case and screw it into the FD case, plug in the keyboard and that's it. No technical know how or soldering required, the built unit is tested and comes with a money back guarantee.

### Spectrum Keyboard and Case Kit £33.95

Our Mother Board for the spectrum has 2 slots at £15.95 or 3 slots at £19.95, this unit also fixes inside the case. p & p 80p.

### SPECTRUM SOUND AMPLIFIER £5.95 + 80p p & p.

Complete with leads, volume control and loud speaker in tough ABS Plastic case measuring 5" x 3" x 1" just plugs into your spectrum MIC input.

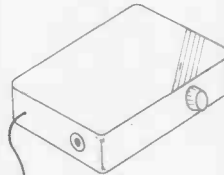

### SPECTRUM PLUG PLANNER — £18.95 + £1.00 p & p

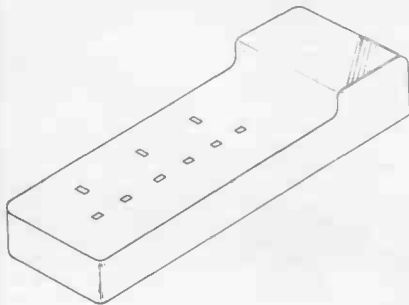

Complete with 3 metres of cable, three 13 amp sockets for TV, Tape etc AND 9 volt at 2 amp power supply with power jack to fit Spectrum or ZX81

**The ever popular FD42 Keyboard and case for ZX81 £39.93 including VAT & Post**  
**FD42 as a kit £33.95 including VAT & Post**  
**FD42 Built only £24.95 including VAT & Post**  
**FD42 Keyboard Kit £18.95 including VAT & Post**

**GUARANTEED 14 DAYS DELIVERY FROM RECEIPT OF ORDER, OR CALL TO THE ZX CENTRE.**

Mail to **FULLER MICRO SYSTEMS,**  
 The ZX Centre, Sweeting Street, Liverpool 2. England, U.K.

AD Code

*Please Supply:-*

Name .....

Address .....

SAE for more details — Enquiries: Tel. 051-236 6109

**FULLER FD SYSTEM**

# Better trade with Cumana and get the choice of a whole range of Top Quality Disk Drives



A BIG PLUS!  
includes  
SWITCH UNIT for  
80 or 35  
track use



For business systems the 8035. This Unit has the capacity of 4 1/2 Apple drives and can also read all 35 track Apple Software.

A low cost Apple compatible disk drive - quiet and reliable operation.



We offer a wide range of high quality disk drives for Apple, TRS-80 and many other popular computers including the BBC Micro (Model B), NASCOM, Genie and Superbrain. Our continued high reputation depends on supplying professional users with top quality trouble-free products, completely dependable and quiet in operation. And, Cumana make you a promise that when there are better products we will be supplying them; and at prices to keep our Dealers ordering!

DEALER  
and OEM  
ENQUIRIES  
WELCOMED



Cased 40 track and 80 track dual drives with internal power supply units.

Cased 40 track and 80 track single drives with internal power supply unit.

TRIDATA integrated business package now available on Cumana 40 and 80 Track Model III Drives. Contact TRIDATA: Tel. Q21 622 6085.

Internal Drive Kits for the TRS 80 Model III 40/80 Track Double Sided

## CUMANA LTD

35 Walnut Tree Close, Guildford, Surrey GU1 4UN.  
Telephone: (0483) 503121 Telex: 858306

Apple is the Registered Trade Mark of Apple Inc.

**No hassle 12 MONTH WARRANTY**

## G.M.MICROTRONICS LTD

UNIT 14, GODINTON WAY INDUSTRIAL ESTATE,  
GODINTON ROAD, ASHFORD, KENT TN23 1JB  
Telephone: ASHFORD (0233) 38671/38672

# 6808 COMPUTER

The 6808 computer comprises of separate  
double eurocards as outlined below:-

## CPU Card

Comprises of 6802/6808 C.P.U.  
8K of on Board Ram (+ 128 Bytes in 6802)  
Up to 4K of Rom ie 2 x 2716 Eproms.  
and address decoding for other boards.

## IO Card

Comprises of 2 x 6821 P.I. A. I.C.S.  
1 x 6840 P.T.M.  
2 x 6850 A.C.I.A. with RS232 outputs.  
and two on Board Baud Generators to set up  
any Baud rate required

## VDG

Gives 6K of Memory Mapped Graphics + Alpha  
Display using 6847 I.C. also has on Board Sound  
generator.

## Backplane

Backplane Accommodates up to 11 x 80 pin  
edge connectors power requirements  $\pm 5V$ ,  $\pm 12V$

### Available Shortly

6809 Computer system with twin disk drives  
(8" double sided double density) 65K user Ram,  
14" colour monitor.

Ideal for small business accounts and word  
processing

ex. Works price £4200.00 Plus VAT  
Business Package software available

## G.M.MICROTRONICS LTD.

UNIT 14, GODINTON WAY INDUSTRIAL ESTATE,  
GODINTON ROAD, ASHFORD, KENT TN23 1JB  
Telephone: ASHFORD (0233) 38671/38672

*"Add the power of speech  
to your computer"*

## TMS 5100 TALKING BOARD as featured in ELEKTOR

Features 170 word vocabulary in  
3 Eproms

Easily interfaced to any computer  
(via Bus or Parallel port) ie:

Acorn, Atom, Apple, Atari, Pet,  
Vic, and ZX80/81.

Requires  $\pm 12v$  @ 50 ma and  
 $+5v$  @ 300 ma.

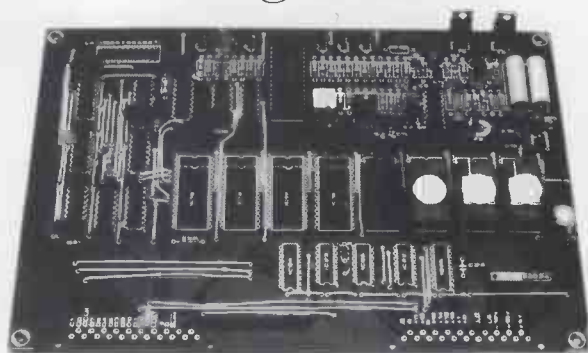

|  |          |
|--|----------|
| GM510 Talking Board Kit (with interface IC's)    | £82.95p  |
| GM511 Power supply Kit to Power above            | £16.10p  |
| GM5100 Ready Built with power supply and cased   | £144.00p |
| Design notes (inc in above) if bought separately | £1.00p   |

## SOFTY II NOW IN STOCK

@ £182.00 inc VAT

ALSO AVAILABLE SHORTLY

## 6808/6809 6u Board Expandable Computer System

Send for further details and specification

Please send the following items:

- Box
- Softy II
  - GM510 Talking Board Kit
  - GM511 P.S.U. Kit
  - GM5100 Ready Built Cased Unit
  - Further Details
  - Design Notes
  - 6808/9 Details

I enclose cheque P/O for value of £..... please add £2.00  
p&p. All prices inc. VAT.

Name .....

Address .....

..... Post Code .....



# Software for CP/M<sup>TM</sup>

## MICROPRO

|             | £  |
|-------------|--|
| WORDSTAR    | MICROPRO's comprehensive word processing system<br>250.00  |
| MAILMERGE   | Added power to WORDSTAR for mailing lists, standard letters, etc<br>60.00  |
| SPELLSTAR   | Dictionary on a disk for WORDSTAR spelling checking<br>120.00  |
| DATASTAR    | MICROPRO's data entry, validation and retrieval system<br>170.00   |
| SUPERSORT I | Sorting, extracting and merging at high speed from MicroPro. Includes Relocatable version for inclusion in your own software<br>120.00 |
| CALCSTAR    | MICROPRO's spread sheet and financial modelling system. Combine with WORDSTAR to get impressive end results.<br>150.00                 |
| WORDMASTER  | Video text editor for programmers and simple Word Processing<br>60.00  |

## MICROSOFT

|                | £   |
|----------------|---|
| BASIC-80       | MICROSOFT's popular and powerful BASIC Interpreter (MBASIC)<br>150.00*  |
| BASIC Compiler | Compile your BASIC-80 programs for speed and protection<br>190.00*  |
| FORTTRAN-80    | Fortran compiler to ANSI X3.9 1966 except COMPLEX data<br>210.00*   |
| COBOL-80       | The COBOL compiler for microcomputers. (BASIC, FORTRAN and COBOL compilers include MACRO-80, LINK loader, LIBRARY manager and CREF utilities.)<br>310.00* |

## MISC

|             | £   |
|-------------|---|
| CBASIC-2    | COMPILER SYSTEMS widely used compiler/interpreter for BASIC<br>65.00        |
| CB-80       | CBASIC compatible compiler<br>280.00  |
| PASCAL/M    | SORCIM's PASCAL<br>120.00   |
| SUPERCALC   | SORCIM's spread sheet and modelling system<br>170.00                        |
| MILESTONE   | Project Management and Scheduling from Organic Software<br>160.00           |
| dBASE II    | Relational Database Management from Ashton Tate<br>380.00                   |
| dUTIL       | Programming aid for dBASE II<br>50.00                                       |
| QUICKSCREEN | Screen formatter for dBASE II<br>90.00                                      |
| MICROSTAT   | Statistical program library from ECOSOFT for (and needs) BASIC-80<br>150.00 |
| PLI-80      | Digital Research PLI Compiler<br>310.00                                     |
| BT-80       | Record Retrieval for PLI-80<br>125.00                                       |
| MAC         | Digital Research 8080 Macro Assembler<br>57.00                              |
| SID         | 8080 Symbolic Debugger<br>47.00   |
| ZSID        | Z80 Symbolic Debugger<br>63.00  |
| DESPOOL     | File Print Spooler for CP/M<br>31.00  |
| TEX         | Tex editor<br>63.00   |
| SPELLBINDER | Lexisoft's Wordprocessing and Office Management System<br>275.00            |
| PRO PASCAL  | Z80 True Pascal Compiler<br>190.00  |

All products are available in 8" SD, SS, Superbrain 5" SS, North Star Horizon QD format except those marked \* which are not available in North Star format.

## THIS ISSUE'S SPECIAL OFFER

**25% OFF**  
list price

### MICROPRO 3 PRODUCT PACKS

WORDPACK (WORDSTAR, MAILMERGE & SPELLSTAR)  
DATAPACK (DATASTAR, CALCSTAR & SUPERSORT)

(Offer ends 31st October 1982)

All products are supplied complete with full originators documentation.

Please send large s.a.e. for full details. **TRADE ENQUIRIES WELCOME**

Ordering Instructions: Cash with order. Specify disk format. Add £3.00 per item P&P. Add 15% VAT



# the soft option (UK)LTD

PO BOX 11 CRANBROOK KENT TN17 2DF Tel. (058 080) 310

# Probably the fastest microcomputer in the universe

## the **JUPITER ACE** only £89.95.



### All inclusive Price

For £89.95 you receive your Jupiter Ace, a mains adaptor, all the leads needed to connect to most cassette recorders and T.V.s (colour or black and white), a software catalogue and a manual.

The manual is a complete introduction to the world of personal computing and a course in FORTH programming on the Ace.

Even if you are a complete newcomer to computers, the manual will guide you step by step from first principles to confident programming.

The price includes postage packing and V.A.T.

### Key Features

- Revolutionary microcomputer language FORTH.
- Full-size moving-key keyboard.
- User-defined high-resolution graphics.
- Programmable sound generator.
- Floating point arithmetic.
- Fast cassette interface.
- Upper and lower case ascii character set.
- 24 x 32 character flicker-free display.

### The Jupiter Ace uses FORTH

The Ace is set apart from all other personal computers on the market by its use of a revolutionary language called 'FORTH'. Some computer languages are easy for humans to understand, others are easy for computers; FORTH is most unusual in being both. Its underlying principles are so simple that it takes even a newcomer to computers only a few minutes to learn how to do calculations on the Ace, yet the very same principles are powerful enough to allow you to invent your own extensions to the language itself.

At the same time, the memory-saving coded form used to store your programs inside the Ace allows it to obey them very fast — typically in less than a tenth of the time it would take to do the same thing using a different language. Amongst other things, this makes the Ace ideal for games.

FORTH's unique combination of speed, versatility and ease of programming has already made it a prime choice for professional applications as diverse as pub games and radio telescopes, and gained it an enthusiastic national user group. Now the Jupiter Ace can bring this addictive language into your own home.

### Designed by Jupiter Cantab

Leading computer Designers Richard Altwasser and Steven Vickers have a reputation for pushing technology forwards. After playing the major role in creating the ZX Spectrum they formed Jupiter Cantab to develop their latest brainchild the Jupiter Ace.

### Technical Specification

#### Hardware

##### Processor/Memory

Z80A running at 3.25 MHz.  
8K bytes ROM 3K bytes RAM.

##### Input

40 moving-key keyboard with auto-repeat on every key.

##### Output

Memory-mapped 32 x 24 character display with high resolution user graphics. Output to drive normal UHF TV set on channel 36.

##### Sound

Provided by internal loudspeaker.

##### Cassette

Load Save & Verify at 1500 baud, separate data storage.

#### Software, FORTH

##### Data Structures

Integer, Floating point and String data may be held as constants, variables or arrays with multiple dimensions and mixed data types.

##### Control Structures

IF-THEN-ELSE, DO-LOOP, BEGIN-WHILE-REPEAT, BEGIN-UNTIL, all may be mixed and nested to any depth.

##### Operators

Mathematical +, —, X, ÷,  
Logical AND, OR, NOT,  
XOR.

Comparison <, >, =.

##### Program Editing

FORTH words may be listed, edited and redefined. Comments are preserved when words are compiled.

### Order Form



The **Jupiter Ace** is available only by mail order. Please allow up to 28 days for delivery.

Send cheque or postal order with the form to:—

JUPITER CANTAB, 22 FOXHOLLOW, BAR HILL, CAMBRIDGE CB3 8EP

Please send me:—

JUPITER ACE MICROCOMPUTER(S) @ £89.95.

Name. Mr/Mrs/Miss

Address

\_\_\_\_\_  
\_\_\_\_\_  
\_\_\_\_\_ E



## lower case chip + SHIFT KEY MOD

- \* Adds the full lower case set to your APPLE II
- \* Complete with clip-on SHIFT KEY modification
- \* Lower case letters have true descenders
- \* Compatible with most word processing packages
- \* Available in most European languages
- \* Comprehensive documentation covers installation & software

! " # \$ % & ' ( ) \* + , - . / 0 1 2 3 4 5 6 7 8 9 : ; < = > ?  
 @ A B C D E F G H I J K L M N O P Q R S T U V W X Y Z [ \ ] ^ \_ ` { | } ~  
 a b c d e f g h i j k l m n o p q r s t u v w x y z ( ) [ ] ^ \_

Requires Revision 7 (and upward) APPLE II  
 PRICE £34.00 + V.A.T.

## Visiplot Driver Routines

If you have Visiplot, a graphics printer and one of the following — Grappler, Digitek Printmaster, Pkaso, then our intelligent printer and Driver Routine is a must.

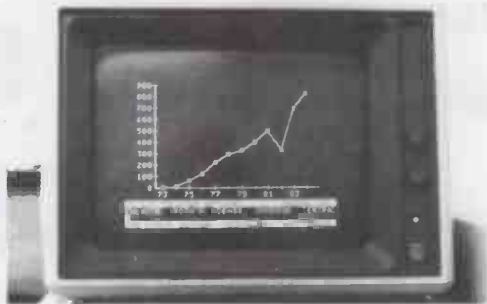

- \* Send direct from Screen to graphics printer — allowing image to be enlarged, rotated, printed black/white, white/black, centralised etc.
- \* Simple menu selection enables you to send graphics screen image directly to printer.

Our Visiplot intelligent driver routines allows you to take full advantage of your printer card capabilities.

£19.95 + V.A.T.

## VISICALC UTILITIES

VisiCalc Utilities Apple computer program:

Enables you to list out on your printer or VDU all the worksheet formulae.

Allows you to display or print those formulae too wide for the VisiCalc display area.

Find command lets you trace column/row references in the worksheet.

Re-format the printout of your worksheets with variable column widths, additional text headings, dates, page control and numberings.

If you have a clock card the date and time are automatically included in your printout.

Visiprint format files can be saved to disc for future use.

Retail Price £34.95 + VAT

- \* Improves VisiCalc significantly as regards the Apple II.
- \* A useful audit tool.
- \* Enables one to do things with VisiCalc that are otherwise impossible.
- \* Accountancy May 1982.

Send for reprint of above review  
 and VisiCalc Utilities fact sheet.

**LEICESTER**  
 computer centre limited

67 Regent Road, Leicester LE1 6YF. Tel: 0533 556268



## When your computer goes down will it be an inconvenience or a disaster?

Microcomputer systems form an indispensable part of our modern working life. Their power and convenience make it easy to forget just how complex they are — until they go wrong!

We hope you will have talked to us long before that happens. In a 'crisis', a fast reliable response is the only type of service you are going to accept.

microserve offers you a complete range of servicing, maintenance and repair plans. With our **microsure** maintenance contract, for example, we'll have a fully trained service engineer on your door step within hours. Other servicing plans include installation, workshop repair and system upgrades.

microserve are specialists in the maintenance and service of Cromemco, North Star and Comart Microcomputer systems. We operate from service centres throughout the UK, with the technical support of one of the largest microcomputer groups in the country.

For more information, call us today on 0480 215005, or fill in and return the coupon below. It won't inconvenience us, but it might save you from a disaster!

To: microserve, Freepost, Little End Road, Eaton Socon, St Neots, Huntingdon, Cambridgeshire PE19 3BR.

Name \_\_\_\_\_

Company \_\_\_\_\_

Position \_\_\_\_\_

Address \_\_\_\_\_

Tel. no. \_\_\_\_\_

**microserve**™

A service of the Comart group of companies  
 London, Manchester, Birmingham, Glasgow, Nottingham, Southampton, Cambridge.

# LONDON COMPUTER CENTRE



TOMORROW'S COMPUTING TODAY

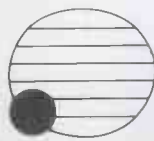

**ACT  
Sirius 1**

£2395

8088 Processor  
128K RAM  
1.2 Mb Disk Storage

**Now available**  
Z 80 CP/M Add-on board  
to run all CP/M 8 bit or  
16 bit software **£299**

Wordstar Magic Wand Spellbinder  
Spellstar D Base II T/Maker Calcstar  
Milestone Datastar Microstar  
Fortran Cobol Pascal or any CP/M  
software

## TELE-VIDEO SINGLE-USER TO MULTI-USER

NOW UPGRADED NO EXTRA CHARGE

802E 100K EXTRA DISK STORAGE  
**£2170**

Superbrain compatibility  
Faster disk access  
Green Screen. True descenders  
22 Function Keys

802DE 2 Mb Disk Storage **£2295**

802HDE 14 Mb Hard Disk 1

Mb Floppy **£3990**

806 6 User 10 Mb Hard Disk **£4095**

816 16 User 23 Mb Hard Disk **£7385**

800 64K User Station **£1025**

800 64 K user station **£1025**



Prices above based on exchange rate \$2 = £

Save £300 on this LCC  
Software Starter Pack

|                         |             |
|-------------------------|-------------|
| Wordstar                | <b>£250</b> |
| Wordstar Trainer Manual | <b>£ 25</b> |
| Dbase II                | <b>£350</b> |
| Supercalc               | <b>£175</b> |
|                         | <b>£800</b> |
| Special Package Deal    | <b>£500</b> |
| Saving £300             |             |

**NEW**

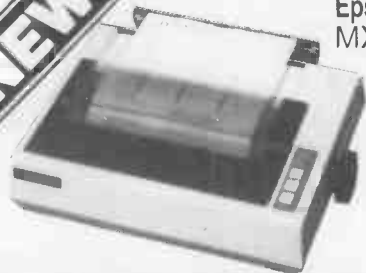

Epson Type 3  
MX 80/FT  
MX 100

**NEW**

New Superbrain 2  
from £1595  
Dedicated Wordstar Keypad



AUTO SHEET FEEDER  
£580

New! 12" Wide  
Automatic  
Sheet Feeder  
fits all below



## AUTHORISED TANDY DEALERS

Model I  
48K System  
2 Disk Drives  
Green Screen  
Complete **£995**

Model II  
with TRS DOS  
and CPM at  
no extra charge  
from **£1995**

Model III  
16K **£599**  
48K **£649**  
48K with 2 disk  
drives **£1295**



## DAISY WHEEL PRINTERS LETTER QUALITY PRINTING



- \* FLOWRITER RP 1600. 60 CPS The most intelligent Daisy. Proportional spacing with Right Justification on WORDSTAR, WORDPRO, APPLE WRITER SCRIPSIT etc. **£1500**
- \* TEC 40. 40 CPS. JAPANESE DIABLO 630 uses Diablo Daisy Wheel & Ribbons. **£1135**
- \* DAISY WHEEL II 60 CPS. RICOH 1600 Daisywheel **£1050**

## HARD DISKS

for Superbrain,  
TRS 80 Model II, Apple

Model 6 6 Mb Formatted **£1595**  
Model 12 11.5 Mb Formatted **£1895**

- \* Specially designed Hybrid heavy duty power supply
- \* Data Error Recovery



All prices are Exclusive of VAT and Delivery. Dealer Enquiries invited on all Products.  
Large range of CPM Software available. Please phone for Prices.

*Demonstrations on all models.*

43 GRAFTON WAY, LONDON W1P 5LA (Opposite Maples)  
OPENING HOURS: 11-7 MON-FRI 12-4 SAT Tel: 388 6991/2  
24 hour answer phone: 01-388 5721

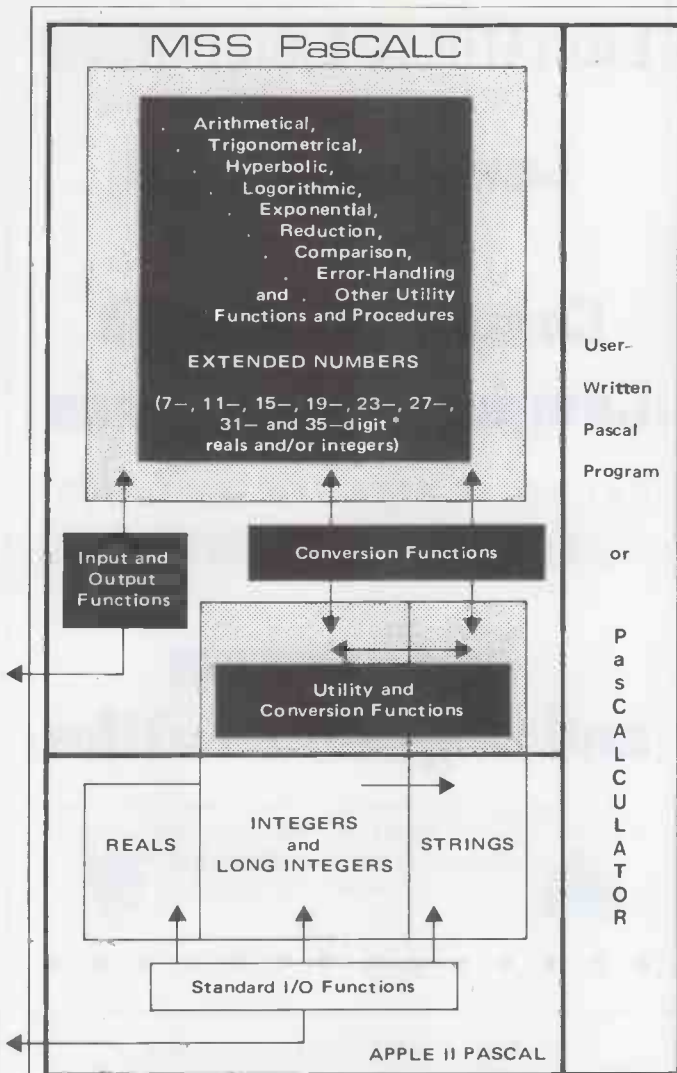

Logical Relationship between a User-Written Pascal Program, Apple Pascal and PasCALC.

To MATHEMATICAL SOFTWARE SERVICES, FREEPOST, Guildford, Surrey, GU1 1BR.

Find enclosed cheque/PO for £73.60 for one set of PasCALC and PasCALCULATOR software for precision levels 7, 11, 15, 19, 23, 27, 31 and 35.\*

\* Circle five precision levels unless you want the standard set (underlined)

Allow two weeks for delivery

PCW 1

To order, write your name and address on the form, showing which 5 precision levels you want, and post it with a cheque or PO to Mathematical Software Services, FREEPOST, Guildford, Surrey, GU1 1BR. No stamp is needed on your letter.

Pascal is the most versatile high level language generally available for microcomputers today, and its popularity is steadily growing. Now, to enhance APPLE II Pascal 1.1, MSS (Mathematical Software Services) brings you

## PasCALC

### Enhancement in Depth

Extended Number TYPE gives a choice of precisions from 7 to 35 digits, and allows you to mix integers and reals in your Pascal calculations.

### Enhancement in Function

More than 70 functions and procedures (see the diagram) for Extended Numbers, Pascal integers, long integers and strings.

- You choose precision at compile-time, so there is no need to re-program when you move from, say, a precision level of 11 digits to one of 23.
- A comprehensive error-handling procedure specially designed to handle your own run-time errors.
- PasCALC is distributed as a suite of Pascal-readable modules with detailed instructions for mounting it in the Pascal SYSTEM.LIBRARY.

PasCALC is written in Pascal, designed with the aim of making greater computational power available to general user and specialist alike. It requires a 48K APPLE II with at least one disk drive, and it can be used by any Pascal program — such as

## PasCALCULATOR

which is distributed with PasCALC. PasCALCULATOR is a powerful interactive (conversational) command processor for doing calculations at the keyboard. Simply boot Pascal, exec PasCALC and away you go. For example, you can find  $(1/(S*\text{SQRT}[2*P]))*\text{EXP}[-\text{SQR}[X-M]/(S^2*2)]$  in only one step!

- 26 names (A..Z) available for keeping intermediate values during the session.
- Ten commands can be RETAINED at any one time for later recall, saving time and reducing keying errors.
- Commands can be REPEATED too — ideal for observing convergence of a result.
- Full Extended Number 'mixed' arithmetic and range of precisions, with many built-in functions.
- Both parentheses (priority of calculation) and built-in functions [brackets] can be nested to any depth.
- Optionally printed session log—no need to write down results at the keyboard.
- Both e and π (to 35 digits) are automatically set up at the start of every session.

### Extract from Optional Log (Precision Level 15)

```

Enter command:
Y:=Y+P^(2*LOGE[10-(5*E/4)])
0.936471836457736E0
Enter command:
A:=0.125E1
0.125000000000000E1
Enter command:
X-SINIP-EXPCA/(B+Y)J^D]
-0.185890363973163E1
Enter command:
RETAIN
Retained as command 5
Enter command:
A:=0.15E1
0.150000000000000E1
Enter command:
COMMANDS
X-SINIP-EXPCA/(B+Y)J^D]
0.826354927584729E-1
Enter command:
LISTV
-----
LIST OF VARIABLES
-----
A = 0.150000000000000E1
B = 1
D = 5
E = 0.271828182845905E1

```

PasCALC and PasCALCULATOR: £64.00 plus £9.60 VAT or \$144.00 including insured airmail delivery.  
100-page User's Guide only: £12.00 (\$20.00 airmail).

MATHEMATICAL SOFTWARE SERVICES  
33 St Margarets, London Road, Guildford, Surrey GU1 1TL.  
Guildford (0483) 69055

APPLE is a registered trade mark of Apple Computer Corporation, and PasCALC and PasCALCULATOR are trade marks of Mathematical Software Services. \* Precision limited to 27 digits maximum for some real functions.

# informatics

## MICRO BULLETIN

**BE UP-TO-DATE WITH ALL  
THE VITAL NEWS IN THE  
MICRO COMPUTER INDUSTRY.**

*In our fast-moving business the right piece of news can often put you ahead of your competition ... alter your plans ... even the very strategy of your business ... but only if it reaches you in time.*

The Infomatics group of publications is launching a new weekly newsletter to cater specifically for people in the micro computer industry. Published every Monday, the Infomatics Micro Bulletin will be packed with information about what is happening on the micro front – both hardware and software. Produced by the same publisher as Personal Computer World and MicroDecision, the micro newsletter will carry up-to-date information on what is happening in the US and Japan, as well as news from the UK.

We'll be talking about new products coming along from the Japanese and American manufacturers and spotting those who want representation in the UK and Europe. And we'll be reporting on those companies abroad which want to market British systems and software.

The information will be aimed at people in the business – software houses, dealers and manufacturers – rather than hobbyists and users. It will therefore be essential reading for those who want to stay up-to-date with events and pick up the best deals first.

Annual subscription to the Micro Bulletin is £85, and will include an automatic subscription to Infomatics magazine.

So send off now for this week's FREE issue of the Micro Bulletin and for details on how to subscribe.

To: Infomatics Micro Bulletin,  
VNU Business Publications B.V.,  
FREEPOST 38, London W1E 6QZ  
Yes, please send me my free issue of Infomatics Micro Bulletin.

Name \_\_\_\_\_

Company \_\_\_\_\_

Position \_\_\_\_\_

Address \_\_\_\_\_

Postcode \_\_\_\_\_

Telephone \_\_\_\_\_

**FREEPOST  
NO STAMP NEEDED**

## Lion Micro Computers

### London's widest range of Computer Books & Computer Magazines

EXTENSIVE RANGE OF SOFTWARE  
ACCESSORIES AND PERIPHERALS

### For experts and beginners alike

Lion House, 227 Tottenham Court Road, London W1P 0HX  
Telephone: 01-580 7383 & 01-637 1601 Telex: 28394 Lion G.



Open 9 to 6 Mon-Sat  SEND LARGE SAE FOR OUR LISTS



## UNIVERSITY OF MANCHESTER DEPARTMENT OF EXTRA-MURAL STUDIES



### RESIDENTIAL MICROCOMPUTER COURSES AT THE UNIVERSITY CONFERENCE CENTRE – HOLLY ROYDE

Learn Basic, Practical BASIC Fee: £189  
Monday-Friday, 27 September-1 October, 1982

BASIC on the ZX81 Fee: £59  
Friday-Sunday, 22-24 October, 1982

Start Programming with CBM Disk Drives Fee: £59  
Friday-Sunday, 29-31 October, 1982

Machine Code on the ZX81 Fee: £59  
Friday-Sunday, 10-12 December, 1982

BASIC Programming Fee: £82.50  
Friday-Sunday, 14-16 January, 1983

Advanced CBM Disks Fee: £59  
Friday-Sunday, 4-6 March, 1983

The fees quoted include tuition and full board accommodation in comfortable single study bedrooms. The conference centre is situated in its own gardens, approximately 4 miles south of Manchester city centre. For a fully detailed leaflet please contact Lynn Palethorpe, Department of Extra-Mural Studies, The University, Manchester, M13 9PL or telephone 061-273 3333 ext 3076.

# SOFTWARE FOR CP/M®

HIGH QUALITY SOFTWARE - WITH HIGH QUALITY SERVICE

★ **NEW!** The Formula: £300. Application builder and reporter. SUPERCALC: £165. Spread sheet financial planning. SPELLSTAR: £125. Option for Wordstar.

|   |      |   |      |
|---|------|---|------|
| <b>WORDSTAR</b> - Professional word processing software. On-screen formatting, wordwrap, pagination, line and character count on view. Micro-justification on daisy-wheel printer. Search and replace. Block/paragraph manipulation. External file read/write. Background printing during editing etc.                  | £250 | <b>MICROSOFT FORTRAN COMPILER</b>   | £205 |
| <b>MAIL-MERGE</b> - Powerful Wordstar enhancement for file merging and document personalisation.  | £65  | <b>MICROSOFT COBOL</b>  | £310 |
| <b>DATASTAR</b> Screen orientated system for Data Entry, Retrieval and Updating.  | £175 | <b>MAGSAM</b> - Versatile easy to use Keyed File Management System for Microsoft Basic or CBASIC.   | £130 |
| <b>SUPERSORT</b> - Sort, merge and selection program.   | £125 | <b>CIS - COBOL - ANSI' 74</b> implementation to full level 1 standard. Supports random, indexed and sequential files, features for conversational working, screen control, Interactive debugging, program segmentation etc. | £425 |
| <b>CONFIGURABLE BUSINESS SYSTEM (CBS)</b> - Unique information management system with user definable files, powerful report generator, menu-driven for ease of use. No programming experience necessary!  | £225 | <b>FORMS-2</b> - Automatic COBOL code generator for screen formats.   | £100 |
| <b>ACCOUNTING PACKAGES</b> by Median - Tec: <b>PAYROLL, SALES, PURCHASE, NOMINAL</b> Specially developed by UK software house to exacting specifications. Written in Microsoft Basic each package may be customised by end user, all are widely used. Ledgers are open Item. Payroll caters for weekly and monthly pay. | £500 | <b>PASCAL-Z</b>   | £255 |
| <b>PROJECT COST CONTROL/JOB ACCOUNTING</b> - A comprehensive set of programs to monitor budgets, account for expenditure and project completion etc. Ideally suited for contractors. Written in CBASIC-2.   | £150 | <b>STRUCTURED BASIC</b> - Relocatable compiler  | £160 |
| <b>STATISTICS PACKAGE</b> - Over 25 routines including Regression & ANOVA   | £100 | <b>CBASIC-2</b> - Extended Disk Basic pseudo compiler and run-time interpreter.   | £75  |
| <b>MATHS PACKAGE</b> - Over 40 easily used routines.  | £100 | <b>SELECTOR III - C2</b> - Information management system written in CBASIC-2  | £185 |
| <b>IBM - CP/M COMPATIBILITY</b> - Powerful utility to transfer data to/from IBM machines in standard disk format.   | £110 | <b>SELECTOR IV</b> - Upward compatible version of III with enhanced reporting.  | £300 |
| <b>MICROSOFT BASIC INTERPRETER</b>  | £155 | <b>BSTAM</b> - Telecomms facility for exchanging files between CP/M computers.  | £110 |
| <b>MICROSOFT BASIC COMPILER</b>   | £205 | <b>ASC0M</b> - Facility for communicating with other computers.   | £95  |
|   |      | <b>TRANSFER</b> - CP/M to CP/M file exchange - telecomms source code  | £95  |
|   |      | <b>MACRO 80</b> - Macro Assembler   | £99  |
|   |      | <b>CP/M 2.2 - Standard Version 8" Single Density.</b>   | £99  |

Please contact us for availability of other products  
All orders must be PREPAID. Add £1 per Item P & P (Minimum £2.00) and VAT  
CP/M is trade mark of Digital Research



## TELESYSTEMS LTD

P.O. Box 12, GREAT MISSENDEN, BUCKS, HP16 9DD

Telephone (02406) 5314



## MicroShell™ conducts your CP/M™ computer with more power than ever before!

### WHAT IS MICROSHELL?

MicroShell is a normal CP/M program which adds a powerful set of commands to all programs running under CP/M. MicroShell remains in your computer, out of the way to continue to process your commands.

### WHAT WILL MICROSHELL DO?

All the normal CP/M commands, plus:

- Automatic Disk and User Management - No more copying all your programs to each disk you use and having directories filled with programs. With MicroShell you can work on a nice clean disk or in a separate user area and MicroShell will find your programs from another drive or user number automatically! You'll save time and precious disk space.
- Powerful Redirection Capability - You can send screen output to a file or to the printer. Or send printer output to a file. Or take program input from a file instead of the keyboard.
- Much More: Multiple commands on a line, more powerful and faster "submit" capability, and user-definable prompt.

### DEALERS - MICROSHELL GIVES YOU:

- An interface to the computer that can be tailored to the user's level of experience.
- Automatic execution of an application program at startup.
- MicroShell can manage self-running demos to free up your salesmen from demonstrating software packages; have the software package sell itself!

### WILL MICROSHELL RUN ON MY COMPUTER?

If your computer runs CP/M 2.2, that's all you need to run MicroShell. Most popular 8 and 5 inch disk formats available. And MicroShell runs on Apple-CP/M, and IBM PC with "Baby Blue".™

CP/M™ TM Digital Research, UNIX™ TM Bell Labs, Wordstar™ TM MicroPro, Baby Blue™ TM XEOEX



### GIVE ME SOME EXAMPLES!

- Run Wordstar™ (or your favorite word processor) from any disk drive or user area: MicroShell will automatically find the programs and overlays as they are needed.

- Wish you could save the screen from some program for later use or to edit into a report? With MicroShell, you can!

Just redirect the output into a file. Have a program that prints a report you want to save but it will only go to the printer? With MicroShell you can direct the printer output into a file.

- Tired of entering the same commands time after time into a program? Put them into a file and have MicroShell supply them to the program from the file.

- Want to do something else while a long program runs? Change MicroShell's prompt to sound the bell on your terminal.

### SOFTWARE DEVELOPERS - MICROSHELL GIVES YOU:

- A powerful development environment with many UNIX™ features, and some that even UNIX doesn't have.
- MicroShell eases the part of software development we all dislike: documentation. With MicroShell, you can run your program and collect the output in a file.

CALL OR WRITE TODAY!

**asro**  
INFORMATION  
SYSTEMS

P.O. Box 159, Brighton, BN1 3NA  
Phone: 0273-21979

# Computer Enterprises

## Computers

IBM

IBM Personal Computer £2490  
Up to 512k RAM, 5, 12, 23Mbyte Hard disk,  
CPM Card £295, Colour/Graphics, CP/M86,  
Wordstar, Supercalc, dBASE 2, TIM-III,  
Light Pen, Recreational/Educational Soft-  
ware Available.



**ACT Sinus 1** 128k RAM 1,2Mbyte £2395  
floppy with 2.4 Mbyte floppy disk £2895  
CPM Card £299, Hard Disk (5, 12 23Mbyte)  
Telex £1495, DMS £395, UCSD Pascal £250.

NorthStar

Advantage 64k ram, 720 floppy Disk £1990  
Horizon 64k RAM 18Mbyte Hard Disk

OKI if 800 64k RAM 800k floppy £4250  
CONCEPT 256k RAM, Edward,  
Logicalc, CPM emulator, disk

interface for only £3990  
VECTOR 4/20 CPM and CPM86 £2875  
OSBORNE + Free software + RING £1295  
TELE-VIDEO Single/multi user from £1990  
SHARP MZ80B With 12Mbyte Winchr.

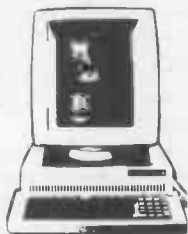

RAIR Blackbox/ALTOS Multiuser Sys. Ring £3375



## Printers



Seikosha GP 100 . . . . .£189  
Epson MX80T-3 . . . . .£320  
Epson MX80FT-3 . . . . .£349  
Epson MX82T . . . . .£330  
Epson MX82FT . . . . .£375  
Epson MX100FT-3 . . . . .£459  
M. Tally MT120(I) . . . . .£390  
M. Tally MT140(L) . . . . .£695  
Prism 80 150cps . . . . .£595  
Prism 132 150cps . . . . .£750  
1. Auto sheet feed . . . . .£149  
2. Sprint Mode (200cps) . . . . .£149  
3. Graphics . . . . .£ 99  
4. Colour . . . . .£299  
Prism 80 (with 1, 2, 3) . . . . .£790  
Prism 132 (with 1,2,3,4) . . . . .£1295  
Microline M80A . . . . .£235  
Microline M82A . . . . .£345  
Microline M83A . . . . .£475  
Microline M84A . . . . .£899  
Nec 8023 80col, 100cps . . . . .£375  
Tec 1550 136col,120cps . . . . .£585  
Star DP848P (ft,80cps) . . . . .£295  
Star DP84S . . . . .£335  
ANADEX DP9500(L) . . . . .£795  
ANADEX DP9501(A) . . . . .£1100  
ANADEX DP9620(A) . . . . .£1195  
TEC Starwriter F40 . . . . .£1115  
TEC Starwriter F55 . . . . .£1475  
QUME Sprint 9/35 . . . . .£1395  
QUME Spring 9/45 . . . . .£1590  
QUME Sprint 9/55 . . . . .£1790  
NEC 3510 R . . . . .£1290  
NEC 7710 R . . . . .£1550  
NEC Spinwriter . . . . .£1895  
DIABLO 630 RO . . . . .£1680  
DIABLO 630 KSR . . . . .£1875  
Ricoh 1600 . . . . .£1250  
Ricoh 1600S . . . . .£1350  
Ricoh Flowriter . . . . .£1490  
OLIVETTI DY211 . . . . .£795  
OLIVETTI DY311 . . . . .£1100  
T/Printer . . . . .£390  
FUJITSU 80cps . . . . .£1690  
Smith Corona . . . . .£456  
SILVER REED EX55 KSR . . . . .£790  
OLYMPIA ESQ 103 . . . . .£895  
BROTHER Crown Ranier . . . . .£690  
Brother 8300 Portable . . . . .£465

## Software

Wordstar . . . . .£245  
Datastar . . . . .£165  
Calcstar . . . . .£140  
Supersort . . . . .£115  
Dbase II . . . . .£365  
PRO Pascal . . . . .£175  
Bstam . . . . .£ 90  
Basic Compiler . . . . .£175  
Cobol Compiler . . . . .£290  
Insurance Broker . . . . .£1600  
Integrated Acct . . . . .£1000  
News Agents Pack . . . . .Ring  
Motor Trader . . . . .Ring  
Doctors System . . . . .tba  
Mr. Retailer . . . . .Ring  
RING for others . . . . .!!!!



## Monitors/Terminals

BMC Black/Green . . . . .£ 69  
BMC Colour . . . . .£199  
SANYO B/Green . . . . .£ 99  
KAGA 12" Green . . . . .£ 79  
KAGA 14" Colour . . . . .£235  
TELEVIDEO from . . . . .£400  
HAZELTINE Esprit . . . . .£425  
LEAR SIEGLER . . . . .£390  
VIEWPOINT A2 . . . . .£496

## Disk Systems

Corvus 6Mbyte . . . . .£1990  
Corvus 10Mbyte . . . . .£3390  
Corvus 20Mbyte . . . . .£4290  
ICE 12Mbyte . . . . .£2495  
Cumana 35/80 track . . . . .RING

## Consumables

Fanfold paper (2000) . . . . .£20  
Disks for 10 from . . . . .£15  
Ribbons & Wheels . . . . .Ring

Cables & Interfaces available.

For information & orders  
01-543 4729/01-947 8837

SHOW ROOM:

608, Kingston Road, London SW20 8SA

EXPORT, Colleges, Govt, LEASE, HP Enquiries WELCOME.

All items new and carry manufacturers GUARANTEE.

Add VAT and 1.5% to all orders for Delivery.

All prices subject to change without notice.

RING FOR LATEST PRICES AND QUOTATIONS.!!

# Personal Disk Tidy

New  
Secure  
Convenient  
Economical



### NEAT, CLEAN, SECURE

- Slim format - easy to lock in a drawer or a brief-case
- Suitable for all private data or security material
- Dust-proof wallet

### RENEW YOUR RECORDS ANYTIME

- Unique replacement file register
- Convenient work log to record stage of calculations and entries
- Keep constant track of links between programmes

### CLEAR DISPLAY, EASY REACH

- Holds 12x5 1/4" Diskettes - ideal with your personal computer
- Disks stand up for easy visibility, easy access

### Single copies

£6.80 plus 70p postage (including VAT)

Dealer enquiries welcome.



JAMES  
BURN  
OXFORD  
Standards

Stanton Harcourt Road,  
Eynsham, Oxford

Telephone Oxford (0865) 880458

# NASHUA QUALITY DISKETTES

What more is there to say?

Free  
Library  
Case



Frank Skinner  
Nashua Computer Products,  
Cory House, Bracknell, Berkshire RG12 1ET  
Tel: Bracknell (0344) 52711 Telex: 848821

**NASHUA**

# THE PERSONAL COMPUTER GUIDE

TIM HARTNELL

The Complete Handbook to Selecting and Using Small Computers

A unique introduction to the exciting world of personal computers, including:

- ★ An explanation of how they work and what they can do for you
- ★ A detailed analysis of the available systems including the BBC, Commodore and Sinclair models, examining specifications, commands, software and other vital information
- ★ How to get the most out of your computer
- ★ A step-by-step guide to programming
- ★ A complete set of over 40 programmes
- ★ Written by Tim Hartnell, the U.K.'s leading authority on small computers

Packed with ideas and fully illustrated with photographs, line drawings and information panels. **ONLY £5.95**

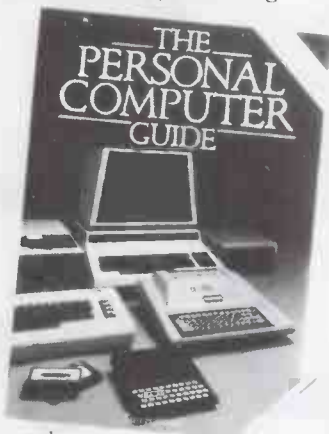

Available from all good bookshops everywhere, or by mail order (adding £1.00 to cover postage) from INTERFACE, 44/46 Earls Court Road, London W8 6EG.

## FOR YOUR MICRO COMPUTER NEEDS

- MICRO COMPUTERS
- ACCESSORIES
- PERIPHERALS
- EXTENSIVE RANGE OF SOFTWARE
- WIDE RANGE OF BOOKS & MAGAZINES
- IN HOUSE AFTER SALES SERVICE DEPARTMENT

STOCKISTS FOR APPLE, OSBORNE, NEWBRAIN ETC.

### Lion Micro Computers

**THE SPECIALISTS**

Lion House, 227 Tottenham Court Road, London W1P 0HX

Telephone: 01-580 7383 & 01-637 1601

Telex: 28394 Lion G.

Open 9 to 6 Mon-Sat



# NASCOM

## BRITISH AND BEST

### SYSTEMS

|                                   |         |
|-----------------------------------|---------|
| 48K NASCOM 3.                     | £499.00 |
| 8K NASCOM Micro Ed.               | £399.00 |
| NASCOM Single Drive.              | £470.00 |
| NASCOM Dual Drive.                | £685.00 |
| NASDOS Disc Operating System.     | £45.00  |
| CP/M Disc Operating System.       | £100.00 |
| Hitachi Tape Recorder.            | £25.00  |
| 12" Green Screen Plastic Monitor. | £99.00  |
| 12" Green Screen Metal Monitor.   | £125.00 |
| Epson MX80 F/T 3. Printer.        | £389.00 |
| TEC 1550 Printer.                 | £699.00 |

### ADD-ONS

|   |         |
|---|---------|
| Castle Tape Interface.                          | £17.50  |
| Milham A/D Converter.                           | £49.50  |
| Screen Weave Eliminator.                        | £8.75   |
| Screen Flash Eliminator.                        | £14.75  |
| Programmer's Aid.                               | £28.00  |
| Arfon Speech Board.                             | £85.00  |
| W.S. Big Ears.                                  | £45.00  |
| PMG Soundbox.                                   | £40.50  |
| CMOS 2K Ramboard.                               | £95.00  |
| CMOS 32K Ramboard.                              | £185.00 |
| I.O. Systems Pluto high res. Graphics Board.    | £399.00 |
| Colourgraphics NASCOM AVC On Demonstration Now. | £155.00 |
| RAM B 64K Upgrade                               | £30.00  |

All Prices exc. VAT.

## TWO MORE BRITISH COMPUTERS

The new Welsh Dragon 32 with colour and sound. High resolution graphics and 32K user memory.

**£199 inc VAT**

Program tapes, cartridges and joysticks available.

The very popular Sinclair ZX 81.

**£49.50 inc VAT**

Printer and program tapes also available.

We will give a generous trade in on a ZX 81. Purchased from us if you later wish to upgrade to a Dragon or a Nascom.

### NASCOM

Networking up to 32 Machines on one master.

### SOFTWARE

Over 100 items in stock covering business, educational games.

**NAS-SYS/NAS-DOS** Suppliers:-

NASCOM - applications packages.  
Dove Computer Services - polished system, software.  
Program Power - superb games and utilities.  
Mike York - extensions to BASIC.

### Business & Leisure Micro Computers

VISIT OUR GREATLY EXPANDED SHOW ROOM  
16, The Square, Kenilworth,  
Warwickshire CV8 1EB.  
Telephone: (0926) 512127.



# MicroRAPPORT

## The Relational Database System for Micro Computers

For more information or to order your copies of MicroRAPPORT just contact: Peter Barnes, Database Products Group, Logica Limited, 64 Newman Street, London W1A 4SE Telephone: 01-637 9111

MicroRAPPORT is a proven Relational DBMS for CP/M\* based microcomputers. It has an easy to use Interactive Query Language for retrieving data and formatting simple reports, a utility program for loading data and a powerful command interface for use within Fortran programs. It is a derivative of RAPPORT, the popular DBMS for mini and mainframe computers.

MicroRAPPORT can handle 16 data-base files holding up to 30 Megabytes of data. It is powerful, very efficient and proven on a wide range of machines.

# logica

\*CP/M is a trademark of Digital Research

## AMBIT's Z8--TBDS A COMMERCIAL ADVANTAGE:

A complete SBC in Eurocard format, simply understood and programmable in BASIC from any RS232 terminal

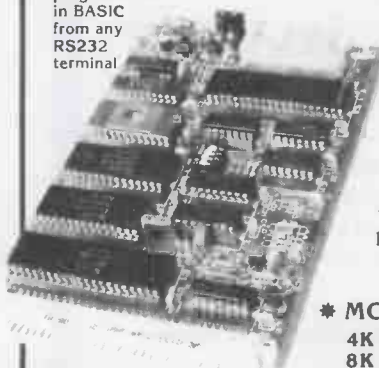

\* **MORE SPEED**  
ZILLOG Z8 - BASIC/DEBUG CPU FOR SPEEDY PROGRAMME DEVELOPMENT

\* **MORE VERSATILITY**  
RS232, 24 I/O LINES  
2 COUNTER TIMERS  
6 LEVEL INTERRUPT CAPABILITY

\* **MORE SUPPORT**  
REGULAR FEATURES IN R6EW

\* **MORE FOR YOUR MONEY**  
4K MONITOR/UTILITY SOFTWARE  
8K BYTE QUASI STATIC RAM  
EPROM PROGRAMMER

£160 built  
£140 kit  
£ 33 PSU cassette I/F built  
plus 15% VAT and 50p P/P.

\* **MORE SCOPE**      \* **MORE APPLICATIONS**  
MINIMAL CHIP CONFIGURATION CPU/LATCH/ROM EXECUTES BASIC CODE FROM POWER-UP.

## NEED WE SAY MORE?

Oh yes, and it's off the shelf, designed and made in England.

AMBIT INTERNATIONAL, 200 North Service Road, Brentwood, Essex CM14 4SG.  
Telephone No. (0277) 230909 Telex: 995194

## 256K RAM CARD

FOR NASBUS / GEMINI 80 SYSTEMS

### NEW MAP 80 SYSTEMS

8x8 CARD WITH MEMORY ARRANGED IN FOUR 64K BLOCKS.

VERSATILE PAGE MODE OPTIONS OR MORE EXTENSIVE MEMORY MAPPING FACILITIES

GUARANTEED OPERATION AT 4MHZ WITHOUT WAIT STATES.

SOFTWARE SUPPORT AVAILABLE FOR CP/M VIRTUAL DISK.

MEMORY PROVIDED IN FOUR SIZES WITH UP TO 256K BYTES ON EACH CARD.

THE PRICE FOR THE MINIMUM CONFIGURATION CARD OF 64K IS £150 + carr. + vat. INCLUDING ALL NECESSARY DECODING FOR FURTHER EXPANSION.

MAP 80 SYSTEMS  
333, Garratt Lane, London SW18  
Tel: 01-874 2691



WORD PROCESSING  
SALES LEDGER  
NOMINAL LEDGER  
PURCHASE LEDGER  
FINANCIAL MODELLING

BUSINESS  
COMPUTERS  
COMPUTERS  
COMPUTERS  
COMPUTERS  
COMPUTERS  
COMPUTERS

**AUTOFILE** offer the **SIRIUS 1**, the powerful 16-bit micro-computer

**AUTOFILE** supply a range of packaged software:

- MICRO-MODELLER — Financial Modelling
- PULSAR — Business Accounting
- SUPERCALC — Electronic Worksheet
- WORDSTAR — Word Processing
- SPELLSTAR — Spelling Check
- MAILMERGE — Direct Mailing

**AUTOFILE** has a team of programmers to cater for your individual requirements.

**AUTOFILE** will understand your needs and provide a solution to fit your application — and your pocket.

**AUTOFILE** with **SIRIUS 1** offer a new approach to micro-computers.

AUTOFILE LIMITED  
799 WESTON ROAD  
SLOUGH  
BERKSHIRE  
SL1 4HR

SLOUGH (0753) 75772

AUTOFILE  
AUTOFILE  
AUTOFILE  
AUTOFILE  
AUTOFILE  
AUTOFILE  
AUTOFILE

Send to: Autofile Limited, 799 Weston Road, Slough, Berks SL1 4HR.

Please send me more information on Sirius I, the powerful, 16-bit microcomputer.

Please send me information on your range of packaged software

Name \_\_\_\_\_ Position \_\_\_\_\_  
Company \_\_\_\_\_ Telephone \_\_\_\_\_  
Address \_\_\_\_\_

# village computer services



**We are very proud to announce that  
we are now dealers for the superb  
IBM PERSONAL COMPUTER.**



At £2,950 it now comes as standard with 64K Ram (expandable to 512K), 40K Rom, Twin 320K Disk Drives, PC-DOS, Basic, and Parallel Interface. We also sell Visicalc (256K version), Wordstar, Mailmerge and the SYSTEMATICS INTERNATIONAL Integrated Ledger System for the IBM PC. Please call Jeremy Ensor for a demonstration but hurry!

**The West London Microcentre,  
6 Pavilion Parade, Wood Lane, London W12 0HQ.  
Telephone: (01)-743 9000**

## VIDEO GENIE and TRS80

**THE ROM-VIDEO GENIE & TRS 80  
(3 ROM Models)**

*Are you fed up of loading a lower case drive every time you switch on? - Want your name inside your computer - Better loading (TRS80) - Sick of bouncy keyboards-s!*

*You need our new ROM—simply remove old—plug in new.*

- 1) Firmware driver for lower case
- 2) Security code displays—(your name & post code?)—up to 21 characters
- 3) Improved tape loading
- 4) Alleviates repeating characters (key-bounce)
- 5) Checks for feature ROMS

**£14.95 + VAT + P&P (80p)**

**FEATURE ROMS** £18.95 + VAT + P&P (80p)

**A series of ROMS starting with FEATURE 'A'**

- 1) Single keystroke commands e.g. Shift A = Auto etc.
- 2) Flashing cursor (can be toggled on/off)
- 3) Repeating characters—with delay—(toggle)
- 4) Machine code monitor and editor
- 5) System load and save for backing up those system Programs—uses no RAM and so can deal with a FULL 16K program

### NEW

**FEATURE 'B'**—extended basic

- 1) Merge—two basic programs to one
- 2) Renumber
- 3) Screen print
- 4) Various basic tools PLUS

Access and Barclaycard accepted.

## General Northern Microcomputers (GNOMIC)

46 Middle Street, Blackhall, Hartlepool, Cleveland. Tel. Peterlee (0783) 863871

### Plug on for feature ROMS

Now you can simply plug on the back of your computer, insert ROM and away you go.

**VG £29.95 inc. ROM A OR B + VAT + P&P TRS80 £34.50 + VAT + P&P (80p)**

**48K RAM**—internal  
**TRS80 & VG £43.50 + VAT + P&P (80p)**  
Plug in our modules. Connect three wires (VG) or five (TRS80). You are not required to piggyback chips. Keep your old RAM (or sell it!). Compatible with expansion.

### LOWER CASE HARDWARE (VG & TRS80)

Unplug two IC's, plug in two modules, connect three wires—EASY! £19.00 + VAT + P&P

### BOOKS

"Disassembled Handbook for TRS80"—A Self Teach—Series of Books—Written by Bob Richardson of New York. Very well received by U.S. Reviewers, **Essential Reading** for TRS80, Video Genie & Radio Hams.

Vol. 1 Decoding the ROM & Calls, etc. **£6.45**

Vol. 2 Using Calls, to shorten programs, etc. **£8.75**

Vol. 3 DiA—AD, Spooling, etc. **£10.50**

Vol. 4 Teletype, Morse Techniques **14.50**

Vol. 5 Voice Systems **TBA**

+ Much else in each volume.

Various Books—Lists on application.

+ VG—Expansion—Disk Drives—Printers, etc.

Details on application.

### EPSON PRINTERS

**MX80T Type III**

**£285 + CARR. + VAT (Cash/Chq. only)**

**M x 80 FT II**

**£315 + CARR. + VAT (Cash/Chq. only)**

### WBATH

5.25 SSSI) Floppy Disks

including FREE library case

£16.00 per ten + V.A.T. + 80p P&P

## COMPUTERS WITH CP/M FROM MICROTEK

The SHARP PC-3201 is a versatile Business Computer which handles everything from Business to Technical computation. It features sophisticated screen performance with disk storage from 600K to 2 Megs, the software available includes CP/M accounting functions, Payrolls and specialised programs. Full system £2850 + VAT.

The SHARP MZ-80A is a new compact personal computer that we modify to give an 80 column screen. The CPT, keyboard and cassette based data storage are incorporated in one complete system. Ideal as a CP/M Business system. From £475 + VAT.

The NORTH STAR ADVANTAGE is a powerful integrated graphics computer with two 360k floppy drives 96k, 280 CPU, 8Key electric-style keyboard and CP/M, al within its case. From £2095 + VAT.

We write programs for particular purposes to order. Our own CP/M packages include several for solicitors time recording, client data base, local government, estimating, accounting etc.

For further details write or ring:

**MICROTEK**

15 Lower Brook St. Ipswich Suffolk IP4 1AQ  
tel. Ipswich (0473) 50152/52466

where software meets hardware



### GAMES PACK

Beat this for value! Five 16K programs Plus two 1K programs

- 3-D Battle (Micode - 1K)
- City Bomb (Micode - 1K)
- Warp Wars (Basic & Micode - 16K)
- Snake (Basic 16K)
- Sweet Tooth (Basic & Micode - 16K)
- Sialom (Basic 16K)
- Black Holes (Basic 16K)

**ALL ON ONE CASSETTE FOR ONLY £4.95 (\$9.90)**

### NEW GRAPHICS TOOLKIT

(another masterpiece by Paul Holmes)

22 exciting MACHINE CODE routines that give you control over your screen as never before!

**(ZX81 - 16K RAM ONLY)**

Draw/Under draws or deletes your multi-character shape which is defined in a REM statement.

Foreground On/Off use this to 'protect' existing characters on your screen.

Border/Unborder draws a border round the edges of your screen area. Edit lines can be used if required.

Fill fills any number of lines you specify, starting at any line you specify, by your chosen character.

Reverse converts all characters to their inverse video, control as in FILL.

Print Position Controls UP, DOWN, LEFT, RIGHT. Alter your next PRINT position in the direction indicated.

Editprint moves next PRINT position to first edit line.

Scroll Facilities UPSCROLL, DOWNSCROLL, RIGHTSCROLL, LEFTSCROLL. Scroll your screen in the direction indicated.

Onscreen/Offscreen turns your screen on or off.

Background On/Off fills your screen by your specified character.

An ESSENTIAL addition to your 16K RAM ZX81

### TOOLKIT

(written by Paul Holmes)

Provides the following additional facilities:

Line renumber - you state starting number and increment value. GOTO's and GOSUB's included in line renumber.

Search and List - searches for and lists every line containing specified character.

Search and replace - changes every occurrence of a character as you require.

Free space - tells you how many free bytes you have left.

### NEW BATTLESHIPS & CRUISERS GAME

(16K - ZX81)

First computer version of this popular game of strategy and tactics. Both grids on view together. Establish the position of your fleet then locate and destroy the computer's fleet. Visual display shows hits and misses made and gives running score.

**ONLY £4.95 (\$9.90)**

Search and Replace will search the screen for every occurrence of the character you specify and replace it with your new character.

Square draws a square or rectangle from your specified co-ordinates.

All these routines are in machine code for SUPERFAST response! GRAPHICS TOOLKIT uses only 2K of your RAM and that includes space to load the programmers TOOLKIT described above.

**ALL FOR ONLY £5.95 (\$11.90)**

This includes a cassette with 2 copies of the program, 2 copies of a demonstration program plus a comprehensive instruction booklet with examples. All prices are fully inclusive.

### SPECIAL GRAPHICS ROUTINES

Hyper graphics mode - graphics never seen on a ZX81 before.

Fill - fills your screen instantly with your specified character.

Reverse - changes each character on your screen to its inverse video.

TAPE ROUTINE - provides a system WAIT condition until a signal is received in the cassette ear jack.

All these routines are written in machine code and together take up only 1K of your precious RAM - an incredible achievement!!

**FOR 16K ONLY £4.95 (\$9.90)**

As reviewed in 'Your Computer' March 1982

### 16K RAM PACK

**ONLY £26.50 (\$49.95)**

Quite simply the best available plus FREE 'Alien Attack' (7K-Micode) on cassette - Value £5.75 (\$11.00).



Fully built tested and guaranteed. Uses existing power supply (min. 600 m.a.) Compatible with printer.

No wobble problems. Gold plated edge connector for perfect contact with your ZX81. Normally despatched within 10 days of receipt of your order.

With advances in microtechology we are now able to offer the

### 64K RAM PACK.

Same quality as the 16k but giving massive memory to your ZX81, with external dimensions no larger than the 16K RAM Pack (above).

**ONLY £62.95 (\$119.95).**

### SINCLAIR COMPUTERS

We are the leading world-wide Sinclair export specialist including Norway, Sweden, Finland and Denmark. Write for our surprisingly low prices.

### PRINTERS



Buy any of the below and get a free interface kit and word processor program for UK101 or Superboard. Seikosha GP100A £199. OKI Microline 83A £446. OKI Microline 84A £799. OKI Microline 80 £235. OKI Microline 82A £333. Epson MX70T £269. Epson MX80T/3 £319. Epson MX80F/T3 £349. Epson MX100/3 £429.

### VIC 20 COMPUTER

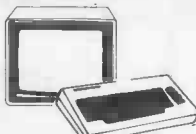

Two special offers: - If it is bought with the Vic 20 we can supply the cassette recorder for £30.43. Alternatively we will supply a free kit with each Vic 20 to allow the use of an ordinary cassette recorder. Vic 20 £155. Ordinary cassette conversion kit £6. Vic 20 cassette recorder £36.50. High resolution cartridge £27.95. Machine code monitor £27.95. Vic printer £175.

Ram cartridges:- 3K £24, 8K £35, 16K £57. Game cartridges:- Sargon II £19, all others £15 each.

Joystick £6.52. Intro to Basic Part 1 £13. New low cost memory board, no need for a mother-board, comes with 3K Ram on board - socket for a Ram + sockets for another 24K of low current Nmos Ram. (Just plug in chips to expand memory) £49. 27K version £109. Extra memory chips £6 per 2K.

### UK 101 AND SUPERBOARD

32x48 display expansion kits UK101 £9, Series 1 Superboard £14. Guard band kit for Superboard only £10. The below accessories suit both the UK101 and Superboard:- Extra RAM £2-10 per K. Cegmon £22-50. Wemon £14-95. Word processor program £10. Centronics interface kit £10. 610 expansion board £179. Cased mini-floppy disc drives with DOS single £275, dual £415.

### NEW GENIE 1 £299

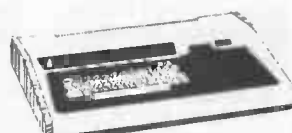

Genie 1 16k £299, 48k £330, EG3014 expander box 16k £179, 32k £189. Minifloppy disc drives single £199, dual £369. Double density converter £72. Parallel printer interface £36. High resolution graphics unit £82.

### SHARP COMPUTERS

We can supply any Epson MX80 printer to run direct from the MZ80K (I/O box not needed) for £39 plus printer price. We also specialise in interfacing printers to the MZ80K, MZ80A and MZ80B both with and without the I/O box.

### 5V POWER KITS

Fully stabilised 5V computer and TTL power kits. Short circuit and over-voltage protection 1.5A £7.83, 3A £12.17, 6A £20.87

Postage £3.50 on computers, £4.50 on printers and 50p on other orders. Please add VAT to all prices. Official credit and overseas orders welcome.

## SWANLEY ELECTRONICS

Dept PCW, 32 Goldsel Rd, Swanley, Kent BR8 8EZ  
Tel Swanley (0322) 64851

OVERSEAS CUSTOMERS PLEASE NOTE: ALL PRICES ARE APPLICABLE FOR EXPORT, INCLUDING AIRMAIL POSTAGE. PAYMENT MAY BE MADE IN STERLING (MONEY ORDER NORMALLY AT YOUR BANK) OR YOUR OWN U.S. \$ CHECKS. MADE PAYABLE TO JRS SOFTWARE. DESPATCH AVAILABLE 7 DAYS FROM RECEIPT OF ORDER.

**JRS SOFTWARE**

19 WAYSIDE AVENUE, WORTHING, SUSSEX. BN13 3JU Telephone: (0903) 85891

# Software for TRS80®

SCHOOL DATABASE

CLASSES) PUPIL(S)

2A

UNZULY DATA?

Master it with

**ELECTRIC ENOTE Book**

Amies, Maths

MAIN SUBJECT PHYSICS

ENGLISH

MATHS

Subject(S)

Catford

TIME(S)

LESSON(S)

You name it... ENB can tame it!

The All-Purpose Data Manager for TRS-80 £69.95  
Minimum System-48K, 1 DISK, Mod I or III, or Video Genie

**southern  
software**

PO Box 39, Eastleigh, Hants, England, SO5 5WQ

## MIDWICH HAS MOVED! OUR PRICES HAVE TOO — DOWN!

### MEMORIES \*\*NEW LOWER PRICES\*\*

|                      |      |                 |      |
|----------------------|------|-----------------|------|
| 2114 Low Power 200ns | 0.80 | 4116 200ns      | 0.70 |
| 2708 450ns           | 2.79 | 4116 150ns      | 1.10 |
| 2716 450ns (5V)      | 2.10 | 4118 150ns      | 3.38 |
| 2716 350ns (5V)      | 3.59 | 4164 200ns (TI) | 4.65 |
| 2716 450ns (3 rail)  | 5.95 | 4816/4516 100ns | 3.25 |
| 2732 450ns           | 3.90 | 5516 200ns      | 9.38 |
| 2732 350ns           | 4.40 | 6116P3 150ns    | 4.30 |
| 2532 450ns           | 3.60 | 6116LP3 150ns   | 5.75 |

### BBC MICRO UPGRADE KITS \*\*NEW LOWER PRICES\*\*

As some parts are still in short supply please check availability before ordering.

|        |  |       |
|--------|--|-------|
| BBC 1  | 4516/4816 x 8 100ns                                  | 25.50 |
| BBC 2  | Printer/User I/O kit (IC69, 70 + PL9, 10)            | 8.00  |
| BBC 4  | Analogue input kit (IC73, 77 + SK6)                  | 6.70  |
| BBC 5  | Serial I/O and RGB kit (IC74, 75 + SK3, 4)           | 11.45 |
| BBC 6  | Expansion bus and tube kit (IC71, 72, 76 + PL11, 12) | 6.25  |
| BBC 21 | Printer cable complete                               | 13.00 |
| BBC 22 | Connector for user port with 36" cable               | 2.00  |
| BBC 44 | Analogue input plug with Cover                       | 2.25  |
| BBC 55 | 5 and 6 pin DIN plugs for Serial I/O and RGB input   | 0.99  |
| BBC 66 | Connector for Bus port with cable                    | 3.50  |

VISA

24 Hour Telephone order service for credit card holders.  
All prices exclude VAT and carriage (0.75 on orders under £10 nett)  
Official orders from educational and government establishments, and public companies accepted. Credit accounts available to others (subject to status).  
All orders despatched on day of receipt. Out of stock items will follow on automatically at our discretion or a refund will be given if requested.  
NO SURCHARGE FOR CREDIT CARD ORDERS



## MIDWICH COMPUTER CO LTD

Dept PCW, Rickinghall House, Rickinghall, Suffolk IP22 1HH  
Telephone (0379) DISS 898751

Please make a note of our new address  
& telephone number

# Software for all

72 NORTH STREET, ROMFORD, ESSEX. TEL 0708 60725

Announce the launch of their  
range of **BBC** programs

**Grand Prix** For Model B only.  
Time Trials around our race track. Includes computer controlled car to hinder your progress. 9 levels of difficulty £5.95

**BEEBTREN**  
For Model A or B, real time advanced Startrek Game. Extra facilities include "probe satellites" "damage reports" & "on-board computers". £7.95

**J.R.** For Model B only.  
Two player game, features include, exploration, drilling, employment and price wars. £6.95

**INVADEERS** For Model A or B.  
Classic Arcade game. With colour & sound. £6.95

**Paralander VIC-20**  
For unexpanded model, graphics and sound are incorporated into this absorbing battle between you (the dare-devil) and the elements. £4.50

**Programmers** We are looking for good quality programs covering games, utilities & education. We pay excellent rates. Please write or phone us on (0708) 60725. Dealer enquiries welcome.

## Attention Dragon Owners! Software Coming Soon!

We're only a few minutes from your Post Box.  
So why not try our mail order service.

**GHOST MAZE** For Model B  
Our own version of this popular Arcade game With colour and sound. 9 levels of difficulty. £6.95

**Cobra/Robo-Swamp**  
For A or B (please state version required). Two addictive games — insomniacs delight! £6.95

**DATABASE** For Model A or B  
Accepts up to ten definable fields. Facilities includes Quick Search, sort and Hard copy — capable of storing up to 300 complete records in memory (Model B). £9.95

**Character Generator**  
For Model B only. Useful utility program enables user to re-define character set using Mode 4. displays new character in graph form. £4.95

**ZX Spectrum Disassembler** Useful Utility Programme £4  
Fits in 16K.

NAME ..... Please send me: Add £1 p&p per order.  
ADDRESS ..... £  
..... £  
..... £  
..... £  
I enclose cheque/P.O. for £.....  
OR  
Please debit my Access/Barclaycard No. ....  
72 North Street, Romford, Essex.  
Tel: Romford (0708) 60725

Available in  
KENT & SUSSEX  
NOW



## ACT SIRIUS 1 16 BIT MICRO

*with wide range of application software*

THE DATA PROCESSING COMPANY  
Burton House, 69 Sandgate Road, Folkestone,  
Kent. Tel: (0303) 41618

### ■ The New Range of Software

■  
designed for management  
assessment development and  
training

■  
stand 302

■ Ulster Management Centre ■

## The '6809' centre

The FLEX 9 Operating System for '6809' Based Micro-Computers.

This disk operating system is now the standard single user system for machines using the powerful '6809' micro.

Having many advantages over similar operating systems for other micro-computers, this system can now be run on many different '6809' based machines.

Furthermore, the Configurable Version is available for implementation on custom '6809' computers.

Programs written to run with this operating system are almost completely machine independent, thus allowing the easy transfer of software.

There is a wide range of software available for this system, some of which is listed below. Please send for our full list.

|  |        |         |
|--|--------|---------|
| DRAGON 32,6809 based 32k colour computer | EX VAT | INC VAT |
|  | 173.04 | 199.00  |

### '6809' HARDWARE, RUNNING FLEX9.

|  |         |         |
|--|---------|---------|
| Convert your APPLE II to FLEX—with the new EXCEL—9 '6809' board. Complete with FLEX9 on 5 1/4" disk.                     | 181.74  | 209.00  |
| APPLE II, with EXCEL—9 Board, 48K RAM, 40 x 24 Video Output, two 5 1/4" disk drives, with 240 Kbyte capacity, with FLEX9 | 1549.57 | 1782.00 |
| FUJITSU MICRO—8, with 64K RAM, colour graphics on 14" screen, two 5 1/4" disk drives with 656 Kbyte capacity, with FLEX9 | 2346.09 | 2698.00 |
| SWTPC S/09, with 64K RAM, 12" intelligent terminal, two 5 1/4" disk drives with 740 Kbyte capacity, with FLEX9           | 3338.26 | 3839.00 |
| STIRLING 77—68 KIT, based on 8" x 8" bare PCB's, now with 64K RAM, and Disk Controller for 5 1/4" or 8" Disks.           |         |         |

Send for further details on any of these systems, or their component parts.

### SOFTWARE—6800 & 6809—on Cassette—300 Baud, CUTS, S1 Format.

|   |        |        |
|---|--------|--------|
| 6800 Disassembler, with Move function,            | 10.00  | 11.50  |
| 6800 Text Editor, with Source Listing,            | 28.00  | 32.20  |
| 6800 Assembler, with Source Listing,              | 28.00  | 32.50  |
| 6800 Text Processor, with Source Listing,         | 28.00  | 32.50  |
| 6800 Relocator, with Source Listing,              | 16.09  | 18.50  |
| 6800 8K Basic Interpreter (V2.3),                 | 15.22  | 17.50  |
| 6809 Text Editor, Cassette to Cassette,           | 32.61  | 37.50  |
| 6809 Macro Assembler, Memory to Cassette,         | 32.61  | 37.50  |
| 6809 10.5K Basic Interpreter,                     | 48.70  | 56.00  |
| FLEX9, 6809 Disk Software, on 5 1/4" or 8" Disks. |        |        |
| Configurable FLEX, with Text Editor & Assembler   | 120.00 | 138.00 |
| Sort/Merge Package, with File Editing Facilities  | 48.70  | 56.00  |
| Debug Package, a complete 6809 Simulator          | 48.70  | 56.00  |
| Disk Utilities, Additional Commands for FLEX      | 48.70  | 56.00  |
| Text Processor, for Text Formatting               | 48.70  | 56.00  |
| Text Editor & 6800/6809 Macro Assembler           | 69.57  | 80.00  |
| Disk & Memory Diagnostics, Further FLEX Commands  | 48.70  | 56.00  |
| Extended Basic, Advanced Business Basic for 6809  | 62.61  | 72.00  |
| Extended Basic Pre-Compiler, for Extended Basic   | 32.61  | 37.50  |
| Pascal, 6809 Machine Code Compiler                | 130.43 | 150.00 |
| 6800 Cross Assembler, runs on 6809 under FLEX     | 173.91 | 200.00 |
| RMS, A Record Management System for 6809          | 145.22 | 167.00 |
| Tabula Rasa, Financial Reporting Package          | 120.00 | 138.00 |
| Stylograph, The Complete Word-Processing Package  | 173.04 | 199.00 |
| Micro-Modeller, Now Available for FLEX9           | 694.78 | 799.00 |
| DYNACALC, the Spreadsheet Program for FLEX        | 140.00 | 161.00 |

FULL RANGE OF APPLE II EQUIPMENT ALWAYS IN STOCK, RING FOR PRICES.

MAIN LONDON DEALER FOR SHARP MZ-80A. 477.39 549.00

- Come and try any of our systems or make use of our mail order service.
- All prices include carriage charges within the mainland UK.
- All prices are correct at time of going to press and subject to availability.
- Send for our latest price list and catalogue covering our vast range.
- Further information is available on all the products listed, send for details.
- Store opening hours—9.30 to 5.30—Monday to Saturday—Access & Visa.
- STIRLING MICROSYSTEMS LTD
- THE '6809' HARDWARE & SOFTWARE STORE.

# STIRLING MICROSYSTEMS

241 Baker Street, London NW1 6XE.  
Telephone: 01-486 7671.

# GHOST GOBBLERS! YUGDAB FIGHTERS! 2 GREAT NEW ARCADE GAMES FOR YOU

NEW! From Cornsoft

NEW! From Cornsoft

**Scarfman**  
WITH SOUND!!

**BOTH GAMES CAN  
BE PLAYED WITH OR  
WITHOUT THE MICRODEAL  
JOYSTICK  
SEND FOR DETAILS**

**Space  
Castle**  
WITH SOUND!!



America's latest Arcade craze. Its Eat or be Eaten. You control SCARFMAN around the maze, gobbling up everything in your path. You attempt to eat it all before the monsters devour you. Available from your local dealer or **£11.95**

Both Games Tandy Model 1 or 3 Level 2 and Video Genie Cassette 16K

**SPECIAL OFFER**  
Both Games for Just  
**£22**  
Both Games **£40**  
+ Microdeal Joystick

Prices include V.A.T. & Postage

See us at the PCW show on Stand 280

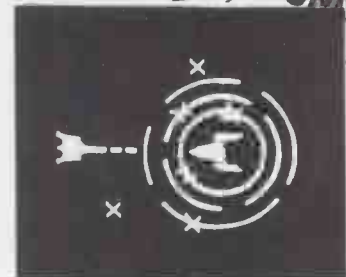

Will you save the Andromeda Galaxy by destroying the space castle or will the evil warlord Yugdab continue to rule unmolested? Locked in battle with Yugdab your main defence is your ability to skillfully handle your ship. **£11.95**

## MICRODEAL

**DEAL HOUSE, BRIDGES, BODMIN  
CORNWALL PL30 5EF TEL: 0726 850821  
DEALER ENQUIRES WELCOME**



Are you ready for

# Cosmic Guerrillas

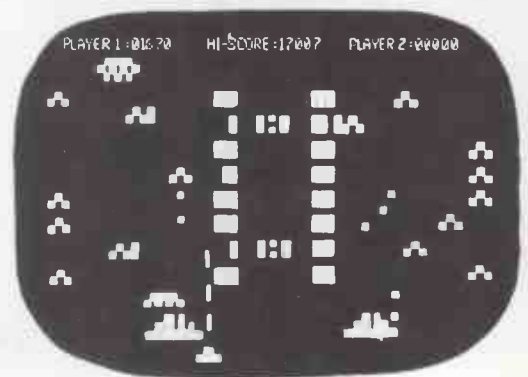

It is totally different from any other arcade type game for the action is in two entirely different sections of the screen at the same time. Just like the real arcade game of the same name.

And it is fast, very fast. The speed of both the bombs dropping and your own firing requires quick responses indeed.

The aim is to protect your two bases in the middle of the screen from guerrilla attacks. This is hard, for they come at you from both sides of the screen at the same time, knocking out and removing your defences until they get the base. You defend by firing at the guerrillas as they attack. Not so easy though for they rain down bombs whilst moving across. Then there is the high flying attacker bombing you as well. And if this isn't enough, there's a low flying attacker too, which keeps changing direction when you least expect!

That's not all, for the guerrillas not only move randomly across the screen but at random speeds as well. Which means whilst you may be busy tracking one ambling across, another will suddenly zip away at your defences.

For once and for all the problem of levels of play has been solved. Cosmic Guerrillas simply gets harder and harder until eventually you are not fast enough anymore. Sound of course.

A sensible £9.50 Vat and post paid

FOR TANDY TRS-80 and VIDEO GENIE. Return first class post service guaranteed. Credit card holders ring in your order before 4pm for delivery tomorrow! Or use our 'after hours' ordering service for delivery by first available post. Full descriptive catalogue available upon request. All Kansas software carries an unconditional guarantee (So if it fails in five years it will still be replaced--free!).

# Kansas

Kansas City Systems, Unit 3, Sutton Springs Wood, Chesterfield, S44 5XF. Tel. 0246 850357

*It's here!*

# **The new XEROX 820 micro-computer system**

Budgeting-Planning-Forecasting-Wordprocessing etc.

A brilliant new development specifically designed for the decision making businessman. And his pocket. Made by Xerox the 820 is one of the most inexpensive and versatile computers on the market. And you can keep adding to the system from a wide range of software options.

Also you can have the full backing of the Rank Xerox on-site, full service and maintenance agreement, so you can buy in total confidence.

So if you're a businessman looking for a superb micro-computer system, come along and see the new Xerox 820.

XEROX 820



Now that you've read this advertisement, perhaps you would like to see the computer in action. We, at Cream Computers, are not here to push computers down your throat, in fact, we are here to guide you towards the best system that you can buy. When you've decided that you want a computer but you can't see exactly what you want to come to Cream. It's as simple as that We'll even show you and your employees how to use the computer so that it can become one of the staff as quickly as possible.

Call us at:

**Cream Computers**

**380 Station Road Harrow, Middlesex HA1 2BE on 01-863 -0833**

**RANK XEROX**

COMPUTER

**AUTHORISED DEALER**

Xerox and Rank Xerox are Registered Trade-Marks of Rank Xerox Limited



# THE ACT SIRIUS 1 WITH



## JARMAN ACCOUNTING SOFTWARE

is available now from Logic Computer Systems

- Sales Ledger with Invoicing
- Purchase Ledger with Costing
- Nominal Ledger with Cash Book and Budgetary Control
- Payroll and Personnel Records
- Stock Control

Jarman high quality intergrated accounting software, already available on other microcomputers, now realises the full potential of the Sirius 1.

For more information call us on (01) 222 1122 or 5492 to-day.

**The only serious choice for business**

### LOGIC COMPUTER SYSTEMS

31 PALMER STREET, LONDON SW1H 0PR

(01) 222 1122 or 5492

LOGIC COMPUTER SYSTEMS specialises in the application of Microcomputers for business. Our services include systems development, installation, training and support. Please call for an appointment to discuss your requirements and to arrange a demonstration.

### Microcomputer Training Courses in Guernsey

Free software with your holiday course



**EXAMPLE:**  
Write your own turnkey control program in 1½ hours then take it home with you FREE!

Your chance to gain an insight into the ultra-modern world of the self-programming microcomputer in the fascinating Channel Island of Guernsey.

Call or write NOW for details of our VAT free comprehensive, high-speed 'do-it-yourself' courses. We have something for everyone whatever your age or background. Using VISICALC and CORP or CODEWRITER program generators we interface you right away with Apples or Pets... one machine per student. Learning is entertaining! After a few hours you will be writing professional suites of programs with our amazing new program generators now selling worldwide. Part time courses are available day or evening for business, scientific, educational and hobbyist applications. Accommodation and travel arranged as required at reasonable rates.

Book now with     
Further details from:-  
DYNATECH MICROSOFTWARE LTD.  
Microcomputer Training Centre,  
Summerfield House, Vale, Guernsey,  
Channel Islands.  
Tel: 0481 47377, Telex: 4191130.

The 5th Personal Computer Show World STAND 456

## NASCOM

### Special Offer from SRS!

We have the last of the makers stocks of the

**NASCOM IMP**  
Serial Printer with imprint  
(Graphics ROM)



(Previous price before being discontinued £325 + VAT)

GREAT VALUE!

ONLY  
**£199.95**  
EX. VAT

## apple C.O.R.P.

Come & see the complete APPLE II system with C.O.R.P. program generator. It's incredible — now anyone can write what they require and C.O.R.P. will work out the program for you — call into our new store at Watford and see it for yourself.

We are pleased to advise our customers that we are members of the SPECTRUM COMPUTER GROUP and can supply all the items featured in SPECTRUM'S ad's in THIS issue.

**spectrum**



### SRS MICROSYSTEMS

94 The Parade, High Street, Watford, Herts.  
Telephone (0923) 26602

You'll value our experience, you'll value our prices, free Securicor delivery or post on orders over £50. Access & Barclaycard welcome. Hire purchase and part exchange available E. & O.E.



# “The Apple ][ is limited to 64K RAM...”

(...EXPERT c.1981)



## “Rubbish, the fact is ...”

... my Apple ][ has  
**128K** <sup>①</sup>  
and I run  
80K Visicalc Models”  
(P.A. TO M.D.)



... my Apple ][ has  
**192K** <sup>②</sup>  
and I run  
128K Basic Programs”  
(PROGRAMMER)



... my Apple ][ has  
**320K** <sup>③</sup>  
and I manipulate  
arrays of up to 250 x  
250 elements in RAM”  
(BOFFIN)



Yes the Apple ][ once again shows its versatility – just add U-RAM 16, 32 or 128K RAM boards to your Apple with appropriate software and you can have the capabilities the other manufacturers only dream of.

① Basic Apple with one U-RAM 32. ② Basic Apple with one U-RAM 16 and one U-RAM 128. Chained program. ③ Basic Apple with one U-RAM 16 and two U-RAM 128.

## U-MICROCOMPUTERS

a range of quality peripheral cards to enhance your Apple

We now make more Apple cards than Apple!

### PRICE LIST

#### Boards

|                            |         |
|----------------------------|---------|
| U-RAM 16- 16K RAM board .. | £65.00  |
| U-RAM 32- 32K RAM board .. | £85.00  |
| U-RAM 64- 64K RAM board .. | £180.00 |
| U-RAM128-128K RAM board .. | £275.00 |

#### Software

|  |        |
|--|--------|
| Memory Manager 16 (MMS 16)                       |        |
| DOS relocater for U-RAM16 ..                     | £15.00 |
| Versa MMS (VMMS)                                 |        |
| DOS relocater for other boards                   | £15.00 |
| Versa Visi expand (VVE)                          |        |
| Versatile Visicalc expansion* ..                 | £50.00 |
| Versa RAM disc (VRD)                             |        |
| Versatile disc emulation software DOS 3.3* ..... | £50.00 |

\*Work with U-RAM16, 32, 64 and 128, and multiple and mixed boards.

Prices exclude VAT.  
Order from your local dealer.



# ZX Spectrum

## 20 Programs £6.95

The ZX Spectrum has brought advanced computing power into your home, The Cambridge Colour Collection, a book of 20 programs, is all you need to make it come alive.

**No experience required.** Simply enter the programs from the book or load them from tape (£2.95 extra) and run.

**Amazing effects.** All programs are fully animated using hi-res graphics, colour and sound wherever possible.

**Entirely original.** None of these programs has ever been published before.

**Proven Quality.** The author already has 30,000 satisfied purchasers of his book of ZX81 programs.

### Hours of entertainment

- **Lunar Landing.** Control the angle of descent and jet thrust to steer the lunar module to a safe landing on the moon's surface.
- **Maze.** Find your way out from the centre of a random maze.
- **Android Nim.** Play the Spectrum at the ancient game of Nim using creatures from outer-space.
- **Bjorhythms.** Plot the cycles of your Emotional, Intellectual and Physical activity. Some would say this is not a game at all.

### Improve your mind

- **Morse.** A complete morse-code training kit. This program will take a complete beginner to R.A.E. proficiency.
- **Maths.** Adjustable to various levels, this program is an invaluable aid to anyone trying to improve their arithmetic.

### Run your life more efficiently

- **Home Accounts.** Keeping track of your finances with this easy-to-use program will enable you to see at a glance where the money goes and plan your spending more effectively.
- **Telephone Address Pad.** Instant access to many pages of information.
- **Calendar.** Displays a 3 month calendar past or future, ideal for planning or tracing past events.

### ORDER FORM:

Send Cheque or P.O. with order to:-  
Dept. B., Richard Francis Altwasser, 22 Foxhollow, Bar Hill,  
Cambridge CB3 8EP

Please send me

- Copies Cambridge Colour Collection Book only £6.95 each.  
 Copies Cambridge Colour Collection Book & Cassette  
£9.90 each

Name: \_\_\_\_\_

Address: \_\_\_\_\_

# SIRIUS 80 CARD

## CP/M 80 for the Sirius 1

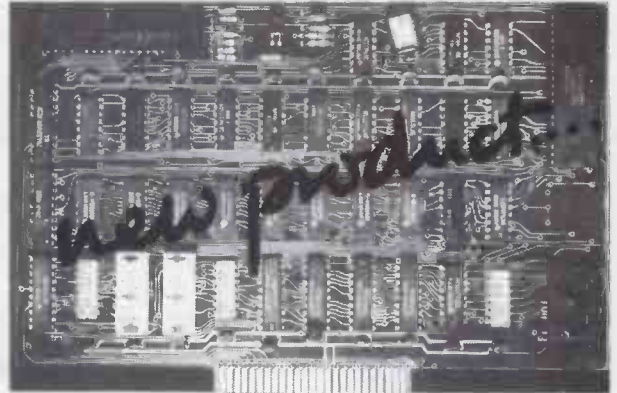

- Allows all standard CP/M 80 2.2 software to run without modification.
- The card simply plugs into any one of the four internal expansion slots and comes complete with a disk containing all the usual CP/M utilities.
- By typing a single command, the system can alternate between CP/M 80 and CP/M 86. Files generated under either CP/M are identical in structure, providing file compatibility between operating systems.
- The card also has a Corvus hard disk interface allowing the CORVUS range of Winchester drives to plug directly into the SIRIUS. The drives can be accessed under CP/M 80 or CP/M 86.
- Includes "drive M" disk drive utility. This software enables you to access extra RAM cards in the system as a very fast CP/M pseudo disk drive.
- Z80 4 or 6 MHz with no wait states.
- 64K RAM
- Corvus hard disk interface.
- Multi-user with hard disk:-
- Up to 64 Sirii can share 1 hard disk

Sirius 80 card (4 MHz)..... £299.00  
Sirius 80 card (6 MHz)..... £335.00



All prices are ex VAT

**small systems engineering limited**

2-4 Canfield Place, London NW6 3BT. Telephone: 328 7145 Telex 264538

# Portable Computers + Free Software

**SHARP COLOUR GENIUS**



ONE OF THE MOST POWERFUL  
POCKET COMPUTERS ON EARTH

PRICES including VAT  
PC1500 COMPUTER £169.95  
plus FREE £20 software voucher  
CE 150 PRINTER £149.95  
plus FREE £20 software voucher  
CE 151 4K RAM MODULE £49.95  
plus FREE 10 software voucher

CE 155 RAM MODULE £79.95  
plus FREE £10 software voucher  
Vouchers on request with order  
CSR 150 20x paper rolls £5.84  
EA 850B Set of black pens £3.09  
EA 850C Set of colour pens £3.09

PC-1500 Up to 11.5K user memory (3.5K internal + add-on 4K CE-151 or 8K CE-155) maintained during power-off and battery change.

16K Extended BASIC language (PLUS CE-150 8K Graphics BASIC).

CE-150 FOUR colour high resolution (500 x 200) printer/plotter with 9 type sizes and 4 print directions.

Two cassette control, for bulk data & program storage, with remote control. Full range of science and math functions (statistics with MICROL software).

Up to thirty-six separate programs immediately accessible.

Twenty-six character LCD display doubles as 1092 point mini-graphic display with BASIC program control).

Tone generator with BASIC repetition, frequency and duration control. Built-in alarm clock and calendar functions, usable in BASIC program. One and two dimensional arrays (numeric and text).

Full range of text manipulation (LEFT, RIGHT, LEN, VAL, MID, CHR, etc.). Qwerty typewriter-style keyboard with separate numeric keypad.

'Advanced' programming capabilities with PEEK, POKE, CALL etc.

350+ page User Manuals

Sixty-way system expansion socket for optional add-ons (see below).

Three-way power option (with CE-150) - standard HP7 batteries for PC-1500, or EA-150 mains adaptor. CE-150 contains rechargeable batteries and is supplied with EA-150 adaptor.

Optional add-ons include: CE-150 printer/plotter/cassette adaptor, CE-151 4K memory module, CE-155 8K memory module, CE-153 140 key custom keyboard (Summer 82), RS232C communications interface (Autumn 82), CE-152 custom cassette recorder (Autumn 82), custom system briefcase (Autumn 82).

Dimensions  
PC-1500: 195W x 25.55H x 86Dmm (7.11/16 x 1 x 3 3/8") Wt 375g (0.83lb).  
CE-150: 330W x 50H x 115Dmm (13 x 2 x 4 1/2") Wt 900g (1.98lb).

COLOUR BROCHURE ON REQUEST

IF YOU SEE A BETTER OFFER, WE WILL BEAT IT

**THE SCIENTIFIC PORTABLE COMPUTER**

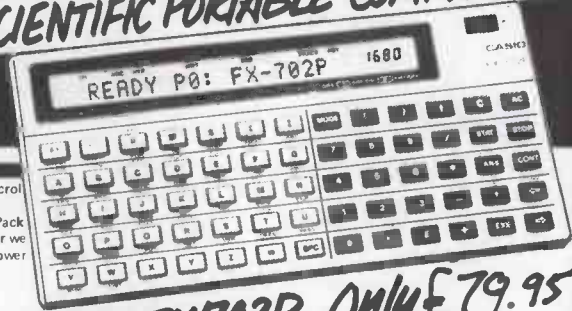

Plus FREE Microl Professional Programming Pack (RRP £9.95) or we will beat any lower price by 5%

**CASIO FX-702P ONLY £79.95**

The widest range of math, science and statistics (55 in all, including Regression and Correlation). BASIC programming FOR/NEXT looping; 8 levels. Edit, debug and trace modes.

240 hours lithium battery life. Dimensions: 17 x 165 x 82mm. Weight 176kg.

MICROL 702 PROCOS

Professional computing solutions on tape. Save up to 90% of programming time with this electronic equivalent of pen and paper. 'Visicalc-type' system answers 'what if...' questions and analyses trends £24.95.

Peripherals for the FX-702P, 602P, 601P and 502/501P

FA-2 Remote controls cassette interface £19.95

FP-10 Permanent hard copy printer, mains or battery powered £44.95

702 PACKAGE DEALS

PACK A: FX-702P + MICROL PPP £79.95

PACK B: FX-702P + FA-2 + MICROL PPP + MICROL PROCOS £129.90

PACK C: FX-702P + FP-10 + FA-2 + MICROL PPP + MICROL PROCOS £144.85

**The World's fastest Programmable?**  
**Casio FX-602P**  
**ONLY £69.95**

With FREE MICROL Professional Pack (RRP £9.95)

Or we will beat any lower price by 5%

50 scientific functions. Up to 512

program steps, up to 88 memories, all protected

when switched off. 10 programs, P0 to P9.

GOTO, up to 10 pairs. Up to 9 subroutines, nestable up to 9 levels. 33 parentheses at 11 levels.

Peripherals FA-2 Interface £19.95

FP-10 Printer £44.95

CASIO FX-601P Now only £39.95

Similar to the FX-602P but with 128 program steps; 11 memories; 18 ( ), up to 6 levels; up to 9 subroutines, nestable up to 4 levels.



**PC-1500 Professional Software on Tape**

SHARP CE-15A Fourteen Applications Programs £14.95.  
MICROL 1500 PROCOS

Procos enables you to create powerful, reliable programs to solve all kinds of number-based problems, in just minutes, even if you have never programmed a computer before. Handling up to 256 items of data simultaneously, 'Visicalc-type' features help you examine the effects of changes in data, analyse trends and answer 'what if...' questions £34.95

MICROL 1500 I.M.S. (Information Management System)

Professional management of data, coupled with the simplicity of one-touch commands, to store, inspect, update, select and print information to your exact requirements £34.95

MICROL STATIX Brings the advantages of statistics to the 1500. Automatic calculation of mean, standard deviation and linear regression. £9.95

BC SOFTWARE 1500 PROPAK 1 A set of easy-to-use routines for programs development, with:- RENUMBER, REORGANISE, DELETE, ANALYSE and INVERT SCREEN £9.95 BROCHURE ON REQUEST

**Computerised Programmable Keyboard/Organ Casiotone CT-701**  
**ONLY £44.5**



Program the 345 melody steps and the 201 chord steps (max) with music specially scored in bar code and read by a light pen, or enter your own chords

and melody via the keyboard, with full editing and repeat facilities. 3-way replay: Automatic; One Key Play; Melody Guide (lights above the keyboard indicate the next note to play). Split keyboard; 20 superb rhythm accompaniments; fingered or auto chords with walking bass and arpeggio; fill in and effect buttons. 37% x 13-7/16 x 5". Weight 12.5kg (27.6lb). CT-601. As 701 but without programming functions £39.95

All Casiotones available. Details on request

**TEMPUS**  
**MICROL**

Dept. PCW, 38 Burleigh Street,  
Cambridge CB1 1DG  
Telephone (0223) 312866

Prices include VAT, P&P. Send cheques, P/O, or phone your credit card number. Delivery by return.



TEMPUS, 38 Burleigh Street, Cambridge

Please send me.....

I enclose cheque/P.O. value £..... or I wish to pay by Access/Barclaycard/Visa, number:-

Name .....

Address.....

PCW

**FREE!**

# WORD PROCESSING SYSTEM VALUE £92.00

With every purchase of latest models of



PLUS  
12 MONTHS  
WARRANTY

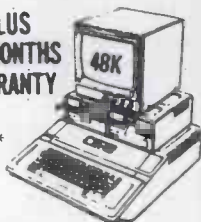

\*COMPLETE BUSINESS ACCOUNTING SYSTEMS\*  
PRINTERS \* ACCESSORIES \* STATIONERY \*

\*ACORN ASSEMBLED  
2K RAM 8K ROM £172.50  
ALL ACORN SOFT CASSETTES £11.50

\*VIC 20 COLOUR COMPUTER PLUS  
FREE GAMES AND PROGRAMMING BOOK

\* ATARI 400 16K + FREE GAMES FROM £199.95\*

\* ATARI 800 16K + FREE GAMES FROM £449.95\*

16K RAM BOARDS for the Atari 44.95

32K RAM BOARDS for the Atari 89.95

**FREE** £75.00 OF SOFTWARE WITH SHARP MZ80A 48K  
SHARP MZ80K-48K PC 1211 £74.75 PC 1500 £169.95

NASCOM SPECIAL EDITION £494.44

ATARI SOFTWARE  
ADD £2.00 p&p PER ORDER

SCOTT ADAMS ADVENTURES

1 - 12 16.50

PACMAN 29.95

GALACTIC CHASE 15.95

JAW BREAKER 19.95

TEMPLE OF APSHAI 27.60

CRUSH CRUMBLE CHOMP 19.95

INVASION OF ORION 17.25

DATESTONES OF RYN 13.80

RESCUE AT RIGEL 20.75

STAR WARRIOR 27.60

KRAZY SHOOTOUT 29.95

REAR GUARD 16.45

AIRSTRIKE 15.95

ACTION QUEST 19.95

CRYPTS OF TERROR 20.45

GHOST HUNTER 19.95

## GODFREYS COMPUTER CENTRE

28/32 EAST WALK BASILDON 289379



## VOTRAX TYPE 'N' TALK

- \* Unlimited Vocabulary
- \* Built-in microprocessor with text-to-speech algorithm
- \* RS232C interface—connects in same circuit as any terminal or runs on its own.
- \* Speaks any plain English text that is sent to the terminal
- \* Built-in audio amplifier (no speaker)
- \* 750 character buffer
- \* Band rates to 9600
- \* Data echo
- \* De-selectable and addressable
- \* Phoneme access modes

educational &  
quantity discounts

PRICE  
**£275**  
+VAT

U.K. Distributor: **INTELLIGENT ARTEFACTS**  
Cambridge Road, Orwell, Royston, Herts.  
Tel: Cambridge (0223) 207689

A NEW STAR IN THE HEAVENS

# PROCYON



THE STAR

PROCYON is pleased to announce that you may now obtain our products direct from the manufacturer.

### PRO-DIS

- For the BBC Micro. The superb RAM resident Colour disassembler with Hex/ASCII memory dump, full and easy memory editing on all functions, and memory COPY facilities. Fits ANY BBC Micro. Don't fool around with toy disassemblers from the cowboys. This is from the authors of DISATOM! Please state 16k or 32k. £5.95

### DISATOM

- the supremely comprehensive toolkit and disassembler for the ATOM. Look at this:

|                            |                                    |
|----------------------------|------------------------------------|
| AULD-targetable OLD        | AUTO-line numbering                |
| COPY-areas of memory       | CURSOR-key cursor control          |
| DELETE-BASIC lines         | DUMP-value of variables used       |
| DIR-directory              | ERUD-run with error check          |
| EXERC-string in fn or cend | FINO-m/c code, assembler and BASIC |
| HEADR-freeze top lines     | HELP-recover bad tapes             |
| HIGH-1200 BAUD taping      | IRKEY-a GET command                |
| LOW-300 BAUD taping        | NIKE-really thorough NEW           |
| ON ERROR-trap errors       | OUT-MS 232 output from cas socket  |
| PAGE-new text space        | PULL-can exit FOR, GOSUB, DO loops |
| READ-reads DATA statement  | DATA-Data as a list in program     |
| RESTORE-move data pointer  | REN-line renumber                  |
| TAPE-for really bad tapes  | TONE-music, and out to tape too    |
| ZERO-all variables to zero |                                    |

MACHINE LEVEL FUNCTIONS:

Function

DISASSEMBLE-any area of memory, edit/modify directly as desired

HEX DUMP-any part of memory, with direct edit/modify

ASCII DUMP-any memory as its ASCII equivalent, with edit/modify

TRACE-any m/c code routine, setting all registers etc.

M/C DEVELOP-a command for high powered m/c code program writers

These m/c commands make the machine absolutely TRANSPARENT, and it is worth the time of even a novice to learn how to handle them.

### FUSION

- a 17 page, covered manual with demo programs to help you join the ATOM and DISATOM. £1.00

### SOFTSWITCH

- a plug-in (no ribbon cables!) board for the A000 utility socket that allows 4x8 ROMs to be resident, each selectable from Keyboard or Program! Always come up on ROM 0, then you choose. Ideal with DISATOM in socket 0. Mechanically stable, and does not interfere with any other boards in the ATOM. £19.95

### PRO-LOG

- An Analogue to Digital converter board for ATOM. 8 inputs, allows 2 joysticks with 4 fire buttons, or any other like combinations. Has many built-in software commands. Easy to fit, and gives you real games power. £25.95

Add 15% VAT. Make cheque/p.o. payable to FOCUSPLAN LTD.. Send your order to PROCYON 57 Westgate, Cleevehoe, West Yorks BD 19 5HH. Trade Orders welcome.

LOW COST HIGH TECHNOLOGY FROM THE STAR

## THE FORTH EXPERTS

The Forth on disc for:-

PET 3.0 or 4.0. with 4040 £53 (plus £7.95 VAT)

TRS80 (MMS. forth) (sale) £50 (plus £7.50 VAT)

North Star Horizon (all models) £78 (plus £11.70 VAT)

CP/M (supersoft) for North Star £33 (plus £4.95 VAT)

BOOKS:- (no Vat)

'Using Forth' (Force/79) £11

'Starting Forth' (Brodie, soft) £11

'Threaded Interpretive Languages' (Loeliger) £9

6502 Source Listing £6

Forth Installation manual £6

LIMITED QUANTITY ONLY

AUGUST 1980 Forth edition of Byte

... expensive but essential £10

OTHER SOFTWARE:-

PET DISC Debug £15 (plus £2.25 VAT)

'Atomic pencil' CAD for ATOM £10 (plus £1.50 VAT)

POSTAGE REGARDLESS OF SIZE OF ORDER £2.50

Write for details to

## INTELLIGENT ARTIFACTS

Cambridge Road, Orwell  
Royston, Herts SG8 5QD  
Tel Cambridge (0223) 207689



# Sumlock

Manchester



## microcomputer world

### SHARP

### MZ-80A



*First and foremost*

MZ 80A 48K COMPUTER **£549.00 (inc VAT)**

THE NEW FULL KEYBOARD COMPUTER FROM SHARP

**\*COMPLETE WITH SOFTWARE PACK:**

**EDUCATION** — HANGMAN, GEOGRAPHY, ARITHMETIC

**GAMES** — LUNAR LANDER, TEN-PIN BOWLING,

SPACEFIGHTER, IDENTIKIT, CLEVER CRIBBER

D-DAY, BREAKOUT, STAR TREK, SCRAMBLE,

SPACE INVADERS

**HOME FINANCE** — HOME BUDGET, BANK RECOUL,

BANK LOAN, MORTGAGE

**BASIC TUTORIAL** — BASIC TUTORIAL 1

BASIC TUTORIAL 2

BASIC TUTORIAL 3

BASIC TUTORIAL 4

PLUS BASIC BASIC and THE BASIC ENCYCLOPAEDIA

two very useful additions to your library

**TWO YEAR WARRANTY ON SHARP HARDWARE parts and labour**



**SPECIAL OFFER  
PCW SHOW**

## VIC-20

|           |                             |                |  |   |                         |
|-----------|-----------------------------|----------------|--|---|-------------------------|
| VIC 1001  | VIC 20 computer             | <b>£169.95</b> | VIC 2803   | Programmers reference guide   | <b>£9.95</b>            |
| VIC 1530  | C2N cassette deck           | <b>£44.95</b>  | VP 014   | Spiders from Mars ctg.  | <b>£24.95</b>           |
| VIC 1515  | VIC printer                 | <b>£230.00</b> | VP 010   | Amok  | <b>£6.99</b>            |
| VIC 1540  | Single floppy disc          | <b>£396.00</b> | VP 026   | Alien blitz   | <b>£7.99</b>            |
| VIC 1210  | 3K RAM cartridge            | <b>£29.95</b>  |  |   |                         |
| VIC 1110  | 8K RAM cartridge            | <b>£44.95</b>  |  |   |                         |
| VIC 1111  | 16K RAM cartridge           | <b>£74.95</b>  | SC 09  | <b>STACK ACCESSORIES</b><br>Paddles (1 pair)  | <b>£11.50</b>           |
| VIC 1212  | Programmers aid ctg.        | <b>£34.95</b>  | SC 12  | Light pen   | <b>£28.00</b>           |
| VIC 1212A | Super expander ctg.         | <b>£34.95</b>  | SC 11  | Analogue joystick   | <b>£14.95</b>           |
| VIC 1213  | Machine code monitor ctg.   | <b>£34.95</b>  | SC 14  | Low cost RS232 interface  | <b>£19.84</b>           |
| VIC 1311  | VIC joystick                | <b>£7.50</b>   | SC 16  | Games port multiplexer  | <b>£37.95</b>           |
| VIC 1312  | VIC paddles (1 pair)        | <b>£13.50</b>  | GPA  | Games port adaptor cable  | <b>£19.84</b>           |
| VIC 2501  | Introduction to Basic (1)   | <b>£14.95</b>  | SC 13  | Rom switch board  | <b>£44.00</b>           |
| VIC 1901  | Avenger ctg.                | <b>£19.95</b>  | SC 06  | Full RS232C interface   | <b>£56.00</b>           |
| VIC 1902  | Star battle ctg.            | <b>£19.95</b>  | SC 15  | Memory expansion board —<br>with 3K RAM expandable with<br>chips to full VIC capacity (29K) | <b>£56.35</b>           |
| VIC 1904  | Super slot ctg.             | <b>£19.95</b>  | VIC KIT2   | Hi resolution and toolkit<br>command single ROM to fit in<br>SC15                           | <b>£33.25</b>           |
| VIC 1905  | Jelly monsters ctg.         | <b>£19.95</b>  |  |   |                         |
| VIC 1906  | Alien ctg.                  | <b>£19.95</b>  | DUST COVERS for VIC 20 and C2N<br>(approved CBM product) |   | <b>£3.75</b><br>per set |
| VIC 1907  | Super lander ctg.           | <b>£19.95</b>  |  |   |                         |
| VIC 1909  | Road race ctg.              | <b>£19.95</b>  |  |   |                         |
| VIC 19    | Rat race ctg.               | <b>£19.95</b>  |  |   |                         |
| VIC 2801  | Learn computing with VIC 20 | <b>£1.95</b>   |  |   |                         |
| VIC 2802  | VIC revealed                | <b>£10.00</b>  |  |   |                         |

**COMPLETE LIST OF HARDWARE AND SOFTWARE AVAILABLE BY REQUEST**

We only advertise what we have in stock at the time.

All items are ex stock. Telephone/mail order

despatched within 24 hours. Carriage free U.K. mainland

**Sumlock Manchester**

**Dept YC1**

**Royal London House**

**198 Deansgate**

**Manchester**

**M3 3NE**

OPEN MONDAY TO SATURDAY  
PARKING WATSON ST. N.C.P.



keep up to date  
join our free mailing list

Dragon 32 in stock £199.50

# 061 834 4233

# VISICALC™



## The world's most popular business program for the Apple ][ Over 150,000 copies sold worldwide

### VisiCalc 3.3 139.00

VisiCalc is the astute businessman's right arm, an 'Electronic Worksheet' which replaces pencil and paper, automatically, and quickly, calculating the solutions to numeric problems in the fields of finance, marketing, production, engineering, and other areas of endeavour.

The 'WHAT IF...' facility allows him to see the effects of changing an assumed figure, e.g. Bank rate, in his projected plan. Now, thanks to VisiCalc no longer do such re-calculations take hours of work. He can easily try alternative figures, and quickly assess trends.

VisiCalc 3.3 requires an Apple ][ with a minimum of 48K Bytes of RAM (memory) running under DOS 3.3. This leaves 19K Bytes of memory for the 'worksheet' itself, which may be increased by adding one, or more, optional RAM BOARDS, with appropriate software from the following.

### Ramex 16K RAM Board 89.00

Increases memory available for VisiCalc from 19K to 34K.

### Saturn 32K RAM Board 144.00

Used with either VC-Expand, or VC-Expand/80, this board will increase the memory available for VisiCalc to 49K for one board, and to 81K if two boards are fitted. These figures become respectively 65K and 97K if a 16K RAM board is also fitted.

### Saturn 128K RAM Board 359.00

With either VC-Expand, or VC-Expand/80 brings the memory available to VisiCalc up to a minimum of 145K, or 177K maximum if both 32K and 16K RAM boards are also fitted.

*The comprehensive software, included, allows this board to be used as a Pseudo-Disk under DOS, Pascal, or CP/M, and is supplied on three disks together with a 73 page manual.*

### VC-Expand 55.00

Software required with VisiCalc when expanding the system with Saturn RAM Boards. Display is still the standard 40-column format.

### VC-Expand/80 69.00

Version of VC-Expand that in conjunction with the Videx Videoterm board gives the far superior 80-column display.

### Videx Videoterm 199.00

This popular 80-column display board is required when the system is to be enhanced with VC-Expand/80 and one or more Saturn RAM Boards. The optional Inverse Video ROM is included in the price. It is recommended that one of the switch options below is also used with this board.

### Videx Switchplate 15.00

Permits the Apple ][ display to be switched between 40- and 80-column without having to unplug and change cables.

### Videx Soft Video Switch 24.00

Same as the Videx Switchplate, but switches automatically between 40- and 80-column displays under software control.

### Videx Enhancer ][ 99.00

A MUST for every serious user of the Apple ][ and a most useful adjunct to the keyboard. Provides upper and lower case characters with true descenders, a type-ahead buffer, user definable keys, auto-repeat on keys, etc.

*Only suitable for Revision 7 Apple ][s with piggy-back PCB style keyboards.*

**\*\*Please ask about other VisiCorp and Videx products\*\***

**SPECIAL OFFERS**

|  |        |
|--|--------|
| 1 VisiCalc + 16K Ramex                         | 219.00 |
| 2 VC-Expand/80 + Videoterm + Soft Video switch | 285.00 |
| 3 Saturn 32K RAM + 128K RAM                    | 479.00 |
| Combined offers 1 and 2                        | 499.00 |
| Combined offers 2 and 3                        | 749.00 |
| ALL 3 OFFERS COMBINED                          | 959.00 |

When an Apple ][ is fitted with a Z-80 card, the whole wide range of CP/M software becomes available. Ask about WordStar and its associated software by MicroPro, or the range of business control software programs by Padmede.

**MAIL ORDER ONLY**      **PACKING AND POSTAGE EXTRA**  
(Orders over £100, add £3.00: under £100 add £1.75: or under £30 add 75p)

Please add 15% VAT and send your payment with order to:



**PARKINS ASSOCIATES PCW**  
20 RIDGEWAY, RAYLEIGH, ESSEX SS6 7BJ  
Tel: 0268 743928

LOCAL DEMONSTRATIONS CAN BE ARRANGED BY PRIOR APPOINTMENT

VisiCalc is a trademark of VisiCorp, Apple is a trademark of Apple Computers Inc., Ramex is a trademark of Vergecourt Ltd., VC-Expand and Saturn are trademarks of Saturn Systems Inc., and Videx & Videoterm are trademarks of Videx Inc.

# Where do you start?

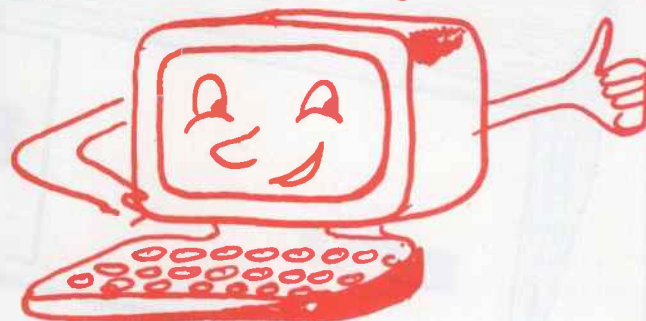

**“On a government-assisted  
MICRO AWARENESS COURSE  
for BUSINESSMEN”**

**A series of 10 or 20 one-day  
seminars to suit your  
availability....**

**Commencing end of  
September in London,  
Birmingham & Manchester.**

**WRITE FOR FULL DETAILS TO:**

**COMPUTOTECH LTD.**  
**Shropshire House**  
**Capper Street**  
**London WC1**  
**01-636 8134**

**SPECIAL OFFER!**

North Star Advantage with dual d/s floppies  
**£1,095**

# EXTEND YOUR HORIZON

## Upgrade your NorthStar



- \* 12 M.byte 5 1/4" Winchester disk ..... £2,100
- \* DOS driver for Winchester disk ..... £300
- \* Random access NS BASIC file handler ..... £500
- \* PROM at FC00. 63K addressing CP/M ..... £50
- \* RAMSWITCH board. 71K addressing for DOS ..... £250
- \* Overlay facility for NS BASIC .... £500
- \* Bisynch 3780 communications driver ..... £500
- \* Local network driver (9600 baud polled) ..... £500

**SPECIAL OFFER!**

North Star Horizon with 12 M.byte + Quad disk and all upgrades  
**£5,585**

# TANTUS MICROSYSTEMS LTD.

91 SHEEN ROAD, RICHMOND, TW9 IYJ. Tel: 01-940 7299

# COMPUTERS & PERIPHERALS

## We supply:

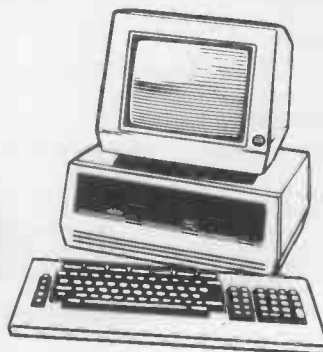

Includes a standard CP/M-86 MS-DOS Microsoft 16 bit Basic

**£2395**

Buy a typewriter which you can use with your computer. Silver Reed/Olivetti RS232 - Centronics - IEEE interfaces now available.

**SPECIAL OFFER**  
Olympia KSR



**£950**

- Graffcom
- Wordstar 3
- Mailmerge
- SuperCalc
- Full training provided

Dealer enquiries about training welcome

- ACT Sirius 1 16 Bit Micro
- Superbrain £1650
- British Micro £1350
- Apple £650
- Leasing Facilities Available

- Anadex DP9500 £899
- Microline 834 £475
- Typewriter/Printers/Disks
- RicoH Flowriver £1450

London Office  
22 Davids Road, SE23

01-668 1163  
Callers by appointment

Surrey Office  
53 Purley Oaks Road,  
SANDERSTEAD



# The Box with a Byte

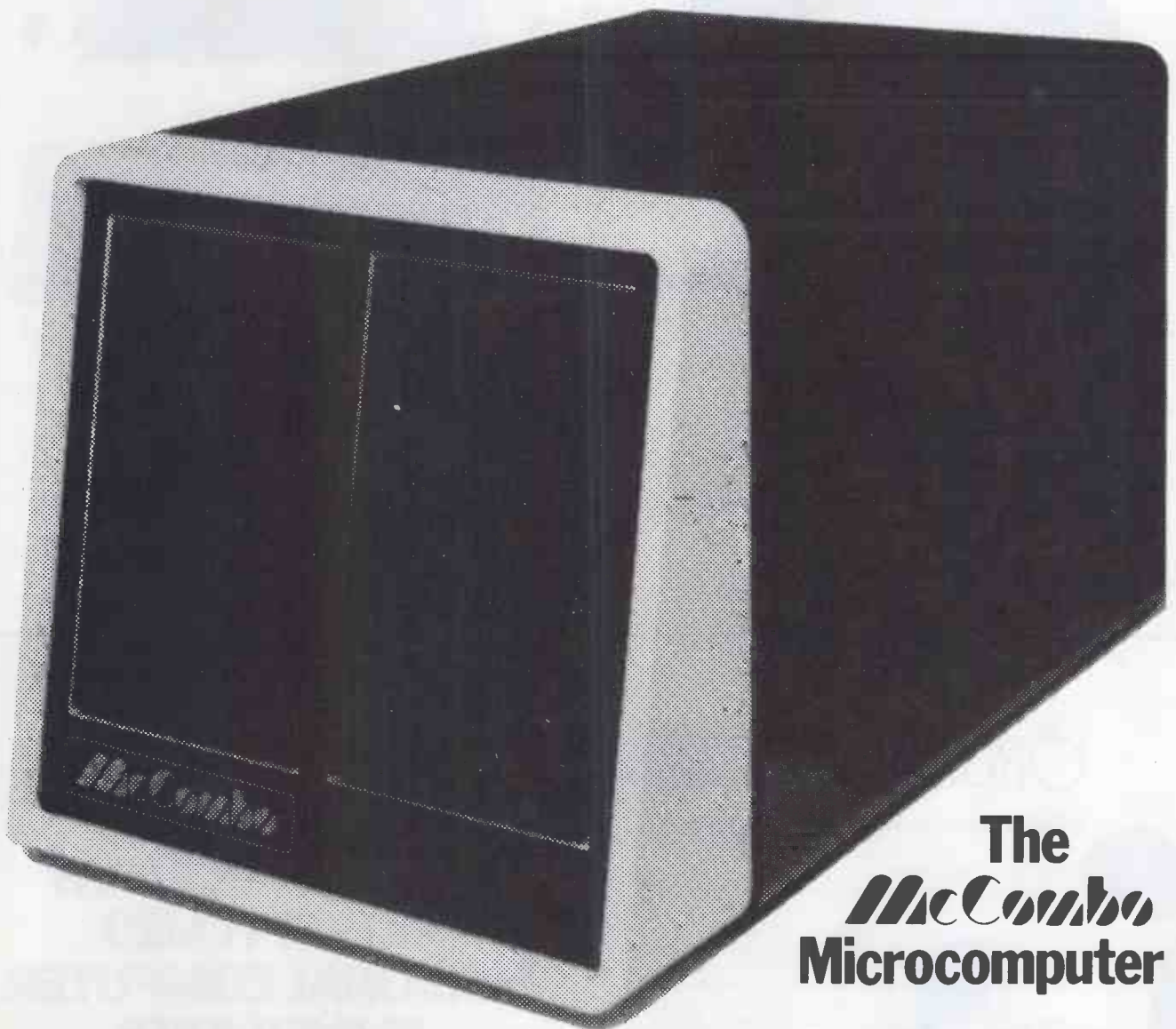

## The *McCombo* Microcomputer

The McCombo is a micro-computer that allows you to build up your ideal system.

Just plug in the terminal, printer, VDU and modems of your choice and you have a system tailor-made for your needs.

Now there is no need to accept the limitations of one part of a standard system – with the McCombo you can choose the best from the best.

### What makes the McCombo good:

- Z80 based at 4MhZ
- 64K RAM
- 12K EPROM
- CP/M Compatible
- Hard disc option

### What makes it better:

- 8-timers (4-user addressable)
- solid steel casing

### What makes it exceptional:

- 4 serial ports
- 1 Centronic
- and a price tag of only £1,088.

For more details just clip the coupon below.



Zytek International  
Products Limited  
2 Ganton Street,  
London W1V 1LJ  
Telephone: 01-934 9462/3/4

|  |                          |
|--|--------------------------|
| To: Zytek International Products Limited 2 Ganton Street,<br>London W1V 1LJ Telephone: 01-934 9462/3/4 |                          |
| Please rush me more details of the McCombo Microcomputer.  | <input type="checkbox"/> |
| I am interested in dealership – send me your dealer pack.  | <input type="checkbox"/> |
| <small>(BLOCK CAPITALS PLEASE)</small>   |                          |
| Name   | _____                    |
| Address  | _____<br>_____<br>_____  |
| Postcode   | _____                    |
| Telephone number   | _____                    |

THE FINEST PRINTER/TYPEWRITERS MONEY CAN BUY.

## THE CROWN ONLY £399 + VAT



The ideal home daisy wheel printer/typewriter up to 12 CPS - 6 extra daisy wheels available - 14 character correction - carbon ribbon - speed test - all the features you would expect of an electronic portable typewriter/printer Centronic parallel - IEEE - RS232.

Ask your local computer or office equipment dealer for further information. EXSTOCK DELIVERY.

## THE CROWN RANIER ONLY £795 + VAT

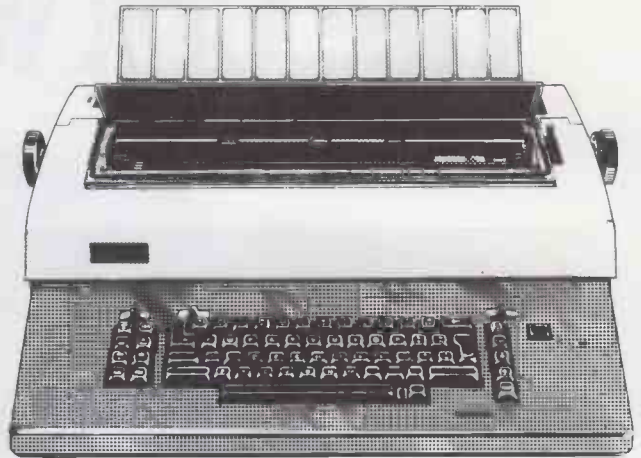

We offer a heavy duty daisy wheel printer/typewriter at the flick of a switch. This machine has the very latest linear motor - no cables or belts to break, stretch or wear. Beware of light weight, low cost machines, these can never give long term reliable service. THIS MACHINE WILL!! CENTRONICS or IEEE interface. Interchangeable daisy wheels - variable pitch - whole line memory. Easily copes with standard printed forms. Uses standard IBM ribbons and lift off correctors. Perfection as a typewriter (used by local authorities). Perfection as a printer.

**SOLE UK DISTRIBUTOR. TRADE ENQUIRIES INVITED**



**CROWN BUSINESS CENTRE**

**56-58 SOUTH ST., EASTBOURNE,  
SUSSEX. (0323) 639983.**

# ARBORCRAFT



### Micro Computer Mobile Work Stations

High quality 'no glare' melamine finished work surface with post formed long edges. Reinforced polyester coated steel support frames and large twin wheeled castors for ease of movement. Keep your micro off the dining room table and always available.

Choice of 3 models from £98.85 plus VAT. (Access). Money back guarantee. Allow 21 days delivery. Business enquiries welcomed. Phone or send for detailed brochure and order form.



Arborcraft Limited, 137 Watling Street, Radlett, Herts WD7 7NQ  
Telephone Radlett (09276) 3126 24 hour answering service.

Please send me your illustrated brochure and order form for the Arborcraft Micro Computer Mobile Work Stations.

Name \_\_\_\_\_

Address \_\_\_\_\_

Post code \_\_\_\_\_

## THE REMARKABLE NEW OLIVETTI M20 PERSONAL COMPUTER IS AVAILABLE FROM JOHN RICHARD & COMPANY.

21 North High St., MUSSELBURGH,  
Midlothian EH21 6JA.

Or 'phone 031-665 8282 and ask  
for Bill Marshall or Rod Taylor.

# TWO BOOKS YOU CAN'T AFFORD TO BE WITHOUT

## SUCCESSFUL PROFESSIONAL AND BUSINESS MICROCOMPUTING

We live in an age of cheap computing power.

For the first time the cost of a computer is within the reach of the small businessman, the professional or the private citizen.

But will your desk top computer be a boon or a curse?

Will it increase your profits or disrupt your workplace?

Success in computer installation depends on taking a logical approach to your task — the Systems Approach; the side of the microcomputing revolution they didn't tell you about.

*Desk Top Computing*, from the publishers of *PCW*, Britain's largest-selling micro magazine, tells you.

Lyn Antill explains, in language plain enough for the most non-technical user, the secrets of Systems Analysis.

Step by step, this book tells you how to:

Define exactly what tasks you wish your computer to undertake.

Choose the right machine for your present and future needs.

Buy off-the-peg software.

Hire and supervise a programmer when necessary.

Write program specifications tailored to *your* staff and working methods.

Test programs and introduce them into your business with minimal disruption.

Maintain and modify programs.

Also included are several case studies covering the installation of desk top computers in small businesses.

## COMPREHENSIVE BENCHTESTS OF TWENTY-FIVE LEADING MICROCOMPUTERS

Here are twenty-five of the most popular micros in the world benchtested to the exacting standards that only *PCW* insists upon before going into print.

We believe that even rival publications here and in the USA will concede that *PCW's* Benchtests have set an industry standard which is now a byword.

Completely updated and revised by Dick Olney, *Benchtest Special* contains 164 pages of fascinating and essential information covering hardware, software, speed of operation, potential, expansion, documentation and conclusions on each machine.

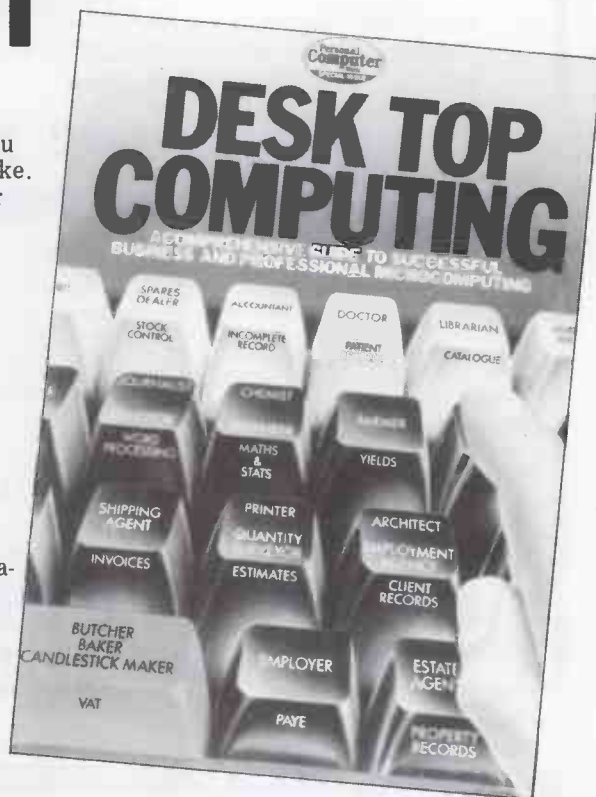

For just £1.50 you can obtain the results of hundreds of hours of Benchtesting by our skilled team of reviewers.

We are not exaggerating when we say that demand for this special issue has been enormous and we advise you to send off now, using the coupon below, before we go out of stock.

### MACHINES TESTED INCLUDE:

- |                   |                    |
|-------------------|--------------------|
| ABC 24            | NEC PC-8001        |
| Acorn Atom        | OKI if-800         |
| Apple II          | Onyx C8002         |
| Atari 400 & 800   | Osborne O1         |
| BBC               | Sharp MZ-80B       |
| Computer          | Sharp PC-3201      |
| CBM 8032          | Sinclair ZX81      |
| Commodore VIC     | Superbrain         |
| Cromemco System 3 | T199/4             |
| DAI Personal      | Transam Tuscan     |
| Computer          | TRS-80 Model II    |
| HP-85             | Tandy Model III    |
| IBM Personal      | TRS-80 Color       |
| Computer          | Vector Graphic VIP |

Please send me . . . . . copies of *PCW's Desk Top Computing* @ £2.25 (inc postage) and/or . . . . . copies of *Benchtest Special* @ £1.80 (inc postage).

I enclose a cheque for £. . . . payable to *Personal Computer World*, 53/55 Frith Street, London W1A 2MG

Name . . . . .

Address . . . . .

. . . . .

. . . . .



If you are puzzled by the lack of good application software for CP/M micros; then puzzle no longer. - Ask about

We are exclusive distributors for UK of SERENDIPITY SYSTEMS packages for Apple & CP/M; of MAGSAM index sequential access routines for CBASIC and IFO-Information File Organiser - the best data base package available for use with Apple.

our **GANG OF FOUR**  
**MAILFLOW    MINIMODEL    DATAFLOW    BILLFLOW**

Automatic Mailshot system works with DATAFLOW to produce individually addressed letters to selected addressees at a rate of 200 per hour. Allows you to send out more mailshots, at lower cost, with better response. Special price £75.

Financial Modelling system for CP/M: Very easy to use: Flexible report layouts: consolidation: can handle large models simply and practically. Designed by business consultants for use by real businessmen. R.R.P. £299.

The easy-to-use, fast and flexible Database management and information retrieval package for CP/M systems. If you can file it manually; then you can file it faster and better with DATAFLOW. R.R.P. £99.95

Client Billing for "Professional" business - Accountant, Consultant, Engineer, Surveyor: Invoicing, Sales Ledger, Work-in-progress, Analysis Contribution by Fee-earner: With Nominal Ledger forms complete system from Time Sheet to Balance Sheet. R.R.P. £375.

Also ask about; Inter-Stat, Advanced Maths and Video Message packages for Apple  
 Ask for leaflet on; Serendipity Ledgers and Stock Control for CP/M  
 All CP/M packages NOW AVAILABLE for **APPLE II**

**GREAT NORTHERN** Computer Services Limited  
 16 Town Street, Horsforth, Leeds LS18 4RJ. Telephone [0532] 589980

*see us at  
 Compec 82*

# CUT-PRICE COMPANIONS

*"Far and away the best -  
 Your Computer Magazine*

**THE ZX81 COMPANION** by Bob Maunder is now available at **ONLY £4.95** with a **FREE SUPPLEMENT** on the ZX Spectrum!

**LINSAC** is also producing a **SPECTRUM COMPANION** series, and the first title, 'The Spectrum Games Companion' is available from October at £5.95.

The above prices include UK postage. Send cheques to:

**LINSAC** (PCW)  
 68 Barker Road, Middlesbrough TS5 5ES

# Knights Unbeatable Sharp & Atari Deals

## SHARP

|   |      |
|---|------|
| Sharp MZ-80A + 20 programs                              | £419 |
| MZ-80A with PASCAL + 28 programs                        | £429 |
| MZ-80A with PASCAL, FORTH, MACHINE CODE and 32 Programs | £449 |
| MZ-80B with BASIC, MACHINE CODE + ASSEMBLER             | £899 |

## ATARI

|                               |      |
|-------------------------------|------|
| ATARI 400 with 25 programs    | £217 |
| ATARI 800 with 25 programs    | £429 |
| ATARI disk unit + 25 programs | £259 |

*We guarantee to supply Sharp and Atari at unbeatable prices. Prices exclude VAT but include Securicor delivery - note we accept credit cards without making surcharges.*

**Knights T.V. & COMPUTERS**  
 108 ROSEMOUNT PLACE ABERDEEN  
 Telephone 0224 630526 Telex 739169



### APPLE III BUSINESS SYSTEM



|                       |         |
|-----------------------|---------|
| Disk Drive            | £319.95 |
| Silentype Printer     | £199.95 |
| Universal P/Interface | £119.95 |
| Apple Business Basic  | £ 79.95 |
| Pascal III            | £149.95 |
| CP/M Software III     | P.O.A.  |
| Quick File III        | P.O.A.  |
| Visicalc III          | £149.95 |
| Mail List Manager     | £ 99.95 |
| AppleWriter III       | £119.95 |
| Business Graphic III  | £ 99.95 |
| Access III            | £ 84.95 |
| Script III            | £ 69.95 |

**£320 off**

**£2099**

### APPLE II BUSINESS SYSTEM



**£300 off**

**£1056**

|                          |         |                   |          |
|--------------------------|---------|-------------------|----------|
| Apple II 48K             | £599.95 | AppleWriter II    | £ 79.95  |
| Disk Drive               | £239.95 | WordStar          | £199.95  |
| Numeric Keyboard         | P.O.A.  | Magic Wand        | £ P.O.A. |
| TV Modulator             | £ 14.00 | Beneath Apple DOS | £ 11.95  |
| Joystick                 | £ 24.95 | Bags of Trucks    | £ 24.95  |
| Hand Controller (paddle) | £ 14.95 | DOS 3.3 Toolkit   | £ 36.95  |
| Apple World              | £ 29.95 | Graphics Tablet   | £399.95  |

### MONITORS

|                     |         |                        |         |
|---------------------|---------|------------------------|---------|
| 12" Green H Res     | £ 99.95 | Visible                | P.O.A.  |
| 12" B/W             | £ 99.95 | Visicalc Real Estate   | £ 37.95 |
| 12" Amber Philips   | £119.95 | Personal Finance       | £ 39.95 |
| Kega Colour         | P.O.A.  | MicroModeler           | £549.95 |
| 14" Microtec Colour | £299.95 | MicroPlanner           | £649.95 |
| 20" Sunny RGB       | £381.95 | AppleLogo              | £109.95 |
| Visicalc (3.3)      | £ 99.95 | PASCAL Language System | £220.00 |
| Visiplot            | P.O.A.  | Bridge Tutor           | £ 19.95 |
| Visidex             | £119.95 | Utopia Graphic         | £ 39.95 |
| Visiist             | P.O.A.  |                        |         |

### INTERFACE CARDS

|                  |         |                 |         |
|------------------|---------|-----------------|---------|
| Parallel Printer | £ 85.00 | Language Card   | £ 94.95 |
| Centronics       | £ 99.95 | Eurocolour Card | £ 64.95 |
| Integer Card     | £ 89.95 |                 |         |

# XEROX 820

820/5 and 820/8 SUPER DENSITY 64K CP/M UP TO 1.6mb TWIN DISK DRIVES LANGUAGE OPTIONS BUSINESS SOFTWARE WORD PROCESSING

£1750

# ATARI

**Atari 400**  
with 16K RAM  
**£164.95**

**Atari 800**  
with 16K RAM  
**£417.55**

|                       |         |                  |         |
|-----------------------|---------|------------------|---------|
| Program Resources     | £ 43.15 | Asteroid         | £ 24.95 |
| Disk Drive            | £259.95 | Basketball       | £ 21.75 |
| Thermal Printer       | £173.95 | Blackjack        | £ 12.95 |
| Interface Module      | £117.45 | Caverns of Mars  | £ 24.95 |
| 16K RAM Pack          | £ 56.95 | Centipede        | £ 24.95 |
| Paddle (Pair)         | £ 12.17 | Computer Chess   | £ 21.76 |
| Joystick (Pair)       | £ 12.17 | Missile Command  | £ 24.95 |
| Interface Cable       | £ 11.30 | Pac Man          | £ 24.95 |
| Word Processor        | £ 86.99 | Space Invaders   | £ 24.95 |
| Mortgage and Loan     | £ 12.95 | Star Raiders     | £ 24.95 |
| STATISTICS            | £ 12.95 | Super Breakout   | £ 21.75 |
| Inv. to Programming 1 | £ 17.39 | Touch Typing     | £ 16.95 |
| Inv. to Programming 2 | £ 19.95 | Hangman          | £ 12.95 |
| Inv. to Programming 3 | £ 19.95 | Assembler Editor | £ 34.79 |
| French Language       | £ 31.95 | Italian Language | £ 31.95 |
| German Language       | £ 31.95 | Spanish Language | £ 31.95 |

# Sinclair ZX81

|                 |         |                        |        |
|-----------------|---------|------------------------|--------|
| ZX 81           | £ 43.45 | Bylong Deeper          | £ 4.95 |
| ZX 16K RAM Pack | £ 25.95 | Gateway Guide          | £ 6.45 |
| ZX Printer      | £ 51.95 | Getting Acquainted     | £ 5.95 |
| Super Program 1 | £ 4.30  | Hints & Tips           | £ 4.25 |
| Super Program 2 | £ 4.30  | Mastering Machine Code | £ 7.50 |
| Super Program 3 | £ 4.30  | RDM Part A             | £ 7.00 |
| Super Program 4 | £ 4.30  | English Lit 1          | £ 6.95 |
| Bio Rhythms     | £ 6.05  | English Lit 2          | £ 6.95 |
| Backgammon      | £ 5.17  | Geography 1            | £ 6.95 |
| Chess           | £ 6.05  | History 1              | £ 6.95 |
| Fantasy Games   | £ 4.13  | Maths 1                | £ 6.95 |
| Space Raider    | £ 3.43  | Spelling 1             | £ 6.95 |

# VIC-20

|                      |         |                       |          |
|----------------------|---------|-----------------------|----------|
| VIC 20               | £165.25 | Avenger               | £ 15.95  |
| Cassette Unit        | £ 39.95 | Star Battle           | £ 15.95  |
| VIC 20 Printer       | £195.00 | Super Slot            | £ 15.95  |
| VIC 20 Discdrive     | £309.95 | Jelly Monster         | £ 15.95  |
| 3K Add-on RAM        | £ 24.95 | Alien                 | £ 15.95  |
| 8K Add-on RAM        | £ 36.95 | Road Race             | £ 15.95  |
| 16K Add-on RAM       | £ 59.95 | Rat Race              | £ 15.95  |
| Joystick             | £ 6.52  | Blitz                 | £ P.O.A. |
| Paddles              | £ 11.74 |                       |          |
| Super Expander       | £ 28.95 | Introduction to Basic |          |
| Programming Aid      | £ 28.95 | Part 1                | £ 13.00  |
| Machine Code Monitor | £ 28.95 | Part 2                | £ 13.00  |

# DRAGON 32

**32K RAM**  
**£169.95**

# SHARP

**PC-1211**  
**£54.95**

**PC-1500**  
**£139.95**

|                          |         |                             |         |
|--------------------------|---------|-----------------------------|---------|
| CE 122 Printer/Interface | £ 59.95 | CE 151 4K RAM               | £ 34.75 |
| FA 850B Marking Pen      | £ 7.95  | CE 155 8K RAM               | £ 62.95 |
| CE 150 Printer/Interface | £121.75 | CE 15A Pro Software (Logic) | £ 12.95 |

**MZ 80A**  
**£434.95**

**MZ 80B**  
**£899.95**

|                            |         |                           |          |
|----------------------------|---------|---------------------------|----------|
| MZ-80FB Twin Disk          | £590.00 | MZ-80F1 Interface Card    | £ 99.00  |
| MZ 80 SFD Single Disk      | £399.95 | MZ-80MDB Master Diskette  | £ 29.00  |
| MZ 8 AEU Expansion Unit    | £ 99.00 | MZ-80DD2 F DOS            | £ P.O.A. |
| MZ 80AMD Master Diskette   | £ 29.00 | MZ-88T02 Pascal           | £ P.O.A. |
| CPM MZ 80A CP/M            | £ 65.00 | MZ-80DPB Double Precision | £ P.O.A. |
| MZ 80 P5 80 Col. Printer   | £349.00 | MZ 8T70AE FDDS (K)        | £ 75.00  |
| MZ 80 P6 80 Col. Printer   | £409.00 | MZ 8T70BE Basic Computer  | £ 45.00  |
| MZ 80 P9 132 Col. Printer  | £745.00 | MZ-80 P3 Printer          | £345.00  |
| MZ-8AD02 F DDS             | £ 85.00 | MZ-80 I/O                 | £ 99.00  |
| MZ 88P51 Printer Interface | £ 30.00 | MZ 80T20 Machine Language | £ 20.00  |
| MZ 8KP2 Printer Interface  | £ 30.00 | MZ 8T40E Pascal           | £ 39.95  |
| MZ 80B CP/M                | £ 65.00 | CP/M                      | £ P.O.A. |

# hp HEWLETT PACKARD

|        |         |          |         |
|--------|---------|----------|---------|
| HP 32C | £ 39.95 | HP41CV   | £189.95 |
| HP 11C | £ 61.95 | HP41C    | £145.95 |
| HP 15C | £ 82.95 | Printer  | £290.95 |
| HP 17C | £ 91.95 | Cassette | £329.95 |
| HP 18C | £ 91.95 |          |         |

# PRINTERS

|                 |          |                |          |
|-----------------|----------|----------------|----------|
| Centronic 737 2 | £ 319.00 | TEC Starwriter | £1185.00 |
| Epson MX80T 3   | £ 359.00 | Dihwin DV311   | £1039.00 |
| Epson MX80FT 3  | £ 455.00 | Dialflo 630    | £1630.00 |
| Dume 9 45       | £1753.00 |                |          |

# GAMES

SEND STAMPED ADDRESSED ENVELOPE FOR FREE CATALOGUE

# BOOKS

SEND STAMPED ADDRESSED ENVELOPE FOR FREE CATALOGUE

|  |       |                             |         |
|--|-------|-----------------------------|---------|
| Apple Pascal Games                     | 11.45 | ZX80 Interfacing Book       | 19.05   |
| Basic Progs for Scientists & Engineers | 11.50 | 6502 Ass Lang Prog          | 11.95   |
| CP/M Handbook                          | 11.60 | 6800 Ass Lang Prog          | 11.95   |
| 6502 Application Books                 | 10.25 | Advanced 6502 Interfacing   | 10.45   |
| 6502 Games                             | 10.25 | Graphic Software for Micros | 15.95   |
| Apple Interfacing                      | 7.65  | Pascal for Human Beings     | 4.95    |
| Apple Pascal                           | 10.60 | BBC Computer Revealed       | 7.60    |
| Applesoft Language                     | 7.65  | Your Atari Comp             | 400/800 |
| Basic Comp Progs for the Home          | 9.50  | 30 Hour Basic (BBC)         | 5.60    |
| CP/M User's Guide                      | 11.30 | Atari Sound & Graphics      | 6.75    |
| Micro Interfacing H'book               | 6.35  |                             |         |

LEASING & RENTAL TERMS AVAILABLE.

# DEANS of Kensington

Tel 01-937 7896  
Opening hours Mon to Sat 9.30-6.30pm  
Prices are subject to change without Prior Notice  
Add 15% VAT

\*Send orders with cheque to DEANS at 191 Kensington High Street, London W8

# BIGBOARD II

A stunning new successor to the popular 'BIGBOARD'

FEATURES  
INDUSTRY STANDARD  
"SASI" INTERFACE  
FOR 5.25"  
WINCHESTER  
HARD DISKS!

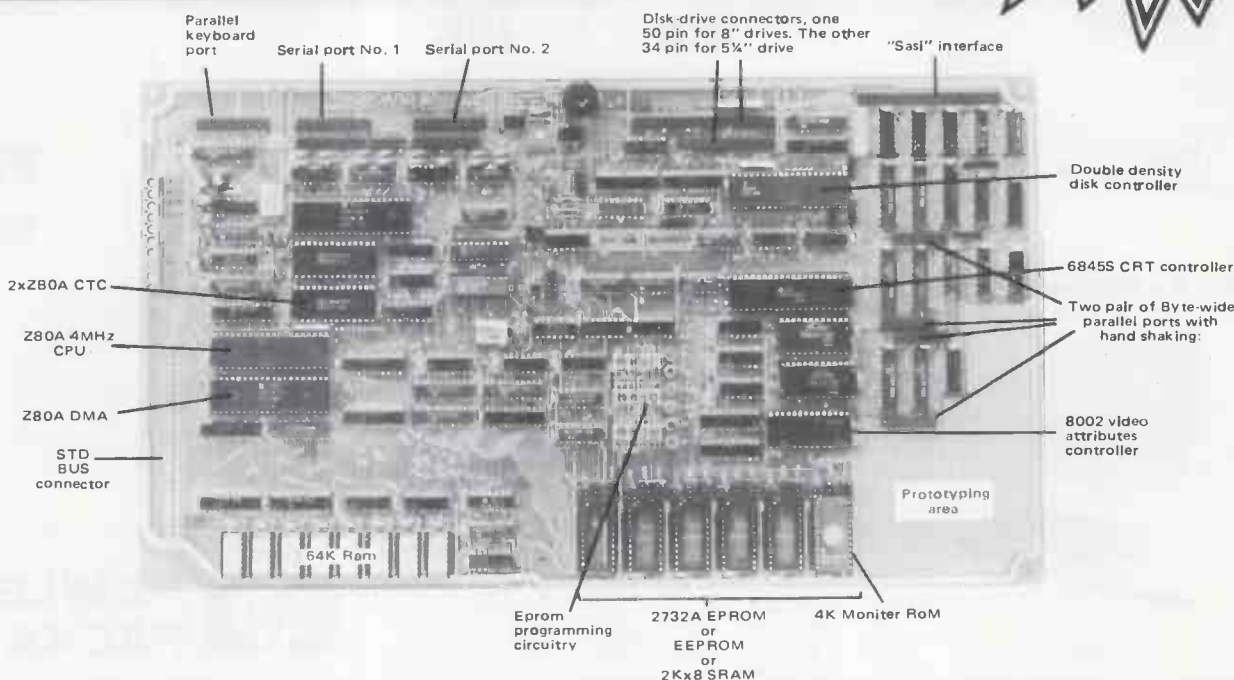

Bareboard + ROM + Documentation + Monitor Source disk only £199 + p & p £4 = £233.45 inc.

Complete kit + Documentation + Monitor Source disk only £425 + p & p £5 = £494.50 inc.

Assembled & tested + Documentation + Monitor Source disk only £499 + p & p £5 = £579.60 inc.

CP/M with CBIOS for the BIGBOARD II £125 + VAT = £143.75 inc. CBIOS only £25 + VAT = £28.75 inc.

**YOU GET ALL THIS ON A SINGLE BOARD—NO HIDDEN EXTRAS  
A TRULY REMARKABLE SINGLE BOARD MICROCOMPUTER—  
SUPER FAST, RELIABLE AND IT RUNS CP/M 2.2!**

- **4MHz Z80A CPU AND PERIPHERAL CHIPS'**  
The new BIG BOARD II computer runs at 4MHz. Its monitor code is lean, uses Mode 2 interrupts, and makes good use of the Z80A DMA chip
- **64K DYNAMIC RAM + 4K STATIC CRT RAM + 24K E(E) PROM OR STATIC RAM**  
"BIG BOARD II" has three memory banks. The first memory bank has eight 4164 DRAMs that provide 60K of user space and 4K of monitor space. The second memory bank has two 2Kx8 SRAMs for the memory-mapped CRT display and space for six 2732As, 2Kx8 static RAMs, or pin compatible EEPROMs. The third memory bank is for RAM or ROM added to the board via the STD bus. Whether bought as a bare board, a full kit, or assembled and tested, it comes with a 2732A EPROM containing the monitor.
- **MULTIPLE-DENSITY CONTROLLER FOR SS/DS FLOPPY DISKS**  
The new BIG BOARD II has a multiple-density disk controller. It can use 1793, 1797 or 8877 controller chips since it generates the side signal with TTL parts. The board has two connectors for disk signals, one with 34 pins for 5.25" drives, the other with 50 pins for 8" drives.
- **VASTLY IMPROVED CRT DISPLAY**  
The new BIG BOARD II uses a 6845 CRT controller and 8002 Video Attributes controller to produce a display that will rival the display of quality terminals (such as DEC VT-100). Characters are formed by a 5x7 dot matrix on 15.75 KHz monitors and a 7x9 dot matrix on 18.60 KHz monitors. The display is user programmable with the default display 24 lines of 80 characters.
- **STD BUS CONNECTOR**  
The new BIG BOARD II brings its bus signals to a convenient place on the PC board where users can solder an STD bus card-edge connector. Any of dozens of controller cards can be plugged directly into it, and it can as well be connected by a bus cable to industry-standard card cages.
- **DMA CONTROLLER**  
The new BIG BOARD II has a Z80A DMA chip that will allow byte-wise data transfers at 500KBytes per second and bit serial transfers via the Z80A SIO at 880 Kbits per second with minimal processor overhead. Though the monitor for the new computer uses the DMA chip mainly for transferring data to and from disk,

the chip can readily be used for other things since its "wait/ready" pin can be connected under software control to some half a dozen signal lines. When a hard-disk subsystem is connected to our "BIG BOARD II" via its "SASI" interface, the DMA chip makes breath-taking disk performance possible.

- **"SASI" INTERFACE FOR WINCHESTER DISKS**  
The BIG BOARD II implements the Host portion of the "Shugart Associates Systems Interface". Adding a Winchester disk drive is no harder than attaching a floppy-disk drive. A user simply 1) Runs a fifty-conductor ribbon cable from a header on the board to any of several inexpensive controller cards (such as Xebec S1410) for Winchester drives that implement the controller portion of the SASI interface, 2) Cables the controller to an appropriate drive, and 3) Provides power for the controller-card and drive. Since our CBIOS contains code for communicating with hard disks, that's all a user has to do to add a Winchester to a system!
- **A Z80A SIO/0 = TWO ASYNCHRONOUS/SYNCHRONOUS SERIAL PORTS**
- **A PARALLEL KEYBOARD PORT + FOUR OTHER PARALLEL PORTS FOR USER I/O**  
The new BIG BOARD II has one parallel port for an ASCII keyboard and four others for user-defined I/O. When the computer is powered-up or reset, the monitor looks for a carriage-return at the keyboard and serial ports. If the first carriage-return the monitor gets comes from the parallel keyboard, the monitor uses the board's video display circuitry to communicate with the user via a CRT. If the first carriage-return is typed at an ASCII terminal attached to a serial port, the monitor autobauds and makes the terminal the system console.
- **TWO Z80A CTCs = EIGHT PROGRAMMABLE COUNTERS/TIMERS**  
The new BIG BOARD II has two Z80A CTCs. One is used to clock data into and out of the Z80A SIO/0, while the other is for systems and applications use.
- **PROM PROGRAMMING CIRCUITRY AND SOFTWARE**  
The BIG BOARD II has circuitry and drivers for programming 2716s, 2732As, or pin-compatible EEPROMs.
- **SIZE: 394mm (15½") x 222mm (8¾")**



**Vincelord Ltd**

Dealer enquiries welcome

Suite 2, 26 Charing Cross Rd London WC2 Tel. 01-240 0213/0217 Telex - 295173 VILORD G

# OEM - BUSINESS - DIY INCREDIBLE? BUT BELIEVE IT

Build a professional 1.6Mbyte (formatted!) business system for ONLY £1,375 + £25 carriage +VAT equals £1,610 inc. We supply complete hardware, peripherals and system software (CP/M compatible disk operating system) - you put them together. YOU GET ALL THIS IN KIT FORM! YOU ASSEMBLE!

1. ZAND 80 Single Board Computer (complete assembled and tested) with 64k RAM, 24x80 character video, 9x13 dot matrix display with true lower case, blink/non-blink cursor, 2xRS232, parallel ASCII keyboard port, Real Time Clock, Multiple Density Disk Controller (1767) PLUS 'ZANDOS' (CP/M) compatible disk operating system with useful routines and utilities **£395**

2. Two 1Mbyte (800K formatted per drive!) Quad track density (9CTPI - 80 Track) double sided 5¼ disk drives complete with assembled cables and connectors for both drives @ £275 each **£550**

Switch Mode Power Supply for the

complete system **£100**

4. Attractive, professional metal case beautifully finished in brown to house items 1 to 3 above complete with front and back panels and fixing kit (measures 470.8mm W x 362mm D x 147.1mm H) **£80**

5. Professional Microprocessor based (uses 6809 CPU, CMOS RAM and EPROM!) 111 Key ASCII Keyboard with separate 20 function keys (freely programmable from the keyboard via 'PROG' Key!), cursor block and numeric pad beautifully cased in a low profile case with matching colours (pale brown) **£150**

6. 12" Monitor in case **£100**

Any of the above items also available separately at prices quoted. TOTAL before £25 carriage and VAT equals **£1375**

(Total inclusive Price equals £1610)

**Business Software - We can supply powerful WORD PROCESSING & ACCOUNTING PACKAGES written in COBOL. Ask for details.**

We also offer super prices on PRINTERS  
Fast Dot Matrix:  
100 CPS NEC 8023BE-C ONLY £325 plus £8 carriage plus VAT equals **£382.95 inc**

Serial Interface for above with 4k buffer £99 plus £1 p&p plus VAT equals **£115 inc**

Most popular DAISY WHEEL: TEC STARWRITER F10-40R 40CPS ONLY £1095 plus £25 carriage plus VAT equals **£1,288 inc**

## NEC 8023B-C

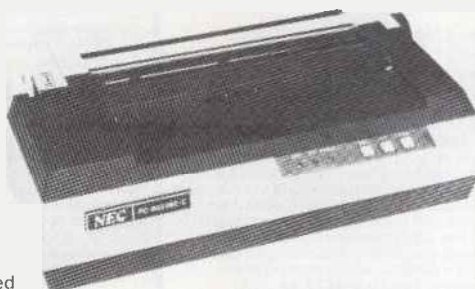

FAST 100CPS DOT MATRIX PRINTER/PLOTTER FASTER THAN MX80!  
BETTER GRAPHICS THAN OKI 82A!

The Most Advanced Low Cost Printer Outstanding Graphics, Print Quality & Performance

Recommended Price £399

Our Price £350 carriage free plus VAT = £402.50 inc.

Plus free box of paper (2,000 sheets 11" x 9¼") worth £20!

Stand Alone Serial Interface (to 9,600 baud) with PSU & 4K buffer £115 inc.

- Lower case descenders
- Superscript subscript, underlining
- Several character sizes & styles (Pica, elite, proportional, reduced, enlarged, enhanced etc)
- 5 unique alphabets
- Greek and Math symbols
- Adjustable tractors
- Single sheet friction feed
- Powerful programmable paper feed
- Special ribbon cartridge
- Backward carriage return
- 4.5" to 10" paper width
- Original plus 3 copies
- Centronics type parallel interface (standard)
- 2K Buffer

- 100CPS print speed
- Bi-directional logic seeking - increment mode
- 80, 136 column
- High resolution dot graphics - 144 x 160 dots/inch
- proportional spacing
- 7 x 9 dot matrix for alphanumerics & symbols
- 8 x 8 dot matrix for character generator graphics
- Output to printer on character by character or dot by dot basis
- Auto reversal (up to down) of ribbon maintains clarity for long period
- ASCII 96 characters - JIS 160 characters - character generator graphics 64 characters - European 14 characters
- Horizontal & vertical tabbing

Optional plug-in serial (RS232C) interface with own PSU, selectable baud to 9,600 and 4K buffer £99 + £1 P&P + VAT = Total £115

## THE BIGBOARD OEM - INDUSTRIAL - BUSINESS - SCIENTIFIC SINGLE BOARD COMPUTER PCB

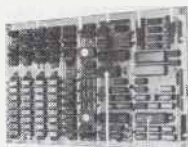

Vast user group & bi-monthly Journal "MICROCORNUCOPIA" details sent with documentation.

- 64K RAM
- 2 x RS232
- 24 x 80 characters
- Parallel ASCII Keyboard Port
- Real Time Clock
- 2K System Monitor
- Size: 8½" x 13¼" same size as an 8" drive
- Z80 CPU
- Two Port parallel
- Video Port
- Floppy Disk Controller (1771) for up to 4 8" SSSD drives
- Runs CP/M 2.2
- 2K Character Generator (upper & true lower case)
- Requires +5V @ 3A, ±12V @ 0.5A

Available ONLY as blank PCB which comes complete with full documentation, the Character Generator ROM, the PFM 3.3 Monitor ROM and a diskette with the Source of BIOS, BOOT, PFM 3.3 Monitor and Printer Routines

£115 + £5 P&P + VAT = Total £138

## 64K S100 STATIC RAM

**NEW!**

**LOW POWER!  
RAM OR EPROM!**

Supplied as partial Kit  
Blank PCB + Docu. + 64K SRAM (32 x TMM2016P 150NS RAMS)  
**ONLY £130 + VAT (£149.50 inc.)**

Blank PCB + Docu. **ONLY £50 + VAT £57.50 inc.)**  
TMM2016 150NS (2Kx8)  
Chips **ONLY £2.80 plus VAT**



### FEATURES

- \* Uses new 2K x 8 (TMM 2016 or HM 6116) RAMs.
- \* Fully supports IEEE 696 24 BIT Extended Addressing.
- \* 64K draws only approximately 500 MA.
- \* 200 NS RAMs are standard. (TOSHIBA makes tmm 2016s as fast as 100 NS. FOR YOUR HIGH SPEED APPLICATIONS.)
- \* SUPPORTS PHANTOM (BOTH LOWER 32K AND ENTIRE BOARD).
- \* 2716 EPROMs may be installed in any of top 48K.
- \* Any of the top 8K (E000 H AND ABOVE) may be disabled to provide windows to eliminate any possible conflicts with your system monitor, disk controller, etc.
- \* Perfect for small systems since BOTH RAM and EPROM may co-exist on the same board.
- \* BOARD may be partially populated as 56K.



# Vincelord Ltd

Suite 2, 26 Charing Cross Road, London WC2  
Tel: 01-240 0213/01-240 0217 Telex: 295173 VILORD G

# COMPUTER WAREHOUSE

THE 'ALLADINS' CAVE OF COMPUTER AND ELECTRONIC EQUIPMENT

## HARD DISK DRIVES

Diablo/DRE Series 30 2.5 mb. fully refurbished DEC RK05 media and software compatible. Front load **£550**. Top load **£295**.  
PSU for 2 drives **£125**.  
Diablo-Dre 44A-4000A or 4000B 10 mb 5+5 removable pack new and refurbished from **£995**.  
CDC 80 mb removable pack DEC RM03 media and software compatible brand new from **£2,950**.  
Honeywell 5+5 10 mb drives **£450** good s/h condition. For more information on controllers, expansions and ready-to-go sub systems contact sales office.

## DISTEL ©

The UK's FIRST free of charge, 24 hr. public access data base. Get information on 1000's of stock items and order via your computer and credit card. On line now, 300 baud. CCITT tones, full duplex, fully interactive.

**DON'T MISS THOSE BARGAINS CALL NOW, IT'S FREE!**  
7 days per week 24 hrs. per day  
**01-683 1133**

## COMPUTER 'CAB'

All in one quality computer cabinet with integral switched mode PSU. Mains filtering and twin fan cooling. Originally made for the famous DEC PDP8 computer system costing 1000's of pounds, and designed to run 24 hours per day. The PSU is fully screened and will deliver a massive +5v DC at 17 amps, +15v DC at 1 amp and -15v DC at 5 amps. The unit is fully enclosed with removable top lid, twin fan cooling, mains filtering, trip switch, 'power on' and 'run' LED's, aluminium front panel and rear cable entries. Give your system that professional finish for only **£49.95 + £9.50 carr.** — Dim. 19" wide 16" deep 10.5" high. Usable area 16" w. 10.5" h. 11.5" d. Units are in good but used condition 240 or 110 working — complete with data. Largest stocks of PDP8 spares — enquire.



## COOLING FANS

Keep your "Hot Parts" cool and reliable with our range of professional fans.  
ETRI 99XU01 Miniature equipment fan 240 vac working DIM 92 x 25 mm BRAND NEW complete with finger guard. Makers price **£16** our price **£9.95**.  
BUHLER 89.11.22 micro miniature 8-16 v DC reversible fan. Measures only 62 x 62 x 22 mm. Uses a brushless DC servo motor almost silent running ideal portable equipment, life in excess of 10,000 hours. BRAND NEW manufactures price **£32.00** our price **£12.95**.  
MUFFIN/CENTAUR cooling fans DIM 120 x 120 x 38 mm tested ex equipment 240v **£6.25** 115v **£4.95 + pp** **£1.90**.  
KOOLTRONICS Powerful snail type blower gives massive air movement with centrifugal rotor DIM as a cube 8" x 8" x 6" air aperture 2.5" x 2.5" with flange fixing. BRAND NEW 110v 50Hz ac working ONLY **£9.95 + £1.90 pp**



## 8" FLOPPY DISK DRIVES

Unbelievable value the DRE 7100 & 7200 8" disk drives utilise the finest technology to give you 100% bus compatibility with most drives available today, the only difference being our PRICE and the superb manufacturing quality. The 7100 single sided & 7200 double sided drive accept hard or soft sectoring. IBM or ANSI standard giving a massive 0.8 MB (7100) & 1.6 MB (7200) of storage. Absolutely SHUGART, BASF, SIEMENS etc compatible. Supplied BRAND NEW with user manual and 90 day warranty.  
7100 single sided ..... **£225.00 + 9.50 + vat**  
7200 double sided ..... **£295.00 + 9.50 carr + vat**  
full technical manual **£20.00** alone **£9.00** with drive, refund of difference on purchase of drive.  
SHUGART s/h 800-2 8" Drive's 110v 50Hz motor **£160 + £9.50 carr.**  
Removed from working equipment but untested. SA120 Alignment disk's **£9.95**

## 9" Monitors

DT10 Monitor a complete MOTOROLA 9" video monitor housed in an attractive metal case DIM approx. 10" deep 16" wide and 11" high. The monitor has a 75 ohm composite video input with a bandwidth of 18 mhz. A separate internal PSU delivers 5v dc for external use and 12v DC for video monitor. The case has sufficient room inside for mounting other units such as 5" disk drives etc. Internal pots give full control over all monitor functions. Supplied in a tested, as new or little used condition. 240v AC operation **£55.00** Carriage and Insurance **£10.50**.  
MOTOROLA 9" open chassis monitor. Standard 240 v ac with composite 75 ohm video input, bandwidth in excess of 18 mhz. Monitors are ex equipment and although unguaranteed they are all tested prior to despatch, and have no visible burns on the screens. Dim approx. 9" x 9" x 9". Supplied complete with mains and input lead. Ideal ZX81 etc or giving the tele back to the family!  
Black and White phosphor **£35.00 + £9.00 Carr.**

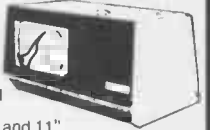

## SUPER SCOOP

### CENTRONICS 739-2

The "Do everything Printer" at a price that will NEVER be repeated. Standard Centronics interface, full graphics, 4 type fonts with high definition & proportional spacing for word processor applications, 80-132 columns, single sheet, roll or sprocket paper handling plus much more. Available only from DISPLAY ELECTRONICS at a ridiculous price of only **£299.00**  
Options: carriage & insurance **£10.00**  
Interface Cable **£10.00**  
RS232 Converter **£45.00**

**SAVE £250**



## TELETYPE ASR33 I/O TERMINALS

FROM **£195 + CAR. + VAT**  
Fully fledged industry standard ASR33 data terminal. Many features including ASCII keyboard and printer for data I/O auto data detect circuitry. RS232 serial interface, 110 baud, 8 bit paper tape punch and reader for off line data preparation and ridiculously cheap and reliable data storage. Supplied in good condition and in working order.  
Options: Floor stand **£12.50 + VAT**  
KSR33 with 20ma loop interface **£125.00 + Sound proof enclosure £25.00 + VAT**



## SOFTY 2

The amazing SOFTY 2. The complete "toolkit" for the open heart software surgeon. Copies, Displays, Emulates ROM, RAM and EPROMS of the 2516, 2532 variety. Many other features include keyboard, UHF modulator. Cassette interface etc. Functions exceed capabilities of units costing 7 times the price! Only **£169.00 pp** **£1.95** Data sheet on request

## MAINS FILTERS

Professional type mains filters as used by "Main Frame" manufacturers. Ideal for curing those unerving hang ups and data glitches — fit one now and cure your problems.  
Suppression Devices SA5A upto 5 amp load **£5.95**  
Corcom Inc F1886 upto 20 amp load **£9.50**  
Corcom Inc F1900 upto 30 amp load **£12.25**

## RECHARGEABLE BATTERIES

CYCLON type D001 sealed lead acid maintenance free 2v 2.5 ah. will deliver over 300 amps on short circuit! Brand new at only **£2.95**  
SAFT VR2C size 'C' 1.2v 2 ah. nickel cadmium **£1.50** each 10 for **£11.50**

## D.C. POWER SUPPLY SPECIALS

Experimentors PSU Ex-GPO unit all silicon electronics. Outputs give +5v @ 2 amps, +12v @ 800 ma. -12v @ 800 ma. +24v @ 350 ma. 5v @ 50 ma floating. Dim 160 x 120 x 350 mm. All outputs fully regulated and short circuit proof. Removed from working equipment, but untested. Complete with circuit. Transformer guaranteed. Only **£14.50 + £2.50 pp**.  
POWER ONE CP143 super compact unit giving continuous output of 5v @ 5 amps. dim. 215 x 67 x 80 mm. BRAND NEW and guaranteed only **£21.00 + £1.50 pp**.  
CUSTOM POWER CO55 5v @ 3 amp. Very compact unit dim. approx 60 x 90 x 190 mm. Semi open chassis, full crowbar overvoltage protection. Tested Ex Equipment. **£11.95 + pp** **£1.25**  
MINI SYSTEM PSU Ex equipment unit ideal for the small micro. Outputs give 5v @ 3 amps. +12v @ 1 amp and -12v @ 300 ma. Crowbar overvoltage protection and current limit. Fully tested. Dim 70 x 165 x 320 mm. Complete with Circuit only **£12.95 + £2.00 pp**.  
PERIPHERAL SYSTEM SUPPLY. Fully cased unit supplied in a Brand new or little used condition. Outputs give 5v @ 11 amps, "+1" 15-17v @ 8 amps, "-1" 15-17v @ 8 amps and "+2" 24v @ 4 amps. All outputs are crowbar protected and the 5 volt output is fully regulated. Fan cooled. Supplied tested, with circuit **£55.00 + £8.50 carr.**  
MAIN FRAME SUPPLY. A real beefy unit designed for MINI or MAINFRAME use outputs give 5 volts @ 50 amps. +12v @ 5 amps. -12v @ 10 amps. All output are fully regulated with crowbar overvoltage protection on the 5v output. Supplied with circuit and tested. Ex-Equip. 110v AC input. Only **£99.95 + carr.** **£10.50**.

## RCA FULLY CASED ASCII CODED KEYBOARDS



IDEAL TANGERINE OHIO ETC.

Straight from the USA made by the world famous RCA Co., the VP600 Series of cased freestanding keyboards meet all requirements of the most exacting user, right down to the price! Utilising the latest in switch technology. Guaranteed in excess of 5 million operations. The keyboard has a host of other features including full ASCII 128 character set, user definable keys, upper/lower case, rollover protection, single 5V rail, keyboard impervious to liquids and dust, TTL or CMOS outputs, even an on-board tone generator for keypress feedback and a 1 year full RCA backed guarantee.  
VP601 7 bit fully coded output with delayed strobe, etc. **£43.95**  
VP611 Same as VP601 with numeric pad **£54.95**  
VP506 Serial, RS232, 20MA and TTL output with 6 selectable Baud Rates **£64.26**  
VP616 Same as VP606, with numeric pad **£84.34**  
Plug and cable for VP601, VP611 **£2.25**  
Plug for VP606, VP616 **£2.10**  
Post, Packing and Insurance **£1.95**  
ORDER NOW OR SEND FOR DETAILS

## 300 BAUD DATA MODEMS

Join the communications revolution with our standard EX GPO 2a/b data MODEMS. Modem operates on standard CCITT tones with full auto answer facilities. Will switch to ANSWER or ORIGINATE. Standard RS232 v/o connections. Ideal networks. DISTEL etc. Complete with data. Untested but good condition **£55.00** carr. **£8.50**.

## 1200 BAUD DATA PUMP MODEMS

Compact unit for use with private or "Dial up lines". Designed to work in pairs at any baud rate upto 1200 full duplex (4 wire circuit) or half duplex (2 wire circuit). Features include remote test facilities. RS232 v/o lines etc. Supplied with data in working order, but less case cover **£65.00 + £4.50 carr.**

## 66% DISCOUNT

### ELECTRONIC COMPONENTS & EQUIPMENT

Due to our massive bulk purchasing programme which enables us to bring you the best possible bargains, we have thousands of I.C.'s, Transistors, Relays, Cap's, P.C.B.'s, Sub-assemblies, Switches, etc. etc. surplus to our requirements. Because we don't have sufficient stocks of any one item to include in our ads, we are packing all these items into the "BARGAIN PARCEL OF A LIFETIME" Thousands of components at giveaway prices! Guaranteed to be worth at least 3 times what you play plus we always include something from our ads. For unbeatable value! Sold by weight.

2.5kls **£4.25 + pp** **£1.25**  
10kls **£10.25 + pp** **£2.25**

5kls **£5.90 + pp** **£1.80**  
20kls **£17.50 + pp** **£4.75**

DISPLAY ELECTRONICS

All prices quoted are for U.K. Mainland, paid cash with order in Pounds Sterling PLUS VAT. Minimum order value **£2.00**, Minimum Credit Card order **£10.00**. Minimum BONAFIDE account orders from Government depts., Schools, Universities and established companies **£20.00** Where post and packing not indicated please ADD **60p + VAT** Warehouse open Mon-Fri 9.30 — 5.30. Sat. 10.15 — 5.30. We reserve the right to change prices and specifications without notice. Trade, Bulk and Export enquiries welcome.

64-66 Melfort Road, Thornton Heath, Near Croydon, Surrey  
01-689 7702 — 01-689 6800 Telex 27924





## INGENIOUS Genie I

All the features of the EG3003 system plus: \* *Machine Language Monitor*  
\* *Fitted Sound* \* *Renumbr Command*  
\* *Full Lower Case* \* *Screen Print*

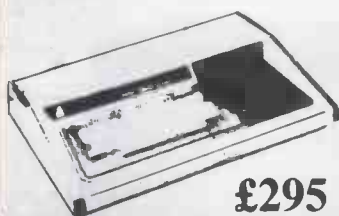

16K

£295 + VAT

## The Second Generation Personal Computer

### Highest performance lowest price

- \* 48K
- \* 16 Colours
- \* Multiple Resolution Graphics
- \* Split screen modes

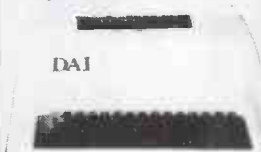

**DAI**

£595

+ VAT

## Genie II

### The MacroComputer

Offering all the advantages of the Genie I system, with the benefit of advanced design for the professional user.

- \* *4 Defineable Function Keys*
- \* *Full Upper & Lower Case*
- \* *Terminal Routines*
- \* *Facility to upload & Download*
- \* *Screen Print*
- \* *Includes T.V. Modulator*

£310 + VAT

## Acorn Atom

Special features include  
\* **FULL SIZED KEYBOARD**  
\* **ASSEMBLER AND BASIC**  
\* **HIGH RESOLUTION COLOUR GRAPHICS**

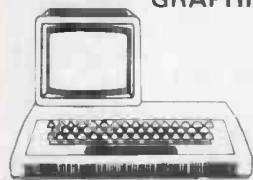

from:

£120

+ VAT



*watch this space*

## VIC 20

Comprehensive facilities at a realistic price.



8 Col. modulator  
Plugs into T.V.  
3.5K User Ram  
Uses Pet Basic  
Includes Power supply ready to use.

£165.00

VIC cassette

£39.00 + VAT

## TANTEL 'PRESTEL' adaptor

Converts any black and white or colour T.V. for 'PRESTEL' reception.

£160 + VAT

## Printers

The most compact 80 column impact graphic-dot printer available  
AT A VERY COMPACT PRICE

**seikosha GP80**

£195 + VAT

ALSO

EPSON MX80\*EPSON MX100  
ANADIX\*PAPER TIGER\*TEC  
SCRIPTA\*MICROLINE 80

## EG3023

Special adaptor to allow connection of TRS 80 to GENIE peripherals

## EG3014

GENIE low cost 16K expander

FOR

BLANK  
TAPES  
C12

DISK-  
ETTES

BITS

RIBBONS  
for most  
printers

BOOKS

LABELS

SOFT-  
WARE

LISTING  
PAPER

(9½ x 11)  
£9.00 per box  
2000 sheets

MONITORS

all this and  
much much  
more . . . .



# MicroStyle

29 Belvedere, Lansdown Road, Bath.  
Telephone: (0225) 334659.



**North East  
Micro-Computer  
Centre &  
Enthusiasts  
Corner**

Acorn-BBC-Video Genie  
Apple, Dragon

Printers: Seikosha, Epson, Daisy Wheel  
(£5.50) etc Disc Drives  
Range of integrated circuits

Accessories: plugs, cables etc  
Consumables; paper, cassettes, diskettes,  
ribbons etc

Soon: for BBC micro  
Forth Rom, fast cos, acoustic coupler.

Maintenance: Full service available

For Information & Prices contact:

**HCSS Associates**  
0533 Durham Road  
Low Fell  
Gateshead  
Tyne & Wear  
Tel: (0632) 821924

let the  
**DRAGON 32**  
fire your  
imagination . . .



**for only £199.50**  
Plus £5 Post & Packing

*No other computer offers  
you all these features  
at any price . . .*

- 32K RAM MEMORY
- PROFESSIONAL STANDARD KEYBOARD
- 1 YEAR WARRANTY
- 9 DISPLAY COLOURS
- 5 DISPLAY RESOLUTIONS
- EXCEPTIONAL GRAPHICS CONTROL
- 5 OCTAVE SOUND GENERATOR
- DIRECT MUSIC COMMANDS
- REAL-TIME CLOCK/TIMER
- MICROSOFT EXTENDED COLOUR BASIC
- PLUG-IN CARTRIDGES AVAILABLE
- CENTRONICS PARALLEL PRINTER PORT
- SOCKETS FOR JOYSTICKS
- SOCKETS FOR FULL CASSETTE CONTROL
- EXCELLENT CASSETTE FILE HANDLING
- COMBINED AUDIO/DATA INPUT FACILITY
- AUDIO OUTPUT VIA T.V.
- EXPANDABLE TO 64K RAM
- POWERFUL 6809E MICROPROCESSOR
- FREE 160 PAGE TRAINING MANUAL
- BRITISH MADE

*Available now from:*

**ComServe**

98 TAVISTOCK STREET, BEDFORD MK40 2RX.  
TELEPHONE: BEDFORD (0234) 216749

|                                 |                                     |
|---------------------------------|-------------------------------------|
| ACORN ATOM<br>BBC MICROCOMPUTER | SUPERBRAIN<br>TORCH                 |
| SHELTON SIGNET                  | RAIR BLACK BOX<br>ICL MICROCOMPUTER |

Business systems with speciality software from Dental  
Appointments Package to Integrated Accounts.

**CP/M BUSINESS SYSTEMS**

FROM £2,750 including printer and software

**SUPER OFFER**

SUPERBRAIN QD at only £1950  
limited amount of ACORN ATOMS  
at only £125  
including VAT and delivery.

CONTACT US FOR DETAILS  
OF THE FABULOUS NEW TORCH COMMUNICATOR  
● NEW FROM VIXSOFT  
BBC DISASSEMBLER £5.95 inc VAT

**VIXON COMPUTER SYSTEMS**

49 GRIMSBY ROAD  
CLEETHORPES  
TEL. GRIMSBY (0472) 58561



KEEP YOUR OPTIONS WITH

# MIRAGE

## A NEW GENERATION OF DATA BASE

MIRAGE has been thought out on a human scale. Design and set-up of a Data Base take less than an hour.

MIRAGE offers just the right number of features to solve your business problems.

MIRAGE uses relational data management techniques to achieve unique flexibility.

MIRAGE can be accessed directly from your programs. Unlimited on-line addition, retrieval and modification of your informations.

MIRAGE has response time which will surprise you.

MIRAGE enables you to use normal, existing files. Its structure is easy to modify interactively.

### MIRAGE main specifications and tools :

99 files of 65535 records.

Possibility to have 1 direct access key and 5 chained access keys per file.

Independence of data and pointers.

Multi-users possibility is under development.

For creation :

- DBSCHEMA, design tool
- DBUTIL, preparation tool

For Programming :

- DBPUT, to add a record
- DBGET, to read a record
- DBDELETE, to suppress a record

MIRAGE, is programmed entirely in PASCAL and is independent of any Operating System. Initially available under CP/M at £ 475 excl. VAT. Training and technical support on demand. MIRAGE is a product of DATASOFT International.

For additional information, please write to :

**DATASOFT INTERNATIONAL** 17, CARLISLE STREET, SOHO SQUARE, LONDON, W1V 6 PE

DEALERS AND OEM ENQUERIES WELCOME

### DISKS & TAPES

- 5 1/4" SSSD BASF £17.95 + VAT
- 5 1/4" SSDD BASF £21.45 + VAT
- 5 1/4" DSDD BASF £25.95 + VAT
- 5 1/4" Cleaning Set £16.50 + VAT
- 5 1/4" Library Case £1.90 + VAT



Cassettes (C20) 65p All storage media is top quality—No High St. rubbish.

Add £1.50 p. & p. per box.

28 Disk protection folder £10.49 + VAT

## Micro-Spares

SUPPLIERS TO TRADE LOCAL GOVERNMENT EDUCATION INDIVIDUALS & BUSINESS INDUSTRY

### VALUE

COMPUTERS PERIPHERALS COMPONENTS & NATIONWIDE MAINTENANCE

19 ROSEBURN TERRACE, EDINBURGH EH12 5NG  
031-337 5611

#### PAYMENT AND DELIVERY

Payment is by Cheque, Postal Order, ACCESS, VISA etc. PLEASE add postage and VAT. All in stock items sent same day. All non Kit items have a 1 year guarantee.

ALL PRICES APPLY TO END SEPTEMBER 1982

#### COMPONENTS

| MEMS           |       |
|----------------|-------|
| 4116 (200nS)   | 73p   |
| 2708           | £1.50 |
| 2716 (5V RAIL) | £2.11 |
| 2114L          | 95p   |
| CONNECTORS     |       |
| 25W plug       | £1.50 |
| 25W socket     | £1.89 |
| Covers         | £1.20 |

**NEW!** **IN STOCK**  
Only £155 + VAT  
The new colour board from Lucas  
**now**

## nascom PRODUCTS

|                                      |         |
|--------------------------------------|---------|
| <b>KITS</b>                          |         |
| Nascom 1, with NAS-SYS 1 less P10    | £112.50 |
| Nascom 2, no user RAM                | £202.50 |
| <b>BOARD LEVEL</b>                   |         |
| Nascom 1, with NAS—SYS 1 less P10    | £126.00 |
| Nascom 2, no user RAM                | £238.50 |
| <b>CASED SYSTEMS</b>                 |         |
| Nascom 3, no user RAM                | £338.40 |
| 8K user RAM                          | £36.00  |
| 16K user RAM                         | £90.50  |
| 32K user RAM                         | £103.50 |
| 48K user RAM                         | £117.00 |
| <b>POWER SUPPLY</b>                  |         |
| Kit form                             | £29.95  |
| <b>MEMORY CARDS</b>                  |         |
| RAM B memory card with 16K RAM—kit   | £72.00  |
| RAM B memory card with 16K RAM board | £90.00  |
| Additional 16K RAM                   | £13.50  |
| Additional 32K RAM                   | £27.00  |
| <b>I/O BOARDS</b>                    |         |
| I/O boards for 3x P10                |         |
| 1 x CTC, 1 x UART (kit) ex P10       | £40.50  |
| P10 for above I/O                    | £10.80  |
| CTC for above I/O                    | £12.60  |
| UART for above I/O                   | £14.40  |

## SHARP MZ80K

**48K Computers unbeatable prices £315 + VAT**

High Resolution Graphics for MZ80K  
**£110 + VAT**

|   |         |
|---|---------|
| <b>DISC SYSTEMS</b>   |         |
| Nascom single disc drive (350KB) incl. FDC card (Nascom) dual disc drive (350KB each) | £423.00 |
| Incl. FDC card  | £616.50 |
| NAS DOS disc op system  | £40.50  |
| <b>SOFTWARE</b>   |         |
| NAS-SYS 1 ROM   | £10.80  |
| NAS-SYS 3 EPROM   | £18.00  |
| ZEAP 2.1 for NAS  | £26.30  |
| SYS in 4 x EPROM  |         |
| ZEAP 2.1 for NAS  | £22.50  |
| SYS on tape   | £22.50  |
| BK microsoft basic in ROM   | £18.00  |

### TOP VALUE PRINTERS TOP VALUE

|                                      |             |
|--------------------------------------|-------------|
| Anadex DP8000 B & O Matrix           | £300 + VAT  |
| Tec 45 & 55 Cps Daisy Wheel          | £995 + VAT  |
| Silver Reed Typewriter/Printer RS232 | £500 + VAT  |
| RIKOH RP1600                         | £1149 + VAT |
| Triumph-Adler Stylist                | £595        |

### from £307 EPSON PRINTERS PRINTERS

|                |            |
|----------------|------------|
| MX80FT—I       | £307 + VAT |
| MX80FT—II      | £315 + VAT |
| MX80FT—III     | £327 + VAT |
| MX100 Type III | £439 + VAT |
| MX82FT         | £330 + VAT |

### TERMINALS/MONITORS

|                              |            |
|------------------------------|------------|
| BMC 12v Green Screen Monitor | £119 + VAT |
| Televideo 910 Terminal       | £425       |
| Televideo 925 Terminal       | 525        |
| Televideo 950 Terminal       | £615       |



1 YEAR GUARANTEE ON ALL NON KIT ITEMS

## GEMINI

The Gemini MultiBoard concept is the logical route to virtually any microcomputer system you care to name. Whether you require a business system, an educational system, a process control system or any other system, there is a combination of MultiBoards to fulfill that function.

This concept ensures maximum flexibility and minimal obsolescence. Maintenance and expansion is greatly enhanced by the modular board design. MultiBoard is based on the 80-BUS structure, which is finding increasing acceptance among other British manufacturers, thus broadening the product base.

#### HARDWARE (BUILT & TESTED)

|                                  |        |  |        |
|----------------------------------|--------|--|--------|
| QM802 54K RAM card               | £140   | QM813 Z80 CPU/64K RAM card                     | £225   |
| QM803 EPROM ROM card             | £65    | EV814 IEEE 486 card                            | £140   |
| QM807 3A PSU                     | £40    | GM815-1 Single drive disk unit with PSU (350K) | £325   |
| QM808K* EPROM programmer         | £28.50 | GM815-2 Double drive disk unit with PSU (700K) | £550   |
| QM809 FDC card                   | £125   | GM816 Multi I/O board                          | £140   |
| QM810K 5A PSU 8 slot motherboard | £69.50 | AM819 Speech board                             | £85    |
| QM811 Z80 CPU card               | £125   | AM820 Light Pen                                | £35    |
| QM812 Z80 IVC card               | £140   | AM821 ASC II keyboard                          | £57.50 |

#### SOFTWARE

|   |     |  |      |
|---|-----|--|------|
| GM512 CPM 2/2 for MultiBoard              | £90 | GM524 Gem Dis disassembler/bugger tape | £30  |
| GM517 Gem-Zap edit/asrm tape              | £45 | GM525 Gem Dis disassembler/bugger disk | £30  |
| GM518 Gem-Zap edit/asrm disk              | £45 | GM526 Comal-80 tape                    | £100 |
| GM519 Gem Pen editor text formatter tape  | £45 | GM527 Comal-80 disk                    | £100 |
| GM520 Gem Pen editor text formatter EPROM | £45 | GM528 APL disk                         | £200 |
| GM521 Gem Pen editor text formatter disk  | £45 |  |      |

**THE GALAXY COMPUTER FOR BUSINESS ETC**

|  |                                |
|--|--------------------------------|
| <b>Hardware</b>                              |                                |
| *Twin Z80A CP/M System                       | *Prog. Character Generator     |
| *54K Dynamic RAM                             | *160 x 75 Pixel Graphics       |
| *800K Disk Storage (Formatted)               | *Centronics Parallel I/O       |
| *80 x 255 Screen Format                      | *RS232 I/O                     |
| *Inverse Video                               | *Light pen interface           |
|  | *59-Key ASCII Keyboard         |
| <b>Software</b>                              |                                |
| *Full 64K CP/M 2.2 with screen edit facility | *GEM-ZAP Assembler/Editor      |
| *Comal-80 structured BASIC                   | *GEM-PEN Text editor           |
|  | *GEM-DE BUG debugging software |
| Galaxy System                                | £1450 + VAT                    |
| Green Screen Monitor                         | £117 + VAT                     |

INTEREST FREE CREDIT AVAILABLE

# ALGRAY SOFTWARE

## TRS-80 model I & III – VIDEO GENIE SOFTWARE

**AIR ATTACK TRS-80 16k, model I & III – £8.95**

Presenting a new dimension in Arcade games: The Third! Defend the East Coast against hordes of enemy aircraft swarming in. Excellent graphics, machine code with sound.

**FROG RACE TRS-80 16k, model I & III – £5.95**

From the arcades comes FROG RACE. Your aim is to see Road Safety observed! Cross a motorway then a river hopping on the backs of the crocodiles, logs etc. Progressively more difficult until you are eventually squashed! drowned! or eaten!; Collect a few lady frogs for a bonus!!! Super fast machine code with sound.

### PET

**SUB COMMANDER ROMS 2,3,4, 16k & 32k – £9.95**

Command a WWII sub on a seek and destroy mission, graphics plus tactical display add up to a game of tactics and deep cunning.

**MAZEMAN ROMS 2,3,4 8k – £9.95**

Everybody must have seen 'PACMAN' in the arcades, if not your quest is simple, simply steer your eater around a maze avoiding the inhabitants until you get the power pills scattered around and then chase them. An added dimension with this variation is the ability to set the speed and number of ghosts. WITH SOUND!

**ASTROIDS ROMS 2,3,4 8k – £9.95**

You must have seen this game somewhere, so buy it and spend endless hours clearing the space lanes.

### VIC-20

- SPACE STORM 3k – £6.95
- COSMIC BATTLE 3k – £4.95
- SUPER WORM 3k – £4.95
- JUNGLE 3k – £4.95
- CODE BREAKER 3k – £4.95

### ATARI

- CAVERNS OF MARS 16k – £23.95
- CONVERSATIONAL FRENCH 16k – £31.95
- GERMAN 16k – £31.95
- ITALIAN 16k – £31.95
- GHOST HUNTER – £17.95
- FROGGER – £19.95

PLUS LOTS MORE IN OUR CATALOGUE – 75p (refundable on purchase)

Please specify machine, memory etc.

All prices fully inclusive of VAT, post & packing etc. (no extras); Use our freepost address:

**FREEPOST, ALGRAY Software, 33 Bradbury Street, Barnsley, S. Yorkshire S70 6BR**

# CHRISALD

*As we GROW, our prices SHRINK!!!!*  
**VALUE UNBEATABLE ANYWHERE IN UK**

|                     |               |
|---------------------|---------------|
| Epson MX80, t       | £315.00       |
| Epson MX80, ft 1    | £355.00       |
| Epson MX80, ft 2    | £355.00       |
| Seikosha GP100      | £189.00       |
| CUMANA dual disk    | £369.00       |
| CUMANA single disk  | £199.00       |
| 11"x9½" fanfold     | £ 16.50/2000  |
|                     | £ 10.00/1000  |
| GENIE 1 & 2         | £289.00       |
| Vic20               | £173.00       |
| 9", 12MHz+ Monitor  | £ 99.00 green |
|                     | £ 95.00 b/w   |
| GENIE LE19 Rom Unit | £24.50        |
| ROM EP1             | £12.00        |
| Nascom 2, kit       | £220.00       |
| Nasom 2, built      | £280.00       |
| Verbatim Discs 40t  | £ 19.85/10    |
| 80t                 | £ 28.50/10    |

**ALL VIC ACCESSORIES · ALL NASCOM OPTIONS**  
**ALL EXPANSION**  
*prices exclude VAT but delivery free in 50 mile rad.*  
**BOOKS – COMPONENTS – HELP – ADVICE**

BARCLAYCARD/ACCESS Welcome. Orders taken by telephone and dispatch from stock same day.

# CHRISALD

13 High Street, Berkhamsted, Herts  
 TELEPHONE (04427) 74569 or 5704

Open 9am to 5.30 weekdays (lunch 1-2)  
 9am to 1.15pm Saturdays.  
 (Answerphone service outside hours)

Two day courses in  
 computer programming  
 held September through  
 to November at  
 The Post House Hotel, Bayswater

# Poste-haste to the Post House

## Introduction to BASIC

REF. NO. IB 31 – SEPT 27-28/NOV 22-23

## Structures in Programming

REF. NO. SP 33 – OCT 28-29

The fee includes course manuals and lunch, upon receipt of fee a course timetable is issued. Registration is at 9.30 am.

### Meares Training Limited

500 Gresham House, 150 Regent St., London W1R 5FA  
 Tel: 01-450 1380

**£172.50**  
 INC. VAT

# CP/M - MP/M PAYROLL

NOW ONLY **£250** + VAT  R.R.P £395

## 'PAYMASTER'

THE COMPREHENSIVE PAYROLL PACKAGE  
FOR COMPANIES LARGE & SMALL  
OPERATES ON FLOPPY OR HARD DISK.

Dealer Enquiries also invited

**WARWICK COMPUTERS LTD.**

BUSINESS SYSTEMS AND SERVICES  
King's House, King Street, Bedworth CV12 8LL  
Tel: 0203-317746

MODEL/TYPE: \_\_\_\_\_  
DISK DRIVES: \_\_\_\_\_  
NO OF EMPS.: \_\_\_\_\_  
CONTACT NAME: \_\_\_\_\_  
ADDRESS: \_\_\_\_\_

# We've opened up the whole country.

**MASS  
MICROS**

- WE SUPPLY NATIONWIDE
- WE INSTALL NATIONWIDE
- MAINTAINED NATIONWIDE
- BEST PRICES NATIONWIDE
- LEASING SCHEMES

Our unique service allows you to buy anywhere in the UK with the confidence and knowledge that the equipment we supply is at the right price and supported.  
Our experience of putting together the correct system for you ensures full satisfaction.

- \* COMPLETE RANGE OF SOFTWARE, PRINTERS AND PERIPHERALS
- \* 12 MONTHS NEXT DAY SERVICE INCLUDING PARTS, LABOUR AND TRAVEL TO YOUR SITE

**MASS  
MICROS**

- ASK FOR SERVICING QUOTES ON NEW AND EXISTING EQUIPMENT

Wellson House, Brownfields,  
Welwyn Garden City, Herts.  
Tel: Welwyn Garden (07073) 31436/7  
Telex 298641

Please send for FREE information pack on Apple  CBM  Superbrain   
Printers  Maintenance

Name .....

Company .....

Address .....

Ref. PCW/2 .....

Tel No: .....

**SPECIAL PRICES**  
Aug/Sept All Models  
Floppy Disks £12 per box

AUTHORISED  
DEALERS

 **commodore**

 **ICARUS  
SUPERBRAIN**

 **apple**

**TABS**

# Keep your apple on your own tree.

## Any personal computer is vulnerable

The system, its controller cards and its peripherals can be stolen when left unattended. Unauthorised users can intrude.

Power surges can destroy or corrupt programs and vital data.

Heat can also cause problems.

And, in the office or home, power and interface cables can make a smart system look a jungle of wires.

Designed by approved consultants to Apple Computer Inc., Station II is a simple device that removes these problems at a stroke, as thousands of Apple users in the USA have discovered.

Add up the potential cost of these problems and the price of the solution — Station II — will come as a pleasant surprise. £89 plus VAT. For Apple users the arrival of Station II is a windfall not to be missed. (Dealer terms available on request)

**Fletcher Dennys Systems Ltd.**, the sole European distributors, can offer immediate delivery. So, secure your Apple system NOW by filling in the coupon.

## Station II



Please send me  Station II units @ £105.25 inc. VAT post & packing  
 optional integrated fan kits @ £58.85 inc. VAT post & packing

Name \_\_\_\_\_ Telephone \_\_\_\_\_

Address \_\_\_\_\_

I enclose a cheque for

Please debit my Access the sum of

£

Access card number

**Fletcher Dennys Systems Ltd.,**

97c Elgin Avenue, London W9 2DA Tel. 01-286 7374

Dealer Enquiries Welcome

**British SPELLGUARD™**

**THE PROFESSIONAL SPELLING CHECKER**

- \* TOTALLY BRITISH SPELLING
- \* SOFTWARE PRODUCT of the YEAR 1981
- \* Recommended by OSBORNE for the OSBORNE 1 Personal, Portable Computer
- \* Over 3,000 Licensed Users
- \* 20,000+ Word dictionary
- \* Legal, Medical & Financial dictionaries

### BRITISH SPELLGUARD

- \* The *VERY BEST* Spelling Checker
- \* The *PERFECT PARTNER* to Wordstar, Magic Wand, Electric Pencil and many more
- \* The *BRITISH* version of America's top product

**VISION ASSOCIATES**

57 Woodham Lane,  
New Haw,  
Weybridge,  
Surrey KT15 3ND.

Tel: Weybridge (0932) 55932

# New from Millbank!

THE AMAZING



**WALTERS 120**

The new Dot Matrix printer which proves there has never been a better time to buy British.

- 120 cps. 80/132 columns.  9 x 9 dot matrix.
- True descenders.  Bi-directional/logic seeking.
- Choice of plug-in interfaces.
- High resolution/block graphics.

**£395.00** (ex VAT)

(with centronics interface).

MILLBANK COMPUTERS LIMITED

Millbank House · Amyand Park Road · Twickenham Midd. TW1 3HN  
Telephone: 01-891 4691

# Scribelight

## now offer Epson Printers

- \* IBM recommended
- \* Compatible, with correct interface, to:-  
IBM, DEC, APPLE, BBC, PET, SIRIUS...  
— we have yet to find a modern computer that is not compatible!
- \* Lowest prices we have found for all models
- \* Bi-directional and Logic seeking
- \* Bit image printing

|                    |           | RRP  | Our Price | Your Saving |
|--------------------|-----------|------|-----------|-------------|
| MX 80 Type III     | (80 cps)  | £349 | £299      | £50         |
| MX 80 F/T Type III | (80 cps)  | £389 | £339      | £50         |
| MX 82 F/T          | (80 cps)  | £409 | £359      | £50         |
| MX 100 Type III    | (100 cps) | £499 | £439      | £60         |

Interfaces available for all above computers at discount rates.  
For example: RS232C — £26, IEEE — £31

All prices exclusive of £10 P&P and 15% VAT.

Send cheque with order to:- Scribelight Ltd  
76 High Street  
Blunham  
BEDS

Enquiries to: 0480 860549 (office)  
or: Mr J Papworth on 0767 40387  
after 6 p.m.

# NOT

## just another Apple bit copier

Put Locksmith back on the shelf! SNAPSHOT removes copy protection, and copies most programs that no bit copier can touch — including the bit copiers themselves!

SNAPSHOT will copy any program that runs on a 48K Apple II (except for programs that require a Z-80 card or that repeatedly access their own disc while running.) For example, SNAPSHOT will copy every bit copier now sold in less time than it takes you to read this paragraph. SNAPSHOT is a peripheral card that uses your language card\* to interrupt a running program and dump the entire contents of 48K and registers to an unprotected backup disc.

Unlike bit copiers, SNAPSHOT requires no complex parameter changes or trial-and-error tedium. SNAPSHOT is also ideal for debugging your own programs or analysing others' programs. And SNAPSHOT can be used to temporarily suspend your work with one program while you use another program. For example, you could interrupt word-processing a letter to look up an address on a database, then resume processing the letter where you left off.

- Repeatedly interrupt and resume any program
- Full monitor capabilities to examine, modify, trace, single-step, or disassemble an interrupted program
- Copies from DOS 3.2 to DOS 3.3
- Faster and easier to use than any bit copier
- Lets you suspend work with one program while you use another
- List "unlistable" programs; Make custom modifications

**PRICE £95.00 from Dark Star Systems**

Terms: Add 15% VAT, P&P Included. Check with order, please. Postage £1 outside UK, £3 outside Europe. Dealer terms available. \* Requires one drive and Apple, Microsoft, Ramex or Digitek language/RAM card. Other brands: specify when ordering.



54 Robin Hood Way, Greenford, Middx. UB6 7QN Phone 01-900 0104

## ozwise expands!

### BIGGER PREMISES

At 236 Imperial Drive, Harrow, just 150 yards from Rayners Lane tube, (Piccadilly and Metropolitan lines)

### BIGGER STOCKS

Come and see the new Sirius I and Apple II and Apple III, Vic-20 personal computer, Business software, education, games

### BIGGER RANGE

Choose from over 40 different printers, 12 different monitors, over 200 business programs, utilities and language systems, over 300 education and games programs plus books, magazines, disks, ribbons etc. All either in stock or available at short notice.

### BIGGER DISCOUNTS

Epson MX80 F-T New Type 3 only £329  
Epson MX100 New Type 3 only £429  
Vic-20 Personal Computer only £152.13  
Apple Visicalc only £85  
12" Green screen Monitors from £89  
Apple Videx 80 Column card only £159  
Oki Microline 80 only £269  
Please add VAT — Credit card holders telephone your order

CALL FOR LATEST SPECIAL OFFERS

AND WE STILL PROVIDE THE SAME EXCELLENT SERVICE!

Drop in and see us or write/call for our full catalogue

BUSINESS USERS call for an appointment with one of our consultants.

01-429 1060

# CASSETTES

**BiBi** can fill all your needs

**DUPLICATING.** Need 50 to 50,000 Programme copies within 10 days?

Our facilities include short-run in-cassette copying, high-speed volume duplicating, on-cassette body printing, labelling, over-wrapping.

**BLANKS.** Making your own copies?

Any length Blank Cassettes, loaded with error-free batch-certified HM-1260 Cassette Tape

**PROGRAMMES.** Want wider distribution — to the High Street?

We'll be pleased to talk to you about licensing/distributing any Programmes for popular micro models.



BiBi Magnetics Limited

All enquiries and materials are treated in the Strictest Confidence.

Contact Write Phone

101/105 Plough Road, London SW11 2BJ

Kildare Borrowes

Freepost

London SW11 2BR

01-223 5955



# Micro General

## MATRIX PRINTERS...

Please contact us for advice on printer selection

### MICROLINE 82A £349 + VAT

Fast 120 cps model having true descenders on lower case. Serial/Parallel Interfaces are switch selectable.



### MICROLINE 83A £499 + VAT

Full width printer with descenders on lower case. Prints at 120 cps and could replace larger printers giving lower costs. Serial/Parallel Interfaces are switch selectable.

### MICROLINE 80 £235 + VAT

Special low price for this rugged and reliable 80 cps printer. Supplied complete with Roll Paper Holder.



### EPSON MX-80F/T TYPE III

£389 + VAT

The Type III printers now have Auto-underline, Super-script and Sub-scripts.

### EPSON MX-100 TYPE III

£499 + VAT

Fantastic Value. 100 cps.

### TEC STARWRITER DAISYWHEEL PRINTER

Very reliable 132 column 40 & 55 cps models. 1 Year warranty.

From £1285 + VAT

### NEW! MICROLINE 84 £949 + VAT

200 cps Standard Printing with descenders 136 Columns. Proportional Print (Near letter quality 18 x 18 Matrix). Pin-addressable graphics. Sub-script, super-script, underlining. Emphasised print, Down-line loadable character set.

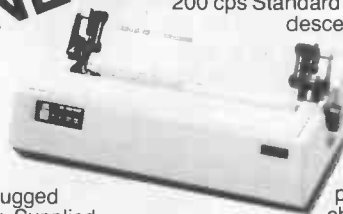

**MICRO GENERAL** 6 The Birchwoods, Tilehurst, Reading, Berks. Tel: 0734 25226

## Try Trader-Trust Trader- Trader Computers

### 16-bit NorthStar Advantage

Trader Computers Limited brings you the new North Star ADVANTAGE 8/16 - an integrated graphics desk-top computer that can run 8-bit CP/M and DOS software and 16-bit MS/DOS software. With a 12" green bit-mapped graphics and/or character display, 64Kb RAM expandable to 256Kb, 20Kb video RAM & 2Kb boot PROM, 5Mhz Intel 8088 & 4Mhz Z80-A, two quad-capacity floppy disc drives, Selectric® style 87-key keyboard with 15 function keys. Complete with business graphics, diagnostic and demonstration software, this ADVANTAGE retails at only £2450.00 plus VAT. The North Star ADVANTAGE 8/16 is also available with a 5Mb mini-Winchester hard disc at £3350.00 plus VAT.

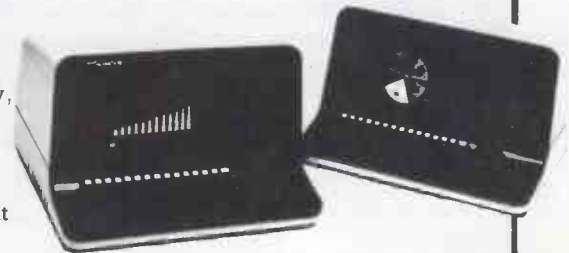

Trader Computers Limited brings you HMSOS - the sophisticated all-British MULTI-USER operating system for Z80-based micro computers. HMSOS features include: Self-configuration for number of users • File locking in BASIC Tape back-up utilities for Winchester drives • Pseudo-keyboards for background tasks

Interrupt-driven printer spooler • Disc handling out-performs CP/M  
HMSOS costs only £150.00

The North Star Horizon: A high-speed 4 Mhz Z80-A CPU, 64kb High-Speed Dynamic RAM, optional PROM, S-100 Bus, Two Serial Ports, one Parallel port, and two integrated 360kb 5¼inch quad-capacity Floppy Disc Drives. With 30,000 in use throughout the world you know it's a proven system

|  |          |
|--|----------|
| Horizon 64k 2 quad .....               | £1995.00 |
| Horizon 64k 1 quad + 5Mb Shugart ..... | £2995.00 |
| Horizon 64k 1 quad 20 Mb Rodime .....  | £4095.00 |

DEALERS! TELEPHONE US NOW FOR UNBEATABLE TRADE PRICES.

**Trader Computers Ltd 65 Loudoun Road London NW8 0DQ**  
Telephone 01-328 3484

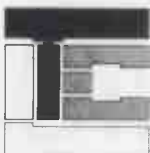

# Happy Memories

| Part type               | 1 Off | 25-99 | 100 up |
|-------------------------|-------|-------|--------|
| 4116 200ns              | .83   | .72   | .66    |
| 4116 250ns              | .75   | .65   | .60    |
| 4816 100ns For BBC comp | 2.45  | 2.10  | 1.95   |
| 4164 200ns              | 4.95  | 4.55  | 4.20   |
| 2114 200ns Low power    | 1.15  | 1.00  | .90    |
| 2114 450ns Low power    | .95   | .85   | .80    |
| 4118 250ns              | 3.25  | 2.85  | 2.65   |
| 6116 150ns CMOS         | 3.70  | 3.20  | 3.00   |
| 2708 450ns              | 2.60  | 2.25  | 2.10   |
| 2716 450ns 5 volt       | 2.60  | 2.25  | 2.10   |
| 2716 450ns three rail   | 5.75  | 5.00  | 4.65   |
| 2732 450ns Intel type   | 3.95  | 3.45  | 3.25   |
| 2532 450ns Texas type   | 3.95  | 3.45  | 3.25   |

Z80A-CPU £4.35      Z80A-P10 £3.25      Z80A-CTC £3.25  
 6522 PIA £3.98      7805 res £.50      7812 res £.50

Low profile IC sockets:

Pins 8 14 16 18 20 22 24 28 40  
 Pence 9 10 11 14 15 18 19 25 33

Soft-sectored floppy discs per 10 in plastic library case:

5 inch SSSD £17.00    5 inch DSDD £21.00  
 8 inch SSSD £19.25    8 inch DSDD £23.65  
 5 inch SSDD £19.25    8 inch DSDD £25.50

74LS series TTL, large stocks at low prices with  
 DIY discounts starting at a mix of just 25  
 pieces. Write or 'phone for list.

Please add 30p post & packing to orders under £15 and VAT @ 15%.  
 Access & Barclaycard welcome. 24hr service on (054 422) 618.  
 Government & Educational orders welcome, £15 minimum. Trade  
 accounts operated, phone or write for details.

Prices are still tending to drop, 'phone for a quote before you buy.



Happy Memories (PCW),  
 Gladestry, King ton, Herefordshire,  
 HR5 3NY  
 Tel: (054 422) 618 or 628

# SOUND TRAINING

## training that

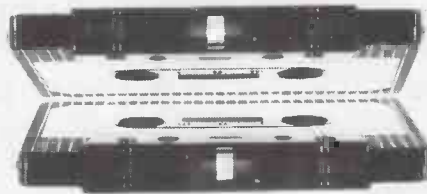

## speaks for itself

audio training packs for CP/M, Wordcraft 80,  
 WordStar and MailMerge ... and more

... or we'll develop training packs for your  
 own software

\* Registered trade mark



ask us for details of our audio training  
 packs and training design services

✉ CP Sound Training  
 36 Widemarsh Street, Hereford HR4 9EP  
 ☎ Hereford (0432) 275132

## UK101 - SUPERBOARD - 6502 MICROS Low-cost\*Hi-quality\*enhancement kits

### LIVEN UP YOUR GRAPHICS!

Program 128 of your own characters for games, graphs, displays, etc. The only limit is your imagination, this is not supplied - everything else is! Board size 8 1/2" x 6". Complete Kit £39.95

### TIDY UP YOUR PERIPHERALS!

No more birds' nests, put all your eggs in one basket. Our Motherboard has SIX J1 type outlets AND a 5 volt regulated supply. All you need is a suitable transformer and a heatsink. Complete Kit £27.50

### PARK YOUR PROMS HERE!

Our EPROM board has room for 4, located between 8000 and 9FFF. Convert your software into firmware and throw away those utilities tapes. Fully address buffered so no bus overloading. Use single rail 2716 EPROMS. See our range below; Board size 7" x 4 1/4". Complete Kit £24.50

### PROGRAMMED EPROMS

GRAPHICS PROGRAMMING AID - construct blocks and input characters direct into RAM. Displays enlarged character for easy programming. Ready programmed with inverse indocset under software control. For use with GRAPHICS BOARD ONLY £9.50

REVISED MACHINE CODE EXTENDED MONITOR £7.50

UK TOOLKIT - all the usual BASIC TOOLKIT functions, only more sophisticated Renumber, Find, Delete, List, etc, 2 x 2/76 £17.00

All kits are supplied with a high quality 40 pin plug ready moulded onto a ribbon cable. (Deduct £4.00 if not required). All our kits plug in, there are no modifications required to the main board of your computer.

**SPECIAL OFFER**

While stocks last - a limited number of prototype 8K address selectable RAM boards. These require slight modification (details supplied) to bring up to full specification. Double sided bare boards only £5.00

Bare boards for all our kits are available on request. All prices are fully inclusive - no hidden overheads or VAT. Send SAE for further details.



FREEPOST,  
 RUBERY, REDNAL,  
 BIRMINGHAM B45 8BR  
 (No stamp required)

## INTERFACE AND UTILITY CARDS FOR



### ANALOGUE 8/8

8 Channel input plus 8 Channel output. Optional 10v. or 5v. F.S.; 8 bit resolution.

ANALOGUE 8/8 . . . . . £179 + VAT

### ANALOGUE 12/12

12 bit analogue input converts in 20uS. 10v. or +5v. F.S. plus 12 bit analogue output and 16 bit parallel I/O and timers.

ANALOGUE 12/12. . . . . £195 + VAT

### UNIPROM

Programmes 2516/2716, 2532/2732, 2764 EPROMS. It also doubles as a 32 bit parallel I/O port.

UNIPROM . . . . . £145 + VAT



# ACT SIRIUS 1

SYSTEMS FROM  
 £2395

EDC PHOTONIC LTD.  
 Tector House, 103 Washway Road, Sale,  
 Cheshire. Tel: 061-973-8367  
 DEALER ENQUIRIES WELCOME

# PHOTONIC



# INTERFACE MANAGEMENT

presents

## FINANCIAL MODELLING USING DESK TOP COMPUTERS

Conducted by  
NICK LEVY D.M.S., MBIM, MIIM  
Principal, Interface Management

The object of the seminar is to enable managers, including first time computer users, to devise and develop their own business models for:

- Budgeting • Cash flow analysis • Investment analysis
- Financial reporting • Plus the performance and analysis of many other management functions.

**A UNIQUE OPPORTUNITY TO IMPROVE YOUR ABILITY TO ANALYSE AND PLAN YOUR BUSINESS ACTIVITIES**

Seminars held in:

Bath, Bristol, Bournemouth, Gatwick, Heathrow, London, Manchester, Norwich, Oxford, Solihull, Stratford-on-Avon.

For further details return the coupon or telephone:

**INTERFACE MANAGEMENT**

26 Queen Victoria Street, Reading RG1 1TG.  
Tel: (0734) 475375. Telex: 849021

Name .....

Address .....

.....

.....

Telephone .....

# Magnetic Media

14-20 GEORGE STREET, BALSALL HEATH,  
BIRMINGHAM B12 9RG.  
TEL: 021-440 8338

## for TRS 80 owners

FOLLOWING OUR SUCCESSFUL LAUNCH INTO THE SOFTWARE BUSINESS LAST MONTH AS PROMIZED WE ARE PLEASED TO PRESENT A FURTHER SELECTION OF WELL KNOWN PROGRAMS AT VERY LOW PRICES:-



|  | DISC  | CASS  |
|--|-------|-------|
| MISSILE ATTACK   | 10.50 | 9.50  |
| ARMOURED PATROL  | 11.25 | 10.25 |
| GOBBLE MAN   | 10.50 | 9.50  |
| BLACKJACK MASTER   | 11.50 | 10.50 |
| BATTLE TREK  | 9.50  | 8.50  |
| DRAGON QUEST   | 10.50 | 9.50  |
| SEND 75p FOR FULL CATALOGUE WHICH WILL BE REFUNDED WITH FIRST ORDER WE ALSO OFFER 3 NEW PROGRAMS:- |       |       |
| SPACE CASTLE   | 11.50 | 10.50 |

*YOUR FIGHTER IS BEING ATTACKED BY A FORCE FIELD FROM THE SPACE CASTLE OF YUGDAB BEFORE THE BATTLE IS OVER YOU YOU WILL HAVE SURMOUNTED SUPREME OBSTACLES.*

|   |       |       |
|---|-------|-------|
| SEA DRAGON  | 13.75 | 12.75 |
| <i>A FASCINATING SUBMARINE GAME</i>   |       |       |
| ASYLUM 2  | 13.75 | 12.75 |
| <i>A SEQUEL TO ASYLUM WITH EXCELLENT GRAPHICS. A GAME WITH AWESOME POSSIBILITIES.</i> |       |       |

NEW FROM MAGNETIC MEDIA

|   |       |      |
|---|-------|------|
| TASK FORCE  | 11.50 | 9.50 |
| <i>YOU ARE CAPTAIN OF A DESTROYER YOUR MISSION IS TO SAVE 3 OF YOUR COUNTRIES TOP SCIENTISTS AFLOAT IN A LIFEBOAT IN ENEMY WATERS - BUT YOU WILL HAVE TO DESTROY ENEMY SHIPPING AND SUBS WHILE RUNNING THEIR EXTENSIVE MINE FIELDS.</i> |       |      |

NAME .....

ADDRESS .....

PLEASE SEND ME

..... AT £

..... AT £

..... AT £

..... AT £

I ENCLOSE PAYMENT FOR £

### BBC SOFTWARE CASSETTES

MISSILE CONTROL the first implementation on the BBC Micro of the popular arcade game £9.00  
 MAZE MAN an authentic version of the popular arcade game. £6.00  
 BALLOONS a highly original game that soon becomes compulsive playing. £6.00  
 DISSASSEMBLER the memory dump routine includes a scrolling back in memory facility £5.00

### 30+ PROGRAMS FOR THE BBC MICROCOMPUTER

This Book contains program listings, with explanations & tips on using the BBC Micro  
**GAMES UTILITIES GRAPHICS & MUSIC**  
 'ASTRO RUN' 'FASTFINDER.' '3D GRAPHICS'  
 Most programs will run on Models A & B  
 Edited by C.J. Evans, various Authors.  
 A pair of cassettes with all the programs is available.

BOOK £5.00  
 BOOK & CASSETTE SET £9.00

### CASSETTE LEADS for the BBC Micro

The BBC Micro comes with an incomplete lead cassette lead  
 7Pin Din to 2x3.5mm & 1x2.4mm minijacks £4.00  
 7Pin Din to 5Pin Din & 2.5mm minijack £4.00  
 7Pin Din to 7Pin Din £4.00  
 7Pin Din PLUGS Two for £0.65  
 6Pin Din PLUGS (for RGB socket) Two for £0.65  
 5Pin Din PLUGS (360° for RS232) Two for £0.65

### TELEVISION/MONITOR LEADS

Phono plug to Co-aux with high quality cable £3.00  
 BNC Plug to Phono plug (ie BBC Micro to Rediffusion TVRM) £2.20

### RS423 LEADS

RS423 tTO RS423 (BBC Micro to BBC Micro)  
 Allows two BBC Micro's to 'talk' to each other  
 Two metre cable £4.00  
 Four metre cable £5.00

### PRINTER CABLES

BBC to 36 way CENTRONICS TYPE CONNECTOR £17.00  
 BBC to 25 WAY D TYPE (FOR USE WITH RS232) £9.50  
 TORCH to 36way CENTRONICS TYPE CONNECTOR £20.00

### BBC UPGRADE KITS

Ram Upgrade 8 x 4816 (100ns)  
 Special offer £29.00  
 Full Upgrade kit £62.00

### PRINTERS

STAR DPB8480 From £250.00 inclusive of VAT  
 80 CPS : 80/96/132 COLS  
 Bidirectional Logic Seeking CENTRONICS RS232  
 = £217.39+£32.61 VAT = £235.00+£35.25 VAT  
 Tractor with Friction Feed = £250.00 = £270.25  
 (24hr Securior Delivery for printers £8.00)

VAT included where applicable POSTAGE: add 50p on all Orders under £10.00

## C. J. E. Microcomputers

Dept (PCW), 25 Henry Avenue, Rustington, W. Sussex. BN16 2PA (09062) 6647.



# STAR DP-8480

Manufactured by STAR Co. LTD., Japan

## MINIPRICED, MAXISPEED, MICROPRINTER!

The STAR DP-8480 printer is so reliable, our service team are quite bored! It's a friendly printer too, being compatible with the BBC microcomputer, Acorn Atom, Tandy and most other major computers.

And fast! With 80 columns, 80 cps (also 96 and 132 cols.) plus bi-directional, logic-seeking print head.

There's traction feed and friction feed on both the RS232C and the Centronics models and at a price that's almost embarrassing: RS232C with traction feed is £301.15, centronics friction feed is £243.63 and the traction feed version only £267.86 (plus VAT and delivery).

All available from stock so there's no waiting!



CENTRONICS TRACTION FEED  
 £219.00  
 (PLUS VAT AND DELIVERY)

TRADE DISCOUNTS  
 AVAILABLE

A MEMBER OF THE  
 ROXBURGH GROUP  
 OF COMPANIES



# DATATOTAL COMPUTERS LTD

UNIT 1 HAYWOOD WAY, IVYHOUSE LANE, HASTINGS, SUSSEX TN33 4PL  
 Tel 0424 444460 Telex 957066



# Discover our range of CP/M software.

Although we must admit we have not yet found the cure to the common cold, we have found the solution to a problem that's almost as daunting. The task of choosing and buying your CP/M software.

We hold one of the largest ranges of CP/M software, covering most applications and uses. These are supplied over various formats including: I.C.L. Personal Computer, I.B.M., Rair, Sirius, Superbrain, Apple, etc.

So if you are fed up with suffering, when all you really need is sound advice and off-the-shelf service, then give us a call.

**Telephone: 01-387 8832 or 01-388 9927.**



Software Limited, Duchess House, 18/19 Warren Street,  
London W1P 5DB.

## It's rather like finding the remedy to the common cold!

CP/M is the trademark of Digital Research.

**Attractive quantity & dealer discounts available**

# ADVERTISERS INDEX

|                              |            |                           |             |                        |               |                     |             |
|------------------------------|------------|---------------------------|-------------|------------------------|---------------|---------------------|-------------|
| ACT                          | 50+136/137 | C/WP                      | 123,125+127 | Lion Microcomputers    | 246+249       | Prentice Hall       | 38          |
| Acornsoft                    | 47         | Dark Star                 | 282         | L&J Computers          | 115           | Procyon             | 262         |
| Action                       | 26         | Datalink                  | 189         | Logica                 | 250           | Raven               | 140         |
| Adda                         | 234,235    | Data Processing Company   | 255         | Logic Computers        | 258           | Research Machines   | 92          |
| Algray                       | 279        | Datarite                  | 227         | London Computer Store  | 244           | John Richard        | 268         |
| Allmarc                      | 42         | Datatotal                 | 286         | Lowe Electronics       | 20/21+118/119 | Scriblight          | 282         |
| Allrian                      | 18         | Dataview                  | 62+231      | Magnetic Media         | 285           | Silica Shops        | 28          |
| Altwasser                    | 260        | Deans of Kensington       | 271         | Magnum                 | 284           | Silicon Valley      | 27          |
| Ambit International          | 250        | Digitus                   | 1           | Maplin                 | 52/53         | Snclair             | 55,56/57,58 |
| Apple Computers              | 106        | Discom                    | 196         | Map 80                 | 250           | Sirton Comps        | 192         |
| Apple Orchard                | 30         | Disking                   | 162         | Mass Micros            | 280           | Small Syst Eng      | 260         |
| Appropriate Technology       | 93         | Display Electronics       | 274         | Mathematical Software  | 245           | Soft Option         | 241         |
| Arborcraft                   | 268        | Dragondata                | 40/41       | Meares Training        | 279           | Software For All    | 254         |
| Astro Information Systems    | 247        | Dynatech                  | 258         | Melbourne House        | 6             | Software Ltd        | 287         |
| Atari                        | 33         | ECTF                      | 46          | Memotech               | 154           | Software Rental     | 94          |
| Atlanta Data Systems         | 18         | EXC                       | 284         | Metrotech              | 180/181       | Southern Software   | 254         |
| Audio Computers              | IBC        | Electronic Office Service | 67to75      | Microage               | 233           | Spectrum            | 11,12/13    |
| Autofile                     | 251        | Equinox                   | 44/45       | Micro Centre           | IFC           | SRS                 | 258         |
| BB Magentics                 | 282        | Fletcher Dennys Systems   | 281         | Microcomputer Business |               | Startech            | 15          |
| Beebug                       | 174        | Fuller Micros             | 238         | Systems                | 25            | Stemmos             | 44          |
| Bergqvist & Hoberstad        | 152        | GB Computer Products      | 24          | Microcomputer Products | 60/61         | Stirling            | 255         |
| Bonsai                       | 135        | Gemini Marketing          | 32          | Microdeal              | 256           | Sumlock             | 264         |
| Brighton Computer Centre     | 161        | Gemini Microcomputers     | 81          | Microfirm              | 91            | Superior Systems    | 232         |
| British Micro                | 86/87      | General Northern Micro    | 253         | Micro General          | 283           | Swanley             | 253         |
| Bug-Byte Software            | 9+95       | GM Microtronics           | 240         | Microl                 | 16/17         | Systems of Tomorrow | 153         |
| Bunch Books                  | 82/83      | GNCS                      | 270         | Micro Products         |               | Tabs                | 80          |
| James Burn                   | 248        | Godfreys                  | 262         | Software               | 89            | Tandy               | 168         |
| Business + Leisure Computers | 249        | Graffcom                  | 43          | Microserve             | 243           | Tantus              | 266         |
| Cambridge Computer Store     | 230        | Grama                     | 237         | Microspares            | 278           | TDI                 | 14          |
| Castle Electronics           | 10         | Grundy                    | 64/65       | Microstyle             | 275           | Technomatic         | 22          |
| Caxton Software              | 104        | HAL Computers             | 35+37       | Micro Technology       | 236           | Telesystems         | 247         |
| Chromasonic Electronics      | 158        | Happy Memories            | 284         | Microtek               | 253           | Tempus              | 261         |
| Chrialid                     | 279        | HCCS                      | 277         | Microtraffic           | 118           | Texas               | 8           |
| City Microsystems            | 111        | Hewlett Packard           | 160/161     | Microvalve             | 169           | Texon               | 278         |
| CJE Microcomputers           | 286        | Icarus                    | 197         | Midwich                | 254           | Time Data           | 44          |
| Comart                       | 5          | Inchico                   | 263         | Millbank               | 281           | Trader Comp         | 283         |
| Commodore                    | 76/77+113  | Independent Computer      |             | Molimerx               | 116/117       | Transam             | 97          |
| Communication Project        | 284        | Engineers                 | 47          | Monolith               | 45            | Transtech           | 66          |
| Compshop                     | 23         | Intelligent Artefacts     | 262         | Nashua                 | 248           | Ulster              | 255         |
| Compsoft                     | 130        | Interface                 | 285         | NEC                    | 88            | U-Micros            | 259         |
| Computech                    | 59         | IO Research               | 200         | Northchamber           | 188           | Univ. Man.          | 246         |
| Computer Ancillaries         | 48         | IO Technology             | 148/149     | North Star             | 38            | Vega Comps          | 4           |
| Computer Enterprises         | 248        | Jarogate                  | 36          | O'Brien                | 174           | Viewfax             | 258         |
| Computer Peripherals         | 266        | J&V Johnson               | 90          | Office Efficiency      | 25            | Viewfax             | 96          |
| Computer Plus                | 174        | JRS                       | 253         | Olivetti               | 84/85         | Village Comp Serv   | 252         |
| Computer Supermarket         | 54         | Jupiter                   | 242         | Open Computer Services | 156           | Vincelord           | 272/273     |
| Computotech                  | 265        | Kansas                    | 256         | Ozwise                 | 282           | Virgin Books        | 249         |
| Comserve                     | 276+277    | Knights TV                | 270         | Parkins                | 265           | Vision Ass          | 281         |
| Comshare                     | 51         | Kram                      | 228/229     | Pearl                  | 78/79         | Vixon Comp Sys      | 277         |
| Cream Computers              | 257        | Kuma                      | 18          | Personal Comps         | OBC           | VNU                 | 29/246      |
| Crellon Microsystems         | 235        | Lasky                     | 100         | Pete & Pam             | 19            | Warwick             | 280         |
| Crofton Electronics          | 276        | Leicester Computer Centre | 243         | Phoenix                | 110           | X-Data              | 7           |
| Crown Business Centre        | 268        | Lifeboat Associates       | 31          | Pinner Wordpro         | 276           | Xitan               | 63          |
| Cumana                       | 239        | Linsack                   | 270         | Power International    | 177           | Zytek               | 267         |



We hear with immense mirth that ACT's multi-million pound TV advertising campaign, destined to assault our screens soon, has run foul of the Advertising Standards Authority on the grounds of gross sexism. The ad is now being re-shot with 'Squire' Allason, no less, taking the place of the offending scantily-clad female... Early morning Radio 4 listeners were treated to an hour of micro wisdom recently when David Tebbutt and Martin 'Voiceless' Banks starred on a phone-in together, answering the eager questions of the listening public. All went well until someone asked what grade 'A' levels are required to study computer science; turns out that both 'Voiceless' and 'Tebbo' are too old to have been through the 'A' level mill and could only advise about taking a clean rag into the exam to wipe the

slate off... Editor Rodwell has become quite insufferable since he bought himself a massive and totally ostentatious BMW motorcycle. He's taken to going around offering suitable young ladies a 'quick blast up the M4', so far without any of them being silly enough to accept. His enthusiasm was considerably dampened, though, when he tore a muscle trying to heave the megabike onto its centre stand for the first time, to the amusement of Dick 'Poison Pen' Pountain, who rides a Honda... In an effort to get this edition on sale at the PCW Show, your Editorial and art room teams worked their \*\*\*\*s off and managed to produce an entire issue in just a week and a half... The habit of certain publications (not PCW) of accepting 'financial remuneration' in exchange for front-cover publicity for whichever

machine they're reviewing seems now to be regarded as the norm by some companies in the micro business. A very large manufacturer, who really should know better, recently offered us such a bribe to get his machine onto our cover. And we thought we'd made it quite clear that this approach *never* works with us — in fact our immediate inclination is to drop the machine altogether... Have you ever wanted to work for PCW? You have? You must be mad! No, that's wrong, what we mean is that we're on the lookout for another person to join our editorial team. Essential qualifications are several years' experience in high-technology journalism, preferably in the micro industry, a good appreciation of the uses and applications of microcomputers and the problems faced by those

trying to use them, and a good working knowledge of currently available micro systems, both hardware and software. You also need a high tolerance to bad language, a liking for black coffee (real), unless you're prepared to buy your own milk, and a willingness to get stuck into all the boring bits — like reading galleys, answering readers' letters and phone calls, fending off over-eager PR persons and helping out with mundane admin-type work as and when required. We want you to write (*don't ring*) with a full CV and examples of recent work to: The Editor, *Personal Computer World*, 62 Oxford Street, London W1A 2HG, before the end of September. We're an equal opportunities employer, which means we'd prefer applications from nubile young... (*All right, that'll do — Ed.*)

# MORE MEMORY FOR MICROS !

look at what we can offer:



**RAMPACKS**  
for SINCLAIR ZX81

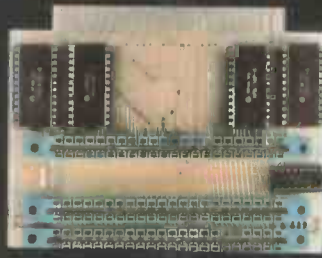

**VCS 8K** for VIC  
8k RAM+3 slots **£44**

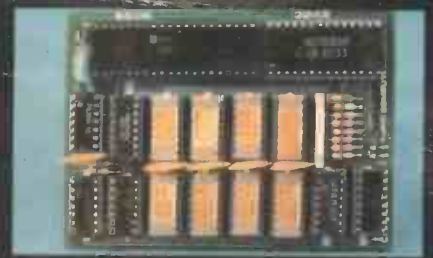

**DU01** for ATOM  
64k RAM only **£70**

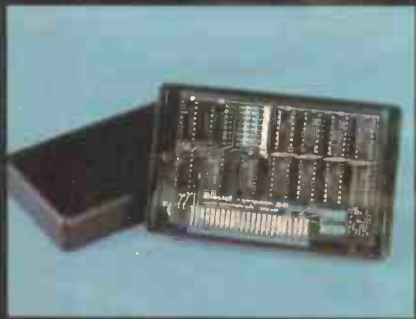

**16K** - the only upgradable  
to 56k on the market -

OUT OF STOCK



add up to 20k RAM+16k ROM

**VCR 20** for VIC  
4K-£24, 2k increment-£5

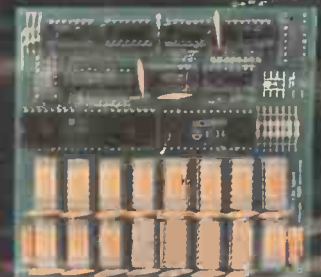

**DRC** for PET  
64K-£80 128K-£130

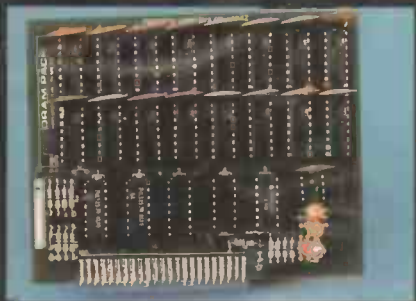

**32K bytes** - £29

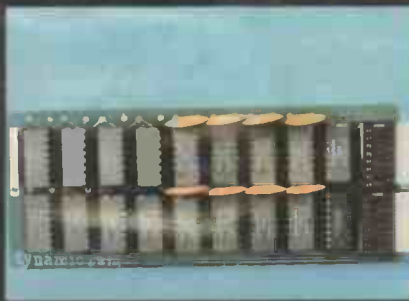

**32K add on RAM** £46

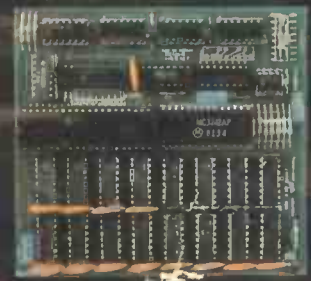

**32K add on RAM** **£69**

## TRS80-V.GENIE UK101:

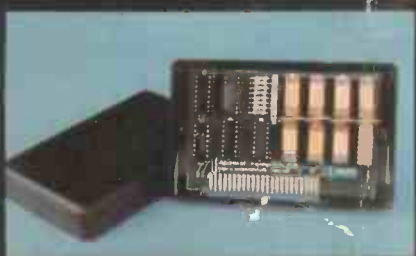

**56K** - exceptional low  
power consumption -  
**£44.90**

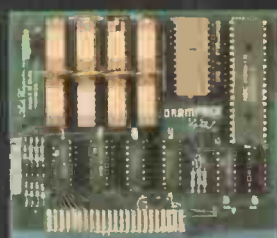

**64K + Eprom programmer &**  
**user port** - only **£79**

FOR A FREE BROCHURE, RING LINDA OR  
SUE ON SOUTHEND (0702) 613081  
FOR CREDIT CARD ORDERS, RING JACKIE  
OR PAM ON SOUTHEND (0702) 618144

CHEQUES AND P.O.'s TO:

## AUDIO-COMPUTERS

87 BOURNEMOUTH PARK ROAD,  
SOUTHEND ON SEA - ESSEX SS5 2JJ

ALL PRICES INCLUDE V.A.T. AND POSTAGE

TELEX 995337 G AUDCOM

A TRADEMARK OF SOLIDISK LTD

# Our best add-ons come with a smile



The reason that Personal Computers Limited is the first and most professional computer company is not just the fact that we supply the best equipment and software around but we excel in technical support!

We believe that to use your system successfully certain intangibles are essential such as correct advice, helpful suggestions and perhaps most importantly, user support.

Our highly trained staff will always be available to help you make your system work well for you . . . and always with a smile!



Here are a few of our best complete personal computer systems:

- **BUSINESS ACCOUNTING SYSTEMS** including invoicing, sales, purchase and general ledger systems.
- **FINANCIAL PLANNING SYSTEMS** using the well known Visicalc and Micromodeller programs.
- **WORD PROCESSING** — the Format 80 system is one of the cleverest programs available.
- **GRAPHICS SYSTEMS** — for producing pie charts, histograms and line charts — in full colour if necessary.
- **COMMUNICATIONS** — facilities allow Apple personal computers to communicate with Prestel, Dow Jones, other Apples and mini and mainframe computers.
- **PERSONAL COMPUTER NETWORKS** — A flexible distributed computer system allowing for the sharing of Data, Printers, Programs and storage.

Contact our offices now learn more about how a personal computer can work hard for you. Alternatively why not visit our showrooms at 218 & 220/226 Bishopsgate London EC2M 4JS

## Personal Computers

218 & 220/226 Bishopsgate, London EC2M 4JS Tel. 01 377 12

**HOME COMPUTER CENTRE NOW OPEN**

COME TO 218 BISHOPSGATE

FOR A VIC OR SINCLAIR DEMONSTRATION

LEASING & RENTAL TERMS AVAILABLE.