

Personal Computer

UNIQUE
INTRO FOR
THE NEWCOMER

US \$2.00/FF8:80/LIRE 1700/DM 3.80/FL4.00/BF 59
DKr 10.75/Skr 7.65/NKr 10.50/A Sch 28/S Fr 3.50/Pts 135

World AUGUST 1980 60p

EUROPE'S LEADING MICRO MAGAZINE

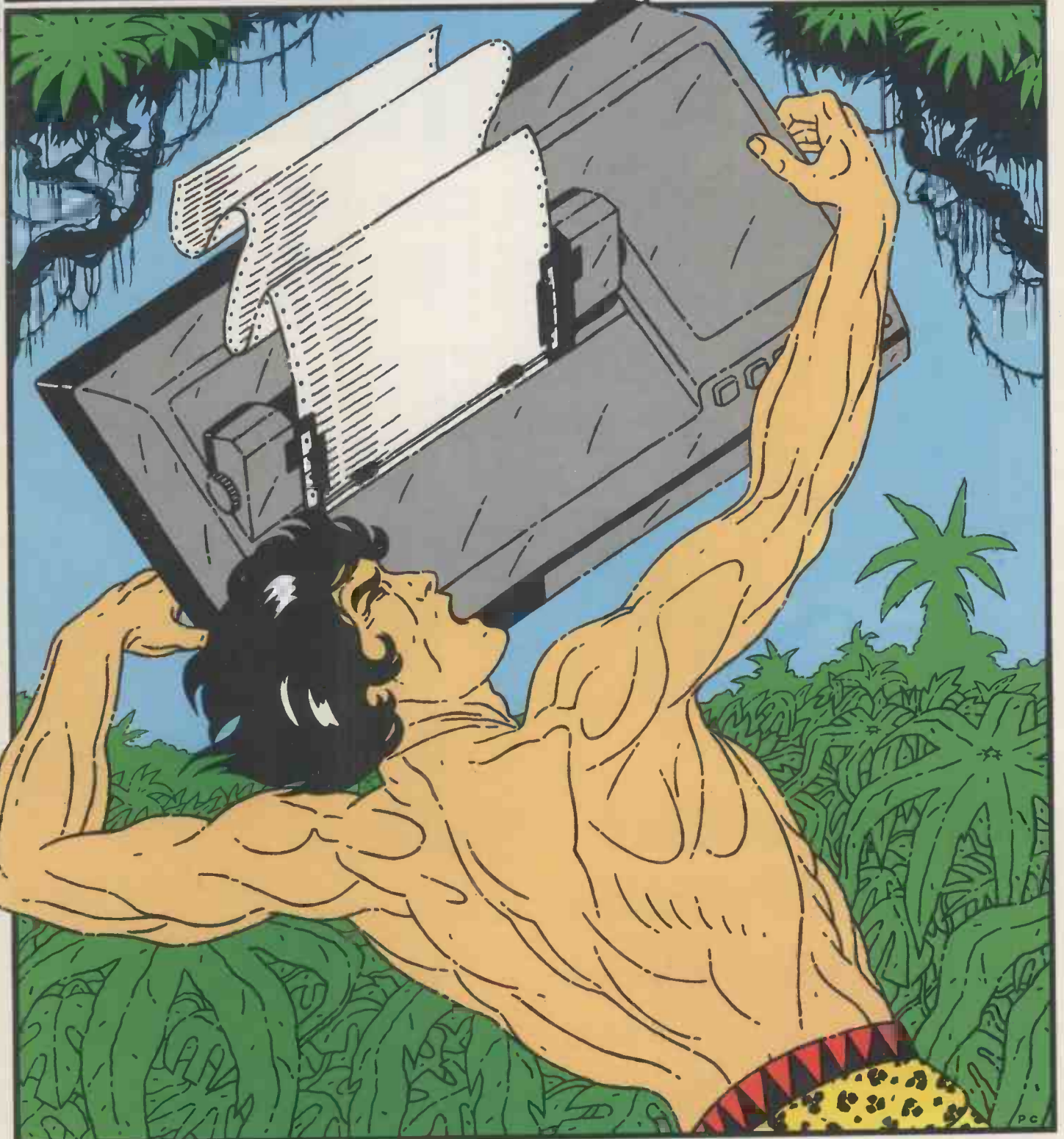

HACKING THROUGH THE PRINTER JUNGLE
A 'Jane's Guide' to all the options

The best computers PLUS the best service

At MicroCentre, we're concentrating our resources on what we genuinely believe are the very best computers available today. . . . Cromemco computers, naturally. This way we can offer you the best deal possible.

What we don't do

What we don't do is spread our expertise thinly amongst umpteen different systems, or try to stock every S100 product on the market. We don't claim to offer "impartial" advice on the best buy. And we don't sell from price lists or catalogues.

The MicroCentre approach

Some micro-computer suppliers work like that, but we don't. Because we realise that when you're buying a computer you want more than the "brochures and boxes" approach. You want to see computers running; to try them out with different software products; to study the documentation; above all, you want expert answers to your most searching questions.

Cromemco specialists

That's why we've specialised in Cromemco systems. Not simply because we think Cromemco systems are the best serious computers available at the price.



MicroCentre's Cromemco demonstration room, with the full range of Cromemco computers, peripherals, operating systems and software products on permanent exhibition. Why not pay us a visit? We're only an hour's Shuttle flight from Heathrow!



Cromemco Model Z-2H hard disc computer. 10 megabyte hard disc, 2 floppy discs, Z-80 computer and 64K memory. MicroCentre price £5,326.

But because by doing so we can dedicate our time, energy and resources to giving you the highest standard of Cromemco support possible.

demonstration; expect the full range of Cromemco peripherals; single-user and multi-user systems; and interactive graphics.

Demonstrations

So when you visit MicroCentre expect to find Cromemco systems on permanent

Software

Expect a choice of operating systems and compilers to evaluate; expect complete documentation; and expect the largest collection of Cromemco systems software in the UK.

Expertise

Expect to find in-depth professional expertise at MicroCentre, the kind that is only acquired by installing Cromemco systems all over Britain. Expect a thorough appreciation of how Cromemco systems can be applied . . . in business, scientific research, industrial engineering, medicine and education.

Support

Expect to get frank, accurate answers to your questions at MicroCentre. Above all, once you've bought a Cromemco system from us, expect to get a very high standard of technical support with your hardware enhancements and continuing software needs.

At MicroCentre, simply expect the best.

For  **Cromemco... call the experts**

**NOW IN SPACIOUS
NEW SHOWROOMS**

Tel. 031-556 7354

MicroCentre

**STILL IN
CENTRAL EDINBURGH**

Complete Micro Systems Ltd., 30 Dundas Street, Edinburgh EH3 6JN

CONTENTS

Volume 3 No 8 August 1980

36 NEWSPRINT: Guy Kewney reports in his inimitable style.

43 YANKEE DOODLES: Tom Williams with the latest goings-on in sunny California.

46 COMMUNICATION: Our readers in their own write.

48 BACK ISSUES: Find out what you've missed!

50 BENCHTEST: Does the SuperBrain live up to its ads? Sue Eisenbach trepans.

57 GATEWAYS TO LOGIC: Continuing Derek Daines' unique series on teaching micro-computing to others. This month he looks at Boolean Algebra.

60 INTERRUPT: Stephen Castell on the legal anomalies of computer/information technology.

63 LEISURE LINES: More brainbursters from J J Clessa.

65 COMPUTER ANSWERS: Our experts tell you all you wanted to know about micros and weren't afraid to ask.

68 CASSETTE FILES: Talib Shaman suggests a file handling system for the humble cassette.

73 MICRO CHESS: A super chess machine described by micro chess expert Kevin O'Connell.

74 BOOKFARE: Malcolm Peltu reviews two micro revolutions and a third wave.

78 COMPUTER GAMES: In this month's episode of his definitive series, David Levy looks at draughts.

85 CHECKOUT: The ROMPLUS+ for the Apple II.

89 YOUNG COMPUTER WORLD: It's that man again, Derrick Daines, with the latest news for younger readers.

90 FACE TO FACE: Is your computer friendly? David Hebditch on the man/machine interface.

93 A SWITCH IN TIME: Don't miss *Crossroads* while you're on holiday! Tape it with this handy control interface.

96 SYSTEMS: Mike Knight concludes this series with a second look at Sales Ledger.

98 CALCULATOR CORNER: A Pentathlon program for all you keyboard athletes.

101 NEWCOMERS START HERE: Our quick intro to the world of microcomputing.

102 DIRECT ACCESS: IN STORE, USER GROUPS, DIARY DATA and TRANSACTION FILE.

112 PRINTERS: Our bumper review of printers, compiled by Mike Dennis.

129 PROGRAMS: Get those fingers tapping on our readers' latest listings.

130 BLUNDERS: Where we climb onto our penitent's stool.

163 CHIP CHAT: Europe's leading microgossip page — news, rumours...facts, even!

Founder
Angelo Zgorelec

Editor
David Tebbutt

Deputy Editor
Peter Rodwell

Executive Editor
Bruce Sawford

Editorial Office
(01-637 7991/2/3)



Cover Illustration
Philip Carter — with a tip of the hat to the late Edgar Rice Burroughs.

Consultants
John Coll, Mike Dennis,
Michael James, David Hebditch,
Sheridan Williams,
Dr. Adrian Stokes, Dr. Stephen Castell.

Advertisement Manager
Stephen England
(01-631 1786)

Advertisement Executive
Patrick Dolan
(01-631 1682)

Micomart
Jacquie Hancock
(01-631 1682)

Group Advertising Director
Richard Howell (01-631 3187)

Production Manager
Dick Pountain

Art Director
Paul Carpenter

Art Assistants
Julia Davies,
Jimmy Egerton

Typesetter
Jane Hamnell

Published by SportsScene Publishers (PCW) Ltd., 14 Rathbone Place, London W1P 1DE, England. Tel: 01-637 7991/2/3. Telex: 8954139 A/B 'Bunch' G. London.

Copyright notice
Personal Computer World is published by SportsScene Publishers (PCW) Ltd. © 1980

Felden Productions. No material may be reproduced in whole or part without written consent from the copyright holders.

Printed by Riverside Press, Whitstable.

PCW welcomes all unsolicited material (written, photographic and illustrative) and although no guarantee can be given as to its safe return, reasonable care and attention will be exercised.

Guidelines for contributors

PCW welcomes articles of interest. Don't be put off if your style of writing is 'under developed'. . . true worth lies in the content, and shaping features comes naturally to us! Manuscripts should not exceed 3,000 words and authors are asked to use triple-spaced lines with a wide left-hand margin; diagrams, listings and/or photographs should be included wherever possible. Please enclose a stamped, self-addressed envelope if you would like your article returned.

Because of the foregoing, it is necessary to add that the views expressed in articles we publish are not necessarily those of Personal Computer World. Overall, however, the magazine will try to represent a balanced viewpoint.

Finally, before submitting an article, please check it through thoroughly for legibility and accuracy.

DIRTY MAINS! CORRUPT DATA?

Is your computer suffering from the effects of unstable mains or from high voltage transients and momentary supply breaks, which you probably do not even notice otherwise?

Have you counted the cost of the loss of a day's data input or, worse still, the corruption of a whole programme?

If not, when you do you may get an unpleasant surprise — particularly if you then compare it with the low cost of a Galatrek Constant Voltage Transformer.



For a cost ranging from only £75 (ex workd) + VAT you can get:—

- * STABILISATION OF $\pm 1\%$
- * TRANSIENT ATTENUATION
- * MOMENTARY POWER BACK-UP
- * RAPID RESPONSE
- * OUTPUT TOTALLY ISOLATED
- * PROTECTION FOR STABILISER AND EQUIPMENT UNDER OVERLOAD AND SHORT-CIRCUIT CONDITIONS

Standard range covers ratings from 250VA to 5kVA. Higher ratings to order.

Model AK250 at £75 ex works + VAT, one of a range of 90 models covering most voltages.

Galatrek VOLSTAB Constant Voltage Transformers are based on a Galatrek innovation on the well established ferro-resonant saturable reactor technique. They offer high performance with minimal size and weight at a highly competitive price.

They contain no moving parts and are very reliable in service. They will provide close regulation within the limits specified. So consider carefully the Six Star Features listed above. And consider carefully the cost of system 'hiccups' resulting from mains supply irregularities.

Then complete the coupon below to secure your copy of our new 12 page catalogue listing our whole range of stabilisers and cutouts. Or ring Ron Koffler on 0492 640311.



Scotland Street, Llanrwst,
Gwynedd LL26 0AL, North Wales, Britain.
Telephone: Llanrwst (0492) 640311
Telex: 617114 Answer back—GALAHU
Telegraphic Address GALAWATT.

U.K. Marketing Agent:
Danesbury Marketing Ltd.,
Tavistock House,
Bedford MK40 2QD
Tel: 0234 213571 Telex: 825633 OTSS-B

CUTOUT NOW AND POST TODAY

ON FREEPOST LL99 No stamp necessary

Mark first class

- PLEASE recommend a stabiliser for the following:

.....
.....

- PLEASE send me your new 12 page catalogue

Name

Sent By

Tel No

Tick if trade Tick if OEM

Address

.....
.....

NEW



ANADEx 9500 Series from STACK

GENERAL SPECIFICATIONS

Number of Columns:

Character Spacing:

Printing Rate:

throughput-minimum
maximum

DP-9500

132 or 175

10 or 13.3 cpi

selected by data

source or by internal switch

150 or 200 cps

60lpm

200 lpm for 10 ch lines

DP-9501

132 or 220

10 or 16.7 cpi

120 or 200 cps

50lpm

Features

- * 132, 175 or 220 columns, 120, 150 or 200 characters per second
- * 50-200 lines per minute, bi-directional printing with line scanning logic
- * 150 M characters print head life
- * 650 M characters with heavy duty head
- * Tractor feed, multiple copy plain paper
- * 7 x 9, 9 x 9 or 11 x 9 matrix with optional graphics capability
- * Special character sets available as options
- * 6 or 8 lines per inch, selectable
- * 10, 13.3 or 16.7 cpi, selectable
- * Communications control selectable

Interfaces

Parallel bit (1 KHz max data rate), RS-232C and 20-60 mA current loop. All three included as standard, switch selectable.

Baud Rates

50, 75, 110, 135, 150, 300, 600, 1200, 1800, 2200, 2400, 3600, 4800, 9600*

*RS-232C only

Switch selectable.

Character Font

Standard 96 character ASCII set with true descenders and underlining selected by RS code. Double width printing selected by SI code. Alternative character sets available as plug-in EPROMS.

DP-9500

£895

plus VAT

DP-9501

£995

plus VAT

Printing Method

9-wire dot-matrix, impact, bi-directional with line scanning logic.

Ribbon

Black ribbon in replaceable cartridge. Life expectancy in excess of 6 million characters.

Additional Features

Other operating features set by internal switches or by the data source include (a) 10 second time-out, (b) parity bit recognition, (c) byte length, (d) X-ON, X-OFF operation, (e) STX/ETX operation. Internal switches also provided to select (i) Truncate or wraparound print mode and (ii) Automatic line feed.

Physical

Width 26.6" (67.6cms), Depth 15.4" (39.2cms), Height 8.3" (21.0cms).

Graphics

Plug-in option enables printing of continuous graphics under control of data source, with resolution of 72 dots per inch vertically and 60 (DP-9500) or 75 (DP-9501) dots per inch horizontally.

Buffer

500 bytes of FIFO as standard. Optional 2K additional.

Paper (Fan-Fold)

Tractor fed, any width to maximum of 15.6" (397mm).

Interfaces for 9500 Series

PET Parallel **£45**

Parallel Addressable **£106**

RS232 **£89**

RS232 Character Switchable **£132**

APPLE Parallel **£130**

RS232 Serial **£113**

Please ring Graham Knott or Jeff Orr
for other interfacing requirements.
Prices exclude VAT.

Stack Computer Services Ltd
290-298 Derby Road, Bootle,
Liverpool L20 8LN.
051-933 5511.



Gourmet Goodies

Super software from the world's leading microsoftware supplier.

- | | | | | | | | |
|----------------------------------------------------------------------------------------------------------------------------------------------------------------------------------------------------------------------------------------------------------------------------------------------------------------------------------------------------------------------------------------------------------------------------------------------------------------------------------------------------------------------------------------------------------------------------------------------------------------------------------------------------------------------------------------------------------------------------------------------------------------------------------------------------------------------------------------------------------------------------------------------------------------------------------------------------------------------------------------------------------------------------------------------------------------------------------------------------------------------------------------------------------------------------------------------------------------------------------------------------------------------------------------------------------------------------------------------------------------------------------------------------------------------------------------------------------------------------------------------------------------------------------------------------------------------------------------------------------------------------------------------------------------------------------------------------------------------------------------------------------------------------------------------------------------------------------------------------------------------------------------------------------------------------------------------------------------------------------------------------------------------------------------------------------------------------------------------------------------------------------------------------------------------------------------------------------------------------------------------------------------------------------------------------------------------------------------------------------------------------------------------------------------------------------------------------------------------------------------------------------------------------------------------------------------------------------------------------------------------------------------------------------------------------------------------------------------------------------------------------------------------------------------------------------------------------------------------------------------------------------------------------------------------------------------------------------------------------------------------------------------------------------------------------------------------------------------------------------------------------------------------------------------------------------------------------------------------------------------------------------------------------------------------------------------------------------------------------------------------------------------------------------------------------------------------------------------------------------------------------------------------------------------------------------------------------------------------------------------------------------------------------------------------------------------------------------------------------------------------------------------------------------------------------------------------------------------------------------------------------------------------------------------------------------------------------------------------------------------------------------------------------------------------------------------------------------------------------------------------------------------------------------------------------------------------------------------------------------------------------------------------------------------------------------------------------------------------------------------------------------------------------------------------------------------------------------------------------------------------------------------------------------------------------------------------------------------------------------------------------------------------------------------------------------------------------------------------------------------------------------------------------------------------------------------------------------------------------------------------------------------------------------------------------------------------------------------------------------------------------------------------------------------------------------------------------------------------------------------------------------------------------------------------------------------------------------------------------------------------------------------------------------------------------------------------------------------------------------------------------------------------------------------------------------------------------------------------------------------------------------------------------------------------------------------------------------------------------------------------------------------------------------------------------------------------------------------------------------------------------------------------------------------------------------------------------------------------------------------------------------------------------------------------------------------------------------------------------------------------------------------------------------------------------------------------------------------|------------------------------------------------------------------------------------------------------------------------------------------------------------------------------------------------------------------------------------------------------------------------------------------------------------------------------------------------------------------------------------------------------------------------------------------------------------------------------------------------------------------------------------------------------------------------------------------------------------------------------------------------------------------------------------------------------------------------------------------------------------------------------------------------------------------------------------------------------------------------------------------------------------------------------------------------------------------------------------------------------------------------------------------------------------------------------------------------------------------------------------------------------------------------------------------------------------------------------------------------------------------------------------------------------------------------------------------------------------------------------------------------------------------------------------------------------------------------------------------------------------------------------------------------------------------------------------------------------------------------------------------------------------------------------------------------------------------------------------------------------------------------------------------------------------------------------------------------------------------------------------------------------------------------------------------------------------------------------------------------------------------------------------------------------------------------------------------------------------------------------------------------------------------------------------------------------------------------------------------------------------------------------------------------------------------------------------------------------------------------------------------------------------------------------------------------------------------------------------------------------------------------------------------------------------------------------------------------------------------------------------------------------------------------------------------------------------------------------------------------------------------------------------------------------------------------------------------------------------------------------------------------------------------------------------------------------------------------------------------------------------------------------------------------------------------------------------------------------------------------------------------------------------------------------------------------------------------------------------------------------------------------------------------------------------------------------------------------------------------------------------------------------------------------------------------------------------------------------------------------------------------------------------------------------------------------------------------------------------------------------------------------------------------------------------------------------------------------------------------------------------------------------------------------------------------------------------------------------------------------------------------------------------------------------------------------------------------------------------------------------------------------------------------------------------------------------------------------------------------------------------------------------------------------------------------------------------------------------------------------------------------------------------------------------------------------------------------------------------------------------------------------------------------------------------------------------------------------------------------------------------------------------------------------------------------------------------------------------------------------------------------------------------------------------------------------------------------------------------------------------------------------------------------------------------------------------------------------------------------------------------------------------------------------------------------------------------------------------------------------------------------------------------------------------------------------------------------------------------------------------------------------------------------------------------------------------------------------------------------------------------------------------------------------------------------------------------------------------------------------------------------------------------------------------------------------------------------------------------------------------------------------------------------------------------------------------------------------------------------------------------------------------------------------------------------------------------------------------------------------------------------------------------------------------------------------------------------------------------------------------------------------------------------------------------------------------------------------------------------------------------------------------------------------------------------------------------------------------------------------------------------------------------------------------------------------------------------------------------------------------------------------------------------------------------------------------|----------------------------|----------|----------------------------|----------|--------------------------------|----------|
| <p style="text-align: right; font-size: small;">Software
with
Manual</p> <p>DIGITAL RESEARCH</p> <ul style="list-style-type: none"> Ⓜ CP/M* FDOS - Diskette Operating System complete with Text Editor, Assembler, Debugger, File Manager and system utilities. Available for wide variety of disk system including North Star, Helios II, Micropolis, ICOM (all systems) and Altair. Supports computers such as Sorcerer, Horizon, Cromemco, Ohio Scientific, RAIIR Black Box, Research Machines, Dynabyte, etc. £75/£15 □ CP/M version 2 (not all formats available immediately) £95/£15 □ MP/M £195/£25 □ MAC - 8080 Macro Assembler. Full Intel macro definitions. Pseudo Ops include RPC, IRP, REPT, TITLE, PAGE, and MACLIB. Z-80 library included. Produces Intel absolute hex output plus symbols file for use by SID (see below) £55/£10 □ SID - 8080 symbolic debugger. Full trace, pass count and break-point program testing system with back-trace and histogram utilities. When used with MAC, provides full symbolic display of memory labels and equated values £45/£10 □ ZSID includes Z80 mnemonics, requires Z80 CPU £50/£10 □ TEX - Text formatter to create paginated, page-numbered and justified copy from source text files, directable to disk or printer £45/£10 □ DESPOOL - Program to permit simultaneous printing of data from disk while user executes another program from the console £30/£1 <p>MICROSOFT</p> <ul style="list-style-type: none"> □ BASIC-80 - Disk Extended BASIC Interpreter Version 5, ANSI compatible with long variable names, WHILE/WEND, chaining, variable length file records £155/£15 □ BASIC Compiler - Language compatible with Version 5 Microsoft interpreter and 3-10 times faster execution. Produces standard Microsoft relocatable binary output. Includes Macro-80. Also linkable to FORTRAN-80 or COBOL-80 code modules £195/£15 □ FORTRAN-80 - ANSI '66 (except for COMPLEX) plus many extensions. Includes relocatable object compiler, linking loader, library with manager. Also includes MACRO-80 (see below) £205/£15 Ⓜ COBOL-80 - ANSI '74 Relocatable object output. Format same as FORTRAN-80 and MACRO-80 modules. Complete ISAM. Interactive ACCEPT DISPLAY, COPY, EXTEND £325/£15 □ MACRO-80 - 8080/Z80 Macro Assembler. Intel and Zilog mnemonics supported. Relocatable linkable output. Loader, Library Manager and Cross Reference List utilities included £75/£10 Ⓜ XMACRO-86 - 8086 cross assembler. All Macro and utility features of MACRO-80 package. Mnemonics slightly modified from Intel ASM86. Compatibility data sheet available £155/£15 □ EDIT-80 - Very fast random access text editor for text with or without line numbers. Global and intra-line commands supported. File compare utility included £45/£10 <p>EIDOS SYSTEMS</p> <ul style="list-style-type: none"> □ KISS - Keyed Index Sequential Search. Offers complete Multi-Keyed Index Sequential and Direct Access file management. Includes built-in utility functions for 16 or 32 bit arithmetic, string/integer conversion and string compare. Delivered as a relocatable linkable module in Microsoft format for use with FORTRAN-80 or COBOL-80 etc £190/£15 □ KBASIC - Microsoft Disk Extended BASIC with all KISS facilities, integrated by implementation of nine additional commands in language. Package includes KISS REL as described above, and a sample mail list program £295/£25
To licensed users of Microsoft BASIC-80 (IM BASIC) £215/£25 <p>MICROPRO</p> <ul style="list-style-type: none"> □ SUPER-SORT 1 - Sort, merge, extract utility as absolute executable program or linkable module in Microsoft format. Sorts fixed or variable records with data in binary, BCD, Packed Decimal, EBCDIC, ASCII, floating, fixed point, exponential, field justified, etc. etc. Even variable number of fields per record! £125/£15 □ SUPER-SORT II - Above available as absolute program only £105/£15 □ SUPER-SORT III - As II without SELECT/EXCLUDE £75/£15 □ WORD-MASTER Text Editor - In one mode has super-set of CP/M's ED commands including global searching and replacing, forward and backwards in file. In video-mode, provides full screen editor for users with serial addressable-cursor terminal £75/£15 □ WORD-STAR - Menu driven visual word processing system for use with standard terminals. Text formatting performed on screen. Facilities for text paginate, page number, justify, center, underscore and PRINT. Edit facilities include global search and replace, read/write to other text files, block move, etc. Requires CRT terminal with addressable cursor positioning £255/£15 <p>GRAFFCOM</p> <ul style="list-style-type: none"> □ PAYROLL - Designed in conjunction with the spec for PAYE routines by HMI Taxes. Processes up to 250 employees on weekly or monthly basis. Can handle cash, cheque or bank transfer payments plus total tracking of all year to date figures. Prints emp master, payroll log, payslips and bank giros. Requires CBASIC-2 £475/£15 □ COMPANY SALES - Performs sales accounting function. Controls payments of invoices and prints sales ledger and aged debtors report. Suitable for any accounting period. Comprehensive VAT control and analysis of all sales invoices. Requires CBASIC-2 £425/£15 | <p style="text-align: right; font-size: small;">Software
with
Manual
Alone</p> <ul style="list-style-type: none"> □ COMPANY PURCHASES - Performs purchase accounting function. Controls invoices, credit & debit notes. Prints purchase ledger, aged creditors report and payment advices. Comprehensive VAT control and analysis of all purchases. Interfaces with the NAD system. Requires CBASIC-2 £425/£15 □ GENERAL ACCOUNTING - Produces Nominal Ledger, Trial Balance, P/L and Balance Sheet. Define your own coding system. Interactive data entry plus optional data capture from Company Sales and Company Purchases. Requires CBASIC-2 £375/£15 □ STOCK CONTROL Maintains stock records, monitors stock levels to ensure optimum stock holding. Details include stock desc., product code, unit, unit price, quantity on hand on order/minimum. Stock analysis reports can be weekly, monthly, quarterly etc. Interfaces with Order Entry Invoicing system. Requires CBASIC-2 £325/£15 □ ORDER ENTRY & INVOICING Performs order entry and invoicing function. Handles invoices for services and consumable items, part orders and part quantities. Sales Analysis report shows sales movements and trends for user-defined period. Interfaces with Stock Control, ADD and Company Sales systems. Requires CBASIC-2 £325/£15 □ ADD - Complete control of all your names & addresses including suppliers, clients, enquiries etc. Assign your own coding system and select all output via the report generator. Will print anything from mailing labels to directories. Requires CBASIC-2 £225/£12 □ COMPLETE ACCOUNTING PACKAGE - Combined Company Sales, Company Purchases, General Accounting, and ADD systems £950/£45 □ SALES ORDER PROCESSING PACKAGE - Combined Stock Control, Order Entry and Invoicing and NAD systems £550/£30 <p>STRUCTURED SYSTEMS GROUP</p> <ul style="list-style-type: none"> □ ANALYST - Customised data entry and reporting system. User specifies up to 75 data items per record. Interactive data entry, retrieval and update facility makes information management easy. Sophisticated report generator provides customised reports using selected records with multiple level breakpoints for summarisation. Requires CBASIC-2, 24 x 80 CRT, printer and 48K system £125/£10 □ LETTERRIGHT - Program to create, edit and type letters or other documents. Has facilities to enter, display, delete and move text, with good video screen presentation. Designed to integrate with NAD for form letter mailings. Requires CBASIC-2 £105/£15 □ NAD Name and Address selection system - interactive mail list creation and maintenance program with output as full reports with reference data or restricted information for mail labels. Transfer system for extraction and transfer of selected records to create new files. Requires CBASIC-2 £45/£12 □ QSORT - Fast sort/merge program for files with fixed record length, variable field length information. Up to five ascending or descending keys. Full back-up of input files created £50/£12 <p>SOFTWARE SYSTEMS</p> <ul style="list-style-type: none"> □ CBASIC-2 Disk Extended BASIC - Non-interactive BASIC with pseudo-code compiler and runtime interpreter. Supports full file control, chaining, integer and extended precision variables etc. £75/£10 <p>MICRO FOCUS</p> <ul style="list-style-type: none"> □ STANDARD CIS COBOL - ANSI '74 COBOL standard compiler fully validated by U.S. Navy tests to ANSI level 1. Supports many features to level 2 including dynamic loading of COBOL modules and a full ISAM file facility. Also, program segmentation, interactive debug and powerful interactive extensions to support protected and unprotected CRT screen formatting from COBOL programs used with any dumb terminal £400/£25 □ FORMS 2 - CRT screen editor. Automatically creates a query and update program of indexed files using CRT protected and unprotected screen formats. Output is COBOL data descriptions for copying into CIS COBOL programs. No programming experience needed. Output program directly compiled by CIS COBOL (standard) £100/£12 <p>MICRO DATA BASE SYSTEMS</p> <ul style="list-style-type: none"> □ HDBS - Hierarchical Data Base System. CODASYL orientated with FILES, SETS, RECORDs and ITEMs which are all user defined. ADD, DELETE, UPDATE, SEARCH, and TRAVERSE commands supported. SET ordering is sorted, FIFO, LIFO, next to prior. One to many set relationship supported. Read/Write protection at the FILE level. Support FILES which extend over multiple floppy or hard disk devices. □ MDBS - Micro Data Base System. Full network data base with all features of HDBS plus multi-level Read/Write protection for FILE, SET, RECORD and ITEM. Explicit representation of one to one SET relationships. Supports multiple owner and multiple record types within SETs. HDBS files are fully compatible. □ MDBS-DRS - MDBS with Dynamic Restructuring System option which allows altering MDBS data bases when new ITEMs, RECORDs, or SETs are needed without changing existing data. <table border="0"> <tr> <td>HDBS-Z80 version</td> <td>£135/£25</td> </tr> <tr> <td>MDBS-Z80 version</td> <td>£395/£25</td> </tr> <tr> <td>MDBS-DRS-Z80 version</td> <td>£455/£25</td> </tr> </table> <p style="text-align: right; font-size: small;">8080 Version available at £45 extra
Z80 version requires 20K RAM. 8080 version requires 24K RAM.
(Memory requirements are additional to CP/M and application program.)</p> <p>When ordering HDBS or MDBS please specify if the version required is for 1) Microsoft L80 i.e. FORTRAN-80, COBOL-80, BASIC COMPILER, 2) MBASIC 4, XX, or 3) BASIC-80 5.0.</p> | HDBS-Z80 version | £135/£25 | MDBS-Z80 version | £395/£25 | MDBS-DRS-Z80 version | £455/£25 |
| HDBS-Z80 version | £135/£25 | | | | | | |
| MDBS-Z80 version | £395/£25 | | | | | | |
| MDBS-DRS-Z80 version | £455/£25 | | | | | | |

Software for most popular 8080/Z80 computer disk systems including NORTH STAR HORIZON, VECTOR MZ, OHIO SCIENTIFIC, CROMEMCO, PROCESSOR TECHNOLOGY, RAIK BLACK BOX, DYNABYTE, SD SYSTEMS, RESEARCH MACHINES, ALTAIR, EXIDY SORCERER, IMSAI, HEATH, and 8" IBM formats

- OTHER**
- Software with Manual / Manual with Manual / Manual Alone
- PASCAL/M** — Compiler generates P code from extended language implementation of standard PASCAL. Supports overlay structure through additional procedures. Lists and the SEGMENT procedure type. Provides convenient string handling capability with the added variable type STRING. Untyped files allow memory image I/O. Requires 56K CP/M. £196/£20
 - PASCAL/Z** — Z80 native code PASCAL compiler. Produces optimised portable reentrant code. All interfacing to CP/M is through the support library. The package includes compiler companion macro assembler and source for the library. Requires 56K and Z80 CPU. Version 2 Includes all of Jensen/Wirth except variant records. £155/£15
 Version 3 Upgrade with variant records and strings expected 2/80. £206/£15
 - PASCAL/MT** — Subset of standard PASCAL. Generates ROMable 8080 machine code. Symbolic debugger included. Supports interrupt procedures. CP/M file I/O and assembly language interface. Real variables can be BCD, software floating point, or AMD 9511 hardware floating point. Version 3 includes Sets, Enumeration and Record data types. Manual explains BASIC to PASCAL conversion. Source for the run time package requires MAC (See under Digital Research). Requires 32K. £135/£20
 - TINY C** — interactive interpretive system for teaching structured programming techniques. Manual includes full source listings. £45/£30
 - BDS C COMPILER** — Supports most major features of language, including Structures, Arrays, Pointers, recursive function evaluation, linkable with library to 8080 binary output. Lacks data initialization, long B float type and static B register class specifiers. Documentation includes "C" Programming Language book by Kernighan & Ritchie. £60/£10
 - WHITESMITHS' C COMPILER** — The ultimate in systems software tools. Produces faster code than Pascal with more extensive facilities. Conforms to the full UNIX Version 7 C language, described by Kernighan and Ritchie, and makes available over 75 functions for performing I/O, string manipulation and storage allocation. Compiler output in A-Natural source. Supplied with A-Natural. Requires 60K CP/M. £325/£20
 - POLYVUE/80** — Full screen editor for any CRT with XY cursor positioning. Includes vertical and horizontal scrolling, interactive search and replace, automatic text wrap around for word processing, operations for manipulating blocks of text, and comprehensive 70 page manual. £70/£12
 - POLYTEXT/80** — Text formatter for word processing applications. Justifies and paginates source text files. Will generate form letters with custom fields and conditional processing. Support for Daisy Wheel printers includes variable pitch justification and motion optimization. £45/£10
 - ALGOL 60 Compiler** — Powerful block-structured language featuring economical run time dynamic allocation of memory. Very compact (24K total RAM) system implementing almost all Algol 60 report features plus many powerful extensions including string handling, direct disk address I/O etc. Requires Z80 CPU. £110/£12
 - Z80 Development Package** — Consists of (1) disk file line editor, with global inter and intra-line facilities; (2) Z80 relocating assembler, Zilog Mostek mnemonics, conditional assembly and cross reference table capabilities; (3) linking loader producing absolute Intel hex disk file for CP/M LOAD, DDT or SID facilities. £50/£12
 - ZDT** — Z80 Debugger to trace, break and examine registers with standard Zilog/Mostek mnemonic disassembly displays. Facilities similar to DDT £20 when ordered with Z80 Development Package. £30/£7
 - DISTEL** — Disk based disassembler to Intel 8080 or TDL/Xitan Z80 source code, listing and cross reference files. Intel or TDL Xitan pseudo ops optional. Runs on 8080. £35/£7
 - DISILOG** — As Distel to Zilog Mostek mnemonic files. Runs on Z80 only. £35/£7
 - TEXTWRITER III** — Text formatter to justify and paginate letters and other documents. Special features include insertion of text during execution from other disk files or console, permitting recipe documents to be created from linked fragments on other files. Has facilities for sorted index, table of contents and footnote insertion. Ideal for contracts manuals, etc. £75/£3
 - POSTMASTER** — A comprehensive package for mail list maintenance that is completely menu driven. Features included keyed record extraction and mail production. A form letter program is included which provides neat letters on single sheet or continuous forms. Compatible with NAD files. Requires CBASIC-2. £85/£10
 - XASM-68** — Non-macro cross-assembler with nested conditionals and full range of pseudo operations. Assembles from standard Motorola MC6800 mnemonics to intel hex. £115/£15
 - XASM-65** — As XASM-68 for 6500 Technology MCS-6500 series mnemonics. £115/£15
 - WHATSIT?** — Interactive data-base system using associative tags to retrieve information by subject. Hashing and random access used for fast response. Requires CBASIC. £70/£15
 - XYBASIC** Interactive Process Control BASIC — Full disk BASIC features plus unique commands to handle bytes, rotate and shift, and to test and set bits. Available in integer, Extended and ROMable versions.
 Integer Disk or Integer ROMable. £165/£15
 Extended Disk or Extended ROMable. £215/£15
 - SMAL/80** Structured Macro Assembly Language — Package of powerful general purpose text macro processor and SMAL structured language compiler. SMAL is an assembler language with IF-THEN-ELSE, LOOP-REPEAT-WHILE, DO-END, BEGIN-END constructs. £40/£10
 - SELECTOR III-C2** — Data Base Processor to create and maintain multi Key data bases. Prints formatted, sorted reports with numerical summaries or mailing labels. Comes with sample applications including Sales Activity, Inventory, Payables, Receivables, Check Register, and Client/Patient Appointments, etc. Requires CBASIC Version 2. Supplied in source code. £185/£12
 - CPM/374X Utility Package** — has full range of functions to create or re-name an IBM 3741 volume, display directory information and edit the data set contents. Provides full file transfer facilities between 3741 volume data sets and CP/M files. £125/£7
 - BASIC UTILITY DISK** — Consists of (1) CRUNCH-14 Compacting utility to reduce the size and increase the speed of programs in Microsoft Basic and TRS-80 Basic. (2) DPFUN — Double precision subroutines for computing nineteen transcendental functions including square root, natural log, log base 10, sin, arc sin, hyperbolic arc sin, etc. Furnished in source on diskette and documentation. £30/£10
 - THE STRING BIT** — Fortran character string handling. Routines to find, fill, pack, move, separate, concatenate and compare character strings. This package completely eliminates the problems associated with character string handling in FORTRAN. Supplied with source. £30/£10
 - BSTAM** — Utility to link one computer to another also equipped with BSTAM. Allows file transfers at full data speed (no conversion to hex), with CRC block control check for very reliable error detection and automatic retry. We use it! It's great! Full wildcard expansions to send *.COM, etc. 9600 baud with wire, 300 baud with phone connection. Both ends need one. Standard and M versions can talk to one another. £75/£6
 - STRING/80** — Character string handling plus routines for direct CP/M BDOS calls from FORTRAN and other compatible Microsoft languages. The utility varies contains routines that enable programmes to chain *.COM file, retrieve command line parameters, and search file directories with full wild card facilities. Supplied as linkable modules in Microsoft format. £50/£12
 - STRING/80** source code available separately. £185/n.a.
 - VSORT** — Versatile sort/merge system for fixed length records with fixed or variable length fields. VSORT can be used as a stand-alone package or loaded and called as a subroutine from CBASIC-2. When used as a subroutine VSORT maximizes the use of buffer space by saving the TPA on disk and restoring it on completion of sorting. Records may be up to 255 bytes long with a maximum of 5 fields. Upper/lower case translation and numeric fields supported. £105/£15
 - CBS** — Configurable Business System is a comprehensive set of programmes for defining custom data files and application systems without using programming language such as BASIC, FORTRAN, etc. Multiple key fields for each data file are supported. Set-up program maximizes system to user's CRT and printer. Provides fast and easy interactive data entry and retrieval with transaction processing. Report generator program does complex calculations with stored and derived data, record selection with multiple criteria, and custom formats. Sample inventory and mailing list system included. No support language required. £185/15

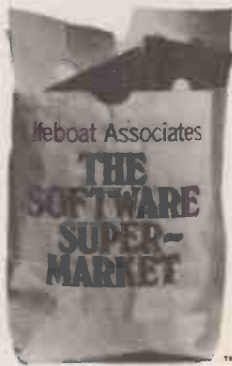

Orders must specify disk type and format, e.g. North Star-Horizon single density.

Add VAT to orders for software (not manuals alone) Add 50p per item postage and packing (minimum £1)

All orders must be prepaid (except COD or credit card) Make cheques POs etc payable to Lifeboat Associates.

Manual costs are deductible from subsequent software purchase

Lifeboat Associates
32 Neal Street
London WC2H 9PS
01-379 7931

Modified version available for use with CP/M as implemented on Heath and TRS 80 Model 1 computers.

User license agreement for this product must be signed and returned to Lifeboat Associates before shipment may be made.

*CP M is a trademark of Digital Research
**Z80 is a trademark of Zilog Inc.

The Software Supermarket is a trademark of Lifeboat Associates.

EFFECTIVE MARCH 1980

**SPECIAL
OFFER**

AS RECOMMENDED BY COMPUTING TODAY – THE CENTRONICS 'MICRO-PRINTER'

Ask most people what they would like as their first peripheral and the chances are they will say "Printer". Here is an attractive electrostatic printer from the famous firm of Centronics. Capable of printing in three sizes of typeface it is easily attached to your machine by way of the parallel interface. The logic is fully TTL compatible and STROBE, Acknowledge and Busy lines are provided to make life easy. "Cost of this wonderful peripheral is a mere £195.00 + VAT The printer comes complete with documentation, connector and cleaning paper as well as a roll of the printing paper." (extract from COMPUTING TODAY).

**Ex-STOCK from HENRY'S
Ideal for PETS-TANDY-NASCOM's**

Specification

- 150 lines per minute
- Selectable 20 40 80 columns
- 120 m/m aluminium – Finish paper unaffected by Heat, Light or Humidity.
- Full character ASC II set.
- Paper Feed, 220-240AC mains.
- On-Off Print Select.
- Paper Advance – Empty Controls.
- Size 10½ x 13½ x 4½" Weight 10lbs

Ideal for Home or Small Business use.

LIMITED QUANTITY DON'T DELAY

Brand new boxed fully guaranteed list price of this machine. **£459.95 inc. VAT.**

OUR PRICE

£195.00 plus VAT

POST PAID



**CENTRONICS
QUICK PRINTER**

Complete with Full documentation connector & Printing Paper –

HALF PRICE OFFER

Just Plug in and it's ready to go!

AS RECOMMENDED BY "COMPUTING TODAY" MARCH/MAY 1980

Your London & National Nascom Distributor.
Export Orders deduct VAT, but add 5% carriage
Official Export & Educational Orders welcome
Our Telex 262284 Mono Ref. 1400 Transonics

**COMPUTER SEND
BROCHURE 15p
FREE STAMP**



HENRY'S

Computer Kit Division

404 Edgware Road, London, W2, England
01-402 6822

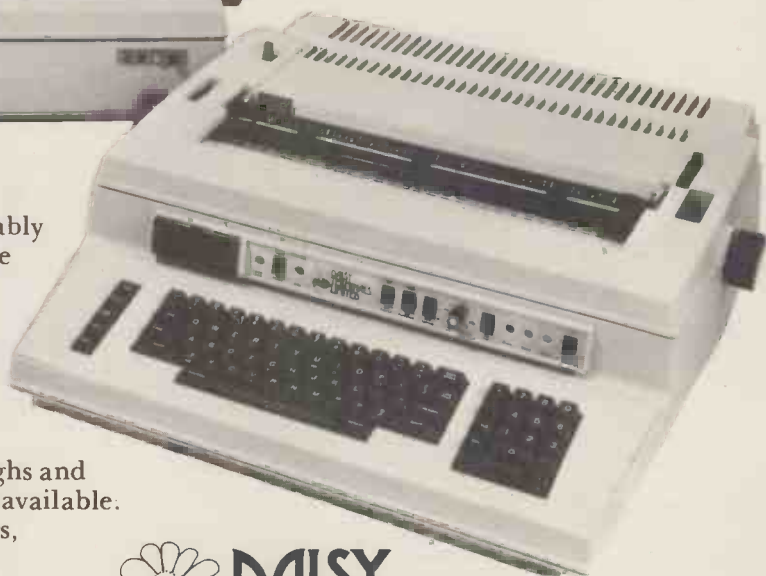
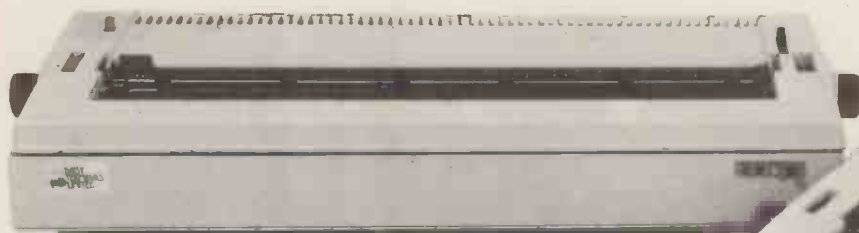

Our 87Q series of Daisy Wheel Terminals is probably the most comprehensive in Europe. Wide Carriage and Twin Print Head Models are available for special applications with 26 inch carriage and 192 character set. Full serial asynchronous/synchronous communications. The new Qume proportional wheels can be used with the auto proportional print mode.

Special protocols can be incorporated for Burroughs and IBM systems. Diablo compatible command codes available. Full range of options including Auto Sheet Feeders, Tractors and Stands.

We are main distributors for the Qume Sprint Micro 5 printer terminal in KSR or Receive Only versions and 45 or 55 C.P.S. Ex-stock delivery. Full Field Service Support.

For details or demonstration please contact



**DAISY
TERMINALS LIMITED**

Bridge Road, Haywards Heath, West Sussex.
Telephone: (0444) 57546 & 57256 Telex: 877134

TCL PASCAL

Standard PASCAL
with P-code interpreter and linker,
following the ISO/BSI working draft.
Compiler operates in two modes:

Resident in RAM—makes
PASCAL as easy to learn as BASIC
Disc mode—with full set of
PASCAL commands.

Many enhancements to standard
PASCAL. Fully validated. Runs in
32K of RAM.

- TCL PASCAL for CP/M and PET is available now
at £120 plus VAT including Manual. Carriage paid.
- TCL PASCAL Manuals are available at £9.50 each.
Carriage paid.

®
CP/M

Compatible with all
systems. IBM format on 5"
or 8" discs.
Manual—TCL PASCAL
for CP/M.
Runs on TUSCAN,
TRITON, 380Z, TEI, TRS80
computers.

*
PET

Unique features include
interface to PET BASIC and
clock.
Available now for PET 3032
on 5" disc.
Manual—TCL PASCAL
for PET.

** Available from TCL SOFTWARE and all Commodore
PET dealers now.*

I am interested in the TCL PASCAL compiler. Please send me:

- The TCL PASCAL Manual for PET CP/M* at £9.50
 - The TCL PASCAL Manual and DISC for PET CP/M* at £138.
- *Delete as necessary and specify 5" or 8" disc for CP/M.

NAME _____

ADDRESS _____

TELEPHONE _____

TCL SOFTWARE

We mind our language!

TCL SOFTWARE
12 CHAPEL STREET, LONDON NW1 5DH
TEL: 01-402 8137
TELEX: 444198

©TCL PASCAL is copyright of TCL Software. OEM licences available.

1ST BIRTHDAY SPECIALS

Software for the TRS-80, APPLE, PET, SORCERER

Visicalc

Regular Price

Special

~~£105~~

£99

Hailed as the 'single most important piece of software', reviewed in all major magazines, VISICALC can do all your calculations, projections and planning.

Calculate sales projections, income taxes, personal budget, costing estimates, wages, engineering changes. For example, you can design your own sales forecasting format in making the important 'what if' business decisions.

Includes book and step-by-step instructions for the complete beginner. VISICALC alone justifies the purchase of an APPLE!! A must for everyone. Cannot be recommended too highly.

VISICALC requires 32K APPLE 11 with one disc.

Adventure

~~£12.50~~ EA £10 EA

ADVENTURE by Scott Adams is incredibly complex, detailed and fascinating. It is like no other program you have ever seen! Defeat exotic wild animals to get treasures, or work out how to get out of a quicksand bog. You can communicate through two-word commands such as 'go south', 'climb tree', 'throw ax', 'look around', etc.

Unlike most available games ADVENTURE is full of surprises. It may take you more than an hour to 'find a treasure' and will probably take days or weeks of playing to get a good 'score'.

"Out of 50 programs reviewed ADVENTURE was rated No. 1 . . . highly recommended" in *80 Software Critique* No. 7. Eight different adventures available: ADVENTURELAND, PIRATES ADVENTURE, MISSION IMPOSSIBLE ADVENTURE, VOODOO CASTLE, THE COUNT, STRANGE ODYSSEY, MYSTERY FUN HOUSE and PYRAMID OF DOOM

If you haven't seen ADVENTURE try the mini-adventure sampler (usually £7.50) for only £6. Available for TRS-80, APPLE, PET, SORCERER (16K).

Editor Assembler Plus

~~£25~~

£20

Plus what? Well, you get the features of the T-bug and the original editor/assembler plus macros and conditional assembly, plus extra commands like substitute, move, copy and extend, plus Z-bug, a powerful debugging monitor with an 8 level breakpoint capability. Available for TRS-80 16K tape.

Electric Pencil

~~£95~~

£85 (tape)

~~£140~~

£125 (disc)

A true word-processing program for the TRS-80. Editing? Just position the cursor with the arrow keys . . . one-key commands let you change, delete or insert. Fully adjustable margins, left/right justification, variable spacing, page headings and more. Save or recall your text with tape or diskfiles. Available for TRS-80 16K.

Sargon II

~~£25~~

£22.50

Sargon, the chess program that came first in the Microcomputer Chess Tournament, has become Sargon II - a new, faster version. The new even more versatile. It is equally entertaining for the experienced player as for the novice. Positions may be pre-set for problem solving. The hint mode allows you to ask the computer what it suggests when you are baffled. Available for TRS-80 16K and APPLE (tapes).

Space Invaders

~~£12.50~~

£10

The video game that has swept the world comes right into your own home! Fifty-five aliens advance and shower you with lethal writhing electric worms. As you shoot the aliens, one by one, they quicken their descent. They whizz across the screen wearing away your parapets, your only defence, coming closer and closer to your level. This is the original invader game, with original moon creatures and action twice as fast as any other invader game available: available for TRS-80 SUPER-INVADERS also available for APPLE 32K.

~~£16~~

£14.50

NEW - for the Sinclair ZX80

30 Programs for the SINCLAIR ZX80 1K! This new book has just been published: Special price only £5.95 (usually £6.95). Covers educational, scientific, and game programs. All with full listing and detailed explanations. This book is a must for the ZX80 user.

30
PROGRAMS
FOR THE
SINCLAIR
ZX80
1K

BEAM SOFTWARE

BEAM SOFTWARE PUBLISHING, 24 Red Lion Street, London WC1
Write for complete catalogue

Name

Address

MICROCOMPUTER

TOTAL FOR PROGRAMS £

(Orders under £20 add £1 p & p)

Cheque/P.O /Cash enclosed

Prices include VAT where applicable.

RAIR

GRAFFCOM

The complete small business Microcomputer system £5250



MODEL 1420
Video terminal



BLACK BOX
Microcomputer



MODEL 730
Miniprinter

Now available from **one source**, a complete microcomputer system, **plus** integrated small business software, supported by UK wide **on-site** maintenance.

Hardware

BLACK BOX Microcomputer

Advanced desk-top microcomputer system incorporating dual double-density, double-sided minidisk drives, 48K bytes of RAM memory, dual serial I/O interfaces, real time clock.

MODEL 1420 Video terminal

High performance video terminal featuring typewriter-style keyboard, 24x80 screen, alternate numeric/function keypad, cursor controls, dual intensity display.

MODEL 730 Miniprinter

100 cps printer featuring three-in-one paper handling, cut sheet, fan fold or roll paper, 80/132 column printing, expanded printing, high legibility upper/lower case printout.

Software

Payroll

PAYE/HMI Taxes routines; weekly or monthly; cash, cheque or giro; etc.

Sales Accounting

Sales ledger; aged debtors; statements; VAT control; etc.

Purchase Accounting

Purchase ledger; aged creditors; payment advices; VAT control; etc.

General Accounting

Nominal ledger; trial balance; profit and loss; balance sheet; etc.

Stock Control

Full stock descriptions; optimises stock levels; recorder lists; etc.

Order Entry & Invoicing

Services and consumables; part orders or quantities; sales analysis reports; etc.

To RAIR Limited 30-32 Neal Street London WC2H 9PS
Telephone: 01-836 4663. Telex: 298452

Name _____

Position _____

Company _____

Address _____

Telephone number _____

I wish to order the complete system

Please send more information

Dealer enquiries welcome.

Leasing or rental terms available.

GW Computers Ltd

89 Bedford Court Mansions, Bedford Avenue, London W.C.1.
call only by appointment



SUPERBRAIN™

Intelligent Video Terminal Systems

350K or 700K of Disk Storage

SuperBrain's CP/M operating system boasts an overwhelming amount of available software in BASIC, FORTRAN, COBOL, and APL. Whatever your application . . . General Ledger, Accounts Receivable, Payroll, Inventory or Word Processing, SuperBrain is tops in its class. And the SuperBrain QD boasts the same powerful performance but also features a double-sided drive system to render more than 700K bytes of disk storage and a full 64K of RAM. All standard!



COMPUSTAR™

MULTI-USER TERMINAL SYSTEM

CompuStar user stations can be configured in a countless number of ways. A series of three Intelligent-type terminals are offered. Each is a perfect cosmetic and electrical match to the system. The CompuStar 10-a 32K programmable RAM-based terminal (expandable to 64K) is just right if your requirement is a data entry or inquiry/response application. And, if your terminal needs are more sophisticated, select either our CompuStar 20 or CompuStar 40 as user stations. Both units offer dual disk storage in addition to the disk system in the CompuStar. The Model 20 features 32K of RAM (expandable to 64K) and 350K of disk storage. The Model 40 comes equipped with 64K of RAM and over 700K of disk storage. But, most importantly, no matter what your investment in hardware, the possibility of obsolescence or incompatibility is completely eliminated since user stations can be configured in any fashion you like — whenever you want — at amazingly low cost!

DISK STORAGE

Options for the Superbrain and CompuStar Video Terminal

"Backup" for the 20 megabyte Century Data drive is provided via the dual disk system housed in the CompuStar or the SuperBrain. The Control Data CMD Drive features a removable, front-in-sertable top loading cartridge of 16 megabyte capacity plus a fixed disk capacity of either 16 or 80 megabytes.

Each drive is shipped equipped with an EIA standard 19" rack mounting system and heavy duty chassis slide mechanisms to permit easy accessibility for fast and efficient servicing.

**** WIDELY USED IN UK AND USA ****
**** TESTED AND PROVEN ****
**** POWER AT YOUR FINGERTIPS ****
**** JUST COMPARE THIS LIST ****

++ ROBUST SET OF PROGRAMS WITH ERROR TRAPS COVERING PET DOS RENAME MALFUNCTIONS, CASUAL USER, ERROR, DISK FAILURES, PET DOS MISMANAGEMENT BLOCK ALLOCATIONS, DISK FAILURES, FAST STROKE KEY ENTRIES, CONTROLLED INPUT WITH VISIBLE LINE LENGTH, AND DATE VERIFICATIONS PREVENTING ERRONEOUS DATE ENTRY.

++ COMPREHENSIVE DATABASE MANAGEMENT SYSTEM INCLUDES

**** FILE CREATE/DELETE/SEARCH
**** RECORD CREATE/DELETE/SEARCH/AMEND/PRINT 4 WAYS
**** RECORD SORT BY ANY FIELD BOTH ALPHA OR NUMERIC
**** RECORD INDEX, FIELD, & FIELD ELEMENT SEARCH (EG NO.: TOWN OR SURNAME)
**** FOUR ARITHMETIC FUNCTIONS TO USE AS CALCULATOR ON LAST FOUR FIELDS
**** AUTO CHECK TO PREVENT DOUBLE ENTRY WITH FILE MANAGEMENT SYSTEM DYNAMICALLY ALLOCATING INFORMATION FOR MINIMUM DISK SPACE CONSUMPTION.

++ AUTO INVOICE NUMBERING (WITH OVERRIDE OPTION), PLUS AUTO PRINTOUT INTEGRATED WITH ADDRESS AND STOCK FILES FOR PAYMENT TERM DISCOUNT, AGENT ALLOCATION, PRICE INDEX RETRIEVAL AND AUTO STOCK UPDATE; NOMINAL CODES RETRIEVED FROM ADDRESS FILES MAY BE OPTIONALLY OVERRIDDEN.

++ POWERFUL ALTERNATIVE DOUBLE ENTRY SYSTEM (GENERAL AND OPEN ITEM) INCLUDING NOMINAL CODES PROVIDING A BUREAU TYPE FACILITY FOR TRACKING MONTHLY TRADING FIGURES AND TAX ACCRUALS.

++ CURRENTLY USING 16 SALE AND 66 PURCHASE COMMODITY CODES WHICH ARE AUTOMATICALLY WRITTEN INTO LEDGERS FROM ADDRESS FILES (INCLUDES OVERRIDE OPTION).

++ AUTOMATIC TRIPLE POSTING OF SALES/PURCHASES TO INVOICE & GENERAL & OPEN ITEM LEDGERS WITH COMPLETE AUDIT TRAIL TO INCLUDE ACCOUNT VERIFICATION ON PAYMENTS IN/OUT, SO THAT DISCREPANCIES ARE RE-ALLOCATED TO OUTSTANDING ACCOUNTS, OR OPTIONALLY WRITTEN OFF AS DISCOUNTS TO THE CASH BOOK. THIS FACILITATES PART PAYMENTS.

++ FINAL LIQUIDITY STRIKES A COMPLETE AUDIT TRAIL BALANCE WITH CREDITORS AND DEBTORS O/S AMOUNTS, BANK BALANCES, STOCK MOVEMENTS, AND REMAINING STOCK VALUE TO GIVE PROFITABILITY OF COMPANY IN BOTH FINANCIAL AND STOCK ASSET TERMS.

++ POWERFUL ACCOUNT TRACKING FACILITIES INCLUDE AUTO STATEMENT PRODUCTION FOR ALL ACCOUNTS EXCLUDING NIL BALANCES, WITH DATE COMPARISON AGE ANALYSIS TO: * CURRENT * 30 DAYS * 60 DAYS * 90 DAYS * AND APPROPRIATE MESSAGES WHEN A DATE BLOCK HAS AN INCLUSION.

++ COMPLETE SEARCH/CREATE/AMEND/DELETE/SORT/FACILITIES ON ANY SIGNIFICANT LEDGER HEADING AGAINST EITHER OPEN OR GENERAL LEDGER IN DATE/INVOICE/ACCOUNT/AGENT/ NOMINAL CODE/HEADINGS, FOR FULL INFORMATION RETRIEVAL SUCH AS A SHORTLIST OF OVERDUE ACCOUNT FOR A SPECIFIED MONTH, ACCOUNT LEDGER CARD RETRIEVAL, NOMINAL ANALYSIS ETC.

++ FAST INPUT ECHO FUNCTION TO ENABLE REDUCTION OF KEY STROKES ON REPETITIVE DATA, PLUS PRINT AUDIT TRAIL OF ANY FILE CHANGES.

++ NO — SPECIAL PRINTED STATIONERY NEEDED SO 50-100 INVOICES COST YOU A FRACTION OF A PENNY EACH, AND THEY ARE FORMATTED PRECISELY TO FIT IN A STANDARD 'RYMAN' WINDOW ENVELOPE FOR CONVENIENT POSTING. TRACKING PROGRAM ENABLING PRINTING OF PAST INVOICES — RECALL ON SCREEN, PLUS MONITOR OF SPECIFIED SALES — PURCHASES OF COMMODITIES BY CODE.

++ MONTHLY QUARTERLY TAX CALCULATIONS PLUS STANDARD MAILING TICKET PRINT FACILITIES.

++ ADD-ON OPTION OF AUTO STOCK MOVEMENT REPORT AND UPDATE QUANTITY ON HAND PLUS VALUATION OF RESIDUE AS RESULT OF PURCHASES AND SALES.

++ ADD-ON OPTION OF AUTO BANK UPDATE FROM RECEIVABLES AND PAYABLES AGAINST LEDGERS.

++ PET STORES UP TO 2200 ADDRESSES OR UP TO 4000 SIMPLE LEDGER RECORDS ON ONE DISKETTE WITH 160K OF USER MENU CALLABLE PROGRAMS FROM OTHER DISK — ONLY ONE PROGRAM DISK — AND THE HARD CORE PROGRAMS CAN'T BE BUSTED.

++ SUBSTANTIAL USER GROUP IN UK AND ABROAD WITH ALL POSITIVE FEEDBACK IMPLEMENTED EVERY 3/4 WEEKS AND REDISTRIBUTED FREE OF CHARGE (EXCEPT COST OF DISK AND MAILING 50-70 POUND P.A.) SO YOU BECOME PART OF A COMMON-WEALTH OF USERS WORKING WITH AN IDENTITY OF INTERESTS.

++ THIS MUST BE SURELY THE MOST COMPREHENSIVE, COMPACT, PROVEN, AND COST-EFFECTIVE ONGOING PACKAGE ON THE MARKETPLACE AT THIS POINT IN TIME.

++ TOTAL PRICE VERSIONS 475 POUNDS . . . ADD-ON STOCK OPTION 100 POUNDS . . . ADD-ON BANK OPTION . . . 100 POUNDS . . . REMAINING PROGRAMS 18, 20, 22, 23 JOINTLY 100 POUNDS.

++ THINK OF JUST KEYING IN 100 INVOICES, 50 CHEQUES? (PROVIDED YOU LEFT YOUR PRINTER ON WITH PAPER IN) YOU COULD LEAVE OUR PROGRAMS TO DO ALL THE SECRETARIAL POSTING AUTOMATICALLY AFTER WHICH YOU MAY SET IN MOTION THE AUTO STATEMENT RUN, THEN YOU CAN SIMPLY POST OUT ALL PAPERWORK WITH STATEMENTS AGE ANALYSED WITH APPROPRIATE COMMENTS.

++ CPM VERSION SPECIAL *** WRITTEN ON THE NEW SUPERBRAIN PROCESSOR WITH THREE HIGHER LEVELS OF OPERATION.

***** 1 = ALL FILES ARE FULLY RANDOM ACCESS SO RETRIEVAL OF ANY RECORD IN THE SYSTEM TAKES NO LONGER THAN SEVERAL SECONDS FOLLOWED IMMEDIATELY WITH THE OPTION TO AMEND/PRINT/DELETE/QUIT/OR CARRY ON SEARCHING THROUGH ANY FIELD.

***** 2 = ENTIRE FORMER SET OF PET PROGRAMS ARE NOW JUST ONE PROGRAM RESIDENT IN CORE. ONCE INVOKED FROM DISK (UNDER M-BASIC) THE USER MAY INSERT TWO EMPTY DATA DISKS IN BOTH DRIVES OF THE SYSTEM ENABLING A HIGHER MAGNITUDE OF DISK SPACE FOR MORE DATA STORAGE. (STANDARD SUPERBRAIN TWIN DRIVES CAN STORE 3000 STOCK ITEMS OR 4500 LEDGER RECORDS. 800K SUPERBRAINS CAN STORE 7000 NAMES AND ADDRESSES OR 9000 STOCK ITEMS OR 12000 LEDGER RECORDS * ALL INSTANTLY RETRIEVABLE) NEW 20 MEGABYTE HARD DISK STORAGE CAN HANDLE 40000 NAMES AND ADDRESSES OR 60000 LEDGER ENTRIES.

***** 3 = FULLY TRANSLATABLE PROGRAM WITH RESIDENT VOCABULARY WHICH MAY BE TRANSLATED INTO ANY FOREIGN LANGUAGE IN A MATTER OF HOURS.

***** MAIN MENU DISPLAY *****

**New! Produced in U.K. and widely used in England and the U.S.A.
Complete Business Package**

**INCLUDES EVERYTHING FROM INVENTORY TO SALES SUMMARY
PROMPTS USER AND VALIDATES ENTRIES. MENU DRIVEN**

BUS VER 3.00 TO ver 9.00 PET AND CP/M
APPROXIMATELY 60-100 ENTRIES/INPUTS REQUIRE 2-4 HOURS WEEKLY
AND ENTIRE BUSINESS IS UNDER CONTROL

* PROGRAMS ARE INTEGRATED .. SELECT FUNCTION BY NUMBER

- | | |
|-----------------------------------|--------------------------------------|
| 01=*ENTER NAMES & ADDRESSES. | 13=*PRINT CUSTOMERS STATEMENTS |
| 02=*ENTER/PRINT INVOICES | 14=*PRINT SUPPLIER STATEMENTS |
| 03=*ENTER PURCHASES | 15=*PRINT AGENT STATEMENTS |
| 04=*ENTER A'C RECEIVABLES | 16=*PRINT TAX STATEMENTS |
| 05=*ENTER A'C PAYABLES | 17=GENERAL HELP |
| 06=*ENTER' UPDATE INVENTORY | 18=ALTER VOCABULARIES |
| 07=ENTER' UPDATE ORDERS | 19=PRINT YEAR AUDIT |
| 08=*ENTER' UPDATE BANKS | 20=PRINT PROFIT' LOSS A'C |
| 09=*REPORT SALES LEDGER | 21=ENDMONTH MAINTENANCE |
| 10=*REPORT PURCHASE LEDGER | 22=PRINT CASHFLOW FORECAST |
| 11=*INCOMPLETE RECORDS | 23=ENTER PAYROLL (NO RELEASE) |
| 12=*EXAMINE PRODUCT SALES | 24=EXIT SYSTEM |

..... ENTER WHICH ONE?

DATABASE MANAGEMENT INCLUDES

*** FILE CREATE'DELETE'SEARCH *** RECORD CREATE'DELETE'SEARCH'4 OPTION PRINT *** RECORD SORT ANY FIELD ALPHA OR NUMERIC *** INDEX SEARCH OR GENERAL SCAN'PRINT IN ANY FIELD (EG TOWN OR NAME) *** 4 ARITHMETIC FUNCTIONS TO USE AS CALCULATOR ON LAST 4 FIELDS *** AUTO CHECK TO PREVENT DOUBLE ENTRY TO FILE MANAGEMENT SYSTEM, DYNAMICALLY ALLOCATING INFORMATION TO MINIMISE DISK SPACE CONSUMPTION

VERY FLEXIBLE. EASY TO USE

G.W. COMPUTERS U.K. ARE THE PRODUCERS OF THIS BEAUTIFUL PACKAGE
VER 3.00 (EXC PROG 19,20,22,23)=475.00, VER 4.00 INCLUDES AUTO STOCK-UPDATE=575.00, VER 5.00 INCLUDES AUTO BANK UPDATE=675.00, VER 6.00 IN CORE=775.00, VER 7.00 (INC 19,20,22,23) NOT YET RELEASED=875.00, VER 8.00 RANDOM ACCESS=900.00, VER 9.00 TRANSLATEABLE=975.00. +++EACH LEVEL OVERRIDES LOWER ONE

**WE EXPORT TO ALL COUNTRIES CALLERS ONLY BY APPOINTMENT
CONTACT TONY WINTER ON 01-636 8210
89 BEDFORD COURT MANSIONS, BEDFORD AVENUE, LONDON W.C.1.
NOTE!!! All versions, especially 9.00 use broad financial principles and 9.00 is one 16K core program releasing both disk drives for data storage, as well as being translateable into any foreign language**

IMPORTANT!!! We also sell the hardware for the above tasks to enable the purchase from one source. Note that A * complete *** CBM system with Bus Ver 3 is 2215 pounds and A *** complete *** superbrain system with bus ver 3 and dec printer is 3345 pounds.**

PET +	PET +	PET +	PET +	SOFTWARE	+	SOFTWARE	SUPERBRAIN +	SUPERBRAIN
CBM 3032 32K		650.00		BUS VER 3.00		475.00	SUPERBRAIN 320K	1795.00
CBM 3040 DISKS		650.00		BUS VER 4.00		575.00	TWIN Z80 64K+CRT	
CBM 3022 PRINTER		425.00		BUS VER 5.00		675.00	+2 D'D-S'S DRIVE	
CBM 8032 32K		875.00		BUS VER 6.00		775.00	SUPERBRAIN 800K	2500.00
CBM 8050 1MEG DISKS		875.00		BUS VER 7.00		875.00	TWIN Z80 64K+CRT	
CBM EPSON PRINTER		395.00		BUS VER 8.00		900.00	+2 D'd-D'S DRIVE	
CBM MULTI USER		650.00		BUS VER 9.00		975.00	M'USER S'BRAIN	3950.00
CBM 3032 + EPSON +		0		CBM WORDPRO II		75.00	LINKS UP TO 16	
CBM 3040 + BUS V3		2215.00		CBM WORDPRO III		150.00	SUPERBRAINS ON	
				CPM WORD-STAR		250.00	MULTI TASKING	
PRINTERS +	PRINTERS			CPM MBASIC 80		150.00	COMPUSTAR	
DIABLO 1650 40CPS		2150.00		CPM COBOL 80		320.00	20 MEG ADD-ON	5250.00
DOLPHIN 125CPS BD80		495.00		CPM PASCAL MT		150.00	S'BRAIN HARD DSK	
OKIDATA MICROLINE		575.00		CPM FORTRAN 80		200.00	INTERTUBE III	450.00
PAPER TIGER 195CPS		575.00		CPM DATASTAR		175.00	EMULATOR TERM'L	495.00
TELETYPE 43SR 30CPS		875.00		CPM PASCAL-M		250.00	NEW MULTI TERM'L	
DEC-LA34 TRACT 30CP		875.00		CPM BYSTAM S'BRAIN		75.00	EMULATES FOUR	
NEC-SPINWRITER		1595.00		CPM SUPERSORT		120.00	TERMINALS BY	
QUME DAISY SPRINT5		1950.00		CPM BASIC COMPILER		190.00	SPECIAL FUNCTION	
TEXAS 810 150		1390.00		CPM DESPOOL		30.00		
				CPM BYSTAM IMS'N-STAR		75.00	TANDY MODEL II	1950.00
SPECIALS +	SPECIALS			CPM TEXTWRITER		75.00	APPLE II 16K	675.00
N'STAR QUAD .7 MEG		1500.00		CPM POSTMASTER		75.00	COMPUCOLOR 32K	1750.00
IMS 5000 48K D'D		1500.00		CPM SELECTOR 3		180.00	IEEE TO RS 232	150.00
COMPUTHINK * 800K *		795.00		CPM CBASIC		75.00	IEEE TO PARALLEL	160.00
2 WAY CRDLESS PHONE		195.00		CPM MACRO 80		75.00	IEEE'RS232 BI'DI	195.00
TELEPHONE ANSWER		230.00		CPM W'STAR M'MERGE		310.00	IEEE MODEM	295.00
1 WAY CRDLESS PHONE		80.00					CAT MODEM	135.00
				BUS MANUAL *****		9.00	WARRANTY	
							90 DAY FREE REPLACEMENT	

**SPECIAL INSTITUTION AND UNIVERSITY DISCOUNTS
STOCK AND COMING ROUND. (BARCLAYCARD WELCOME OTHERWISE
CHEQUE WITH ORDER)
CONTACT TONY WINTER 01-636 8210
89 BEDFORD CT MANS, BEDFORD AVE W.C.1.**

VERY SPECIAL GAMES !

NEW from PREMIER PUBLICATIONS, the leaders in exciting, original computer games:

AIR TRAFFIC CONTROL

Play under pressure to keep up to twelve planes from colliding in the crowded airways. Twenty levels of play.

CHALLENGE!

Beat the clock to find the odd man out. Almost infinite levels of play, and the better you do the harder it gets!

SCRAMBLER

Unscramble the letters to find the hidden word. Educational and highly entertaining.

TIME-MAZE

THE maze game. Beat the clock by navigating and blasting your way through a devilishly devious maze. Succeed, and your next game's even harder.

*FOUR VERY SPECIAL GAMES
AT A VERY SPECIAL PRICE!*

Sold individually, these games could cost you £5 – £8 each. But to introduce you to the PREMIER software range, we're offering all four for only £9.95.

AVAILABLE NOW

for TRS 80 (Level 2) VIDEO GENIE, UK 101 (8k) and SUPERBOARD (8k).

ORDER NOW!

And we'll also send you a bonus voucher worth £2 off your next PREMIER software pack. Just send cheque/PO for £9.95 plus 50p p&p (total £10.45), quoting product reference GPA, to:

PREMIER PUBLICATIONS,
12 Kingscote Road,
Addiscombe, Croydon.
01-656 6156

*10 day money-back Guarantee of Satisfaction.
(Over 80,000 programs sold to date)*



STCS

ST Commercial Systems Ltd

24 Ranelagh Road, London W5 5RJ
England

SuperBrain

COMPLETE twin Z80 CP/M computer system with 64K RAM twin double density disk drives, printer, 2 RS232 ports, integral VDU and BASIC or FORTRAN. Plus a full year's guarantee . . . £2,800+VAT

Printer

MICROLINE-80 by OKIdata, the quietest, most reliable little printer available – 40, 80, or 132 characters per line with graphics.

Software

Microsoft BASIC or FORTRAN for no extra charge.

Guarantee

All hardware fully guaranteed for a year. If anything goes wrong we'll have an engineer on your premises within 24 hours – wherever you are in Britain.

SPECIAL Educational and quantity discounts – Dealer enquiries invited:

We also stock CP/M software:-

Wordstar, Selector, all Microsoft languages, CBASIC . . . and lots more.

AND . . .

TELEVIDEO terminals – call for prices. Very special dealer deals.

NEC Spinwriters – all models.

CALL Maria or Gerry: 01-840 1926 anytime 01-992 2909 after hours.

COMPUTER APPRECIATION

86 High Street, Betchingley, Redhill, Surrey. RH1 4PA Godstone (0883) 843221

DATA DYNAMICS MODEL RO 390 PRINTERS

- ASCII coded plain paper hard-copy printer.
- 110 Baud serial interface, 20mA current loop/V24/RS232.
- In excellent condition, tested and fully operational.
- All units with very low hours (mostly under 500 hours).
- Current list price £800.00.
- Our price £120.00 + VAT and carriage.

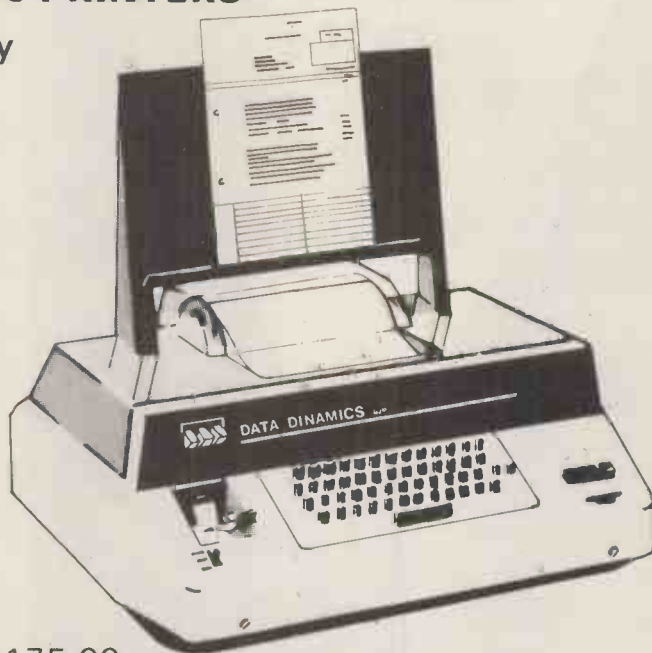

N.B.

- **KSR 390** (with keyboard) available at £175.00.
- **ASR 390** with reader and punch (illustrated) available at £350.00.
- Many other items in stock. Send for list.

The Rohan Computing Collection.....

Qume
CIFER
digital
OKI

Sprint 5/45 Daisywheel printer/terminal. Ideal for word processing and general use. RS 232 standard, successfully installed on PET's, Apples, Tandy TRS 80, Sorcerer etc...

Wordstar The best word processor for cpm systems. Special version with addressing facility.

Wordcraft Converts a 32k PET & discs into a superb word-processor.

VDU's The most legible VDU's on the market, superbly made and British. All black or seafoam finish. Detachable 62 or 102 key keyboards. Lear Seigler and VT52 emulation.

2684 Microcomputer as VDU's but 2nd Z80, integral disc and CPM, graphics facility.

LA 34 The best desk top, full width, 30cps terminal, 10, 12, 16 characters per inch, optional tractor.

LS 120 180 cps terminal.

11/03 & 11/23 computer systems available with CAP MicroCOBOL, accounts, Autoclerk.

Microline 80. The smallest and quietest desk top printer available (61db) 5, 10 or 16 characters per inch, 40, 30, 132 wide. Standard machine will take 9.5 inch sprocket feed paper, roll and single sheet. With centronics interface, PET IEEE or user port interface, Tandy TRS 80 directly to keyboard unit without expansion box.

TNW 2000 The only bi-directional PET to RS 232 interface we know that runs Qumes etc. at full speed i.e. 1200 baud £165.00. Also available Teletype 43, North Star, Rair Black Box.

TRADE & EDUCATIONAL ENQUIRIES WELCOME,

Rohan Computing 52 Coventry St., Southam, Warwickshire CV33 0EP. Tel: Southam (092681) 4045

Array Processing from Silicon Glen on the West Coast of Scotland

Video Vector Dynamics Ltd announce what will be one of the most significant innovations in microcomputing during the 1980's — The VP 9500 Vector Processor.

For more details contact:

Video Vector Dynamics Ltd
39 Hope Street,
Glasgow G2 6AE
Telephone number 041-226 3481/2

INTEGRATED SMALL BUSINESS SOFTWARE ISBS

Professional Business Packages for Microcomputer systems include:

- PAYROLL
- STOCK CONTROL
- ORDER ENTRY & INVOICING
- COMPANY SALES
- COMPANY PURCHASES
- GENERAL ACCOUNTING
- NAME & ADDRESS SYSTEM

Available as individual modules or complete system to run on RAIR BLACK BOX, NORTHSTAR, HEATH, CROMEMCO, DYNABYTE, IMS 5000/8000, ALTOS, ALTAIR, SUPERBRAIN, MICROMATION and most other 8080 based systems.

Contact Lifeboat Associates, 32 Neal Street, London WC2 or your nearest dealer.

GRAFFCOM 52 SHAFTESBURY AVENUE
SYSTEMS GROUP LONDON W1 01-734 8862

EXPANDORAM II

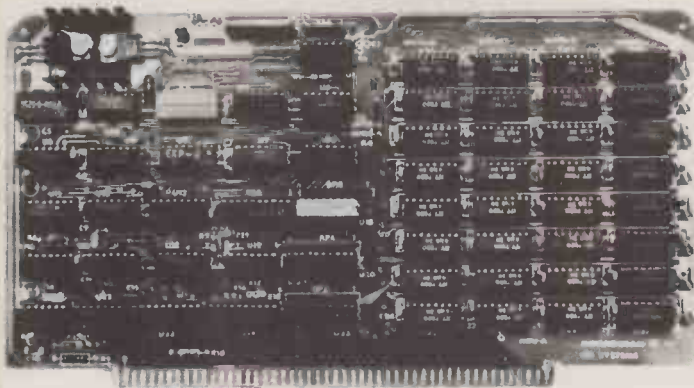

Expandable Random Access Memory Board

Features

- * S-100 Bus Compatible
- * 4MHz Operation
- * Board Select for Multi-user System
- * Expandable Memory from 16K to 256K using 16K or 64K devices
- * DIP Switch selectable boundaries at any 16K or 64K boundary
- * Page Mode Operation Allows up to 8 boards on a Bus
- * Operates with Z80 CPUs
- * Phantom Output Disable and a manual Switch Selectable Output Disable
- * Power Dissipation — 5 watts, Typical
- * Wait States and Invisible Refresh Synchronized
- * 4-64K Banks are available with 4164's

The ExpandoRAM II provides a low cost means for expanding Random Access Memory capability for computers using the S-100 Bus structure. The board's design allows eight boards to operate from the same S-100 Bus.

Page mode operation provides the system with the capability of servicing multiple users without RAM interference. Synchronization of the wait state and invisible refresh deliver faster operation, allowing processing speeds up to 4MHz.

The ExpandoRAM II is compatible with most S-100 CPUs based on the Z80 microprocessor. When other SD SYSTEMS 200 series boards are combined with the ExpandoRAM II, they create a microcomputer with exceptional capabilities and features.

OUR PRICE: £129.00 + VAT (Kit Form) Built & Tested from:— **£295.00 — £495.00 + VAT.**

For further information on this board, or any other boards in our comprehensive range i.e.: SBC100, Versafloppy I + II, VDB8024, Z80 Starter Kit etc. Please write or telephone.



Unit A2 9 Longford Avenue
Kilwinning Industrial Estate
Kilwinning Ayrshire KA13 6EX
Tel. 0294 57755 Telex 779808

TREND®

Numerical Control or Baudot 5 unit code conversion with the **RPT 18**

Paper Tape Reader Punch Terminal

- ★ ASCII – Baudot 5 unit code version.
- ★ ASCII – NC code version.
- ★ Microprocessor – controlled.
- ★ Modem or current loop interface.
- ★ Simple editing facilities.



For quote and further details, 'phone:—
Bourne End (06285) 24977 or telex 849408 Trend G.

Trend Communications Limited,  DATA COMMUNICATIONS DIVISION

Knaves Beech Estate, Loudwater, High Wycombe, Bucks HP10 9QZ.

TREND®

Teleprinter **'RO'**

- ★ Hard copy
- ★ 80 or 132 column
- ★ 7 x 5 dot matrix
- ★ 5 or 8 unit code
- ★ Black/red printing
- ★ Optional pedestal
- ★ Modem, current loop, telegraph or parallel interface
- ★ UNICOM news selector



For quote and further details, 'phone:—
Bourne End (06285) 24977 or telex 849408 Trend G.

Trend Communications Limited,  DATA COMMUNICATIONS DIVISION

Knaves Beech Estate, Loudwater, High Wycombe, Bucks HP10 9QZ.



Typewriter Quality Printing

on your
microcomputer for

£ **960** + VAT
or Easy Terms

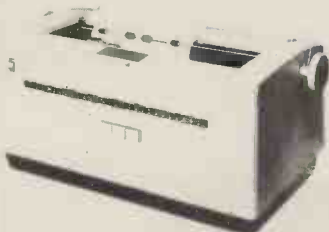

The CPS 3982 is a fully re-conditioned IBM 3982 'golf ball' printer with special CPS electronics designed for use with your microcomputer.

90 day warranty and nationwide maintenance service agreement available.

Features

- Interchangeable golf ball print head (mathematical font available)
- 132 print positions
- Serial port 110 Baud via a 25 way 'D' socket (RS 232 type)

Options:-

- Pin feed platen
- PET IEEE interface
- APPLE Serial interface card

For more information and easy terms facilities
'phone 021-707 3866 Telex 312280 CPS G



CPS (DATA SYSTEMS) LTD

Arden House, 1102 Warwick Road,
Acocks Green, Birmingham B27 6BH

CPS are PET and APPLE Dealers

Kemitron

SINGLE BOARD
SYSTEMS
From £65

Z80 + 64K
8" DISKS + CP/M
From £2,000

FLASH
8070 LOW-COST DEVELOPMENT
SYSTEM NOW AVAILABLE

WE DESIGN AND PRODUCE OUR OWN SYSTEMS. THIS MEANS THAT WE CAN OFFER LOW COST, FLEXIBLE MICRO-COMPUTERS. WE ARE ALSO ABLE TO PAY ATTENTION TO YOUR INDIVIDUAL REQUIREMENTS. OUR TECHNICAL STAFF ARE ALWAYS AVAILABLE TO CUSTOMERS. KEMITRON MACHINES COMBINE RELIABILITY WITH THE LATEST DEVELOPMENTS. CALL US ON CHESTER (0244) 21817 OR WRITE FOR DETAILS TO

Kemitron Electronics Limited,
Chester Computing Centre,
21-23 Charles Street,
Hoole,
Chester CH2 3AY

KINGSTON

KINGSTON — KRK 1

A hardware repeat key for the PET number/cursor pad — a boon to the busy programmer and the ambitious games programme writer. Aided by the detailed instruction programme the average PET owner can upgrade his machine in a couple of minutes without fear of a fatal 'no-no'.
£17.50

KINGSTON — KRK 2

Initially the KRK 2 was conceived as a definitive full keyboard repeat key. However, Kingston ingenuity has optimized on their patented board accessing techniques to allow two invaluable features to be added:

The first, a warm keyboard reset from otherwise fatal crashes. The second, a selectable keyboard tone which allows touch entry at otherwise impossible speeds. We can say with confidence that this unit is an absolute must for any PET user who wants to get the best from his machine.
£35.00

KINGSTON — KC 1

A totally new concept in PET's communication with the outside world. At long last the programmer is free from the limitations of the IEEE bus. INPUT, PRINT, LOAD and SAVE to an external RS232 device are now possible without recourse to ingenious/tedious software. A comprehensive on-board firmware package allows all manner of hitherto impossible functions to be achieved including keyboard selectable configuration with full modem control.
£135.00

KINGSTON — KC 2

Having achieved one level of impossibilities, we knew someone would need more so here it is —

Simultaneous access to two RS232 serial devices or networks with all the features of the KC 1 and more besides. With this device we give PET users serial RS232 I/O capabilities, which the owners of much more expensive machines would envy.
£150.00

KINGSTON — KSB 1

A twenty-way RS232 multiplexing/switching box with 'mind-blowing' potential — Applications of the unit are legion and range from simple networking through multiple disc sharing to multidevice complexes based on a single processor.
£350.00

CMC ADA 1200

A low budget IEEE 488/RS232 unidirectional interface, with a proven record of reliability (Field failure rate better than .1 percent). Since the unit is not addressable it is not recommended for use with the Commodore Disc.
£65.00

CMC ADA 1400

An addressable IEEE 488/RS232 unidirectional interface, which is proving even more reliable than the ADA 1200 from which it was developed. While it was designed to offer only standard RS232 output it is sufficiently 'beefy' to cope with a number of less demanding current loop applications without modification.
£90.00

CMC SADI

SADI — The microprocessor based serial and parallel interface for the Commodore PET. SADI allows you to connect your PET to parallel and serial printers, CRT's, modems, acoustic couplers, hard copy terminals and other computers. The serial and parallel ports are independent allowing the PET to communicate with both peripheral devices simultaneously or one at a time. In addition, the RS232 device can communicate with the parallel device. Special features for the PET interface include:

- Conversion to true ASCII both in and out.
- Cursor controls and function characters specially printed.
- Selectable reversal of upper and lower case.
- PET IEEE connector for daisy chaining.
- Addressable — works with other devices.

Special features for the serial interface include:

- Baud rate selectable from 75 to 192000.
- Half a full duplex.
- 32 character buffer.
- X-ON, X-OFF automatically sent.
- Selectable carriage return delay.

Special features for the parallel interface include:

- Data Strobe — either polarity.
- Device ready — either polarity.

Complete with power supply, PET IEEE cable, RS232 connector, parallel port connector and case.
£175.00

CMC AIM 161

A low budget IEEE 488 16-channel analogue to digital converter for the competent programmer who wants to 'do his own thing', With a 5-12 volt reference voltage the unit is normally accurate to better than .5%.
£90.00

CMC PETSET

An AIM 161 specially configured for plug-in and switch-on use by the less technically graded user. The unit has a number of helpful extras including an input connector board allowing simple screw connection to the outside world.
£135.00

CMC APPLESET

Similar to the PETSET, saving that the unit is configured for use with the APPLE.
£135.00

CMC TANDYSET

Similar to the PETSET saving that the unit is configured for the TANDY TRS80.
£135.00

CMC XPANDR 1

Analogue to digital conversion of up to 128 channels can be achieved by simply connecting as many 16-channel AIM 161 units as you need through this smart board.
£40.00

T
N
W

Corporation

TNW 2000

With over 2,000 units sold, this IEEE 488/RS232 interface can truly be said to be tried and tested. Features include the conversion of both PET and true ASCII, daisy chaining and full address selection.

Standard RS232.

£135.00

Current Loop.

£150.00

TNW 3000

A bi-ported, bi-directional IEEE 488/RS232 interface offering everything the discriminating programmer could ask for. Features include independent crystal controlled Baud rate on both ports and fully implemented RS232 with extensive control line options allowing responsive throttling.
£220.00



SSM — A10

Two powerful APPLE interface boards in one:

The first an RS232 serial with three handshaking lines (RTS, CTS and DCD), rotary switch selection of nine standard baud rates from 110 to 19200, including 134.5 for selectrics and the modes of serial communication under software control.

The second a double bi-directional parallel with four additional interrupt and handshaking lines, and interface configuration under software control.
£105.00

NOTES

- Every Kingston product is carefully burned in and tested before dispatch.
- Kingston's guarantee, warranty and service undertakings are probably the best in the business — If you would like to see what real customer concern is all about, then send for a copy of our standard Guarantee Form!
- All prices quoted by Kingston are inclusive of packaging and shipping, but do not include V.A.T. — Please add 15% V.A.T. to any order.
- We have a number of new and exciting products 'in the pipeline' including:
 - A family of rugged, low budget EPROM programmers and duplicators.
 - A number of new cost effective printers, including daisywheels and single and double pass (better quality) matrix.
 - A low cost TRS expansion.
 - A flexible/expandable industrial control system.
 - Emergency standby power units, ranging from a .5 KVA baby to a 9.5 KVA mainline system.

If you have an interest in any of these items, give us a call. As you might expect from a company which prides itself in being different, we maintain an engineer on call eighteen hours a day, seven days a week to help you.

KINGSTON COMPUTERS LTD

Scarborough House, Scarborough Road, Bridlington. Telephone 0262 73036

PCW 16



AT LAST IT'S BEEN DONE!

EVERYBODY'S BEEN TALKING ABOUT

DISTRIBUTED PROCESSING

INTERTEC DATA SYSTEMS

THE MANUFACTURERS OF THE REMARKABLE

SUPERBRAIN™

MICRO COMPUTER
HAVE NOW ANNOUNCED THE

COMPUSTAR™

MULTI USER SYSTEM

COMPUSTAR IS THE FIRST LOW COST MICROCOMPUTER DISTRIBUTED PROCESSING SYSTEM.

COMPUSTAR WILL SUPPORT UP TO 16 TERMINALS

UP TO 4 COMPUSTAR UNITS CAN ADDRESS A SINGLE HARD DISC

BY ALLOWING:-

1. **USERS** TO ACCESS A COMMON DATA BASE.

2. **TH** TERMINAL HAS **TWO Z80A** PROCESSORS AND 32K OR 64K RAM

3. **DATA** IS TRANSFERRED FROM HARD DISC OR BETWEEN USERS AT 64K BAUD.

4. **THE** SYSTEM REALLY GIVES INCREDIBLE RESPONSE SPEED —

5. **IN** FRAME PERFORMANCE AT MICRO PRICES

SO **SUPERBRAIN™**

UNRIVALLED PRICE/PERFORMANCE

- * 64K RAM * CPM 2.2 OPERATING SYSTEM
- * DUAL FLOPPY DISCS — 320 KB
- * DUAL Z-80 PROCESSORS
- * DUAL COMMUNICATION PORTS
- * FULL 80 COLUMN SCREEN

£1950 + VAT

LEASE £73 P.M. OVER 3YRS — RENT £40 P.W.

OPTIONS

- * 600 KB DISCS £500 (May '80)
- * 1.6 MB DISCS £850 (June '80)
- * S-100 BUS ADAPTOR £250 (June '80)
- * PRESTEL (subject PO approval) £550 (July '80)

MODULAR CONSTRUCTION GIVES HIGH RELIABILITY
SIMPLE SERVICING — NATIONWIDE
SERVICE CONTRACT £240 PA

DEALERS

TERODEC (MICROSYSTEMS) LTD
BOYD MICROSYSTEMS LTD
M.A.P. COMPUTERS LTD
MICRO MANAGEMENT LTD
PICOBYTE LTD
SYSTEMS MICROS LTD

Camberley, Surrey (0252) 874 790
Bushley Heath, Herts (07) 950 0303
Oldham, Lancs (061) 633 3084
Frinton-on-Sea, Essex (02556) 4592
Birmingham (021) 328 4840
Telford, Staffs (0952) 460 214



COMPUSTAR MULTI TERMINAL CONTROLLER

64K RAM 720K DISCS £3950.00
64K RAM 1.5 MB DISCS £4250.00

USER TERMINALS

32K RAM £1300.00
64K RAM £1400.00
64K + 32K DISCS £1950.00

UPGRADE KIT FOR SUPERBRAIN TO COMPUSTAR
TERMINAL PROCESSOR £ 75.00

HARD DISCS

CMC WINCHESTER 20MB £3950.00
CDC 36MB FIXED/REMOVEABLE DISC DRIVE £6590.00

(These disc sub systems include a controller/interface and can also be used with Superbrain™ models.)

** SPECIAL OFFER **

TERMINAL SYSTEM — COMPUSTAR 64K + 1.5 MB DISCS.

+ 2 x 32K TERMINAL PROCESSORS

+ 20 MB CMC WINCHESTER

TOTAL PRICE £9500

6 MONTHS WARRANTY ON ALL INTERTEC PRODUCTS

** NEW REDUCED PRICES **

SOFTWARE AVAILABLE FOR DEMO AT OUR SHOWROOMS

LANGUAGES:

MICROSOFT BASIC INTERPRETER £175
MICROSOFT BASIC COMPILER £185
MICROSOFT COBOL £325
CIS COBOL £400
PASCAL 'M' £125

UTILITY PACKAGES

* IBM EMULATION! *
2780/3780 1ST INST SUBS. £500
WORDSTAR VERS 2.0 £265
MAIL MERGE £ 60

DATABASE SYSTEMS

MDBS CODASYL £450
SELECTOR III £185
MICRO-PRO DATA STAR £195

NEW FROM DIGITAL RESEARCH

* PL/1 £250

WE ARE NOW SOLE DISTRIBUTORS ON SUPERBRAINS
FOR GRAHAM-DORIAN SOFTWARE SYSTEMS EUROPE

1. Sales Ledger	£500	2. Purchase Ledger	£500
3. Nominal Ledger	£500	4. Payroll	£500
5. Job Costing	£500	6. Order Entry/Invoicing	£500
7. Inventory	£300	8. Cash Register	£300
9. Point of Sale	£300	10. Wholesale Inventory	£300
11. Manufacturing	£500	12. Dental (Aug '80)	£500
13. Apartment Management (Aug '80)	£300		

All Software Requires CBASIC £ 85

OTHER SOFTWARE: OSBOURNE ACCOUNTS PAYABLE/REC £150
ROGIS STOCK CONTROL £450



Encotel Systems Ltd

Showroom at Croydon, Surrey Telephone: Upper Warlingham 5701 Telex: 896559

ATTRACTIVE OEM, EDUCATIONAL & DEALER DISCOUNTS AVAILABLE

KNIGHT'S T.V. & COMPUTERS

108 Rosemount Place, Aberdeen.
Tel: (0224) 630526.
Telex: 739169.

GRAHAM KNIGHT (GM8FFX) WITH HIS SHARP MZ-80K GENERATING TV PICTURES WHICH ARE BEING TRANSMITTED VIA HIS AMATEUR RADIO AND TELEVISION STATION.

Video signals from the Sharp computer are converted to 28MHz and then to 435MHz. Professional standard, vestigial sideband, fast scan TV pictures are then transmitted using 150w of power to feed 176 element antenna. Computer generated pictures have been received over 150kms.



Dear Microfans,

We have been very busy since our letter last month. Sharp have introduced the MZ-80P printer (£517), the dual floppy disk unit (£780), and the PC-1211 pocket computer £91. The floppy disk system is very good giving a total 280K memory per twin disk unit. The printer is tractor fed, capital and small letters plus graphics can be printed at 100 characters per second. We have been using the disks and the printer for two months now and we find them to be reliable and easy to use with the MZ-80K. The new pocket computer has all the usual functions of a programmable calculator plus the convenience of BASIC – it even has an optional cassette interface and commands to operate a printer.

Due to our large volume sales of Sharp Radio, Television, and Microcomputer products we have been able to reduce the prices on the MZ-80K. The 20K model now costs just £459, the 24K model is £477, the 36K is £539, and the full 48K memory MZ-80K is now £577. All our prices include free RED STAR delivery, free membership of the International Sharp User Group, one year's full guarantee, and of course our exclusive offer of 50 free programs. These cover all the aspects of microcomputing and include business, educational, and games programs. Our special dis-assembler, byte searcher, memory dumper, and renumber, are included in this free package alongside the more light hearted Startrek, Cosmic Explosions, and Sharp Organ Keys programs.

As you can see from the above picture I use the MZ-80K for my amateur radio hobby – the Sharp tracks communication satellites for me. We also use the Sharp MZ-80K at work every day to assist in servicing our rental television sets. This application of microcomputers has caused a great deal of interest in the trade and we have recently given three lectures and demonstrations at the Radio Trade Association Conference at Torquay, at a RETRA/PYE "Servicing in the Eighties" training seminar at Edinburgh, and at the Radio Industries Club Gleneagles Conference. There, we took a non technical person from the audience and got him to actually repair a television set being instructed by just the MZ-80K. Since then we are being chased by the National TV Rental firms who want to get the same system. In association with RETRA and PYE we will again demonstrate this application of the MZ-80K at Leeds in November.

The international Sharp Users Group has gone from strength to strength with members in 14 countries. We run this completely independently of Sharp, membership is free if you buy the MZ-80K from us, otherwise it is £3 annually and we will send you the magazines with all the latest Sharp news from Japan and around the World. We will also send you a free "Space Invaders" tape – so you can't go wrong joining, even if you bought your Sharp from another dealer.

We have 60 programs available for the Sharp – send for our price list and ask about our PAYE package which can run on the 20K model. If you are thinking of buying a Sharp write, telephone, or telex for personal service. After all we have been giving personal service to our customers for 40 years and in these troubled times it pays to deal with people who are well established and are interested and involved in the new technology. The latest edition of the Sharp User Group Newsletter details the disks, the printers, the pocket computer, and a great deal of new information about the Sharp MZ-80K – write for a free copy.

Happy computing,
Graham Knight

P.S. Almost forgot to say please add VAT to the above prices and remember we accept Barclaycard and Access.

P.P.S. The Newsletter also has details of the MZ-40K and a review of the recent Japanese micro exhibition.

Keenstar

Now the sky's the limit!

Keenstar. A great new range of exciting products that will enable you to exploit your micro to the maximum. Our reputation as one of the country's leading microcomputer consultants and supplier of leading brands is enhanced still further by this latest addition to our extensive range of micros, peripherals, software and services.

Micros such as Apple, Pet, North Star Horizon and Sharp. Fast and reliable printers from Anadex and Qume. Bespoke and packaged software. And a level of service second to none. From single applications to expandable systems. From full system design through installation, commissioning and staff training to outstanding after-sales-service.

Send off for the new Keenstar catalogue and you will see over 200 interface boards, special applications software and associated products. All designed to let you take the lid off computing. Why go elsewhere when you'll find all you need to build your microsystem under one roof. It's a roof to us, but with the advent of Keenstar there's no ceiling to your system! While you're waiting for your catalogue just browse through the tiny fraction of what is available listed below. Now that Keenstar's arrived you can really let your imagination loose.



SI00 HARDWARE

K 20001 N 450ns static RAM Board	241.13
K 20002 N 300ns static RAM Board	269.50
K 20003 N 200ns static RAM Board	275.00
K 20004 N 2200 Mainframe	295.00
K 20005 N WireWrap Board	30.00
K 20006 N Solder Tail Board	30.00
K 20007 N Extender Board	30.00
K 20008 N 8080 CPU Assembled	180.00
K 20009 N Z-80 CPU Assembled	220.00
K 20010 N Memory Mapped Video Interface	160.00
K 20011 N I/O Mapped Video Interface	180.00
K 20012 N 80 x 24 Video Interface (2MHz)	295.00
K 20013 N 80 x 24 Video Interface (4MHz)	330.00
K 20014 N 80 x 51 Upgrade (2MHz)	70.00
K 20015 N 80 x 51 Upgrade (2MHz)	70.00
K 20016 N Parallel I/O Interface	110.00
K 20017 N 2P + 2S I/O Interface	175.00
K 20018 N Music Synthesiser (4)	220.00
K 20019 N Prototyping Board	65.00
K 20023 N 2708/2716 EPROM Programmer	180.00
K 20024 N 4K 1702 EPROM Board	110.00
K 20025 N 16K 2708 EPROM Board	130.00
K 20026 N Active Terminator	55.00
K 20027 N 15 Slot Motherboard	140.00
K 20028 N Extender Board	30.00

APPLE HARDWARE

K 11502 A Sony Colour TV. S/colour	349.00
K 21001 A ROM/PROM Board	65.00
K 21002 A Programmable Timer	130.00
K 21003 A BCD Analogue to Digital	120.00
K 21005 A WireWrap	20.00
K 21006 A Solder Tail Board	20.00

K 21007 A Extender	20.00
K 21008 A Etch Board	20.00
K 21009 A Asynchronous serial card	130.00
K 21010 A Synchronous serial card	130.00
K 21011 A P.I.a	110.00
K 21012 A Arithmetic Processor	280.00
K 21013 A Lower Case Adaptor	55.00
K 21014 A Apple Serial/Parallel Interface	130.00

NORTH STAR SOFTWARE

K 02001 O Word Star	255.00
K 02002 O Wordmaster	75.00
K 02003 O Supersort I	125.00
K 02004 O Supersort II	105.00
K 02005 O Supersort III	75.00
K 02006 O Whatsit? (N. Star)	95.00
K 02007 O Whatsit? (CP/M)	125.00
K 02008 O CP/M	95.00

PET SOFTWARE

K 03001 O 6502 Assembler	20.00
K 03002 O Microchess	15.00
K 03004 O Gammon Gambler	15.00
K 03005 O Time Trek	15.00
K 03006 O Graphics Pak	15.00
K 03007 O Stimulating Simulations	15.00
K 03008 O Bridge Partner	15.00

PRINTERS

K 01030 P Anadex DP 8000	575.00
K 1083 P Qume 45 R0	2280.00

APPLE BUSINESS SOFTWARE

K 01137 B Visi Calc	95.00
K 01176 B Desktop Plan	95.00
K 01182 B CCA Data Management	95.00

K 01183 B Whatsit?	99.00
K 01186 B Easy Writer - Original	95.00
K 01885 B Easy Writer Pro	180.00

TERMINALS

K 11711 T Cifer (Wordstar terminal)	1150.00
-------------------------------------	---------

APPLE SOFTWARE

K 01136 S Apple-Pip (disc Doctor-Apple)	95.00
K 01138 S Microchess	15.00
K 01138 S Warlords (tape)	7.00
K 01139 S Bridge Challenger	15.00
K 01178 S Checker King	15.00
K 01179 S Gammon Gambler	15.00
K 01180 S Bridge Partner	15.00
K 01181 S Stimulating Simulations	10.00
K 01184 S Apple-Doc	20.00

5b the Poultry, Nottingham NG1 2HW
tel: 0602 583254
telex: 37297 (keenco)

28 Lower Addiscombe Road
Croydon CR0 6AA
tel: 01-680 4646



Keen Computers

Please rush me the new Keenstar catalogue.

Name _____

Position _____

Organisation _____

Address _____

PCW AUG.

Micro U.K.

The business & leisure microcomputer conference

The main event

Micro UK is the conference component of the year's most important business and personal computing show.

Top-line US and European specialists are coming to London to present a comprehensive update on current advances in technology and to discuss the practical aspects of putting together and implementing micro systems successfully.

The multi-stream structure offers the widest possible subject choice and gives each delegate the flexibility to tailor his attendance to suit his own requirements.

The first two days concentrate on the use of micros in industry and commerce and the third day is devoted to a series of half-day teach-ins for the personal computer enthusiast.

Whether you come for one, two or three days, your conference fee buys you entry to the sessions of your choice, unrestricted access to the PCW exhibition (usually £2 per visit) and a chance to meet the speakers face-to-face in a special Micro UK feature.

Outline

each heading desc

Conference (4 and 5 September)

Technology Stream I

Processors and Memory

memory chips – special purpose chips – bit slicing
– new systems architecture – Motorola 6809 –
Intel 8086 – Zilog Z8000 – 16 bit micros

Storage Systems

diskettes – single/double density – single/double
sided – hard disks – 8" Winchester technology
fixed/changeable – costs and reliability

Communications

modem technology – PO facilities – data link
controls – high level protocols – local area
networks – Prestel – personal computer networks

Systems Review

survey of micro systems – Texas Instruments
TI 99/4 – Apple III – Triumph Adler Alphatron
Sinclair ZX80 – other new releases

Technology Stream II

Monitors and Operating Systems

CP/M – MP/M – low level monitors – multi-testing
– multi-user operating systems – utility
program

Languages

BASIC – Business BASIC – Pascal – PL/1 – APL
language developments

Programming and Quality Control

program design – debugging tools – project control
– program productivity

Micro U.K.

is in conjunction with the third

programme – is a half-day session

Development Systems

development and programming aids – ROM – EPROM – simulators – testing

Applications Stream

Retail and Distribution

stock control – order processing – point of sale – billing – financial management

Manufacturing

process control – production control – inventory management – job scheduling

Word Processing

special purpose/general purpose hardware – peripherals – displays and printers – cost justification

Professional Office Systems

time recording – client billing – diary management – client services

Teach-ins (6 September)

Game Playing on Micros

DIY Circuit Building

Music and Microcomputers

Micros for the Disabled

Simulation and Business Games

Technology and Concepts for the Businessman

Building your own System

The Personal Computer Network

Personal Computer World Show

Meet the experts

As well as the wide-ranging 'traditional' conference sessions, Micro UK offers you a unique opportunity to meet some of the world's leading micro authorities face-to-face and get expert advice on your very own systems and equipment.

It's the next best thing to personal consultancy – and at a fraction of the cost.

This special feature is available on all three days only to Micro UK delegates. Get the full conference brochure now and make sure of your place. Phone the conference office on Uxbridge (0895) 30594 or clip the coupon below.

The Micro UK Conference Office,
106 Field Heath Road, Hillingdon,
Middlesex UB8 3NL.

Please send me _____ copies of the full conference programme.

Name _____

Position _____

Organisation _____

Address _____

Tel. No: _____

PCW

the software house

146 OXFORD STREET LONGON W.1

TELEPHONE 01-637-2108

PROGRAMS for APPLEII/ITT 2020

(N.B. Hires programs prefixed (H))

Please send me the following:

(H) SUPER INVADERS (tape)	£12.00
APPLE PILOT (language) disc	£30.00
VISICALS (disc)	£105.00
CCA DATABASE (links to Visicalc)	£60.00
(H) SARGON II Chess (tape)	£20.00
(H) MICROCHESS Disc	£17.00
(H) MICROCHESS Tape	£12.00
THREE MILE ISLAND (simulation) disc	£24.00
ENGINEERING MATHS tape	£9.00
(H) WILDERNESS CAMPAIGN tape Integer	£9.00
(H) WILDERNESS CAMPAIGN disc Integer	£11.00
(H) DUNGEON CAMPAIGN tape Integer	£7.50
(H) DUNGEON CAMPAIGN disc Integer	£9.00
(H) HIGHER GRAPHICS Integer disc	£15.00
(H) AUTOSHAPE II Hires shape maker disc (A)	£25.00
(H) APPLE COLLISION (Arcade style race) disc	£10.00
(H) APPLE 21 (blackjack) Integer tape	£6.00
(H) TEMPLES OF APSHAI Adventure tape	£15.00
(H) TEMPLES OF APSHAI Adventure disc	£26.00
ADVENTURE disc (4 Adventures)	£28.00
SCOTT ADAMS' ADVENTURES (each) tape	£10.00
WIZARD'S MOUNTAIN Adventure (disc) (A)	£11.00
BLANK DISCETTES (10) (guaranteed)	£24.00
APPLE DISC TUTORIAL	£34.50
STOCKLOCK Stock Control system	£80.00
SUPER MAIL LIST	£57.00
AIDES Data Base Utility	£140.00
DISC TEXT COPIER — copies any disc file	£15.00

SEND FOR OUR
NEW FREE
CATALOGUE
FOR THE:
APPLE
TRS 80
SORCERER
& PET

All previous programs
are still available.

We have the *LARGEST*
selection of software
in Britain *and* at the
LOWEST prices.

We now stock books
and magazines.

Name

Address

.....

.....

.....

enclosed

Please add 50p.

for orders

under £15.00

P.O /Cheque/Access

For Access:

Card No.

Expiry date

Signature

PROGRAMMERS: We pay 15% royalty and URGENTLY need new business and utility programs, adventures, and graphic games.

HARD COPY!
HARD COPY!
HARD COPY!
HARD COPY!
HARD COPY!
HARD COPY!
HARD COPY!
HARD COPY!
HARD COPY!
HARD COPY!
HARD COPY!
HARD COPY!
HARD COPY!
HARD COPY!
HARD COPY!
HARD COPY!
HARD COPY!
HARD COPY!
HARD COPY!
HARD COPY!
HARD COPY!
HARD COPY!
HARD COPY!
HARD COPY!
HARD COPY!
HARD COPY!
HARD COPY!
HARD COPY!
HARD COPY!
HARD COPY!
HARD COPY!
HARD COPY!
HARD COPY!
HARD COPY!
HARD COPY!
HARD COPY!
HARD COPY!
HARD COPY!
HARD COPY!
HARD COPY!

A new approach to hard copy

A main printer for micro-computers.
A second printer for minis.
Fully programmable with own memory.
The most versatile 96 column printer you've seen.
New from Weyfringe.

Meets so many applications

Century prints invoices, statements, and ledger accounts for business routines. Takes care of data-logging for systems linked to process control and instrumentation. Century accepts friction-fed single A4 sheets, sprocket fed continuous stationery, even tally rolls.

Century has all the features

You'll need the literature to appreciate just how much care has gone into Century's design; to see the options that come with a fully programmable printer. Clip the coupon for your free copy of the Century literature and compare performance with any printer you've ever thought about.

Technical outline

Available now as a receive-only terminal.
Out soon as keyboard send-receive model.
Continuously self-diagnostic.
112 CPS nominal throughput rate; bi-directional.
Baud rates up to 9K6.
Condensed print feature (up to 132 columns on A4).
Interface flexibility - RS 232, parallel centronics etc.

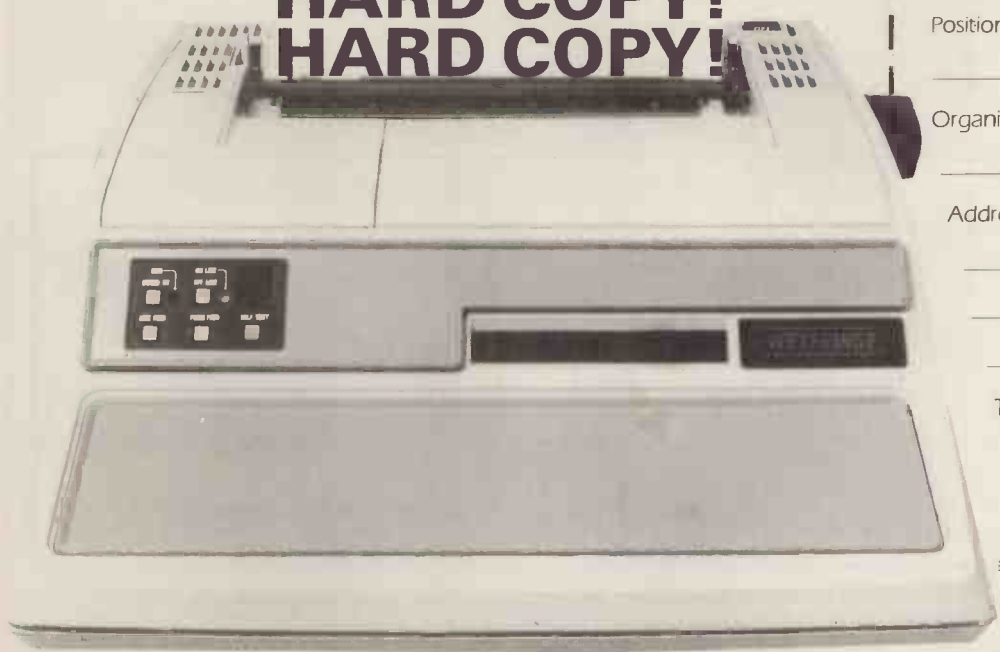

Please send me full details on the Weyfringe Century printer. PCW 80

Name _____

Position _____

Organisation _____

Address _____

Tel No. _____

Weyfringe Ltd
Longbeck Road, Marske, Redcar,
Cleveland TS11 6HQ.
Tel: (0642) 470121



DOLPHIN BD-80P

NOW AVAILABLE EX STOCK FROM



**micro
BITS**

end
user
£525

DEALER ENQUIRIES INVITED

- ★ 125 CHARACTERS PER SECOND
- ★ 80 CHARACTERS PER LINE
- ★ BI-DIRECTIONAL PRINTING
- ★ INTERNAL 9-LINE BUFFER
- ★ COMES COMPLETE WITH ANY ONE OF THREE PLUG IN INTERFACES.
 - 1) RS 232C + 20mA CURRENT LOOP
 - 2) IEEE for the PET
 - 3) PARALLEL

The many advanced features are summarised in the following specification:

- 9 x 7 dot matrix
- 10 Characters per inch
- 6 lines per inch
- Full ASC 11 96-Character set
- 750 Character buffer
- Continuous duty print head
- 64 Graphic Characters 11 x 7 matrix
- 10 user Definable Characters
- Double width characters
- 10 lines per second paper advance
- Adjustable sprocket feed
- Original and up to two copies
- Horizontal and vertical tabs
- Self test
- 132 characters per line optional
- Complies with V.D.E. 0875 electrical noise regulations to medical standards
- Quiet operation

**micro
BITS**

CRAYWORTH (Computer Services) LTD

34b London Road
Blackwater Camberley
Surrey England

Tel: Camberley (0276) 34044
Telex: 858893

open Monday - Friday 9 a.m. - 6 p.m.
Saturday by appointment only
Personal callers welcome.
Please phone first if you require a personal demonstration

MICROCOMPUTER SYSTEMS & PERIPHERALS

ZILOG; CROMEMCO; NORTH-STAR; EXIDY.
Elbit, Lear Siegler & Hazeltine VDU's.
NEC Spinwriter printer.

Software and Consultancy.

We can offer a wide range of well proven software for our entire range of computers, from languages through to Commercial Accounting Systems, Payroll and Stock Control.

Full Consultancy, Programming and Prototype Hardware Design are our speciality.

NEWBURY NEWBURY NEWBURY

Smart Micro-based Visual Display Terminals

24 lines of
80 characters
per line. 96 ISO/ASCII
character set. Dual interface -
CCITT V24 and 20/60 mA
current loop. Selectable half or full
duplex. Green phosphor non glare display.

Hard copy print out
Numeric pad
Video output for external monitors

7000



7002

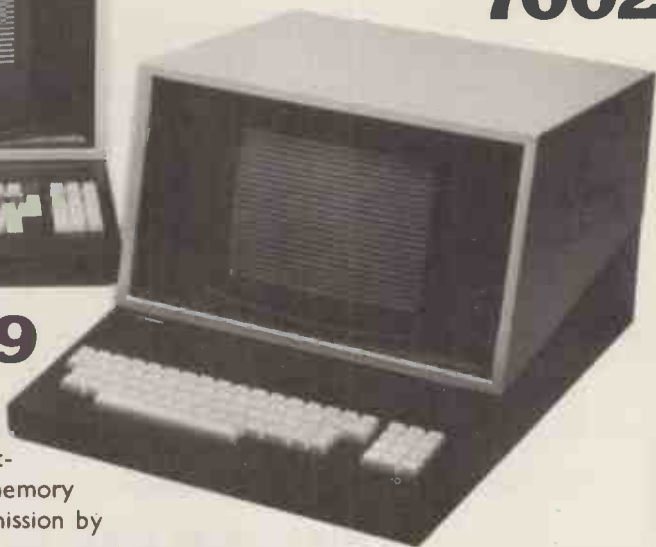

7007/9

Full key-
board edit-
ing features. Addi-
tional 6 pages of memory
(7009). Block transmission by
line or page.

Matrix Printer



125 cps
printing speed
CCITT V24 (RS232)
interface
80-132 characters per line

from **£460***

Prices from

£495*

Emulations:

APL, DEC VT52, ICL 7181 Honeywell
VIP 7006 & 7250

*Prices inclusive of delivery in UK and cables
ready to plug in.

Free standing

Monitor



NEWBURY LABORATORIES LTD

Head Office & Sales:
King Street, Odiham, Hampshire RG25 1NN
Tel: 025-671 2910 Telex: 858815

Sales and Service:

North East Tel: York (0904) 412043
North West Tel: Stockport 061-491 0134
Midlands Tel: Birmingham 021-707 7170
East Anglia Tel: 0223 64862

THE BEST OF BOTH WORLDS!



We are appointed distributors for:

QUME Sprint 5

daisywheel impact printers, Britain's most advanced letter quality terminal. 45 and 55 cps options on read-only and keyboard models. OEM or end user sales and all supplies and accessories available ex-stock.



FACIT 4520/21

dot matrix printers. A new family of 80.col/100cps and 132.col/150.cps matrix machines. High quality and *very* appealing prices. These new FACIT machines are among the quietest matrix printers around. And all supplies and accessories are available ex-stock.

We are also developing three small business systems with full software back-up ranging in price from £2,000 to £25,000. And our service support, as users of our equipment will testify, is second to none.

IF YOU WANT PERFORMANCE AND RELIABILITY FROM YOUR SYSTEM OR PERIPHERALS . . . IT'S AS SIMPLE AS ADC.

access data communications ltd.

Access Data Communications Ltd., 228, High Street, Uxbridge, Middlesex.

Telephone: North - Hull (0482) 659165: South - Uxbridge (0895) 30831 or 59205.



Dyad Developments are pleased to announce that they have been appointed UK Distributors of

COMPUCOLOR II

The Compucolor Corp. are now supplying them with their up to date systems and these have been found to be exceptional in performance and reliability. These second generation machines represent the most sophisticated and powerful small computers available today and at only half the cost of their counterparts.

WHAT YOU GET

13" colour video monitor
Built in disc drive RS232C port, selectable Bdr
High resolution graphics
Two character sizes
Extended Basic with DOS
Vector plotting
And much more

Typical Prices

8K	User RAM	£ 998
16K	" "	1078
32K	" "	1198
	Additional Disc Drive	310
	Soundware (music)	30
	Assembler	15
	Text Editor	15

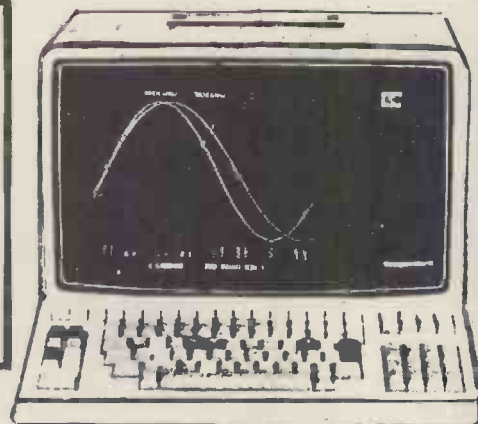

DEALER INQUIRIES WELCOMED prices excl. VAT

The Priory - Great Milton - Oxon - OX9 7PB - Tel (08446) 729

ENTER THE COMPUTER AGE

**NOW
TO WIN A TRIP
TO HONG KONG**
See your dealer for
details



See it at the following dealers

VIDEO GENIE SYSTEM £425 inc VAT

3 Line Computing
Hull 445496

Advance Television Services
ShIPLEY 585333

Amateur Radio Shop
Huddersfield 20774

Bredhurst Electronics
Handcross 400786

Briers Polytechnic Bookshop
Middlesbrough 242017

Buss Stop
Watford 40698
Newport Pagnell 610625

Cambridge Microcomputers Ltd
Cambridge 314666

Catronics Limited
Wallington 01 669 6700/1

Cavern Electronics
Milton Keynes 314925

Computer Business Systems
Lytham 730033

Computerama Limited
Bath 28819

Computopia Limited
Leighton Buzzard 376600

Computer and Chips
St Andrews 72569

Derwent Radio
Scarborough 65996

Eiron Computers Limited
Dublin 808575/805045

Eley Electronics
Leicester 871522

Gemsoft
Woking 22881

Leisuretronics
Blackpool 27091

Marton Microcomputer Services
Northampton 890661

Matrix Computer Systems Limited
Beckeatham 01 658 7508/7551

Microdigital Limited
Liverpool 227 2535

Midland Microcomputers
Nottingham 298281

Microtime Products Limited
Watford 38423
Basingstole 56417

Mighty Micro Limited
Burnley 32209/53629

MRS Communications
Cardiff 616936/7

Optelco
Rayleigh 774089

Route 66
New Cross 01 732 8608

SMG Microcomputers
Frasersend 55813

Tryfan Computers
Bangor 52042

University Radio
Nottingham 45466

Ward Electronics
Birmingham 021 554 0708

SOLE IMPORTERS

LOWE ELECTRONICS

BENTLEY BRIDGE
CHESTERFIELD Rd.
MATLOCK
DERBYSHIRE DE4 5LE

Trade Enquiries Welcome



TAP THE ALTERNATIVE

PET SOFTWARE

BUSINESS

EDUCATION

PERSONAL

TAP modular software will provide a solution for your Text and Address Processing applications.

Our brochure will tell you how.

Write or telephone for one today

We Offer

- * WPS Word Processing System £85
- * MAS Membership Accounting System £75
- * PRS Personell Record System £70
- * MLS Mailing System £45

Your Invoice

- For any combination of above no greater than:-
- * TBS TAP Business System £125

For Less Specific Applications

- * TAP Text and Address Processor
£20 Tape version
£40 Disc Seq. files.
£65 Disc Random Access

For School P.T.A's

- * SLS Small Lottery System £45

9 Massey Ave., Hartford. Cheshire CW8 1RF
Tel: 0606 76265



HARTFORD SOFTWARE



WHYMARK 801 Printer



WHYMARK 801 PRINTER

A plain paper, programmable, intelligent printer. Up to 150 columns, bi-directional: print speed of 71 lines per minute. Proportional spacing for upper and lower case letters with PET graphics plus 10 special graph plotting characters. Designed and manufactured by Whymark Instruments for quiet and reliable operation. Will link directly with the PET IEEE 488, Centronics, RS 232/V24 at 75-9600 band.

End User Price £750.

WHYMARK INSTRUMENTS LTD.

6, Holmesdale Road, Reigate, Surrey, RH2 0BQ.
Telex 945389.

Telephone Sales Office Ringwood 04254 77012

FOR A CHOICE OF PRINTERS CONTACT DACOLL



Centronics 730, 702, 703 6000 series.
Keyboard or Receive Only Teleprinters.
Models available ex stock.
U.K. wide maintenance.

DACOLL ENGINEERING SERVICES LIMITED

DACOLL HOUSE
GARDENERS LANE
BATHGATE
WEST LOTHIAN
SCOTLAND
0506 56565



DACOLL-BRINGING YOU BETTER COMPUTING

Test run the Pragma printers



INSTALLED PRICE FROM £2,864

Do a trial run on the Pragma printer of your choice and find out what price/performance is all about. The range includes three machines, operating at speeds of 150, 300 and 600 lpm respectively. They each feature 9 x 7 matrices and produce superior print quality up to 7 copies. Double height characters are standard, there is a wide choice of special characters, and 6 or 8 lines per inch spacing is interface selectable.

All printers employ a simple moving shuttle print mechanism, which substantially reduces the number of moving parts and greatly increases machine reliability and life. In addition, all three machines do a superb job on producing bar codes, special OCR characters, labels and special logos in a variety of sizes and styles. The machines also feature a plot mode, which produces high quality plotting in multiple copies.

All our printers are available with a variety of options, special features and are compatible with RS232, Centronics, Dataproducts, PDP11, DG and Versatec. Most machines are available from stock to 30 days delivery, and we're ready to arrange a demonstration or evaluation on your site with your system.

pragma limited

Middlesex House 29 High Street
Edgware Middlesex HA8 7UU England
Telephone: 01-952 8471 Telex: 922625



Small
Systems
Engineering
Limited

IEEE-488/PET INTERFACES

NEW ...

TYPE B200 Bi-directional serial interface

£186

C.B.M. Disk compatible, software selectable Baud rates, switchable code conversion, RS 232C input and output handshake.

Type C

£120

Serial interface - output only
PET disk, compatible, RS232 C Handshake (Printer Busy), switch selectable Baud rates, Listen Address link selectable.

All type C interfaces now incorporate switchable code conversion to match print to PET screen display.

Type G.P.I. A.P.

£249

Micro-based, bidirectional with buffering. The General Purpose Interface allows free use of PET's INPUT # statement without hangup problems. Software changeable BAUD rates optional features include: Second Serial I.O. Port, 20 mA Loop I.O.

Addressable parallel (disc compatible) for Centronics, Anadex etc.

£106

Also available with switchable code conversion.

Non addressable parallel

£45

TV/Video monitor interface

£35

Pet Memory Expansion Boards internally mounted.

24K

£328

32K

£432

S100 BOARDS

Dynamic Memory Boards

IEEE-S100 Specification Timing
Transparent on Board Refresh
4Mhz Z80 Operation with no wait states.
Fully tested and Burned In
Bank Select versions available -
North Star, Cromemco and Alpha Micro
I.O. Port Bank select
Bank Size to 64K in 16K increments

Size	Standard	Bank Select
64K	£449	£595
48K	£398	£539
32K	£346	£483

P&T IEEE-488 Interface

Provides S100 computers with IEEE-488 Controller, Listener, Talker, Capability

£350

SOFTWARE

PETE PET intelligent terminal package

£200

NEW ...

BISYNC 80

IBM 3780 emulation software for CPM Micros

£425

Please note our new address and phone number!

24 Canfield Place, London, NW6 3BT

Telephone: 01 328 7145/6 Telex 8813085 (Abecus)



**60 CHARACTERS PER SECOND
RICOH RP-1600 THE FASTEST DAISY
WHEEL PRINTER. £1320**

FAST, heavy duty commercial DAISY WHEEL printer, with high quality printout, coupled with low noise necessary for office environment. Nationwide service by NEXOS. 90 day warranty provided at your premises.
124 char: upper/lower case. • 10/12 chars: per inch giving 126 or 163 columns. • 15 inch wide frintion platen. • /reverse Top of the form, BOLDING, underline, and host of other features. • Centronics type parallel interface as standard.
options: serial interface 60 • PET interface 65 • APPLE interface 75.



**OKI MICROLINE 80/132. THE QUIET
PRINTER YOU CAN LIVE WITH £495**

THE QUIETEST DOT MATRIX AVAILABLE. 40, 80, OR 132 COLS PER LINE • EXCELLENT PRINT QUALITY • 3 WAY PAPER HANDLING: LETTERHEADS, FANFOLD, OR PAPER ROLLS • GRAPHICS • IDEAL FOR SOFTWARE WRITTEN FOR LARGE 132 COL PRINTERS • CONTINUOUS RATING PRINTING DAY IN AND DAY OUT • CENTRONICS PARALLEL STANDARD. OPTIONS: RS-232, PET, APPLE. DEALER ENQUIRIES INVITED

NEW MAXI ANADEX WITH GRAPHICS £895

Takes up to 13.5 inch wide paper • Upper/lower case with decenders • £ sign • 132 or 175 chrs/line with double width printing • Fast 150 CPS bi-directional logic seeking printing • Heavy duty print head giving 650 million chrs print life • serial, Parallel and Current Loop interfaces built in • Host of other features found on printers costing twice as much.



EPSON TX-80 £395

DOT-MATRIX PRINTER PET GRAPHICS. PRINTS 80 COLUMNS ON PLAIN RAPER AT 90 CHARACTERS/SECOND. ADJUSTABLE TRACTOR • UPPER/LOWER CASE • DOUBLE WIDTH PRINTING • MICRO CONTROLLED • SELF TEST • HEAVY DUTY PRINT HEAD USING JEWELL BEARINGS FOR LONG LIFE • MADE BY SHINSHU SEIKI AN AFFILIATE OF SEIKO WATCH CO OF JAPAN. INTERFACE: CENTRONICS PARALLEL, OPTIONS: PET, APPLE, AND SERIAL.



ANADEX DP-8000 NEW LOW PRICE £475

FAST 112 CHARACTERS PER SECOND • BOTH RS-232, AND CENTRONICS PARALLEL INTERFACES BUILT IN • UPPER/LOWER CASE WITH £ SIGN



**NEW TRS-80 MODEL 1 48K SYSTEM
WITH DUAL DISC DRIVES. £1250**

NEW GREENSCREEN VDU, WITH ROCK STEADY DISPLAY, REDESIGNED 32K EXPANSION INTRFACE WITH TROUBLE FREE DISC OPERATION, TWO 40 TRACK TEAC DISC DRIVES, COMPLETE WITH CABLES.
TRIDATA SALES, PURCHASE, INVOICING, PAYROLL PACKAGES AVAILABLE.

WITH DESK AND EPSON PRINTER £1750

NEW SUPER BRAIN DUEL DENSITY £1875/QUAD

DENSITY £2250

NOW WITH CP/M 2.2, & INCREASED DISC STORAGE. TWIN Z80-A 1MHZ • 2 DISC DRIVES, DUAL DENSITY 320 K QUAD DENSITY 700 K STORAGE • 64 K RAM • HIGH RESOLUTION 12 INCH CRT. 80 x 24 LINES UPPER/LOWER CASE • 2 RS-232 PRINTER PORTS • CPM 2.2 OPERATING SYSTEM • MBASIC, COBOL, FORTRAN, PASCAL, WORD PROCESSING & ACCOUNTS PACKAGES AVAILABLE. DEALER ENQUIRIES INVITED



TRS-80 MODEL £1999



STATE OF THE ART SECOND GENERATION COMPUTER. OVER 10,000 ALREADY SOLD IN USA. 8 SLOT BUS ENSURES EXPANSION OF HARD DISCS & OTHER PERIPHERALS. 76 Key professional keyboard, self test on POWER UP. TRSDOS & LEVEL III BASIC STANDARD. CP/M AVAILABLE AS OPTION, making a wide range of accounting, educational, scientific & word processing packages instantly usable. NATIONWIDE SERVICE THROUGH 180 TANDY STORES & COMPUTER CENTRES.

LOW COST WORD PROCESSOR I

BASED ON TRS-80 LEVEL 2 16K, CASSETTE RECORDER, ELECTRIC PENCIL SOFTWARE, UPPER/LOWER CASE MOD, PRINTER INTERFACE AND OKI DOT MATRIX PRINTER. COMPLETE READY TO GO £1095. FREE MAILING LIST PROGRAM. WORD PROCESSOR II SAME AS ABOVE BUT WITH 48K, 2 DISC DRIVES AND RICOH DAISY WHEEL PRINTER £2575

WORD PROCESSOR III

BASED ON SUPERBRAIN COMPUTER SHOWN ABOVE. WITH RICOH PRINTER & "MAGIC WAND" THE ULTIMATE IN WORD PROCESSING. LETTERS AUTOMATICALLY FORMATTED WITH ADDRESSES FETCHED FROM SEPARATE FILE. COMPLETE SYSTEM £3395 INVOICING, STOCKCONTROL, SALES LEDGER, PURCHASE LEDGER, PAYROLL AVAILABLE FOR ABOVE COMPUTERS. FROM £250 PER PACKAGE.

PRICES QUOTED ABOVE DO NOT INCLUDE VAT. PHONE OR CALL FOR FURTHER DETAILS OR DEMONSTRATIONS.

LONDON COMPUTER CENTRE LIMITED

**43, GRAFTON WAY, OFF TOTTENHAM COURT ROAD, LONDON W1
TEL: 01-388 5721 OPENING HRS: 11-7 MON-FRI, 12-4 SATS.**

MICRO SYS LTD
58 HIGH STREET
PRESCOTT
MERSEYSIDE TEL: 051 426 7271

NOTHERN DEALERS

HORIZON SOFTWARE LTD
REGENT HOUSE
16 WEST WALK
LEICESTER LE1 7NG TEL: 0533 556550

VECTOR GRAPHIC COMPLETE

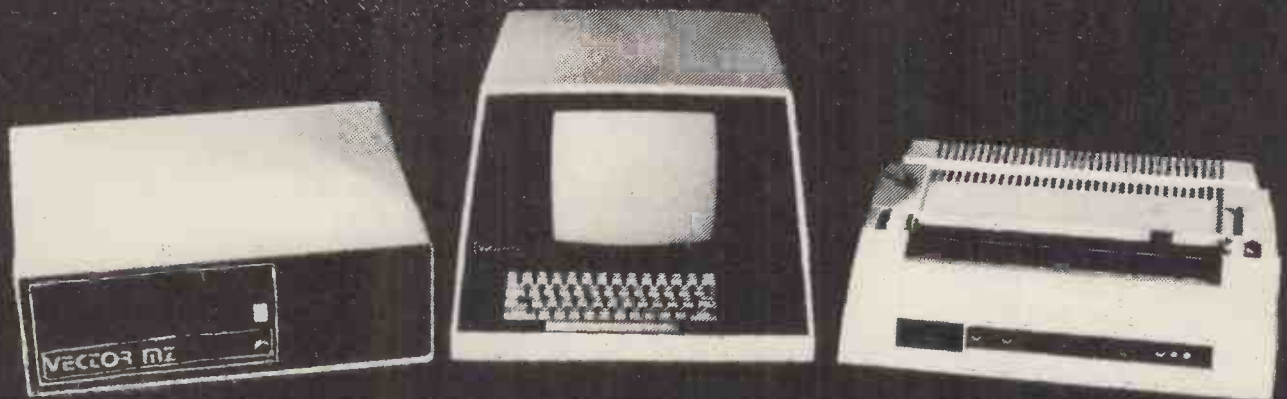

Micro-computers for research, laboratory work, word processing, business systems, Schools, Colleges, Universities and Industry. At Almarc, when you buy Vector Graphic Micro-computers, you get Almarc's experience of over 200 systems installed throughout the U.K. and their back-up of full service facilities carried out by experienced staff. Plus an ever growing list of compatible software including:
Pascal, Fortran, Cobol, APL, Algol, C Basic Compiler, etc.

Vector MZ Spec

- ★ 56K Bank Selectable Ram.
- ★ 3 Serial Ports, 2 Parallel Ports.
- ★ Twin Disc Drives, 630K Capacity.
- ★ 280 CPU, with Fast 4MHZ Clock.
- ★ Prom Programmer (2708).
- ★ Interrupt Handling on I/O Board.
- ★ 18 slot Motherboard.

Vector System B

- ★ Vector Mindless Terminal.
 - ★ Flashwriter II Video Board (24 × 80).
 - ★ MDOS + CP/M2 Operating System.
- Plus Microsoft Version, 5 basic options.
Plus many S100 Bus add-ons, such as Extra Memory, A/D-D/A Boards, High Resolution Graphic, etc.

We will be pleased to demonstrate any of the Vector Graphic Systems, please contact:

ALMARC
DATA SYSTEMS LTD

906 Woodborough Road, Nottingham. Telephone: (0602) 625035

Specialists in Vector Graphic Equipment.

SEE US AT THE
'ONLINE' MICRO SHOW, WEMBLEY
JULY 22nd to 24th
STAND No. 23

Periflexible to suit your requirements



PERIFLEX 0/0 and 5 1/4" SYSTEMS

PERIFLEX 0/0

19 slot mother chassis to accept S100 cards, includes case, PSU and fan.
£420.00

PERIFLEX 00/16

16K static RAM, 4MZ Z80 CPU, 2 serial 3 parallel I/O ports, 2K PROM, 19 slot S100 Motherboard.
£975.00

PERIFLEX 630/32

32K static RAM, 4MZ Z80 CPU, 2 serial 3 parallel I/O ports, 2K PROM, dual 5 1/4" Micropolis drives, 620K storage, 9 slot S100 Motherboard, CPM/MDOS operating system.
£2080.00

PERIFLEX 630/48

As 630/32 but with 48K static RAM.
£2300.00

PERIFLEX 8" SYSTEMS

PERIFLEX 1024/32

32K static RAM, 4MZ Z80 CPU, dual 1.2 Mbyte 8" floppies, 2 serial 3 parallel I/O ports, 2K PROM, CPM operating system.
£2660.00

PERIFLEX 1024/48

As 1024/32 but with 48K static RAM.
£2880.00

PERIFLEX 1024/64

As 1024/32 but with 64K static RAM.
£3100.00

OPTIONAL EXTRAS

Wide range of Micropolis 5 1/4" drives available ex-stock for S100 SYSTEMS, TANDY, SORCERER, etc. Various types of VDUs and printers, and a wide range of applications software readily available.

OEM & S100 WINCHESTER DISKS

Micropolis 8" 6.2M to 31M hard disks available shortly complemented by our own PEREX cartridge back-up.

STOP PRESS — Micropolis have just announced a double sided 5 1/4" floppy disk drive with a fantastic 630K storage (formatted).

VECTOR GRAPHIC

MZ 56K Z80 4MZ with 630K twin micropolis disk drives £2645.00
SYSTEM B as MZ but with mindless terminal £3220.00

LOW COST GRAPHICS

A4 digital plotter £695.00
11" x 11" digitiser £555.00
Both complete with RS232C interface.

FOR FURTHER DETAILS AND DELIVERY CONTACT US TODAY!

Periflex computers
Micropolis 5 1/4" disks
Vector Graphic computers
Micropolis hard disks

OFFICIAL SINTROM DEALERS

AMBIT INTERNATIONAL Brentwood, Essex 0277 230909	OPTRONICS Twickenham, Middx 01 892 8455
ELECTRON SYSTEMS Sandy, Beds 0767 81195	RESEARCH RESOURCES Welwyn Garden City, Herts 07073 26633
GPW LTD Portsmouth, Hants 0329 285731	B. WHITTAKER LTD Crowborough, Sussex 08926 4462
MICROBITS Camberley, Surrey 0276 34044	
MIDAS Seyling, Sussex 0903 813913	
M&R SYSTEMS Wisbeck, Cambs 0945 5900	



**Sintrom
Electronics**

Sintrom Electronics Ltd
Arkwright Road, Reading,
Berks RG2 0LS
Tel: Reading (0734) 85464
Telex: 847395



**VERY COMPETITIVE TERMS
AVAILABLE FOR
DEALERS &
OEMs**

ALTOS

The ALTOS ACS 8000 range of business/scientific micro computers creates a new standard in quality and reliability in high technology micro computers.

High Technology

Floppy Disk System The ACS 8000 single board Z80 floppy disk based micro computer utilises the ultra reliable Shugart 8 inch, IBM compatible, disc drives, double density — single sided, and providing 1 M. byte of data storage. Featuring the ultimate in high technology hardware: a fast 4 MHz Z80 CPU, 65 kilobytes of 16 K dynamic RAM, 1 kilobyte of 2708 EPROM, an AMD 9511 floating point processor (OPTIONAL) a Western Digital floppy disc controller, a Z80 direct memory access (OPTIONAL), Z80 parallel and serial I/O two serial RS232 ports, 1 parallel port and a Z80 CTC Programmable Counter/Timer (real time clock). In essence, the best in integrated circuit technology.

Hard Disk/Multi User Systems The Winchester hard disk/multi user systems are now available supporting up to 4 simultaneous users and providing a maximum of 58 Megabytes of hard disk data storage.

The systems are truly flexible and allow expansion of the ALTOS floppy disk system to keep pace with the users requirements.

Still single board, features include * a high speed I/O section with up to six serial ports and one 8 bit Parallel port * up to 208K of on board RAM.

* High speed (4 MHz) D.M.A. control as standard.

Yes, mini power and at micro cost too.

Built-in Reliability

The ACS 8000 range are true single board micro computers making them extremely reliable and maintainable. All electronics are socketed for quick replacement. Complete diagnostic utility software for drives and memory is provided.

The board and Shugart floppy disk drives are easily accessible and can be removed in less than ten minutes.

Quality Software

Unlimited versatility. The ACS 8000 range support the widely accepted CP/M and MP/M operating systems plus basic (Microsoft and CBasic), Cobol, Pascal, and Fortran IV. All available now.

Logitek in conjunction with its own microsoftware house, Interface Software Ltd. of Camberley are able to supply a wide range of proven 'off the shelf' business software including general accounting, word processing, stock control, mailing list etc.

There are already over 1000 micro computer installations using this software.

A track record which we consider speaks for itself. Why re-invent the wheel when there is standard software of this quality available now?

After Sales Support

Logitek are supported by DDT Maintenance Ltd. who provide a nationwide field maintenance service for ALTOS products and offer the option of maintenance contracts.

Availability

Logitek carry deep shelf stocks of ALTOS hardware and compatible peripherals.

If you are a dealer who may be interested in promoting ALTOS and/or Interface Software by joining the fast growing network of approved suppliers, contact Logitek.

We can offer you something rather special now.

Approved Dealers

SCOTLAND: Aethrotol Consultancy Services, Tel: 041-641-7758/9. Robox Ltd., Tel: 041-221-5401. Peter MacNaughton and Associates, Tel: 073-888-267.
NORTH EAST AND YORKSHIRE: Shermac Computers, Ltd., Tel: 0632-837405. Monitor (Data Processing) Ltd., Tel: 0423-60670. Metrodata, Tel: 0532-623788.
Derwent Electronics Ltd., Tel: 0904-53990. Sheffield Computer Centre, Tel: 0742-53519. NORTH WEST: Computer Business Systems, Tel: 0253-730033.
Minicom Business Machines, Tel: Kirkham 686617. B & B Computers Ltd., Tel: Bolton 26644. Kewill Systems Ltd., Tel: 0706-44337.
MIDLANDS: East Midlands Computer Services, Tel: 0602 267079. Evans Jackson, Tel: 0522-30371. Microspecific, Tel: 0572-2528.
Saba Computer Systems Ltd., Tel: 021-643-2021. CLE-COM, Tel: 021-444-3618 or 021-472-8233. SOUTH WEST: Validata Services, Tel: 0225-705957.
Opco Ltd., Tel: 0285-75225. BEDFORD: Starwest Computer Services, Tel: 0234-57135.
SOUTH EAST INCL. LONDON: Boyd Microsystems Ltd., Tel: 01-950-0303. Computer Systems Analysis, Tel: 02813-85389. Silicon Chip, Tel: 0753-70639.
Micro Market, Tel: 01-979-9824. Systematika, Tel: 01-485-3634. Logic Box, Ltd Tel: 01-222-1122. Profac Computer Services Ltd., Tel: 0276-25247.
Kewill Systems Ltd., Tel: 09322-22448. Action Computer Services Ltd., Tel: 01-502-1311. EAST ANGLIA: Proloc Computer Services Ltd., Tel: 0502-714038.
SOUTH: Software Development Services, Tel: 0962-68956. Wendmore Management Services Ltd., Tel: 04895-6318.
CHANNEL ISLANDS: Jersey European Airways, Tel: 0534-44171.

LOGITEK

LOGITEK, E.I.C. Electronics Ltd. All enquiries to: Portland St. Chorley, Lancs. Tel: 02572-66803
also at: 30 Kelvin Ave., Hillington Industrial Estate, Glasgow, G52 4LH.



COMPUTER WAREHOUSE

NOW OPEN
MONDAY-SATURDAY
9.30-5.30

THE CHIPS ARE DOWN
MOSTEK, INTEL, NEC, MOTOROLA
I.C. PRICES SLASHED!

A massive purchase of brand new "state of the art" data processing equipment enables us to offer the following chips at never, and we mean never to be repeated prices.

8085A-2	Central Processor	£11.99
8155C	256x8 Static Ram	£8.95
8253C	Programmable Interval Timer	£8.95
8255A	Programmable Peripheral Interface	£9.95
8259A-8	Programmable Interrupt Control	£4.75
8755A	2Kx8 Eprom 16 1/0 Lines	£34.50
2716	5volt Single Rail 2Kx8 Eprom	£10.25
2708	1Kx8 Eprom	£4.95
4116	16K Dynamic 250ns Rams 8 for	£28.50
2102	1K Static 450ns Rams 8 for	£6.75
1702	256x8 Eprom	£3.75

And Remember All Chip Prices Include V.A.T.

All above I.C.s are brand new or removed from new unused socketed P.C.B.'s. Eproms supplied washed.

All full spec. and guaranteed

DATA DYNAMICS 390 ASCII PRINTERS



ONLY
£135 + CAR + VAT

An advantageous purchase enables us to offer you these superb condition quality printers at a fraction of their original cost. The 390 is a standard Teletype printer housed in a soundproof case. Standard features such as 80 columns, 20ma/RS232 interface and 110 Baud enable direct connection to your M.P.U. Supplied in excellent condition and guaranteed in working order.

SEMICONDUCTOR 'GRAB BAGS'

Amazing value mixed semiconductors, include transistors, digital, linear I.C.'s, triacs, diodes, bridge recs. etc. etc. All devices guaranteed brand new, full spec. with manufacturers markings, fully guaranteed.
50 + BAG £2.95 100 + BAGS £5.15

MUFFIN FANS

Keep your equipment Cool and Reliable with our tested ex-equipment "Muffin Fans" almost silent running and easily mounted. Available in two voltages. 110 V.A.C. £5.05 + pp 65p OR 240v A.C. £8.15 + pp 65p DIMENSIONS 4 1/2" x 4 1/2" x 1 1/2"

ELECTRONIC COMPONENTS & EQUIPMENT
66% DISCOUNT

Due to our massive bulk purchasing programme which enables us to bring you the best possible bargains, we have thousands of I.C.'s, Transistors, Relays, Cap's., P.C.B.'s, Sub-assemblies, Switches, etc. etc. surplus to our requirements. Because we don't have sufficient stocks of any one item to include in our ads., we are packing all these items into the "BARGAIN PARCEL OF A LIFETIME" Thousands of components at giveaway prices! Guaranteed to be worth at least 3 times what you pay plus we always include something from our ads. for unbeatable value!! Sold by weight

2.5kls £ 4.75+pp £1.25 5kls £ 6.75+pp £1.80
10kls £11.75+pp £2.25 20 kls £19.99+pp £4.75

COMPUTER BARGAINS

NORTH STAR HORIZON, 56K Ram, dual double sided, double density floppys, 4 I/O ports, software etc, as new £1850.00.
CASE 16 Bit Processor, 16K Ram, dual 8" floppys V.D.U. etc. running £1250 + VAT.

★ SHUGART SA800 ★
8" Floppy Disk Drives
as new £225.00 + VAT

SUPERVALUE P.C.B. SPECIAL

Another great buy. Board contents include 62 Digital I.C.'s all located in 14 pin D.I.L. sockets. Original cost over £90, our price only £4.95+PP 65p.

OPTO SMASH!

TIL 302/MAN 7 7 segment LED readout common anode direct drive (via resistors) from 7447 £1-10 each
TIL 119/OC72 Darlington opto isolator 3 for £1.00.
TIL305 0.3-7 x 5 matrix LED alphanumeric readouts £3.75 each.
PHOTO TRANSISTOR
Fairchild FPT-100 NPN silicon 30v 25ma. 4 for £1.00.

DISPLAY I.C. AND TRANSISTOR BARGAINS NEVER CHEAPER

All I.C.'s and Transistors by well known manufacturers and fully guaranteed. No fall outs. Comprehensive data on I.C.'s 15p per type.
2N4351 N channel MOS FET.
2N4352 P channel MOS FET.
60p each £1.00 per pair.
HIGH VOLTAGE NPN POWER SWITCHING transistors BVcbo 600v BVceo 500v BVebo 15v 1c 5amps Pc 125 watts HFE 60 typ ft 2.5 mhz ideal invertors, etc. TO3 £1.60 each 4 for £5.40.
BF258 NPN 250v @ 200ma 45p each 3 for £1.08.
I.R. BS801 2.5 amp 100v bridge rec. P.C. mount long leads 35p each 4 for £1.08.
IN4998 4 amp 100v P.C. mount diodes long leads 14p each 10 for £1.10.
LM309K +5v 1.2 amp regulator £1.10 each 6 for £5.35.
AGFA C10 computer grade cassettes complete with library cases 68p each, 10 for £5.50
IN4004 SD4 1 amp 400v diodes 7p each 18 for £1.00.
I.R. 12 amp BRIDGE RECS. 400 volt £1.25 each.
POWER DARLINGTON SCOPPI!
MJ1000 NPN 60v 90v 8 amps TO3 95p each
2N6385 NPN 80v 100v 10 amps TO3 £1.75 each
MJ4030 NPN 60v 150v 16 amps TO3 £2.25 each

DECADE 0-9 THUMBWHEEL SWITCHES. Stackable, gold plated contacts, dim. 33 x 43 x 8 mm. 90p each, 10 for £5.50.
Miniature Continental Series 12VDC 4c/o plug in relays £1.30 each.
Greenpar 50R BNC Chass. socket single hole fixing 65p
C90 Audio Cassettes screw type construction 45p each 3 for £1.00.
Bulbs 24v 14 watt white frosted S.B.C. 8 for £1.00.
Bulbs 12v 100 watt clear, base similar S.B.C. 45p each.
S.B.C. Bulb Holders All steel cad. plated panel mount easily fixed via nut and round hole, ideal disco displays, scoreboards, etc. 4 for £1.10.
VMOS VMPI Siliconix TO3 power FET 0-60v, DC-200 mhz will drive direct from CMOS etc, £1.50 each, full date 30p.
Heavy Duty Flat Insulated Earth Braid 100-200 amp braided tinned copper in heavy clear PVC sheath 50p per metre. £6 for 15 metres + PP £1 per 15 metres.
BULGIN miniature 6 way male chassis mount socket and matching free plug 60p each, 2 for £1.10.
Red L.E.D.'s full spec. 0.2" 14p each. 10 for £1.25.
Red L.E.D.'s 0.125" 10p each 10 for 80p)
Dynamic Stick Mics 600Ω with built in on/off switch complete with lead and min. jack plug £1.15 each. 10 for £10.00.
TO5 HEATSINKS "Thermaloy" black anodised press on aluminium finned type 18p each. 8 for £1.00.

I.B.M. I/O GOLF BALL TYPEWRITERS

Still the cheapest way to superb quality print, when interfaced they will print at 15 C.P.S. and give indistinguishable copy as if typed by a highly paid secretary! A large range of type fonts make them ideal for all word processor applications, and even without the computer they still function as a quality electric typewriter. Supplied in 2 grades.
1) Good general condition with I/O mechanics/ £295.00 + VAT
electrics may require modification for full correspondence use. Complete with interface data.
2) Serviced, modified, and ready to go via aculab interface complete £355.00 + CARR + vat
ACULAB parallel to IBM inter- £165.00 + CARR
face for Apple, Sorcerer, TRS80, etc. + VAT

BARGAINS GALORE!

In our walk round Warehouse
NOW open Monday to Saturday 9.30-5.30

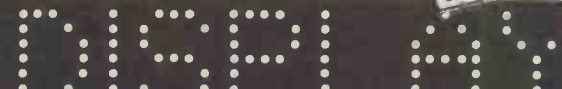

ELECTRONICS

Dept. PCW 64-66 Melfort Rd., Thornton Heath, Surrey. MAIL ORDER
Telephone 01-689 7702 or 01-689 6800 INFORMATION

Unless otherwise stated all prices inclusive of VAT. Cash with order. Minimum order value £2.00. Prices and Postage quoted for UK only. Where post and packing not indicated please add 40p per order. Bona Fide account orders minimum £10.00. Export and trade enquiries welcome. Orders despatched same day where possible. Access and Barclaycard Visa welcome.

In stock now test equipment, microprocessors, teletypes, transformers, power supplies, scopes, sig. gen's, motors, peripheral equipment, I.C.'s, tools, components, variacs, keyboards, transistors, microswitches, V.D.U.'s sub-assemblies + thousands of other stock lines. Just a mere fraction of our vast range, is displayed below. 100's of bargains for callers.

SUPER 77 KEY KEYBOARD KIT

We've done it again! We've purchased a large quantity of C P CLARE top quality keyboard reed switches plus full QWERTY keytop sets and thrown in a PCB to enable you to customise the keys just as YOU want them, just add and wire an encoder chip and you can arrange ASCII, BAUDOT, anything! Adding up to a quality keyboard which would normally cost around £100.00. Supplied with layout and assembly info at only £26.99 + £1.50pp.

HOW TO GET HERE
Victoria, London Bridge or Holborn Viaduct to Thornton Heath 1 minute from Thornton Heath Station.

POWER SUPPLY UNITS

5 VOLT 2.5/8 AMP TTL Made for TTL this compact ex computer systems unit features a 10 amp transformer. DC outputs of 5 volts @ 2.5 amps and 7.5 volts @ 5 amps are available. The 5v output is fully regulated and smoothed with electronic current limiting. May be easily modded for 5 volts @ 7-8 amps. Sold complete with circuit, believed working but untested. £8.25 + £1.60pp.
5 VOLT 3 AMP Ex computer systems, complete on one small chassis, features full regulation and crowbar over voltage protection. £8.50 + pp 80p

PRINTERS

CENTRONICS 101A 132 column Matrix printer, serial/parallel input £525 + VAT
DATA PRODUCTS 300-1100 L.P.M. 80 column Barrel printer, standard T.T.L. parallel interface £650 + VAT
Many other printers available from £45.00

KEYBOARDS

★ **76 KEY ASCII CASED** ★
At last a coded 76 key cased ASCII keyboard at the right price. Housed in an attractive light grey case, this unit was originally made for ICL for use in airport reservation systems so only the BEST parts were used. It has everything, we think, to meet your most exacting requirements, numeric keypad, upper and lower case, cursor controls, single 5 volt rail, serial and parallel data outputs, single eight LEDs mounted on the case. Supplied with circuits, believed brand new, but may have minor scratches on cases.
Only **£43.50** + £1.60pp

★ LOW PRICE CHASSIS ★



A special bulk purchase enables us to offer the above keyboard at a lowest ever price. 49 coded keys encoded into a direct TTL compatible 7 bit output. Features such as delayed strobe, 5 volt D.C. single rail operation and rollover protection make this an absolute must for the MPU constructor! Supplied complete with connection diagram and connector, at a secondhand price of only **£20.00** + P.P. £1.60
SUPER CASED VERSION Same as above spec. but housed in attractive two tone moulded, free standing case. Unit also includes an all TTL parallel to serial converter (no details etc.
£27.50 + P.P. £1.85

TOROIDAL TRANSFORMERS

HP 240v pri. sec. 2 x 30v @ 4 amps 2 x 18v @ 1 amp £11.00 + p.p. £1.95 dimensions 4 1/2" x 2 1/2"
PR 240v pri. sec. 15-0.15 @ 2 amps dimensions 3 1/2" x 2 1/2" £4.95 + p.p. 99p.
TM 240v/110v pri. sec. 15-0.15 8VA dimensions 2 1/2" x 1 1/2" £1.95 + p.p. 30p.
All voltages measured off load.

Plugs, Sockets & Connectors Cannon 'D' Range		
Ways	Plug	Socket
9	£1.03	£1.26
15	£1.17	£2.01
25	£1.72	£2.58
37	£2.35	£4.14
50	£2.90	£5.46

25 way ex-equip. plug or socket £1.25
Edge connectors, gold plated

0.1"DS	85 way	£3.99
0.1"DS	45 way	£2.45
0.15"DS	56 way	£3.25
0.156DS	36 way	£2.00

All connectors easily cut to size
1000's of other connectors ex stock



PET 2001



from £425

commodore authorised dealers

TRS 80



from £365

From Radio Shack Corp.

APPLE II

from £695



authorised dealers

SORCEROR

from £1730



authorised dealers

ADVANCED SYSTEMS



MICROCOMPUTERS ETC

For Hardware, Software, Peripherals, Consultancy and Competitive Prices.



BASIC SYSTEMS

PET 3016 (16K RAM) and large keyboard * £550.00
 PET 3001-6 (PET with 8K memory + integral cassette) * £425.00
 PET 3032 (32K RAM) and large keyboard * £695.00
 PET C2N External Cassette Deck £53.00

ACCESSORIES

IEEE/RS232 Serial Interface 'A' £106.00
 Output only
 IEEE/RS232 Serial Interface 'B' £186.00
 IEEE to IEEE cable £24.00
 Programmers Toolkit - 10 powerful new commands for your Pet - plug in ROM chip 8k and 16k

PET SET 1 16 Channel AD Converter £166.00
 c.w. all interfacing requirements

BASIC SYSTEMS

TRS 80, 4K Level I consisting of Keyboard with 4K memory, Video Unit, Cassette Drive and 240V power supply unit
 TRS 80, 4K Level II (as above with Level II Basic) £499.00

TRS 80, 16K RAM £275.00
 TRS 80, Expansion Interface with 16K RAM £360.00
 TRS 80, 32K RAM £160.00

ACCESSORIES

Radio Shack Phone Modem £40.00
 UHF Modulators (licensed with leads for 625 lines) £345.00
 RAM upgrade (4-16K, 16-32K, 32-48K) supplied and fitted at our premises (Kit £80.00)
 S100 interface for TRS 80 (16 slots) £375.00
 TRS80 CPU 2 speed mod. £26.00

BASIC SYSTEM

Apple II Plus computer - APPLESOFT extended basic in ROM - (16K RAM) - video output £695

ACCESSORIES

Real time clock/calendar card - 1/1000 sec to 388 days with interrupt, software controllable £128.00
 Speechlab - provides voice control for the Apple £127.00
 SuperTalker - adds human speech output £136.00
 ALF Music Synthesizer Card £180.00
 A1-02 Data Acquisition Card £180.00
 Graphics Tablet £462.00
 AC Line Controller £270.00
 RAM Upgrade (16-32K, 32-48K) £69.00
 Hobby Prototype Card £20.00
 Romplus - u./i/c. mixed text/graphics £108.00

BASIC SYSTEMS

Sorcerer (inc UHF Modulator) 16K RAM £730.00
 32K RAM £830.00

ACCESSORIES

Ready Video Disk Unit (High Resolution, monitor with Integral 630K Dual Drive) £1790.00
 CP/M on Disk £145.00

ADVANCED SYSTEMS

TRS 80 Model II with Integral B floppy disk drive and up to 64K RAM. Expandable up to 3 Megabytes Disk Storage (Available for demonstration - by appointment only).
 ACT 800 Systems providing 108K RAM, 48K User RAM, full res screen, high-res graphics, Ultra-fast data access and up to 4.8 MBbytes on-line disk storage

PET BUSINESS SYSTEM

comprising
 TRS 80 3032 Micro computer, CBM 3040 Dual Disk Drive, 48K User RAM, full res screen, high-res graphics, Ultra-fast data access and up to 4.8 MBbytes on-line disk storage

Special Offer!
 Tractor Feed Printer and all cables £895.00

ORDER NOW!

DISKS

PET 3040 (dual drive) 343K User storage * £895.00
 CompuLink (dual drive) 400K storage £895.00
 CompuLink (dual drive) 800K storage £1145.00
 TRS80 3315.00
 Shugart drive £315.00
 Micropops Dual Drive (384K storage) £299.00
 Convus Hard Disk (11mb) £3500.00
 Apple Drive - 118K storage 1st drive £349.00
 Apple Drive - 118K storage 2nd drive £289.00
 Convus Hard Disk (11mb) £3500.00

PRINTERS

Easy 2-Dual Drive (30K, storage) £495.00
 Convus Hard Disk (11mb) £3500.00

PRINTERS

IBM 3022 (80 cps) with PET graphics - tractor feed * £425.00

TRS 80 Screen Printer (text) £345.00
 New Radio Shack Micro Printer £245.00
 Teletype 43 KSR Serial (pin or punch) £825.00
 132 columns - Ink professional printers for microcomputers - high speed (up to 280 cps, upper/lower case) P.O.A.
 OKI - parallel/serial (pin or punch) £499.00
 DOLPHIN B808/P tractor printer (125 cps) £825.00
 bi-directional, 40-80 columns - optional 132, cf case B graphics, Available with Centronics Micro Printer (20, 40) £525.00
 80 cps selectable £395.00
 Health WM 14 serial (80, 96, 132 cps selectable) £475.00
 IBM 3022 (80 cps) with PET graphics P.O.A.
 Teletype 43 KSR Serial (pin or punch) £825.00
 SILENT PRINTER FOR APPLE - allows printing of high res. graphics £349

ETC.

Diskettes 5 1/4 (blank) boxed (min order 10) each £3
 C12 Cassettes (min order 10) each £0.35p
 4 voice operated answering £130.00
 voice operated twin cassette £130.00
 Pace E2-PHONE - Cordless Telephone £225.00
 Hitachi Video Monitors 9" 112" resp. £127/£187
 BOOKS - Large range of microcomputer related terminals

Penland V1, 80 char/24 lines 2 page memory £980.00

PROGRAMMABLE CALCULATORS, TEXAS INSTRUMENTS, Business Programmable Calculators (We are authorised TI dealers)

IF YOU DON'T SEE IT - ASK IF WE HAVE IT

SOFTWARE

PET SOFTWARE authorised dealers - over 160 programmes on cassette and disk. Send for STAGE ONE COMPUTERS/S/W dealers - RETAD, Stock Control, etc. Send for list £16.00
 74 Common BASIC Programs on one tape P.O.A.
 PACT Business Software - Sales and Purchase Ledger, Invoicing, etc. £150.00
CBM DISK-BASED BUSINESS SOFTWARE
 COMWORTH (UCDOS) DRHD IV powerful word processor, low/high levels, £76/£150.00
 COMWORTH (UCDOS) DRHD IV powerful word processor, low/high levels, £76/£150.00
 COMBIS - BUSINESS INFORMATION SYSTEM - Storage & Retrieval of all types of company records £150.00
 COM ACCOUNTS - Full Financial Business Accounting System incl. Sales, Purchase, Nominal Ledgers, monthly/quarterly employees, 650.00
 COMPLANNER - Personal information tool for the busy executive £500.00
 WE are authorised CBM Business Software Dealers! Send for List.
 GO 1011 - Assembler Development System £50.00
 GO 1010 - Lisp Interpretive Language (Artificial Intelligence) £76.00
 CAR INSURANCE QUOTATIONS - computerised car insurance quotation suitable for insurance brokers (TVJ/S/W) £25.00
 TRS 80 IMAGE QUOTATIONS - suitable for agents/mortgage brokers (TVJ/S/W) £25.00
 COMAC III SUITE - computerised accounting for TRS 80 (TVJ SOFTWARE) £75.00
 STOCK CONTROL - complete inventory control - recorder level - P/O's etc. £115.00
 CP/M £95.00
 PORTMAN includes compiler, relocatable assembler text editor and linking loader £195.00
 PASCAL - tomorrow's programming language today in-ter/di-rect, string search block movement, adjustable line length, insert/delete, string search block movement, adjustable line length, £48.00
 ELECTRIC PENCIL - powerful word processor allows full cursor movement, entry, delete, insert and list of records and retrieves data for display or break routine £8.00/£28.00
 RS-2-DISK MONITOR - powerful system manipulates disk data, has Z 80 £150.00
 ST800 communications software £25.00
 NEWDOS - TRS800S with corrections and enhancements £60.00
 BASIC - Screen to print in two steps, DOS commands from LIBRARY 100 - an assortment of 100 programs £39.00
 SARGON CHESS - 16K Level II - the 1979 Champ Version! £14.00

APPLE
 Macintosh 2.0 Chess, Disk U-DRAW II - High Resolution graphics editor. Create a figure then rotate, expand, contract etc and store on disk £18.00
 LISP - programming language suitable for research in artificial intelligence £27.00
 3-MILE ISLAND - Complex disk based game simulating nuclear reactor £52.00
 VISUALC - Instant Visual Calculation - provides a powerful planning and forecasting £27.50
 APPLE WORD PROCESSOR - Complete text editing, storage and retrieval of text (disk based) £95.00
 LITTLE GENIUS - Comprehensive disk based Apple Soft Tutorial £42.00
 ACT AppWare and MOUSE authorised software dealers - Many programs on cassette and disk. Send for list.
 SORCEROR many programs available - send for list.
 Word Processor Rompac Development Pac £70.00

* 5% DISCOUNT ALLOWED FOR EDUCATIONAL ESTABLISHMENTS

T&V JOHNSON (MICROCOMPUTERS ETC) LTD

Member of the TVJ Group of Companies
 149 Cowley Road, Oxford OX4 1JF
 48 Gloucester Road, Bristol BS7 8BH
 (0272) 422061
 (0865) 721461

Hours of business
 Mon-Fri, 9.30 - 5.30
 Sat, 9.00 - 1.30

Directors: Dr. R.V. King BA MBE
 T.S. Johnson BA BSc
 A.S. Barton ACI, CMAA
 (All prices correct at time of compilation)

Prices of goods in TVJ...
 (All prices correct at time of compilation)



Guy Kewney, PCW's newshound, 'paws' his latest cocktail of product news, rumours, gossip and speculation.

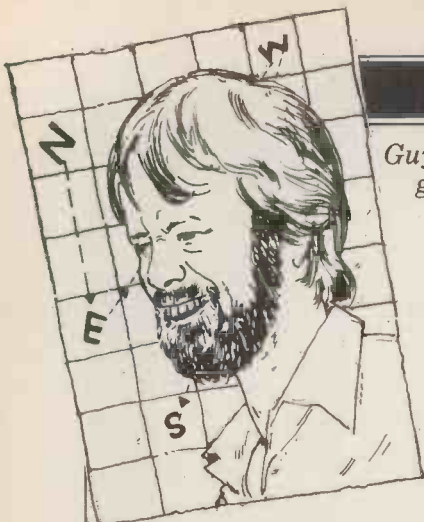

Breaking-in

The way to produce a cheap computer is to put it all on one board, and in one box, a formula followed by the Transam Tuscan.

It's also an S100 computer, which makes it the first such animal. Normally, S100 bus-based computers are described as 'mainframes' because of their apparent similarity to normal computer industry products. They sit in expensive boxes, and have a minimal amount of circuitry on each board, thus requiring the user to buy at least four or five boards to get a working system.

Nigel Stride, director at Transam, claims that the Tuscan includes the equivalent of five boards of 'normal' S100 bus compatible products on one board. This main board will cost £195 plus VAT.

However the really interesting thing about it is that it's aimed to compete directly with large systems built up around PET and Apple — as the following figures, (supplied by Transam) seem to show.

A PET 32k system with dual drives and cables plus a parallel interface would cost £1649. An Apple 32k system with a 16 kbyte expansion memory and similar peripherals would cost £1516. A similar Tandy TRS-80 would come to £1712.

By contrast, the Transam machine would include the standard diskette operating

system, CP/M (only the TRS-80 has CP/M out of the above list, and that's a non-standard version) and the S100 expandability, plus a printer interface included as standard, that all comes to £1505.

The machine will no doubt be reviewed in due course in PCW. It's possible that I will instantly agree with Sue Eisenbach, regular contributor to this publication and director of the Advisory Centre of the South Bank Polytechnic.

Sue said enthusiastically: "This is just what we have been waiting for — a Z80 based, S100 computer for a quarter of the price of a Research Machine 380Z!"

It's also possible that this is one of the last chances for a new machine to break through into the market. As things stand, the Appletandypet stranglehold on the software market is still not complete. It remains difficult to find exactly the software you want for those machines, because there's so much dross about, which has to be filtered through. But it's also possible that breaking the grip which Appletandypet has on the minds of software providers (a big market for the software) will require rather more competitive pricing than that offered by the Tuscan. In particular, the Apple price looks dangerously close, and at the £1,500 level, is £11 worth the risk... even

with integral diskette and CP/M? I'd like to see a little more space between the prices.

Theirs is the glory

The announcement of the Transam Tuscan has been perfectly timed to benefit from the blaze of good publicity for Transam which was given by Commodore.

Commodore has approved, and adopted, Transam Pascal for use on the PET. The reason is simple enough, it's the only version of Pascal small enough to fit into the maximum 32 kbytes of the PET and leave room for a useful user program; it's also portable enough to be put onto the PET quickly and cheaply.

Transam's software subsidiary TCL Software provides the same compiler on a CP/M diskette for £120.

Just in case the full glory of the achievement hasn't struck home, it should be noted that the Commodore adoption of TCL Pascal is not merely for the UK (important though the UK may be, taking some 20% of the world PET sales), it's world-wide. No other software house had done the work needed to get them into a position to take the prize. Details on 01-402 8137.

Plug-in sorcery

The arcade game company Exidy has sold its Sorcerer to another American company called Recortec, and presumably will become the Personal Micro Computers Sorcerer, when Recortec sets up PMC as its operating subsidiary to market it.

The most noticeable thing about the future of the Sorcerer as planned by Recortec is the decision to keep the Rompak.

Rompak is plug-in software, normally only offered on very cheap video games and by Texas Instruments on its 'home' computer.

It has attractions, Ian Litterick pointed out (Litterick is trying to establish a micro National

Computing Centre) because it discourages piracy (nice for the manufacturer) and is quick to load (nice for the user). But it isn't reliable, and it doesn't get into high volume, and, part of the same thing, can't be transferred to other machines.

PMC says it's happy about the Rompak — "We've got the quality problems cleaned up now" — but how convincing a claim this is a matter of judgement. PMC sells the Hong-Kong built Video Genie, a \$500 imitation of the TRS-80. There are some 300,000 TRS-80s out in the field (Radio Shack admits to only 150,000) and some 200 Genies. Perhaps we should save the cheering for a week or two.

Little green Apples

When Apple becomes an Irish computer company, will it mean cheaper computers in Britain?

The question is being most seriously asked by the people who make the alternative version of the Apple II, ITT. Until the two top Apple men — Mike Markkula and Steve Jobs — arrived in London recently to announce the Apple III, the makers of the ITT 2020 thought their future was secure.

It remains possible that Apple is bluffing, in order to get better terms. But the information that Steve Jobs gave me has not been given to ITT direct and that's not the way one starts negotiations when one is anxious to succeed.

The history behind the Apple/ITT deal was, as Jobs put it: "We were a new, struggling company with few resources and they were a big consumer group with manufacturing and marketing ability in Europe. But things have changed."

Indeed they have. The original deal provided ITT with a finite number of Apple II processor boards, which they could adapt to European standards of power and video and market under their own label. When that supply of boards came to an end, the deal would be renegotiated.

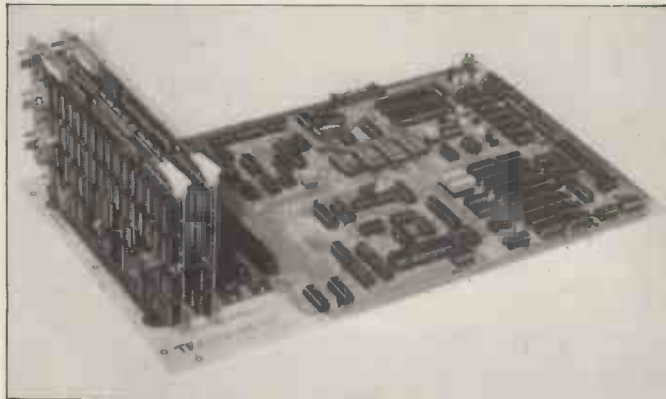

The Transam Tuscan

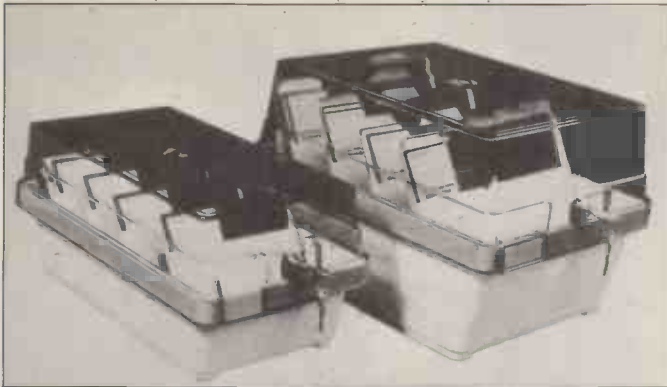

The natural successor to the index-card tray is the diskette box. BFI Electronics of Surrey has introduced a box for each size of diskette, capable of storing up to 70. It has a clear top, non-scratch feet, and internal dividers to allow neat storage of just a few. The boxes are said to be airtight and lockable. Details on 01-941 4066.

According to my calculations, based on hints and nods thrown out by ITT a year or so ago, the supply of Apple boards should have seen ITT through to about now.

According to Steve Jobs, who really ought to know, no further deal has been arranged, and if it is, new terms will apply. And, he said specifically, "ITT will not get the rights to make Apple III."

The Irish plans could mean that Apple has no need of ITT any more. The idea is to start with a factory in Cork, and indeed, advertisements to recruit staff have been running in Eire. (A fat lot of good they are doing, by the way. Everybody knows that the minicomputer giant DEC is building a Cork factory, and nobody knows about Apple's plans because, after all, they were secret. So everyone assumes the adverts are to recruit DEC people).

That hiccup apart, the initial plan is to employ around 150 people in Ireland by the end of this year in what is called a peripherals factory but at which Apple II computers will be built. Eventually all European marketing will be handled from Cork, and some 1,430 people will be employed.

Apart from ITT, another discard of this move will be Eurapple, the independent subsidiary which controlled European distribution from its California base. Apple now seems to share my own unenthusiastic view of this arrangement, and is terminating it.

As for the Apple III, it's more expensive, prettier and has more characters on the screen than the Apple II, plus an integral diskette, and you can also stand your book on the keyboard while typing. For the rest, wait for our bench test later this year.

PET payroll

A payroll program which will run on a PET with either Commodore or CompuLink disk drives is available from

Intex Datalog. It's designed for up to 200 employees, plus 400 ex-employees; some 50 systems have been installed so far, says the maker, and the phone number for details is Eaglescliffe (0642) 781193.

Seek and ye shall find

It was, I think, the late Jean-Paul Sartre who refused to give a young man advice in a ticklish personal and family predicament on the grounds that if he had wanted to be told "stand by your mother," he would have asked a priest and if he had been anxious to be told "abandon home and seduce the wench," he would have asked a soldier friend, and that in asking Sartre, he had shown clearly that he wanted to be told "decide for yourself, don't ask me".

Britain's share in the new chip-making company, Inmos, would appear to be in serious jeopardy, if this logic applies to the visit by Industry Minister Sir Keith Joseph to California.

The Good Knight has had a year or more to decide whether he knew enough about the semiconductor business, and to get basic facts. He could have asked SRI International (and, in fact, he did) and he could have asked MIT in Boston (and he did) and he could have got on the phone to people in California.

The people he actually chose to ask advice from were Intel, through the medium of their publicity organisation, Regis McKenna. Sir Keith is not daft: he knows what Inmos's greatest, established, most profitable rivals would say if asked "Is Inmos a good idea?" He was obviously looking for well-expressed, informed and convincing reasons for changing known personal opinions — which had previously been in favour of letting the NEB have the money, to give to Inmos.

Success elevates - like hot air

Commodore, the ex-calculator company which makes the PET, has had a personality reshuffle, with a lot of the company's top marketing people bowing out.

The change should affect American more than British PET buyers, because two of the UK kingpins have been selected for elevation into the international marketing hierarchy.

The reason is simple enough. PET's marketing practices in America have earned it the number three slot although it was ready first, and was cheapest. Tandy is first and Apple second. In the UK, PET is in first slot. Accordingly, American marketing chiefs have been given the boot, and British ones, promotion.

It means that Kit Spencer, the man whose face has appeared on many a Commodore advert in these pages, becomes a nearly-vice-president. He and his Slough-based colleague, Bob Gleadow have been put 'in charge of' international marketing, and 'there is a possibility' that they will be made vice-presidents, according to Dick Sandford, now one of the very top men in the country.

The difference between marketing in America and here is obviously quite important. That difference, Sandford says, is the fact that in America, marketing executives change jobs from one silicon company to another so fast that you hardly have time to see them behind the desk. It's called the revolving door syndrome — an executive comes in one side and out the other. Sometimes, miraculously, he turns from Clark Kent into Superman in the process —

sometimes the transformation is the other way.

If that is how business is done on the West Coast, says Sandford, his company is going East — to the Norristown, Pennsylvania headquarters of MOS Technology. It's there the PET was originally conceived, by the inventors of the 6502 microprocessor itself; their company was bought by Commodore.

The explanation is interesting but lacks fine conviction. For a start, the factory in Santa Clara is staying, and so is the dealer division boss.

Insiders say two things: one is the unkind suggestion that all the worthwhile marketing people available in California have tried Commodore desks for size and found them uncomfortable, and the second, the unarguable fact that UK marketing has done a good job while California marketing has not.

Just to drive the point home, the one thing UK marketing has done that US marketing has abstained from doing is — advertising. No Commodore advertising has ever been placed by Commodore in the US... dealers have, but headquarters has not. In the UK, dealers have contributed to advertising but Commodore has coordinated it. Impressed?

Sirius and siriuser

Sometime, (way back in the middle of last year) a couple of people with pretensions to a sense of humour decided to set up a partnership to do something serious. They started to produce micro-processor-based professional sound-mixing consoles and they graduated from this into becoming suppliers of

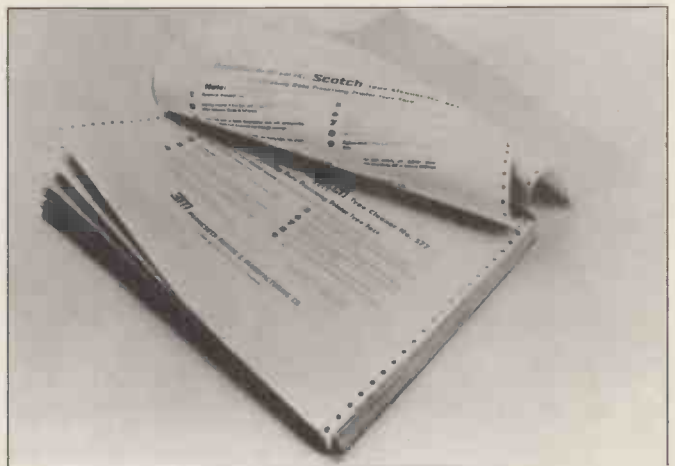

It may look just like computer print-out but it's in fact a printer cleaner. You feed it into your printer and as long as it makes marks on the paper without its ribbon, the type is dirty. When it comes out clean, the type is clean. It's Scotch Type Cleaner no 577: details from 3M on Bracknell (0344) 26726.

software for Ohio Scientific computers. This, they tell me, they still do.

The sense of humour manifested itself in a decision to register the partnership as Sirius Cybernetics, taking their cue from the remarkable radio series, *The Hitchhikers' Guide to the Galaxy*. It has been mentioned (the series, not the company) on these pages in the past.

The first prototype console is due to appear late this year. It's based on the OSI 502 processor board which uses the 6502 micro-processor. The partnership, still being quite serious, then went on to design boards and write utility software, both compatible with the OSI gear, and adding facilities which Ohio had neglected to provide.

The first was a pair of line editor programs, SC101 for the C1 Superboard, and SC 201 for the C2 and C4 Ohio systems. These are sold via the sole distributors, Mutek in Corsham, Wiltshire, and are about to be superseded by a new, faster and more elegant version known as the SC-1202.

Serious things came to an end with a jolt when the partners found mention of a company called Sirius Cybernetics Ltd of Leamington Spa. It was mentioned in these pages too, but the partner concerned, Richard Elen (who edits an audio magazine called *Sounds International*, I think) read it in *Kilobaud*. (*what's that? — Ed*). It's another magazine. (*Is there another one? — Ed*).

That nice Mr Elen wrote at once to his partnership's namesake, apologising for having inadvertently trodden on toes. Over to Richard Elen.

"We wrote: 'As it seems that we are working in rather similar fields (and listen to the same radio programmes) and as it appears that you quite likely had the name first, would you like us to

change ours to something else?' — expecting the answer 'yes'."

Well, continues Elen: "Surprisingly enough, our partnership (which had graciously *not* had notepaper printed yet, just in case) heard nothing of the sort from Mr Sirius Cybernetics Ltd. In fact we heard nothing whatsoever. And there was no such company listed in the Leamington Spa phone book (or anywhere else, for that matter). In fact nothing further was head of SC Ltd until our eyes were attracted to a writeup in *Computing* and in the June issue of *PCW*. Here, SC Ltd were mentioned as the producers of a SWTPC compatible memory board — but again, no telephone number was given. Nobody seems to have seen one of said boards, either. Perhaps someone can shed some light on the subject?"

It won't be me. I had a phone call from Mr Cutler of Sirius (Leamington) claiming to resent my suggestion that he was a mindless jerk. I suspected a prank: for those who can't get Radio 4, the marketing division of the Sirius Cybernetics Corporation is defined in the *Hitch Hikers' Guide* as "a bunch of mindless jerks, who'll be the first against the wall when the revolution comes," — quote from the Douglas Adams' script. One could as convincingly pretend innocence about a maternity home called Some Mothers Do Have 'em. I told Cutler as much, and promised to believe in him as soon as he sent me a photograph of his products. It still hasn't come.

The partnership, however, does exist and it's a prime mover behind the UK OSI user group. Contact Richard Elen and George Chkiantz at 12 Bennerley Road, London SW11 6DS, or phone George on 01-228 4839. Or again, contact the distributor, Mutek, on 0225 743289 in Corsham, Wilts.



The 'smallest and cheapest acoustically coupled telephone modem on the market', the Sendata Model 1071 weighs only half a kilo and costs £149 from Peripheral Hardware.

The company also imports a slightly larger, faster model 1080: details on 01-941 4806.

Sinclair/Cary -where are they now?

There are still people to whom the Sinclair ZX 80 is merely a number and a few letters — and to whom the news that Sinclair has settled his fight with Chris "Spangles" Cary will come as a perplexing non-informational item. For those of you who want a full resume of the whole fight, I can do little better than refer to the 12 June copy of *Computing*, where there is a long piece explaining it all most lucidly (I wrote it). For the rest of you, the news is simple: Uncle Clive and ex-DJ Chris settled it before they went to court.

The terms of the deal are very pleasing to both sides and anyway neither wanted a long, inconclusive and, most important, expensive legal battle. Cary had set up his new company, MicroAce, in Orange County, California, and was anticipating some problems in supplying the UK kit market; he wasn't all that keen on having to turn out ready-built computers.

Sinclair, on the other hand, was equally dubious about supplying kits to the US market.

Uncle Clive had nerved himself up for the effort. He told me, about a week before the hearing of his injunction against MicroAce (preventing MicroAce from copying the ZX80 keyboard), that his original plan had been not to sell kits: "Then I found that a great many American kit buyers were asking for the ZX80," he said, "and we have been very pleasantly surprised by the low number of returns from builders. It's such a simple kit that most people manage to get it working straight away."

So Sinclair had decided to try and sell kits to Americans. It wasn't a simple plan, nonetheless, and the idea that

Cary might like to take on the responsibility must have struck like one of those cartoon film 'IDEA!' flashes.

The American sales campaign for the ZX80 doesn't start until August, although both Cary and Sinclair will be showing the device at various trade fairs before then.

The all-important Federal Communications Commission approval for the micro-computer has been given for the Sinclair machine. It does not broadcast more than the strictly defined limits allow — a situation Uncle Clive has achieved by lining the inside of the case and the underside of the keyboard film overlay with metal, turning the whole surround into a Faraday Cage. The MicroAce does not (yet) incorporate this improvement: however the FCC rules don't apply to kits until January 1981, so this shouldn't prove to be a problem. The nice thing about the whole saga is that one is no longer bound to pretend that the MicroAce is not a copy of the ZX80. The nasty thing about it is that it means the MicroAce will not be sold to UK buyers for £50 after all.

And the fascinating thing is the fact that the Americans will be buying the system for less than the British — despite the fact that it's made in Britain — and even so, Sinclair expects to sell no more than four times the UK market size in the US. He analysed, "I think figures which purport to show that Americans buy ten times what we do, or even 20 times, are derived from products which are launched in America and then sent over to Britain. The market there is always a year, or two years, or even three years, more advanced, so it looks much bigger but I've always found that it roughly follows population."

So: we aren't getting any MicroAces — not legally — because Cary 'submitted to'

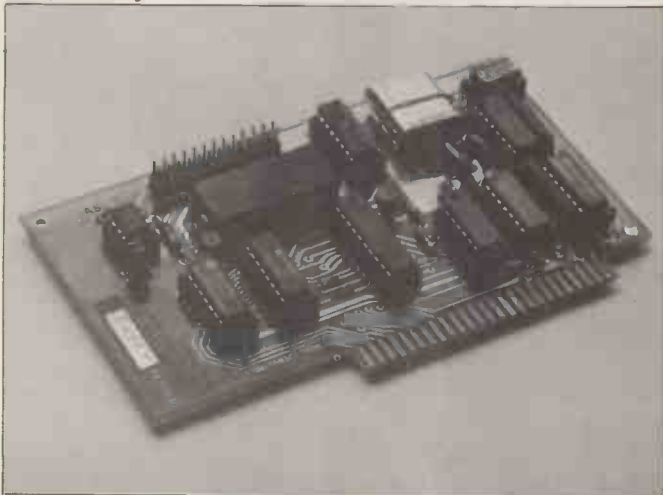

Wego computers has been appointed distributor for California Computer Systems cards — including interface cards for Apple II, plug-in audio-video attachments to PET, and some S100 products. Details on 0883 49235.

Buy a microcomputer for under £500 and you could be on your own! Unless it's a Commodore PET



Commodore produce Britain's number one microcomputer. But we don't stop there. We also insist on providing comprehensive support throughout our national dealer network.

Our dealers can examine your needs and demonstrate which hardware and software will suit you best. Their trained engineers are always at hand and a 24-hour field maintenance service is available. Your local dealer can tell you more about the following Commodore Services.

The Commodore PET
The Commodore PET computer range covers everything from the self-contained unit at under £500 to complete business systems at under £2,500.

Commodore Business Software and Petpacks
Our software range covers hundreds of applications. Business software includes Sales and Purchase Ledgers, Accounting, Stock Control, Payroll, Word Processing and more. In addition over 50 Petpacks are available covering such titles as Strathclyde Basic Tutorial, Assembler Development System, Statistics, plus our Treasure Trove and Arcade series of games.

Commodore Approved Products
Compatible products of other manufacturers with Commodore's mark of approval are also available.

Commodore Courses
Commodore offer a range of residential training courses and one day seminars. An excellent start. And when you have installed your system the PET User's Club Newsletter can keep you informed of new ideas and latest developments.

LONDON AREA

Adda Computers Ltd,
W5, 01-579 5845
Advanced Management Systems,
EC2, 01-638 9319
Byteshop Computerland,
W1, 01-636 0647
C.S.S. (Business Equipment) Ltd,
E8, 01-254 9293
Capital Computer Systems,
W1, 01-637 5551
Centralex-London Ltd,
SE13, 01-318 4213
Cream Microcomputer Shop,
HARROW, 01-863 0833
Da Vinci Computer Shop,
EDGWARE, 01-952 0526
L & J Computers,
NW9, 01-204 7525
Home and Business Computers,
E12, 01-472 5107
Merchant Systems Limited,
EC4, 01-353 1464
Metyclean Ltd,
SW1, 01-828 2511
Micro Computation,
N14, 01-882 5104
Micro Computer Centre,
SW14, 01-878 3206
Sumlock Bondain Ltd,
ECL, 01-250 0505
Sumlock Bondain Ltd,
EC4, 01-526 0487
T.L.C. World Trading Ltd,
WC2, 01-839 3894
TOPS TV LTD,
SW1, 01-730 1795

HOME COUNTIES

G. M. Marketing,
ANDOVER, 790922
HSV Microcomputers,
BASINGSTOKE, 62444
MMS Ltd,
BEDFORD, 40601
Elex Systems Ltd,
BRACKNELL, 52929
DDM Direct Data Marketing Ltd,
BRENTWOOD, 229379
Amplicon Micro Systems Ltd,
BRIGHTON, 562163
RUF Computers (UK) Ltd,
BURGESS HILL, 45211
T & V Johnson (Microcomputers
Etc) Ltd, CAMBERLEY, 20446
Cambridge Computer Store,
CAMBRIDGE, 65334
Wego Computers Ltd,
CATERHAM, 49235
Dataview Ltd,
COLCHESTER, 78811
South East Computers Ltd,
HASTINGS, 426844
Alpha Business Systems,
HERTFORD, 57423
Brent Computer Systems,
KINGS LANGLEY, 65056
Isher-Woods Business Systems,
LUTON, 416202
South East Computers Ltd,
MAIDSTONE, 681263
Micro Facilities Ltd,
MIDDLESEX, 01-979 4546
J. R. Ward Computers Ltd,
MILTON KEYNES 562850
Sumlock Bondain (East Anglia) Ltd,
NORWICH, 26259
T & V Johnson (Microcomputers
Etc) Ltd, OXFORD, 721461
H.S.V. Microcomputers,
SOUTHAMPTON, 22131
Super-Vision,
SOUTHAMPTON, 774023
Xhan Systems Ltd,
SOUTHAMPTON, 38740
Stuart R Dean Ltd,
SOUTHEND-ON-SEA, 62707
The Computer Room,
TUNBRIDGE WELLS, 41645
Orchard Electronics,
WALLINGFORD 35529

Petalect Ltd,
WOKING, 63901
Oxford Computer Systems,
WOODSTOCK, 811976

MIDLANDS AND SOUTH HUMBERSIDE

Byteshop Computerland,
BIRMINGHAM, 622 7149
CPS (Data Systems) Ltd,
BIRMINGHAM, 707 3866
Camden Electronics,
BIRMINGHAM, 773 8240
Computer Services Midlands Ltd,
BIRMINGHAM, 382 4171
Catlands (Computers) Ltd,
BURTON-ON-TRENT, 812380
Itek Systems,
COVENTRY, 86449
Jondane Associates Ltd,
COVENTRY, 664400
Davidson-Richards Ltd,
DERBY, 366803
Caddis Computer Systems Ltd,
HINCKLEY, 613544
H.B. Computers,
KETERING, 83922
Taylor-Wilson Systems Ltd,
KNOWLE, 6192
Machsize Ltd,
LEAMINGTON SPA, 312542
Office Computer Techniques Ltd,
LEICESTER, 28631
Lowe Electronics,
MATLOCK, 2817
Betos (Systems) Ltd,
NOTTINGHAM, 48108
Byteshop Computerland,
NOTTINGHAM, 40576
Keen Computers Ltd,
NOTTINGHAM, 583254
Teldata Computing,
STOKE-ON-TRENT, 813631
Systems Micros,
TELFORD, 460214
McDowell Knagg & Associates,
WORCESTER, 427077

YORKSHIRE AND NORTH HUMBERSIDE

Ackroyd Typewriter & Adding
Machine Co. Ltd, BRADFORD, 31835
Allen Computers,
GRIMSBY, 40568
Microware Computers Ltd,
HULL, 562107
Microprocessor Services,
HULL, 23146
Holdens Ltd,
LEEDS, 459459

South Midlands Communications Ltd,
LEEDS, 782326

Yorkshire Electronics Services Ltd,
MORLEY, 522181
Computer Centre (Sheffield) Ltd,
SHEFFIELD, 53519
Electronic Services,
SHEFFIELD, 668767
Hallam Computer Systems Ltd,
SHEFFIELD, 663125

NORTH EAST

Dyson Instruments,
DURHAM, 66937
Currie & Maughan,
GATESHEAD, 774540
Wards (Office Supplies) Group,
GATESHEAD, 605915
Eltron Ltd,
HARTLEPOOL, 61770
Fiddes Marketing Limited,
NEWCASTLE, 81517
Newcastle Computer Services,
NEWCASTLE, 615325
Format Micro Centre,
NEWCASTLE, 21093
Tripoint Associated Systems
Consultants Ltd,
SUNDERLAND, 73310

SOUTH WALES AND WEST COUNTRY

Radan Computational Ltd,
BATH, 318483
Computer Corner,
BAYSTON HILL, 4250
Bristol Computer Centre,
BRISTOL, 23430
C.S.S. (Bristol) Ltd,
BRISTOL, 779452
T & V Johnson (Microcomputers
Etc) Ltd, BRISTOL, 422061
Sumlock Tabdown Ltd,
BRISTOL, 26685
Sigma Systems,
CARDIFF, 34869
Office and Business Equipment
(Chester) Ltd, DEESIDE, 817277
A.C. Systems,
EXETER, 71718
Micro Media Systems,
NEWPORT, 59276
J.M. Computer Services Ltd,
NEWQUAY, 2863
Devon Computers,
PAIGNTON, 526303
J.A.D. Integrated Services,
PLYMOUTH 62616
Business Electronics,
SOUTHAMPTON, 738248
Computer Supplies (Swansea),
SWANSEA, 290047

NORTH WEST AND NORTH WALES

Tharstern Ltd,
BURNLEY, 38481
B+B (Computers) Ltd,
BOLTON, 26644
Preston Computer Centre,
PRESTON, 57684
Catlands (Computers) Ltd,
WILMSLOW, 527166

LIVERPOOL

Aughton Microsystems Ltd,
LIVERPOOL, 548 7788
B.E.C. Computers,
LIVERPOOL, 263 5738
Rockcliff Brothers Ltd,
LIVERPOOL, 521 5830

MANCHESTER AREA

Byteshop Computerland,
MANCHESTER, 236 4737
Computastore Ltd,
MANCHESTER, 832 4761
Cytek (U.K.) Ltd,
MANCHESTER, 872 4682
Executive Reprographic Ltd,
MANCHESTER, 228 1637
N.S.C. Computer Shops Ltd,
MANCHESTER, 832 2269
Sumlock Electronic Services
(Manchester) Ltd,
MANCHESTER, 834 4233
Professional Computer Services Ltd,
OLDHAM, 624 0665
D. Kipping Ltd,
SALFORD, 834 6367
Automated Business Equipment Ltd,
STOCKPORT 061-432 0708

SCOTLAND

Holdene Microsystems Ltd,
EDINBURGH, 668 2727
Microcentre,
EDINBURGH, 556 7354
Aethotrol Consultancy Services,
GLASGOW, 641 7758
Byteshop Computerland,
GLASGOW, 221 7409
Robox Ltd,
GLASGOW, 221 5401
Mac Micro,
INVERNESS, 712203
Thistle Computers,
KIRKWALL, 3140

IRELAND

Softtech Ltd,
DUBLIN, 784739
Medical & Scientific Computer
Services Ltd, LISBURN, 77533

To: Commodore Information Centre,
360 Euston Road, London W1 3BL, 01-388 5702

PCWD2

Please send me further information about the Commodore PET.

Name _____

Position _____

Address _____

Intended application _____

Do you own a PET? YES NO

Commodore

This list covers dealers participating in our advertising.

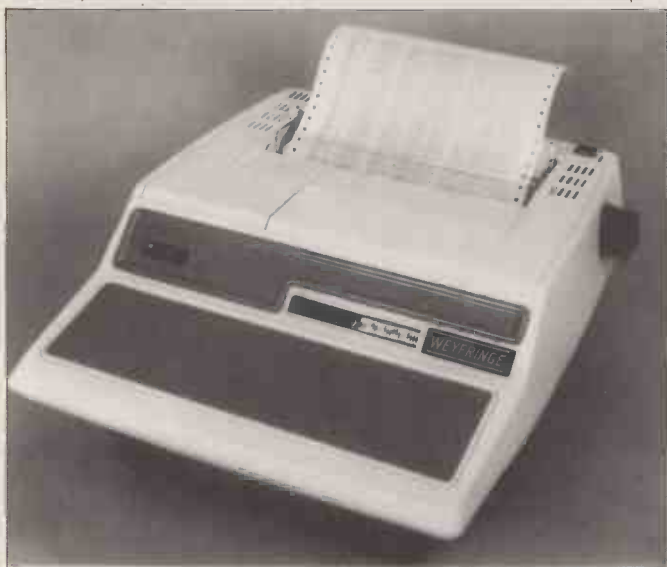

The makers of this printer are Weyfringe of Cleveland (Teesside) and it's the Century "to meet the print-out requirements of a wide range of microsystems" which apparently means it has an RS232 interface. I am printing the pic only out of a sense of mischief: I like the keyboard. Details on 0642 470121.

(that is, did not contest) the injunction prohibiting UK sales. The question of what we will get is vague. Sinclair himself doesn't say, partly for genuinely commercial reasons of secrecy, partly because of his slight tendency to paranoia when it comes to press statements, and partly because he hasn't yet made up his mind. He will offer add-ons for the machine, is my guess, but just what they will be remains to be decided.

You can ignore, however, suggestions that it's technically impossible to expand the system using the denser memory chips known as dynamic memory. Dynamic memory does need refreshing if the data is not to evaporate, and on the ZX80 micro the Z80 does provide a refresh line which Sinclair has used for controlling the television signal. All these things have been said, and all are true. It's also true, however, that most dynamic memory boards are designed for micros other than the Z80, and include their own refresh circuits. One such will be designed (by somebody) for the ZX80, you see if it isn't.

It won't necessarily be Uncle Clive who designs it, however. Whatever his plans for this market, they don't necessarily involve the ZX80 itself. He's described the machine as a 'nine-month wonder' — a phrase which should not be interpreted too literally, but which certainly indicates his way of thinking.

By this time next year, he expects, I think, to have sold some 20,000 to 25,000 UK systems, and maybe twice as many in America; but he also expects that this will be half the total demand for the ZX80. By then, newer ideas will have arrived in the 'video-calculator' market (as it

might perhaps be called). And there'll be many who continue to buy because they've designed courses around the ZX80. And people who have built interesting software which runs only on the ZX80 will generate sales too, because by then inflation and price cuts will have brought the price of a kit down to £50 or less, effectively, and anybody who wants one can have it.

At that point, Sinclair and Cary expect the sales to tail off quite sharply. They may be wrong; I think there's a year more life in the product than they imagine, although of course, it won't be at the present, astonishing level of sales. By the time you read this, Uncle Clive will have passed the 10,000 sales mark, and Cary will have 2000 kits in a California warehouse waiting to go out. That's a remarkable performance. I just hope somebody is showing these figures to the Prime Minister, who still clings religiously to the notion that any commercial venture worth considering will be done by the Thorns, the EMIs, the Plesseys, the Sonys and other established giants. Sometimes, I wonder if, if . . . well, if her belief in the Welfare State isn't actually more deeply ingrained than anybody else's: that Somebody Big Out There Will Look After Us, if we Just Give Them The Chance.

The Currymen

The men who are going to lead washing machine retail chain, Currys, into the micro age have been named as Ian Smith, John Hubble, Geoff Sheridan and Jim Minnis. Smith is in charge of regional sales for London and the

South East — which may one day be an onerous task, but for now it involves setting up the Micro C micro shop in New Malden, in south London's suburbs. Hubble covers the West Midlands — and establishes a store in Birmingham, off Union Street; Sheridan is covering the East Midlands from a Nottingham shop; Minnis sets up shop in Bristol.

Learning the game

That rather large company, IBM, is widely believed to have no part in the micro-processor market. True, in America it has set up one or two typewriter and dictating machine shops where the 5100 range of desk-top computers will be sold and software services provided, but that's hardly a threat to Radio Shack (Tandy).

Just as a snippet, an aside to this month's Ingersoll story, I will pass on the fascinating detail that Atari Personal Computers will be distributed in America by Science Research Associates. Science Research Associates? It just happens to be an educational publisher . . . and it also just happens to be a wholly-owned subsidiary of IBM. It may lead to nothing — but it's a step in an interesting direction.

Doublevision

The Doublevision add-on for Apple computers, providing separate graphics screen and print screen, is available through Mike Sterland's company Personal Computers (it was mentioned in our West Coast Faire report — PCW May). Details on 01-626 8121.

This year, next year....

I am anxious to hear from anyone who can prove that Commodore's 8050 disk drive

will be available when the company says it will be — in August.

In this industry, products are inevitably delivered later than promised and not much is thought of it. However there was a year's delay between the announcement of the Commodore printer, and its eventual availability; during those 12 months we heard constant and reassuring noises from Commodore that the problem had been overcome and that deliveries were imminent. Similarly, there was nearly a year's delay between the first showing of the PET prototype, and its full availability.

I would assume that Commodore has become a different company, and has learned from its mistakes, but for one fact . . . an ex-employee recently mentioned that many of the components needed for the super new disk drive were not yet even being ordered.

Of course he may have been mistaken, but before I announce the availability of the 8050 I would like more convincing evidence than the appearance of a prototype at the PET Show in London. Don't become anxious: if the proof is readily to hand, I will have it in plenty of time to print it before the product is due to be officially launched — and no harm will have been done.

Brain transplant

Distribution in the UK for Intertec SuperBrain will now be handled by Sun Computer Services of Hampton, Middx. Sun has announced prices of £2650, £1950 and £625 for SuperBrain QD, SuperBrain DD, and Inter-tube products respectively; details on 01-941 4824.

Success story

The company which owns the software publisher Petsoft

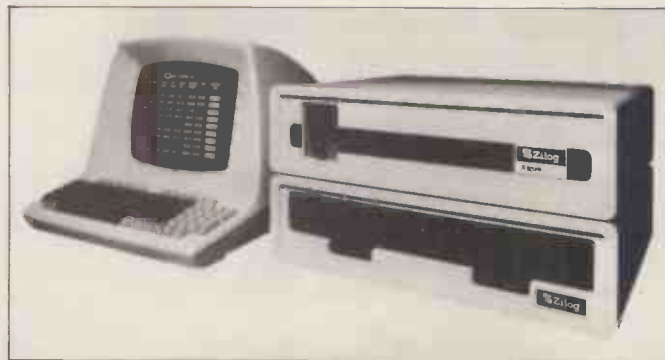

Local networking, says chip maker Zilog, is "a means of tying together diverse pieces of equipment simply and economically within a local area. The lower cost system elements are distributed, while the more expensive ones are shared." This is Zilog's MCZ-2 product range, using Z-net for local networking. Details in the UK on 0628 36131.

Logic box

Most people are confused
when confronted by the
"Micro Maze".

We stock and advise on a wide
range of systems from the
bottom range of "micro" up
to the "mini" level.

Let us be your guide.
Our consultants can set you
on the right path and advise
as to the most cost-effective
steps to take.

Contact our sales consultants
Peter Coleman
Jock Eggeling

ADVICE IS PART
OF OUR SERVICE

LOGIC BOX LTD

31 PALMER ST LONDON SW1

01 222 1122/5492

WH14.

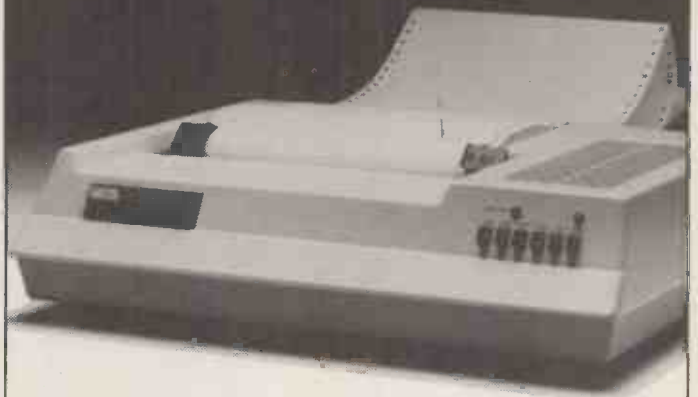

First in line.

If you're looking for an above average line
printer at a lower than average price then the WH14
from Zenith Data Systems is your first choice.

Microprocessor controlled, this compact table-
top unit can be used with most computers through a
standard serial interface. It provides hard-copy output
of your programmes as you execute them, plus handy
copies of address lines, lists and other programming
data for educational or business applications.

Features include:

- 5 x 7 Dot matrix printing
- Clear easy-to-read images
- Upper and lower case characters
- Operator/software selectable line width:
132, 96 and 80 characters per line.
- Sprocket paper feed with adjustable spacing
- Stepper motor feeds allows 6 or 8 lines per
inch vertical.
- Form feed operator/computer control
- Microprocessor based electronics

And at £510, exclusive of VAT and delivery
charges, the WH14 puts economy first in line too.

Generous OEM
discounts are available.

**Zenith
data
systems**



For full details of the WH14, complete this coupon and
return it to:

Zenith Data Systems Division, Heath Electronics (UK) Ltd.,
Dept. (PCW 8), Bristol Road, Gloucester, GL2 6EE.

Name _____

Company _____

Address _____

WH14

has reported turnover increases, and profit increases. For once the figures don't need careful analysis: they are up 79% and 93%, to £5.6 million and £720,000 respectively. Full details from ACT at 5-6 Vicarage Road, Edgbaston, Birmingham B15 3ES.

Be smart

A school which cannot afford to buy more than one PET computer — by order of the local authority — is selling its own computer-aided learning programs publicly to raise money for more hardware. The software was written by deputy head Don Walton, and by a ten year old boy: eight programs are available on cassette tape.

Details from Houghton County Primary School in Cambridgeshire: phone St. Ives (0480) 63398.

Joint concern

If you plan a microcomputer but can't find anyone with a factory, then an astonishing new company being evolved in Bradford should be worth a second thought.

It's being set up by John and Tony Martinez, together

with Bradford Council's economic development department. The Martinez brothers have been making micro power supplies for over a year, with their company Microvitec. Now they hope to make video equipment, personal computers, and similar hardware.

Where the deal really looks interesting is the 'joint factory' idea. Bradford Council will custom-build factories on a £500,000 worth plot of land, either for making Microvitec equipment, or for a company which wants a product made — in which case the factory could be run as a joint subsidiary company. Bradford's economic development coordinator I N Page has details on 0274 29577.

Courses

Courses on microprocessors generally are being organised by the City University with the support of the IEEE. A course on micro trends starts on 11 September for two days; a Pascal programming course lasting four days starts on 16 September; a micro evening class lasting ten evenings starts 13 October and runs to 15 December, and a three-



Microchips "are like the seven league boots in the fairy tale; those who do not have them will not win the race". So said the Duke of Gloucester's scriptwriter when the Duke opened the Micro 80 Exhibition in Northampton. Rather more impressive was the pronouncement of one of the exhibitors, Horizon Software, that its products (written in Cobol) for Z80-based processors such as TRS-80, North Star Horizon and Superbrain, are guaranteed. The software is guaranteed for a year, and if legislation causes changes, these will be provided even after the warranty period expires. In the pic with the fairy tale Duke is M Shafique, the director of Horizon Software, who makes this promise.

day introductory course on micros runs from 29 to 31 October.

They're not all in London: for details, phone 01-253 4399, or write to Eileen Baker, room E511, Micro Laboratories, City University, Northampton Square, London EC1V 0HB.

REMove them

In writing a program, the programmer tries to make sure that there are lots of REMarks and spaces (in Basic) to explain what each section of code is doing. The importance of these cannot be overstressed, say software experts — so a product which diligently removes them sounds a bit strange.

The product is a software package called PACKS from Data Associates of Framingham, Massachusetts; it removes REMarks and spaces so that programs will load faster and run quicker. It runs on Tandy TRS-80 micros, working with diskettes. Details of this \$20 product from Box 882, Framingham, Mass 01701.

Between the DEC's

A piece of computer hardware which could open up a corner of the micro market to the minicomputer giant, Digital Equipment, has been launched in the UK by micro distributor Sintrom.

It interfaces the 'skeleton' of DEC's universal PDP-11 computer range — the skeleton being the layout of wires behind the computer, (and called the Unibus) — to the company's microprocessor LSI-11 range; this uses something called the Q bus.

Sintrom's device is the Quiverter.

In so doing, it goes some way to overcoming one of the hardest problems to be encountered in converting from one Digital Equipment system to the other — the block formed by the operating software. DEC software is so complex that programmers trained in one operating system find it impossible to transfer to any alternative, especially when there's the problem of incompatible hardware to overcome.

Sintrom claims that its £450 device will allow Unibus devices — printers, disks and so on — to be put into LSI 11 microsystems, for which special Qbus peripherals are not so readily available and it also allows cheap LSI-11 controllers to be added to an existing Unibus system.

If and when the world puts the LSI-11 on one chip, this device could be a way of circumventing Digital Equipment's control of its market through patents on the Unibus.

The Quiverter is made by Able Computer, but Sintrom will give full details; they're on Reading (0734) 85464.



This data storage device looks like a disk drive but it isn't. It only takes 8 kbytes; it takes four seconds to read that 8 kbytes, and it's designed to interface with 8-bit micros. It's such a strange concept that it seems worth printing it just for strangeness' sake. Details on Rye (079 73) 3777 from Roxburgh Electronics.



The company also makes a £280 thermal printer which can print graphics and do video hard copy.

Cytek seminars

Cytek has transferred its microcomputer software and systems business to Old Trafford, Manchester, and is planning evening seminars for Manchester and Liverpool, with Leeds a future possibility. Details from Sue Matthews on 061-872 4682; the new address is Sandringham House, 9 Warwick Road, Manchester M16 0QQ.



Tom Williams, our man in Silicon Gulch, brings the latest look at what's happening on the US micro scene

Some of the industry's leading figures recently gave us a candid and revealing insight into how they see their companies and the micro industry in general both now and in the immediate future.

Speaking at the third annual Rosen Research Personal Computer Forum in New Orleans were Steve Jobs of Apple, Chuck Peddle of Commodore, Bill Gates of Microsoft, John Roach, vice president of Radio Shack, Allan Alcorn of Atari, and many others. These representatives of the industry showed general agreement on how the personal computer market had developed and where it was headed. They even managed to be rather uncertain about the same things, but more on that later.

"...personal computers should be seen as tools which amplify the natural capabilities of the human mind."

Some very interesting observations were made by Apple's Steve Jobs on what he understood by the term 'personal computer', and how he perceived the personal computer beginning to penetrate large corporations. A computer is a 'personal computer', according to Jobs, when a one-to-one relationship develops which gives the user a feeling of independence and power that he could not experience in a large data processing environment or which wouldn't be possible without the aid of the computer. To achieve this relationship, Jobs said, personal computers must include general purpose capabilities, especially data and word processing. The 'nuts and bolts' must be shielded from the user in such a way that the machine itself recedes into the background and the user sees it solely as tool for his particular task. On the bottom line, Jobs says, personal computers should be seen as tools which amplify 'the natural capabilities

ties of the human mind'.

A market for such personal computers is beginning to open up in really large corporations because certain employees are beginning to recognize the value of these machines for their professional needs. Thus, one employee may bring his own computer to work and begin using it for his job. This will attract the attention of others in his department who will start talking about how much easier such a machine would make their lives. Eventually, someone will get the ear of middle management and a number of machines will be approved for purchase. Then other departments will want some. At that point purchasing will say "Wait!" and will approach the manufacturer for volume pricing. At that point the personal computer has done its insidious work and has worked its way into the giant corporation.

There is at last a pervasive realization in the industry that software has become the most important factor in the personal computer market. The slogan 'software sells hardware' has given way to, 'software defines the product', a phrase coined by Bill Gates. All manner of manufacturers are now clamouring for major software houses to adapt quality software packages to run on their machines.

In a sense, this has limited the possibilities of smaller software firms getting a major part of the market to those that already have access to the manufacturer's distribution channel. As an example of this, Microsoft, which started by supplying systems software and languages to manufacturers and OEMs, has recently opened a consumer products

"...the personal computer has done its insidious work..."

division. Dan Fylstra, of Personal Software, another major US software house, discussed the costs involved in producing a finished software product. The most critical consideration, according to

Fylstra, is the people involved in writing and debugging the code. Productivity among programmers varies enormously, and the man-hours/weeks/months is the major cost of a software product. The biggest danger to quality software products, Fylstra

"Software piracy—that supposedly innocent trading between friends"

says, is still software piracy—that supposedly innocent trading between friends.

Most of the participants in the Forum were pretty clear about their perceptions of the market. They could predict what types of machines would be in demand from the small business and professional user, and companies such as Apple (for small business) and Hewlett-Packard (for the professional) are adjusting their strategies accordingly. But there was one segment of the personal computer market about which the participants seemed to have only vague ideas, and this was the so-called 'home market'.

Jeff Rochlis of Mattel made the very sage observation that in order to appeal to the mass consumer, a home computer had to provide a clearly perceivable value that was unique and not a duplication of some other service. And, he said, it had to do this for under \$500. But when he came to talk of exactly *what* that clear value should be, he gave no clear answer, only nebulous mentions of "education, individual finances, communications, etc." This does not reflect any clearly focused idea of the home market which is to be pursued. Nonetheless, Rochlis announced that Mattel had already spent over \$10 million to develop its Intel-livision home computer; they know there's a market out there somewhere, but they're not quite sure just where it is.

A number of interesting announcements were made at the Forum, one of them

being that Radio Shack would be marketing a home videotex terminal. The terminal, which contains a modem to plug into the phone and attaches to the aerial socket of a television set, has a colour display of 32 characters and 16 lines. It was developed in cooperation with the US Department of Agriculture in an experiment called 'Project Green Thumb'. This was a Videotex service for farmers in Kentucky which would allow them to access weather reports, listings of latest farm prices, advice on what crops to plant, news, and so on, over a Prestel-like system.

Now Radio Shack has entered into an agreement with CompuServe, which operates one of the two US nation-wide personal computer networks. Under this agreement, Radio Shack will be sole retail distributor for CompuServe, and CompuServe is adjusting its display format to be compatible (including colour) with the Videotex terminal by Radio Shack.

In another announcement, Ed Roberts, president of Zenith Data Systems, announced that Zenith had been working in a mutual development project with the Massachusetts Institute of Technology to develop a 16-bit multi-user micro-computer based on the Motorola 68000. An operating system similar to the Unix system developed by Western Electric Bell Labs had been developed by MIT.

Roberts said that the new machine would have from 7 to 8 Mbytes of RAM, a microprocessor-controlled high resolution graphics display and hard disk storage comprising 10 Mbytes fixed and 10 Mbytes removable storage. The machine, prototypes of which will be available later this year, seems to reflect Zenith's belief that there is still a market for high-end machines in the microcomputer industry.

Roberts added that Zenith, which purchased the Heath Company about a year and a half ago, was working on its own version of a home computer. This machine would be sold through the regular Zenith distribution channel of consumer electronics stores, which in the US is also the outlet for the huge Zenith line of televisions and stereos.



Why PETSOF Business Software

WORDCRAFT

WORDCRAFT A true Word Processor for the 32K PET. Wordcraft is a genuine word processing system, easy to understand and use, but containing all the facilities normally found only on more expensive dedicated Word Processors. Features include scrolling in both vertical and horizontal directions (to overcome small screen size), up to 117 characters wide and 98 lines deep for a full page of text. Written entirely in machine code for speed and compactness. Truly the Rolls-Royce of PET Word Processors. Send for brochure. £325 on CompuThink Disk system.

ACT SALES LEDGER

ACT SALES LEDGER A powerful system developed to ACT's own high standards. Provides full facilities for maintenance of the Sales Ledger, preparation of a list of outstanding balances and printing of statements. All data including new customer details, invoices, credits, cash and transfers are entered under step by step guidance on the display screen. Printed results include Audit List, Aged Debtors List, Control Accounts and Statements. For 32K PETs. Full manual supplied. Brochure available on request. £120 on Commodore Disk. £95 on Cassette.

STOCK CONTROL

STOCK CONTROL Powerful and flexible stock system with full facilities for recording and control of stock information. An audit listing is automatically printed which itemises all transactions including the entry amendment and deletion of master stock information, issues receipts, allocation purchase orders. Printed reports include Full Stock Control, Stock Valuation, Reordering Report, Audit Listing. The system is highly flexible.

£50 on CompuThink or Commodore Disk

ACT PURCHASE LEDGER

ACT PURCHASE LEDGER £120 Developed by ACT's own software teams this comprehensive package includes full facilities for the maintenance of the Purchase Ledger, the preparation of a list of outstanding balances and printing of remittance advices. The system produces the following printed results: Audit List, Aged Creditors List, Control Accounts, Purchase Ledger Record, Remittance Advice Cheques and Payments List. For 32K PETs. Full manual supplied. Brochure available on request. £120 on Commodore Disk. £95 on Cassette.

PAYROLL 200

PAYROLL 200 Comprehensive, easy-to-use package for small businesses with up to 200 employees. Facilities provided include Holiday Pay, Sick Pay, Bonus Payments and two rates of overtime, as well as allowing a 'Standard week' to be specified for each employee. Weekly and monthly summaries are provided and amendments necessary because of a Budget are made very easy. Prints wage slip and coin/note analysis. Tax & NI are computed automatically from knowledge of employees codes. Update service available. Full manual provided. £50 on Commodore or CompuThink Disk. Cassette system also available at £25

PETPLAN BUSINESS SIMULATION

PETPLAN BUSINESS SIMULATION Petplan is a general management business simulation game which is exciting to play. Already it is widely used by colleges and Industrial Trainers to teach the skills needed to run a business. The program creates the model of a manufacturing company; you take the decisions. You will need to hire workers, invest in plant and premises, set advertising budgets and prices. At each stage screen reports (which may be printed out) show the results of decisions as they take effect. 50 page manual and voice guide on cassette. For 32K PETs. £60 on Cassette.



are No.1 in...

are for the PET

VISICALC
PROBLEM SOLVING
SOFTWARE

VISICALC PROBLEM SOLVING SOFTWARE Acclaimed by the press as the most outstanding piece of PET software yet written, VisiCalc is a new breed of problem solving software that takes the hard work out of planning, projections and costings. Once your first projection is complete, you are ready to use the powerful recalculation feature. It lets you ask 'What if', examining new options and planning for contingencies. What if sales drop 20% in October? Just type in the sales figures and VisiCalc instantly updates all other figures affected by October sales. Invaluable to businessmen and students alike. Full manual supplied. Available late June. £125 on Commodore Disk.



Petsoft sell more programs in Britain than anyone else, for two simple reasons:

Quality and Value!

You will find Petsoft programs on sale in more than 200 computer shops throughout the country, and in many more all over the world. We invite you to try them.

If you can't find the program you need, contact us directly. We offer over 200 titles and can supply you directly. We will even take credit card orders over the telephone. Since we normally carry all programs in stock, you won't have long to wait.

PET is the trademark of Commodore.

Petsoft is backed by the resources of Applied Computer Techniques Ltd., Britain's leading computing group. With over fifteen years experience of developing business software, ACT has a reputation second to none in the industry. That is your guarantee.

If you would like more information on any of the programs mentioned on these pages, clip out the coupon. We will see that a free copy of our complete PET software catalogue reaches you without delay.

Plus

Some other PETSOFT products described in our catalogue:

Programmers Toolkit £55

Plug-in ROM Chip adds nine useful commands to PET BASIC including RENUMBER, TRACE, DUMP, FIND and APPEND.

Talking Calculator £10

Calculator program with synthetic speech via user port sound generator.

Micro Pools Package £20

A scientific approach to winning the Football Pools, on cassette.

6502 Assembler Tutorial £25

How to program in 6502 Assembly language. On CompuThink or Commodore Disk.

Presto Digitizer £42

Electronic tablet accepts handwritten input for the PET.

User Port Sound Generator £27

for Talking Calculator program, electronic music etc. With volume control.

76 Common Basic Programs £15

Adam Osborne & Associates classic collection of financial and mathematical programs on cassette.



Radclyffe House, 66-68 Hagley Road
Edgbaston, Birmingham B16 8PP
Tel: 021-455 8585 Telex: 339396 ACTNET

Prices exclude VAT and where correct at time of going to press.

ACT Petsoft

Please rush a FREE copy of the latest Petsoft catalogue to:

Name:

Address:

Postcode:

I have an... 8K PET
 16K PET
 32K PET
 No PET yet

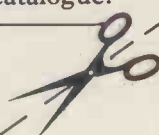

COMMUNICATION

PCW welcomes correspondence from its readers. Be as brief and concise as possible and please add "not for publication" if your comments/questions are to be kept private.

Address letters to: "Communications", Personal Computer World, 14 Rathbone Place, London W1P 1DE.

Sharp reminder

I recently purchased a Sharp MZ-80K personal computer (an excellent unit) but I have not yet seen any MZ-80K programs in PCW. I realise this is a fairly recent micro, but I'm sure there are a number of MZ-80K users who would like to see programs in your magazine.

I wonder if any programs such as the PET, TRS-80, Apple, etc, can be modified or is it possible to make a conversion sheet to modify PET programs to Sharp. Keep up the good work with an excellent magazine. Martin Regan, Southport, Merseyside

The fact that we publish so many PET programs is a reflection of the PET's market dominance. We have published MZ-80K programs in the past and we'll publish more if we receive any which satisfy our 'quality/novelty' criteria (see last month's PCW) — Ed.

Anomalies explained

I read with interest your reviewer's comments in the June issue on the results of the disk tests applied to the TRS-80 Model II; he mentioned that the tests to access a sequence of records in reverse order took slightly less time than the same accesses performed in the more usual forward sequential manner.

I looked back through similar reviews in past issues, and in fact the tests accessing records in the reverse order generally do take slightly less time. The exceptions were instances where the forward sequential pass took a surprisingly short time to run, typically less than a quarter of the time expected. The following suggested explanation is based on considerations applied when sizing large mainframes and their application programs to estimate run-times and resource utilizations. The basic ideas are the same because the micro's floppy disk is similar, though smaller and less sophisticated than its non-floppy multi-platter brother.

As explained in the review, the tests were conducted on an otherwise empty disk. So most forward sequential accesses would be to the next sector in the same track, and only occasionally would the head have to change tracks. However, the speed of rota-

tion, and the time taken to do the minimal amount of processing between accesses, would normally be enough to place the head beyond the start of the next sector. The micro then has to wait for the sector to come round again. The cycle time per forward access therefore is that for a complete revolution plus a sector, whereas that for reading or writing backwards through the file would be the time for one sector less than a complete revolution.

Those machines in which the forward sequential tests took a remarkably short time presumably did so because the minimal processing between each access was completed before the beginning of the next sector was reached. However, most application programs would contain more than this minimal amount of processing, and would then require a full revolution of the disk, for which the shorter forward sequential disk test timings would be most misleading. J M Barnes, Enfield, Middx.

Disabled group

The British Computer Society has a Committee for the Disabled, among whose aims are the development of computer-based aids for the disabled.

There is in this country a number of people developing aids for sufferers from almost every kind of disability, and the advent of the micro-computer has accelerated the trend to new inventions. So far there has been far too little done by way of providing a means whereby such people can get in touch with each other and find out what has been done and what is being attempted; indeed, a wheel has been re-invented on occasion. Many aids have been invented and developed "one-off" by the inventor for himself or for a friend or relation. Such an inventor could have gained help from contact with others working on the same problem or could have helped others working on the same or a similar problem. As a first step towards the information service which we believe essential, the subcommittee is collecting the names and addresses of people and organisations working in this field; we should be very glad to hear from any who are interested whether as sufferers, inventors or manufacturers. We feel sure that this is not merely a national problem and are seeking similar help via organisations for informa-

tion science in most of the English-speaking world.

May I, through you, ask any who could contribute, or even who wish merely to comment, to get in touch with me, Helen Townley at 117 Wickham Chase, West Wicham, Kent, BR4 0BQ

Tangerine dream

A word of praise for Tangerine Computers. I ordered a Microtan 65 Computer for my son's birthday.

A few days before it was due I asked my wife to give them a ring to find out if it was in the post. They told her there was a breakdown somewhere on the line and it would be delivered in a week or two.

So, the next day I telephoned the firm myself; a gentleman in a firm and civilised way calmed my primitive pent-up anger and let me explain my position. After listening to me he told me there must have been a break in communications; "Cliche", I thought. He told me he would ring me back in an hour's time, which he did. Not only did he find me a computer but had arranged for it to be sent to me at my local station the next day in time for the birthday.

That's what I call a good service, which I have never come across in this day and age. The attitude usually seems to be — we haven't got it, but there are plenty of people on the waiting list. Derek Clewley, Borehamwood, Herts.

Coupler addresses

I would be grateful if you could supply me with the addresses of the firms supplying the acoustic couplers and modems as described in your May edition. D Lindsay, Chester

Several readers have asked for these, so here they are: Anderson-Jacobsen, The Estate Office, Station Approach, Shepperton, Middx TW17 8AP. K&N Electronics Ltd., Cordwallis Street, Maidenhead, Berks. Modular Technology, PO Box 117, Watford, Herts WD1 4PD. Peripheral Hardware Ltd, Link House, Pool Close, West Molesey, Surrey KT8 0HW. Post Office, Postal HQ, St Martins-le-Grand, London EC14. Transdata, 11 Garrick Street, London WC2 — Ed.

MK14 surprise

In the June PCW L V Cooper states that the MK14 uses FFF7H to FFFFH as RAM, instead of 0FF7H to 0FFFH.

This is unfortunately not the case, but even if the monitor did require memory at this location, the MK14 would still work properly as these nine locations are just used to hold images of the SC/MP registers before and after execution of a user program.

The critical RAM address is the 18 bytes from 0F00H which must be present for the monitor to work at all.

The reason that the SC/MP micro has only 12 address lines is that the internal logic will only process 12 address lines.

What this means is that if an instruction (of any type) references what would seem to be an address outside of the current 4k block, the carry or borrow to the address line 13 is ignored.

So the monitor instruction at location 000BH, C0 F2 (LD -E) loads from 0FFEH and not FFFEH as might be expected.

Here's a surprise program for MK14s. Load and run at 0F12H.

```
f12 C0 3D F0 3C
f16 F0 3B C8 37
f1A F0 36 C8 34
f1E 1F C8 32
f21 8F 55 C0 2D
f25 D4 7B 9C E9
f29 C4 0D 35 C4 00 31
f2F C4 3F C9 03 8F 00
f35 C4 3F C9 02 8F 00
f3B C4 7C C9 04 8F 00
f41 B8 11 9C EA C9 00
f47 90 C9
```

For the best effect, turn the lights off!

G Phillips (MK14 Users' Group), London NW9

Powerpack

In answer to the question about the Powertran Club in the June PCW, there is such a club and those interested should apply to Mr P L Proberts, 50 Cromwell Road, London SW19 8LZ. The annual subscription is £5 (which includes a monthly newsletter) and they also have details of the Mk III monitor. C J Pink, Rainham, Kent

Bouquets and Brickbats

Your magazine "Hits the spot", as our American friends would say, so I'm glad to join up for a year.

What I like about it is its extrovert attitude. Personal computing is a fast moving subject and it doesn't do any good to be parochial. We need to know all about developments in the USA (especially California) and in Japan too. Your recent article on the 5th West Coast Computer Faire helped a lot.

But you get a brickbat along with the bouquets for the Benchtest on Hewlett-Packard's HP-85. Guy Kewney's article was very informative but I think he missed a point — or perhaps indeed he made it when he wrote that "The business user would do better looking elsewhere. . .". This machine is quite clearly designed for the scientist and engineer. These professionals need technical software, not business software. They want for example packages for statistics, engineering, numerical methods etc. The quality of software is a big factor in people's purchasing decision. Could we perhaps have more information in future on this aspect? QSE Didcot, Oxon (Real name supplied).

Yes, you're dead right — we should serve the scientific/engineering community better. We would like to hear from people who feel that their experience and writing ability could help us remedy this situation — Ed.

Tape tips

I have recently acquired a Viatron System 21 together with a matching tape drive. If any of your readers have any relevant manuals they would be willing to loan or general information they could pass on regarding this and any other Viatron equipment, I would be very grateful. If there is anyone else out there struggling with one of these things perhaps we could get a Viatron users' group going.

Also, is there a 6800 (specifically MEK 6800 D2) group still going somewhere? P A Dion, London NW3

Groupgrovel

We were very pleased to see a review of the OSI C2-4P in PCW April 1980. Apart from the sheer pleasure of seeing a British magazine even mention OSI equipment, it was good to see such an objective review in your pages. Your reviewer's comments on OSI's ghastly documentation were particularly apposite; this is one of the areas that we, the UK OSI

User Group, are working on. We are intending, among other things, to produce our own Challenger 'manual' in the near future: a kind of 'everything you wanted to know about the Challenger but couldn't find easily in the manual'.

Our current Newsletter includes a modification to give the Superboard a display more like the C2 instead of its normal, somewhat ugly, 32x32 (if you're lucky) format.

Keep up the good work with a great magazine: and please cover more OSI information in the future — no-one else seems to know about them!

Richard Elen/George Chkiantz, OSI User Group, London.

The big time

I recently ran your Basic Benchmark programs on the University of Manchester Regional Computer Centre (UMRCC) CDC Cyber 72 system. The system is based on a Cyber 72 for undergraduate teaching at both the University of Manchester and at UMIST as well as two other systems comprising an ICL 1904S and a 1906A, each of which fronts its own CDC 7600. The '72 is mainly used to provide interactive facilities and as a result supports over 120 terminals distributed over both campuses; it has a 60-bit word length and utilises a three-address instruction format.

The Benchmarks were run under the NOS 1.3—485E operating system using the Basic subsystem and the times quoted include the compilation time.

Benchmark	Time (seconds)
1	0.060
2	0.056
3	0.088
4	0.085
5	0.132
6	0.242
7	0.329
8	0.409

If you think these are fast then a note in the UMRCC Cyber 72 User Manual will change that — in trying to convey an image of the Cyber 72's power, it states that the 72 has approximately 1/20th of the computing power of the CDC 7600! N Davies, Manchester.

Gulp! I suppose we'll now have someone running the Benchmarks on a Cray 1! But your timing for BM8 looks wrong — it should be lower than the time for BM7 — Ed.

Conversion wanted

I recently bought an OSI C1P which I want to use with a Teletype 28 ASR so that I can both obtain hard copy and read in programs using the Teletype's paper tape reader. Do you know where I can find an ASCII to Baudot conversion table? P Knight, Sevenoaks, Kent

Does this help? — Ed.

Symbol	Baudot	ASCII
A—Z	1 — 26	65 — 90
Space	31	32
—	1	45
?	2	63
.	3	58
3	5	51
%	6	37
@	7	64
8	9	56
(11	40
)	12	41
:	13	46
.	14	44
9	15	57
0	16	48
1	17	49
4	18	52
,	19	39
5	20	53
7	21	55
=	22	61
2	23	50
/	24	47
6	25	54
+	26	43

Baudot uses 29 as a letter shift and 30 as a figure shift — hence the duplication of codes 1 to 26.

Calc counters

The following points may be of interest to Mr Buckley ('The Forgotten Interface',

Computer Answers, PCW May 1980):

— just for raw number-crunching capability a Texas TI-30, or any other cheap non-programmable scientific calculator, is a wiser choice than a TI-58 for interfacing with a micro or some other device (never forget Murphy's Law!). — built-in debouncing in pocket calculators makes them *very slow* at the input interface, typically no faster than .1 or .2 seconds per input signal (either every single digit or function). Thus, the UK 101, with its fast 8k Microsoft Basic, will usually do better all by itself than if trying to borrow help through a 'tortoise'.

I must add that I use as an alarm timer/seconds counter a battered Sinclair Cambridge (remember them?). I could set it to ring a few years from now (if the batteries lasted that long . . .), and, when not counting time, it still performs happily as a desk-top four-function calculator. Nevertheless, I wouldn't dream of interfacing my TI-58 to my Ohio Superboard — and I think I would succeed in interfacing them, if I cared to, without really 'removing' the TI-58's keyboard, as Sheridan Williams thinks necessary.

Finally, as to Sheridan's suggestion of electro-mechanical 'key-pressers' to interface computer LSIs to programmable calculator's chips, I wonder if he would be thinking also of using thermionic tubes to latch the 'key-pressers' — the resulting dinosaur might even work! S Sa Nogueira, Lisbon, Portugal

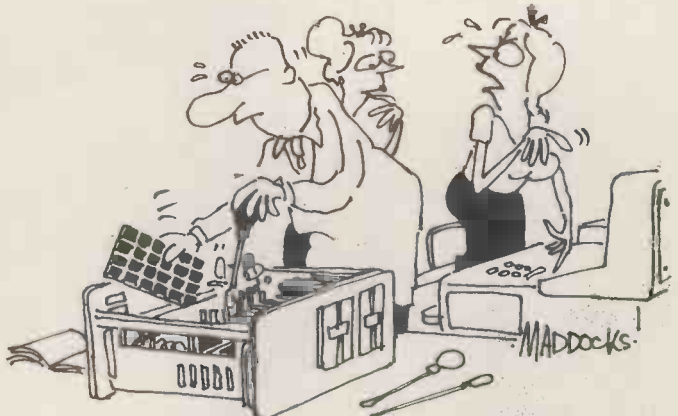

I left a whole slab of chocolate right there on my desk...

Personal Computer

World

FEATURE INDEX

Index to current volume, up to, and including, last month. (Previous volumes were indexed in March and April 1980 issues).

Hardware Projects		HP 41C review	3-4
Z80 Homebrew	3-1	Artificial Intelligence	3-5
Selective PROM copier	3-3	Accounts on TI-59	3-5
TV to Monitor conversion	3-3	Data Packing	3-6
MK-14 Expansion	3-4	Sharp PC1211 evaluation	3-7
Teletprinter conversion	3-5	Special Features	
Adding a Z80 to a 6800 system	3-7	Computer Retailers' Association	3-1
Benchtest Evaluations		Christopher Evans tribute	3-1
Luxor ABC 80	3-1	Show chess results	3-1
WH 89	3-2	The British Computer Society	3-2
ACT System 800	3-2	Astrology — case study	3-2
Panasonic JD 700U	3-3	IEEE-488 bus explained	3-2
Sinclair ZX-80	3-4	Economic simulation	3-3
Challenger C2 4P	3-4	Modem evaluations	3-5
Texas TI 99/4	3-5	5th West Coast Faire report	3-5
Altos ACS 8000-2	3-5	Wave Synthesis on Nascom 1	3-5
Hewlett Packard HP-85	3-5	Overcoming PET printer problems	3-5
Benchmark Timings summary	3-5	Random numbers	3-5
TRS-80 Model II	3-6	Sound to colour conversion	3-3
Sintrom Periflex 630/48	3-6	American report	3-3
Acom Atom	3-7	Simple approach to programming	3-3
DDE SPC/1 Series	3-7	Communication aid for disabled	3-4
PASCAL	3-1,2,3,4,5	Imphex — intelligent game PET	3-4
David Levy's Games	3-1,2,3,4,5,6,7	House of Commons report	3-4
On the line	3-1,2,3	Interrupt handling	3-6
Viewdata	3-4,5,6	Case Study — Compucolor installation	3-6
Pascal Part 10 — Concluded	3-6	Poem	3-6
IEEE interface — Part 2	3-6	Power supplies explained	3-6
Chess	3-7	Power supply design	3-6
Gateways to Logic	3-7	Program structuring in Basic	3-6
Face to Face — the man/machine interface	3-7	Sandbach school system	3-6
Network Notes	3-7	M6800 preview	3-7
Fact Sheets (Fax)		Case Study — Apple Installation	3-7
6800 opcodes	3-1	3-D Plotting	3-7
6502 opcodes	3-2	Package evaluations (systems)	
Personal Opinion (Interrupt)		Sales Ledger	3-1
The end of work? Lord Avebury	3-1	Purchase Ledger	3-2
Protest against technological determinism	3-3	Payroll	3-3
Who needs the CRA?	3-4	Word Processing	3-4
Schools computing — David Firnberg	3-4	Information retrieval & databases	3-5
Stating the obvious	3-5	Integrated accounts packages	3-6
Micros in big businesses	3-5	Stock Control	3-7
Animistics — a look at 'friendly' computers	3-7	Indexes	
Evaluations (Checkout)		Back Issues 1-1 to 2-4	3-2,3
Video Genie	3-2	Back Issues 2-5 to 2-8	3-4
Vector Graphic Flashwriter II	3-2	Programs	
Apple II Symtec light pen	3-3	BASIC Star Wars	3-1
Microdata UV8 EPROM eraser	3-5	PET Alien Attack	3-1
Softy intelligent EPROM programmer	3-6	Revas (conclusion) Reverse assembler for Z80	3-1
Exatron stringy floppy	3-6	Planet name generator — 6800	3-1
380Z High Resolution Graphics	3-7	Naming Nascom files	3-2
Calculator Corner		380Z Pictures	3-2
TI 58/9 Pseudo opcodes	3-1	Fuel tank calculations — PET	3-2
Casio Fx 502P Brag	3-1	PET large numeral generator	3-2
Casio Fx 501/2P Master Pack	3-2	PET tank battle	3-2
TI 58/9 Economics Simulations.	3-2	BASIC string handling routines	3-2
Programming efficiency	3-3		
Casio random number generator	3-3		

MK-14 scrolled messages	3-3	UK101 Dogfight	3-6
6800 Keyword retrieval system.	3-3	MK14 Frequency counter	3-6
PET Kaleidoscope	3-3	North Star Maths test	3-6
Efficient character storage		PET Sweeper	3-6
Z80 Assembler	3-3	PET Delete/Renumber	3-6
UK101 Dodgems	3-4	PET Cat and Mouse	3-7
TRS-80 Fox and hounds	3-4	UK 101 Graph Plotter	3-7
MZ 80K Sine wave addition	3-4	UK 101 Black Box	3-7
PET Backgammon	3-5	TRS-80 Graphics	3-7
UK101 Nedge	3-6	PET Robot Nim	3-7
PET Horse race	3-6	PET Golf	3-7
BASIC Renumber	3-6		

Personal Computer

World

BACK NUMBERS

Volume 1 No. 1 May 1978
Nascom 1/77-68: The Mighty Micromite/A charity system

Volume 1 No. 2 June 1978
Research Machines 380Z/Computer in the classroom/The Europa Bus.

Volume 1 No. 3 July 1978
Buzzwords — A to Z of computer terms/Pattern recognition/Micro music

Volume 1 No. 8 December 1978
Computers and Art/3-D Noughts and Crosses/Mickie — the interviewing micro.

Volume 1 No. 10 February 1979
Review — the Attache/Word on word processing/Micro assembler for the 6800/Sinclair to MPU interface/Draw pictures, written in Tandy Level II

Volume 2 No. 1 May 1979
Small computers for small organisations/Sorcerer graphics/Chess Programming Hints/Parkinsons Revas.

Volume 2 No. 2 June 1979
MSI 6800/Witbit — disassemble your programs/The Multilingual Machine/Polytechnical Processing.

Volume 2 No. 3 July 1979
Vision link: Interfacing and Software for the Superscamp VDU/Pet Preening/Extended cursor graphics for the TRS-80.

Volume 2 No. 4 August 1979
The North Star Horizon/High Speed Cassette Interface for the SWTP 6800/Garage Accounting program/Apple Medical Application.

Volume 2 No. 7 November 1979
PCW Show issue/6800 Bug/Hard disc security/Detecting literary forgeries/Benchtest — the Challenger C3

Volume 2 No. 8 December 1979
Micro-controlled toys/NASCOM — words and music/Systems — stock control/Benchtest — the Micro-mation Z-Plus.

PLEASE NOTE THAT THE FOLLOWING ISSUES ARE SOLD OUT

VOLUME 1 Nos. 4, 5, 6, 7, 9, 11, 12

VOLUME 2 Nos. 5, 6

VOLUME 3 Number 1

ALL OTHER ISSUES MAY BE ORDERED USING THIS FORM.

Any one issue 95p; Any two issues £1.75; Any three issues £2.50; Any four issues £3.00. All additional issues @ 50p each. Binders @ £2.95. All prices include post and packing. Cheque or P.O. payable to (PCW) SportsScene Publishers Ltd., 14 Rathbone Place, London W1P 1DE. Please allow up to 3 weeks for delivery and don't forget to state clearly your name and full address with your order. Please send me the following copies of PCW. I enclose a cheque/P.O. for £

Volume 1	Volume 2	Volume 3
1 2 3 8 10	1 2 3 4 7 8	2 3 4
<input type="checkbox"/> <input type="checkbox"/> <input type="checkbox"/> <input type="checkbox"/> <input type="checkbox"/>	<input type="checkbox"/> <input type="checkbox"/> <input type="checkbox"/> <input type="checkbox"/> <input type="checkbox"/> <input type="checkbox"/> <input type="checkbox"/>	<input type="checkbox"/> <input type="checkbox"/> <input type="checkbox"/>

Name _____

Address _____

*Tick appropriate boxes

Delivery on all items is usually ex-stock. Maximum delivery on all products is **GUARANTEED WITHIN SIX WEEKS** of order acceptance! Prices shown in colour are special offers for a limited period only.

COMMA COMPUTERS is one of the largest suppliers of computer terminals and micro computers in the United Kingdom. The bulk purchasing power that has given Comma Computers customers low prices and fast deliveries is now combined with software expertise and the benefit of having full field and in-house support

facilities – developed to serve the 1500+ customers who, in the past three years, have accepted the Comma Computers Challenge! Additions are continually being made to the Comma product range, so if you don't see what you are looking for, it is still worth a 'phone call to check on availability and price.

ACCEPT THE COMMA CHALLENGE...

MICRO COMPUTER COMPONENTS

The following comprises only a selection of the range of DEC and DEC compatible components we are able to offer. Please call for a quote for your specific requirements

DIGITAL EQUIPMENT CORPORATION PROCESSOR

DEC KD11-HC LSI-11/2 CPU with 32Kb RAM	£895
DEC KD11-R LSI-11/1 CPU with 32Kb RAM	£1350
DEC KDF11-HD LSI-11/23 CPU with 64Kb RAM	£1848
DEC KDF11-HF LSI-11/23 CPU with 128Kb RAM	£2772
DEC KDF11-GD LSI-11/23 CPU with 32Kb RAM	£2156
DEC KDF11-SG LSI-11/23 CPU with 160 Kb RAM	£3449

PROCESSOR OPTIONS
DEC KEF11-AA Floating Point Instruction Set £258
DEC KEV11-Extended and Floating Point Instruction Set £115

EXPANSION MEMORIES
DEC MSV11B 4K by 16-bit memory £395
DEC MRV11-BA PROM/RAM memory includes 512 byte RAM £199
DEC MSV11-DD 64Kb RAM including on board refresh £895
DEC MXV11-AA Multi-function module. Includes 8K byte RAM £492
DEC MXV11-A2 Bootstrap PROMS £33

COMMUNICATIONS OPTIONS
DEC DUV11-F Serial Interface Unit £160
DEC DUV11-KA RS-423 to 20Ma in-line converter £85
DEC DUV11-DA Synchronous Line Interface £420
DEC DZV11-B Four Line Asynchronous Multiplexer V24 £525

INTERFACE OPTIONS
DEC AAV11-A 12 bit, D/A Converter £850
DEC ADV11-A 12 bit, A/D Converter £895
DEC DCK11-AA Interface Chip Set £35
DEC KWV11-A Programmable Real-Time Clock £495

PERIPHERALS
DEC RL11-AK 5.2Mb top loading removable cartridge subsystem and controller £3388
DEC RL01-AK Add on 5.2Mb top loading removable cartridge disc drive £2495
DEC RXV21-BD Dual drive double density, 1024K bytes capacity plus DMA LSI-11 interface board £2556
DEC TUS8-BB Dual drive tape cartridge subsystem £595
DEC PB11-AY Desk-Top Universal PROM PROGRAMMER for connection to systems using RT11. Includes serial interface £1293

ACCESSORIES AND OPTIONS
DEC BA11-MF Expander box backplane and power supply £860
DEC Selection of cables Price on request
DEC H780-J Power Supply £450
DEC H9270 Backplane/card guide assembly £123
DEC H9273-A Nine slot backplane/cord guide assembly £363
DEC H9281-BA Housing assembly for four LSI modules £67
DEC H9281-BB Housing assembly for eight modules £104
DEC H9281-BC Housing assembly for twelve modules £135
DEC H8921-AA 2 x 4 backplane £50
DEC H8921-AB 2 x 8 backplane £70
DEC H8921-AC 2 x 12 backplane £99
DEC REV11-A Refresh/Bootstrap/Diagnostic/Terminator £175
DEC REV11-C Refresh/Bootstrap/Diagnostic/terminator £175

SOFTWARE PACKAGES
DEC RT-11 Real Time Operating System for 11/03 processors:
QJO13-CQ on DECpock (RL01) £985
QJO13-CX on Floppy Disc (RX02) £985
QJO13-CY on Floppy Disc (RX01) £775
DEC FORTRAN/RT-11 optimizing extended supersets of the ANSI standard FORTRAN IV language running under RT-11: QJ813-CQ on DECpock (RL01) £431
DEC BASIC-11 running under RT-11: QJ913-CY on Floppy Disc (RX01) £388
DEC Multi-user BASIC/RT-11: QJ921-CQ on DECpock (RX02) £425
DEC RSX-11M disc based real-time operating system: QJ738-CQ on DECpock (RL01) £2494

DEC COMPATIBLE COMPONENTS

INTERFACE OPTION

COMMA DRV-11 Equivalent £135

EXPANSION MEMORIES

CDC Memory Module 16K by 16-bit £350

PERIPHERALS

Draco 0.5Mb dual drive including controller (RX01 compatible) £1550

Dnco 1.02 Mb dual drive including controller (RX01 compatible) £1990

CDC Hawk 10Mb cartridge disc drive (RK05 Software compatible) £3250

CDC Hawk controller £840

CDC Phoenix 96Mb cartridge disc drive (RK06 Software compatible) £5250

CDC Phoenix controller for LSI-11 £2800

CABINETS

34" x 23" x 30" high, includes power distribution, cables and fans £395

34" x 23" x 60" high, includes power distribution, cables and fans £450

MICRO-COMPUTER SYSTEMS

DIGITAL EQUIPMENT CORPORATION

DEC PDP 11/03, RK02 (1.02 Mb disc) £4995

DEC PDP 11/23, RK02 (1.02 Mb disc) £5995

DEC PDP 11/703, RL01 (10Mb disc) £8995

DEC PDP 11/703, RL02 (20Mb disc) £10750

DEC PDP 11-23/703, RL01 (10Mb disc) £9750

DEC PDP 11/23/703, RL02 (20Mb disc) £11500

DEC PDP 11/03, TUS8, dual tape cartridge system £3250

All of the above prices are for original DEC equipment (except for cabinets) and include a minimum of 64Kb memory, floating point arithmetic options, RT11 run-time licence and are eligible for maintenance by DEC.

DEC COMPATIBLE SYSTEMS

Comma Robin 03 (5Mb RK01 compatible floppy disc system) £3995

Comma Robin 23 (as above but with DEC11/23 processor) £4750

Comma Kestrel 03 (1.02Mb RK01 compatible floppy disc system) £4500

Comma Kestrel 23 (as above but with DEC11/23 processor) £5250

Comma Hawk 03 (10Mb RK05 compatible cartridge disc system) £6950

Comma Hawk 23 (as above with DEC11/23 processor) £7650

Comma Phoenix 03 (96Mb RK06 compatible SMD system) £10750

Comma Phoenix 23 (as above with DEC11/23 processor) £11500

Four serial line interfaces are included in both DEC and DEC compatible micro computer systems and additional original DEC memory can be added at a price of £895 per 64Kb.

NORTH STAR HORIZON

8 bit micro-computer supporting CPM Operating System and comprising 32K memory, 2 serial and 1 parallel ports. Additional memory modules are available of £260 per 16K.

HRZ 1D, 180Kb disc drive £1495
HRZ 2D, 360Kb disc drives £1650
HRZ 2Q, 720Kb disc drives £1995

ANCILLARIES

SERVOGOR 281 Flat Bed Microprocessor Controlled multi-colour platter £2950

SIGMA GOC 5250 Graphics Option Controller - converts most VDUs to full graphics terminal £1995

MIDLECTRON M62 P/T Reader Punch - £1295 M42 P/T Reader Punch £895
ASCII/Telux Cod Conversion £10750

TRANSDATA 307 Acoustic Coupler £210
307 A Acoustic Coupler £185



VISUAL DISPLAY UNITS

DIGITAL EQUIPMENT CORPORATION

VT100 80/132 col with del keyboard £1195

VT132 As above + block trans/edit £1325

NEWBURY LABORATORIES

NL7000 Teletype compatible £425

NL7000C As above + cursor addressing £545

NL7002 As 7000 + num keypad & w/case £545

NL7002 (1K) Runs BASIC language £680

NL7002 (12K) As above with add memory £760

NL7002C As 7002 with cursor addressing £645

NL7007 As 7002 with block trans/edit £760

NL7007 (14K) As 7007 with 7 add pages £795

NL7009 As 7007 (14K) + project field £795

NL7009 APL As 7009 with APL char set £850

NL7009 with VT52 with emulation £795

NL7009 with ICL7181 emulation £1150

NL7009 with ICLQLSA emulation £825

NL7009 with Honeywell VIP 7250 emulation £850

NL7009 with Honeywell VIP 7001/6 emulation £1150

HAZELTINE CORPORATION

1400 Thy compatible + cursor addressing £550

1410 as 1400 + numeric keypad £590

1420 as 1410 + highlighting/ function keys £650

1500 as 1420 + upper & lower case £785

1510 as 1500 + edit facility £880

1520 as 1510 + block transmission £1050

1552 as 1520 + VT52 emulation £975



LEAR SIEGLER

3A Teletype compatible, XY cursor addressing £535

31 Tele type compatibility, edit and protected field facilities £795

42 As 31 plus up to 8 pages of memory £1075

3AG With Retrographics Option £1395

PERICOM

6801 Thy compatible del keyboard + edit £895

6802 as 6801 + function keys £1175

6803 80/132 cols + block transmission £1285

6804 as 6802 with extended keyboard £1385

COMMA'S MIX'N MATCH OFFERS

Comma offer you a guaranteed discounting structure for orders on any mix of products matched to meet your needs. It is not necessary to specify exactly what equipment from the Comma range will be required, nor the date it will be required. Provided that order and delivery are within a twelve month period, Comma will give a discount based on forecast requirements. Call for full details. All prices shown are 'one off end-user'. They are the most you need pay. Discounts start at three units, whether of the same specification or 'Mix'n Matched'.

FIELD SERVICE & MAINTENANCE
Field maintenance on your computer terminal and micro computers is available at competitive prices whether the hardware was bought from Comma or not. Specialist engineering and customising services are also available throughout the U.K. on a wide range of equipment. Comma Customer Engineers are skilled in preventative and remedial maintenance AND, for a limited period only, Comma are offering a special discount on maintenance contracts for new customers. Call for a quote - now!

To: Comma Computers Limited, West Horndon Industrial Park, West Horndon, Brentwood, Essex CM13 3XJ
Please contact me with complete information including price and delivery on _____
Please add my name to your mailing list so that I receive early notification of your 'special offers' on _____
Name _____
Position _____
Organisation _____
Address _____
Postcode _____ Telephone _____

COMMA COMPUTERS LTD

BRENTWOOD (0277) 811131

**BENCH
TEST**

SUPERBRAIN



The early SuperBrain adverts seemed too good to be true — then subsequent delays in its reaching the market place sparked off rumours of trouble. Now that the SuperBrains are here, do they live up to those original ad claims? Sue Eisenbach investigates. . .

Hardware

The Superbrain QD is a single unit personal computer weighing approximately 23kg and with physical dimensions 54cm wide by 57cm deep by 37cm high. Both in appearance and weight it seems like a VDU and, in fact, Intertec do market several VDUs in the same, attractive, white and grey structural foam case. However, in performance terms, it is, of course, a far cry from the humble glass teletype. The top of the case is attached to the base by means of four securing screws. Inside, the system is seen to be divided into four self-contained modules — the keyboard/CPU; the disk drives; the shielded CRT and the power supply. All are easily accessible without further fiddling

except for the disk drives which require the release of another two fixing screws (each) before they are detached and available for inspection.

The heart of any SuperBrain is the CPU/keyboard module. This contains two 4 MHz Z80As — one to handle the processor and screen I/O while the other takes care of disk I/O. The SuperBrain QD comes with 64k of dynamic RAM as standard (32 4116s) whereas an ordinary SuperBrain comes with 32k as standard but with sockets for another 32k. The machine also has 1k of static RAM for use by the second processor and 2k of ROM for bootstrapping at power-up. The rest of the board contains the character and keyboard encoder circuitry, the disk controller (FD1791) and the communication elec-

tronics — including two serial ports (switchable synchronous or asynchronous) which are under software control. Thus baud rate, parity, the number of stop bits and the transmission mode can be set from the keyboard. A 22-pin cable connector handles power and signals and a second 40-pin Z80A data bus connector is available for future expansion. At the moment, according to the documentation, a Centronics compatible parallel interface can be connected directly to this bus. Also promised (but not yet available) is an S100 bus adapter to allow the attachment of a single S100 board inside the SuperBrain case, next to the disk drives.

The keyboard generates the full 128 ASCII character set. The 76 keys include a separate numeric pad with a

row of cursor control keys and an alpha-lock. A nice feature is the pair of red keys at the lower corners of the keyboard. When depressed singly these have no effect; when depressed together however, the system re-boots itself — a two-handed operation which makes an accidental re-boot very hard to do. The only way I could get the screen to clear was `^L^K^J` (where `^` = 'control'), which is not ideal.

The CRT consists of a 30cm P4 phosphor tube mounted in an aluminium chassis whose screen displays 24 lines of 80 characters. The white characters on a grey background are composed of a rather cramped 5x7 dot matrix on a 7x10 character field. The result is that some of the lower case letters are somewhat unconventionally formed, especially those requiring descenders — the whole gives a vague 'ransom note' impression. The video circuit is mounted in the base of the CRT chassis and is easily accessible.

The SuperBrain QD is supplied with twin Shugart double-sided, double-density mini drives (Model 450) which on the review machine were completely reliable and noticeably quieter than single-sided drives. Each disk holds 338 kbytes formatted (700k unformatted) in G8 sectors at 512 bytes/sector — which makes the reading of normal 128 bytes/sector disks rather complicated. Average access time is 250 milliseconds (35ms track-to-track) with a transfer rate of 250 kbits/second from 300 rpm drives.

The 240 V power supply is fitted in Britain. Bad placement of the transformers can cause a screen waver but the review machine's transformers were all fitted behind the drives and caused no discernible interference.

Software

The system boots in with "64K SUPERBRAIN QUAD DENSITY DOS VER 3.0 FOR CP/M 2.2"

at the top of the screen. Along with CP/M 2.2, the review machine was supplied with both the compiler and interpreter for Microsoft's MBasic 5.0, Digital Research's new PL/1 compiler, SORCIM Pascal/M and Wordstar. SuperBrain's operating system contains several utility programs to deal with, for instance, the conversion of 128 bytes/sector disks to the 512 bytes/sector required by the latest DOS system. I never actually succeeded in getting this one to work — the program always failed with a 'disk not ready' message, so it can't be as straightforward as it seems and certainly more complex than on some other machines I have used. The two serial ports, on the other hand, can be easily re-configured by means of the program CONFIGUR, whereby the baud rate, parity etc. can be changed simply by selecting the required value from a menu.

PIP contains two functions, INP and OUT, which, according to the manual, allow the SuperBrain to be connected (and to behave as a dumb terminal) to another computer or to permit the transfer of ASCII or Hex files between the two machines. After some hours of struggling to make the connection with an LSI 11 according to the manual, I phoned Encotel, who had provided the review machine, and discovered that an



A trepanned SuperBrain — note the heavy shielding between CRT and disk drives.

extra signal was required to make contact with the SuperBrain.

Once that was accomplished I had no trouble connecting up and transferring files from the LSI 11 to the SuperBrain via INP.

There is a size limitation of 25k per file and this must contain all the dialogue between the keyboard and the remote processor, as well as the file data itself. It is, of course, necessary to edit this dialogue out to return the file to its original state. I was also able to use the SuperBrain as a dumb terminal via INP, although the SuperBrain was not as dumb as I would have liked. The connection could be broken for instance by rapidly striking one or more of the keys, in which case PIP was liable to abort. Fortunately, upon re-connection, everything was usually all right. Another way to break the connection was to attempt to list rubbish (e.g. a binary file) on the screen in which case PIP again would abort, but the LSI would continue listing out to nothing.

OUT should have enabled the transfer of files from the SuperBrain to the other machine. After failing to get this

to work, I was informed that this version of OUT contained a bug, the patch for which was still on its way from America.

The BIOS portion of DOS is provided as a source program to simplify modifications to the peripheral drivers. The Basics have already been reviewed by me elsewhere (*quite favourably in PCW December 1979 — Ed*), so we pass to the latest Wordstar which contains the nice feature of displaying a directory listing just before you load the file in, so that forgetful operators can remind themselves of the precise name of the file they require without having to return to operating system level. You can also switch disks (the 'logged — in disk') without leaving Wordstar — so that you could keep all the text files on one disk, and Wordstar itself, write-protected if necessary, on another. Long sessions could ensue without ever leaving Wordstar or having to re-set all those editing parameters — the package becomes more like a full operating system every time I use it!

Pascal/M is a fairly large Pascal compiler requiring at least 56k of memory

Technical Data

CPU:	2 Z80A 4 MHz
Memory:	64k dynamic RAM, 1k static RAM, 2k ROM
Keyboard:	76 keys, full ASCII
Screen:	12" white on grey
Cassette:	N/A
Disks:	2 drives, 5¼" double density, double sided
Printer:	N/A
Bus:	Z80A 40-pin data bus
Ports:	2 serial
System Software:	CP/M
Languages:	Basic 80, PL1, Pascal/M, 8080 assembler

The ANADEx DP 9500

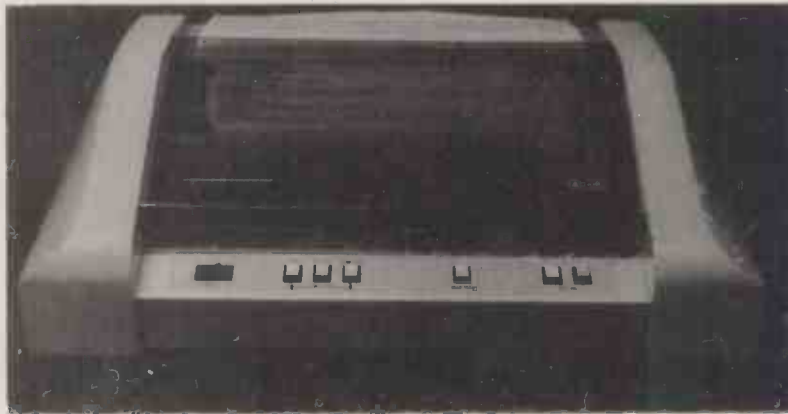

LIST PRICE

£895

*Quantity Discounts
Available*

IF YOU REQUIRE A COST EFFECTIVE PROFESSIONAL STANDARD DOT MATRIX PRINTER WITH GRAPHICS CAPABILITY, THEN CONSIDER THE ANADEx DP 9500 SERIES

K.S.L. SELL THE ANADEx PRINTER RANGE IN SCOTLAND AND SUPPORT IT THROUGHOUT THE UK AND IRELAND, AS THE ANADEx APPOINTED SERVICE AGENT.

Call:



KODE SERVICES LTD,
CRAWFORD CHAMBERS,
CALENDAR ROAD,
FALKIRK, SCOTLAND
Telephone: Falkirk 22766

Telex: 449335

PROGRAMMER SW1

**Commercial experience unnecessary.
Sound knowledge of BASIC essential.**

Do you gain satisfaction from writing elegant, reliable programs which utilise system resources efficiently?

Do you want to become a member of a small growing team developing application programs within a progressive professional firm?

We have Hewlett Packard 3000 Series III and HP2000 Access systems, running on BASIC in interpretive and compiled forms, with 180 megabytes of online storage and 20 user terminals. We can offer challenging programming fare, principally evolving new applications and extensions for our real-time database.

Please apply in writing to C. W. Jonas FRICS

**DRIVERS
JONAS**

Chartered Surveyors
16 Suffolk Street
London SW1Y 4HQ
01-930 9731

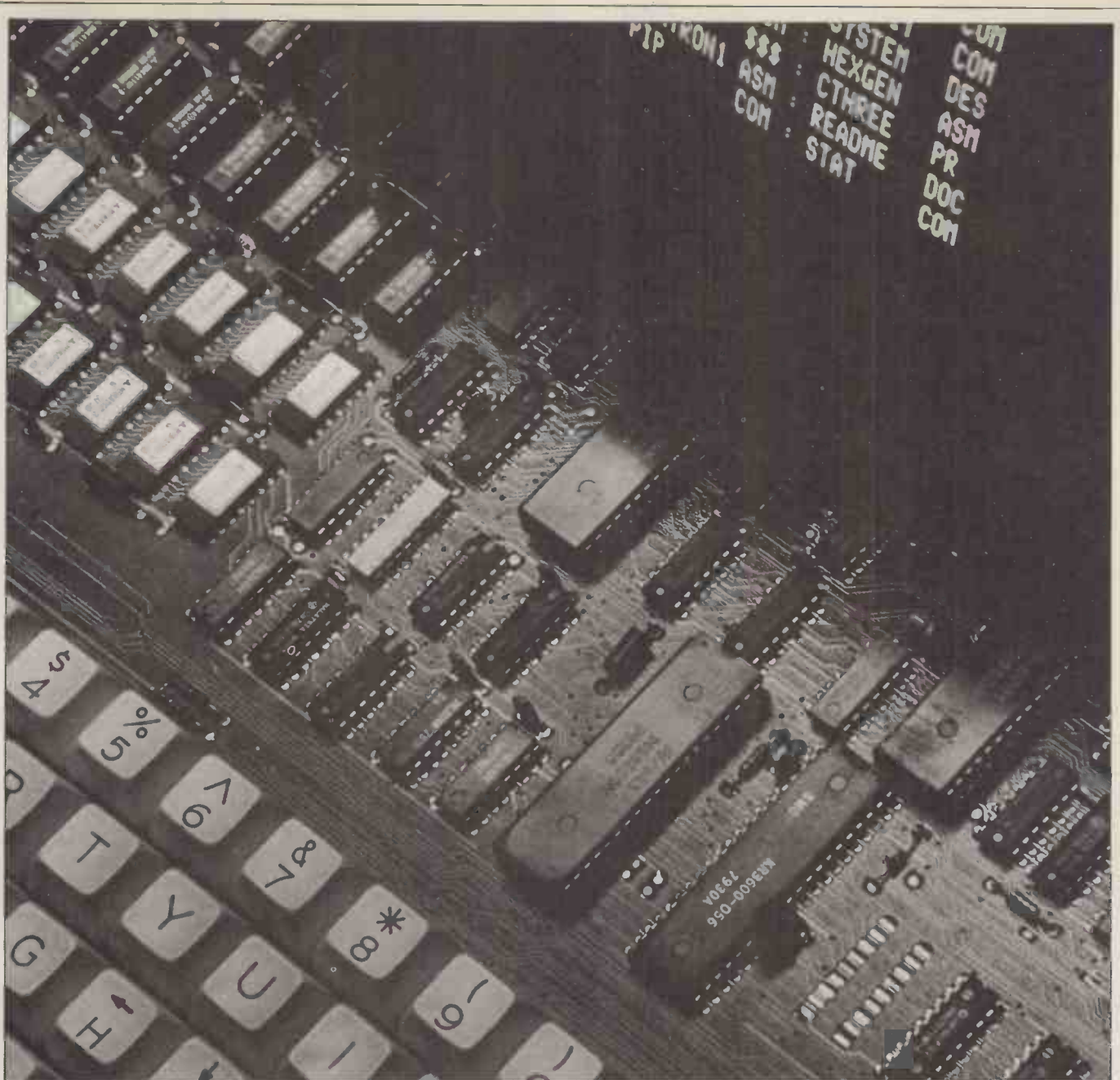

and compiling to pseudo-machine code (p-code). This implementation is 'extended' using UCSD and the definition of ADA for guidance. Such extensions include SEGMENTation, STRINGS and string functions, untyped files, an extended character set for identifier names, direct access files and a random number generator.

Digital Research's PL/1-80 is the first implementation of PL/1 on a micro that I've seen. It is based on the ANSI General Purpose Subset (Subset G). The subset G does not include the following attributes or functions: DEFINED, FLOAT, DECIMAL, LIKE, PICTURE, FILE (allowed only in an OPEN statement), asterisk extents, dynamic arrays, ATANH, DATE, STRING, and TIME VALID; while the following features have been added: %REPLACE, READ and WRITE for variable length ASCII records, GET EDIT extended to full record input in a format, intrinsic functions ASCII and RANK. In order to run a PL/1 program it must first be compiled using a three-pass compiler which produces relocatable machine code, and then

linked with the runtime subroutine library before it can be executed.

Potential

With its neat, integral appearance and CP/M operating system, the SuperBrain was designed to fit into a commercial environment. Other than Wordstar, I was not supplied with any application software on the review machine although plenty of CP/M software is available. I was lent a manual for Data Star, a filing system which permits the entry of information via forms on the screen, with range and format checking, into a file with multiple keys. According to its documentation, Data Star allows a user to select records satisfying given criteria and can be used in conjunction with programs in most languages.

Either the second serial port or the Centronics compatible connector can be used to interface a printer to the SuperBrain and that about exhausts the physical enhancements possible on the single stand-alone machine. Although

this is not necessarily a limiting factor — 64k RAM and 680k storage constitute a pretty respectable micro-offering in the commercial environment — Intertec's plans to provide a link-up capability through the Compustar and the machine's ability to behave like a terminal of arbitrary intelligence, make the SuperBrain a reasonable prospect for any multi-user or distributed processing application. I particularly liked the fact that the multi-user system allows for the sharing of expensive peripherals without overloading either the processors or the data-bus — a mistake which some of Intertec's competitors have made to their cost.

As an intelligent terminal in a distributed processing system, the SuperBrain certainly has the right looks and it is compact, about the same size and shape as a fairly standard VDU. Unfortunately, the review machine did not have all the software necessary to turn it into a robust, truly intelligent terminal.

Looking at the machine from an educational viewpoint, it has some limitations. I suspect that the case

Buying Computers?

Commodore PET 32K
£675.75 plus VAT

Sharp MZ-80K
£520.00 plus VAT

ITT 20/20 16K
£623.00 plus VAT

ACT 808 inc dual disk drive
£3950.00 plus VAT

We'll give you more than a good deal

Under one roof in London's West End you can find:

HARDWARE:

A comprehensive range of hardware to meet most applications - and budgets, with terms to suit you.

SOFTWARE:

Probably the widest range of off-the-shelf software in the UK. Try out the packages and choose the one that suits you.

CONSULTANCY SERVICES:

To apply micro computer systems to business, education or the home, make an appointment with our trained professionals for friendly advice based on extensive experience of discussing problems with many others like you.

MAINTENANCE AND REPAIR CLUB: that guarantees microcomputer users minimum downtime at very attractive premiums.

REFERENCE MATERIAL:

A library of publications covering all aspects of the microcomputer world, including back issues of this and other important periodicals.

DEMONSTRATIONS:

Regular, free demonstrations of business software - phone for details, times etc.

LION MICROCOMPUTER CENTRE

is the single source to meet all your requirements. The above prices do not apply to account sales.



LION MICRO-COMPUTERS

Small Computers - to make your business bigger
Lion Computer Shops Ltd., Lion House, 227 Tottenham Court Road
London W1 (First Floor) Telephone 01-637 1601
Telex 28394 Lion G.
Open 9 to 6, Monday to Saturday (Thursday to 7)



CHROMASONIC electronics

PHONE OR SEND S.A.E.
FOR LATEST PRICE
LIST ON ALL OUR
RANGE

56 FORTIS GREEN ROAD MUSWELL HILL LONDON N10 3HN
TELEPHONE 01-883 3705 01-883 2289

your soundest connection in the world of components

PETS



ALL WITH NEW KEYBOARD AND GREEN SCREEN

2001-8N 8K RAM £399
2001-16N 16K RAM £499
2001-32N 32K RAM £599
CASSETTE DECK £55

INTERFACES AVAILABLE

X-Y PLOTTERS, ANALOGUE TO DIGITAL CONVERTORS,
16 CHANNEL INTERFACES,
BI DIRECTIONAL INTERFACES ETC.

UKIOI

THE FASTEST GROWING FOLLOWING KIT £199 OF THEM ALL

- * Free sampler tape
- * 8K BASIC in ROM
- * 4K RAM expandable to 8K on board
- * Kansas City tape interface
- * RS232 interface
- * Full Qwerty keyboard



BUILT & TESTED £249

NEW MONITOR ALLOWS FULL EDITING & CURSOR CONTROL £22 8 x 2114 £22.50

LS Series

74LS00	.18	74LS30	.20	74LS86	.27	74LS151	.81	74LS190	.86
74LS01	.18	74LS32	.26	74LS90	.57	74LS153	.52	74LS191	.86
74LS02	.18	74LS33	.26	74LS91	.97	74LS154	1.30	74LS192	1.04
74LS03	.19	74LS37	.23	74LS92	.69	74LS155	.72	74LS193	1.04
74LS04	.20	74LS38	.23	74LS93	.60	74LS156	.72	*74LS194	.86
74LS05	.22	74LS40	.20	74LS95	.81	74LS157	.57	74LS195	.97
74LS08	.20	74LS42	.65	74LS96	1.16	74LS158	.57	74LS196	.97
74LS09	.22	74LS47	.81	74LS107	.32	74LS160	1.09	74LS197	.97
74LS10	.20	74LS48	.81	74LS109	.32	74LS161	.69	74LS221	.92
74LS11	.20	74LS49	.81	74LS112	.32	74LS162	1.16	74LS240	2.08
74LS12	.20	74LS51	.18	74LS113	.32	74LS163	.69	74LS241	2.08
74LS13	.37	74LS54	.18	74LS114	.32	74LS164	1.06	74LS242	2.08
74LS14	.65	74LS55	.18	74LS112	.69	74LS165	.72	74LS243	2.08
74LS15	.20	74LS73	.33	74LS123	.72	*74LS166	1.65	74LS245	2.50
74LS20	.20	74LS74	.30	74LS124	1.39	74LS168	1.71	74LS247	1.09
74LS21	.20	74LS75	.40	74LS125	.36	74LS169	1.71	74LS248	1.09
74LS22	.20	74LS76	.27	74LS126	.36	74LS170	1.72	74LS249	1.09
74LS26	.20	74LS78	.27	74LS132	.60	74LS173	.81	74LS251	.96
74LS27	.20	74LS83	.78	74LS133	.39	74LS174	.97	74LS253	.92
74LS28	.22	74LS85	.81	74LS136	.36	74LS175	.97	74LS257	.92
				74LS138	.65	74LS181	2.77	74LS258	.92
				74LS139	.65	*74LS188	2.75	74LS259	1.39
				74LS145	.97	74LS189	2.08	74LS261	4.50
								74LS266	.37
								74LS273	1.70
								74LS279	.57
								74LS283	1.09
								74LS289	4.50
								74LS290	.91
								74LS293	.91
								74LS295	1.30
								74LS298	1.16
								*74LS348	1.39
								74LS352	1.04
								74LS353	.92
								*74LS362	4.21
								74LS365	.55
								74LS366	.55
								74LS367	.55
								74LS368	.55
								*74LS373	.78
								74LS386	.36
								*74LS393	.84
								*74LS668	1.17
								74LS670	1.71

PRINTERS

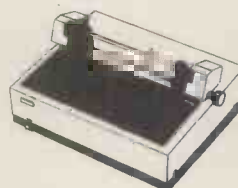

EPSON TX-80
£395

Dot-matrix printer with Pet graphics Interface: Centronics parallel, options: PET, Apple and serial.

Please add VAT 15% to all prices. Postage on computers, printers & cassette decks charged at cost all other items p&p 30p. Place your order using your Barclay or Access Card. (Minimum telephone order £5.00) Trade & export enquiries welcome. Credit facilities arranged

Memory map

BIOS	FFFFH
BDOS	FA00H
CCP	EC00H
	E400H
USER	
AREA	
CP/M	0200H

Bench marks

BM1	1.56
BM2	5.25
BM3	14.01
BM4	13.91
BM5	14.77
BM6	26.26
EM7	43.24
BM8	5.56

Disk Tests

D1	0.95
D2	16.41
D3	26.35
D4	14.41
D5	13.02

All times in seconds

would rapidly become fairly shabby after a period of being humped from room to room and bashed about in 'normal' school use. Although the screen is memory-mapped and the user can therefore direct characters to any desired screen-position, there is no graphics capability as such, and there appears to be no obvious method of adding this feature — which is so desirable for the teaching of programming, for Computer Aided Learning and for good computer games. The SuperBrain is also a very unlikely laboratory tool as the only possibilities for interfacing are through the two serial and single (optional) Centronics parallel port.

Expansion

The review machine was fully expanded — a minimal SuperBrain has 32k RAM and two single-sided, double-density drives (340k total). Intertec Data Systems showed two expansion products at the NCC. The first was the Z80A to S100 bus converter which will allow a single S100 card (for example a hard disk controller) to be installed in the case and thus be built into the system. The second way to expand the SuperBrain is to turn it into an intelligent terminal operating in a multi-user system. Intertec has announced the Compustar multiuser system in which up to 15 SuperBrains can be connected to a master processor which controls access to hard disks and printers, etc. The drives will be Century Data Systems 20 Mbyte Winchesters, or CDC 32 Mbyte or 96 Mbyte cartridges. According to the sales brochures, up to four Compustars can be connected



Neat and simple. . . rear view of the SuperBrain.

to the same cartridge drives. We await developments with interest. . .

Documentation

The review machine came with a large SuperBrain user's manual, plus six others. The user's manual looks like a mail-order catalogue, complete with thumb-index. After the first few pages of advertising, a table of contents is reached wherein are listed the names of all the standard software manuals available within a CP/M system with Basic 80, plus several sections devoted to the SuperBrain. I found this format much easier to use than the dozen or so independent manuals in a ring binder which one has come to expect from the (better) firms. I was not that impressed however by those sections produced by Intertec themselves. Firstly, they document an ideal system rather than the system that actually exists, and secondly, they tend to gloss over the details which might pin the manual down to one particular SuperBrain specification.

The other manuals provided were for Pascal/M, Wordstar, Data Star and PL/1 (three manuals). The Pascal/M manual has a table of contents, is paginated, indexed and clearly written. It is not a Pascal manual however (since Jensen and Wirth have written one which every Pascal user presumably possesses), but rather a description of how to use Pascal/M in particular, and how it differs from 'standard' Pascal. The —Star manuals are comprehensive but are rather turgid with fairly heavy-handed descriptions of the various processes and procedures — a shame since the programs are really very good.

The three PL/1-80 manuals comprise a language manual, Link-80 operator's guide and an applications guide. They are all paginated and have detailed tables of contents. All are in the same, concise, in-house style as the CP/M manuals. The language manual defines the language but without giving any examples. The Link-80 operator's guide has chapters on the linkage editor, relocatable macro assembler, the librarian, interfacing conventions and runtime subroutines. The applications guide is a tutorial book which provides the examples required to learn PL/1-80.

Conclusion

The SuperBrain is a compact, attractive 'single-box' computer, containing two Z80As and running under CP/M. It's competitively priced in relation to other mini-floppy, Z80A, CP/M systems. It doesn't contain a number of slots for a variety of different boards, so in that sense it hasn't the versatility of some of its competitors. However, its big plus is that it's an integral, stand-alone system.

It has some lovely touches, like the programmable serial I/O ports and the two-button re-set, and apart from some reservations regarding the software which controls the data transfer to another processor, I found the SuperBrain completely reliable, a pleasure to use, and very impressive with the new, quiet double-density, double-sided drives.

At a glance

FIRST IMPRESSIONS

Looks	****
Setting up	****
Ease of use	****

HIGH LEVEL LANGUAGES

Basic	****
Cobol	N/A
Fortran	N/A
Pascal	****
PL/1	****

PACKAGES

Business	N/A
Education	N/A
Home	N/A

PERFORMANCE

Processor	****
Cassette	N/A
Disk	****
Peripherals	N/A

EXPANSION

Memory	*
Cassettes	N/A
Disks	N/A
Bus	**

COMPATIBILITY

Hardware	**
Software	****

DOCUMENTATION

--	------

VALUE FOR MONEY

--	------

Newbury VDUs from £372 (SAVE c£75!) DEC
 64K Memory Modules from £760 (SAVE
 c£140!) LSI-11 Components and Options 15%
 off (SAVE £££s!) DRV-11 Equivalent £120
 (SAVE c£15!) Transdata Acoustic Couplers
 from £166 (SAVE c£19!) North Star Horizon
 Memory Modules £230 (SAVE c£30!) 25% off
 Selected Conferences (SAVE £££s!)
 Centronics Printers from £405 (SAVE c£45!)
 Cole Terminal Desks from £78 (SAVE c£20!)
 Diablo Printers from 12.5% off (SAVE £££s!)
 Discounts being negotiated for Travel, Tickets,
 Publications, Finance ... (SAVE YOUR
 SUBSCRIPTION TO COMPUTERCLUB!)

JOIN
 NOW - FOR
 A FREE ENTRY IN
 COMPUTERCLUB'S
 WIN-A-PET
 COMPETITION

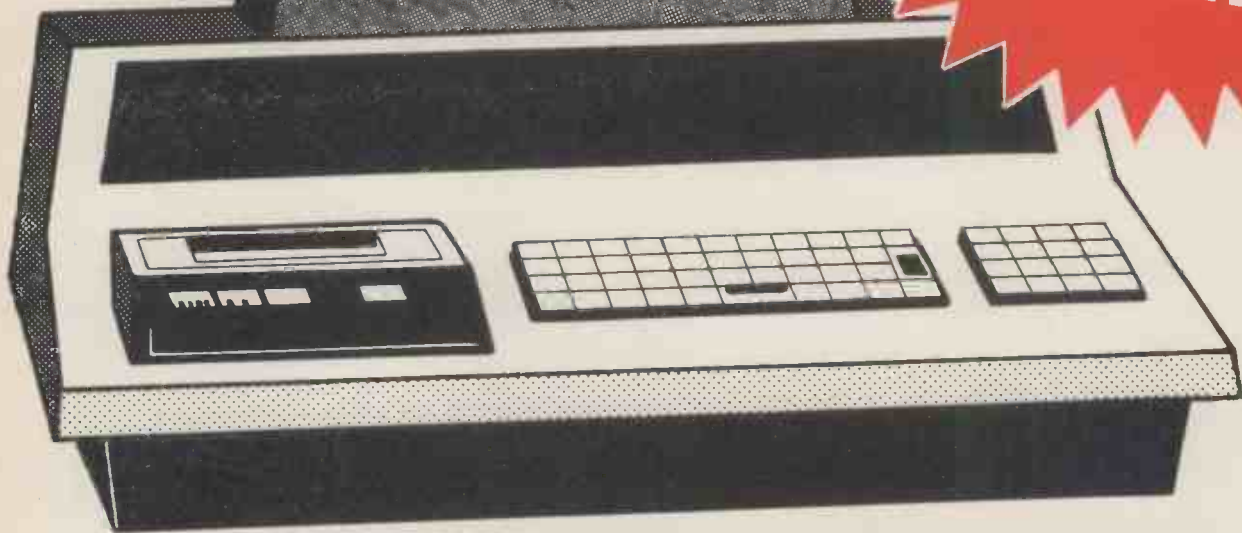

**YOU ARE ONE OF THE 'NOW'
 COMPUTERPEOPLE - AREN'T YOU? JOIN**

COMPUTERCLUB

**AND GET SOME
 REAL VALUE FOR YOUR
 MONEY** (SEE SUMMER SPECIAL OFFER)

*Discounts on Micros, Components, VDUs, Printers
 (already includes products from manufacturers
 such as DEC, North Star, Newbury Laboratories ...
 and more soon).

*Discounts on Conferences, Seminars, Education
 Programmes, Publications ... International Travel
 offers to leading overseas events.

*Newsletter with details of the above, Exhibition
 Tickets, Jobs, For Sale, Wanted, Swaps, Tips,
 User Groups ... and News of Interest to YOU.

Subscription saving discounts now available on systems,
 software, components and peripherals for PET, SHARP,
 ITT, ACT, RICOH, OKI, EPSON, ANADEX, NASCOM.
 COMPUKIT, SUPER BRAIN ... and lots more soon.

To COMPUTERCLUB,
 42 Great Windmill Street, London W1V 7PA

Please enrol me as a Member of Computerclub before
 31st August 1980 so that I can:

1. Take advantage of the 'Summer' Subscription that
 represents a saving of £5.75 over the rate thereafter. A
2. So that my name will be included in the FREE Win-a-Pet
 Draw taking place on 1st September 1980.

I enclose a Cheque/Postal Order made payable to
 COMPUTERCLUB for £7.50 (£6.52 + 15% VAT - an of
 VAT receipt will be sent with your Membership Card).

Send me further details of Membership at £13.25 in the
 enclosed stamped addressed envelope.

Name _____

Address _____

Signed _____ Date _____

*This offer applies to UK residents only.
 Overseas subscription is £20.

GATEWAYS TO LOGIC

CHAPTER 2: ON TO BOOLEAN ALGEBRA

Derrick Daines continues his unique guide to teaching others the basics of microcomputing.

When I was in my teens I 'discovered' the public lending library. It was only half a building — the other half had been destroyed by bombs — and tarpaper was nailed up to keep out the wind and rain. I haunted the place. In there I had uncovered the wonderful world that lay beyond the war-torn streets of Grimsby. Not for me the fantasy of fiction, for I had found the non-fiction shelves and the world of fact to be fairytale enough.

One day I happened to come across the name of one George Boole (1815-1864), a Lincoln mathematician, who was apparently one of those able but slightly eccentric men that the Victorians threw up in abundance. He had written a few obscure papers, a book on symbolism and had even been awarded a medal by the Royal Society in 1844. I felt more than a passing interest. At that time I sang in a church choir and the name of the incumbent was a Reverend Boole. I knew that Rev Boole came from Lincoln and as Boole was not a common name, I reasoned that there was probably some connection.

Accordingly, on the next Sunday I asked Rev Boole if he had had a relative called George who was a mathematician. Oh yes, he said off-handedly, that was his grandfather. He of course had never met him, but he did know that his grandfather had started a school in Lincoln and the story in the family was that after school, George used to potter about upstairs in his little study, 'doing things', but nobody quite knew what. Nobody took much notice of it, he said. There was a faint air of fond indulgence and the conversation lapsed.

About 20 years later, having been abroad for some time, I arrived back in Grimsby and stepped out of the station to be confronted by a news-agent's placard which read, "Local Grandson of Famous Scientist!" My mind leapt the intervening years to that brief conversation with the vicar. Quickly I bought a paper and sure enough, there on an inside page was a photograph of Rev Boole alongside an account of his grandfather's work; it had now become known world-wide as Boolean Algebra.

What had happened? What had lifted George Boole's work from near total obscurity into world-wide prominence — almost a hundred years after his death? In a word, the computer had happened. George had had the wholly original idea of reducing a statement made in English to a single algebraic letter so that it could be manipulated in a manner similar to numeric or ordinary algebra. At the time the idea had had

little, if any, practical use but when the computer materialised it was found that the two complemented each other perfectly. Not only was the computer able to manipulate the most complex Boolean statements with consummate ease, but Boolean Algebra also presented the best possible method of describing computer action — a method moreover that could be understood by engineers the world over. It transcended language barriers the same way as mathematics; anyone could understand it, no matter what their native tongue. Not bad for one man's slightly eccentric ideas carried through in his spare time!

Think back to Venn diagrams. Instead of labelling one hoop RED, meaning 'All blocks that are red are inside this circle,' if we label it 'A', then we have taken the first and most fundamental step towards understanding Boolean. Similarly, a second hoop could be labelled 'B', meaning 'All blocks inside this hoop are large.'

A dot placed between two letters is by convention read as AND, so the statement for the overlapping area of two hoops is A.B which means, 'All blocks in this area are both red and large' (Fig 1).

A is read as NOT A and is taken to be shorthand (in our example) for 'All

blocks in this area are not red', or if you prefer 'No block in this area is red.' The OR statement is a little tricky — take for example 'boys or girls are allowed in'. Do we mean boys only or girls only, or do we mean boys and girls? In fact we use both definitions in common speech, frequently interchanging them as necessary to suit our purpose. To prevent confusion therefore it's wisest never to use OR on its own, but rather always to preface it with the conditional 'exclusive' or 'inclusive'. Exclusive-or of course excludes the possibility of having both attributes at once, while the Inclusive-or allows for this possibility.

Unfortunately there has not until recently seemed to be much common ground in the use of symbolism for either the inclusive-or or the exclusive-or. Mathematicians have used one symbol, industry another and the writers of books on 'sets' yet a third. Moreover, some of these symbols have been subject to change over the years so that switching from one text book to another can be a little confusing. In this series I shall use the addition sign (+) for the inclusive-or and the shorthand term 'ex-or' for the exclusive variety.

'If A then B' or, as it is sometimes called, implication, may be confusing or difficult to understand for some (Fig

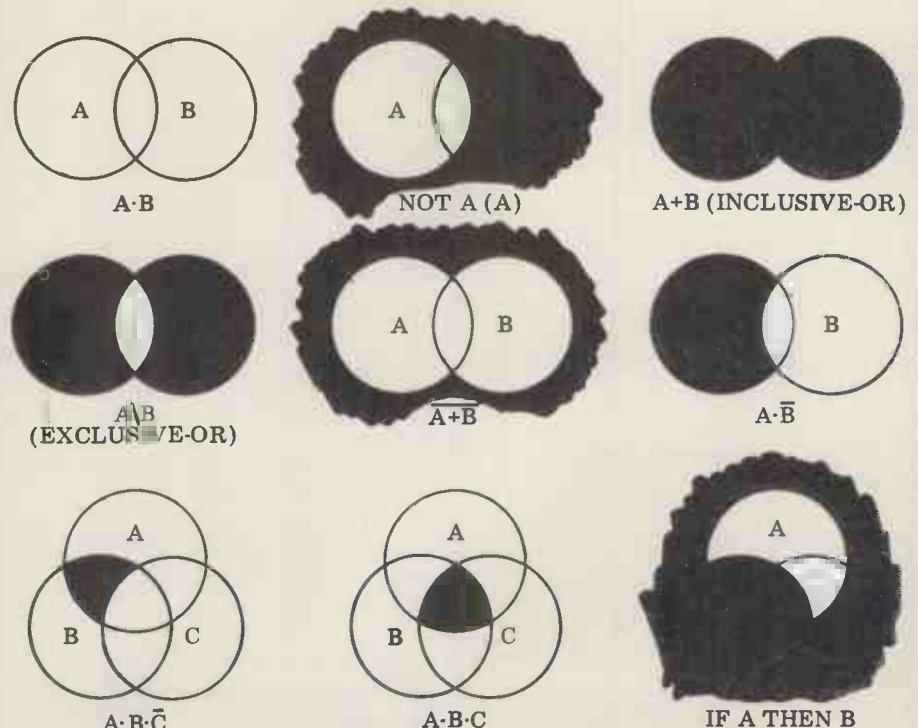

Fig. 1 In each case, the shaded area represents the truth of the statement

1). The clue here is to remember that 'If A then B' has got nothing to say about conditions in C or about the area outside the three hoops. The only conditions NOT allowed are A alone, or A only with C.

The reader is now equipped to study Figure 1 very carefully and should not proceed until it has been fully understood.

Window cards

A window card system for Venn Diagrams was devised by Martin Gardner of the *Scientific American* and modified by Cundy & Rollett for their very fine book, *Mathematical Models* (Clarendon Press, 1960). It's based on the notion that if windows are cut in cards corresponding to different Boolean statements, then holding the cards in superimposition will reveal the logical elements that are true in all the applied statements.

The reader is referred to the work by Cundy & Rollett for a detailed description of a beautifully-devised system of cards of an equilateral shape, the idea being that each card may be made to do treble duty as it's turned around. (Fig 2). This of course cuts down the work of preparation if they are to be used repeatedly. Such a set ought to be in the possession of every teacher expecting to devote a fair amount of time to Venn diagrams and Boolean algebra. Ideally, the sets should be cut out of hardboard or thin ply . . . if vanished, such a set will

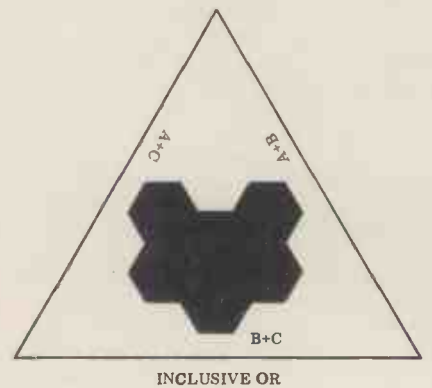
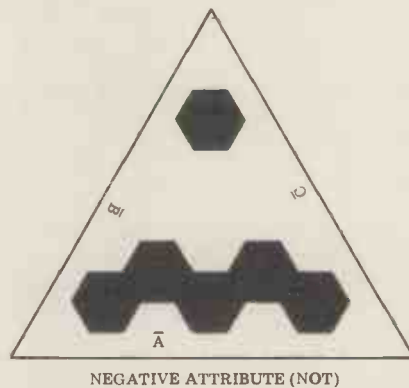
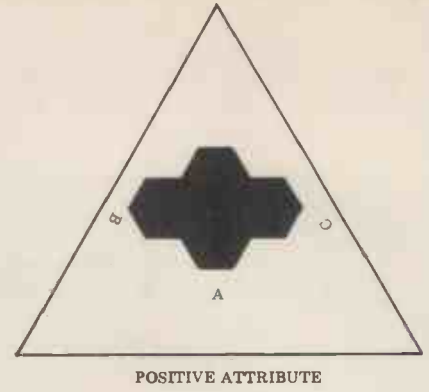
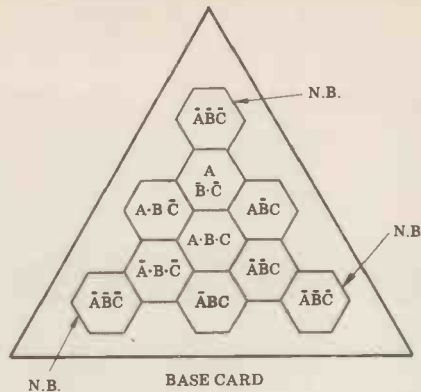

Fig 2 Note that the area outside the hoops has been reduced to three hexagons

TELEPHONE
0734 595269
READING, BERKSHIRE. (24 HOUR SERVICE)

EVERY PROGRAM ALWAYS IN STOCK

MAIL ORDER
PO BOX 88
READING, BERKSHIRE.

<p>*GAMES* TREASURE TROVE OF GAMES NO: 1 £10.00 You control the landing of the module on the moon. Put the letters into sequence in as few moves as possible. On the basis of the clues given, find the Wumpus before he finds you.</p> <p>TREASURE TROVE OF GAMES NO: 2 £10.00 Deflect the moving ball to hit the target. Your PET deals the cards — you place your bet and play. Two amazing space battle games.</p> <p>TREASURE TROVE OF GAMES NO: 3 £10.00 Guide Concordo to the runway and land — if you can. Try to contain the fast moving ball.</p> <p>TREASURE TROVE OF GAMES NO: 4 £10.00 Play large scale Noughts & Crosses against your PET. Two versions for old and new rom machines.</p> <p>TREASURE TROVE OF GAMES NO: 5 £10.00 Guide the glider to its landing place.</p> <p>TREASURE TROVE OF GAMES NO: 6 £10.00 Take on your PET at Backgammon.</p> <p>TREASURE TROVE OF GAMES NO: 7 £10.00 Design the cellular structures necessary to sustain life in future generations.</p> <p>TREASURE TROVE OF GAMES NO: 8 £10.00 As sophisticated PET version of the classic board game.</p> <p>TREASURE TROVE OF GAMES NO: 9 £10.00 You are the sheriff and you must get rid of ten outlaws who are out to get you.</p> <p>TREASURE TROVE OF GAMES NO: 10 £10.00 Lead your squadron of Spitzers into battle against the enemy bombers.</p> <p>ARCADE SERIES NO: 1 - INVADERS £7.00 The PET version of the "Space Invaders" games that is sweeping the nation.</p> <p>ARCADE SERIES NO: 2 - ACROBAT £7.00 Another game popular in the pubs and clubs of the land. Control the see-saw on which two men are bouncing up and down, hitting the moving balloons above them.</p> <p>ARCADE SERIES NO: 3 - 3D STARTREK £7.00 The ultimate Star Trek game. See the stars go as you zoom through space in warp drive on your mission to save the universe. (Tread boldly! Instruction booklet supplied.)</p>	<p>MP 040 OSC Lunar Lander MP 041 Jumbo Jet Landing MP 042 Draw Poker MP 043 Galaxy Games MP 044 Star Trek MP 045 Grand Prix MP 046 Backgammon MP 047 Space Flight MP 048 Asterix MP 049 Ohello MP 050 Reverse MP 051 Polo MP 052 Star Trek MP 053 Pirinopoly MP 054 Sorcerer's Castle MP 055 Jason & the Argonauts MP 056 Dodge City MP 057 Molecules & Atoms MP 058 Horse Race MP 059 One Arm Bandit MP 060 Squadron Scramble MP 061 Tower of Hanoi MP 062 Subkiller MP 063 Minefield MP 064 Arcade Series No. 1 - Invaders MP 065 Arcade Series No. 2 - Acrobat MP 066 Arcade Series No. 3 - 3D Startrek</p>	<p>MP 070 R.L.C. CIRCUIT ANALYSIS MP 071 DRAWING LOAD AND DIE DESIGN MP 022 and MP 023 ROCKSTOCK ARDENSTOCK MP 024 DATA BASE UTILITY MP 025 COST ESTIMATION MP 027 SURVEY ANALYSIS MP 009 MORTGAGE ANALYSIS MP 033 BOOKS MP 057 STOCK MARKET TRENDS MP 021 PAYROLL MP 007 BASIC MATHS MP 008 BASIC STATISTICS 1 MP 030 BASIC STATISTICS 2 MP 050 NUMERICAL METHODS PACK 1 MP 049 LINEAR PROGRAMMING MP 055 BEST LINE AND LEAST SQUARES MP 031 USER PORT COOKBOOK MP 003 DISASSEMBLER MP 004 MACHINE CODE PACK GO 010 LISP (DISK) GD 001 ASSEMBLER DEVELOPMENT SYSTEM (DISK)</p>
-------------------------------------------------------------------------------------------------------------------------------------------------------------------------------------------------------------------------------------------------------------------------------------------------------------------------------------------------------------------------------------------------------------------------------------------------------------------------------------------------------------------------------------------------------------------------------------------------------------------------------------------------------------------------------------------------------------------------------------------------------------------------------------------------------------------------------------------------------------------------------------------------------------------------------------------------------------------------------------------------------------------------------------------------------------------------------------------------------------------------------------------------------------------------------------------------------------------------------------------------------------------------------------------------------------------------------------------------------------------------------------------------------------------------------------------------------------------------------------------------------------------------------------------------------------------------------------------------------------------------------------------------------------------------------------------------------------------------------------------------------------------------------------------------------------------------------------------------------------------------------------------------------------------------------------------------------------------------------------------------------------------------------------------------------------------------------	------------------------------------------------------------------------------------------------------------------------------------------------------------------------------------------------------------------------------------------------------------------------------------------------------------------------------------------------------------------------------------------------------------------------------------------------------------------------------------------------------------------------------------------------------------------------------------------------------------------------------------------------------------------------------------------------------------------------------------------------------------------------------------------------------------------------------------------------------------------------------------------------------------------------------	--------------------------------------------------------------------------------------------------------------------------------------------------------------------------------------------------------------------------------------------------------------------------------------------------------------------------------------------------------------------------------------------------------------------------------------------------------------------------------------------------------------------------------------------------------------------------------------------------------------------------------------------------------------------------------------------------------------------------------------------------------------------------------------------------------------------

COMING SOON IN ARCADE SERIES BREAKOUT 'NIGHT DRIVER' RACING CARS

PET PACK
commodore
software

PETSET £15.75
GETS PET OUT OF CRASHED CONDITIONS WITHOUT LOSING BASIC EASILY INSTALLED.

ACCESSORIES
BLANK VERBATIM DISKS PER BOX OF 10 £26.00
BLANK CASSETTES PER PACK OF 5 C5 £2.50, C10 £2.75
THE PET REVEALED BY NICK HAMPSHIRE £9.75
6500 PROGRAM MANUAL £5.00
6500 HARDWARE MANUAL £5.00

CHEQUES AND POSTAL ORDERS TO AUDIOGENIC SOFTWARE OR QUOTE CARD AND NUMBER
POST AND PACKAGE 25p FIRST ITEM THEREAFTER 10p PER ITEM. ALL PRICES INCLUDE VAT.

give many years' wear. Middle or secondary pupils may gain much from making their own sets of cards, but generally speaking younger children do not have the necessary skills to ensure the accuracy needed for a triangular set.

The simpler type, suited for student construction, should be square — a shape swiftly and accurately cut on a guillotine. A template of hard-board is needed for every ten or twelve pupils, of standard dimensions and with a triangle taped or painted on it — indicating the position of three holes. To use the template, the pupil simply places it over his card and pricks through the three holes, giving him the three centres around which he may inscribe circles of a standard radius — say $1\frac{1}{2}$ inches.

A base card is prepared first as in Figure 3. This is common to all problems. Note that for convenience, the entire area outside the three circles is reduced to an irregular shape at top right. This is a universally adopted and useful convention which removes the obvious difficulty entailed when this area is to be revealed by a window.

A thin overlay card is now required for each Boolean statement, based on Figure 1, where the window is to be the shaded part. It avoids waste if the pupil lightly hatches the area to be cut away and has the teacher check it before cutting is done. The Boolean statement should be written on the face of the card. Note that sometimes little bridges of card should be left to hold inner parts in place.

When all cards representing statements have been cut, they are superimposed over the base card; the Boolean statement common to all (and hence true), is read off the base card through the windows.

The following two examples will suffice to show the type of problem suitable for window cards.

Example 1

In a certain school where children study French, German and Latin, the following restrictions are imposed. French and German may not be studied together. If Latin is taken, then German must also be studied. At least French or German must be taken. What therefore are the possibilities for study?

We label French as A, German as B and Latin as C. It's then clear that the three Boolean statements are A ex-or B, if C then B, $A + B$. From these we can produce the three window cards of Figure 3 and if they are superimposed over the base card, we can read that the possibilities are A (French alone), B, (German alone), or B.C (German and Latin together).

Of course, most people could have solved the problem in their heads, but we are here concerned (i) with proof that the system really does work, and (ii) with a model of how a logical machine would do the job.

Example 2

Mack, Jack, Bill and Tom are four hermits living on a remote Scottish mountain. One day Tom is found with a knife in his back, very dead. Mack, Jack and Bill trudge many weary miles to report the incident to the police and

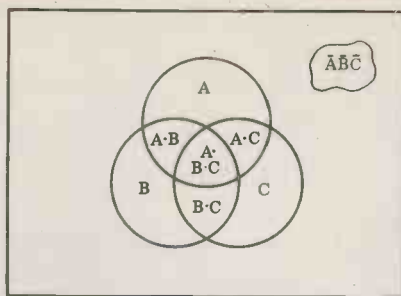

BASE CARD

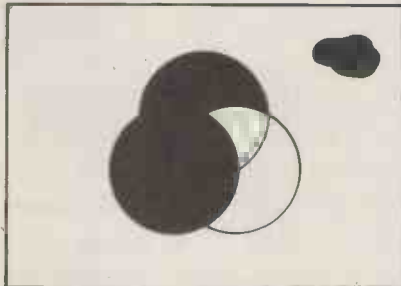

IF C THEN B

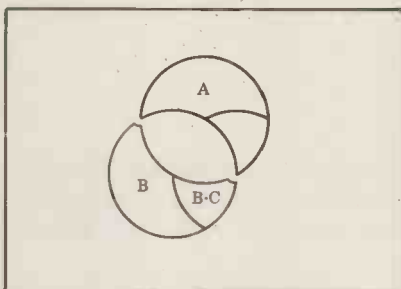

CARDS ASSEMBLED

Inspector McPlod takes a statement from each of them.

Mack said, "Ah dinna ken anything about it."

Jack, "Bill told me that he saw Mack do it."

Bill said, "I think Mack and Jack did it together."

If we make two assumptions, (1) that only the guilty lie and (ii) that Tom was not murdered by anyone outside of these three, what are the possibilities? Using his window cards, Inspector McPlod knew whom to arrest for murder. Do you? (The answer is in the Appendix.)

Computer operation

It should by now be clear that Boolean algebra is easily handled by computers because a binary bit can represent one statement — 1 for yes or true; 0 for no or untrue. The reader should be able to see that combinations of binary coded words may represent the most complex Boolean statements and the computer can readily compare binary words in a manner analogous to the window cards — and so determine the truth or falsity of a large number of statements.

Just as the lie detector is not magic but gains results in the hands of a skilled operator from the measurement of skin reaction, heart beat and respiration of the person under test, so neither is the computer magic for it depends upon the rigorous application of common-sense rules. What gives the computer its magic-seeming ability in the eyes of many people is that, being a machine, it can handle thousands of statements at lightning-fast speed.

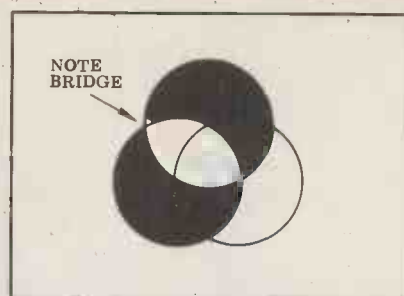

A EX-OR B

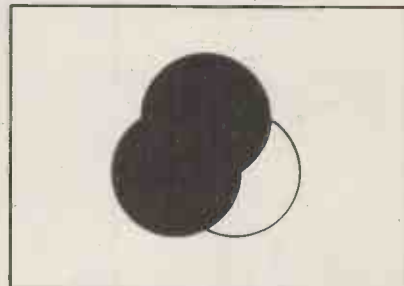

A+B

Fig 3 Black areas are to be cut out

So far we have looked briefly (and superficially) at how the computer can handle Boolean statements. Readers who are especially interested in Boolean algebra will find many books in any library or bookshop that cover the subject far more comprehensively than there is time to do here. In a later chapter we shall see how Boolean algebra can describe computer operation.

Appendix

The solution to Example 2 is as follows:

Let A=Mack did it; B=Jack did it; C=Bill did it. Now Mack's assertion that he knows nothing about the crime implies that Jack and/or Bill did it. This can be reduced to $B + C$ (remembering that + indicates the inclusive-or). Jack's statement is interesting. If Bill was telling the truth (when he told Jack that Mack did it), then A is true. If not, then he (Bill) was the guilty party and C is true. Jack's statement therefore can be reduced to A ex-or C. Of course, Bill's statement reduces to $A.B.C$ (A and B, not C).

We now have three logical statements to consider: $B + C$; A ex-or C; $A.B.C$. If we assemble three overlay cards representing the truth of these statements, no part of the base card shows through . . . nobody killed Tom. Since this is patently untrue, one or more of the statements must also be untrue. Therefore we assemble the three overlay cards in all possible permutations of two, omitting one in turn. If we omit the first card, nothing shows through — therefore Mack's statement must be untrue. That is to say, if he really knew nothing about it, then nobody killed Tom!

Checking further, we find that the same remarks hold true of Jack's statement, while if we omit the last card (that is, check to see if it was a lie), we find that the only possibility remaining is A alone — that Mack did it unaided. This is self-contradictory. If Bill is lying (making him guilty), the only logical conclusion is that Mack did it! Therefore the ONLY TRUE STATEMENT is Bill's; Mack and Jack committed the murder together.

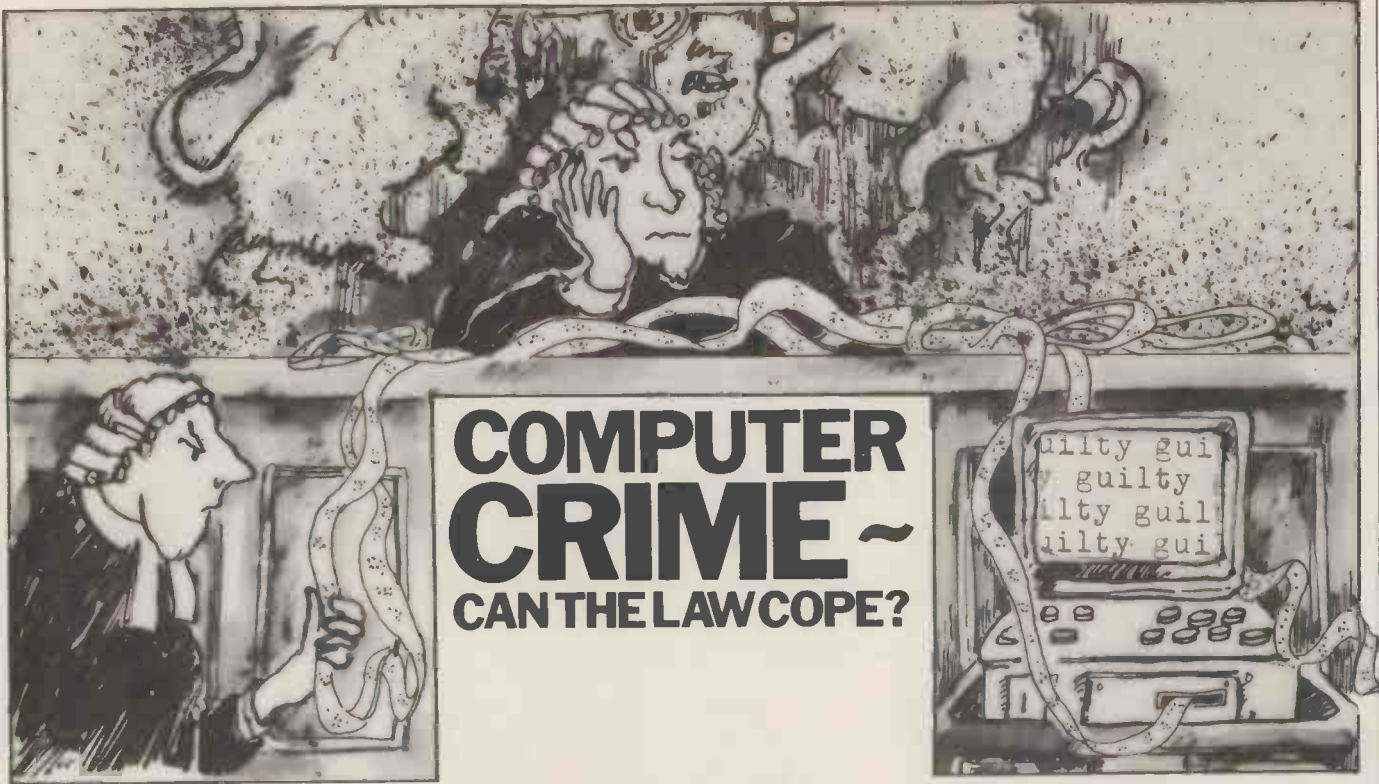

COMPUTER CRIME ~ CAN THE LAW COPE?

Computer fraud, invasion of privacy, software copying and hardware imitations — surely these are all 'crimes'? Commonplace they may be but the law is almost powerless to act. In this 'interrupt' Dr Stephen Castell unravels the issues and points a way ahead.

Information technology and the law

Lawyers can no longer afford to remain ignorant of the potential impact and implications of microelectronics-powered Information Technology.

Mini- and micro-computer word processing, accounting and time-costing systems to aid the lawyer in the (hopefully) more efficient and effective administration of his practice are increasingly developing and penetrating the UK legal market sector. In addition, commercially-available computer-assisted legal information retrieval systems and other information services have at last been launched in Britain (Infolex/Prestel in 1978, Eurolex/BOC Datasolve in June 1980, Lexis/Mead Data and Lawtel/Prestel coming shortly.) The highly-skilled UK lawyer — whose reputation for well-trained professionalism is probably second to none in the world, but whose adoption of business technology anything more advanced than a leather-bound tome and a quill pen in an exciting shade of grey has been on the whole rather less than rapid or enthusiastic — is now being approached on all sides by specially-designed information technology products, services and media; it's becoming increasingly difficult for him to ignore it.

And as fast as he attempts to assimilate, evaluate and decide on such technology as will suit his own individual practice's needs, he is going to have to deal professionally with the wider impact of this whole powerful micro-processor mix of computers, communi-

cations, office automation and 'informatics' on business, commerce and, indeed, society at large.

Many observers are viewing with growing concern what they feel to be serious gaps in existing legal norms, concepts and precedents. These are just a few of the issues arising from the growth of Information Technology: Evidence — What is the status of computer-generated material as evidence in a Court of Law? Should printout be admissible?

Copyright — does material stored on computer media in 'electronic publishing' systems have the usual copyright protections? And if it does, how can an infringement be detected, if the transgressor is itself a computer?

Software, video and database products — what is the correct 'intellectual property' right to afford to this material to protect it from 'bootleggers' and 'pirates'?

Computer fraud — are there any technological safeguards available to combat one of the world's fastest-growing 'white collar' crimes?

Privacy and security — with an increased reliance on computerised databanks and 'heuristic' programming, what are the individual's legal rights and freedoms? (If a robot is a sentient being, what are his legal rights...?) How much legal concern should be felt over the Police National Computer, say, or even over the US military computer that persists in giving erroneous Early Warnings that appear to many to be putting the world on the brink of accidental Nuclear War (Sorry about that madam, just a software fault, you understand...)?

Bad taste/libel/slander/obscene/criminal

material — does existing legislation cover electronic media? Is digitised pornography on a disk actionable?

What, if anything, is being done?

The good news is that lawyers themselves are already beginning, it seems, to take some action on these issues, if only indirectly.

The Law Society of England, the English solicitor's professional governing body, has for several years had within its 'Non Contentious Business' remit a Computer Services Committee meeting frequently to consider a number of aspects of the impact of computer technology on the profession. The pioneering UK Society for Computers & Law (formed in 1973), which has links with this Committee and, indeed, with the Law Societies of Scotland, Wales and Northern Ireland, as well as with the British Computer Society, is now an established focus for development and discussion in this area, publishing a seminal quarterly journal and regularly holding seminars and workshops on many relevant issues. (Its Annual Conference, which attracts many hundreds of UK and international delegates, was held this year in early July at York University and featured the widest range of discussion on the topic 'Lawyers in the 80s' — word and data processing systems, information retrieval, Prestel, litigation support, electronic office — together with an Exhibition comprising over 30 commercial participants.)

The Society for Computers & Law addressed in particular the issue of

INTERRUPT

computer-assisted legal information retrieval and formed a special Sub-Committee which worked long and hard — but quickly — to produce in February 1979 its report 'A National Law Library — The Way Ahead' (available from the Administrative Secretary, 11 High Street, Milton, Nr. Abingdon, Oxon). This was followed at the beginning of 1980 with the incorporation of a new company — The National Law Library Limited (TNLLL), wholly-owned by a new charitable National Law Library Trust and having the financial backing of all the UK Law Societies. From February to May this year TNLLL carried out a whistle-stop seminar tour of more than 20 local law societies all over England, Scotland and Wales, beginning the essential work of educating the 'grass roots' of the legal profession to the joys and challenge of mechanised/computerised law-library facilities. TNLLL having declared itself non-competitive with established commercial vendors of products and services for the legal sector, should therefore have a vital, comfortable and constructive relationship with them. It could above all have a crucial independent and objective role to play in not only assisting the average lawyer in assessment of the bewildering range of products now competing for his attention (and wallet), but also, and in my view most importantly, in taking the lead in coming to grips with some of the vexed issues — such as software protection, copyright, etc. — mentioned above.

These established, corporate efforts are now also beginning to be stimulated by a growing number of individual initiatives — some, again most gratifyingly, by lawyers themselves. To begin with, many of the individuals involved with the Society for Computers & Law have long had personal records as leaders of the 'technology impact on the law' debate, and anyone coming

after them must surely be in their debt for their pioneering — and, indeed, continuing — work.

Alistair Kelman, a practising barrister, has recently caused something of a new stir by his outspoken suggestion for amendment to the 1956 Copyright Act, defining a new legal concept of 'transmutation' to cover the intellectual property represented by computer software. He has also drawn the Home Secretary's attention to the implications and shortcomings (to put it mildly) of the ruling in the January 1980 *R v Pettigrew* Appeal Court decision which held that computer printout was not admissible in Court as evidence in Criminal Proceedings. In April, Kelman attracted a standing-room only audience to a British Computer Society Specialist Group meeting (which normally achieves 20 enthusiasts maximum) to hear him discuss these timely issues, and he appeared with similar effect in June on a European study Conferences/Infolex one-day London Conference 'Computer Information Systems & The Legal Profession' with an eclectic presentation on 'The Impact of Computer Technology on Legal Jurisprudence'.

On the specific issue of software protection and, indeed, the related concept of (don't laugh too hard) software 'quality', Graham Ross, a Merseyside solicitor, has put forward some private ideas for a 'Software Register' and associated (but probably unworkable) vetting, registration and arbitration procedures.

As long ago as September 1976, I made personal submissions to both the Royal Commission on Legal Services and the Data Protection Committee, which were coincidentally sitting and considering at one and the same time. Some parts of those submissions, bear quoting now: "...Rather than impose rules, restrictions, costly administrative and security overheads, etc., on the holders of computer files of 'personally identifiable' data, I believe there is much merit in the idea of giving the individual statutory property rights in his own personal information, with equitable and legal remedies for infringements...The Younger Report concluded that people were far more worried about the *threat* of computer-infringement of private data than the *actuality*....The simplest way to realise a body of 'Licensed Data Protectors' is to introduce the desired expertise into an existing professional body by way of appropriate training...I would suggest that there could be established a new profession of 'computer lawyer', composed of persons with both computing and legal professional expertise and qualifications...The...best thing the Data Protection Committee could do, in my view, is to promote a concerted campaign of Computer Awareness...If the public were generally more able to come to a balanced view on most computer issues, without the fear arising from ignorance, many future computer and privacy problems would, I think, be averted....It occurs to me

that the future impact of computers and associated technology on many aspects of business and private life may have profound legal implications. When considering the future training of entrants to the legal profession... give some considerable thought to extending the understanding and expertise of legal practitioners into these areas of technology."

More recently, in March this year, I presented at Viewdata '80 (the first major international conference on all aspects of videotex) a paper on 'Prestel and the law'. Again, I quote: "Prestel itself, in common with an increasing number of other Information Technology products and services designed with mass appeal, defies simple definition and itself requires a new conceptualising. For example, by focussing on the various component parts of the system in turn, it may variously be regarded as:

- a publishing medium
- the publication itself
- the means of production of the published text
- the content of the publication
- an (electronic) information system
- an (electronic) communication system
- an intelligent device for searching publications
- a game
- an (educational) toy
- 'the fifth TV channel'
- a computerised databank
- an advertising hoarding.

It may well be that Prestel has a separate and distinct legal status for each of these definitions. For example, if it is to be regarded as a 'publication', then the legal concepts evolved over the years to cover the rights of those involved with 'publications' (which includes authors, publishers, printers, the subjects of written material, advertisers, etc.), and the normative legal procedures developed for resolving conflicts over these rights, are the correct ones to apply....I personally doubt, however, whether these existing concepts and norms cover a 'publication' whose pages are capable of infinite and variable ...'re-publication' any moment of the day, and where no permanent record is available of earlier published versions....

One could go on with similar illustrative examples covering a number of other concepts like: 'duty of care'; 'product' liability; civil, criminal and 'bad taste' liabilities; 'ownership'/ 'privacy' of information, etc....the vexed issue of computer software protection has of late come in for a great deal of discussion, with at least one draft Parliamentary Bill, a Green Paper, and a judgement in the Courts giving the protection as that of a 'performing' right, as for musical works: all of this further emphasises the point that



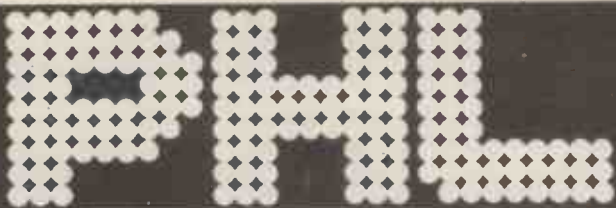

...when you need a dependable supplier, an authorised distributor with a comprehensive range of products at keen prices, backed by large stocks for fast delivery, with full after-sales support. We promise you a rapid response.

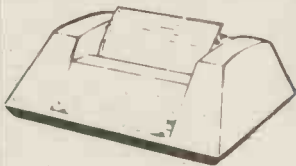

ANADEX DP8000

Exceptional value and high reliability. 84 lines per minute, 112 cps. Parallel and serial interfaces as standard. 96 ASCII set, 9 x 7 font. Variable tractor. Forms handling facilities. 1K buffer store. Options include 2K extra store IEEE interface.

from only **£516**



LEAR SIEGLER ADM-3A

The most popular visual display in the world. 1920 character screen capacity. Cursor addressing. Dual interface. Auxiliary port. Wide range of speed and word formats. Options include Tektronix 4010 compatible graphics.

from only **£570**



SPECIAL
£1275
OFFER

TEXAS 810

Compact 150 cps 132 column printer. Optimised bi-directional printing. Adjustable tractor feeds, 3 - 15 inches. 9 x 7 dot matrix. RS232 interface. Forms control options. Other serial and parallel interface options. Compressed print option.



TELETYPE 43

Versatile, economic and reliable 30 cps, serial interface keyboard printer. 132 or 80 columns. 94 ASCII set, 9 x 7 font. Cnsp, high quality printout. Microprocessor controlled. Portable versions. Character set options.

from only **£775**



TYPEWRITER TERMINAL

Two machines for the price of one. Typewriter style friction feed for single documents, letters etc. Pin feed for continuous business stationery. Electric typewriter keyboard layout and touch. Left and right hand margin setting. Crisp, high quality printout.

from only **£799**



SPECIAL
£739
OFFER

For a limited period only

DIGITAL LA 34

30 cps desk top terminal/Roll feed, paper widths from 3-14 $\frac{7}{8}$ inches/EIA interface/Selectable character widths, 10, 12, 13.2 and 16.5 characters per inch/Full 96 ASCII character set/7 x 9 dot matrix/Options include a 20mA interface, tractors to accept sprocket feed paper and numeric keypad.

PERIPHERAL HARDWARE LIMITED

Armfield Close West Molesey Surrey Telex 922175

SOUTH
01-941 4806

NORTH
Harrogate 501263/4

IRELAND
Dublin 952316

NEC Spinwriter®

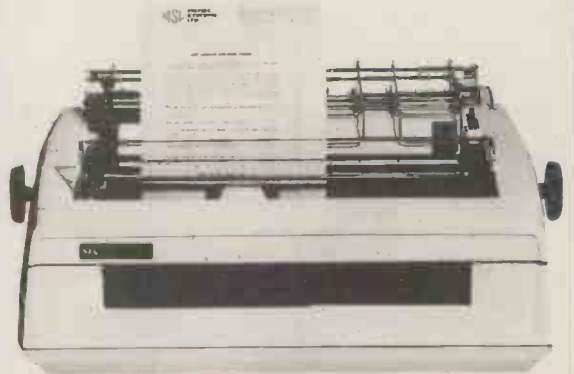

EX-STOCK FROM MEMEC SYSTEMS

At last! NEC's official UK distributor can supply this magnificent range of high quality, word processing printers from stock.

- 55 cps optimised and bidirectional. Quiet, reliable, beautifully engineered and a credit to your system.
- The best range of interfaces:- Centronics parallel, RS232 Serial plus Diablo and Qume interfaces, amongst others.
- RO, Keyboard and APL versions available.
- Cut sheet feed and plotting available.

**MSL MEMEC
SYSTEMS
LTD**

Thame Park Industrial Estate,
Thame, Oxon OX9 3RS
Telephone: Thame (084 421) 5471
Telex: 837508

PHONE
084 421 5471

INTERRUPT

a difficult period of rapid evolution of new concepts lies ahead."

I have suggested that in Viewdate '81 a whole Conference Session be devoted to 'Prestel and the law'....

The way ahead

On 21 May 1980, in the Law Society's 'Guardian' Gazette (the premier legal professional weekly journal), two barristers — John Scannell and Sheila Richardson — and I had published an article "BERTIE, the First Electronic Barrister — Computer Information Retrieval Accepted as Constituting 'Publication'."

The article began: "A specially-designed portable microcomputer and telecommunications system, described by its makers, Luddite Legal Systems Ltd., as 'the world's first ultra-intelligent-machine lawyer' and given the acronym BERTIE (for Barristers' Equipment for the Retrieval of Teleological Information Electronically) yesterday (31 June) became the first non-human advocate to be given the right of audience in an English court. BERTIE successfully defended Mr. Steen C T Pellash in a prosecution for a contravention of the Prevention of Depositors Act 1934".

BERTIE, so this 'case report' goes, successfully gains the acquittal of his client Pellash by:

1) quoting as *precedent* an account of a case which, although accessible by computer-assisted retrieval communicating direct with the computer phototypesetting system of The Times newspaper, is not to be published as a Times Law Report in The Times itself until the *following day*;

2) assembling in Court all the relevant financial records, in hard copy, of his client's Guernsey bank (the absence of which had been the reason for Pellash's

prosecution for suspected fraud in the first place), generated by having on-line access to the counter-entries held in the computer files of all the bank's customers, 'nostro' banks etc..

Spoof this article may have been, but it ends as follows: "Mr. Jack Lennax, prosecuting counsel, said afterwards: 'This case raises a number of important issues, not the least of which is the doubt now cast on *Pettigrew*. The outcome could have a profound effect on all those at the criminal Bar. I shall personally be taking action to see that the Bar Council is fully aware of these matters and responds accordingly.' Later it was announced that Mr. Lennax was to launch a Barristers' Action Group on Information Technology (BAGIT), but at the time of going to press no details of its proposed aims and objectives were available."

Now 'bag IT', who knows, may well be what some entrenched members of the legal profession would like to do with Information Technology and the challenging problems that I have suggested its spread and impact raises. But these problems, if only because of the pressure exerted by the 'information power to the people' of low-cost microcomputer systems, will refuse to be bagged or gagged and, one can be confident, will not just go away. Nor can the normal legal evolutionary process of first tentative actions in court, leading to a pragmatic hammering out of legal norms and concepts in the light of subsequent connected judgments — culminating eventually, perhaps, in a new branch of legislation and regulatory procedures — be allowed, in my view, to take its usual course in this case. Indeed, with reference to the recent Clive Sinclair/Micro Ace controversy, Alistair Kelman has been quoted as saying "Going from trial to trial is a bad way of sorting out an unsatis-

factory law".

Information Technology — its impact and ramifications, quickly focussing quintessentially on the nature and power of the Information Resource itself — is far too profound an issue to allow lawyers (and the sometimes crude development process of the practice and administration of legal jurisprudence) to handle it by themselves. (If you don't believe me, I recommend you read John McHale's "The Changing Information Environment", Elek Books, London, 1976, ISBN 0 236 40052 5).

What may be needed is, rather, some focal initiative involving information technologists (that includes, yes — you, the readers of PCW), lawyers and whoever else, which will be an agency for AGITation and for proactive, catalytic motion: an Action Group on Information Technology, perhaps.

I in fact proposed AGIT in all seriousness in letters two years ago published in *Computer Weekly* and *Computing*, and subsequently in several letters in the *Financial Times*. Briefly, AGIT's main preoccupations were proposed as being the definition of a 'national objective' on Information Technology, which would of necessity include an informed evaluation and analysis of the 'best' legal response on issues like software piracy, privacy/security/fraud, evidence, etc. (perhaps leading to a new simplified legal concept like an 'Information Right'); it would also create more adequate avenues of venture capital financing of Britain's embryo microelectronics-based IT businesses (but that's another Interrupt...)

How many more pirated packages and R v Pettigrew's do we need before we start AGITating?

LEISURE LINES

with J J Clessa

It's quite typical of the computer population in general, and the readership of PCW in particular, that when a problem is given which they can't solve the reaction is not "I can't do it", but instead "It can't be done"!

What arrogance! Anyway it was very satisfying for me, after months of abuse about the problems being too easy, to find one that floored so many. Out of 45 replies only 7 had the correct solution which was $(\frac{11}{2})^2$. If you add 5 to this you get $(\frac{19}{2})^2$ and if you subtract 5 from it you get $(\frac{31}{2})^2$. All of which are perfect squares — obviously the majority of readers assumed that perfect squares implied an integer value.

Anyway, it was easier to pick the winner this month — none of Tebbutt's random number nonsense — and the

lucky man is Mr C M Nash of Peterborough. If that didn't brighten your day Mr Nash I'm sure the prize will — 25 lightbulbs are on their way!

Quickie

An old chestnut: If a brick weighs 7 lbs plus half a brick, what is the weight of a brick-and-a-half? Sorry, as usual no answers, no prizes.

Prize puzzle

A woman goes into a supermarket and purchases four items. Before she goes to the checkout she decides to work out the cost using her new pocket calculator. However, she is neither very numerate nor very adept in the use of a calculator. By mistake she hits

the X key instead of the + key for each transaction. The result she arrives at is £7.11 and, when she arrives at the checkout, the assistant adds up the items in the normal way and gets the result £7.11. The woman is satisfied and pays, never knowing the stupid blunder she'd made. What was the cost of each item involved?

Answer please on a *postcard* (all letters go in the bin) by 31 August to: Puzzle No 12, PCW, 14 Rathbone Place, London, W1P 1DE.

Prize of the month

This month's prize — a trio of the excellent new gold and yellow PCW binders (as condemned by Diego Rincon of *Computing Toady*).

SHARP BY MAIL

SHARP MZ-80K

20K RAM £477.50
32K RAM £529.00
36K RAM £549.00
48K RAM £599.00

Inc. basic tape and manual

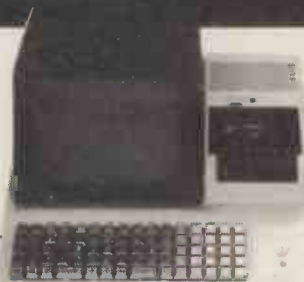

SHARP MZ 80 P3

Line printer 80 Col.
100 c.p.s. £517.00

SHARP MZ 80 FD

Disc Drive Twin discs—double sided
70K bytes per side £ 9.00

SHARP MZ 80 I/O

Expansion Board interfaces
Printer and Disc Drive to the MZ 80K £99.00

SYSTEM PRICES

MZ 80K-36K RAM +
MZ 80 P3 + MZ 80 FD +
MZ 80 I/O £1849.00

MZ 80K-48K RAM +
MZ 80 P3 + MZ 80 FD +
MZ 80 I/O £1899.00

All machines and Peripherals tested prior to dispatch.

MACHINE LANGUAGE TAPE & MANUAL £21.95

ASSEMBLER TAPES & MANUAL £42.00

BEM C15 TAPES 10 FOR £5.95

50 FOR £26.95

SHARP PC 1211

Hand held
computer—
1K Ram. Basic
language.
Alpha-
numeric
keyboard—
24 character display

£89.95



SHARP CE 121
Tape interface £13.95

ADD 15% V.A.T. ALL MACHINES GUARANTEED 12 MONTHS



**BUSINESS & ELECTRONIC
MACHINES**

7 Castle St, Edinburgh EH2 3BB Tel 031-226 5454

ORDER FORM from NAME _____

ADDRESS _____

QUANTITY	DESCRIPTION	PRICE

Carriage FREE over £100 (add £2 if under)

I enclose my *cheque/charge my Access/Trustcard/
Barclaycard/Visa No. _____

ADD 15%
V.A.T.

Signature _____

TOTAL

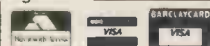

**CARD HOLDERS 'PHONE YOUR ORDER
-24 HOUR SERVICE. *Delete as applicable**

Introducing
MAIL ORDER
from Intex

A NEW
SERVICE
FOR YOU!

MAIL ORDER DEPARTMENT CASH WITH ORDER ONLY

PET		DEMAGNETISERS	
2001-8	£450.00	Curved Head (Mains)	4.00
3016	550.00	Cassette (Battery)	12.00
3032	695.00		
3022 printer	425.00	WORKBOOKS	
C2N Cassette Deck	55.00	TIS WORKBOOKS (NO VAT)	
IEEE to IEEE Lead	25.00	Set of 6	18.00
PET to IEEE Lead	20.00		
3040 Disk	695.00	CONNECTORS	
Computhink 400K for		PET USER/IEEE PORT	1.25
8K via exp/PET	825.00	PET 2nd CASS PORT	.95
For 16/32K	895.00	Covers for USER/IEEE	
800K Unit	1145.00	PORT Connector	2.50
24K Expandapet	320.00	D52 RS232 Connectors	
		Male/Female	3.25
INTERFACES		Covers	2.50
Small sys, Serial C	120.00		
Serial B Bi-Dir	175.00	KIM	
TNW2000 Bi-Dir	165.00	KIM 1	99.95
All IEEE/RS232		KIM 3B	99.95
PETSET 1 A/D	166.00	KIM 4	69.95
Stockists of PETSOF & COMMODORE SOFTWARE		NASCOM	
		Nascom 1 (kit)	125.00
PAPER		Nascom 1 (Built)	140.00
TCM100 Roll	2.50	Nascom 2 (Kit)	295.00
Anadex/PET 80 Col	15.00	Power Supply (kit)	29.50
Teletype 132 Col	25.00		
PR-40 Roll	1.00	SEND FOR OUR FULL SOFTWARE & MAIL ORDER PRICE LIST -	
CASSETTES		DUST COVERS	
C12 Cass Highgrade Per		PET (All models)	£5.75
10 in library cases	4.00	PET 3040	£3.50
DISKETTES		COMPUTHINK DISK	3.00
PET 3040 per 10	25.00	T/T 43 PRINTER	5.75
APPLE " "	25.00	Anadex DP8000 Printer	3.50
C/THINK D/D Per 10	35.00		

ALL PRICES ARE EX. VAT.
PLEASE ADD 50p p&p ON SMALL ITEMS £2.50
ON LARGER ITEMS

ALL GOODS DESPATCHED BY RETURN OF
POST OR YOU WILL BE NOTIFIED OF ANY
DELAY & OFFERED AN ALTERNATIVE OR THE
RETURN OF YOUR MONEY



Don't delay
SEND
NOW!

Name
Address Phone
Item No.

INTEX DATALOG LIMITED EAGLESCLIFFE INDUSTRIAL ESTATE, EAGLESCLIFFE, STOCKTON ON
TEES, CLEVELAND TS 16 0PN, ENGLAND, TELEPHONE: EAGLESCLIFFE 781193 (STD Code 0642).
CABLES: INTEXRAD, STOCKTON ON TEES, TELEX 58252.

Intex

COMPUTER ANSWERS

Answers to questions are invariably published two months or more after arrival; if you require a copy of the reply earlier please enclose an SAE. I am receiving an increasing number of questions from people who stress that the question is NOT for publication — these can be answered but will be charged for at a rate commensurate with the research needed. Send your questions to me, Sheridan Williams, at 35 St Julian's Road, St. Albans, Herts.

the value to be returned in 'USR value to'. Before we can actually run the Basic program with the subroutine inserted we must inform Basic that BASEND is now changed, otherwise it will start storing the program and variables on top of your subroutine; we do this by altering BASEND to include the new subroutine. We must also alter BBUFV which points to the new BASEND+1.

Examples of the uses to which a USR function can be put fall into two categories. . . 1) To perform a routine that is otherwise too difficult to write in Basic, for example accessing the real-time clock . . . 2) To perform a routine faster than it could be performed by Basic itself (e.g. multiplication by a power of two could be achieved far faster as a succession of arithmetic left shifts.) SW

Hard and soft sectors

Please would you explain what is meant by hard and soft sectored disks.
R G Struthers, Fife

A floppy disk sleeve contains three holes — the read/write window, the centre spindle and another called the sector marker window. If you rotate the disk in its sleeve and look in this window you will see a hole pass under it. If, during one rotation of the disk, you only see one hole pass by, then you have a soft sectored disk. On a hard sectored disk you will see 10 or maybe 16 holes, each marking the beginning of a sector. It's essential to use the correct type of disk in a system and this will be either hard or soft sectored.

In soft sectored format the using system may record one long record or several smaller records; each track is started by a physical index pulse (prompted by the hole), and then each record is preceded by a unique record identifier. Each field on a track is separated from adjacent fields by a number of bytes which are provided to allow the updating of one field without affecting other adjacent fields.

In hard sectored format, the system may record 10 or 16 sectors per track with each sector being started by a physical sector pulse.
SW

Get it?

I have access to a North Star Horizon with a Lear-Siegler ADM-3A terminal, and release 5.0 North Star Basic. I would like a GET command on this machine similar to the one printed a few months ago for the RML 380Z but I don't want to go into machine code; can it be done in Basic? Could you also tell me the upper and lower RAM addresses for screen accessing, for use with the FILL (POKE) statement. I've tried experimenting with various values but I've only succeeded in crashing the system.
Graham Kirby, Pitlochry, Perthshire

There must be many small businesses/ schools/colleges with systems like the North Star Horizon/Cromemco/Rair etc . . . I wonder why I get so few questions about these machines? Anyway straight on to the GET command problem — a solution like Table 1 should work.

The initial FILL statement may vary from system to system but you'll find it by looking in the manual under 'personalising Basic', Here it will tell you how to switch off the 'control-C' break. This is done with a FILL S + 24, 1 where S is the base address for Basic; it's usually 2D00H (11520). You mustn't forget to switch the control-C back on using FILL S+24, 0 before you stop the program. INP(2) checks to see if a key has been pressed and sets the second bit from the right to a one — this is decoded in line 1010. If a key has been pressed (ie A<>0) then to find which it is we use INP(3) which returns the ASCII code of the key but with even parity; so line 1020 strips off the left-most

bit. We must now check to see if a control-C (ASCII code 3) has been pressed; if it hasn't we return to the main program. As you can no doubt work out, the key scanning routine starts at line 1000. If you only want to know whether a key has been pressed and not which one, you need only use INP(2).

Your second question can be answered simply by saying that the screen is not 'memory mapped' so there is no area of memory that holds the screen contents. VDUs used with systems like the Horizon always support the routines necessary for moving the cursor around; as I don't have an ADM-3A at hand, the information has been gleaned from the manual kindly sent to me by Lear Siegler.

Firstly you must have the cursor mode switch ON and this is done by means of the internal switches inside the VDU. With the keyboard facing you, look at the set of switches at the back and to the right; set switch 7 to ON (it's labelled CUR CTL so you should find the correct one). To place the cursor in row X and column Y you must transmit from the computer an 'ESC' followed by an '=' followed by the row and column address codes. To clear the screen use CHR\$(26), and to 'home' the cursor use CHR\$(30).

Here is a defined function that will allow you to implement direct cursor addressing — as used by all professional programmers (none of this scrolling nonsense). To put the cursor in position X, Y just say PRINT FNC\$(X,Y) followed by whatever you want there. The program in Table 2 will place random Xs all over the screen.

For those of you with

```
10 FILL 11544,1
20 PRINT"TOUCH A KEY PLEASE "
30 GOSUB 1000:IF B=0 THEN 30
40 PRINT CHR$(B)
50 GOTO 20
1000 B=0
1010 A=INP(3)\IF INT((A-4*INT(A/4))/2)=0 THEN RETURN
1020 B=INP(2)\IF B>128 THEN B=B-128
1030 IF B<>3 THEN RETURN
1040 FILL 11544,0\STOP
```

Table 1

```
5 PRINT CHR$(26)
10 X=INT(RND(0)*23)
15 Y=INT(RND(0)*79)
20 PRINT FNC$(X,Y),"X"
30 GOTO 10
40REM-----
1000 DEF FNC$(X,Y)
1010 IF X<0 OR X>23 THEN RETURN ""
1020 IF Y<0 OR Y>79 THEN RETURN ""
1030 RETURN CHR$(27)+"="+CHR$(X+31)+CHR$(Y+31)
1040 FNEND
```

Table 2

More on research

I was most interested to read your answer to the letter about GETting a character from the keyboard of a Research Machines 380Z. Perhaps you would answer another question about the same machine. How do I write a USR subroutine in Basic for some special purpose.

R Tobin, Slough

You will find a brief explanation about USR subroutines in the notes supplied with Basic. It's worth noting, however, that you must be familiar with machine-code programming before you can write a USR routine. It's not possible in such a brief reply to show you how to write a program but I shall outline the main points regarding use of the USR function.

When the statement Y=USR(X) is made in Basic, the variable Y is assigned the value calculated by a machine code program previously written and planted somewhere in memory. USR need not actually return a value, and X could be a dummy variable (i.e. not used or altered by the machine code segment), but the statement must be used in the above form. If this statement were used without any machine code subroutine being available, then you would get an error message. This is because when the USR function is called, Basic will jump to the location pointed to by the 'USR transfer vector', and only an error routine resides there at present.

You will find a table of addresses which will be needed with the release notes for each version of Basic that you have. The best place to put the machine code program is at the end of the Basic interpreter; this area will begin at location BASEND+1. Let's assume that there is a program at BASEND+1; this will probably need to refer to the function argument (in this case X), to be found at 'USR value from'. When the subroutine needs to return a value to Basic we must place

aculab

floppy tape,

The tape that behaves like a disc,
For TRS-80 LEVEL II.

Connects directly to TRS-80 Level 2 Keyboard. Operating and file handling software in ROM. 8 commands add 12 powerful functions to Level 2 BASIC. No buttons, switches or volume controls. Full control of all functions from Keyboard or program. Daisy chain multiple drives. Certified digital tape in endless loop cartridges. Reads and writes in FM format at 9000 Baud. Soft sectored with parity and checksum error detection for highly reliable operation—just like discs. Maintains directory with up to 32 files on each tape, tapes may be write-protected. Supports Basic and machine-language program files, memory image and random access data files. 12 character filespecs —: "FILENAME/EXT:d" (d is drive no. 0-7). Automatic keyboard debounce. Full manual with programming examples and useful file-handling routines.

COMMANDS (usually followed with a filespec and possible parameter list).

@SAVE, @LOAD, @RUN —for BASIC programs, machine language programs and memory image files. **@GET, @PUT** —moves a 256-byte record between a random access file and BASIC's data buffer. **@KILL** —removes a file from the directory and releases tape sectors for immediate re-use. **@LIST** —displays file directory along with sector allocation and free sectors. **@NEW** —formats tape and creates a blank directory.

Master drive with PSU, Manual and a selection of tapes.

£167-00 +£2-00 pp+vat.

Slave drives with PSU £122-00 +£2-00 pp+vat.

(Export orders pp charged at cost)



For further
information,
Telephone
0525 371393

aculab Ltd.
24 Heath Road,
Leighton Buzzard,
Beds. LU7 8AB

Personal Computer World

BINDERS KEEPERS LOSERS WEEPERS

Half the people you meet today are not preoccupied with pollution, perversion or persecution. It's worse than that — they've lost a copy or two of PCW and don't know where to find replacements.

So keep *your* copies of PCW in a beautiful bright yellow binder. £2.95 worth of smart security.

Just check the coupon at the foot of the page.

SUBSCRIPTIONS

Over two years ago PCW became the first magazine in Europe to deal exclusively with the home and business use of Personal Computers. It has been an unqualified success. The current subscription list stands at well over 3,000, with a staggering 70% renewal rate! PCW reader loyalty is already a byword in the publishing business. We aim to keep it that way. So if you are having difficulty in obtaining PCW at your newsagent, why not take out a subscription and have the magazine mailed to you direct?

UK Subscriptions: £8.00

USA Subscriptions: \$20.00

Subscriptions elsewhere: £9.80

Binders: £2.95

Please send me the next 12 issues of PCW

Please send me ___ PCW Binders

NAME _____

ADDRESS _____

(Block capitals please)

I enclose cheque/P.O. for £ _____ made payable to
Sportscene Publishers Ltd.

Send coupon to PCW (Subscriptions), 14 Rathbone
Place, London W1P 1DE. Allow at least 14 days for
processing.

other VDUs the same sort of technique will apply, and all you will have to change is the code in lines 1030 and 5. The Elbit VDU and some others also support more advanced facilities such as the ability to clear a whole line, or a portion of the screen and you can also protect parts of the screen from being erased. Good luck and have hours of fun (sorry, work!).
SW

Solving UK's problems

I am writing a program which involves long division of a three byte number by a single byte number, to run on a UK101. It works nicely till the divisor is a number above 7FH — when everything goes haywire. Is this because the UK101 regards single byte numbers above this as negative? If so, how can I overcome the problem?

I would also like to interface my UK101 to my Olivetti ET221 electronic typewriter, both to provide hard-copy from the UK101, and to extend the memory capacity of the typewriter, which includes a Z80. Could this be done in a completely non-destructive way, as the typewriter is still under warranty?

K. P. Wood, Wakefield

In common with other 6502-based machines, (and in fact with most other 8 bit machines), the UK101 uses 'two's complement' notation to handle negative numbers. In this, negative numbers are formed in binary by turning each bit of the number into its opposite (ie. 1s become 0s, and 0s become 1s) and then adding one bit (ie. 00000001) to the result. This leads to positive numbers all having 0 as the leftmost bit, and negative numbers all having 1 in the corresponding position. Hence, as you have correctly worked out, all single bit numbers in excess of 7FH (127 Dec.) are treated as negative.

To overcome this you will have to use two-byte divisors. This is not as difficult as it might sound, as the 6502 instruction set is designed to cope with multi-byte subtraction and division is, of course, just protracted subtraction in essence! For example, the coding to subtract one two-byte number from another is:

```
LDA NUM1
SBC NUM2
STA NUM3
LDA NUM1+1
SBC NUM2+1
STA NUM3+1
```

This takes the first byte of Number 2 and subtracts it from the first byte of Number 1, storing the result in Number 3. The second bytes of the two numbers are then

dealt with in the same way. Note that this particular set of instructions takes care of the carry from byte to byte. I hope this information will now let you complete your program.

Your second query poses very much more difficult problems. Not only is there the commercial difficulty of your Olivetti ET221 (a very nice machine!) still being under warranty, there are also formidable technical problems.

Firstly, you say that the Olivetti has a Z80 micro-processor in among its memory, and wonder about interfacing this micro-processor to the one in your UK101. Well the micro-processor in the UK101 is a 6502 . . . and the instruction sets of the Z80 and the 6502 are quite different and incompatible. But that may not be the end to incompatibility problems. It's not particularly likely that Olivetti will have used the ASCII code for representing characters within their typewriter. After all, this code is intended for external communication, and the typewriter is not intended to communicate electrically with anything outside itself.

Now, translating one code into another is not too difficult if you have enough memory to spare to hold the look-up tables, and if (in the case of your typewriter) you know what both the codes are! Interfacing a Z80 and a 6502 is another matter altogether, and might involve them communicating with one another in a common high level language for which they both had compatible compilers, or even using another microprocessor as a go-between (or 'front-end processor' to give it its official jargon name).

All in all, I must recommend against trying to establish any electrical (or electronic) link between your UK101 and your Olivetti ET221. A mechanical link could be more satisfactory, and devices to connect electric typewriters to computers are currently being advertised at between £300 and £400 approx., excluding VAT.
P L McIlmoyle

Nag on display

Every year I am asked to do the commentary for the Pony Club horse trials. I would like to record all of the riders and 'Nags' as print statements in the UK101 I hope shortly to own, thus going to a line number would read the data on the horse and rider — whose competition number would be the same. This simple idea would have a few small refinements.

Firstly, I would like to be able to type in the number of the horse and have the data

displayed as a line. This line should correspond to the position of the horse on the course e.g. the last horse just started would be at the bottom of a list, perhaps below a thick line, with the horse before that on the line above, so that as each horse starts below the line the previous one is moved up. How can this be arranged? How can I remove a horse from the VDU that has finished the course?

Also, could you please suggest a SAFE way of providing power for the machine from a 12-volt car battery, with the aim of the battery lasting for up to 10 hours, even with the VDU also running off it?

J.J.W. Spencer, Neach Hill, Nr. Shifnal.

This is an interesting application and one which again illustrates the wisdom of the 'systems approach'; that means sitting down and carefully studying the whole problem before even thinking of writing a program.

Let's look at our actual objectives in a little more detail. The basic aim is to get some information displayed on the VDU in response to the entry of a single number. But from this single number the computer has to decide whether to display the information at the bottom of the screen, which way to move the rest of the display, or whether to delete information already displayed about a horse that has now finished the course. If we sit down to code this up at this stage we will probably think of getting the computer to ask questions such as 'What is the number of the horse?', and 'Delete or add?'. But these questions will appear on the screen, confusing the details of the competitors and taking up valuable lines, so that it might only be possible to show eight horses at a time!

So look at the problem from another angle. What we are saying to the computer is, 'here is a number of an entrant — if it's on the screen it must have been entered for deletion — if it's not already on the screen it must be a fresh starter, so display the details on the bottom line'. Fine . . . but how can the computer 'know' what's already on the screen? With a memory-mapped screen we could do this the elegant way by directly searching through the screen contents. Now the UK101 has a memory-mapped screen, but we can only get at this in machine code. So let's look at the hard slog method of deleting a line from the screen . . . re-write the whole screen! As it turns out this approach will also let us move the details of the previous starter up past the heavy line.

Instead of storing the competitors' details as PRINT statements, store them as DATA statements, with the

competition number as the first item. For example: 120 DATA 17, "PUFFING BILLY", "LIZZIE BORDEN". We can now make use of the UK101's powerful array facilities to set up three arrays of sixteen rows each, with a DIM statement: 100 DIM A(16), B\$(16), C\$(16). These arrays between them hold all the data that's on the screen. The program can, of course, read the arrays to find what's on the screen, then alter this information in the arrays, clear the screen, and rewrite it with the new information from the arrays.

The way the program will now work is that after setting up the arrays it issues a single INPUT statement followed by a semi-colon. This will only put a "?" on the screen, and keep on the same line for you to enter just the competitor's number. A FOR/NEXT loop is now used to scan array A to see if that number is already in the array, and hence on the screen. If it is, the program should branch to a sub-routine which sets that element of A to zero and the corresponding elements of B\$ and C\$ to blank (" "). Another FOR/NEXT loop should then be used to write all 16 lines of the arrays to the screen. If the first loop does not find the competitor's number in array A a RESTORE statement should be executed. Yet another FOR/NEXT loop (loops are very useful!) then goes through all the DATA statements with READ A, B\$, C\$ till a value of A and the corresponding values of B\$ and C\$ are then put into the last rows of the arrays, after yet a further loop has moved the details from row two to row one and so on till row 16 has been moved to row 14. Yes, row 14 . . . for row 15 always holds the heavy line! Now re-write the screen, and all the new information will be on it, including the heavy line in the right place!

I'm glad to see your concern with electrical safety — high voltages do not mix well with possibly wet grass, not to mention rain! The main problem is, of course, the VDU. I would suggest that you use one of the fairly small (10-12 inch) TV sets specially designed to operate from 12 volt car batteries. As these take no less than 20 watts, the current drain will be under two amps.

The UK101 calls for eight volts. Use a serial voltage stabiliser to reduce the 12 volts of the car battery to this level. Not only will this give better voltage regulation than just a Zener diode, it will significantly reduce the power drain.

This set up should keep you going safely for a full ten hours from a fully charged car battery. Don't expect it to start a car at the end of it, though!
P. McIlmoyle

GETTING IT TAPED

Talib Shaman explains how you might develop software for handling cassette-based data files. Although based on his experiences with a Nascom 1, the story should prove extremely interesting to those considering the same problem on other machines.

Cassette file handling

Some micros do not have the software facility whereby a program can create data (information) files or access and update existing ones. Such a facility is essential in areas where an 'ongoing' record of information is to be maintained (for instance with book-keeping, stock control, payroll, etc). For those of you who do not have such a facility this article offers guidance on generating software that will make good use of the cassette tape for data file maintenance. The practical examples that I include come from software which I developed for the basic NASCOM; I've called it TSAM (Tape Sequential Access Method).

File structure

Supposing we have a stock control system in which it is necessary to maintain the following information about every item in stock:

- Item number or code
- Price
- Quantity in stock
- Supplier
- Re-order level

In a manual system a clerk would maintain a stock file. This could be a book with one page per item, or a tray with one card per item. In a computer system this file could be held on a magnetic tape. On this tape file, items are recorded one after another (serially) and each item is called a record. The *record*, in this example, would hold the item code, price, quantity in stock, etc. (Fig 1). A record therefore would only need to hold values such as for example, A616040. It's up to you to define and know what each part of the record represents — in this case, the first three bytes are the item code followed by two bytes for the price and so on. These different divisions within the record are called *data fields*.

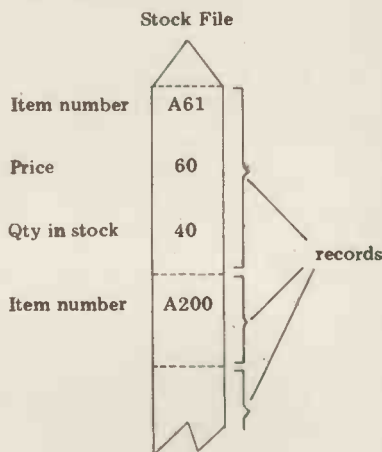

Fig 1

In order to detect where a file starts and finishes on a tape or a cassette, each file needs a *header* and *trailer* record. The file header is physically the first record and the trailer is the last on the file (Fig 2). These records need not be of the same format as the data records. Their format is decided by the software which maintains and accesses the files. One common 'piece' of information which a file header contains, is the file identification.

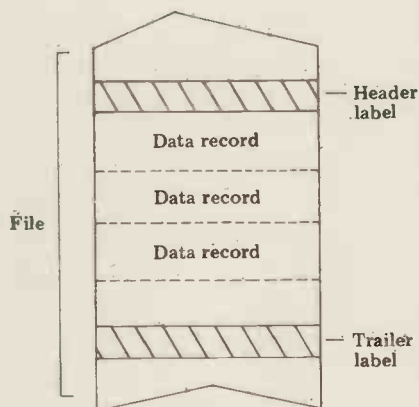

Fig 2

Other typical information is:

- File version (this is incremented as the file is updated)
- Date of last update
- Data record size
- etc.

Usually, the trailer doesn't have much information apart from, in some cases, a count of the records on the file. This, if maintained, would be automatically updated by the software.

Access method

The way a file is organised or structured decides the ways or the methods by which we can access it. A tape file as shown earlier, is organised in a serial fashion — records follow one another physically. With this architecture, records can be maintained in an ascending or descending (sorted) sequence of one or a combination of data fields from those records. These fields upon which the file is sorted are called *Sort Keys*. In our stock control example, the file could equally well be sorted on item number, or price and so on.

Reading a tape file from start to finish is a *serial* access (records are read as they are physically found on the file). However, if the file happens to be sorted, then the access is *sequential* with respect to the sort key.

In the majority of tape file applications, files are maintained in a sorted order. This is so, not only to provide sorted output or reports but

also to speed up the location of the required records from the file. If we take an example and suppose that on a sorted control file the record for item A95 is needed, then all we have to do is to read the file and match the stock item number in every record we read against that required until either we find the record for that item or come across an item higher in number (which would suggest that the stock item does not exist).

In the case of an unsorted file, all the records must be read before it can be decided that the item does not exist. Furthermore, in the case of an unsorted file, the search has to start from the beginning, whereas with sorted files, the search can continue from the current position within the file — so long as the value of the key in the current record (stock item number) is lower than the value required (we are assuming an ascending sort, which is true in the majority of cases).

To read a record from cassette into memory or to write a record out takes a long time in computing terms. These time-costly operations are called Physical Input/Output Operations (Physical I/Os). Somehow, these have to be reduced and the way this is done is to move more than one record (a *block* of records) between memory and secondary storage when a physical I/O is performed. Having read a block of records you can then read one record at a time from the block (which is now in memory) and when the whole block is read, another block is transferred from cassette. In this way, we are reading all the records we want but making fewer physical I/Os. Besides other factors, the reduction of these physical I/Os is related to the number of records in a block; the number of records per block is called the *blocking factor*.

To expect every program which needs to access the file to perform these operations and to open and close files etc. is to expect a great deal of code duplication. Instead therefore, a piece of software called the *Access Method* can be used to organise, open and close files and block and deblock records. The user's program can be provided with simple commands to communicate its requests to the Access Method which performs all those complex and, in most cases, hardware dependent tasks like switching between tape units and communicating with the monitor and the operator.

So far we have concentrated on basic terminology and concepts in order to pave the way for the serious topic of designing our data management software. Now, instead of 'throwing' principles and methodologies at you to think about and possibly misinterpret, I shall take my actual Access Method (TSAM) and 'walk' you through the

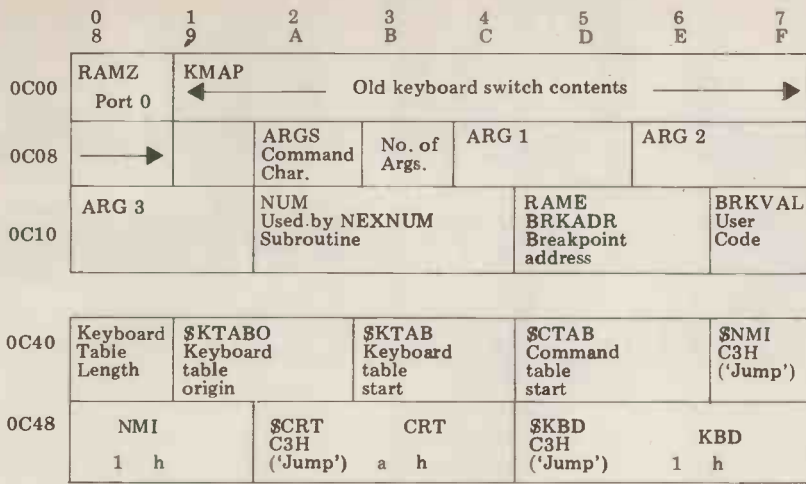

Fig 3

various stages I had to go through in order to develop it.

Background

The design process was made up of the following distinct stages:

- Identifying and conceptually defining the services which the software (TSAM) should provide.
- Understanding how the various data related routines of the monitor are invoked.
- From the two stages above, determining:
 - What monitor routines to modify and how to do it
 - What monitor routines to use directly
 - What new routines to introduce
- Writing and testing the software

This approach was essential in order to take advantage of the existing complex data handling routines already present in the monitor.

Basic requirements

Four basic functions were required:

- OPEN a file

A function which when called by a program, with certain parameters, instructs the operator to mount the required file on a specified free deck for input or output. Upon mounting of the file, the OPEN function, in the case of a new file, generates and writes the header label - or in the case of an existing file, reads the

header label and checks that the file mounted is the file requested.

- READ a record

Whereby a record is read from an opened file. The record is placed in a known area of memory, ready for use by the user program. Once the end of file is detected, the READ function returns a suitable response code to the user program. (All TSAM functions return a response code in a known area of memory to signal completion or error conditions. The calling program should always test these.)

- WRITE a record

The user program places a record in a certain area of memory and calls this function which outputs it to the corresponding file.

- CLOSE the file

Having finished with a file, the user program calls this function which

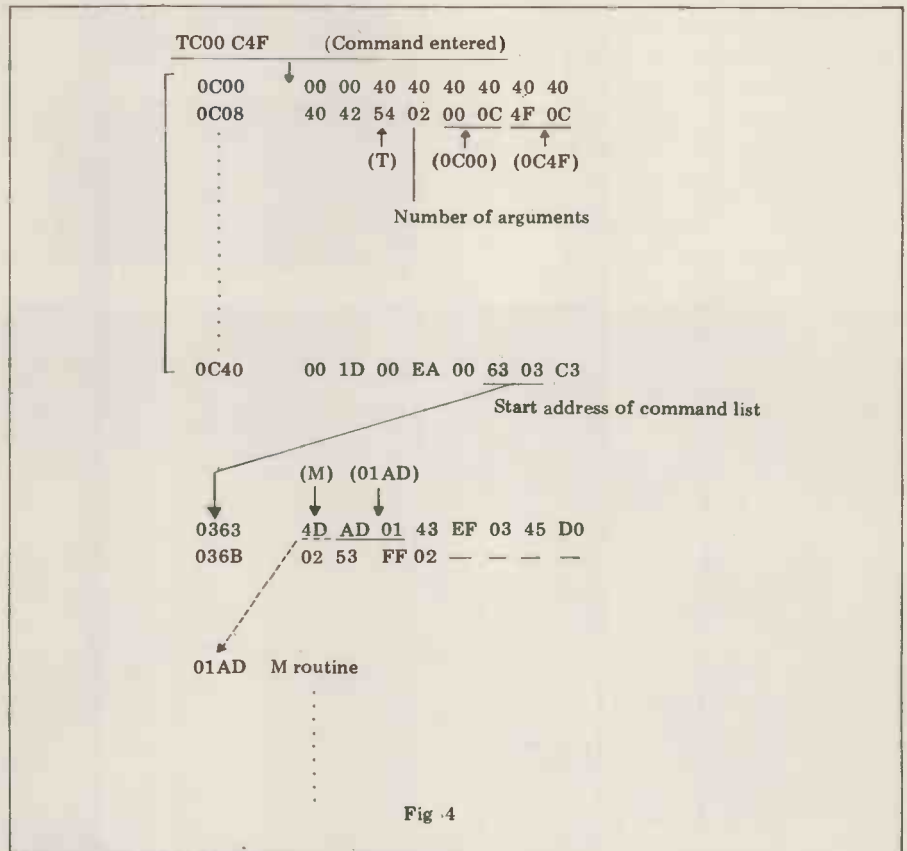

Fig 4

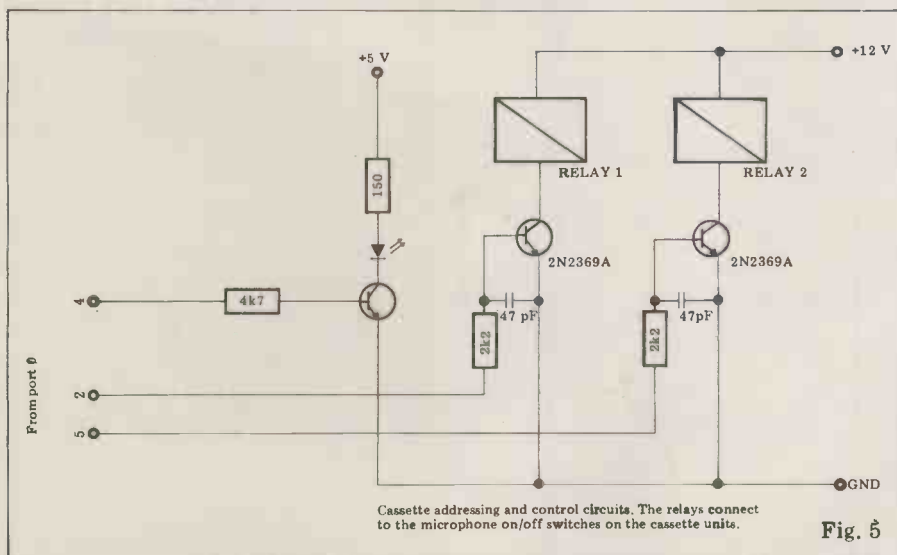

Fig. 5

writes a Trailer label to that file and frees the deck.

Another requirement is for more than one cassette deck to be interfaced to the machine and be addressable by TSAM. TSAM also needs to identify and switch on the corresponding cassette to enable record reading and writing and to switch off again afterwards.

Notice that a record, in TSAM version 1 (covered here), may represent a block (more than one record). It's up to the users, if they wish, to handle record blocking and de-blocking.

The MONITOR routines

The machine used for TSAM was the NASCOM basic kit (NASBUG with less than 1 kbyte of user memory

Grrrraphics

The Paper Tiger™ puts more bite into everything you do.

The Paper Tiger strikes again. With DotPlot™ high performance graphics. Now you can get a powerful printer with state-of-the-art graphics for less than the price of most matrix printers alone.

DotPlot lets you print screen graphics, draw illustrations, write block letters, plot charts, and more. All under software control.

And, DotPlot includes an expanded 2K-byte buffer. It can hold text from a full 24-line by 80-column CRT screen.

That's not all. Every Paper Tiger gives you 8 software-selectable character sizes. 80 and 132 column formats. 96 upper/lower case characters. Reliable stepper-motor paper drive. Adjustable width tractor feed. Continuous duty cycle operation.

You get multi-part business forms handling. Forms control. Re-inking ribbon system. Parallel/serial interface. Self diagnostics. Paper-out sensor. Uni-directional print speeds to 198 characters/second. And more.

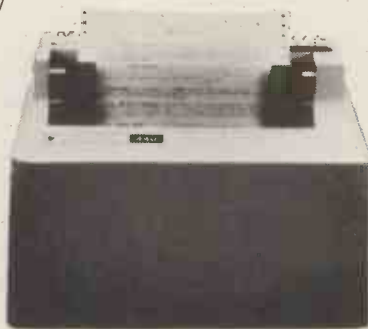

microsense computers limited

Finway Road, Hemel Hempstead, Herts HP2 7PS
Tel (0442) 48151 and 41191
Telex: 825554 DATEFF G

Available from Apple Dealers throughout the UK.
OEM/Dealer enquiries welcome.
Recommended retail price £598 (excl. VAT)



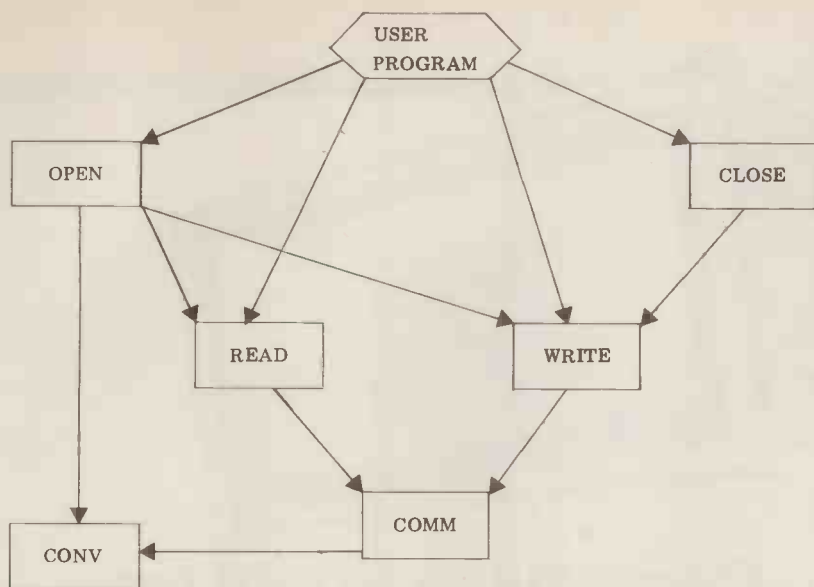

Fig 6 TSAM modules

available).

The Input/Output routines available in the NASBUG are keyboard driven and are:

- **LOAD:** when invoked from the keyboard, reads a cassette tape and loads the contents into corresponding memory addresses. The file consists of 8-byte records each preceded by a memory address from which they were recorded originally. Header and Trailer labels are represented by a high pitched tone (no actual data).
- **DUMP:** when invoked from the keyboard with two parameters (Start address and Finish address), writes the contents of memory defined by the two parameters, to the cassette deck. The formatting of data (8-byte records) and Header/Trailer tones, as described under LOAD, is performed here.

An important fact is that only one cassette is supported and the operator has to switch it on/off and engage it in the right mode (Read/Record) prior to invoking these routines.

The Design

It soon became clear that if TSAM was to fit in less than 1 kbyte (leaving room for a user program) without having to interact directly with ports, then LOAD and DUMP routines had to be utilised. I also needed to be able to address and control more than one cassette deck.

After some thought and experimentation, I found a way of modifying the LOAD and DUMP routines to suit my purpose. This was made possible through two facts:

- The monitor utilises REFLECTIVE lists for servicing and invoking routines
- The monitor maintains these lists as part of the user RAM. They, therefore, can be modified by software.

The monitor maintains the reflective lists in a table at 0C00H - 0C4FH (Fig 3).

When a command is entered on the keyboard, the monitor moves the command character, the number of arguments and the arguments themselves, to locations 0C0AH - 0C10H of the reflective table.

To tabulate this table, enter (TC00

C4F). In the display, you'll find that these locations are set as follows:

```

0C0A 54 (T),
0C0B 02 (Number of
arguments),
0C0C/D 00 0C (=0C 00 which is
argument 1)
0C0E/F 4F 0C (0C4F which is the
second argument).
  
```

What you are looking at is the setting which corresponds to the Tabulate command you just entered.

Having set the command character and arguments, the monitor looks at locations 0C45/46H (which hold the address of the command table) and makes a jump to the address held in there (the address in your tabulation is 63 03H (03 63H)).

At address 0363H, there is a command list. This list holds for every monitor command, the command character and the address within the monitor where the routine for this command is found. This shows that the M (Memory) command, for example, starts at location 01ADH.

The monitor scans the list and matches the command character from 0C0AH with one from the command list and jumps to the routine at the corresponding address. (Fig 4 shows the progress from command entry to execution.)

Each monitor routine extracts its parameters from address 0C0BH - 0C11H, and it is this that enables TSAM to invoke the monitor routines:

- locations 0C0BH - 0C11H are set accordingly
 - a call is made to the required routine
- For addressing and controlling the two cassette decks, the spare bits (Q5 and Q2) of port 0 are utilised (Fig 5).

Bits Q5 and Q2 are connected, through some simple switching circuits, to the cassette ON/OFF relays (any low voltage, high speed will do).

To switch a cassette on, the accumulator (RA) is loaded with a suitable value and is output to port 0. The values chosen allow for switching the LED on/off to indicate data transfer.

For data flow between port and cassettes, the existing connections are channelled to both cassettes (Pins 5,3,4 on the main board). The fact that the

two cassette input/output lines are joined does not matter, since only one cassette is active at a time.

The 12V line of the PSU is quite adequate and the load on it is quite minimal (use low power/high Z relays).

TSAM occupies 575 bytes (06C0H - 0E9FH). This includes control blocks, parameters, lists and record buffers (the maximum record size allowed is 80 bytes).

TSAM consists mainly of six modules (Fig 6):

- OPEN
- CLOSE
- READ
- WRITE
- CONV
- COMM

The user program interacts only with the top four modules. CONV and COMM are internal service routines used for converting internal format to display format for communicating with the operator, and for reserving, freeing, controlling, and identifying tape decks.

TSAM divides its memory space into two regions (Fig 7):

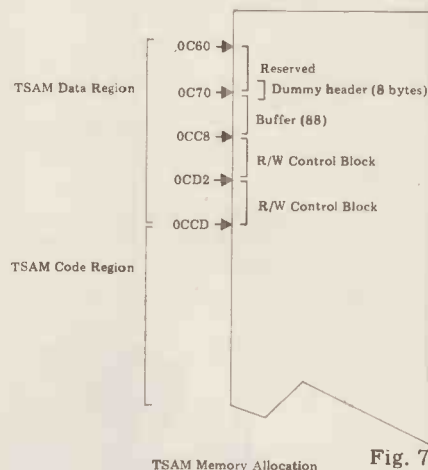

Fig. 7

- Buffers, Control Blocks and Switches
- Software Programs

The Data Region must always be reserved for TSAM. The Software Region, however, offers flexibility. The user need only load those modules of TSAM necessary for that particular run. The software is written to be position independent. The only factors that change are the address to which the user program issues the call and the address to which related modules refer. This approach enables economy on memory utilisation - 'you only load what you need'.

In Fig 7, the buffer is the area where the input record is placed by TSAM to write away. The dummy header is an 8 byte block appended by TSAM to reduce the data error rate and allow the cassette to reach the correct speed before data input/output.

The Read/Write Control Blocks are areas created and maintained by TSAM to keep track of active files and cassette decks, there being one for each deck.

The 16 bytes reserved area includes the OPEN block (Fig 8) where the user program supplies various parameters to TSAM like File name, Read/Write indicator and record size. In the same area, TSAM communicates the response code to the user program.

GOTO page 131

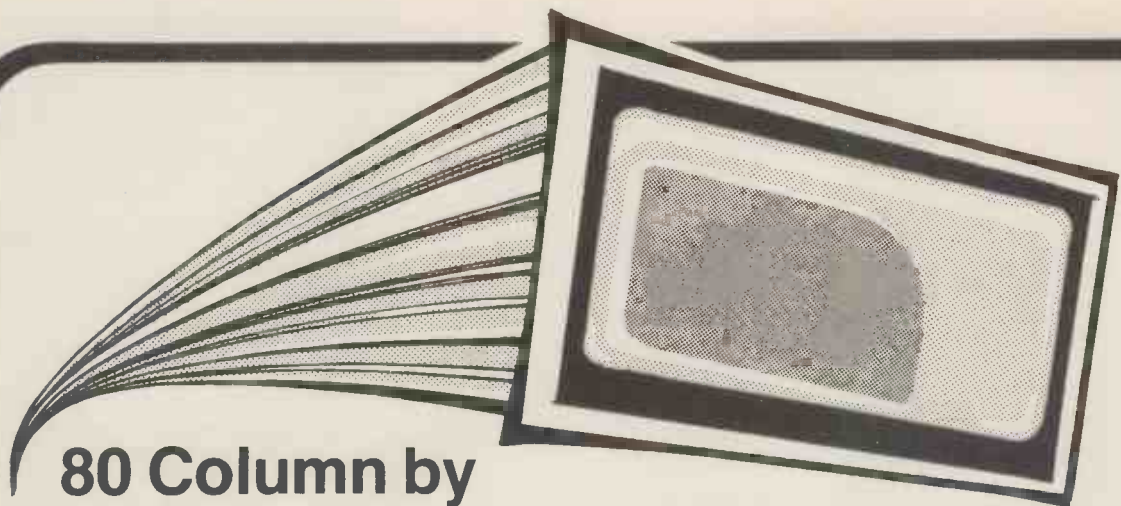

80 Column by 24 Line Plug-in Compatible Board for the Apple II Computer

SPECIFICATIONS

- * 80 Columns X 24 lines.
- * Upper and lower case data entry using the Apple II keyboard.
- * Includes 128 upper and lower case 5X8 dot matrix ASCII character set and inverse alpha characters.
- * Characters can be user definable.
- * Includes VBC video balance circuit which allows the user to display 80 columns on an inexpensive 8 MHZ CRT monitor.
- * Shift lock feature.
- * Works with Apple Pascal and Apple Basic.

- * Incorporates Pascal and Basic control characters.
- * All monitor-type escapes are valid.
- * Follows protocols of Pascal and Basic operating systems.
- * Compatible with All Apple II peripherals.
- * Effective baud rate greater than 10,000 fast scrolling and clearing.
- * Synchronous operation with Apple II.
- * Can be used with Apple II communication interface board to act as self contained terminal for time-sharing or other applications.

Video Board

Nett	Vat	Total
275.00	41.25	316.25

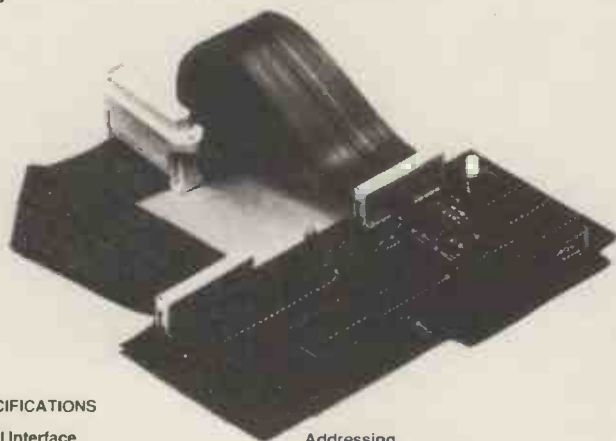

SPECIFICATIONS

Serial Interface

- * One RC-232 interface with EIA receivers and drivers
- * Available handshaking lines --Request--To--Send (RTS), Clear--To--Send (CTS), Data--Carrier--Detect (DCD)
- * Rotary switch selectable baud rates-- 110, 134.5, 300, 600, 1200, 2400, 4800 (9600 and 19200 baud available under software control for printers)
- * External clock input for up to 500K baud
- * Software controlled modes:
 - 7 or 8 data bits
 - Even or odd parity
 - 1 or 2 stop bits
 - 1, 16, 24 baud rate divisor
 - Master reset
 - RTS mode control
- * Double buffered send and receive registers
- * Supports full duplex operation

Parallel Interface

- * Two bi-directional 8-bit ports
- * Four additional interrupt and handshaking lines
- * Interface configuration and data direction controlled by software

Firmware

- * 256 bytes of on-board PROM

Addressing

- * 6 memory mapped registers

Cable Assemblies

- * Serial interface-- 6 inch ribbon cable with DB-25 socket
- * Parallel interface-- 18 inch ribbon cable with uncommitted end

PC Board

- * High grade FR-4 blue epoxy.
- * Double sided solder mask with silk screened parts legend and gold-plated edge connector contacts.
- * Dimensions-- 2.7" x 6.3" (excluding edge connector contacts).

Miscellaneous

- * PROMs and data buffer power-down when not addressed
- * Sockets provided for all ICs

A.I.O.

Nett	Vat	Total
105.00	15.75	120.75

AIO™ Serial & Parallel Apple Interface

TWO BOARDS IN ONE

The AIO Apple Interface allows maximum flexibility for interfacing your Apple II with peripherals such as printers, plotters, terminals, modems and other computers. The AIO can communicate with both serial and parallel devices. It can even interface with both at the same time. And you won't need to write any software to operate the AIO. It comes complete with the necessary software and on-board firmware to handle serial and parallel communications.

APPLE III

Interested?? Please ring 051-933 5511!!

Please ring Paul Fullwood or Carl Phillips for other interfacing requirements.

Stack Computer Services Ltd
290-298 Derby Road, Bootle,
Liverpool L20 8LN.
051-933 5511.



MICROCHESS

Micro chess is becoming enormously popular — witness the first world championships to be held at the next PCW show. Every month, Kevin O'Connell reports on the 'state of play'.

SUPER SYSTEM

The Chess Champion Super System III* took the Blue Riband of the commercial chess computer industry to SciSys—W Ltd in Hong Kong when it appeared on the West German market last autumn. Available in the UK since the Spring, it took that Riband for three main reasons: (1) playing strength, (2) features and (3) observance of the laws of chess. Now, before I go any further I have to point out that although I hope my assessment of this product is unbiased, it's not a disinterested one, since I did, for commercial gain as well as for fun, help to design the program and the machine's features.

When System III appeared on the market its main rival, in terms of playing strength, was Fidelity's Voice Chess Challenger. I conducted a 17-game match between the two which showed the playing strength to be about the same, at least from the chess master's point of view. The overall result was 10-7 in favour of System III, which was playing at a slight time disadvantage.

System III also came closer than any other program to creating a major sensation when, earlier this year, it achieved a winning position against the human world champion, Anatoly Karpov. The circumstances were unique: the West German department store chain of Horten sponsored a chess tournament at Bad Kissingen to help promote interest in chess and in sales of chess computers, especially the System III. During the tournament a day was set aside when each of the Grandmasters played 25 games simultaneously against an army of System IIIs. After 32 moves of one of the world champion's games, he was a rook down, with a lost game; he still, however, had one threat.

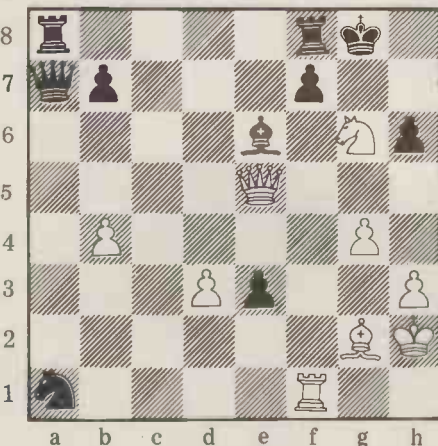

From the diagram, System III (with the black pieces) played Rf8-d8, a blunder that allowed the world champion to save his honour with Qe5-h8 checkmate (Qa7-b8 instead of Rf8-d8 would have won). A horrible end for the program, but history had been made and that game is still making the rounds of the world's chess press.

The most notable features of System

III are its four modular accessories. Two of them, a power pack and a CMOS memory, are relatively unexciting, but the other two are major advances on previously available chess machine hardware. An LCD chess board and an electronic printer can be clipped on to the sides of the master unit, as shown in the photograph.

The LCD board solves the problem — around since the first chess computer appeared three years ago — of knowing whether you have the same position on the chess board as the computer has on its internal board. If you do make any mistakes or simply want to change the board position — perhaps because you

made a chess mistake, blundering away one of your pieces — then the keyboard system, with its 'takeback' feature and 'enter position' mode allows such changes to be made.

All serious chess players keep records of the games they play and if you have ever played any games against a chess computer, you may also wish that you could consult the moves of a game you played against it. You'll be pleased to hear that a printer is available as an accessory to this versatile system. I show here the printer's output for the game against Karpov referred to above. The print-out includes two diagrams which you can elect to have whenever you like. The repetitive 'MD' indicates that I was using the 'More Data' function which allows you to print out the record of any game, GOTO Page 131



```

♠C2 C4MD      ♠E7 D8MD      ♠F6xE5MD
♠B1 C3MD      ♠A5xB4MD      ♠B2xE5MD
♠G2 G3MD      ♠A3xB4MD      ♠G7 G8MD
♠F1 G2MD      ♠C5 A7MD      ♠H4 G6MD
♠F8 C5MD      ♠H7 H6MD      *****
♠G8 F6MD      ♠G7xF6MD      ♠( ) ( ) (♠) ♠( )
♠E8 G8MD      ♠D1 D2MD      (♠) ♠( ) ( ) ♠( )
♠D7 D6MD      ♠H8 H7MD      ( ) ( ) (♠) ( )
♠C8 E6MD      ♠F5 E6MD      (♠) ( ) (♠) ( )
♠A7 A5MD      ♠H7 G7MD      ( ) ( ) ( ) ♠(♠)
♠D8 E7MD      ♠C6 D4MD      (♠) ( ) ( ) ♠( )
♠E6 F5MD      ♠D4 B3MD      *****
♠G8 H8MD      ♠B3xA1MD      ♠F8 D8
♠C3 D5MD      ♠D7 C6MD      01*♠E5 H8*
♠D5 C3MD      ♠D6 D5MD      *****
♠C4xD5MD      ♠C6xD5MD      ♠( ) ( ) (♠) ♠( )
( ) ♠(♠) (♠) ♠(♠) ♠(♠)
( ) ♠(♠) (♠) ( )
(♠) (♠) ♠(♠) ♠(♠)
( ) ♠( ) ( ) ( )
(♠) ( ) ♠( ) ♠(♠) ♠(♠)
(♠) ( ) ♠(♠) ♠(♠)
( ) ♠( ) ♠( ) ♠(♠)
♠F2 F4MD      ♠D4xE3MD      *****
♠F4xE5MD
    
```

Printout of the Karpov game

calls the "self help movement" — the mushrooming of groups such as the Parents of Gays and Lesbians, Depressives Associated and Citizens to Bring Broadway Back. He believes that this movement indicates a rejection of mass society and standardisation.

This 'de-massification' is one trend which he believes will lead to a philosophy of 'small-within-big is beautiful' which will become possible within the intelligent environment that allows individuals and groups to remain interlinked while living and working within small communities. Computers are assisting in de-massification he claims and in breaking down the obsession with the standardisation that came as a by-product of mass-production.

However, he dismisses any contradictory trends as being the final throes of the Second Wave, rather than accepting that if there is a Third Wave it may be very different to his own vision. There's growing evidence, for example, that office automation could lead to the implementation of automation management methods in white collar work . . . the same trend that once created the manufacturing production line with its attendant emphasis on product standardisation, dehumanisation of work tasks and alienation of the workforce. And where would the standard McDonald hamburger be without computer control?

Society is, if anything, becoming more standardised with America, the most conformist society of all. In the early 20th Century, at the peak of the Second Wave, American entertainment was anarchic and individualistic. Now, despite a myriad of radio and TV stations and Citizens Band Radio, standard pap is churned out — and the use of electronic technology seems merely to increase the volume of pap rather than change the quality.

The superficiality of *The Third Wave* is epitomised in a section on 'the new image of nature'. Toffler comments, "Whether we examine opinion surveys or the lyric of pop songs, the visual imagery in advertising or the content of sermons, we find evidence of a heightened, though often romantic, regard for nature." It's not an uncommon sight in America to see someone drinking a calorie-free drink at breakfast to wash down



half-a-dozen pancakes with syrup. Or to see an 'ecologically sound' advertisement for some totally unnatural product like alcohol or even cigarettes. Nobody could seriously take the imagery of advertising as meaning anything other than a carefully planned consumer hook.

I fear that *The Third Wave* will be overvalued because of Toffler's reputation and his slick journalistic style; it's peppered with quotable quotes and so many new Tofflerisms that one or two may join future-shock in our cultural vocabulary. If it had been written by somebody else, I doubt whether it would even have been published and clearly the decision to provide this sort of space for a review is based more on Toffler's reputation than on any particular merit.

There are many other less pretentious books which say much more in rather fewer words — such as the recent double-barrelled British paperback assault, which is reviewed following the next headline break . . .

PL²

On the same early summer's day, two books were published with the same title, at the same price, by authors with similar names (initials PL) from publishers whose names possess the same first and last letters. The title of the books is *The Micro Revolution*. Their coincidental publishing

graphically illustrated the rush to publish that has followed in the wake of the 'Great Micro Debate', swelling the volume of futuristic predictions to new heights.

It would be a pity, however, if the confusion over names and the volume of other material on the subject caused these two books to be ignored because each, in its own way, is an excellent contribution to the micro discussion. Both are by experienced professional journalists — Peter Large, technology correspondent of the *Guardian*, and Peter Laurie, Editor of *Practical Computing*. Although in some respects their books cover similar territory, they could have been accurately differentiated had Laurie's book (published by Futura) been entitled something like 'a guide to information technology' because it's primarily an easy-to-read introduction to the nature of the technology that may cause the 'revolution'. On the other hand, Large's book (published by Fontana) is primarily about the applications of the technology.

Both writers are technological enthusiasts, excited by the technological potential, although aware of possible negative effects. Their differing degrees of optimism are summarised by the (thankfully) different subtitles given to the books. "The microchip that will change your life" (my italics) is the Large motto on the front cover; Laurie's, however,

is more doubting: "A change for the better or worse?" Neither book says much that has not already been said in the Micro Debate. What is interesting is that they say it in a much more practical and succinct style than Alvin Toffler with his more philosophically rambling approach (see above.)

Peter Large has given an elegant shape to his book by starting with a short story called 'a day after tomorrow' which examines the lifestyles of Jane and Joe Babbage in an idyllic electronic future. Jane is a newspaper editor and Joe a General Practitioner and they live and work in Cornwall using all the facilities of the wired society to carry out the jobs, educate their children and entertain themselves from the end of a computer terminal.

Large systematically shows how the technological elements that compose the Babbage lifestyle, although apparently futuristic in the short story context, are generally available today. The chapter titles indicate the familiar ground covered, including 'Getting rid of money', 'Of satellites and laser light', 'Jobs that have gone' and 'The threat to privacy.'

Using his skill as a reporter and the information available to him on *The Guardian*, Large provides a good, enjoyable round up of the state of the micro art as it was in 1979. He quotes extensively from the Brigade of Pundits who have been quick with micro quotes, which gives the book the feel of an extended newspaper article. Although this immediacy lays itself open to the erosions of time and rapid technological innovation, its main thesis and the trends it indicates are stronger than the transient accuracy of any particular forecast relating to whether a particular capability is or will be available.

The flavour of Peter Laurie's *Micro Revolution* is also reflected by the chapter titles, which are simply called things like 'Data', 'Memory Devices' and 'Software.' It seems as if the book was originally conceived as a technical introduction to the subject but was then dressed in 'social relevance' garb in order to catch the Third Wave tide.

This is a pity, because it devalues the uniqueness of the book, which is as an extremely lively educational aid of the 'All you ever wanted to know about computers but were afraid

APPLE COMPUTER SYSTEMS APPLE COMPUTER SYSTEMS APPLE CO
 MPUTERS MICROSENSE COMPUTERS MICROSENSE COMPUTERS M
 APPLE COMPUTER SYSTEMS APPLE COMPUTER SYSTEMS AP
 MICROSENSE COMPUTERS MICROSENSE COMPUTERS MICROSENSE C
 COMPUTERS MICROSENSE COMPUTERS MICROSENSE COMPUTERS

Apple Price List

Product Code	Description	Retail Price (£)		Retail Price (£)
HARDWARE				
A2S1016P	APPLE 16K VIDEO OUTPUT ONLY	695.00	A2L001A	APPLE II REFERENCE MANUAL
A2M0003	DISC DRIVE WITHOUT CONTROLLER	299.00	A2L0002	6502 HARDWARE MANUAL
A2M0004	DISC DRIVE WITH CONTROLLER	349.00	A2L0003	6502 SOFTWARE MANUAL
A2M0016	16K ADD ON RAM	69.00	A2L0005	APPLE II BASIC PROGRAM MANUAL
CARDS & ACCESSORIES				
A2B0001	PROTOTYPE/HOBBY CARD	15.00	A2L0006	APPLE II REFERENCE MANUAL
A2B0002	PARALLEL PRINTER INTERFACE CARD	104.00	A2L0012	DOS 3.2 MANUAL
A2B0003	COMMUNICATIONS CARD	130.00	A2L0018	APPLE II BASIC TUTORIAL MANUAL
A2B0005	HIGH SPEED SERIAL INTERFACE CARD	113.00	GENERAL ACCESSORIES	
A2B0006	PASCAL LANGUAGE SYSTEM	299.00	A2D0000	(10) BLANK APPLE DISCETTES
A2B0007	CENTRONICS CARD	130.00	A2M0009	VINYL CARRYING CASE
A2B0009	APPLESOFT FIRMWARE CARD	116.00	AD/LB	MINI DISC LIBRARY BOX
A2B0010	INTEGER CARD	116.00	MD5172	DISCOFLEX FILING CASE—MINI
MHP-X003	MOUNTAIN HARDWARE CLOCK/CALENDAR CARD	160.00	APP1	APPLE DESK TWO TIER
MHP-X006	MOUNTAIN HARDWARE SUPERTALKER	171.00	APP2	PRINTER TABLE
MHP-X007	MOUNTAIN HARDWARE ROM PLUS BOARD	116.00	APPLETEL	APPLETEL SYSTEM
MHP-X015	MOUNTAIN HARDWARE ROMWRITER	101.00	DUST/IAPP	DUSTCOVER FOR APPLE II
E2B100	EUROCOLOUR CARD	79.00	E2B013	APPLEJUICE RESERVE POWER SUPPLY
E2B101	APPLE BLACK & WHITE MODULATOR	14.00	PRINTERS & ACCESSORIES	
E2B102	A1-02 DATA ACQUISITION CARD	180.00	A2M0034	SILENTYPE 80 COLUMN GRAPHICS PRINTER
10-5-16	ALF MUSIC SYNTHESIZER CARD	142.00	A2C0001	10 ROLLS OF THERMAL PAPER FOR SILENTYPE PRINTER
10-5-17	ALF TIMING MODE INPUT BOARD	14.00	HUSH100/A	MICROHUSH 100 PRINTER C/W APPLE INTERFACE
13-3-2	ALF ALBUM MUSIC DISKETTE NUMBER ONE	12.00	HUSH/PAP	16 ROLLS THERMAL PAPER 80FT LONG
13-3-4	ALF ALBUM MUSIC DISKETTE NUMBER TWO	12.00	HUSH/PAP/E	2 ROLLS THERMAL PAPER 80FT LONG
13-5-5	ALF ALBUM MUSIC DISKETTE CHRISTMAS	12.00	TIGER/G	PAPER TIGER PRINTER WITH GRAPHICS OPTION
A2M0015	HEURISTICS SPEECH LAB	122.00	TIGER/C	CONNECTOR CABLE FOR TIGER PRINTER
A2M0019	PROGRAMMERS AID 1	27.00	TIGER/D	GRAPHICS SOFTWARE FOR TIGER PRINTER
A2M0027	AUTO START ROM PACK	38.00	TIGER/P	TIGER PAPER 2,000 SHEETS 11" x 9 1/2" S/PART
A2M0029	GRAPHICS TABLET	462.00	TIB10	TEXAS OMNI 810 PRINTER
E2B104	HEURISTICS CONTROLLER 70	52.00	LP5	PAPER 2000 SHEETS 11" x 15" S/PART
E2B105	HEURISTICS SPEECHLINK 2000	160.00	LP9	PAPER 3000 SHEETS 8" x 12" S/PART
E2B107	IEEE INTERFACE	212.00	VIDEO MONITORS	
SOFTWARE				
A2D0005	CONTRIBUTED SOFTWARE VOL3 3-5	60.00	VM129	12" BLACK AND WHITE VIDEO MONITOR
A2D0006	CONTRIBUTED SOFTWARE VOL3 1-2	27.00	VM910	9" BLACK AND WHITE VIDEO MONITOR
A2D0009	MICROCHESS 2.0 CHESS DISK	15.00	VM906	9" HIGH RESOLUTION BLACK AND WHITE VIDEO MONITOR
A2D0010	DISC UTILITY PACK	15.00	VM/C	CABLE FOR VIDEO MONITOR
A2D0012	APPLE BUSINESS CONTROLLER PROGRAM	340.00		
A2D0013	APPLE POST PROGRAM	27.00		
A2D0018	APPLE BOWLING DISCETTE	9.00		
A2D0025	APPLE CASHIER PROGRAM	194.00		
A2D0026	APPLE WORD PROCESSING PROGRAM	42.00		
A2T0013	MICROCHESS 2.0 CHESS CASSETTE	15.00		
E2D001	VISICALC DISC & BOOK COMPLETE	95.00		

Prices exclusive of carriage and VAT and are correct at time of going to press. Available from Apple Dealers all over the UK—for your nearest please contact Microsense Computers. Dealer/OEM enquiries welcome.

microsense computers limited

Finway Road, Hemel Hempstead, Herts HP2 7PS
 Tel (0442) 48151 and 41191
 Telex: 825554 DATEFF G



SOLE UK DISTRIBUTOR
apple computer

Apple is a trade mark of Apple Computer Inc., Cupertino, C.A., USA



APPLE COMPUTER SYSTEMS APPLE COMPUTER SYSTEMS AP
 COMPUTERS MICROSENSE COMPUTERS MICROSENSE COMBIT

BOOKFARE

to ask in case you did not understand the answer' ilk. On each subject covered (which includes advanced topics such as artificial intelligence as well as basic Basics) he provides sufficient depth to give a real grasp of the technicalities. In some areas, particularly artificial intelligence, this level might be too deep but it's easy to skip over anything that appears too heavy for personal tastes.

His comments on the social implications of the technology are tantalisingly brief because his anarchic, manic-depressive views provide an individual perspective on what has become a hackneyed subject.

The last chapter of the Laurie book is only eight pages long and is a reprint of articles published by him in the *New Scientist* in a column entitled 'Pig Ignorant.' In this he humorously describes his own futreshock when meeting the computer enthusiasm of his then-twelve-year-old son, which develops into a freewheeling look at the organisational and social power groups which will dictate the shape of the micro revolution. Laurie's book is worth reading just for this Pig Ignorant section for those old lags who feel they already know enough about the technology. For newcomers to the whole subject, the PL2s offer, in their different ways, two of the best micro primers around.

Included in this month's Bookfare were:

The Third Wave by Alvin Toffler (Collins, £8.95)
The Micro Revolution by Peter Large (Fontana, £1.50)
The Micro Revolution by Peter Laurie (Futura, £1.50)

TECHNICAL REVIEWS

by Peter Rodwell

Microcomputer Components Data Book (Zilog Inc, \$5.00)
Despite the wave of publicity given to the new generation of 16-bit processors, you'll find precious few of them actually in the market place right now. One reason for this (other than the technicality that manufacturers are said to be having a hell of a time trying to make them) is that the CPUs by themselves are useless — they need a cast of supporting chips to enable them to function in the environment for which they were designed. Thus, even if you can get your hands on one of Zilog's Z8000 CPUs, you'll not be able to use it to its full capabilities without the extras to hang onto it. But until these appear you can at least read about them in the new Zilog Data Book.

As well as giving pure

technical details on the Z8001 and Z8002 chips, the book includes a useful tutorial on these devices, which makes it easier to understand their capabilities than reading a straightforward data sheet. But more interesting still are the support chips which Zilog intends to produce, both immediately and in the future.

Taking prime place among these is the Z8010 memory management unit, which is sufficiently complex to merit its own explanatory tutorial. If you want to use the Z8001 — the segmented version — then you'll need to know all about the MMU to exploit its full potential.

The book also describes the Zilog Z-Bus, designed for use with the Z8000 family. This family includes the Z8034 Universal Peripheral Controller, a slave processor similar to the Z8 with facilities which include 2k of on-chip ROM, three programmable I/O ports and six levels of priority interrupt. Then there's the Z8030 Serial Communications Controller, which gives you two independent full-duplex channels with fully programmable protocols, operating at up to 1 Mbit per second. If that leaves you cold then there's also a couple of pages on the Z8038 FIFO I/O interface unit and one page on the Z8060 FIFO buffer unit.

Coming soon, and thus receiving only a few paragraphs of text each, are three further devices: the Z8016 DMA controller will be able to handle transfers at up to 2 Mbytes per second, and to keep things sorted out Zilog also intends to give us the Z8065 burst error processor. But what is interesting is the proposed Z8052 CRT controller, which will be handy for word processing, scientific and mathematical applications as it allows all sorts of wonders such as mixed typefaces, vertically and horizontally-split screen formats and "simple line drawing capabilities".

At the back of the book are three memory devices, the Z6115 and Z6116 dynamic RAMs, respectively 8k x 1 and 16k x 1, and the Z6132 4k x 8 'quasi static' RAM. Quasi static means that it's a dynamic RAM chip with on-board refresh circuitry which makes it look like a static chip as far as the rest of the system is concerned. This is such an obvious solution that I can't understand why it wasn't done right from the start; maybe it's something to do with the "... high-performance depletion-load double-poly n-channel silicon-gate MOS technology..." which Zilog use to make it.

On more familiar ground, though, there's a whole section at the start of the book devoted to the Z80 family,

one addition to which is the Z80 DART (dual asynchronous receiver/transmitter), which offers two separate full duplex channels, both with modem controls, and should prove useful if you don't need the synchronous capability of the Z80 SIO.

Machine Language Programming from the Ground Up (Hubert S Howe Jr (A J Harding (Molimerx), £8.50)
This book is inaccurately titled as it deals not with machine language programming as a general subject but with assembler language programming for the TRS-80. Having said that, though, I must immediately add that it's a useful guide for anyone wanting an introduction to low-level Z80 programming; it's also handy for any TRS-80 owner who wants to 'get inside' the machine.

Of the book's 17 chapters, five deal exclusively with various aspects of the TRS-80. The remaining 12 cover in detail the concept of low-level programming, number bases, the Z80's architecture and instruction set, assembler language programming in general and those of its various aspects which are likely to be of greatest difficulty for the beginner. This latter group includes using the stack, reading and printing numbers, organising arrays and tables, moving data, integer, BCD and (briefly) floating point arithmetic, logical and bit operations and 8 and 16-bit multiplication and division. Each of these subjects gets a separate chapter and all are likely to be useful to the owner of any Z80-based system. There are plenty of programming examples.

TRS-80 owners will find the five machine-dependent chapters useful, even for Basic programming in some

cases. The Level II Basic ROM is thoroughly dissected and addresses given for all the main subroutines, although, as the book points out, only a few of these (I/O sub-routines, for example) are useful for assembler programming. Particularly handy is a list of all the RAM locations used by the Basic interpreter, with notes of their functions. The final four chapters deal in detail with cassette I/O and tape formats, USR subroutines in Basic, TRSDOS disk subroutines and a final, rather short, look at disk files.

The book is an amalgamation of a series of articles which the author wrote for the US *TRS-80 Monthly News Magazine* and although it has been Anglicised there are one or two references to American products which may not be available here. The author does occasionally let his transatlantic enthusiasm get the better of him; consider, for example, "The execution of one line in a Basic program may require millions or even billions of machine instructions" or, more oddly, when discussing the speed at which data is transferred between disk and RAM, "... this is so fast that it cannot be done in Basic at all."

At first sight the book seems a little over-priced, considering that it has been typed on a word processor and printed by Battle Instant Print, but then you're paying for the information it contains rather than for a masterpiece of the printer's art.

The 'ground', up from which the book progresses, is as far as I could discover, the correct pronunciation of 'mnemonics'; in case you wondered, it's "nem-on-iks".

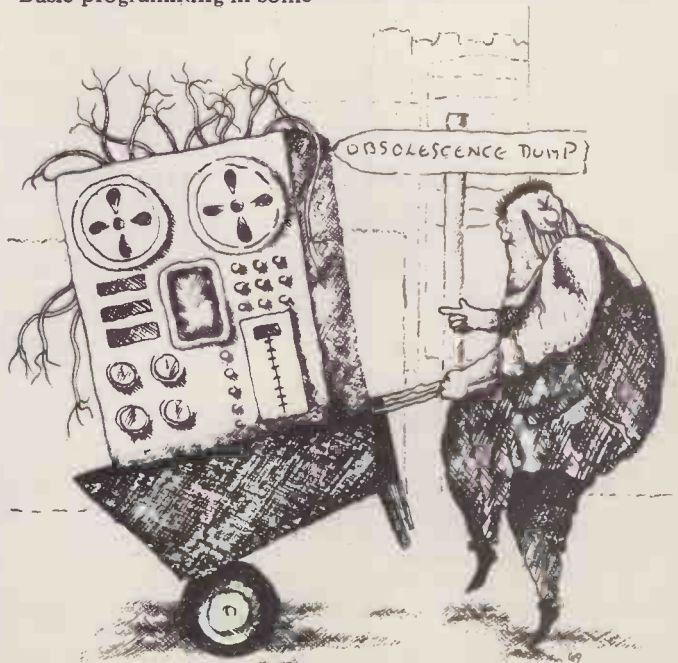

COMPUTER GAMES

by David Levy



DEBATING DRAUGHTS

Up to now this series has been devoted entirely to the general principles involved in writing programs to play intelligent games. This month we start on a new tack, with upcoming articles that will describe specific games in some detail and comment on the most notable work in each field. From now on I shall be happy to accept readers' letters for consideration. These should be written in English and addressed to me at 104 Hamilton Terrace, London NW8 9UP, England, and while I shall endeavour to answer the most interesting letters within future articles, under no circumstances will any reader receive a personal reply — I'm sorry but I'm much too busy.

The subject of the present article is the game of draughts (known as checkers in North America and dames throughout much of continental Europe). I have already described one of the learning techniques employed in Arthur Samuel's checker program; now we shall be making a closer inspection of other aspects of this famous project. The article will conclude with some additional comments on computer learning, as applied to games.

Samuel's checker program

Arthur Samuel began to program checkers in 1952, using an IBM 701 computer. It was rewritten for the IBM 704 in 1954 and the following year the first learning mechanism was introduced.

The fundamental program structure employed a minimax tree search, since

the alpha-beta algorithm had not yet been invented. All moves were examined to a depth of 3-ply, and the program would look selectively at moves at the next ply, provided that:

- (i) The move was a capture;
- (ii) The previous move was a capture; or
- (iii) The move offered the opponent the chance to exchange men.

At the next ply the program ignored all moves for which the previous move was not a capture, and at the sixth ply and deeper levels in the tree only capture moves were examined. By the time the program reached this depth the number of moves being examined from any position was small, but it was still possible for the program to find itself getting involved in ridiculous capture sequences, and so at a depth of 11-ply the search would terminate if either side was more than two kings ahead (an overwhelming advantage). At 20-ply the search terminated under all circumstances so that the program did not run out of memory for storing the

tree.

Samuel's criteria for pruning the tree were chosen in such a way as to encourage the evaluation of positions that were quiescent, and to discourage evaluation in turbulent positions. The concepts of quiescence and turbulence are perhaps better understood when related to the two different aspects of game playing: strategy and tactics. Strategy involves planning and manoeuvring. Tactics (e.g. capturing) are used to punish blunders and to convert a strategic advantage into something more concrete, such as material. The argument in favour of Samuel's approach is that the three ply of exhaustive search gives the program some strategic grasp of what is happening, while the deeper tactical search ensures that it does not perform erroneous evaluations in turbulent positions. The necessity to restrict the deeper search in this way is clearly dependent on the nature of the game and the number of branches at each node of the tree (the branching factor). The number

of positions evaluated in an alpha-beta search is roughly proportional to $b^d/2$ where b is the average branching factor and d is the depth of search, and anything that can be done to reduce the 'b' will produce a combinatorial improvement in playing speed.

The evaluation function used in the early version of Samuel's program employed 39 terms or features, only 17 of which were in use at any one time. The features were temporarily suspended from duty if and when it was found that they did not contribute significantly to the evaluation process. Correlation measurements indicated which of the 17 features currently in use were the least effective, and once the effectiveness dropped below some threshold value they were replaced by the features at the top of the reserve list, while the rejects were added to the bottom of the reserve list. Material was the dominant feature, and Samuel recognized the need to encourage the program to trade off pieces when it was ahead but to avoid exchanges when behind. This may be accomplished in various ways but the most reliable is probably to determine the value of

(program material — opponent's material) X (greater side's material) / (lesser side's material)

A full list of the other features in the linear part of the evaluation function is given below. There were in addition some non-linear terms in the function. In the following list the board notation is as used in the draughts (checkers) literature:

	32		31		30		29
28		27		26		25	
	24		23		22		21
20		19		18		17	
	16		15		14		13
12		11		10		9	
	8		7		6		5
4		3		2		1	

ADV (Advancement)

The parameter is credited with 1 for each passive man in the 5th and 6th rows (counting in passive's direction) and debited with 1 for each passive man in the 3rd and 4th rows.

APEX (Apex)

The parameter is debited with 1 if there are no kings on the board, if either square 7 or 26 is occupied by an active man, and if neither of these squares is occupied by a passive man.

BACK (Back Row Bridge)

The parameter is credited with 1 if there are no active kings on the board and if the two bridge squares (1 and 3, or 30 and 32) in the back row are occupied by passive pieces.

CENT (Centre Control I)

The parameter is credited with 1 for

each of the following squares: 11, 12, 15, 16, 20, 21, 24 and 25 which is occupied by a passive man.

CNTR (Centre Control II)

The parameter is credited with 1 for each of the following squares: 11, 12, 15, 16, 20, 21, 24 and 25 that is either currently occupied by an active piece or to which an active piece can move.

CORN (Double-Corner Credit)

The parameter is credited with 1 if the material credit value for the active side is 6 or less, if the passive side is ahead in material credit, and if the active side can move into one of the double-corner squares.

CRAMP (Cramp)

The parameter is credited with 2 if the passive side occupies the cramping square (13 for Black, and 20 for White) and at least one other nearby square (9 or 14 for Black, and 19 or 20 for White), while certain squares (17, 21, 22 and 25 for Black, and 8, 11, 12 and 16 for White) are all occupied by the active side.

DENY (Denial of Occupancy)

The parameter is credited with 1 for each square defined in MOB if on the next move a piece occupying this square could be captured without an exchange.

DYKE (Dyke)

The parameter is credited with 1 for each string of passive pieces that occupy three adjacent diagonal squares.

EXCH (Exchange)

The parameter is credited with 1 for each square to which the active side may advance a piece and, in so doing, force an exchange.

EXPOS (Exposure)

The parameter is credited with 1 for each passive piece that is flanked along one or the other diagonal by two empty squares.

FORK (Threat of Fork)

The parameter is credited with 1 for each situation in which passive pieces occupy two adjacent squares in one row and in which there are three empty squares so disposed that the active side could, by occupying one of them threaten a sure capture of one or the other of the two pieces.

GAP (Gap)

The parameter is credited with 1 for each single empty square that separates two passive pieces along a diagonal, or that separates a passive piece from the edge of the board.

GUARD (Back Row Control)

The parameter is credited with 1 if there are no active kings and if either the Bridge or the Triangle of Oreo is occupied by passive pieces.

HOLE (Hole)

The parameter is credited with 1 for each empty square that is surrounded by three or more passive pieces.

KCENT (King Centre Control)

The parameter is credited with 1 for each of the following squares: 11, 12,

15, 16, 20, 21, 24 and 25 which is occupied by a passive king.

MOB (Total Mobility)

The parameter is credited with 1 for each square to which the active side could move one or more pieces in the normal fashion, disregarding the fact that jump moves may or may not be available.

DIA (Double Diagonal File)

The parameter is credited with 1 for each passive piece located in the diagonal files terminating in the double-corner squares.

DIAM (Diagonal Moment Value)

The parameter is credited with 1/2 for each passive piece located on squares 2 removed from the double-corner diagonal files, with 1 for each passive piece located on squares 1 removed from the double-corner files and with 3/2 for each passive piece in the double-corner files.

MOVE (Move)

The parameter is credited with 1 if pieces are even with a total piece count (2 for men, and 3 for kings) of less than 24, and if an odd number of pieces are in the move system, defined as those vertical files starting with squares 1, 2, 3 and 4.

NODE (Node)

The parameter is credited with 1 for each passive piece that is surrounded by at least three empty squares.

OREO (Triangle of Oreo)

The parameter is credited with 1 if there are no passive kings and if the Triangle of Oreo (squares 2, 3 and 7 for Black, and squares 26, 30 and 31 for White) is occupied by passive pieces.

POLE (Pole)

The parameter is credited with 1 for each passive man that is completely surrounded by empty squares.

RECAP (Recapture)

This parameter is identical with Exchange, as defined above. (It was introduced to test the effects produced by the random times at which parameters are introduced and deleted from the evaluation polynomial.)

THRET (Threat)

The parameter is credited with 1 for each square to which an active piece may be moved and in so doing threaten the capture of a passive piece on a subsequent move.

Different sets of weightings were tried in the evaluation function and an initial set was chosen by playing through a series of checker games from a book and computing the correlation coefficient of the moves chosen by the program and those chosen by the original (human) player.

Rote learning

The most elementary type of learning worth programming is the storing of a large number of game positions together with their scores as determined by the evaluation function. Samuel pointed out that if a score for a position was arrived at as a result of a 3-ply search, the next

MOVE	PHASE 1	PHASE 2	PHASE 3	PHASE 4	PHASE 5	PHASE 6
1-5	0.07	0.09	0.12	0.06	0.05	0.05
1-6	0.11	0.18	0.15	0.06	0.07	0.02
etc.					

time this position is encountered as a terminal node in the tree (say at depth 3) the evaluation of the root position will be made on the basis of a search which has, in one variation, been examined to a depth of 6-ply. In this manner a program with a large storage capability could learn to play a game such as checkers rather well. The problem facing personal computer users is clearly one of space, and without a floppy disk system the task will be impossible for any moderately interesting game. Even with a floppy, games such as checkers will very soon use up all available memory.

Move-phase-tables

Another method of learning, described in 1974 by Arnold Griffith, is quite unusual. Griffith discovered that in each particular phase of the game a certain move would, fairly consistently, either be a good move or a bad move. This is an oversimplification of his thesis, but it will suffice for the purpose of this article.

Griffith analysed a number of games from draughts books. Whenever an expert player made a move, Griffith noted the move and defined the position arising after that move as a 'strong' position. A position which would have arisen after an alternative

move was assumed to be less desirable, and hence termed a 'weak' position. He then tabulated all the possible forward moves, of which there are 49, and for each forward move he noted the proportion of occasions in which this move led to a strong position in each phase of the game (1st ten moves, 2nd ten, 3rd ten, 4th ten, 5th ten and move 50 onwards). The first rows of his table are shown above.

When the program came to evaluate a move it could simply look up the table entry corresponding to the particular move and the appropriate phase of the game. One way of utilizing such a method would be to employ Michie's probabilistic approach described last month, since this would provide a more global view of whether a particular path in the tree was heading in a desirable direction.

I must confess that I find Griffith's method somewhat curious, but it appears to work to a certain extent in draughts, and presumably the same will be true in other games which (a) have a fairly restricted move set, and (b) have a dependence relationship between the various phases of the game and the moves themselves. In chess, for example, the move of the king towards the centre of the board is usually very undesirable until the end game is reached, but the game is so complex

that very few rules of this type could be used for phase-tables, and the number of possible chess moves is so vast that the whole approach would be useless. I would be very interested to hear from any reader who successfully applies the phase-table method to a game playing program.

Monthly tasks

In previous articles I have set a monthly task to test the readers' understanding of particular principles in the programming of computer games. Since this month's article heralds a new phase in my series, in which I shall be concentrating on specific games, I will not be setting any more tasks for the reader. I hope that some of you will write successful game playing programs, and that you will write to me with any interesting ideas or discoveries.

Bibliography

Griffith, A.K. *A Comparison and Evaluation of Three Machine Learning Procedures as Applied to the Game of Checkers*. Artificial Intelligence, volume 5 (1974), pp. 137-148.

Samuel, A. *Some Studies in Machine Learning using the game of checkers*. IBM Journal of Research and Development, volume 3 (July 1959), pp. 211-229.

Samuel, A. *Some Studies in Machine Learning using the game of checkers - II - recent progress*. IBM Journal of Research and Development, volume 11 (November 1967), pp. 601-617.

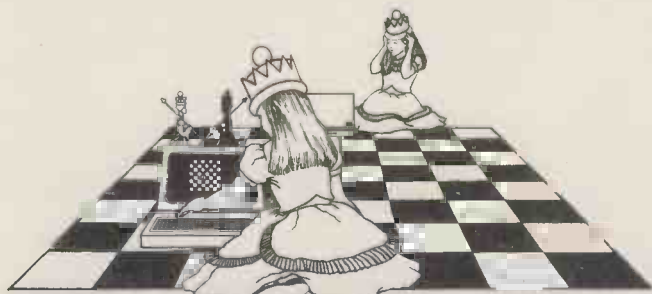

WORLD MICROCOMPUTER CHESS CHAMPIONSHIP

A major attraction at the Third Personal Computer World Show will be the first ever official World Microcomputer Chess Championship, held under the auspices of the International Computer Chess Association.

The Championship is open to both commercial and non-commercial entrants, with a first prize of £500 for the highest-placed non-commercial contestant.

For further details, write immediately to David Levy,
c/o Personal Computer World, 14 Rathbone Place, London W1P 1DE.

The 3rd
**Personal
Computer**
World
Show

The Third Personal Computer World Show is at the Cunard International Hotel, 4 - 6 September.

Make your micro

MIGHTY



Get the most out of your microcomputer with Graham-Dorian Business software.

At any given time, your hardware is only as useful as the software you run in it. Our programs let you realise the full potential of your hardware

Graham-Dorian provides highly detailed and well documented programs. All pretested on the job. Each so comprehensive that it takes little time to learn to run a program — even for someone who's never operated a computer before.

Graham-Dorian programs are on-line now working for us and others around the world. They are ready to go to work immediately or to be tailored for your more specific needs. Each package contains a software program in BAS and INT film form plus a user's manual and hard copy SOURCE LISTING.

Programs are compatible with most major computers using CP/M disk operating systems, and come in standard 8" or on various mini-floppy disks.

Graham-Dorian stand behind dealers with technical advice.

Yes, there's a world of difference in business software. Graham-Dorian has more per-package capabilities and more packages (with new ones added every few months).

Distributors for Micropro:- Wordstar, Datastar & Mailmerge. CP/M for Tandy Model I & II

†GDSS are appointing UK Dealers and European Distributors. Enquiries and applications invited.

*CBASIC-2 is a trade mark (copyright 1980) of Compiler Systems, Inc. GDSS are the European Distributor for CBASIC-2.

The Graham-Dorian line now includes these packages:

- Nominal Ledger
- Purchase Ledger
- Sales Ledger
- Job Costing
- Order Entry & Invoicing
- Payroll
- Manufacturing Inventory
- Manufacturing Job Costing
- Wholesaler Inventory
- Retailer Inventory
- Cash Register
- Apartment
- Surveying
- Dental

CBASIC-2*

Ask your dealer for a demonstration soon.



Graham-Dorian Software Systems

A division of Graham-Dorian Enterprises & Terodec (Micro Systems) Ltd.

17 The Gallop, Yateley, Camberley, Surrey.
Tel: (0252) 874790/(0344) 51160

Britain's first com puter kit.

The Sinclair ZX80.

£79.95

Price breakdown
ZX80 and manual: £69.52
VAT: £10.43
Post and Packing FREE

Please note: many kit makers quote VAT-exclusive prices.

You've seen the reviews... you've heard the excitement... now make the kit!

This is the ZX80. 'Personal Computer World' gave it 5 stars for 'excellent value.' Benchmark tests say it's faster than all previous personal computers. And the response from kit enthusiasts has been tremendous.

To help you appreciate its value, the price is shown above with and without VAT. This is so you can compare the ZX80 with competitive kits that don't appear with inclusive prices.

'Excellent value' indeed!

For just £79.95 (including VAT and p&p) you get everything you need to build a personal computer at home... PCB, with IC sockets for all ICs; case; leads for direct connection to a cassette recorder and television (black and white or colour); *everything!*

Yet the ZX80 really is a complete, powerful, full-facility computer, matching or surpassing other personal computers at several times the price.

The ZX80 is programmed in BASIC, and you can use it to do quite literally anything from playing chess to managing a business.

The ZX80 is pleasantly straightforward to assemble, using a fine-tipped soldering iron. It immediately proves what a good job you've done: connect it to your TV... link it to an appropriate power source... and you're ready to go.

Your ZX80 kit contains...

- Printed circuit board, with IC sockets for all ICs.
- Complete components set, including all ICs—all manufactured by selected world-leading suppliers.
- New rugged Sinclair keyboard, touch-sensitive, wipe-clean.
- Ready-moulded case.
- Leads and plugs for connection to domestic TV and cassette recorder. (Programs can be SAVEd and LOAded on to a portable cassette recorder.)
- FREE course in BASIC programming and user manual.

Optional extras

- Mains adaptor of 600 mA at 9 V DC nominal unregulated (available separately—see coupon).
- Additional memory expansion boards allowing up to 16K bytes RAM. (Extra RAM chips also available—see coupon).

*Use a 600 mA at 9 V DC nominal unregulated mains adaptor. Available from Sinclair if desired (see coupon).

The unique and valuable components of the Sinclair ZX80.

The Sinclair ZX80 is not just another personal computer. Quite apart from its exceptionally low price, the ZX80 has two uniquely advanced components: the Sinclair BASIC interpreter; and the Sinclair teach-yourself BASIC manual.

The unique Sinclair BASIC interpreter offers remarkable programming advantages:

- **Unique 'one-touch' key word entry:** the ZX80 eliminates a great deal of tiresome typing. Key words (RUN, PRINT, LIST, etc.) have their own single-key entry.
- **Unique syntax check.** Only lines with correct syntax are accepted into programs. A cursor identifies errors immediately. This prevents entry of long and complicated programs with faults only discovered when you try to run them.
- **Excellent string-handling capability**—takes up to 26 string variables of any length. All strings can undergo all relational tests (e.g. comparison). The ZX80 also has string input to request a line of text when necessary. Strings do not need to be dimensioned.
- **Up to 26 single dimension arrays.**
- **FOR/NEXT loops nested up to 26.**
- **Variable names of any length.**
- **BASIC language also handles full Boolean arithmetic, conditional expressions, etc.**
- **Exceptionally powerful edit facilities,** allows modification of existing program lines.
- **Randomise function,** useful for games and secret codes, as well as more serious applications.
- **Timer under program control.**
- **PEEK and POKE enable entry of machine code instructions,** USR causes jump to a user's machine language sub-routine.
- **High-resolution graphics with 22 standard graphic symbols.**
- **All characters printable in reverse under program control.**
- **Lines of unlimited length.**

Fewer chips, compact design, volume production—more power per pound!

The ZX80 owes its remarkable low price to its remarkable design: the whole system is packed on to fewer, newer, more powerful and advanced LSI chips. A single SUPER ROM, for instance, contains the BASIC interpreter, the character set, operating system, and monitor. And the ZX80's 1K byte RAM is roughly equivalent to 4K bytes in a conventional computer—typically storing 100 lines of BASIC. (Key words occupy only a single byte.)

The display shows 32 characters by 24 lines. And Benchmark tests show that the ZX80 is faster than all other personal computers.

No other personal computer offers this unique combination of high capability and low price.

Z80 A microprocessor—new, faster version of the famous Z-80 microprocessor chip, widely recognised as the best ever made.

Sockets for TV, cassette recorder, power supply.

SUPER ROM.

Clock. Rugged, flush, Sinclair keyboard.

RAM chips.

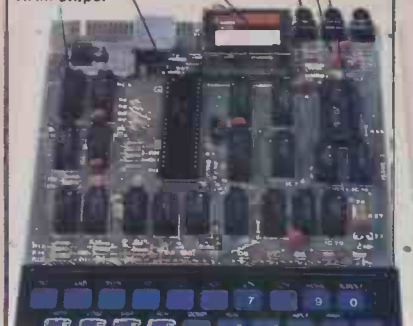

plete

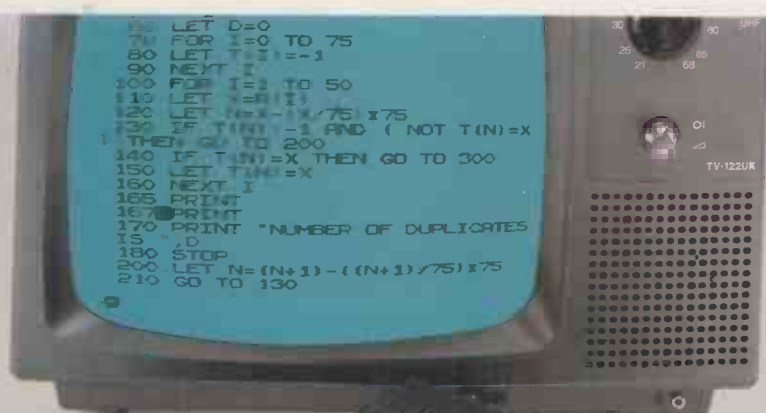

The Sinclair teach-yourself BASIC manual.

If the features of the Sinclair interpreter mean little to you – don't worry. They're all explained in the specially-written 128-page book *free* with every kit! The book makes learning easy, exciting and enjoyable, and represents a complete course in BASIC programming – from first principles to complex programs. (Available separately – purchase price refunded if you buy a ZX80 later.) A hardware manual is also included with every kit.

The Sinclair ZX80. Kit: £79.95. Assembled: £99.95. Complete!

The ZX80 kit costs a mere £79.95. Can't wait to have a ZX80 up and running? No problem! It's also available, ready assembled, for only £99.95.

Demand for the ZX80 is very high: use the coupon to order today for the earliest possible delivery. All orders will be despatched in strict rotation. We'll acknowledge each order by return, and tell you exactly when your ZX80 will be delivered. If you choose not to wait, you can cancel your order immediately, and your money will be refunded at once. Again, of course, you may return your ZX80 as received within 14 days for a full refund. We want you to be satisfied beyond all doubt – and we have no doubt that you will be.

sinclair ZX80

Science of Cambridge Ltd

6 Kings Parade, Cambridge, Cambs., CB2 1SN
Tel: 0223 311488.

ORDER FORM

To: Science of Cambridge Ltd, 6 Kings Parade, Cambridge, Cambs., CB2 1SN.
Remember: all prices shown include VAT, postage and packing. No hidden extras.
Please send me:

Quantity	Item	Item price £	Total £
	Sinclair ZX80 Personal Computer kit(s). Price includes ZX80 BASIC manual, excludes mains adaptor.	£79.95	
	Ready-assembled Sinclair ZX80 Personal Computer(s). Price includes ZX80 BASIC manual, excludes mains adaptor.	£99.95	
	Mains Adaptor(s) (600 mA at 9 VDC nominal unregulated).	8.95	
	Memory Expansion Board(s) (each one takes up to 3K bytes).	12.00	
	RAM Memory chips – standard 1K bytes capacity.	16.00	
	Sinclair ZX80 Manual(s) (manual free with every ZX80 kit or ready-made computer).	5.00	

NB. Your Sinclair ZX80 may qualify as a business expense.

TOTAL £

I enclose a cheque/postal order payable to Science of Cambridge Ltd for £

Please print

Name: Mr/Mrs/Miss

Address

PCW/8

Can your business, research project or teaching laboratory be made more efficient? Yes. Today's users demand complete, high performance micro computer systems. Expandable to meet future needs and with software capable of immediate application.

The North Star Horizon is the answer. A cleverly balanced configuration: Z80A processor with 12 slot S100 chassis, one parallel and two serial interface ports. Now with double or quad capacity too.

The compact design gives you value for money and economy of space. The Horizon will not break your bank or your desk top.

Quick delivery and nationwide service are only part of the attraction. Add to this the wealth of software available, including the well known CP/M, and you can see why the Horizon has already sold in thousands.

The reason for its success is simple.

The North Star Horizon reflects your needs.



For technical specification and details of your nearest dealer contact Britain's leading North Star Supplier.

 **comart**

PO Box 2, St. Neots, Cambridgeshire.
Tel: (0480) 215005. Telex: 32514.
COMART G.

**North Star Horizon
reflects a new age in computing**



ROMPLUS+

A useful feature of the Apple II is its seven-slot expansion motherboard which allows you to plug in all sorts of interesting devices. Apple itself very sensibly encourages other companies to develop these add-ons, one of which is the Mountain Hardware ROMPLUS+, reviewed here by Dr Robert Beynon.

The Mountain Hardware ROMPLUS+ permits the Apple II user to commit important machine code programs to EPROM or ROM, and to call these 'customised' programs as required. Six ROMs or EPROMs may be accommodated on a ROMPLUS+ board giving 12 kbytes of user defined firmware in total (Fig 1).

Most people will probably buy a ROMPLUS+ with the Keyboard Filter already on board. This is a clever piece of firmware which greatly expands the potential of the Apple II by allowing the following capabilities:

1. Mixed text and high resolution graphics on the screen
2. Upper and lower case text
3. User definable character fonts
4. User definable macro-commands
5. Multiple-coloured text

From this list alone it's apparent that the combination of ROMPLUS+ and Keyboard Filter is a powerful addition to the repertoire of any Apple II. In the scientific and educational fields this product fills an important gap in the available facilities.

Installation

The package, which is supplied ready-built, is accompanied by a disk containing demonstration and utility programs (DOS 3.2) and two manuals... one for the ROMPLUS+ and one for the Keyboard Filter. Explicit instructions are given for the installation of both products (in our case the Keyboard Filter was already inserted in Socket #1 on the ROMPLUS+). The ROMPLUS+ can be plugged into any slot except slot #0 and is ready for initialisation. The demonstration programs do not assume that the ROMPLUS+ is in a particular slot because the manufacturers have provided a program, called SLOT FINDER, which locates it automatically. This program is also supplied as a text file so that it can be tagged onto user programs using the EXEC command. This approach is elegant and precludes the interminable swapping over of cards that can otherwise occur (Fig 2).

Initialisation

Initialisation of the ROMPLUS+ from either Basic or the monitor is achieved by means of the normal peripheral commands; PR# (slot) or IN# (slot) where (slot) is the number of the slot

Figure 1

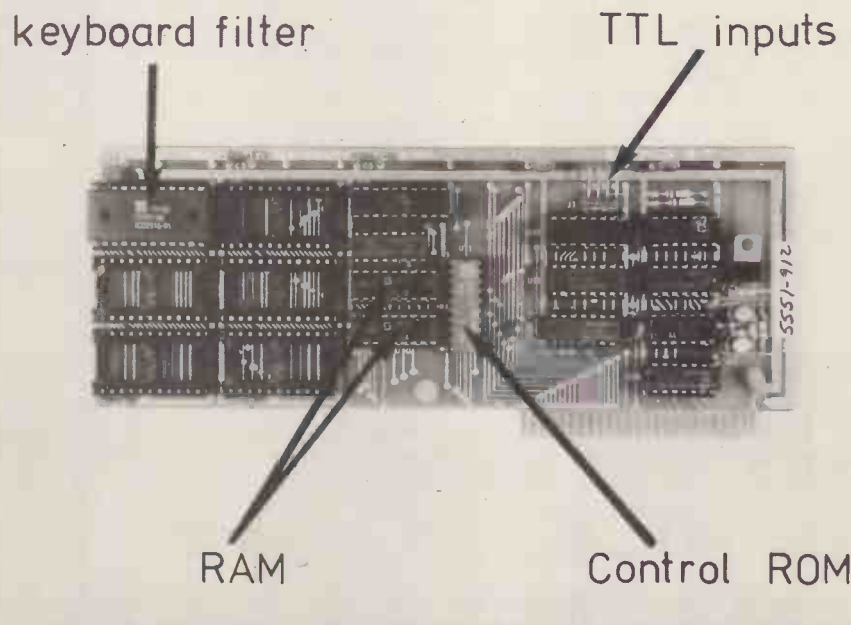

The ROMPLUS+ with Keyboard Filter installed in socket #1; 255 bytes of RAM may be used as a scratchpad by the ROMs and are mapped into the region CFF0H-CFFEH. This RAM may be activated or deactivated at will.

Figure 2

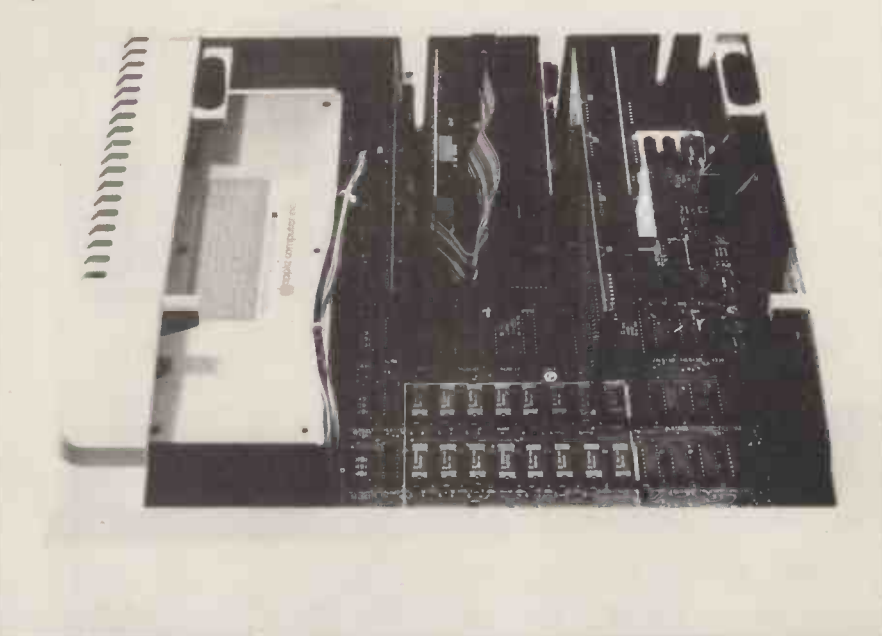

Easy system expansion. From left to right, Apple Integer Basic, high speed serial card (driving a plotter), parallel output card (driving a printer), the ROMPLUS+ and the disk controller.

containing the ROMPLUS+; therefore it's initialised in the same way as any other peripheral card. Then, a second command must be given that can be intercepted by the controlling firmware on the ROMPLUS+, and which specifies the number of the ROM or EPROM to be used (usually 1 in the case of the Keyboard Filter). This command must also select one of the four entry points into the Keyboard Filter software. These are:

- A: First time initialisation using graphics screens
- B: Re-initialisation using graphics screens
- C: First time initialisation using text screen
- D: Re-initialisation using text screen

The entry point selected affects the features that will be available because of the type of display that is used. A and B both use the 8 kbyte high resolution graphics memory areas (Fig 3) and permit text and graphics with upper and lower case. C and D use the normal 1 kbyte text screen area and do not allow graphics or lower case unless a new character generator ROM has been fitted.

With the keyboard filter initialised, a whole new range of facilities are available using single key commands that are intercepted by the firmware. (A list of these commands is given in Table 1) Let's look at some of those features in more detail.

Mixed text and graphics

Although the original Apple design did not allow for mixed text and graphics several software solutions have been developed in the past, with varying degrees of difficulty associated with their use. The Keyboard Filter makes all these solutions seem laborious by comparison. When initialised in the graphics mode (options A or B) the Apple uses the area of memory from 2000H to 4000H (8 kbytes) for all of its screen display. This is the normal high resolution graphics area that permits plotting to a resolution of 280 x 192 individually addressable points. The point plotting, line drawing, shape scaling and rotating commands may be used as normal. In addition, however, text may be displayed on the screen (but at a much greater memory overhead). Mixed text and graphics are now easy; treat the screen either as a text page (using the PRINT, HTAB and VTAB commands) or as a graphics page (using HPLOT, HPLLOT TO, DRAW, SCALE, & ROT commands) and develop properly annotated graphs or diagrams! (Fig 4)

Multiple character sets

When using the Keyboard Filter in graphics mode a character set comprising upper and lower case letters is used. The CTRL-L command switches between normal or upper case and lower case letters. The lower case characters cannot be used in Basic and give syntax errors so it's useful to be able to revert to upper-case-only

operation. Lower case may, however, be used in PRINT statements for display on the graphics pages. This can cause problems as printing on the bottom line of the screen will cause scrolling of the page, including all text and graphics!

The Keyboard Filter also allows the use of alternative character sets or fonts. Alternative fonts can be useful for providing additional characters (mathematical or Greek symbols for example) or sideways lettering, etc. These fonts occupy 1 kbyte each and are stored in RAM starting at the default location of 6000H — just above the second page of high resolution graphics (HGR2 in Fig 3). Selection of different fonts is by means of the CTRL-F command, followed by the number of the font required.

Several fonts are supplied on the disk and may be loaded at will. Most of them are used in the demonstration programs and are of limited value in any other context. Any of the fonts may be displayed in different colours provided that consideration has been given to the idiosyncrasies of the Apple's colour display (no mixing of odd or even vertical lines in the character).

Editing functions

For Apple users who do not have the old ROMs the Keyboard Filter brings the editing facilities up to and past those given by the Autostart ROM. Editing is initiated by means of a CTRL-E command, immediately after which the I, J, K, M keys control cursor movement. Screen copying or erasing, using the 'forward arrow' and 'back arrow' keys is active and the REPEAT key works with all of these. The cursor control is exited by pressing any other key, which is displayed as normal — an improvement on the Autostart ROM which loses the first character after the cursor control mode is exited. The most useful feature is provided by pressing CTRL-W. This moves the cursor to the far right of the screen (or text window) and copies the line as it

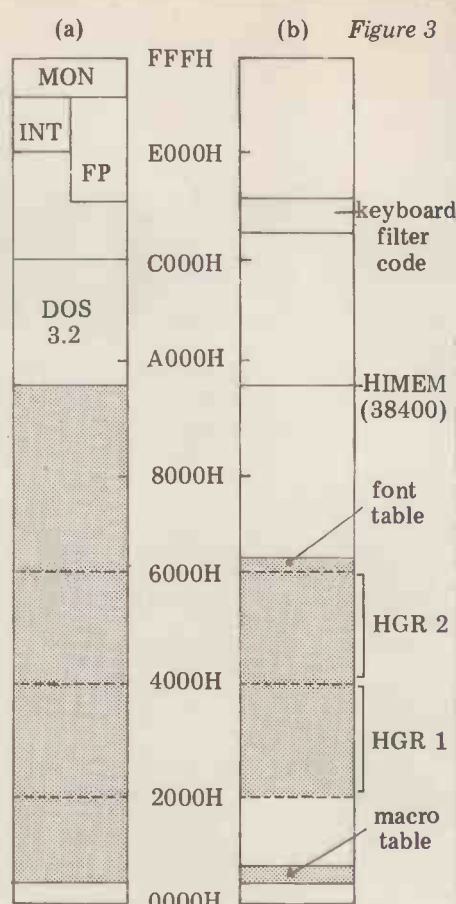

Apple II memory map. (a) Normal memory map — the shaded area indicates user workspace (including two graphics screens) with DOS 3,2 installed. MON= monitor, INT= Apple Integer Basic, FP = Applesoft Basic. (b) The areas of memory used by the Keyboard Filter and ROMPLUS+ are shaded.

goes. Editing the first few characters in a 200-character line involves considerably less time and reduces the opportunity for faulty copying of strings — an attractive addition to the Apple's facilities.

Table 1

Command	Normal	Function
CTRL-C	Normal	Stops program or listing
" D	Normal	DOS control character
" E	Edit	Allows cursor control*
" F	Font	Selects new font*
" G	Normal	Rings 'bell'
" H	Normal	Backspace
" I	Inverse	Toggles inverse mode
" K	Peripheral	See text*
" L	Lock	Simulates shift lock
" M	Normal	Carriage return
" O	Overstrike	Allows overprinting
" P	Page	Switches display page
" Q	Peripheral	See text*
" R	Raw	Toggles raw mode
" S	String	Prints a keyboard macro*
" T	Tint	Selects colour of text*
" V	Shift key	In modified Apples — see text
" W	Copy	To end of line — see text
" X	Normal	Terminates current line
" Z	Zap	Clears current screen

The single key commands used in controlling the functions of the Keyboard Filter. The command CTRL-V is used with Apples that have a modification allowing normal use of the Shift Key. (We have not tried this modification as we are unsure of its effect on Apple operation without the Keyboard Filter activated). Commands marked with an asterisk must be followed by other characters to complete the instruction.

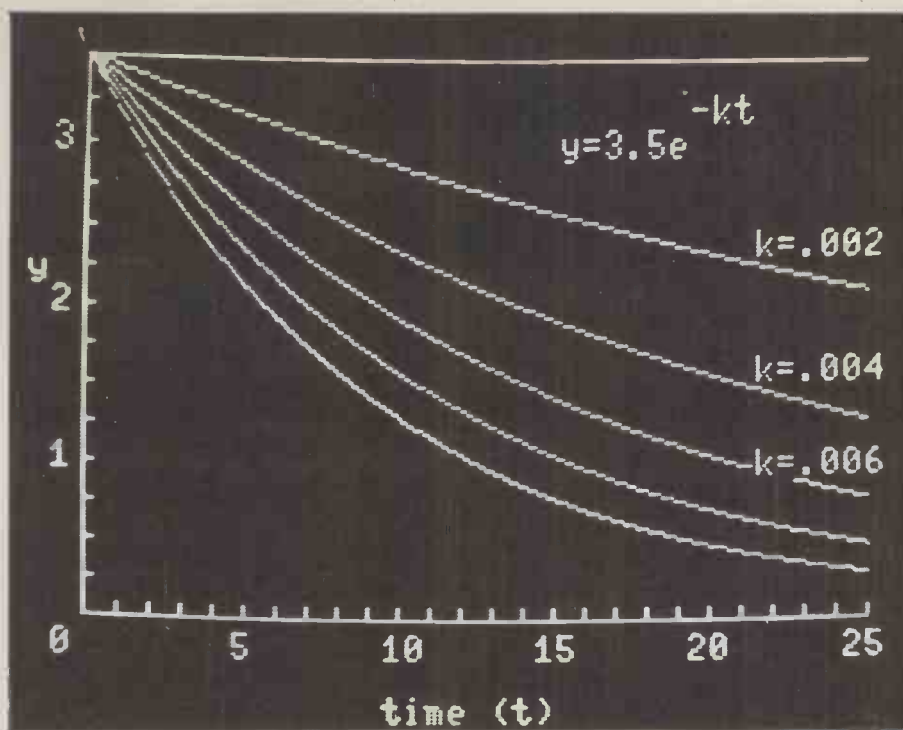

Figure 4 A sample of the mixed text and graphics facility of the Keyboard Filter.

Keyboard macros

The Keyboard Filter allows the definition of 60 'keyboard macros', defining a macro as a sequence of commands that are executed by entering a single character from the keyboard (prefixed by a CTRL-S). The commands consist of a string of up to 63 characters that may include control characters or carriage return. For example, CTRL-S C might cause the execution of the macro string 'CATALOG (carriage return)'. Their use is restricted to direct mode, however, as programs cannot call macros. (Also, using one macro to call another, in the words of Mountain Hardware, makes the Keyboard Filter "very, very confused"!). Macros are stored in a table at the default value of 800H.

Demonstration and utility programs

The demonstration and utility programs are all supplied on disk - I do not know whether cassette users are catered for. Owners of Europlus Apples be warned - all but one of the programs are in Integer Basic! (A word of thanks here to Roy Stringer of Microdigital - an Integer card was sitting in slot #0 within one hour of a frantic telephone call). The demonstration programs are really impressive and include 1 inch high Gothic script and a little man running across the screen. All of the features of the Keyboard Filter are demonstrated and illustrate its potential.

Three utility programs are provided - a font editor, a macro editor and the previously described 'slot finder' program. The first two are good quality programs which allow the user to define his own font tables or macro tables and are comprehensive and easy to use.

It was a pleasure to run these high-quality programs. The software support for this product is excellent apart from

the provision of Integer Basic programs; hopefully this will be rectified in the future.

Memory conflicts and solutions

The Keyboard Filter manual discusses the most probable memory conflicts that are likely to arise, usually with systems having less than 48 kbytes of RAM. Fig 3(b) shows the areas of memory that can be used by the Keyboard Filter. Because both high resolution graphics pages may be used one problem may arise by division of the available memory space. Between the lowest memory location 800H (LOMEM) and the beginning of the first graphics page 1FFFH, only 6 kbytes is available if that page is used. The second block of memory, from 6000H to 9600H (HIMEM) constitutes a 14 kbyte block which could be used if the lowest memory location was altered to 6000H.

Alternatively, if only one graphics page was required (HGRI) then LOMEM could be set to 4000H - giving 22 kbytes for user programs. Note that the font table uses a section of memory at 6000H - right in the middle of program space. In practice this is unimportant as the font tables (and macro tables) contain no address-sensitive information and can be relocated at will (instructions are provided for doing this).

The other type of memory conflict arises in the reserved ROM space of the memory map (above 6000H). The Keyboard Filter occupies the address space from C800H to CFFFH, an area normally reserved for ROM on peripheral cards. As the ROMPLUS+ is addressed as a peripheral card this should mean that a printer card for example, could not be used simultaneously with the ROMPLUS+. In fact, the Keyboard Filter maintains its own set of addresses which allow it to activate or deactivate other peripheral cards such as the parallel printer card. Problems arise, however, with cards such as the high speed serial interface, because this card uses the same memory space for control ROMs. When the Keyboard Filter activates the serial interface card, the response of the latter is to deactivate the former! No solution to this problem exists... cards such as the ROMPLUS+ and the serial card or the clock card cannot be active simultaneously.

Conclusions

This brief resumé of a powerful piece of hardware cannot do full justice to its potentialities. The ease of use of most of the facilities and the provision of good utility software combine to make the ROMPLUS+ and Keyboard Filter a very attractive feature. It will also be interesting to observe the appearance of new ROMs or EPROMs which slot into the sockets on the ROMPLUS+. The text/graphics facilities alone are enough to justify purchase of this peripheral - the other features provide additional reasons. If I sound impressed then I have conveyed my personal opinions correctly.

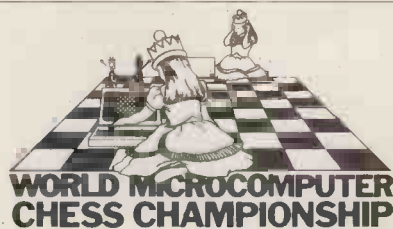

A major attraction at the Third Personal Computer World Show will be the first ever official World Microcomputer Chess Championship, held under the auspices of the International Computer Chess Association. The Championship is open to both commercial and non-commercial entrants, with a first prize of £500 for the highest-placed non-commercial contestant.

For further details, write immediately to David Levy, c/o Personal Computer World, 14 Rathbone Place, London W1P 1DE.

The 3rd
**Personal
Computer**
World
Show

The Third Personal Computer World Show is at the Cunard International Hotel, 4 - 6 September.

'TUSCAN' FROM TRANSAM



Take a step up to your next Computer!

THE CONCEPT

How many ways are there to build an S100 system? Not many, and all expensive. TUSCAN changes all that.

Five S100 boards on one single board—just for starters. Plus five extra slots for future expansion.

What a combination! Z80 and S100 with the TRANSAM total package of system and applications software.

How do we do it? Our prices start at £195 and you can build up in easy stages to a fully CP/M compatible disc based system. Something to think about!

THE HARDWARE

The first Z80 single board computer with integral S100 expansion. British designed to the new IEEE (8 BIT) S100 specification, the TUSCAN offers total system flexibility. A flexibility available now.

The board holds the equivalent of a Z80 cpu card, 8k ram, 8k rom video and I/O cards with 5 spare S100 expansion slots and offers a price/performance ratio which is hard to beat.

Just compare our price with a commercial S100 ten slot motherboard with this specification.

THE SOFTWARE

TUSCAN offers the user the choice of system monitor, editor, resident 8k basic, resident Pascal compiler or full CP/M disk operating system. All options are upwards

compatible and fully supported with applications software. Both 5¼" and 8" drives are supported in double density.

THE PACKAGE

TUSCAN is available in kit form or assembled. With several hardware and software options to suit your requirements and budget. Attractive desk top case also available holds 2 x 5¼" Drives.

TRANSAM

NOBODY DOES IT BETTER!

Send to Transam Components Ltd., 12 Chapel Street, London NW1

I am interested in the TUSCAN Z80 based single board computer with S100 expansion and enclose a S.A.E. for further details.

Name _____

Address _____

Telephone _____

TRANSAM COMPONENTS LTD., 12 CHAPEL STREET, LONDON NW1. TEL: 01-402 8137. TELEX: 444198

DIALOGUE STRUCTURE AND DESIGN METHODOLOGY

David Hebditch looks towards dialogues in this, his second visit to the man/machine interface

Before considering methodologies in detail, it's perhaps appropriate to examine the *structure* of dialogues in typical commercial microcomputer systems.

The generic use of the term 'dialogue' may be applied to a group of related and structurally or syntactically similar exchanges with the system. The grouping might be related to terminal types or application areas. For example, a 'forms mode dialogue' can take place on a display and a conversational dialogue on a serial printer. Clearly, order entry is likely to be different in style from interactive program development.

Within each 'dialogue' there may be a number of 'transactions' (see Figure 1), each being a self-contained exchange with the computer and comprising one or more input and one or more output messages. A Sales Accounting Dialogue might include an Order-Input Transaction, a Credit Note Transaction, a Customer File Update Transaction and so on.

In turn, each message will consist of a number of data items plus various formatting and control characters.

Figure 2 illustrates how a user might have access to a *transaction handler* which will enable him to select the transaction-processing routine he wishes to talk to. Once in the transaction he can get to another by returning to the handler or, in some cases, by going directly via a 'next transaction' field in the input format. This is shown in more detail in Figure 3. The transaction selection may be performed by selecting from a menu list or by entering a transaction code.

There are strong arguments for dialogue design to be one of the first activities in the design of the overall system. Computer usage is likely to be well integrated with the jobs of the user staff. So, from that point of view, the collection of dialogues can act as a definition of total system functionality.

The system designer's involvement with a dialogue may be relatively short-lived. On the other hand, many users may have to live with it for a number of years. Also, the designer's perception of 'ease-of-use' and 'ease-of-learning' is likely to be quite different from that of the ultimate user. The message here is that the user *must* be involved in the development of the dialogue; experience shows that this approach always pays dividends. When the system is being developed for no particular user or group of users (e.g. a package) it's important for the designer to carefully monitor the initial installations.

Figure 4 illustrates the recommended sequence in the design of dialogues. The approach is essentially 'top down' (what else!) and corresponds to the general structure of dialogues illustrated in

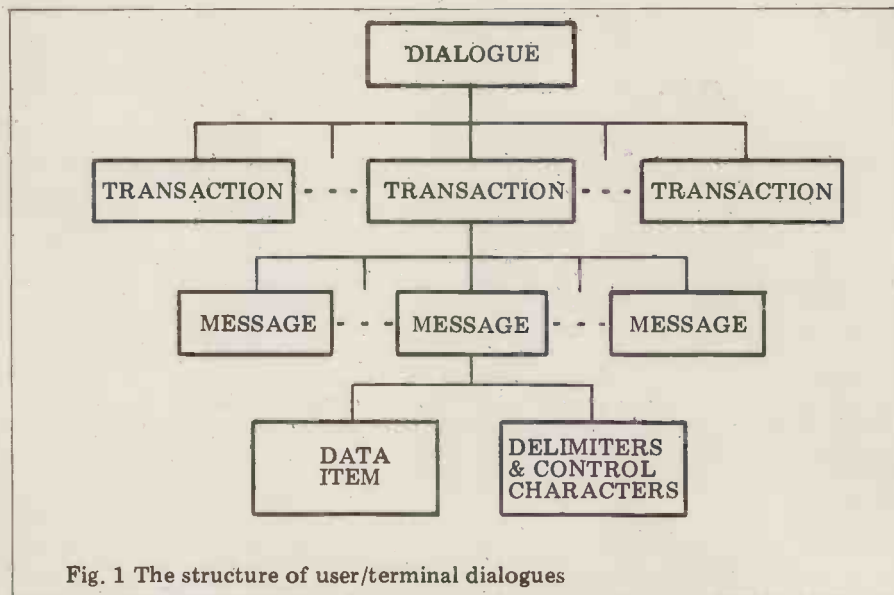

Fig. 1 The structure of user/terminal dialogues

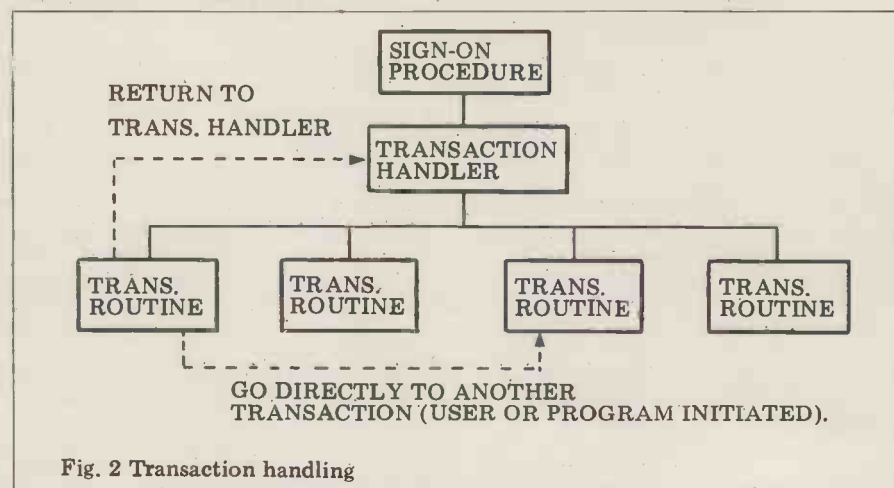

Fig. 2 Transaction handling

Figure 1 above. Subsequent articles in this series will discuss each of the design stages in more detail.

Note that *error-handling* is difficult to isolate to one step in the process. In practice, the error-handling mechanisms of a dialogue can cause more design and development problems than any other aspect. One of the major benefits of a system where the user interacts directly with the computer is the resultant improvement in data quality. It is urged, therefore, that this consideration be kept in mind during *each* stage of the design process.

Choosing the most appropriate *style* of dialogue is probably the most crucial stage of the design process. The implications of getting it wrong can be fearful. In three case histories I know quite well (two in the private sector and one in the public sector) major mainframe computer projects had to be scrapped (at losses ranging from £90,000 to £300,000). In each instance the dialogue style selected was quite

inappropriate to the user environment; one too complicated, one too long-winded and other too inefficient. Program structures tend to correspond very closely with dialogue structures and revising the latter is often just not feasible.

Figure 5 attempts to illustrate the complexity of relationships between the various dialogue styles and their influencing factors. In fact, the number of combinations is unmanageably large. A process of reduction, therefore, needs to be applied to the various influences. The designer needs to work through the areas shown, specifying all the influencing factors. Each of the styles described in next month's article will produce varying degrees of 'fit' with the chosen influences.

Experience with this technique has shown that it's best to view the process as one which *deselects* inappropriate styles rather than the other way around. Only careful thought and discussions

FACE TO FACE

Fig. 4 a structured approach to dialogue design

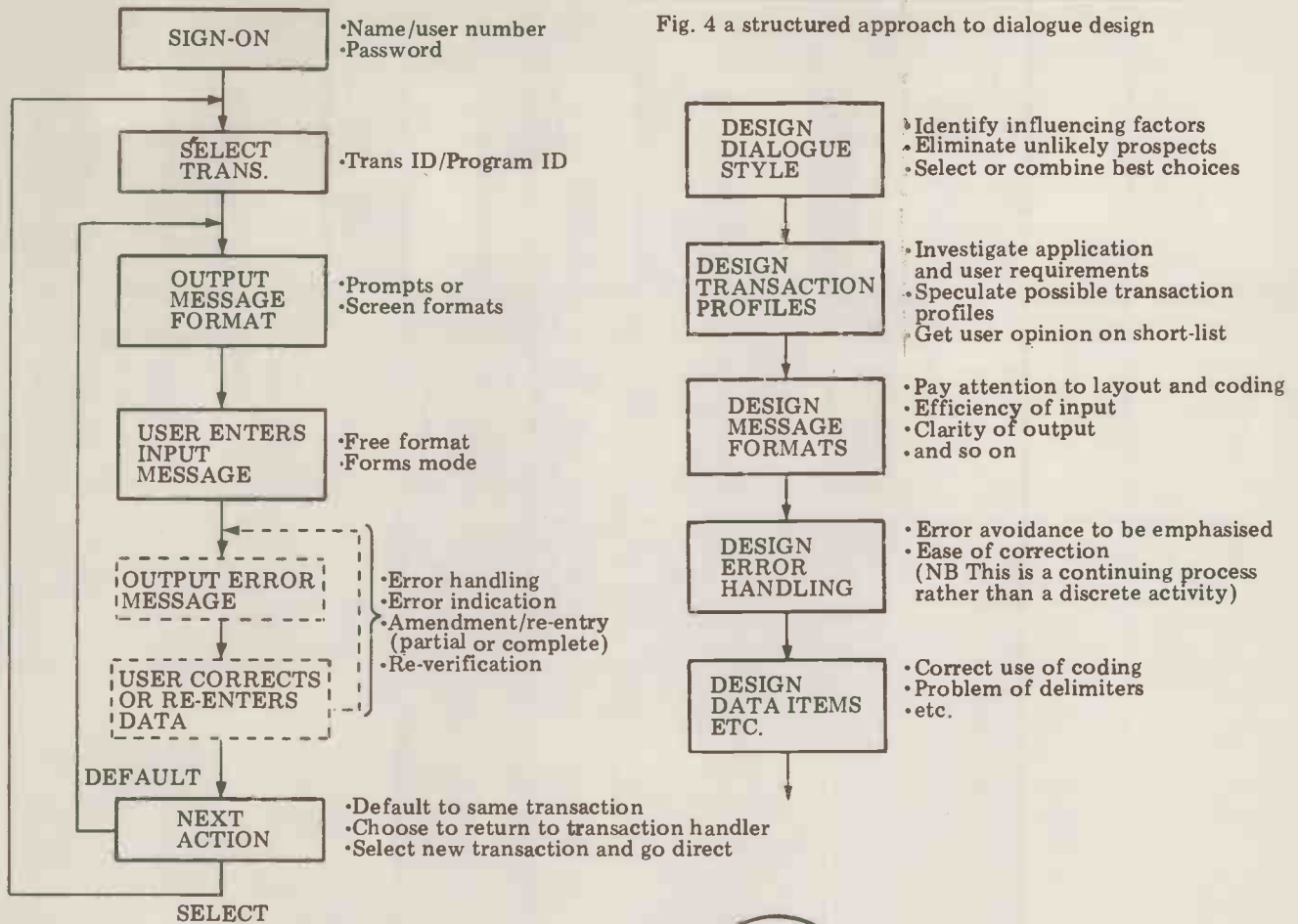

Fig. 3 Profile of a typical dialogue

with users can get the best combination of styles.

Next month I will begin a review of the main styles of dialogue available to the designer of microcomputer based systems.

1 Purpose	Enquiry/Data Input/Database Admin.
2 Operator Type	Specialist/Regular/Casual
3 Operator Roll	Active/Passive
4 Operator Intelligence	High/Average
5 Operator Tolerance	High/Low
6 Level of Training	Less than 5 mins/ Less than 1 day/ More than 1 day
7 Response Time	Less than 1 sec/ 1-4 secs/ Over 4 secs/ Over 15 secs
8 Volume of Data	High/Low/ Input/Output
9 Terminal Type	Slow Keyboard-Printer/Fast Keyboard-Printer/TTY-Compatible VDU/ Commercial VDU
10 Local Processing	Intelligent Terminal
11 Complexity of Data	High/Low/ Input/Output
12 Multiple Applications	Multiple Applications per terminal

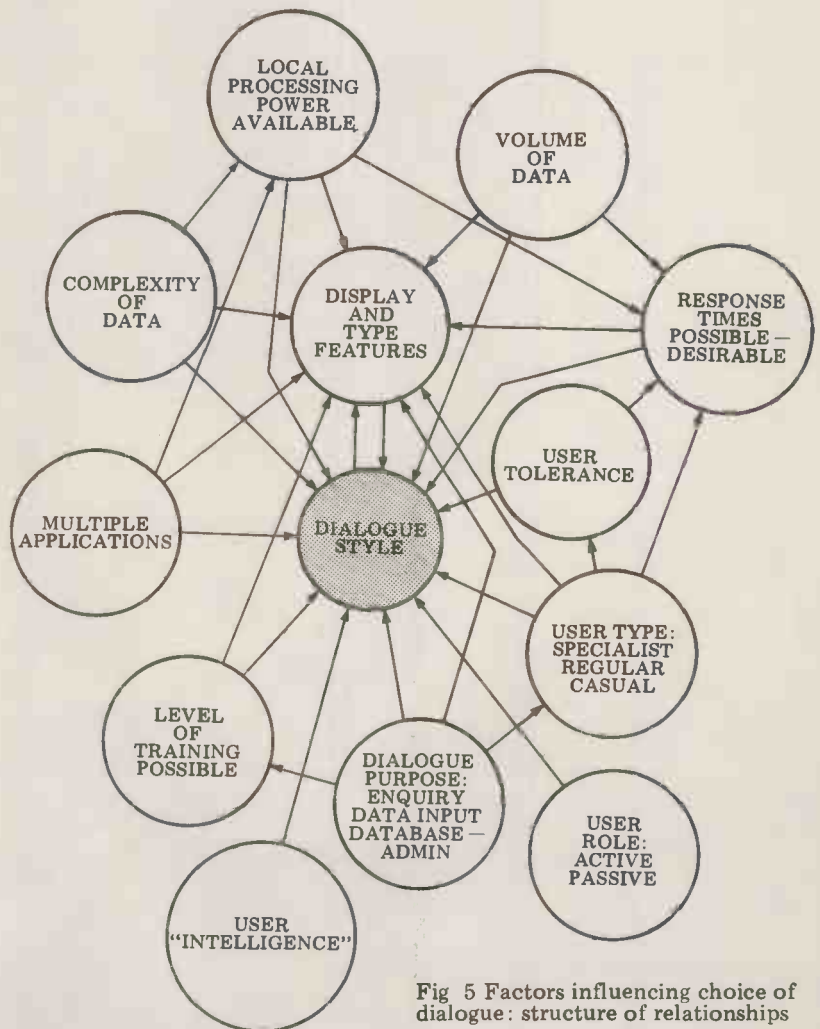

Fig 5 Factors influencing choice of dialogue: structure of relationships

BYTE SHOP

COMPUTERLAND

your specialist Computerstore.

Cromemco System Three

Well-proven systems for the serious user. Our computer stores are staffed by business experts, backed by first class maintenance support. Call in for advice and a demonstration of our range of systems.

The Cromemco buyer is choosing well-proven design, reliability and expandability. Start with a single terminal and grow into a multi-user system as your requirements expand. Excellent Cromemco software includes COBOL, FORTRAN and RPG-II. Ask for a demonstration of the Cromemco hard-disk and talk over with us how your application can be programmed.



North Star Horizon

The reliable and long-established commercial favourite. Ask about our BYTE SHOP- developed packages – Invoicing, Sales and Purchase Ledger, Incomplete Records, Cash-Flow Analysis, Stock Control, etc. And use your Horizon to type perfect letters – it is an excellent word-processor.



Nottingham
92a Upper Parliament Street
Nottingham NG1 6LF
Tel. 0602 40576 Telex. 377389

Manchester
11 Gateway House
Piccadilly Station Approach
Manchester
Tel. 061-236 4737 Telex. 666168

Birmingham
94-96 Hurst Street
Birmingham B5 4TD
Tel. 021-622 7149 Telex. 336186

Glasgow
Magnet House
Waterloo Street
Glasgow Tel. 041-221 7409
Telex. 779263

BYTE SHOP
COMPUTERLAND
– your specialist Computerstore.

London
48 Tottenham Court Road
London W185 4TD
Tel. 01-636 0647

A SWITCH IN TIME

If you're going on holiday and can't bear to miss 'Crossroads' then your computer could make a useful (if expensive) time switch to control the family video recorder. Alternatively, as John Nottage explains, a number of other devices may be controlled by way of this simple, handy interface.

The system outlined here, which produces multiple function control from a few components, relies on simple serial data. By sending a predetermined number of pulses from a single output port, up to 15 different operations can be controlled and only a single pair of wires is required to send the data over distances of up to several hundred metres. Timing lines are not needed. The system is slow enough to enable the serial data to be programmed in Basic; at the same time it's quite capable of operating at machine language speed.

The hardware of this system can be made to drive almost anything. It was originally designed to control a Grundig video recorder, thereby enabling several different recordings to be made without any intermediate resetting. The all-electronic operation of the Grundig lends itself very well to this form of control; by using some type of solenoid on the record, stop and channel change functions, it should be possible to use the system to control other makes of video recorder.

Computer output

The most versatile device to attach to the output of the computer seems to be the National quad line driver type MM88C29. This integrated circuit uses almost no current from its single 5 V supply and has an on resistance of about 20 ohms; it can drive lamps, relays and solenoids directly, as well as feeding down long lengths of cable to a schmitt trigger such as the 74C14. The circuit using one MM88C29 is shown in Fig 1. Data is encoded in Basic as a number of pulses — between two and 16 pulses to give 15 different functions; the use of one pulse is avoided to reduce the chance of a spurious signal affecting the system.

Decoder/Controller

Fig 2 shows the circuit for the

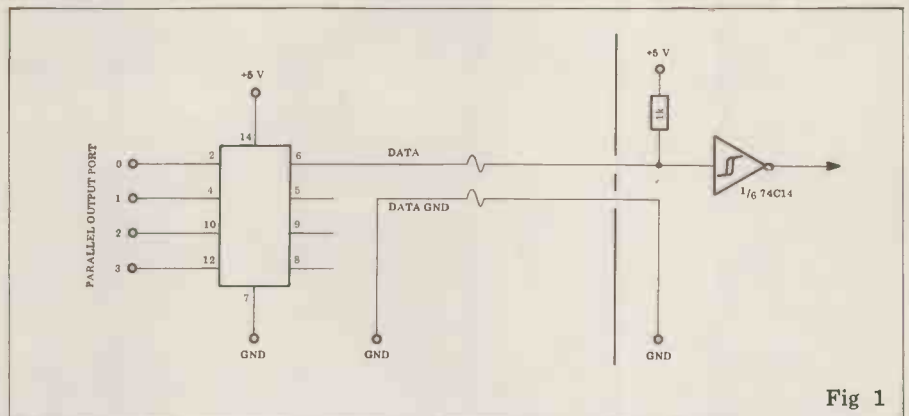

Fig 1

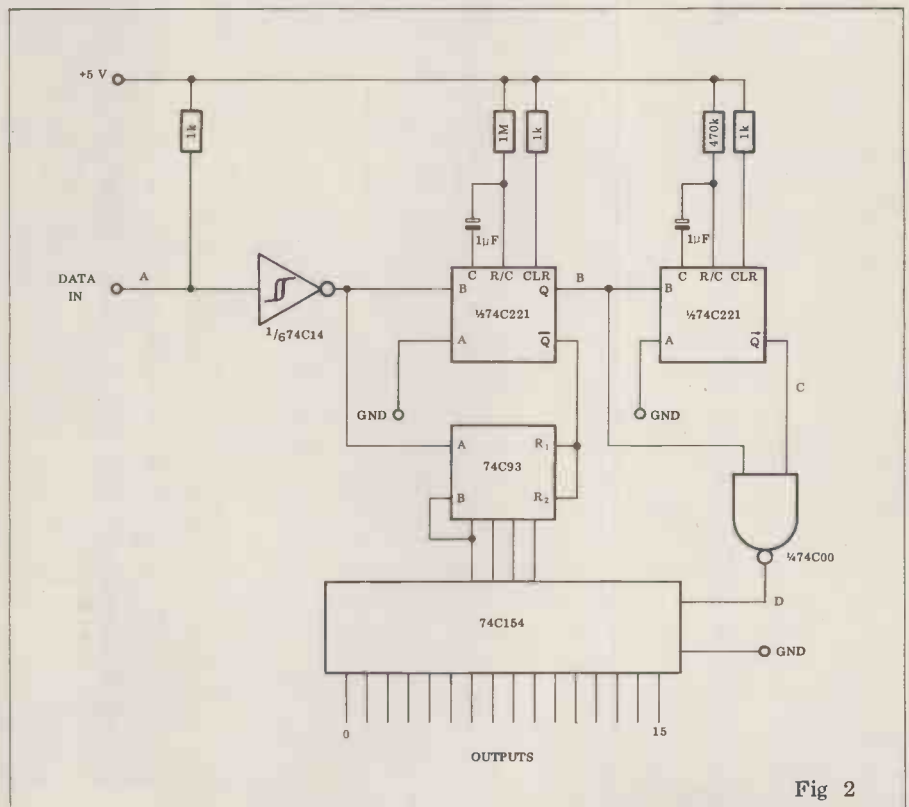
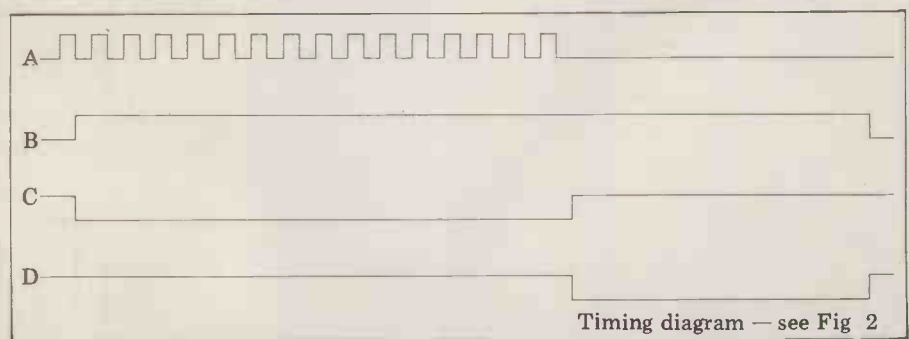

Fig 2



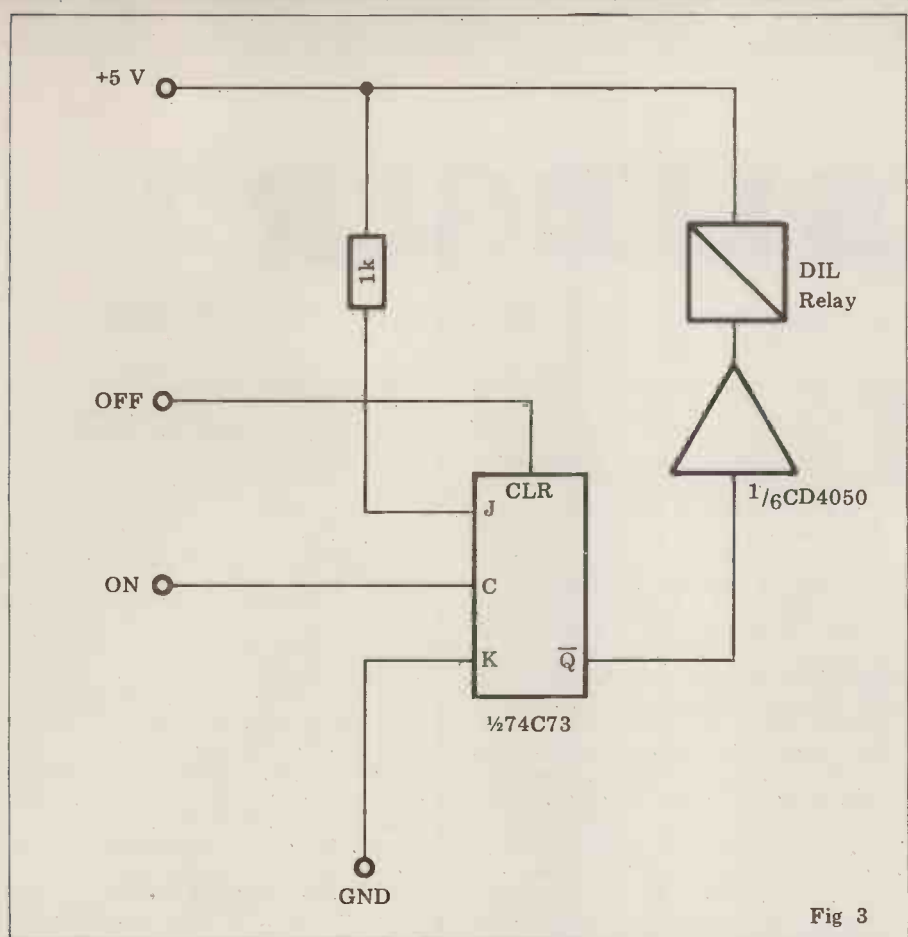

Fig 3

decoder and basic controller. The serial data is fed from the MM88C29 into 1/6th of a 74C14 hex schmitt trigger. The resulting clean output is used to trigger half a 74C221 monostable, which in turn triggers the other half. The continuing series of input pulses is counted by the now enabled 74C93 binary counter. After the output of the second half of the 74C221 goes high again the resulting low from the output of the 74C00 enables the 74C154 4 to 16-line decoder for the remainder of the duration of the output pulse from the first half of the 74C221. This gives an output pulse from the appropriate pin on the 74C154 of about half a second.

It requires one pulse to trigger the system, so an input signal from the computer of three pulses will give a one half second negative pulse from output pin 2 on the 74C154. Similarly, six pulses will produce the pulse on output pin 5. The timing of the monostables can be adjusted to suit the type of program, though the values given will work for both machine language and Basic. Changing the values of the first half of the monostable will increase or decrease the duration of the main output pulse. The timing of the second half is set so that 16 pulses at Basic speed can be input while its Q output remains high. This time can therefore be reduced for a machine code program and the timing on the first half reduced by the same amount if needed.

Optional circuit additions

A simple addition to enable the system output to switch some device on and off is shown in Fig 3. The pulse

clocks the 74C73 and switches the relay on; another output is then used to clear the device and switch the relay off. Note that the 74C series of CMOS ICs will not drive relays directly but the hex buffer type CD4050 will happily drive a dual-in-line (DIL) relay. For larger current supply, the MM88C29 is again the useful choice.

If you intend to use the controller to drive a video recorder then you can adapt the circuit in Fig 4 to most solenoid control functions. In the original circuit, six channel change relays were chosen. This was entirely due to the availability of a suitable 7-pin plug and socket to connect the controller to the small panel of DIL relays soldered into the body of the

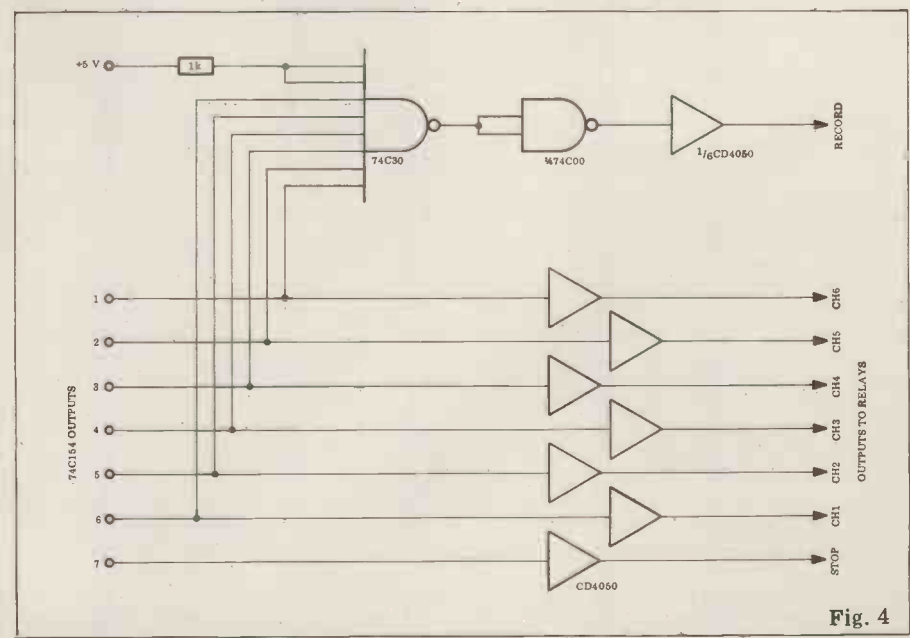

Fig. 4

VCR immediately behind the channel select module. The Grundig already has a remote control socket, so this, combined with the channel change connection, is the only extra requirement. Again all DIL relays are used, each with a buffer in series.

Assembly

The whole decoder can be assembled on a small piece of Veroboard using a Verowire wiring pen to produce a neat and reliable result in a short time. Power requirements with CMOS ICs are tiny, so a small 100 mA transformer is adequate. If the device is only used for pulse generation, not for holding relays, then battery operation would be practical. Two or three 0.1 μF decoupling capacitors should be connected between +5 V and chassis at points around the board.

Software

The following subroutine is taken from a complete recording schedule control program for an 8k PET. Other computers should require equally simple routines. The only input needed is C, which in the case of VCR control would be the channel number. A value of C=7 is used for stopping recording.

```

First set the output port:
50 POKE 59459, 1: POKE 59471, 0
Now the subroutine:
10000 FOR I=1 TO C+1: REM SETS
NO. OF PULSES
10010 POKE 59471,1
10020 POKE 59471,0
10030 NEXT I: RETURN

```

This routine, when incorporated in a complete program, can provide full and precise control of many different devices including audio and video recording. It can be programmed as far in advance as you wish — but don't forget leap years and British Summer Time! The other problem on the PET is the inaccurate clock but it's quite easy to allow for this in the software. In my own PET I found it gained a little over five seconds an hour; I overcame the difficulty by subtracting five seconds every hour and seven seconds every 24 hours and the clock is now within one second a week when running my recording program.

SALES LEDGER 2

Mike Knight of Mike Rose Micros returns to 'Sales Ledger' and peruses and reports on available documentation.

No matter what our business the prime function is to sell — be it goods, services or expertise; therefore the heart of a company's success lies in close control of its customers' payments. This month I'm taking another look at this important field — The Sales Ledger.

Functional requirements

1. We must be able to post any transactions to the account of the customer concerned, whether invoices, credit notes or cash.
2. We will need to have aged balances to enable us to keep a close eye on our customers indebtedness and also to help us to fix a credit limit on each customer.
3. Allocation of cash against invoices will be essential as will. . .
4. Analysis of VAT amounts.
5. We will wish for a free choice of accounting system, either balance forward or open item; in some cases we may ask for the ability to change easily from one to the other.
6. Our accountant will wish to see postings to the Sales Day book and Cash book.
7. Some of us may want remittance advices to allow our customers to tell us which invoice they are paying.
8. Certainly we will all wish to see the ability to link into other functions such as Invoicing, Nominal Ledger or Stock Control even if it's not needed at the present.

PETACT SALES ACCOUNTING

This package is available on Commodore disk or cassette from Petsoft, Birmingham (021-455 8686) or any of its countrywide dealers. The 7 programs are written in Basic and Assembler and will link to Petact Invoicing. The minimum hardware required is a 32k PET, 80 col printer and either disk drive or cassette costing £1950 or £1450 respectively. The package costs are £120 for the disk version and £95 for the tape. The ledger is based on a balance forward system with open item for the current month, and comes supplied with a concise operating manual which gives a step by step 'idiots guide' to system operation. Petsoft runs regular seminars and courses in its Birmingham Training Centre and its dealers will provide training if necessary. All programs are continuously maintained and any bugs or corrupted programs are fixed or replaced. Pre-printed stationery should be available ex-stock from your local dealer. Petsoft is always happy to answer any customer queries and offer advice and guidance by phone or letter.

PADMEDE SALES LEDGER SYSTEM
The system is disk based and available

from Padmede Computer Services, Odiham (025671 2434) or any of 30 dealers countrywide. The package, costing £300 and consisting of one program written in Applesoft Basic and machine code, is fully linked to Padmede's nominal ledger. The minimum hardware required is a 48k Apple II with two disk drives and a printer, costing approximately £2000. The system will also run on the ITT 2020. Either Padmede or its dealers usually install this package as part of a turnkey system and will provide training as required — usually for between half a day and a day. Advice and guidance is always available and backup is provided either by the dealer or on a direct hotline to Padmede and any corrupted program will be replaced. Some customisation is relatively simple as the system is parameter driven. The package is supplied with a users manual of a very high standard, which obviously has the first time buyer in mind. There are hints on transferring from your existing system and a very sensible section on protecting yourself from disaster — which makes good reading for any micro-user.

TRIDATA

This package was first reviewed in January 1980 and the only changes are that Tridata now offers both customisation and training services at a cost of £98 per day.

S.N.I.P.

Our regular readers will recognise this product instantly — it's the 'S' part of Benchmark's system (St. Austell 0726 61800) and as usual is available both as a stand alone package or as part of the fully integrated suite (Sales, Nominal, Invoicing and Inventory and Purchase). We've looked at the package as a whole (June 1980), the Purchase Ledger (February 1980) and also the Inventory section (July 1980). The stand alone price for Sales Ledger is £250 and the system is designed to run on a 32k North Star Horizon with 2 disk drives, VDU and printer at an approximate cost of £3725. Each package is set up to the user's volumes and customised with the user's company name. There's a 90 day warranty on the software during which time it will be supported free — bugs discovered outside this period will be notified to the user and an amended program supplied for the cost of the disk. The package comes complete with full media including security diskettes, system specification and full operating instructions of a very high standard.

GRAFFCOM

The package, costing £450, is available

from Graffcom Systems Ltd., London (01-734 8862) or from its main distributor, Lifeboat Associates, London (01-836 4663); there are also a number of dealers. It's designed to run under CP/M and requires 48k of memory, 2 disk drives, VDU and a printer (ask Graffcom for its list of compatible machines). Support is available over the phone to all registered users and if the problem cannot be resolved, Graffcom will investigate further in-house and in turn advise the user of the position. Tailoring can be undertaken and estimates are quoted on receipt of outline requirements. The package can be used as a stand alone system or in conjunction with Graffcom Integrated Small Business Software Order Entry, Invoicing, Name and Address and General Accounting systems. I've not seen the Sales Ledger Manual but in general Graffcom's documentation is of a high standard.

G.L.A.S.

This system was reviewed in both January and June 1980 and there have been no significant changes.

GRANT BUSINESS SYSTEMS SALES LEDGER

Reviewed first in January 1980, there are just a few additional comments I wish to make. The customer has the choice at the time of purchase whether to maintain an open item or brought forward accounting system, although open item is generally recommended. In addition to the 5 hours free editing, the Micro Computer Centre will make further amendments to any package at a cost of £10 per hour. The package is now available to run on Apple computers.

Due to lack of sufficient documentation or information at the time of going to press the following packages have not been included in the grid.

ADVANCED BUSINESS SYSTEM

This package was reviewed in the Stock Control section last month (July 1980). The Sales Ledger is part of the Stock Control/Invoicing/Sales Ledger package costing £1000. The average sales ledger volumes based on a single CBM 3040 dual drive are 400 sales accounts with 1400 sales transactions — but volumes can be adjusted between ledgers and transactions to meet client requirements. I've not seen the operator guide for the Sales Ledger section as this is being updated at present. The system runs on a CBM 32k with 3040 disk drives and a 3022 tractor printer at an approximate cost of £2200; it can be expanded up to double 3040 disk drives, making the hardware costs

SYSTEMS

£3100. There's a £300 charge for software amendments for this expansion.

SALES CONTROL SYSTEM

This package is supplied direct from Compssoft Ltd., Guildford (0483 39665) at a cost of between £1500 and £2500. It's designed to run on a PCC 2000 64k computer costing £6000 and this hardware can be expanded up to a 5 user 80 Mbyte System. Two printers adds another £3000 to the price.

The package includes 1000 Customer files, 1000 Product files, 300 Order files, 3000 Accounts received and 99 VAT codes. There are 6 programs which are written in Basic and linkages to other packages are possible. Compssoft provides installation, training, full phone and site backup and will customise any package for you. Although I've not seen the user manual, if it's of the same standard as the Information Retrieval System documentation (reviewed May 1980) it will be concise, easy to read and should present no problems to the first time user — whilst fulfilling the needs of the more techni-

cally-minded among us.

POWERSALES

This system will be available in October 1980 from Arclon Associates Ltd., London (01-445 2878). I've only seen the systems specification and so cannot comment on the documentation; it does, however, appear to bode well of things to come.

COMPUTACCOUNT SALES LEDGER

Available from Computech Systems, London (01-794 0202) and priced at £295, Computaccount's Sales Ledger is designed to run on Apple or ITT 2020... that's 48k with 1 or 2 disk drives, a 132 col printer and a TV or monitor (average price £2200). The company will provide installation, training, advice and guidance and both telephone and site backup. It will also replace free of charge any corrupted program if the medium is not damaged. The volumes quoted for the minimum configuration are: up to 500 customer accounts, up to 1600 transactions, over 100 user selected analyses and ageing

over four user selected variable periods.

OTHER SALES LEDGER PACKAGE SUPPLIERS

Grant Business Systems 01-876 6609, Compssoft 0483 39665, Arclon Associates 01-445 2878, Computech 01-794 0202, Isher-Woods 0582 416202, Logma Systems Design 0204 389854, Tridata 021-622 1754.

Having covered all the chosen applications once and the two major ones twice, this month marks the close of the 'Systems' section in its present form. From next month we shall be presenting a bi-monthly grid which will show the application packages offered by machine and supplier. The 'in-between' months will give an update of any additional packages notified to PCW.

We shall also begin a new series which will take the prospective user through all the stages necessary for a successful purchase and installation of a microcomputer system.

TASKS AND VOLUMES	PETACT SALES ACCOUNTING	P.S.L.S.	TRIDATA	SNIP	GRAFFCOM	GLAS	GRANT BUSINESS SYSTEMS	
TASKS								
Post invoices	*	*	*	*	*	*	*	
credit notes	*	*	*	*	*	*	*	
cash	*	*	*	*	*	*	*	
Allocate cash			*	*	*	*	*	
Unallocated cash				*	*	*	*	
Balance Forward	*	*	*	*	*	*	*	
Open item			*	*	*	*	*	
Mixed system								
Aged balance	*	*	*	*	*	*	*	
Aged Debtor analysis	*	*	*	*	*	*	*	
Statements	*	*	*	*	*	*	*	
VAT analysis		*	*	*	*	*	*	
Sales Day book		*	*	*	*	*	*	
Cash Day book				*	*	*	*	
Link to invoicing		*	*	*	*	*	*	
Link to nominal ledger			*	*	*	*	*	
Link to stock control					*	*	*	
VOLUMES								
Max customers	1000	900	999	500		200	999	
Max transactions	3500	4500	1350	2000		1400	1350	
COSTS (in £s)								
Package	Disk Tape	120 95	300	225	250	450	1000	750
Min hardware	Disk Tape	1950 1450	2000	3334	3725	Varies	2500	2335
Total	Disk Tape	2070 1545	2300	3559	3975	Varies	3500	3085

Dick Pountain is on holiday. This month our own Peter Rodwell presents a very interesting program sent in by one of our readers.

PENTATHLON FOR FX502P

International politics rarely rears its ugly head in this corner but I'm sure that at least some of you must be pondering the weighty question of whether or not to heed Mrs Thatcher's call to rally round and boycott the Olympics.

Even if you never contemplated spending this summer in Moscow but are still a sports fan, the news that Olympic TV coverage is to be drastically reduced must have come as a blow. So this month, to soften that blow, here's a Pentathlon program by S Williams which you can run on your FX502P and which will enable you to win (and award) yourself your very own Gold Medals.

Program description

The program consists of five independent games and an accumulating 'score-board'. The size of memory available necessitates simple models for each game, and they have been written to provide enjoyable entertainment rather than to stick strictly to mathematical approximations.

The sports available are somewhat unusual and are unlikely to be adopted by the International Olympic Committee as replacements for the present five. They are Pistol Shooting, Discus, Hang Gliding, Bowls and Show Jumping. Each game follows a route similar to that given by the flow diagram of Fig 1. The displayed variables are position of target, windspeed or height of jump. The control functions consist of shot position, angle of throw, angle of attack, velocity or roll, or speed of jump.

Each game is worth a maximum of ten points towards the total score and the games may be played in any order, although 1,2,3,4,5 gives a varied Pentathlon. To start, key PO. This clears the accumulator and sets a constant in M6.

Pistol shooting

P1 — The display will show a field of nine '1's, representing the shooting range, with a randomly positioned '8' as the target. During the following pause, the player enters

the position of the '8', counting from the *right*. If correct, the '8' is removed and a new target is set. If incorrect, the target remains and another is added. A shot is only accepted at the new target. At the end of ten shots the number of hits is displayed, followed by the cumulative total.

Discus

P2 — A random windspeed will be displayed. This will remain constant during the game. The angle of throw must be adjusted down from the optimum 45° for still air, in order to take account of the wind. After each throw, the length will be displayed. Three throws are permitted, the longest being taken to calculate the game score. This will be displayed at

the end and added to the accumulator.

Hang gliding

P3 — Launched from a height of 100 m, the player has to maximise his distance travelled overland by altering his angle of attack, according to the speed of a randomly gusting headwind. The optimum angles of attack are 5° for a wind of 10 m/s up to 20° for still air. The windspeed will be displayed at the start of the game and after each 10 m drop. During the following two-second pause, the angle of attack must be entered and the cumulative distance travelled will then be displayed. On touchdown, the final score is calculated and displayed as before.

PENTATHLON PROGRAM LISTING

<ul style="list-style-type: none"> ● P0,INV MAC 1,0,Min6 		<ul style="list-style-type: none"> Clear all (M)emories. Load M6.
<ul style="list-style-type: none"> ● P1,INV SAC MR6,Min0 INV 10^x,/9,=,Min1 LBL 0 GSB INV P7,+,1,=,INV INT, Min2 	5 steps	<ul style="list-style-type: none"> Clear M's 7,8,9. Load shot counter. Generate field of '1's. Store. Generate random no. between 1 & 2. Store.
<ul style="list-style-type: none"> ● MR1,/,MR2,INV 10^x,= INV FRAC,*,MR6,=,INV INT,MinF 8,INV x=F,GOTO 0 MR2,MinF,GSB INV P6,M+1,M+1 1,M-8 MR1,INV PAUSE INV x=F,GSB INV P6 INV DSZ,GOTO 0 MR8,GSB INV P8 	45 steps	<ul style="list-style-type: none"> Select target position in field according to random number. Check if target set. If so, reselect. Set new target. Readjust score. Display targets. Enter shot. Hit? If so, remove target. Loop x 10 Display game total. Add to Acc.
<ul style="list-style-type: none"> ● INV P6,-,1,M+8,=,INV 10^x *,7,=,M-1 	10 steps	<ul style="list-style-type: none"> Remove target and adjust score. Set throw counter. Generate random windspeed between 0 and 20 m/s. Display windspeed. Enter angle of throw
<ul style="list-style-type: none"> ● P2,3,Min0 1,MinF,-,INV RAN#,Min1 =,Min2,MR1,*,2,0,= LBL 0 HLT 	10 steps	<ul style="list-style-type: none"> Calculate length of throw. Select longest throw. Store. Loop x 3. Display longest throw.
<ul style="list-style-type: none"> ● tan,/,MR2,=,INV tan⁻¹,Min3 sin,*,MR3,cos,*,1,4,0,= INV x>=F,MinF INV DSZ, GOTO 0 INV PAUSE 	10 steps	<ul style="list-style-type: none"> Calculate length of throw. Select longest throw. Store. Loop x 3. Display longest throw.

Bowls

P4 — The 'jack' is positioned randomly between 0 and 10 m from the player. This distance is displayed. A 'roll velocity' between 0 and 10 m/s is entered and the score is calculated from the separation distance of the bowl from the jack. This is displayed after each roll. Roll velocity and distance travelled are not linearly related. Three rolls are permitted and the scores are totalled. The maximum score possible declines for the second and third roll, so it pays to make the first one count. The final score is displayed and added to the accumulator.

Show jumping

INV P5 — The height of each of nine fences (6,7 or 8 ft!) is displayed in turn and, within 1 sec, a 'jump speed' of 3, 4 or 5 must be entered (no entry results in breakneck speed). A time for the jump is derived and time penalties are added for an unsuccessful jump. The faster the jump and higher the fence, the greater the chance of penalties. The cumulative time is displayed after each jump and the score is derived and displayed at the end of the course.

<ul style="list-style-type: none"> ● MRF,/,7,GSB INV P8 ● P3,INV SAC ● MR6,INV x²,Min0 ● LBL 0 ● GSB INV P7,MinF ● /,(1,3,-,.,6,* ● MRF,INV PAUSE,INV PAUSE ● INV x=F,GOTO 2 ● =,MinF,1,1,5,-,1,x+MF ● INV x>=F,GOTO 1,INV 1/x ● LBL 1 ● *,1,5,=,INV INT ● M+8,MR8,INV PAUSE ● MR6,M-0,MR0,INV PAUSE ● INV x=0,GOTO 2,GOTO 0 ● LBL 2 ● =,MR8,/,MR6,INV x² ● GSB INV P8 ● P4,INV SAC ● 3,Min0 ● GSB INV P7,Min1 ● LBL 0 ● -HLT ● INV x²,/,9,= ● INV ABS,+/-,+,MRO,+ ● 2,=,INV INT ● +/-,INV x>=0,AC,+/- ● INV PAUSE,M+8 ● MR1,INV DSZ,GOTO 0 ● MR8,GSB INV P8 ● INV P5, INV SAC ● .,6,7,8,6,6,8,7,6,7 ● LBL 0 ● *,MR6,=,Min1 ● INV INT,MinF ● INV x=0,GOTO 2 ● 6,-,MRF,INV RND 1,INV PAUSE ● INV x=F,9 ● *,M+8 ● MRF,=,INV 1/x,*,3,=,MinF ● INV RAN#,INV x>=F,GOTO 1 ● 8,M+8 ● LBL 1 ● MR8,INV PAUSE ● MR1, INV FRAC ● GOTO 0 ● LBL 2 ● 1,1,-,MR8,/,7,GSB INV P8 ● INV P7,INV RAN#,*,MR6,= ● INV P8,=,INV INT, INV PAUSE ● M+5,MR5,HLT 	<p>41 steps</p> <p>55 steps</p> <p>32 steps</p> <p>56 steps</p> <p>5 steps</p> <p>7 steps</p>	<p>Display game total. Add to Acc.</p> <p>Clear M's 7,8,9</p> <p>Load height counter.</p> <p>Generate windspeed.</p> <p>Part calculation of hor. travel.</p> <p>Display windspeed. Enter angle of attack.</p> <p>No input? If none, end game.</p> <p>Part calculation of hor. travel.</p> <p>Accumulate. Display distance travelled.</p> <p>Display new height.</p> <p>Loop x 10.</p> <p>Display game total. Add to Acc.</p> <p>Clear M's 7,8,9</p> <p>Set roll counter.</p> <p>Generate random 'jack' pos. Store.</p> <p>Display jack pos. Enter roll vel.</p> <p>Calculate bowl/jack separation.</p> <p>Calculate score.</p> <p>Turn negative score to zero.</p> <p>Display score and accumulate.</p> <p>Recall jack position. Loop x 10.</p> <p>Display game total. Add to Acc.</p> <p>Clear M's 7,8,9</p> <p>Heights of fences.</p> <p>Load course.</p> <p>Select new fence.</p> <p>End of course? If so, go to 2.</p> <p>Display height of fence. Enter jump speed.</p> <p>No entry? If none, assume 9.</p> <p>Accumulate jump time.</p> <p>Calculate value of jump.</p> <p>Successful jump? If so, go to 1.</p> <p>If not, add 8 time faults.</p> <p>Display elapsed time.</p> <p>Select next fence.</p> <p>Loop x 9.</p> <p>Display game total. Add to Acc.</p> <p>10 x random number.</p> <p>Display game score.</p> <p>Accumulate and display current Pentathlon score.</p> <p>Total steps: 256</p>
------------------------------------------------------------------------------------------------------------------------------------------------------------------------------------------------------------------------------------------------------------------------------------------------------------------------------------------------------------------------------------------------------------------------------------------------------------------------------------------------------------------------------------------------------------------------------------------------------------------------------------------------------------------------------------------------------------------------------------------------------------------------------------------------------------------------------------------------------------------------------------------------------------------------------------------------------------------------------------------------------------------------------------------------------------------------------------------------------------------------------------------------------------------------------------------------------------------------------------------------------------------------------------------------------------------------------------------------------------------------------------------------------------------------------------------------------------------	-----------------------------------------------------------------------------------------------	--------------------------------------------------------------------------------------------------------------------------------------------------------------------------------------------------------------------------------------------------------------------------------------------------------------------------------------------------------------------------------------------------------------------------------------------------------------------------------------------------------------------------------------------------------------------------------------------------------------------------------------------------------------------------------------------------------------------------------------------------------------------------------------------------------------------------------------------------------------------------------------------------------------------------------------------------------------------------------------------------------------------------------------------------------------------------------------------------------------------------------------------------------------------------------------------------------------------------------------------------------------------------------------------------------------------------------------------------------------------------------------------------------------

Memory contents

- 0 — Counter .0 to .F — not used
- 1 — Working Register
- 2 — Working Register
- 3 — Working Register
- 4 — Not used
- 5 — Event Accumulator
- 6 — Constant '10'
- 7 — not used
- 8 — Game Accumulator
- 9 — not used
- F — Test/Working Register

NOTATION

- * means multiply (x)
- / means divide (÷)
- INV is equivalent to 2nd Function.

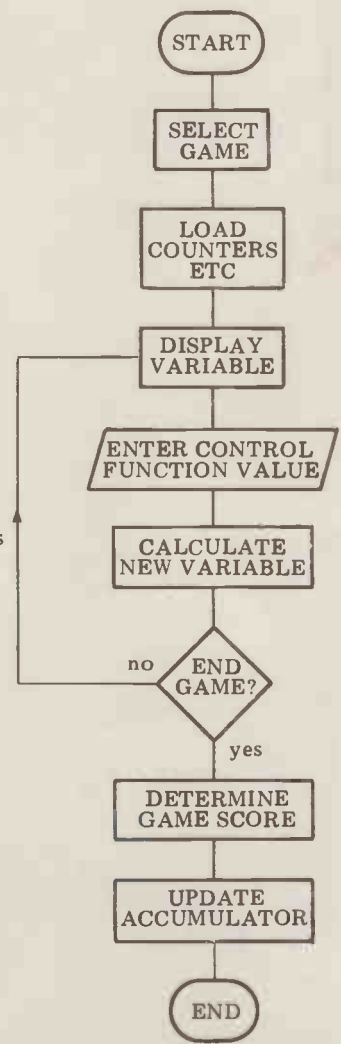

Fig. 1

STAY ON THE LEADING EDGE

It isn't easy! Few industries are changing as rapidly as microelectronics. We ought to know — *Personal Computer World* is Europe's leading micro magazine and in living up to that claim, each month PCW brings you reports on the latest hardware, software, education and business developments, answers your questions and gives you the most interesting features and programs.

Not only were we Britain's first micro publication but we were also the first to sponsor our own exhibition in the UK. So if you want to keep on the leading edge of micro technology come to the Third Personal Computer World show at the Cunard International Hotel, London, 4 — 6 September.

Last year's PCW show was a great success and this year it will be bigger than ever! The Show will feature a massive display of the latest hardware, software and literature, courtesy of manufacturers and dealers from around the world. You'll be able to take part in or watch the first official World Microcomputer Chess Championship and attend Micro UK, a three-day event of conferences, seminars, teach-ins and round table 'meet the expert' discussions. Further details of the Microcomputer Chess Championship are available from David Levy, c/o PCW. Use the reply card for further Show information or tickets, or write directly to Timothy Collins, Montbuild Ltd., 11 Manchester Square, London W1M 5AB.

The 3rd Personal Computer World Show

"At this rate (11.30am on 2nd day) we will cover our very considerable costs at the show with the sale of our minor products. We also have at least three months' worth of follow up work on orders from the business sector."
Michael Dean, Managing Director,
Katanna Management Services

"We have met a complete spectrum of the potential buyers of our products. It has been a marvellous show for us."
David Taylor, Managing Director,
Heath (Zenith)

"The interest of the overseas trade visitors has been absolutely outstanding."
Peter Older shaw, General Manager,
ACT Petsoft

"This show has done more for the image of the Society than any other we have participated in."
Martin Carrington,
Technical Information Officer,
British Computer Society

"This exhibition is the one and only national rallying point for the home enthusiast."
R. Warren, Amateur
Computer Club

"We are very pleased with the show. We have seen all of the people we wanted to see."
Graham Clifton,
Transam Components

"We have taken about £4,000 in cash and enquiries worth about £40,000 on just one item alone. We are delighted with the quality of visitor."
Marketing Manager,
Keen Computers

"A fine exhibition for the businessman to see a completely different way of meeting his needs."
Philip Virgo, Secretary of the
Parliamentary Computer Forum

"On the strength of this show, we will certainly exhibit next year."
Clifford Shilling, Managing Director,
C.S. Microcomputers

"At 11 o'clock on the first day of the Show we had done enough business to pay for the stand. Everything else was pure profit."
Colin Stanley, Director,
HB Computers

"The layout and planning of the exhibition was perfect for this type of show."
Chris Mead, Sales & Marketing
Director, CIS Ltd

"The quality of the visitors has been excellent. We have had a very successful show."
Ted Russell, Tandy Corporation

NEWCOMERS-START HERE

What follows is a brief guide for the microcomputing novice. It has been designed for quick reference — with all the key words in bold type; of course if you're feeling adventurous, you're welcome to read it right through. Whichever way, we trust you will find it helpful. Happy Microcomputing!

Welcome to the confusing world of the microcomputer. First of all, don't be fooled; there's nothing complicated about this business, it's just that we're surrounded by an immense amount of necessary jargon. Imagine if we had to continually say "numbering system with a radix of sixteen in which the letters A to F represent the values 10 to 15" when instead we can simply say "hex". No doubt soon many of the words and phrases we are about to explain will eventually fall into common English usage. Until that time, PCW will be publishing this guide — every month.

We'll start by considering a microcomputer's functions and then examine the physical components necessary to implement these functions.

The microcomputer is capable of receiving information, processing it, storing the results or sending them somewhere else. All this information is called data and it comprises numbers, letters and special symbols which can be read by humans. Although the data are (yes, it's plural) accepted and output by the computer in 'human' form, inside it's a different story — they must be held in the form of an electronic code. This code is called binary — a system of numbering which uses only 0s and 1s. Thus in most micros each character, number or symbol is represented by eight binary digits or bits as they are called, ranging from 00000000 to 11111111.

To simplify communication between computers, several standard coding systems exist, the most common being ASCII (American Standard Code for Information Interchange). As an example of this standard, the number five is represented as 00110101 — complicated for humans, but easy for the computer! This collection of eight bits is called a byte and computer freaks who spend a lot of time messing around with bits and bytes use a half-way human representation called hex. The hex equivalent of a byte is obtained by giving each half a single character code (0-9, A-F): 0=0000, 1=0001, 2=0010, 3=0011, 4=0100, 5=0101, E=1110 and F=1111. Our example of 5 is therefore 35 in hex. This makes it easier for humans to handle complicated collections of 0s and 1s. The machine detects these 0s and 1s by recognising different voltage levels.

The computer processes data by reshuffling, per-

forming arithmetic on, or by comparing them with other data. It's the latter function that gives a computer its apparent 'intelligence' — the ability to make decisions and to act upon them. It has to be given a set of rules in order to do this and, once again, these rules are stored in memory as bytes. The rules are called programs and while they can be input in binary or hex (machine code programming), the usual method is to have a special program which translates English or near-English into machine code. This speeds programming considerably; the nearer the programming language is to English, the faster the programming time. On the other hand, program execution speed tends to be slower.

The most common microcomputer language is Basic. Program instructions are typed in at the keyboard, to be coded and stored in the computer's memory. To run such a program the computer uses an interpreter which picks up each English-type instruction, translates it into machine code and then feeds it into the processor for execution. It has to do this each time the same instruction has to be executed.

Two strange words you will hear in connection with Basic are PEEK and POKE. They give the programmer access to the memory of the machine. It's possible to read (PEEK) the contents of a byte in the computer and to modify a byte (POKE).

Moving on to hardware, this means the physical components of a computer system as opposed to software — the programs needed to make the system work.

At the heart of a microcomputer system is the central processing unit (CPU), a single microprocessor chip with supporting devices such as buffers, which 'amplify' the CPU's signals for use by other components in the system. The packaged chips are either soldered directly to a printed circuit board (PCB) or are mounted in sockets.

In some microcomputers, the entire system is mounted on a single, large, PCB; in others a bus system is used, comprising a long PCB holding a number of interconnected sockets. Plugged into these are several smaller PCBs, each with a specific function — for instance, one card would hold the CPU and its support chips. The most widely-used bus system is called the S100.

The CPU needs memory in which to keep programs

and data. Microcomputers generally have two types of memory, RAM (Random Access Memory) and ROM (Read Only Memory). The CPU can read information stored in RAM — and also put information into RAM. Two types of RAM exist — static and dynamic; all you really need know is that dynamic RAM uses less power and is less expensive than static, but it requires additional, complex, circuitry to make it work. Both types of RAM lose their contents when power is switched off, whereas ROM retains its contents permanently. Not surprisingly, manufacturers often store interpreters and the like in ROM. The CPU can only read the ROM's contents and cannot alter them in any way. You can buy special ROMs called PROMs (Programmable ROMs) and EPROMs (Erasable PROMs) which can be programmed using a special device; EPROMs can be erased using ultra-violet light.

Because RAM loses its contents when power is switched off, cassettes and floppy disks are used to save programs and data for later use. Audio-type tape recorders are often used by converting data to a series of audio tones and recording them; later the computer can listen to these same tones and re-convert them into data. Various methods are used for this, so a cassette recorded by one make of computer won't necessarily work on another make. It takes a long time to record and play back information and it's difficult to locate one specific item among a whole mass of information on a cassette; therefore, to overcome these problems, floppy disks are used on more sophisticated systems.

A floppy disk is made of thin plastic, coated with a magnetic recording surface rather like that used on tape. The disk, in its protective envelope, is placed in a disk drive which rotates it and moves a read/write head across the disk's surface. The disk is divided into concentric rings called tracks, each of which is in turn subdivided into sectors. Using a program called a disk operating system, the computer keeps track of exactly where information is on the disk and it can get to any item of data by moving the head to the appropriate track and then waiting for the right sector to come round. Two methods are used to tell the computer where on a track each sector starts: soft sectoring

where special signals are recorded on the surface and hard sectoring where holes are punched through the disk around the central hole, one per sector.

Half-way between cassettes and disks is the stringy floppy — a miniature continuous loop tape cartridge, faster than a cassette but cheaper than a disk system. Hard disk systems are also available for microcomputers; they store more information than floppy disks, are more reliable and information can be transferred to and from them much more quickly.

You, the user, must be able to communicate with the computer and the generally accepted minimum for this is the visual display unit (VDU), which looks like a TV screen with a typewriter-style keyboard; sometimes these are built into the system, sometimes they're separate. If you want a written record (hard copy) of the computer's output, you'll need a printer.

The computer can send out and receive information in two forms — parallel and serial. Parallel input/output (I/O) requires a series of wires to connect the computer to another device, such as a printer, and it sends out data a byte at a time, with a separate wire carrying each bit. Serial I/O involves sending data one bit at a time along a single piece of wire, with extra bits added to tell the receiving device when a byte is about to start and when it has finished. The speed that data is transmitted is referred to as the baud rate and, very roughly, the baud rate divided by 10 equals the number of bytes being sent per second.

To ensure that both receiver and transmitter link up without any electrical horrors, standards exist for serial interfaces; the most common is RS232 (or V24) while, for parallel interfaces to printers, the Centronics standard is popular.

Finally, a modem connects a computer, via a serial interface, to the telephone system allowing two computers with modems to exchange information. A modem must be wired into the telephone system and you need British Telecom's permission; instead you could use an acoustic coupler, which has two obscene-looking rubber cups into which the handset fits, and which has no electrical connection with the phone system — British Telecom isn't so uppity about the use of these.

Britain's most up-to-date and comprehensive guide to the selection of microcomputer equipment, compiled for PCW by Richard Olney of Heuristic Consultants.

Machine (Price from)	Main Distributor/s (No. of Dealers)	Hardware	Software	Miscellaneous (Documentation)
ABC 80 (£790)	CCS Microsales: 01-444 7739 (TBA)	16-40K RAM; Z80A; C: 12", 16x40 b&w VDU; 4680 bus; IEEE 488; RS232 port; option — dual 5¼" F/D (160K, own DOS), £895	DOS: BASIC:	Graphics loudspeaker with 128 effects; Viewdata compatible: (S)
ACT System 800 (£3950)	ACT: 021 455 8686 (50)	48K RAM; 6502; dual 5¼" F/D (800K); 12", 30x64 VDU; 1 S/P; 1 P/P	MDOS: BASIC: A: PL/M: Forth: Fifth: Cesi: Pilot	Fully IBM compatible K/B; high resolution graphics; available with dual 8" F/D (2.4MB), £4950: (E)
Alpha Micro (£8,200)	Alpha Micro (UK) Ltd 01-250 1616 (TBA)	64K-16M RAM; 16 bit; dual 8" F/D (2.4MB); 6 S/P; modular	multi-user O/S: BASIC: M/A: Pascal: U	Expands to 1200 MB, 32 terminal system: (E)
Altos ACS 8000 (£3,398)	Logitek: 02572 66803 (TBA)	64K RAM; Z80; 1K ROM; dual 8" F/D (1MB); 2 RS232; 1 P/P	CP/M: BASIC: Fortran: Cobol: Pascal: M/A	(S&H)
Apple II (£695)	Microsense: 0442 41191 (190)	16-48K RAM; 6502; 8I/O slots; option — single 5¼" F/D (116K) £349	O/S: BASIC: Pascal: games:	280x192 high res graphics; integer BASIC in 6K ROM (S)
Athena 8285 (£7955)	Butel-Comeo Ltd: 0703 39890 (TBA)	64K RAM; 8085A; dual 5¼" F/D (644K); 12", 25x80 VDU; 150 cps printer; RS232C port; options — dual 8" F/D (2MB)	AMOS: T/E: BASIC: Cobol: Fortran: Pascal: APL: M/A	Extended ASCII K/B with numeric pad; graphics; many fully integral configurations possible: (S)
Atom (£120)	Acorn: 0223 312772 (N/A)	2-11K RAM; 6502; Full keyboard; C int: T.V. int: 20 I/O lines; 1 P/P	BASIC in 8K ROM: A: Cass OS	High resolution graphics on bigger model; colour monitor O/P; loudspeaker (B)
Attache (£7,000)	R.H.Thorpe Ltd: 0276 29492. R.J.Spiers Ltd: 0603 416573 (TBA)	48K RAM; 8080; dual 8" F/D (616K); 9", 16x64 b&w VDU; 180 cps printer	ExBASIC: Fortran	(S)
Billings BC-12FD (£4,295)	Mitech: 04862 23131 (TBA)	64K RAM; Z80A; dual 5" F/D (640K); 12", 24x80 b&w VDU	DOS: BASIC: Fortran: Cobol: A	8" F/D (2MB) to replace 5", £6,000; additional dual 8" F/D, £2,750 (S)
Canon BX-1 (£3,850)	Canon Business Machines (UK) Ltd: 01-680 7700	64K RAM; 6800; Single 5¼" F/D (65K); 12", 25x80 VDU; 5xV24 ports; options — single 5¼" F/D (65K), £1,500	DOS: ExBASIC: A:	Also supplied with integral thermal printer instead of VDU: (S&H)
CBS Mk 2&3 (£5900;£8648)	Compelec: 01-636 1392 (N/A)	64K RAM; Z80; dual 8" F/D (1MB); 12", 24x80 VDU; 132 col, 30 cps printer; 2 S/P; 1 P/P	CP/M: BASIC	Mk. 2 with 2MB F/D, £5,900. Can upgrade to Mk.3 — £8,150 (11MB H/D and 4 more S/Ps); Desk mounted: Up to 44MB H/D possible, £4,529 extra; multi user system with 208K RAM, £10,648: (S&H)
Challenger 1P & C2 (1P, £238; C2, £404)	CTS: 0706 79332; MBM: 01-980 3993; Mutek: 0225 743289; Millbank Computing: 01-549 7262. U-Micro-computers: 0606 853390. Byte Shop: 01-518 1414	4-32K RAM; 6502; C int: RS232 port:	O/S: BASIC: A: ExBASIC	D/A conv; col capability: 8K microsoft BASIC in ROM; option — dual 5¼" F/D (160K), £550; for C2, dual 8" F/D (1.15MB) and 20MB H/D; runs OSI business software on 8" F/D. (S)
Challenger C3 (£2,334)	As above	32-56K RAM; 6502, 6800, Z80; dual 8" F/D (1.15MB); 2-16 S/P	OS65U: BASIC: CP/M: Fortran: Cobol	Also C3B & C3P H/D modules: 74MB for about £10,000: (S&H)
Comma VO3 (£4,200)	Comma: 0277 811131: (N/A)	32K RAM; LSI 11; dual 8" F/D (512K); 4 serial DLU1S ports; modular	RT11 O/S (£750): BASIC: Cobol: Fortran	Many configurations possible: (H)
Compucolor II (£998)	Abacus: 01-580 8841: (6)	8-32K RAM; 8080; 13", 32x64 8-colour VDU; single 5¼" F/D (51K); RS232 port	ExBASIC (ROM): A	16K module, £1,078; 34K, £1,209; maintenance and programming manual available: (I)
Compucorp 625 (£6,000)	Compucorp: 01-952 7860: (17)	60K RAM; Z80; dual 5¼" F/D (700K); 9", 16x80 b&w VDU; 40 cps printer; 1 RS232 port	A: BASIC: U	Also 655 model with 320K F/D capability and 12", 20x80 VDU — £4,345 (B)
Cromemco System 2, System Z2H, System 3 (£1,995/£4,998/£3,293)	Comart: 0480 215005; Datron: 0742 585490; Microcentre: 031 225 2022 (20)	64K RAM; Z80; dual 5¼" F/D (346K) Sys 2 and Z2H... dual 8" F/D (1.24MB) Sys. 3: S/P: P/P	CDOS: BASIC: Cobol: Fortran: Multi-user BASIC: A:	All systems expandable to multi-user (2-7 users), £3,455 £6,400; 11 and 22MB options; also dual 8" F/D (996K) on Sys. 2 and 3: (E)
DAI (£998 48K)	Data Applications (UK): 0285 2588 (TBA)	12-48K RAM; 8080; C int: 24x60 VDU int; RS232 port; Over 20 industrial ints; 2 C ints	BASIC (ROM): U (ROM)	Up to 255x335 resolution graphics: 3 notes and noise generator; PAL output to TV; games paddle
Diablo 3000 (£9450)	Business Computers Ltd: 01-207 3344 (TBA)	32K RAM; 8085; dual 8" F/D (1.2MB); 12", 24 x 80 b&w VDU; 45cps printer	DOS: DACL: A: U:	Selection of business packages supplied in price: (S)
Digital Microsystems DSC-2 (£3525)	Modata: 0892 4 1555 (10)	64K RAM; Z80; dual 8" F/D (1.14MB); 4 RS232 ports; EIA port	CP/M BASIC-E: CBASIC: Cobol: Fortran: Pascal	14 or 28 MB H/D available or additional F/D units: (H)
Durango F-85 (£8,250)	Comp Ancillaries: 07843 6455 (12)	64K RAM; 8085; dual 5¼" F/D (1MB); 9", 16x64 green VDU; 132 col 165 cps printer; N/P	O/S: DBASIC	Takes up to 5 work stations; fully integrated system; options — additional dual 5¼" F/D (1MB) and 12 MB H/D: (S)
Dynabyte DB8/1 (£1,500)	Dynabyte UK/Europe Ltd: 0723 65559 (6)	32-64K RAM; Z80; S100 bus; 2 RS232 ports; 1 P/P	CP/M: BASIC: Cobol: Pascal	Expands to multi-user system; option — dual 8" F/D (1MB), £2,000; also DB8/2 with dual 5¼" F/D (400K), £3,000 (E)
Equinox 200 (£7,500)	Equinox: 01-739 2387 (N/A)	64-256K RAM; Z80; 10MB H/D; 1 S/P; 1 P/P	CP/M: CBASIC: cobol: Fortran:	Multi-user MVT/FAMOS available in place of CP/M: (S/H)

List of Abbreviations

- A Assembler
- B BASIC
- C Cassette
- E Extensive

- F/D Floppy disc
- G/C Graphics card
- H Hardware
- H/D Hard disc
- I Introductory
- Int Interface

- M/A Macro assembler
- N/A Not available
- N/P Numeric pad
- O/S Operating system
- P/P Parallel port
- S Software

- S/P Serial port
- T/E Text editor
- TBA To be announced
- U Utility

Please note: Software items listed in *italics* are not included in the basic price of the equipment. All prices are exclusive of VAT.

IN STORE

Machine (Price from)	Main Distributor/s (No. of Dealers)	Hardware	Software	Miscellaneous (Documentation)
Euroc (£7,995)	Eurocalc Ltd: 01-405 3113 (TBA)	64K RAM: 8080A: dual 8" F/D (1MB); 15", 25x80 b&w VDU; 132 col 140cps printer	CP/M: CBASIC: A: U:	A year's maintenance and stationery supply inc: (S)
Executive Minicomputer	Binatone 01-903 5211	See Video Genie		
Exidy Sorcerer (£749)	Liveport Data Products 0736 798157 (27)	16-48K RAM: Z80: RS232: 1P/P: S100 connector: 30x64 VDU 1/O: option - dual 5 1/4" F/D (630K), £1200	O/S: ExBASIC (ROM): Editor: A: CP/M: Algol: Fortran	High resolution graphics capability: 32K version, £799: 48K, £849: User programmable character set: (I)
HP 85 (£2,240)	Hewlett Packard Ltd: 0734 784774 (16)	16-32K RAM: C.P.U.: 5" 16x32 b&w VDU: C (200K): 64 cps printer: RS232 port: 4 P/P	BASIC:	Full dot matrix graphics: N/P: compact portable unit: (S)
IMS 5000 (£1,935)	Equinox: 01-739 2387 (20)	32-64K RAM: Z80: dual 5 1/4" F/D (320K)	CP/M: CBASIC: Cobol: Fortran:	3 drives option: (S&H)
IMS 8000 (£3,515)	As above	64-256K RAM: Z80: dual 8" F/D (1MB)	CP/M: CBASIC: Cobol: Fortran: MicroCOBOL	Multi-user MVT/FAMOS available in place of CP/M: (S&H)
IMSAI VDP 42 (£3,900)	Computermarket: 0603 615089 (TBA)	32-64K RAM: 8085: dual 5 1/4" F/D (400K): 9", 24x80 b&w VDU: 1 S/P: 1 P/P	IMDOS (CP/M comp): A: ExBASIC: U: CBASIC: Cobol: Fortran	Supports 8 additional F/D drives: also available, VDP 44 with F/D (780K), £4,400: (H)
IMSAI VDP 80 (£6,200)	As above	32-64K RAM: 8085: dual 8" F/D (1.2MB): 12", 24x80 b&w VDU: 1 S/P: 1 P/P	IMDOS: A: ExBASIC: U: CBASIC: Cobol: Fortran	(H)
ITT 2020 (£867)	ITT: 0268 3040 (15)	16-48K RAM: 6502	Monitor: A: ExBASIC: Dis A:	360x192 high res graphics: Ex-BASIC in 6K ROM: options: single 5 1/4" F/D (116K), £425; 16K RAM, £110, RS232 port, £96: 32K system, £931: 48K system, £995: (B)
LSI M-One (£5995)	LSI Computers: 04862 23411	8K RAM: 8080: dual 8" F/D (1.2MB): 12", 24 x 80 b&w VDU	FMOS: A	A choice of standard business package included in price: (S)
LSI M-One Model 5 (£9900)	As above	16K RAM: 8080: dual 8" F/D (2.4MB): 2x12", 24x80 VDU's: 120cps bidirectional printer	FMOS: A	One of the VDU's is for inquiry only: (S)
LX-500 (£3,500)	Logabax Ltd: 01 965 0061 (13)	32K RAM: Z80: dual 5 1/4" F/D (180K): 12" 25x80 b&w VDU: 100cps printer	DOS: BASIC: A	Other printers available: (S)
Megamicro (£6,080)	Bytronics: 0252 726814 (5)	256K: 8080A: dual 8" F/D (1MB): 12", 20x80 b&w VDU: 120cps printer: 2 S/P: 2 P/P	CP/M: U	(H&B)
Microstar 45 Plus (£4800)	Microsense: 0442 41191 (30)	64K RAM: 8085: dual 8" F/D (1.2MB): 3 S/P: RS232 port	STARDOS: CP/M: BASIC: Cobol: Fortran	(E)
MSI 6800 (£1,203)	Strumech: 05433 4321 (5)	16K RAM: 6800: C: 9", 16x64 b&w VDU: 1 S/P	BASIC: Mini A: U	Up to 8 serial or parallel ints possible: (S&H)
MSI 6800 System 1 (£2,175)	As above	32K RAM: 6800: dual 5 1/4" F/D (160K): 9" 16x24 b&w VDU: 1 RS232 port	DOS: BASIC: U: A: Fortran	As above: option - dual 8" F/D (624K), £1,640: (S&H)
MSI 6800 System 2 (£7,500)	As above	56K RAM: 6800: single 8" F/D (312K): 10MB H/D: RS232 port: 9", 16x64 b&w VDU	DOS: BASIC: Multi-user BASIC: A	Rack mounted: options - dual 8" F/D (624K), £1,640; 10MB H/D, £4,250: (S&H)
MSI System 7 (£5,200)	As above	56K RAM: 6800: dual 5 1/4" F/D (640K): 9", 16x24 VDU: 1 P/P	DOS: BASIC: A	Choice of FDOS, SDOS or Flex: also option - 10MB H/D: (H&S)
Nanocomputer (£420)	Midwich: Waltham Cross 29310 (TBA)	4K RAM: 2K ROM: Z80: C int: 8 digit LED: K/B: RS232 port: 4 P/P	Machine language: BASIC: A: T/E:	Designed for hardware education: expandable to 64K RAM system with F/D: (E)
North Star Horizon (48K, £4,650)	Comart: 0480 215005; Comma: 0277 811131; Equinox: 01-739 2387 (20)	24-56K RAM: Z80A: dual 5 1/4" F/D (360K): 15", 24x80 b&w VDU: 150 cps printer: 2 1 P/P	DOS: BASIC: CP/M Cobol: Fortran: Pascal	(E)
Oxford Mini-computer	Binatone 01-903 5211	See Video Genie		
Panasonic JD740U; JD840U (£4550, £5500)	Teletronix: 01-262 3121 (10)	56K RAM: 8085A: 2-4K PROM: dual 5 1/4" F/D (570K) JD740U: dual 8" F/D (2MB) JD840U: 12", 24 x 80 b&g VDU: 3xRS232 ports.	CP/M: BASIC: Microcobol	Also available - JD700U with 140K disc capacity, £4175; JD800U with 1/2 MB disc, £4750 : (S)
Pascal Microengine (£2,080)	Pronto: 01-599 3041 (TBA)	64K RAM: MCP 1600: 2 RS232 ports: 2P/P: options - dual 5 1/4", F/D (1MB), £1550: dual 8" F/D (2MB), £1950	BASIC: Pascal	CPU has user written word set: : (s)
Periflex 630/48; 1024/64 (£2500; £3300)	Sintrom: 0734 85464 (5)	48K RAM, 630/48: 64K RAM; 1024/64: Z80: dual 5 1/4" F/D (630K), 630/48: dual 8" F/D (1MB), 1024/64: 2xRS232 ports: 1 P/P: Options - dual 5 1/4" F/D (630K) £859; dual 8" F/D (1MB) £1025	CP/M: BASIC: Fortran: Cobol: A	One day installation training on site included in price (S&H)
PET 8k, 16k, & 32k (£450, £550 & £695)	Commodore: 01-388 5702 (150)	8-32K RAM: 6502: C: 9", 25x40 VDU: IEEE 488 port: option - dual 5 1/4" F/D (353k), £695: same but (800k), £895	O/S: BASIC (in 8k ROM) Forth: Pilot	Disk controller for 8k model £30. Now 8032 with 80 column screen (32k) £895: (I)
Powerhouse 2 (£1,175)	Powerhouse Micros: 0422 48422 (TBA)	32-64K RAM: Z80A: 5", 27x96 b&w VDU: 1 P/P: RS232 port	FDOS: BOS: BASIC: ExBASIC: (14K EPROM), £260	Graphics card available, £190: option - dual 5 1/4" F/D (700K): (I)
Rair Black Box (£2,300)	Rair: 01-836 4663 (N/A)	32-64K RAM: 8085: dual 5 1/4", F/D (160K): 2 RS232 ports	CP/M: BASIC: Cobol: Fortran: M/A	16K RAM expansion, £250; dual 5 1/4" F/D (520K) £1,000: (H)
Research Machines 380-Z (£1,048)	Research Machines: 0865 49791 (N/A)	16-56K RAM: Z80A: C: RS232 port:	Tiny BASIC: graphics: A: ExBASIC: CBASIC: Cobol: Fortran: Algol: CP/M: U:	Designed for education: high res graphics being developed: options - dual 5 1/4" F/D (168K), £895 and dual 8" F/D (1MB), £1,695: 56K version, £1,654: (S)
SDS 100 (£4,290)	Airamco: 0294 57755 (11)	64K RAM: Z80: dual 8" F/D (1MB): 12", 24x80 VDU: S100 bus: RS232 port: N/P: 1 P/P	CP/M: A: ExBASIC: Cobol: Fortran	Facility for 8K PROM: (E)

DATA LINK

Microcomputer Systems Limited

Systems software for business, industrial and scientific applications

PRINTERS

Paper Tiger (with graphics)	£598
Centronics 730	£525
Centronics 737	£656
Centronics 701	£1276
Centronics 702	£1635
Centronics 703	£1935
Centronics 735	£2022

ALL PRICES EX VAT

DISKETTES ETC

BASF Top Quality Unconditional 12 Month Guarantee

5.25" Mini Single Sided Soft Sectored/Single Density	£25.00	(Box of 10)
5.25" Mini Single Sided Hard Sectored/Single Density	£25.00	" "
5.25" Mini Single Sided Soft Sectored/Double Density	£26.00	" "
5.25" Mini Double Sided Soft Sectored/Double Density	£30.00	" "
8" Single Sided Soft Sectored/Single Density	£26.50	" "
8" Single Sided Soft Sectored/Double Density	£27.50	" "
8" Double Sided Soft Sectored/Single Density	£40.00	" "
8" Double Sided Soft Sectored/Double Density	£40.00	" "

DISKETTE LIBRARY CASES

5.25" Mini Diskette Library Case for 10 Diskettes	£2.50
8" Diskette Library Case for 10 Diskettes	£3.00

DISKETTE TRAY WITH LOCKABLE LID

A6 5.25" Mini Diskette Tray with Lockable Lid: 30-40 capacity	£16.00
60-80 capacity	£18.00
A5 8" Diskette Tray with Lockable Lid: 30-40 capacity	£22.00
60-80 capacity	£25.00
9" Plain Listing Paper (per 2,000 sheets)	£16.00

We also stock an extremely comprehensive range of computer books

DATA LINK

10 Waring House, Redcliffe Hill, Bristol BS16TB
Telephone: Bristol (0272) 213427



Computer Gamble?

Visit Cambridge Computer Store and load the dice in your own favour! We have one of the biggest selections of microcomputers and peripherals in the country and the expertise to help you choose the right system. Most of the equipment listed below you can see on demonstration and buy off the shelf:

TANDY TRS 80 • APPLE • PET • HORIZON
CROMEMCO • COMPUKIT • ACORN • INFOTON
LEAR-SIEGLER • CENTRONICS • ANADIX

Back-up this impressive range with truly professional standards of advice and after-sales support and you'll take the gamble out of computer selection.

Cambridge Computer Store

1 Emmanuel Street, Cambridge CB1 1NE
Telephone (0223) 65334/68155

IN STORE

DIRECT ACCESS

Machine (Price from)	Main Distributor/s (No. of Dealers)	Hardware	Software	Miscellaneous (Documentation)
S.E.E.D. System One (£2,175)	Strumech: 05433 4321 (4)	32-56K RAM: 6800: dual 5 1/4" F/D (160K): 9", 16x24 b&w VDU: RS232 port	DOS; BASIC: U; Fortran: Cobol: M/A	Up to 8 I/O ports: max of 4 F/D drives: option — dual 8" F/D (624K): (E)
Semel 1 (£2,900)	Strutt Electrical: 0822 5439 (N/A)	16-64K RAM: Z80: single 8" F/D (250K): 12", 24x80 b&w VDU: RS232 port	BASIC: Cobol: Fortran	Supports up to 8 drives option — single 8" F/D (250K), £500: (I)
Sharp MZ-80K (£480)	Sharp Electronics (UK) Ltd: 061-205 2333 (50)	6-34K RAM: Z80: C: 10", 24x40 b&w VDU: option - dual 5 1/4" F/D (280K), £780	BASIC (in 14K ROM) A	Graphics: loudspeaker: 18K RAM version £529; 22K £549; 34K £599: (B)
Sinclair ZX80 (£100)	Science of Cambridge: 0223 311488 (N/A)	1-16K RAM: 780-1: C int: T.V. int: full K/B: 44 pin expansion port	4K BASIC in ROM	CPU is NEC 3.25 MHz version of Z80A: available as kit, £80: mains adaptor £9: (S)
Sirocco (£3,900)	Elvingate Computers: 069 245189 (TBA)	64K RAM: Z80: dual 5 1/4" F/D (940K): 12", 24x80 VDU: RS232 port	CP/M: CBASIC: Cobol: MBASIC: Fortran	Direct memory addressing: memory mapped VDU: free standing keyboard: option — 10MB H/D: (S&H)
Smoke Signal Chieftain 1 (£3,050)	Windrush Micro Designs 069 245189 (TBA)	32-64K RAM: 6800: dual 5 1/4" F/D (160K): 12", 24x80 VDU: 112 cps printer: RS232C port	DOS: BASIC: DBASIC: RBASIC: A: Fortran: U	Also Chieftain 3 with dual 8" F/D (1MB), £3,950 (E)
Solitaire WP & BS200 (£6,750 & £7,950)	Solitaire KPG: 01-995 3573 (TBA)	64K RAM: 8085: 14" VDU (with own CPU): 45 cps printer: CPU port: dual 5 1/4" F/D (700K) with "WP", and dual 8" F/D (960K) with "BS200"	DOS: BASIC (optional on the "WP")	All Solitaire systems are compatible: graphics on 11x13 dot matrix: (S)
Solitaire/HBS100 (£9,500)	As above	64K RAM: 8085: 10MB H/D: 14" VDU (with own CPU): 200 cps printer: CPU port	DOS: BASIC	Up to 8 interface terminals can be used: also HBS200 with 20-80 MB of H/D: HBS100 limit is 40MB: (S)
Sord M100 ACE (£2,650)	Midas Computer Services Ltd: 0903 814523	48K RAM: Z80: single 5 1/4" F/D (143K): 12" 24x64 col VDU RS232 port	O/S: BASIC	With colour graphics: 8K ROM: option — single 5 1/4" F/D, £300: (I)
Sord M223 (£3,500)	As above	64K RAM: Z80: single 5 1/4" F/D (350K): 12", 24x80 b&w VDU: S100 bus: RS232 port	O/S: BASIC	Other configs possible: extra F/D, £450: (I)
SPC/1 (£3,755)	Digital Data: 01-727 6668 (TBA)	64-1024K RAM: 8085A-2: dual 5 1/4" F/D (180K): 24x80 b&blue VDU: 2xRS232 ports: options — single 8" F/D (1MB) £1090; 20 MB H/D £7650.	Mikados: COMOL: Pascal: A	Large choice of extras and peripherals, with 32K RAM and single F/D (no Pascal) £1995: (S)
Superbrain (£1,995)	Icarus: 0632 29593 (TBA)	64K RAM: 2xZ80: dual 5 1/4" F/D (320K): 12", 25x80 b&w VDU: S100 bus: RS232: TRS80 port	CP/M: A: BASIC: Cobol: Fortran: APL Pascal	Limited graphics: mainframe int available: options — dual 5 1/4" F/D (320K): dual 8" F/D (2.4MB): 8-120 MB H/D: (S&H)
System 80 (£1505)	Nascom: 02405 75155 (20)	16-48K RAM: Z80A: single 5 1/4" F/D (280K) 80 cps printer: TV: int: RS232 port: option — single 5 1/4" F/D (280K) £240	CP/M: 8K BASIC	Choice of EPROM firmware (extra): colour graphics £140 (kit): (S&H)
Tandberg EC10 (£5,000)	Tandberg: 0532 35111: (N/A)	50K RAM: 8080A: single 8" F/D (250K): 12", 25x80 b&w VDU: RS232 port	ExBASIC (24K): Multi-user BASIC: A: U: Cobol	(S&H)
Tandy TRS 80 Level 1 (£380)	Tandy: 021 556 6101 (200)	4-16K RAM: Z80: C: 12", 16x64 b&w VDU	BASIC: A:	BASIC in 4K ROM: upgradable to level 2: (I)
Tandy TRS 80 Level II (£515)	As above	4-48K RAM: Z80: C: 12", 16x64 b&w VDU: RS232 int: 1 P/P	BASIC: M/A: Fortran	16K machine includes N/P: 4-16K upgrade, £120 (£85 without pad): max config, £1,005: option — single 5 1/4" F/D (78K), £478 (max of 4): (I)
Tandy TRS80 Model 2 (£2290)	As above	32-64K RAM: Z80A single 8" F/D (500K) 12", 24x80 VDU: 2S/P 1P/P	DOS: BASIC	Keyboard has numeric pad: 64K version, £2250: (S)
TECS (£1,600)	Technalogs: 051 724 2695 (TBA)	16-56K RAM: 6800: 8K PROM: RS232 port: C int	BASIC: T.DOS: Prestel: Monitor:	256 ch graphics: Prestel compatible: plugs into standard TV: option — dual 5 1/4" F/D (320K), £800: (S&H)
TEI 208 (£3,841)	Abacus: 01-580 8811 (5)	32-60K RAM: 8080/8085: dual 5 1/4" F/D (320K): 9", 24x80 green VDU: 3 S/P: 3 P/P	CP/M: BASIC: Cobol: Fortran: Pascal: Algol	(S&H)
TEI 212 (£4,886)	As above	32-60K RAM: 8080/8085: dual 8" F/D (1MB): 15", 24x80 green VDU: 3 S/P: 3 P/P	CP/M: BASIC: Cobol: Fortran: Pascal: Algol	(S&H)
Terodec DPS 64/1-4 (£3,014)	Terodec (Micro-systems) Ltd: 0344 51160: (TBA)	64K RAM: Z80: dual 8" F/D (1MB): 12", 24x80 b&w VDU: 2 S/P: 3 P/P	CP/M: BASIC: Cobol: CBASIC: Fortran: Algol: Pascal	TMZ 80, enhanced model in integral work station, £5,495 (with 4MB F/D): DPS 64 with 2MB F/D is £3,319: options — dual 8" F/D (1MB), £1,150: dual 8" F/D (2MB), £1,455: (S&H)
TI99/4 (£750)	TI: 0234 67466 (TBA)	16K RAM: 26K ROM: 9900: 24x32 b&w VDU: 2 C int: RS232 port	OS: BASIC	Various peripherals available soon; can run 16 colour TV screen: (S)
Triton L8.2 (£611)	Transam: 01-402 8137 (N/A)	32K RAM: 8080: C int 16x64 VDU int: 1 S/P: 1 P/P	OS: A: Pascal: M/C: BASIC: CP/M	Graphics: 5 1/4" or 8" F/D are available: (S&H)
Vector Graphics MZ (£2,595)	Almarc: 0602 625035: Sintrom Microshop: 0734 85464: Metrotech 0895 57780: (5)	56K RAM: Z80: dual 5 1/4" F/D (630K): 3 S/P: 2 P/P	DOS: BASIC: A: CP/M2: Algol: CBASIC: Cobol: Fortran: Pascal	Includes PROM burner: also System B with graphics and N/P, £3,195: (E)
Video Genie EG 3003 (£378)	Lowe Electronics: 0629 2817: Binatone: 01-903 5211 (N/A)	16K RAM: Z80: 500 bps C: 32x64 TV int: extra C int: 1 P/P	BASIC: M/A: Fortran	BASIC in 12K ROM: graphics available: F/D under development: Binatone call their 16K model "Executive Minicomputer" and a 4K version, "Oxford Minicomputer" — prices TBA: (I)

List of Abbreviations

A Assembler	F/D Floppy disc	M/A Macro assembler	S/P Serial port
B BASIC	G/C Graphics card	N/A Not available	T/E Text editor
C Cassette	H Hardware	N/P Numeric pad	TBA To be announced
E Extensive	H/D Hard disc	O/S Operating system	U Utility
	I Introductory	P/P Parallel port	
	Int Interface	S Software	

Please note: Software items listed in *italics* are not included in the basic price of the equipment. All prices are *exclusive* of VAT.

New Apple Software

ACT Appleware bring you Britain's best range of software for the Apple.

including

VISICALC

£125

A powerful problem solving package that adapts itself to any numeric problem. 1980 Program of the Year.

APPLE INVADERS

Probably the best Apple version of this exciting space game.

TINY PASCAL

£12

No hardware needed to use this implementation of the acclaimed Pascal language. Just load and go.

£40

MICROCHESS

The most widely used personal computed chess program in the world. A great opponent for novices and advanced players.

£15

TALKING DISK

An exciting speech synthesis package containing five programs. Stores and retrieves your own voice data.

£14.95

CCA DATA MANAGEMENT SYSTEM

Names and addresses, inventory information - CCA handles any data that can be organized into records or files. Use it to build your own business system.

£75

BRIDGE PARTNER

You against the computer in over ten million different hands.

£10

Plus more than seventy other exciting programs in the latest Apple catalogue. Send or call for your free copy.

Try Appleware programs at your nearest dealer. Or order by mail. For credit card holders we accept telephone orders too.

ACT Appleware

Software for Apple II Computer

Radclyffe House, 66/68 Hagley Road, Edgbaston, Birmingham B16 8PF
Telephone 021-455 8585 Telex 339396

ACT Appleware
Please rush me my free copy of the new
Appleware catalogue.

My name is.....
My address is.....
..... Postcode.....

Apple is the trademark of Apple Computers Inc.
All prices quoted are exclusive of VAT and were
correct at press date.

Machine (Price from)	Main Distributor/s (No. of Dealers)	Hardware	Software/ Firmware	Miscellaneous (Documentation)
Zenith WH-11A (£4,359)	Heath Ltd 0452 29451 and 01-636 7349 (N/A)	LSI 11: 16-32K RAM: 25x80 VDU: S/P: P/P	O/S: <i>BASIC: Fortran: A: U:</i>	PDP 11 compatible: option — dual 8" F/D (512K): (S&H)
Zenith Z89 (£1,490)	As above	16-48K RAM: Z80: single 5¼" F/D (102K): 12", 25x80 b&g VDU: RS232	<i>BASIC: A: H.DOS: CP/M: MBASIC: CBASIC: Fortran</i>	3 drives option: (I)
Zentec (£5,700)	Zigal Dynamics Ltd: 02405 75681 (1)	32-64K RAM: 2x8080: dual 5¼" F/D (512K): 15", 25x80 b&w VDU: RS232 port	O/S: A: U: <i>BASIC: Micro Cobol</i>	User programmable character set: option — dual 8" F/D (1MB): (S)
Zilog MCZ 1/05 (portable), MCZ 1/20A (£4,200, £4800)	Micropower: 0256 54121; Memec: 084421 5471 (N/A)	64K RAM: Z80: dual 8" F/D (600K): RS232 port: MCZ 1/20 A only... 1P/P: option—10MB H/D, £7100	RIO: O/S: <i>Cobol: BASIC: Fortran: Pascal 1/05... M/A: U 1/20A... PLZ: U</i>	Available desk top or rack mounted: Debug in 3K PROM: 1/20A runs multi-user Cobol and has up to 5 terminals and 40MB possible: (S&H)
Z Plus (£4,000)	Rostronics: 01-874 3665 (TBA)	32-64K RAM: Z80: dual 8" F/D (1MB): 2 S/P: 2 P/P	CP/M: A: U: <i>BASIC: Cobol: Fortran: Pascal</i>	(S&H)

SINGLE BOARDS

Machine (Price from)	Main Distributor/s (No. of Dealers)	Hardware	Software/ Firmware	Miscellaneous (Documentation)
Acorn (£65)	Acorn: 0223 312772 (N/A)	1.1/8K RAM: 6502: EPROM socket; Hex K/B: C int: 8 digit LED display: up to 16 ports: options — Eurocard 64 way connector: VDU card: Full K/B card	¼K monitor: <i>BASIC</i>	Kit: programmable address linking; on board 5V regulator: available assembled, £79 (S&H)
Aim 65C (£265)	Pelco: 0273 722155 (4)	1-4K RAM: 6502: 12K ROM: full K/B: 20 char LED display: 20 char thermal printer: Cx2: RS232 port.	A: Dis A: T/E: 8K monitor in ROM	Available as S100 system with A or BASIC in ROM (£480) from Portable Micros (0280 702017): they also have briefcase version (£750) (E)
Cromemco SC (£260)	Comart: 0480 215005 (17)	1K RAM: Z80A: 8K EPROM sockets: RS232 port: 3 P/P: option — S100 bus.	<i>Monitor and control BASIC in EPROM</i>	5 program interval timers: can put own BASIC programs in EPROM (E)
ELF II (£114)	Newtronics: 01-348 3325	1/4K RAM: RCA 1802: Hex K/B: 2 digit LED: TV int: C int: RS232 port: options — 4K RAM, £69; full K/B: VDU card	1K monitor: A: Dis A: T/E: <i>BASIC: 244</i>	TTY, n-line decoders: low resolution graphics (high resolution available) kit (H)
Explorer (£295)	Newtronics: 01-739 1582 (15)	4K RAM: 8085: Hex K/B: RS232 port: S100 bus: C int: options — 6 slot S100 £32; 8K EPROM sockets £50.	2K monitor: <i>CP/M: BASIC</i>	Programmable 14 bit counter: kit (S&H)
H8 (£262)	Heath: 0452 29451 (TBA)	4K RAM: 8080A: Octal K/B: 6 digit LED; speaker: options — single 5¼" F/D (102K), £399; 16K RAM, £314; C int, £72	1K monitor: <i>BASIC in RAM: FORTRAN: T/E: A: U:</i>	Kit (S&H)
Hewart 6800S (£299)	Hewart: 0625 22030 (N/A)	16K RAM: 6800: full K/B: VDU int: 2xC int; 1 S/P: 2 P/P: option — 16K RAM, £90	1K monitor: A: T/E	Can be upgraded with 6809 (H)
Hewart 6800 MkIII (£152)	As above	1K RAM: 6800: VDU board: options — single 5¼" F/D (75K), £350; PROM programmer, £32; calculator board, £32	1K monitor	(H)
Mk 14 (£39.95)	Science of Cambridge: 0223 311488 (N/A)	8060: 1/4-2K RAM: Hex K/B: 7 char LED: options — VDU int (32x16 with graphics), £29; C int, £6; PROM prog, £10, 2K memory expansion, £15	Machine code	Designed for control applications rather than high level computing expansion (H)
Microtan 65 (£69)	Tangerine: 0353 3633	1K RAM: 6502: 16x32 T.V. int: options — TANEX board, 7K RAM, 6K ROM, 8K BASIC; 3S/P	1K TANBUG monitor: <i>BASIC</i>	Optional 64x64 pixel graphics: (E)
Nascom 1 (£165)	Nascom: 02405 75155 (20)	4K RAM: Z80: full K/B: TV int: 2 P/P: 1 S/P	2K monitor: <i>BBASIC: tiny BASIC: A: T/E: U</i>	Now available as Nascom 2 with 8K RAM and 8K microsoft BASIC in ROM, £295: (S&H)
77/68 (£90)	Newbear: 0635 30505 (N/A)	4K RAM: 6800: LED: C int: VDU int.	1K Monitor: <i>BASIC:</i>	Expandable to racked Nascom compatible system: (B)
SBC 100 (£135)	Airamco: 0294 57755 (11)	1K RAM: Z80: 8K ROM: S100 1 S/P: 1 P/P: option — voltage regulator	1K monitor: <i>DOS in ROM</i>	Kit: available assembled, £196 (E)
Superboard (£188)	MBM: 01-981 3993 (N/A)	4-8K RAM: 6502: 10K ROM: full K/B: VDU int: C int: options — RS232; single 5¼" F/D (100K), £316; 8K RAM, £188	<i>BASIC in 8K ROM:</i>	Available with 32K RAM and single 5¼" F/D, £867 (S&H)
SYM-1 (£160)	Newbear: 0635 30505 (N/A)	1-4K RAM: 6502: bps C int: VDU int: 2x6522 ports: option — TV int.	4K monitor: <i>BASIC: A</i>	Can be expanded to 64K RAM (S&H)
Triton 4.1 (£286)	Transam: 01-402 8137 (N/A)	2K RAM: 8080: 3K ROM: full K/B: 16x64 VDU or TV int: C 1 S/P: option — 2K RAM, £30	1K monitor: 2K <i>BASIC: U</i>	64 character graphics: 8 levels interrupt: kit (S&H)
Triton 5.1 (£294)	As above	2K RAM: 1K VDU RAM: 8080: C int: T.V. int	1¼K monitor: 2¼K <i>BASIC: A: Dis A: 8K BASIC: Pascal</i>	Graphics facility: disc interface running CP/M, about £200: (S&H)
Triton L5.2 (£296)	As above	¼K RAM: 8080: C int: 16x64 VDU int: keyboard: 1S/P: 1P/P	1.5K monitor: 2.5K <i>BASIC</i>	Graphics: kit form: easily expandable
Tuscan (£170)	As above	8K RAM: 8K ROM: Z80: 6xS100 slots: RS232 int: T.V. int: C int	8K monitor: or 8K <i>BASIC</i>	DD disc controller, £195: graphics: (S&H)
UK 101 (£210)	Computer Shop: 01-440 7033	4K RAM: 6502: full K/B: 16x48 VDU or TV int: C int: RS232 port: option — 4K RAM, £49	1K monitor: 8K <i>BASIC: Dis A: U</i>	Graphics: will run Superboard software (S&H)

List of Abbreviations A Assembler B BASIC C Cassette E Extensive	F/D Floppy disc G/C Graphics card H Hardware H/D Hard disc I Introductory Int Interface	M/A Macro assembler N/A Not available N/P Numeric pad O/S Operating system P/P Parallel port S Software	S/P Serial port T/E Text editor TBA To be announced U Utility
-------------------------------------------------------------------------------------	--------------------------------------------------------------------------------------------------------	------------------------------------------------------------------------------------------------------------------------	------------------------------------------------------------------------

Please note: Software items listed in *italics* are not included in the basic price of the equipment. All prices are *exclusive* of VAT.

USER GROUPS INDEX

As promised, here is a complete printout of our User Group Index. If we have failed to include YOUR group, then please address the relevant information to PCW (User Group Index), 14 Rathbone Place, London W1P 1DE. Notification of changes will also be appreciated. The next full listing will appear in PCW's November edition. In the meantime we shall of course continue to publish User Group Index update information — as and when it reaches us.

NATIONAL

11s Users Group. A sort of help service only. No meetings no newsletter. Contact: Pete Harris, 119 Carpenter Way, Potters Bar, Herts, EN6 5QB. Tel: 0707 52091 or 01-248 8000 Ext. 7065.

The 6502 Users Club. Hoping soon to hold regional and national meetings, they offer "support, encouragement and fellowship". Contact: Walter Wallenborn, 21 Argyle Ave., Luton, Beds LU3 1EG.

77/68 Users Group. Quarterly Newsletter. Free membership for 1st year if you buy the 77/68 instruction manual, £1.50 thereafter. Contact: Newbear Computing Store, 40 Bartholomew St., Newbury, Berkshire.

9900 Users Group TIMUG. Contact: Chris Cadogan, 21 Thistle Downs, Northway Farm, Tewkesbury, Glos.

Amateur Computer Club — 2650 Library. No meetings, no newsletters, the library serves to act as a help point for disseminating 2650 related data on demand. Contact: Roger A. Munt, 51 Beechwood Drive, Feniscowles, Blackburn, Lancs BB2 5AT (0254 22341).

Minicomputer Users in Secondary Education (MUSE). MUSE is the national organisation for coordinating activity in schools, teacher training institutions, colleges of technology and so on. Meetings are held on both a regional and national basis. For full details on MUSE's range of activities, contact the Treasurer, R. Trigger, 48 Chadcoote Way, Catshill, Bromsgrove, Worcestershire.

Exidy Sorcerer Users Group. Newly formed, and a division of the U.S. User Group. Fee is £5 p.a. Write, stating what hardware you own to: Andy Marshall (Micro44), 44 Arthurs Bridge Road, Woking GU21 4NT (04862 66084).

UK Intel MDS Users Group. Contact: Lewis Hard, 29 Chaucer Rd., Bedford.

Ithaca Audio S100 bus UK User Group. Contact: Dave Weater, 16 Etive Place, Cumbernauld, Glasgow O67 4JE. Phone 02867 36570.

MK14 Club. Bi-monthly magazine called "Complement and Add". Contact: Geoff Phillips, 8 Podsford Rd., London NW9 6HP.

Independent PET users Group. Contact: IPUG, 57 Clough Hall Road, Kids Grove, Stoke-on-Trent, Staffs.

Research Machines Ltd. National User Group. Contact: M.D. Fischer, PO Box 75, Oxford, OX4 1EY, for a registration form.

UK Apple Users Group. Contact: (Keen Computers) 5 The Poultry, Nottingham, Tel: 0602 583254/5/6.

Central Program Exchange. Full membership (£25 Europe, £40 overseas) provides 30 free programs p.a. Small User Service (£10 Europe, £20 overseas) provides 10 free programs p.a. Contact: Mrs Judith Brown, The Polytechnic, Wilfruma St., Wolverhampton, WV1 1LY.

Cosmac Users Club (proposed) For People using the RCA 1802, Cosmac ELF, ELFI, Super ELF etc. Those interested contact James Cunningham at 7 Harrowden Court, Harrowden Road, Luton LU2 0SR (enclosed sae, please).

TRS-80 Users Group. Contact: Brian Pain, 40a High St., Stony Stratford, Bucks.

ZX80 Users Club. The group's aim is to create and share software which will fit within the machine's 1K RAM. Membership is free and first move will be to distribute a newsletter. Address to write is: c/o Tim Hartnell, 93 Coningham Road, London W12.

Ohio Scientific UK User Group. Independent of OSI, an important role will be the disentangling of poor documentation. There will be regular newsletters and membership is at present £5 per year. The group will initially be concerned with the practical aspects and applications of OSI systems — rather than with games. Contact Tom Graves at: 19a West End, Somerset, BA16 0LQ.

National Personal Computer Users Association. The NPCUA is intended to pool the vast combined resources of owners and users of all types on personal computers in the UK, and to disseminate information between members. Projects, newsletters and bulk discounts possible. Nominal subscription is £8. . . send SAE for membership application form to Secretary E.J. Keeley, 11 Spratling Street, Manston, Ramsgate, Kent.

Medical Micro Users Group. Set up to enable medical micro users to locate programs already written in their field by other medics. Newsletters and meeting in the pipeline — contact P.J.V. Dixon, c/o MEDICOM, 1-2 Hanover Street, London W1.

UK Pet Users Club. Contact: Commodore Systems Division, 360 Euston Road, London NW1 3BL.

British TI Users' Club. A loose association of owners and users of Texas Instruments programmable calcs, the club exists for the purposes of information and program exchange (and is in no way sponsored by TI). The main activity is production of a (roughly) monthly newsletter and membership costs £5.50. Details from 2 Woodside Crescent, Clayton, Newcastle-under-Lyme, Staffs ST5 4BW.

ZX80 Users Club. Bi-monthly newsletter. Low cost software. Technical support. Subscription £6 (UK), £10 (overseas). Contact: D. Blagden, PO Box 159, Kingston upon Thames, Surrey, KT2 5UQ. (s.a.e. for further information).

COMP 80 Users Group. Monthly newsletter. Annual subscription £5. Contact: Philip L. Probetts, 50, Cromwell Road, Wimbledon, London, SW19 8LZ.

SOUTH

Independent PET Users Group — South. Free membership — meetings the first Wednesday of every month. £1.50 to receive monthly newsletter. Contact: John C. Nuttall, 56 West Street, Shoreham-by-Sea, Sussex BN4 5WG.

NORTHWEST

Amateur Computer Club — North west group. Meetings 1st and 3rd Thursdays monthly at St. Peter's Chaplaincy, Precinct Centre, Oxford Rd., Manchester. Contact: Jane Lomas, 9 Crescent Court, Alderfield Rd., Chorlton, Manchester, M21 1JX. Tel: 061 881 1933.

TRS 80 — North West Group. Subscription £5. Newsletter £3 (for 6 issues). Meetings last Wednesday monthly (not Dec) at the Stag Hotel, Carswood, Nr. Wigan. Contact: Melvyn D. Franklin, 40 Cowlees, Westhoughton, Bolton, BL5 3EG. Tel: 0942 812843.

Northwest Computer Club. Fortnightly meetings. 25p attendance fee. No subscriptions. Contact: John Lightfoot, 135, Ashton Drive, Frodsham, Warrington, Cheshire, WA6 7PU. Tel: 0928-31519.

IRELAND

Computer Education Society of Ireland. A voluntary organisation that consists of a national body and an expanding number of local branches. Their brief is to monitor computer education in Ireland. *National CESI* (£3 p.a.) — Dairmuir McCarthy, 7 St. Kevin's Park, Kilmacud, Blackrock, Co. Dublin. *Cork branch* (£1 extra) — Michael Moynihan, Colaiste an Spioraid Naomh, Bishopstown, Cork. *Dublin branch* (£1.50 extra) — Jim Walsh, C.B.S. Naas, Co. Kildare. *Limerick branch* (£1 extra) — Sr. Lourda Keane, Convent F.C.J., Laurel Hill, Limerick. *Waterford branch* (£1 extra) — Mr. Hugh Dobbs, Newtown School, Waterford. *Kilkenny branch* (£1 extra) Sr. Helen Lenehan, Presentation Secondary School, Kilkenny.

WALES

Gwent Amateur Computer Club. Covering the Gwent and Cardiff areas, the club has its own computer room and technical library. Meetings are held once a week on Wednesdays at 10 Park Place, Newport. Contact Ian Hazell on 0633 277711 (office hours).

SCOTLAND

The Grampian Amateur Computer Society. They meet every 2nd Monday of the month at the Holiday Inn, Bucksburn, Aberdeen and there's a monthly newsletter. For more details, contact M. Basil, Orton Cottage, Burnside, Lumphanan, Kincardineshire, Grampian Region (033 983 284).

The Scottish Amateur Computer Society. Meetings are on the 1st Wednesday of each month in the Lothian Room of the Grosvenor Hotel, Edinburgh — also in Fife on the 4th Wednesday of each month. . . locations variable. Details from Secretary, Alistair MacPherson, 6 Curriehill Castle Drive, Balerno, Edinburgh 14.

AVON

Bristol Computing Club, £3.00 p.a. Meetings 3rd Wednesday, monthly. Contact: Leo Wallis, 6 Kilbirnie Rd., Bridge Farm Estate, Bristol, BS14 0HY. Tel: Bristol 832453.

Brunel Technical College Computing Club. The club divides into two sections. . . the "skilled" and the "not skilled". They share alternate Wednesdays at the College. Contact: S.W. Rabona at 18 Castle Road, Worle, Weston-Super-Mare, Avon, BS22 9JW (0934 513068).

Compukit User Club. Details, contact P. Crabbe Esq., 21 Jones Close, Yatton, Avon (0934 834808).

BERKSHIRE

The Thames Valley Amateur Computer Club. Meetings are on the first Thursday of every month and from November on, that will be at "The Southcote", Southcote Lane, off the Bath Road, Reading, Berks. Starting time, 7.00pm. Contact: Brian Quarm (Camberley 22186) OR Brian

Steer (Slough 20034).

CLEVELAND

Cleveland Micro Computer Users Group. Adult Meetings 3rd Tuesday monthly, under 18s — 2nd Tuesday. Yearly subscription £2 (£18), £3 (£18-21), £5 (£21+). Journal. Contact: J. Telford, 13, Weston Crescent, Norton, Cleveland.

DEVONSHIRE

Exeter and District Amateur Computer Club. General meetings 2nd Tuesday monthly, specialist meetings 3rd or 4th Tuesday. £5.00 p.a. Contact: Doug Bates, 3 Station Road, Pinhoe, Exeter, Devon.

Plymouth and District Amateur Computing Club. Subscription £5.00 p.a. Meetings last Wednesday monthly. Contact: Keith Gould, c/o JAD Ltd., 21 Market Ave., Plymouth 62616 or 2 Brook Rd., Ivybridge 2399.

COUNTY DURHAM

Computer Club. Business & Word Processor section meets Fridays 7.30, Scientific & Recreational Saturdays 10.00. Contact: L. Boxell, 8 Vane Terrace, Darlington. Tel: 0325 67766.

Northeast PETS. Contact: Jim Cocallis, 20 Worcester Road, Newton Hall Estate, Durham. They meet the 2nd Monday of each month for software tuition and the 3rd Monday for hardware tuition (both in addition to normal activities). They start at 7.00pm and meet in the PET Lab, Newcastle Polytechnic, Ellison Building, Newcastle upon Tyne.

EAST ANGLIA

Anglia Computer User Group. Contact Jan Rejzl, 128 Templemere, Sprowston Road, Norwich NR3 4EQ.

EAST MIDLANDS

East Midlands TRS-80 Independent User Group. Free newsletter from Mike Costello, 17 Langbank Avenue, Rise Park, Nottingham NG5 5BU.

ESSEX

TRS80 User Club (Chelmsford). Now part of the National TRS80 User Club. Contact: Michael Dean, 22 Roughtons, Galleywood, Chelmsford, Essex.

The Colchester Microprocessor Group. Meetings held at the University of Essex on the second and fourth Wednesdays of each month — 7.30 pm start. Membership is open to all, on payments of £5 annual sub (£1 for full-time students). Contact: the Information Centre at the University on the evening of the meeting.

Compukit User Club. Details, contact Adrian Waters, 117 Haynes Road, Hornchurch, Essex RM11 2HX (Hornchurch 40490).

Springfield Computer Club. Special interest in Sorcerer but beginners and others welcome. Meetings 1st Friday monthly. Contact: Stephen Cousins, 1, Aldeburgh Way, Springfield, Chelmsford, Essex CM1 5PB. Tel: 0245 50155.

GLOUCESTERSHIRE

Cheltenham Amateur Computer Club. Meetings, 4th Wednesday

USER GROUPS INDEX

**DIRECT
ACCESS**

monthly, 7.30pm start.
Contact: Mr. M. Pullin, 45 Merestones Drive, The Park, Cheltenham, GL50 2SU (Cheltenham 25617).

HAMPSHIRE

Southampton Amateur Computer Club. Meetings 1st Wednesday monthly (not July, Aug. or Sept.). Contact: Paul Dorey, Department of Physiology, University of Southampton, Southampton, SO2 3SU or Tel: Paul Maddison on Winchester 4433 Ext. 6955.

HERTFORDSHIRE

Harpden Microprocessor Group. They hold meetings every fortnight, cover a wide range of interests and attract members from the area around Luton, St. Albans and Welwyn. Contact: David James, 5 Ox Lane, Harpenden, Herts AL5 4HH (05827 5366).

KENT

Medway Amateur Computer and Robotics Organisation. Contact: Tony Aylward, 194 Balmoral Rd., Gillingham, Kent. Tel: Medway 56830.

North Kent Amateur Computer Club. Meetings, the second Tuesday of each month — usually at the Charles Darwin School, Jail Lane, Biggin Hill, Kent. The sub is £2.50 per annum (£1 for students). More members are needed. . . contact: Barry Biddles at 3 Acer Road, Biggin Hill, Kent (09594 71742).

LANCASHIRE

Merseyside Microcomputer Group. Several sub-groups including: 380Z User's Group (Alan Pope on 051-548 500 Ext 189); Computer Education Society (Mr M. Trotter on 051-652 1596); SC/MP Special Interest Group (Bob Perigo on 051-677 6716); PET Special Interest Group; 6800 and 77/68 Special Interest Group; Apple Special Interest Group. The Secretary is John Stout of the Dept. of Architecture, Liverpool Polytechnic, 53 Victoria Street, Liverpool L1 6EY (051-236 0598).

North Lancs User Group. Contact John Robinson, 12 Harold Ave., Blackpool, Lancashire.

LEICESTERSHIRE

The Leicestershire Personal Computer Club. Meetings held the 2nd Monday in each month, at Leicester University and Loughborough University alternately. They start 7pm. Membership is £2 per annum (£1 for under 16s). Contact: Miss Jill Olorenshaw (Club Secretary)

c/o Arden Data Processing, Municipal Buildings, Charles Street, Leicester (0533 22255) OR Mr Dick Foden (Club Chairman) at 11 Gaddesby Lane, Rearsby, Leicester.

LINCOLNSHIRE

Lincolnshire Microprocessor Society. Various meeting places. For up-to-date information, contact the Hon. Sec., Mr Eric Booth, Senior Common Room, Bishop Grosseteste College, Newport Lincoln.

LONDON

Southgate Computer Club. Meetings 1st Wednesday and 3rd Thursday monthly during term time. Newsletter. Contact: Paul Woolley, Southgate Technical College, High Street, London N14 6BS. Tel: 01-888 6521.

East London Amateur Computer Club. Meetings 3rd Tuesday monthly. £2.50 p.a. (¼ price to school students). Contact: Dr. Graham Crisp, 45 Leadale Ave., Chingford, London E4 8AX. Tel: 01-520 6010.

The North London Hobby Computer Club General meetings held on a Wednesday evening, once a month — specialised topics on three evenings each week. Location: The Polytechnic of North London. Contact: Robin Bradbeer (Chairman) at the Dept. of Electronic and Communications Engineering, Polytechnic of N. London, Holloway, N7 8DB (01-607 2789).

SELMIC (South East London Microcomputer Club). £5 subscription. Meetings at Woolwich Polytechnic. Contact: John Williamson, 129 Greenvale Rd., Eltham Park, London SE9 1PG. Tel: 01-850 4195.

Croydon micro/small computer group. Contact Vernon Gifford, 111 Selhurst Road, London SE25 6LH.

LONDON & SOUTH EAST

Sharp MZ-80K User Group. Contact: Joe L.P. Seet, 16, Elmhurst Drive, Hornchurch, Essex, RM11 1PE. Tel: 04024 42905.

MIDDLESEX

Sunbury Amateur Computer Club. Membership free. Contact Mr S N Taylor, 8 Priory Close, Sunbury on Thames, Middlesex. TW16 5AB. Tel: Sunbury 86649.

Harrow Computing Group. Meetings on alternate Wednesdays at 7pm in room G43 of Harrow College of Higher Education. They welcome anyone with an interest in computers — with or without a machine. Membership is free. For further information contact Bazyle Butcher, 16 St. Peter's Close, Bushey Heath, Herts WD2 3LG (01-950 7068).

IPUG setting up in Teddington. Interested? Contact: G. Squibb, 108, Teddington Park Road, Teddington, Middlesex.

OXFORDSHIRE

Oxfordshire Microcomputer Club. £5.00 p.a. Contact: S. C. Bird, 139 The Moors, Kidlington, Oxford OX5 2AF Tel: Kidlington (08675) 6703.

Microsoc the Oxford University micro group holds shared meetings with the Oxford Microcomputer Club. Contact: M. Bourla, St. John's College, Oxford.

SURREY

Richmond Computer Club. Held the second Monday of each month at the Richmond Community Centre (20p per meeting), members have the use of a good range of equipment. Contact: Robert Forster, 18a The Barons, St. Margarets, Twickenham, Middx (01-892 1873).

Surrey Microprocessor Society. (SUMPS) Covering Surrey plus bits of South London and other adjacent counties. Anyone interested in joining, call Mike on 01-642 8362.

SUSSEX

A Crawley computer club has recently been formed, open to anyone interested in personal computing, with or without computing facilities. The intention is to hold meetings weekly, and publish a monthly or bi-monthly newsletter. Details, contact either Mr J. Fieldhouse, 18 Seaford Road, Broadfield, Crawley, West Sussex (Crawley 542509) — or — Mr J. M. Clarke, 31 Hyde Heath Court, Pound Hill, Crawley, West Sussex (Crawley 884207)

WARWICKSHIRE

ACC (Midland) Group. They meet every 3rd Saturday in room P109 at Lanchester College, Coventry . . . no sub, no magazine. Contact: Roy Diamond (Chairman), 27 Loweswater Road, Coventry, Warks (0203 454061).

WEST MIDLANDS

Research Machines 380Z. West Midlands User Group. Further details from: Peter Smith, Birmingham Educational Computing Centre, Camp Hill Teachers Centre, Stratford Road, Birmingham, B11 1AR. Tel: 021 772 6534.

West Midlands Amateur Computer Club. Meets the 2nd & 4th Tuesday of each month, usually at Elmfield School, Love Lane, Stourbridge, West Midlands. Annual sub is £3 (£2 if full time student). . . visitors welcomed without obligation. For more information contact John Tracey of 100 Booth Close, Kingswinford, West Mids (0384 70097).

Compukit User Club. Details, contact S.H. Grisvenor Esq., 11 Bernard Road, Oldbury, Warley, West Midlands (021-422 3298).

YORKSHIRE

ShIPLEY College Computer Group (Sorcerer/6800). They meet Tuesdays (software) and Wednesdays (hardware/advanced) between 7.00 & 9.00 pm. Contact Paul Channell on ShIPLEY 595731.

West Yorkshire Microcomputer Group. Formed following an inaugural meeting on October 23rd, a varied diary of events has been drawn up. For details contact the Chairman, Phillip Clark, Care Computer Services, 15 Wellington Street, Leeds LS1 4DL (0532 450667) OR the Secretary, Keith Knaggs, Price Waterhouse & Co., Leeds (0532 448741).

South Yorkshire Personal Computing Group. Meetings are on the second Wednesday of each month in Room F135, St. Georges Building, Sheffield University. Experts and beginners welcomed alike, contact Paul Sanderson (Secretary), 8 Vernon Road, Totley, Sheffield S17 3QE (0742) 351895.

DIARY DATA

**DIRECT
ACCESS**

London, England	1980 Microcomputer Show. Online Conferences Ltd., Cleveland Road, Uxbridge, UB8 2DD. Tel: 0895 39262	July 22 — July 24
Birmingham, England	Computer Graphics '81 Exhibition. Online Conferences Ltd., Cleveland Road, Uxbridge, UB8 2DD. Tel: 0895 39262	Aug 11 — Aug 13
Philadelphia, USA	Personal Computing 80. (America's largest East Coast micro show). PCAF '80 c/o Philadelphia area Computer Society, Box 1954, Philadelphia, Pa 19105	Aug 21 — Aug 24
Salford, Lancashire	1980 Salford Microprocessor and Microcomputer Exhibition. Dr E A Flinn (Exhibition Director), Dept. of Electrical Engineering, University of Salford, Salford M5 4ET. Tel: 016-736 5843	Sept 2 — Sept 4
London, England	The 3rd Personal Computer World Show. Montbuild Exhibitions Ltd., 11 Manchester Square., London W1M 5AB. Tel: 01-486 1951	Sept 4th — Sept 6th
Stuttgart, Germany F.R.G.	Hobby Electronics Exhibition CES (Overseas) Ltd., Bridge House, 181 Queen Victoria Street, London EC4. Tel: 01-236 0911.	Sept 10 — Sept 14
Paris, France	SICOB. French Trade Exhibitions, 54, Conduit St., London W1R 9SD. Tel: 01-439 3964.	Sept 17 — Sept 26
Plymouth, England	Business Equipment Exhibition BEX. Douglas Temple Studios Ltd., 104b, Old Christchurch Rd., Bournemouth, BH1 1LR	Oct 1 — Oct 2

Clearly ahead of its time.

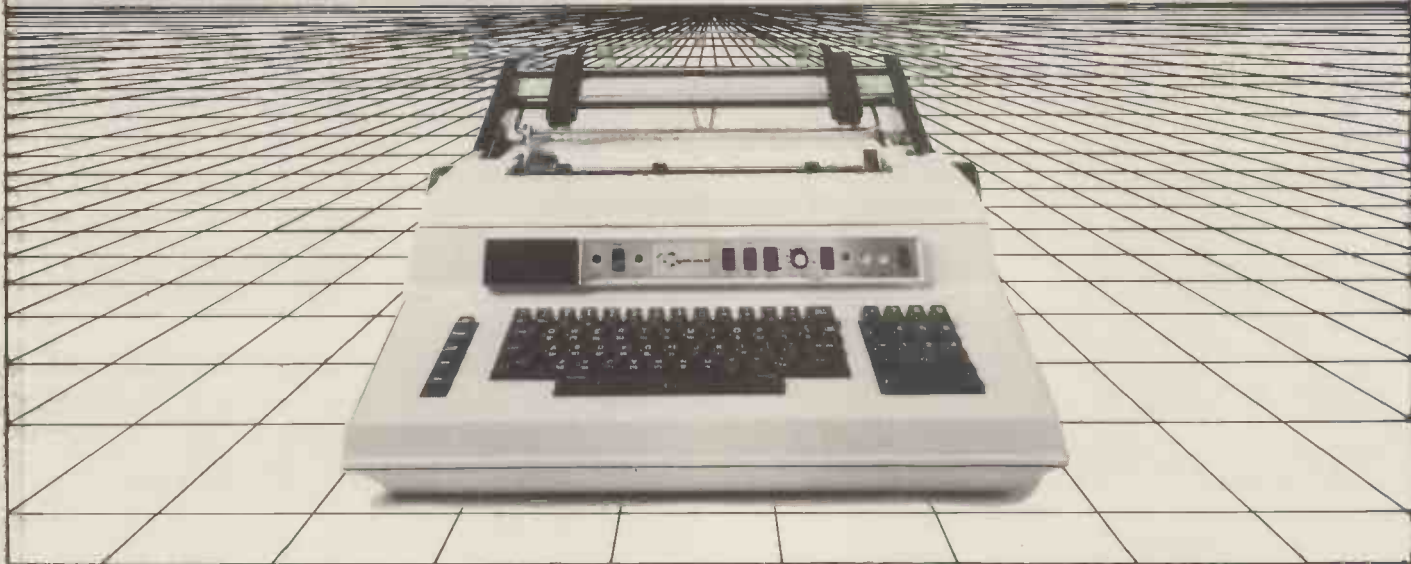

Line Printer



Matrix Printer



Ink Jet Printer



Qume's Sprint 5

When you buy what is regarded as the best daisywheel printer terminal in the world - the Qume Sprint 5 - you expect a backup service to match. ISG Data Sales Ltd., your official UK distributor of Qume terminals, provide just that:-

- On-site installation, commissioning, service and maintenance by our own trained engineers.
- Fast response to service calls
- Maintenance contracts
- Ex-stock delivery of Qume terminals, accessories and supplies
- Purchasing or leasing options
- THE MOST COMPETITIVE PRICES AROUND. FROM £1805 installed (Excl. V.A.T.)

The Qume Sprint 5 offers:-

- Letter perfect printing at 45 or 55 cps.
- Over 50 different type styles including APL, scientific symbols and international character sets
- Smart microprocessor utilisation for powerful flexibility
- 43 Qume-defined commands for operator control
- Convenient switch selectable functions on front panel
- Built-in diagnostics
- Serial or parallel interface
- MultiColor ribbons

If you want to be ahead of your time, ask for Qume - from ISG Data Sales, your official UK distributor

Qume®
isg data sales ltd

Fairacres Estate, Unit 9,
Dedworth Road, Windsor, Berkshire.
Telephone: Windsor (07535) 57955
Telex: 849110.

For sale

PET 2001 . . . 8k, green screen, soundbox, books, 15 tapes, Microchess etc, cost £750 8 months ago, as new, accept £450. Tel Swanley (0322) 601150.

Compukit UK101 . . . fully assembled and working with case, switchable 1/2 MHz, 4K RAM, 8k Microsoft Basic, 2k monitor, extended monitor and games on tape, plus R Zaks Programming the 6502, all for only £270 ono. Tel Mike on 01-534 5331 (Forest Gate, E7).

Creed Envoy . . . data printer, ASR, ASCII, V24, upper/lower case, handbook, £250. Tanberg TDC 3000 digital cartridge recorder, documentation, £100. Nascom keyboard £25, Tel Doug Mounter, Walton (0953) 882110.

Nanocomputer . . . Z80 trainer with breadboard and 3-vol manual, diagrams, etc. Cost over £430, as good as new. Texas TI59 prog. calc. with mag. card storage, full documentation, two packs mag cards, spare battery charger/mains adapter, good as new, £165 ono. Both must go asap! Tel 031-664 3877 evenings & weekends.

Teletype . . . ASR33, excellent cond, RS232/V24, stand, isolation transformer, lectern, 110 baud, switch selectable simplex/duplex, single step on tape reader, interface to Nascom II without mods. Haggle around £250. Tel Brian Steadman, 021 360 6731.

TRS-80 . . . Level II 16k, with numeric pad, expansion interface, disk drive with DOS, editor/assembler package, PSU, all manuals and program aids, cost over £1100 at today's prices, accept £800 ono. Tel James Blake, Aldeburgh 2393 (evenings) or write Roundhill Cottage, Saxmundham Road, Aldeburgh, Suffolk.

TRS-80 . . . printer interface, commercial unit, operates from cassette port, £12. Also Radio Shack editor/assembler (manual & cassettes), £10. Tel I R Sinclair, Hedingham (Essex) 61004.

ASR 33 . . . Kode teleprinter, current loop interface, inc. service handbooks, spare paper rolls. £320. Farnborough, Hants, (0252) 42921 (evenings).

Westrex . . . KSR33 Teletype with stand, ASCII, RS232, works with Nascom, £250 ono, Tel Ipswich 714716 (evenings/weekends).

PET 2001 . . . 8k, 7 months old, little used, green screen, soundbox, TIS workbooks, lots of programs, £440. Tel 01-597 4364.

UK101 . . . 8k cased, runs at 1/2 MHz, RS232 in and out, (very fast Basic at 2 MHz), £330 inc games & utilities. Tel Erith 35868.

Nascom II . . . fully built and working, as new, 32k memory expansion, graphics, assembler language tape, full documentation and tape drive relay, £420. Tel Luton 503321 after 6 pm.

For sale or swap . . . for 8k PET, Sinclair ZX80 & adaptor, carrying case etc, £90. Centronics LS01 dot matrix printer, hardly used (ex ODO 11/40), tractor fed, parallel interface, stand, £475. Tel Uxbridge 56574 evenings. not weekends.

Acorn . . . 6502 microcomputer, built and working, inc. all documentation, £75 ono. Tel Ilkley 600437 (evenings).

Unfinished . . . project, PET 2001 8k with IBM golfball typewriter for conversion to printer. House purchase forces sale, £650. Tel Karl 01-831 6781 ext 242.

For sale . . . Programming the 6502 and 6502 Applications Book by Zaks, cost £7.50 each, yours for £11 for both. Plus Electronic Computers by Westwater, free! Tel Dumbarton (0389) 64384.

Micro books as new, half price inc postage. Small Computer Systems Handbook, Sol Libes, £3.30. An Introduction to Microcomputers - Vol 1, A Osborne, £3.60, Computer Dictionary and

Handbook, Sippl & Sippl (hard cover 750 pages), £7.75. Programming the 6502, R Zaks, £4.10. A McMillan, 18 Torridge Road, Keynsham, Bristol BS18 1QQ.

Acorn . . . microcomputer system 1, built & tested with PSU and manual, £85 inc p&p. Tel 0526 43089.

PET 2001 . . . 8k plus manuals plus instructional and games cassettes, £350 ono. Tel 01-761 0743 (home) or 01-580 4468 ext 3271.

PET . . . CBM floppy disk drive, £675, brand new. Texas TI59 calculator, £145. Tel 0386 870841

PET 2001-8 . . . only 3 months old, green screen, fitted soundbox with good games software, £500 ono. Tel Sunbury-on-Thames 84239.

8k memory boards . . . SWTP type MP-8, built and tested, \$50 bus, \$98 each. Tel Cambridge (0223) 314934.

Nova 820 . . . 16 bit minicomputer with 32k word memory, homebrew teletype interface with manual and schematic, £300. ASR33 Teletype with pedestal in good cond., £250. Tel Pete 01-570 8057, evenings.

Computhink . . . 800k dual disk unit complete with DOS logic board for PET. Inc full operating and fitting instructions, technical help if required, only 6 months old, perfect order, bargain at £800 ono. CMC-ADA 1200 PET to RS232 interface for Teletype 43 and others, £50 ono. Tel Flintwick (0257) 2221.

Sharp MZ -80K . . . 5 months old, perfect cond., 6k RAM after Basic loaded, manual & programs inc personal accounts, Othello, Space Invader, £500. Tel Sheffield (0742) 302124.

PET 8k . . . Old ROM, good cond., £415. PET tool kit, £47. Tel Hoddesdon 44640.

UK101 . . . built and working, with TV output lead, cassette I/O sockets, 4k user RAM, new monitor in EPROM, fully cased, £200 ono. Mr A Harris, 43 George Road, Farncombe, Godalming, Surrey or tel Guildford 893883 ext 38 (day only).

77-68 . . . professionally built CPU board, all ICs socketed, fully tested, plus Newbear PCBs: 4k RAM, VDU1, MON1 and design manual for 77-68 system and notes. Mr C North, 29 Kent Road, Harrogate, N. Yorks. Tel Harrogate 62241.

Exidy Sorcerer . . . 32k, Basic and development packs, UHF modulator if required, £595 ono. Pullen, Reigate 48906.

Philips Videopac . . . computer with 3 cartridges (2,4,11). Must sell, getting PET. Complete, £130 ono, must collect. Tel Port Talbot 87472.

Basic . . . for Nascom 1. Nascom's Super Tiny Basic in 3 EPROMs, surplus to requirements (I've got 8k Basic now), complete with documentation £28. Tel Melrose (089 682) 2832 after 6pm.

Nanocomputer . . . plus power supply, unused, £240 ono. Tel John Reid on Aylesbury 86500 (work hours).

SS50 6809/6802 Processor Board . . . (Percom), board can use 6809 or 6802 CPUs. Onboard ACIA, PIA, 1k RAM, Psymon monitor; board can be used standalone if required: 1 Meg and 16 Meg addressing - unused, £100. Tel 0455 35621 (evenings/weekends).

Nascom 1 . . . 8k Microsoft Basic, 16k memory, Vero Case, Keyboard Keyboard Cabinet, PSU and documentation - £325 ono. Tel 0704 28472.

Grandstand Colour TV Game Console . . . eleven cartridges - bowling, mazes, blackjack, spitfire, nim and mindreader, video whizball, doodling, shooting gallery, tic tac toe, robot war, torpedo alley, dodge it, space war, pinball with many variations -

£100. Ring Mike Carlton on Sheffield 78555 (ext 4063) - office hours.

Acorn System 1 . . . assembled and tested, almost unused. Also Rodney Zak's "Programming the 6502" - £50. Tel 0287 24288.

Acorn Micro (Eurocard) . . . extra RAM, PSU and full documentation and circuit diagrams for connection to P.E. VDU. Hardly used - £75 ono. Tel 0783 229121

Nascom 1 . . . with T4, UHF modulator and 'colour graphics' (can be used on B&W TV). Computer, PSU and tape all built into wooden case with auto cassette turn off. Manuals, books, tapes and programs supplied - £160 ono. Tel Liverpool (051) 708 9765.

ASR 33 Teletypes . . . one good condition (£150), the other tatty (£50). Also Sinclair ZX80 ono. Tel Ware 67519 (after 5pm).

77-68 . . . 4k RAM board (low power), £55; rack, £15; backplane with five connectors, £10. Also 6800 mini board (copy of Heathkit ET3400) separate housed hex keyboard/display. Built on Vero 8 x 8 inch card (77-68 compatible) c/w 1k monitor and 512 bytes RAM - ideal dev system. Less CPU and 3 x 74LS241 chips, £65. Tel Medway (0634) 573183.

Grandstand/Fairchild . . . fully programmable TV game, 1 year old, works properly, £50 ono (includes power supply, plug, box, instructions and 1 cartridge). Cost me £80. Also 3 cartridges: spitfire, baseball, breakout - £10 each or £30 the lot. Alternatively, Game plus the cartridges, £80. All in good condition, tel Barry on 01-501 1661 (after 7pm before 6/9/80 - then after 5pm).

Sym-1 micro . . . 4k, old and new monitors, 8k Basic in ROM Tangerine 1648 VDU (UHF output), 5 amp PSU, Alpha-Numeric keyboard (cost £100+) plus full set of manuals and tech notes - £350 ono. Contact Mr N Smith, 116 Holborn Hill, Millon, Cumbria LA18 5BW, or phone Millom (0657) 3591.

VDU Cossor DIDS 401-2A . . . 1k buffer, editing, new CRT fitted, spare keyboard unit, full technical manual. Requires external sync drive. Don't know if it works, hence £45 or why? Tel 01-951 0305 (evenings).

TRS-80 Level II . . . 16k system complete with cassette, keyboard, latest video display. As new, still under guarantee, software, £495 ono. Tel 01-644 9454 (Sutton).

Sinclair ZX80 computer . . . fully assembled, including all leads and power supply. Brand new, £85. Contact Mr F Van Dyken, 1 Wyndham Road, Woking, Surrey - Tel 04862 22581.

PC100C . . . printing unit for TI58/59, 9 months old - £120 ono. Tel 021-353 4209.

S100 16K dynamic RAM boards, factory assembled by Altair, on-board refresh and timing, unused. Full doc, only £90 each. 8080 CPU board (full kit) by Byte magazine - £55. Tel 0632-468041 (evenings).

1 x Prototyping board, 1 x Mother-board PCB, 18 slot, 1 x S100 8k RAM PCB, some sockets - only £35. Also 1 x 2112 and 1 x 8212, first £3 takes them. Write to Karl, Rose Cottage, Lower Frankton, Oswestry, Salop SY11 4PB.

MK14 . . . fully working, cased with PSU, tape interface, extra RAM and RAM I/O, keyboard, all doc plus Kemitron programming guide and Micom assembler - £55 inc postage. Also spare SC/MP chip (INS 8060N) MkII version - £5.50 inc postage. Tel 0969 23462 (after 6pm).

Wanted

PAL 11-S, LINK 11-S and ED-11 . . . paper tape software wanted for standalone DEC PDP 11-05. I have the computer and the manuals, but no tapes! Contact N. Charnley, 9 Aston Street, Oxford or Tel 0865 725475 (evenings).

Mains Transformer Design Program . . . wanted for 32k PET. Please phone Mr Tidman on 01-948 3702.

Help . . . could any reader who can supply technical information concerning a Sperry Univac twin digital cassette unit manufactured approx. 6 years ago. Kindly contact John on 0440 3660.

Nascom 1 memory board . . . 8, 16 or 32k, must be less chips; also will consider 8k Basic in ROM. Phone Chris Rose on Tiverton (08842) 57657 - day - or Tiverton 57886 - night. Or write to 3 Belmont Road, Tiverton.

TI59 . . . with PC1000B/C print cradle. Must be in good working order with documentation. Around £200. Contact P. Fairlamb, 89 Moubury Grove, South Queensferry, West Lothian, EH30 9PD. Tel 031-331 3501.

Please help . . . prove to me that I'm not the only nut with a Nascom in the Scottish Borders. Get in touch with Bill on Melrose (089-682) 2832.

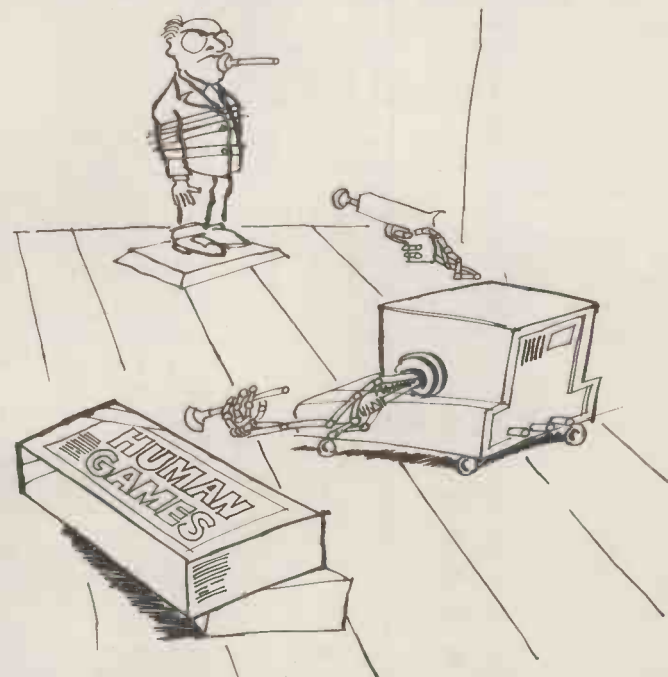

PRINTERS

by Mike Dennis

There are over a hundred printer manufacturers in the world today and the wide range of facilities they offer frequently causes of a great deal of confusion. This month's exhaustive review sets out to explain how the various types of printer work and what options they offer; an easy-to-understand reference chart has been included to help you choose the printer most suited to your requirements. Every manufacturer and distributor whose name we could muster was asked to send as much literature (including operator and service manuals) as possible. Happily the response has been enormous.

For many of us, our first introduction to printers (or 'hard-copy' devices) was with the old teletype (TTY) . . . it was both excruciatingly slow and very noisy. Still, in its time the TTY was synonymous with hard-copy and it wasn't until the advent of the dot-matrix mechanism that any real change took place in the status quo. From that day on there has been a seemingly endless stream of improvements but, although the cost has dropped quite dramatically in a number of areas, the printer still comprises a major part of a system's total cost.

However, to the business user they are essential and, as program listings disappear off the top of the screen at an ever increasing rate, other computer users soon place a printer high on their list of priorities. The problem is — which one?

Basic concepts

Printers consist of three main components — the printing mechanism, a way to move the paper about and the controlling electronics. In addition there are other minor components such as a power supply, case and, where applicable, a ribbon. However, the heart of any printer is the printing mechanism itself and this is worth a comprehensive examination in its own right.

The first thing you notice is that some mechanisms are common to many printers. Some individual printer manufacturers buy-in the mechanism from an OEM supplier and then add the rest of the components to their own particular specification. This is one of the main reasons behind the proliferation of printers and, although the

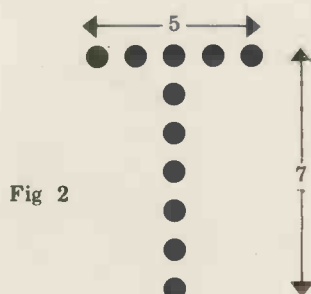

Fig 2

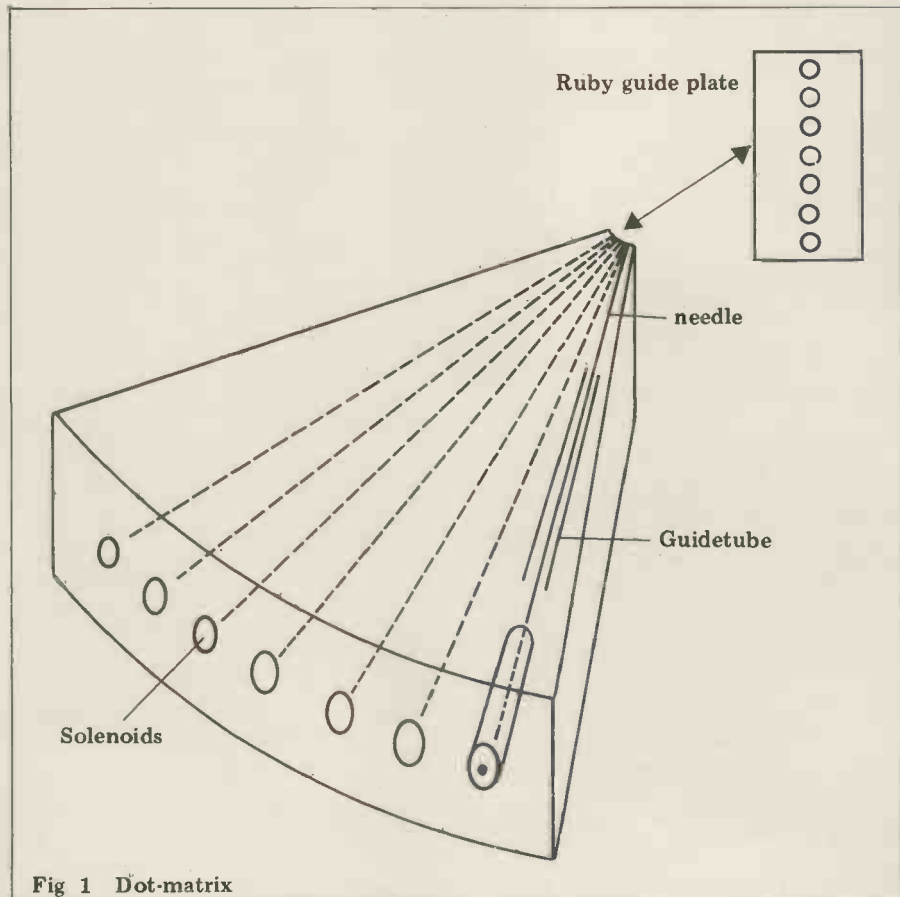

Fig 1 Dot-matrix

various suppliers were asked to disclose any areas of common interest, many were rather coy about it. Unfortunately that made true cost comparisons and value-for-money assessments all the more difficult.

The mechanisms themselves can be defined by three basic characteristics.

1 How the character is placed on the paper. *Impact* types such as the TTY use a hammer or similar object to strike the paper with the appropriate character. *Non-impact* types such as thermal printers as the name suggests do not strike the paper but use alternative methods.

2 How the character is formed. Fully-formed characters such as those in normal typewriters will print the whole character simultaneously. The alternative is to assemble the character by printing dots into a pre-defined

pattern — the dot-matrix. This implies several printing actions to print one character whereas fully-formed characters require only one.

3 The number of characters printed or assembled at a time. If it's only one character, then the printer is a *character* printer. The alternative method is to print a whole line of characters in one go — the *line* printer.

All the various types of printers are summarised in Table 1 according to their characteristics; these I shall now examine in greater detail.

Impact printers

The earliest form of impact printer was the ubiquitous teletype or teleprinter and models such as the Creed 7B can still be picked up for around £25 on the second-hand market. The characters to

Table 1	
IMPACT	NON-IMPACT
Dot-matrix	Thermal
Golf-ball	Electrosensitive
Daisy-wheel	Ink-jet
Drum	Laser
Chain	Electrographic
Comb	
TTY	
Spinwheel	
FULLY-FORMED	
CHARACTERS	MATRIX
Golfball	Dot-matrix
Daisy-wheel	Comb
Drum	Thermal
Chain	Electro-sensitive
Spin-wheel	
TTY	
CHARACTER	LINE
Golfball	Drum
Daisywheel	Chain
Spinwheel	Comb
TTY	
Dot-matrix	
Thermal	
Electrosensitive	

be printed are arranged as small printing elements or 'type-slugs' and they lie in grooves around an annular ring. As the code for each character arrives at the TTY, this ring is rotated until the correct element is in the firing position. A hammer then strikes the element which in turn presses a ribbon against the paper and the character is typed.

Each element has to be capable of printing two characters since there's insufficient room to fit all the elements around the ring. Shifting between the two character sets is accomplished by moving the whole carriage assembly on which the paper is mounted. Upon receipt of the 'figures' code, the carriage latches mechanically and thereafter all printing codes access the figures character set. The mechanical latch is reset to its other position only when the 'letters' code arrives, and from then on the 'letters' character set is printed.

Not a lot happened in the printer world until the arrival of Centronics and the dot-matrix mechanism. Early examples of this type of mechanism shared one common feature, namely a vertical row of pins or needles that were attached to solenoids or electromagnets. When energised, they 'fired' the needle at the ribbon and thus made a mark on the paper — see Fig 1. The

actual number of needles fired at any one time would depend on the character to be printed; the print-head mechanism or needle assembly would then move one column along, fire the next selection of needles and so continue to build up the desired character until complete. For example, the letter B would require all seven needles to fire for column 1 whereas the letter T would only need the top needle. Thus any character could be made up or assembled by firing the pins in a pre-defined dot-matrix. As can be seen from Figure 2, the early matrix dimensions had five columns and fired up to seven needles.

Since the needles needed to hit the paper both quickly and hard in order to maintain print quality and speed, the solenoids had to be large and powerful. This, in turn, meant that the needles had to be bent to make room for them which, in turn, meant more friction and heavier hammers. As the needles slid up and down their guides a couple of rather unpleasant things happened. One, the tube bores wore out and two, the friction generated heat, reducing maximum operating speed and useful life. Another disadvantage with the somewhat limited matrix of 5 x 7 was the comparative coarseness of the printed characters — diagonals in particular suffered badly.

The first problem has been cured in a number of ingenious ways. The early arrangement was for mounting the solenoids in the horizontal plane but since this has meant angling some of the needles quite severely many manufacturers now mount them radially. Thus the needles don't have to be bent as much which in turn means lower friction and wear, and less heat generation — resulting in an improved printing rate and head life. Another bonus is that the needles can be made harder which again enhances the print quality and head life. As you can see many compromises have to be made when designing dot-matrix heads and it's hardly surprising that firms like DRE use computer assistance to optimise head design.

Another improvement is to separate the needle from the driving solenoid; this is the basis of the 'ballistic' or 'free-flight' head. The principle is to hold the needle back against a spring and to release the stored energy at 'fire' time. After the needle has printed the dot, it rebounds and this rebound energy is used in conjunction with a smaller

solenoid to compress the spring again, ready for the next release — see Figure 3.

This idea of storing energy appears in Facit's Stored Force Flex Hammers. Here the solenoids are arranged in a semi-circle and the needles are replaced by very hard 'pips' mounted directly onto the armatures; these pivot when the power is applied. This drives the 'pips' towards the paper and, providing the hammer travel is kept low (so Facit claims), head life is lengthened considerably — see Figure 4.

The problem of legibility has been partly overcome by the use of finer matrices — such as 7 x 7 or 9 x 7. Table 2 lists the currently available formats and Fig 5 shows a 9 x 7 half space float. In fact, some of the dot-matrix formats are so fine that Japanese (or Katakana) characters can be printed — which is really going some. Of course, since each needle can be fired individually, it didn't take the printer manufacturers long to realise that virtually any character could be printed provided the original matrix dimensions were fine enough (hence 7 x 9) and the necessary control was available (at this point, enter the microprocessor). This explains the Nx9 or Nx12 that some manufacturers supply, the N meaning that the number of columns needed to make up a character is a variable and under program control. If a large

Common formats		other formats	
H	V	H	V
5	7	6	7
7	7	8	7
9	7	8	8
9	9	10	9
N	9	11	9
N	12	15	14

number of columns is used then the fidelity of the printed character is improved and approaches that obtainable from a typewriter. An increase in characters can be printed, although many printers have no lower-case descenders. This gives rise to that horrible looking format where the tails of p, q, y etc. sit up on the line ... thus PQY. Some of the 7x7 formats boast true descenders but very often the descender is in fact quite minimal. You really have to buy a printer with a 9 needle head if you're after superb descenders; then you're also likely to get underline capability as well.

Fig 3

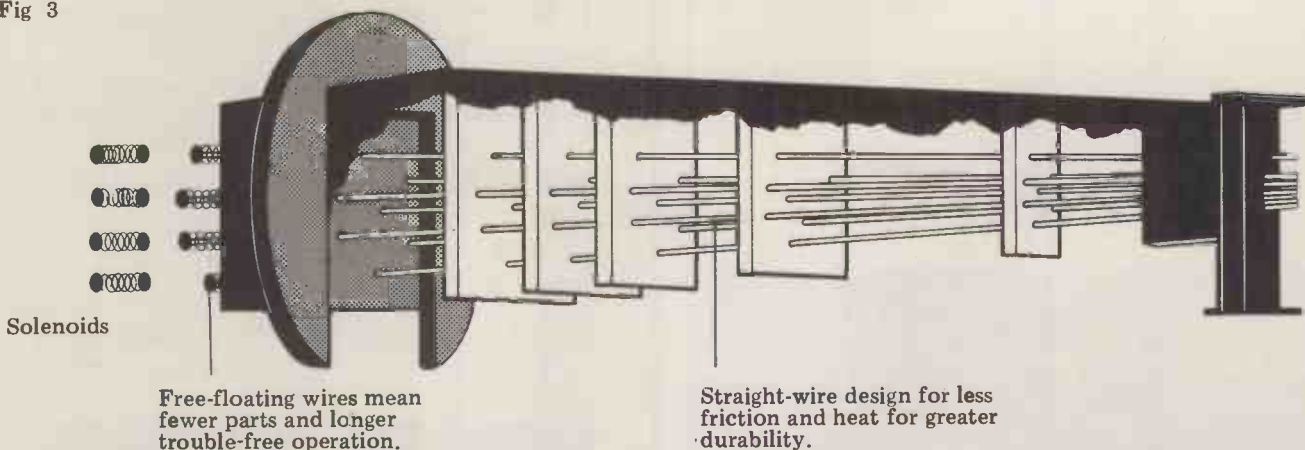



L&J COMPUTERS

3 CRUNDALE AVENUE, KINGSBURY NW9 9PJ 01-204 7525

THE "PET" SPECIALISTS



NEW LOW, LOW 'PET' PRICES!!

Pet 8K (large keys)	£420
Pet 16K	£499
Pet 32K	£630
Ext. cassette decks (+ counter)	£55
PET Friction Feed printers	£400

**TRY US!
YOU WILL NOT BE
DISAPPOINTED**

AVAILABLE FROM STOCK

Printers	Disc Drives	Sundries
PET 3023	PET 3040	Tool kits: library cases
PET 3022	Compu 400K	Disks: C12 cassettes
Centronic 779	Compu 800K	Paper (roll & tractor feed)
Spinwriter	Interfaces	Labels: Dust covers

WE ARE NOW TAKING ORDERS FOR THE NEW 8000 SERIES CBM'S FOR AUGUST DELIVERY.

8032 (80 col. screen: new keyboard)	£895
8050 (974 K/Bytes: new DOS)	(£895)

(Sae for details: Demonstrations NOW)



**COMPLETE SYSTEMS
FROM £1700!!**

**THE ESTIMATES WE SUPPLY & INSTALL ARE COMPLETE
ESTIMATES GIVEN FREE WITH NO HIDDEN EXTRAS:
FULL BACK-UP: GUARANTEED EXPERTISE.**

PRICES DO NOT INCLUDE VAT

SOFTWARE

As well as a full range of Petsoft and Commodore Software, we have some highly reliable "Home-Brewed" programs available.

STOCK CONTROL & INVOICING £60
(Handles up to 500 items - 32k) (80 on 16K). Stock depleted on invoicing, search etc. Cassette, disk (& colour print option).

STOCK TAKING £230
Basic program which can be tailored to suit most trades. Beautiful print-out!

OUTSIDE SERVICES (For Mini-Cabs etc.) £220
Weekly or monthly invoices - cheque writing facility - optional deductions. (16 or 32K + disk + printer).

MACHINE HIRE £420
Covers hiring of machines, customers, due & overdue. Hiring Charges: Machine History: Printouts for all Sections. Ideal for Typewriter & Pland Hire Firms.

CASH BOOK £90
Enter daily/weekly amounts printout and totals, weekly monthly analysis, totals and balances.

Sae for free software booklet

Specialists in:

Commodore Business Programs
Bristol Trader, Item & Monitor
Superpay Word Processing

**SPECIALISED SOFTWARE APPLICATIONS
UNDERTAKEN. RING FOR DETAILS**

PERSONAL SHOPPERS WELCOME
Phone & Mail Orders accepted.

**ALL GOODS SENT SAME DAY WHEREVER POSSIBLE
LARGE S.A.E. FOR LISTS ETC.**



NASCOM 1

NASCOM 2

Floppy Disk Controller

Add the power of floppy disks to your Nascom 1 or 2 computer system. Complete kit comprising of Controller Card, top and monitor in Eprom, jump-on reset logic and full conversion instructions supplied.

This kit will allow Nascom users to run standard CP/M software on 5 1/4" or 8" floppy disks.

For Full details write today to
AIRAMCO LIMITED.

airamco
AIRAMCO LIMITED

Unit A2
9 Longford Avenue
Kilwinning Industrial Estate
Kilwinning Telex 779808
Ayrshire KA13 6EX
Telephone 0294 57755

QUALITY COMPUKIT UK101 SOFTWARE

STARTREK - 8K MORE EXCITING THAN THE
MOVIE - ESPECIALLY WRITTEN FOR UK101
GREAT GRAPHICS - £6.75

BREAKOUT - 4K NOW THIS POPULAR CULT
PUB GAME IN YOUR OWN HOME - £3.25

RAMTEST - TEST YOUR "RAM" WITH THIS
EASY TO USE PROGRAM - £2.75

AUTOLINE RENUMBER - RENUMBER YOUR
PROGRAMS AUTOMATICALLY INCLUDING
"THEN", "GOTO" + "GOSUBS". EASY TO USE AND
GREAT VALUE - £6.95

**SHORTLY TO BE RELEASED SOUND BOX AND
JOYSTICKS FOR YOUR 101.**

**ALL OUR PROGRAMS ARE ON GOOD QUALITY
TAPE AND PRICES ARE FULLY INCLUSIVE - NO
HIDDEN EXTRAS WITH US!**

**FOR DETAILS OF THESE AND OTHER GAMES
SEND LARGE SAE TO:-**

**J. M. ELECTRONICS
P.O. BOX 71
NORWICH NR6 7JE**

**P.S. MIGHTY MICRO HAVE DISK-DRIVE UNITS
FOR UK101! GIVE THEM A RING ON (0923)
38923.**

SOUND BOX NOW £14.95

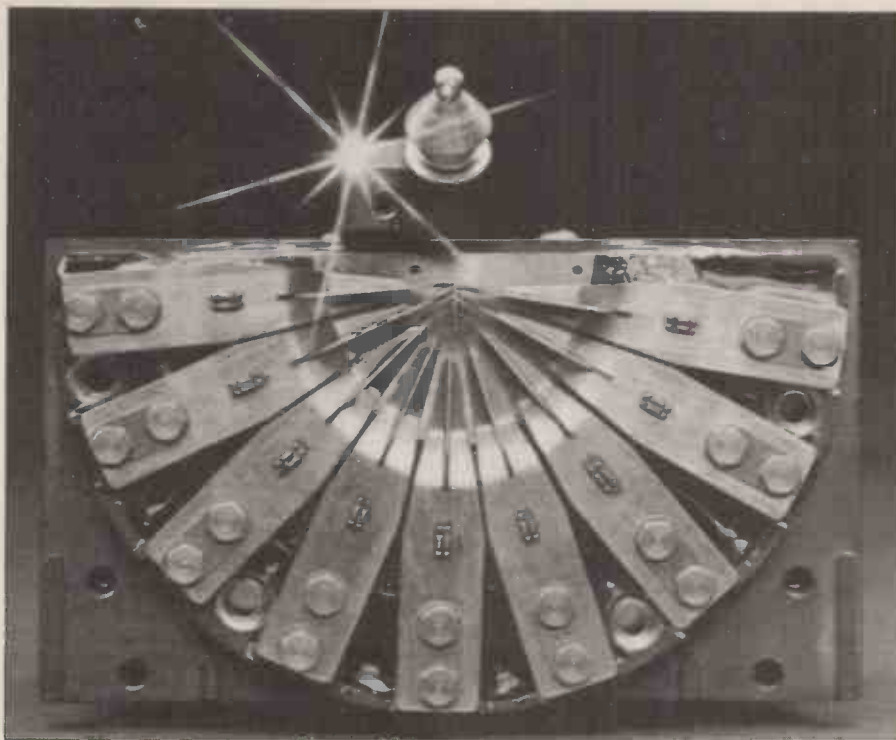

Fig. 4

There are many other advantages to be gained from microprocessor control and some of these will be discussed later. However, one significant trend emerging and, currently being marketed or developed by a number of manufacturers (such as Binder — Racal Recorders — and Centronics) is the dual-purpose printer. These work on a fine dot-matrix format that's capable of typewriter quality printing. This is of particular importance in word-processing applications. There's a penalty of course . . . in this case a slowing down of the printing rate because more dots have to be printed per character. When speed is of prime importance (such as when printing listings) then the matrix format can be 'coarsened-up' for much faster output.

The nett result is to have two printers in one and the ability to switch between the two types of performance with a software switch. The Binder 41 32KP can either print a standard dot-matrix at 240 cps (characters per sec) or a 'correspondence' font at 85 cps. Currently the average price of this type of printer is still high but I wouldn't mind betting it'll drop quite a lot before too long.

I've dwelt on dot-matrix printers at some length — because it's in this area that some of the most exciting developments are being made. However there are other types of impact printer.

Daisy-wheel print elements are very similar to typewriter slugs in that they're fully-formed although in this case, mounted on the ends of radiating metal spokes — see Fig 6. You can see, perhaps, a slight similarity with the TTY. Upon receipt of the appropriate character code, a ROM inside the printer will effect rotation of the wheel so as to correctly line up the wanted character with the hammer, and also decide on the appropriate hammer velocity. The wheel is then struck. Currently, the number of characters or 'petals' on a wheel is limited to a maximum of 96 although Qume does offer the facility of simultaneously

mounting two daisy-wheels at a time, making a total of 192 available characters. The alternative to this is to use the 'spinwheel' as used by the NEC Spinwriter. Here 64 petals are bent up, effectively increasing the radius and enabling 128 characters to be fitted (there being two characters per petal).

Apart from the obvious advantage of superior print quality, one daisy-wheel can also be easily exchanged for another of different typeface; there are over 100 such typefaces currently available. There are differences too in the materials used to make the wheels, Qume tending to opt for plastic, with Diablo preferring metal (although I see that it does now offer both). There are arguments both for and against and, although metal wheels last longer, with plastic wheels coming out at around a third of the cost, that's one argument that doesn't hold much water. The only slight advantage that metal wheels have is in producing a marginally crisper print. Plastic wheels, however, are so cheap you can stock up with three times as many different typefaces for the same cost. Yet another advantage of plastic wheels is that, being lighter and therefore possessing less inertia, they can be spun round faster than metal ones. The printing speed — always one drawback of the daisy-wheel — is typically a maximum of 55cps with plastic wheels and only 45cps for metal. For many uses this speed is too low and you can see why there is the feverish development in matrix printers that I discussed earlier.

Another feature of daisy-wheel printers, often overlooked, is that if you purchase the version with a keyboard (which usually costs about another £200) since you can operate it in a 'local' mode, you've effectively made yourself an electric typewriter for only '£200'. Where else can you buy one of that quality and at that price? And a final plus . . . the daisy-wheel is the only printer I know of that's capable of printing sub and super-

scripts.

The last of the impact devices to be considered (at least as far as 'character' printers are concerned) is the faithful IBM Selectric and variations thereof. These are now appearing on the re-furbished (second-hand) market with suitably modified insides and an interface to suit your computer. The printing mechanism in this case is a golf-ball; a fully-formed character printer, the individual symbols are raised up from the surface of a metal ball. This ball is attached to a mechanism of almost frightening (well, it is to me!) complexity which twists and raises the correct portion of the ball into the firing line. In common with other hairy mechanical devices, the golf-ball print speed is quite slow — about 15 cps. The print quality, however, is superb . . . some would say the best as it's effectively an electric typewriter. Again, it offers the advantage of having exchangeable typefaces, although you have to be 100% certain that the electronic interface fitted can handle your choice; with the differing golfball layouts available, you might well end up printing gibberish.

Non-impact printers

The two main types of non-impact printer are electro-sensitive and thermal. Both operate on a similar basis to matrix printers but instead of needles they use (respectively) an electric field or a heat field. Both require special paper and the electro-sensitive type is that nasty looking silvery stuff. The thermal paper is creamy-white in colour and produces quite a readable print . . . far less objectionable in my opinion. A typical price for thermal paper is £2.00 for an 80' roll — which makes it fairly expensive — while the other type is cheaper. The advantages of both thermal and electro-sensitive are a relatively high speed (about 40 cps for the Trendcom 100 thermal printer) and an almost sublime silence when in operation — it sounds so effortless. One possible disadvantage, apart from the special paper, is that the paper width is sometimes limited (less than 5") but there's an increasing number of manufacturers (Trendcom included) now offering an 8½" width.

Another, perhaps more serious, disadvantage inherent in both designs is that only one copy can be made at a time as opposed to up to 6 that some of the impact printers can manage.

Typewriter modifications

Last but by no means least in the mechanisms is a strange beast that defies any classification in the printer camp per se. I refer to the Keypak which is a handy device and clips over an existing electric typewriter keyboard. Small solenoids in the Keypak then depress and actuate the existing typewriter keys. Restrictions are that the typewriter must have a powered carriage-return and a certain amount of adjustment of external timing delays is needed to suit the particular typewriter used. What you get is, effectively, correspondence quality print at whatever maximum speed the

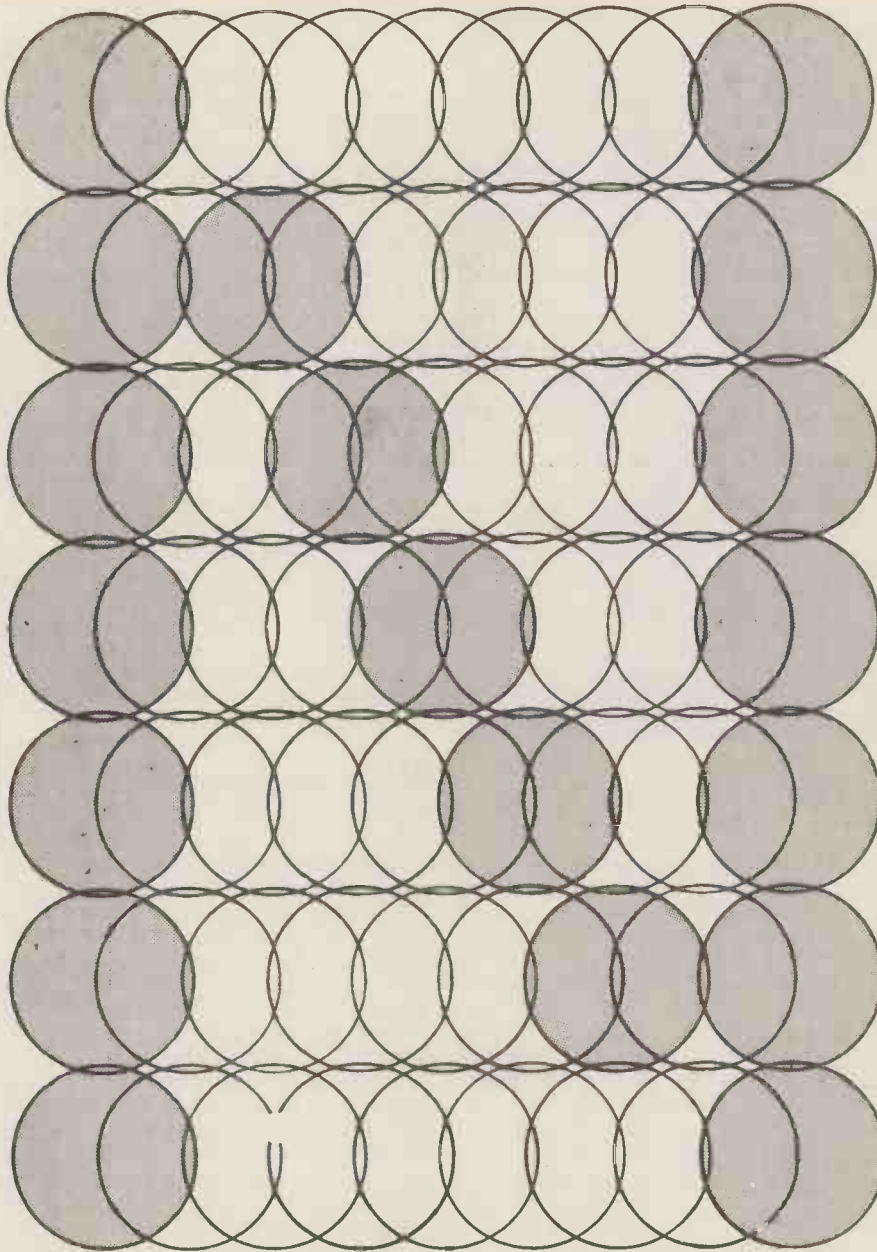

Fig. 5 9 x 7 Half space matrix font

typewriter will run. I also hear rumours of another add-on that lives underneath the keys but was unable to find out any more information on it.

Line printers

If throughput is a problem then the line-printer is just the job for you, although you will find most of them rather expensive. Three methods of printing are used — namely the drum, the chain and the comb — all of which print a complete line in one go. Both drum and chain methods use fully formed letters and also strike the *paper* against the ribbon and then on to the character on the chain or drum. This is known as 'back-striking', as opposed to the 'front-striking' mechanism of the ordinary typewriter where it's the character that does the striking. In the drum printer, the characters are arranged in rows down the axis of the drum — a complete row of 132 A's (assuming it's a 132 column printer), then a row of B's etc. Behind the paper is a row of 132 hammers, each being activated when the appropriate character passes it. For one line of print to be made the drum must revolve once. The paper then

moves up to the next line and the process is repeated.

The chain, or train, mechanism comprises a series of metal slugs joined together and driven along a guide channel in front of the paper and ribbon. Each slug comprises one character and, when it reaches the appropriate column, the paper is struck from behind by the corresponding hammer — very similar in fact to the line printer.

A closely related mechanism is used by the band printer but this time the characters are impressed on a metal band that is then used in a similar fashion to the chain or train. One advantage of the band printer is that bands can often be changed quite easily, to effect repair or font change. If the character set is duplicated in either chain, train or band then a speed improvement will result. The actual number of hammers also varies and the maximum throughput occurs when there is one hammer per column on the paper. This makes the printer correspondingly more expensive and so, to compromise, some printers share one hammer between two or four columns and the mechanism or the paper is

moved sideways during printing.

The third type of line printer uses the 'comb' mechanism. Pioneered by Tally it's a compromise between the number of active elements (hammers) and the printing speed. The comb has 132 teeth and on the end of each tooth is a hardened 'pip' — see figure 7. Behind the tooth is, wait for it, yes — an electro-magnet! The design is quite ingenious because, to print a dot, the required comb is pulled back with the magnet and then released . . . whereupon the tooth flies back and strikes the ribbon on to the paper. This is only the first dot in the character that we are building up and the comb is then moved sideways to the next dot position within character and the required teeth fired. Don't forget that since we have 132 hammers we could be building up 132 characters simultaneously. When all the dots have been fired for the first row, the paper has to be advanced by one dot row position ready for the next row of dots to be printed. However, to save time the comb row moves over in the opposite direction. The comb therefore reciprocates along the print line, making $3\frac{1}{2}$ complete cycles per character row — see Figure 8. The end result is a printer with no fast-moving parts or requirement for critical timing.

A different principle is used by OKI in its line printers. Here either 22 or 33 small solenoids are used with the needles attached directly to the armatures. Because they are mounted at right angles to the paper there's no question of bending the needles and so normal dot-matrix type problems are eliminated. Each hammer or solenoid is shared between 6 or 4 characters respectively and each character is then assembled in a similar fashion to the 'comb'.

Cautionary note

The important point with any quoted line speeds/minute is that it depends on the number of characters per line, and this applies to all types of printer. Also remember that although a uni-directional printer may be quoted as having a printing speed of 120cps — time will be wasted while it does a carriage return. The effective throughput will be less than a printer running at the same quoted characters/sec, but with bidirectional printing capacity.

Paper control

There are three main types of paper movement or control, the most common being the 'pin-feed' which uses computer listing paper with sprocket holes down each side. At the end of the platen (the roller that the paper goes round) are spikes or 'pins' that locate with the holes in the paper and drive it along at line-feed time. The drawback with early versions was that the distance between the sprockets was fixed and so you were stuck with using only one size of paper. The alternative was to purchase different platens to suit different paper types and some manufacturers have gone along that line by simplifying the changeover procedure.

Another method is to do away with the platen altogether and have a

NASCOM

Yes, we're still around



NASCOM 2

Kit includes all parts to build CPU board which has resident 8K microsoft BASIC and 2K NAS-SYS 1 monitor for machine code programming.

Included with kit is a fully assembled LICON QWERTY SOLID STATE KEYBOARD specially designed to exploit the potential of the NAS-SYS monitor. Other interfaces include video to monitor or domestic TV, Kansas City standard cassette interface (300/1200 baud) or RS232/20mA teletype interface.

In addition to full character generator graphics ROM is provided to give BASIC on board graphics capability.

System uses Z80A which gives selectability between 2 or 4 MHz.

Nascom 2 Kit Price
£225 + VAT

Power supply - 3 amp. Suitable for powering of basic Nascom 1 or 2 and memory expansion.

£32.50 + VAT

NASCOM SOFTWARE

CPU card can accommodate either 8K of static memory or 8 2708 EPROMS. This allows for inclusion of standard firmware on board.

ASSEMBLER Version 2.0 of ZEAP (Z80 Editor Assembler Package) offers in 4K features found normally only in far larger programs. A comprehensive line editor is provided in addition to an assembler operating in standard Z80 mnemonics. Direct assembly to memory allows immediate program execution. ZEAP can take advantage of special features of NAS-SYS, which was itself developed on this assembler. Supplied on tape at £30.00 plus VAT or in 4 x 2708 EPROMs at £50.00 plus VAT.

DISASSEMBLER The NAS-DIS3K disassembler reverses the effect of assemblers such as ZEAP by turning machine code into assembler program, automatically labelling and cross-referencing to produce a complete program listing, saving hours of tedious hand disassembly when program analysis is required. Supplied in 3 x 2708 EPROMs at £37.50 plus VAT.

DIAGNOSTIC PACKAGE

NAS-DEBUG is a 1K addition to NAS-DIS which provides remarkable facilities for error elimination, including a full register display which may be edited by the cursor. An unusual feature is the provision for examination of the program in assembler as the machine single-steps through it. A second video page may be assigned to allow work on programs which use the screen.

A very powerful assembler-based system for program development could be realised on

a NASCOM-2 with appropriate external memory by fitting the 8 ROMs containing ZEAP, NAS-DIS and NAS-DEBUG into the sockets on the computer board. This system would function immediately on switching on, without needing programs to be loaded from tape.

Supplied in a 2708 EPROM at £15.00 plus VAT and must be operated with NAS-DIS.



NAS-SYS 3. THE NEW OPERATING SYSTEM FOR NASCOM 2. SUPPLIED IN 1 x 2716 EPROM

NAS-SYS 3 is the latest in the current series of Nascom monitors and includes features such as adjustable keyboard repeat and cursor speed, full interrupt handling and a number of powerful routines and commands making this probably the most comprehensive 2K monitor ever written for a microcomputer.

£40 + VAT

RAMBOARDS

SERIES B ram board gives user option of 16K, 32K or 48K of DYNAMIC RAM. These boards can be arranged in page mode to allow use of up to 4 with NASCOM 2. Boards are fully buffered but PAGE MODE facility is an optional extra. This card can be used at 4MHz without wait state.

16K: £140 + VAT 32K: £200 + VAT 48K: £250 + VAT

NASCOM IMP PLAIN PAPER PRINTER



The Nascom IMP (Impact Matrix Printer) features:

- 60 lines per minute • 80 characters per line • Bi-directional printing • 10 line print buffer • Automatic CR/LF • 96 characters ASCII set (includes upper/lower case, \$, £) • Accepts 8½" paper (pressure feed) • Accepts 9½" paper (tractor feed) • Tractor/pressure feed • Baud rate from 110 to 9600 • External signal for optional synchronisation of baud rate • Serial RS232 interface.

£325 + VAT

NASCOM-1

Kit Price **£125 + VAT**

12" x 8" PCB carrying 5L SI MOS packages. 16 1K MOS memory packages and 33 TTL packages. There is on-board interface for UHF or unmodulated video and cassette or teletype. The 4K memory block is assigned to the operating system, video display and EPROM option socket, leaving a 1K user RAM. Complete with keyboard.

All prices are manufacturers suggested prices.



Nascom Microcomputers

NASCOM MICROCOMPUTERS LTD
52 BROAD STREET
CHESHAM, BUCKS.

For full details please contact your nearest Nascom Distributor

ADDA COMPUTERS
17-18 The Broadway,
Ealing, London W5 2NH
Tel: 01-579 5845

***BITS & PC's**
18 Ryegarth, Wetherby,
W. Yorks. Tel: 0937 63774

***BUSINESS & LEISURE MICROCOMPUTERS**
16 The Square,
Kenilworth, Warwickshire.
Tel: 0926 512127

BUSS STOP (PHOTO ACUSTICS) LIMITED
255A St Albans Road,
Watford, Herts.
Tel: 0923 40698

THE CAMERA CENTRE
122 Dalton Road,
Barrow-in-Furness,
Cumbria LA 14 1JH.
Tel: 0229 20473

COMP SHOP
14 Station Road, New
Barnet, Herts. EN5 1QW.
Tel: 01-441 2922

COMPUTERLAND
92A Upper Parliament St,
Nottingham.
Tel: 0602 40576

COMPUTERLAND
11 Gateway House,
Station Approach,
Piccadilly, Manchester 1.
Tel: 061-236 4737

COMPUTERLAND
94-96 Hurst Street,
Birmingham.
Tel: 021-622 7149

COMPUTERLAND Magnet House, Waterloo Street,
Glasgow. Tel: 041-221 7409

COMPUTERLAND
426-428 Cranbrook Road,
Gants Hill, Ilford, Essex.
Tel: 01-554 2177

COMPUTERLAND
48 Tottenham Court Road,
London W1.
Tel: 01-636 0647

COMPUTER MANIA
The Priory, Great Milton,
Oxon. Tel: Gt. Milton 729

OATRON MICRO CENTRE
Latham House
243 London Road,
Sheffield. Tel: 0742 585490

ELECTRONIC SERVICES
7 Berkeley Precinct,
Eccleshall Road, Sheffield.
Tel: 0742 668767

***ELECTROVALUE LIMITED**
28 St Judes Road,
Englefield Green,
Egham, Surrey TW20 0HB.
Tel: 07843 3603

MICROTEK
54 Orford Street,
Ipswich, Suffolk.

***ELECTROVALUE LIMITED**
680 Burnage Lane,
Manchester M19 1NA.
Tel: 061-432 4945

ELEY ELECTRONICS
112 Groby Road,
Glenfield, Leics.
Tel: 0533 871522

HAPPY MEMORIES
19 Bevois Valley Road,
Southampton, Hants.
Tel: 0703 39267

***HENRYS RADIO**
404 Edgware Road,
London W2.
Tel: 01-723 1008

***INTERFACE COMPONENTS**
Oakfield Corner,
Sycamore Road, Amersham,
Bucks. Tel: 02403 22307

INTEX DATALOG
Eaglescliff Industrial Estate,
Eaglescliff, Stockton-on-Tees,
Cleveland TS16 0PN.
Tel: 0642 781193

JPS
9 East Street,
Colne, Huntingdon.
Tel: 0487 840710

A & G KNIGHT
108 Rosemount Place,
Aberdeen AB2 4YW.
Tel: 0224 630526

***LOCK DISTRIBUTION**
Neville Street,
Middleton Road,
Oldham, Lancs. OL9 6LF.
Tel: 061-652 0431

MICRODIGITAL
25 Brunswick Street,
Liverpool L2.
Tel: 051-227 2525

NEWBEAR COMPUTING STORE LIMITED
40 Bartholomew Street,
Newbury, Berks. RG14 5LL.
Tel: 0635 30505

PIPS COMPUTER SERVICES
15 Sandhill, Quayside,
Newcastle-on-Tyne.
Tel: 0632 615939

P & O COMPUTERS
529 Antrim Road,
Belfast.
Tel: 772417

TARGET ELECTRONICS
16 Cherry Lane,
Bristol BS1 3NG.
Tel: 0272 421196

TEKDATA
Federation Road,
Burslem, Stoke-on-Trent.
Tel: 0782 813631

V & T ELECTRONICS
82 Chester Road,
London N19.
Tel: 01-263 2643

*Full Range Distributor

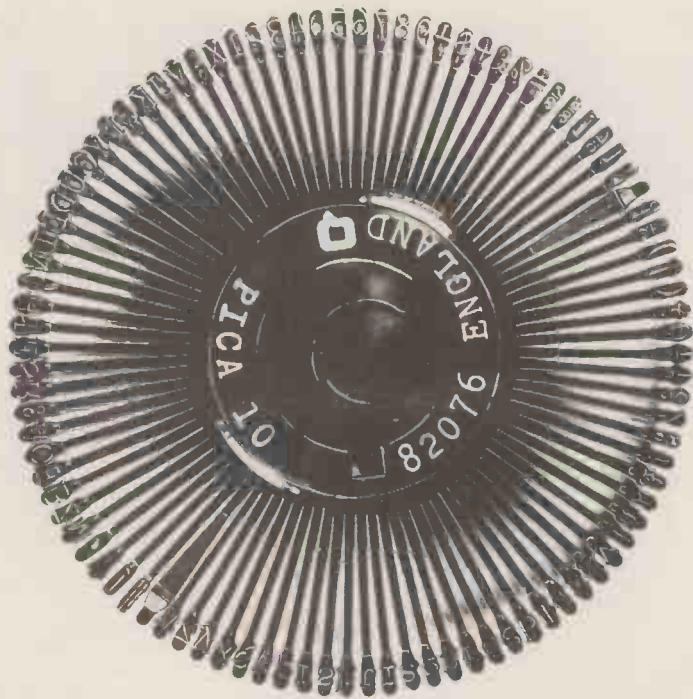

Fig 6

narrow strike plate behind the paper fire-line and then to pull the paper over this plate. In this case the sprockets are mounted on a separate rod along which they can be slid to accommodate different widths of paper. The disadvantage with some of these pin-feeds is that the paper is not under very tight control as there is no tension holding it back below the print line. This turned out to be a problem, especially with forms such as invoices etc, and so the adjustable tractor was developed. This device (standard fitting for some, while an optional extra for others) can be adjusted for paper width and also provides a firm 'traction' path through which the paper is driven. Another feature is that for about 3 inches above the print line, the paper is held flat which makes reading while printing much easier. This 3 inch path also means that there are more teeth in contact with the paper than with the pin-feed and so there is less chance of the paper jamming or tearing.

Where the control of paper movement is really critical — when graph plotting for example — then the technique is to use a double-tractor mechanism both before and after the strike plate. The paper is therefore really gripped tightly and pulled hard back against the strike plate. The double-tractor also means that the paper can be moved backwards which again is a great asset when graph plotting. Don't automatically think that the forms-tractor is always better than the pin-feed because some of these

tractors that are optional extras can move about a bit, albeit by only a tiny amount . . . a small point that you should be aware of.

The next method is the friction feed and this is used where sprocket holes are taboo — for instance when writing to your girlfriend! The operation is identical to a typewriter and usually works fine. The only problem arises when continuous stationery is used as, after a time, no matter how carefully you insert the paper it will gradually creep along the roller; you end up typing off the sheet.

Friction feeds are definitely for those who detest invoices with holes down the side. The alternative name to this feed is the 'single-sheet' feed and, as the name suggests, you put in the sheets one at a time. Well, computers are supposed to save you time, remember, and it can be irritating to stand around feeding the thing. Therefore a handy gadget to have at this time is the single-sheet feeder which takes approximately 200 single invoices or letter heads and will feed them one at a time into the guts of the printer, print them and then stack them up neatly for you in a little tray!! The drawback is that the gadget costs about £750 and tends to be used only with daisy-wheel printers.

Paper can be fed or loaded into the printer from a number of directions. One of the easiest is from the top where it goes in like a typewriter, and one of the worst is where it goes in the back — as in the Microtek. Other options offered are bottom feed and front feed, although bottom feed may be a

factory fitted option.

Many printers fit 'paper-out' indicators that either light a lamp or buzz where appropriate. Among the paper terms that you may come across is 'fan-fold' where the paper is folded alternately, as in a fan; this makes storage of the printout much more manageable. Most printout paper is fan-folded. Some paper comes as two-part and with or without a carbon; copies can be easily made. If you're going to make copies, then make sure that your printer is capable of producing the required number at a time. Printers such as some Facit models feature a 'floating' print head that automatically compensates for different thicknesses of paper whereas some others need the hammer intensity and head adjustment to be performed manually.

There are extra features that are worth looking out for (which are not always automatically provided but that you might find important) . . . for instance printers with facility for winding the paper forward or backwards manually; it's also nice to be able to tear off the paper at a convenient point. Many printers have the tear-off point some way on from the print line which means that you can't start new sheets from the top of the page.

In general terms paper handling is fairly straight-forward and there aren't usually any great problems. Remember, though, that friction feeds do mean that you can print on virtually any form of paper . . . even stencils and offset litho masters and that is often quite important.

This next section is one closely associated with paper — the choice of ribbon. Features to look out for here are the life of the ribbon, how easy it is to replace and how much it will cost. The current buzzword appears to be the 'Mobius' loop where both the top and bottom halves of the ribbon will eventually be used. Some use 'intelligent' ribbons — such as Qume's Multistrike which is supposed to wind the ribbon on only as far as the width of the last printed character, thereby lengthening the ribbon's life. For really excellent print quality you need a 'singlestrike' (or carbon) ribbon which, although producing exemplary print, only lasts for one pass and then has to be thrown away. Some printers feature two-colour printing (usually red and black) and there's even a superb colour printer by Trilog that uses a three colour ribbon in the company's own colour plotter/printer.

Taking Control

Some of the modern trends in micro-processor control have already been mentioned but, before I expound on the

Fig 7

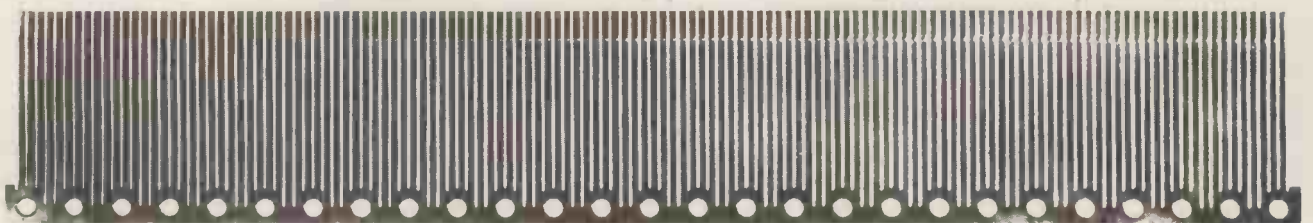

other advantages, I ought perhaps talk a bit on the simpler (?) task of interfacing. Printers interface to their host computer via either a serial or a parallel interface.

Because printer mechanics are much slower than electronics, many serial interfaces operate at a slow baud rate. Sometimes the maximum speed at which a printer will work (eg. 55cps) falls between two of the standard electronic baud rates — here, 300 and 600 baud. If the computer transmits at 300 baud then the printer is not being used at its fastest pace but at 600 baud, the speed is too high for it. The answer adopted by many manufacturers is to include a buffer (usually up to around 2k) inside the printer which will absorb occasional bursts at the higher rate without losing any characters. The problem of baud rate matching is still there and if the computer transmits a large chunk of data — eg. a listing — then the buffer will overflow in a very short time. If this type of operation is anticipated, it's important to make sure that whatever serial interface is used possesses a handshaking control that can inhibit the computer from sending any more data after the printer buffer has been filled up.

The proper answer is to use a parallel interface and there's a so-called standard — the Centronics interface. Many people advertise that they follow this standard but occasionally I have known people to run into trouble; certain elements within the interface didn't quite tie up as well as they should have — check therefore that your computer will interface satisfactorily. Handshaking is inherent in parallel interfaces and thus data transfer rate is not a problem.

Another aspect of control is the VFU or Vertical Forms Unit which uses tape cartridges, punched tape or microprocessors and ROMs to govern the vertical movement of paper. The simplest example is the 'forms-length' switch that tells the printer how many lines there are on the form, thus enabling it to move the top of the next form after the previous one has been printed. I refer, of course, to continuous stationery. Other, more sophisticated, VFUs allow movement to one of several predefined positions on, for example, an invoice. These might mark the head of form, the start of an address, the first item line and the total box. Some manufacturers even provide battery backup to maintain the forms information in the event of a power failure!! The whole trend seems to be to shift a lot of the intelligence associated with form presentation from the computer into the printer and to offer the user more and more flexibility; personally I think that too much flexibility can often confuse the issue.

The matrix printers also have a field day, thanks to microprocessor control. Apart from those facilities that I've already mentioned, there are other goodies such as the ability to change the number of characters per line or even to print double height, width or size characters; others allow multiple printing passes along the line to build up exotic characters. The enhanced matrix printers are heavily microprocessor

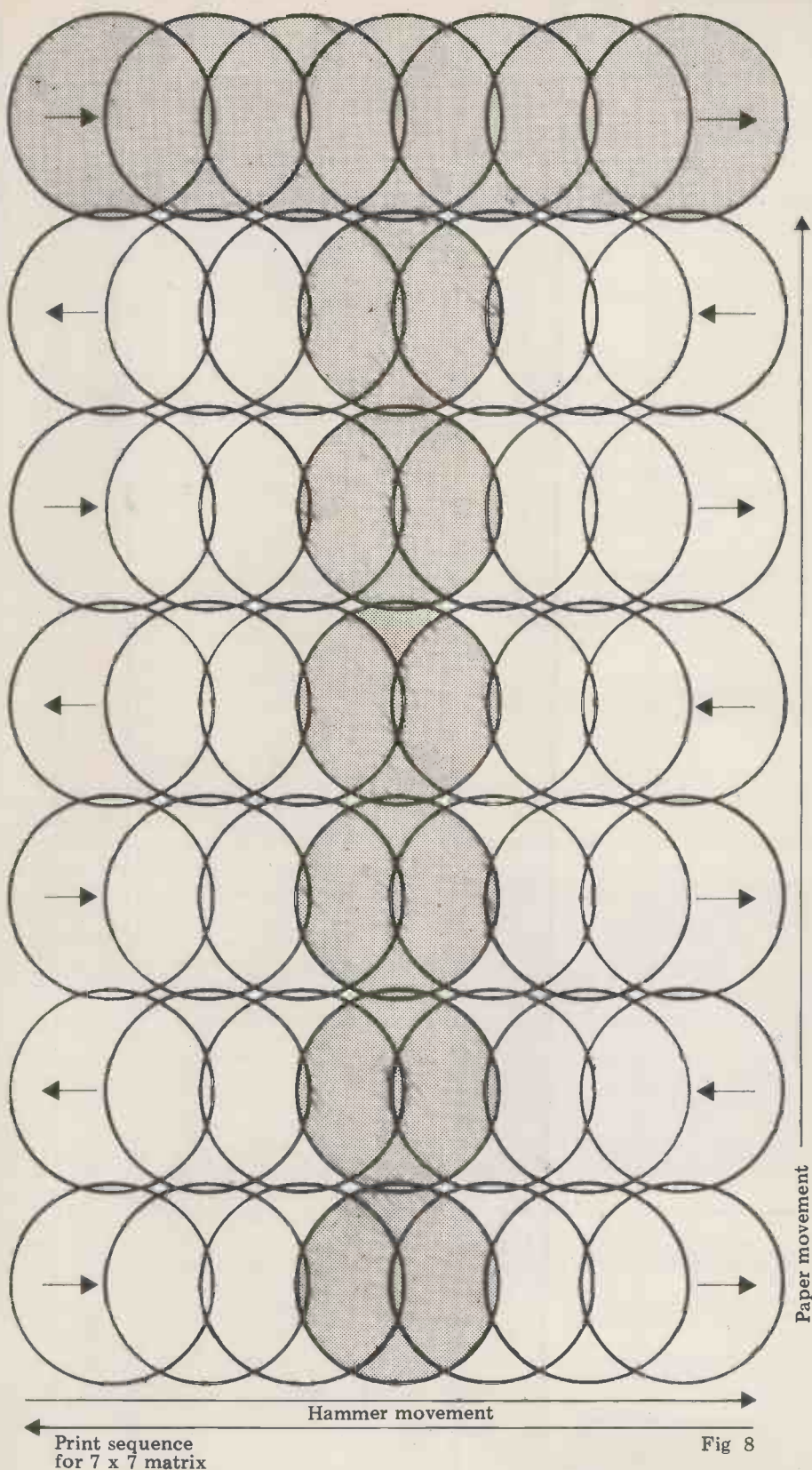

Fig 8

controlled and perform many of these functions.

Word processing hasn't been ignored either as several printers will justify the text for you and proportionally space it. The principle behind proportional spacing is that for ease of legibility each letter doesn't occupy the same horizontal space. When allowance is made for this fact (ie. the print head doesn't move along the same amount for each character) the result looks much better.

Conclusions

I hope the foregoing has given prospective buyers some help in finding their way through the printer jungle. If I could crystal ball gaze then I'd say hang fire for a while as I suspect there are some interesting printers lurking in the wings, particularly in the area of dual-purpose and enhanced matrix printers. My advice for buying is to take your time and to decide what exactly are your requirements before

MICROMART

BIAS POWER SUPPLIES FOR SYSTEM EXPANSION TO 64K

BIAS 1 for general micro use
+5 @ 10 amps ±12v @ 2 amps
-5 @ 1 amp KIT £42.50

BIAS 3 for S100 systems
+8v @ 10amps
±18v @ 3.5amps KIT £40.20

Over Voltage Protection
- optional B1 - £12;

HEAVY ALLOY CASE
150 x 150 x 200
includes switches, connectors,
pre-drilled £12

Assembled & Guaranteed add £15

Specialists in Multirail Supplies

Mail order to:

ONUSTECH ENG LTD

474 CHISWICK HIGH RD
LONDON W4
01-995 0160

p&p £3.50

Prices excluding VAT.

To advertise in
MICROMART
Please ring Jacquie Hancock
on 01-631 1682

CLEARANCE SALE

- Intertec Superbrain with integrated VDU, keyboard, 64K RAM and twin disk drives: **£1290**
- Motorola MEK6800D1 kit, includes 6800 MPU, I/O chips, memory etc. Parts useful for 77/68 **£48**
- Vero KM4 case and card frame. for housing plug-in micro boards: **£35**
- Dynamco case, suitable for housing micro boards. Stylish appearance with front panel and built-in power supply: **£30**
- Memory-mapped VDU interface kit, 64 characters x 16 lines: **£25**
- Verowire prototyping kit with spare wire: **£15**
- Precision Petite mini-drill kit with drills, saws, grindstones, flexible drive and stand: **£20**
- MM5262 dynamic 2K RAMs (quantity 300) with support chips to make 64K byte memory. **£95**

All items as new and with full documentation.
Postage and VAT to be added to above prices.

Contact B. Jarvis,
Telephone: Aylesbury (0296) 630364

looking at any printers. That way you stand least chance of being swayed by all the frills and furbelows in your search for the printer that's right for you. Also important, of course, is that you buy at the right price.

Acknowledgements

My thanks go to all the manufacturers who took the trouble to reply to our requests. Particular thanks go to OKI, Walters Microsystems and Intelligent

Artefacts. Personal thanks go to Ed Sturmer of Memec, Mike Jordan of ISG, Richard Bond of Racal Recorders and Joe Hemani of DRE. Brickbats go to Commodore and Tandy for sending absolutely nothing and to Sharp for sending information on disk drives.

Using the chart

You will find that many figures in the chart are approximate; you should therefore only use it as a 'broad-brush'

	Agile (ISG Wind- sor 57955)	Anadex 09905 6333			Intelligent Artefacts 022020 689	
	A1	DP 1000	DP 8000	DP 9500	Base 2 M80B	700
Model	A1	DP 1000	DP 8000	DP 9500	Base 2 M80B	700
Print mechanism type	DW	DM	DM	DM	DM	DM
Line or character	CR	CR	CR	CR	CR	CR
Speed cps	Max 55		112	200	80	60
	Min			120		
Lines/min	Max			200		90
	Min			60		13
Characters/line	80					
	132					
	other	40		175/220	72/96/120	
Characters/inch horizontal	12			10/16		10
Lines/inch vertical	6			6/8	6	6
Proportional spacing						
Bidirectional printing						
Justification						
Multiple copies						
Ballistic head						
Matrix format			7x9	7,9 or 11 x9	7x5	7x5
Change print size						
Change type font						
No. in character set		64			21	
Headlife (million chrs)				100/650	100	
Descenders						
Underlining						
Ribbon life (million chrs)	normal				5	
	carbon					
Mobius loop type?						
Graphics						
Bidirectional movement						
Pin feed						
Tractors						
Dual tractor						
Paper widths	Min					
	Max					
Friction feed						
Sheet feeder						
Paper cutter						
Serial interface						
Max baud rate		2400	9600	9600	19200	
Buffer	Opt.		2048		1920	
	Fixed	104	12			
Parallel interface						
Parallel transfer rate (ch/sec)		1000	1000			C
Self-test						
VFU						
Switchable forms length						Opera
Punched tape						Horiz.
8 Channel cartridge						
Electronic + No. channels						
Paper-out sensor						
Measurement in inches	width	11	19	27	14	25
	depth	16	14	15	10	20
	height	6	7	8	3	8
Approx weight (lbs)		11		35	9	60
Cost		£450	£575	£995	£390	£1257

This printer is similar to Qume but configured as required

outline for making a preliminary choice. Where options are available they are indicated and a brief word given on the facilities offered. Don't assume, because a feature is missing, that a particular printer hasn't got it. It may mean that it simply wasn't mentioned in the literature. The converse may also hold true. Another point to bear in mind is that many facilities are inter-related — such as selection of characters per line versus speed.

To repeat, this chart is by no means

exhaustive although it certainly exhausted me preparing it!! Make a few preliminary selections, send for the actual literature and, armed with your new found knowledge, ask a few pertinent questions.

A few printer/keyboard combinations that are usually considered as being terminals are not included in the chart, the distinction in some cases being a bit nebulous.

Centronics
Burgess Hill
45011

701	702	703	704	730	737	753	779	780
DM	DM	DM	DM	DM	DM	DM	DM	DM
CR	CR	CR	CR	CR	CR	CR	CR	CR
60	120	180	180	100	80/50	130/150	60	60
120	260	370	400			260	90	90
25	50	70	70			50	21	21
10	10	10	10	10		10	10/16.5	10
6	6	6	6	6		6	6	6
7x5	7x7	7x7	7 or 9x7 or 9x9	7x7	Nx9 or 7x8	Nx9	7x5	7x5
			96	96	96			
				4	4			
				10	10			
			9600					
			256	80				
t r o n i c s S t a n d a r d								
controlled vert forms posn.								
25	25	25	25	15	15	25	20	20
20	20	20	20	11	11	20	18	18
8	8	8	8	5		8	8	8
60	60	60	60	12	12	60	45	45
£1399	£1635	£1935	£2022	£525	£656	£2022	£995	£1081

MICROMART



NASCOM 1&2

Due to great response we can NOW OFFER :-

Invasion Earth! (NS/G)	£9.95	Super Startrek*	£9.95
Space Fighter (NS/G)	£7.95	Sialom (NS/G)	£5.95
Alien Labyrinth (NS/G)*	£7.95	Lab rinth (NS/G)	£5.45
Secret Agent (NS/G)	£5.95	Minotaur (NS)	£5.95
Sheepdog Trial (NS)	£5.95	Othello	£5.45
3D Noughts & Crosses (NS)	£5.95	Code-Breaker	£4.95
Submarine Chase (G)	£5.45	Biorhythm (NS/G)	£4.45

(*min 16K, G=graphics, NS=NAS-sys only)

WRITTEN ANY PROGRAMS? — WE PAY HANDSOME ROYALTIES!

Send Chq/P.O. + 45p/order p&p or SAE for catalogue.

Trade Enquiries Welcome

PROGRAM POWER 5 Wensley Road,
Leeds LS7 2LX Telephone (0532) 683186

PET A/D INTERFACE, SOUNDBOX

Put PET to good work measuring/recording/ displaying up to 8 analogue voltage inputs simultaneously with INPET 8, or one channel with INPET 1. Basic and machine code operating programs free with either unit. All interfaces are ready built and simple to use.

INPET 1 single channel £65

INPET 8 eight channel £75

Let PET play or make noises in games with CB2 sound ready built interface with free program.

PET SOUND £20

SOFTWARE on cassette

High resolution 1-8 channel bar graph display in basic £6

High resolution 1-8 channel bar graph display in machine code for very fast display of all channels £12

Single channel chart recorder £6

Please add 15% VAT to total order and state OLD or NEW ROM PET.

Alphur Electronics, 29 Holme Lane, Bradford
BD4 0QA. Tel: 0274-685926

SYSTEMSCRIBE

SMALL SYSTEMS SOFTWARE

Programming is a logical procedure: logical programming begins with coding sheets.

SYSTEMSCRIBE Coding Sheets, designed to be useable with most languages, are ideal for the microcomputer programmer (whoever does the keying-in will appreciate them too!)

Pads of 50 sheets: 25 x 80 format.

3 pads for £4.50 (including VAT and postage).

SYSTEMSCRIBE LIMITED

62 Daws Heath Road, Thundersley, Benfleet
Essex SS7 2TA

APPLE/ITT SOFTWARE

OVER 100 TITLES in our
FREE catalogue.

Customised Software is Our
Speciality.

Write or Telephone for Further
Information & Our Price List.

Spider Software

98 AVONDALE ROAD
SOUTH CROYDON
SURREY

TEL. 01-680 0267

Hardware Also Available.
Highest *Royalties* Paid
For GOOD Programs.

MICROMART

EPROMPT ERASER



- CLEARS UP TO 32 CHIPS IN 30 MINS ON 200-250V A.C.
 - CONTINUOUS 253.7nm BEAM. SAFE & SIMPLE. GUARANTEED
 - **£39** C.W.D. **£40** NETT 30 DAYS - ALL INCLUSIVE !
- TRADE ENQUIRIES INVITED FOR SUBSTANTIAL DISCOUNTS
ALL ORDERS AND ENQUIRIES POST-FREE TO:

TEX MICROSYSTEMS LTD.

FREEPOST, ST. ALBANS, HERTS. AL1 1BR
ST. ALBANS GK077 / TRING 4797

TRS80 MODEL II SOFTWARE

CLEARTONE BASIC preprocessor
adds LONG DATANAMES,
MACROS with parameters,
automatic SUBSCRIPT calculation.
Produces clear BASIC source programs.
Comprehensive ERROR FLAGGING.

DISC DUMP utility for 80-column printer

SCREEN PRINT utility - for incorporation
into BASIC programs

CROSS-REFERENCE utility

All the above items supplied on discette for
£27.50 inclusive (in UK)

Other programming aids under development.

We use these utilities to produce a wide range of
BUSINESS APPLICATIONS SOFTWARE.

CLEARTONE COMPUTER CONSULTANTS LTD,
Prince of Wales Industrial Estate, Abercarn,
Gwent, NP1 5RJ.
Telephone 0495-244555

DEALER ENQUIRIES WELCOME

DISKWISE LTD

THE Apple agents for
Devon & Cornwall.

Complete business systems
from £2250 ex VAT

EXCLUSIVE HOTEL
MANAGEMENT SYSTEM
(inc Booking & Guest billing)
& TV RENTAL
MANAGEMENT

Dealer enquiries welcome

DISKWISE LTD.

TREKENNER,

LAUNCESTON

TEL 05797 628

PETS - We Sell Them

As authorised Commodore Dealers we stock
and supply all PET Hardware, Computink
Discs, Oki Microline 80 Decwriter LA34,
Texas 810, Qume Sprint 5 - all at com-
petitive prices

PETS - We Buy Them

Part Exchange is very welcome, we also
buy for cash.

PETS - We Hire Them

Our specialist hire service, with main-
tenance included for all Commodore equipment.

- Complete systems for evaluation
- Multiple units for educational courses
- Single units for individual use

From 1 day upwards, all units available.
Delivery by arrangement, anywhere in UK.

PETS - Software

We are fully authorised BUSINESS SOFT-
WARE DEALERS for Commodore Soft-
ware - COMPAY, COMSTOCK,
WORDPRO etc. Also PETSOF, BRISTOL
SOFTWARE, LANDSLER PAYROLL &
HOTEL SYSTEM.

PLUS for ACCOUNTANTS, the unique
CSM INCOMPLETE RECORDS PACKAGE
- this is the best available.

MAIL - ORDER

All Hardware and Software can be bought
by Mail Order Delivery by Securicor, or
Registered Post. Discounts for Cash & Carry
or Mail-Order. Access accepted or by
Leasing (subject to acceptance)

MICRO-FACILITIES LTD

127 High Street, Hampton Hill, Middlesex,
TW12 1 NJ. 01-979 4546 or 01-941 1197

Centronics
Burgess Hill
45011

DATA C
061-941 2361

		Centronics Burgess Hill 45011		DATA C 061-941 2361			
Model		781	791	Screen Image	DM1 40P	DM1 80P	52
Print mechanism type		DM	DM	E	P	P	I
Line or character		CR	CR	CR	CR	CR	
Speed cps	Max Min	60	60		80	120	
Lines/min	Max Min	120 43	210 45		120	90	
Characters/line	80 132 other						
Characters/inch	horizontal	10	10				
Lines/inch	vertical	6	6				
Proportional spacing							
Bidirectional printing							
Justification							
Multiple copies							
Ballistic head							
Matrix format		7x5	7x5				
Change print size							
Change type font							
No. in character set				Viewdata Teletext	96	96	
Headlife (million chrs)							
Descenders							
Underlining							
Ribbon life (million chrs)	normal carbon						
Mobius loop type?							
Graphics							
Bidirectional movement							
Pin feed							
Tractors							
Dual tractor							
Paper widths	Min Max				4	9	
Friction feed							
Sheet feeder							
Paper cutter							
Serial interface							
Max baud rate					600	600	
Buffer	Opt. Fixed						
Parallel interface		Centronics Standard					
Parallel transfer rate (ch/sec)		Centronics Standard					
Self-test							
VFU							
Switchable forms length							
Punched tape							
8 Channel cartridge							
Electronic + No. channels							
Paper-out sensor							
Measurement in inches	width depth height	20 18 8		13 10 4			
Approx weight (lbs)		45		10			
Cost		£1200	£1370	£500	£350	£188	£7

Key:

DM	Dot Matrix
DW	Daisy Wheel
DR	Drum
SW	Spin Wheel
GB	Golf Ball
CM	Comb
CH	Chain
PH	Print Head
P	Pressure Sensitive
E	Electro Sensitive
TH	Thermal
*	Half Space Facility
▨	Optional
▩	Standard

MICROMART

PET HIRE Southampton

Weekly charges:

8K large keyboard £23, 32K £30,

Tractor Printer, Floppy Disk £30, Manuals, Tutorials, Games included.

New low Commodore prices:

16K from £475, 32K from £565, Printer £425, Floppy Disk £695

All prices exclude VAT
Ex hire machines available
Official Commodore Dealer
SUPER-VISION
13 St James Road
Shirley, Southampton
Telephone (0703) 774023
After hours (0703) 554488

PET MEMORY EXPANSION

8K to 16K £75
8K to 32K £140
16K to 32K £140

Top quality components fitted to existing board. Fully guaranteed. Applies to all 'New ROM' PETS.

Phone/Write:

Andy Hudson
2 Juniper Close, North Baddesley
Southampton
0703 733608 abytme

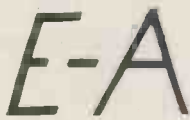

Electronic Aids
(TEWKESBURY)
Tel. (0386) 831020

New programs for CBM/PET include:

SPITFIRE shoot down an enemy plane. £3.00

INDEX PROGRAM takes the labour out of making an index for a book. Index can be saved on files between working sessions. £15.00

FUNCTION plots graphs on the screen. . . £10.00

BEGINNER four programs on one cassette to get you started in BASIC . . . £10.00

ADVANCED PROGRAMMING four programs £12.00

PRIMARY MATHS four programs £12.00

Special programs to order
Dealer enquiries welcome
Prices include postage.
Please state type of machine when ordering.

Mythe Crest,
The Mythe,
Tewkesbury
Glos. GL20 6EB

STOP LOOKING!

By now you will be as bewildered as we were. THE TEXAS T1-99/4 was designed for *your home* not for budding scientists. If you can read this advert, you will be able to enjoy HOME COMPUTING as soon as you connect up!

HOW MUCH?

Console with 12" B&W TV/MONITOR, CASSETTE RECORDER, all cables, books etc. only £750 INC. VAT.

Console with full 16 COLOUR 14" TV/MONITOR
Cassette Recorder cables books etc. only £975

No hidden extras - our prices inc. V.A.T.
We are not experts - you don't have to be!
H.H.S. Ltd. 822/4 Kingstanding Road,
Birmingham, B44 9RT. Tel. 021-354 2083

		Diablo 04862 791191	Dolphin Walters 0494: 445172: Datac 061-941 2361: Pronto 01-599 3041		DSH 01-952 8471	DTC ISG Wind 57955	
Model			BD 80	BD 136	M50	200	30
Print mechanism type		DW	DM	DM	DW	DM	DV
Line or character		CR	CR	CR	CR	CR	CF
Speed cps	Max	45	125	240	50	200	45
	Min						
Lines/min	Max						
	Min						
Characters/line	80						
	132						
	other			136			
Characters/inch	horizontal		10		10/12	10	
Lines/inch	vertical		6	6	6/8	6	
Proportional spacing							
Bidirectional printing							
Justification							
Multiple copies		14	2			5	
Ballistic head							
Matrix format			9x7	9x7 or 9		9x5	
Change print size							
Change type font							
No. in character set		96	96	96	96		96
Headlife (million chrs)							
Descenders							
Underlining							
Ribbon life (million chrs)	normal						
	carbon						
Mobius loop type?							
Graphics							
Bidirectional movement							
Pin feed							
Tractors							
Dual tractor							
Paper widths	Min						4
	Max						15
Friction feed							
Sheet feeder							
Paper cutter							
Serial interface							
Max baud rate		9600					120
Buffer	Opt.	2304	2048				
	Fixed	256	400	16000			168
Parallel interface							
Parallel transfer rate (ch/sec)		2000					
Self-test							
VFU							
Switchable forms length							
Punched tape							
8 Channel cartridge							
Electronic + No. channels							
Paper-out sensor							
Measurement in inches	width		21			23	
	depth		17			18	
	height		7			13	
Approx weight (lbs)			25		22	45	
Cost		£2200	£525	£1100	£1400	£1700	£17

Key:

- DM Dot Matrix
- DW Daisy Wheel
- DR Drum
- SW Spin Wheel
- GB Golf Ball
- CM Comb
- CH Chain
- PH Print Head
- P Pressure Sensitive
- E Electro Sensitive
- TH Thermal
- * Half Space Facility
- Optional
- Standard

icotel -660 26	Epson 01-439 6288	Facit 0634 401721				Heath 0452 29451	Ipex 0101-213- 368 3679	Lear Siegler 0276 34044
icotel SL80	TX80	4506	4530	4555	4520	WH 14	Spin- term	300
	DM	TH	DM	DM	DM	DM	DW	DM
	CR	CR	CR	CR	CR	CR	CR	CR
	125	28	220	60			55	180
			150					
					60			
		14	198			96	136/163	136
	10		10/15			10/16	10/12	10/16
	6		6/8/10	6		6/8	6/8	6/8
			5	3	1		5	5
	7x6 7x5	7x5				7x9	7x5	9x7
			Various	63	96	96	128	96
	100				100			
	2							10
	4							
	10				9		16	16
	9600		4800		9600	4800	1200	9600
							256	2048
	80		500		700		256	
	17		26	19		18		27
	13		21	19		14		17
	8		10	8		5		8
	21		65	55		25		150
	£395	£100	£1680	£640	£640	£510		£1350

Specification as Base 2 (page 120)

MICROMART

ZX80

Large range of low-priced ZX80 software, games and education. For catalogue, write: ZX80 Users Club, C/- Tim Hartnell, 93 Coningham Road, London, W12

CHEAP PRINT

Printer, interface, software (output routines), even paper. All you need for print from your

NASCOM or TRITON

These are surplus printers, completely rebuilt to like new by the GPO factory, with all parts subject to wear replaced with new, fitted with interface, tested and guaranteed. Character set: ABCDEFHIJKLMNOPQRSTUVWXYZ

1234567890-!@&£?.,: Impact print with proper type, not dot matrix. Accepts typing paper or 8 1/2 inch rolls.

Sample letter SAE, or send a cheque to - Iolo Davison
Littlefield Hawling
Cheltenham Gloucestershire GL54 5SZ
State computer and monitor used (any NASCOM or Triton),

£58.50

Plus carriage, (USUALLY £9 in South and Midlands).

UK101 PROGRAMS

Kelly's Heroes - At last, the programme of the movie! Use grenades to reach the bullion.

Hangman - The old chesnut with some new graphic twists - large expandable vocabulary.

Rear End Johnny - Gun enemy aircraft out of the sky - dynamic action game.

Breakout - The arcade game, UK101-style. Can you knock out ALL the bricks?

FREE WITH ALL ORDERS - Extremely daft graphic programme. "Dogfish Derby". Will Ethel or Danny Dogfish win the race of the Decade?

Price £1.50 each, £5.00 for all four
This price covers cassette, printed listing and P&P

All programmes run on 4K machines

From Mark Leese Software
56, Comeragh Road
London W.14

The ZX80 MAGIC BOOK

Programs to run. Games to play.
Improving the picture. Adding
RAM. Programming tips, debugging
programs. And lots more for
£4.75.

TIMEDATA Ltd. 57 Swallowdale
Basildon, Essex

Bring your

☆ ★ UK IOI ☆ ★

into the outside world with our new interface available ready built £15.50 inclusive or just the clear instructions, software and applications manual £6..... add sound to your games, switching operations (e.g. cassette recorder, even disco lights), add D/A to plot graphs, measure temperature, voltage, position etc . . . almost limitless applications. For further information send S.A.E.

4 game cassette still available only £6 ☆ UNIVERSITY COMPUTERS 112, HUNTINGDON ROAD CAMBRIDGE CB3 0HL

MICROMART

Dola Software

117 BLENHEIM ROAD, DEAL, KENT

Basic and machine code programs for UK101/
Superboard, Acorn and RML 380Z.

Our library includes:-

UK101/Superboard

1. Subroutine library for screen formatting
2. Full screen digital clock - with alarm, 1 sec/day
3. Auto line number
4. Renumber Basic programs
5. Simple interface to drive NASCOM printer

Acorn

1. Digital frequency meter, Auto ranging between pulses/sec and secs/pulse
2. Baudot code teleprinter interface
3. Morse code
4. Monitor commentary

380Z

1. Single step in Basic, with automatic listing of variables at end of each line
2. Fast plotting (no loss of picture) and dynamic graphics
3. Get key while Basic is running
4. Battleships, and other games
5. All machine code subroutines loaded from Basic
6. General purpose subroutines

Send S.A.E. for full description of these, and many other, programs.

µHex EPROM PROGRAMMERS

426 2508/2708/2758/2516/2716
Dual and Single supply Eprons, £95

416 2704/2708/2716 Dual only. £65

480 2704/2708 Kit £35. Built £40.

All programmers require only standard power supplies.

The 426 & 416 are cased and have push-button selection.

Program any length block into the Eprom. Software included. Range covers 280, 8080, 6800 and 6500. State machine.

PIO, PIA INTERFACE MODULES

Available for 280/8080 and 6800/6500.

Prices include carriage. Please add VAT SAE for further product information.

MICROHEX COMPUTERS

UNION STREET, TROWBRIDGE, WILTS.

STOP PRESS: SUPERBOARD II,
UK 101, TRS 80 COMPATIBLE

COLOUR YOUR NASCOM!



DAZZLING COLOUR GRAPHICS FOR
NASCOM 1 & 2

Genuine bit-addressable "pixel" system for straight-forward programming of pictorial or mathematical functions.

8 Colour display plus 8 colour independent background facility. Full documentation with FREE SOFTWARE: powerful sub-routines for vector generation, demonstration program for animated effects. All runs in Nascom 1 without expansion. Complete with UHF Colour Modulator for operation with normal colour TV set. Superior design allows connection to most other micro-processor systems - send us diagrams etc of your b & w video circuitry for free advice. Don't be fooled by the price: this is a top quality product which will transform your computer.

KIT AVAILABLE FOR **£45** + VAT
LIMITED PERIOD AT

READY BUILT & TESTED £59 + VAT

**WILLIAM
STUART
SYSTEMS Ltd**

Dower House, Billericay Road,
Herongate, Brentwood,
Essex CM13 3SD.
Telephone: Brentwood (0277) 810244

	Malibu 0101- 805 4961990	MEMEC 084-421 5471	Newbear 0635 30505	OKI Slough 49117	Pa Ti		
Model	165	NEC	8300	Microline 80	DP 125	Pa Ti	
Print mechanism type	DM	DW	DM	DM	PH	DI	
Line or character	CR	CR	CR	CR	L	CR	
Speed cps	Max 165 Min 90	55	125	80		19 57	
Lines/min	Max Min			101 21	125	27 42	
Characters/line	80 132 other	136/163		40		96	
Characters/inch horizontal		10/12	10	10		10	
Lines/inch vertical			6	6/8		6/	
Proportional spacing							
Bidirectional printing							
Justification							
Multiple copies			3		4		
Ballistic head							
Matrix format	9x10			9x7	9x7	7 8	
Change print size							
Change type font							
No. in character set		128		96	96	96	
Headlife (million chrs)				200	500		
Descenders				No			
Underlining							
Ribbon life (million chrs)	normal carbon						
Mobius loop type?							
Graphics							
Bidirectional movement							
Pin feed							
Tractors							
Dual tractor							
Paper widths	Min Max	3 16	5 10	3 9	4 16	2 10	
Friction feed							
Sheet feeder							
Paper cutter							
Serial interface							
Max baud rate		1200			9600		
Buffer	Opt. Fixed		80		21 132	20	
Parallel interface							
Parallel transfer rate (ch/sec)							
Self-test							
VFU							
Switchable forms length							
Punched tape							
8 Channel cartridge							
Electronic + No. channels					12		
Paper-out sensor							
Measurement in inches	width depth height	28 19 9	25 16 9	18 15 7	14 10 5	24 33 10	16 13 12
Approx weight (lbs)		48	60	20	18	77	20
Cost		n/a	£1850	£475	£500	£2250	£5

Key:

- DM Dot Matrix
- DW Daisy Wheel
- DR Drum
- SW Spin Wheel
- GB Golf Ball
- CM Comb
- CH Chain
- PH Print Head
- P Pressure Sensitive
- E Electro Sensitive
- TH Thermal
- * Half Space Facility
- Optional
- Standard

Printrm 01-894 5511	Qume (Mill- bank) Compu- ting 01- 549 7262)	Racal 0703 843265			Mighty Micro 0923 38923	Tally 0734 580141	Terminet 01- 402 4100	
879	Sprint 5	1000	2000	4000	Super Print 2	M 80-MC	MT 1602	200
DM	DW	DM	DM	DM		DM	DM	DM
CR	CR	CR	CR	CR		CR	CR	L
180	55	150	200	240		200	160	200
120	45			85		140		
75							200	
							70	
	158							136/224
10		10	10				10	10/16.5
6		6	6	6		6	6	
5		6/7	6/7	7/8		5	5	8
7x7		7x7	7x7	9x7		7x7*	7x7*	9x7
95	96					64	96	
						100		100
								2
								16½
9600	1200							120
256		1k/2k	1k/2k	1k/2k				2/256
				512				
18	24	21/26	21/26	21-35				
22	15	20	20	20				
8	8	9	9	9				
25	44	80	80	80				
£725	£2200	£1600	£1700	£2100		£1000	£1380	£1450

Specification as Base 2 (Page 120)

MICROMART

Printronic Computer Systems

Hardware & professional Software for APPLE II

For further details contact
PRINTRONIC Ltd. Raglan, GWENT, NP5 2ET.
 Tel: Raglan (0291) 690 214

- Sales Ledger £300
- Nominal Ledger £450
- Purchase Ledger £400
- Incomplete Record Accounting . £450
- Job Costing £300
- Stock Control £300
- plus many more Complete Business Systems from around £3000

APPLE & ITT 2020 BUSINESS SOFTWARE

Professionally written packages now available with comprehensive manuals, built-in validity checks, interactive enquiry facilities, user options, satisfying accountancy, Inland Revenue and Customs & Excise requirements. On diskette under DOS 3.2 in Applesoft with SPACE utility. Not adaptations. Written for Apple System. Support all printer interfaces. Sales, Purchases and General Ledgers £295-00 each. Manual only £3. Payroll £375. Manual only £4. General Ledger supports Incomplete Records, Jobs Costing, Branch and Consolidated Accounts, etc. General Ledger Applications Manual £10. Prices exclusive of V.A.T. From our shop or your nearest stockist.

COMPUTECH SYSTEMS
 168, Finchley Road, London NW3,
 Tel: 01-794 0202

CARDIFF MICRO CENTRE

- PETs
- +
- SHARP MZ-80s
- +
- HEWLETT PACKARD
- +
- COMPUTER BOOKS

SIGMA SYSTEMS

54 Park Place
 Cardiff 21515/34869

6250 BAUD for NASCOM 1

This ultra-fast cassette interface board will provide reliable data storage and recall at up to 6250 BAUD on most standard cassette recorders.
 e.g. 1K of data loaded in less than 1½ seconds.

The modifications required are minor and full documentation is supplied with each board which comes built, tested and guaranteed.

For immediate delivery send £15.95 + 35p P&P to:-

J. C Hunter
 65 Portland Street, TROON
 Ayrshire, Scotland
 or 'phone 0292 311513

Also a competitively priced EPROM programming service is provided where we can supply the EPROM's programmed to your listings or programme your own EPROM's on a 24 hour turn round basis. Please write or telephone for details.

THE INTRUDERS FOR NASCOM 1 OR 2

There is now a NASCOM version of the addictive pub game **SPACE INVADERS**. Full feature game with extra facilities including 3 levels of skill and practice mode.

3.5K object code runs under any monitor in 5.5K.

Send SAE for full details or for immediate delivery of this superb game send only £10 for object code on tape with object listing and instructions, stating which machine is in use.

Contact:

J. ATKINS, 37 WELLINGTON RD.,
MAIDENHEAD, BERKS. SL6 6DH

Microsystem Manufacturer seeks Systems/ Software House Agents.

We have been appointed distributors in the UK to market an advanced and growing range of microcomputer-based systems suitable for business, process control and industrial use.

Our principal is a large American company and a leader in technology. We are now looking for a defined number of systems/software specialists to package software with these systems and supply complete products to the end user. We can offer an attractive agreement to the selected partners. For a real profit and growth opportunity write a brief description of your company's capabilities and size and send to Box No. 289 Personal Computer World 14 Rathbone Place London W1P 1DE

Which Way?

● If you're lost in the Micro Maze and don't know which way to turn... turn to us

● For impartial advice from an independent consultant... consult us

● For bespoke software designed to meet your needs... you need us.



37 Purbrook Gardens
Purbrook, Portsmouth
(Waterlooville 53775)

		Transdata 01-240 2713	Texas Bedford 67466			Trend 06285 24977	
Model		313	OMNI 820RO	OMNI 825RO	810	RO 800	Cen
Print mechanism type		TH	DM	DM	DM	DM	DM
Line of character		CR	CR	CR	CR	CR	CR
Speed cps	Max	30	150	75	150	30	112
	Min						
Lines/min	Max				440		
	Min				64		
Characters/line	80						
	132						
	other						96
Characters/inch	horizontal				10	10	
Lines/inch	vertical				6/8		6
Proportional spacing							
Bidirectional printing							
Justification							
Multiple copies			5	3	6	3	
Ballistic head							
Matrix format			9x7	9x7	9x7	7x5	9x7
Change print size							
Change type font							
No. in character set		94	128	128	64		96
Headlife (million chrs)							90
Descenders							
Underlining							
Ribbon life (million chrs)	normal						2
	carbon						
Mobius loop type?							
Graphics							
Bidirectional movement							
Pin feed							
Tractors							
Dual tractor							
Paper widths	Min		3	3	3		
	Max		15	15	15		
Friction feed							
Sheet feeder							
Paper cutter							
Serial interface							
Max baud rate		300	9600	600	9600	300	960
Buffer	Opt.						100
	Fixed	64	1280	256	256		
Parallel interface							
Parallel transfer rate (ch/sec)							
Self-test							
VFU							
Switchable forms length							
Punched tape							
8 Channel cartridge							
Electronic + No. channels							
Paper-out sensor							
Measurement in inches	width	16			25	19	19
	depth	10			20	15	15
	height	5			8	6	6
Approx weight (lbs)		12			55	24	25
Cost		£790	£1450	£1090	£1450	£870	

Key:

DM Dot Matrix
DW Daisy Wheel
DR Drum
SW Spin Wheel
GB Golf Ball
CM Comb
CH Chain
PH Print Head
P Pressure Sensitive
E Electro Sensitive
TH Thermal
* Half Space Facility
Optional
Standard

Keypak available from Capital Computer Services, 01-637 5 Logabax LX100 and LX200 from Logabax, 01-965 0061 or Kingston, 0262-73036.

The following supplied information too late to be included grid:

Data Dynamics, 01-848 9781.

Tandy, 021-556 6101.

Whymark, 07372 21753.

PROGRAMS

Nightmare Park

by Bob Chappell

Fight your way through the Gorillas and challenge for those readers with PETs. Blabbers of Nightmare Park. A great Listing courtesy Lion House

```

10 REM**AUTHOR-BOB CHAPPELL 14/5/80**
20 W=RND(TI):S#=""
30 PRINT"WELCOME TO NIGHTMARE PARK." :PRINT"THE SHORTEST ROUTE MAY NOT BE THE BEST."
35 PRINT"YOU MAY ONLY MOVE NORTH,SOUTH OR EAST."
40 PRINT"STAY ON THE PATH." :PRINT"ABANDON HOPE ALL YE WHO"
45 PRINT"ENTER.....":GOSUB9600
50 FORN=1TO5:PRINT"ENTER NIGHTMARE PARK":NEXT:GOSUB9600
60 P#=""
110 P1=33291:P=33291:E3=83:Y1=0
270 GOSUB9600
280 P=P1:PRINT"GO NORTH,S OR E?"
285 GETH#:"H#="" :GOTO285
287 GOSUB9600
290 IFH#="N" THENA=-40:GOTO330
300 IFH#="S" THENA=40:GOTO330
310 IFH#="E" THENA=1:GOTO330
320 GOTO280
330 P1=P+A:IFPEEK(P1)=32GOTO10000
340 IFPEEK(P1)=5 THEN12000
350 POKEP,102:POKEP1,E3
352 X=INT(5*RND(TI)+1):J=4
355 IFP1>33297ANDP1<33315 THENJ=3
357 IFX<JGOTO280
358 Y1=Y1+1
360 X=INT(15*RND(1)+1)
365 IFX=7ANDY1>10GOTO360
370 ONXGOTO1000,1500,2000,2500,3000,3500,4000,4500,5000,5500,6000,6500
380 X=X-12:ONXGOTO7000,7500,8000
1000 B#="" :W#="UNICORNS!":F=94
1002 PRINT"STAMPEDEING!":W#:"PRESS 'L' TO GO LEFT,'R' FOR RIGHT"
1005 X=0:D=32988
1010 GOSUB9700:PRINT"GO":FORN=1TO20:GETH#:"H#="" :NEXT:C=32988:POKEC,E3
1020 FORN=1TOX:A=INT(6*RND(TI)+3):POKEC,32:FORB=1TO2:PRINTSPC(A):B#;SFC(A);
1022 NEXT:GETH#:"H#="" :L" THEND=C-1
1023 IFH#="R" THEND=C+1
1025 POKEC,32:C=D:POKEC,E3
1027 IFPEEK(C+40)=F THENPOKEC+40,170:GOTO1080
1030 NEXT:IFX=50GOTO1070
1040 X=50:B#="" :GOTO1020
1070 GOSUB9600:PRINT"YOU SURVIVED!":GOSUB9600:GOSUB9810:GOTO270
1080 GOSUB9600:PRINT"YOU WERE TRAMPLED!":GOTO9800
1500 W#="BLABBERS!":F=209
1501 PRINT"YOU ARE SURROUNDED BY":W#:"PRESS 'F' TO FIND NOS. BETWEEN 0-8 TO VANQUISH"
1502 E1=INT(9*RND(TI)):E2=INT(9*RND(TI)):E4=INT(9*RND(TI))
1504 D1=F:D2=F:D3=F
1510 POKE33306,E3:C1=32937:C2=32946:C3=32955:C4=33297:C5=33315:C6=33657
1520 C7=33666:C8=33675:FORN=1TO10:POKEC1,32:C1=C1+41:POKEC1,D1:POKEC2,32
1530 C2=C2+40:POKEC2,D2:POKEC3,32:C3=C3+39:POKEC3,D3:POKEC4,32:C4=C4+1
1540 POKEC4,D1:POKEC5,32:C5=C5+1:POKEC5,D2:POKEC6,32:C6=C6+39:POKEC6,D3
1550 POKEC7,32:C7=C7+40:POKEC7,D2:POKEC8,32:C8=C8+41:POKEC8,D1
1555 IFC1=33306 THEN1700
1560 GETH#:"H#="" :GOTO1560
1565 A=VAL(H#):IFA=E1 THEND1=32
1570 IFA=E2 THEND2=32
1580 IFA=E4 THEND3=32
1590 IFD1=32ANDD2=32ANDD3=32 THEN1610
1600 NEXT
1610 PRINT"YOU ARE LUCKY!":GOSUB9600:GOTO270
1700 PRINT"YOU SCORPED!!!!":GOTO9800
2000 PRINT"YOU ARE THE MAD MATHEMATICIAN!!!":PRINT"YOU HAVE 10 SECONDS TO ANSWER"
2005 PRINT"THE FOLLOWING QUESTION CORRECTLY:-"
2010 T=0:GOSUB9600:FORN=1TO6:A=INT(9*RND(TI)+1):T=T+A
2020 PRINTA:"+":NEXT:PRINT"WHAT IS YOUR ANSWER?":A
2030 IFA<T THEN2060
2035 PRINT"YOU ARE CORRECT.....":GOSUB9600
2040 IF(TI-1)>600 THENPRINT"YOU TOOK TOO LONG!!!!":GOTO2070
2050 PRINT"YOU HAVE CHEATED DEATH!":GOSUB9600:GOTO270
2060 PRINT"YOU ARE WRONG!!"
2070 PRINT"PREPARE TO DIE!!!!":GOTO9800
2500 PRINT"DEATH RAYS!! KEEP STILL AND HOPE!":FORN=1TO5:Z(N)=0:NEXT
2510 GOSUB9600:PRINT"GO":POKE33268,E3:FORB=1TO5
2512 F=0:A=INT(14*RND(TI)+5):FORA2=1TOB:IFA=2(A2) THENA2=B:F=1
2515 NEXTA2:IFF=1GOTO2512
2520 Z(B)=A:A1=A+20:FORN=1TO21:PRINTTAB(A);"\ "
2522 A=A+1:FORX=1TO50:NEXTX:NEXTN
2525 IFPEEK(33268)>E3 THEN2550
2527 PRINT"GO":FORN=1TO21:PRINTTAB(A1);"/ " :A1=A1-1:FORX=1TO50:NEXTX:NEXTN
2528 IFPEEK(33268)>E3 THEN2550
2540 PRINT"GO":NEXTB:GOSUB9600:PRINT"GO NEAR THING!":GOSUB9600:GOTO270
2550 GOTO9800
3000 W#="LURGI!":F=42
3005 PRINT"MULTIPLYING":W#:"PRESS 'M' TO REACH THE EXIT"
3010 PRINT"MS=N,2=S,4=N,6=E":GOSUB9700
3020 B=33633:T1=TI:PRINT"GO":POKE32768,5:POKEB,E3
3025 FORN=1TO30:A=INT(930*RND(TI))+32776:IFPEEK(A)=E3 THEN3025
3028 POKEA,F:NEXT:IFTI-1>3600 THEN3200
3030 FORN=1TO6
3035 GETH#:"H#="" :THEN3035
3040 POKEB,32:IFA#="8" THENB=B-40
3050 IFA#="2" THENB=B+40
3060 IFA#="4" THENB=B-1
3070 IFA#="6" THENB=B+1
3080 IFPEEK(B)=F THENPOKEB,209:GOTO3200
3085 IFB>33767ORB<32768 THENB=33633
3090 IFB=32768 THEN3190
3100 POKEB,E3:NEXT:GOSUB9810:GOTO3025
3190 PRINT"YOU ESCAPED!!":GOSUB9600:GOTO270
3200 GOSUB9600:PRINT"YOU WERE MISTAKEN BY":W#:"GOTO9800
3500 PRINT"CRUSHER!! ONLY 1 LETTER WILL STOP IT":POKE33666,E3
3505 X=INT(25*RND(TI))+65
3510 PRINT:FORN=1TO21
3514 PRINT"GO":FORA1=1TO36:PRINT"GO":NEXT:PRINT

```

MICROMART



MICROTYPE STAK-PAK

CASSETTE STORAGE SYSTEM FOR EASY PROGRAM FILING.

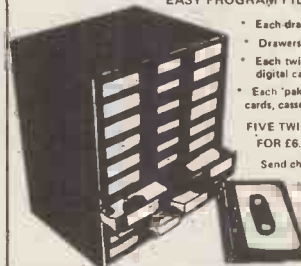

- Each drawer section takes 2 cassettes.
 - Drawers lock together vertically.
 - Each twin pack comes with 2 C10 digital cassettes.
 - Each 'pak' is complete with index cards, cassette and drawer labels.
- FOR £6.60 INC. VAT & P&P.
Send cheques or Postal Orders to:
MICROTYPE, PO Box 104,
HEMEL HEMPSTEAD,
HERTS HP2 7QZ.

TOPMARK Computers

dedicated to
APPLE II

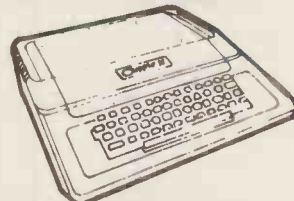

Simply the best!

Full details from Tom Piercy on
Huntingdon (0480) 212563

DOUBLE VISION

80 columns x 24 lines

video display
with upper and lower case
(plug in board)
Compatible with

Apple II

Apple II plus

PASCAL.

Built in light pen capability
Shift lock feature
full 96 ASCII character set

fantastic value £165.00 + VAT

Leicester Computer Centre Ltd.,
109 Queens Road, LEICESTER
LE2 1TT Tel. 0533 708483.

PRIVATE SALE

1 EXIDY SORCERER
WITH 32K RAM
1 S200 EXPANSION UNIT
DUAL DOUBLE DENSITY
DISK DRIVE
£1470

Tel. Ilminster (04605) 4117
or write
D. J'AT Systems
Station Road, Ilminster, Som.

Problems?

SELECTION CAN BE A PROBLEM

HARDWARE, SOFTWARE FIRMWARE, ANYWHERE?

NO - NOT ANYWHERE DROP US A LINE WE'LL GLADLY ASSIST

Eastern Systems Ltd

43 HIGH STREET,
WESTON-SUPER-MARE
AVON

CROMENCO SYSTEM THREE

Once only: A single unit (surplus to requirements) comprising:
20 slot S100 motherboard
Z80A 2/4Mhz Microprocessor PCB
1 MByte Floppy Disk
Parallel Printer Controller
Full Manuals
CDOS operating system
Structured Basic and Screen Editor
System Utilities, XFER,ASM,STAT etc

Only £3500.00 VAT paid

Write to Box No 205
Personal Computer World
14 Rathbone Place
London W1P 1DE



OVERPRICED COMPUTERS INADEQUATE PERSONAL MICROS?

Modata supply Dealers and OEMs with Digital Microsystems competitively priced Single and Multi-User computers which include Reliable Floppy and Hard Disk storage.

ie.DSC-2: Z80 at 4MHz + 64Kb +
2 x SSDD 8" Floppies for 1Mb + CP/M
£3525 E.U

WHY NOT FINDOUT MORE?
0892 41555

Modata Ltd. 30 St. Johns Road,
Tunbridge Wells, Kent TN4 9NT

MINE OF INFORMATION LTD

1 FRANCIS AVENUE,
ST ALBANS AL3 6BL
ENGLAND

Phone: 0727 52801
Telex: 925 859

MICROCOMPUTER CONSULTANCY & BOOK SELLERS

FUN & GAMES

```

3515 IFD>20THEN3540
3520 GETA$ :IFA$="" :GOTO3520
3530 IFASC(A$)=>THEN3590
3540 NEXT PRINT "GAME RUSHED!" :GOTO9800
3550 PRINT "TIME CAPED!" :GOSUB9600 :GOTO270
4080 PRINT "WELCOME TO THE START!!!" :P1=33291 :GOSUB9600 :GOTO270
4500 PRINT "MANIACAL MEMORY TESTER!!" :PRINT "MEMORISE THIS TO PACIFY HIM!"
4510 GOSUB9700 :FORI=1TO5 :Z(N)=INT(2*WRND(TI)+65) :NEXT :PRINT "0000000000000000"
4520 :FORI=1TO5 :PRINTCHR$(Z(N)) :NEXT :FORI=1TO500 :NEXT :PRINT "0000"
4530 :FORI=1TO5 :PRINT "WHAT WAS LETTER?" :NEXT :PRINT "0000"
4535 GETA$ :IFA$="" :GOTO4535
4537 PRINTA$ :IFASC(A$)<2(N)THEN4560
4540 NEXT :PRINT "WELCOME!!" :GOSUB9600 :GOTO270
4560 PRINT "WELCOME!! CURTAINS FOR YOU!" :GOTO9800
5000 PRINT "WELCOME!! OF BARRS!!" :PRINT "ACROSS YOUR FINGERS!"
5010 C=33508 :GOSUB9600 :PRINT " " :B$="" :POKEC,3 :FORI=1TO15
5040 A=INT(4*WRND(TI)+3) :FORB=1TO6 :PRINTSPC(A);B$;SPC(A); :NEXT
5070 :FORI=1TO250 :NEXT
5100 NEXT :GOSUB9600 :IFPEEK(C)<E3THEN5120
5110 PRINT "WELCOME!! MISSED!" :GOSUB9600 :GOTO270
5120 PRINT "WELCOME!! MISSED!" :GOTO9800
5500 PRINT "WELCOME!! THE EGOTISTICAL GORILLA!!" :PRINT "TELL HIM HIS NAME OR BE!"
5510 PRINT "DISMANTLED!!" :PRINT "A FLASH OF LIGHTNING REVEALS IT BRIEFLY"
5520 A=INT(4*WRND(TI)+1) :IFA=1THENA$="CLARENCE"
5530 :FORI=1TO6000 :NEXT :IFA=2THENA$="PERCIVAL"
5540 :IFA=3THENA$="STALEY"
5550 :IFA=4THENA$="WINSTON"
5555 A=INT(15*WRND(TI)+3) :FORI=1TOA :PRINT " " :NEXT
5560 PRINTA$ :FORI=1TO150 :NEXT :PRINT "WELCOME!! WHAT'S MY NAME?" :INPUTB$
5570 PRINT "WELCOME!! UH...ERR... DAT IS... " :GOSUB9600 :IFB$<>A$GOTO5590
5580 PRINT "CORRECT!! RIGHT!!" :GOSUB9600 :GOTO270
5590 PRINT "WRONG!! RIP!! CRACK!!... SQUASH!!..." :GOTO9800
6000 PRINT "WELCOME!! THE DOORS!!" :PRINT "BEHIND ONE IS A STARVING LION!"
6010 :FORI=1TO3 :A$(N)=" " :NEXT :PRINT " " ;TAB(8);"1";TAB(18);"2";
6020 :PRINTTAB(28);"3" :A1=4 :GOSUB9600 :FORI=1TO3 :A$(N)=" " :NEXT
6030 PRINT "WELCOME!!"
6035 GETA$ :IFA$="" :GOTO6035
6037 X=VAL(A$) :A1=INT(3*WRND(TI)+1) :E=1000
6040 GOSUB9600 :GOTO6150
6070 A=6 :FORB=1TO3 :PRINT "WELCOME!!" :FORI=1TO7 :PRINTTAB(A);A$(B)
6080 :IFB=3ANDB=A1THENA$(B)="LION!"
6090 :IFB=4ANDB1<4THENA$(B)=" "
6100 :FORC=1TO200 :NEXT :NEXT :A=A+10 :NEXT :RETURN
6150 PRINT "WELCOME!!" :IFA<>XTHENPRINT "FORTUNE HAS SMILED ON YOU!" :GOSUB9600 :GOTO270
6160 GOTO9800
6580 B$="" :W$="" :STINGERS! :F=30 :GOTO1002
7000 W$="WARRIORS!" :F=25 :GOTO1501
7500 W$="ZIGZAGGERS!" :F=26 :GOTO3005
8000 PRINT "WELCOME!! THE GRUESOME GAMBLER!!" :PRINT "WELCOME!! CHALLENGES YOU TO THROW A";
8005 PRINT "HIGHER OR" :PRINT "LOWER DICE ROLL, UNFORTUNATELY, HE WONT";
8007 PRINT "MERRY WHICH UNTIL AFTER YOU THROW!!" :PRINT "YOUR LIFE IS THE STAKE."
8010 GOSUB9700 :GOSUB9600 :PRINT "WELCOME!! THROWS...";
8020 A=INT(6*WRND(TI)+1) :B=INT(6*WRND(TI)+1) :PRINT " " ;A ;" AND " ;
8022 GOSUB9600 :PRINT " " ;B ;" D=A+B :PRINT " " ;" D :GOSUB9600
8025 PRINT "WELCOME!! WILL YOU TRY FOR A HIGHER OR" :PRINT "LOWER SCORE (H OR L)"
8030 GETA$ :IFA$="" :GOTO8040
8040 :IFA$="H"THENA$=6 :B=6 :GOTO8050
8042 :IFA$="L" :GOTO8030
8045 A=3 :B=3
8050 A=INT(6*WRND(TI)+1) :B=INT(6*WRND(TI)+1) :PRINT "WELCOME!! YOU THROW...."
8060 PRINT " " ;A ;" AND " ;
8062 GOSUB9600 :PRINT " " ;B ;" A=A+B :PRINT " " ;" A :PRINT " " :GOSUB9600
8070 GOSUB9600 :PRINT "WELCOME!! THE BET WAS THAT HE WOULD SCORE " ;
8072 B=INT(2*WRND(TI)+1) :IFB=2THENPRINT "LESS!" :GOTO8100
8075 PRINT "MORE!" :GOSUB9700 :IFD>ATHEN8200
8080 GOTO8150
8100 GOSUB9700 :IFD<ATHEN8200
8150 PRINT "WELCOME!! CURSES!! YOU WIN!!" :GOSUB9600 :GOTO270
8200 PRINT "WELCOME!! YOU LOSE!" :GOTO9800
9000 PRINT "WELCOME!!"
9010 PRINTTAB(10);LEFT$(P$,12)
9020 :FORI=1TO2
9030 PRINTTAB(10);" " ;" " ;" " :NEXT
9040 PRINTTAB(10);LEFT$(P$,12);" "
9050 :FORI=1TO2
9060 PRINTTAB(10);" " ;" " ;" " ;" " :NEXT
9070 PRINT "IN " ;LEFT$(P$,24);" "
9080 PRINTTAB(10);" " ;" " ;" " ;" " ;" " :NEXT
9090 :FORI=1TO3
9100 PRINTTAB(10);" " ;" " ;" " ;" " :NEXT
9110 PRINTTAB(10);" " ;" " ;LEFT$(P$,18)
9120 :FORI=1TO2 :PRINTTAB(10);" " ;TAB(19);" " ;" " ;" " :NEXT
9130 PRINTTAB(10);LEFT$(P$,21)
9140 POKEP,83
9150 PRINTTAB(15);"WELCOME!! NIGHTMARE PARK!"
9160 RETURN
9500 PRINT " " ;" " :FORI=1TO7 :PRINTS$ :NEXT :RETURN
9600 :FORI=1TO2000 :NEXT :RETURN
9700 :FORI=1TO4000 :NEXT :RETURN
9800 GOSUB9600 :PRINT "WELCOME!! NIGHTMARE PARK CLAIMS ANOTHER VICTIM!!!"
9802 GOSUB9810 :END
9810 :FORI=1TO20 :GETA$ :NEXT :RETURN
10000 PRINT "WELCOME!! YOU FELL INTO THE ABYSS!!!" :GOTO9800
12000 PRINT "WELCOME!! YOU BEAT THE PARK THIS TIME" :PRINT "BUT NEXT TIME....."
12010 GOTO9800
    
```

BLUDNERS

Apologies for not mentioning Ian Jones of the Mighty Micro in our Stringy Floppy review — he lent us the machine for the photographs.

In June's case study we erroneously gave Kestrel's phone number as Hitchin — it should have been Hemel Hempstead 69175. (Gulp! — Sorry Kestrel)

Young Computer World Program Cont. from Page 89

```

450 POKEP,65 :POKEJ,32 :J=P
460 D=D+1 :IFD=7 :INT(D/40)*40 THEN POKEP,32 :GOTO1000
470 POKED,43 :POKED+1,61 :POKED+2,45 :POKEL,32 :L=D
480 GOTO430
1000 REM MISSILE FIRE
1006 P=P-40
1007 IFP<32768 THEN I030
1010 POKEP,65 :POKEJ,32 :J=P
1020 GOTO1006
1025 F3=F3+1
1030 POKEJ,32 :GOTO320
3000 PRINT "WELCOME!! THE ALIEN FLEET HAS PASSED, OUT OF 9 "
3001 PRINT "ALIENS? 9-F3 WERE LEFT TO "
3005 PRINT :PRINT "ATTACK THE BASE"
3010 FORT=1TO10 :GETR$ :NEXT
3011 IF F3<F4 THEN PRINT :PRINT "THIS IS THE HIGHEST SCORE SO FAR": F4=F3 :GOTO3010
3012 PRINT :PRINT "TODAYS HIGHEST SCORE IS "F4" HITS": PRINT
3016 IF F3=9 THEN PRINT :PRINT "THE BASE IS SAVED YOU ARE A HERO!!!!!!!"
3017 IF F3=8 THEN PRINT :PRINT "THE LAST ALIEN CRAFT WAS DESTROYED ON ITS ATTACK RUN"
3018 IF F3<2 THEN PRINT "THE ALIENS MADE A THOROUGH JOB OF IT, ALL IS LOST!!!"
3019 PRINT :PRINT "GRTQ PLAY AGAIN PRESS ANY KEY"
3020 GETR$ :IFR$="" THEN3020
3030 F3=0 :E=0 :GOTO1
4000 PRINT "WELCOME!! YOU USED UP YOUR AMMO, OUT OF 9 ALIEN": PRINT
4010 PRINT "CRAFT, "9-F3" SURVIVED TO RAVAGE THE BASE"
4020 PRINT :PRINT "YOU DESTROYED "F3
    
```

```

● 4030 G0T03010
10000 A=42:G0SUE20000:A=160:G0SUB20000:A=102:G0SUB20000:A=81:G0SUB20000:F=F+1
10015 F3=F3+1
● 10016 A=87:G0SUB20000:A=46:G0SUE20000:A=32:G0SUB20000
10020 G0T070
20000 P0KEP:A:P0KEP+1,A:P0KEP-1,A:P0KEP+40,A:P0KEP-40,A
● 20010 P0KEP+2,A:P0KEP-2,A:P0KEP+80,A:P0KEP-80,A
20020 P0KEP+39,A:P0KEP+41,A:P0KEP-41,A:P0KEP-39,A:RETURN
50000 PRINT"G♥"
● 50010 PRINTTAB(13)"SPACE DEFENCE!"
50040 PRINT:PRINT:PRINT" YOU ARE THE WEAPONRY OFFICER OF THE ":PRINT
50050 PRINT"ASTEROID BASE AT THE TIME OF THE ALIEN "
● 50060 PRINT"ATTACK.
50065 PRINT"GRRPRESS ANY KEYG_"
50066 GETR$:IFR$=""THEN50066
50067 PRINT"G♥"
● 50070 PRINT:PRINT" YOUR SCANNERS TELL YOU THAT 9 ":PRINT
50080 PRINT"ALIEN SHIPS ARE THUNDERING ACROSS":PRINT
50090 PRINT" THE SURFACE TOWARDS THE COMPLEX!"
● 50100 PRINT:PRINT" YOU HAVE TIME ONLY TO ENGAGE THE ":PRINT
50110 PRINT"WEAPONRY COMPUTERS,BUT NOT THE TARGET ":PRINT
50120 PRINT"COMPUTERS:-YOU WILL HAVE TO TAKE THE ":PRINT
● 50130 PRINT"ALIENS ON BY YOURSELF AND ON MANUAL!!!!"
50140 PRINT" YOUR MISSILE SYSTEMS ,NUMBERED FROM ":PRINT
50150 PRINT" FROM 1T09 ARE ACTIVATED BY KEYING IN ":PRINT
● 50160 PRINT"THE APPROPRIATE NUMBER ON THE KEYPAD,YOU"
50170 PRINT"HAVE TO SCORE A DIRECT HIT TO DESTROY ":PRINT
50180 PRINT"THE ALIEN CRAFT!!GRRPRESS ANY KEY TO BEGING_G♥"
● 50190 GETR$:IFR$=""THEN50190
50200 G0T010
60005 W2=W2+40
60015 P0KEW3,32
● 60016 W3=E9

```

Note:G precedes a screen control key.

Getting it Taped Cont. from P. 71

```

0C60 File Number (1)
0C61 Record Size (1)
0C62 Read/Write Ind (1)
0C63 Unit Number (1)
0C64 Date (3)
0C67 Response Code (1)

```

Fig 8 OPEN block.

Using TSAM

To open a file the user program loads the file number of the file required into 0C60H. The Read/Write indicator (0C62H) is set to 1 or 2 according to whether an existing file or a new file is to be opened. In the case of a new file, the record size is moved to 0C61H whereas for an existing file, TSAM will set this from the file header block.

Having done this, a call can then be made to OPEN. This will communicate with the operator via the screen, telling him what files to load and on what deck and whether to engage the deck for

reading or recording.

Having completed its task, OPEN will set the response code (0C67H) to reflect the result of the operation and return to the calling program at the instruction immediately following the call.

To write a record the file number is loaded in 0C60H and the record is moved to the buffer starting at location 0C78H. A call to WRITE is then made. Using the R/W control block which OPEN created, WRITE will know how much of the buffer to write and onto what deck.

To read a record, a call is made to READ having set 0C60H. READ will place the record in the buffer starting at 0C78H and a response code will be returned in 0C67H. This will indicate the end of the file when this is the case.

To close a file, simply set 0C60H and call CLOSE.

To those venturing into developing their own software — good luck. Should you need to know more do not hesitate to write to me at 229 Derby Road, Beeston, Notts. NG9 3AZ.

Super System cont. from page 73

whether played by the machine or not. Just for fun I allowed System III to have the pleasure of making the mating move this time(!) — (the asterisk before the move indicating that it was played by the computer).

Printout

System III was the first chess machine to observe all the important rules of chess. Long gone (by a year at least!) are the days when one could complain about chess computers which made illegal moves, could not castle or observe the formalities when it came to making 'en passant' captures. However, at the time of writing, System III is still, after almost a year, the only one which recognises the important rules concerning draws by three-fold repetition of position and under the so-called '50-move rule'. According to the latter rule a game is drawn after 50 moves by each side (100 ply) if in that time no pawn is moved and no piece is captured.

System III is also much better than any other machine on the market at solving chess problems. A problem is a

composed position, not one which arose in the course of a game. You often see chess problems in newspaper columns and can recognise them by the caption which is always of the type 'White to play and mate in x moves'. System III can solve any problem, up to and including mate in 5 moves (9 ply).

My thanks go to Andrew Page and Michael Hicks-Beach of Action Gable, System III's UK distributors, for the loan of a complete system. Next month I shall be looking at Sargon 2.5. Since you will undoubtedly be going to the PCW show, why not take a look yourself at the programs competing in the First World Microprocessor Championship. I expect to be in attendance every day and look forward to meeting some of you there.

The main System III unit can be bought for about £150 and the entire system, complete with smart carrying case is available for around £400.

*Chess Champion Super System III is used as a trade name on the Continent; in the UK it is known as Chess System III/Chess Master, and in the USA as Chess System III/Grandmaster, hence my uniform reference to System III.

MICROMART

To advertise in
MICROMART
Please ring Jacquie Hancock
on 01-631 1682

APPLE or 2020

80 char. x 24 row video board upper & lower case. Plug into slot 3 & update your basic disc with supplied master.

English video output a b/w monitor.

£210 + p/p + VAT = £244.95

Pascal update disc = £20 + VAT.

Blink/non blink cursor. Supports light Pen. Updates old F8 rom to new type editing functions.

Ideal for professional applic.

Mail Order:

DMS Electronics

South Anston, Sheffield S31 7EX
0909-78-3918

NORWICH

The computer store that puts you on
the right road

Sales, Service and Software

Professional systems and home
computers by CompuCorp,
Commodore and Adler.

Commodore Software, Appointed
stockist. Pet Soft Software

COME AND SEE THE
PROFESSIONALS

SUMLOCK BONDAIN (EAST
ANGLIA) LTD
32 PRINCE OF WALES ROAD
NORWICH
Tel NORWICH (0603) 26259

WESTFARTHING COMPUTERS

Thinking of a computer?

Independent professional advice can
save your firm thousands and ensure
you get a useful, reliable system. We
charge a consultation fee but do not
take commissions on sales, so our
recommendations are unbiased.
National service.

Phone Helston (03265) 4098 for
brochure.

Also complete systems supplied, with
local software and hardware experts.

MICROCOMPUTER CONSULTANTS



Micro-Computer Centre for the MIDLANDS

Nascom and Commodore Specialists

A full range of micro computers and peripherals are available, whether buying or browsing we can give helpful and friendly advice.

Commodore Business Systems are suitable for the professional office, the small business or the sole trader. We will be pleased to give advice and a demonstration.

Nascom 2 systems can be fully built and tested to order. We are sole distributors for the Micro Type case for Nascom 1 and 2, also stockists of the William Stuart colour graphics and full range of 'add-ons'.



Business & Leisure Micro Computers

16 The Square, Kenilworth, Warwickshire CV8 1EB.
Tel: (0926) 512127

FOR ALL YOUR MAIN REQUIREMENTS FROM ONE SUPPLIER JUST LIFT THE PHONE...

0252-518022/518717

Continuous Stationery — all types pre-printed including letterheads.

Listing Paper — all sizes. Continuous labels — plain and printed. Printer ribbons, Pet, Anadex etc.,

3M Data Recording Products
ACCO Continuous Stationery filing systems

A FEW OF OUR OUTSTANDING BARGAINS

3M Personal Digital Computing
Cassettes 10min
Individually boxed 47p each, minimum order 10
30min
53p each, minimum order 10

5¼" Mini Diskettes, 100% error free, storage box. £2.25p each, minimum order 10 as above put in plastic library case £2.46p each, minimum order 10

8" Diskettes, 100% error free, storage box, (state type)
From £2.60p each, minimum order 10 as above but in plastic library case
From £2.85p each, minimum order 10

* NEW LINE — Smart Diskette binder, anti static, holds 20. 5¼" £15.25 each as above but for standard 8" Diskettes £17.25 each

Add VAT and 80p post & packing for each item ordered, all despatched within 24 hours.

11 x 9½" Plain listing 60 gsm, boxed 2000 sheets only £14.00 per box.

* ACCO paper binders, a must for all stationery filed or regularly used, from £1.86 each

* NEW LINE — Genuine A4 size continuous letterheads, for FREE quotation for letterheads or any other form, send sample and state quantity required.

PERSONAL CALLERS & TRADE ENQUIRIES

WELCOME

Clearsons Ltd.

Lynwood House 1 Camp Road Farnborough
Hampshire GU14 6EN

IF

..... you want the best service
you need professional advice
years of experience impress you
you are trying to find the best computer equipment
as well as the finest software

MICROSOLVE

is the Company to contact

MICROSOLVE COMPUTER SERVICES LTD

3rd Floor (rear),
MIDDLESEX HOUSE,
29-45 High Street,
EDGWARE,
Middlesex.

(exit 4 M1/20 mins. West End).
(prices ex. VAT)

01-951 0218/9/0

We cover a full range of equipment including the APPLE II (from £695/16K); the MICROSTAR multi-user system (from £4,950) and the powerful ALPHA MICRO which will run 1 to 22 terminals — the most cost effective system available today.

WE OFFER A COMPLETE SERVICE which encompasses advice, systems design, sale and installation of computer and peripherals, as well as tailor-made software, where necessary. There are fully documented ACCOUNTING and WORD PROCESSING PACKAGES etc., for Accountants, Solicitors, Manufacturers, Retailers, Medical Practitioners in fact all business applications.

ALSO in stock are PRINTERS, VDUs, CONTINUOUS STATIONERY, DISKETTES, DISK BOXES, all from the best names in the computer world — TEXAS, LEAR SEIGLER, TALLY, QUME, PAPER TIGER etc.

So if you either wish to buy a computer to program yourself or take advantage of our service TELEPHONE NOW FOR AN APPOINTMENT.

MICROSOLVE MICROSOLVE

**TRS-80 owners!!
Double Disk Capacity
with the Phantom
Double-Density Module**

Provides double density modification to your current TRS-80 Expansion interface
Increases storage capacity up to 204K bytes (on single 40 track drive.)

Includes all hardware and software.

£165



**Load
Fast!**

TRS-80 programmes & data

with the Phantom Disk Drive system

*23% more storage capacity than TRS-80
*40 track patch at no Extra charge.
Two drive system £495
Four drive system £935
Two drive cable £20
Four drive cable £30

NEW



Single drive system

£265

The only 16k complete computer for under £400

Keyboard computer, power supply, UHF modulator and all cables to plug into your own TV set and cassette recorder and go!!
16K of user RAM for decent size programmes and data, sophisticated level II Microsoft BASIC.
Complete with level I and level II programming manuals. What more could you ask?

EX-STOCK



Now! Numeric keypad included

TRS-80
£382

Expansion interface £199.09
4K level I computer £251.30

This lot must be today's best buy!

**Galaxy 2000
by Compu/Think**

(.8 Megabyte Disks) £2,950
(2.4 Megabyte Disks) £3,960

SPECIAL - GALAXY prices include Compu/Think Pagemate Database and Report Writer at no charge

The most advanced complete microcomputer system available. Includes CPU, 12" CRT, full keyboard, 2 quad-density disk drives, 2 megahertz 6502 hybrid processor (double speed), 108 K system memory, high resolution (512 x 240) graphics, programmable character fonts, microsoft extended BASIC, DOS with random access I/O, full complement of I/O ports, monitor with debug, trace and tiny assembler, fifth (PL/M and fourth combination) interpreter, complete editing and entry with split screen capability, 64 microprogrammable opcodes, business software (with Database) available.



EX-STOCK

2001-8N
(8K RAM New large keyboard)

£425

NEW 80-Col.
32k £825

Super-Pets are here!

40 & 80 COLUMN

Now you can

- list unlistable programmes using the 6502 non-maskable interrupt facility! - just hit the new 'abort' button to jump out of programme into command mode
- recover from crashes without switching off - just hit the new 'reset' button.
- add sound to your programmes!

The hardware is built-in - just write sounds into your programme using our simple directions.

2001 - 16N (16K RAM and new large keyboard) £550
2001 - 32N (32K RAM and new large keyboard) £690

External cassette deck, suitable for all Pets £53
CBM dual drive mini floppy £695
Tractor feed printer with Pet graphics £395
Pet high-res. graphics 200 x 320 £259

Get into print this easy way!



EX-STOCK

**Anadex DP 800
dot-matrix printer**

*Speedy 112 ch/s bidir.
*Fits A4 page-up to 80 cols.
*Up to 4 copies. *Precision form-filling with sprocket feed. *Special headings using double-width chars. *Modern paper format to match A4 filing systems. *Other paper sizes with adj. sprocket.
*Full punctuation, U/L case, £ sign, 96-ch. set.
*Reliable - strongly built. 100 M.ch. head.

Knock down price!

£499

Interfaces and cables -
Pet £45 Ohio £30
TRS-80 £40 Sorcerer £25
Apple £69



**IBM golfball printer
ideal for
word-processing**

*Forget expensive Spin-Wheel printers - the Golfball produces equal quality at up to 15 ch. per sec. *Match various typewriter styles with IBM interchangeable heads.
*Completely reliable - each machine rebuilt by IBM trained engineers and fully guaranteed. *Precision form-filling possible with 15 in. pin-feed platen.

Non-keyboard version

£595

Keyboard version £695 (illus)
Interfaces and cables -
Pet £45 Ohio £63
TRS-80 £35 Sorcerer £25
Apple £69



**Phantom 400/800
Thermal Printer**

*Stop disturbing others with noisy printout! *Neat, clear, 96-ch. set, U/L case & symbols, in text mode.
*Fast, 48 ch/s bidir. *Reliable - robust - only two driven parts.
*Plug in and go, built in PSU, detailed manual. Thermal paper in 80 ft rolls less expensive than electro-sensitive paper and now - dot hyphen addressable graphics too!!

For only **£249** (40 col) A snip!

80 col model (800) £359
Interfaces and cables -
Pet £45 Ohio £63
TRS-80 £40 Sorcerer £25
Apple £69

Up to 1.6Mb for PET!

and 'on-line' with the CompuThink Disc System

*Allows powerful business programmes using 16 Extra BASIC commands. *Easy to connect and use - plugs directly into 16/32K PETs, detailed manual supplied.
*Simple startup (no difficult procedures to remember) as Disc Op. System in ROM. *Ready to run - useful programmes supplied free; full set of professionally written business packages available - Sales and Purchase Ledger, Stock Control, Payroll etc., *Real-Time processing, Engineering and Commercial boundaries overcome with full language support - Business BASIC, Assembler, FORTRAN, COBOL, PASCAL, FORTH, FIFTH, PLM, PILOT & CESIL.

24K Memory expansion with dual disc: for old ROM 8K PET £275 for new ROM 8K PET £320



Basic 400K
dual disc
system

only

£840

800K £1,095
1.6 Mb £2,190

EX-STOCK

**You can afford to
start computing now!**

Fully tested complete with 4K RAM. Extra 4K RAM £35

£220

*Powerful programming possible - 6502 processor, fast 8K Microsoft floating-point BASIC (easy to learn). Superior utilities, 53 key key-board, giving upper and lower case, user-definable keys, gaming and graphics chs. Ultra-fast and powerful machine code from keyboard.

*No intricate soldering or metal work. Computer supplied assembled in ready-made case. *Reasonable sized programmes in 4K RAM. *Expandable to 24K RAM in case, drives discs, printer, available items include Assembler/Editor and Extended Monitor. *Programme interchangeability/reliability - Kansas City tape interface. *Save programmes on own cassette recorder - all cables supplied.

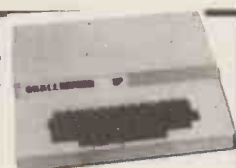

at a lower price than equivalent kits



LTD.

your dealer for Bath, Bristol and S.W

Tel: Bath (025) 333232

5 Cleveland Place East, London Road, Bath, BA1 5DJ.

Special terms available for educational and government establishments - dealer enquiries invited.

24 hr ordering service
Full after-sales service in our own workshops
One year guarantee on all new machines



Please add £10 Securicor delivery on computers etc plus 15% VAT on all prices



Scotland's Complete Microcomputer Service

now supply and support:

HARDWARE:
 Apple II Systems and Peripherals
 Commodore Business Systems
 A wide range of VDUs, printers, etc.

SOFTWARE:
 Incomplete Records Accounting
 Sales Ledger
 Purchase Ledger
 Nominal Ledger
 Stock Control
 Payroll
 Word Processing
 Database

Software can be tailored to your requirements or written completely to your specifications.

Our service is comprehensive, ranging from advice on system selection through installation and implementation, to operator training and comprehensive Hardware and Software maintenance.

You don't have to take our word for it.

Call us and arrange a demonstration. **GATE MICROSYSTEMS LTD.,**
 THE NETHERGATE CENTRE,
 66 NETHERGATE,
 DUNDEE.
 TEL: (0382) 28194.

New low book prices

Also dealers for Acorn, Apple, Microstar and Alpha Micro.



CompUtopia
 LIMITED

30 Lake Street, Leighton Buzzard, Bedfordshire
 Tel: (0525) 376600 24 hour Answering Service.

BASIC & BASIC PROGRAMS

Microsoft Basic Knecht.	£7.20
The Mighty Micro Chris Evans.	£5.90
32 Basic Programmes for the PET Rugg/Feldman.	£10.50
The PET Revealed Hampshire.	£10.00
Mind Appliance T G Lewis.	£5.20
Introduction to Microcomputers Vol 0 -- The Beginner's Book Adam Osborne	£5.00
Introduction to Microcomputers Volume 1 -- Basic Concepts Adam Osborne	£6.30
G402 6502 Games Book Zaks.	£8.20
Peanut Butter & Jelly Guide to Computers Jerry Willis	£6.60
C201 Microprocessors: from Chips to Systems Rodney Zaks	£7.90
Illustrating BASIC Donald Alcock	£2.80
Microcomputers in the Three R's: A Teacher's Guide Christine Doerr	£5.40
Little Book of BASIC Style: How to write a program you can read John Nevison	£5.40
Programming in BASIC for Business Bosworth/Nagel	£6.90
Basic Handbook David Lien	£11.30
BASIC and the Personal Computer Dwyer/Critchfield	£11.90
Computer Programs that Work! Lee/Beech/Lee.	£4.00
Basic Computer Games David Ahl (Ed)	£5.90
More Computer Games David Ahl (Ed)	£5.90
Some Common BASIC Programs Poole/Borchers.	£7.90

6502/6800/8080/Z80

8080A/8085 Assembly Language Programming Lance Leventhal.	£8.20
Z80 Assembly Language Programming Lance Leventhal.	£8.60
Z80 Microcomputer Handbook William Barden.	£6.90
Sargon: A Computer Chess Program Dan & Kathe Spracklen	£9.50

6800 Assembly Language Programming Lance Leventhal.	£8.00
6502 Assembly Language Programming Lance Leventhal.	£8.90
C202 Programming the 6502 Rodney Zaks	£8.20
First Book of KIM Butterfly et al.	£7.50
D302 6502 Applications Book Rodney Zaks	£8.50
Programming a Microcomputer: 6502 Microprogram- ming MOS' KIM-1 Caxton C Foster.	£7.50
Practical Introduction to Pascal Wilson/Addyman	£4.40
Pascal User Manual & Report Jensen/Wirth	£6.80
Introduction to Pascal Welsh/Elder	£7.60
Programming in Pascal Peter Grogono	£8.80
Microcomputer Problem Solving using Pascal Kenneth Bowles.	£8.90

OTHER READING

Cheap Video Cookbook Don Lancaster	£4.40
How to Build a Computer-Controlled Robot Tod Loofbourrow.	£5.10
C207 Microprocessors' Interfacing Techniques Lesea/Zaks.	£9.50
Computerisation for the Small Business Cluff	£5.30
How to Profit from your Personal Computer T G Lewis	£5.70
Vol 1 Fundamental Algorithms Donald Knuth	£11.00

Books will be despatched within 24 hours or our acknowledgement giving precise delivery date. All prices include p&p within the UK. Outside the UK please add 10% or 20% for foreign currency and Eurocheques.

For details please contact 30 Lake Street, Leighton Buzzard. Tel: (0525) 376600. When ordering please state your Barclay-card number or send your cheque/postal order.

Superboard II

8k MICROSOFT BASIC 4k RAM
- comes ready built (no hidden kit repair charges)
fully expandable to 32k dual floppy
system with printer.

Standard Superboard 50Hz £159.95 + VAT
610 Expansion Board 8k RAM
ONLY £159.95 + VAT

IP CD3P Minifloppy Disc, Cased,
PSU, 2 copies DOS ONLY £275 + VAT

4k RAM ONLY £24 + VAT
Plastic Case, Beige ONLY £26 + VAT

Challenger IP-Metal Cased, Superboard, PSU modulator ONLY £219 + VAT

NEW BUILT
48 X 32 VIDEO
VERSION
£199 + VAT

50Hz version
- NO FLICKER

Super Print 800

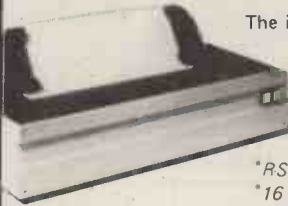

Probably the most
highly featured
printer for the
lowest cost!

80 COLUMN HIGH
PERFORMANCE IMPACT PRINTER

The ideal companion for PET, APPLE, TSR80,
Exidy, Superboard, Compukit, Ohio
Challengers and most micro's

Rugged metal enclosure makes it ideal
for home computing, small business
systems, data logging etc.

*RS-232, 20mA, IEEE 488 and Centronics I/O
*16 Baud Rates to 19,200

*60 Lines per minute - Bidirectional

*5 print densities 72,80,96,120 or 132 Chr/Line

*Self Test Switch *2k Buffer

*Tractor and Fast Paper Feed/Graphics

Model 800 MST ONLY £399 + VAT

Low price PETS
- large keyboard
16k - £499 + VAT
32k - £599 + VAT



SOFTY

INTELLIGENT
EPROM PROGRAMMER

Connects directly
to TV. Develop,
Copy, Burn,
Verify 2708, 2716 and with modification 2516.

ONLY £120 + VAT Built & Tested
£100+VAT Kit. £20+VAT Built Power Supply

!!!! SPECIAL SCOOP !!!!

Verbatim Discs in fives

5 1/4" - £1.85 (each) + VAT

8" - £2.20 (each) + VAT

VIDEO GENIE based on TRS80



Utilises Z80, 12k level II Basic, 16k RAM,
Integral Cassette Deck, UHF O/P,
all TRS80 features ONLY £369 + VAT

ZT DRIVING COMPUTER

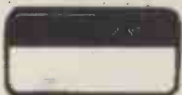

NEW

*MPG Instant *MPG Average *Gals. used
since fillup *Miles to empty *Elapsed time
*Time to empty ONLY £77.50 + VAT

STRINGY FLOPPY



NEW

Combines economy of cassette with speed &
reliability of disc. (TRS80 exp.int.not req.)
ONLY £159 + VAT (inc. 20 wafers (Tapes))

Mighty Micro

In association with Watford Electronics

BUY IN CONFIDENCE - In the event that we are unable to deliver your goods within 7 days, we do not bank your remittance until such time we have the goods to despatch. If on receipt of your order, the goods do not meet with your satisfaction, return within 7 days for full refund. All goods covered by manufacturers guarantee.

Please add VAT at 15%. Carriage extra, will advise at time of order. Official orders welcome. Product details on request. Trade and export enquiries welcome.

33 CARDIFF ROAD, WATFORD, HERTS. Telephone: (0923) 38923

PO Box 17, 61 NEW MARKET SQ, BASINGSTOKE, HANTS. (0256) 56417

Mail Order and Enquiries to Basingstoke



Happy Memories

4116	200ns	£3.95	4116	150ns	£5-50
2114	200ns	£3.45	2114	450ns	£3.45
2708	450ns	£4.95	2716	5 volt	£13.50

MEMOREX mini discs soft sectored £19-95 per ten

WE'VE MOVED!

All prices include VAT. 30p postage on orders
below £10. Access & Barclaycard. All orders to:

Dept.PCW

Happy Memories

Gladestry,
Kington, Herefordshire HR5 3NY
(054422) 618

INTERACTIVE Data Systems

Interactive Data Systems

14 Buckman Close - Greenleys - Milton Keynes - MK12 8AB
Telephone (0908) 313997

DATA PROCESSING SYSTEMS - INDUSTRIAL CONTROL SYSTEMS
Sales - Design - Manufacture

THE BRITISH \$100.

At last you can buy a range of \$100 boards manufactured to the highest standards in the U.K., compatible with the new I.E.E. \$100 specification and competitive in price with anything the Americans can throw at us.

Z80 CPU. A basic 4MHz CPU board with all the logic and buffers required to drive the \$100 bus.
Kit £84 A & T £105

SBMC A 4MHz Z80 single board microcomputer featuring 2 RS232 ports (or 20mA) with full handshaking, 1K of scratchpad memory, up to 16K of EPROM and a 4 channel counter/timer/vector interrupt.
Kit £178 A & T £235

16K SRAM This is a 16K static memory board utilising the industry standard 2114 memory chip.
Kit £174 A & T £198

FDC Any combination of 8" and 5", single or double sided floppy disk drives can be handled in single or double density with this board.
Kit £177 A & T £198

TERM 40 Active termination board for reduction of crosstalk and ringing in the bus.
A & T £32-50

Information PCI Process Control Interface, 8 channels relay isolated output, 8 channels opto-isolated input, 8 bit TTL I/O, 4 x 8 bit D/A, 8 x 8 bit A/D.

VIDEO Video Keyboard terminal RS232 Serial Interface.
24 x 80 characters £250

Details from the Distributors:-
MENDIP COMPUTERS
57 Bath Road, Wells, Somerset, BA5 3HS.
Telephone: (0749) 75249

INTERTRONIX
83 West Street, Farnham, Surrey GU9 7EN.
Telephone: (0252) 722011

TOMORROW TODAY

at
Birmingham Computer Centre

Commodore official distributors



3016, 3032, 3008 PETs
The reliable value for money system with after sales support, instruction and training facilities and a wide range of programmes.



3040 DUAL DRIVE FLOPPY DISC
The latest in disc technology. Low cost with reliable data transfer.



3022 PROFESSIONAL PRINTER
The high specification printer. Prints all PET characters onto paper and accepts labels, printed forms, cheques etc.



48K
Disc drive with controller
£1,044 + VAT

Apple authorised distributors
The sophisticated quality system with a reputation for advanced design and innovation.

**Camden Electronics, First Floor,
462 Coventry Road, Small Heath,
Birmingham B10 0UG.
Telephone 021 773 8240**
Open Mon.-Sat. 9.30-6.00 p.m.

A MEMBER OF THE COMPUTER RETAILERS ASSOCIATION

INTELLIGENT ARTEFACTS LTD

SMALL COMPANY ACCOUNTS

SOFTWARE FOR NORTH STAR HORIZON

- COMBINED CASH/DAYBOOK TRANSACTION FILE + ACCOUNT NAMES
- COMBINED SALES/PURCHASE LEDGER
- INTERACTIVE — TOLERANT NAME MATCHING, ERROR CHECKING ETC.
- COST AREA ANALYSIS
- AGED DEBT ANALYSIS, STATEMENTS
- AUDIT TRAIL
- AUTO BANK BALANCE
- MANAGEMENT REPORTS — PROFIT/LOSS, ASSET RATIOS, ETC.
- APPROVED VAT METHOD
- FAST, FREE MAINTENANCE
- LOCKED BASIC WITH 3-LEVEL PASSWORD SYSTEM
- NO SPECIAL STATIONARY REQUIRED
- TAILORING SERVICE
- £520 + VAT
- COMPLETE SYSTEMS WITH HARDWARE FROM £3300

INTELLIGENT ARTEFACTS LTD
Cambridge Road, Orwell, Royston, Herts.
Telephone: Arrington 689

Apple extras that won't break the bank!

Talk to Apple VOICE RECOGNITION CARD
4 Demo Programs. Manual Quality Microphone. Full Guarantee.
£99

TRS80 LEVEL 1
Complete one off as new.
£250

MICROPRODUCTS PARALLEL CARD
A low cost parallel card.
£25

SUPER SOUND GENERATOR Like ALF but half the price. Complete musical tutor — quite sensational.
£90

SPARE DISK CONTROLLER CARDS
£35

SPARE GAMES PADDLES
£10

CENTRONICS 779 PAPER STACKERS
£5

PRINTERS Axiom 801
For Apple II or PET an excellent listing printer. 80/40/20 column. 96 characters. 120 lines per minute. Parallel ASCII. Reverse printing. 2K Buffer. 2K User Prom Memory. Software Select 3 character sizes. 2 FREE ROLLS OF PAPER. FREE INTERFACE.
£220

These special prices for a limited period only. Phone 01 626 8121 between 9.30 a.m. and 5.30 p.m., Monday to Friday, to avoid disappointment.

All prices excluding VAT

Personal Computers Ltd.

194 · 200 Bishopsgate, London EC2M 4NR. Tel: 01 626 8121 Telex: 888264

CAMBRIDGE LEARNING ENTERPRISES

Self Instruction Courses

Microcomputers are coming - ride the wave! Learn to program.

Millions of jobs are threatened but millions will be created. Learn BASIC - the language of the small computer and the most easy-to-learn computer language in widespread use. Teach yourself with a course which takes you from complete ignorance step-by-step to real proficiency, with a unique style of graded hints. In 60 straightforward lessons you will learn the five essentials of programming: problem definition, flowcharting, coding the program, debugging, and clear documentation

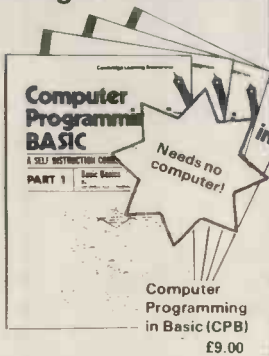

BOOK 1 Computers and what they do well: READ, DATA, PRINT, powers, brackets, variable names; LET; errors; coding simple programs. **BOOK 2** High and low level languages; flowcharting; functions; REM and documentation; INPUT, IF...THEN, GO TO; limitations of computers, problem definition. **BOOK 3** Compilers and interpreters; loops, FOR...NEXT, RESTORE; debugging; arrays; bubble sorting; **TAB BOOK 4** Advanced BASIC; subroutines; strings; files; complex programming; examples; glossary.

Also **THE BASIC HANDBOOK (BHB) £11.50** An encyclopaedic guide to the major BASIC dialects. A must if you use other peoples' programs

and: **ALGORITHM WRITER'S GUIDE (AWG) £4.00** Communicate by flow chart! Learn to use Yes/No questions for: procedures, system design, safety, legislation etc.

Understand Digital Electronics

Written for the student or enthusiast, this course is packed with information, diagrams, and questions designed to lead you step-by-step through number systems and Boolean algebra to memories, counters, and simple arithmetic circuits; and finally to an understanding of the design and operation of calculators and computers

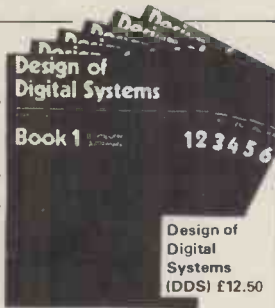

BOOK 1 Decimal Octal, hexadecimal, and binary number systems and conversion between number systems; negative numbers; complementary systems. **BOOK 2** OR and AND functions; multiple-input gates; truth tables; De Morgan's Laws; canonical forms; logic conventions; Karnaugh mapping; three-state and wired logic. **BOOK 3** Half, full, serial, and parallel adders; subtraction; processors and ALU's; multiplication and division. **BOOK 4** flip flops; shift registers; asynchronous, synchronous, ring, Johnson, and exclusive-OR feedback counters; ROMS and RAMS. **BOOK 5** Structure of calculators; keyboard encoding; decoding display-data; register systems; control unit; PROM; address de-coding. **BOOK 6** CPU; memory organisation character representation; program storage; address modes; input/output systems; program interrupts; interrupt priorities; programming, assemblers; computers; executive programs; operating systems.

DIGITAL COMPUTER LOGIC & ELECTRONICS. (DCL) £7.00
A course covering the material in italics above, but at a slower pace. (4 vols)

GUARANTEE — No risk to you. If you are not completely satisfied your money will be refunded without question, on return of the books in good condition.

PLEASE SEND ME: —

CPB (£9.00)
BHB (£11.50)
AWG (£4.00)
DDS (£12.50)
DCL (£7.00)

Quantity

FOUR WAYS TO PAY:

- 1) A U.K. cheque or a U.K. postal order (Not Eire or overseas)
- 2) A bank draft, in sterling on a London bank (available at any major bank)
- 3) Please charge my Access/M.Ch Barclay/TrustC/Visa Am. Exp. Diners
- 4) Or phone us with these credit card details - 0480 67446 (ansaphone) 24 hour service.

Card No. Signed
THESE PRICES COVER THE COST OF SURFACE MAIL WORLDWIDE. AIRMAIL:
Eur, N.Af, Mid.E. add 1/2 to price of books: Jpn, Aus, N.Z. Pcfc add 1/2: elsewhere add 1/2

Name
Address

U.K. Delivery: up to 21 days (or send 50p for 1st cl.p.)

Cambridge Learning Enterprises, Unit 93 Rivermill Site, FREEPOST, St. Ives, Huntingdon, Cambs PE17 4BR England.

Proprietors: Drayridge Ltd., address as above, Reg. in Eng. No. 1328762

BIRMINGHAM Computer Centre

NEW

HIGH SPEED
PROFESSIONAL

MATRIX
PRINTER

NOW WITH PET GRAPHICS
PLUS 10 USER DEFINED GRAPHICS

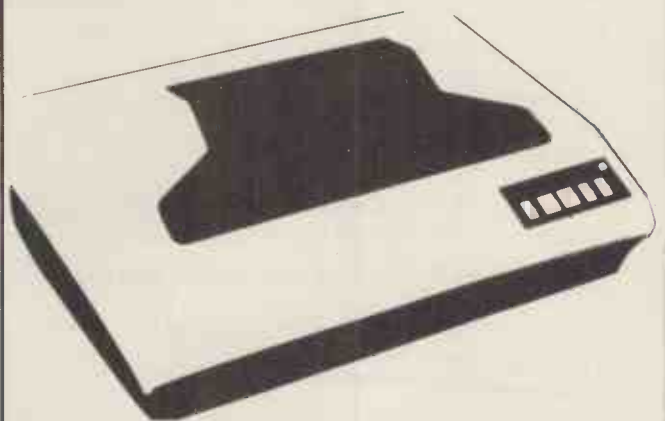

Full ASC II 96 Character Set plus Graphics
plus 750CH Buffer 2K,
Extra Buffer available
UNI — or Bi-Directional
IEEE or Parallel Interface Plugs
direct into PET.
No Interface needed
£525

COMMODORE'S 3022 PRINTER

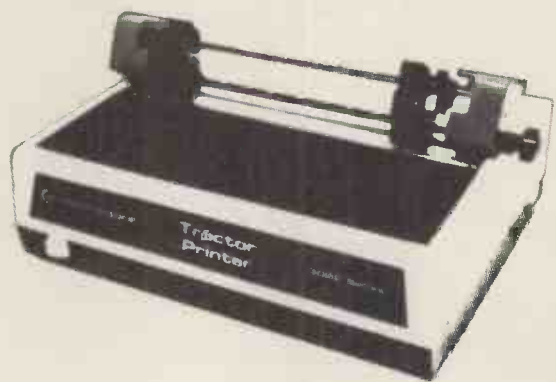

FROM £375

★ **NEW LOW PRICE** ★
Tractor Feed — Genuine C.B.M.

Camden Electronics
First Floor

462 Coventry Road
Small Heath, Birmingham B10 0UG
Phone: 021-773 8240





The Software Solution

We all know that a computer system is only as good as the software and that much of the applications software hitherto available has proved to be the weak link. Written in Microsoft basic for use with CP/M based hardware, Interface Software is probably the most comprehensive and robust application software currently available, which really will transform your micro-computer into an effective problem solving tool.

Applications Software

- Nominal Ledger
- Sales Ledger
- Purchase Ledger
- Payroll
- Incomplete Records
- Word Processing (Wordstar)
- Mailing Address
- Etc.,

Systems Software

- CP/M
- MP/M
- MBasic 5.0 (CP/M) Interpreter/Compiler
- CBasic (II) Interpreter/Compiler
- Fortron 80 Compiler
- Cobol 80 Interpreter/Compiler
- Pascal 80 (UCDS) Interpreter
- Z80 Macro Assembler

Recommended by Logitek for the ALTOS microcomputer and Rostronics for the Micromation but of course suitable for any CP/M based machine.

For more details contact Jim Reid or Sue Archer at:-

DEALER ENQUIRIES WELCOME.



INTERFACE SOFTWARE LIMITED,
100, PARK STREET,
CAMBERLEY,
SURREY.
Telephone (0276) 27982.

SALE OF THE CENTURY

Sensational Price Reductions in Memories

2114	450 NS	2.50
2114	300 NS	2.75
2114	200 NS	2.95
4116	200 NS	3.00
4116	150 NS	3.50
4315	450 NS 4K CMOS RAM (4Kx1)	9.95
6514	450 NS 4K CMOS RAM (1Kx4)	7.95
2708	450 NS	4.25
2716	5V 450 NS	10.95
2732	32K EPROM 5V 450 NS	29.95

NEW GI COMPUTER SOUND CHIP

AY-3-8910. As featured in July BYTE. Fantastically powerful sound & music generator. Perfect for use with any 8 bit microprocessor. Contains 3 tone channels, noise generator, 3 channels of amplitude controls, 16 bit envelope period control, 2 parallel I/O, 3 D/A converters plus much more. All in 40 pin DIP. Super easy to interface to the S-100 or other Buses. ONLY £8.25+ VAT. Add £2.25 for 60 page data manual. Free copy of BYTE article.

SAM'S BOOKS AT LOWEST PRICES

COMPUTER BOOKS

- Microcomputer Primer (2nd Edition) NEW £7.17
- Microcomputers for Business Applications £5.37
- The Howard W. Sams Crash Course in Microcomputers. NEW £10.50
- Fundamentals of Digital Computers (2nd Edition) £5.97
- Getting Acquainted with Microcomputers. £5.37
- How to Buy & Use Minicomputers & Microcomputers. £5.97
- Computer Graphics Primer NEW £7.77
- TEA: An 8080/8085 Co-Resident Editor/Assembler NEW £5.37
- 6502 Software Design (Book 1). £5.70
- (Book 2). £5.97
- BASIC Programming Primer. £5.37
- DEBUG: An 8080 Interpreter Debugger. £3.75
- How to Program Microcomputers. £5.37
- Computer Dictionary (3rd Edition) NEW £7.17
- Boolean Algebra for Computer Logic £3.95
- Computers & Programming Guide for Scientists & Engineers (3rd Edition) NEW £9.57
- Microcomputer Interfacing with the 8255 PPI Chip £5.37
- Programming & Interfacing the 6502, with Experiments £7.17
- TRS-80 Interfacing NEW £5.37
- Z-80 Microcomputer Design Projects. NEW £7.77
- Z-80 Microprocessor Programming & Interfacing - Books 1 and 2 (Book 1) £6.97 (Book 2) £7.77

- Microcomputer - Analog Converter Software and Hardware Interfacing £5.70
- The 8080A Bugbook: Microcomputer Interfacing and Programming £6.30
- The S-100 and Other Micro Buses £3.95
- The Cheap Video Cookbook. £3.75
- TV Typewriter Cookbook £5.97
- Using the 6800 Microprocessor. £4.77
- Z-80 Microcomputer Handbook. £5.37
- 8085 Microcomputer Design NEW £5.97

COOKBOOKS

- TTL Cookbook £5.70
- Active-Filter Cookbook £8.97
- TV Typewriter Cookbook £5.97
- CMOS Cookbook £6.30
- IC Timer Cookbook £5.97
- The Cheap Video Cookbook. £3.75
- IC Converter Cookbook £8.37
- IC Op-Amp Cookbook (2nd Edition) £8.97

All devices are brand new, factory prime, full spec.

Ordering Information: Unless otherwise stated, for orders under £50 add 50p p&p. Add 15% VAT to total. No VAT on books. All items are subject to prior sale and therefore subject to availability. Prices are subject to change without notice.

MicroByte,
Unit 9-10 1st Floor,
Block E,
38 Mount Pleasant,
London WC1X 0AP.
Tel: 01-278 7369
or 01-837 1165
Telex: 8953084

CPU'S		CHARACTER GENERATOR		SUPPORT DEVICES		INTERFACE	
6502	7.95	RO-3-2613UC	4.50	6520	4.95	DM8123	125p
Z80	7.95			6522	7.95	MC1488	90p
Z80A	9.95	UARTS		6533	8.95	MC1489	90p
Z8001	125.00	AY-5-1013A	2.98	6551	10.95	75150	125p
Z8002	95.00	AY-3-1015D	3.50	Z80 PIO	6.95	75154	125p
		IM6402	3.50	Z80A PIO	6.95	75182	195p
DEVELOPMENT MODULE		KEYBOARD ENCODER		Z80 CTC	5.95	75322	250p
Z8000DM	1099.00	AY-5-2376	7.95	Z80A CTC	6.95	75324	325p
FLOPPY DISK CONTROLLER		SHIFT REGISTERS		Z80 DMA	19.95	75325	325p
FD1771 B-01		3341 PC FIFO	4.95	Z80 S10/0	29.95	75361	350p
Single Density		700 KHZ	4.95	Z80A S10/0	34.95	75365	295p
IBM		3341 APC FIFO	5.50	Z80 S10/1	29.95	75451	50p
Compatible	24.95	1 MHz		Z80A S10/1	34.95	75491/2	75p
FD 1791 B-01		3342 PC 64 bit shift register	4.95	Z80 S10/2	29.95	8T28	175p
Dual Density		3347 PC 80 bit shift register	4.95	Z80A S10/2	34.95	8T95	175p
IBM				MC14412VL	7.97	8T97	175p
Compatible	49.95						

NEW 4K (1Kx4) CMOS RAM Low Power 450 NS ONLY £7.95 8 FOR ONLY £56 + VAT

To Toshiba TC5514P (same as 6514) is a full static read write memory organized as 1024 words by 4 bits using CMOS technology. Because of ultra low power dissipation, the TC5514P can be used as battery operated portable memory system and also as a nonvolatile memory with battery back up. The TC5514P operates from a single 5V power supply with a static operation, so that the no refresh periods are required. This simplifies the power circuit design.

The three state outputs simplify the memory expansion making the TC5514P suitable for use in a microprocessor peripheral memory. Since the minimum data retention voltage is 2V, the battery back up system needs only simple circuit. By using Toshiba's original CMOS technology, the device circuitry is not only simplified but wide operating margin and noise margin are also realized. The TC5514P family is moulded in a dual-in-line 18 pin plastic package, 0.3 inch in width.

FEATURES

- Low Power Dissipation - 10pW/Bit (TYP.) @3.0V (STANDBY)
- 10uW/Bit (TYP.) @5.0V (OPERATING)
- Data Retention Voltage 2V 5.5V
- Single 5V Power Supply
- 18 Pin Plastic Package
- Full Static Operation
- Three State Output
- Input/Output TTL Compatible
- Access Time 450 NS

Floppy Disk Systems AT LOW COST

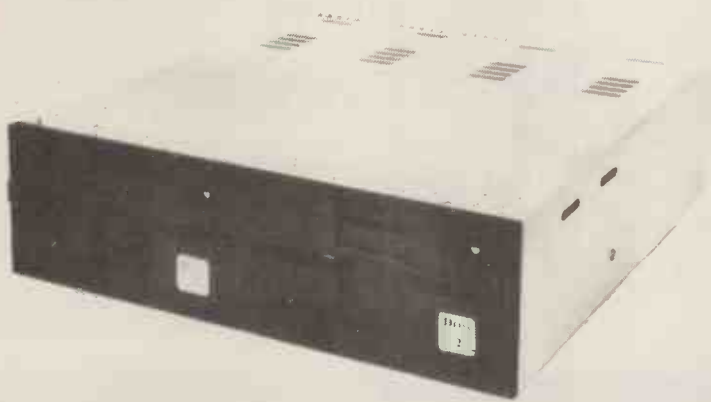

FOR THE APPLE® II and ITT® 2020

- * Mains Powered Dual Disk Unit.
- * 2 Disks Each Giving 116K Bytes.
- * Completely compatible with Apple® II and ITT® 2020 Disk controller cards.

Height: 92 mm Width: 149 mm
Length: 300 mm Weight: 7.8 Kg.

DUAL DISK UNIT £498

FOR THE TRS80, SWTP, SUPERBRAIN,
NORTH STAR HORIZON, HEATHKIT ETC. ETC.

40 Track single disk unit	£236
77 Track single disk unit	£345
40 Track Dual disk unit	£440
77 Track Dual disk unit	£645

- * Mains powered disk systems
- * Shugart SA400 Interface compatibility
- * Daisy chain up to four drives

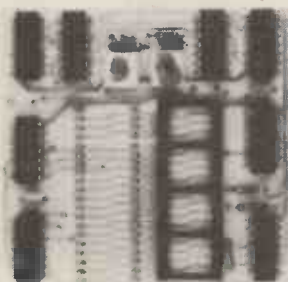
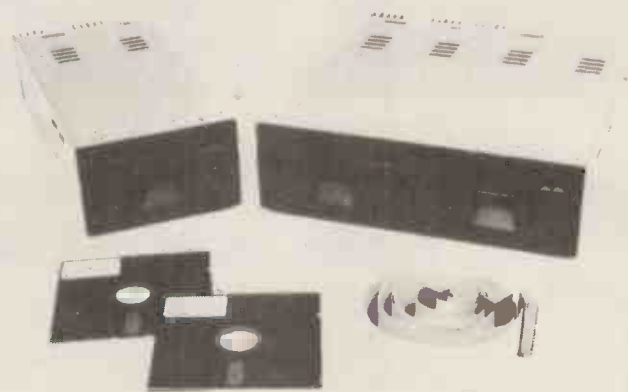

FOR TRS80 USERS

The PERCOM DATA SEPARATOR eliminates read and verify errors on the inner (higher numbered) tracks of your Disk Systems. Plugs into the expansion interface. No soldering – takes 5 minutes to fit.

£20 WITH FULL INSTALLATION INSTRUCTIONS

TRS80 DISK CABLES:	2 Drive Cable	£22.50
	4 Drive Cable	£34.00

Call your nearest dealer for a demonstration:

London Computer Store, 43, Grafton Way, London W1. Tel: 01-388-5721

Katanna Management Services, 22 Roughtons, Galleywood, Chelmsford, Essex. Tel: 0245-76127

Sevet Trading, 14, St. Paul's Street, Bristol 2. Tel: 0272-697757

EWL Computers Ltd., 8, Royal Crescent, Glasgow Tel: 041-332-7642

Data Plus Computer Services, 67, Bridge Street, Manchester. Tel: 061-832 3265

CUMANA LTD., 35, Walnut Tree Close, Guildford,
Surrey. GU1 4UN.
Tel: (0483) 503121
Telex: 859680 (Input G)

*Please add VAT to all prices.
Delivery at cost will be advised
at time of order.*



centralex

CENTRALEX-LONDON LTD
8-12 Lee High Rd, London SE13
Tel: 01-318 4213/4/5/6/7
9.30 am - 5 pm Mon to Fri -
Evenings and weekends by
appointment

A comprehensive range of Microcomputers Equipment, Peripherals, Software and Services for those who value Professional Standards, Guidance and Continuing Support for Hardware and Software.

APPLE
TEXAS
MICROPOLIS
DIABLO
MICROLINE

PET
OHIO SCIENTIFIC
CENTRONICS
QUME
HITACHI

ITT 2020
CROMEMCO
ANADEX
DEC
LEXICON

EXIDY
MICROSTAR
INTEGRAL
DATA GENERAL
ETC. ETC.

HORIZON
SHUGART
TELETYPE
EPSON

INFORMEX-80 Printer

£ 399+VAT



Special offer - for a limited period

For PET, APPLE, EXIDY, TRS80, ETC
A high quality, high speed printer
(125 cps) Upper and lower case letters
plus graphics as standard
Interface and cable for TRS80, PET,
APPLE or RS 232 £69 + VAT
Tractor feed option only £39

ALSO Training, Consultancy, Systems Design,
Programming and Software

PAYROLL - INVOICING - STOCK CONTROL -
SALES/PURCHASE LEDGER - VAT - MEDICAL
RECORDS - EDUCATIONAL & ENGINEERING
PROGRAMMES - HOTEL RESERVATION - ESTATE
AGENTS - BUILDING MAINTENANCE - COBOL -
FORTRAN - ETC.

Maintenance Contracts including stand-by equipment during repair
periods - Free Delivery Nationwide - Terms arranged - Credit Cards and
official orders accepted.



EIGHT USEFUL UTILITIES FROM THE KANSAS COLLECTION For the Tandy TRS-80 and the Video Genie

Rescue.

This is the miracle program!
It will retrieve a program that has been
either NEWed, hooked up in a CLOAD?
situation or lost in any similar way.
It even works after you have pressed
the re-set button with an expansion box
fitted!
It loads after you have lost your program
and rescues it in a few seconds to be run
or worked on as you wish.

Typewriter

The most infuriating thing when using a
printer is that upper and lower case is
actually reversed from that of a normal
typewriter - the shift-key giving lower
case instead of caps.
This program reverses all that, with the
shift-key operating the caps and the
normal position producing lower case
when outputting to a printer.

Delay

Allows control of the screen's read-out
to nine different speeds, which can be
varied by actual program statements.
As this also works with graphics and
large characters, this is absolutely ideal
for any kind of display, limited only by
the imagination! Again, very simple to
bring into operation, by using just a
single command.

Ascertain

Two for the price of one here. This
program will ascertain exactly what that
tape is - whether Basic, System or
Source, and what is more will spell out
its name. So no longer will you not be
able to load System tapes through not
knowing their names.

Also forget visionload programs, for
within the first few bytes Ascertain will
tell you if you have a bad load. And not
just with Basic programs either, but
System loads too.

Protect Ascertain in memory and use it
at will, especially whilst you juggle with
your volume setting for loads...

**ONLY FROM KANSAS
AT A SENSIBLE
£6.25 each**

Or any three for £17

Return first class post service Merge

Enables any number of Basic programs
or sub-routines to be joined together,
either with one residing in memory or
from separate tapes.

There is no limit to the number of
programs or routines which can be
joined into a single program, and is an
ideal way to include sub-routines
without having to write them out every
time.

Very easy to use with only two
commands, unlike the complicated
Proload.

Byte saver

Cut out all your unwanted spaces,
and at the same time speed up program
execution with Byte Saver.

This useful utility speeds through your
Basic program taking out all the
unnecessary bytes, but leaving those in
the print and data statements. This
allows you to write your programs
leaving plenty of spaces for ease of
reading, then take them all out when completed.
Takes only a few seconds and displays
the number of bytes saved.

Double-up.

At long last - you can have two pro-
grams up and running in your micro
together!

Either load them both and work on
each, or load one and then another
later, still retaining the first one.

Either can be RUN, worked on in any
way and/or saved. And the line numbers
do not have to follow on, as there is
no interaction whatsoever. Absolutely
ideal when you are modifying a program
and want to refer to the original from
time to time - have them both in!

Copy

Copy System tapes easily and quickly
with this utility, with various commands
to make copying more versatile.

Even allows verification to make sure
it has copied perfectly. Being a Kansas
program it is of course better than the
normal copy programs, in that details of
the program being copied is actually
shown on the screen.

Kansas

Kansas City Systems, Unit 3, Sutton Springs Wood, Chesterfield, Derby Tel 0246 850357

Philips Mini-Digital Cassette Recorder.

CASSETTE RECORDER

The Mini-Digital Cassette Recorder (Mini-DCR) can operate in the following modes: Idle, Read, Write, Backspace and Rewind. Complementing the quality and reliability of the Mini-Digital Cassette Recorder are Philips mini-cassettes certified for digital data recording applications. These mini-cassettes use tape which is certified for freedom from drop-outs. Mini-cassettes have been widely used for program loading in Philips office computers during the last four years, and over half a million are already in service. Low cost, low power consumption and compact size of the Mini-Digital Cassette Recorders mean they are ideal for program loading and updating applications as well as providing a highly convenient data capture facility.

Ample capacity for program loading and data interchange is provided by the 128 k byte capacity, and the high data transfer rate of 6000 bits/sec allows quick reading and writing of programs and data.

PRICES INCLUDING MANUAL
 MINI D.C.R. £95 ea. + VAT
 INTERFACE from £42.50
 INCLUDE £2.25 FOR CARRIAGE ETC.

Manual available separately price £10.00. Refundable on receipt of order.



INTERFACE BOARD

This compact interface board was designed specifically for the purpose of interfacing the Philips Mini DCR to a Micro-computer. Power consumption is very low, enabling it to be powered from the micro-computer that it is serving. Flexibility of the system was held as paramount, address decoding can be changed simply by moving links.

By using subroutines held in the micro-computer to control the system the user can make his controlling program to suit his own particular needs and can be as simple or as complicated as necessary.

CURRAH

COMPUTER
COMPONENTS

79 Crowland Rd. Hartlepool Cleveland.
TS 24 2JN. Phone 0429 / 871900

LEICESTER

computer centre limited

present **tridee** 2 exciting programs

An exciting new addition to your Pascal library - enables you to create 3D graphics, viewable from any angle and distance. As easy to use as Turtlegraphics. Procedures include Ortho, Perspec, Rotate, View, Move to-3, View-from.

Complete with comprehensive instructions £49.95 + VAT

Animations and Simulations for Education

Ready made programs bring life to your demonstrations using the HGR facility of the Apple computer to illustrate points covered in lectures in elementary algebra and statistics.

Program includes:

CAPILLARY FLOW - Poseuille's equation with animation.

EXPONENTIAL PLOTTER - Plots curves of exponential growth and decay, colour coded.

RADIOACTIVE DECAY - Simulates radioactive decay, shows how half life is always constant.

THE GENERATION GAME! - Simulates growth in real time of a bacterial population, with histogram.

DERIVATIVES - Shows how $\frac{dy}{dx}$ can be approximated as closely as desired to $\frac{dy}{dx}$.

QUADRATURE - Trapezoidal and Simpsons rule, with graphics.

NON-LINEAR PLOTS - Shows how non-linear relations (e.g. $y = x^2$, $y = \exp(x)$) may be linearised.

CORRELATION - Shows the linear regression and values for various sets of data.

RESIDUALS - Animation to show that as a line is moved in space, the 'least-squares' fit does minimise the SSR.

ROUNDING ERROR - Histograms to show distribution of rounding error for n (specified) value.

NORMAL ERROR - As above, for gaussian distribution.

FOURIER ANALYSIS - Computes the fourier coefficients (both sine & cosine series) for an input data set, prints them and then:

1) permits a reconstruction of the original function to be computed and displayed in graphics using any defined number of coefficients

2) displays a histogram of the magnitude of the coefficients.

LISSAJOU'S FIGURES - Simulates the movement of a swinging pendulum attached to the bob of another pendulum, swinging in planes at right angles to one another.

Amplitudes and frequencies may be chosen and the resulting patterns are traced across the screen.

Complete with instructions £29.95 + VAT

LEICESTER COMPUTER CENTRE LIMITED

109 QUEENS ROAD, LEICESTER LE2 1TT. Tel 0533 708483

BITS & BYTES

COMPUTER PRODUCTS

WE ARE PLEASED TO ANNOUNCE THAT
THE FOLLOWING ARE ON PERMANENT
DISPLAY IN OUR NEW PREMISES

NASCOM

PET

PET

SHARP

INTERTEC

SUPERBRAIN

IN ADDITION, WE HAVE OUR USUAL
FULL RANGE OF ADD-ONS AND
ACCESSORIES.

4 WESTGATE, WETHERBY,
WEST YORKSHIRE LS22 4UL



0937 63744



SOFTY Software Development System **EX-STOCK**

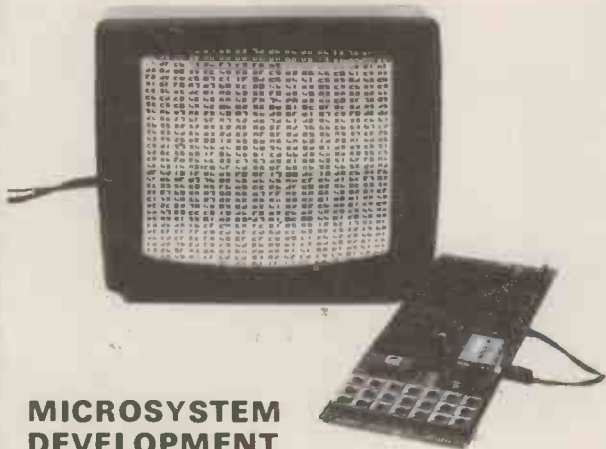

MICROSYSTEM DEVELOPMENT USING SOFTY

SOFTY is intended for the development of programs which will eventually become software residing in ROM and forming part of a microsystem. During the development stage of a microsystem, SOFTY will be connected in place of the firmware ROM via a ribbon cable, terminated in a 24 pin DIL plug.

Data may be entered into the SOFTY RAM via the serial port, parallel port, direct memory access, or the keypad, and manipulated using the assembler key-functions. When the program has been entered, the internal microprocessor can be 'turned off', and the external microsystem and its resident microprocessor allowed to access and run the program in SOFTY's RAM and/or programming socket. In this way modification can be made until the required program is complete — the contents of the RAM being clearly visible as a 'page' on TV or monitor. 4 pages are available, 2 of the Data RAM and 2 of the programming socket.

In the end, when the program is complete and working, the DIL plug is removed and replaced by an EPROM device programmed by SOFTY. SOFTY is able to program the 2704/2708/2716 family which have 3 voltage rails.

To help in the process of program development SOFTY has various assembler key-functions, which include — block shift without overwriting, block store, cursor control, match byte and displacement calculations (for jumps, etc.) A high speed cassette interface is also provided for storing working programs and useful subroutines. Software is supplied for serial data transfers — which means that you can write an assembler for your favourite MPU in BASIC on your Superboard, UK101, NASCOM, etc. and transfer the hex code directly to EPROM via SOFTY. The serial transfer program runs in the scratchpad and can be easily loaded from cassette, or the programming socket. Besides software development and EPROM programming, SOFTY has other uses — as a training aid, or as a control computer in its own right, with up to 2K bytes firmware, 1K of RAM, 22 I/O ports and Direct Memory Access.

SOFTY Kit-of-parts (including zero insertion force socket for EPROM programmer, ribbon cable and 24 pin D.I.L. header plug for connection to the system under development).

Price £115 (inc. VAT, p&p)

SOFTY power supply built and tested £23 (inc. VAT, p&p)

SOFTY built and tested £138 (inc. VAT, p&p)

Write or telephone for full details

SOFTY CONVERSION CARD —

Enables SOFTY to program the single rail EPROMs 2508, 2758, 2516, (INTEL 2716), 2532.

Selection of device type and 1K block are by 4 way pcb slide switches. Programming socket is zero insertion force. Supplied ready built with Dip Jumper for connection to SOFTY. £46.00 (inc. VAT, p&p).

MODEL 14 EPROM ERASERS



MODEL UV141 EPROM ERASER

- Fast erase times (typically 20 minutes for 2708 EPROM)
- 14 EPROM capacity
- Built-in 5 to 50 minute timer to cater for all EPROMs
- Safety interlocked to prevent eye and skin damage
- Convenient slide-tray loading of devices
- MAINS and ERASE indicators
- Rugged construction
- Priced at only £89.70 (inc. VAT, p&p)

MODEL UV140 EPROM ERASER

Similar to Model UV141 but without timer
Low price at only £70.73 (inc. VAT, p&p).

WRITE OR TELEPHONE FOR FULL DETAILS OR SEND CHEQUES / OFFICIAL COMPANY ORDERS TO:

GP Industrial Electronics Limited

(Retail Sales), Skardon Place, North Hill, Plymouth
PL4 8HA. Telephone: Plymouth (0752) 28627
TRADE AND EXPORT ENQUIRIES WELCOME



M&C BUSINESS SERVICES LTD

introduce order entry on your micro

A new suite of programs written by professionals to fit a range of popular Microcomputers.

Let your Microcomputer take the clerical drudgery from:

STOCK CONTROL
WORKS INSTRUCTIONS
DELIVERY NOTES
& INVOICING

All from one data input routine.

Apart from supplying business software we offer a complete range of Management Services expertise, from Work Study and O&M through to Systems Analysis, design and programming. A telephone call will give you a free consultation with one of our Business Analysts and you could soon be setting professional help with your daily problems.

M & C BUSINESS SERVICES LTD
122 HAVELOCK STREET,
KETTERING, NORTHANTS
Tel: (0536) 86652



Erase Eproms in 8 minutes for under £100

£97 delivered in U.K. + V.A.T.

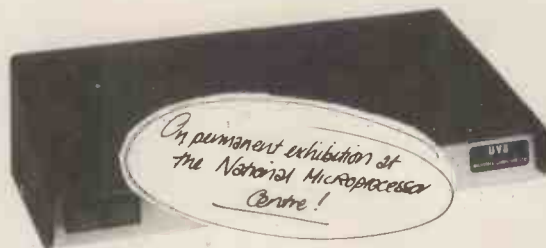

The high speed, high capacity model UV8 sets new performance and price standards.

- Cuts typical erasure times by a factor of 5
- 8 MINUTE SOLID STATE TIMER
- Capacity up to 14 EPROMS
- 2708 type erased in 4 to 7 minutes
- High intensity 254 NM UV source
- Safety interlock automatically starts timing sequence
- Audio tone signals erasure cycle complete
- Internal switch to extend erase time.

MICRODATA Computers Ltd, Belvedere Works, Bilton Way, Pump Lane Industrial Estate, Hayes Middlesex.

Telephone (01) 848 9871 (6 lines)

Telex 934110

Sales Ledger

Nominal Ledger

Inventory & Invoicing

Purchase Ledger

- * easy to use
- * fully documented
- * simple operator interface
- * alphanumeric stock Part Numbers
- * fully integrated or stand alone
- * full validation and range checking

The system is generated to meet individual customer requirements.

A typical double density two disk system will hold:--

- 200 accounts
- 99 rep/agents
- 150 nominals
- 500 nominal transactions
- 75 supplier orders
- 100 suppliers
- 500 account transactions
- 99 sales codes
- 99 nominal heads
- 350 stock items
- 200 order transactions
- 300 supplier transactions

Price: £950 plus VAT

PAYROLL: £350 plus VAT

TIME LEDGER: £250 plus VAT

DEALER ENQUIRIES WELCOME

BENCHMARK COMPUTER SYSTEMS LIMITED
Tremena Manor, Tremena Road,
St. Austell, Cornwall PL25 5QG
Telephone: 0458/43418
0761/62435: 0726/61000

PET users!

SAVE UP TO
90% ON
PROGRAM DEVELOPMENT
TIME

by using **ComPasS**
the new programming aid

PLUS!

- Random access routines
- Effective data handling
- Flexible screen formatting
- Big savings in program testing
- Consistency with standard sub-routines
- Easier program maintenance

ComPasS is an easy-to-use new package containing parameter-driven BASIC programming routines to handle the input and output of data to and from tape and disc files. ComPasS will set you on the right course—and save you time, money and frustration.

Ring CPS or contact your nearest PET dealer.

DEALERS!

TWO more NEW packages from CPS

'NEWSBOY'—a system for Newsagents accounting and delivery control (over 70 programs).

'GOLD'—a product costing and invoicing system for Manufacturing Jewellers.

'phone us for more information 021-707 3866



CPS (DATA SYSTEMS) LTD

Arden House, 1102 Warwick Road,
Acocks Green, Birmingham B27 6BH.
Telephone: 021-707 3866
Telex: 312280 CPS G

MICRO MARKET

The professional people
All your favourite systems
at prices you can afford

We offer a wide range of personal, professional and business systems, and peripherals at discount warehouse prices but with a support service more comprehensive and efficient than full price stores. All machines carry our extended no quibble warranty, and 'Micro Maintenance' offers you competitive maintenance agreements or repair services on all equipment after the warranty period. Our in-house software division is always available to offer advice and solutions to your software problems, as are the staff of 'Micro Maintenance' to help with your hardware and peripheral attachment difficulties.

EXTRACTS FROM OUR PRICE LIST

COMPUTERS

SUPERBRAIN from £1850

EXIDY SORCERER from £699

ALTOS from £2158

VDU's

INTERTUBE II from £525

PRINTERS

PAPER TIGER (NOW WITH GRAPHICS AND 2K. BUFFER FEATURES AS STANDARD)

ANADEX DP 8000 £545

ANADEX 9500 £499

SUPPLIERS

FULL RANGE OF TOP QUALITY DISKS, CASSETTES, PAPER ETC. ALWAYS AVAILABLE

ALL PRICES EXCLUDE V.A.T.

PHONE, CALL OR WRITE FOR COMPLETE PRICE LIST AND DEMONSTRATIONS TEL:01-751 5044/5
TWX: 8954428 138 CHALMERS WAY, NORTH FELTHAM TRADING ESTATE, FELTHAM, MIDDY.

"MICRO MARKET AND MICRO MAINTENANCE ARE PART OF SUN COMPUTING SERVICES LTD"



MAD HATTER SOFTWARE

LOOKING FOR SOFTWARE?

We have the VERY BEST!
Business, Utility or Games for
APPLE, TRS 80, PET
and SORCERER.

Send for our catalogue or ask
your local dealer.

MAD HATTER SOFTWARE

146 Oxford Street, London, W1.

Dealer Enquiries welcomed:
Telephone 01-637 2108

MICRO-SALES MICRO-LEASE MICRO-HIRE MICRO-BOUGHT MICRO FOR YOUR REQUIREMENT

We have the best in Micros, Apple, Intertec Superbrain (rapidly becoming industry standard). Horizon are just some. Low maintenance rate after 1 year guarantee, if you ever need it.

MICROSALES: APPLE II + IN COLOR, WITH OTHER CARDS FOR HOBBYIST, EDUCATIONALIST, BUSINESS, PROFESSIONALS, 64K PASCAL, FORTRAN, APPLE-FORTH AND OTHER SOFTWARE.

INTERTEC SUPERBRAIN

32K/64K AND MORE WITH \$100 EXPANSION INDUSTRY STANDARD CP/M, SYSTEM, TWO Z80 OPERATIONS. TWO QUAD DENSITY OR DOUBLE DENSITY DRIVES NICELY PUT TOGETHER WITH A SCREEN

PCM PASCAL
APL FORTRAN OEM, Educational, &
ASM COBOL dealship enquiries welcome
PLM 80

MICRO-CUSTOM DESIGN REQUIREMENTS: LET US IMPLEMENT YOUR IDEAS IN ALL AREAS ASPECT OF COMMUNICATIONS MAPCON REGISTERED CONSULTANTS.

MICROLEASE: TAKE ADVANTAGE OF LEASING. THERE MAYBE PLENTY FOR YOU AND FOR HAVING A MICROSYSTEM.

MICROHIRE: APPLE, HORIZON, SORCERER, PET, TRS 80, SUPERBRAIN. SOME BELOW £12 PER WEEK. NO DELIV. COLLECT CHARGES IN LONDON.

BARGAIN CORNER: SLIGHTLY USED MICRO-COMPUTERS, APPLE, ITT2020, SORCERER, PETS, TRS80, FROM AROUND £300 - £600.

PROMGLOW LTD

Present address 12 Dene Road, N11.

Moving to a new shopping precinct comparable to Westend.

North London Woodgreen, Piccadilly Line

Ring: 01-368 9002. Mon-Sun, Including Evenings

For communication aspects ring: 01-435 4493.

NEW from Datac

The CENTRONICS 730-80 column printer

Will handle pin feed continuous stationery, roll-paper and cut sheets without modification.

Extremely compact - only 37 x 28 x 13cm (WDH)

Light weight -
less than 4.5 kg (10 lb)

Fast - 100 ch/sec

Low cost
(£499 one-off price)

Choice of parallel or serial
(RS232C) interfaces

Simple and reliable

Contract servicing
available



Datac LIMITED

TUDOR ROAD, ALTRINCHAM,
CHESHIRE, WA145TN, ENGLAND

Tel: 061-941 2361/2

OFFICIAL CENTRONICS DISTRIBUTORS

SPECIAL OFFER

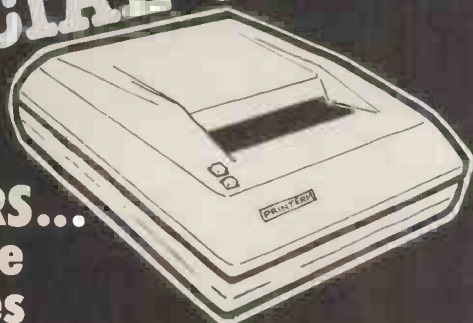

PRINTERS... Complete Packages Interfaced to your PET or Apple

MODEL 879V

High quality 120 cps 80 column bidirectional pinfeed printer with 9 x 7 matrix and software selectable top of form, forms length and expanded print capability.

MODEL 879VP-1

Suitable for PET systems using tape cassette or CompuThink floppy disc drives.

MODEL 879VP-2

Suitable for PET systems using Commodore discs.

MODEL 879VA

Suitable for Apple or ITT 2020 Micro systems and supplied complete with a high speed serial interface card.

MODEL 879V

Standard unit with RS232 interface for coupling up to a wide variety of systems.

Limited number of friction-feed units are available at the same price.

£495

£520

£550

£475

Buy NOW while stocks last!

LEEWAY DATA PRODUCTS LIMITED

Gresham House, Twickenham Road, Feltham, Middlesex TW13 6HA.
Telephone: 01-894 5511 and 01-898 5757 Telex: 27419

FIRST NAME IN

MICROHIRE

CCS MICROHIRE

NEW MONTHLY RATES * (1 MONTH PLUS)

8K PET **£79./Month**

16K PETS/APPLES/ETC. Each
DOUBLE DISK DRIVE Item
PRINTER **£89./Month**

32K and 48K COMPUTERS . . **£99./Month**

These are C.W.O. rates on our Standard Terms.
If you want something different to these
terms, please call Letchworth (04626) 73301

C.C.S. MICROHIRE
7 The Arcade, Letchworth, Herts SG6 3ET

A PEDIGREE PRINTER FOR YOUR PET



THE DOLPHIN BD80P IS A THOROUGHbred
IMPACT LINE PRINTER

- * BRITISH MADE *
- * HIGHLY RELIABLE *
- * LOW COST *

£525

The BD80P is supplied with either:—

- * IEEE—PET PLUG IN INTERFACE *

or

RS232C/20MA current loop or PARALLEL
INTERFACES

IDEALLY SUITED FOR BUSINESS SYSTEMS
EDUCATIONAL APPLICATIONS etc etc.

The main features of the DOLPHIN BD80P are:—

- * 125 characters per second
- * 80 characters per line with 132 character option
- * FULL ASCII 96 character set and 64 graphic characters
- * Continuous duty high quality print head
- * BI-DIRECTIONAL PRINTING; QUIET OPERATION
plus many other advanced features

DEALER AND EDUCATION
DISCOUNTS AVAILABLE

pronto

ELECTRONIC SYSTEMS LTD.

466-478 CRANBROOK ROAD
GANTS HILL ILFORD ESSEX IG2 6LE

Tele: 01-599 3041/2 Telex: 8954213

For Sales and Technical Support 01-554 6222



KRAM

KEYED RANDOM
ACCESS METHOD

Now available in the UK!

KRAM is quite simply a revolution in microcomputer disk access techniques, and another FIRST for the PET! Just plug the KRAM ROM into your 16K/32K PET, load the rest of KRAM's machine language logic from disk (just like DOS), and with the ten commands illustrated below you have complete control of your disk data, either directly by individual key, or sequentially in forward or reverse ASCII order. KRAM is a development of "VSAM" mainframe techniques. KRAM is fast, compact, and does not interfere with BASIC. You'll wonder how you managed without it! Get cracking - get KRAM!

CREATE

KCS="CREATE O:MAILFILE,120,15,1: SYS 24600

This example tells KRAM to create an indexed file called MAILFILE on the disk in drive zero, with a record length of 120 characters and a key length of 20 characters which starts at position 1 of the record. KRAM looks at the RESERVED variable KCS to identify the function and its parameters; the SYS call tells KRAM to execute the function. The record length can be any value up to 254 characters and the key up to 48 characters, a total of 302. KRAM packs as many records into the 255 character disk block as necessary.

OPEN

KCS="OPEN O:MAILFILE": SYS 24579 This tells

KRAM that we will want to make accesses to the file called MAILFILE on the disk in drive zero. KRAM returns in location zero (peek (0)) the file number by which this file can be accessed during the rest of the program.

ADD

KCS="ADD 1,NAS,ADS": SYS 24591 This tells

KRAM to add to file number one the data in variable ADS whose key is NAS. For example in a mailing list, the key NAS might be the name 'SMITH A.J.' and ADS might be the address '120, HIGH STREET, ANYTOWN'. Any normal double character string variable can be used to denote the key and the record.

GET

KCS="GET 1,NAS,ADS": SYS 24582 This tells

KRAM to get from file number one the data belonging to the key NAS and put it into variable ADS. In our example, if NAS was 'SMITH A. J.', KRAM would read the address '120, HIGH STREET, ANYTOWN' from file and put it into variable ADS. If we weren't sure of the exact surname, we could give KRAM the key 'SM' and it would get for us the next alphabetically higher name beginning 'SM', together with its address! Or if we gave KRAM a blank key, it would find the first name and address on file.

READ

KCS="READ 1,NAS,ADS": SYS 24585 This tells

KRAM to read the data belonging to the next highest key following the name in NAS, and put it into variable ADS. In our example, a complete file of names and addresses could be read in alphabetical order, starting at any name in the file, simply by executing successive READ commands! For instance, having got Mr A. J. Smith from file, executing the READ command as above would get us say 'SMITH M.' in NAS together with his address in ADS.

READ -

KCS="READ-1,NAS,ADS": SYS 24585 This works

like READ except BACKWARDS! It tells KRAM to read the data belonging to the next lowest key preceding the name in NAS, and put it into ADS. For instance, having read 'SMITH M.' with the forward read, executing the backward read as above would get us 'SMITH A.J.' in NAS together with his address in ADS.

PUT

KCS="PUT 1,NAS,ADS": SYS 24588 This tells

KRAM to rewrite to file number one the data in variable ADS which belongs to key NAS. For instance, if we wanted to change Mr A.J. Smith's address, we would simply set NAS equal to 'SMITH A.J.', ADS equal to his new address, and execute the PUT function.

DELETE

KCS="DELETE 1,NAS,ADS": SYS 24594 This tells

KRAM to delete from file number one the key contained in NAS and its associated data contained in ADS. In our example, to delete Mr A. J. Smith from the file, we would simply set NAS equal to 'SMITH A.J.', ADS equal to his address, and execute the DELETE function. KRAM will release for further use the disk space made available by the deletion.

CLOSE

KCS="CLOSE 1": SYS 24597 This tells KRAM that

file one is finished with for now. KRAM updates the BAM on disk, but the file can still be used without another OPEN command.

INITIALIZE

SYS 24600 This function is used at the beginning of

each program to clear KRAM's work areas and buffers.

The examples above illustrate the use of KRAM in a mailing list application, with disk access times from less than one second. KRAM can of course be used in any application program with the Commodore disk where programmer time, user time and disk space are at a premium.

Each KRAM package includes a ROM which plugs into the middle ROM socket of the 16K/32K Pet, a demonstration disk with a mailing list program and a 40-page User Reference Manual. KRAM is available by post (cash with order) price £115 including VAT, or by credit card phone the KRAM 24 Hour Order Desk on 01-546 7256; or see your nearest dealer. (Quantity discounts available).

Calco Software

Lakeside House, Kingston Hill, Surrey KT2 7QT 01-546-7256

Mainframe software at a micro price

Master Your Micro FAST with...

Little Genius floppy diskette based courses will teach you, how to use your system and how to realise the full potential of the "Mighty Micro". These fully interactive computer lessons will guide you quickly to a high level of understanding and confidence in your ability to make the most of your microcomputer system.

Courses now available:

- Applesoft BASIC
- Advanced Applesoft BASIC
- Using your Apple
- Palsoft BASIC
- Advanced Palsoft BASIC
- Using your 2020
- PET BASIC
- Advanced PET BASIC



Little Genius

Each course, comprising a floppy diskette, and starting instructions, costs only £40.00 plus VAT.

SPECIAL "3 in one" OFFER for 3 courses covering the same system only £99.00 plus VAT.

Little Genius courses are available from most computer retail outlets, or direct mail order from:

LITTLE GENIUS

Suite 504, Albany House, 324 Regent Street, London W1R 5AA.
Telephone: 01-580 6361

M I C R O C O N T R O L



apple

SALES
SERVICE
OFFICIAL DEALERS

for further details write or phone

224 EDGEWARE ROAD
LONDON W2 1DN

Tel (01) 402 8842

MULTI-USER, MULTI-TASKING MICRO SYSTEMS FROM £5000

For business, education and scientific use.

- Cartridge storage 10MB to 1200MB.
- Comprehensive utilities.
- Word processing.
- Multi-language (languages supported include Basic, Cobol, Fortran, APL, Pascal etc.)

OEM and Dealer enquiries invited.

EQUINOX

COMPUTER SYSTEMS LIMITED
Kleeman House, 16 Anning Street,
New Inn Yard, London EC2A 3HB.
Tel: 01-739 2387 & 01-729 4460



Somebody's going to need more than long arms for this computer jungle

Your business is not exactly the same as any other and neither are its problems. Any solutions are probably unique and must be tailored exactly for you.

You know your business better than anyone else and any system designed should use your knowledge. The micro-computer specialist should show you how to use the computer to meet your business requirements.

You should be able to get the micro-computer which best suits your business. It should be chosen after your requirements are specified.

You and your staff have a right to know all about YOUR system, including helping to program it if you want to. Training is your right — not an additional service.

If microcomputers cannot satisfy your business needs, you want to know — you don't want false promises.

67 Nova Road, Croydon, Surrey CR0 2TN.
Telephone: 01-688 6013

MIKE ROSE MICROS

ANADIX DP8000 PRINTERS offered at £350.00

Due to our changing to 132 character Printers, we are selling used Anadex DP8000 Printers, all less than a year old, for £350.00.

VAT & Delivery extra

FARMLAN
Netherton Ross-on-Wye
Herefordshire

NOW THEY
TELL ME!

**KINGSTON
CHRONICLE**

**KINGSTON
PERIPHERALS
MAKE
MICROS'
MIGHTY
MICE!**



MEET THE FAMILY



... THERE MUST BE ONE HERE FOR YOU

The Exidy family is a sophisticated range of products designed to meet the ever increasing variety of computing needs, including home and business uses, educational and laboratory applications, industrial process control etc.

The Exidy range has been designed with built-in growth capacity to take the risk factor out of computer investment. The Sorcerer Computer now has a memory expansion capability from 8K up to 48K within its own cabinet, enabling the system to grow with your needs plus the ability to add many additional plug-in facilities such as disk drives and pre-programmed ROM PAC's.

The standard configuration includes a 63 key typewriter-style keyboard and a 16 key numeric pad. Remote control for dual cassettes. Serial RS232 and parallel interfaces, Z80 processor, 4K resident operating system, 8K Microsoft BASIC in separate plug-in ROM PAC cartridge, 64 character x 30 line display, 128 upper/lower case ASCII character set and 128 user defined graphic symbols, operators manual, introduction to basic programming, connecting leads. All Exidy equipment is backed up by a 12 month warranty covering both parts and labour.

The Word Processing ROM PAC features auto wraparound, dynamic cursor control, variable line length, global search and replace, holding buffer for re-arrangement of text, right justification, line width and line to line spacing, underlining or boldfacing, text merging and a macro-facility permitting tasks such as formletter typing, multiple column printing of automatic forms entry.

Or send coupon
for further information to:

SOLE DISTRIBUTORS

Geoff Wilkinson
LIVEPORT DATA PRODUCTS
The Ivory Works, St. Ives, Cornwall.
0736-798157

Now contact your nearest dealer:

The NORTH

BASIC COMPUTING, Oakville, Oakworth Road, Keighley, W. Yorkshire. 0535 65094
E. S. MICROCOMPUTERS, 7 Berkeley Precinct, Eccleshall Road, Sheffield S11 8PN. 0742 668767
GLYSTHYDON LTD., Nook Farm, Rake Lane, Warton, Preston, Lancs. 0772 633138
MICRODIGITAL, 25 Brunswick Street, Liverpool L2 0BJ. 051 227 2535
MICROPUTE, 7 Westbourne Grove, Manchester M20 8JA. 0625 612 759
MAGNUM CONSULTANTS, 57 Fairburn Drive, Garforth, Leeds. 0532 867897
T.W. COMPUTERS, 293 London Road, Hazelgrove, Stockport. 061 4668187

MIDLANDS

M & R SYSTEMS, 20 Norwich Road, Wisbech, Cambs. 0945 5900
MIDLAND MICROCOMPUTERS, 1 Cherry Wood Drive, Aspley, Nottingham. 0602 298 281
GRIFFIN & GEORGE Birmingham, Manchester, London, Eastkilbride 01-997 3344

LONDON and the SOUTH EAST

MICROBITS, 34b London Road, Blackwater, Camberley, Surrey. 0276 34044
SLOUGH MICROSHOP, 120 High Street, Slough, Berks. 0753 22855
HOME & BUSINESS COMPUTERS, 445 High Street, Manor Park, London E12. 01-472 5107
E. M. G., 30 Heathfield Road, Croydon, Surrey CRD 1E4. 01 688 0088
INFORMEX LTD., 8-12 Lee High Road London SE13. 01-318 4213
N.I.C., 61 Broad Lane, Tottenham N15. 01-808 0377
TVJ MICROCOMPUTERS, 165 London Road, Camberley, Surrey CU15 3JS. 0276 62506
C.C.S. MICROSALES, 7 The Arcade, Letchworth, Herts. 046 26 73301

WALES and the WEST

ELECTROPRINT, 5 Kinsdown Parade, Bristol BS6 5UD 0272 292375
G W P ELECTRONICS, 55 Cobham Road, Fern Down Industrial Estate, Wimborne, Dorset. 0202 893838
TRYFAN COMPUTERS, 3 Swifts Buildings, High Street, Bangor, Gwynedd LL57 1UW. 0248 52042
TVJ MICROCOMPUTERS, 48 Gloucester Road., Bristol 0272 422067
LIVEPORT. DATA PRODUCTS, The Ivory Works, St. Ives, Cornwall 0736 798157

PLEASE SEND DETAILS OF THE EXIDY RANGE

NAME _____

ADDRESS _____

the choice was ours...
...now its yours

1 letter quality
2 speed 60 C.P.S.
3 economy

RICOH RP.1600

- **Printing speed - 60 C.P.S.**
- 124 character print wheel
- Integral PET Interface
- Line width - 136 characters (10 characters per inch)
- 163 characters (12 characters per inch)

**Complete word processing systems -
PET, Wordcraft, R.P. 1600 also available**



small systems engineering limited

2-4 Canfield Place · London · NW6 3BT · Telephone 01-328 7145/6 Telex: 8813095 (Abacus)

1 speed 150-200 C.P.S.
2 matrix flexibility
3 economy

**ANADEX D.P. 9500/01 LINE
PRINTER**

- Bi-directional printing with shortest distance sensing logic
- High density graphics
- 50 to 200 + Lines/Min. 150/200 CPS with 9 x 9/7 x 9 Character font or 120/200 CPS with 11 x 9/7 x 9 Character font
- 132/158/176 or 132/165/198/200 Columns
- Parallel, RS-232-C and Current Loop Interfaces; Standard, PET Interfaces available.

Prices: 9500 - £895
9501 - £995



We think you could do better with a **NEW MODEL 3 MICROCOMPUTER CASE**. If you own a **SUPERBOARD, UK101, Nascom 1 or Nascom 2, MICROTYPE** have the professional answer.

Look at these features:

*Made in strong, black ABS plastic together with all fixing screws and full assembly instructions. *Space for expansion boards (up to 5 for Nascom), colour add-ons, etc. *Room for force-feed fan ventilation. *Space for numeric pad and additional keys, etc. *Flat top for T.V. monitor, papers, also recessed to hold cassettes. *Ribbed base for screw fixing of boards without scratching worktops. *Recessed back for cables and connectors. *Can be sprayed with conventional car paints without cracking or peeling.

All this for just £24.50 + £1.50 P&P + VAT.
Send cheques or postal orders for £29.90 to:-



MICROTYPE

P.O. Box 104, Hemel Hempstead, Herts. HP2 7QZ.
Please state type when ordering. S.A.E. for details.

S Software for TRS80[®]

**ACCEL
Compiler for
TRS80 BASIC**

Speeds execution of correct Level 2, BASIC programs by compiling the common statements to Z80 machine-code.

- Develop and debug normally.
- Compile for production work.

ACCEL (16K)

Great value at £19.95

DLOAD	Load program segments.....	£4.95
ZBUG	Debug Z80 programs.....	£11.95
TSAVE	Prepare system tapes.....	£4.95
RENUM	Re-number BASIC programs.....	£5.95
FGRAP	Fast Graphics.....	£4.95
XREF	Program cross-reference.....	£5.95
SDUMP	Symbolic dump.....	£2.95
LIFE	(16K) 48 x 64.....	£3.00
USRN	Multiple USR calls.....	£2.95



Southern Software programs are self-relocating, load-anywhere, machine-code, well documented. They run in 4K Level 2, unless otherwise stated.

SOUTHERN SOFTWARE PO Box 39, Eastleigh, Hants. SO5 5WQ



SIRTON COMPUTERS

76 Godstone Road, Kenley (Nr Croydon)
Surrey CR2 5AA
Tel: 01-668 0761/2

MIDAS S100 SYSTEMS

MIDAS 1:	From £895
MIDAS 2:	From £1880
MIDAS 3:	From £2460
MIDAS 4:	From £6300

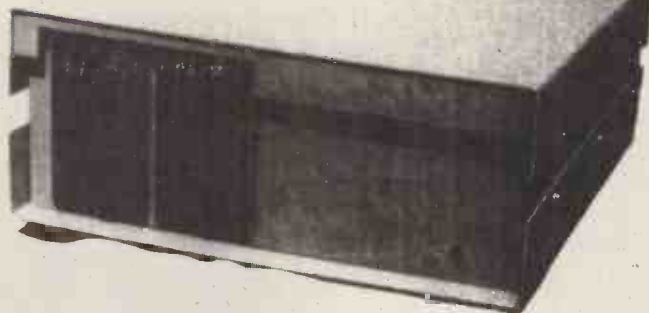

- Our versatile Z80 Microcomputers are available as standard units or custom configured to your exact specification from a comprehensive range of stocked S100 boards.
- Disc storage capacity of the MIDAS 3 can be 2M Bytes, expandable to over 20M Bytes with a Winchester Hard Disc Unit in our MIDAS 4 range.
- MIDAS runs under CP/M and MP/M is also available. Other Software includes M-BASIC, C-BASIC, FORTRAN, COBOL, CIS-COBOL, PASCAL and Word Processing.
- A MIDAS 3, with 64K RAM and 2M Bytes storage on two 8" drives with two Serial I/O Ports and CP/M 2 only £3200.
- Printers, VDUs and other peripherals stocked to give complete package systems at keen prices.
- Business Packages include Accounts, Sock Control, Purchase Ledger etc etc.
- OEM and Dealer enquiries welcome.

ITHACA DPS-1



With 4 MHz MPU-80 (Z80) CPU from £895. All Ithaca boards and many others available to make complete system. Also companion dual 8" Disc Drive Enclosure.

WRITE OR PHONE FOR CATALOGUE
SIRTON COMPUTERS WAS FORMERLY SIRTON PRODUCTS

INTELLIGENT ARTEFACTS LTD

TI99/4 Computer



Ideal For Education

Features Include:

- Powerful TI Basic based on the original Dartmouth
- Programmable sound – compute tempered scales, chords etc.
- Programmable colour graphics – define any character or shape, don't just put up with a collection of triangles and bars.
- Programmable speech synthesis option.
- Comes with modified SKANTIC 14 inch colour TV which also serves as a second television.
- Uses low cost cassette
- Much home and CAL software already available on plug in ROM-PAKS
- £860 complete + £129 VAT



INTELLIGENT ARTEFACTS LTD
Cambridge Road, Orwell, Royston, Herts.
Telephone: Arrington 689

Da Vinci Computer Shop

65, High Street, Edgware, Middx HA8 7DD.

Open

Mon-Fri 9-5.30

Sat 9.30-5.30



Tel 01-952 0526

NEW PRICE PETS

CBM 32K £695.00
CBM 3040 FLOPPY £695.00
CBM 3022 PRINTER £425.00

NEW 80 COLUMN
SCREEN PET
£895.00

NEW 1 MEG DISC
DRIVE £895.00

DUPLICATE
DAISY PRINTER
£2115.00

SALES/PURCHASE -
LEDGER ACCOUNTING
INCOMPLETE RECORDS

WORD PROCESSING
INVOICING - PAYROLL

STOCK CONTROL
INFORMATION RETRIEVAL



OUR SYSTEMS ARE MASTERPIECES - COME AND SEE THEM!

SOUND EFFECTS & MUSIC

FOR PET, SUPERBOARD, UK101, NASCOM

A startling addition to games & other programs. Capable of up to 3 simultaneous outputs.

EXAMPLES: Lasers, explosions, whistling bombs, telephone tones, racing cars, sirens, musical instruments, drums, cymbals.....almost any conceivable sound!!!!

Stereo output, doppler sweep & amplitude control give a truly dynamic depth to the sound.

By careful design of hardware the processor time used is minimal.

Also includes two 8 bit I/O ports that can be used for control and/or monitoring of various devices switches, lamps etc.

Complete built & tested unit with selectable output for stereo amplifier or small speaker, demo program & full instructions.

Nascom version suits 77 way Nasbus, CompuKit & Superboard versions on 40 pin D.I.P. connector. Pet version with 40 pin edge connector.

EX-STOCK **£45** ALL INC.

£ Has your Business outgrown its Software? \$ Fed up with those games?

IF YOU HAVE ANY REDUNDANT ORIGINAL SOFTWARE ON PROFESSIONAL LABELS FOR PET OR OTHER MICROS THEN WHY NOT TURN THEM INTO CASH! WE BUY AND SELL. WRITE OR PHONE TODAY!

Superboard II

@ £1.50 ea. FIFTY, FLYWALK, NUMBERS.

@ £2.00 ea. MOTORCYCLE JUMP, MOONBASE ATTACK, DRUNK'S MAZE, ALIEN ATTACK, DEATHROIDS, OBSTACONSTRUCTION!

@ £2.50 ea. CODEMASTER, AWARI.

@ £3.25 ea. DAWN PATROL, SIMPLY ADD, ALPHARAPID, DIGITAL TIMER, CALENDAR.

Simple 'music' & tones from your Superboard/UK101 kit of parts & tape £4.50

Nascom

@ £4.50 ea. ALIEN LABYRINTH

@ £3.00 ea. MUSICAL STAVE

@ £2.50 ea. MINEFIELD

Pet

@ £2.00 ea. TIE FIGHTER ATTACK, ANGLO-METRIC, SAFECRACKER

@ £2.50 ea. TREASURE HUNT, UFO CAPTURE, SAPPER, PAWNSTRIKE

Research Machines 380Z

@ £4.00 ea. SURVIVAL, CRACKER, PINBALL, ONE ARM B.

@ £10.00 ea. HOTEL BOOKING, MAILING LIST, SMALL BUSINESS STOCK CONTROL

TELEPHONE/ADDRESS DIRECTORY

@ £15.00 ea. DISASSEMBLER

ALL PRICES INCLUSIVE

Always wanted quality original programs for publication. Top rates of commission paid.

Easicomp
Spronston, NORWICH. LTD.

For details write or phone

0508 46484

BY OSBORNE

Introduction to Microcomputers Series

Vol 0: Beginners Book	£ 5.95
Vol 1: BASIC Concepts	£ 6.30
Vol 2: Some Real Microprocessors (without binder)	£ 18.95
Vol 2: Some Real Microprocessors (with binder)	£ 24.70
Vol 2: Updating supplement set Nos. 1-6	£ 18.95
Vol 3: Some Real Support Devices (without binder)	£ 11.95
Vol 3: Some Real Support Devices (with binder)	£ 17.70
Vol 3: Updating supplement set Nos. 1-6	£ 18.95
1 binder (Specify for Vol 2 or 3)	£ 5.75
1 Updating supplement (Specify for Vol 2 or 3)	£ 4.00
PET and the IEEE 488 (GPIB) bus	£ 9.95
6800 Programming for Logic Design	£ 6.30
8080 Programming for Logic Design	£ 6.30
Z80 Programming for Logic Design	£ 6.30
Z80 Assembly Language Programming	£ 8.15
6502 Assembly Language Programming	£ 8.25
8080A/8085 Assembly Language Programming	£ 7.95
6800 Assembly Language Programming	£ 7.95
Accounts Payable and Accounts Receivable	£ 13.15
Payroll with Cost Accounting	£ 13.50
General Ledger	£ 12.25
Some Common BASIC Programs	£ 7.95
Running Wild	£25.00

GENERAL

See Magazines and Subscriptions!

See Osborne Books!

Microprocessors from Chips to System	£ 7.00
Microprocessor Interfacing Techniques	£ 9.95
Numbers in Theory and Practice (A BYTE publication)	£ 5.50
Cheap Video Cookbook	£ 4.30
CMOS Cookbook	£ 7.50
IC OP-AMP Cookbook	£ 8.95
RTL Cookbook	£ 4.25
TTL Cookbook	£ 7.50
Ciarcias Circuit Cellar	£ 5.50
First Book of Kim	£ 7.00
Buyers Guide to Microsoftware	£ 2.40
Calculating with BASIC	£ 4.95
Computer Programs that Work (In BASIC)	£ 2.95
Dr Dobbs Journal, Volume 1 (Coming soon)	£13.95
Dr Dobbs Journal, Volume 2 (Coming soon)	£13.95
Dr Dobbs Journal, Volume 3 (Coming soon)	£13.95
Best of BYTE	£8.95
Scolbi BYTE Primer	£8.95
Best of Creative Computing, Vol 1	£6.95
Best of Creative Computing, Vol 2	£6.95
Program Design	£4.25
Programming Techniques: Simulation	£4.25
PIMS - A Database Management System	£5.95
Best of Interface Age - Software	£9.95
Programming the Z8000	TBA

FOR THE Z80

See Osborne books!

32 BASIC Programs for the TRS-80 (Level II)	£10.10
Introduction to the T-Bug (TRS-80 Machine Lang. Monitor)	£4.50
Z80 Software Gourmet Guide and Cookbook	£ 8.50
Programming the Z80 (ZACS)	£ 9.95
Z80 Instruction Handbook (Wadsworth)	£ 2.95

FOR THE 6800

See Magazines and Subscriptions!

See Osborne Books!

6800 Software Gourmet Guide & Cookbook	£ 7.15
6800 Tracer - An aid to 6800 Program Debugging	£ 3.95
Tiny Assembler	£ 5.75
RA 6800 ML - An M600 Relocatable Macro Assembler	£ 15.95
Link 68 - An M6800 Linking Loader	£ 5.50
MONDEB - An Advanced M6800 Monitor Debugger	£ 3.50

CONCERNING LANGUAGE

SCELBAL - BASIC Language Interpreter (Source Code)	£ 15.00
Instant BASIC	£ 6.95
Basic BASIC	£ 6.50
Advanced BASIC	£ 6.00
My Computer likes me . . . when I speak in BASIC	£ 2.75
Users Guide to North Star BASIC	£ 10.00
A Practical Introduction to PASCAL	£ 3.95
Microsoft BASIC	£ 6.50
Secret Guide to Computers	T.B.A.
Best of Micro, Vol 1	£ 5.50
Best of Micro, Vol 2	£ 5.50
Programming the 6502 (Zacs)	£ 7.95
Programming the 6502 (Foster)	£ 6.75
6502 Applications	£ 7.95
6502 Software Gourmet Guide and Cookbook	£ 7.25
32 BASIC Programs for the PET	£10.10

FOR THE 8080

See Osborne Books!

8080 Programmers Pocket Guide	£ 1.95
8080 Hex Code Card	£ 1.95
8080 Octal Code Card	£ 1.95
8080 Software Gourmet Guide & Cookbook	£ 7.15
8080/8085 Software Design	£ 6.75
8080 Standard Monitor	£ 9.95
8080 Standard Assembler	£ 9.95
8080 Standard Editor	£ 9.95
8080 Special Package: Monitor, Editor, Assembler	£ 20.00
BASEX: A Simple Language and Compiler for the 8080	£ 5.50

FOR FUN

Starship Simulation	£ 4.50
SARGON - A Chess Game (for the Z80)	£ 9.50
BASIC Computer Games	£ 5.00
More BASIC Computer Games	£ 5.50
What to do After you Hit Return	£ 8.95
8080 Galaxy Game	£ 6.95
SUPER-WUMPUS - A game in 6800 Assembler Code & BASIC	£ 4.25
Computer Music Book	£ 6.75
Computer Rage (A board game)	£ 6.95
Artist and Computer	£ 3.95
Games, Tricks and Puzzles for a Hand Calculator	£ 2.49
Introduction to TRS-80 Graphics	£ 5.75
Take My Computer Please . . . (Fiction)	£ 3.25
Introduction to Low Resolution Graphics for Pet, Apple, TRS80	£ 5.50

FOR THE NOVICE

See Magazines and Subscriptions!

See Osborne Books!

How To Make Money With Your Microcomputer	£5.75
From the Counter to the Bottom Line	£10.00
Your Home Computer	£ 5.95
Introduction to Personal and Business Computing	£ 5.50
Getting involved with Your Own Computer	£ 5.50
How to Profit from Your Personal Computer	£ 5.50
Microcomputer Potpourri	£ 1.95
Hobby Computers are Here	£ 3.95
New Hobby Computers	£ 3.95
Understanding Microcomputers and Small Computer Systems	£ 6.95
Understanding Microcomputers and Small Computer Systems and Audio Cassette	£ 8.75
Getting Down to Business With Your Microcomputer	£ 5.50

MAGAZINE BACK ISSUES

Micro 6502 Journal	£1.75
Personal Computing	£1.95
Interface Age	£2.95
Dr Dobbs Journal	£1.95
Computer Music Journal	£3.75
Recreational Computing	£1.95
BYTE	£2.95
Creative Computing	£1.95
Calculators and Computers	£1.95
Kilobaud Microcomputers	£2.95
Compute - for the 6502	£1.95
68' Micro	£1.95
80-Microcomputing	£2.25
On Computing	£1.95
Compute II - for the Single Board	£1.95
Magazine Storage Box (Holds 12)	£1.50

MAGAZINE SUBSCRIPTIONS (all processed within 3 weeks)

Micro 6502 Journal	(12 issues) £13.50
68 Micro	(12 issues) £17.50
Personal Computing	(12 issues) £17.50
Interface Age	(12 issues) £25.50
Dr. Dobbs Journal	(10 issues) £15.00
Recreational Computing	(6 issues) £10.50
BYTE	(12 issues) £25.00
Creative Computing	(12 issues) £17.00
Kilobaud Microcomputing	(12 issues) £22.00
Compute for the 6502	(6 issues) £10.50
80'-Microcomputing	(12 issues) £21.00
Compute II - for the Single Board	(6 issues) £10.50

HOW TO ORDER:

Send cash, postal order, cheque card number to L.P. Enterprises, Room 8, Cambridge House, Cambridge Road, Barking, Essex IG11 8NT. All payment must be in Sterling and drawn against a U.K. bank.

Please note: If you wish to pay by Diners Club credit card, we must have your signature. For any payment by credit card, we need the expiry date of the card and the address that the credit card company knows (although we can send the goods to an alternative address).

All publications are published in the U.S.A. and are stocked in Britain by L.P. Enterprises. Prepaid orders are despatched by return of post, or advice concerning.

For more information on any of these items, please phone, write or visit. (We are open during office hours).

TRADE ENQUIRIES WELCOME

THE PETMASTER SUPERCHIP

JUST LOOK AT WHAT YOU WILL BE ABLE TO DO WHEN YOU PLUG IN YOUR PETMASTER SUPERCHIP.

- Automatic repeat facility on all keys or just insert/delete, space and the cursor movement keys
- Adjustable repeat delay/speed
- Graphics/lower case toggle
- Variable cursor flash speed
- Scroll screen up or down
- Escape from quote mode
- Erase line up to cursor
- Erase line from cursor
- Insert or delete line



ONLY **£45** PLUS VAT

ADD COUNTLESS NEW FEATURES TO YOUR EXISTING MACHINE !
Many of the SUPERCHIP's useful functions are similar to those only available on the new 8000 series Superpets. And most may be accessed either from the keyboard or from Basic.

WRITE NOW FOR MORE DETAILS

PLUS

- SINGLE KEY ENTRY OF 26 OF THE LONGEST AND MOST COMMON BASIC WORDS
- RETRACE FACILITY WHICH ENABLES YOU TO DISPLAY AT ANY TIME THE LAST 10 LINES EXECUTED. OTHERWISE RETRACE IS INVISIBLE TO THE USER !
- 'SHRINK' routine which eliminates REMs and unnecessary spaces from your program
- 'REVERSE' routine which reverses any part of the screen (black/white to white/black)
- 'MOVIT' subroutine for instantaneous transfer of any area of memory

TOOLKIT COMPATIBLE !

NEW ROM VERSION AVAILABLE NOW

OLD ROM OWNERS WRITE FOR DETAILS



SUPERSOFT

28 Burwood Avenue - Eastcote - Pinner - Middlesex
Phone 01-866 3326 anytime



255 ARCHWAY RD
LONDON N6 5BS Tel 01-348 3325

JUMP ON A S-100 BUS SYSTEM WITH THE EXPLORER/85 PRO' KIT

EXPLORER/85

The really expandable computer kit. FEATURES:-*Fast 8085cpu*8K Microsoft -80 Basic*2K Monitor System*1k Video RAM*Full Qwerty KeyBd(upper & lower case)*Interfaces for monitor/TV*Cassette with relay control
Expandable to 64K*. 6S-100 buses*supplied with full documentation.
4K version as kit £299* 16K kit version £399. Lots of optional extras.

64K, S-100 DYNAMIC RAM Bd

Features *Hidden retreash*low power*Latched data outputs*200ns 4116s RAMs*On Board crystal*8k Bank selectable*Designed for 8080:8085:280 systems. 16K kit at £149:16k expansion kits £70

ELF11 SNIP LIMITED OFFER ONLY £39-95

Ideal starter kit of control board fully expandable to full computer. Kit includes RCA 1802 cpu*¼k RAM*1861 Video chip*Dual Display*Hex Keybd*Full documentation.

COMPUKIT UK101

6502 based cpu*8K Basic*Full Qwerty KeyBd*expandable to 8K on board* Complete with P.S.U.& RF Modulator...Kit version £199 W&T £249 Cabinet (Plastic) £29 : Assembler/Editor £14-90

PETS

8k built-in cassette £425*8K large Keybd £450, 16K..£550, 32K..£695. Tractor feed printer £425. Dual floppy discs £695.

TTT

2020 (colour)....£650: 16K upgrade kits at £56

ALL PRICES QUOTED ARE EX VAT + P & P
cheque or cash with order or ACCESS or Barclaycard

Queues at Millbank!

for



Qume Sprint 5 Daisywheel Printers.

These high quality 45/55 KSR and RO printers are now available at attractive trade prices — from **£1389.00** (excl. VAT)
No other daisywheel printer offers this level of quality, performance and flexibility.
TSE Daisywheel print wheels allow a choice of over 50 different type faces.

HIGH PERFORMANCE SYSTEMS TOO!

Word processing and a wide range of general business functions at highly competitive OEM prices

Ring or write for details:

MILLBANK COMPUTERS LIMITED

East Lane, Kingston upon Thames, Surrey Telephone: 01-549 7262

POWERFUL MICROS

AT THE RIGHT PRICE

- Multi-User ● Multi-Tasking
- Multi-Language ● Hard Disc Storage ● Word Processing
- Priced from under £5000

Languages supported include – Basic, Cobol, Fortran.
OEM, Educational and Dealer enquiries invited

EQUINOX

COMPUTER SYSTEMS LIMITED
Kleeman House, 16 Anning Street
New Inn Yard, London EC2A 3HB
Tel: 01-739 2387 & 01-729 4460



...British S100 BOARDS...

(MANUFACTURED IN THE U.K. TO IEEE BY INTERACTIVE DATA SYSTEMS)

IDS SBMC	Single Board Micro Computer, Z80A, 4MHZ, 1K RAM, up to 16K EPROM, 2 SERIAL PORTS!	KIT £178 A&T £235
IDS 16K SRAM	4 MHZ Static RAM using 2114 chips.	KIT £174 A&T £198
IDS DFDC	Double/single density, Double/single sided Floppy Disc Controller, up to 4 drives.	KIT £177 A&T £198
IDS SFDC	As IDS DFDC but Single Density only.	KIT £109 A&T £140
IDS IOC	2 Serial, 2 Parallel port I/O Controller.	KIT £107 A&T £130
IDS PCI 10	Process Control Interface, opto-isolated, TTL and analogue inputs, relay, TTL and analogue outputs (multichannel)	KIT £195 A&T £223

...£15 OFF ABOVE BOARDS...

SPECIAL OFFER FOR CASH ORDERS EXTENDED TO 10th AUGUST 1980

IDS 8K SRAM	4MHz Static RAM using 2114 chips (available August)	FT.B.A.
IDS Z80 CPU	Z80A, 4MHZ CPU board.	KIT £84 A&T £105
IDS TERM 40	Active Termination Board.	KIT £25 A&T £32.50
ALSO		
7M.BD	7 slot Mother Board (excluding connectors)	EA £16
15M.BD	15 slot Mother Board (excluding connectors)	EA £24
S100 CONN	Edge connectors for Mother Board (solder tail)	EA £2.90
DP 8000	Anadex dot matrix printer, RS232 interface	EA £495
CHIPS	Diskette Drives	
	2114, Low Power SRAM for 4 MHz operation*	EA £4.75
	2716, 450nS Single supply EPROM	EA £19.95
	Z80A, 4MHZ CPU	EA £11.20
	2708, 450nS EPROM	EA £6.65
	4116, Dynamic RAM for 4MHz operation*	EA £5.95
	* 350nS or better	

CATALOGUE Includes fuller details of above items and more... (Free)

Please add 15% VAT to all prices. P&P 50p under £15. MAIL ORDER ONLY

Mendip Computers

57 Bath Road, Wells, Somerset, BA5 3HS. Telephone 0749 (WELLS) 75249

PET PRICES DOWN

AT THE ...

BUSS STOP

PET 3,000 Series	KIM	
8K RAM	£379	KIM1 £93.00
16K RAM	£495	KIM 3B £96.95
32K RAM	£625	KIM 4 £65.00
Dual Disk Drive	£625	PET-IEEE LEAD £18.75
Printer Friction	£337	IEEE-IEEE LEAD £23.44
Printer Tractor	£383	PETSOFT TOOL KIT FOR
Ext Cassette	£49.50	16K/32K £55.00
		8K £75.00

New Super Pets on Demonstration Now.

8032 New 32K Pet	£895.00
8050 950K storage disk unit	£895.00

Order now to avoid disappointment

Pascal compiler now available for Pet

NASCOM 2 – SYSTEM 80

PLEASE PHONE FOR SYSTEM 80 PRICES

VIDEO GENIE EG 3003 – 16KRAM

FULLY TRS80 LEVEL II COMPATIBLE!!

THIS READY TO GO SYSTEM ONLY £339.00

NEW-DOLPHIN BD80P PRINTER

PET/IEEE, PARALLEL OR RS232 INTERFACE BUILTIN.

UNBEATABLE BRITISH VALUE AT £525.00

SOFTWARE – 10 C12's £4.50

PETSOFT 10 5¼" DISKS £25.00

1000 SHEET OF PAPER £8.40

BRISTOL SOFTWARE FACTORY, COMMODORE BUSINESS SOFTWARE, WIDE RANGE OF BOOKS & MANUALS IN STOCK.

PHONE FOR KEENEST D.E.M. AND EDUCATIONAL USER CHARGES

PLEASE PHONE FOR CARRIAGE CHARGES ALL PRICES

+ VAT CHEQUES TO BUSS STOP (PHOTOACOUSTICS) LTD.

Ring Rod Eva for details or just call in at the BUSS STOP

255a St. Albans Road, Watford, Herts. (entrance in Judge Street)

Phone: Watford 40698 or Newport Pagnell 610625

DATRON of SHEFFIELD

for

Cromemco the ultimate name in micros



DATRON import direct from Cromemco, California.
DATRON can supply Nationwide.
DATRON can provide maintenance nationally
DATRON can give you the realistic prices.
DATRON have in stock:-

SYSTEM2 64 K £ 2095

SYSTEM3 64 K £ 3398

10M HARD DISC £ 5373

DATRON can supply Systems 2 and 3 with Multi-Tasking facilities.

DATRON easily accessible - in the centre of the country.

Write or telephone for FREE colour brochure on System 3 or Z-2H.
We use Cromemco for our own business, why not call in for a demonstration.



DATRON MICRO CENTRE
DATRON INTERFORM LTD

2 Abbeydale Road, Sheffield S7 1FD.
Telephone 0742-585490. Telex 547151.

SOFTWARE by the PROFESSIONALS



ARE YOU FED UP WITH WADING THROUGH THE SOFTWARE JUNGLE???

CAN'T YOU FIND ANY REAL BUSINESS SOFTWARE???

STOP LOOKING!!! WE'VE GOT IT

If you're looking for a £50 business package or games DON'T call us.

We are one of the foremost micro-computer applications 'Software Houses' in the country and our packages developed for the UK, offer facilities normally found only on larger and more sophisticated computer systems.

The packages are simple to use, robust, secure against crashing, extremely flexible and cover most of the normal requirements of a small business.

We provide a 12 month warranty, with all our software products, plus advice, support and backup.

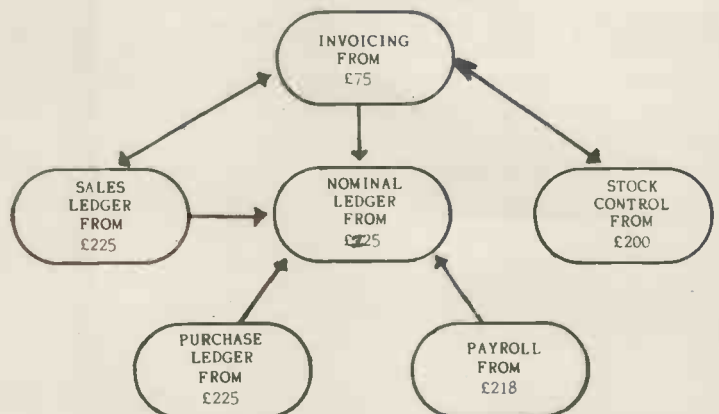

TRIDATA MICROS LTD.,

SMITHFIELD HOUSE, DIGBETH, BIRMINGHAM B5 6BS TEL. 021 622 6085

Tridata

MEET THE FAMILY



... THERE MUST BE ONE HERE FOR YOU

The Exidy family is a sophisticated range of products designed to meet the ever increasing variety of computing needs, including home and business uses, educational and laboratory applications, industrial process control etc.

The Exidy range has been designed with built-in growth capacity to take the risk factor out of computer investment. The Sorcerer Computer now has a memory expansion capability from 8K up to 48K within its own cabinet, enabling the system to grow with your needs plus the ability to add many additional plug-in facilities such as disk drives and pre-programmed ROM PAC's.

The standard configuration includes a 63 key typewriter-style keyboard and a 16 key numeric pad. Remote control for dual cassettes. Serial RS232 and parallel interfaces, Z80 processor, 4K resident operating system, 8K Microsoft BASIC in separate plug-in ROM PAC cartridge, 64 character x 30 line display, 128 upper/lower case ASCII character set and 128 user defined graphic symbols, operators manual, introduction to basic programming, connecting leads. All Exidy equipment is backed up by a 12 month warranty covering both parts and labour.

The Word Processing ROM PAC features auto wraparound, dynamic cursor control, variable line length, global search and replace, holding buffer for re-arrangement of text, right justification, line width and line to line spacing, underlining or boldfacing, text merging and a macro-facility permitting tasks such as formletter typing, multiple column printing of automatic forms entry.

Or send coupon
for further information to:

SOLE DISTRIBUTORS

Geoff Wilkinson
LIVEPORT DATA PRODUCTS
The Ivory Works, St. Ives, Cornwall.
0736-798157

Now contact your nearest dealer:

The NORTH
6ASIC COMPUTING, Oakville, Oakworth Road, Keighley, W. Yorkshire. 0535 65094
E. S. MICROCOMPUTERS, 7 Berkeley Precinct, Eccleshall Road, Sheffield S11 8PN. 0742 668767
GLYSTHYDON LTD., Nook Farm, Rake Lane, Warton, Preston, Lancs. 0772 633138
MICRODIGITAL, 26 Brunswick Street, Liverpool L2 0BJ. 051 777 7836
MICROPUTE, 7 Westbourne Grove, Manchester M20 8JA. 0625 612 759
MAGNUM CONSULTANTS, 57 Fairburn Drive, Garforth, Leeds. 0532 867897
T.W. COMPUTERS, 293 London Road, Hazelgrove, Stockport. 061 4568187

MIDLANDS
M & R SYSTEMS, 20 Norwich Road, Wisbech, Cambs. 0945 5900
MIDLAND MICROCOMPUTERS, 1 Cherry Wood Drive, Aspley, Nottingham. 0602 298 281
GRIFFIN & GEORGE Birmingham, Manchester, London, Eastkilbride 01-997 3344

LONDON and the SOUTH EAST
MICROBITS, 34b London Road, Blackwater, Camberley, Surrey. 0276 34044
SLOUGH MICROSHOP, 120 High Street, Slough, Berks. 0753 22855
HOME & BUSINESS COMPUTERS, 445 High Street, Manor Park, London E12. 01-472 5107
E. M. G., 30 Heathfield Road, Croydon, Surrey CR0 1EA. 01 688 0088
INFORMEX LTD., 8-12 Lee High Road, London SE13. 01-318 4213
N.J.C., 61 Broad Lane, Tottenham N15. 01 808 0377
TVJ MICROCOMPUTERS, 165 London Road, Camberley, Surrey CU15 3JS. 0276 62506
C.C.S. MICROSALES, 7 The Arcade, Letchworth, Herts. 046 26 73301

WALES and the WEST
ELECTROPRINT, 5 Kinsdown Parade, Bristol BS6 5UD 0272 292375
G.P.W. ELECTRONICS, 55 Cobham Road, Ferndown Industrial Estate, Wimborne, Dorset. 0202 893888
TRYFAN COMPUTERS, 3 Swifts Buildings, High Street, Bangor, Gwynedd LL57 1UW. 0248 52042
TVJ MICROCOMPUTERS, 48 Gloucester Road., Bristol 0272 422061
LIVEPORT. DATA PRODUCTS, The Ivory Works, St. Ives, Cornwall 0736 798157

PLEASE SEND DETAILS OF THE EXIDY RANGE

NAME _____

ADDRESS _____

Now available On Earth



THE SHARP MZ-80 COMPUTER SYSTEM

Sharp have been associated with many major advances in electronic technology in space and here on Earth. We have introduced the most sophisticated production techniques for electronic circuitry to set world renowned standards of reliability into every product.

That's why the MZ-80K and its range of peripherals is going to change the way you think about microcomputers. The Sharp MZ-80 System now includes the MZ-80K processor backed with the MZ-80FD dual drive, double sided mini-floppy disk unit to give rapid, effective, sequential and random access, to huge amounts of stored information with incredibly fast response times.

Our new MZ-80P3 printer makes a good impression as well. Its fine definition dot matrix

head prints across 80 columns, at 100 characters per second, with full graphics capabilities.

The Sharp MZ-80 System is a new approach to computer applications, and their efficient use by human beings.

Our aim is to make computers and their related equipment relatively simple and therefore better understood and better used by those they are designed to serve.

Whether you are looking for a business system, or a system for educational or personal use—take a look at Sharp, it will change the way you think about computers.

Send me details of the complete Sharp MZ-80 System and the name and address of my nearest stockist

Name _____

Address _____

PCW/8

Sharp Electronics (UK) Limited, Sharp House, Thorp Road, Newton Heath, Manchester. M10 9BE Tel: 061-205 2333



COMPUTER APPLICATIONS

INNOVATIVE

TRS-80 SOFTWARE

FROM THE PROFESSIONALS

NEW!

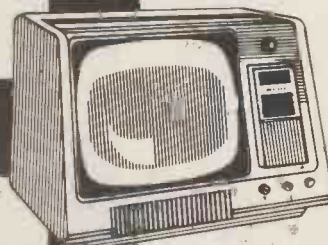
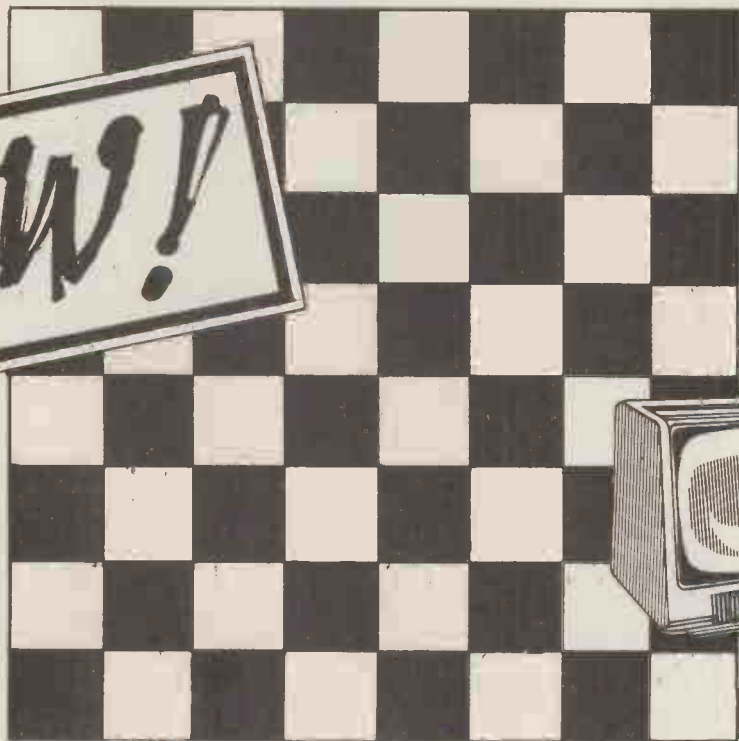

DRAUGHTS

Now for the TRS-80 Model I, following on in the same tradition as the chess playing games of Micro-Chess, Z-Chess and the Sargons, is a new program for playing computer Draughts. Standard rules are followed including Huffing and Crowning. Excellent graphics with a solid black and white chequered pattern board. You can choose from 6 levels of play - it seems to be pretty well unbeatable at the highest level. The computer response time for this machine language program is exceptionally good, varying from less than 1 second to 80 seconds. A special feature allows the player to instruct the computer to play a particularly aggressive game. Levels of play may be changed during play. Supplied on cassette for a 16K or greater memory size or on disk for 32K up. A further example of our continuing search for English written software, we are shortly to sell this program in the USA where no comparable program exists.

£14.95

Inclusive of VAT. Add £3.45 for Disk.
Both plus 75p P & P.



Send large SAE (27p) for our current catalogue of TRS-80 software. Add £1.85 for a binder

A.J.HARDING (MOLIMERX)

28 COLLINGTON AVENUE, BEXHILL-ON-SEA, E.SUSSEX. TEL: (0424) 220391

TELEX 86736 SOTEX G FOR A. J. HARDING



NB

NewBear
in 1980

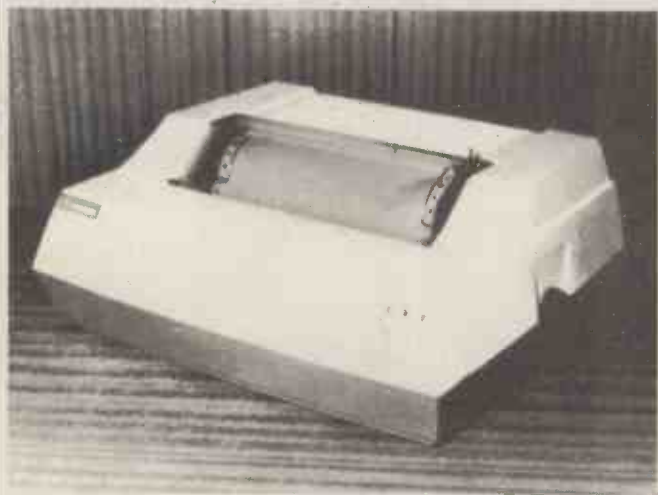

8300 RM PRINTER

80/132 ch per line (switchable); 125 c.p.s.; 2K Buffer; V24 RS232/Current loop interface; Speed switchable between 110-9600 baud; Double width char. available under software control; sprocket feed; 7 x 9 dot matrix; Paper width 4.5" to 9.5".

Price £525 + carriage

SPECTRONICS U.V. EPROM-ERASING LAMPS

PE14	Erases up to 6 chips, takes approx. 19 mins	£ 56.00
PE14T	Erases up to 6 chips, takes approx. 19 mins	£ 76.58
PE24T	Erases up to 9 chips, takes approx. 15 mins	£111.22
PR125T	Erases up to 16 chips, takes approx. 7 mins	£237.84
PR320T	Erases up to 36 chips, takes approx. 7 mins	£384.09

U.V. EPROM ERASING CABINET

PC1000	Erases up to 72 chips, takes approx. 7 mins	£842.83
PQ2000	Erases up to 144 chips, takes approx. 7 mins	£1227.69

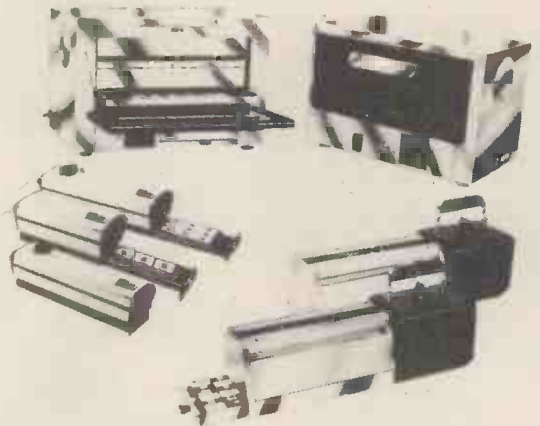

SHARP MZ80K From £480

Z-80 based CPU; 4K bytes monitor ROM; Internal memory expansion up to 48K bytes of RAM; 14K extended BASIC (occupies 14K bytes of RAM); 10" video display unit - 40 characters x 25 lines; 80 x 50 high resolution graphics; 78 key ASC11 keyboard alphabet (capital & small) plus graphics, Built in music function; Fast reliable cassette with tape counter-1200 bits/sec.; 50 pin universal BUS connector for system expansion-printers, floppy discs etc.

Zen Assembler/Editor	£19.50
Machine code tape and manual	£19.00
Assembly code tape and manual	£45.00

Sharp Basic Listing	£30.00
Sharp Monitor Listing (fully commented)	£15.00
Sharp basic manual	£ 7.00

Look!

SPECIAL OFFER	£
2708	4.50
4116	5.99
2716 (5w)	13.50

BOOKS

	AUTHOR	PRICE
The S100 and other Micro-buses Software Development	Poe	£ 5.15
Computers & Commonsense Architecture of Small Computer Systems	Jones	£14.45
Principles of Data-base Management	Hunt	£ 3.95
16-bit Microprocessor Architecture	Lippiatt	£ 4.50
65Q2 Assembly Language Programming	Martin	£12.99
Introductory Experiments with Digital Electronics and 8080A Book 1	Dolhoff	£16.70
Book 2	Osbourne	£ 6.95
Microcomputers for Business Applications	Rony	£ 8.40
Handbook of Microprocessors, Microcomputers and Minicomputers	Rony	£ 8.40
Introduction to Microprocessors	Barden	£ 5.80
The VNR Concise Encyclopedia of Mathematics	Lenk	£11.65
Micro Program Software Development	Levanthal	£ 9.45
Handbook of Electronic Analysis Using Programmable Calculators	Gellert	£15.35
	Duncan	£13.45
	Murdock	£19.90

GAMES

32 Basic Programs for the PET	Rugg	£ 8.90
Game Playing with Computers	Spencer	£10.20
Game Playing with Basic	Spencer	£ 4.20
Star Ship Simulation		£ 5.10
SARGON		£ 9.50

BASIC

The Basic Handbook	Lien	£11.00
Learning Level II	Lien	£11.00
Basic with Business Applications	Lott	£ 8.40
Illustrated Basic	Afcock	£ 2.50

Z80 BOOKS

Introduction to TRS80 Graphics	Inman	£ 5.75
Z80 Instant Programs (book) for Nascom	Hopton	£ 7.50
Z80 Instant Programs (cassette) for Nascom	Hopton	£10.00
Z80 Assembly Language Programming	Osbourne	£ 8.15

6502

Programming the 6502	R. Zaks	£ 7.95
6502 Applications Handbook	R. Zaks	£ 7.95

Terms: Official Orders (min. £10). Barclaycard & Access welcome. Add 15% to hardware prices. Book prices include p & p. Send for Catalogue and new May Booklist. All mail order to Newbury.

Mail Order & Head Office: 40 Bartholomew Street, Newbury, Berks. Tel: 0635 30505

Manchester Showroom: 220-222 Cheadle Heath, Stockport. Tel: 061 491 2290

Birmingham Showroom: 1st Floor Offices, Tivoli Centre, Coventry Road, Birmingham. Tel: 021 707 7170

XITAN SYSTEMS LTD

The South's CROMEMCO experts

Need a Hard Disk System with FAST RELIABLE Backup?

Xitan now have the answer with the Z-2H plus DC300 Tape cartridge BACKUP system (S100 controller, drive, psu & software).

The Cartridge BACKUP system is available separately for existing Z-2H users (13.4 Megabyte capacity - 1 Megabyte per 5 minutes).

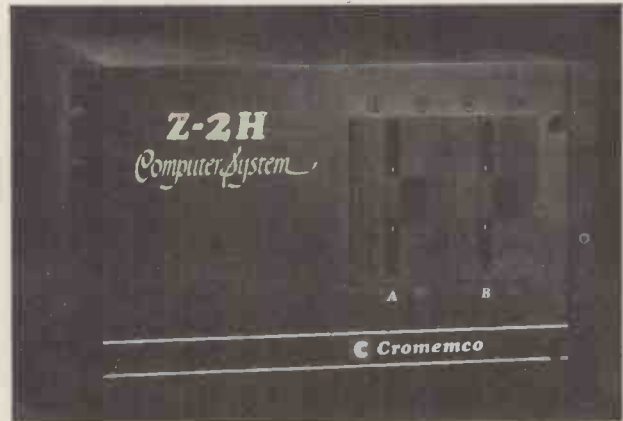

Utilities/Software for CROMEMCO Systems.

Tired of XFER - Use FCOPY or DFCOPY. Single sided 8" copy in 54 seconds, Double sided 8" copy in 104 seconds, £50.00 ea. Need to build Assembler libraries - try LIBR at £50.00.

CP/M 2.2 and MP/M 1.1 available for System 3 and Z-2H systems.

EASYFORM. For creation/editing of forms on the 3102 VDU with structured Basic. Forms useable from Cobol, Fortran etc. £160.00.

BUSINESS SOFTWARE

CROMEMCO systems - a complete Business system based on the system 3 from CAP-CPP. Phone for an appointment to see it running.

For the smaller customer, we have an integrated Sales, Purchase and Nominal system for the North Star Horizon.

Nothing fancy - but installed and running for over 7 months. IT WORKS!

WHATIF! Cash Flow, Accounts budgetting utility. Just released. Incredible value at £95.00.

Also available an Incomplete Records system for the Horizon.



SPECIALS.

Real Time Clock - S100 - 100 microseconds up to 99,999 days £155.00. Hi-Tech S100 PAL colour card, 24 x 40 Prestel format £295.00. Video Vector Fastlib £495.00. Dual Tandon Double/sided 40 track mini-floppy sybsytsem £625.00.

INTEGRATED SPECIALIST SYSTEMS.

MEDIDATA 32,000 patient Doctors' system. Installed & running. Prices from £7500.00.

RETURNED ALE. Run a brewery? Keep track of returned ale and reclaim Excise Duty. Track down production & storage problems. Copes with 10,000 + barrels. Prices from £8500.00.

Xitan Systems also supplies and stocks vdu's, printers, NORTH STAR HORIZON computers, Commodore Business Machines PETs, S100 boards, and books. We are here to demonstrate the range of quality microcomputer systems available for use today. Ring up for an appointment now! You'll not be disappointed. We have Osborne's Sales Ledger and Payable Ledger in source form for use on Cromemco System 3 with CBASIC2, and we can offer a customising service on these programs. Additional software includes Microsoft Basic Interpreter and Compilers, Cbasic, Macro80, and CP/M for the North Star Horizon.

Xitan Systems Ltd., 23 Cumberland Place, Southampton SO1 2BB.

Tel: (0703) 38740

Hours Tue-Sat 9.30 am to 5.30 pm

APPLE II PET ITT 2020

Top quality systems

DATABANK IS A BRITISH SOFTWARE HOUSE

STOCK CONTROL · SNOOKER
 PAYROLL · NOUGHTS & CROSSES
 BANK ACCOUNT · CROSSWORD
 SALESMAN · SPACE DOGFIGHT
 CASH REGISTER · STARTREK
 LIBRARY INDEX · PHASER
 ASTRONOMY · JET FLIGHT
 STATISTICS · SPACESHIP
 GRAPH PLOT · KLINGON

FLOPPY DISK
 SOFTWARE



1 Program only £10.
 Any 5 for just £20.
 10 for £30. 18 for £40.
 Including disk & postage etc.

All at lowest prices ever

FREE: Any five of the above programs,
 with either: **WORD PROCESSOR £40**
MAILER/LETTER £50 All Inc.

PHONE NOW FOR YOUR DEMONSTRATION

DATABANK

66, Queens Road
 Loughborough
 Leicestershire LE11 1HD
 0509 217671

Just fill in the boxes and post us your cheque, now

APPLE II
 PET
 CBM DISK
 ITT 2020
 COMPUTHINK

NAME.....
 ADDRESS.....

 Postcode.....

CASH REGISTER
 CROSSWORD
 MAILER/LETTER
 LIBRARY INDEX
 DOGFIGHT
 WORD PROCESSOR
 ASTRONOMY
 STARTREK
 STOCK CONTROL
 STATISTICS
 PHASER
 PAYROLL
 GRAPH PLOT
 JET FLIGHT
 BANK ACCOUNT
 SNOOKER
 SPACESHIP
 SALESMAN
 NOUGHTS & CROSSES
 KLINGON

DO PLEASE SEND MORE DETAILS

ADVERTISERS INDEX

Access Data	26	Databank	162	Knights	18	Personal Computers 136/OBC	
Aculab	66	Datac	144	L & J Computers	114	Petssoft	44/45
Airamco	14/114	Datalink	104	Leicester Comp Store	141	PHL	62
Almarc Data Systems	31	Datron	156	Lifeboat Associates	4/5	Premier Publications	12
Appleware	106	Davinci	152	Lion Microcomputers	54	Pragma	29
Audiogenic	58	Display Electronics	34	Little Genius	146	Promglow	144
Beam Software	8	Drivers Jonas	52	Liveport	157	Pronto	145
BEM	64	Easicomp	152	Logic Box	41	Rair	9
Benchmark	143	Equinox	147/155	Logitek	33/138	Research Machines	149
Bits & Pc's	141	Encotel	17	London Computer		Rohan	13/110
Business & Leisure	132	Farmplan	147	Store	30	Science of Cambridge	82/83
Buss Stop	155	Galatrek	2	Lowe Electronics	27	Sharp	158
Byte Shop	92	Gate Microsystems	134	LP Enterprises	153	Show Ad.	100
CCS	145	GP Industrial		M & C Business Services	142	Sintrom	32
Cambridge Learning		Electronics	142	Mad Hatter	144	Sirton Products	151
Enterprise	137	Graffcom	14	Mecem	62	Small Systems	29/150
Camden Electronics 136/137		GW Computers	10/11	Mendip	155	St. Commerical	
Cambridge Comp Store	104	Happy Memories	135	Microbits	24	Systems	12
Calco	146	AJ Harding		Microbyte	138	Softwarehouse	22
Centalex	140	(Molimerx)	159	Microcentre	IFC	Southern Software	150
Chromasonic	54	Hartford	28	Micocontrol	146	Stack	3/72
Clearsons	132	Heath	41	Microdata	142	Supersoft	154
Comma	49/56	Heather	41	Microsense	70/76	Sun	144
Comart	84	Henry's	6	Microsolve	132	Terodec	81
Commodore	39	J. M. Electronics	114	Mictotrend	94	Transam	7/88
Comp Shop	IBC/164	ISG	110	Microtype	150	TVJ Microcomputers	35
Computerama	133	Intelligent Artifacts	136/152	Micro UK	20/21	Trend	15
Computermania	26	International Data	135	Mighty Micro	135	Tridata	156
Comutist Dair Electronics	9	Intex Datalog	64	Mike Rose Micros	147	Video Vector	14
Computopia	134	Kansas City Systems	140	Millbank	154	Weyfringe	23
CPS Data	143/148	Keen Computers	19	Nascom	117	Wymark	28
Cumana	139	Kemitron	148	Newbear	160	Xitan	161
Currah	141	Kingston		Newbury	25		
Daisy	6	Computers	15/16/148	Newtronics	154		
Dacoll	28	Kode	52				

CHIP CHAT

Latest Microvictim to byte the dust is Abacus. It seems their backer backed out and the rumoured asking price is between £30,000 and £50,000, if you're interested; of course that doesn't include Derek Rowe's scarf... Newcastle comes to the coal! US magazine *Creative Computing* will be at the PCW show and Micronet, the American interactive personal computer network, is showing strong interest... Seen at the recent PETshow — 'Squire' Allason and 'Bumper' Harris deep in conversation. What can the dynamic duo be plotting now?... Talking of the 'Squire', why has microgossiper 'Inside Trader' of PET-dedicated *Printout* magazine written to ask if he can take over Chip Chat — does he need the money? Don't ring us, as they say... Having dropped the Sorcerer, Comp Shop's 'Spangles' Cary

cut his losses by managing to fit the left-over disk drives to (wait for it) the Nascom II... *CPUCN* — the Commodore PET Users Club Newsletter — describes Baroness International (Commodore's PR hacks) as a *Pubic Relations* firm. No comment... Look out for news soon of a spectacular micro from, of all places, Brazil; called the Maleca IV, its preliminary spec looks outstanding, says our spy in the coffee fields... Bad news for those who know Martin Banks — a journalist — as 'Legless'; from now on, he tells us, he wants to be called 'Superstar'. Little does he realise that only those who write for PCW merit this accolade. Incidentally, the PCW random anagram generator calls him BAN ARM STINK. Who's next?... Commodore's latest marketing masterpiece is said to be a prerequisite that dealers must

be moving £10,000 worth of PETs a month before they'll be permitted to sell the 80-column SuperPET. Micro-nonsense seems to be on a similar wavelength as, apparently, Apple dealers must also shift set quantities of Apple IIs before they can sell the Apple III; ITT 2020 vendors needn't apply, we're told... Broadcast over the PA at the PETshow, a reminder to exhibitors to refrain from calling the machine a 'PET' when talking to French visitors as it sounds like their word for 'fart'... *Info World* publisher John Craig now has room for expansion following the dramatic exit of three of his editors, Sam, Tom and Linda; PCW hopes it's business as usual; *Info World* isn't a bad rag... Room-letter Grand-Met extends its GRIP on microcomputing with the purchase of Hi-Tech, makers of S100 colour video boards.

Look out for some interesting pub games, maybe... More Micrononsense! That worthy firm of Apple dealers has taken to sending out a booklet entitled *Computers in Education*. Unfortunately the first page illustration shows a classroom full of kids using PETs... We just received pages 49-60 of an update to a reference manual; unfortunately, nowhere, not even in the form of a covering letter, could we find the name and address of the sender. Only a telephone number provided a clue to the sender's identity — Molimerx. Now that's what we call confidence!... Our correspondent Steve Withers writes to ask if 'Gonzo Talbot' is the result of putting 'Guy Kewney' through the IBM data encryption algorithm.

COMPUPHONES

**YOU NEED NEVER MISS AN IMPORTANT CALL AGAIN
TWO CORDLESS TELEPHONE SYSTEMS — DIRECT FROM USA**



THE ALCOM only **£147 + VAT**

Base station connects to your telephone line. Remote handset clips to your belt and gives you push-button dialling — Bleeps when call arriving — Nicad rechargeable batteries. Charger in base unit.



THE BOHSEI only **£125 + VAT**

Base station connects to your telephone line. Remote handset stylishly designed in red — Push button dialling comes complete with charger unit for batteries in handset.



LOW COST TELEPHONE ANSWERING MACHINE only **£99.95 + VAT**

Microprocessor controlled answering machine. Plug into your phone line. Records any phone call messages. Remote bleeper enables you to listen to your messages from anywhere in the world. Uses standard cassettes. Comes complete with mains adaptor, microphone, remote bleeper, base unit, cassette with 30 sample pre-recorded messages.

THE NEW ANADEX DP9501
A PROFESSIONAL PRINTER



- Bi-directional printing
- Up to 220 chars/line with 4 print densities
- 500 char buffer
- RS232C and Centronics Parallel interface built in
- Full software control of matrix needles allowing graphics capability
- 200 chars/sec • Adjustable width tractor feed.

All this for only **£995 + VAT**.

NASCOM-2 WITH FREE POWER SUPPLY & 16K RAM B BOARD

only **£305 + VAT** Subject to Availability

NASCOM 2 DISC DRIVES

- Add a powerful, double density, mini floppy disc to your Nascom system.
- Disc Controller Card includes Nasbus 6 S100 interface
 - Will control 4 Drives.
 - CPM operating system.
 - Extended Disc Basic Compiler.
 - Power supply included

One Disc System — **£499 + VAT**
Additional Disc Unit — **£299 + VAT**

COMPLETE MICRO SYSTEMS

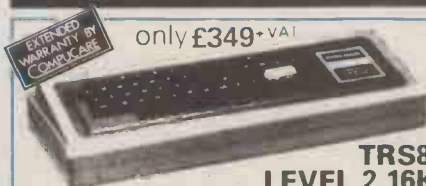

only **£349 + VAT**

TRS80 LEVEL 2 16K

Fully converted to UK T.V. Standard. Comes complete with easy to follow manuals. UK Power Supply. Cassette Leads. Sample tapes. Special box to enable you to plug into your own TV. Recommended for first time-buyers. Just plug in and go. Full Range of Software Available.

Interface to Centronics Parallel for TRS80 **£75.00 + VAT**

TRS80 EXPANSION INTERFACE

only **£295 + VAT**
Expand your TRS80 by 32K. 32K Memory on board. Centronics parallel port. Disk controller card. Real time clock. Requires Level II Basic. Interface for 2 cassette decks. complete with power supply.

NEW REDUCED PRICES

8K **£399**
16K **£499**
32K **£599**

RRP £795 for 32K

The PEDIGREE PETS Very popular for home & business use.

8K Microsoft Basic in ROM. 8K Pet 32K & 16K with new improved keyboard. All with green screen.

Cassette Deck **£55 extra**. Full range of software available.

Interface PET IEEE — Centronics Parallel. Not decoded **£49.00 + VAT**. Decoded **£77.00 + VAT**.

PRINTERS

SPECIAL SCOOP GET YOURSELF A PRINTER FOR YOUR PET AND SAVE A FORTUNE

only **£349 + VAT**

Full Pet Graphics including cables. Ready to go.

EX-STOCK.

RRP **£540** only **£479 + VAT**

ANADEX DP8000

Super Quality — Low cost printer. Tractor Feed with full 96 ASCII character set. Accepts RS232C at baud rates between 100 and 9600 and Parallel Bit data.

Attaches either directly or through interfaces to Pet, Apple, TRS80, Sorcerer, Nascom, Compukit etc.

MONITORS



video 100

12" BLACK & WHITE LOW COST VIDEO MONITOR

only **£79 + VAT**

- Ideal for home, personal and business computer systems
- 12" diagonal video monitor • Composite video input
- Composite video input • Compatible with many computer systems • Solid-state circuitry for a stable & sharp picture
- Video bandwidth - 12MHz + 3dB • Input impedance - 75 Ohms • Resolution - 650 lines Minimum In Central 80% of CRT; 550 Lines Minimum beyond central 80%.

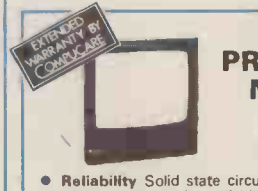

HITACHI PROFESSIONAL MONITORS

9" — **£129**
12" — **£199**

- Reliability Solid state circuitry using an IC and silicon transistors ensures high reliability. • 500 lines horizontal resolution. Horizontal resolution in excess of 500 lines is achieved in picture center. • Stable picture. Even played back pictures of VTR can be displayed without jittering.
- Looping video input. Video input can be looped through with built-in termination switch. • External sync operation (available as option for U and C types) • Compact construction. Two monitors are mountable side by side in a standard 19-inch rack.

WE ARE NOW STOCKING THE APPLE II EUROPLUS AT REDUCED PRICES

48K **£690**
32K **£649**
16K **£599** + VAT

Getting Started APPLE II is faster, smaller, and more powerful than its predecessors. And it's more fun to use too because of built-in features like:

- BASIC — The Language that Makes Programming Fun.
- High-Resolution Graphics (in a 54,000-Point Array) for Finely-Detailed Displays.
- Sound Capability that Brings Programs to Life.
- Hand Controls for Games and Other Human-Input Applications.
- Internal Memory Capacity of 48K Bytes of RAM, 12K Bytes of ROM; for Big-System Performance in a Small Package.
- Eight Accessory Expansion Slots to let the System Grow With Your Needs.

You don't need to be an expert to enjoy APPLE II. It is a complete, ready-to-run computer. Just connect it to a video display and start using programs (or writing your own) the first day. You'll find that its tutorial manuals help you make it your own personal problem solver.

NEC SPINWRITER

only **£1599 + VAT**

NEC's high quality printer uses a print "thimble" that has less diameter and inertia than a daisy wheel, giving a quieter, faster, more reliable printer that can cope with plotting and printing (128 ASCII characters) with up to five copies, friction or tractor fed. The ribbon and thimble can be changed in seconds. 55 characters per second bidirectional printing — with red/black, bold, subscript, superscript, proportional spacing, tabbing, and much, much more.

THE ATARI VIDEO COMPUTER GAMES SYSTEM

£99.00 + VAT

Atari's Video Computer System now offers more than 1300 different game variations and options in twenty great Game Program™ cartridges!

Have fun while you sharpen your mental and physical coordination. You can play rousing, challenging, sophisticated video games, the games that made Atari famous. You'll have thrill after thrill, whether you're in the thick of a dogfight, screaming around a racetrack, or dodging asteroids in an alien galaxy. With crisp bright colour (on colour TV) and incredible, true-to-life sound effects. With special circuits to protect your TV.

Most Cartridges only £13.90 + VAT. Prices may vary with special editions. Basic Maths, Airsea Battle, Black Jack, Breakout, Surround, Spacewar, Video Olympics, Outlaw, Basketball, Hunt & Score*, Space War, Sky Diver, Air Sea Battle, Codebreaker*, Miniature Golf.

Extra Paddle Controllers — **£14.90 + VAT**

*Keyboard Controllers — **£16.90 + VAT**

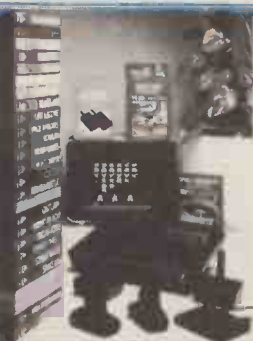

STOP PRESS SPACE INVADERS NOW IN STOCK £25 + VAT



COMMERCIAL • EXPANDABLE • COMPLETE TRS 80 - MODEL II

EXTENDED WARRANTY BY COMPUKARE

This new unit from the world's most successful micro company is now available immediately with software.

The basic unit comes complete with 64 thousand characters (bytes) of Memory. The built in 8" floppy disc adds another 1/2 million extra characters including the disc operating system. More disc expansion is now available.

The Model II is a complete unit with a full keyboard including a numeric pad and 12" screen which gives 24 lines of 80 characters. The computer is supplied with both the disc operating system and the Level III Basic.

A full self test routine is written into the power up procedure to eliminate incorrect operation. Both serial and parallel expansion sockets are standard. A printer is a plug-in operation.

Both hardware and software necessary to talk to a mainframe are included. Terminal usage is very possible. With the addition of CPM2 you can operate with COBOL, FORTRAN, MBASIC, CBASIC in which languages are many other applications packages i.e. accounting, payroll stock etc.

64K 1-Disk Model II **£1995.00** + VAT
RRP £2250.00

CP/M2	£95.00
CIS COBOL	£400.00
C BASIC	£75.00
M BASIC	£155.00
FORTRAN	£220.00
WORDSTAR	£255.00

1 DISK EXPANSION Room for 3

500K per Drive gives total
of 1.5M Byte — 1 Drive plus Cabinet **£799** + VAT

COMING SOON

26 megabyte
Hard Disc
multi-user
DOS

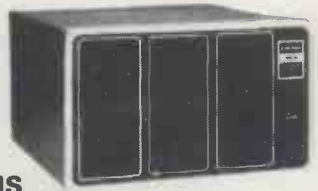

WE USE THIS MACHINE IN OUR BUSINESS

COMPUKIT UK101

EUROPE'S FASTEST SELLING ONE BOARD COMPUTER



- ★ 6502 based system — best value for money on the market.
- ★ Powerful 8K Basic — Fastest around
- ★ Full Qwerty Keyboard
- ★ 4K RAM Expandable to 8K on board.
- ★ Power supply and RF Modulator on board.
- ★ No Extras needed — Plug-in and go.
- ★ Kansas City Tape Interface on board.
- ★ Free Sampler Tape including powerful Dissassembler and Monitor with each Kit.
- ★ If you want to learn about Micros, but didn't know which machine to buy then **this is the machine for you.**

40 pin Expansion Jumper Cable for CompuKit expansion **£8.50** + VAT

Build, Understand and Program your own Computer for only a small outlay.

KIT ONLY £179 + VAT
NO EXTRAS NEEDED

The **CompuKit UK101** comes in kit form with all the parts necessary to be up and working, supplied. No extras are needed. After plugging in just press the reset keys and the whole world of computing is at your fingertips. Should you wish to work in the machine code of the 6502 then just press the M key and the machine will be ready to execute your commands and programmes. By pressing the C key the world of Basic is open to you. This machine is ideal to the computing student or Maths student, ideal to teach your children arithmetic, and is also great fun to use. Because of the enormous volume of users of this kit we are able to offer a **new reduced price of £179** + VAT

Available ready assembled, tested & ready to go **£229** + VAT

NEW MONITOR FOR COMPUKIT UK101 • In 2K Eprom 2716
• Allows screen editing • Saves data on tape
• Flashing cursor • Text scrolls down **£22.00** + VAT

BITS & BYTES

8MHz Super Quality Modulators	£4.90
6MHz Standard Modulators	£2.90
C12 Computer Grade Cassettes	10 for £4.00
Anadex Printer Paper — 2000 sheets	£25.00
Floppy Discs 5 1/4" Hard and Soft Sector	£3.50
Floppy Disc Library Case 5 1/4"	£3.50
Verocases for Nascom 1 & 2 etc.	£24.90
Keyboard Cases	£9.90

FOR THE COMPUKIT

Assembler/Editor	£14.90
Screen Editor Tape	£5.90
Game Packs	
1. Four Games	£5.00
2. Four Games	£5.00
3. Three Games 8K only	£5.00
Space Invaders	£5.00
Chequers	£3.00
Real Time Clock	£3.00
Case for CompuKit	£29.50

All Prices exclusive VAT

EXTENDED WARRANTY BY COMPUKARE
We give a full one year's warranty on all our products.

We now have in stock demonstration models of the Atari 800 and Texas 99/4.
COME AND SEE THEM

SPECIAL OFFER
We will part exchange your Sinclair ZX80 for any of our products.



NEW TV GAME BREAK OUT

Has got to be one of the world's greatest TV games. You really get hooked. As featured in ETI. Has also 4 other pinball games and lots of options. Good kit for up-grading old amusement games.
MINI KIT — PCB, sound & vision modulator, memory chip and de-code chip. Very simple to construct. **£14.90** + VAT
OR PCB £2.90 MAIN LSI £8.50 Both plus VAT



Refurbished ZX80's—fully guaranteed **£69.90** + VAT
(Supply dependant upon stocks).

We have one of the largest collections of Computer Books under one roof, along with racks of software for the PET and TRS80.
COME AND SEE FOR YOURSELF

COMP SHOP
"Europe's Largest Discount Personal Computer Store"

Please add VAT to all prices — including delivery. Please make cheques and postal orders payable to **COMP SHOP LTD.**, or phone your order quoting **BARCLAYCARD, ACCESS, DINERS CLUB** or **AMERICAN EXPRESS** number.
CREDIT FACILITIES ARRANGED — send S.A.E. for application form.

14 Station Road, New Barnet, Hertfordshire, EN5 1QW Telex: 298755 TELCOM G
Telephone: 01-441 2922 (Sales)

OPEN - 10 am - 7 pm — Monday to Saturday
Close to New Barnet BR Station — Moorgate Line.

★ **NOW IN IRELAND** at: 80 Marlborough St., Dublin 1. Tel: Dublin 749933
★ **COMP SHOP USA**, 1348 East Edinger, Santa Ana, California, Zip Code 92705.
Telephone: 0101 714 5472526



COMP COMPUTER COMPONENTS
(Part of the Compshop Ltd. Group)

We are now entering our fourth financial year of dealing solely in the personal computer market — in fact, we started it! Over this period, Personal Computers Limited have formed a group of graduate specialists who will help you in the fields of word processing, financial planning, statistics, economic modelling, forecasting, accounting systems, foreign exchange, banking and oil exploration.

We also do rather well with computer graphics and highly recommend the graphics tablets and our plotter for Apple.

We can also offer two excellent items of software — Format 40 and Visicalc — at a combined price of **ONLY £189**, and the Super Sound Generator for only **£90!** (excl. V.A.T.)



8" Disk Drive (above left)

Our 8" disks are still as popular as ever — 2 drives give you 1.2MB with all the reliable security of Shugart Technology. Easily interfaced to Apple, uses the same D.O.S.

A.I.O. Serial and Parallel Card (above centre)

Three hand-shake lines (R.T.S., C.T.S. and D.C.D.). Firmware for serial interfaces on-board, software for parallel printer available, 2 bi-directional 8 bit parallel ports, plus 4 additional interrupt and hand-shaking lines.

Light Pen (above right)

A much sought after product which we introduced to the U.K.

80 Character Card (below left)

... opens up the real commercial world for all Apple owners.

Paper Tiger (Below centre)

132 character line, plus graphics, 8 character sizes, ordinary paper, multiple copy, upper and lower case 96 character, parallel/serial, form control.

Centronics 730 (Below right)

A substantial, robust printer from a major manufacturer. 3 way paper handling system, 100 character per second. Special low-cost including interface. 96 characters.



Items pictured

Sharp MZ — 80K

A new generation of personal computer, self contained, versatile and starting at only £570 (excl. VAT). Explore the Zilog Z80 now the easy way. Disks and printer available shortly.

Numeric Keypad

... with 8 function keys is a must in all financial applications.

TCM 100 & TCM 200

... both now have graphics as well as their own power supply, essential with this type of printer.

Qume Sprint 5

The quality word processing printer. Clean, clear executive reports the way you want them. Can print up to 5760 points per square inch — or even print in 2 colours.

This is what we do...

and we do it rather well!



Personal Computers Limited
194-200 Bishopsgate, London EC2M 4NR. Tel. 01 626 8121

For further information, please complete this coupon and post to:
Personal Computers Limited, 194-200 Bishopsgate, London EC2M 4NR

NAME _____
ADDRESS _____

*** Now here, detail**
APPLE