

The Post Office Electrical Engineers' Journal

R.A. Roe.
ES 56

VOL 74 PART 2 JULY 1981



THE POST OFFICE ELECTRICAL ENGINEERS' JOURNAL

VOL 74 PART 2 JULY 1981

Contents

Editorial	69
The Development of the Ambassador Range of Telephones and Production of the Basic Instrument D. A. Pritchard and P. A. Burton	70
Monarch 120—The System Software I. D. C. Park	81
CAIRO: Computer Analysis of Incident Recorder Output for TXK4 R. C. Morris and J. M. Stewart	86
Provision of Digital Transmission in the Junction Network I. G. Dufour	92
Monarch 120—Maintenance Facilities R. E. Walters	99
Determination of Large Reflector Profiles by Microwave Wavefront Reconstruction D. J. Edwards	106
Power Supplies for Small Telecommunications Centres Part 1—DC Power Plant Nos. 235 and 236 R. H. Howard	113
AMBLE: Automatic Memory-Board Loading Equipment R. W. Elson	118
The Soil as an Engineering Material Part 1—Soil Properties D. G. Clow	122
Prestel: The First Year of Public Service W. R. Broadhead	129
EBX8000 Stored-Program Control PABX V. A. E. Fountain	134
The First TXE4A Exchange —D. A. Ritchie and L. H. Lawrence	137
The New ASCE and the Junction Network A. Hills	139
Profiles of Senior Staff	142
Institution of Post Office Electrical Engineers	143
Associate Section Notes	144
Notes and Comments	145
Book Reviews	121, 141
Post Office Press Notices	91, 98, 105, 117, 128, 133

Published in April, July, October and January by *The Post Office Electrical Engineers' Journal*,
2-12 Gresham Street, London EC2V 7AG.

Price: 80p (£1.30p including postage and packaging). Orders by post only.

Annual subscription (including postage and packaging): home and overseas £5.20.
(Canada and the USA \$12.00.)

Price to British Post Office staff: 48p.

© 1981: The Institution of Post Office Electrical Engineers.

Good Morning

It's the dawn of the digital 80's from GEC Telecommunications. Now with a total network capability in digital transmission systems up to 140 Mbit/s, microwave radio systems, coaxial-cable and optical-fibre line systems and a complete range of digital multiplex.

Versatile business communications systems, including P.A.B.X.'s from 4 to over 5,000 lines using digital switching and stored programme control.

The dawn of digital technology from GEC Telecommunications...make an early start.

GEC

Telecommunications

GEC Telecommunications Limited,
P.O. Box 53, Coventry CV3 1HJ England.

A Management Company of
The General Electric Company Limited of England.

Quality that speaks for itself

Ryford produced the tooling for these handsets for British Telecom and moulded them in a wide variety of colours.



..... just one example of the RYFORD capability in precision toolmaking and moulding for the telecommunications industry.

RYFORD

Precision Toolmakers and Moulders for the Plastics Industry
 Brickyard Road, Aldridge, Walsall, England, WS9 8SR
 Telephone: 0922 55877 Telex: 336779

Good things come in little packages!

In a telephone exchange, the layout and equipment racking makes it extremely tricky to fault find with the conventional oscilloscope. The 'SCOPPLE' (designed & developed by Southways in conjunction with STC) is effectively a mini scope, with the time-base frozen, it will display AC or DC voltages in 2 ranges, ie $\pm 12V$ $\pm 50V$ on a bright green LED display with a red LED to indicate centre zero. Pulses down to 1 Mille/Sec can be seen in the normal mode or for fleeting pulses, a storage mode can be switched in. — The Post Office tried it, and they found it so useful they gave it a number PO.Tester 286A

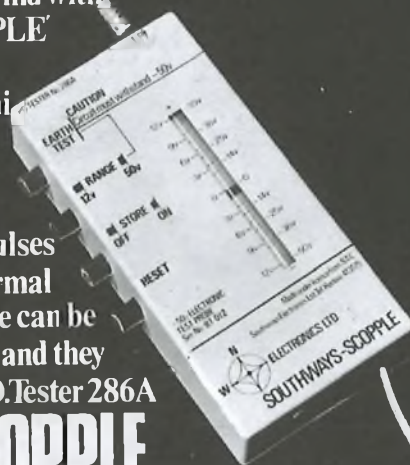

THE SOUTHWAYS SCOPPLE

We design, develop and manufacture electronic testing equipment for use in the tele-communications industry. P.O. Approved.

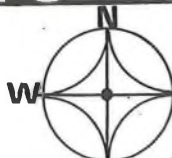

ELECTRONICS LTD.
 Horsecroft Place, Harlow Essex.
 Telephone (0279) 413179

SOUTHWAYS

Please send further information about the Scopple

Name _____

Address _____

The Post Office Electrical Engineers' Journal

BOARD OF EDITORS

- D. Wray, B.SC., C.ENG., F.I.E.E., Chairman
E. Davis, C.ENG., M.I.E.E.
C. E. Rowlands, B.SC., C.ENG., M.I.E.E.
F. V. Spicer, B.A.
L. W. F. Vranck
A. W. Welsh, C.ENG., M.I.E.E.
G. White, B.SC., PH.D., SEN.MEM.I.E.E.E.

Managing Editor

- V. L. Dunhill, B.SC., C.ENG., M.I.E.E.

Deputy Managing Editor

- A. R. Lawrence, C.ENG., M.I.E.E.E.

Secretary-Treasurer

- B. Farr

Advertisement Manager

- N. G. Crump

EDITORIAL

Until it was changed to Senior Director of Engineering in 1967, the professional head of engineering and science in the British Post Office (BPO) was known as the *Engineer in Chief*. This post has been held since 1870 by a succession of distinguished engineers, all of whom have made outstanding contributions to the development of telecommunications and its service to the community. This change of title anticipated the change, in 1969, of the status of the BPO to that of a Public Corporation. The British Telecommunications Bill currently passing through Parliament will make further changes to the status of the BPO and, in light of these, new appointments to the Board of British Telecom have been made, one of which includes the designation Engineer in Chief.

The Board of Editors, on behalf of the Members of the Institution of Post Office Electrical Engineers, extend their congratulations to the President of the Institution, Mr. J. S. Whyte, C.B.E., on his appointment as Engineer in Chief and Managing Director (Major Systems) of British Telecom.

Against the background of the proposals in the British Telecommunications Bill to open up competition for the supply, installation and maintenance of certain types of attachments to the network, the BPO is developing new ranges of customer apparatus which take advantage of the advances in technology and are well able to serve future customer requirements. The standard telephone, the 700-type instrument, is soon to be replaced by a new integrated range of instruments known as the *Ambassador* range.

The development and production of the basic instrument in the *Ambassador* range are covered in this *Journal*.

The Development of the Ambassador Range of Telephones and Production of the Basic Instrument

D. A. PRITCHARD, and P. A. BURTON†

UDC 621.395.61: 621.395.631.3

The conception, design and development of the Ambassador range of telephone instruments, and the production of the basic instrument, are described in this, the first of a series of related articles. Other articles to be published in later issues of this Journal will include descriptions of the latest MF4 and 10 pulses/s loop-disconnect signalling realizations, the electronic plan system and a new plug-and-socket arrangement.

INTRODUCTION

The 700-type instrument¹ has been the standard telephone since 1959 and, in its many forms, in conjunction with a variety of add-on units, can be adapted for use in most situations. It can be used for simple direct exchange lines and PBX extensions, and the more complex multi-line/secretarial-type installations, all of which can make use of a wide range of additional facilities provided by auxiliary and ancillary apparatus.

However, to meet the market needs, it was decided that a new range of apparatus should be developed which

- (a) was modern in appearance,
- (b) was easy to install, maintain and recover,
- (c) allowed a simplification of installation wiring and a rationalization of plan numbers, and
- (d) had high reliability.

This series of instruments is to be known as the *Ambassador* range (see Fig. 1) and, in this article, the concept, design

† Product Development Unit, Telecommunications Headquarters

principles and development phases are outlined; also, the production telephone instruments are described in more detail.

CONCEPT

To determine a basic shape that was both aesthetically appealing and functional, DCA Design Consultants were contracted to produce a new handset design and a complementary apparatus profile that would

- (a) be suitable for a wide range of instruments,
- (b) enable instruments either to stand alone or to be electrically and mechanically connected to others to form composite units,
- (c) be suitable for use in both the table and wall-mounted modes,
- (d) be primarily intended for press-button use, and
- (e) be capable of evolving, if required by technological advances, to smaller, lower-profile units that retain the common styling.

Constraints placed upon the designer for the first family of



FIG. 1—Ambassador range telephones

instruments were that

(a) the new handset should be capable of accepting the present transducers (Transmitter Inset 16, or its replacement, and the Receiver Inset 4T),

(b) although primarily intended for press-button use, the instruments should be able to accommodate standard dials used in British Post Office (BPO) telephone instruments,

(c) the instruments should be capable of accepting either a standard BPO bell (with volume control) or a tone caller, even when a dial is fitted,

(d) all apparatus in the range should be quick and easy to install, maintain and recover, and

(e) all apparatus in the range should have high reliability.

The Design of the Handset

It may seem that a designer has complete freedom to produce an attractive, unusually shaped, eye-catching design for the handset; in practice, this is not so. Any new handset (other than one aimed at the gimmick market) must be a compromise, constraints being imposed by

(a) *ergonomics*—head dimensions, ear-to-lip distances, hand sizes,

(b) *acoustic requirements*—earcap and mouthpiece size, shape and position,

(c) *component sizes*—particularly microphone and receiver,

(d) *use*—horizontal and/or vertical positions (table and wall-mounted instruments),

(e) *production engineering*—suitable for moulding in large quantities, tolerancing problems minimized, robust, and

(f) *cost*—special materials avoided, simple to assemble, low unit cost and long life.

The starting point is the diagram in Fig. 2. This shows users' lip positions relative to the ear; also hand clearances. To avoid touching the lips, the mouthpiece must not cut through the ellipse, but moving too far beyond the ellipse reduces the microphone sound pressure and the signal level sent to line. The position in which most customers hold the handset is also very important. This is affected by, for example, overall dimensions, handle grip size, weight and balance. Ideally, with the earcap held comfortably against the ear (forming the seal necessary for a good low-frequency response), the mouthpiece should fall naturally into position near, but not touching, the lips of most users.

A typical design sequence could be

(a) to produce sketches/drawings of various proposals,

(b) to make solid models of the best designs and do preliminary checks on ergonomics (ear-to-lip dimensions etc.),

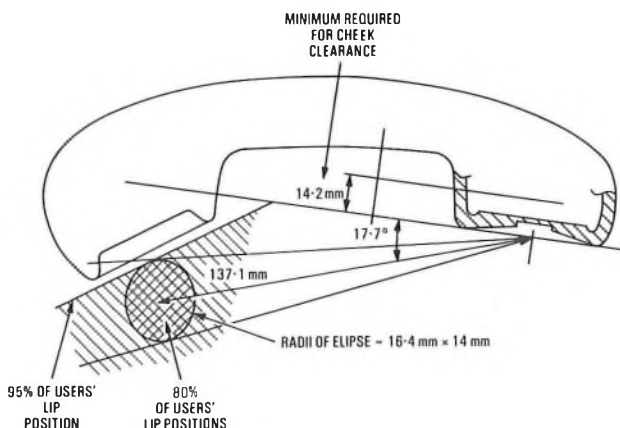

FIG. 2—Telephone handset design limits

(c) to produce a hollow model of the chosen design to confirm that transducers can be housed and that the design is practicable, and do further ergonomic checks (ease of holding, balance etc.),

(d) to use the hollow models to do preliminary checks on likely gravity-switch operation (table and wall-mounted modes), and "walk-on" properties; that is, the ability to settle down into the gravity-switch-operated position when carelessly replaced,

(e) to produce models suitable for acoustic testing,

(f) to do initial acoustic tests; that is, objective measurements² using artificial ears and mouths to determine microphone and receiver sensitivities and frequency responses, and

(g) to do subjective testing³, using customers to determine the overall acceptability of the handset. This is a most important stage which is not attempted until the other tests indicate a reasonable chance of success because obtaining statistically significant results requires a large, carefully-controlled and costly experiment.

It is generally necessary to modify and redesign at each stage, arriving at the final design through a series of iterations.

The handset resulting from this exercise was fully developed, documented and taken through to production by the design consultant on behalf of the BPO. High-capacity tooling was commissioned, and the handset, coded 16A, has been in quantity production since mid-1979 (see Fig. 3). It has already been adopted for the Accord (Loud-Speaking Telephone No. 8), Herald terminals, and Monarch operators' consoles, as well as Ambassador telephone instruments.

The Design of the Modules

The design sequence for a series of instruments is similar to, and interactive with, the handset design. Again, many constraints are imposed, including hand and finger sizes, dexterity and strength, and visual aspects—sizes of lettering and customers' eyesight etc. However, the most important aspects are the component sizes (bell/tone-caller, dial/press-button unit, transmission components etc.), as these dictate the overall volume required.

Working within these constraints, in conjunction with the BPO, the most promising designs were modified and refined by the designer and, finally, a series of working prototype instruments was produced. These were low-angle, straight-sided units that could be made in a variety of widths and heights, and demonstrated that all the criteria imposed by the BPO had been met. Furthermore, although the dimensions of the first series of modules were dictated by component sizes using current technology, the overall design was such that modules could, if required, evolve to an even lower profile, while retaining both complete electrical/mechanical interconnectability and a harmoniously related family appearance. The range of end profiles and modular heights are shown in Fig. 4.



FIG. 3—Handset 16A

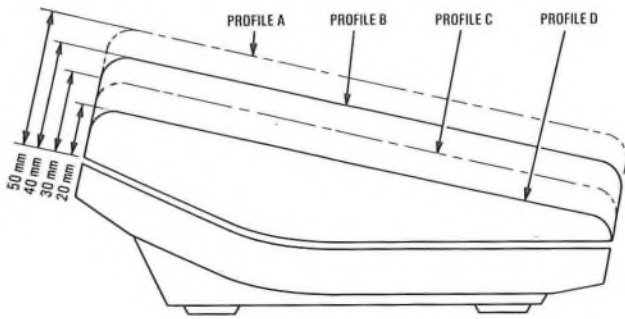

FIG. 4—Modular equipment heights

The Installation Approach

The installation policy originally adopted for the 700-type telephone was the use of hard-wired instruments that were capable of being modified in the field to do almost any job. As a consequence, a large terminal field, which has had to be increased with the advent of press-button instruments, was provided. Also, numerous add-on/alternative parts and adaptors, together with a complementary series of auxiliary apparatus were developed.

This gave the BPO the advantage of telephones with considerable versatility, but did not lead to simple instruments that could always be easily and quickly installed. Already, it has been found to be advantageous to depart from the original approach and to stock factory-made instruments, ready for use for specific installations. Examples of this are the Telephones No. 746R and Planphones A. For the former, there is no need to book out and fit the recall button and Switch 5A-4, and change the straps in the Telephone No. 746; for the latter, which comprises a Telephone No. 706F combined with a Plan-set N625, Plan 107/105 installations are considerably simplified. It has also been recognized that installation, maintenance and recovery could be simplified by moving away from hard-wired apparatus.

Taking this approach further, a concept emerged of a series of instruments, all of which would, as far as practicable, be installed as issued, with connexion being simplified by using plugs and sockets. These instruments would cover most simple installations, but by definition, would not be made capable of field modifications for use on any of the more complex plan systems.

A Family of Instruments

Plug-and-socket connexion imposes a practical limit to the number of contacts used and, hence, to the number of line-cord conductors. Also, to produce a reliable and cheap connector, the system used must lend itself to fast automatic machine assembly and termination. This virtually dictates the use of an in-line connector and ribbon-type cordage. To meet these criteria (and for aesthetic reasons) not more than 8 line-cord conductors is desirable; so a maximum of 6 conductors, which is the same number as used in North America, was chosen. (Details of the plugs, sockets and cordage that have been developed will be given in a subsequent article in this *Journal*.)

As the *basic* instrument is designed solely for use on simple plan numbers, another telephone is needed for the more complex multi-line and secretarial plans; so that this instrument can use the same plugs and sockets as the *basic* instrument, its line cord must have no more than 6 conductors.

This constraint leads away from systems in which the number of pairs connecting the instruments is dependent on the number of stations and the facilities provided (as with the present Plans 2/2A and 107/105), and towards a system in which the number of pairs is low and independent of the stations and facilities. A system that satisfies these criteria is one having 2-pair, star-connected instruments, which send data control signals over one pair to a central control box. Such 2-pair systems have colloquially become known as *skinny wire* systems; one such electronic plan system and its *plan* instrument, which is to be introduced by the BPO, will be described in a subsequent article in this *Journal*.

The *basic* and *plan* instruments together will cater for a very large percentage of the station population, but there will remain a small, but significant, number of stations requiring special facilities. To cover this market, a *facility* instrument has been conceived in the same styling as the other two telephones. This instrument is wider and has the versatility to cover a diverse market by accepting, at its right-hand end, a variety of modules.

Adopting an installed-as-issued policy, plug-and-socket connexion and *skinny-wire* instruments has therefore led to the concept of the following 3 family-related telephones (see Fig. 5):

(a) The Basic Instrument

This caters for direct exchange lines, PBX extensions, Plans 1A and 4, and normally uses 3 conductors (4 with earth), but



FIG. 5—Basic, plan and facility telephone instruments. (The facility telephone shown has an integral tape dialler)

up to 6 for special installations. This instrument could cater for up to 90% of all installations.

(b) *The Plan Instrument*

This is a wider instrument with additional buttons, and caters for the remaining more complex plans; it normally uses 4 conductors and up to 6 for special installations. This could cater for up to 90% of the installations not covered by the basic instrument.

(c) *The Facility Instrument*

This is an even wider window-type instrument which is capable of accepting a variety of modules and uses a maximum of 6 conductors. This instrument caters for the special installations that will not be covered by the other 2 instruments.

All the instruments are to be made in the common styling previously described.

DESIGN PRINCIPLES

The principles upon which the more detailed design was based were:

- (a) avoidance of delay at the development stage by making the best use of technologies/components either available at the time or in the immediate future;
- (b) wherever practicable, adoption of a design which, although initially based on current components, could evolve to take account of emerging technologies;
- (c) extension of the concept of the simple-to-install and easy-to-maintain instrument.

Electrical

Transmission is based on the conventional inductive hybrid transformer of the 700-type telephone; other components are updated to improve their reliability, but with due weight given to the ability to change to an active transmission circuit. The transducers adopted are the Receiver Inset 4T and the Microphone Inset 21A, the latter being the electronic high-reliability replacement for the carbon Transmitter Inset 16.

Both 10 pulses/s loop-disconnect and MF4 signalling⁴ employ custom-designed integrated circuits, and the former uses a circuit having no battery or relays. For the 10-address repertory dialling variants that were required for both signalling modes, batteries have been used for memory retention, because non-volatile stores were not then available. Details of the signalling circuits are to be given in a subsequent article in this *Journal*.

For the incoming calling device (bell or tone-caller), it was considered essential to change to parallel connexion (see Fig. 6) for 2 reasons:

- (a) It becomes possible to eliminate the break contact from the socket. This contact increases the socket cost and is a known source of faults, but is essential when series-connected calling devices are used.
- (b) It enables plan wiring to be simplified now and paves the way for 2-wire instruments in the future. As long as the BPO is using 10 pulses/s loop-disconnect signalling in conjunction with telephones that have bells, it is necessary to use an anti-tinkle wire for multi-station installations. With MF4 telephones or telephones using electronic calling devices, tinkle is either not present, or can be eliminated, making 2-wire connected instruments possible.

In order to ring 4 parallel-connected calling devices from the line, they must be of high impedance to achieve maximum efficiency.

Designers of modern telephones have the choice of plug-and-socket or hard-wired connexion at the following interfaces:

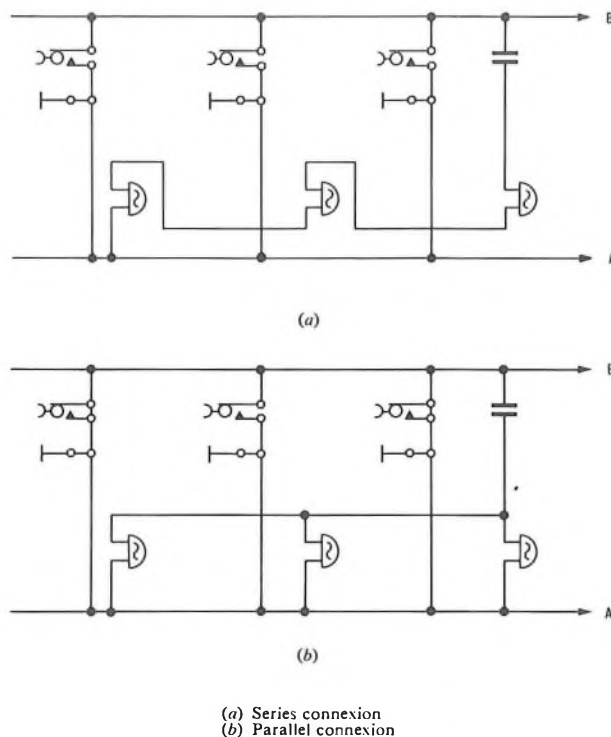

FIG. 6—Series and parallel connexion of incoming calling devices

- (a) wall-mounted terminal block to line cord,
- (b) line cord to telephone,
- (c) telephone to handset cord, and
- (d) handset cord to handset.

The use of plug-and-socket connexion at (a) alone, (a) and (b), (a) and (b) and (c), or all 4 interfaces has colloquially become known as $\frac{1}{4}$ -modular, $\frac{1}{2}$ -modular, $\frac{3}{4}$ -modular or fully-modular, respectively. For the Ambassador range of telephone instruments, the $\frac{3}{4}$ -modular approach has been adopted, as this simplifies the connexion of both auxiliary apparatus (for example, subscribers' private meters, answering machines, and callmakers), and additional-facility handsets (for example, amplified handset, and visual ringing-indication handset).

Mechanical

To simplify installation and maintenance, it was decided to make it possible, without removing the instrument cover,

- (a) to provide or change the battery (only needed for the 10-address variant), and
- (b) to remove or replace both the line and handset plugs from the telephone.

For this purpose, covered compartments were provided, which were accessible from the outside and fixed with screws to inhibit removal by customers.

A press-button unit with a 16-button array on common spacing has been used to ensure that all the instruments, including the basic, have the capability of providing those facilities, in addition to recall, that are likely to become commonplace in the first half of the 1980s; for example, 10-address repertory dialling, repeat last number, on-hook dialling. The 16-button unit provides 4 facility buttons, which are differentiated from the standard buttons by being a different colour.

DEVELOPMENT

With the external design of the instrument known, and the handset fully developed, it was then required to develop and

production engineer a range of modern, simple-to-install-and-maintain, reliable instruments. They had to be suitable for either standing alone or being connected to others to form composite units, and be able to accommodate a press-button unit or dial, and a bell or tone-caller. The instruments are primarily intended to be installed as issued, are $\frac{3}{4}$ -modular plug-and-socket connected, and are part of a family of *skinny-wire* instruments, using high-impedance calling devices.

To progress from design concepts and models to high-quantity, high-quality hardware, a series of linked, design, development and production contracts was let, using a main contractor and specialist sub-contractors. This brought together the necessary Industry and BPO expertise and specialist knowledge relating to instrument design and development (acoustical, electrical, and mechanical), electronics, connector technology and production engineering.

In response to pressure to produce a new-look instrument as soon as possible, it was decided to freeze the design at a fairly early stage of the development, and, based on that information, to lay down production tooling for an initial quantity of telephones. This enabled the first supplies to be brought forward some 12 months, and most of the first production order has been completed and is in use in Leeds, Sheffield and in the London Telecommunications Region. The telephones to be purchased in the follow-up order will have an almost identical external appearance, but will be modified internally as a result of continued development/value engineering and know-how gained in production, together with feedback from field staff and customers.

The remainder of this article describes the first production items in detail and outlines the differences expected in the follow-up production.

THE PRODUCTION TELEPHONE

As one of a harmoniously related range of modules, which will be capable of being physically connected to other units in the range, the new basic instrument is low-angled and flat-sided with a north-south facing handset. This instrument, which has a case consisting basically of 2 major mouldings, incorporates several novel features. It has a new shape of standard information label and carrier, which is built into a flip-up lid (see Fig. 7). This lid lifts to reveal an additional information label which is useful for recording such information as the addresses to be accessed by the repertory-dialling variant. The instrument incorporates an integral carrying handle, which is convenient to use with the handset either on or off-hook, and a moulded-in feature of the base facilitates left, right or rear line-cord entry.

The same instrument can be used on the table, and in several wall-mounted modes; either fixed with a wall bracket



FIG. 7—First production basic instrument

at an angle of 12° to the vertical (permanent mounting), or placed on one or possibly two shelf-type wall brackets, allowing it to be portable within the limits of the extensible line-cord (casual mounting).

Internally, the instrument consists of a sandwich of parallel signalling and transmission boards, located on the base moulding, but with the press-button unit registered against the top cover. There is no termination field, the handset and line plugs connecting directly to the transmission printed-wiring board via the sockets. Some provision for alternative strapping is made, using pins mounted on the printed-wiring board and push-on connectors. These features can be seen in Fig. 8.

The Handset 16A

The Handset 16A is shorter and flatter than the Handset 3, and consists of 2 main clip-together mouldings, fixed with a single screw at the earcap end (see Fig. 9). A styling feature is made of the part-line between the mouldings by chamfering each at 45°. The handset is moulded in acrylonitrile/butadiene/styrene (ABS) plastic some 4 mm thick and has sufficient strength without need for an internal lattice, thereby leaving as much space as possible for any extra components required in the facility handset etc.

The receiver is acoustically sealed directly to the inner face of the earcap (as in the Handset 3). However, the microphone is positioned using a polyethylene ring, which enables a constant material thickness to be maintained in the microphone area of the lower moulding, thereby minimizing the chance of sink marks. (It also simplifies the adoption of an alternative microphone.) Each transducer is held in position, under pressure, by an easily removable acetal copolymer clip. The microphone clip also anchors the cord grommet, and channels in the lower handset moulding serve to position the receiver wires.

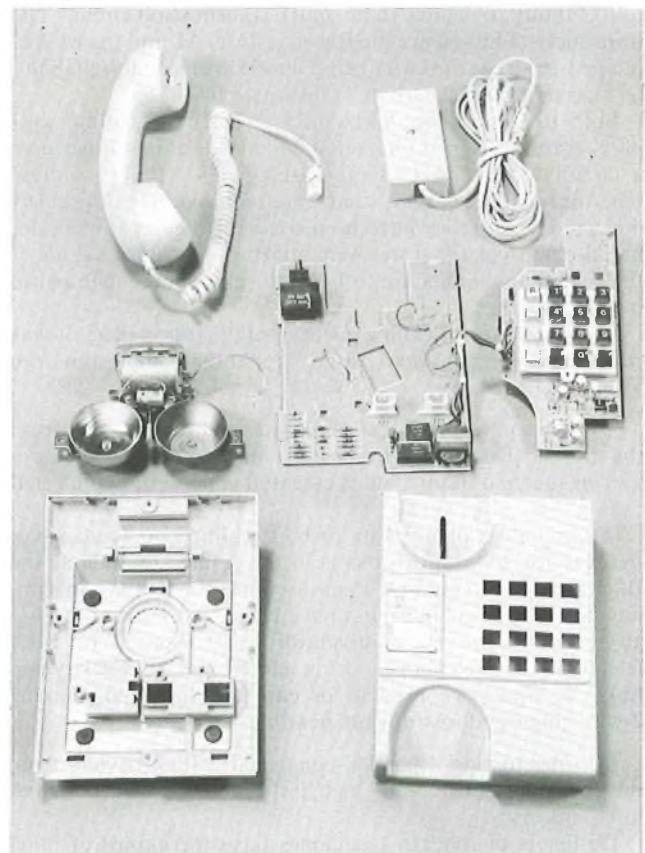

FIG. 8—Exploded view of press-button telephone



FIG. 9—Exploded view of Handset 16A

Top Cover

The telephone-cover moulding is made in ABS to provide a high-gloss finish that is relatively scratch resistant. The complete cover consists of 2 main and 3 smaller mouldings, and some further parts that make up the gravity switch mechanism (see Fig. 10).

Designed for 2-screw fixing to the base, with 2 locating tongues on its back edge such that it lifts straight off, the cover avoids the problems encountered on 700-type instruments, which pivot about the front edge. It also incorporates the carrying handle, and holes through which the press-button unit or dial protrudes.

The finger pocket and flip-up lid is formed by 2 separate

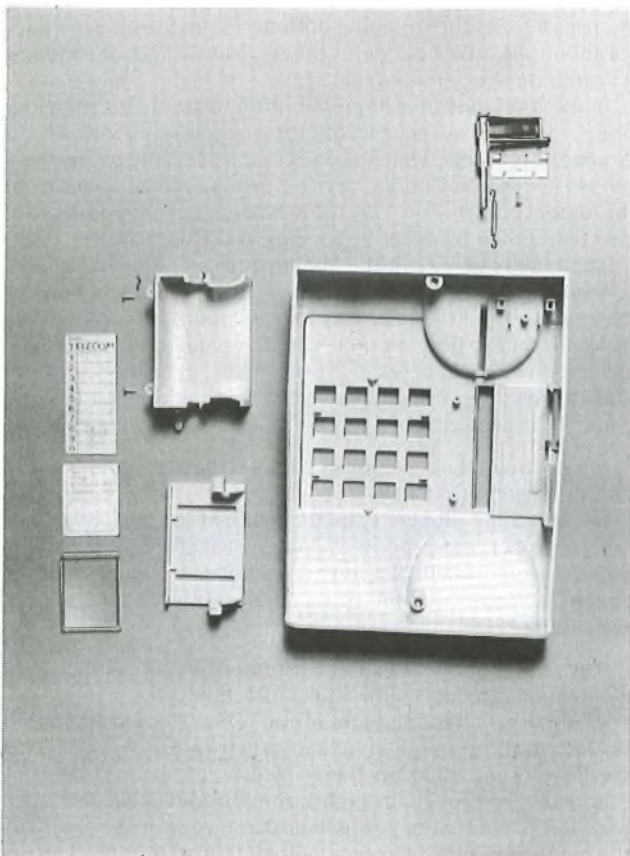

FIG. 10—Exploded view of top cover

mouldings, the lid being retained on 2 spring pivots within the pocket. The pocket slides into 2 moulded slots and is retained by 2 self-tapping screws. The bar forming the carrying handle has a recess on its top surface, in which a label for additional information can be stored. The lid, which flips up to reveal this additional information label, also has a recess and transparent cover for the exchange-number information. The transparent cover is easily removed by raising the lid and pressing it out from the underside.

To avoid tolerancing problems, which can lead to sticking plungers, the gravity-switch operating lever forms part of the cover and consists of the lever, a retaining-plate, a fixing screw and a helical spring. The gravity switch is reverse acting such that, when the cover is removed, the switch takes up the *on-hook* condition. This enables the linesman's latch to be dispensed with.

Inside the top cover, 4 spacing lugs and 2 locating lugs ensure that the cover traps the keypad securely when the base and cover are screwed together. Two tapped inserts, set in moulded pillars, are used for this fixing.

Base

The base of the instrument is moulded in the same material as the top cover, and the same colour is used for both top cover and base.

The complexity of the telephone is mainly contained in the base moulding (see Fig. 11). It has a transducer cavity for a tone-caller, but also permits a bell to be fitted, and the rotary volume control for the bell or the tone-caller emerges from a slot in the rear. The line cord fits into channels around the transducer cavity, and this enables the customer to exchange the cord entry to the left, right or rear of the instrument. The channel is such that a 4- or 6-way cord fits in it edge on and is retained. A further channel leads the handset cord out under the front edge of the instrument.

The handset and line cord channels lead to a connexion box, into which are presented jacks, mounted on printed-wiring boards, to which the plug-ended cords are connected. The connexion box has a clip-on lid and also a retaining screw.

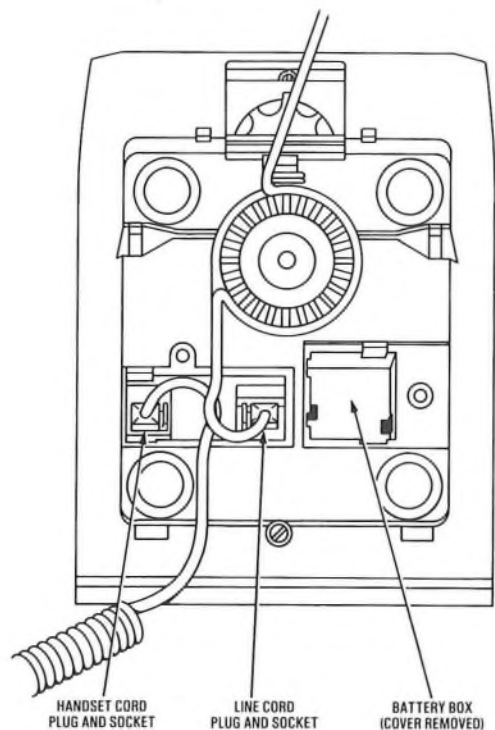

FIG. 11—Base moulding of Ambassador instrument

A further box is also moulded in the base to take a battery, which is required for the 10-address repertory-dialling facility; the design is such that the box can be physically altered by a peg, to permit either a primary or secondary battery to be fitted, as required, without the danger of fitting the wrong one. This box also has a clip-on lid with a retaining screw.

Two hooks are raised in the inside of the base moulding at the rear to hold the bell mechanism, which is also retained by 2 screw inserts at the sides. The volume control knob emerges from a slot in the rear of the case, and there are 2 further cavities in this area: the first is a slot forward of the volume control which retains the instrument in its permanently wall-mounted mode; the second slot is at the rear and is for the casual wall mounting—this is also used to house one of the 2 cover fixing screws, the other being under the front skirt.

The telephone feet are the same as those used in Telephone 746, but are slightly sunk into the base so that, when a tone-caller is used, the transducer is the correct distance from the table to provide a tuned-horn effect to achieve maximum volume.

Press-Button Unit and Signalling Board Assembly

The press-button unit presents to the user a 4 × 4 array of buttons: the numerals 0-9 and ★ and # (numerical) in one colour, and the 4 left-hand buttons (facility) in another colour. From a signalling point of view, there are 2 keypads: a 4 × 3 for the numerals, and a 4 × 1 for additional facilities.

The buttons are rectangular (12 mm × 10 mm) at their base, but at the top surface of the case, the sides taper by 1 mm and the other corners are rounded, giving a top surface appearance of 10 mm × 8 mm. They are spaced at 18 mm centres, in both vertical and horizontal planes, and have slightly dished tops. These button sizes and spacings were chosen to minimize keying errors, being within the recommendation of the Human Factors Division of the BPO Research Department. The material used is ABS and the buttons are at present two-shot moulded, although other types of button marking are still being investigated.

Buttons that are not required for use are locked up by a clip so that they cannot be depressed. The clip is sprung on round the button stem, and can be removed by taking off the button top, withdrawing the clip and replacing the button top. The 16 buttons are all single make-contact collapse-action low-force mechanisms, making contact by a helical spring with 2 parallel links in the printed-wiring board.

The printed-wiring boards used to hold press-button unit contacts, and throughout the telephone, are of random fibreglass construction, because reliability is improved and it is easier to punch the holes consistently with the required accuracy than on other types of board.

Additional board area is provided around the press-button unit for all the signalling components; in this way, various telephone types can be produced simply by changing the signalling board. The variants available by changing the signalling board are

- (a) 10 pulses/s,
- (b) 10 pulses/s plus 10 address,
- (c) MF4,
- (d) MF4 plus 10 address, and
- (e) recall—earth or timed break.

On the underside of the signalling board is a mounting bracket, which is used both to support and to define the height from the transmission board (see Fig. 12). The bracket is fixed to the press-button unit by 2 nuts and bolts, which pass through the signalling board and rigidly clamp the 3 parts together. The mounting bracket is webbed to give it strength and has 4 legs: one at the back and one at the front for support; and 2 with hooks that clip and slide into the

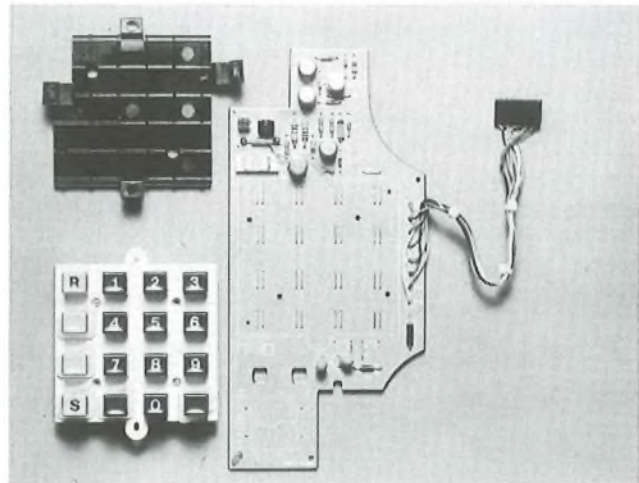

FIG. 12—Press-button unit and signalling board

transmission board to provide a precise location.

The signalling circuit is electrically connected to the transmission board by an 8-wire interconnecting lead with a polarized plug. At the signalling board end, the leads are soldered directly into holes in the printed-wiring board. The electrical details of the signalling circuits, and a more comprehensive description of the press-button unit, will be the subject of a subsequent article in this *Journal*.

Transmission Board

The transmission board, which has been coded Telephone Unit D94752, measures 143 mm × 190 mm, and contains the diode bridge, the gravity switch, the line and handset jacks, the transmission circuit, the regulator and a number of connector posts for strapping options. Holes are also included for mounting a new design of buzzer, but this is not available with the early telephones.

In the 700-type range of press-button instruments, the diode bridge is provided as part of the signalling circuit. In the Ambassador range, which is designed specifically to be press-button use (but with a dial option), it was decided to associate the diode bridge with the transmission circuit because the cost could then be offset by savings in the regulator.

The gravity switch in the 700-type instruments has caused reliability problems in 3 distinct areas: the linkage between the plungers and the microswitch; the plungers; and the lack of high contact pressure and wiping contacts on the microswitch. In the Ambassador instruments, the gravity switch and its operating mechanisms have been redesigned to overcome these problems by incorporating the following changes:

- (a) no intermediate linkage is used between the plunger and the switch mechanism;
- (b) a floating plunger is used as part of the top cover; and
- (c) an open type springset is used, which provides all the requirements of reliable contacts—higher pressure, twinned contacts, wipe, freedom from adjustment—and is a semi-sealed unit.

The switch provides two make and one break contacts, and is mounted directly on the transmission board.

The line and handset jacks are of a new design, which will be described more fully in a later article in this *Journal*. They are directly mounted on the printed-wiring board such that plug access is through the board from the underside. Each jack provides 6 connexions to the board and is designed such that the plugs cannot be incorrectly fitted or crossed over. The line socket is marked JL and the handset socket marked JH; they

are connected such that if, for example, a Handset 16D (with a neon ringing indicator) is required, the 6-way handset cord and plug can be correctly connected to the circuit without removing the telephone cover.

With the exception of the regulator, the transmission circuit is identical to that of a Telephone 746, except that a Microphone Inset 21A is used in place of Transmitter Inset 16A to give added reliability. The regulator is simplified compared with that currently used, because a diode bridge is provided at the head of the line. This enables 4 of the diodes to be omitted. The components have also been improved and standardized. The old Rectifier 209C has been replaced by 4 silicon diodes, each with a resistor in series, and the 2 Resistor Bulbs No. 1A have been replaced by fixed value resistors.

A number of 0.6 mm square section posts are used instead of the previous screw terminals, and wires, soldered to the board at one end with a female connector on the other, replace the previous straps for the few occasions where alternative strapping is required. Where more than one connector could be required to connect to a terminal, 2 or even 3 posts, marked with the same number, are used.

The transmission board is located into the base at the same angle as the cover of the instrument; it is supported on posts raised from the base moulding, and on the inside faces of the battery and connexion boxes. The board is retained by a single screw, which is located just to the rear of the line socket (JL) and screws into a threaded insert in the base moulding. Provision has also been made for 2 metal tongues to be connected to the board and protrude into the battery box to form the battery connexions.

Bell Assembly

The ringer, which has been coded Bell Unit 8001, is a complete sub-assembly, consisting of a Bell 79D, a volume control, the gongs and a mounting bracket. This enables the complete unit to be assembled, adjusted and tested prior to mounting in the telephone base, thereby lowering the reject rate and improving the quality of the product.

The Bell 79D (see Fig. 13) is a high-impedance version of the single-coil low-impedance Bell 79A, the only difference being that the coil has 24 000 turns of 0.08 mm wire giving a 4 k Ω DC resistance compared with 12 000 turns of 0.112 mm wire giving a 1 k Ω DC resistance on the 79A.

The volume control consists of 2 mouldings and a microswitch which gives an electrical bell disconnect position. The 2 mouldings fit together such that one provides a rotating member to inhibit the hammer movement of the bell by means of a helical spring; the other, to which the microswitch is fixed, provides set locations for the **LOUD**, **MEDIUM**, **SOFT** and **OFF** positions. When set to the **LOUD** position, the helical spring is moved such that it does not impede the hammer movement, whereas in the **MEDIUM** position, the spring allows the hammer to strike one gong fully and just touch the other. When in the **SOFT** position, the spring restricts the hammer movement even further and allows the hammer to hit only one gong; when switched to **OFF**, it mechanically clamps the hammer against one gong and operates the microswitch to disconnect electrically the bell coil.

The bell gongs are modified Gongs 24A and B (used in Telephone 746 etc.). Because of the height restriction caused by the transmission board, the gongs have been reduced in height by simply pressing the conical tops flatter. This slight change of shape has little or no effect on the sound output of the bell. The bell mechanism, the volume control and the gongs are all fitted to a Y-shaped bracket; the bell is adjusted by varying the current through it. On this type of mechanism, it is not possible to adjust the bell volume by rotating the bell gongs because they are clamped; a label to this effect is stuck on the telephone's base.

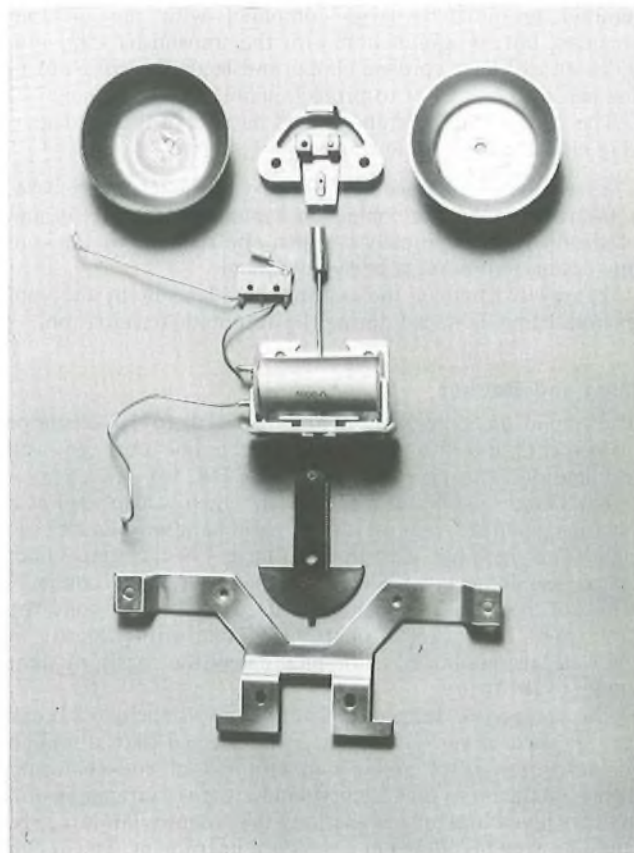

FIG. 13—Exploded view of bell unit

Cordage

New cordage has been developed for the Ambassador range of telephones, designed so that it could be connected to the new miniature plug and be machine terminated.

The physical shape of the cordage is, to a large degree, defined by the method used to clamp the plug to the cord in such a way that it would resist an 80 N force without damage. To achieve this requirement, the sheath is slightly D-shaped. The sheath material is PVC, but a slightly harder grade than that used on other current cordage has been adopted for the Ambassador instruments because the cordage is held in very close proximity to the ABS of the telephone base in the cord grooves. If the older cordage had been used, it would have caused a migration of plasticizer; thus, only 50% of plasticizer is used in the new design, making it slightly stiffer. The sheath has a rib along the flat side of the D as an identification mark when the plugs are terminated.

The conductors are Standard British Tinsel, consisting of 8 flat copper conductors, wound first in pairs, and then the 4 pairs wound round a nylon thread. This has PVC insulation extruded over it, to form a conductor 1 mm in diameter. The conductors are held flat when the sheath is extruded to form a 4-way cordage of dimensions 5.5 mm by 3.5 mm, and a 6-way cordage of size 7.5 mm by 3.5 mm. The conductor insulation on the cordage currently being supplied is all neutral colour, but later supplies will have one core bearing the manufacturer's coding colours.

When the cordage is required to have spade tags on one end, the normal Tag 207 is used, but a heat-shrunk coloured sleeve is put over the crimp to identify the conductor. The sleeve colours will be the same as those currently used in the Telephone 746.

The helical handset cords are wound such that, on the finished article, the round section of the D shape is on the outside, giving an aesthetically pleasing appearance. The

handset grommet is large compared with the previous versions, but in conjunction with the transmitter clip, provides an excellent cordage clamp and leads the cord out of the end of the handset to protect against flexing damage.

The dimensional tolerancing and flatness of the cordage is very critical for the following reasons:

- (a) it must be retained in the groove in the telephone base;
- (b) when being terminated on a plug, the end 10–12 mm of sheath is automatically stripped and damage to the conductors/insulation must be avoided; and
- (c) any twisting of the cordage could result in the conductors being damaged during the automatic termination.

Plug and Socket

The connexion of the handset and line cords to the telephone instrument, and the connexion of the line cord to wall termination, is by plug and socket (see Fig. 14).

The plug incorporates a side latch, which is also used as a polarizing feature; it is on the left for a handset plug and the right for a line plug. The plug can have 4 or 6 contacts and, hence, terminate 4- or 6-way cordage. Two basic configurations of the connector system are used: in the telephone, the plug enters the socket through the printed-wiring board; on the wall terminating box, the plug enters the socket at right angles to the board.

The sockets are designed specifically not to include a break jack as used in current jacks. It was decided that, although for most uses only 4 contacts are required, all sockets would have 6 contacts, so that facility handsets (for example, neon), and a wider range of installations that require larger cords, could be accommodated in a standard instrument. The design had to cater for 2 diametrically opposed situations: an installation where the telephone is frequently moved (for example, a Plan 4); and a situation where a wall jack remains unused for a considerable period of time. To achieve satisfactory performance in both situations, gold-plated contacts had to be used and, to minimize the amount of gold, the contacts are gold flashed all over and selectively plated to 5 μm in only the contact area.

To meet the safety requirements of the International Electrotechnical Commission and the British Standards Institute, the socket aperture is small enough to prevent the insertion of the Standard Test Finger II quoted in BS3042 (1971). The design allows for each plug and socket to have 4 mutually exclusive keyways and these are determined during moulding. Currently, only the A keyway is being produced.

Terminal Block

A co-ordinated range of wall terminating units is currently under development and these will be described in a later article in this *Journal*. The provisional designs used for the

advance production is described here. To connect the telephone to the installation wiring, 2 versions of a provisional terminal block have been developed. Both have a common case of dimensions 90 mm \times 50 mm \times 28 mm, and 2 lids are available: a captive lid for when the telephone is not removeable by the customer; and a non-captive lid for Plan 4 situations. The plug entry is "throated" to prevent damage to the plug, and the lid is retained by a single screw.

The master jack contains the socket, the bell capacitor, an opt-out-of-service resistor and lightning protection, all mounted on a printed-wiring board. Currently, screw terminations are used, but development is in hand to introduce insulation displacement terminals. For the secondary jack, no components are required other than the socket and the terminals. To expedite early production, an identical design is used for both master and secondary jacks, but the capacitor, resistor and protector are not fitted on the board of secondary jacks.

It should be noted that the terminal numbers in the termination block are reversed to those in the telephone because a cord with a plug at each end introduces an inherent reversal in the contact numbers; that is terminal 1 on one plug connects to terminal 6 on the other. The termination block is used to correct this inherent twist.

FIRST PRODUCTION VARIANTS

Apart from the signalling options (10 pulses/s loop disconnect or MF), 2 further variants were produced in the initial production run: a dial telephone; and an on-hook dialling/tone-calling press-button instrument.

The 2 variants use the same base, transmission board and ringer, but the dial telephone has a different top cover to accommodate a rotary dial. The dial has only one of its off-normal contacts connected for this circuit configuration and it plugs in to the same pins as the press-button unit. A special dial-support moulding has been produced which clips to the transmission board in the same way as the support bracket of the press-button unit. The dial-support moulding also provides a position for 2 buttons.

The on-hook dialling instrument enables calls to be initiated without lifting the handset. The bottom left-hand button (marked S) is pressed, with the handset on-hook, a latching circuit seizes the line, and dial tone can be heard in the tone-caller transducer via a monitor amplifier. The appropriate digits can then be keyed and call-progress tones monitored. When the called subscriber answers, a conversation can be held by lifting the handset, but it is possible to revert to the monitor mode by pressing the S button, irrespective of whether the handset is on or off hook. When in the handset mode, the call can be cleared by replacing the handset or, when in the monitor mode, by re-pressing the S button.

The on-hook dialling variant of the telephone is not offered with a bell option because the tone-caller is common to the monitor amplifier circuit. To make the telephone more acceptable for use in open-plan offices, the tone-caller uses different frequencies to those used in Telephone 722. On the recommendation of Research Department Human Factors Division, it was decided to use 2 frequencies in a 5:4 ratio, at 1 kHz and 1.25 kHz, with each frequency being switched on alternately at a rate of 16 Hz.

FOLLOW-UP PRODUCTION

The Ambassador telephone described in the preceding paragraphs had development frozen at an early stage in order to bring forward the first production run, accepting that the resulting design may not have been optimized. As a result of continued development, and building on the experience gained, various modifications have been made. The appearance remains almost unchanged, but modifications have been

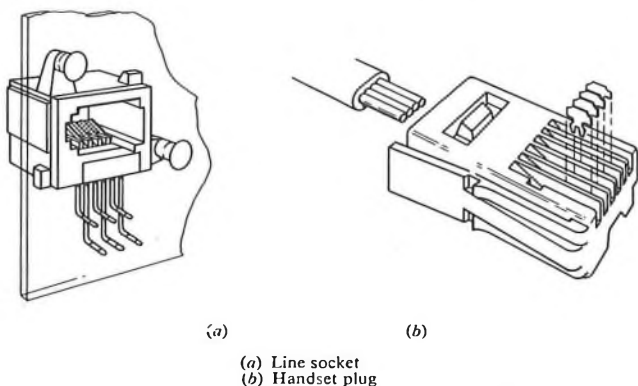

FIG. 14—Illustration of plug and socket

made to allow mechanical interconnexion, to reduce the cost and to improve further the reliability. The circuit, and its use in standard plan extensions, however, remains the same.

To enable the instrument to be mechanically interconnected with a range of add-on units currently under development, the base moulding has had to be re-designed, with the tone-caller transducer cavity being moved towards the back left-hand corner. The battery and connexion boxes have been moved to the left and will have a common cover; room is therefore left for the 2 slots and 2 studs that form the fixings for the interconnexion bracket.

Four relatively minor, but important, changes have been made to the cover moulding. A recess of half material thickness is moulded in above the part-line of the case and base, immediately behind the handset receiver cavity, to give an off-hook position when the telephone is permanently wall mounted. The reverse angle at the front of the handset transmitter cavity is removed and brought out parallel to the base, to avoid the handset being put in a position where it looks to be on-hook, but has not operated the gravity switch. The right-hand side of the cover has a cut out, and a filler piece which is removed when the instrument is mechanically interconnected. The last, but probably most important, modification to the cover is a small nib added to the upright section of the receiver cavity in front of the gravity-switch operating lever. This ensures that the handset walks on when in the table mode and, in conjunction with a small recess in the handset, is firmly retained in the permanently wall-mounted mode.

The major change inside the instrument is the revised layout of the transmission board to include the signalling components. This enables the keypad to become a separately replaceable item, remote from its signalling circuit. It also removes the height restrictions under the signalling board to allow more freedom of component layout.

Wall Mounting

The Ambassador range of instruments has been designed for wall mounting as well as for use in the table mode. Three types of wall mounting are under development: one permanent bracket, which will use a similar design for basic and plan Telephones; and 2 casual brackets for use with only the basic instrument (see Fig. 15). All the brackets are designed to use a standard wall-mounting plate; this screws directly to the wall, either as an individual item including a jack, or over a British Standard outlet box, in which case the jack is not required.

The permanent bracket, which mounts the telephone at an angle of 12° to the wall, slips directly on to the wall plate; the telephone is then plugged into the jack with a short line cord and slid on the bracket from the top. A clip-on section locks the telephone into position.

Two casual wall-mounting brackets are under consideration, both of which fit directly on the wall plate. One has a shelf, some 220 mm deep, on which the telephone can be put (see Fig. 15); the other holds the instrument at an angle of 24° to the wall. In both cases, the telephone is portable within the

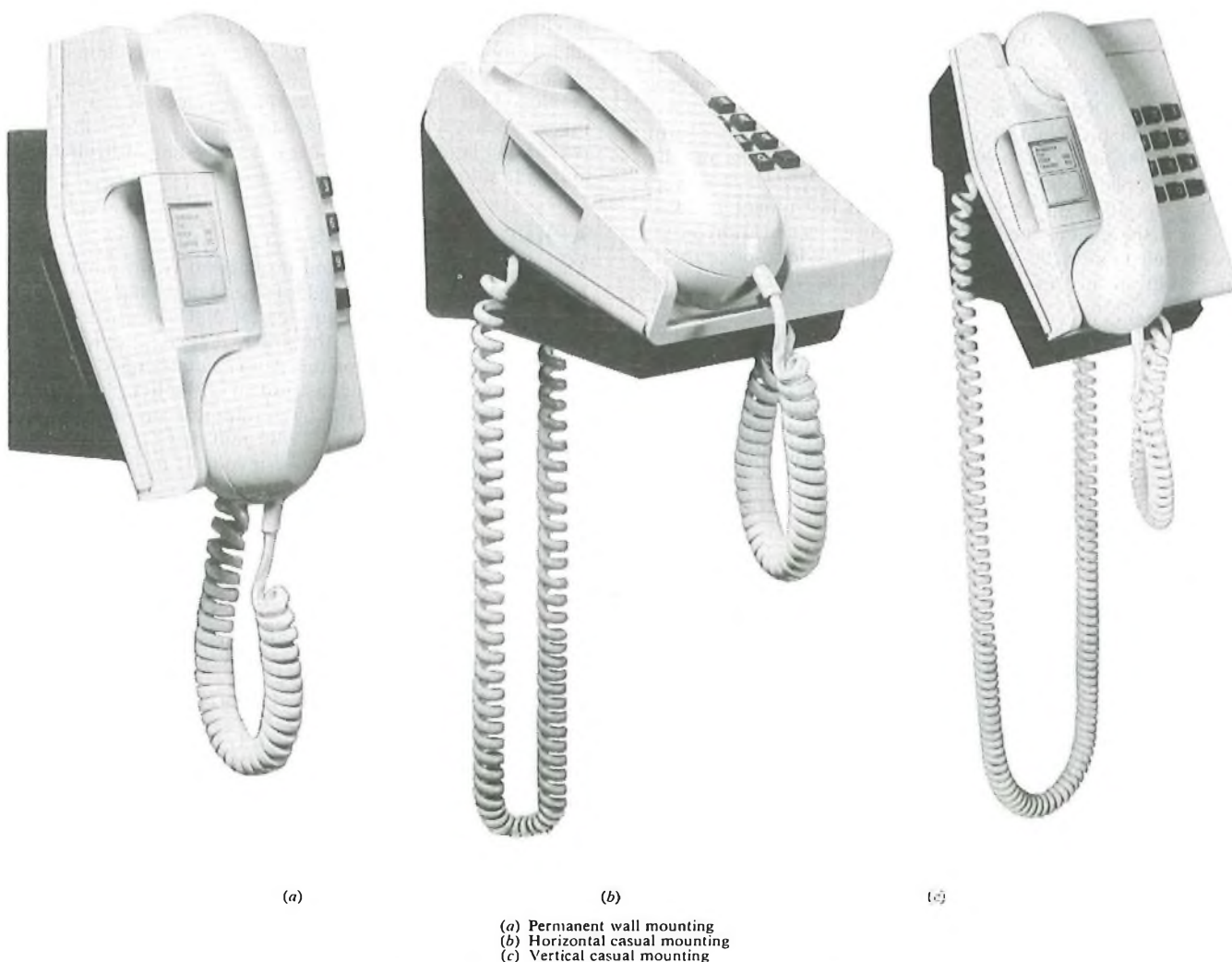

FIG. 15—Wall mounting of Ambassador instruments

limit of the extensible line cord.

Handsets 16B, C, D and E

The Handset 16B retains virtually the same external appearances as the Handset 16A, but has a small recess in the underside of the earcap, and a "pepper pot" type of earcap—a series of small holes instead of one large hole. The former assists handset retention when the telephone is wall mounted, and the latter prevents the ear lobe from touching the conducting, but isolated-from-line, front face of the receiver; this reduces further the chance of shock, which can occur only under fault and breakdown conditions.

Handsets 16C, D and E provide receive amplification, visual indication of ringing and transmitter cut-out respectively. No special handset mouldings are required, the top half of the standard handset having a single 23 mm diameter hole punched in it to accommodate the volume control of the receive amplifier, the neon, or the change-over switch (locking or non-locking), see Fig. 16. At this stage, it is not possible to provide more than one of these facilities at the same time, but each is designed for use with the new inductive coupler currently being developed.

The Handsets 16C and E use the standard 4-way cord, and the Handset 16D uses a 6-way cord. Full facilities are obtained simply by unplugging the standard handset and plugging in the required variant.

DOCUMENTATION AND CODING

The 8000 series of codes has been reserved for telephones using the Ambassador connexion method; these instruments will be coded between 8000 and 8999. The range is split into blocks of 100 numbers, such that 8100–8199 is for dial telephones, 8200–8299 is for 10 pulses/s loop-disconnect keyphones, 8300–8399 is for MF keyphones, 8400–8499 is reserved for future telephones, which have some other form of signalling, and 8500–8599 is for the plan telephone and the electronic plan system.

The specification for each individual instrument is given the same number as the telephone; hence, Specification S8200 is for Telephone 8200, which is a 10 pulses/s, loop-disconnect, press-button instrument, and covers the testing for the complete assembly.

The installation and maintenance information will not form part of the N diagram series as has been the case with previous instruments, but a Technical Instruction in the S10 series—Guide Notes (Customer Apparatus)—has been issued. This is in booklet form and contains a description of the instruments, and instructions for installation and maintenance. All the diagrams necessary for these purposes, including diagrams of 700-type instruments modified to interwork with the Ambassador range, are included.

CONCLUSIONS

A joint BPO/British industry venture has produced, from a series of linked design, development and production contracts, an attractive, versatile range of harmoniously-related telephone instrument modules, capable of evolving to keep abreast of technological advances. The family of telephone instruments is designed to be installed as issued, and is plug-and-socket

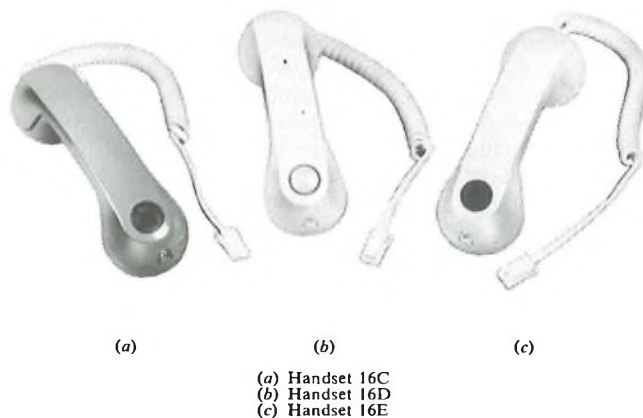

FIG. 16—Handsets 16C, D and E

connected to enable the wiring to be simplified and plan extensions to be rationalized.

The basic Ambassador telephone was first shown publicly in Geneva at TELECOM 79, where it won considerable acclaim as the modern instrument supporting System X on the highly successful joint BPO/British Industry stand. Since then, production tooling has been commissioned and manufacture of the first 70 000 instruments began in July 1980. Trials in Leeds and Sheffield followed shortly and, as part of a phased launch, instruments have been supplied to the London Telecommunications Region and the North Eastern Telecommunications Region in early 1981. The follow-up production of the basic Ambassador instrument will be slightly modified to enhance its versatility by enabling it to be mechanically connected to other items currently being developed for the range; for example, Harmony, subscribers private meter, answering/recording machines and callmakers. A national launch with the basic Ambassador instruments is anticipated in early 1982.

ACKNOWLEDGEMENTS

The design, development and production engineering of the Handset 16, and the design of the Ambassador range of instruments was carried out by DCA Design Consultants (Warwick) on behalf of the BPO. The development and production engineering of the Ambassador range of instruments, of which the basic instrument is the first, was carried out for the BPO by GEC Telecommunications Ltd. and their two sub-contractors: TMC and BICC Burndy. The authors wish to thank all those involved, in both Industry and the BPO, for all their endeavours.

References

- 1 SPENCER, H. J. C., and WILSON, F. A. The New 700-Type Table Telephone—Telephone No. 706. *POEEJ*, Vol. 52, p. 1, Apr. 1959.
- 2 WEBB, P. K., and ELLIS, J. G. A Computer-Based System for the Design, Measurement and Assessment of Telephone Sets. *POEEJ*, Vol. 74, p. 25, Apr. 1981.
- 3 RICHARDS, D. L. Telecommunications by Speech: The Transmission Performance of Telephone Networks. Butterworths.
- 4 CARD, S. E., and LITTLEMORE, D. T. Push-Button Telephones. *POEEJ*, Vol. 67, p. 224, Jan. 1975.

Monarch 120—The System Software

I. D. C. PARK, B.TECH., M.SC., C.ENG., M.I.E.E.†

UDC 621.395.2: 621.374

The Monarch 120 is a digital switching call-connect system for use at customers' premises. Previous articles^{1, 2} have described the overall system organization and the operator's console. This article describes the software for the central processor, which controls the operation of the exchange and provides comprehensive support for the maintenance engineer. The way in which the software is developed to support new facilities is also described.

INTRODUCTION

The Monarch 120 system is a digital-switching stored-program control (SPC) call-connect system for use at customers' premises, which is now going into service in the British Post Office (BPO) network. It offers a wide range of facilities, both to the extension user and the administration. The implementation of these facilities, and additions to the facility set, are practicable only because SPC techniques are used. In turn, SPC for a small exchange such as Monarch is economic only because of the recent dramatic reduction in the cost of microprocessors and their support circuits.

In order to make the production of control software a manageable task, a large proportion of the software is written in a high-level language (CORAL 66). Only those parts of the software whose execution time must be minimized are written in assembly language.

GENERAL DESCRIPTION

The significant features of the software for Monarch are:

(a) It is, by microprocessor standards, large. The volume of code in the launch version of Monarch is nearly 90 Kbytes, and the total amount of memory used by the central processor is 120 Kbytes.

(b) It is functionally divided into a number of processes known as *application processes* (APs), each of which has a specific task to carry out.

(c) APs are loosely coupled, and communicate over defined interfaces by messages passed via the operating system. Changes within one AP therefore have a minimal effect on other APs, and it is reasonable for different programmers to work in parallel on different processes.

(d) The exchange hardware is handled purely by scanning. Pulses, known as *interrupts*, are used only to allow real-time clocks to initiate scanning at the required intervals.

The software for Monarch may be considered in 3 parts:

(a) The operating system (OPSYS), which allocates processor time to the various APs doing the real work of running the exchange, provides communication between APs, and performs various common services.

(b) The telephonic APs, which handle the setting up of the calls through the exchange. These comprise the exchange scan AP (XSCAN) and the call-processing AP (CPRO).

(c) The non-telephonic APs which perform various ancillary tasks not directly involved with setting up calls through the exchange. These comprise the man-machine interface AP (MMI), the maintenance and diagnostic AP (MAD), the

call logging AP (CLOG), the traffic recording AP (TREC), and the list AP (LISP).

Application Processes

Exchange Scan AP

XSCAN is responsible for scanning the exchange hardware for significant events, and for controlling the hardware in response to commands from CPRO. It buffers CPRO from the details of the way the exchange hardware operates, so that CPRO need be concerned only with handling telephonic events such as new call, digit received, and connect path. XSCAN maintains in its data area a set of *handler records* containing information for each port on the exchange; this information includes the state of each port (for example, free, being rung, in speech, dialling).

Call Processing AP

CPRO is responsible for controlling the setting up of calls through the exchange. It maintains in its data area a number of *call records*; each call record holds information relating to one call, including the ports involved in the call, any digits received, and the state of the call.

Man-Machine Interface AP

MMI provides the means for human interaction with the system to examine or change the system database or to execute diagnostic tests. For this a telephone instrument, the operator's console, or a teletype can be used as a terminal.

Maintenance and Diagnostic AP

MAD runs a schedule of tests to check the exchange hardware. These tests are carried out while the exchange is operating. Any faults found are entered in a fault record which can be examined by the maintenance technician by using the MMI. The maintenance technician can also run tests on specific parts of the exchange using the MMI. A fuller description of the maintenance and diagnostic facilities on Monarch is given in another article in this issue of the *Journal*³.

Call Logging AP

CLOG provides the facility for the customer to log details of outgoing calls on a printer connected to a serial interface port on the equipment cabinet. It accepts details from CPRO of each outgoing call as the call is completed, calculates the duration of the call, and passes the information to be printed to LISP.

Traffic Recording AP

TREC provides a means of monitoring the use of hardware and software system resources, such as MF4 signalling digit receivers, exchange lines, and call records. Counts of success-

† System Evolution and Standards Department, Telecommunications Headquarters

ful and failed attempts to use each resource during the nominated traffic recording period are made, and the counters can be examined using an MMI command.

List AP

LISP provides data formatting and printer handling functions for all those APs which need to display information on one of the 3 printers which can be connected to the system: the system-monitor printer, the call-logging printer, and the MMI teletype. LISP also accepts MMI commands from the keyboard of the MMI teletype and passes them to the MMI.

Frequency of Operation

Each AP is divided into a number of parts based on the frequency with which each part runs. There is an *initialization* routine for each process which runs when the system is *cold started* after a power failure, or because the *watchdog*³ has detected a system malfunction. These routines put the exchange hardware and the data for each process into a known, quiescent, state. The main part of each process is known as the *background* part. Each background part is started by OPSYS when the AP has a specific task to perform; when it has finished performing this task it returns control to OPSYS. A background task may be interrupted if there is more important work for the central processor to do; execution of the task is eventually resumed at the point of interruption. Because a background task may be interrupted, it has no sense of time; if the time interval between two events is important, a background process may request OPSYS to send it a message after a specified time has elapsed. Some processes have *foreground* parts in addition to the background and initialization parts. These foreground parts are run periodically by OPSYS in response to periodic interrupts from the system real-time clocks. There are two rates: slow foreground, which is run every 128 ms, and fast foreground, which is run every 8 ms. The processes that have foreground parts are XSCAN, MAD, and LISP.

The slow foreground part of XSCAN scans all ports of the exchange for events such as an extension line looped, a recall, or a call clear-down, and reports these events to CPRO by messages passed via OPSYS. The fast foreground part of XSCAN scans those ports which are in the DIALING state to assemble loop/disconnect pulses into dialled digits, and scans the outputs of active MF4 digit receivers for valid digits.

The fast foreground part of MAD monitors the output of the ringing generator to check its frequency. If the frequency falls outside the required limits, an alarm is raised; if the ringer fails, the exchange goes into the FALLBACK state in which the central processor is halted and the exchange lines are connected directly to designated extensions to provide a limited service.

The fast foreground part of LISP scans the status of the interfaces to each of the system printers to see whether the printer is ready to receive a character, and scans the status of the MMI keyboard interface to see whether a new character has been typed in.

The organization of the various parts of the software is shown in Fig. 1.

THE CUSTOMER'S DATABASE

The customer's database is one of the most important parts of the Monarch system; it defines the characteristics of each individual installation. The database consists of a series of tables which define, amongst other things:

- (a) the extension numbering scheme;
- (b) the translation from directory number (DN) to equipment number (EN);
- (c) the type of circuit (for example, extension, exchange line, inter-PBX line, SSMF4 receiver) associated with each EN;

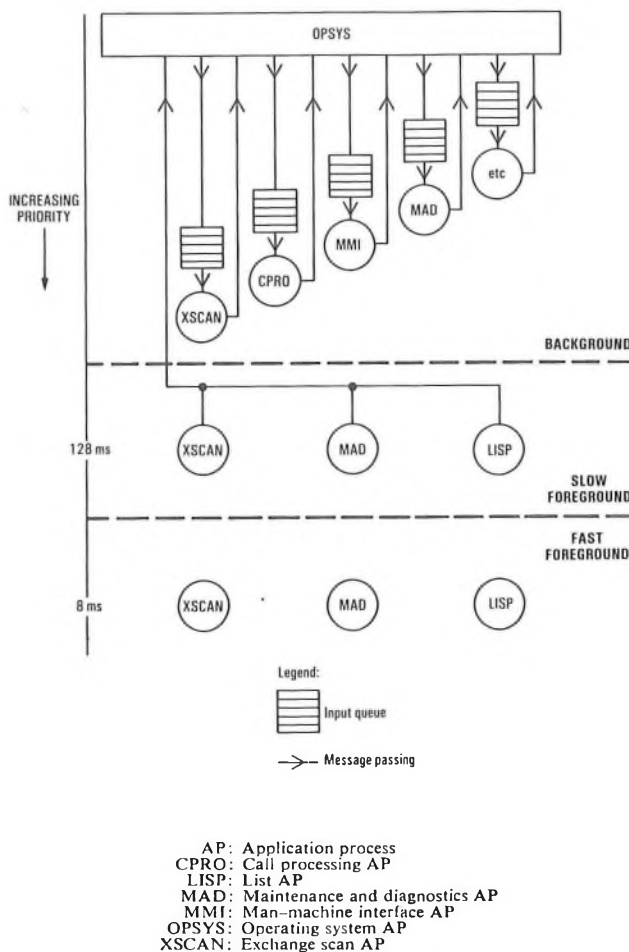

FIG. 1—Software organization

(d) class-of-service (COS) information (for example, whether an extension uses SSMF4 or loop/disconnect signaling); and

(e) call barring and diversion information.

The database occupies a 4 Kbyte block of complementary metal-oxide semiconductor (CMOS) battery-backed random-access memory (RAM) to provide security against short-term power failures. When a system is configured in the installation workshop⁴, the database is entered into a programmable-read-only memory (PROM); the database is copied from the PROM to RAM when the system is first powered up, or after a power failure which has lasted so long that the version of the database in the battery-backed CMOS RAM has become corrupt. Certain parts of the database RAM copy may be altered by the customer or by the service engineer using MMI commands; normally these changes are not entered into the PROM, but an MMI command is available to the service engineer to copy the current version of the database in RAM to a new PROM while the exchange is running.

The customer's database is prepared in the first instance from data entered on forms by sales staff. A program on a mainframe computer accepts the data from the forms, and translates them to a format suitable for loading into a target system. When the commissioning workshop is ready to configure a system to the customer's requirements, the database contents are sent over a data link to a microcomputer⁵ which programs the database PROM.

CALL HANDLING

As an illustration of the way in which the work of handling the exchange is divided up between the different processes, a narrative description of the handling of a basic extension-to-

extension call is now given. To simplify the description, the details of how OPSYS schedules the background processes are omitted from the main description.

The scheduler is entered every 128 ms on the completion of the slow foreground routines, and whenever a background process has completed handling its current task. The background processes are scanned in a fixed priority order, and the highest priority executable background process is entered. A background process is executable if it has been interrupted, or if it is dormant and has a task waiting in its queue. The priority order of processing is fixed; XSCAN has the highest priority, and TREC the lowest.

The first step in handling a call occurs when the slow foreground part of XSCAN detects a loop from an extension. XSCAN sends a *new call* message with the EN of the calling extension to CPRO, and puts the extension into a TEMPORARY PARKED state to prevent the loop from causing more *new call* messages.

When CPRO receives the *new call* message, it checks the COS of the calling extension to see whether the extension is expected to use loop/disconnect pulsing, or SSMF4, or either. (The rest of this description assumes that the extension is expected to use either type of signalling.) If the extension is expected to use SSMF4, CPRO asks XSCAN to seize an SSMF4 digit receiver, then enters a WAIT state until a reply is received from XSCAN.

When XSCAN receives the *seize* message, it allocates a free SSMF4 receiver and sends a *seize OK* message to CPRO, which then relates it to the appropriate call by means of the call record number. CPRO then sends messages to XSCAN to: set the state of the extension to DIALLING; connect the calling extension to the SSMF4 receiver; connect *dial tone* to the calling extension; and ENABLE the SSM4F receiver. It then enters a further WAIT state until digits have been received.

When XSCAN receives the *set state to dialling* message, it changes the state of the extension from TEMPORARY PARKED to DIALLING and puts the extension's EN on to a list of ENs that are scanned every 8 ms, to allow loop-disconnect pulses to be assembled into digits. The *connect* messages cause the selected SSMF4 receiver to be connected to listen to the extension and the extension to be connected to listen to the dial tone port. The *enable SSMF4 receiver* message causes the signalling output of the SSMF4 receiver to be scanned for digits. The extension user hears dial tone, and dials or keys the number of the extension he requires.

If the extension instrument is a dial telephone, the first digit is assembled from the loop-disconnect pulses and XSCAN sends a *digit received* message to CPRO. When CPRO receives this message, the fact that it came from the extension EN rather than the SSMF4 receiver EN indicates that the SSMF4 receiver is no longer needed. CPRO sends messages to XSCAN to connect *silence* to the SSMF4 receiver and to set the state of the MF4 receiver to FREE.

If, however, the extension is an SSMF4 keyphone, the first digit is detected from the SSMF4 receiver, so that the *digit received* message to CPRO bears the EN of the SSMF4 receiver rather than the EN of the extension. CPRO recognizes from this fact that the SSMF4 receiver is still required, but as the extension need no longer be scanned for loop-disconnect pulses, CPRO sends a message to XSCAN to set the state of the extension to LISTENING.

In either case, when the first *digit received* message is received from XSCAN by CPRO, *dial tone* must be disconnected; this is done by connecting the calling extension to *silence*. CPRO then waits until enough digits have been received to identify the called extension. When the last digit has been received, if it was from a dial telephone, CPRO sends a message to XSCAN to set the state of the extension to LISTENING; if an SSMF4 receiver was used, CPRO sends a message to XSCAN to set the state of the SSMF4 receiver to FREE.

CPRO then refers to the database to see whether calls to the required extension are barred or diverted; if they are not, CPRO refers again to the database to obtain the EN of the called extension, and sends a message to XSCAN to mark the called extension.

When it receives the *mark* message from CPRO, XSCAN examines the state of the called extension and, if it is FREE, replies to CPRO with a *mark OK* message. If the called extension is not free, XSCAN replies with a *mark fail* message which also gives the state of the extension.

If CPRO receives a *mark fail* message, it sends a message to XSCAN to connect the calling extension to *engaged* tone or *number unobtainable* (NU) tone as appropriate. If CPRO receives a *mark OK* message, it sends messages to XSCAN to connect *ring tone* to the calling extension and to ring the called extension, and enters a WAIT state until the called extension answers or the calling extension clears.

When XSCAN receives the *ring extension* message, it sets the state of the called extension to MARKED and applies ring current to the called extension. The exchange ring current supply is continuous; cadencing is carried out by the XSCAN slow foreground task for each extension separately, so that ringing always starts as soon as a called extension is marked. Four different ring current cadences are available.

When the called extension answers, XSCAN slow foreground task detects the loop, disconnects ring current, and sends a *called-subscriber answer* message to CPRO.

When CPRO receives the *called-subscriber answer* message, it sends messages to XSCAN to connect the calling extension to the called extension, and the called extension to the calling extension (2 paths must be set up through the switch, as each path provides only unidirectional transmission), and to set the state of each extension to SPEECH. CPRO then enters a WAIT state until either of the extensions clears.

When one extension clears, this is detected by XSCAN slow foreground task, which sends a *clear* message to CPRO; first party clear is used. CPRO then sends messages to XSCAN to set the state of both extensions to FREE, and releases the call record used during the call.

When XSCAN receives the *set state to free* messages, the extension which has cleared becomes dormant, but the other extension generates a new call if the loop persists for long enough to be detected as a new call condition by XSCAN slow foreground task.

SOFTWARE DEVELOPMENT

Software development work for Monarch now consists primarily of 3 tasks:

- (a) the addition of new facilities to Monarch 120 for the customer and the administration;
- (b) changes and additions to software to support new hardware which offers lower cost or improved performance; and
- (c) changes and additions to software to provide variations on the Monarch theme (for example, a private circuit automatic tandem exchange, and larger PABXs with capacities of 250 and 500 extensions).

This section describes how a facility progresses from the identification of a need to the installation in customers' premises of systems including that facility.

Identification of New Facility

The first step is the identification of the need for a facility: by market research in the case of a customer facility, by maintenance staff in the case of an administration facility, or by the project team in the BPO's Marketing Executive in the case of software to support new hardware. Examples of these 3 types of facility are the provision of abbreviated dialling codes for individual extensions (a customer facility), remote access to MMI for maintenance (an administration facility),

and the support software for a new design of line shelf (software to support new hardware).

The second step is the agreement between those requesting the facility (Marketing Executive) and the implementors (the software team) on the exact definition of the facility. Once this definition has been agreed, work can proceed in parallel on writing test schedules and user documentation and the production of the software. When the facilities have been defined, it is possible to make estimates of how long is needed to implement each facility; the facilities which will make up a software release can then be defined. The timescale for the production of the software release is then agreed between the software team and Marketing Executive. At this stage, the facility set is given a *generic code*; for example, 120B2. The first part of the code defines the size of the exchange (for example, 120, 250 extensions), the letter defines the level of the facility package (for example, B for basic, C for enhanced, T for tandem), and the last digit defines any addition of facilities which do not change the level of the facility package. This last distinction arises because both the basic and the enhanced facility packages will be marketed in parallel, but

there will be a need to add further facilities to the basic package as time goes on.

Software Modification

The third step is the identification by the software team of the parts of the software that need to be modified to implement the facility. Besides the changes to one or more of the APs, many facilities will require changes to the form of the customer's database. These changes must be notified to the BPO's Data Processing Executive staff, who will modify the database preparation program so that databases for the new facility may be available at the same time as the facility software.

The fourth step is the design by software engineers of the modifications to the control software. Three important principles govern the design of Monarch software:

- (a) the use of top-down design⁶;
- (b) the use of structured programming principles; and
- (c) the use of a high-level language as far as possible, exceptions being outlined below.

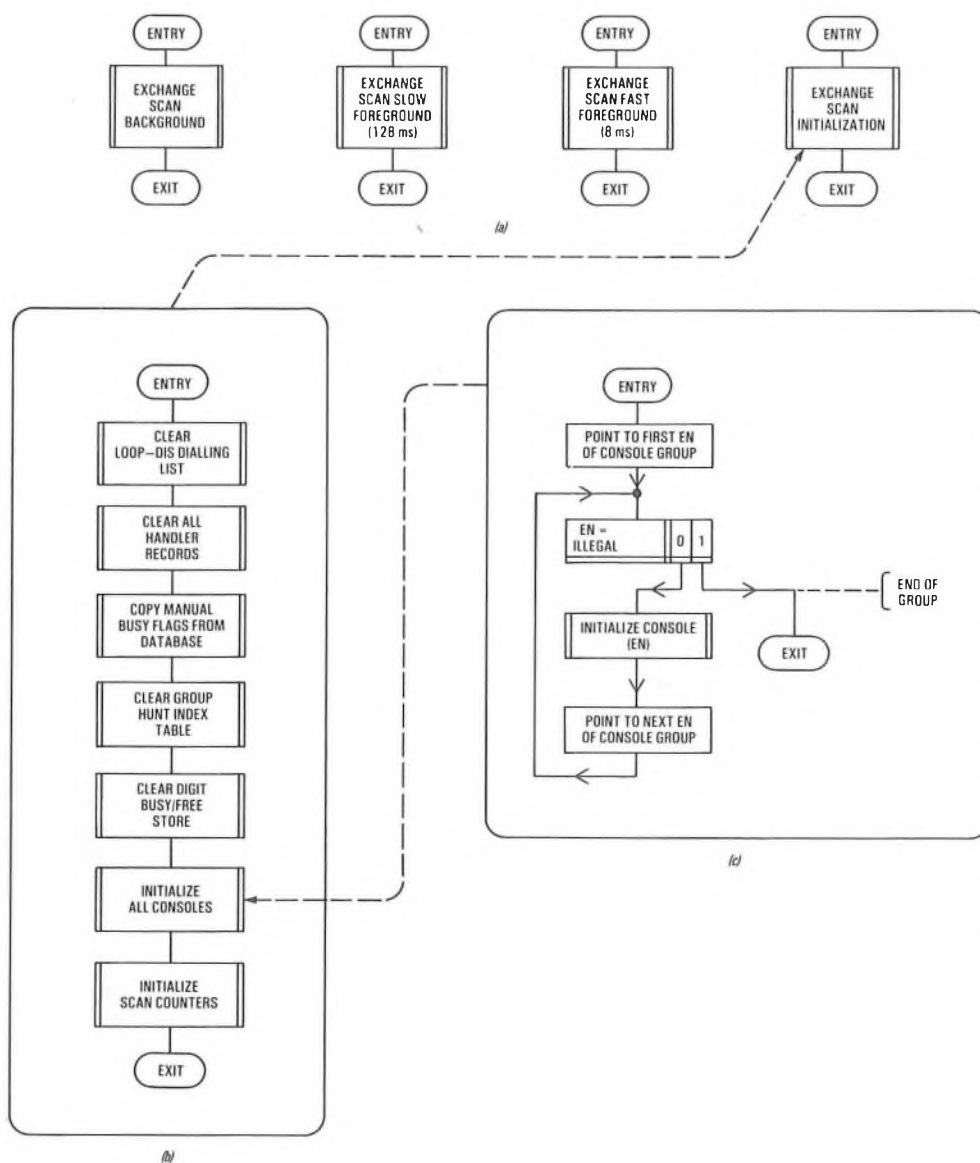

(a) Exchange scan overview
 (b) Exchange scan initialization
 (c) Console initialization
 EN: Equipment number LOOP-DIS: Loop-disconnect

FIG. 2—The chart expansion process

Top-Down Design

The use of top-down design requires that each process should be described by a single progression chart which fits on to a sheet not larger than A3 size. The symbols on this chart consist of an entry, an exit, decision boxes, task boxes and macro boxes.

Where a process includes routines that are called on interrupt, the top-level chart may include an extra entry and exit symbol for each level of interrupt; it then becomes in effect 2 or 3 charts sharing the same piece of paper.

Each macro box may be expanded as a further chart consisting of an entry, an exit, and more decision boxes, task boxes, and macro boxes. This process continues until each box on the chart represents a primitive operation that can be coded. An example of the expansion process is given in Fig. 2.

Structured Programming

The use of structured programming requires that each macro should have a single entry point and a single exit point. Control of looping should be by means of DO-WHILE or FOR statements in a high-level language, and equivalent constructs in assembly language. The explicit use of GOTO is forbidden except that an exit to the notional end of the process is allowed.

Software Language

Most of the code for Monarch is not very time-critical; the exceptions are the periodic scanning routines and some parts of OPSYS, which are written in assembly language to allow them to run quickly. In order to provide a clear link between tasks at progression chart level and assembly-language code, the approach adopted for assembly language programs is to write them in a high-level language similar to CORAL, and then hand compile this to assembly language to achieve a high degree of optimization.

Testing

The fifth step is the testing of the new facility. The changes to implement the facility are made on a base of a system that has been thoroughly tested; the revised processes are then compiled or assembled, and linked together to form a software system which can be loaded into RAM on a development Monarch cabinet. This system can then be run under the control of the In Circuit Emulator (ICE), to check that the facility operates correctly and, as far as possible, that other parts of the system have not been adversely affected.

When all the new facilities composing a software release have been tested in isolation, as described above, the sixth step, that of integration, can take place. All the changes needed to implement the new facilities are made, and the software system is again tested under the control of ICE.

Installation

The seventh step, when these tests are complete, consists of loading the system into PROM at the BPO's 3 captive installations: the British Telecom Research Laboratories at

Martlesham, the Marketing Executive Product Development Unit laboratory in London, and the Monarch Task Force laboratory in London. The first 2 of these sites carry live traffic; the third is used for exhaustive testing by Marketing Executive staff and trained PABX operators. Only when this testing is complete and any bugs discovered have been corrected is the new software release installed in customers' premises. Even after these stages of testing, it is inevitable that, in such a large software system, there are some residual errors. Some of these errors will affect service to the customer; when such errors are discovered by area maintenance staff, they are reported to Marketing Executive service staff, who collate the fault reports, and consult with the software team to decide on how the error may be corrected.

If an error severely affects service, or if the number of accumulated corrections is large enough, a *point release* is issued. The point release is identified by the release number changing from (for instance) 120B1.0 to 120B1.1. No new facilities are added in a point release; it simply corrects the known faults in the original release.

CONCLUSION

This article has given an introduction to some of the many facets of the software for Monarch. With the introduction to service of the first production Monarch units, a major landmark has been reached: the BPO now has a small PABX with a range of facilities that is far ahead of those on the previous range available in the UK. Because Monarch uses SPC, the range of facilities can be enhanced still further, not only for telephony but also for other services, by taking advantage of the fact that Monarch can provide an end-to-end digital connexion. Monarch 120 is seen as the first of a family of exchanges; work is already programmed to provide further enhancement of the facility set for Monarch 120, to provide larger PABXs, and to provide special versions to meet needs such as that for a private circuit automatic tandem exchange; so there will be work to be done on software development for some time to come.

ACKNOWLEDGEMENTS

The author's thanks go to the many members of the Monarch software team, past and present, who have contributed to the project, and provided information for this article.

References

- ¹ POTTER, A. R. Monarch 120—A New Digital PABX. *POEEJ*, Vol. 73, p. 14, Apr. 1980.
- ² WILLETT, G. The Operator's Console for the Monarch 120 PABX. *POEEJ*, Vol. 73, p. 138, Oct. 1980.
- ³ WALTERS, R. E. Monarch 120—Maintenance Facilities. *POEEJ*, Vol. 74, p. 99, July 1981.
- ⁴ BRASSIL, T. G. Monarch 120: A Central Installation-Workshop Facility. *POEEJ*, Vol. 73, p. 176, Oct. 1980.
- ⁵ ELSON, R. W. AMBLE: Automatic Memory Board Loading Equipment. *POEEJ*, Vol. 74, p. 118, July 1981.
- ⁶ MCLEOD, J. A., GARRETT, J., and ATKINS, J. W. A Top-down Approach to the Design and Implementation of Telecommunications Control Functions. Post Office Telecommunications Research Department Report 530.

CAIRO: Computer Analysis of Incident Recorder Output for TXK4

R. C. MORRIS, M.B.I.M., and J. M. STEWART †

UDC 621.395.344.6 : 681.31

The development described in this article improves the performance of TXK4 crossbar exchanges in the trunk transit network and service to the customer by providing local, real-time microcomputer analysis of the incident recorder output.

INTRODUCTION

TXK4 crossbar exchange transit switching centres (TSCs) provide a customer-dialled trunk switching capacity where main network transmission loss and post-dialling delay would otherwise be unacceptable. There are 37 such exchanges in the British Post Office (BPO) network and, although no more will be provided, large extensions to the existing units are planned during the early-1980s. This transit network handles about 6% of the total UK trunk traffic. A block diagram of a typical TSC is shown in Fig. 1.

INCIDENT RECORDER

The performance of a TSC is monitored by an incident recorder (IR) which provides an alpha-numerically coded print-out if, because of a fault or certain instances of con-

gestion, a call attempt fails to mature. Register finders, registers and markers detect failures and activate the IR while the selection path is temporarily held. The identities of the calling elements and other major equipments involved, together with the state of their key relays, are recorded. When this information storage is complete, the IR is released from the detecting element and the call proceeds to second attempt or, if it is already in second attempt, to forced release. The coded information stored in the IR is then output on punched tape in International Telegraph Alphabet No. 2 (ITA2). Subsequently, page copy for local records is obtained by using standard teleprinter equipment. Figs. 2 and 3 show the present output devices and an extract from an exchange print-out respectively. The IR equipment layout is shown in Fig. 4.

The TXK4 system monitors its switching sequence by means of a series of signals that terminate phase time-outs. Expiry of any time-out period, prior to receipt of the appropriate signal, generates a demand for the IR and a subsequent print-out. The main phases of a call are listed in Table 1,

† Mr. Morris is with the Management Services and Sciences Department, Telecommunications Headquarters, and Mr. Stewart is with the Exchange Systems Department, Telecommunications Headquarters

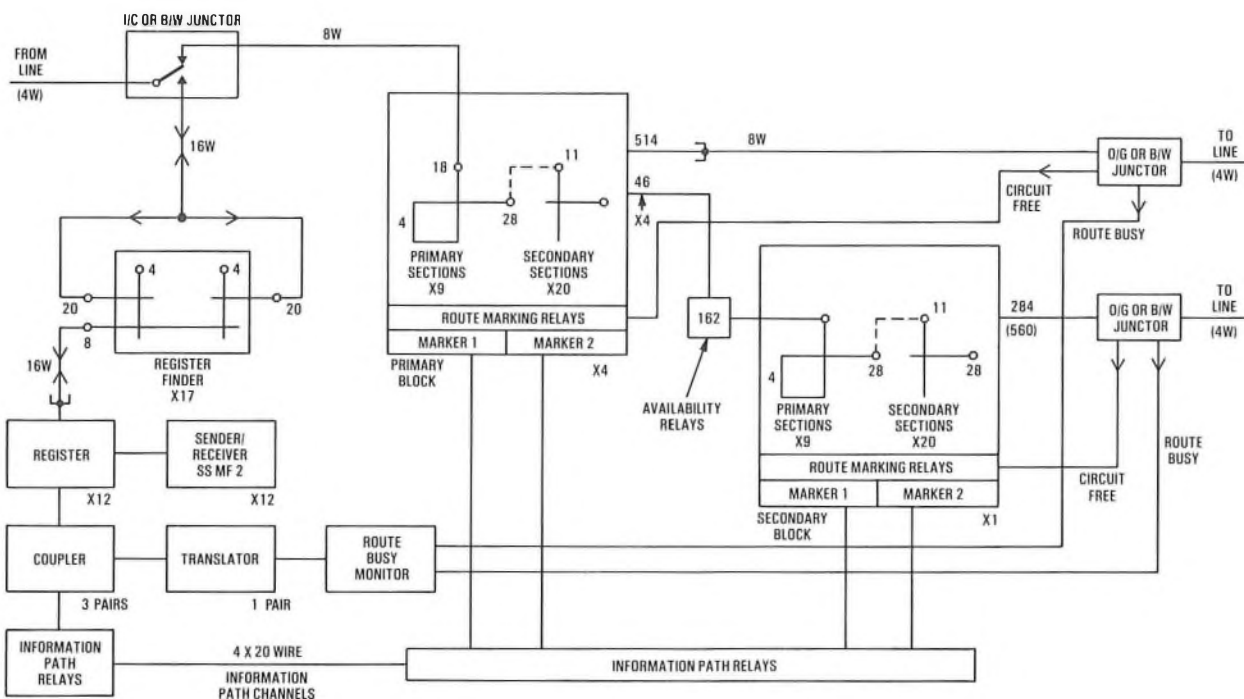

B/W: Bothway
I/C: Incoming
O/G: Outgoing

FIG. 1—TXK4 transit switching centre

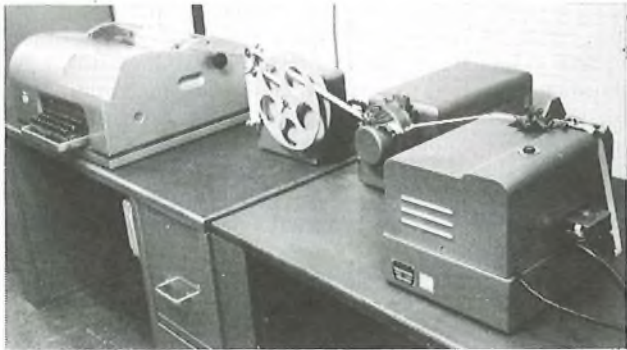

FIG. 2—Incident recorder print-out using auto transmitter and Teleprinter No. 7

```

03/16 1407
REG10.B1JK ICJ----
03/16 1409
REG34.BJK ICJ----
03/16 1409
REG47.BJK ICJ3303
03/16 1409
REG43.BJK ICJ3079
03/16 1410
REG32.BJK ICJ2947
03/16 1410
REG53.CJK ICJ3444 CPL2.ABCDL
03/16 1411
REG31.CJK ICJ2279 CPL2.BCDEFK
03/16 1411
AMKR22/2.ABCDEFIJK IP? PYF08 IAF- SYF09 OGJ----

```

AMKR: Active marker
 CPL: Coupler
 IAF: Inter-aiding frame
 ICJ: Incoming junctor
 IP: Information path
 OGJ: Outgoing junctor
 PYF: Primary frame
 REG: Register
 SYF: Secondary frame

Notes: 1. B1JK, BJK etc. are codes designating certain leads on which conditions are detected by the incident recorder
 2. ? indicates that the equipment was not in circuit at the time of the incident
 3. - or ---- indicate that the equipment cannot be identified because of a clear, or was not in circuit, when the incident recorder was activated

FIG. 3—Typical TXK4 incident recorder output

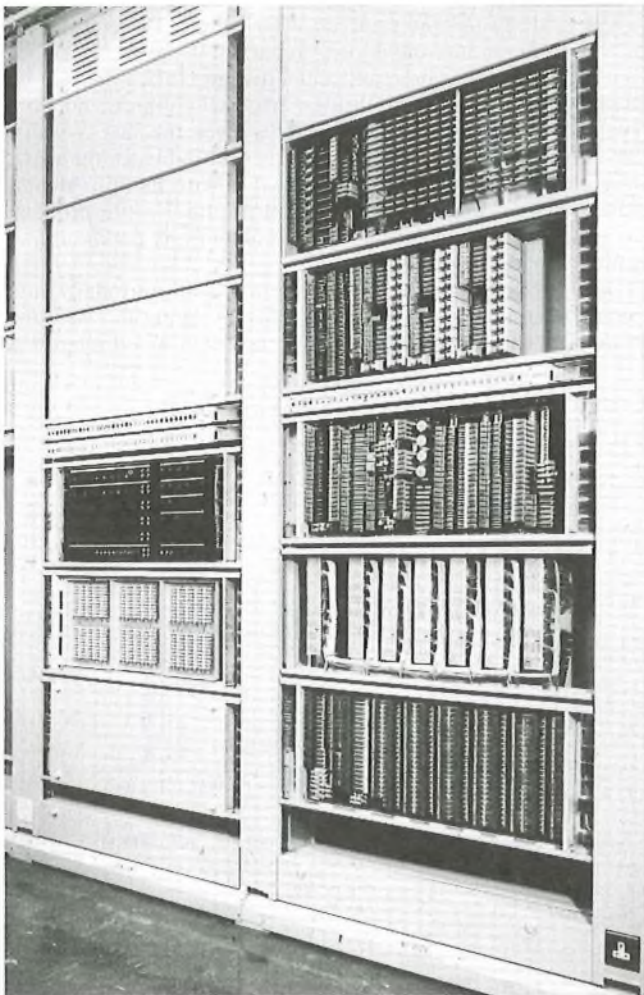

FIG. 4—Incident recorder equipment layout

which also indicates the common-control element that detects a particular phase failure, nominal time-out duration and the key information given in the print-out.

Categories 1-2 and 5-9 relate exclusively to incidents occurring in the control or switching matrix areas of the exchange and are referred to as *switchblock* incidents.

Category 3 incidents indicate that the TXK4 register has not received the necessary 3 digits of the objective national number group code and that it is therefore unable to complete the task. Such incidents are coded *BJK* by the recorder. These letters have no significance other than the designation of certain leads from the IR, which are connected to a combination of relays in the common-control equipment.

TABLE 1
 TXK4 Call Phases and Failure Categories

Cat-egory	Failed Phase	Detect- ing Element	Nominal Time-Out Period	Typical Key Information
1	Register Selection	Register Finder	2.50 s	REG/FDR00
2	Inlet Category or 1st Digit Storage	Register	1.85 s	REG00 <i>AJK</i>
3	2nd and 3rd Digit Storage	Register	1.85 s	REG00 <i>BJK</i>
4	Received Digit Validity Check	Register	Immediate	REG00 <i>BIJK</i>
5	1st Stage Outlet Category	Register	1.20 s	REG00 <i>BJK</i> CPL MKR00/1
6	2nd Stage Outlet Category	Register	1.20 s	REG00 <i>CJK</i> CPL MKR00/0
7	Speech Path Continuity	Register	0.35 s	REG00 <i>GJK</i> IGJ1234 OGJ3456
8	Register Release	Register	0.35 s	REG00
9	Marker Release	Marker	0.15 s	MKR00/1 <i>ABCDEFGHIJK</i>

CPL: Coupler
 ICJ: Incoming junctor
 MKR: Marker
 OGJ: Outgoing junctor
 REG: Register
 REG/FDR: Register finder

Notes: 1. 00 indicates where the incident recorder will print the actual equipment number of the detecting element.
 2. *AJK, BJK* etc. are codes designating certain leads on which conditions are detected by the incident recorder.

Category 4 incidents are similar to those in category 3, except that there is no time-out delay when the incident is detected. An additional character is introduced into the print-out to indicate that corruption of the SSMF2 signalling code has been detected. These incidents are coded *BIJK*.

In categories 3 and 4, which account for over 90% of recorded incidents, the vast majority are the result of failures in a distant originating group switching centre (GSC) and are beyond the direct control of staff in the TSC. These incidents are therefore referred to as *non-switchblock* incidents.

In the case of switchblock incidents, it is necessary to associate a variety of outputs to establish failure patterns before maintenance effort can be directed to problem areas. Non-switchblock incidents must be analysed to establish the exchange in which the problems originated since, in a largely step-by-step Strowger environment, the GSC staff are frequently unaware that problems exist. Information concerning signalling interchange failures is passed to the GSC staff, thus creating a network monitoring facility.

ANALYSIS BY COMPUTER

Visual Analysis

Visual analysis of IR teleprinter incident output is complex, time consuming and above all extremely tedious (see Fig. 3).

Postal Batch Processing

In 1976, the Eastern Telecommunications Board (ETB) and Cambridge Telephone Area, on behalf of the Network Executive, Exchange Systems Department (NE/ES9.2) of the Telecommunications Headquarters (THQ) of the BPO, developed software to enable the IR print-out to be analysed by the BPO's IBM computer. The paper-tape output was sent by post to the computer centre. Separately analysed information for switchblock and non-switchblock incidents was returned to a terminal in the Telephone Area Office. The scheme listed faults per register and marker, and analysed non-switchblock incidents for the incoming route concerned.

Dial-Up Batch Processing

Operation of the postal batch scheme resulted in a significant improvement in the quality of service in the Cambridge TSC catchment area. However, the 3 days that it took for information to be analysed was too long to provide full control of the daily fault situation. The system was therefore further developed for on-line working. To improve communication between the exchange and the computer, IR output is converted from ITA2 to International Alphabet No. 5 (IA5)* by means of a code conversion interface unit (CCIU). Storage is in voice-frequency form, on a magnetic-tape cassette unit. Data is input to the computer twice daily via the public switched telephone network (PSTN), and the analysed output returned on-line to a terminal in the exchange.

The dial-up scheme, which has been in operation for about 2 years in Cambridge TSC, has proved very effective. Faster turn-round means quicker fault clearance, further improvement to service quality and improved utilization of plant.

On-Line Real-Time Processing

In 1979, the Management Services and Sciences Department (MSSD) of the BPO was charged by the Computer Aids for Service Coordinating Committee (CASCC) to evaluate the use of microprocessors as common-control exchange maintenance aids. In consequence, an on-site microprocessor-based system for TXK4 exchanges was developed by the MSSD and the Technology Executive, System Evaluation and Standards Department (TE/SES3). Programming was carried out with the aid of the Cambridge Telephone Area. The system, known as the *computer analysis of incident recorder output (CAIRO)*, includes all the facilities offered by the batch on-line scheme, plus many new features. Separate switchblock and non-switchblock analyses are available over hourly, daily and weekly periods. Thus, immediate, organized information is available to the exchange staff. Statistics over

the longer periods are available for management use. Surveillance continues 24 hours a day, 7 days a week. The more important indicators have threshold warnings to draw immediate attention to serious degradation of service. It is also possible to select for printing-out all incidents having particular code combinations, or those relating to particular equipments over specified numbers of switchblock incidents. Circuit records are held on file and may be accessed on demand. A sample of the print-out suite of CAIRO is given in Fig. 5 (opposite).

The real-time analysis of non-switchblock incidents greatly improves network management, and effectively creates a zone monitoring concept with the TSC as the hub. Incidents can be summated by the computer over given periods, so indicating the significance of a problem. Hourly reports, listing routes in order of the number of false seizures per 100 circuits/hour, are immediately available to exchange staff and several reports, accessed at different times of the day, can indicate growth or decay of trouble on a route. The analysis is so effective that the TSC staff can often detect, by reference to the hourly, non-switchblock reports, whether or when remedial action has been taken at a distant GSC. Fig. 6 shows trend graphs for the Cambridge TSC switchblock and non-switchblock efficiency measurements over the last 5 years. The hourly non-switchblock analysis also indicates the worst traffic circuit on a listed route, together with its fault significance, by quoting the proportion of the total route problem to which it is contributing. Code corruptions per hour per route are shown in Fig. 5(c).

The hourly reports can be accumulated into daily and weekly false seizure reports (Figs. 5(d) and 5(e)), in which the routes are shown alphabetically for long-term trend reference.

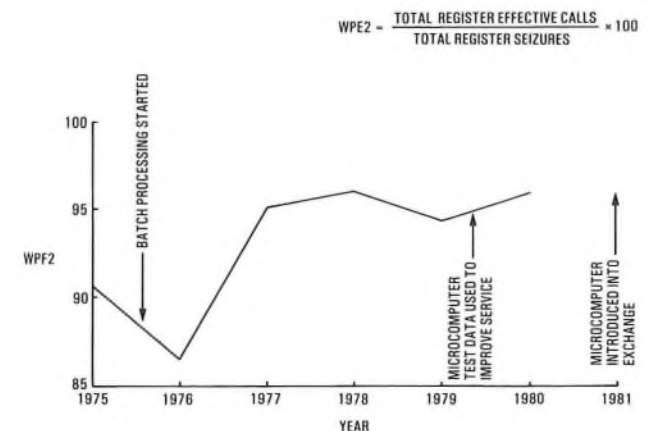
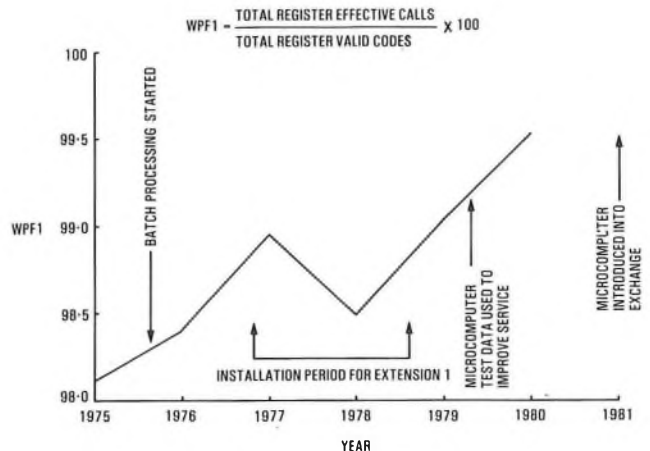

FIG. 6—Cambridge TXK4 weekly percentage figures (WPFs)

* IA5 is also called ASCII—American standard code for information interchange

 REGISTER PERFORMANCE REPORT

DATE:- 9/2/81 TIME:- 13:37

REGISTER	CPL1	CPL2	CPL?	TOTAL	CRITICAL
00	1	2	5	8	20
* 01	7	9	5	21	20
02	1	3	0	4	20
03	4	4	5	13	20
04	7	9	2	18	20
* 05	9	5	6	20	20

(a) Register performance report

 OVER CRITICAL REPORT

DATE:- 9/2/81 TIME:- 13:50

OVER CRITICAL REGISTERS

REGISTER	CPL1	CPL2	CPL?	TOTAL	CRITICAL
01	7	9	5	21	20
05	9	5	6	20	20
17	3	4	7	20	20
41	5	4	13	22	20
50	6	5	10	21	20

(b) Summary of over critical registers

 HOURLY NON-SWITCHBLOCK REPORT

Performance derived from incidents collected in periods:-
 11:53 to 12:23 and 12:25 to 12:55 DATED-9/2/81

ROUTE	FALSE SEIZURES /100 Ccts/Hr	WORST TFC NO	CIRCUIT %AGE OF TOT	CODE CORRUPTIONS PER HOUR
SHIRETOWN	50.00	5	26	3
TOWNLAND	20.00	2	50	0
SEALAND	17.85	4	39	0
WALSTOWN	16.22	31	33	0
ANYTOWN	13.33	1	75	2

There were 6 undefinable junctor numbers
 and 3 unallocated junctor numbers

(c) Hourly non-switchblock report

 DAILY FALSE SEIZURE REPORT

Friday 6/2/81

Performance expressed as the number of
 False seizures/100 circuits/hour over each period

ROUTE	00:00 - 05:00	05:00 - 12:00	12:00 - 18:00	18:00 - 00:00
ANYTOWN	0.00	4.44	11.11	1.67
CARTOWN	0.00	0.00	0.00	1.39
CROSSSTOWN	0.00	1.87	2.22	1.11
NEWTOWN	0.00	1.13	5.65	0.85
OLDSTOWN	0.00	1.33	0.67	0.67
SEETOWN	0.00	1.52	1.52	0.00

(d) Daily false-seizure report

 WEEKLY FALSE SEIZURE REPORT

False seizures/100circuits/Hour averaged over the period 12:00 - 18:00 Hrs

ROUTE	Mon 2 Feb	Tue 3 Feb	Wed 4 Feb	Thu 5 Feb	Fri 6 Feb	Sat 7 Feb
ANYTOWN	21.11	1.67	8.89	6.66	11.11	0.00
CARTOWN	0.00	0.00	0.00	0.00	0.00	0.00
CROSSSTOWN	3.33	1.11	2.78	3.33	2.22	0.56
NEWTOWN	3.39	2.26	3.67	4.80	5.65	0.55
OLDSTOWN	0.57	0.00	0.67	0.00	0.67	0.00
SEETOWN	5.82	0.00	2.27	0.76	1.52	0.00

(e) Weekly false-seizure report

INC. NO	INC TYPE	REG	INCIDENT CODE	ICJ	CPL	INCIDENT CODE	REPORT TXR MKR	INCIDENT CODE	IP	PYF	IAF	SYF	OGJ	MISC
226	5	15	BJK	1695	2	BK								
227	5	13	BJK	2159	2	BL								
228	5	13	BJK	2159	1	BL								
229	5	15	CJK	718	2	BCL								
230	7	50	BJK	3031	2	BCGL	3	ABCEDEG	-					
231	6	14	BJK	795	1	BCDEFK	3	ABCEDEG	-	2	0	12	---	
232	8	---	---	---	---	---	3	25/2 ABCDEFJK	-	5	0	17	---	
233	4	2	GJK	375	---	---								
234	7	41	BJKP	3323	1	BCDEGJK	3	BCDEG						
235	7	41	BJKP	3323	1	BCDEGJL								
236	9	43												
237	5	1	CJK	2085	1	BCDEFK								
238	8	---	---	---	---	---	3	32/2 ABCDEFIJK	-	3	0	0	---	
239	7	34	BJK	2826	2	BCGL	3	ABCDEFG						

(f) Incident report

B/W: Bothway
 CPL: Coupler
 IAF: Inter-aiding frame
 I/C: Incoming
 ICJ: Incoming junctor
 INC: Incident
 IP: Information path
 O/G: Outgoing
 OGJ: Outgoing junctor
 PYF: Primary frame
 SYF: Secondary frame
 TFC:NO: Traffic number
 TXR: Translator

Note: Fig. 5(a) and (b) are switchblock reports; similar reports exist for register finders, markers and translators. Fig. 5(c)-(e) are non-switchblock reports. The data shown is live traffic information on routes into Cambridge TSC. The names given to these routes are, of course, fictitious.

FIG. 5—Typical CAIRO output

COMPUTER ANALYSIS OF INCIDENT RECORDER OUTPUT

Hardware

Fig. 7 shows a typical CAIRO hardware configuration in a TXK4 exchange. The block diagram of this arrangement is shown in Fig. 8.

The on-site real-time analysis of the IR output data in the larger TXK4 exchanges requires an addressable random-access memory (RAM) size that is well in excess of the 64 Kbyte provided with many types of small business computer. Also, it is necessary for up to 7 programs to be running concurrently on the system, including one which is real-time in character. It was therefore decided to use the Alpha Micro 1030 because of its competitive price and because its RAM size is extensible to over 1 Mbyte. The Alpha Micro 1030 computer uses the Western Digital LSI 11 multi-



FIG. 7—Computer hardware

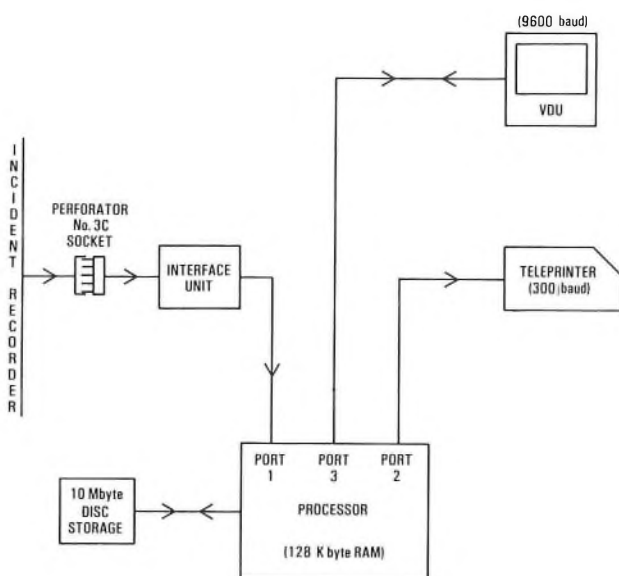

VDU: Visual display unit
RAM: Random-access memory

FIG. 8—Typical hardware configuration

task chip set. This type of machine also supports a hard disc unit with storage capacity of 5 Mbyte on fixed disc, plus 5 Mbyte on exchangeable disc. CDC Hawk disc drives have been used for the CAIRO system.

The visual display unit used for the experimental installations is the Volker Craig 404, and the printer is the DEC-writer IV, which provides a nominal line length of 132 characters (extensible to 216 characters), at 30 characters per second. The CCIU is to a BPO design and is manufactured in the BPO's Procurement Executive Factories Division. The CCIU converts the ITA2 parallel format output from the IR into IA5 format serial input to the computer.

Software

The Alpha Micro 1030 employs the Alpha Micro Operating System (AMOS), and the programming language used is the manufacturer's special Alpha Basic, which gives good file-handling flexibility.

The incoming data from the CCIU is recognized as relating to switchblock or non-switchblock incidents, and is stored appropriately. Data is extracted for switchblock or non-switchblock analysis, after which it is filed for subsequent output reports.

A back-up disc-copying routine can be called up by the user to give maximum system security.

Computer Maintenance

The operation of the TXK4 exchange is not dependent upon the IR or its associated print-out in whatever form; thus the occasional loss of the microcomputer analysis for short periods is tolerable, thereby making a stand-by computer unnecessary. However, an in-house maintenance system is envisaged for the Alpha Micro hardware; meanwhile, a maintenance contract exists. Software maintenance is the responsibility of THQ.

CHOICE OF LOCATIONS FOR EARLY SYSTEMS

Cambridge and Glasgow

Cambridge TSC was the obvious first choice for system evaluation owing to the close involvement of the staff of Cambridge Telephone Area in the microcomputer software development. A second Alpha Micro system has been installed in Glasgow TSC, the largest outside London, in order to gain independent user opinions of the facilities offered.

London

Because of their size and trunking arrangements, the 2 London TXK4 units employ a different IR output coding system. Software development for these exchanges is in progress in order to introduce the benefits of the CAIRO scheme into the London network.

ASSOCIATED MICROPROCESSOR-BASED SCHEMES

Provision for Small Exchanges

For economic reasons, the provision of Alpha Micro systems will be restricted to exchanges with a capacity in excess of about 850 incoming trunk circuits; this represents approximately the 20 largest TSCs. In order to improve the incident-analysis facility for the smaller TXK4 units which do not justify real-time processors, a system that originated in the North Eastern Telecommunications Region (NETR) of the BPO is being evaluated.

The NETR system is based on time-shared use of the standard CASU Super C microcomputers which are used for other tasks in Regional and Telephone Area offices. The computer is limited to 64 Kbytes of RAM and uses double-sided double-density floppy-disc storage. The information from the IR paper-tape output is read into the computer and

a preliminary program performs the ITA2 to IAS conversion. (All TSCs will be equipped with CCIUs in the near future, thus rendering the conversion program unnecessary.) Analysed output provides similar, though less comprehensive, information to that available from the Alpha Micro scheme.

The analysed information produced is less immediate than that provided by the large-exchange scheme. However, turn-round time is considerably less than the postal batch system and the scheme provides more information with greater flexibility than is practicable with the on-line batch system.

Computerization of TXK4 Traffic and Service Meter Data—Software-Controlled Recording On-Line Equipment (SCROLE)

The registers in the TXK4 system provide, by means of meter operations, information on the performance of the exchange as a whole. From the meter readings, 5 sets of weekly percentage figures (WPFs) are calculated, and the resulting statistics are used to quantify exchange performance. The statistics are therefore complementary to those obtained from the CAIRO scheme. However, production, plus the provision of the usual traffic-record information for planning purposes, involves regular reading of a large number of meters (over 8000 in the London units).

In order to reduce the human involvement in these tasks, Network Executive (NE/ES6) has developed a software-controlled automatic meter-pulse logging-and-analysis device.

Hardware consists of a microprocessor-based data logger which services 2 external terminals; the processor used is the Intel 8080A. The data-logging section has been designed for direct connexion to standard call-count and traffic meters. Each pulse is logged internally and transferred to RAM by using multiplexing techniques.

Performance figures, which for economic reasons could be produced on only a weekly basis, can now be output automatically every hour. This provides maintenance staff with a rapid indication of problems as they occur and enables rapid remedial action to be taken, using complementary information which, if required, is available from CAIRO.

CONCLUSION

The multi-frequency signalled, 4-wire-switched transit network, together with its automatic alternative routeing and second attempt characteristics, poses problems for the maintenance staff, especially in large TXK4 exchanges.

The present form of output from the TXK4 exchange IR is chronological and in coded form, and provides only limited assistance in fault finding. The advent of powerful micro-computers enables the IR output to be continuously analysed on-line, providing organized maintenance and network-management information to facilitate rapid fault clearance.

The CAIRO scheme, using the Alpha Micro 1030, has been developed to give these facilities in the larger TXK4 exchanges. Early results from CAIRO have demonstrated the viability of the scheme.

ACKNOWLEDGEMENTS

Thanks are due to the staff of the Cambridge Telephone Area, ETB Headquarters and THQ TE/SES3, MSS2, and NE/ES9 for their considerable part in the CAIRO development. Also to the staff of Glasgow Telephone Area for their valuable second opinion monitoring of the scheme.

Gratitude is expressed to the THQ NE/ES6 staff at Oswestry and to NETR Headquarters for agreement to integrate their related schemes with CAIRO.

Post Office Press Notice

INTERNATIONAL YEAR OF DISABLED PEOPLE

Some of the latest aids developed by British Telecom to help the handicapped, both at home and at work, are going on display throughout the country in 1981, the International Year of Disabled People.

As well as 3 new aids already available to the handicapped, British Telecom will be demonstrating some prototypes of new developments, linked to the latest equipment, which will revolutionize communications for the disabled in the future. The aids already available include the Conquest telephone handset for the hard of hearing. This combines a volume control, visual call signal to indicate incoming calls and houses special equipment to eliminate background noise and clarify incoming speech for wearers of hearing aids. The coin aid, which is already in use in some public places, makes the payphone easier for the disabled or wheelchair-bound to operate by means of levers. For those with a hand tremor, a self-adhesive finger guide has been developed for use with press-button telephones to guide and position the caller's finger over the correct button.

British Telecom spends approximately £500 000 a year on its research and development programme for the disabled. Among the prototypes being developed this year are the stalk

telephone for the physically handicapped, the voice synthesizer for the blind, and a communication terminal linked to the Prestel network for the chronically deaf.

The stalk telephone incorporates a flexible tube attachment operated by press button, which enables the handicapped to use the telephone without holding the handset. The voice synthesizer, being developed for the latest Monarch 120 switchboard, will bring the blind switchboard operator up to date by using the latest technology. By using computer memory, the board activity, normally visually displayed, is translated into speech which conveys the information to the blind operator. Trials are expected to get under way this year on the communication terminal, which enables the chronically deaf to communicate, via the Prestel network, by printing the spoken words on the screen. The terminal has been welcomed as a major communications breakthrough by organizations for the deaf.

British Telecom has released a 20-minute film, entitled *Desire to Work*, which illustrates how its developments are enhancing employment opportunities for the disabled by providing them with the aids to enable them to do a job as competently as anyone else.

British Telecom aids for the handicapped will be on display at major exhibitions throughout the country during the year.

Provision of Digital Transmission in the Junction Network

I. G. DUFOUR, C.ENG., M.I.E.R.E.†

UDC 621.395.3 : 621.374

The additional requirements for digital transmission arising from the introduction of System X have coincided with problems of using existing cables resulting from the adoption of the 2 Mbit/s international standard working. This article reviews the background and shows that, apart from revising the planning rules, the solution in the short-term is to use new metallic-pair type digital transmission cables, and in the medium-term to use a new line code. The likelihood of optical fibres in the longer term is also considered.

INTRODUCTION

The decision to introduce System X has changed the transmission system requirements in the British Post Office (BPO) junction network¹. New junction plant, which for so long comprised of audio cables and transmission equipment, and more recently of 24-channel pulse-code modulation (PCM) on 1.536 Mbit/s line systems, is now dominated by 2.048 Mbit/s line systems (subsequently referred to as 1.5 and 2 Mbit/s respectively). In the present analogue switching environment, these 2 Mbit/s systems must be used with 30-channel PCM multiplex equipment, but, as System X exchanges are introduced, the line systems will connect directly on the digital switch². This article reviews the factors involved in the provision of 2 Mbit/s line systems both on existing quad cables and on new types of cable specially designed for digital transmission.

HISTORY

Audio cables of star-quad, concentric-layer construction³ were introduced in the late-1920s and have, until recently, been the mainstay of junction provision. Thus, by 1980, the total amount of quad cable *in-situ* amounted to 32 million pair-kilometres of which 50% were 0.63 mm diameter conductors, 45% were 0.9 mm diameter conductors, and the residue larger gauges.

By the late-1960s, 24-channel PCM⁴ on 1.5 Mbit/s digital line systems became available. This allowed a several-fold increase in the circuit capacity of the existing quad cables. When circuit growth dictated the provision of new plant, the decision between new cable and 24-channel PCM systems on an existing cable was determined by the economics of the case in question⁵.

The guidelines for selecting pairs in an existing cable for PCM systems were based on an analysis of cable characteristics. This analysis was used to produce relatively simple rules which allowed a specified maximum number of pairs to be taken from each balancing group (balancing groups³ correspond to cable layers, except for the centre core). Within a balancing group, the spatial relationships between the pairs change, along the cable, according to the balancing selections. This prohibits any transmission advantage being taken of cable geometry other than the layer construction, and accounts for the balancing group being used as the basis of the rules.

A separate balancing group was used for each direction of transmission. Up to 50% of the pairs in any one of the inner

balancing groups, to a maximum of 24 pairs, could be used, but a 25% limit applied in the outer balancing group because of sheath proximity effects. Regenerators were spaced at up to 1.83 km which coincided with the normal spacing of loading coils. These simple prescriptive rules allowed error-free systems to be commissioned with little need for cable testing other than to prove the pairs fault free.

The extension of digital transmission to higher capacity systems and the rapid advances in digital switching led to the need for internationally agreed standards. Early 24-channel designs, including the British one, were not considered suitable for such a standard and eventually the BPO adopted a 30-channel format using 2 Mbit/s and higher-order digital line systems⁶. At first, the decision to provide 30-channel PCM systems rather than a new audio cable was made, as for 24-channel systems, on economic grounds. Although requiring wider bandwidth, it was believed that the planning rules used for 1.5 Mbit/s had sufficient margin to be used in a largely unaltered form for 2 Mbit/s.

IMPACT OF SYSTEM X

The decision to introduce digital switching systems with a 2 Mbit/s line interface caused a reappraisal of the economic factors of junction plant provision. The principal factor was that between 2 digital exchanges, only the line systems, having low per-channel cost, were required, with the expensive multiplexing being, in effect, provided free by the exchange. (Junction circuits between an analogue exchange and a digital exchange show savings of one multiplex end.)

Extensive studies were carried out to determine a strategy of lowest-cost plant provision over 20 years. This took into account the planned rate of introduction of System X exchanges and showed that, until firm opening date requirements are known, digital transmission is economic overall for circuits longer than 3 km in non-director areas and longer than 5 km in director areas. However, once the actual location and opening dates of a digital exchange are known, which is increasingly the case, individual cost studies are still appropriate. This so called *3/5 km rule* has greatly increased the number of 2 Mbit/s line systems being planned.

It is unfortunate that at the very time network planners were increasing the demand for 2 Mbit/s line systems, experience in commissioning them was showing that the margin thought to exist in the 1.5 Mbit/s planning rules was proving illusory, at least where 0.63 mm conductors were concerned. The most serious problems showed up as commissioning difficulties (high error rates) on early 2 Mbit/s line systems, and it was rapidly concluded that the planning rules would need to be revised.

† Transmission Department, Telecommunications Headquarters

CABLE CHARACTERISTICS AFFECTING DIGITAL PERFORMANCE

It is useful at this point to review the factors which affect digital performance. The key cable characteristics are *insertion loss*, *near-end crosstalk* (NEXT) and *far-end crosstalk* (FEXT). There are, of course, other characteristics of importance, such as *impedance/frequency*, and *phase delay*. The main crosstalk paths are shown in Fig. 1(a). It can be seen that NEXT occurs between pairs carrying signals in opposite directions of transmission, whereas FEXT occurs between pairs carrying the same direction of transmission. FEXT is distributed over the length of the regenerator section, whereas NEXT is most critical at the point of highest signal-level difference and is thus affected by the cable in the immediate vicinity of the regenerator location. Fig. 1(b) shows additional crosstalk paths, known as *3rd-circuit crosstalk* (3CXT), which arise from particular jointing and regenerator housing arrangements. The interrelationship of the key features and their effect on error-rate performance can be seen from Fig. 2. Details of the line systems designed to use the cables are given elsewhere⁷.

Quad Cables

An urgent review of cable characteristics, using recently available specialized digital test equipment, confirmed that the simple rules referred to earlier did not provide a sufficient operating margin for 2 Mbit/s transmission. NEXT was

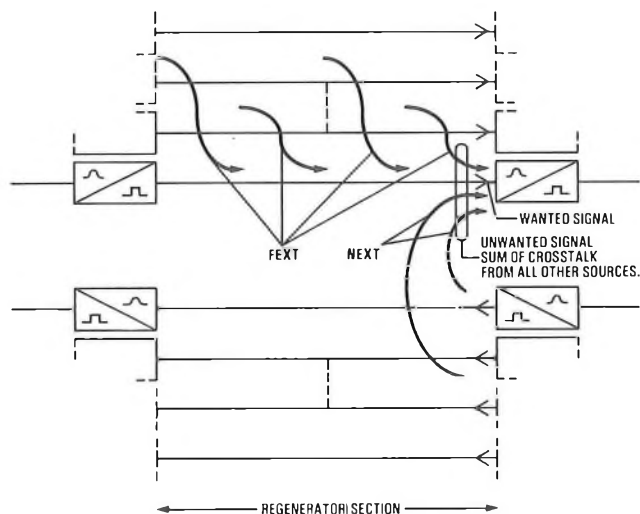

(a) Near-end crosstalk (NEXT) and far-end crosstalk (FEXT)

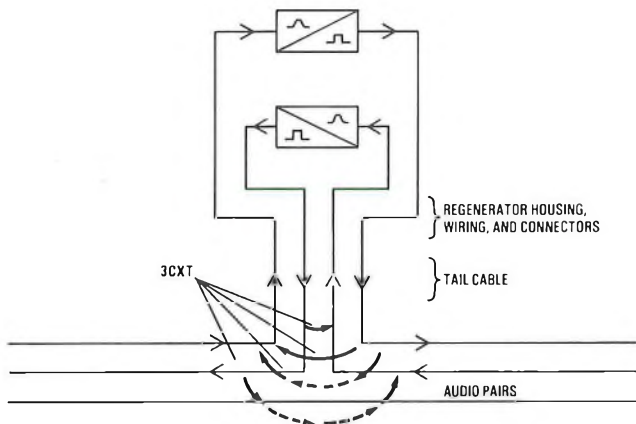

(b) 3rd-circuit crosstalk (3CXT)

FIG. 1—Crosstalk paths

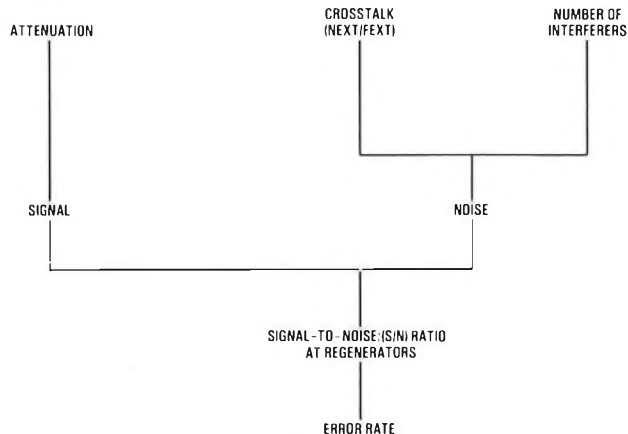

FIG. 2—Effect of cable characteristics on error rate

usually the limiting factor, although on some small cables, FEXT was of equal concern. The factors affecting crosstalk were known to be closely related to cable geometry; references 8–10 give further information, but represent only a small fraction of the published data. Quad cables in the UK are built-up in layers around a central core. Although construction has varied over time and between manufacturers, 2 features are thought to have a major influence on the high-frequency crosstalk performance:

- (a) the number of quad lays (rate of twist), and
- (b) the contra-rotating lay of each layer of quads.

Excluding the core quads, and marker and reference quads (the first and last in each layer), only 4 main quad lays are generally used, 2 of them alternately in each layer. This is shown in Fig. 3, from which it can be seen that the inductive NEXT is most likely to be worst when opposite directions of transmission are in layers separated by an odd number of other layers; that is, when the 2 main quad twist lengths are the same.

Proximity effects worsen NEXT when the opposite directions of transmission are in adjacent layers and, to a lesser but significant degree, when they have one- and two-layer separation. NEXT is also affected when balancing-group 1 is

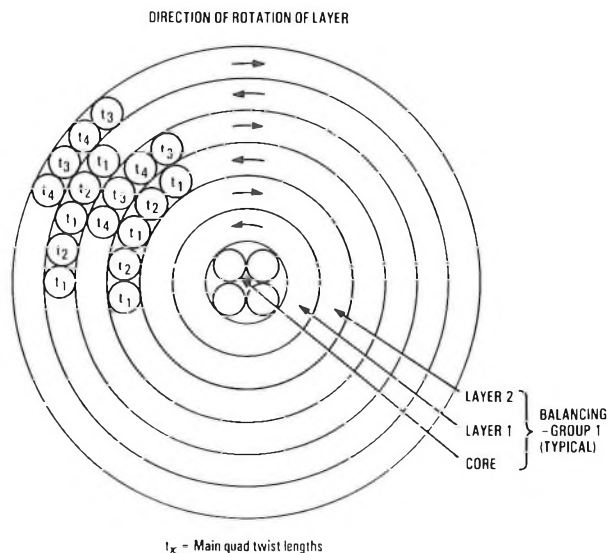

FIG. 3—Quad cable construction

used as this can consist of pairs in the core and up to 3 layers (depending on cable size), at least some of which have twist lengths common to other layers.

FEXT is within layer (except balancing-group 1), but is found to worsen in the outer and penultimate layers owing to sheath effects.

It was confirmed by testing for both NEXT and FEXT with 2 Mbit/s signals that some balancing-group combinations were very much more favourable than others. The best combinations arose with 2-layer and greater separation, and where the outer or penultimate layers were not involved. The combinations most frequently used in practice—pairs in adjacent layers or with one-layer separation—were the most marginal for 2 Mbit/s working. The tests also revealed that certain design features of regenerator housings and tail cables, which had proved satisfactory at 1.5 Mbit/s, were also significant crosstalk contributors at the higher frequencies. Revised planning rules have been published as a result of these tests although a measurement programme¹¹ to characterize the network is continuing and this may lead to the rules being further refined.

REVISED PLANNING RULES

The revised planning rules are complex and no longer prescriptive. They allow the planner to trade-off regenerator spacing against cable-fill according to economic or operational considerations. Considerable testing after interception of the pairs and continual planning involvement are now required. The revised rules reduce the overall digital capacity of existing cables by more than a half. The main casualties are small cables, say 228-pair and less. The new rules actually increase the capacity of some large cables. The format of the revised planning rules is shown in Table 1. The complexity of these compared to the simple prescriptive rules detailed earlier for 1.5 Mbit/s systems can easily be seen. For the first time, the rules are expressed in terms of the probability of success; the published figures assume that 20% more pairs are intercepted than are actually required and that the number of systems shown will be achieved in 99 out of 100 routes. Of course, a high proportion of interceptions will prove capable of supporting many more systems than the published figure. The actual capacity after interception is determined from an analysis of the test results by the planner.

DIGITAL TESTING OF CABLES

The assessment of the ultimate capacity of new interceptions, and the capacity of interceptions already made to the old rules, calls for a relatively simple method of testing. To do

this a barrage testing method for NEXT was devised using a tester assembled from readily available parts. Because the 2 Mbit/s system encodes the signal using a line code known as *high-density bipolar 3* (HDB3)⁹, pseudo-random 2 Mbit/s HDB3 digital signals are applied simultaneously at a regenerator location to all the pairs in the send direction of transmission, and the resultant noise measured individually on the pairs in the receive direction. Where 3CXT is of concern, signals must be applied to the transmit pairs on both sides of the regenerator location. The noise is measured through a filter which simulates the frequency-sensitivity characteristics of a regenerator. The maximum level of noise that allows a commissioning error rate of better than 1 in 10¹⁰ to be achieved has been established by laboratory measurements for a range of line insertion losses measured at 1 MHz. Thus, for any pair in a regenerator section length, the tolerable noise level is known and the barrage-test reading provides a GO/NO-GO result. The test can also be adapted for FEXT measurements.

Barrage testing has the advantage of simulating working conditions without relation to pair-to-pair distributions of crosstalk and theoretical power-sum laws. However, from the point of view of characterizing cable performance, pair-to-pair as well as barrage measurements for both NEXT and FEXT are essential. A microprocessor-controlled digital crosstalk measuring set, the R92 Tester, has been developed by the BPO Research Laboratories for this purpose, and the results obtained from tests on actual cables have contributed to the revised planning rules. Production versions of the tester, to be known as the *Digital Crosstalk Analyser* (DCA), will be used to continue planning rule formulation and will probably also be made available to Regions to pinpoint problems in areas where the barrage GO/NO-GO tester indicates difficulty. The R92 Tester and DCA have been described in detail elsewhere¹².

ALTERNATIVES TO QUAD CABLE

PCM has traditionally been thought of as a way of making better use of cables already in the ground. However, now that digital transmission has become a requirement in its own right, the types of cable optimized for digital transmission have been the subject of worldwide interest. Optical fibres are probably the most publicized example of these. Some years ago it was expected that junction growth would be met by exploitation of the existing quad cable until optical fibres were available. Recently, a combination of events has led to a reappraisal of this view leading to the conclusion that the provision of new metallic-pair cables will increase. These events are:

TABLE 1
Revised Planning Rules

Balancing Group	1 2 3 4				Maximum Number of DLS Possible in Configuration	Routes of 1-4 Regenerator Sections of Bothway DLS for Regenerator Section Attenuations of: (Note 1)				Capacity Reduced to Percentage Shown for:					
	Core	Layer Number				36dB	30dB	25dB	18dB	Routes of:		Longest 2-way Tail Length on Route:			
1		2	3	4	5-9 Regenerator Sections					>10 Regenerator Sections	2m	5m	10m		
Number of Pairs in Layer	8	20	32	44	56										
Configuration of Transmit (T) and Receive (R) Pairs	T	T	R			28	0	3	8	22	85	70	100	100	100
	T	T		R		28	0	3	10	42	80	65	100	100	95
	T	T			R	28	7	34	118	590	80	60	95	80	60
			T	R		32	1	5	16	66	85	70	100	95	90
			T		R	32	0	0	2	10	70	55	100	100	100
			T	R	44	1	4	12	54	85	70	100	95	90	

Example of rules for a 160-pair cable: simpler for smaller cables; increasingly complex for larger cables.

Note 1: The number can exceed the maximum number possible only from a theoretical point of view. Such numbers are required to allow application of the capacity reduction percentages. Resultant numbers which exceed the practical maximum possible are always limited by that number.
DLS: Digital line section

(a) the problems with quad cables and the reduction in their overall digital capacity,

(b) a sharp acceleration in the programme for changing to digital working in the junction network, and

(c) doubt about the timing of optical fibre developments and of the economics of the resulting systems particularly for low growth-rate routes.

The first of these has just been explained in detail and the second is self-evident. It is, however, worthwhile summarizing some of the aspects relating to optical fibres before looking at metallic-pair cable developments.

Optical Fibres

The nature of the UK junction network is that it predominantly consists of short, high-capacity routes and long, low-capacity routes. In terms of route-length, cables of 228-pair or less account for about 70% of all cable.

Cost studies based on projected fibre costs show that optical-fibre systems (OFS) are economically attractive for long, high-capacity routes, which are mainly trunk routes. They are appropriate when growth rates are sufficient to justify 34 Mbit/s systems, and in the junction network this means that OFS already have applications in the major urban areas. This is obviously significant to the London Telecommunications Region which will soon be installing 34 Mbit/s schemes.

For lower growth-rate routes, a number of 2 Mbit/s and 8 Mbit/s schemes are proceeding so that the BPO and the manufacturers can gain experience. Reductions in cable fabrication and multiplex costs are likely to lead to cost-effective junction use, possibly of a 34 Mbit/s design capable of initial operation at 8 Mbit/s. In the meantime, metallic-pair-type cables have been evaluated and adopted for use.

Metallic-Pair Digital Transmission Cables

With standard 1.83 km regenerator spacing on 0.63 mm diameter conductor quad cables, the number of 2 Mbit/s systems is limited primarily by NEXT, which is then critical to error-rate performance. One approach to overcome this is to include an inter-layer concentric-screen in the standard quad cable, see Fig. 4(a). Cable of this type has been satisfactorily evaluated and a scheme is in course of provision. Although this type of cable has some potential, the BPO approach has been to look afresh at digital transmission requirements, and especially at the advantages of pair type cable over quad cable.

CHOICE OF CABLE CHARACTERISTICS

The required high-frequency (HF) attenuation of a cable is a trade-off between cable costs and regenerator costs. Current costs indicate an optimum attenuation of about 8 dB/km, but trends in cost relationships make it desirable to work on the high side of this, in the range 10–15 dB/km. Theory indicates,

and measurements confirm, that for a range of conductor gauges, HF attenuation is determined largely by the overall diameter of the insulated wire, and is relatively insensitive to the conductor diameter. In consequence, if HF transmission alone is considered, the smaller the conductor diameter the better the return on material costs. It is necessary, however, to consider also the DC power requirements of digital systems. The higher the conductor resistance the fewer the number of regenerators that can be connected in series, and the more frequent are intermediate power-feeding stations required.

The power-feeding requirements are significant in the BPO junction network and, for the attenuation range already indicated as desirable, a copper conductor of 0.6 mm diameter would be necessary to cater for lines up to 20 km long. Use of this gauge in conjunction with the optimum attenuation indicates that the desirable mutual capacitance is in the range 35–40 nF/km.

SUITABILITY OF EXISTING DESIGNS

When the desirable characteristics of a pair-type digital transmission cable had been identified, it was realized that a local distribution cable recently standardized by the BPO had near ideal characteristics. The new cable has 0.6 mm copper conductors in unit-twin formation and, for a distribution cable, a relatively low mutual capacitance of 40 nF/km; these primary characteristics had been chosen for reasons outside the scope of this article. The cable follows the normal BPO practice for distribution cables in having cellular-polyethylene insulation, petroleum-jelly filling, and a simple polyethylene sheath without a metallic moisture barrier.

Two Local Cables

The local distribution cable just described has a 1 MHz attenuation of about 14 dB/km which, when considered with the FEXT characteristics, allows regenerator spacings of up to 2.5 km. Excellent NEXT performance is achieved by using 2 cables, one for each direction of transmission, see Fig. 4(b). There was an immediate requirement for cables to be installed for digital transmission and such cable was adopted for use. The 10-pair size was selected because the resulting 8 systems (allowing for some control pairs) gives 240 channels, which corresponds to the majority of new cable applications. The only new development required was for a new small regenerator housing, all other hardware and practices being standard. The first scheme has already been installed in the Wales and the Marches Board (WMTB) of the BPO between Hereford and Fownhope and the full 8 systems have been successfully commissioned¹². Other schemes are in various stages of planning and provision.

Although the two 10-pair cables are useful as an immediate solution in rural areas they are not well suited to those urban parts of the network which cannot yet justify OFS. The use of 2 larger cables is possible and tests are being carried out on 50-pair cables. However, some of the attractions are lost because of additional cabling operations, and benefits accrue from a single sheath alternative; a single sheath version is also more suitable for aerial and armoured applications.

Transverse-Screened Cables

The logical development of the two local cables is to include both directions of transmission in the same sheath and to separate the 2 halves with a screen. A transverse or diametric screen, see Fig. 4(c), is the most convenient way to do this in relatively small pair-count cables. Such cables have been used overseas and one UK scheme using 40-pair (20 + 20) cable has already been completed. Digital tests, using the R92 Tester, predicted very good performance, and this has since been confirmed by the successful commissioning of the full 18 system capacity of the cable. The decision was thus taken to

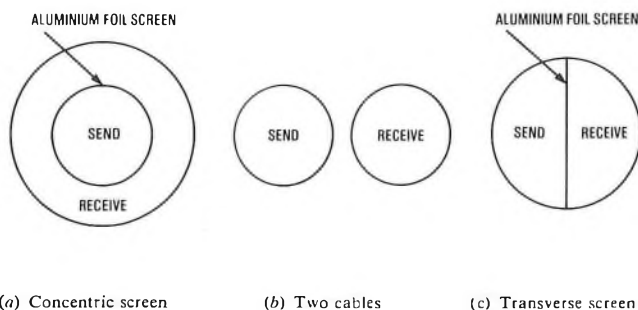
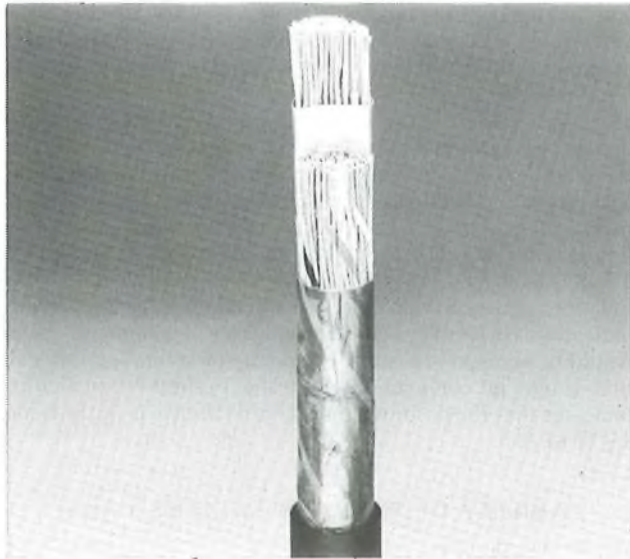

FIG. 4—Diagrammatic representation of cable types



Note: Overall cable diameter 28 mm

FIG. 5—80-pair transverse-screen cable
(Photograph by courtesy of Pirelli General Limited)

proceed with this type of cable, an example of which is shown in Fig. 5.

The requirement for urban areas is for a cable having a channel capacity at least equivalent to the largest quad cable, which has 1040 pairs. An 80-pair (40 + 40) cable meets this requirement with a capacity of 1140 channels, and is consistent with existing manufacturing capabilities.

The pairs in the cable are built-up in 10-pair units each of which is basically the same as that used in the 10-pair/0.6 mm local cable; this gives manufacturing advantages. However, as the cables are primarily used for digital transmission, the construction can be optimized for this purpose and specified accordingly. As well as the 80-pair size, the opportunity has been taken to introduce a 20-pair size, which can be used instead of two 10-pair cables at only a small cost penalty, and also a 40-pair size to give flexibility in the use of spur cables.

CABLE PERFORMANCE

A 0.6 mm pair in either of the local distribution cable or the transverse-screen cable has a 1 MHz attenuation of about 14 dB/km, compared to about 20 dB/km for a 0.63 mm pair in either a standard or concentric-screen quad cable, and thus the former clearly allows greater regenerator spacings to be achieved. At increased spacing the crosstalk characteristics, particularly FEXT, become more important and the new cables have been carefully assessed in this respect.

Over a period of time, the BPO has used a variety of measurement techniques to assess digital crosstalk performance: single frequency, swept frequency, band-limited white noise, single digital source and multiple digital sources have all been employed. Of these, the digital source techniques are preferred because they correspond to the ultimate use of the pairs. The other measurement techniques are more difficult to relate to digital system performance¹⁰.

Digital crosstalk measurements on a typical regenerator section of each type of cable, together with 2 of the many combinations possible in quad cable for comparison, are shown in Table 2. These have been made with the Research Laboratories' R92 Tester in the barrage mode. Plesiochronous pseudo-random 2 Mbit/s signals are sent on all transmit pairs and the received cumulative noise power is measured, on each receive pair in turn, at the decision point of a modified regenerator. The measurement on each receive pair is expressed as a signal-to-noise (S/N) ratio. Experiments with

TABLE 2
Digital Crosstalk Measurements (Typical)

Cable Type	NEXT (S/N)		FEXT (S/N)		Approx Section Length Equivalent to 30 dB Attenuation
	Mean (dB)	Worst Case (dB)	Mean (dB)	Worst Case (dB)	
Two 10-pair (0.6 mm) local distribution cables (same duct: pulled-in together)	52.9	51.0 (8 send signals)	38.3	33.3 (7 send signals)	2.14 km
40-pair (0.6 mm) transverse screen cable	47.7	41.7 (18 send signals)	44.8	37.1 (17 send signals)	2.14 km
228-pair (0.63 mm) quad cable	Good combination (2 layer separation)	45.4	36.4	37.0 (23 send signals)	1.50 km
	Poor combination (1 layer separation)	32.9	24.8 (24 send signals)		

Notes: Tests include tail cables and regenerator housing wiring harness
All results relate to a regenerator section attenuation of 30dB
Tests made with plesiochronous pseudo-random signals

production regenerators show that a minimum S/N ratio of 30 dB measured with the R92 tester is required for virtual error-free operation. This figure includes both NEXT and FEXT contributions.

Tests on an export design¹³ using two 10-pair cables which were optimized for digital transmission showed the excellent NEXT characteristics of 2 cable working with the same good FEXT characteristics of the transverse-screen cable.

The 0.6 mm pair-type cables have adequate audio performance when 88 mH loading-coils are installed at 1.83 km intervals. Temporary audio use prior to the introduction of digital transmission can thus be achieved by closer spacing of regenerator-housings (at 1.83 km) and temporarily substituting loading-coils for regenerators.

INSTALLATION ASPECTS

Junction cables have hitherto required more installation effort than local cables mainly because of the attention given to reducing audio crosstalk in quad cables by pair selection³. Both the two 10-pair and transverse-screen cables can be installed relatively simply, and bring the techniques for local and junction cables closer together. Long-length cabling and straight jointing are employed and, with the transverse-screen cable, the screen continuity is maintained in the joint. Tail cables from regenerator housings are provided such that only simple straight joints are required, and this allows all joints throughout to use heat-sensitive shrink-down sheath closures. The relatively small cable sizes allow all joints and regenerator housings to be in surface boxes if required. Testing is kept to a minimum with simple DC tests to ensure that jointing has been correctly carried out, followed by 1 MHz insertion-loss measurements.

REGENERATOR HOUSINGS

The Case Repeater Equipment No. 1A (CRE 1A), see Fig. 6, has for many years been the standard housing for both 1.5 Mbit/s and 2 Mbit/s line regenerators as well as for other uses. It is of cast-iron construction, is pressurized and has been used in conjunction with a separately supplied 160-pair quad tail-cable and wiring harness. Mention was made earlier that certain features associated with regenerator housings were adequate at 1.5 Mbit/s but were sources of difficulty at 2 Mbit/s. These fall into 3 areas:

- jointing arrangements,
- tail cables, and
- the design of the wiring harness inside the regenerator housing.

All these aspects are being re-engineered to improve the

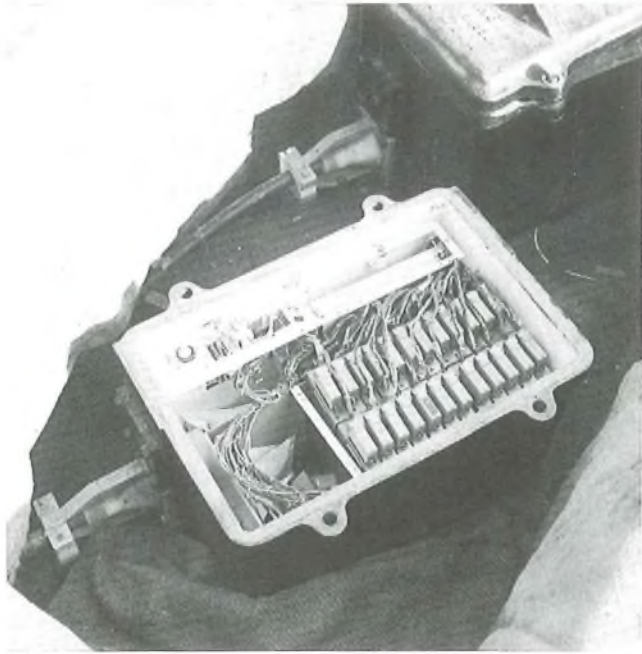

FIG. 6—Case Repeater Equipment No. 1A equipped with regenerators

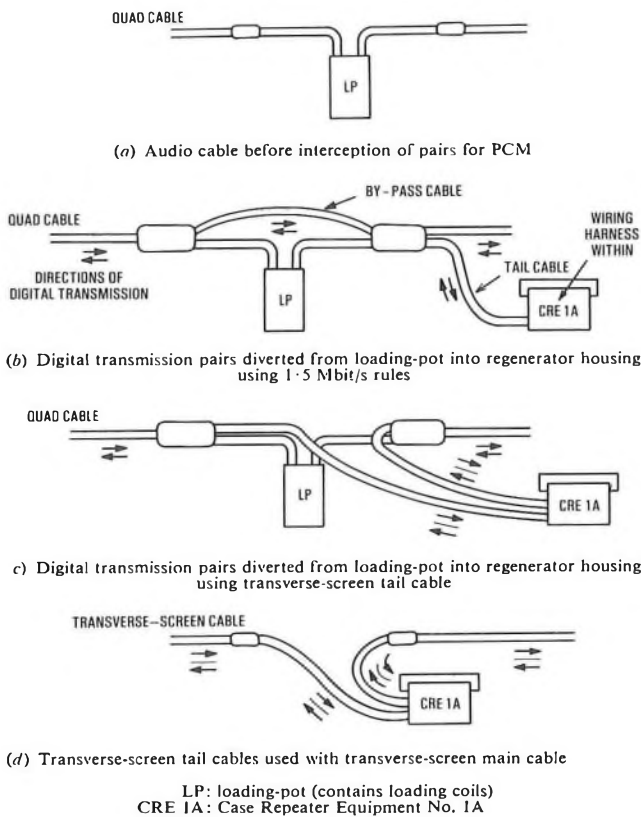

FIG. 7—Some typical jointing arrangements

separation between high-level and low-level signals.

The most significant hardware change is the adoption of a tail-cable arrangement using two 80-pair transverse-screen cables. This has several advantages:

- (a) it contributes less crosstalk than the 160-pair cable,
- (b) it simplifies the jointing arrangements for interceptions on many existing cables, and
- (c) it can be straight jointed to the new transverse-screen cables.



Note: the connectors in the tail cables are as used for export schemes and are not used by the BPO.

FIG. 8—Prototype version of Case Repeater No. 10A

(Photograph by courtesy of STC (Cable Products Division) Limited)

Fig. 7 shows typical jointing arrangements.

The CRE 1A has a capacity to hold regenerators for either twenty-four 1.5 Mbit/s systems, thirty-eight 2 Mbit/s systems, or a combination of both. There is, however, a call for a smaller-capacity housing both for interceptions on existing cables, and for use with the two 10-pair or small transverse-screen cables. A housing to accommodate regenerators for eight 2 Mbit/s systems, called the *Case Repeater No. 10A* (CR10A) has therefore been introduced. This is a glass-reinforced plastic case with integral tail-cables and wiring harness. Early versions have 4 tail-cables for simple jointing in two 10-pair cable schemes. Fig. 8 shows a prototype CR10A in this application; the plugs/sockets are as fitted by a manufacturer on export schemes and are not at present used by the BPO. Later versions of the housing will have 2 transverse-screen tail-cables. The housing is not pressurized but contains a humidity detector connected to an alarm pair.

A further housing known as the *Case Repeater No. 9A*, based on a polypropylene jointing sleeve, has been introduced to hold regenerators for two 2 Mbit/s systems. It is smaller than the CR10A but similar in appearance although having only 2 integral tail-cables. Its application is mainly on existing cables in remote rural areas.

REGENERATORS WITH NEW LINE CODE

Following the difficulties with 2 Mbit/s transmission on quad cables, consideration has been given to change to a line code of the type known as *4 binary to 3 ternary* (4B3T)⁹. Second-generation line systems will use a new design of regenerator with coding that reduces the line rate by 25% without reducing the information rate (1.5 MSymbol/s 4B3T line rate between 2 Mbit/s HDB3 interfaces). Consequently, a system will shortly be available which will reduce the line rate for 30-channel PCM systems to the same as that for 24-channel systems. This casts doubt on the validity of providing/updating interceptions on existing quad cables in accordance with the revised planning rules. Until the implications of the new line code are reflected in the planning rules greater

emphasis is being given to the provision of transverse-screen cables.

CONCLUSIONS

New transmission capacity in the BPO junction network is now predominantly provided by 2 Mbit/s digital systems. In spite of revised planning rules and improved hardware, the overall digital capacity of existing cables is less than was originally expected and there is thus a requirement for cables designed specifically for digital transmission. Optical fibre systems are likely to meet this need eventually but the immediate requirements are being met by new metallic-pair cables particularly of the transverse-screen variety. The adoption of a new line code will allow existing quad cable utilization to be improved.

ACKNOWLEDGEMENTS

The work of many people has made this article possible and the author would like to thank his colleagues in the BPO Telecommunications Headquarters and also the staff of the Eastern Telecommunications Board (ETB), Southend-on-Sea Telephone Area, WMTB, and the Shrewsbury and the Swansea Telephone Areas who have been most helpful in connexion with the provision of new cable types for evaluation. Particular thanks are also given to Mr. J. Warburton, formerly of ETB and now with the Southend-on-Sea Telephone Area, who carried out important work on UK quad cables, leading to the revised planning rules.

References

- ¹ KYME, R. C. The Junction Network. *POEEJ*, Vol. 69, p. 175, Oct. 1976.
- ² HARRIS, L. R. F., and DAVIS, E. System X and the Evolving UK Telecommunications Network. *POEEJ*, Vol. 72, p. 2, Apr. 1979.
- ³ LAWRENCE, A. J., and DUFOUR, I. G. Audio Junction Cables. *POEEJ*, Vol. 69, p. 239, Jan. 1977.
- ⁴ BOLTON, L. J., and BENNETT, G. H. Design Features and Application of the British Post Office 24-Channel Pulse-Code-Modulation System. *POEEJ*, Vol. 61, p. 95, July 1968.
- ⁵ ELLIOTT, J. L. C. The Design and Planning of the Junction Network. *POEEJ*, Vol. 65, p. 12, Apr. 1972.
- ⁶ BOAG, J. F. The End of the First Pulse-Code Modulation Era in the UK. *POEEJ*, Vol. 71, p. 2, Apr. 1978.
- ⁷ WHETTER, J., and RICHMAN, N. J. 30-Channel Pulse-Code Modulation System, Part 2—2.048 Mbit/s Digital Line System. *POEEJ*, Vol. 71, p. 82, July 1978.
- ⁸ CRAVIS, H., and CRATER, T. V. Engineering of T1 Carrier System Repeated Lines. *Bell System Technical Journal*, Vol. 42, p. 431, 1963.
- ⁹ BYLANSKI, P., and INGRAM, D. G. W. Digital Transmission Systems (2nd Edition). Peter Peregrinus Ltd, Ch. 7 and others.
- ¹⁰ USHER, E. S., CATCHPOLE, B. J., and BEASLEY, M. Analysis of Cable Crosstalk Data for Maximising PCM System Application. International Zurich Seminar on Digital Communications, 1978.
- ¹¹ WHETTER, J., and HALL, R. D. The Application of 2 Mbit/s Digital Line Systems to Symmetric Pair Cables. 2nd International Conference on Telecommunications Transmission, London, Mar. 1981.
- ¹² BORLEY, D. Digital Crosstalk Measurement. *Electronics and Power*, p. 737, Sept. 1980.
- ¹³ SPENCER, H. J. C., WILBUD, C. E., and SYMMONS, B. J. Provision of 30-Channel PCM Systems Using 2 Preconnectorized 10-pair Distribution Type Cables Installed in Parallel. International Wire and Cable Symposium, Cherry Hill, 1980.

Post Office Press Notice

PRESTEL INTERNATIONAL SERVICE GETS THE GREEN LIGHT

Worldwide business will have the facts at its fingertips when British Telecom's Prestel International is launched as the first international public viewdata service in July.

The decision to implement this service, which gives users access to a computer information bank by means of a simple television-type display terminal, follows the successful outcome of an international market trial carried out in 1980. The trial involved more than 300 prominent business users in seven countries and received the full co-operation of the telecommunications authorities and carriers concerned.

The full service is expected to follow the pattern found most successful in the trial—information for specific business sectors. This included shipping movements, investment statistics and commodity prices, plus the considerable use of private closed-user groups in which organizations have exclusive use of certain parts of the information bank to meet intra-company needs.

Prestel International will have a single database, or store of information, that will be quite separate from the one used for Prestel in the UK. The database, which will be updated by selected international sources called *information providers*, is designed to enhance and complement rather than to compete with any established national service.

Access to public information on the international database will be available to users normally for the cost of a call on their own country's domestic telephone network. Access to the private closed-user groups will be available via the public

telephone network or data links at the national or international call rate to the nearest computer. Although access will be possible from anywhere in the world, direct support and marketing will be restricted initially to the seven trial countries—Australia, the Netherlands, Sweden, Switzerland, West Germany, the USA, the UK and Hong Kong.

The full international service, like the trial, will be run on a GEC 4080 computer sited in London. A second GEC computer, which will be located in the USA, will be commissioned towards the end of next year; further computers will be brought into service in other countries according to demand.

Logica, the UK-based systems consultancy company which managed the market trial, will continue to manage the public service and will co-ordinate the activities of local organizations that will be marketing Prestel International. Tariff levels for the full service, which will be run on commercial lines, will be announced nearer the launch date.

The trial database involved more than 20 000 pages of information provided by more than 50 national and international organizations; these included, among others, BP, Shell and the House of Lords library.

There are currently 11 countries operating national trial viewdata services; six of these have Prestel computers and software, and all of them use the terminal standards applicable to Prestel. Compatibility with these systems will be particularly valuable.

It is expected that considerable use will be made of the developing packet-switched data services, including Euronet and the International Packet-Switched Service (IPSS); the latter was used by USA participants in the trial.

Monarch 120—Maintenance Facilities

R. E. WALTERS, DIP.E.E., M.SC., C.ENG., M.I.E.E.†

UDC 621.395.2: 621.374

Monarch 120 is a highly modular digital PABX controlled by a microprocessor. Incorporated into it is a sophisticated automatic maintenance and diagnostic system capable of pinpointing most faults to a single replaceable unit. The system also provides excellent facilities for tracing the more obscure faults that might occur.

INTRODUCTION

Monarch 120 is a small digital PABX in service in the British Post Office (BPO) network and is capable of serving up to 120 extensions. It is controlled by a central microprocessor which allows the exchange to offer numerous customer facilities and to support an extensive maintenance and diagnostic system. Monarch 120 has been described in detail in a previous issue of this *Journal*¹; details of its software system, which provides much of the maintenance support, are given in another article in this issue of the *Journal*².

This article describes the maintenance and diagnostic system of Monarch as it is seen by the customer, the maintenance engineer and the specialist. In particular, an explanation is given of how faults, once detected, are reported to the customer, and how the maintenance engineer can check the veracity of the original report on his arrival. The facilities for examining the history of the fault, and the means by which the specialist can gain more and more detail of the past and current operation of the exchange in order to diagnose complex faults are also described.

The exchange automatically tests at least one of its sub-units every 15 s. The means of achieving this level of testing and of providing the facilities available to maintenance staff are also described in detail.

HOW THE SYSTEM APPEARS TO THE USER

The Customer's View

The cabinet containing the equipment itself is normally locked, so the customer's view of the maintenance system is primarily through the operator's console and, where fitted, the alarm box. When a fault is found, the diagnostic software within the cabinet reports it as *urgent* or *non-urgent* dependent upon the severity of its effect on service. The alarm box has 4 lamps: 2 to indicate alarm conditions and 2 to indicate that these alarms are receiving attention. When an alarm is activated, the corresponding lamp lights and an audible indication given. The alarm box can be silenced, by the customer, by depressing the SILENCE BUZZER button, in which case the alarm condition is recorded by the RECEIVING-ATTENTION light. The alarm box is separately powered and its operation can be checked by depressing the test buttons (see Fig. 1). It is a very simple device; hence, failure is most unlikely. Disconnexion from the cabinet causes the alarm box to give an urgent alarm indication.

If the operator's console³ (Fig. 2) is attended, faults are reported direct to the operator. An urgent, or non-urgent, alarm lamp flashes and the console bleeper operates. Normal

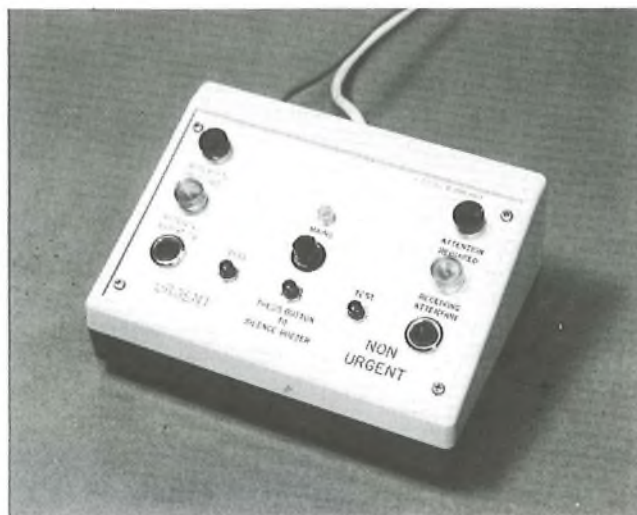

FIG. 1—The alarm box



FIG. 2—The operator's console

telephonic operation of the console can continue until the operator is ready to receive a report of the fault, at which point the operator touches the RECEIVING ATTENTION key. A fault report then appears on the console screen; this may be a telephone off-hook (PG) report which could be dealt with

† System Evolution and Standards Department, Telecommunications Headquarters.

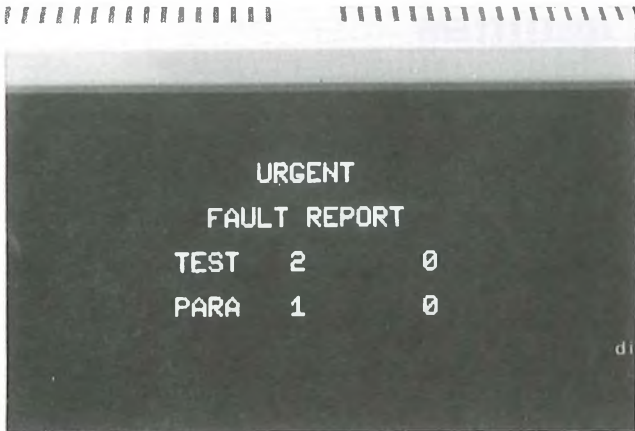

FIG. 3—A typical fault report at the operator's console

locally, or a fault report (see Fig. 3) which means little to the operator but must be noted and reported to the fault-reporting centre. The fault report gives the maintenance engineer a direct indication of the particular printed-wiring board (PWB) on which a fault has been detected.

Should the mains or the ringer supply fail, or should some other major disabling fault occur, the system is forced into *dropback* mode in which case up to 20 exchange lines are switched through to nominated extensions. If power is available, the dropback lamp lights at the operator's console. It is also possible for the operator to force the system into dropback by operating a concealed switch at the console.

The Maintenance Engineer's View

With the exception of periodic replacement of a small data-base retaining battery, no preventive maintenance is required for Monarch 120. Thus, the maintenance engineer's visit would normally be preceded by detection of a fault by the system's maintenance and diagnostic package, or by the occurrence of some difficulty in operation which has been noted by the customer. In either case, the fault would normally be reported by the operator and, if detected by the system, the maintenance engineer can ensure that he arrives at the site with a replacement for the suspected card as specified by the fault report.

Upon arrival, the first action is to check the veracity of the original fault report. This is done in various ways: once the cabinet door has been opened the central processing unit (CPU) can be observed; this is the PWB containing the central control microprocessor and is able to display fault information on 2 hexadecimal (base 16) displays, each having a single digit (see Fig. 4). Codified information giving the identity of the fault is provided by this display. Alternatively the fault record, which is maintained by the control microprocessor, is examined, either via a conventional teletype, a hand-held terminal (see Fig. 5) or the operator's console. A specimen printout of the fault record, as obtained via the teletype, is given below.

FAULT RECORD 2:3:81

LAST CLEARED 10:2:81

TYPE PARAMETER COUNT SEQUENCE REPORTED

2 1 3 3 R

★★★★★★★ END OF RECORD ★★★★★★★

This is the most convenient form of display since the whole record can be observed, whereas the hand-held terminal can display only one line at a time and the console similarly can display only one screen (which corresponds with one line) at a time on its visual display unit (VDU).

The first 2 columns should contain identical information to

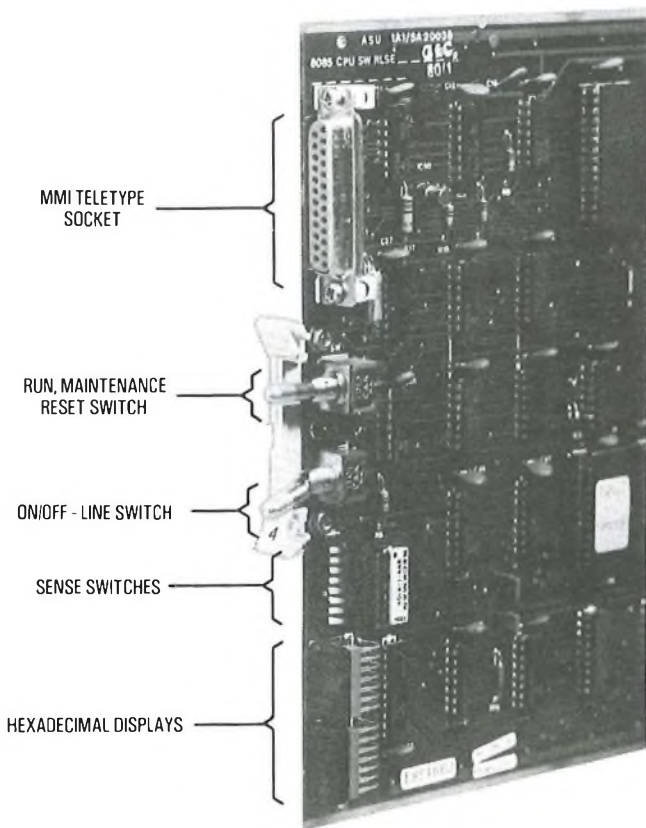

MMI: Man-machine interface

FIG. 4—The CPU card

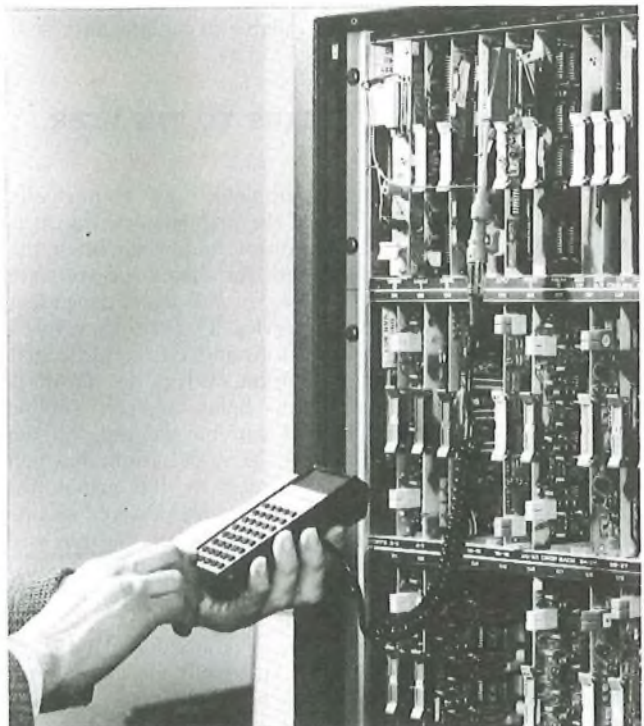

FIG. 5—Use of typical hand-held terminal

that originally reported to the console, the third column indicates how many times that fault has been found and the fourth is an indication of the order in which recorded faults have occurred. The final column indicates whether or not the fault has been reported; a 'Q' in this column would indicate that a report is queued and will be reported when the console is next attended.

The fault record may contain faults other than that originally reported, some of which may have occurred after the original fault; others may not have been reported to the console or caused an alarm. These latter can be of 2 categories: first, those faults which are considered to be intermittent and are therefore recorded but not reported and second, certain peculiarities are recorded which, though not faults in themselves, may be of value in investigating the history of a faulty system. If the fault count reaches its permitted maximum (a cumulative count of 256 faults), then an urgent alarm is given; this protects against the failure to report a recurrent intermittent fault.

Once the original fault report has been confirmed, the maintenance engineer retests the faulty card to ensure that the fault still exists. This is done by using the man-machine interface (MMI) language to specify the appropriate command to run a test, followed by the details given in the fault report. Confirmatory failure generates an addition to the count in the fault record and, if the alarm and hexadecimal display have been cleared, will generate an alarm and set the display to indicate the faulty card. A fresh report to the operator's console will only be given if the alarm has been cleared; otherwise the system remembers that this particular fault has already been reported. This memory of reported faults ensures that the operator is not bothered by the system repeatedly reporting the same fault. A master telephone, operator's console or teletype can be used to initiate a re-run of the failed test. From a telephone, the keyed instruction to re-run would be as follows:

★ 250 ★ 2 ★ 1 ★ 3 #

where 250 is the MMI code for execute diagnostic test.

2 is the test type.

1 is the parameter for test.

3 is the number of times test must be executed.

If correctly keyed, this instruction results in a confirmation tone being returned to the master telephone (obviously the master telephone must be an MF4 signalling keyphone) and memory-board 1 will have been tested three times. The same codes are used at the operator's console—only the digit section of the keyboard together with the CANCEL and WITHDRAW keys are used when communicating via the MMI interface (see Fig. 6 where the console is awaiting an MMI instruction). However, the console is much more communicative for 2 reasons: firstly, the digits are displayed on the VDU as they are entered, so allowing a check to be made; secondly, the console will, if desired, prompt the maintenance engineer. Prompting is best demonstrated by an example; if the instruction described above were entered via the console and a # is used in preference to the second ★, the maintenance engineer will see the following:

★ 250 #

TEST TYPE? 2#

PARAMETER? 1#

VALUE? 3#

The symbols and the figures are keyed in by the maintenance engineer; the system response is shown in italics. Each line appears as a separate screen entry headed *MMI* (see



Fig. 6—Operator's console in use for man-machine intercommunication

Fig. 6). The # is used as a terminator; in any case where the instruction is not complete the system will prompt for the next piece of information required.

It is evident that this procedure is more meaningful, less error prone and, to a large extent, self guiding; the maintenance engineer is prompted by the system. If required, the short form input can be used, exactly as the master telephone input.

The teletype is a more powerful device in that it has a full alphanumeric keyboard and a more versatile printing mechanism. Using the teletype, the same example would appear as follows:

?EDT

TEST TYPE? 2

PARAMETER? 1

VALUE? 3

TEST FAILED.

?

The system responses are shown in italics, the letters and figures are typed by the maintenance engineer and each line is terminated by depressing the RETURN key. Note that meaningful mnemonics can now be used (EDT—Execute Diagnostic Test). The short form

EDT 2, 1, 3

can be used if required, or the input can be exactly as the master telephone for those who are happier using that form.

Regardless of which terminal is used, the MMI package has first to be OPENED to allow access, and a pass-code must be known to do this. Assuming that the reported fault has been confirmed by executing the specified test, the faulty card can be replaced and tested. If all is well, the alarm, the CPU display and the fault record can all be cleared via the MMI facility, and the visit concluded.

If a major failure has occurred and the system is in dropback (that is, certain exchange lines switched directly to extensions) all assistance is not lost. Provided that the CPU is still working, a suite of diagnostic tests termed *off-line diagnostics* are made available. The tests are very similar to those available when the system is functioning normally. If no teletype is available, a full system test can be run via the switches on the CPU (see Fig. 4) and feedback is provided by the hexadecimal displays. However, if a teletype is available, tests can be run selectively, the fault record can be examined, and so on.

The Specialist's View

When the first-line maintenance engineer is unable to correct a fault within a reasonable period, specialist regional or national back-up may be consulted and, if necessary, called in. The facilities afforded by Monarch 120 to the specialist include everything so far described plus additional aids which require detailed system knowledge to be of value. Access to the extra facilities is denied to normal users either via *access level* in the case of MMI or by a *pass-code* barrier in the off-line diagnostic package (the 3 levels of MMI provided are: customer, BPO normal and BPO specialist).

The specialist is allowed, for example, to inject artificial messages into the system, to examine areas of memory and to exercise the automatic restart mechanism. There is another record beyond the fault record that the specialist can examine; this is termed the *software audit record* and contains a detailed history of the last 8 peculiarities noted by the software system. This can be very helpful in obtaining a full picture of the build-up to a complex system malfunction.

If the system is in dropback, then the specialist can exercise the system via the off-line diagnostic package as could the maintenance engineer. Since the tests are somewhat more rigorous than the on-line counterparts, this can be very useful. However, if a fault cannot be pinpointed with these aids, there is yet another aid with which to penetrate the system's safeguards and observe its raw behaviour; this is termed the *off-line monitor*. It is a program which is accessed via the off-line diagnostic package, using a pass-code, and thus can only be used when the system is OUT OF SERVICE. The monitor is a very basic aid, allowing access to all of the microprocessor's memory both for reading and writing. Since the signalling interface and the timeswitch appear to the microprocessor as memory, this is a very powerful tool. Telephone bells can be rung by writing to the relevant signalling byte; extensions can be connected together by writing direct to the timeswitch connexion store. Detailed contents of the original and current data-base can be examined and the latter changed if required; the specialist can even type small programs into the system's read/write memory and execute them.

The monitor is an extremely powerful tool giving access to the innermost details and functions of the system. It allows the specialist to view the entire telephone exchange through the eyes of the control microprocessor. On the other hand its effective operation requires an intimate knowledge of the system software and hardware. The monitor can be used only via a teletype or a VDU connected to the CPU.

TEST AND DIAGNOSTIC FUNCTIONS

The secret of the extensive Monarch 120 maintenance facilities is that test and diagnostic functions were built into the system from the outset. These functions can be subdivided into those provided in hardware and those provided by software.

Built-In Hardware Functions

Any circuitry provided for automatic system checking or testing presents a problem to the designer: what happens if it malfunctions? Or, to put the problem another way, who guards the guards? In Monarch 120 this problem was faced quite simply; the built-in hardware test and maintenance functions are extremely simple so that the probability of failure is negligible.

Built into the CPU PWB is a logic circuit known as *watchdog*. This device ensures that the central control of the exchange is functioning correctly. If the watchdog detects a malfunction, it attempts to restart the system. If, after a number of restart attempts, the control still does not appear to be functioning correctly, the watchdog will close it down, forcing the exchange into dropback mode.

The entire circuitry of the watchdog is built into a single

integrated circuit device specifically designed for use in Monarch. Its operation can be likened to a balloon which has to be maintained in the air by pats from the microprocessor. If the balloon sinks to the ground, then the microprocessor has forgotten to pat and is therefore considered to be malfunctioning. In practice, the pat delivered to the watchdog is a logic pulse, called a *kick*, applied by the control microprocessor program. The watchdog is a complex timer which, if it is not kicked within 160 ms, attempts to restart the microprocessor. At first, kick failures cause *warm starts*. In this case the job currently being performed by the microprocessor is abandoned and a new job begun. Assuming the malfunction is minor and temporary, a warm start may at worst cause one call to fail. If after 13 warm starts attempts the watchdog has not been reset, a *cold start* will occur and, if after 3 cold starts the control has not recovered sufficiently to reset the watchdog, the microprocessor is FROZEN and the system is forced into dropback.

The watchdog is reset by the administration of 256 good kicks after which any previous warm or cold starts are forgotten by the watchdog (though they are always recorded in the fault record).

A cold start is a major event in that all calls are lost since all volatile read/write stores are re-initialized, including the signalling and timeswitch connexion stores. When a cold start occurs the control system (CPU, memory, connexion store etc.) are thoroughly tested before telephonic operation is initiated. Any failure during cold start testing will cause the program to halt at the point of failure which will quickly lead to another attempt at cold starting. This sequence of tests is identical to that applied during power-up of the exchange.

A simplified diagram of the operation of the watchdog is given in Fig. 7; note that the microprocessor can only be UNFROZEN by a manual restart or by removal and restoration of power. Also note that the point in the control program at which kicks are sent to the watchdog is carefully chosen to ensure that kicks are issued only if the program is functioning correctly.

The second item of hardware provided as an aid to testing is known as the *test line unit* (TLU), a PWB which normally resides on the first line unit shelf in a predetermined slot, though it can be moved to aid fault detection if necessary. It performs the following functions:

- (a) tone detection (in digital form),
- (b) signalling patterns reflection,
- (c) digital speech pattern generation and detection, and
- (d) control of the alarm box.

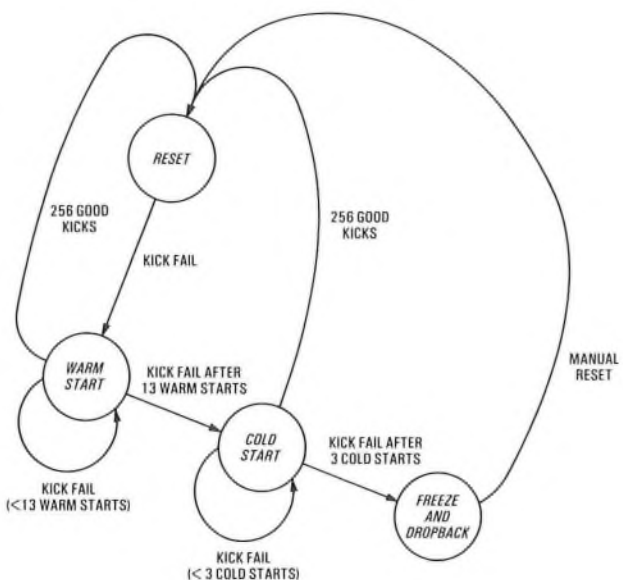

FIG. 7—Simplified diagram of the operation of watchdog

The TLU's role in the maintenance and diagnostic system will become evident in the description of tests applied to the system. The TLU is a relatively simple unit; many of its functions are currently being incorporated into a single integrated circuit.

In addition to the watchdog and TLU, test aids are built into each line unit to enable the control-to-line-unit and line-unit-to-control signalling path to be checked.

The On-Line Maintenance and Diagnostic Software

The programs that test and diagnose Monarch while the system is running are part of the overall software package, sharing resources such as the operating system, the exchange scanning functions and the MMI facilities. These programs reside on the programmable read-only memory (PROM) cards; the maintenance and diagnostic area currently requiring approximately 10 Kbytes of program store. Tests are normally initiated by the expiry of a 15 s time-out message delivered to the background section of the program (that is, the section that is initiated by messages, not interrupts) by the operating system².

The time-out message causes the test scheduler to determine which test is to run next; this it does by incrementing its way through a test schedule table. This schedule is currently 32 entries long and typical entries are in Table 1.

Note that this schedule table enables the designer or the administration to adjust the frequency of testing of any item in the exchange. Since there are 32 entries and individual tests are run every 15 s, it will take 8 min to execute the complete schedule of tests. Entering important control cards twice into the table ensures that they are tested every 4 min. Obviously some tests require a parameter; the extension line unit test for example must be applied to a particular port. In this case, the address of the last port tested is retained and the address of the next port to be tested can then be selected from this. Thus the frequency of testing of a particular line unit depends on how many times that test appears in the schedule and the number of such line units in the system. Thus, if the extension line unit test is entered 10 times in the schedule table and there are 100 extensions, each unit will be tested once every 80 min. Since extension line units predominate, this gives a direct indication of how long it takes to test the complete exchange.

Tests can also be initiated by a request from the maintenance engineer who utilizes the MMI or, in some circumstances, from other parts of the software. Only one test can run at a time, hence requests made to the maintenance and diagnostic process whilst it is already executing a test are queued until the current test is complete. However, it is possible for the maintenance engineer to turn off automatic testing to avoid confusion while he is running tests. This is achieved by using the CPU sense switches (Fig. 4); naturally, automatic testing must be switched back on before the site is vacated.

TABLE 1
Typical Test Schedule

0	Memory	16	Extension Line Unit
1	Memory	17	Exchange Line Unit
2	Memory	18	Exchange Line Unit
3	Signalling Cards	19	Signalling Cards
4	Timeswitch	20	Timeswitch
5	Tone Generator	21	Tone Generator
6	Console	22	MF4 Receiver
7	Ringer	23	Ringer Frequency
8	Exchange Line Unit	24	Exchange Line Unit
9	DC5 Line Unit	25	DC5 Line Unit
10	DC5 Line Unit	26	DC5 Line Unit
11	Signalling Memory	27	Connexion Store
12	MF4 Receiver	28	Conference Unit
13	Extension Line Unit	29	Extension Line Unit
14	Extension Line Unit	30	Extension Line Unit
15	Extension Line Unit	31	Extension Line Unit

The Tests

All units of the Monarch exchange are tested by the maintenance and diagnostic system, most of them directly, but where this is impossible (as it is for the shelf multiplexer for example) they are tested by implication; that is, by testing other items through them. Major items on the control shelf are tested as follows:

(a) *Read-Only Memory (ROM)* All the bytes of an individual memory chip are summed. This sum is then compared with a checksum obtained when the system was first programmed. Any discrepancy indicates a corruption. Checksums are themselves stored in the ROM.

(b) *Read/Write Memory* Each byte is read, inverted, rewritten, read, checked, restored and rechecked. Since inversion changes the meaning of stored data, no other process must be allowed to interrupt whilst a byte is being tested.

(c) *Signalling Input (SIGIN)* A known test pattern is read from the tone generator and checked. This unit is also tested in conjunction with the following unit.

(d) *Signalling Output (SIGOUT)* Spare output port locations are tested as read/write memory. Both signalling units are tested by using the signalling pattern reflexion function of the TLU. A pattern is written to the TLU port in SIGOUT; the pattern is then checked in the corresponding port of SIGIN.

(e) *Timeswitch* Spare locations in the connexion store of the input time-switch are tested as read/write memory. The connexion established by the input timeswitch is checked using the digital speech pattern-generation and detection function of the TLU. A through connexion is established from one port of the TLU to the other. The TLU will indicate to the microprocessor via SIGIN if the pattern it transmits has been received.

(f) *Tone Generator* This is tested using the digital tone detection function of the TLU; number unobtainable (NU) tone is connected to the TLU, which signals success to the microprocessor if the tone is received correctly.

The majority of line units are tested in 2 ways: firstly, the transmission of a particular signalling pattern to a line unit causes a specified reply to be transmitted by that line unit; secondly, the speech path is tested by taking advantage of the mismatch in the 2-wire-to-4-wire converter. Line units are tested only when they are free (that is, on-hook); thus the 2-wire-to-4-wire converter is unterminated and significant power will appear in the transmit direction of the 4-wire path if a tone is connected to the receive direction. The complete test is described in Fig. 8.

NU tone is connected, via the timeswitch, to the receive side of the unit under test. The transmit side of this line unit is connected to the TLU tone detection port. The microprocessor has to power up the line unit; then, after allowing a

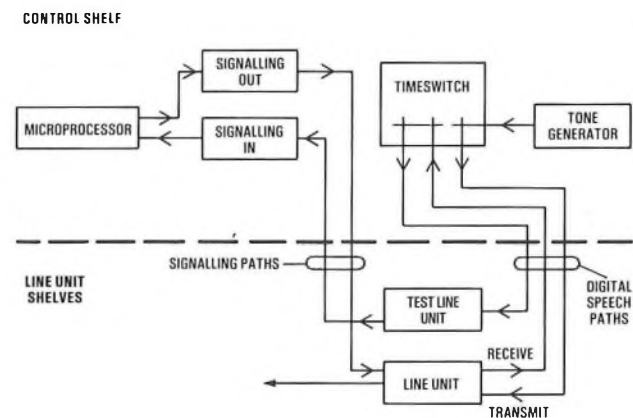

FIG. 8—Line unit speech test

certain time for the circuits to settle, the SIGIN location belonging to the TLU is examined to ascertain whether or not a tone has been detected. If it has, the test path is continuous and the line unit test is successful.

Most line units are tested in the same way, though the console line unit is special and has a unique test. MF4 receivers present a difficult problem since all Monarch 120s do not need an MF4 sender. However, it is possible to build up statistical evidence on the performance of these units by logging the number of failed calls (that is, those that clear before end of signalling) and the number of successful calls processed by each receiver. A threshold level is set for the receivers such that, if a significant failure rate arises, the MF4 receiver test is deemed to have failed.

Fault Analysis

Brief consideration of the line unit test which has been described indicates a very significant point: failure of this test does not necessarily indicate a faulty line unit. Any of the many items involved in the test can cause failure and, indeed, this is the case for most of the tests. The design of the diagnostic software recognizes this and programs are included to analyse the fault in more depth. In short, the system examines each item involved in the test in a carefully determined order. For example, the first thing to be tested is the memory area where a fault in the program store could easily cause erroneous test results. If the memory is given a clean bill of health, the signalling cards are tested, and so on. If any of these common items fail, then this item is assumed to be the faulty unit and fault analysis is applied to it; this continues until all avenues have been exhausted. If no higher order fault is found during fault analysis, then the line unit is retested; if it then passes, the fault is assumed to be intermittent and it is recorded as such but not reported, otherwise it is recorded and reported.

The general procedure in detection of a fault is shown in a simplified form in Fig. 9. Note that fault analysis is applied only to tests that have been initiated automatically. When the maintenance engineer requests the running of tests, he can apply his own analysis; this ensures that the microprocessor does not confuse the maintenance staff by making its own decisions, especially where complex or double faults exist. Note also that fault reports to the operator's console are queued if the console is unattended and will be reported when the console is switched on. Also, though the maintenance and diagnostic system continues to test a faulty unit and keep a record of the number of failures detected, it reports the fault only once. Clearing the fault record will, of course, also clear the record of a fault having been reported.

Normally, detected faults are merely reported; no action is taken to isolate faulty units since there is no spare equipment supplied within the cabinet. However, it is possible for the maintenance system to force the exchange into dropback. This drastic action is taken upon detection of ringer failure.

The Off-Line Diagnostic Software

This package must be able to operate in all fault situations except that of a CPU or power failure. Thus, the program resides in 3 PROM devices on the CPU card itself; some read/write memory is also supplied on the card to support this program. In fact, these memories occupy the same address area as the early part of the main program, off-line mode being selected by an ON/OFF-LINE switch on the front of the CPU card (Fig. 4).

The tests available in this package are more wide ranging and more searching than those supplied in the on-line package, primarily because the exchange is in dropback and hence data areas can be altered. For example, the watchdog and clock can be tested and the read/write memory can be rigorously tested by writing complex patterns across the whole store rather than testing byte by byte. Other facilities are provided;

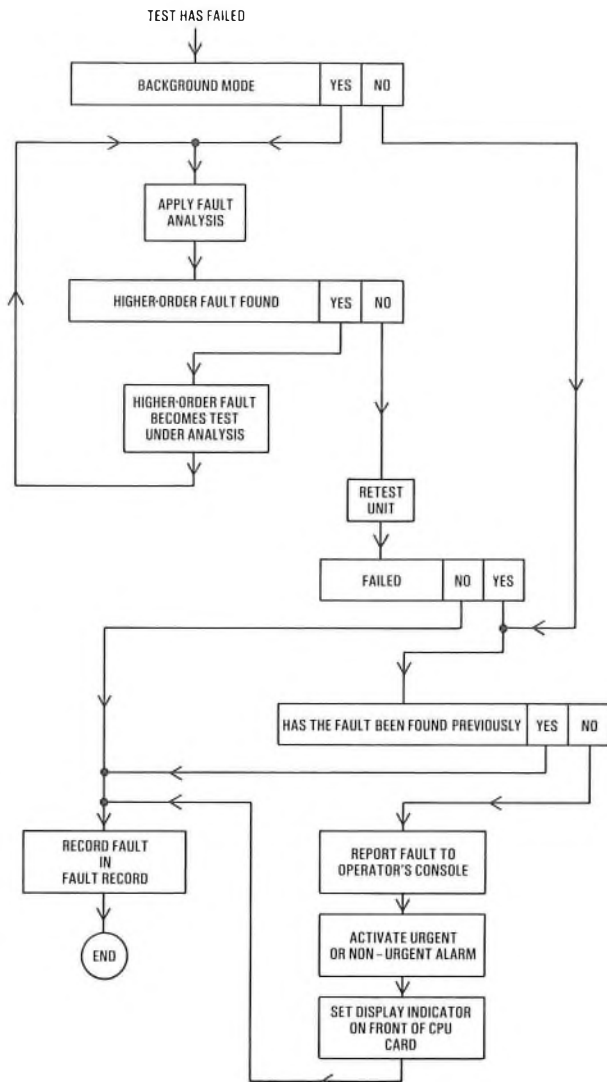

FIG. 9—General fault detection procedure

for example, the position of the TLU can be changed to enable detailed diagnosis of complex line shelf faults.

The off-line package must be executed with the uppermost CPU switch in the MAINTENANCE position; this prevents the watchdog from attempting to restart the CPU during testing.

The Off-Line Monitor

This is the most basic program supplied by the Monarch maintenance and diagnostic system. It is very much a specialist tool requiring detailed knowledge of the exchange for effective operation. The monitor is part of the off-line program and hence resides on the CPU card. Access to it is deliberately made difficult by means of a pass-code check. This is necessary since the monitor is a powerful tool which can be used to over-write areas of the non-volatile data base, or directly to control the hardware of the exchange. The facilities provided are those normally associated with simple computer debug programs; for example:

- (a) Read or write to areas of memory, including the signalling cards and connexion store.
- (b) Examine the contents of the microprocessor's registers.
- (c) Insert a breakpoint into a program.

The off-line monitor has been used extensively during the development of Monarch; however, its use in the field is expected to be a rarity. Operation will be restricted to authorized staff who have the necessary system knowledge to put the facilities afforded to effective use.

CONCLUDING REMARKS

Monarch 120 has a powerful built-in maintenance and diagnostic system capable of locating the majority of faults down to PWB level. This capability has been included at minimal system cost, the specialized items of hardware being the test line unit and the watchdog device. The major development cost has been entailed in providing the software of the maintenance and diagnostic system which now resides in 8 memory chips.

The system exists on a number of levels, each requiring a greater knowledge of the exchange for their operation. Most faults will be correctly reported to the service centre by the customer and will be cured simply by replacing the specified PWB. Where such action does not cure the problem the maintenance engineer can take charge of the diagnostic system and, using his knowledge of the operation of the exchange, determine the true cause of the fault. Beyond this, more piercing facilities are made available to the specialist to assist in the tracing of difficult malfunctions. These specialist functions exist both when the exchange is functioning normally and when the exchange is in dropback mode. If all else fails, the specialist can gain access to the innermost secrets of the control microprocessor via the off-line monitor. Thus a wide and graduated range of facilities are provided to meet virtually all the field problems which may arise in a Monarch exchange.

Sophisticated as the system may be, it does not by any means devalue the importance of common sense diagnostic practice—measurement of the supply voltages on an ailing system is always a good idea.

The reaction to Monarch's maintenance facilities by field staff has been very encouraging. For many, this system represents a first contact with the world of computer and microprocessor control. However, having overcome the usual nervousness exhibited when first communicating with intelligent machines, the staff have shown a great deal of

enthusiasm for the facilities available.

Advantage has been taken of the software based maintenance system by the BPO's Technical Training College. Here a slightly modified program is used which allows course tutors artificially to inject faults into the system via a teletype; the student can then diagnose such faults using the standard facilities described in this article. Students replace cards by instructions given via the teletype, thus avoiding excessive handling of PWBs in the training environment and providing the tutor with a record of the number of changes attempted by the student.

Finally, it should be noted that this article has been written by a designer, not a maintenance engineer. It is a description of the facilities offered by the Monarch 120 and how it was thought they could be used in the field. Actual maintenance practice will evolve with experience; already there is a trend away from the specialist approach to back-up maintenance, complemented by moves to merge the specialist's and the maintenance engineer's facilities. Every confidence exists in the flexibility of Monarch's maintenance system and its resulting ability to cope with different maintenance schemes; extensive field experience is awaited with interest.

ACKNOWLEDGEMENTS

Acknowledgement is given to those engineers in the BPO and UK Industry who have contributed to the design and implementation of the Monarch 120 maintenance and diagnostic system.

References

- ¹ POTTER, A. R. Monarch 120—A New Digital PABX. *POEEJ*, Vol. 73, p. 14, Apr. 1980.
- ² PARK, I. D. C. Monarch 120—The System Software. *POEEJ*, Vol. 74, p. 81, July 1981.
- ³ WILLETT, G. The Operator's Console for the Monarch 120 Digital PABX. *POEEJ*, Vol. 73, p. 138, Oct. 1980.

Post Office Press Notice

NEW EUROPEAN SPECIALIZED SATELLITE SERVICE FOR BRITISH BUSINESS

In December 1980 Mr. Peter Benton, Managing Director of British Telecom, outlined plans for a new business satellite communications service with Europe.

The service, due to start in 1983, is intended primarily for large business organizations with their own internal telecommunications networks, and for other businesses with specialist requirements. The inherent benefits of a satellite system—multipoint operation, speedy service to remote locations, and high-bandwidth transmissions—will make this service attractive to a wide variety of businesses.

The service made possible by an agreement reached last December at a meeting in Paris of the Eutelsat ECS Council, of which British Telecom is a member. The Council decided to modify the European Communication Satellites (ECS) so that all but the first of the five being built will be able to link up with small dish aerials. This function will augment their original role of providing new communication links between the countries of Europe through large earth stations like those run by British Telecom at Goonhilly and Madley.

The Council also decided to lease capacity for specialized small-dish services in the planned French satellite system (Telecom 1) intended mainly for French national use. Both systems will enter service in 1983 and will complement each other in the areas of Europe that they will cover and in the facilities that they will provide. Customers will be offered a variety of options to meet their particular needs.

British Telecom will install small earth-station aerials—about 4 m in diameter—at locations appropriate for users. British Telecom will also install the ground-level link—using conventional telephone cable, optical fibre, or microwave—to connect the aerial to a user's internal communications system.

Each message will be beamed by microwave digital radio from aerial to satellite, which will retransmit it to the receiving aerial at another frequency. Both Telecom 1 and ECS will have extra transponders fitted to operate at the internationally-agreed small dish frequencies of 12 and 14 GHz, supporting customers' transmissions at 2 Mbit/s.

In preparation for operational services in 1983, British Telecom plans to hold trials later next year using the European Space Agency's Orbital Test Satellite (OTS). These trials, which will follow experiments already made with OTS, will ensure that suitable ground equipment and operational arrangements are developed for the full service two years later.

The satellite service will be implemented in parallel with the creation of a digital network within the UK, based on the large trunk telephone exchanges of the System X range. These exchanges will be linked by transmission systems using optical fibres, coaxial cable or terrestrial microwave to provide a multi-purpose national digital communications network which will support a comprehensive, economic and flexible range of voice, data and visual services.

The nation's 30 most important centres will be interconnected in this way by 1985; this will enable British Telecom to provide, within the UK public network, business services comparable to those which it will by then be offering by satellite for private communications with the rest of Europe.

Determination of Large Reflector Profiles by Microwave Wavefront Reconstruction

D. J. EDWARDS, B.SC., M.SC.†

UDC 621.396.67: 621.37.029.6

A technique for the rapid measurement of the profiles of large earth-station antennae by wavefront reconstruction is described. Measurements of antenna profiles that would take a few days by normal measuring techniques can be completed within a few hours, with an accuracy comparable with other methods. An added advantage is that the radio performance can be confirmed at working elevations and frequencies. The technique can also be used for accurate positioning of a subreflector.

INTRODUCTION

The increasing use of the geostationary orbit in satellite communication over recent years has focussed attention on the interference aspects of earth-station antennae. In particular, considerable study has been made of the factors that govern performance for a given antenna design.

For antennae working to a closely packed geostationary orbit, a prime consideration is the risk of interference into and from adjacent satellites. The need to limit the radiation from an earth-station antenna to within a defined angular range has led to the development of a standard radiation level curve, and antennae intended to work to the fixed satellite service must satisfy these requirements in order to limit mutual interference between services to acceptable levels¹.

Earth station antennae are generally multi-reflector antennae and one of the factors which has come under scrutiny is the accuracy of the reflecting surfaces. The departure of a reflecting surface from the designed shape is termed a *profile error* and it has become apparent that this quantity is of major importance in limiting the gain and the general radiation characteristics of an antenna at angles away from the main axis. The problem of profile errors is explored in the following paragraphs and a convenient technique is described for the characterization of the profile by microwave methods.

THE EFFECT OF PROFILE ERRORS

The most common type of earth-station antenna is the reflector type, particularly the dual-reflector configuration (see Fig. 1). The reflectors are required to conform to a specific shape and a

modest degree of departure from this shape can have drastic effects on the performance of the antenna. It can be seen that, in a reflector surface made up of many panels, if one or more are misoriented, energy will not be reflected to (or from) the focus from (or to) a beam on the nominal boresight of the antenna. This shows up as a loss of gain and the generation of wide-angle radiation in undesired directions (see Fig. 2).

It is possible to describe mathematically the generation of those wide-angle sidelobes that are due to profile errors. A surface made from a collection of parts (in this case the panels of the reflector) can have errors in some parts of the surface which bear a relationship to errors in other parts of the surface. For example, an error in one area of a tilted panel will be related to other errors in the panel by the shape of the panel. If such a class of error is repeated on all the panels of a reflector (that is, if all the panels are tilted or misshapen in a similar way) then the errors in the surface have a degree of periodicity. The amount by which errors in the surface are related to errors in other parts is described by correlation theory and is outlined in reference 2.

A number of workers have studied the effect of surface errors on sidelobe gain and Ruze³ has formulated a statistical approach; this characterizes the antenna profile in terms of a root-mean-square (RMS) deviation from the desired profile and an interval over which these profile errors are correlated. Fig. 3 shows the results of a study using this approach in which it is pointed out that features that are correlated over an interval have a unique angle at which their radiation properties become significant. Fig. 4 illustrates this.

At certain angles, radiation from features which are scattering energy tend to be additive; that is, constructively

† International Executive, Telecommunications Headquarters

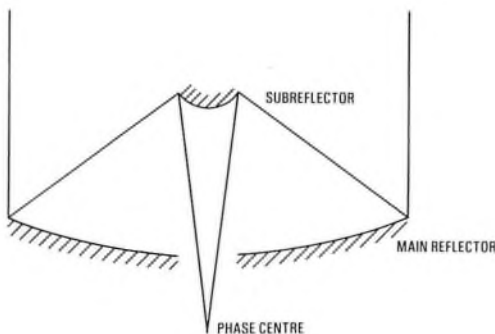

FIG. 1—Dual-reflector Cassegrain system

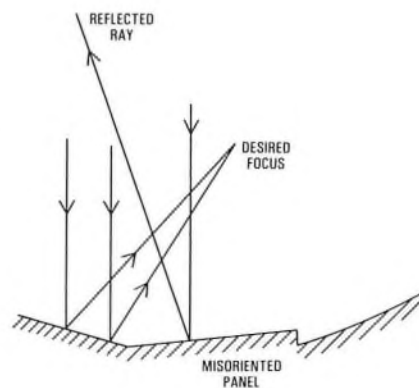
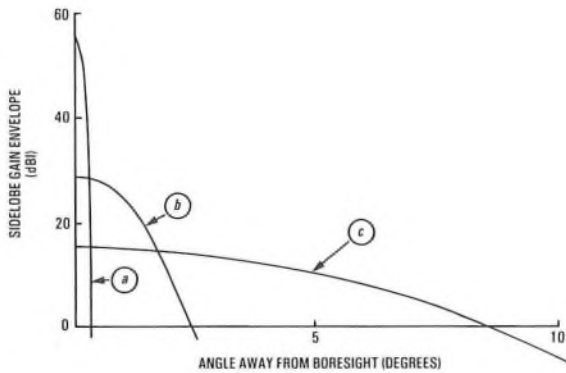

FIG. 2—Misoriented panel



Notes: Curves show levels not exceeded by 90% of sidelobe peaks (after Harris, 1977)

Plot for a 32 m antenna at a frequency of 6 GHz
 (a) RMS profile error 1 mm correlated over 10 m
 (b) RMS profile error 0.5 mm correlated over 1 m
 (c) RMS profile error 0.5 mm correlated over 0.2 m

FIG. 3—Contribution of surface errors to sidelobe radiation

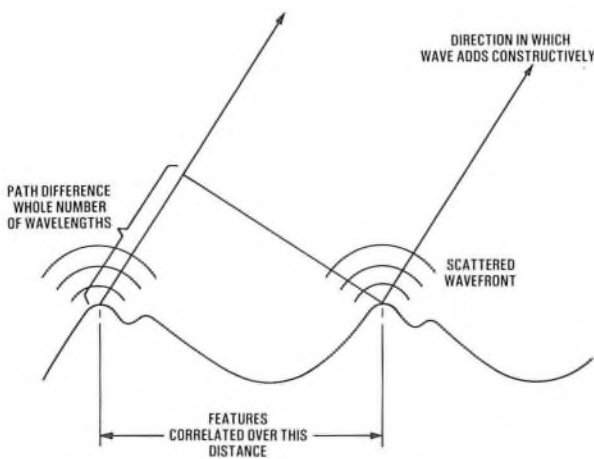

Note: Perfect correlation is shown for clarity

FIG. 4—Contribution of correlated errors to sidelobe gain

interfere. When the path length from the different features is an integral number of wavelengths, the sum of the electric fields of the radiation is zero. The angles at which this occurs are dependent on the spacing of the scattering features. Using this statistical approach, the effects can be averaged and the radiation as a function of correlation interval can be predicted.

As can be seen from Fig. 3, this treatment predicts that a small deviation correlated over a small interval disperses the energy over a wide angle and that, as the correlation interval becomes larger for the same error, the energy becomes confined within a narrow angular range about the mean beam. This type of analysis indicates the importance of profile accuracy in large-reflector antennae, and it is equally important that a reliable method exists to assess and measure the profile of the dish with a high degree of precision.

METHODS OF MEASUREMENT

It is normal practice to measure the alignment of panels in the main dish by civil engineering methods; for example, optical triangulation. The panels are manufactured with identifiable target points and these are sighted, measured and adjusted individually to correct the profile to within a fraction of a millimetre over the whole dish. As can be appreciated, this is an arduous task, requiring a number of men in laborious and repetitive effort for a number of days and can usually be carried out only at a non-operational attitude; either pointing in a horizontal or a vertical direction.

Recently, a method has been developed which offers similar accuracy, is more convenient and can be completed within a few hours. The principle was initially published by Sheffield University⁴ and Cambridge University⁵. The method exploits the mathematical relationship between the radiation pattern of an aperture (in this case, the antenna) and the electromagnetic field in the aperture. A brief outline of the mathematical representation of these fields is given in the following paragraphs.

RADIATION PATTERNS AND TRANSFORMS

Antennae do not, in general, emit or receive signals in only one direction. They usually have a primary direction and their response varies, according to the design, away from this direction with lesser maxima or minima. This property arises from diffraction effects (that is, radiation of a restricted electromagnetic wave) and Fig. 5 shows the optical diffraction pattern arising from a circular aperture with uniform illumination and constant phase. The description of this diffraction pattern in amplitude and phase can be analytically expressed and, with certain approximations at large distances (the far field), can be shown to be the Fourier transform of the radiating aperture function (see Appendix 1).

Examples of similar relationships are encountered elsewhere in the physical world (particularly in filter design and sampling theory). For example, in the optical case, a thin lens can, again with certain approximations, Fourier transform an infinite plane wave to a point at the focus.

Fourier transformation may be carried out with the aid of digital computers and, in the case of large earth-station antennae, the far-field radiation pattern can be transformed (that is, the pattern refocused) to obtain the image of the aperture in both phase and amplitude. The illumination level across the aperture and its profile contour can then be derived.

The relationship between the state of the fields in the aperture and its radiation pattern can be illustrated by looking at the optical analogy of a circular aperture and the radiation pattern at a distant point. In general, electromagnetic energy tends to propagate into regions where there is no other energy (or at least into regions where there is less energy)—it flows downhill. In consequence, light travels away from a source, and for a point, or isotropic, source the energy would be dispersed equally in all directions. In the hypothetical case of an infinite plane wave, all the energy is considered to be

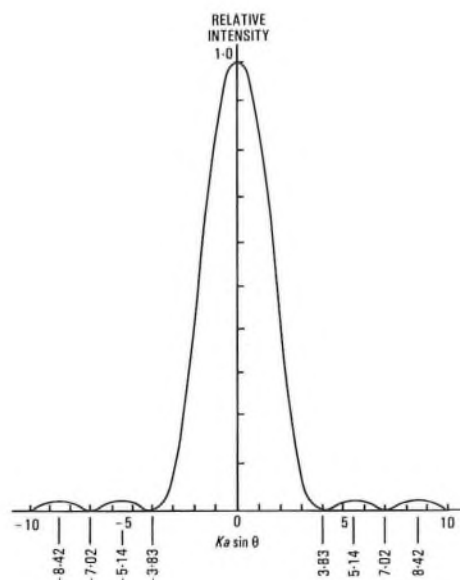

FIG. 5—The Airy pattern

travelling in the same direction, since from all points on the wave front the world looks the same and the energy therefore propagates in the same direction.

If such a plane wave is limited by a circular aperture, the case becomes more complicated and there are now directions that appear preferential to different points on the wavefront. Consequently, the energy disperses away from its previous course at points near the aperture edge.

If points in the aperture are considered as representing a collection of small sources, S in area, then at any distant point, P , the electric field is the sum of all the different contributions from the sources S . In general, as the point P is moved parallel to the plane of the aperture, each of the contributions varies in phase, and the resultant is a changing value. At great distances from the aperture, the only significant parameter is the angle with respect to the normal that the point of observation makes. By approximating the mathematics, that radiation pattern may be calculated. The resulting pattern for this case may be derived from a Bessel function of the form

$$J_0(u) = \frac{1}{2} \int_0^{2\pi} e^{iu \cos \theta} d\theta$$

The square of the function is illustrated in Fig. 5. In optics, this pattern is known as the *Airy pattern* after Sir George Biddell Airy (1801–92).

In the case of an earth-station antenna, the central lobe is the main beam of the antenna. The lesser maxima are the sidelobes, the far-out examples of which are enhanced by imperfections caused by departures from the design. These secondary peaks occur where the derivatives of the function with respect to the variable is zero; that is, where u satisfies the relation

$$\frac{d}{du} \left[\frac{J_1(u)}{u} \right] = 0$$

where J_1 is a Bessel function of order 1. The detail of this analysis can be found elsewhere⁶ but, for the moment, it is sufficient to note that the radiation pattern in such a case can be described adequately using a mathematical approach.

In current antenna designs, the illumination over the aperture is deliberately tapered from a high value at the centre to a low value at the edge. This has the primary effect of reducing the height of the sidelobes, and the principle applies to both reception and transmission. It is of the greatest importance to keep these subsidiary maxima small and any factors, such as profile error, which increases the height of the sidelobe in the response of an antenna also increases the interference potential. (See Appendix 2).

MEASUREMENT BY TRANSFORM METHOD

The relationship between the radiation pattern of an antenna and its surface profile has been outlined. It is now necessary to describe how this radiation pattern is measured, and the method of processing to obtain the desired result.

Pointing the antenna away from the satellite is equivalent to moving the satellite; so, if the received signal from the satellite is measured at the antenna, the signal varies according to the radiation pattern response of the antenna. There is one complication in that, normally, only the power of the signal is measured but, in this case, both the amplitude and phase are required. This necessitates a special receiver which requires two inputs (a reference and the measured signal) in order to give the two desired outputs: the phase and the amplitude. Because a two-dimensional picture of the radiation pattern is required, the antenna must be scanned in azimuth and elevation and the amplitude and phase of the radiation pattern recorded at each point in a plane. Measurement of the radiation pattern of an antenna requires access to the antenna and it is usually of considerable advantage, for operational

reasons, to make this period as short as possible. A micro-processor-controlled data logger therefore accepts the signals and records them in a digital format for input to a computer which later calculates the aperture function of the antenna.

The experimental arrangement is shown in Fig. 6 and consists of a small stationary dish to maintain a reference signal which is inputted into one channel of a dual-channel phase-locked receiver. The reference signal is preamplified with a solid-state low-noise amplifier in order to place the signal levels, which differ because of the different antenna gains, within the working range of the receiver. To provide adequate signal-to-noise ratio, a test carrier from the satellite is normally required; however, depending on the characteristics of the receiver, it is possible to use the satellite beacon. A typical signal budget for the reference channel using a test carrier is shown in Table 1.

TABLE 1
Signal Budgets for Reference Path

Effective isotropic power from satellite	11 dBW
Space loss	197 dB
Gain of reference antenna	31.5 dB
Cable loss	1 dB
Amplifier input power	-155.5 dBW
Estimated antenna noise	40 K
Cable-loss noise	60 K
Amplifier noise	90 K
Total noise	190 K or 22.8 dBK
Carrier-to-noise ratio	-178.3 dB
Boltzmann's constant	-228.6 dB
Noise density (C/N_0)	50.3 dB
Minimum level for receiver to lock, for example	-104 dBm
Amplifier gain	50 dB
Level from reference antenna	-155.5 + 50 dBW
Loop bandwidth (reference channel)	1 kHz
Carrier-to-noise ratio for reference signal	50.3 - 10 log ₁₀ 1000 = 20.3 dB
Minimum carrier-to-noise ratio for phase-locked loop (for comparison)	10 dB

dBW: decibels relative to 1 W.
dBm: decibels relative to 1 mW
dBK: decibels relative to degrees kelvin

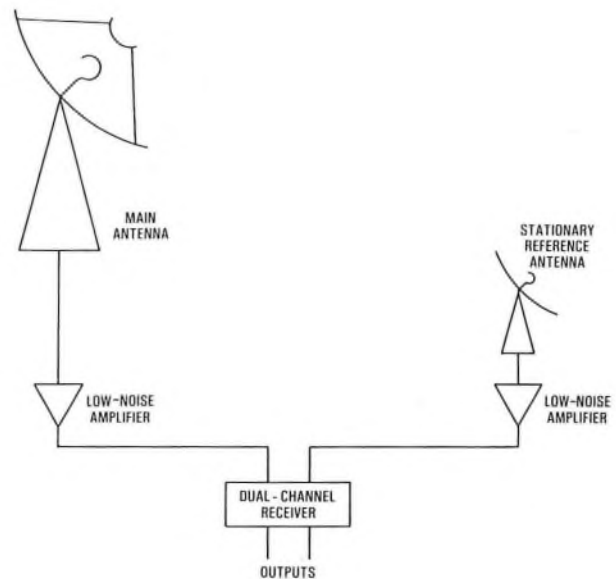

FIG. 6—The experimental arrangement

The output of the dual-channel receiver represents the in-phase and the quadrature components of the antenna pattern. The antenna is scanned raster-fashion, with time, azimuth and elevation being recorded for each cut. Gradually, a grid is scanned and a two-dimensional picture of the radiation pattern is built up.

There are various considerations arising from the practicalities of the method and these are discussed.

SAMPLING AND CONVOLUTION

To make the method practicable it is necessary, for a number of reasons, to limit the measurement of the radiation pattern to a given range about the main axis. This has an effect during the transform process which has to be corrected. In such a restricted measurement, the full radiation pattern is effectively being multiplied by a "top-hat" function; that is, a function which is unity for plus and minus a given range of values, and zero elsewhere. This process is equivalent in aperture space (that is, after transformation) to a convolution of the Fourier transforms of the radiation pattern and the top-hat function.

This relationship can be written

$$f(x)g(x) = F(x) * G(x) \dots \dots \dots (1)$$

where the upper-case function designations are the Fourier transforms of the lower-case functions and * denotes the convolution process².

The calculations must therefore take account of this effect and the method is illustrated graphically in Fig. 7. Function (a) represents the part of the radiation pattern which is measured; note that the function is zero outside the measurement limits. Function (b) shows the points at which data is sampled by the data-logging equipment. The effective function recorded is therefore function (c). This is the product of multiplying function (a) by function (b). If function (c) were to be transformed, the result would be as shown by function (c'); clearly this function does not describe the func-

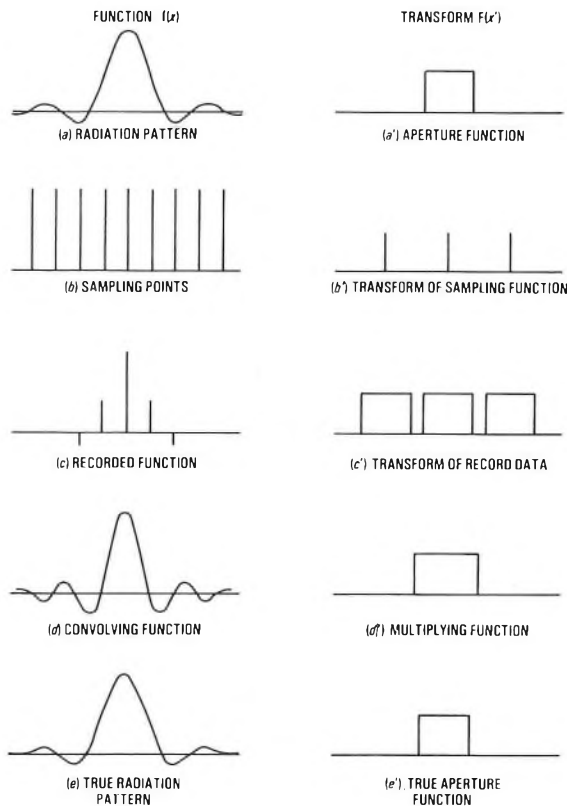

FIG. 7—Sampling and convolution

tion expected (there is only one antenna aperture which would in this representation be a top-hat function). Using relationship (1), it is then possible to negate the effect of the measurement method by convolving function (c) and function (d) in the radiation pattern or by multiplying the transforms of these functions to obtain function (e') which is intended to represent the aperture of the antenna.

A more erudite description of this process can be found in reference 2.

MEASUREMENT ERRORS

There are a number of systematic errors that can be accounted for in the analysis of the results. They are described below and account is taken of them by appropriate treatment of the measured data.

Grid Distortion

The scanning of the antenna in azimuth and elevation does not give an immediately useable square grid for the transformation because the axes of the antenna are not parallel to the incoming wavefront (see Fig. 8). The problem is difficult to visualize but can be summarized as two effects:

- (a) a compression of the real angle along the wavefront due to a rotation in azimuth at a finite elevation, and
- (b) an increase in elevation as the antenna turns away from the track position.

Fig. 8 shows the antenna looking at the satellite at some elevation. The wavefront radiating from the satellite is represented by the plane. As the antenna rotates in azimuth, the antenna boresight draws out a cone. The intersection of this cone with the plane wavefront is thus a curve going upwards either side of the line between the antenna and the satellite. The real azimuth displacement along the wavefront is compressed and the elevation appears to climb up the wavefront. The azimuth compression can be emphasized by remembering that, for a satellite directly above the antenna, a rotation about the azimuth axis produces no effective motion. This distortion must therefore be corrected, either in the calculation of the points of sampling during the measurements or by numerical methods, to obtain the required measurement points in the co-ordinate system of the plane wave from the satellite.

Phase Errors

Analysis of the accuracy with which the phase must be known indicates that the total phase error must not exceed more than a few degrees. All sources of phase error must therefore be identified and quantified. As described earlier, the measurement entails scanning the test antenna; as a result, depending

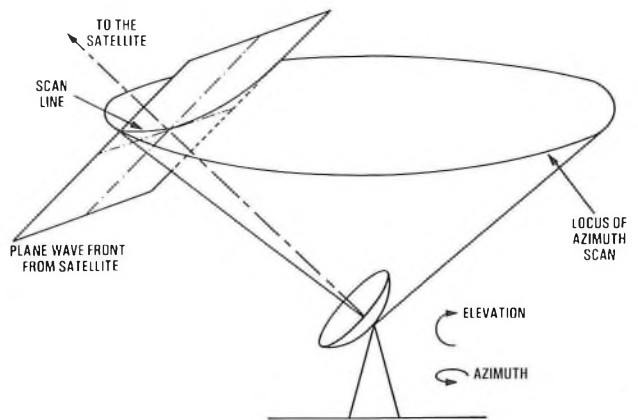

FIG. 8—Distortion for an azimuth scan

on the antenna design, the point of measurement changes position with respect to the measuring plane normal to the propagation direction. The magnitude of this effect can be calculated from antenna geometry and then added to the measured data. Other sources of phase error arise from positional uncertainties and comprise random and systematic errors. The latter can be resolved from available data in the case of antenna-pointing errors (for example, satellite motion), but the former must be assessed and accepted as an uncertainty in the measured signal. A typical error budget is shown in Table 2.

Resolution

The amount of data recorded from the radiation pattern directly controls the resolution of fineness of the detail that can be seen across the surface of the dish. The criteria used in the establishment of the desired resolution are the features it is wished to identify in the measurement (see Table 3). Note that the term "accuracy" refers to the displacement normal to the aperture and "resolution" to the scale of detail across the surface.

In all the discussion so far, the depth of the reflector has been neglected. This assumption is valid if, at all points during the measurement, no change of path length arising from depth difference is detectable across the width of the reflector. Alternatively, it can be said that the maximum angle off boresight must be limited such that

$$d \ll \frac{1}{\lambda} \times \frac{D^2}{n^2}$$

where d is the depth of the reflector, λ is the wavelength, D is the diameter of the reflector and n is the number of sample points separated by λ/D . Appendix 3 puts forward an argument for this limit.

Bennett⁷ has discussed the number of data points required with reference to the desired resolution. In general, for a given resolution (for example, dimensions of a panel), features near this resolution become blurred, depending on the magnitude of the feature. It is therefore important to consider that the resolution required from mathematical considerations must be greater than that which is aimed for in practice. The resolution obtained by this method is approximately D/n , where the number of samples taken is n^2 , and it can be seen that, in order to identify whether a panel is tilted or misplaced, it is necessary to have a number of measured points within the dimensions of the panel.

Bennett argues that a minimum of four measured points is necessary within a reflector panel dimension of $D/16$. Typically, large earth-station antenna panels are accurately shaped

TABLE 2
Typical Error Budget

Type	Magnitude
Pointing error in both coordinates	± 0.05 grid spacing
Thermal noise	-50 dBK
Phase error	$\pm 3^\circ$

TABLE 3
Typical Measurement Parameters

Aerial diameter	30 m
Wavelength	78.1 mm
Maximum spacing of sample points	0.1421°
Practical sampling interval	0.1°
Oversampling	30%
Grid size	32×32
Maximum angular excursion (approx.)	$\pm 2^\circ$
Resolution across reflector	1 m

and therefore, in order to define its attitude uniquely (that is, tilt or shift), three points are sufficient. In practice the measurement is not necessarily looking for the highest resolution and, depending on the purpose of the measurement, values of n of 8, 16, 32 and 64 are used. At 4 GHz, for an antenna of 30 m diameter, a value of n of 32 gives a resolution of about 1 m. This gives roughly three points per panel for panel dimensions of the order of $D/10$.

Table 3 illustrates measurement parameters for the maximum spacing of the sampling points. In practice, sampling is carried out at closer intervals.

SUBREFLECTOR ALIGNMENT

As implied above, this technique can be used for purposes other than panel alignment because gross phase errors can be detected. In particular, those caused by subreflector misplacement can be inferred by fitting data after all other corrections have been implied. The effect of misfocusing can easily be seen during the processing of the data from measurements carried out during the setting-up and refitting of antennae. If the subreflector is placed too near the main reflector, the phase centre of the system is effectively moved inside the focal length of the main reflector. This causes the radiated beam to diverge; that is, the emanating wavefront is not plane, it is curved. The phase leads at the centre and lags at the edges. Conversely, if the subreflector is too distant from the main reflector the wavefront converges.

ROOT-MEAN-SQUARE PROFILE ERRORS

Of prime importance in quantifying the goodness of a reflector profile is the root-mean-square profile error. This can be calculated from the results of the measurement as, effectively, spot values of profile error are available and, from the amplitude distribution, the weighting is known. By weighting the values during the calculations an importance to each point is assigned according to the amount of energy falling on it and, consequently, the relative effect it has on the radiation of the antenna. For example, an error near the edge of an antenna reflector which is less well illuminated does not have the same magnitude of effect as a similar error which is more highly illuminated. Almost invariably, the value here is obtained from significantly more data points than from other methods.

PROCESSING OF THE DATA

A computer program suite has been written which accepts the measurement data plus calibration information and performs the necessary manipulation to obtain the profile contours of the composite reflector and, as a corollary, the aperture illumination function. After correcting for equipment phase and zero levels, the phase variation caused by scanning of the main antenna and the satellite motion must be accounted for. The two matrices representing the phase and amplitude then lend themselves to programs using fast Fourier transformation algorithms.

The resulting matrices thus contain the raw amplitude and phase distributions in the antenna aperture plane. At this point, the phase matrix contains systematic pointing errors and these can be eliminated by fitting. Such errors are caused by encoder misalignment or by inaccuracy in the assumed satellite position. The resulting phase distribution can then be mapped into profile errors and the distribution inspected. Gross misfocusing is easily seen at this point and Fig. 9 shows an example of a divergent wavefront, indicating that the subreflector is too close to the main reflector. Fig. 10 shows the effect of adjusting the data to obtain a best fit. This operation yields the distance through which the subreflector must be moved for optimum working.

Fig. 11 shows the amplitude distribution clearly. The amplitude taper is visible, as are shadows cast by the tripod



Note: Values in tenths of millimetres from ideal

FIG. 9—Profile contour for Goonhilly 3: divergent wavefront

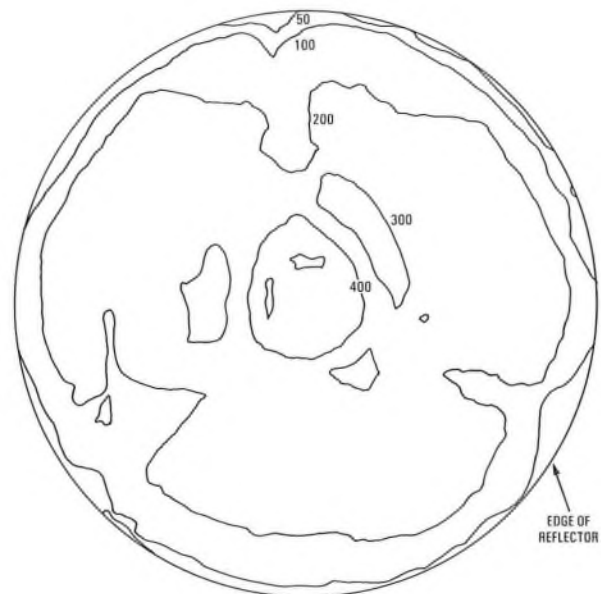

Note: Units are arbitrary

FIG. 11—Amplitude contours for Goonhilly 3



Note: Values in tenths of millimetres from ideal

FIG. 10—Profile contour for Goonhilly 3 after fitting the subreflector

support struts. These results were obtained during subreflector modification and refit of the Goonhilly 3 antenna (a Marconi Polygon antenna). The measurements were performed in the 4 GHz band, and the antenna was subsequently re-accepted into the Intelsat system after the mandatory tests.

CONCLUSION

The principles and method of this rapid technique have been proven by a number of workers. As illustrated here, the method is very well suited to British Post Office (BPO) antennae. The method is valuable from a number of viewpoints, primarily because of its short measurement time and the accuracy of its analysis.

ACKNOWLEDGEMENTS

This work was started in the BPO by Dr. A. B. Harris, who

wrote the original software. My thanks go to him as my mentor in this work. The execution of these measurements was made possible only by the efforts of a number of people; in particular, the staff at Goonhilly and Madley are thanked for their considerable efforts. The co-operation of INTELSAT is also acknowledged.

References

- 1 Recommendations and Reports of The CCIR, Vol. IV (Reports 390, 391 and 465), 1978.
- 2 MAURICE, R. D. A. Convolution and Fourier Transforms for Communications Engineers. Pentech Press, 1976.
- 3 RUZF, J. The Effect of Aperture Errors on the Antenna Radiation Pattern. *Supplemento Al Nuovo Cimento*, Vol. 9, No. 3, pp. 364-380, 1952.
- 4 BENNETT, J. C., *et al.* Microwave Holographic Metrology of Large Reflector Antennas. *IEEE Transactions on Antennas and Propagation*, Vol. AP-24, No. 3, May 1976.
- 5 SCOTT, P., and RYLE, M. A Rapid Method for Measuring the Figure of a Radio Telescope. *Monthly Notes of the Royal Astronomical Society*, Vol. 178, pp. 539-545, 1977.
- 6 RUSCH, W. V. T., and POTTER, P. D. Analysis of Reflector Antennas. Academic Press Inc., 1971.
- 7 BENNETT, J. C. Necessary Criteria for the Diagnosis of Panel Misalignments in Large Reflector Antennas by Microwave Metrology. *Electronics Letters*, 4 Aug. 1977, Vol. 13, No. 16.

APPENDIX 1

Plane Wave Illumination of a Planar Aperture

Consider the special case of a plane wave incident normally on an opening in a plane screen. If the transverse dimensions of the opening are large relative to a wavelength, so that edge effects can be neglected, then, for a general aperture distribution, $F(\xi, \eta, 0)$, the field at a point P is given by

$$\psi(P) = \frac{1}{4\pi} \int_S F(\xi, \eta, 0) \times \frac{e^{-jkr}}{r} \left\{ \left(jk + \frac{1}{r} \right) \cos \chi + jk \frac{\partial \Phi}{\partial n} - \frac{1}{A} \frac{\partial A}{\partial n} \right\} dS,$$

where ξ and η are two coordinates in the aperture which lies on the $z = 0$ plane and r is the distance from this point to the point P , k is the wavenumber, Φ is the phase of the wave in the aperture and n is the surface normal to the aperture plane (see Fig. 12).

The Far Field Approximations

These are concerned with great distances such that the path difference from various points in the aperture is then close to zero. The field at P transformed to spherical coordinates becomes

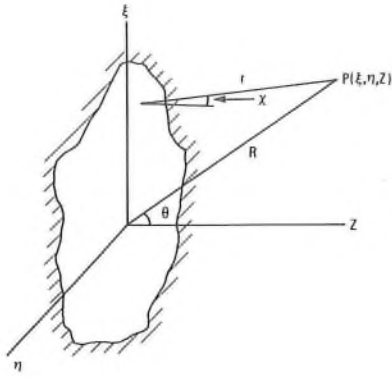

FIG. 12—The coordinate system

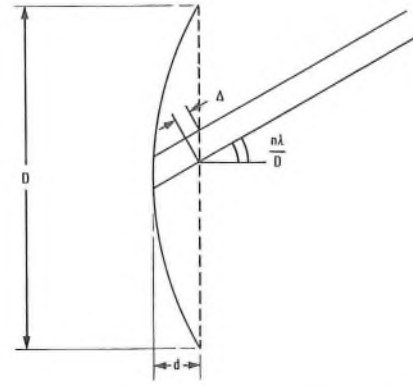

FIG. 13—Two-dimensional representation of path difference

$$\psi(P) = \frac{j}{2\lambda} \times \frac{e^{-jkR}}{R} \int_S F(\xi, \eta, 0) \exp\{jk \sin \theta (\xi \cos \phi + \eta \sin \phi)\} \times \left(\cos \theta + \frac{\partial \Phi}{\partial n}\right) d\xi d\eta,$$

where R is the distance from the centre of the aperture to the point P , θ is the angle between the normal to the aperture and the line of R (that is, the angle off the boresight) and ϕ is the angle made with the ξ axis.

For a constant phase,

$$\frac{\partial \Phi}{\partial n} = 1 \text{ and } \theta \approx 0.$$

$$\therefore \psi(P) = \frac{j}{\lambda} \times \frac{e^{-jkR}}{R} \int F(\xi, \eta, 0) \exp\{jk \sin \theta (\xi \cos \theta + \eta \sin \theta)\} d\xi d\eta.$$

For a circular aperture of radius a , the far field approximation becomes

$$\psi(R, \theta, \phi) = \frac{j}{2\lambda} \times \frac{e^{-jkR}}{R} \int_0^a \int_0^{2\pi} \psi(\rho, \phi') (\cos \theta + \frac{\partial \Phi}{\partial n}) \times \exp\{jk\rho \sin \theta \cos(\phi' - \phi)\} \rho d\rho d\phi',$$

where ρ and ϕ' are the coordinates of the aperture point.

For a constant phase aperture field whose magnitude is $A_0 \times \{1 - (P/a)^2\}^n$,

$$\psi(R, \theta) = \frac{j\pi a^2}{\lambda} \times A_0 \left\{ 2^n \times n! \times \frac{J_{n+1}(u)}{u^{n+1}} \right\} \times \frac{e^{-jkR}}{R},$$

where J_{n+1} is a Bessel function of order $n + 1$ and $u = ka \sin \theta$.

For $n = 0$, this reduces to

$$\psi(R, \theta) = \frac{j\pi a^2}{\lambda} \times A_0 \times \frac{J_1(u)}{u} \times \frac{e^{-jkR}}{R}$$

Thus, the far field pattern of a radiating aperture is proportional to the Fourier transform of the function describing the aperture.

APPENDIX 2

Series Approximation of Radiation Pattern Integral

The aperture distribution may be expanded in a Bessel series

$$f(r_n) = \sum_{n=0}^N a_n \times J_0(ur_n),$$

where N is large enough for a specific accuracy, J_0 is the Bessel function of the first kind and order zero and u_n is the n th root of J_0' (the differential with respect to the argument), $r_n = \frac{r}{a}$ and $u = ka \sin \theta$.

The normalized polar pattern, using the above variables may be written⁷

$$g(u) = 2 \int_0^1 f(r_n) \times J_0(ur_n) r_n dr_n.$$

Combining this with the aperture illumination expansion gives

$$g(u) = -2J_0'(u) \times \left\{ a_1 + \frac{a_2 J_0(u_2)}{1 - u_2^2/u^2} + \frac{a_3 J_0(u_3)}{1 - u_3^2/u^2} \dots \dots \dots \right\}$$

For $N = 2$ and a chosen a_2/a_1 , most commonly used aperture distributions can be modelled. Effective sidelobe suppression can be analysed by suitable choice of a_2/a_1 .

APPENDIX 3

Maximum Resolution Due to Depth of Reflector

From Fig. 13, the maximum angle off boresight is $n\lambda/D$, where n^2 is the total number of samples, λ is the wavelength and D is the diameter of the aperture. For the mathematical formulation to be strictly accurate, the measurement must not be able to 'see' any phase variation across the aperture; however, it is possible for errors in the curved reflector to show a noticeable path-length difference between rays reflected from its centre compared with its edges. The arrangement is simplistically shown for the two dimensional case in Fig. 13 and the maximum path difference which occurs from the dish centre with respect to the nominal depth, d , is considered.

It is required that the path difference, Δ , is very much less than λ . Thus, by simple geometry, regarding $\lambda n/D$ as small,

$$\Delta = \frac{n\lambda d}{D} \times \frac{\lambda n}{D} = \frac{n^2 \lambda^2 d}{D^2} \ll \lambda.$$

Thus,
$$d \ll \frac{1}{\lambda} \times \frac{D^2}{n^2}.$$

It is possible to derive such a limit in a number of ways, all of which yield a similar result.

Power Supplies For Small Telecommunications Centres

Part 1—DC Power Plant Nos. 235 and 236

R. H. HOWARD, B.Sc.†

UDC 621.311: 621.395.721

This 2-part article describes new DC and AC power plants that have been developed primarily for small local exchange modernization; they can also be used for other applications within the public switched telephone network. This part outlines the power requirements for modern small telecommunications centres and describes the new DC Power Plant Nos. 235 and 236. Part 2, to be published in a later issue, will describe a new standard range of 240 V single-phase AC stand-by plant designated Power Plant No. 440.

INTRODUCTION

The public switched telephone network (PSTN) of the British Post Office (BPO) comprises over 6000 telecommunication centres of which almost half are small rural exchanges with less than 600 connexions. Most of these exchanges are equipped with Strowger-type switching equipment which will eventually be replaced by electronic equipment under the network modernization programme. Compared with traditional electro-mechanical exchanges, modern electronic equipment has quite different power load characteristics and therefore equipment modernization introduces the need for corresponding modernization of telecommunications power plant.

Strowger equipment power dissipation is largely proportional to telephone traffic. It is therefore economic in the case of small rural exchanges to provide a battery which, in the event of failure of the mains AC supply, will give an effective energy reserve of 24 hours. Owing to the low rate of discharge, particularly during off-peak periods, battery capacity is directly related to the day-load-to-busy-hour ratio, which is typically 8 : 1. For the same reason it is also possible, in an emergency, to restrict traffic through the exchange and thereby extend the battery reserve period to about 5 days. Thus, although dual-reserve power plant (one hour battery reserve backed by longer term AC stand-by reserve) was introduced in 1960¹, single-reserve DC power plant has remained standard practice for small Strowger rural exchanges with less than 600 connexions.

In contrast, electronic equipment power dissipation is characterized by a high percentage standing load and a much smaller traffic-dependent component. The near constant power dissipation makes single-reserve DC power plant uneconomic and impractical and, with common-control equipment, the option of reducing the power load is not available. Dual-reserve power plant is now the most economic means of providing adequate energy reserve and it has been adopted for all new telecommunications centres within the PSTN.

OPERATIONAL OBJECTIVES FOR POWER PLANT DESIGN

The basic operational objectives of the power plant designs are to meet the widest possible applications within the design constraints of a rationalized range of standard dual-reserve power plants. Initially, small TXE2 exchanges and transmission

repeater stations were the principal locations for power plants but, as local exchange modernization strategy evolved, it became apparent that possible applications would include small proprietary exchange systems, and new digital exchanges such as the UXD5 (developed from the Monarch 120 PABX) or the System X small local exchange and remote concentrator unit. These applications, together with design constraints, determined that the new dual-reserve power plant should have output ratings as shown in Table 1. The Power Plant No. 235 provides a -50 V DC supply and consists of a Rectifier No. 156/. . . and a stand-by battery with sufficient capacity to last one hour at rated output current. The rectifier output current ratings are as shown in Table 1.

TABLE 1
Power Plant Ratings

Power Plant No. 235 Output Rating	Power Plant No. 440 Output Rating
10A } 20A } 40A }	6 kVA
80A	10 kVA

The Power Plant No. 440 provides a 240 V AC single-phase mains/stand-by supply. It consists of a skid-mounted diesel engine generator set, together with associated switch-gear, control equipment and ancillary equipment for fully automatic unattended operation. The operational and design aspects of this plant will be described in Part 2 of this article.

In addition to the -50 V dual-reserve application, it was recognized that a simple polarity reversal of the Power Plant No. 235 would provide a +50 V plant for minimal additional development cost. The existing +50 V Power Plant No. 229 is normally supported by an AC stand-by supply but, because a single rectifier is used, a 24-hour battery is provided to cover rectifier repair time in the event of rectifier failure. Thus a further operational objective is to meet the +50 V requirement for TXE2 and TXE4/4A exchanges with a more compact, cost-effective and reliable +50 V plant. This plant comprises a +50 V Rectifier No. 157/. . . and a nominal one hour battery; it is designated Power Plant No. 236. Output ratings are the same as those for the Power Plant No. 235 (see Table 1).

DESIGN OBJECTIVES FOR POWER PLANT Nos. 235 AND 236

In setting out to develop new DC power plant suitable for

† Energy, Transport and Accommodation Department, Telecommunications Headquarters

dual-reserve applications, constraints were imposed so that the plant should

- (a) provide a reliable 50 V DC supply,
- (b) be cost effective,
- (c) require minimum power accommodation,
- (d) be compatible with AC stand-by Power Plant No. 440,
- (e) facilitate installation by BPO staff, and
- (f) provide for safe maintenance.

From these, came the design objective to provide 2 identically rated rectifiers (load and stand-by), together with a terminal-voltage control regulator within a single cubicle. For ease of installation, battery fuses, together with a DC distribution and battery connexion panel, suitable for cable or busbar connexions, are provided within the rectifier cubicle. To reduce accommodation requirements further, the cubicle requires front access only. To provide for safe maintenance under working conditions, the cubicle is internally partitioned. This self-contained approach aims to provide convenient installation, particularly since modernization implies the need to turn-round exchanges within existing buildings.

A basic design objective was to achieve stable plant operation with a range of battery capacities providing for up to 24-hours reserve at full-rated output, the stand-by battery being provided separately. This facilitates possible re-use of existing batteries and provides an enhanced export specification. There is no need to constrain the relative location of battery and rectifier as each rectifier has its own smoothing filter. Output noise voltages and transients must comply with Post Office Requirement (POR) 2511². Finally, to provide for possible wider applications, the requirement for stable parallel operation of 2 plants is a basic design objective.

SYSTEM DEVELOPMENT

The most significant problem that has to be overcome in modern DC power plants is the provision of no-break power from a stand-by battery when the AC power supply fails. This problem is historical; most equipment has been designed to operate within only narrow input voltage limits which were appropriate for the now obsolete float-battery (2.06 V/cell) power plants. Present practice is to trickle-charge the battery (2.25 V/cell); this minimizes the need for maintenance, but results in an output voltage that is too high if the same number of cells are used as in a float-battery plant. An opposing constraint precluding the use of a smaller number of cells is that, for good utilization of battery capacity, they must be discharged as deeply as the equipment input limits permit. It is therefore necessary to use the same number or a larger number of cells, and to decouple some part, or all, of the battery from the load during normal operation and switch it through to the load, without a break, when required. This requirement is realized in Fig. 1, which is the starting point for the new plant design.

Because it is normally decoupled from the load, the battery cannot contribute to the rectifier ripple smoothing; the

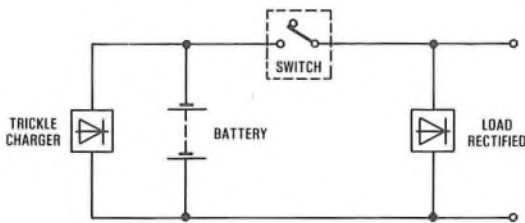

Note: The switch is purely representative of the need to solve the problem of a wide battery trickle-charge-to-discharge voltage range compared with traditional equipment input voltage limits.

Fig. 1—Elements of DC power supply for narrow voltage-limit equipment

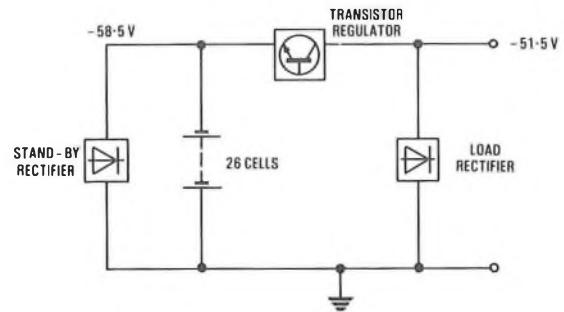

Fig. 2—Basic circuit of Power Plant No. 235

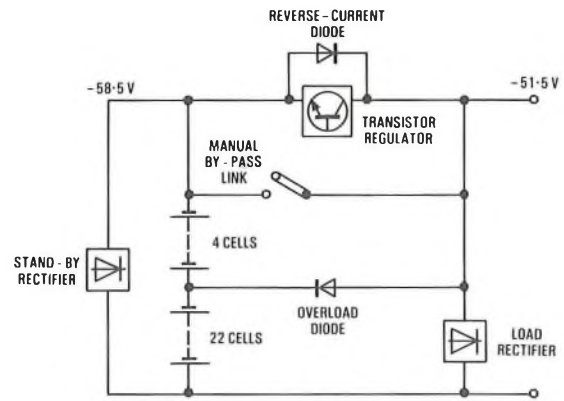

Fig. 3—Main components of Power Plant No. 235

rectifiers are therefore fitted with filters to produce the degree of attenuation required by POR 2511. Neither can the battery supply short duration pulses of load current; thus, to maintain a stable output voltage, the rectifier's dynamic performance needs to be matched to the load. Fig. 2 shows the basic circuit of the new power plant.

The transistor regulator is the natural choice of device for coupling stand-by power through to the load in a controlled manner when required. The regulator is set to conduct if the output voltage falls to 50.4 V and therefore dissipates power only exceptionally under failure conditions. Twenty six cells (one more than usual) are required because, when turned on fully, the transistor regulator absorbs approximately 2 V. Additional components, shown in Fig. 3, are needed to ensure satisfactory operation under all anticipated conditions.

Both the load rectifier and the transistor regulator are constant-current limited for economic reasons, but the overload diode, connected to the 22-cell battery tap, provides a high-capacity current path to enable the blowing of distribution fuses. It also limits the forward voltage seen by the transistor regulator to approximately 12 V maximum. The reverse-current diode protects the transistor regulator from potentially damaging voltage transients on the DC distribution; it also provides a charging path from the load rectifier to the battery.

A manual by-pass link is provided to facilitate isolation of the transistor regulator for maintenance or repair. In operating the by-pass link, the rectifier output voltages are automatically reduced to maintain the plant output voltage within limits.

PROJECT MANAGEMENT PHILOSOPHY

Three important issues were decided before the development of prototype hardware was initiated:

- (a) Because the transistor regulator is connected between the load and the stand-by battery, its reliability and economic feasibility needed to be established to a high level of confidence. This has been achieved by a pilot development contract and presented no particular difficulties, though considerable de-rating of the power-stage transistors is necessary.

(b) An appropriate degree of standardization should be achieved to facilitate maintenance and bulk competitive purchase.

(c) A number of development prototype plants would be ordered to gain operational feedback before the approval of design documents and the initiation of bulk purchase.

POWER CONTROL TECHNIQUES

The rectifiers employ solid-state controllers to achieve a constant output voltage, with automatic over-current limit. Power control by thyristors, rather than by the traditional transducer method, was specified for 3 main reasons:

(a) Each manufacturer of transducers uses different design techniques and problems were foreseen in trying to obtain a standard design.

(b) Although there was no significant cost difference, thyristors were expected to become cheaper than wound components in the future.

(c) Inherent stability can be improved by using thyristor controllers, which have easily controlled time constants.

Secondary phase control is used, with all the thyristors arranged in a midpoint configuration to achieve single-way, full-wave rectification, as shown in Fig. 4.

For the regulator, a modular system of parallel-connected power transistors has been devised; Fig. 5 shows the arrangement for the 40 A rating version. The output transistors are divided into groups of 4, the bases of which are connected together and driven by another power transistor on the same heat sink. Emitter resistors are provided to promote satisfactory current sharing. The components are derated to increase reliability and the regulator can carry the plant rated current with one module (25%) removed. A different configuration is needed for the other polarity, because good quality, high-power PNP transistors are not generally available. In this case, only one PNP power transistor is employed per regulated module (see Fig. 6).

PLANT OPERATION

The various operating modes of Power Plant No. 235 are best

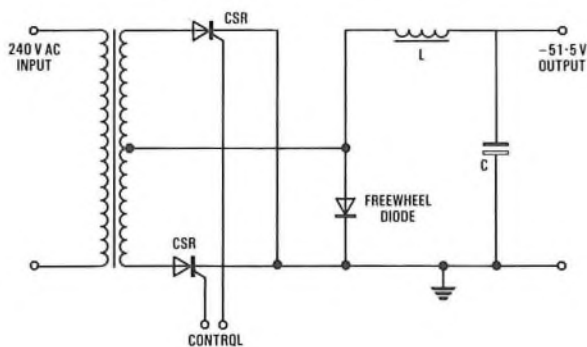

FIG. 4—Rectifier power stage and filter

described by reference to Fig. 3; the same principles apply to Power Plant No. 236, which has positive output polarity.

Normal Mode

In its normal operating mode, the load-rectifier section of Rectifier No. 156 provides load current at 51.5 V. The stand-by rectifier, which is capable of providing the same power as the load rectifier, normally only trickle-charges the battery. The transistor regulator is non-conducting.

AC Supplies Failed

Failure of the mains AC supply causes the battery to discharge via the transistor regulator. The conduction threshold of the regulator is reached when the output voltage falls to 50.4 V and, at this point, it takes over and achieves full load within a maximum response time of 30 ms. Load handover is smoothed by stored energy from the rectifier output filters. Thus, the plant output voltage is maintained within normal operating limits and no step-function changes in voltage are applied to the telecommunications equipment.

Should a total AC supply failure occur (that is, the AC stand-by set fails to start), then the transistor regulator progressively increases its base drive until the power stage is saturated. Thereafter the regulator drops only 2 V and the battery slowly discharges to 48 V after one hour giving 46 V at the plant output terminals. When the AC supplies are restored, the load rectifier takes up the prevailing load current so that the entire stand-by rectifier capacity is available to recharge the battery.

Load Rectifier Failed

Failure of the load rectifier causes the plant output voltage to fall and the transistor regulator to conduct as described above.

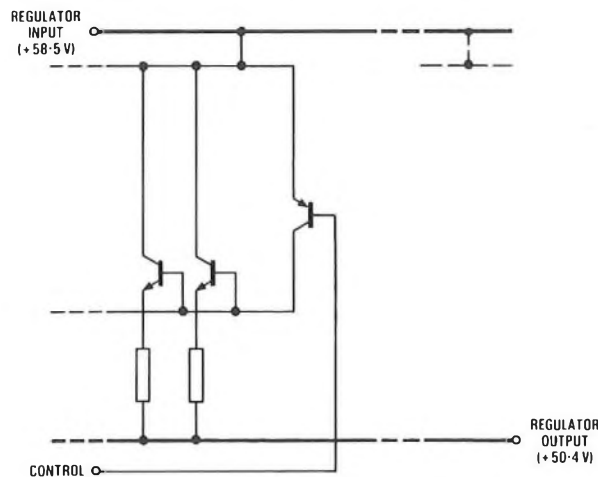

FIG. 6—PNP-NPN transform for positive output transistor regulator

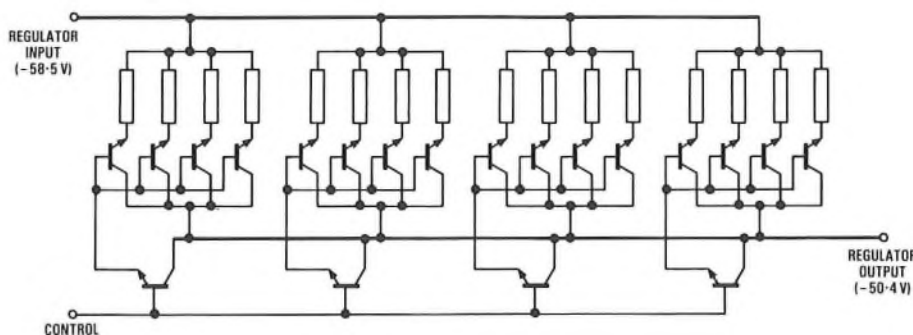

FIG. 5—Transistor regulator arrangement, Rectifier No. 156/40

The load, however, is supplied by the stand-by rectifier via the regulator. The regulator controller senses the plant output voltage and drives just enough base current into the power stage to maintain the output voltage constant at $50.4 \text{ V} \pm 0.1 \text{ V}$. In this condition, the transistor regulator dissipates maximum power, dropping 8 V unless the stand-by rectifier current limit is exceeded and the rectifier output voltage falls.

Load Rectifier Isolated

Two AC supplies are normally provided to the rectifier cubicle; the engine-backed, mains/stand-by supply is connected to the load rectifier and normal mains to the stand-by rectifier. By operating the rectifier input change-over switches, however, it is possible to patch-through the secure supply to the stand-by rectifier instead. The 2 rectifiers are therefore equally power-rated to avoid the possibility of overloading the secure mains supply. To this end, the stand-by rectifier is current-limited to 90% ($51.5 : 58.5 \text{ V}$) of the plant rating.

Regulator By-Passed

If the transistor regulator needs to be by-passed and isolated, the stand-by rectifier output voltage is automatically reduced 51.5 V ; the load rectifier output voltage is simultaneously reduced to 48 V so that the battery voltage falls, to permit insertion of the by-pass link without exceeding the plant voltage limit.

Overload

The plant configuration exhibits considerable overload capability, both long and short term. It can be seen from Fig. 7 that a long-term overload of almost twice the plant rating can be sustained, while a plant output of 50.4 V is maintained.

ALARMS AND FRONT-PANEL CONTROLS

A solid-state detector has been developed to monitor many test points throughout the plant and to initiate alarms under abnormal conditions. Electromechanical relays have thus been replaced by transistor switches and comparators, which permit a greater degree of self-checking than has been possible in the past. This detector is a self-contained unit to facilitate maintenance, and is coded Detector No. 29A for -50 V plant and Detector No. 30A for the $+50 \text{ V}$ version.

Perhaps the most interesting feature of the alarm philosophy concerns the need to know that the transistor regulator is available to conduct. A timer circuit is arranged to reduce periodically the load rectifier output voltage to 48 V , which causes conduction via the regulators at 50.4 V . If the regulator fails to conduct, load current will be drawn via the overload diode. Forward bias of the overload diode is detected by a comparator which initiates an alarm. Correct operation of the timer and all components associated with this facility can be proved by using front-panel test keys during routine maintenance.

Front-panel lamps, powered from a Detector No. 29A, are

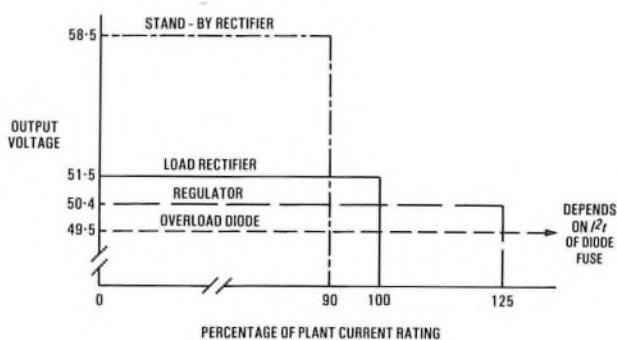
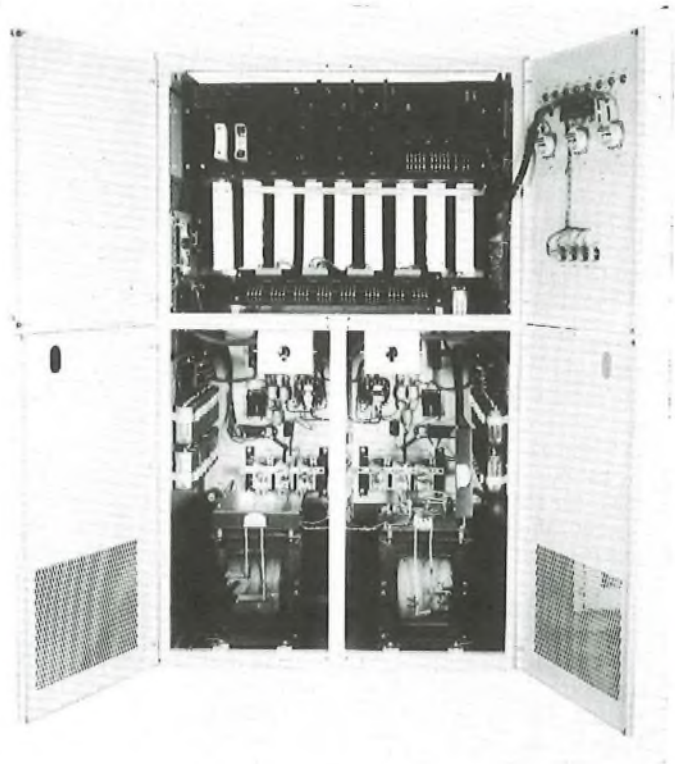

FIG. 7—Component nominal voltage/current characteristics

provided to indicate alarms associated with

- (a) failure of AC supply to load rectifier,
- (b) failure of AC supply to stand-by rectifier,
- (c) plant output voltage high,
- (d) plant overload or transistor regulator failure,
- (e) battery voltage below trickle-charge level, or
- (f) one or more fuses blown.



(a)

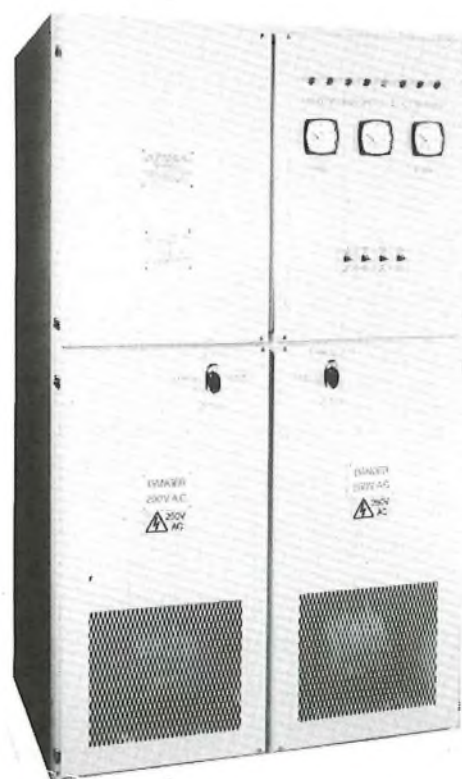

(b)

FIG. 8—Rectifier No. 156/80 cubicle

Ammeters are provided to indicate the current supplied by the load and stand-by rectifier sections. A suppressed-zero voltmeter, with its offset voltage derived by a Detector No. 29A, permits observation of the battery voltage or the plant output voltage.

FIELD PERFORMANCE FEEDBACK

A comprehensive field evaluation using pre-production prototypes has been invaluable in proving the plant's performance, serving many types of equipment in various operating modes. Early installations highlighted the need for fast rectifier response to avoid voltage instability under fluctuating load conditions. Considerable effort was needed at this stage to account for the opposing constraints of high gain for good regulation, minimal response time and stability in all operating modes.

Mechanical refinements have also been effected since the early prototypes were installed. Feedback from on-site installation and maintenance experience has resulted in a single, partitioned cubicle which houses all plant components except the battery. Terminations are conveniently made at the top of the cubicle so that installation is quick and simple. Figs. 8(a) and 8(b) show a typical cubicle arrangement.

Approximately 25 exchanges are now supported by Power Plant No. 235 and/or No. 236 and have accumulated approximately 350 000 plant-hours of virtually trouble-free operation. Design documents were approved after 100 000 plant-hours, and more than 450 rectifiers are being manufactured in 1981 to meet orders from regional power planning groups.

CONCLUSION

The design and development of Power Plant Nos. 235 and 236, together with some of the associated ideas and problems that have to be considered before the hardware stage is reached, have been described in the first part of this article. These new power plants are fully automatic in operation, including the self checking of vital components, and require no routine battery charging. They are simple and convenient to install and a parallel-operation option is available. Standard control circuits are used for improved maintenance. More effort has been made to test the new plants in service than any of their predecessors, and central purchase has now been initiated. They promise to find wide acceptance as a convenient and reliable source of 50 V telecommunications power. Part 2 of this article will describe a new standard range of 240 V AC stand-by power plant.

ACKNOWLEDGEMENTS

Thanks are due to the staff of Cayson Engineering Ltd., Harmer & Simmons Ltd and Brentford Electric Ltd., developing contractors for the rectifiers. The assistance of the many BPO colleagues who have contributed to the development and evaluation of the new plants is acknowledged with thanks.

References

- ¹ PINE, R. Telecommunications Power Supplies—The Next Decade, Part 1—Introduction. *POEEJ*, Vol. 64, p. 2, Apr. 1971.
- ² POR 2511 Issue 1: Telecommunications Equipment Interface with a Negative 50 V DC Power Supply.

Post Office Press Notice

BUSINESS SATELLITE TRIALS TO START THIS YEAR

This autumn, British Telecom will start supplying customers with small dish satellite aerials for commercial trials. The terminals, to be supplied by Ferranti, will be used for commercial trials in preparation for a new satellite communications service with Europe, planned to start in 1983. The aerials will be used in developing and testing the new communication techniques and devices needed for the new service, which will pave the way to a new era in which the nation's businessmen will be able to communicate within Britain and with Europe directly through small aerials placed on their own rooftops, or parked beside their offices.

The new service is expected to be used principally by large business organizations with their own internal communication networks, and other businesses, such as the news media, with specialist requirements.

Benefits to customers of the new satellite service will be three-fold:

(a) Flexibility: service can be introduced at very short notice—by using mobile aerials if necessary—and expanded or reconfigured equally quickly; additional high-speed capacity can be allocated for short periods.

(b) Diversity: digital operation allows many different services—speech, Telex, facsimile, or computer data—to be integrated on the same transmission path, and more advanced services, such as video conferencing, word processing, electronic mail, high-resolution facsimile, high-speed data, can be added quickly at comparatively little extra cost.

(c) Multi-destination broadcasting: a facility of particular advantage for one-way information flow (for example, news dissemination to branch offices for local distribution).

The service is made possible by an agreement reached by European telecommunications authorities in EUTELSAT. British Telecom played a key part in the negotiations. EUTEL-

SAT will provide capacity in 2 satellite systems: European Communications Satellite (ECS) made by a consortium headed by British Aerospace working for the European Space Agency; and Telecom 1, a French government project which will also provide various domestic services for France. The combined EUTELSAT system will cover Europe from the Shetlands to Gibraltar, and from Sweden to Greece. Two complementary transmission techniques will be available: time-division multiple-access (TDMA) and frequency-division multiple-access (FDMA); together they can provide a wide range of services.

The cost of providing the combined satellite capacity for these small-dish applications is expected to be about £55 M, shared between the telecommunication authorities of western Europe. British Telecom's share is expected to be around £5 M, depending on customer use. Small-dish earth-station costs will depend on several factors, including volume of production, but fully equipped TDMA terminals are likely to cost around £250 000, while FDMA terminals could cost less than half as much, and could be very much cheaper if they are needed only for receiving signals.

British Telecom's charges for the new service will aim at covering costs and providing a reasonable return on investment. It is likely that the rate charged will be independent of distance, and therefore unrelated to existing charges for terrestrial private leased circuits in Britain and to Europe.

As a further step towards the fully digital terrestrial network of the later 1980s, British Telecom will also be offering by 1983 new terrestrial services within the UK. In the first instance, these will be private circuits specially designed to meet the needs of non-voice services such as high-speed Telex, computer data and facsimile. They will be available in most large towns progressively from 1983 onwards.

These private-circuit digital data services (PCDDS) will be able to link satellite customers to neighbouring earth stations. More generally, they will provide direct digital customer-to-customer connexions.

AMBLE: Automatic Memory-Board Loading Equipment

R. W. ELSON†

UDC 621.395.2 : 621.374 : 681.3.06

This article describes the automatic memory-board loading equipment which has been designed to allow rapid programming of the Monarch 120 PABX¹, and which can be used to perform basic functional tests on these boards and to display data contained in the programmable-read-only memories.

INTRODUCTION

The advent of the British Post Office's (BPO's) first private automatic branch exchange (PABX) using stored-program control (SPC) brought a need for rapid and reliable programming of the programmable-read-only memories (PROMs) that contain the system's software. Each of the main memory boards, *memory-one* and *memory-two*, hold 24 PROMs, and it is necessary to be able to program these without the need to remove them from the board.

Fig. 1 shows how the memory of the Monarch 120 is structured, and the areas which have to be programmed by the automatic memory-board loading equipment (AMBLE).

FACILITIES REQUIRED IN AMBLE

It was necessary for AMBLE to be able

- (a) to transfer data from either the master PROM or the

† Product Development Unit, Telecommunications Headquarters

random-access memory (RAM) into PROMs known as *customer PROMs*,

(b) to display data from given locations on either the master bus or the customer bus,

(c) to accept data to form the customer's database (site related information) either as a paper-tape or as a modem input from a mainframe computer,

(d) to verify the accuracy of programmed data by comparing the master and customer busses,

(e) to accept and send high-level messages via a visual display unit (VDU) which forms the man-machine interface, and

(f) to be self-contained and powered from a 13 A mains socket outlet.

DESIGN CONSIDERATIONS

It was obvious at the planning stage that AMBLE was going to overlap with the Monarch 120's design in respect of addressing the memory boards; it was therefore decided that a suitably modified Monarch 120 control shelf would form the basis of AMBLE. Fig. 2 gives an overview of AMBLE's

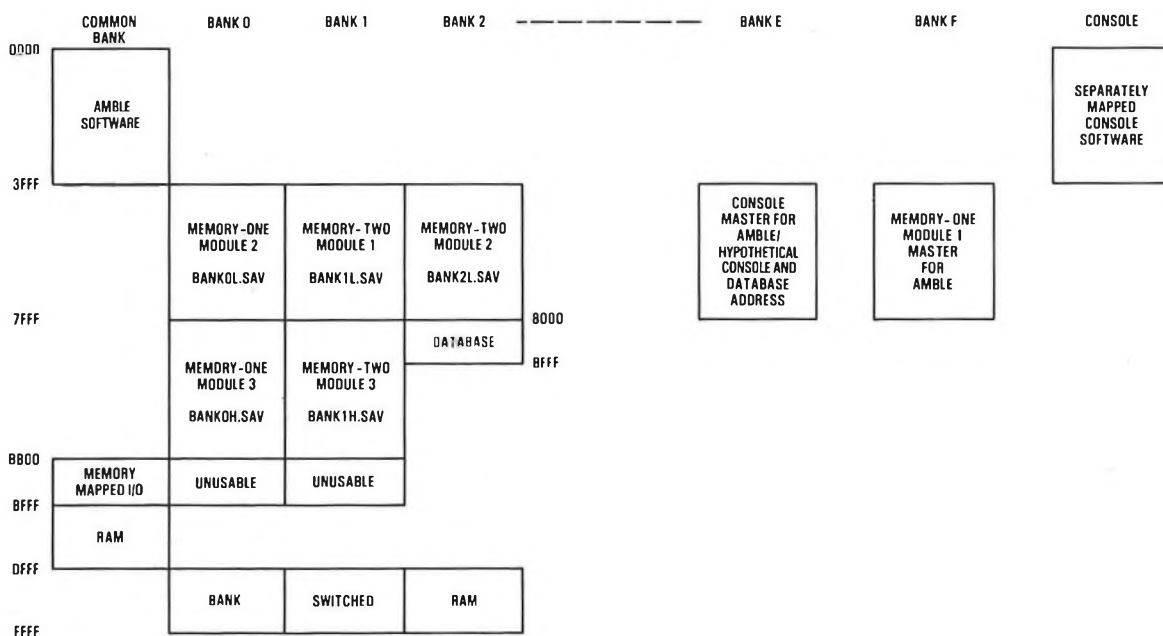

Note: The SAV files are held on floppy-disc
I/O: Input/output
RAM: Random-access memory

FIG. 1—Monarch 120 memory map as configured for AMBLE

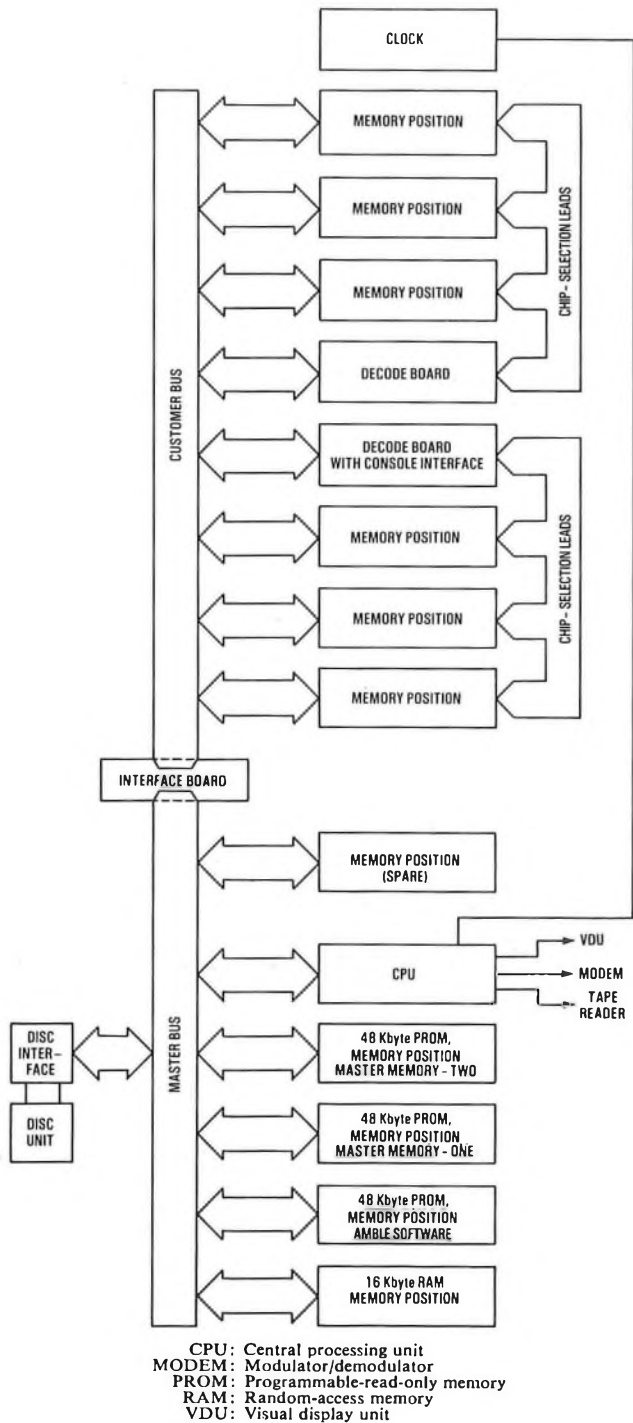

FIG. 2—Block diagram of the AMBLE bus structure

design and shows the split bus structure (that is, the master bus and the customer bus). In the existing design, the software to control AMBLE and the master copy of the software to be programmed are contained on Monarch 120 PROM boards. However, work is well in hand to integrate an 8 in floppy-disc drive into AMBLE; this will then replace these boards and allow for new facilities to be added.

REALIZATION

The Monarch 120's memory is addressed by 16 address lines giving access to 64 Kbyte of memory. There are 4 additional address lines known as *bank-switching address lines*; thus 16 separate banks may be addressed to give a total of 64 Kbyte \times 16 locations. The PROMs are partitioned by hardware into 16 Kbyte modules which can be set by switches to any bank number and 16 Kbyte address range. Practical

considerations prevent the use of all locations: in order that the microprocessor may access some locations (interrupt handling, returns etc.), some modules have their switches set so that the bank address is ignored. The address range covered by that module is then considered as *common bank* and cannot be used elsewhere in the memory map; that is, it appears only once, not 16 times (see Fig. 1).

One main problem occurs when an attempt is made to copy a PROM board; the master and customer PROMs are accessed by the same address and cannot, therefore, be present (or at least active) at the same time on the same bus. Although it would have been possible to change the addressing of the master board, this was considered undesirable, and the solution shown in Fig. 2, and explained below, was adopted.

A further problem was that AMBLE software itself had to be located at common bank, address 0000, so that interrupts etc. could be serviced. There was no rational alternative to this overlap with the Monarch's memory map other than to switch the Monarch module on the master bus to a spare location, and to provide an offset back to the correct address in software for the customer bus.

The Interface Board

The purpose of the interface board is to allow the microprocessor to control 2 discrete busses; it is in fact a set of memory-mapped 8-bit transistor-transistor logic latches, together with a voltage regulator and a monostable to provide the programming pulses (see Fig. 3).

In operation, the data latches are addressed by the master bus; a *write* signal is sent, and this latches the byte which is currently on the master data bus into the latch. The outputs of the latch are connected to the customer bus. Five latches, each having a unique address, are used to establish the address, bank, data and command leads on the customer bus. A similar method is used to capture data being returned from the customer bus and to allow handshaking to take place.

To allow maximum flexibility of AMBLE, 2 interface boards are available. One has the input and output sides of the board connected by wire jumpers so that the interface can be configured for projects other than the Monarch 120; the other is fully connected by the copperwork for use on the Monarch 120 project, the requirements for which are now well defined.

Programming Protocol

The PROM devices currently used are the 2716 type (2 Kbyte \times 8 bits) which can be erased by exposure to an ultra-violet light source. They are programmed by setting the address and data leads and by raising the appropriate lead to +25 V; the chip-enable lead is then raised to a logic high state for 50 ms. As a Monarch 120 has 2 PROM boards (6 \times 16 Kbyte modules), it was decided to design AMBLE so that one Monarch 120 system could be programmed without operator intervention. Each of the 24 PROMs on

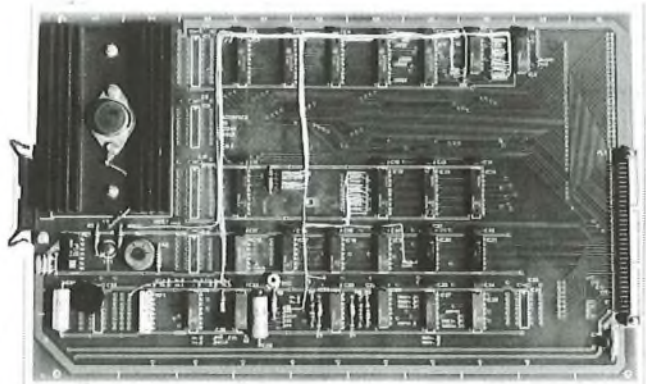

FIG. 3—Configurable interface card showing wire jumpers

each board has its chip-enable lead brought out to the edge connector and these leads are bussed for 4 slots on the AMBLE backplane; that is, half the customer bus. In order to select the correct PROM to be programmed, a decode board is plugged into each half of the customer bus.

The Decode Board

The decode boards have the same type of switchable address decode modules as those on the PROM boards, except that the address decoding on the PROM boards gives an active low output (the READ condition) and is available only on read cycles. The AMBLE decode boards have an active high output (the PROGRAMMING condition) and are available only on write cycles. The outputs from the decode board are connected to the chip-select leads of the PROMs on the 48 Kbyte boards via the backplane.

The Programming Cycle

When a location is to be programmed, the first signal applied to the customer bus is a write signal, which turns on the output stages of the decode boards. At this time, the decode modules themselves are disabled, so all their outputs are high owing to pull-up resistors. The output buffers are inverting, forcing all chip-select leads low; thus no PROM is in the PROGRAM mode. It is, therefore, safe at this stage, to connect the 25 V programming supply to the backplane, and this is achieved by sending a command to the interface board.

Addresses, data and the read command are now put out on the customer bus and allowed to settle. The next command sent to the interface board is prog, which fires the monostable, to turn on the decode modules, and thus select the correct PROM for 50 ms. This is the programming pulse. All commands are now removed from the customer bus with the exception of the write command. As at the beginning of the programming cycle, the write lead is used to force all PROMs into a PROGRAM INHIBIT state. If this was not done, all the PROMs would go into PROGRAM mode (because they are not selected for READ) and the 25 V supply would not have decayed sufficiently to prevent data corruption, typically of the first location in every PROM.

USING AMBLE

When AMBLE is turned on, a menu of commands is displayed at the VDU, and it is necessary to plug in only 2 correctly switched erased PROM boards and to enter a P (for program) at the VDU. AMBLE then asks for a further parameter to specify the range of locations to be programmed. This parameter may be a software release number, enabling AMBLE to use its internal Monarch 120 memory map to program a complete board or a pair of boards, or an address range if only certain locations are to be programmed.

AMBLE then validates the data held on the master boards, ensures that the customer board(s) are erased, and sends a message to the VDU if an error is found or if a board is missing. If all is well, programming commences. The first location to be programmed is again checked for erasure and the master location read; if it contains FF (the erased condition), no further action is taken and the next location is accessed. If information is to be programmed, the programming pulse is applied, as described earlier, and the customer location verified; AMBLE then steps to the next location, and so on, until the desired range of addresses has been programmed. All locations are then verified again. Messages are displayed as each module is programmed and also as they are verified.

Verification and display of data are carried out by similar command sequences with a menu being displayed as necessary to guide users through commands and sub-commands (see Fig. 4).

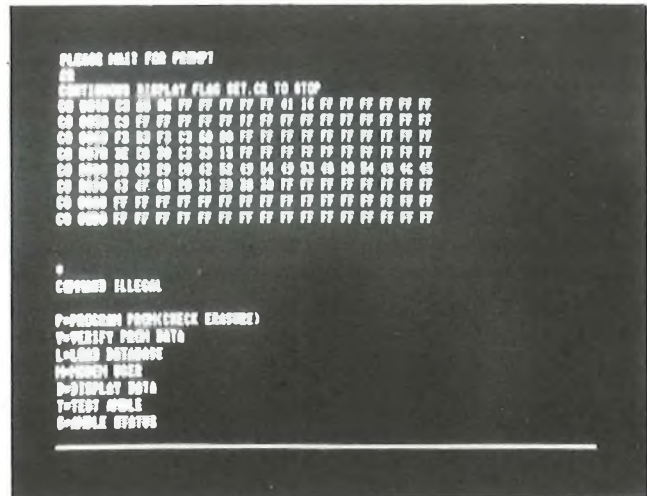

Fig. 4—Display of data in common bank 0040H to 008FH and the command menu

PROGRAMMING OF CONSOLES AND DATA-BASES

To program the PROMs in the console² it is necessary to gain access to the console bus structure; this is achieved by using a header in the microprocessor socket of the console board.

The customer's data-base is contained in a 4 Kbyte PROM, soldered to a small daughter-board of approximately 60 mm square, which plugs into a RAM board on the Monarch 120. So that AMBLE can access and program these areas of memory, a special interface board is needed (see Fig. 5). This takes the form of a decode board with an additional module of address decoding which is gated with a control lead to determine whether the console or the data-base is being accessed. In this manner, both the console and the data-base can be considered to share the same address in a spare location, namely bank E 4000H upwards, although this can be set as necessary by switches.

For the same reasons as stated previously, a hardware offset is provided on the AMBLE board because the console software, which has no bank switching, is located at address 0000. The board also converts the 8080-bus structure of the AMBLE backplane to the 8085-bus structure of the console. The interconnection between AMBLE and the console is made by a ribbon cable which plugs into a D-type connector on the front of the AMBLE board, whilst the daughter-board plugs in by means of the connector which normally connects it to its parent RAM board.

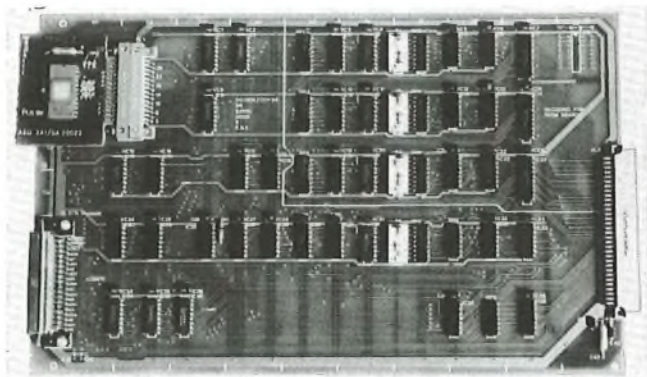

Note: The DIL switches for setting module addresses and the 37-way D-type connector for the console card

Fig. 5—Console and database interface board showing daughter-board in place

PARALLEL PROGRAMMING

The first AMBLES have now been produced and are being used by the BPO's installation workshop at Bridgwater³ and by Plessey and GEC to program Monarch 120 PABXs.

The manufacturers prefer to program several memory-one boards at once followed by several memory-two boards etc. This is easily accomplished by plugging appropriately switched boards into every available slot on the customer bus. In this manner, 3 of each type of board may be programmed or, if both decode boards are set identically, 6 similar boards may be programmed.

This is permissible provided that the power supplies have sufficient output. But there is one major disadvantage: if any PROM is faulty, the programming stops because of failure at the first verification, and manual intervention is necessary to identify the faulty board. Thus, the time saved by programming in this manner is lost. In order to overcome this problem, small outrigger boards could be fitted to each slot on the customer bus. These would enable boards to be switched out of the bus under software control; thus, the faulty board could be identified and programming of remaining boards, if

any, could be continued. A message identifying the exact PROM considered to be faulty would be output. This and other enhancements, such as the floppy-disc drive, will be considered as soon as the basic AMBLE is in production.

ACKNOWLEDGEMENTS

AMBLE has been designed and built over the last 3 years by BPO staff in the Product Development Unit of Telecommunications Headquarters. The author would like to acknowledge the help given to him by his colleagues and by Chemigraphics Ltd., who have produced all the printed wiring-board layouts and prototypes.

References

- ¹ POTTER, A. R. Monarch 120—A New Digital PABX. *POEEJ*, Vol. 73, p. 14, Apr. 1980.
- ² WILLETT, G. The Operator's Console for the Monarch 120 Digital PABX. *POEEJ*, Vol. 73, p. 138, Oct. 1980.
- ³ BRASSIL, T. G. Monarch 120: A Central Installation-Workshop Facility. *POEEJ*, Vol. 73, p. 176, Oct. 1980.

Book Reviews

Radio and Electronics for Technician Engineers. D. A. Jacobs, B.Sc. McGraw-Hill. xii + 295pp. 239 ills. £3.95.

The author states in his preface that his purpose in writing this book was to bring together, and treat at the correct level for technician engineers, a range of topics which cannot be found in any other single book. The author may have achieved his aim, but the student will still require more than this book to obtain a full coverage of the subject. For example, the first chapter deals with circuit theorems, but Kirchhoff's laws do not receive a mention; interstage coupling methods and their effect on overall bandwidth in cascaded amplifiers could have been included; the subject of aerials has not been covered at all.

The author also states that the mathematical content of the book has been limited to the level of understanding of technician engineers who may be independently studying City and Guilds of London Institute (CGLI) courses or Technician Education Council (TEC) courses, but he has made no attempt to relate this content either to CGLI or to TEC syllabi. He assumes that the student will be competent in the use of j operator and some elementary calculus, neither of which are studied by telecommunications technicians taking a TEC course until they reach higher certificate studies.

The book contains chapters on circuit theorems, power measurement and attenuators, capacitor-resistor networks, negative feedback, sinusoidal oscillators, relaxation oscillators, voltage stabilization, miscellaneous circuits (mainly limiter circuits), demodulation, and field and line output circuits. Each chapter includes worked examples and concludes with ten problems and their answers.

Students may find the use of a dot instead of a multiplication sign in some places confusing; otherwise, the material

is well presented with clearly drawn diagrams. The book will be useful to technician students, but will require to be supplemented from other sources.

R. HARVEY

Analog Integrated Circuits. M. Herpy. John Wiley & Sons Ltd. 479pp. 340 ills. £17.50.

This book presents useful information on many aspects of integrated analogue circuits. Beginning with an outline of the basic circuit elements, the author moves on to discuss the relevant aspects of circuit theory and configurations that are useful to the device designer, and to summarize the commercial devices that are available. He presents a short study of applications which includes many practical circuits and some design information; he devotes the final chapters to an interesting study of the use of analogue multipliers for general-purpose non-linear circuits.

The wide range of information contained in this book makes it a very good introductory text for engineers and students of this complex subject. However, it may have less to offer the specialist; for example, the section on filters is particularly limited. Undoubtedly, in terms of applications the most outstanding feature of the book is the author's thorough treatment of the various kinds of non-linear circuits that are used so much in the field of signal processing.

Perhaps the most unfortunate aspect of the book is the attention which the author gives to devices currently available, because devices inevitably date very quickly. In fact, this process has probably already begun since, as the book had to be translated, many of the devices described by the author are now being superseded by superior types of device.

J. W. COOK

The Soil as an Engineering Material

Part 1—Soil Properties

D. G. CLOW, C.ENG., F.I.MECH.E., F.R.MET.S.†

UDC 624.1: 551

The nature of the soil has a major bearing on the design of many aspects of telecommunications plant. Part 1 of this article describes the basic features of the soil and its behaviour under applied loading and during construction work. Part 2, to be published later, will describe how soil properties have played a major role in the design and construction of British Post Office plant.

INTRODUCTION

Telecommunication involves the use of a wide variety of structures which rely on the ground for support, for example, buildings, satellite earth station aerials, radio masts and towers and the ordinary telephone pole, or the structures have to resist forces imposed by the soil, for example cable tunnels, jointing chambers and ducts. An adequate appreciation of the properties of earth materials is necessary to ensure that such structures during construction and in use will be economic, serviceable and safe. The effective and safe operation of electrical and radio equipment relies on the provision of a good electrical earth.

Failure to take sufficient account of the behaviour of soils and rocks is manifested in many ways; for example, major but often avoidable cost escalations occur during construction as unanticipated foundation problems occur, completed buildings suffer damage from excessive or uneven settlement, and the risk to life arising from the collapse of the sides of excavations and trenches.

The relevant academic subject dealing with the borderland between civil engineering and geology is known as *geotechnology*, which is biased either towards soil (or rock) mechanics as a branch of applied mechanics or towards engineering geology, which draws attention to the geological connexion.

The geologist looks at earth materials in terms of their origin, composition, formation through time and their economic potential. The engineer is primarily concerned with their properties as engineering materials, the loads they can carry or exert and their deformation under applied load. The distinction between engineer and geologist cannot be too sharply drawn, and those involved in civil engineering require a working knowledge of a number of aspects of geology to facilitate their work.

Earth materials are distinguished from other materials utilized by engineers in that they are characterized by a great variability in their physical properties and the marked time-dependency of these properties. The inherent uncertainty about material properties poses special problems for the engineer, and it is found that, in the theoretical aspects of geotechnology, much greater dependence tends to be placed on empirical methods than is the case in other branches of mechanics. Case histories play an important part in increasing knowledge of soil and rock behaviour.

CLASSIFICATION

Earth materials are divided broadly into *rock* and *soil*; rock being a coherent material that is either crystalline or cemented, and soil being an uncemented material. These descriptions do not prejudge strength; for instance, a strong soil may carry

a load much better than a weak rock.

The term soil needs further explanation as it has different connotations. In agricultural science, soil is that part of the earth's outer crust which will support vegetable and animal life and which extends at most to 1.5 m below the surface. Soil in this context is characterized by a substantial proportion of organic material in the form of humus. To the engineer this top soil is a most unsatisfactory material, for it is highly deformable and leads to massive and unpredictable settlements under load. The engineer's use of the word soil is what an agriculturalist would regard as subsoil.

Soil is the product of weathering of rock either at or below the earth's surface and is the result of physical, chemical or biological attack of the parent rock. It may be formed either *in situ* or deposited after transportation from elsewhere.

Although rock is defined as a cemented material, it is unlikely that the rock encountered in telecommunications work will be a continuous mass but one which is fragmented to a greater or lesser extent by the presence of fissures and joints. If these joints are open or filled with soft material, then the behaviour of the rock will be governed much more by the size and rate of occurrence of these joints than by the characteristics of the rock itself. The presence of joints is important in relation to the ease of excavation and is significant with respect to the flow of water through rock masses.

Two other categories of earth materials need brief mention. The first is *peat*; this is composed almost entirely of organic matter. The problem with it is that it possesses an extremely high compressibility, reducing to as much as one tenth of its original volume when subjected to load. Although roads and railways have been constructed across peat bogs, they must be regarded as exceptional structures and peat in normal circumstances is an entirely unsuitable material to carry load. The other category is *made ground* or *fill* which is most commonly encountered in urban areas; this can consist of a variety of materials with potential problems of excessive settlement of inadequately-compacted material, spontaneous combustion of organic material, the release of noxious gases or liquids, or the presence of chemicals liable to attack the concrete of foundations and other buried plant or give rise to safety hazards.

Soils are classified in British Standards (BS 1377) by basic particle size as shown in Table 1.

TABLE 1
Particle Sizes in Soil

Type	Range of Particle Size
Stone boulders	> 200 mm
Cobbles	200–60 mm
Gravel	60–2 mm
Sand	2–0.06 mm
Silt	0.06–0.002 mm
Clay	less than 0.002 mm

† Transmission Department, Telecommunications Headquarters

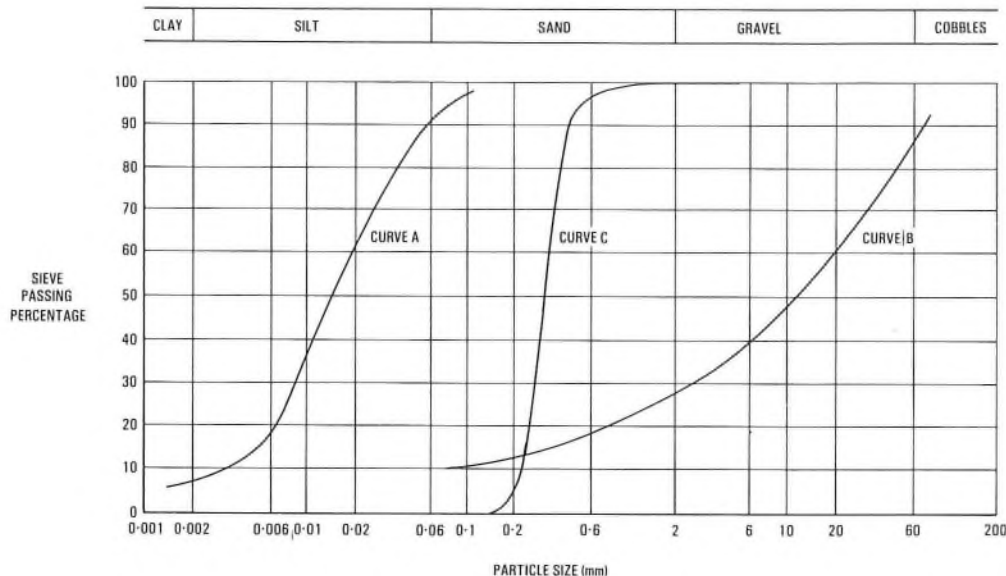

Curve A: Madley Satellite Earth Station site—clayey silt deposited in quiet waters of glacial lake
 Curve B: Madley Satellite Earth Station site—sandy gravel deposited by fast-flowing glacial meltwaters
 Curve C: From site of projected offshore radio tower on North Sea sandbank

FIG. 1—Results of soil particle analysis by sieving

TABLE 2
Visual and Tactile Tests for Soil Recognition

Type	Strength	Recognition Features
Cohesive clays, silts	Very stiff and hard	Brittle or very tough
	Stiff	Cannot be moulded in the fingers
	Firm	Can be moulded in the fingers by strong pressure
	Soft	Easily moulded in the fingers
	Very soft	Exudes between the fingers when squeezed in the fist
Non-cohesive gravels, sands	Compact gravel or compact sand and gravel	Requires pick for excavation, difficult to drive a 50 mm peg in for more than a few inches
	Medium dense gravel, medium dense sand and gravel, or compact sand	Difficult to excavate with a shovel
	Loose gravel, loose sand and gravel, or medium dense sand	Can be excavated with a shovel, 50mm peg driven in easily
	Loose sand	Easily excavated with a shovel
Other	Peat	Fibrous black or brown organic material
	Topsoil	Capable of supporting plant growth
	Fill or made ground	Refuse or excavated soil or rock dumped to fill excavations or to raise ground surface level

Gravels, sands and silts are commonly further sub-divided into coarse, medium and fine. As composite soils commonly

occur with a wide range of particle sizes and proportions, further sub-classifications proliferate. However, it is more informative to the engineer to present the details of a particular soil by particle-size distribution curves of which typical examples are shown in Fig. 1.

For preliminary identification in the field, a simple series of visual and tactile tests is useful as exemplified in Table 2.

COHESIVE AND NON-COHESIVE SOILS

A fundamental division exists between *cohesive* and *non-cohesive* soils as this distinction marks a basic change in important mechanical properties. In the particle size classification of Table 1, only the clays fall into the cohesive category, the others being non-cohesive. The difference in behaviour between the 2 types of soil is best described in terms of the most important engineering property of soils, namely *shear strength*.

If a shear stress is applied to a non-cohesive soil, then the resistance to shearing will be provided by friction between the interlocking particles of soil. It will be apparent that as the compressive force is increased, the shear strength will also increase as the particles are forced into more intimate contact, thereby increasing the frictional resistance.

When the particle size becomes very small indeed, as with clay minerals, then the shear strength depends solely on cohesion between the particles and not on friction, and the soil possesses shear strength even in the absence of any compressive force. This cohesion results from an intermolecular bond between the absorbed water surrounding each particle and the particle itself.

A significant feature of clay soils is that their volume alters according to their water content. This phenomenon has a number of practical implications; for example, during the 1975–1976 drought the drying-out and resultant shrinkage of clay soils gave rise to a high incidence of damage by subsidence to buildings with shallow foundations.

A clay which has been consolidated under normal conditions and which has a water content appropriate to the present amount of overburden is called a *normally-consolidated* clay. However, a large proportion of clays encountered in the UK has a water content much less than this—these are called *overconsolidated*, the London clay being a well-known

example. An overconsolidated clay is one which after deposition was buried under a thick overburden of sediment or ice which has compressed the clay and expelled some of the water content. Subsequently when the excess sediment was eroded, or the ice melted, the amount of overburden was greatly reduced and so the pressure was reduced on the underlying clay. The clay then tends to return to a volume appropriate to the reduced pressure; but it could only expand in the vertical direction as it was still constrained horizontally. The water content increased, but not to the same extent as to match that lost during consolidation; so the clay is now denser and stronger than it would have been if it had not been buried deeply. Such clays tend to be heavily fissured as a result of the vertical expansion. If an excavation takes place in overconsolidated clay, the constraint against horizontal expansion is removed; if the excavation is left open, then in time the clay will slowly revert to the normally-consolidated condition and the shear strength will be reduced accordingly. This may result in delayed failure of initially-stable slopes of cuttings or sides of excavations, sometimes many decades after their construction.

Some clays are termed *sensitive* because, when they are disturbed, they exhibit a marked loss in shear strength compared to the strength in the undisturbed state. This phenomenon can make for considerable difficulty in obtaining realistic results from soil testing, and in construction operations. The effect results from the disturbance to the naturally-developed

microstructure of the soil and is characteristic of clays laid down in marine conditions.

THE INFLUENCE OF WATER ON SOIL BEHAVIOUR

Soil is a material formed from solid particles in contact but, as the contacts are imperfect, voids (or pores) exist between the particles. The ratio of the volume of voids to the total volume is called the *porosity* of the sample. These interconnected voids are likely to be filled partially or completely with water. The presence of pore water is very important in determining the properties of the soil as an engineering material since the water content has a direct impact on the strength of soil to support loads, the amount and rate of settlement, the stability of slopes or sides of excavations, the extent of hindrances to construction arising from wet excavations, and its electrical resistivity.

The pores in the soil are likely to be fully saturated when they are below the level known as the *water table*. The water table level at a given site is usually fairly constant although seasonal fluctuations do occur. The level of the water table is determined by the balance of gravity and atmospheric pressure. Any excavation which penetrates the water table will inevitably lead to the ingress of water.

The effect of pore water on the settlement of structures can be appreciated by referring to Fig. 2, which illustrates an idealized situation. Fig. 2(a) shows a confined volume of soil in

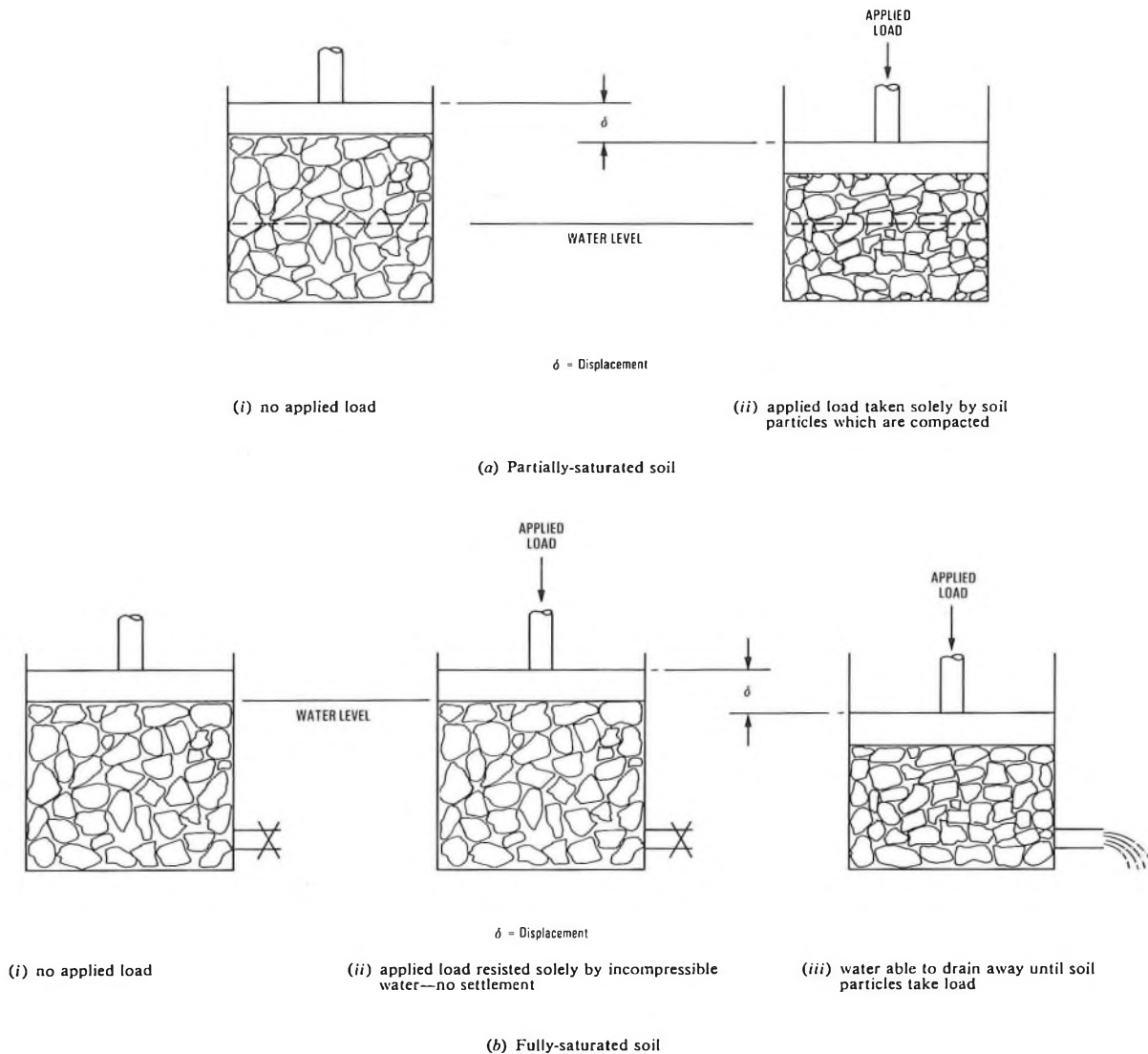

FIG. 2—Models of settlement under applied load

which substantial airspace exists; that is, above the ground-water level. A downward force applied to the volume rearranges and compacts the soil particles, giving rise to settlement, with little or no alteration to the pore water pressure.

In Fig. 2(b), the soil is fully saturated and all inter-particle spaces are filled with water, and any compressive force that is applied will be resisted almost entirely by the incompressible water; thus there will be no settlement. If, however, some of the water is able to escape so that ultimately a pressure appropriate to its natural pressure head is reached, then settlement will occur as the load is transferred entirely to the soil particles as shown in Fig. 2(a). The rate at which settlement occurs will then be largely dependent on the rate at which the excess pore water pressure can dissipate. In the real case the water can escape by seepage into the surrounding soil. The rate at which water can travel through a given soil or rock is called *permeability*. In a granular soil, which is very permeable, settlements occur almost instantaneously as the water can escape readily. In an impermeable clay location measurable settlements may continue for many years.

Table 3 gives typical values of the coefficient of permeability k , which is defined as the *rate of flow per unit area of soil under unit hydraulic gradient*.

TABLE 3
Typical Values of the Coefficient of Permeability

Type of Soil	Coefficient of Permeability k (mm/s)
Gravels	1000–10
Sands	10–10 ⁻²
Soils	10 ⁻² –10 ⁻⁵
Clays	10 ⁻⁵ –10 ⁻⁹

Where the soils are predominantly sandy or gravelly, it is not unknown for the water level in underground jointing chambers to rise and fall with the tide. At the other end of the permeability scale, clay is often used as a seal to prevent leakage from reservoirs and canals. It must be noted that high porosity of a rock or soil does not necessarily lead to a high rate of flow of water through the soil; clay, for example, has moderately high porosity but very low permeability. High permeability however is a characteristic of the more porous materials.

CONTROL OF WATER IN EXCAVATIONS

When the inflow of water to an excavation is a problem, a variety of remedial measures are available if straightforward pumping will not cope with the inflow. Sheet-steel piling driven into the ground can cut off the flow provided the water is not entering through the floor of the excavation, see Fig. 3(a). Alternatively, wellpoint control can be used; this consists of sinking a number of small diameter wells around an excavation and then pumping water from these as shown in Fig. 3(b). This has the effect of locally lowering the water table. Such a solution must be used with caution, however, as the removal of ground water could lead to damage by settlement of the adjacent buildings. A more drastic and expensive solution to the control of water is to resort to ground freezing: the ground is frozen around an excavation to provide an effective temporary barrier to the flow of water. This method is, however, slow to implement and the engineer has to be careful to ensure that the other structures nearby will not be damaged by frost heave. Fortunately, concrete can be cast up against frozen ground, as only a few millimetres of the concrete in direct contact with frozen ground is likely to suffer any damage. Ground freezing is particularly useful in deep level tunnel construction. Another method of sealing off water is to inject the soil surrounding an excavation with a cement grout to create an impermeable curtain, as in Fig. 3(c).

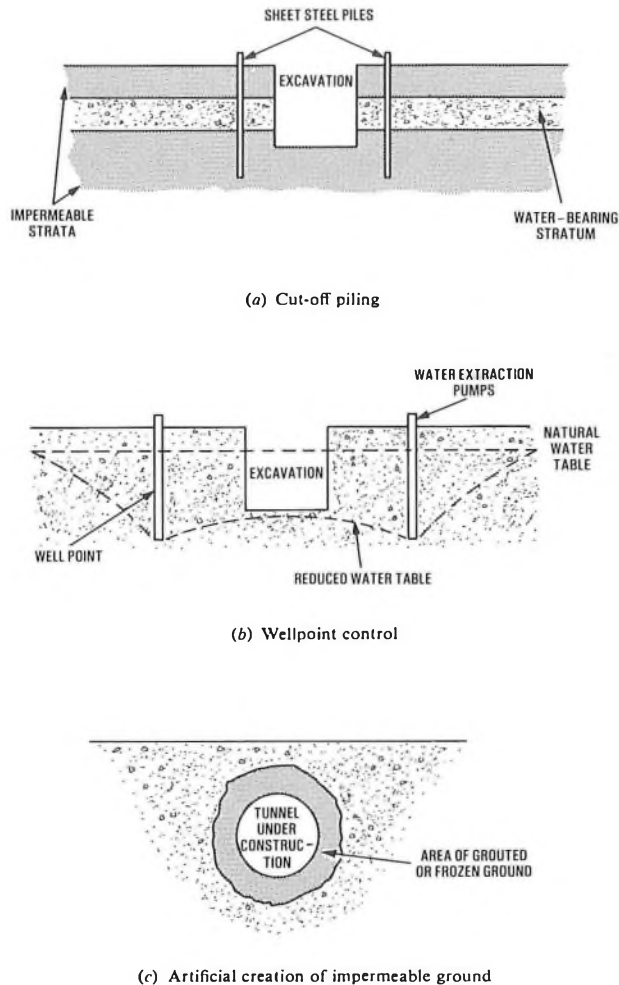

FIG. 3—Methods of controlling inflow of water to excavations

STRENGTH OF SOILS

Many of the customary concepts of strength of materials can be applied to soil to predict its behaviour under load. Rock and granular soils commonly behave in an elastic manner and deformations under load will substantially recover when the load is removed. It is therefore possible to obtain the Young's modulus for a given rock or soil. Cohesive soils, however, behave in a plastic manner and a different approach is necessary.

The most useful parameter in soil strength analysis is shear strength. From the value of shear strength, the ultimate strength under compression can be determined by using semi-empirical methods. If an increasing force is applied to an area of soil, it is considered to have failed in compression when the settlement rate begins to increase rapidly. This point is known as the *ultimate bearing capacity* of the soil. For design purposes the engineer needs to have a value of bearing pressure which has an adequate factor of safety applied to it to cater for doubts about the true nature of foundation loads or the soil's resistance to these loads. The factor of safety used is typically 3; that is, a value of one third of the ultimate strength is used for design purposes.

Table 4 lists typical bearing values for a representative range of rocks and soils. It will be noted that there is a large variation of the values even within the same general type of material.

The soil under a foundation will be most highly stressed at the soil/structure interface and the stress levels will reduce away from this interface. A useful conceptual model for visualizing this dissipation of stresses through the soil is illustrated in

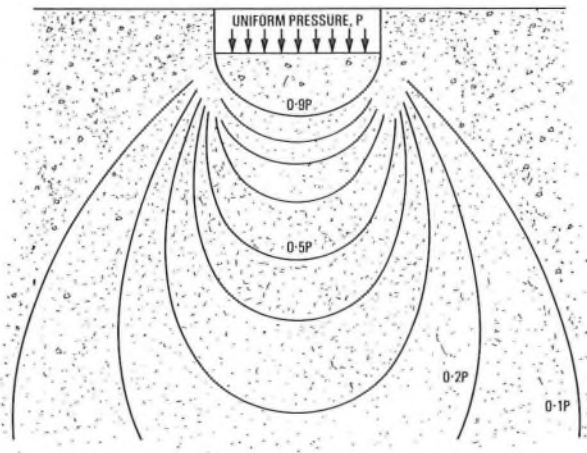

FIG. 4—A typical bulb of pressure showing contours of equal stress beneath a strip foundation

TABLE 4
Typical Allowable Bearing Pressures

Group		Bearing Pressure kN/m ²
Rocks	Hard igneous rock in sound condition	10 000
	Hard limestones and hard sandstones	4 000
	Hard sound chalk	600
Non-cohesive soils	Compact gravel	600
	Compact sand	300
	Loose sand	100
Cohesive soils	Very stiff boulder clays and hard clays	300–600
	Stiff clays	150–300
	Firm clays	75–150
	Soft clays and silts	75

Fig. 4. The plots of the contours of equal stress level are called *bulbs of pressure*. It will be noted that the imposed loads are also spread sideways into the soil, a fact which has to be considered when maximum permissible foundation loads are evaluated or when excavations in the vicinity of existing buildings are considered.

SETTLEMENT AND SUBSIDENCE

Broadly speaking, *settlement* is movement of a structure in the soil resulting from gravitational effects compressing the soil. Settlement also occurs with the change in groundwater conditions in the immediate vicinity of the structure. The term *subsidence* is the displacement of the structure as a result of external events such as the creation of subsurface cavities, either man-made or naturally created.

Subsidence is usually of a higher order of magnitude than settlement and the consequences more serious.

Subsidence

Natural subsidence is commonly the result of the action of water. In rocks, such as limestone, the leaching out of carbonates leads to the formation of underground cavities and fissures which may ultimately collapse. In permeable soils, any flow of water through it may wash out the finer materials. This loss of fine material is a problem when excavations penetrate below the water table in granular soils; water draining into the excavation brings with it a significant amount of sand or silt grade material from the surrounding soil and the resulting subsidence can hazard the stability of buildings or undermine

roads. Water extraction from underlying strata can cause subsidence over wide areas; for example, the ground surface has been lowered in London by 0.23 m over the past 100 years and in Mexico City settlements of up to 8 m have resulted from this action.

The other sources of man-made subsidence are tunnelling and mineral extraction. Modern mining techniques have greatly reduced the damage to surface structures so common in the past. It is now possible to control subsidence so that at the surface a shallow and even subsidence basin which has only a relatively minor impact on buildings and duct routes is formed. A problem continues to exist with early and uncharted workings which may be in a stable condition until new structures which disturb the equilibrium are built.

Surface subsidence is likely to occur as a result of tunnelling operations. The reasons for this are perhaps less obvious than they are for mining where large quantities of sub-surface material are removed. The tunnel may act as a drain altering the surrounding groundwater conditions so that compaction takes place, and the fine material washed out of the soil causes further subsidence at the surface. When the tunnel is being cut, overbreak in which soil or rock is removed in excess of the diameter of the tunnel is very common. The relief of pressure around and in front of the tunnel as it is driven leads to further movement.

EFFECTS OF SETTLEMENT AND SUBSIDENCE

It is accepted that all buildings and similar structures will settle because of the increase in loading of the soil during construction and this settlement will continue after construction, perhaps for many years. The only exception to the general rule would be for buildings founded on sound hard rock.

Whether or not settlement or subsidence is significant in affecting the appearance, serviceability or integrity of a structure depends on many factors. Settlement can be considered to be manifested in one or more of the following modes (see Fig. 5).

- (a) *Absolute settlement*: this occurs when the structure uniformly and bodily sinks into the ground.
- (b) *Angular settlement*: the structure foundation rotates in the ground and leads to tilting of the superstructure.
- (c) *Differential (or relative) settlement*: when different parts of the structure are able to settle at different rates, then relative movement occurs within the structure.

Absolute settlement is likely to cause the least structural distress of the 3 categories given and the most vulnerable areas are non-flexible connexions to surrounding structures such as underground service entries. Settlement, however, is rarely uniform either because the design or use of a building applies uneven pressures to the soil, or because the soil itself has variable properties across the site and differential settlement occurs. In practice virtually all structures have some flexibility and can tolerate some movement. An interaction therefore takes place between the relative stiffnesses of the structure and the soil until equilibrium is attained. The most common indication of such movement is in the form of cracks in brittle materials used in the construction of buildings. The degree of such damage can be used as an indicator of the continuing integrity of the structure.

EFFECTS OF VIBRATION

The usual sources of ground-transmitted vibration are road or rail traffic, pile driving and vibratory methods of soil compaction. Vibration is transmitted better in rock and granular soils than in cohesive soils. The human sensitivity to vibration is high and objections from this source are likely before most equipment or the building structure itself suffers. It is difficult to predict damaging effects in advance although precautions can be taken to minimize effects; for example, in the case of pile

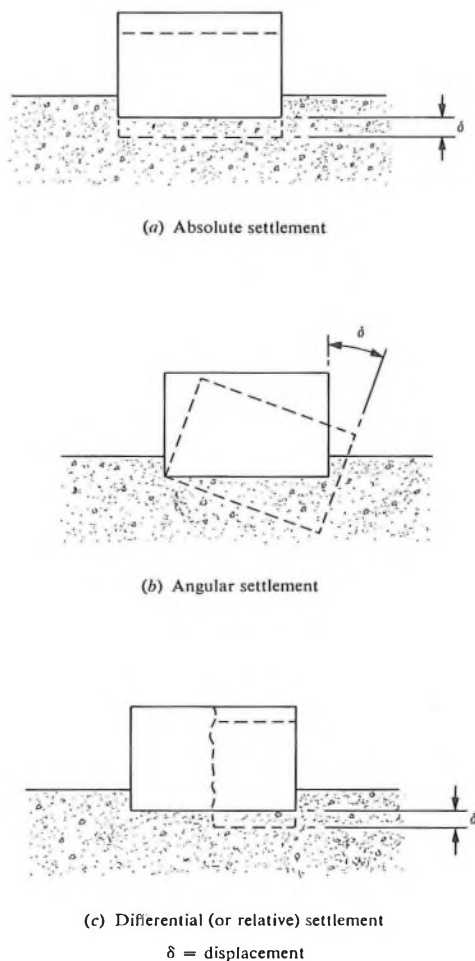

FIG. 5—Forms of settlement in structures

driving the first part of the hole can be augered prior to driving the pile; in other cases a trench excavated between the piling operation and the building or plant at risk will also reduce vibration levels. A particular difficulty in prediction is that the level of vibration in the ground may, when transmitted into a building, set a flexible component such as a suspended floor into resonance and thus give rise to much greater amplitudes of vibration. As a general rule, underground plant is less liable to suffer ill-effects from ground vibration than is equipment in nearby buildings where the magnitude of vibration could be increased by resonant effects.

The natural form of ground vibration is the earthquake. The distribution of earth tremors is widespread throughout the UK, although particular areas suffer greater activity. Historically, some UK earthquakes have been severe, causing extensive damage and some loss of life. However, the risk of serious damage to sound structures is regarded as negligible and special precautions are not normally taken.

Vibration from whatever source can cause significant alterations to the soil structure. In the case of sands and silts, compaction takes place as the particles are shaken down to the optimum density and the pore water expelled into the surrounding soil. In severe vibration conditions, the pore water pressure may increase to such an extent that the waterlogged soil behaves as a liquid and serious damage to any structure founded in the soil results. Clays are unaffected by vibration unless they are very soft.

AGGRESSIVE CHEMICALS IN SOILS

Buried metallic plant such as armouring and lead sheathing of cable, stay anchors, earth rods as well as concrete may be the

subject of attack from chemicals present in the soil in the form of solutions in the ground water.

Naturally-occurring aggressive chemicals come from a variety of sources, most notably from dissolved carbon dioxide and organic acids derived from microbial and other processes of decay of vegetable material, infiltration of sea water into the ground water at coastal locations, and the presence of salts in soils deposited in areas formerly submerged by saline seas.

In the latter category, the most important and widespread occurrence is of sulphates which are present as crystals in the soil and as solutions in ground water in many localities in the UK. In crystalline form these sulphates cause few problems, but when dissolved the resulting solution is highly reactive with tricalcium aluminate, one of the constituent compounds of portland cement. The chemical product of the reaction, calcium sulphoaluminate, is much larger in volume than the original cement in the concrete and disruption of the attacked surface occurs so exposing further surfaces to attack. When aggressive sulphate conditions are encountered, it is essential to use special sulphate-resisting cements which contain a negligible amount of the reactant and to ensure that the concrete is dense and fully compacted. Sea water also contains sulphates and so attacks concrete in the manner described.

The other significant naturally-occurring source of chemical attack on buried concrete is from acidic water most commonly found in peaty fen or moorland areas; in such circumstances it is often necessary to use a concrete with a higher than normal cement content, or to isolate concrete foundations from soil water by an impermeable membrane. In milder acidities it is sufficient to use a dense impermeable concrete. Peat acid is also a hazard for lead-sheathed cables.

Industrial waste products can give rise to problems of chemical attack and adequate prior investigation, especially of made ground in urban or industrial areas, is necessary to ensure a reasonable life of buried plant and a safe working environment.

DETERMINATION OF SOIL PROPERTIES

For all civil engineering works, some form of data will be required on soil behaviour. For minor works, an appreciation of good practice in the locality may suffice; for most structures, *in-situ* and laboratory testing will be needed. Either one or the other, or a combination of the two, is necessary to give basic information on the strength and consolidation characteristics of the soils and the groundwater situation. There are many testing methods available and the selection of these will depend largely on the type of soil to be investigated.

For most sites a substantial amount of preliminary data on soil conditions likely to be encountered can be gleaned from a desk study utilizing geological maps and other records from the Institute of Geological Sciences. In built-up areas, in particular, there are likely to be borehole records available from nearby construction works. Where mining has taken place, comprehensive records will be available for all but the older workings.

In open country, a superficial examination of the site and surrounding features paying attention to road cuttings, quarries, river banks and other topographical features can provide clues to what might be hidden beneath the top soil.

When the construction works are not dependent on the nature of the soil at any great depth, then a simple excavation called a *trial pit* is a useful and simple means of site investigation, as such pits can be dug readily by mechanical excavators. A pit also gives a ready visual idea of sub-soil conditions in cases where other means of investigation, such as boreholes, produce a confusing picture.

For all major structures and for minor structures where there is doubt about the deeper subsurface conditions, boreholes are used.

Typical tests undertaken in boreholes consist of those

which measure either the rate of penetration of a standard tool or the force required to achieve a given penetration of the soil. The shear strength or compressive strength of the soil can be deduced from the results of such tests. Samples of soil from various depths from boreholes are taken for subsequent laboratory testing and examination. These samples may be *disturbed* or *undisturbed* depending on the degree of disturbance to the soil fabric. In practice only disturbed samples can be obtained from soils such as sands and gravels because the particles do not cohere.

In hard rock, boring becomes much more expensive as rotary percussive, rock bit or full-face diamond drilling is required, necessitating a more elaborate drilling rig and slower progress. *In-situ* tests are not normally undertaken in rock where the main objectives are to identify the rock and the degree of fracturing present. Core samples can be obtained by drilling out an annulus of rock and, provided the rock is not heavily fissured, these samples may be subjected to laboratory compression tests. With any type of boring, the rate of penetration of the cutting tool is a valuable indication of the variation in sub-surface conditions, particularly when voids are present.

A borehole can be left open for several hours after drilling in order to establish the position of the natural water table.

Another approach to determining soil strength and settlement characteristics is the plate loading test in which a hole is excavated to the required depth, typically to the foundation level, and loads are applied to a steel plate on a concrete block by means of heavy weights or jacks.

LABORATORY TESTING OF SOILS

Laboratory testing of soils consists typically of obtaining a description of the soil in terms of particle size and distribution, the determination of permeability, water content, density and, most importantly for foundation design, the compressibility and shear strength of the soil. After a soil sample has been extracted from the ground, it is subjected only to

atmospheric pressure which does not represent the situation in the ground where the sample would have been subjected to a surrounding pressure approximately equal to the pressure resulting from the overburden. There are, therefore, 2 classes of tests for shear strength: those which are done with the sample at normal air pressure, called *unconfined* tests, and those which attempt to reproduce natural confining pressure conditions, the *confined* tests. The triaxial compression test is the most common example of the confined test.

It is very important in testing to decide whether or not the water is to be allowed to drain from the sample under test. In the ground, when load is applied to a volume of saturated or partially-saturated soil, the water is forced out at rates which vary according to the permeability of the soil. With building foundations, where the load is applied for a very long period, the water is able to flow away so that an equilibrium state is reached. The soil testing for such an application endeavours to reproduce these conditions—these are called *drained* tests and the water is given sufficient time to dissipate during loading. The *undrained* test is applicable to short-duration loadings situations and may be used for the design of excavations which will be open only for a short period.

CONCLUSION

Sufficient illustration has been given to demonstrate the unique variability of rock and soil as engineering materials. Even a careful site investigation can be no more than a sampling of ground conditions and the engineer has to be able to cope with possible major changes in design and construction technique as construction work proceeds and the sample size becomes larger.

So far this article has concentrated upon a simplified description of the basic engineering properties of soils and rocks with but brief reference to specific applications. The second part of the article will describe a number of examples drawn from British Post Office experience in which soil behaviour has played a major role in design and construction.

Post Office Press Notice

ROYAL MAIL GOES ELECTRONIC—VIA INTELPOST DELIVERY WITHIN HOURS TO 18 UK TOWNS

Intelpost, the Royal Mail's pioneering international facsimile mail service, went nationwide to 18 towns and cities within the UK earlier this year. The launch of the UK network means that customers can send copies of urgent documents to many parts of Britain and have them delivered within hours.

The first organization to herald the electronic age of the Royal Mail was British Caledonian Airways when it used Intelpost to transmit documents from its London office to its Glasgow office.

UK Intelpost provides the foundation for a growing international electronic mail network linking major business centres over the globe. Intelpost offers a cheap facsimile service, the security of the Royal Mail, back-up same-day

collection and delivery by Expresspost messengers and excellent reproduction of original documents.

Intelpost will be useful to businessmen, lawyers, architects, designers, engineers, travel agents and anyone who needs to transmit copies of urgent documents giving perfect reproduction for the same day. It will also take handwritten messages—a novel way of recording a personal greeting to friends and relatives on important occasions like weddings.

Original documents, like drawings, designs or plans, can be handed in at accepting post offices or be collected by a special Post Office messenger. The document is transmitted by high-quality facsimile machine and can be picked up at the distant post office, usually within 2 hours.

Internationally, Intelpost links with Canada, Holland and the USA. And the British Post Office is looking at other countries able to join up with Britain's international network as part of its policy to meet customers' needs.

Prestel: The First Year of Public Service

W. R. BROADHEAD†

UDC 025.3: 681.31

Prestel, the viewdata service provided by the British Post Office, entered public service in March 1979. This article reviews, from a non-technical standpoint, the first year of Prestel's progress, the present state of the network and the administrative arrangements that have evolved during these 12 months. It also considers what has been learnt with the benefit of hindsight, and discusses Prestel's objectives for the future.

INTRODUCTION

Viewdata¹ (or videotex) services enable customers with modified television sets or specially-designed terminals to access information supplied by information providers (IPs) and stored remotely on computer files. Customers can also send messages, for example, for holiday bookings, to those IPs. See Figs. 1 and 2.

Prestel, the viewdata service provided by the British Post Office (BPO), started public service in March 1979 based on a single computer in central London. Prestel is a non-monopoly service operating at arm's length from the BPO's main Telecommunications Business. It does not finance, manufacture or market terminals for users of the service, but the sets, adaptors and peripheral terminal equipment, which are produced by private industry to a BPO specification, require attachment approval.

† Prestel Headquarters, Prestel Executive

GROWTH OF THE SYSTEM

In September 1979, the original single computer was replaced by a small network comprising 2 information retrieval computers and a single update computer used for entering and editing data. This marked the beginning of a major expansion programme in the Prestel computer network, which grew from these 3 computers serving 30% of the telephony population to 18 retrieval computers serving 62% of the telephony population. By the end of 1980, the computer system comprised some 1500 ports (this means that 1500 customers can use Prestel simultaneously, since every user occupies one port in the computer).

Customers registered on 1st January 1980 totalled 3035; twelve months later the total was 7387. In the first quarter of 1980, registrations were running at an average of 260 a month; by the last quarter, this had more than doubled to 560,



FIG. 1—Typical residential viewdata set, which uses a remote control tuner and keypad



FIG. 2—Typical business-user installation in a travel agency

the record month for registrations being October with 677. At the end of 1980, the composition of the Prestel population was 6443 business registrations (87%) and 944 residential registrations (13%), and Prestel had more subscribers than any other computer-based information service in the world. Frame accesses per day rose during the year from 56 200 to 142 500 (one frame or page retrieved by one person equals one frame access).

Further geographical expansion of Prestel's local service will not be undertaken before 1983, and then only when it is profitable. Subscriber trunk dialling (STD) tariffs are not always a disincentive to potential customers, and Prestel welcomes users from outside local access areas, provided there are no technical obstacles to satisfactory service.

An estimated 15 000 Prestel sets were produced during 1980 and by the end of that year there was a profusion of sets and adaptors on the market with over 70 different models from over 30 different suppliers. These terminals may, of course, be used in connexion with private, and possibly competing, viewdata systems. These systems are not, however, regarded as an immediate threat to Prestel which was given, along with the French, CCITT* international standards recognition² for alpha-mosaic viewdata systems^{3,4}, in November 1980. Indeed, the development of private systems to Prestel's internationally agreed standards helps stimulate public awareness of information services and, hence, demand for, and supply of, terminal equipment: every customer of a private system is a potential Prestel user. Complacency, however, is dangerous, since it is imperative that Prestel maintains its technological and market lead. It is important, too, to see the growth of teletext services as beneficial to Prestel; close co-operation between the providers of teletext and viewdata services can ensure, to mutual advantage, economical development of sets and components.

IPs have grown both in quantity and quality. At the beginning of 1980, there were 133 main IPs (a main IP has a contract with the BPO, as distinct from a sub-IP who has a contract with a main IP); at the end of 1980, this had grown to 140 and there were 318 sub-IPs. During the year, the quantity of frames filled by IPs rose from 152 000 to 174 000, and the number of frames sold to IPs increased from 175 000 to 210 000. The number of editing ports for IPs grew from 42 to 85, and hours of editing per day by IPs almost doubled from 108 to 205.

IPs operate freely; editorial control is not exercised by Prestel although Prestel will bar access to information if the IP concerned breaks his contract by, for example, failing to pay his account or by publishing information that breaches the law.

The whole viewdata industry (that is, computer and terminal manufacturers, IPs, and Prestel) derives much benefit from the continuing sales of Prestel systems to overseas administrations (PTTs). 1980 was a good year for Prestel overseas. While the French Teletel pilot trial at Velizy and the Canadian Telidon pilot trial with Bell Canada failed to meet their 1980 target dates, Prestel achieved its sixth PTT sale, to Italy, in December 1980, and 12 countries around the world were running viewdata trials on the Prestel standard, with only one other system—the CAPTAINS system in Tokyo—undergoing actual trials. In the same month, the launch of Prestel International, the world's first public international viewdata service, was announced.

OUTLINE DESCRIPTION OF THE SYSTEM

The Prestel Network

The present Prestel system consists of a network of GEC 4082 computers connected by high-speed data links. There are

2 types of computer centre known as *information retrieval centres* (IRCs) and *update centres* (UDCs). Currently, there are 18 IRCs and one UDC connected in the form of a star network, as shown in Fig. 3. It is planned to enhance the network by provision of a second UDC, as shown in Fig. 4. This will enable the numbers of IPs and their activities to be increased considerably and will give the potential for further expansion in the number of IRCs as required to meet the demand that is forecast for the service.

Inter-computer links are provided by GEC high-level data-link controllers (HDLCs) operating at 4.8 kbit/s over dedicated 4-wire circuits using protocols compatible with the international standard X25 for packet-switched connexions.

The Information Retrieval Centre

IRCs provide Prestel service to customers in the surrounding local-call area. They are normally sited in telephone exchanges chosen in consideration of the forecast levels of traffic and the availability of accommodation. Individual information retrieval computers are unsecured, but continuity of service is provided by installing in each centre, 2 computers currently accessed by separate routes. An exception is London, where 4 centres have single computers. Each customer is registered on both computers or, in the case of London, on 2 centres; in the event of failure of his first choice computer, the customer simply accesses the second machine.

Each IRC computer has at present 208 ports, of which a maximum of 200 are available to users; the remaining 8 ports are reserved for test and control purposes. Access to the user ports is provided by a duplex asynchronous interface, which operates over the public switched telephone network (PSTN) at 1200 bit/s from the computer to the user and 75 bit/s in the reverse direction. The hardware employed is GEC manufactured 16-port multi-channel asynchronous communication control units (MCCCU)¹ connected to BPO Modems No. 20.

The computers are currently equipped with 384 kbytes of

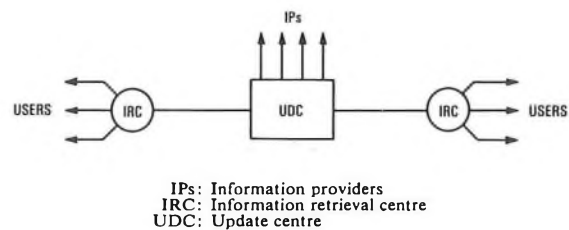

FIG. 3—Present network configuration

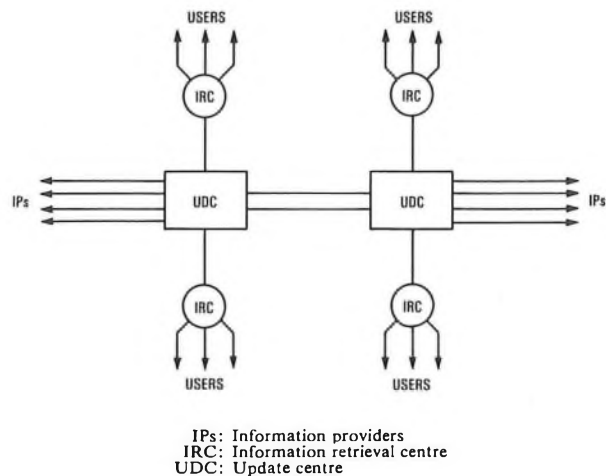

FIG. 4—Enhanced network

* CCITT—International Telegraph and Telephone Consultative Committee

core store and eight 70 Mbyte disc drives comprising:

- (a) one *master* disc containing a *user file* for each registered user (for example, name, address, terminal identity etc.), billing information and other system control data;
- (b) one *system* disc from which the software is loaded into core store when the system is started; and
- (c) six *data* discs holding the database of Prestel frames.

The Update Centre

UDCs provide IPs with access for database creation and editing purposes, and the facility to broadcast these changes to IRCs. The computer has 768 kbytes of core store and a 70 Mbyte disc complement generally similar to the IRC, but including an additional file on which all incoming transactions are written for broadcast to the IRCs.

The MCCCCU interface employed is the same as for the IRCs, and provides 1200/75 bit/s on-line editing over the PSTN. Two other interfaces are available for bulk updating:

- (a) 300/300 bit/s full duplex asynchronous V21 modems for computer-to-computer links, and
- (b) 1200 bit/s half duplex asynchronous V23 modems for use by intelligent editing terminals.

On-line editing facilities are complemented by a magnetic tape bulk update capability, provided by two 9-track 800 bytes/in NRZI tape decks.

Billing

Apart from telephone call charges, which appear on a Prestel user's telephone bill in the normal way, Prestel raises a time-based charge for the period that a terminal is connected to the computer, and a charge, where appropriate, for frames of information. These charges are collected by Prestel; the frame charges are paid to the IP who owns the frame. The time-based charge represents Prestel's revenue. Many frame charges, particularly for frames providing routing information, are set at zero by the IPs.

Billing information is periodically stripped from the retrieval computers to transportable magnetic discs, which are despatched to the UDC and subsequently merged so that charges from various computers relating to one customer are brought together for bill preparation and printing.

THE MANAGEMENT OF THE NETWORK

Regional Prestel Centre

The Prestel service in each of the BPO's Telecommunications Regions is managed from a Regional Prestel Centre (RPC) under the control of a Regional Prestel Manager (RPM). He has a team of marketing, customer service, finance and engineering staff whose numbers naturally depend on the scale of his operation. The FREEFONE service is used for public access to the marketing, registration and customer service functions at the RPC.

The marketing staff are responsible for liaison with, and co-ordination of, the activities of the television terminal manufacturers and retailers, and the operation of a Showroom Certification scheme. It is their job, too, to promote Prestel within the marketing strategy laid down by the UK Marketing Division of Prestel Headquarters.

Customer service staff co-ordinate activities of Prestel and the BPO's Telecommunications Business to ensure satisfactory after-sales service. They also control the staff who are responsible for registering customers with Prestel; that is, the activity of keying customer details into the system over private circuits (also used for interrogation) to ensure, *inter alia*, recognition by the system of a valid customer and the compilation of billing details.

The engineering staff co-ordinate retrieval computer maintenance activity and undertake local developments to aid

the efficient running of the RPC.

The RPC is a profit centre and the finance staff are responsible for budgeting and identifying Prestel expenditure.

RPCs monitor the performance of their local retrieval machines by using the viewdata access monitor and priority incident reporting equipment (VAMPIRE); this is a micro-processor based system, developed by the Prestel Research and Development team, which reports on an RPC television screen (over private circuits) the status of each modem at the computer centre or remote dataplex node.

National Prestel Operations Centre

Overall (and out-of-hours) control of the network and the UDC is vested in the National Prestel Operations Centre (NPOC) which is part of the Operations Division of Prestel Headquarters, where planning, marketing, billing and the Prestel International operation are centralized.

The NPOC has private circuit access to each computer in the network for control, interrogation and monitoring (VAMPIRE) purposes. A simplified representation of the management network is shown in Fig. 5. It will be noted that all administrative private circuits are backed up by PSTN access.

The Thinking Behind The Present Organization

The network and management structures outlined above were seen as appropriate in the light of early (1978) forecasts for Prestel terminals. These forecasts were conceived on the premise that Prestel would be a mass market product for a public avidly seeking information in an electronic age, which

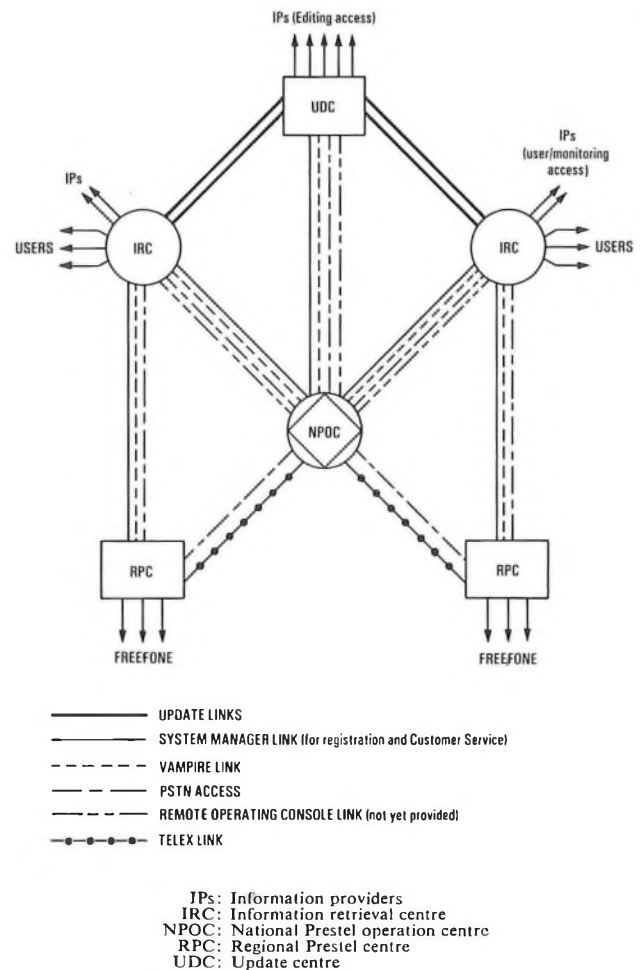

FIG. 5—Prestel management network

had seen phenomenal growth in residential colour television installations and business data processing systems. High demand would enable real terminal costs to be reduced quickly which would stimulate further demand. Prestel would, in effect, sell itself. To meet potential high demand, sites for computers (which can be ordered, installed and brought into service in 15 months) had to be found quickly, and long-term provision of network capacity for Prestel traffic had to be organized. To this end, a Prestel implementation plan was published as the authoritative document against which long lead-time items such as accommodation, lineplant and telephone-exchange switching capacity could be made available.

Experience in the first year of public service has shown that for a number of reasons original forecasts were extremely optimistic. It is important to note, however, that growth in Prestel registrations in the first year of service has exceeded that of Datel connexions and colour-television licenses in equivalent periods.

Early views were that holding times of Prestel calls would greatly exceed those of speech traffic. There was considerable concern that, should high demand arise for service outside the initial local-call service areas, the trunk telephony service would be compromised. Experience to date, however, indicates that holding times of trunk Prestel calls are not significantly longer than those of trunk telephone calls and that there is no evidence of network congestion. Bearing in mind, too, that trunk tariffs are little disincentive to Prestel's specialist business users, Prestel has been able to liberalize the hitherto strict policy of limiting the number of customers from outside the local catchment areas.

Clearly, it is in the interest of the viability of Prestel that growth of traffic should be stimulated. This, in turn, means that Prestel traffic patterns should be closely monitored to ensure that appropriate network provision is made. Early high terminal and holding-time forecasts have ensured, however, that adequate network and switching capacity is available for some time to come.

HINDSIGHT

The slow emergence of a mass market and the evidence of a specialist business market less sensitive to price suggest questions (some, perhaps, controversial) about the appropriateness of Prestel's initial network and its organizational philosophy.

If the Prestel public service were to start again from scratch, would it have been necessary, with the benefit of hindsight:

(a) to provide 2 computers, with separate telecommunications access, for a given catchment area? (If a business customer requires secure service and is prepared to pay for it, why not provide access to a single local computer with alternative access to a distant computer or computers at trunk tariffs?)

(b) to provide a 24-hour service? (A first step in providing a business orientated enterprise could be to introduce a working-hours service with archiving (maybe remote) and maintenance effected outside normal hours.)

(c) to provide a regional organization for registration activities? (It could be argued that a limited initial market could be served by a specialist national centre with a ready pool of staff, for example an auto-manual centre. The early development of automatic registration procedures would defer the need for devolution and would aid short-term cost effectiveness. Similar arguments apply to after-sales service.)

Even if a mass market does emerge quickly (encouraged, perhaps, by the appearance of convenient adaptors), the above questions must still be asked. If an adequate return is looked for, the operation must be run economically and usage must be stimulated to recoup Prestel, BPO network and IP investments. It is clearly counter-productive if there is a risk that

the returns from a large number of customers are less than the cost of connecting and billing them.

THE WAY AHEAD

Although the underlying conviction that demand will at some stage take off has been retained, it is impossible with such a new and revolutionary service to forecast rates of growth with any great confidence. However, an ill-defined path to the future is not helpful to telecommunications planners whose lead times require a stable long-term approach. Therefore, it must be decided where Prestel is going, how the market is to be created, and how the flexibility to respond to requirements that change or markets that emerge is to be retained.

The task facing the Prestel industry is clear and unequivocal: to accelerate the growth of sets connected, and to accelerate their usage. To do this, 3 major issues have to be tackled simultaneously: costs, the product and quality of sales/marketing.

Costs

Prestel's market research suggests fairly firmly that costs are not the major obstacle to the sale of sets in the business sectors being targeted, but that they are a major obstacle to significant penetration of the residential market. All 3 Prestel partners, the BPO, the set suppliers and the IPs each have a responsibility towards costs. The BPO must keep its own expenditure firmly under control so that time-connect charges, particularly in the evening and at weekends, can be allowed to decline in real terms. Competition in set supply, allied to the falling costs of chip technology, will ensure that set and adaptor prices will also decline in real terms. Finally, as the population of Prestel sets builds up, more IPs will be able to adopt the concept of free pages paid for out of advertising. Where IPs choose to charge for pages, competition between IPs will encourage value for money for the Prestel user.

The Product

Again, each of the 3 Prestel partners has to ensure that the product being sold is what the market actually wants. For the set supplier, this means a significant concentration on sets and terminals that will be acceptable to business users (for example, smaller screens, alphanumeric keyboards and printers). In the residential market, which already has 19 million television sets, the adaptor is an obvious product. For the IP, product orientation means providing information services on Prestel that will create amongst specified groups of people the urgent need to get on to Prestel—that will, in other words, clinch set sales. The IP's second task is to provide information services of a quality that will generate increasing use by Prestel subscribers. It is clear from market research that has been undertaken that the quality of information services on Prestel (the message rather than the medium or its cost) is the obstacle standing in the way of faster growth amongst business sectors.

For the BPO, the operator of the Prestel network, there are many product concerns. The Prestel computers have to work reliably round the clock to ensure that updated pages are quickly distributed to all information retrieval computers, and that response times (the time to retrieve a page from the computer) remain excellent. On top of this basic level of good service, which should be taken for granted by Prestel customers, any product improvement should be carried out without users having to change their sets.

Developments will be in two main areas: the size of system, and system enhancements. The size of system, as already discussed, will depend on the record of achievement and the viability of additions to the system and the network. System enhancements, in which interest is being shown and for which demand is emerging, include:

(a) *Ingathering*

The interactive capabilities of Prestel are embodied in the response frame facility whereby a user may, for example, comment, place an order or make a booking by entering details on a response frame whose content is accessed at each IRC in turn by the interested IP. The ingathering facility will enable the IP to glean information from all IRCs at a single transaction and thus enhance the attractiveness of the response frame facility.

(b) *Database Expansion*

There are active plans for the commissioning of additional data discs at IRCs to increase database capacity from 250 000 to 500 000 frames to permit expansion of present services, accommodation for new ones and to provide greater flexibility in the marshalling of data.

(c) *Third Party Database Access (The Gateway Facility)*

There is considerable interest from specific groups of customers and potential customers in a Gateway facility which would enable Prestel users to retrieve information from databases other than Prestel. Appropriate software enhancements and telecommunications planning have been initiated.

(d) *Local Editing*

Clearly there are call charge and possible transmission disadvantages to an IP who is not situated in the local-call-fee area of the UDC. Updating at, and broadcasting from, an IP's local computer would, therefore, be advantageous.

The above features form part of an integral database and network philosophy, devised by the Prestel Research and Development team known as the *Prestel Advanced Network and Database Architecture (PANDA)*.

(e) *Picture Prestel*

Picture Prestel is a development by which an IP can include a still picture in an information frame. Advertising (particularly mail-order business) would benefit by the display of

goods, and there are obvious applications for estate agents, the education world and in, say, banking where signature verification is required.

Such advances (as well as other possibilities such as the capability for enhanced graphics and data encryption) will be introduced with a second-generation service associated with the integrated services digital network, since it is vital that the BPO's product is seen to retain its world lead.

Sales Quality

Finally comes the question of selling. The product can be right and the price can be right, but without good selling, progress will be slow. Sales staff, belonging to all 3 Prestel partners, have to know the product that they are selling and to whom they are selling it.

CONCLUSION

When the public service of Prestel began in 1979, there was much uncertainty about the key issues requiring attention. Today, with over a year's operational experience, there is much greater certainty about what needs to be done. Prestel has a history for those willing to learn. Prestel is now beginning to succeed because it has learnt to adapt itself in the light of experience and feedback from real customers. This is a never-ending process.

References

¹ FEDIDA, S. VIEWDATA: An Interactive Information Medium for the General Public. *POEEJ*, Vol. 71, p. 21, Apl. 1978.

² CCITT Recommendation Nos. S100, International Information Exchange for Interactive Videotex, and F300, Videotex Service.

³ WHALL, A. J. Character Coding for Text Communication, Part 1—Background to Character Coding. *POEEJ*, Vol. 73, p. 154, Oct. 1980.

⁴ WHALL, A. J. Character Coding for Text Communication, Part 2—The Development of Practical Standards. *POEEJ*, Vol. 73, p. 263, Jan. 1981.

Post Office Press Notice

BRITISH TELECOM TO LAUNCH TELETEX

A high speed desk-to-desk message service opening up the era of the electronic office is to be started early next year. This new service will offer Teletex terminal users the ability to prepare and edit correspondence and the means of accurately and rapidly conveying the information to a distant terminal—typically a full page of text will be transmitted in a few seconds. Users of the service will be able to type letters, internal memoranda and other messages on their terminals as if they were ordinary typewriters, and then send the correspondence directly over the telephone network.

Worldwide Teletex standards have recently been agreed by the International Telegraph and Telephone Consultative Committee (CCITT); included in these standards is a technical recommendation for terminals. Its aim is to ensure that users will have at least as much freedom in the way they type their correspondence as they have at present when they use a modern electric typewriter. In its simplest form, the terminal can be an electric typewriter having a communication facility.

A more sophisticated terminal can be a multi-function visual display unit with word-processing and other software packages to perform a variety of specialized business functions.

Text can be prepared in A4 size pages in either vertical or horizontal format. When prepared, the message is held in a store in the terminal; this allows the message to be sent immediately, or delayed for transmission at a time convenient to the user. The store will also receive and hold incoming messages, for display when required. Initially, Teletex will use the public switched telephone network and the packet-switched data service; later, connexions with the Telex network, will be provided to enable Teletex customers to communicate directly with the 90 000 Telex terminals in Britain and with the one million Telex users overseas.

Discussions on arrangements for an international Teletex service with a number of countries, including West Germany, Sweden and Belgium, are in progress; in due course an international Teletex service giving users direct desk-to-desk message communication to many countries will be created.

EBX8000 Stored-Program Control PABX

V. A. E. FOUNTAIN, M.I.T.E., M.B.C.S.†

UDC 621. 395. 25

Since the early-1970s the British Post Office has permitted the private supply and installation of approved large (over 100 lines) private automatic branch exchanges (PABXs). A considerable number of PABXs are now approved and include an increasing proportion of stored-program-controlled electronic systems. One of the largest of these is the EBX8000, catering for up to 8000 extensions and about 2000 exchange or tie lines.

INTRODUCTION

The EBX8000 is an electronic space-division private automatic branch exchange (PABX) using a reed-relay switching matrix under stored-program control (SPC), and provides the sophisticated facilities that are available to users of modern PABXs¹. The EBX8000 was evaluated by the British Post Office (BPO) during 1980 and given type-approval; it was one of a number of SPC PABXs, from different manufacturers, that were offered to the BPO between 1970 and 1980. Some 30 EBX8000 installations are now in service.

The EBX8000 caters for up to 8000 extensions with up to 2000 exchange or tie-line connexions. Large-scale integration (LSI) allows a degree of distributed processing of operations such as timing and scanning of peripheral circuits; for example, exchange lines and tie lines. The characteristic features of SPC exchanges are incorporated in this design; that is, ease of maintenance and introduction of facilities, such as call forwarding, automatic ring back, etc. The system can be expanded in steps of 128 extensions and 16 exchange or tie lines. The exchange is enclosed in a number of cabinets which can vary from a minimum of 5 to a maximum of about 60.

PARTICULAR FEATURES OF THE EBX8000

The particular features of this exchange are

- (a) its large capacity,
- (b) reed switching enabling high-reliability², high-quality transmission and low power consumption to be achieved,
- (c) extension telephones that can be MF4 signalling key-phones or 10 pulses/s telephones, no modifications are required when either is fitted,
- (d) low power consumption, so that natural air convection is sufficient for cooling purposes, and no special environment is required, and
- (e) quiet operation and powered by BPO standard 50 V float-charged batteries, low voltages (for example, 5 V and 12 V) being derived from duplicated high-reliability quiet DC-to-DC converters.

BASIC DESIGN CONCEPTS

With a view to economy throughout the size range, the basic design requirements of the EBX8000 system were that

- (a) the switching central control would be problem oriented, that is, purpose built, and
- (b) the expansion of the exchange would be in small increments.

The processing load of the central computer control is

† Product Development Unit, Telecommunications Headquarters

reduced by distributed processing, decentralizing operations such as timing, scanning and taking simple decisions. This decentralization is realized by the application of LSI techniques³.

Gradual expansion is possible as fundamental units, which can be added according to traffic demands, have been developed⁴. For the peripheral equipment, expansion is further facilitated by the construction system which uses detachable shelves and pluggable cabling.

Since the exchange is principally operating from a common control, the central control unit (CCU) is duplicated to guard against interruptions. This duplication extends to the sub-systems and the bus lines to the peripheral equipment in such a way as to minimize the chances of an overall breakdown.

MAIN SYSTEM ELEMENTS

The trunking diagram (see Fig. 1) shows an outline of the main system elements, which are discussed below. The elements shown within the broken lines are assembled into single- or twin-shelf units which are described later in the Physical Design section of this article.

BASIC SYSTEM OPERATION

Each extension has an associated line circuit (LCT); 64 LCTs form a group. Each group is continually scanned by a line-state scanner (LSS) which operates in conjunction with the line-state memory (LSM). The complete scanning cycle takes 160 ms over a maximum of 128 LSSs. In this way, a change of state of any LCT is detected and the information forwarded via a bus to the CCU.

The data processing unit (DPU), which controls all parts of the system, processes the line-circuit status information and generates a marker command. The marker (MKR) translates this command in conjunction with the access matrices into switching signals that cause the relevant reed-relay cross-points in the switching network to be energized and thus establish a path.

Each extension is connected to the line link network which provides concentration to a first mixing network (IMN), totalling 4 stages of switching. In the larger exchanges a second mixing network (IIMN) is always supplied, to provide a total of 6 stages of switching⁴.

The calling party is first connected to a digit receiver which forwards dial tone to signify that the number can be dialled. The dialled digits are forwarded to the CCU and analysed by the DPU which then initiates the main actions. The first action is to select a peripheral circuit (PCT) and the second is to set up an appropriate path through the switching network via a MKR as before.

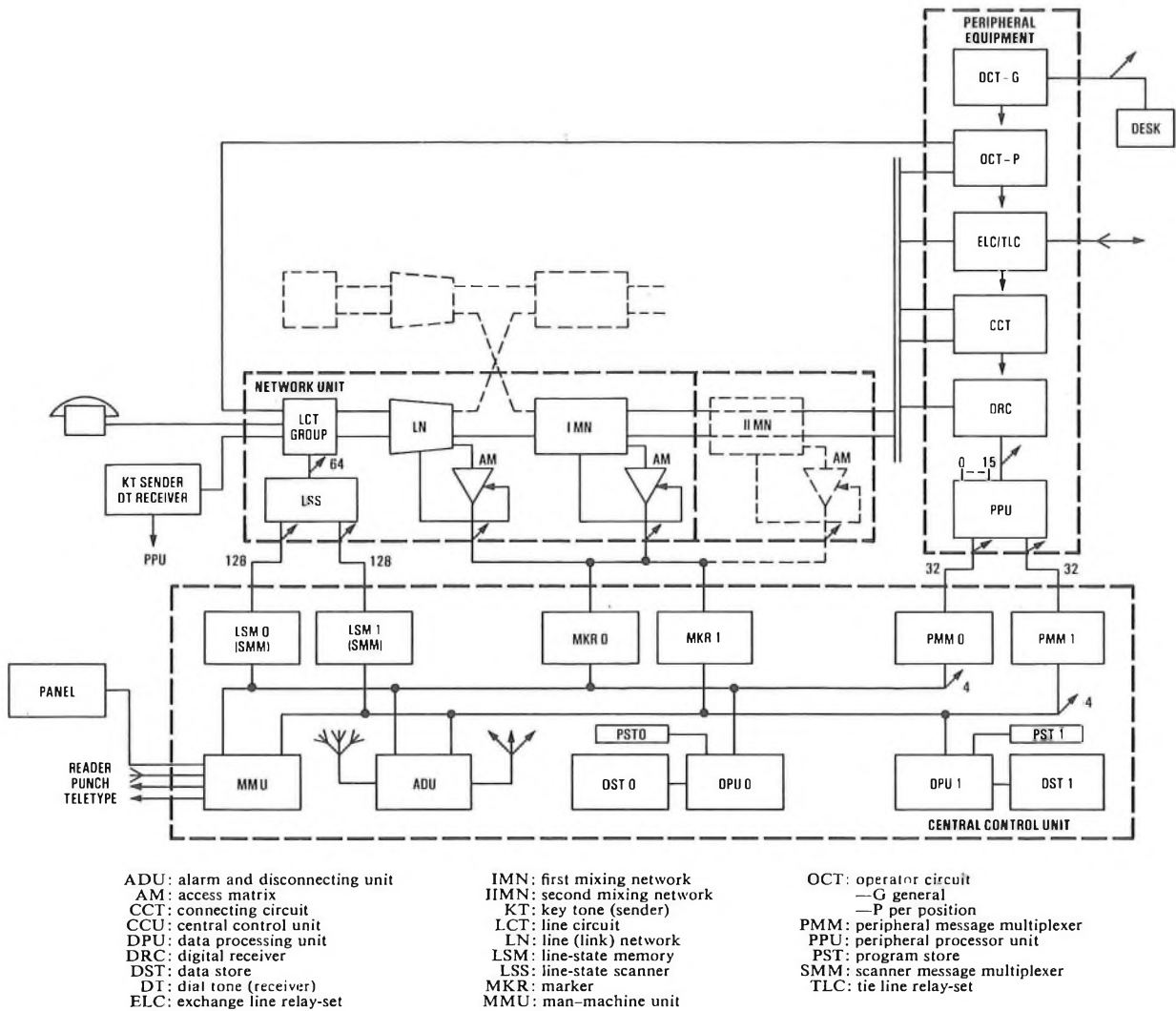

Fig. 1—EBX8000 general trunking diagram

Different types of calls are handled by different PCTs; connexions from an operator to an external line, or an extension, involve the use of an operator circuit, whereas external calls involve either an exchange-line circuit (ELC) or a tie-line circuit. An internal call requires a connecting circuit (CCT).

Up to 16 PCTs are connected to one peripheral processor unit (PPU), which scans each PCT in a fixed sequence every 10 ms. Information from each PPU is sequentially transferred via a bus system to the CCU under the guidance of a peripheral message multiplexer (PMM), which can handle up to a maximum of 32 PPUs. The exchange can be equipped with up to 4 PMMs.

There are 2 identical CCU systems which operate synchronously in a dual mode; that is, main and hot stand-by. Both systems are continually monitored by the alarm and disconnecting unit (ADU) which, under the direction of the DPU, is capable of transferring control from one CCU to the other. In the event of a fault, an alarm is raised, the fault-finding programs are executed by the DPU and the ADU disconnects the malfunctioning units.

The man-machine unit (MMU) is used in conjunction with the MMU control panel and various input/output devices; for example, teletypewriters, etc.

BASIC PROGRAM STRUCTURE

The strength of SPC systems, as compared with other systems, lies in the centrally available data (see Fig. 2). Since all the

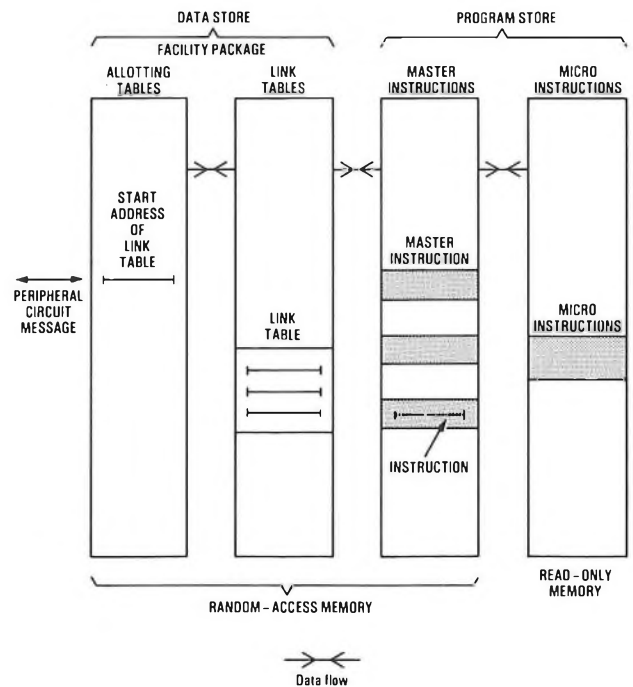

Fig. 2—EBX8000 program structure

essential information is available simultaneously, the programs can take complex decisions of widely differing natures. The advantage of semi-permanent data placed in the data store (DST) is that it can be changed by simple instructions. Some examples of data tables in the DST are:

- (a) switching network mapping,
- (b) dialled-digit analysis for routing and trunk barring,
- (c) service classes,
- (d) translation from directory number into line number,
- (e) extensions for group hunting,
- (f) fault reports, and
- (g) metering data.

The EBX8000's central control has been specifically designed for this application, rather than being an adaptation of a general purpose computer. Routine housekeeping tasks (for example, scanning peripherals) are carried out by an outer ring of distributed autonomous microprocessors; this ring obviates the need for a priority interrupt hierarchy and all communications with central control have the same priority level.

Communication with the special purpose DPU (the mini-computer part of the CCU) is at the level of elementary telephone operations. The number of different operations the machine can perform (the instruction package) must be such that elementary telephony operations are carried out in an efficient manner.

The most elementary operations the machine can perform are micro-instructions; that is, the smallest constituent program step, stored in read-only memory (ROM). With the micro-instructions, control is ultimately effected. A micro-instruction may be *read memory*, *set accumulator*, *set program counter* etc. Several micro-instructions are put together so that they form an instruction; for example, *load accumulator*, *store from accumulator*. A number of instructions can be assembled to form a master instruction; that is, a basic telephony function, which is realized in dynamic random-access memory (RAM). A number of master instructions are coupled together (concatenated) by link tables. A link table represents a telephony function and by concatenating a number of link tables a telephone facility is formed. A number of facilities are gathered into a package, and facilities package telephony can be achieved; that is, each customer can have a set of facilities specific to his requirements⁵.

Thus the program is built up in several levels (see Fig. 2).

Micro-Instructions	ROM
Instructions	RAM
Master Instructions	RAM
Link Table	RAM
Facilities Package	RAM

The micro-instructions, instructions and master instructions are located in a program store (PST) physically separate from the DST holding the link tables and facilities package allotting tables.

The PST contains 4 relatively independent program categories⁵:

- (a) control program,
- (b) call-processing program,
- (c) man-machine-communications program, and
- (d) system-assurance program.

PRINCIPAL APPLICATION OF COMPONENTS

The utilization of different component types within the EBX8000 system is shown below:

- (a) *Reed relays* used in the switching matrix, relay-sets and disconnection of faulty system elements.

- (b) *LSI devices* used in the data store, master instruction store, micro-program store, PPU and LSM.

- (c) *Medium-scale and small-scale integration devices* used throughout the system in low-power transistor-transistor logic devices.

- (d) *Transistor circuits* used for loop detection in relay sets and LSSs, driving and guarding circuits in the MKR, drivers and receivers for the bus line system from the CCU to the LSSs and PPUs, and in the tone generators and receivers.

All integrated circuits and transistors are hermetically sealed.

PHYSICAL DESIGN

All components are fitted on printed-wiring boards which slide into shelves (see Fig. 3). The card dimensions are 240 × 28 mm and can accommodate 64 reed crosspoints or 2 PCTs.

The circuit cards are assembled into shelves in such a way that a shelf, or a combination of 2 shelves, constitutes a functional unit with relatively few connexions to other equipment. The shelf wiring is wrapped; the shelf units are detachable, and their connexions to other units are exclusively of the plug-in type.

Several different types of shelf are used, and the equipments accommodated on these different shelf types are:

- (a) a PPU and 16 CCTs,
- (b) a PPU and 16 ELCs,
- (c) DC-to-DC converters,
- (d) ringing and tone generators,
- (e) IIMN and access relays, and
- (f) IMN and LCTs.

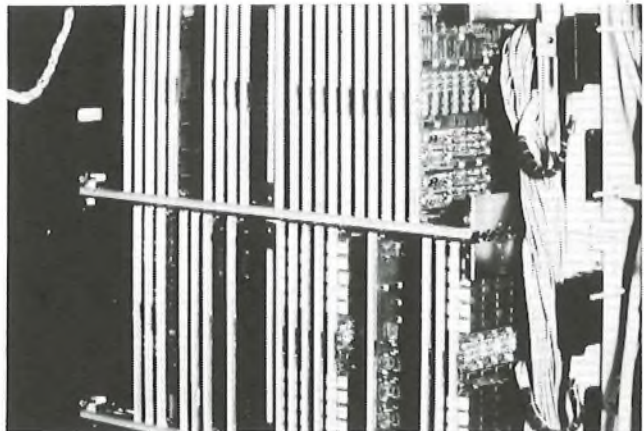

FIG. 3—Central control unit



FIG. 4—Operator's console

A cabinet can house 6 single or 3 double shelves. The dimensions of a cabinet including cable runway are: height 2.2 m, width 0.9 m and depth 0.45 m. The cabinets, which are self-supporting, can be arranged in rows back-to-back against a wall, or in free standing single rows. The standard length of a row is 6 cabinets. The power distribution, however, is laid out for a maximum length of 12 cabinets. Any shorter length of row may be used at will. The operator's console is shown in Fig. 4.

CONCLUSIONS

The installation of the EBX8000 is a further step in the rapid evolution of private telephone exchanges, serving the ever-expanding requirements of the business customer. Its electronic technology base allows an increasing level of sophisticated features to be provided economically.

SPC PABXs will, no doubt, progress to form the nucleus of the integrated office information system of the future.

ACKNOWLEDGEMENTS

The author wishes to thank his BPO colleagues and the

Communications and Control Division of Philips Business Systems for their assistance in preparing this article.

References

- ¹ MICHAELSON, J., and POULSON, S. Use of Facilities in an EBX8000 PABX. *Philips Telecoms. Review*, Vol. 37, No. 2, May 1979.
- ² VAN DER SCHAFF, R. T. Experience with Stored Program Controlled PABX EBX8000. International Conference on Private Electronic Switching Systems, Apl. 1978.
- ³ VAN DER SCHAFF, R. T. EBX8000, a Stored Program Control PABX. *Philips Telecoms. Review*, Vol. 33, No. 3, Sept. 1975.
- ⁴ JUNG, M. M. Random Overflow of Calls between Sub-Groups in a Full-Availability Group of Lines. *Philips Telecoms. Review*, Vol. 37, No. 2, May 1979.
- ⁵ DE KONING, G. C. M. How the Software for Philips SPC Telephone Systems is Assembled. *Philips Telecoms. Review*, Vol. 35, No. 2, June 1977.

Bibliography

CLOUGHLEY, G. The Shell International Private Telephone Network. *Philips Telecoms. Review*, Vol. 39, No. 1, p. 41, Mar. 1981.

The First TXE4A Exchange

D. A. RITCHIE, and L. H. LAWRENCE †

INTRODUCTION

The first TXE4A exchange was successfully introduced into public service in February 1981. The installation of this TXE4A represented the first stage of the modernization of Belgrave, a non-director Strowger satellite in the Leicester linked-numbering scheme, and was a direct replacement of a 5000 line TXS unit.

The order for the Belgrave installation was placed in March 1976 with a planned bring-into-service (BIS) date of October 1980. The actual BIS date, some 4 months later than that originally planned, was the culmination of 12 months of intense activity and effort to minimize the development and production delays of the new system.

THE SYSTEM

After the successful development of the TXE4 Rectory design (RD) by Standard Telephones and Cables Ltd. (STC), further development to reduce system costs was undertaken. This cost reduced system, known as the TXE4A, was achieved by technologically improving the control area, and resulted in a reduction in equipment quantities and types; for example, 483 unit titles were superseded by 215 new unit titles. Large-scale integration, shift registers, electrically-programmable-read-only memories and random-access memories replaced the hard-wired programs and cyclic-store (CS) threadings of the TXE4 RD system. Data for all peripherals (for example, line circuits, incoming and outgoing junctions, registers and routing translations) is electrically inputted into the CS by the use of teletype machines.

In the event of a loss of power the information in the volatile CSs will be lost, but complete reprogramming from a back-up magnetic tape can be carried out within a few minutes after power has been restored.

The line circuits, switching area and relay-sets, however, have not been redesigned and are substantially the same as

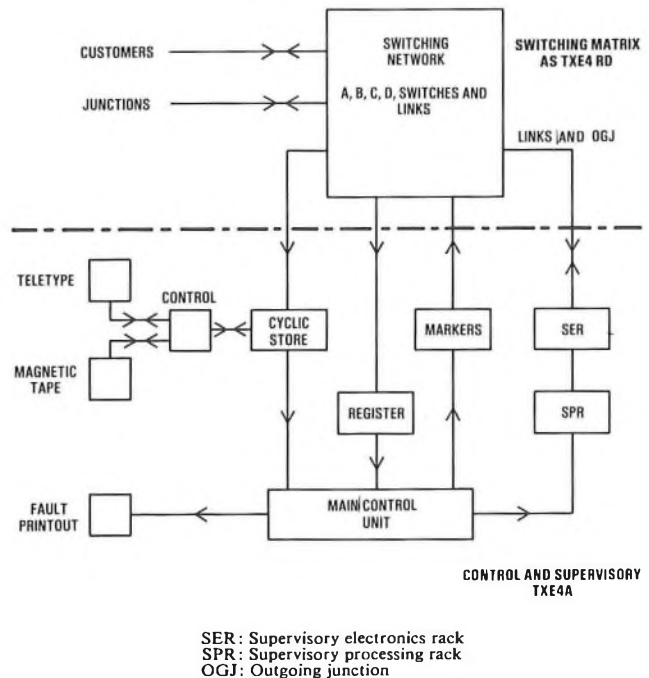

FIG. 1—Block diagram of TXE4A Exchange

those used in the TXE4 RD exchange. Switching is effected by using serial trunking sequences, and scanning rates remain the same as in the TXE4 RD system. Fig. 1 shows a simplified block diagram of the new system.

DELIVERY

In March 1978, STC suggested using modular delivery for the Belgrave TXE4A exchange, stressing the advantages of its use for a first-off exchange; that is, by building and commissioning the exchange in the factory, a rapid feedback of problems in

† Midlands Telecommunications Region and Leicester Telephone Area respectively

development and production would minimize the delay in implementing corrective action.

A series of experiments in the delivery of single modules was undertaken at TXE2 exchanges† and culminated in the successful delivery of Saul TXE2 exchange in the South Western Telecommunications Region. This experiment proved that an assembly of 12 racks, in 2 suites of 6 racks each, fully equipped with slide-in-units, could be transported to the site, and unloaded and positioned in an apparatus room as a complete module without physical or electrical damage to the equipment, so that subsequent connexion of peripheral cables and power could allow the exchange to be quickly ready for service.

As the available space for the TXE4A exchange on the first floor at Belgrave was extremely restricted, modifications were made to the equipment layout to allow modular delivery in 6 modules, varying in size from 2 suites of 2 racks each to 2 suites of 7 racks each, the largest module weighing 12 T.

To reduce hazards, STC developed a revised method of delivery by using a telehoist device, which allowed entry of the modules into the building to be controlled from the exchange floor. Fig. 2 shows the largest module, suspended from a mobile crane, being offered up to the entrance hole that had been specially cut for the purpose; Fig. 3 shows the same module being manoeuvred into position on its air bearings after its weatherproof protection and the telehoist device had been removed. The movement of this module necessitated great care and control, as at one point there was only 12 mm clearance between the module, the ventilation trunking, a roof support pillar and existing equipment. Despite these problems

† Ashton, P.C. Modular Delivery of an Electronic Exchange. *POEEJ*, Vol. 71, p. 206, Oct. 1978.



FIG. 2—Largest module being manoeuvred by telehoist

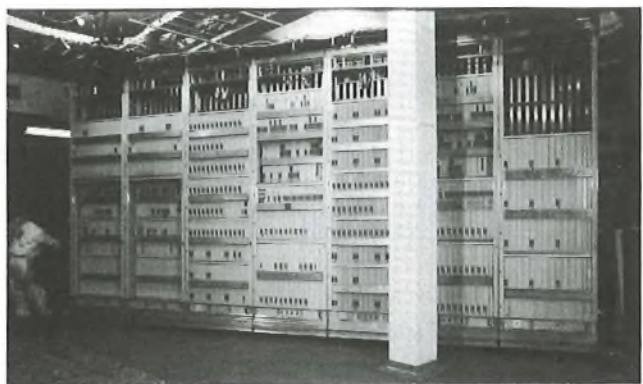

FIG. 3—Module being positioned on air bearings

the module was positioned and aligned with ease in one smoothly executed operation.

The modular delivery of the TXE4A equipment was preceded by the on-site installation of the Strowger racks, frames, runways and bulk cabling; the recommissioning of the exchange commenced only 5 weeks after the delivery of the modules.

COMMISSIONING AND FUNCTIONAL TESTING

At the time of delivery, the programme called for the completion of commissioning and functional testing for a British Post Office (BPO) multi-call sample (MCS) by 1 October 1980. This seven-month period of continuous 24-hour working was fully occupied by recommissioning the equipment after the incorporation of development changes and functional testing, including the proving of the draft functional test manual. Normal supplier quality-assurance procedures applied to the installation and commissioning phases, and functional testing was a joint undertaking.

The exchange was handed over to the BPO for acceptance testing on 26 September. A 12 000 call MCS was successfully completed on 30 September and 18 analysed faults were recorded (the fault limit was 30).

On 1 October, 24-hour working was continued in order to incorporate 72 STC hardware and software changes and 22 BPO hardware changes prior to the BIS date. This work was completed on 21 January 1981, and a re-run of the MCS resulted in only 15 faults, which gave the Leicester Telephone Area management confidence that the exchange would give satisfactory service.

PRIOR TO TRANSFER

With new found confidence, a target BIS date of 28 February 1981 was established and a very tight schedule agreed for the essential software program and translation changes, reconfiguration of junction routes and pre-BIS tests.

Maximum effort continued; joint engineering/traffic testing was carried out at night and all necessary construction work was completed on time.

MAINTENANCE

BPO maintenance staff (Technical Officers) were assigned to the Clerk-of-Work's team from the module delivery date onwards and gained valuable practical experience during the commissioning, functional-testing and acceptance phases of the project. Since January 1981, this staff has been maintaining the exchange and assisting in the validation of the maintenance diagnostic manual.

The BPO's call-through tester was retained on-site up to the BIS date and used continuously to test the exchange prior to changeover.

CHANGE-OVER

At 1300 hours on 28 February 1981, the TXS unit was taken out of service and replaced by the TXE4A. After the change-over, traffic staff rang out a large proportion of the customer's lines and obtained a high reply rate; faults attributable to the change-over were less than 1%.

CONCLUSION

The successful introduction of the first TXE4A exchange into service only 4 months after the BIS date planned in 1976 should be regarded as a magnificent achievement. It was made possible by a very high degree of co-operation and effort at all levels between the staff of STC, BPO Telecommunications Headquarters, the Midlands Telecommunications Region and Leicester Telephone Area. The performance of the fully loaded TXE4A exchange since it was brought into service has been completely satisfactory, with no service-affecting failures.

The New ASCE and the Junction Network

A. HILLS†

UDC 621.395.74: 681.31

This article describes the computerization of the annual schedule of circuit estimates (ASCE) and the uses to which this more flexible version of a long-established planning tool will be put.

INTRODUCTION

Since the 1930s, the British Post Office (BPO) has provided cable planners and circuit-provision groups with forecasts of the circuit requirements for the public switched telephone network (PSTN). Since the early-1960s, these forecasts have been contained in a document known as the *annual schedule of circuit estimates (ASCE)*. The ASCE has been published annually, which requires the forecasts to be examined at least once each year. In the late-1960s, the compilation and publication of the ASCE was computerized as part of the Long Lines Computer Project¹.

The long-lines concept of a computer receiving traffic records and automatically forecasting, planning and producing cable orders and circuit-provision advices proved too ambitious at the time and the project was abandoned as an overall scheme. However, parts of the project continued, including the ASCE. In 1975, the ASCE computer system was examined by a study team, including the author, and the new ASCE was devised, with the aims of reducing the amount of input required and providing more up-to-date information to the planners who use the ASCE as their source document.

CONTENT OF THE ASCE

For convenience, the ASCE is divided into 6 sections and the content and size of each section is shown in Table 1. For BPO organizational purposes, sections 1 and 6 comprise the main network and sections 2, 3, 4 and 5 comprise the junction network².

The ASCE file consists of forecasts of routes. Each route is identified by a unique 6-digit *ASCE entry number (AEN)*. An ASCE route (sometimes known as a *traffic route*) forecast is a forecast of traffic and circuits, or circuits only in some sections, between 2 exchanges. It may contain one or two traffic components (incoming and outgoing) and up to 3 circuit

components (incoming, outgoing and bothway). To identify the individual components a *component direction indicator (CDI)* is added to the AEN (O for outgoing, I for incoming and B for bothway). This combination of AEN and CDI provides a unique identity that can be used by any follow-on computer system without the need to carry all the ASCE information continuously within the follow-on system. It also provides planners with the smallest possible building block and therefore the greatest flexibility in planning.

While the AEN/CDI combination is sufficient identification for most computing purposes, parts of the ASCE output are intended for office use. Each route forecast is therefore labelled with information about the exchanges on both ends of the route. This information consists of: the exchange names and their THQ 1141 code (a unique alphanumeric identifier); an indication of the equipment type and function of the exchanges; the level or code used at the originating exchange to gain access to the route; the busy hour of each component; and an indication of who has the responsibility to provide the circuits, together with a priority indicator. As a further aid to ASCE users, space is available for a number of ASCE notes which give information about the route and any changes that occur during the forecast period.

ASCE forecasts are shown as a circuit requirement at the end of a financial year to carry the traffic expected during that year. The old ASCE held forecasts for the current financial year and 5 years into the future. The new ASCE holds a further 4 forecast years, giving 9 future years in total. This change came about because of the lead times involved in exchange design work, which can mean that a design currently being undertaken could have a brought-into-service date of 5 years hence, and a design (exhaustion) date of 8 years hence. The further forecast years are also available to the line-plant planning computer programs, enabling the effects of the introduction of digital exchanges into the PSTN to be assessed.

FACILITIES OF THE NEW ASCE

The following facilities have been provided with the new ASCE:

(a) *Automatic calculation of radial route length* This is calculated from the National Grid references held on the exchange and station information file (EASI), a data base that the ASCE uses.

(b) *Automatic circuiting* The route forecasts, produced in erlangs, are automatically circuited by the program. The input document tells the program the traffic table to apply and the resultant circuits are inserted in the route record.

(c) *Forecasting* A very simple forecasting module is provided. It applies an input growth rate to an input start point to produce a forecast to the fifth year.

(d) *Extrapolation* One basic precept of the system was to avoid any additional forecasting work. The extrapolation module is designed to take the standard 5-year forecast and automatically produce the remaining 4 forecast years by applying the national long-term growth rate to the forecast, thereby filling the file without incurring extra forecasting.

† Transmission Department, Telecommunications Headquarters

TABLE 1
Content and Size of ASCE

ASCE Section	Number of Routes (as at 3/81)	Type of Routes
1	14067	Between GSCs, Trunk Exchanges, and between GSCs and Transit Exchanges
2	58966	Between local exchanges, local exchanges and GSCs, and between local exchanges and local tandems
3	4028	Internal routes
4	4158	Telex distribution network between Telex exchange and local exchange
5	33522	Service routes
6	1442	Between transit centres

(e) *Reference ASCE* The old ASCE system produced the entire ASCE document once a year and amendments once a quarter. The new ASCE system produces the entire ASCE quarterly. This is done by producing the document on microfiche instead of paper. Microfiche, commonly called *fiche*, are pieces of film 145 mm × 105 mm which, at the reduction used by the ASCE, contain the equivalent of 270 printed pages, together with a title that can be read with the naked eye. They are produced directly from output tapes from the ASCE mainframe computer by use of a computer output on microfilm (COM) machine. COM takes a specially formatted print tape and converts it into images on a cathode ray tube. These images, equivalent to a line of print, are photographed on to microfilm to produce a master fiche. The master fiche can be copied using a diazo process very cheaply and quickly. In terms of printing costs this represents a twenty-six fold saving over the traditional method of photo-litho printing from computer print-out. Fiche take far less storage space, but a special viewer is needed to read them.

(f) *CPC User ASCE* During the study for the ASCE project only one group of users was found to need an ASCE that could be written on—the circuit provision control (CPC) groups. Therefore, the CPC User ASCE was produced. This shows the current and next 2 years on an A4 paper print-out with space available for hand-written notes to allow relay-set numbers to be allocated to ASCE routes.

There are a number of facilities currently under active development which are expected to become operational during 1981. These are:

(a) *Automatic adjustment* This facility will enable groups of forecasts to be adjusted proportionally to meet input targets. This will be done by specifying the year-end target(s) and identifying the forecasts to be adjusted. The process is designed to be operated at any level, from the entire ASCE to one forecast. The facility can be used in 2 modes: *aim*, where the calculations will be done, the results produced, but the file will not be altered; and *hit*, where the results of any adjustment will amend the file.

(b) *ASCE extract* Occasionally, users will need hard copy of parts of the ASCE. Therefore an extract facility is being provided to enable users to obtain exchange-based ASCEs on paper.

(c) *Bulk Update* Many ASCE forecast changes are caused by the opening, extension, or closing of telephone exchanges. As time passes, the programmed dates of these events will change. The bulk-update facility will enable these changes to be moved from one ASCE year to another by inputting to the computer the routes and year involved, and the direction (forward or back) in time the change is to be moved, thus avoiding the need to re-input each forecast individually.

(d) *Interrogation* There is a need to interrogate the ASCE and it is intended to use the rapid access management information system (RAMIS) facility available on the IBM computer. This is a commercially developed package that is very flexible and can be used on-line. Because of the size of the ASCE file, it is proposed to have the questions input on-line, with the processing taking place overnight and the results being returned the following day.

DATA PROCESSING

Input of the basic route and forecast information is by means of documents prepared in Telephone Area Offices (TAOs), which are sent to a processor-controlled keying (PCK) unit. At the PCK unit the documents are keyed onto disc and the disc contents transferred to magnetic tape. PCK offers considerable advantages over punched cards in terms of data preparation, but the ASCE does not use the data-vet facilities that are available, as these will allow only one data error per input form before the form is rejected; this was considered to be too great a burden on those preparing the input documents

for the first time. (Instead, data vets are carried out by the main-frame computer.)

The programmes are written in COBOL, using the multijob on-line facility on an ICL System 4 machine. When the system became operative, it was run on an ICL 2960 computer working in DME (an operating system that makes the 2960 work as a System 4). Finally the system was transferred to an IBM 3033 computer.

The ASCE is stored on a 300 Mbyte disc pack and is held in AEN order as an index sequential file, which considerably speeds access time as the entire file does not have to be searched to find an individual AEN. To give an indication of record size, a full three-component record occupies 1000 bytes. Security copies of the main file and input tapes are made at each run and are kept for 3 subsequent runs.

The major outputs of the ASCE system are the ASCE file, which is passed to the lines planning suites, and the COM tape, which produces the ASCE document and associated statistics. The system also produces hardcopy information for TAOs on the success or otherwise of their attempts to update the ASCE. This is produced on an A4 lineprinter that gives the full 132 character line length on A4 size paper, considerably reducing the handling and storage problems usually associated with print-out. It is proposed to produce this output by using a laser lineprinter when it becomes operational.

USE OF THE ASCE

There are 2 main uses of the ASCE:

- (a) as the authority to install PSTN circuits; and
- (b) as the basic planning document for transmission equipment and line plant.

The use made of the forecasts in individual ASCE years is shown in Table 2.

It is obvious from this multiplicity of uses that the document represents a compromise; for example, because CPC work should reflect the most up-to-date needs of the PSTN, the current year's forecasts should be constantly up-dated, but this conflicts with the need to maintain forecasts at a constant level for a year for planning purposes.

The ASCE can be used in 2 ways: as a working and reference document or, more importantly, as a data base for follow-on computer systems. The major junction network follow-on planning system is CJP3³. It is by this use of the ASCE that the system comes into its own by enabling all forecast changes to be reflected into planning as quickly as possible.

The economic environment in which the BPO operates has been unstable since the early-1970s and prediction of the future has become more difficult. Coupled with this, the PSTN, nationally, has passed through its phase of explosive connexion growth and is settling down to a reduced level of residential growth. These 2 factors combine to make the job of

TABLE 2
Use of the Forecasts in each ASCE Year

ASCE Year	Use
Current	Authority to bring circuits/channels into use
1	Preparation of CP manpower plans; requisition of PCM stores
2	PCM stores ordering; terminal relay-set orders; cable orders placed
3	Forward PCM orders
4	Vetting of plant shortages
5	Identification of PCM system and cable exhaustion

CP: Circuit provision
PCM: Pulse-code Modulation

the ASCE forecaster much more difficult than in the past, because forecasts can no longer be done in isolation by simple projection of past achievement, but they must be more closely related to the economic performance of the country as a whole and the BPO's perception of how its customers will react to future tariff and monopoly changes.

To overcome these difficulties the system of integrated forecasting and planning has been developed. This approach states that, during a financial year, all forecasting and planning must be based on a common set of forecast assumptions, which are agreed between Telecommunications Headquarters and the Regions. These integrated forecasts are used to set the levels of the budgets of the various sectors of the organization. However, budget levels can be determined accurately only when the amount of plant required in any year is known, and plant requirements (except for direct replacement for modernization) stem from forecasts of need. It follows, therefore, that the basic forecasts must be reflected into a requirement of need as quickly and as accurately as possible.

It is proposed to do this by use of the adjustment facility. Once the integrated forecasts have been agreed and ratified, Telephone Areas will produce a series of targets and adjust the ASCE to meet them. It will then be possible to carry the

adjusted ASCE forward to the planning systems and produce modified plans aligned to the new forecasts more quickly than at present. The proposed method will allow any changes to be placed where they will be most effective; for example, a reduction could take place where it is known that over-forecasting has occurred and an increase could be directed to where it would reap the most benefit in terms of growth or service improvement.

CONCLUSION

The new ASCE computer system considerably reduces the amount of routine forecasting and input required to maintain an up-to-date data base for follow-on computer systems, and provides an efficient tool for the management of investment in the junction network.

References

- ¹ CROSS, B. The Long Lines Computer Project. *POEEJ*, Vol. 63, p. 24, Apr. 1970.
- ² KYME, R. C. The Junction Network. *POEEJ*, Vol. 69, p. 175, Oct. 1976.
- ³ PUTT, A. C., and SMITHETT, R. G. CJP3: A Computer Aid to Junction Network Planning. *POEEJ*, Vol. 74, p. 29, Apr. 1981.

Book Review

Physics of Semiconductor Laser Devices. G. H. B. Thompson.
John Wiley & Sons Ltd. xxv + 549 pp. 213 ill. £22.75.

The importance of optical systems to the future of telecommunications must by now be well known to the readers of this *Journal*. Many articles have appeared over the last few years covering both device and systems aspects, and many text books have been written on the subject. These texts and other research work have shown that for many applications, particularly where the distance of the optical link is short or where the required capacity is low, the light source can be a simple semiconductor light-emitting diode. For higher bandwidth systems, particularly over longer distances such as those encountered in the trunk network, it is necessary to use a source with a narrower line width and a faster rise time. In order to achieve these properties, it is necessary to provide optical feedback to the light emission from the semiconductor, and this is accomplished by the use of end-face reflection in the laser diode. The semiconductor laser will therefore be the key component in optical trunk networks of the future.

This book gives a critical survey of the fundamentals of laser operation and the basic properties of the various types of laser diodes. The treatment, however, is sufficiently general that it will not be outdated readily by the rapid advances

which are taking place in this field at the present time. The introductory chapters cover various aspects of the development, design, growth, fabrication and degradation of the more well established laser devices based on GaAlAs. This is followed by three chapters on the fundamental aspects of light emission, optical guiding and carrier confinement. The relative merits of the different types of laser structure are discussed in detail. Subsequent chapters describe the performance characteristics of these structures in terms of their threshold current densities, peak powers, incremental efficiencies and dynamic response. The final chapter discusses lasers with distributed reflections and mention is made in the text of the possible future integration of these devices into integrated optics. The book has a detailed contents list and a very useful index, and each chapter is adequately referenced; the symbols used throughout the text are comprehensively listed at the beginning.

The text is well written and clearly presented with many diagrams to aid understanding. Mathematical formalisms are used when necessary but are not overburdensome. The book is a very useful reference work as well as being suitable for detailed study. The depth of the treatment renders it most suitable for the device physicist, but it could be useful to the system designer when he needs a more detailed understanding of the source phenomena.

R. W. BRANDER

Profiles of Senior Staff

DIRECTOR: LONDON TELECOMMUNICATIONS REGION

A. J. BOOTH, B.SC.(ENG.), D.M.S.



Tony Booth joined the British Post Office in 1957 as an Assistant (Scientific) at Dollis Hill Research Department. His early career in telecommunications research involved him in advanced high-frequency semi-conductor circuit design and he developed a strong interest in computer-aided design techniques.

By 1964 he had become an Experimental Officer and, following part-time study, had graduated from London University with an honours degree in electrical engineering. As an open competition Executive Engineer (which meant a 16% drop in salary), he joined the Organization, Maintenance and Computers division in Telecommunications Headquarters (THQ) to work on information retrieval and investment analysis.

After being appointed a Senior Executive Engineer in 1969, he led a development group providing computer-aided design services; in 1971 he was appointed Assistant Staff Engineer in the Appointments Centre at central headquarters where, as graduate recruitment officer, he visited universities and colleges throughout the UK. He returned to telecommunications work in 1974 and 2 years later became head of Systems Planning Division in the External Telecommunications Executive, now the International Executive.

In 1978, he rejoined THQ as head of its Operational Planning Division controlling capital investment on exchange equipment. In 1979 he became Director in charge of the international network, with responsibility for strategic planning and provisioning for all international voice and non-voice services, ranging from switching centres to submarine cables and satellite communications. In 1980 he was appointed Director of the London Telecommunications Region.

CHAIRMAN: NORTH EASTERN POSTAL BOARD

D. V. DAVEY, C.ENG., M.I.MECH.E., M.I.E.E., F.I.M.H.



Dave Davey is one of a long line of former Royal Naval dockyard apprentices who have made successful careers in the British Post Office (BPO). His first BPO appointment was in 1953 as an Assistant Engineer in the Power Branch of the Engineer-in-Chief's Office, where he was involved in some of the early work on postal mechanization. Later, as an Executive Engineer, he was responsible for the introduction of solid-state rectifiers into telecommunications power supplies and for the provision of power to the first electronic telephone exchange at Highgate Wood. In 1964 he was discovered by John Freebody (another Royal Naval dockyard apprentice), and he spent 4 very happy years in the Treasury's O & M Technical Support Unit.

The opportunity to return to postal mechanization came in 1968 and he took over responsibility for some major postal mechanization projects. In 1970, following a term at the London Business School, he was promoted to Controller at Postal Headquarters with responsibility for the planning of all letter mechanization schemes.

In 1974, he embarked on a very interesting phase of his career when he became Head of the British Postal Consultancy Service (BPCS). During the next 4 years he travelled nearly 500,000 miles and visited 26 countries on BPCS business. Then out of the blue came the opportunity to join Nigel Walmsley in the Postal Marketing Department. The experience was to prove even more exciting and valuable than the time he had spent globe trotting. Somewhat reluctantly he left the marketing field in 1979 to take over as Chief Postal Engineer when Charles Clinch retired.

His latest move, in April 1981, was to the North Eastern Postal Board, where he is now Chairman.

CHAIRMAN: WALES AND THE MARCHES TELECOMMUNICATIONS BOARD

M. L. FORD, F.B.I.M.



Mike Ford joined the British Post Office (BPO) by open entry as a Principal in April 1969 following early voluntary retirement from the regular army, which he had joined straight from school in 1950. He was commissioned from the Royal Military Academy, Sandhurst, into the Royal Artillery, and qualified as an Instructor in Gunnery and at the Army Staff College, Camberley. As a major, he spent 2 years in the Army Training Directorate of the Ministry of Defence prior to his final appointment commanding a field battery.

His first job in the BPO was head of International Tele-

phone Service Policy and Tariffs in the External Telecommunications Executive (ETE), and he claims a minor record by his attendance at a CEPT conference in Sweden just 9 days after joining ETE. Overseas travel was to dominate his life thereafter; he has visited 35 countries on behalf of the BPO to negotiate service agreements etc. and to promote Prestel.

He has had a number of service, policy and marketing jobs in ETE. His main preoccupations have been marketing international leased circuits, establishing London as the natural European hub for major international private networks, initiating new public data services and expanding international direct dialling (IDD) overseas. In 1969, IDD was available to only 15 countries; when he left ETE in 1978, it was available to over 70 countries.

In 1978 he became Deputy Director, Prestel, and directed the successful sales campaign of Prestel software overseas, the promotion of Prestel as an international standard and the creation of a Prestel International service.

He was an active rugby referee until this season and continues to take a keen interest in the sport, a fact which makes his present position in Wales doubly attractive to him.

Institution of Post Office Electrical Engineers

General Secretary: Mr. R. E. Farr, THQ/TE/SES5.3, Room 1420, 207 Old Street, London EC1V 9PS; Tel: 01-739 3464, Extn. 7223
(Membership and other local enquiries should be directed to the appropriate Local-Centre Secretary as listed in the October 1980 issue)

RESULTS OF THE 1980-81 ESSAY COMPETITION

Prizes and Institution Certificates have been awarded to the following competitors in respect of the essays named.

Section 1

Essays submitted by members of the Institution in all British Post Office (BPO) grades below the senior salary structure and above the grades defined in Section 2 below.

Prize of £45 and an Institution Certificate

Mr. G. J. Plumb, Assistant Executive Engineer, Plymouth Telephone Area: *The External Local Line Network—Will it Fulfil its Role?*

This essay deals with the problem of local network cables. Modernization plans are briefly described with the local network clearly demonstrated as the BPO's weakest link. Recommendations for improvements are argued. The essay brings together known problems and poses a number of questions.

Section 2

Essays submitted by BPO engineering staff below the rank of Inspector.

Prize of £45 and an Institution Certificate

Mr. J. C. Duncan, Technical Officer, Reading Telephone Area: *Royal Connections*.

This essay was prompted by the discovery of a telephone cable, unused since 1900, found in the grounds of Windsor Castle. It traces the history of the cable's design and its association with communications facilities provided for Queen Victoria. Well written and presented, it makes fascinating reading. (An article based on this essay was published in the April 1981 issue of this *Journal* under the title of: *Victorian Telecommunications: An Historical Discovery*).

Prize of £20 and an Institution Certificate

Mr. D. W. McIntosh, Technical Officer, Edinburgh Telephone Area: *Changes in Central Edinburgh Telecommunications—Alexander Graham Bell to TXE4*.

This essay traces the history of telecommunications in central Edinburgh from the invention of the telephone to the present day, and refers particularly to building and external plant changes which have affected the area over the period. It is well researched and prepared and makes interesting reading.

Prizes of £15 and an Institution Certificate

Mr. D. E. F. Blandford, Technical Officer, Portsmouth Telephone Area: *End of the Line for Carrier*.

This essay describes the 1 + 1 subscribers carrier system and its facilities. The reader is first given a simple appreciation of frequency filtration principles. The essay has a high technical content and deals with the subject matter in about the right depth.

Mr. M. N. Fletcher, Technical Officer, Blackburn Telephone Area: *Double Trunking in TXK1 Exchanges*.

The essay highlights the problem of double switching at TXK1 local exchanges. In spite of a rather limited treatment of the subject, the essay reads well and is technically accurate. It could have been developed further to include the author's ideas for improving the situation.

Prize of £5 and an Institution Certificate

Mr. D. C. Ferguson, Technical Officer, Aberdeen Telephone Area: *The Future of British Telecom*.

The author does show an awareness of some of the major issues to be faced by British Telecom in the future, but the essay would have made more impact on the reader had it been better structured with a clearly discernable theme.

The Judges decided that no entry on the given theme of the future role of British Telecom was of sufficient merit to warrant the award of the Anniversary Silver Medal.

The prize-winning essays are held in the Institution's Central Library and are available to borrowers.

The Council of the Institution records its appreciation to Messrs. R. J. Bluett, G. Comber, E. J. Lidbetter, A. E. Pye and E. Roberts for undertaking the task of adjudication and providing summaries of the winning entries.

INSTITUTION COMPETITIONS AND AWARDS

The traditional activities of the Institution concerned with the written word have been in decline in recent years because members are increasingly reluctant to commit their ideas to paper. This year there are no medal awards because there were no printed papers during the 1979-80 session which Local Centres could recommend. Once again there were no entries for the Associate Section Paper Awards Scheme. Although there was a slightly improved response to the 1980-81 Essay Competition, the number of entries was extremely small in relation to total membership.

In view of this situation Council has reluctantly decided to terminate the Associate Section Paper Awards scheme, and there will be no further Essay Competitions.

HONORARY MEMBERSHIP

Mr. S. G. Young, first Chairman of the Martlesham Heath Centre, has been elected to Honorary Membership in recognition of his services to the Institution.

THE FEDERATION OF TELECOMMUNICATIONS ENGINEERS OF THE EUROPEAN COMMUNITY (FITCE)

It became apparent in the negotiations with FITCE that the originally proposed IPOEE terms, whereby the normal university degree or equivalent entry qualification would be waived for a period of six months for members of the senior salary structure (SSS) and Executive Engineers, were unacceptable to the Federation, who were concerned with upholding their professional status. A concession was offered by FITCE in respect of SSS members, subject to certain conditions which, Council decided, could not be met. Council has now formally applied for association with FITCE on their normal terms, so as not to debar qualified IPOEE Members from joining FITCE if they so wish.

A list of acceptable qualifications is being compiled, and it is now likely that IPOEE Members with the necessary qualifications will be able to join FITCE later this year.

R. E. FARR
Secretary

IPOEE CENTRAL LIBRARY

The books listed below have been added to the IPOEE library since the publication of the 1974 Library Catalogue. Any member who does not have a copy of the catalogue can obtain one on loan from The Librarian, IPOEE, 2-12 Gresham Street, London EC2V 7AG. Library requisition forms are available from the Librarian, from Local-Centre and Associate Section Centre secretaries and representatives. The form should be sent to the Librarian. A self-addressed label must be enclosed.

5320 *Underground Power Cables*. S. Y. King and N. A. Halfter (1977)

This book contains accurate records of the thermal behaviour of different soils (which are potential recipients of buried electric power cables) under laboratory conditions. The numerous theoretical calculations are mated to the measured results of observed practical application.

5321 *Holograms*. G. Saxby (1980)

This is an illustrated guide to holography which includes instructions on how to produce holograms with available everyday equipment.

5322 *BASIC Programming*. J. G. Kemeny and T. E. Kurtz (USA, 1980)

This book is a comprehensive, easy-to-read introduction to programming in BASIC. In addition to explaining theory and operation, the text covers a number of programming examples which have practical application to working problems.

5323 *Digital Systems Principles and Applications*. R. J. Tocci (USA, 1980)

This is an up-to-date study of digital logic systems; it covers both theory and practical applications.

5324 *Microwaves*. K. C. Gupta (India, 1979)

This book incorporates coverage of a field which is finding a growth of applications in electronics and industry. Apart from the latest developments and techniques, it covers the traditional methods of generation and measurement.

5325 *A Historical Introduction to the Philosophy of Science*. J. Losee (1980)

This book is an historical sketch of the development of views

about scientific method from Plato and Aristotle to the present day.

5326 *Optical Fibre Communication Systems*. C. P. Sandbank (1980)

The book outlines the latest developments in this increasingly important transmission field; it also acknowledges the important role of the British Post Office in the development of operational optical fibre systems.

5327 *The Works of Isambard Kingdom Brunel*. A. Pugsley (1980)

The book surveys the extraordinary achievements of this remarkable Victorian engineer. It is a study not only of the man and his works, but also of a unique age in which enterprise was allowed to flourish.

5328 *Introduction to Minicomputers and Microcomputers*. M. E. Sloan (USA, 1980)

In this introduction to small computers the author assumes the reader to have little background knowledge of electrical theory. The text is a "course" which aims to equip the reader with sufficient knowledge to use a small computer for solving problems.

5329 *BASIC for Home Computers*. B. Albrecht (USA, 1978)

This is a self-contained, self-teaching guide to BASIC programming language which does not require the reader to have immediate access to a computer.

5330 *Radio and Television Servicing: 1979-80 Models*. R. N. Wainwright (1980)

This is the latest edition of this popular series which provides detailed information for servicing televisions, radios, tape recorders and record players.

Associate Section Notes

SOUTHEND CENTRE

Our programme for the past year was not as extensive as we would have liked; however, we had a very pleasant and interesting afternoon/evening return trip on the paddle-steamer, *SS Waverley*, from Tilbury up to Tower Pier, calling at Greenwich en-route. The highlight of this trip was the raising of Tower Bridge to allow our boat to pass underneath. Another outing that the centre arranged was a day trip to Gatwick Airport, with an afternoon visit to Laker Engineering, where we looked over a DC10 airliner undergoing maintenance checks. We were also allowed to visit the safety systems checking department, where the staff gave members a demonstration of life-saving equipment and other rigorous testing procedures carried out under Civil Aviation Authority licence. After tea and a spell on the airport's roof-top public viewing enclosure, our group visited the tower and radar approach. Altogether, this trip was most interesting and informative.

Southend centre entered the National Technical quiz this year and in its first encounter against Evesham managed to win by 34½ points to 32, a score that was a little too close for comfort. The team then went on to play Portsmouth in the quarter finals, but was beaten by 43 points to 26; this time the score was a little too wide for comfort. On this occasion

our team used the London Telecommunications Region's (LTR's) outside broadcasts for the land-line, and LTR's facilities proved to be excellent. Although defeated, our team's participation in the Technical quiz has stimulated keen interest and the centre will be entering again next year.

Our final commitment this year was to take part in the Eastern Telecommunications Board's general knowledge quiz. We played Martlesham, but lost by 18 points to 27. This quiz was also an interesting experience and we will be entering a team next year.

In the coming year we hope to offer an attractive programme that will increase membership and continue to interest our existing members.

B. PUNCHER

SHEFFIELD CENTRE

A successful 1980-81 session was drawn to a close on 2 April 1981 with the presentation of a prestige lecture, a new venture for the centre. The lecture, entitled *Science, Society and the Year 2030*, was presented by Dr. Magnus Pyke at City Memorial Hall, Sheffield.

Invitations were extended to all Associate Section centres through the National Committee, and representatives of Birmingham, Bradford, Harrogate, Hull, Middlesbrough,

Nottingham, Scarborough and Shrewsbury were present in an audience of approximately 400.

The lecture was introduced by Mr. Harlow, the Sheffield centre's chairman, and Mr. Bowles, its secretary. Mr. Bowles said that he hoped this venture would give a lead to other centres and that more events of this kind would herald a new era within the Associate Section that would bring centres together nationally to achieve a more successful, closely-knit society. Dr. Pyke then gave an excellent lecture lasting approximately 1 h 20 min. Afterwards, a vote of thanks was extended by Mr. Kelsey, Chairman of the Senior Section of the North Eastern centre.

Other events during the year included lectures on *System X* and *Measurement and Analysis Centres*, and visits to Boots Pharmaceuticals Ltd. and Doles Moretan Marine Ltd. (narrow-boat builders). The centre is also engaged on 2 projects: a computer project, which ultimately aims to purchase a small business computer and to hold regular computer evenings; and a museum project, the focal point of which will be a Siemens 51-type automatic exchange. The museum will be situated at the Old Worksop Priory telephone exchange, and most of the work will be undertaken voluntarily by members

of the centre. The project has received the full backing and co-operation of the British Post Office at both Area and Regional level. It is hoped that the museum can be opened in approximately 2 years time.

The 1981-82 session commenced in May with the annual general meeting, which was held at the West Street Hotel, Sheffield.

F. R. TURNER

HARROGATE CENTRE

In April 1980, Harrogate centre was re-formed, and it now has 75 members. Because of this support, a programme of 4 visits has been completed so far.

The first visit undertaken this year was to the Royal Ordnance factory at Leeds, where members were shown the British Army's main battle tank; the visit was especially interesting for one particular member who belongs to the Territorial Army.

D. O. ROWSON

Notes and Comments

CONTRIBUTIONS TO THE JOURNAL

Contributions to the *POEEJ* are always welcome. In particular, the Board of Editors would like to reaffirm its desire to continue to receive contributions from Regions and Areas, and from those Headquarters departments that are traditionally modest about their work.

Anyone who feels that he or she could contribute an article (short or long) of technical, managerial or general interest to engineers in the Post Office is invited to contact the Managing Editor at the address given below. The editors will always be pleased to give advice and try to arrange for help with the preparation of an article, if needed.

GUIDANCE FOR AUTHORS

Some guiding notes are available to authors to help them prepare manuscripts of *Journal* articles in a way that will assist in securing uniformity of presentation, simplify the work of the *Journal's* editors, printer and illustrators, and help ensure that authors' wishes are easily interpreted. Any author preparing an article is invited to write to the Managing Editor, at the address given below, to obtain a copy.

All contributions to the *Journal*, including those for Associate Section Notes, must be typed, *with double spacing between lines*, on one side only of each sheet of paper.

As a guide, there are about 750 words to a page, allowing for illustrations, and the average length of an article is about 6 pages, although shorter articles are welcome. Contributions should preferably be illustrated by photographs, diagrams or sketches. Each circuit diagram or sketch should be drawn on a separate sheet of paper; neat sketches are all that is required. Photographs should be clear and sharply focused. Prints should preferably be glossy and should be unmounted, any notes or captions being written on a separate sheet of paper. Good colour prints and slides can be accepted for black-and-white reproduction. Negatives are not required.

It is important that approval for publication is given at organizational level 5 (that is, at General Manager/Regional Controller/THQ Head of Division level) and authors should

seek approval, through supervising officers if appropriate before submitting manuscripts.

Contributions should be sent to the Managing Editor, *The Post Office Electrical Engineers' Journal*, NEP 12, Room 704, Lutyns House, Finsbury Circus, London EC2M 7LY.

SPECIAL ISSUES AND BACK NUMBERS

Copies of the April 1974 issue covering sector switching centres, and the October 1973 special issue on the 60 MHz transmission system, are still available.

Back numbers can be purchased, price £1.30 each (including postage and packaging), for all issues from April 1974 to date, with the exception of April and October 1975 and April 1976. Copies of the April 1973 issue are also still available.

Orders, by post only, should be addressed to *The Post Office Electrical Engineers' Journal* (Sales), 2-12 Gresham Street, London EC2V 7AG. Cheques and postal orders payable to "*The POEE Journal*", should be crossed "& Co." and enclosed with the order. Cash should not be sent through the post. A self-addressed label accompanying the order is helpful.

MODEL ANSWERS

The Board of Editors regrets that, due to circumstances outside its control, the model answer coverage of Technician Education Council courses has not developed in the way that it had been hoped. Steps are being taken to overcome the problems which have been encountered and in the meantime the Board of Editors apologizes to students.

CORRECTION

Book Review: *Reliability and Maintainability of Electronic Systems*.

An error occurred in paragraph 3 of this book review on page 16 of the April 1981 issue of the *Journal*. The correct version is as follows: "... before venturing into fault-tree analysis ...".

Apologies are offered for any confusion that may have been caused.

INDEX TO ADVERTISERS

Advertisements

Communications, advertisement copy, etc., should be addressed to Mr. N. G. Crump, The Advertisement Manager, *POEEJ*, Room 508, 2-12 Gresham Street, London, EC2V 7AG (Tel: 01-357 2089).

No responsibility is accepted by the Journal for any of the private or trade advertisements included in this publication.

GEC Telecommunications Ltd.	1
Herman Smith Ltd.	5
Siemens Ltd.	4
Southways Electronics Ltd.	2
Ryford Ltd.	2

IPOEE CENTRAL LIBRARY

Any member who does not have a copy of the catalogue can obtain one on loan from the Librarian, IPOEE, 2-12 Gresham Street, London EC2V 7AG. Library requisition forms are also available from the Librarian, from honorary local-centre secretaries, and from Associate Section centre secretaries and representatives.

Alternatively, the panel below, or a photocopy, can be used (only by members) to borrow any book listed in the catalogue or in the updating lists published in recent issues of the *POEEJ*. The form should be sent to the Librarian at the address above; a self-addressed label must be enclosed.

IPOEE Central Library LIBRARY REQUISITION FORM <i>For use only by members of the Institution of Post Office Electrical Engineers</i>	
Author
Title
.....	
Catalogue No.	Date
Name
Official Address

The Post Office Electrical Engineers' Journal

Copyright

The entire contents of this *Journal* are covered by general copyright, and special permission is necessary for reprinting long extracts, but editors are welcome to use not more than one-third of any article, provided that credit is given at the beginning or end, thus: "From *The Post Office Electrical Engineers' Journal*".

The Board of Editors is not responsible for the statements made nor the opinions expressed in any of the articles or correspondence in this *Journal*, unless any such statement is made specifically by the Board.

Subscriptions and Back Numbers

The *Journal* is published quarterly in April, July, October and January, at 80p per copy (£1.30 per copy including postage and packaging); annual subscription: £5.20; Canada and the USA: \$12.00.

The price to British Post Office staff is 48p per copy.

Back numbers will be supplied if available, price 80p (£1.30 including postage and packaging). At present, copies are available of all issues from April 1974 to date with the exception of the April and October 1975 and April 1976 issues.

Orders, by post only, should be addressed to *The Post Office Electrical Engineers' Journal*, 2-12 Gresham Street, London EC2V 7AG.

Employees of the British Post Office can obtain the *Journal* through local agents.

Binding

Readers can have their copies bound at a cost of £7.50, including return postage, by sending the complete set of parts, with a remittance, to Press Binders Ltd., 4 Iliffe Yard, London SE17 3QA.

Remittances

Remittances for all items (except binding) should be made payable to "*The POEE Journal*" and should be crossed "& Co."

Advertisements

All enquiries relating to advertisement space reservations, copy, proofs, etc. should be addressed to Mr. N. G. Crump, The Advertisement Manager, *Post Office Electrical Engineers' Journal*, Room 508, 2-12 Gresham Street, London EC2V 7AG (Telephone: 01-357 2089).

Distribution and Sales

Correspondence relating to the distribution and sale of the *Journal* should be addressed to *The Post Office Electrical Engineers' Journal* (Sales), 2-12 Gresham Street, London EC2V 7AG.

Communications

With the exceptions indicated above, all communications should be addressed to the Managing Editor, *The Post Office Electrical Engineers' Journal*, NEPI2, Room 704, Lutvans House, Finsbury Circus, London EC2M 7LY (Telephone: 01-357 4313).

Model-Answer Books

Books of model answers to certain of the City and Guilds of London Institute examinations in telecommunications are published by the Board of Editors. Copies of the syllabi and question papers are not sold by *The Post Office Electrical Engineers' Journal*, but may be purchased from the Sales Department, City and Guilds of London Institute, 76 Portland Place, London W1N 4AA.

SIEMENS

Compact, reliable connectors. Approved for use on TEP.IE.*

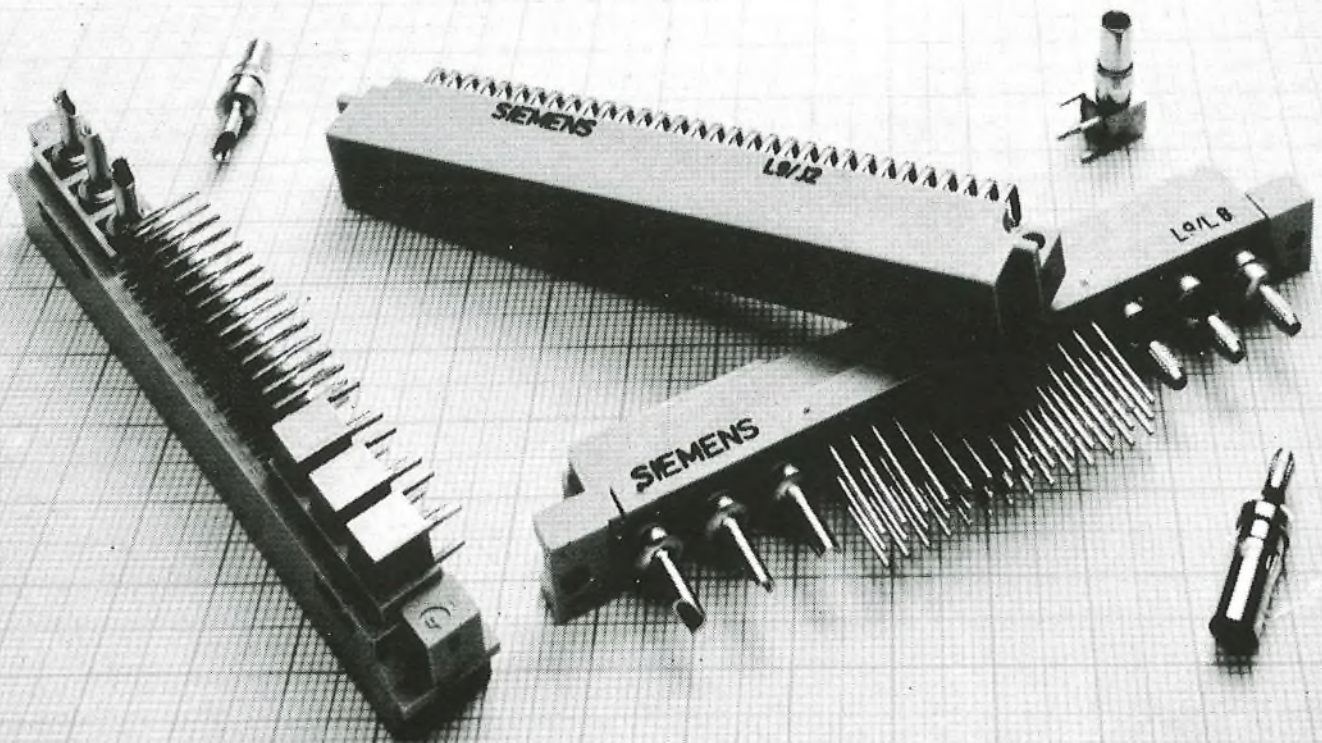

Designed for conditions encountered at speeds in excess of Mach 2, Siemens connectors are the vital links upon which the reliability of today's most sophisticated electronic systems depends. In the continuing development and improvement of our connector ranges, reliability, cost reduction, and space saving are major considerations. Siemens connectors comply with standards specific to communications, electronics and data processing. Two-part connectors are made

according to DIN 41612 and IEC 130-14 standards, with VG95324 military approval, and, therefore meet the demanding environmental requirements of military and avionic systems. These two-part connectors have also been approved by the major UK Government contractors. Siemens Limited, Siemens House, Windmill Road, Sunbury-on-Thames, Middlesex TW16 7HS. Telephone: Sunbury (09327) 85691 Telex: 8951091

In the world of electronic components Siemens has the answer.

* Registered trade mark of the Post Office

Let Herman Smith supply your Equipment Practice requirements

The British Post Office, in conjunction with the telecommunication equipment manufacturers, have developed a new racking system for transmission and other equipment applications.

This is to replace existing 62 Type practice, which Herman Smith have manufactured for many years. It will house equipment in very sophisticated miniaturised forms and will offer a far greater packing density.

Herman Smith on their part will manufacture the metalwork for this new type of racking and supply any company or public body.

The company has full and adequate facilities to make and inspect this equipment—both the rack and the incorporated shelves—to the exacting requirements.

At present, the company is supplying 62 Type wired assemblies and racks to the Post Office and is fully approved for Post Office manufacture and also to 05/24 M.O.D. standards.

Cabinets and sheetmetal fabrications can be made to customers' special requirements.

Enquiries to Peter Bowen,

HERMAN SMITH LIMITED
Cinder Bank Works
Netherton, Dudley
West Midlands DY2 9AH
Telephone: Dudley 52791

