

The Post Office Electrical Engineers' Journal

R. A. Roe
E 556

VOL 73 PART 4 JANUARY 1981



THE POST OFFICE ELECTRICAL ENGINEERS' JOURNAL

VOL 73 PART 4 JANUARY 1981

Contents

Editorial	207
Pattern Definition for the Manufacture of Large-Scale Integrated Circuits C. J. Heslop, R. E. Hines and J. W. Woodward	208
System X: Subsystems	216
Part 5—The Subscribers' Switching Subsystem M. G. Foxton	
Record-Breaking Thrustbore—D. Brakes	222
System X: Subsystems	223
Part 6—Software Subsystems J. A. Elmore	
Margins of Safety in Design D. G. Clow	229
The CCITT No. 6 Common-Channel Signalling System P. J. Walker and D. R. Ballinger	235
UXD5: A Small Digital-Switching Telephone Exchange for Rural Communities J. R. W. Ames, M. J. Elsdon, M. W. Hill and P. A. Trudgett	241
Prestel Comes to Wales—P. L. Bushell and M. Clemitson	246
British Telecom Research Laboratories on Show	248
Optical-Fibre Submarine Cable Systems	250
The Intelligent Telephone	251
Automatic Voice-Response from Telephone Exchanges: Voicedata	252
Slow-Scan Television	253
The Hollow Pole D. Clark	254
System X: The Role of the Switching Systems Test Facility A. Thomas	258
Character Coding for Text Communication	263
Part 2—The Development of Practical Standards A. J. Whall	
System X: Design and Support	268
Part 6—Design Rules J. L. Swaffield	
Institution of Post Office Electrical Engineers	271
Notes and Comments	272
Associate Section Notes	272
Forthcoming Conferences	273
Book Reviews	215, 234, 240, 262, 267
Post Office Press Notices	228, 257, 273

Published in April, July, October and January by *The Post Office Electrical Engineers' Journal*,
2-12 Gresham Street, London EC2V 7AG.

Price: 80p (£1.30p including postage and packaging). Orders by post only.

Annual subscription (including postage and packaging): home and overseas £5.20.
(Canada and the USA \$12.00.)

Price to British Post Office staff: 48p.

© 1981: The Institution of Post Office Electrical Engineers.

Let Herman Smith supply your Equipment Practice requirements

The British Post Office, in conjunction with the telecommunication equipment manufacturers, have developed a new racking system for transmission and other equipment applications.

This is to replace existing 62 Type practice, which Herman Smith have manufactured for many years. It will house equipment in very sophisticated miniaturised forms and will offer a far greater packing density.

Herman Smith on their part will manufacture the metalwork for this new type of racking and supply any company or public body.

The company has full and adequate facilities to make and inspect this equipment—both the rack and the incorporated shelves—to the exacting requirements.

At present, the company is supplying 62 Type wired assemblies and racks to the Post Office and is fully approved for Post Office manufacture and also to 05/24 M.O.D. standards.

Cabinets and sheetmetal fabrications can be made to customers' special requirements.

Enquiries to Peter Bowen,

HERMAN SMITH LIMITED
Cinder Bank Works
Netherton, Dudley
West Midlands DY2 9AH
Telephone: Dudley 52791

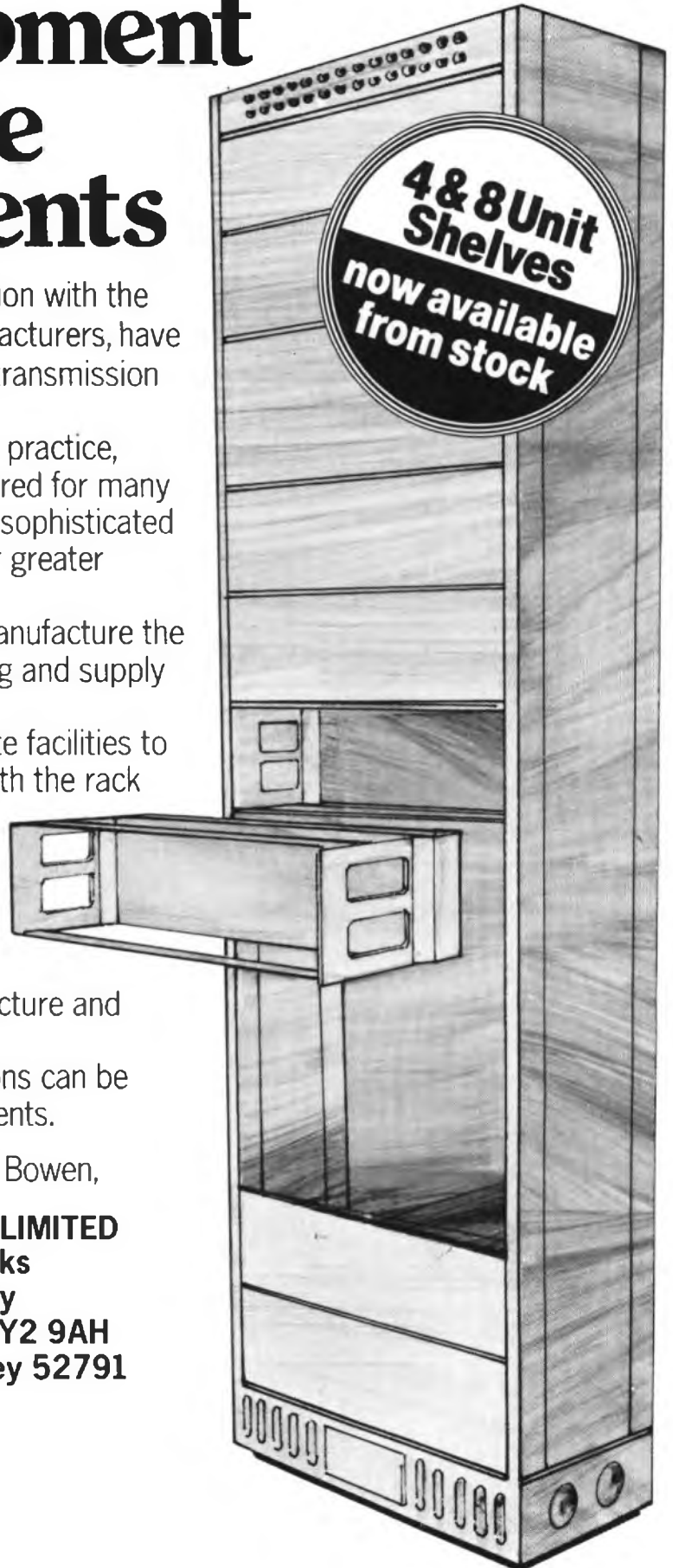

Good Morning

It's the dawn of the digital 80's from GEC Telecommunications. Now with a total network capability in digital transmission systems up to 140 Mbit/s, microwave radio systems, coaxial-cable and optical-fibre line systems and a complete range of digital multiplex.

Versatile business communications systems, including P.A.B.X.'s from 4 to over 5,000 lines using digital switching and stored programme control.

The dawn of digital technology from GEC Telecommunications... make an early start.

The GEC logo is rendered in a bold, stylized, italicized serif font.

Telecommunications

GEC Telecommunications Limited,
P.O. Box 53, Coventry CV3 1HJ England.

A Management Company of
The General Electric Company Limited of England.



"DIGICOUNT"

"DIGICOUNT" is a compact, hand held, self powered, robust, simple to use unit for counting LOOP DISCONNECT PULSES to POST OFFICE LINES, where the number dialled is displayed on a sixteen digit LED display driven from internal CMOS devices.



Applications include confirming outputs from:

- ★ Pre-Programmed Diallers
- ★ Automatic Call Makers
- ★ Viewdata/Prestel Terminals
- ★ Exchange Equipment
- ★ Domestic Telephones
- ★ Short Code Dialling Systems
- ★ Modems
- ★ Delivered Complete with Test Leads and in P.O. Approved "Texon" Case
- ★ Price: Only £150 excl VAT P. & P.
- ★ Local Purchase Orders Accepted

For Further Information Please Contact

area intertrade limited

34 LOWNDES STREET, LONDON SW1X 3HX
TELEPHONE: 01-245 9477/9, TELEX: 914142 CLTRAD G

NEW

"DIGICOUNT"/MF4

"DIGICOUNT"/MF4 is a hand held, battery operated tester supplied in the same package as "DIGICOUNT" (See above).

"DIGICOUNT"/MF4 is uniquely designed so that the unit decodes and displays all the 16 DTFM codes as dialled, with full LED Alpha-Numeric display as illustrated below reading from left to right.



Actual display size

"DIGICOUNT"/MF4 has selectable AUTO/NON-AUTO/MANUAL RESET. Guard times, input sensitivity and other operating parameters will be agreed to meet customers requirements prior to delivery.

For further information please contact:



area intertrade limited

AIL

34 LOWNDES STREET, LONDON, SW1X 3HX
TELEPHONE: 01-245 9477/9, TELEX: 914142 CLTRAD G.

Managing Microprocessors

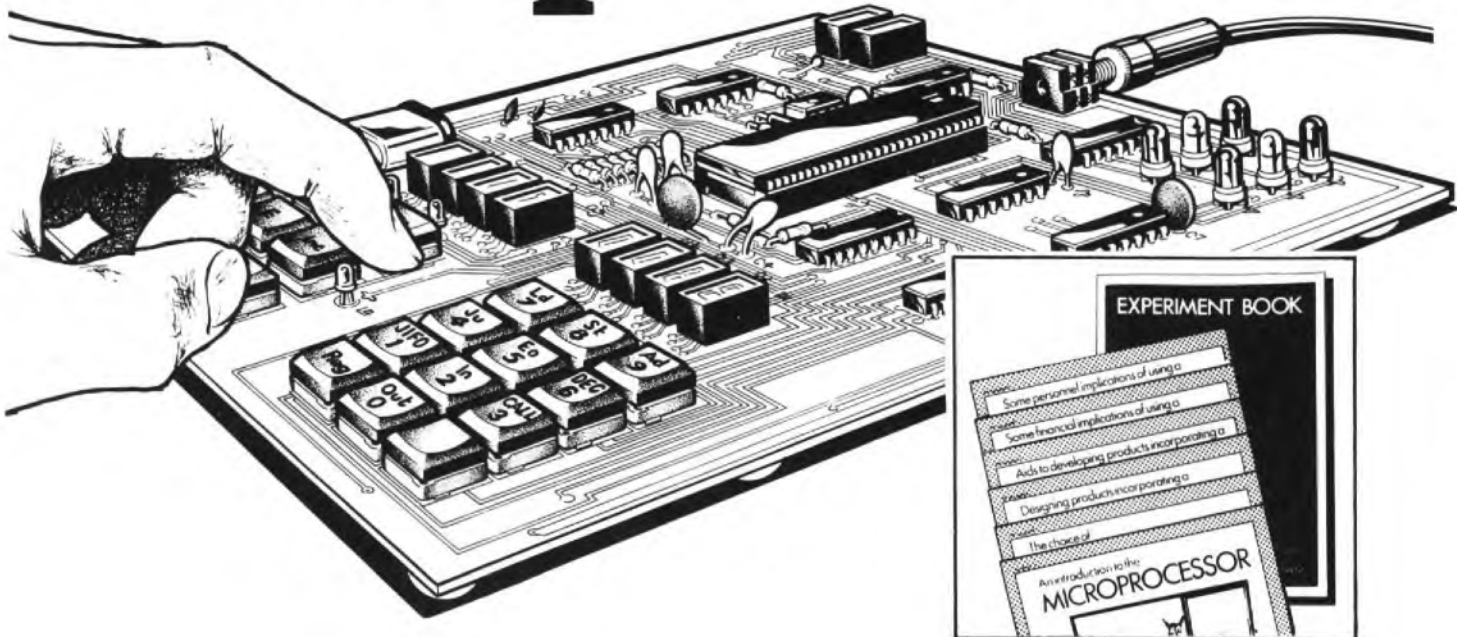

A short course to help managers use microprocessors in industry.

To help the executive who has to make critical decisions regarding investment in new products, the Open University offers an invaluable course – “Microprocessors and Product Development: A course for industry.”

You receive six study books covering an introduction to microprocessors, choosing a microprocessor, designing and developing microprocessor-based products, and the financial and personnel implications of using a microprocessor. To help you practise what we teach we provide a ready-to-use microprocessor system (illustrated above). Using this system you will see the potential of microprocessors.

Involving little time and money, the course will equip technical, financial, personnel, product planning and marketing managers with a working knowledge of how microprocessors will affect everything they do.

The course can be studied at your own pace in your own home, or used as part of an in-company training programme. It is entirely self contained. It involves no tuition, seminars or exams. It takes between 60 and 70 hours to complete.

The fee of £150 is fully inclusive, with no hidden costs. Send the coupon below (or ring 0908 71231) to obtain our brochure which will convince you that the

course will be one of the most profitable investments you will ever make.

To: The Open University,
P.O. Box 188 (MPO),
Milton Keynes, MK3 6HW

Please send me further details of Microprocessors and Product Development:

Name

Company

Address

..... P. Code

 **The Open University**
P.O. Box 188 (MPO), Milton Keynes, MK3 6HW

The Post Office Electrical Engineers' Journal

BOARD OF EDITORS

D. Wray, B.SC., C.ENG., F.I.E.E., Chairman

E. Davis, C.ENG., M.I.E.E.

C. E. Rowlands, B.SC., C.ENG., M.I.E.E.

F. V. Spicer, B.A.

L. W. F. Vranck

A. W. Welsh, C.ENG., M.I.E.E.

G. White, B.SC., PH.D., SEN.MEM.I.E.E.E.

Managing Editor

D. J. Holmes

Assistant Editor

A. R. Lawrence, C.ENG., M.I.E.R.E.

Secretary-Treasurer

B. Farr

Advertisement Manager

N. G. Crump

EDITORIAL

The Institution of Post Office Electrical Engineers (IPOEE) celebrates its 75th anniversary later this year. To mark the occasion, the October 1981 issue of the *Journal* will be a special edition; it will contain double the average number of pages and will be used to review the developments of the past 25 years in many of the principal areas of British Post Office (BPO) activity and to speculate about the future.

The review articles will include coverage of the following topics:

- (a) the evolution of the inland and international networks;
- (b) transmission, switching and signalling techniques;
- (c) customer apparatus;
- (d) postal engineering;
- (e) mechanical and civil engineering; and
- (f) research and development.

The major factors that have influenced the BPO's telecommunications business during the past 25 years will also be featured; for example, changes in technology, the growth of the system and the introduction of new services, and environmental and economic factors.

The proposed commemorative edition will complement the Jubilee edition of the *Journal* published in 1956 and, in addition to providing a wealth of reference material, will provide a most valuable record of the history of the BPO and the IPOEE.

Pattern Definition for the Manufacture of Large-Scale Integrated Circuits

C. J. HESLOP, M.SC., R. E. HINES, and J. W. WOODWARD, B.SC.†

UDC 621.38.049.776

The fabrication of large-scale integrated circuits is becoming increasingly dependent on ultra-fine pattern definition; this article describes both present techniques and future developments in mask making, photolithography and etching.

INTRODUCTION

Telecommunications systems are becoming increasingly dependent on the use of advanced microelectronic circuitry in order that the wide range of services now required by customers can be provided in an efficient and cost-effective manner. Special purpose, custom designed, large-scale integrated (LSI) circuits are finding wide application for functions specific to telecommunications; for example, codecs, digital filters and crosspoint switches. A facility for the design and fabrication of such circuits is available at the British Post Office (BPO) Research Department. After a brief description of LSI circuit fabrication, this article focuses on one aspect of wafer processing, that of pattern definition, and describes both current techniques and future developments in the three basic steps of the process; that is, mask making, photolithography and etching.

OUTLINE OF WAFER PROCESSING

The starting material for the fabrication of an LSI circuit is a wafer of silicon (about 0.4 mm thick) sliced from a cylindrical single crystal ingot. A 75 mm wafer diameter is now an industry standard, but even larger wafers up to 150 mm diameter are envisaged. The p-n junctions from which the active devices are built are formed in the surface of the wafer by doping the silicon with an appropriate element (boron for p-regions, phosphorus or arsenic for n-regions). The fundamental process of planar technology¹ (the technology on which silicon integrated circuits is based) is the growth of a silicon dioxide layer into which holes are etched down to the silicon surface. These holes define the areas to be doped (for example, the source and drain of a metal-oxide semiconductor

(MOS) transistor) and the contacts to the devices. Present day MOS technologies use a silicon gate consisting of a thin oxide (about 100 nm), on top of which is deposited and patterned a polycrystalline silicon layer. Device interconnexions are made by both the polysilicon layer and an aluminium pattern. A cross-section of a typical MOS structure is shown in Fig. 1. A fully-processed 75 mm wafer can contain over 100 identical circuits and, after probe testing to reject non-working circuits, the wafer is sawn, or scribed, and separated to yield the individual circuit die (or *chip*). The die is then mounted in a package, the circuit connexions are bonded to the appropriate pins and the package is sealed.

PHOTOMASK FABRICATION FOR LSI CIRCUIT MANUFACTURE

A key aspect of the fabrication of semiconductor LSI circuits is the precise delineation of patterns in various materials. Photomasks provide the medium for patterning silicon wafers with the multiple layers of circuit element geometries in the production of integrated circuits. Photomasks consist essentially of a repeated array of microphotographs of the circuit layers, and are produced by photolithographic techniques on a glass substrate which is coated with either photographic emulsion or chromium. For many years now, the transfer of the design layout to the photomask has been accomplished by optical systems operating at visible light wavelengths. However, the increasing requirement of smaller geometric features for increased circuit-packing density and operating speed, and demands for shorter mask-production times, is stimulating moves to mask manufacture by electron-beam lithography.

There are three principal stages in producing photomasks:

- (a) the generation of a reticle pattern, which is typically 10 times the final image size;
- (b) the replication of a multi-image array mask at final size; and
- (c) photomask quality control.

A multiplicity of techniques now exist in the semiconductor industry for producing fine geometry photomasks (as shown in Fig. 2); those of current interest to the BPO Research Centre at Martlesham Heath are now described.

Reticle Generation from Rubylith

The simplest input for generating reticles is to use a data tape of digitized circuit-element coordinates to produce a rubylith artwork on a flat-bed plotter coordinatograph². Rubylith is a dimensionally stable laminate of transparent and red-coloured polyester films.

A large sheet of rubylith, typically 1.2 m square, is positioned on the bed of the plotter underneath a cutting head, which makes incisions in the upper red layer of the rubylith.

† Research Department, Telecommunications Headquarters

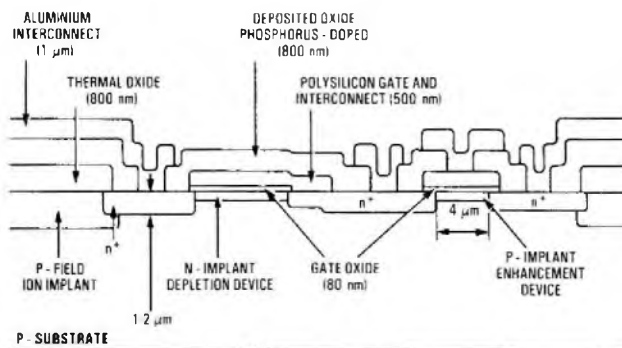

FIG. 1—Block diagram of the cross-section of the n-channel Si-gate 5 V process

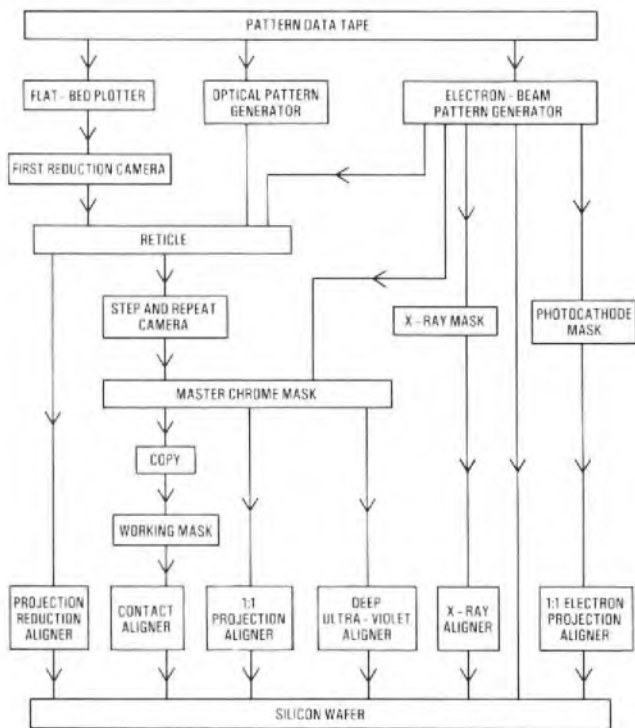

FIG. 2—Techniques for mask production

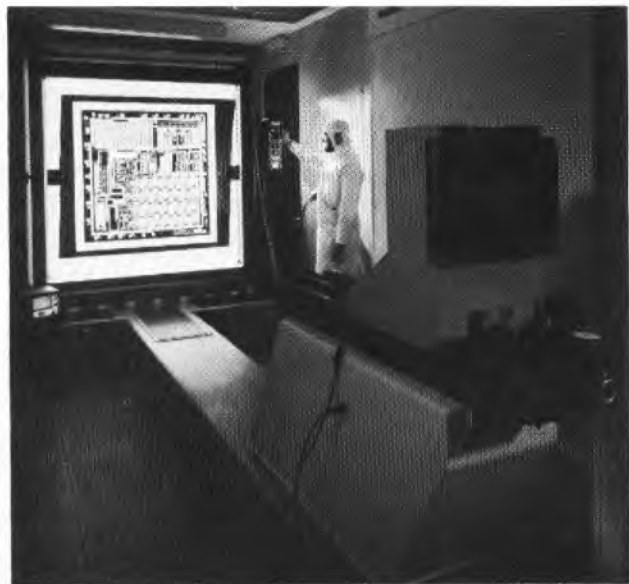

FIG. 3—First reduction camera

The head movements and cutting instructions are computer-controlled from the data tape. By carefully peeling away the red film between the cuts an image of the particular circuit layer is revealed in the transparent film. The image is an accurate magnified (200 or 500 times) reproduction of the final circuit layer pattern. Some 10 layers are currently required in modern integrated-circuit (IC) technologies for producing the eventual circuit, and a rubylith artwork is prepared for each layer.

In the mask-making unit an artwork layer is mounted, by electrostatic attraction, on an optically-flat vertical screen of a first-reduction camera (see Fig. 3). The screen is illuminated from the rear with a diffused high-intensity light source whose spectral output is filtered at 546 nm. A camera is mounted on

the end of a long rigid girder spine which is orthogonal to the copy-holder screen. The camera is equipped with high-quality reduction lenses (1/20 or 1/50 times, depending on the scale of the artwork) for producing an image on a photographic plate which is exactly 10 times final size; the plate, after chemical processing to reveal the image, is known as a *reticle plate*. The aerial resolution of the 1/20 times lens normally used for LSI artwork is 200 lines/mm at f5.6 over a 80 mm field. A reticle is made in turn from each artwork layer.

Although rubylith has proved a useful starting point for producing IC photomasks for the past two decades, it has now been almost superseded by optical or electron-beam pattern generation because of:

- (a) the constraints of the maximum size of rubylith that can be accommodated on the plotter and reduction camera,
- (b) the minimum size of feature that can be practically peeled on the rubylith artwork, and
- (c) the time involved and risk of errors in the peeling operation.

A complex LSI chip such as a digital filter circuit is 5 mm square and has 5 μm geometric features. The chip requires 8 layers of artwork, each of which is 1 m², and a total of about 100 000 shapes have to be peeled, many of which are only 1 mm wide, even at 200-times magnification. The peeling time for this set of artworks is over 200 man hours.

Pattern Generation

Industry has now turned to pattern generators for the fabrication of fine geometry reticles. In these systems, the data design is used in conjunction with a computer to control the movements of an XY stage, located beneath a collimated exposure source whose output is modulated by computer commands. The source can be optical photons or electrons.

An optical pattern generator consists of a light source, a condensing system and a reduction lens, which projects a demagnified image of a variable aperture onto an unexposed photomask located on a servo-controlled XY stage (see Fig. 4). The data tape enables an associated computer to send movement instructions to the stage, set the size and orientation of the variable aperture and modulate the light source. The light source can be either a Xenon flash tube for exposing emulsion plates, or a mercury ultra-violet lamp for exposures on photoresist-coated chrome plates. The variable aperture consists of two pairs of adjustable blades and the aperture opening is capable of being progressively incremented from 5-1500 μm , adjustable in 0.1 μm steps. The pattern is therefore photocomposed by exposing a series of rectangular areas on the reticle plate. Computer software enables the reticle

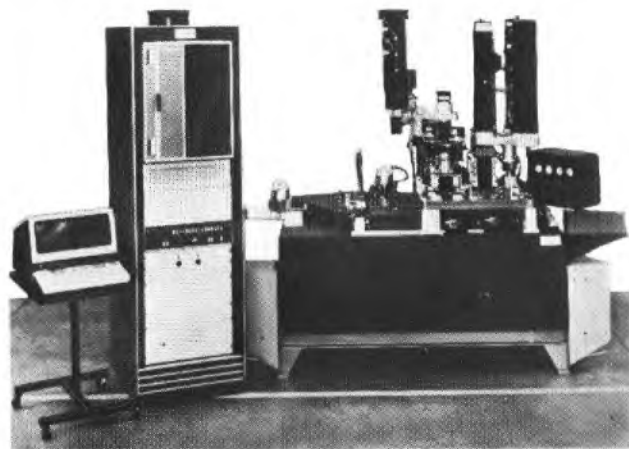

FIG. 4—Optical pattern generator

image to be scaled and the individual elements to be size biased; this is a facility which is increasingly being requested by circuit designers and wafer process engineers, but which is not available on rubylith artwork. Reticle production times using optical pattern generation will obviously be a function of the chip size and its complexity, but are typically less than 2 h per mask level.

An exploratory exercise has been conducted during the past two years to examine the viability of producing reticles of BPO circuit designs by using the pattern generator of a commercial mask-making company. The practicability of the method was demonstrated for several LSI mask sets and it is now hoped to instal an optical pattern generator at the BPO Research Centre in early-1981. The equipment will have the capability of pattern generating either emulsion or chrome reticles.

Step and Repeated Array-Masks

The production of the final-size multi-image array masks is effected by a step-and-repeat camera. The reticle, whether made from rubylith or by pattern generation, is clamped in a holder after adjustment of the reticle orientation, and the image is reduced by 10 times by projection through a high-quality lens onto a photomask plate mounted on a movable XY stage. After exposing the image, the stage moves to the next location for another image exposure, and this sequence of step and exposure continues until the full image array is complete.

The reticle can be illuminated by either a Xenon flash source for exposing emulsion photomasks or by a mercury lamp filtered at 436 nm for exposing photoresist-coated chromium photomasks. Emulsion masks are less expensive and quicker to produce, but generally they have inferior resolution and are less durable than chrome masks; the latter is the preferred medium for LSI applications. Although the projection lens has the capability of resolving $1\ \mu\text{m}$ lines and spaces, careful optimization of exposure, focus and mask processing is necessary for defining $2\ \mu\text{m}$ minimum features on large complex LSI patterns.

Consideration of the depth of focus of the lens demands that the blank mask plates should be flat to better than $2\ \mu\text{m}$ over a 100 mm diameter. The glass used for the mask plates should also have a low coefficient of thermal expansion to minimize image placement errors arising from any temperature variations in the environment where the masks are produced.

To ensure exact placement of the images on a mask and accurate registration from one mask level to another, movements of the XY stage are monitored by laser interferometers whose interference fringe count output provides a feedback control for the stage-stepping motors.

Electron-Beam Mask Fabrication

Optical techniques suffer from several disadvantages when used to produce fine geometry masks. Visible wavelength diffraction limits the minimum linewidth to about $1\ \mu\text{m}$, and the need for two reduction stages causes loss of pattern placement accuracy, as well as relatively long mask-production times. These problems may be overcome by electron-beam lithography, where the shorter wavelength and high resolution of electron beams can produce minimum linewidths down to $0.1\ \mu\text{m}$ or less.

Electron-beam machines are similar in principle to optical pattern generators in that patterns are written on a mask plate located on a movable stage with a focused electron beam controlled by a computer, which provides commands for deflecting and actuating the beam. Scanning electron-beam machines consist of a high-emission electron source, electron focusing lenses and deflection coils, beam modulating pattern generation facilities and a precision XY mask stage, all of which are contained in a high-vacuum chamber. The deflection coils enable the electron beam to be scanned over the writing

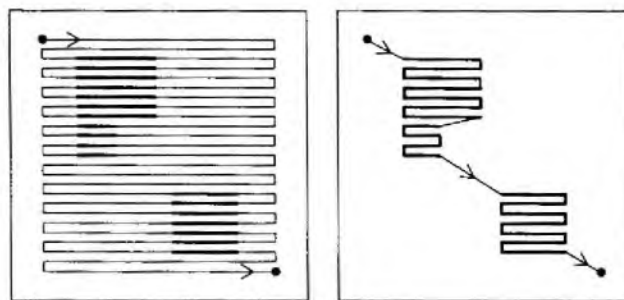

(a) Raster scanning

(b) Vector scanning

FIG. 5—Principles of electron-beam scanning

field in either a raster-scan or a vector-scan mode, depending on the particular machine configuration. With raster scanning (see Fig. 5(a)), the beam scans the full field area and is switched on only when required. In vector-scan instruments, the beam moves only to sites where exposure is needed (see Fig. 5(b)). The maximum field over which an electron beam can be scanned without distortion is typically about $1\ \text{mm}^2$ and, for writing large-area LSI circuit patterns, some method of stitching scan fields together is essential. This can be achieved by accurate monitoring of the mask stage position, by using laser interferometry or by pre-printing a fiducial registration pattern on the mask. This latter technique poses severe technical constraints in both generating and detecting the fiducial marks.

Circuit patterns are written on a chrome mask coated with an electron resist, which is a polymer material whose chemical solubility is changed by exposure to electrons. Since electron beams can be focused to very small diameters, pattern resolution is mainly limited by electron scattering in the resist and mask substrate. These scattering phenomena, which become significant at $1\ \mu\text{m}$ and below, give rise to proximity effects, and it is thus necessary to adjust the exposure for different feature sizes and spacings.

Electron-beam systems can generate 10-times reticles or final-size working masks for wafer lithography. The major factors governing the throughput of the equipment are electron-optical characteristics, beam current and deflection switching rates, electron-resist sensitivity and stage movement times. Advanced commercial machines can produce a 100 mm working mask with $2\ \mu\text{m}$ geometries, direct from a computer-aided design (CAD) data tape, in under 1 h, but the capital cost of such equipment is very high.

Photomask Quality Control

The quality of a set of photomasks used for wafer fabrication has a significant impact on the final yield of working circuits on the silicon wafers.

The three main factors that determine photomask quality and which require tight control are the mask defect density, the mask-to-mask overlay registration and the feature linewidth tolerance.

Mask Defect Density

Mask defects consist of either excess chrome (for example, bridges between and protrusions from the tracks) or the absence of chrome (for example, pinholes and/or breaks in the tracks). These aberrations will be printed from the mask onto the wafer and restrict the number of potential good dice on the wafer. Defects can arise from imperfections which are inherent in the original blank mask plates and from spurious contamination in the multitude of mask processing steps or from the environment in which the mask manufacturing operations are performed.

For the current $5\ \mu\text{m}$ technology, it is customary to define

the defect size as significant if it is larger than $2\ \mu\text{m}$, but future finer geometry processes ($3\ \mu\text{m}$ and below) will entail the definition of significant defects at $1\ \mu\text{m}$. It is possible to predict empirically the yield (Y) of good chips of area $A(\text{cm}^2)$ from a set of N photomasks with an average defect density D (defects/ cm^2) from a statistically derived equation

$$Y = \frac{1}{(1 + pDA)^N},$$

where p is the probability of a defect being ruinous.

Yield curves computed from this formula clearly illustrate (see Fig. 6) that, as the chip size becomes larger, the mask defect density must be reduced in order to obtain acceptable circuit yields. To ensure quality, masks are generally inspected visually for defects by manual scanning with high magnification optical microscopes. As circuit geometries decrease below $5\ \mu\text{m}$ and chip size and complexity increase, manual inspection becomes very exacting and can take several hours for each mask. Sampling inspection plans can ease the labour intensiveness of inspection. Quality specifications for very-large-scale-integrated (VLSI) masks will be even more stringent, with the significant defect size being defined as $1\ \mu\text{m}$ (or even smaller) and the target defect density as 0.05 defects/ cm^2 . Firms making large volume masks are now turning to automated inspection equipment, but present machines suffer from the disabilities of very high capital cost and, even so, they can only just discriminate $1\ \mu\text{m}$ defects—a size that is barely acceptable for VLSI applications.

Two techniques at present being used for reducing mask defects are double reticle stepped masters and defect zapping. In the former method, two reticles are generated and are used sequentially for stepping the master array plate. The probability of both reticles having the same fault in exactly the same location is very low; thus the production of near-perfect masters is made easier. In the second method, optical or laser zapping machines can be used for the localized removal of opaque chrome defects. The defect density of incoming commercial blank plates can range up to 0.1 defects/ cm^2 , and the existing target quality for photomasks supplied to wafer

processing after the multiplicity of optical reduction and chemical processing steps is only 0.2 defects/ cm^2 .

Clearly, major improvements in the quality of the basic raw mask blanks and in mask processing techniques will be required for attaining a target defect density of 0.05 defects/ cm^2 for VLSI masks.

Registration

In practice, for the achievement of acceptable wafer yields, the positional inaccuracy for the superposition of successive mask levels on the wafer should not exceed $\pm 1\ \mu\text{m}$ over the full mask field width ($75\ \text{mm}$ in the case of $100\ \text{mm}$ masks). The inter-mask registration can be measured on a special double-head microscope, known as a *mask comparator*. There is only minimal scope for improving this specification with existing technology, since the absolute positional precision of the XY stages of optical pattern generators, image repeaters and electron-beam mask machines, even with laser interferometric control, cannot be guaranteed to better than $\pm 0.25\ \mu\text{m}$.

Linewidth Control

The linewidth tolerance on photomasks for $5\ \mu\text{m}$ processes is $\pm 0.5\ \mu\text{m}$; the linewidths are measured by manual optical image shearing techniques. As the trend in circuit linewidths moves towards sub-micron dimensions, the tolerance magnitude must also be reduced. However, at about the $1\ \mu\text{m}$ level, optical measuring systems approach fundamental optical diffraction limitations, and the precision of measurement accuracy of both the system and the personnel making the measurements will be comparable with the linewidth tolerance. Optical diffraction effects cause the image intensity of narrow lines to be less than that of wider lines for a given exposure energy. Consequently, the illumination energy required for adequate exposure of the narrowest lines will exceed the optimum illumination for larger features and difficulties will result in controlling both large and small dimensions to the same tolerance level. Direct electron-beam writing of final size masks can obviate this problem, since it is possible to adjust the electron dosage of the resist exposure according to the feature size being written.

PHOTOLITHOGRAPHY

Having produced a set of photomasks, the next task is to transfer the patterns of each mask successively onto the wafer surface in order to delineate the regions of doping, insulation, contact windows and connexion tracks. To achieve this, the wafer has to be coated with a light-sensitive film (called *photoresist*) and exposed through the photomask (see Fig. 7).

Photoresists

High quality photoresists are available commercially and rely for their operation on a high sensitivity to ultraviolet radiation (in a wavelength range of $330\text{--}430\ \text{nm}$) and a low sensitivity to ambient lighting, particularly in the yellow part of the spectrum. Hence, all laboratories concerned with photolithography have yellow filters on both lights and windows. Photoresists are characterized as either positive or negative, according to whether their solubility in a developer solution is increased or decreased after exposure to ultraviolet radiation. After exposure through a photomask and subsequent development, positive resist reproduces a pattern on the wafer in the same sense as the mask, whereas negative resist produces a pattern in the opposite sense. The desirable properties of a photoresist film are

- (a) a uniform and controllable thickness after coating (determined by the viscosity of the resist),
- (b) good adhesion to the substrate,
- (c) freedom from pinholes and particulate matter, and
- (d) resistance to attack by the etching species and ease of removal after etching.

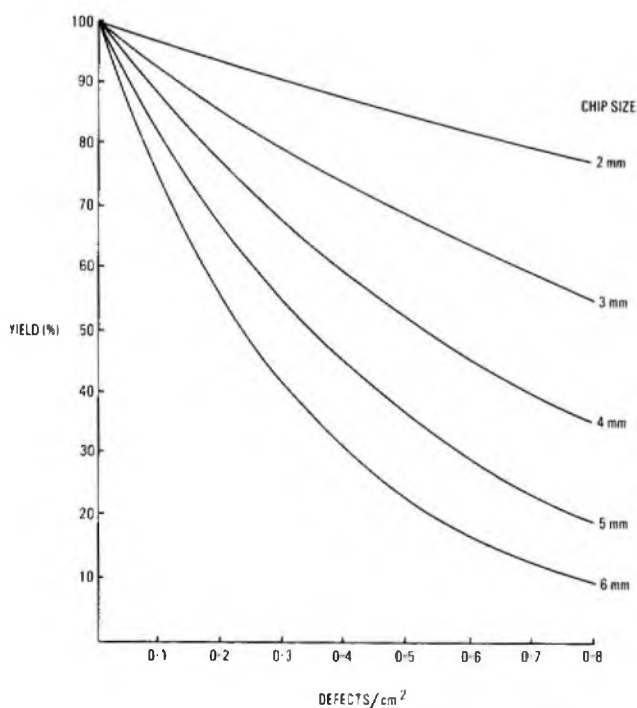

FIG. 6—Potential yield as a function of chip size and mask defect density

Despite the superior linewidth control available with positive resists, negative resist has been popular for many years because, for most applications, a light field mask is required; that is, one in which a large proportion of the pattern area is transparent, thus giving good visibility of the wafer through the mask and hence facilitating alignment. However, as pattern densities have increased, this advantage begins to lose ground, and the pressure to reduce linewidths to $3\ \mu\text{m}$ and below has resulted in a wider use of the positive type.

Coating

The adhesion of the resist is critically dependent on the preparation of the wafer surface and this may require such steps as treatment in a high-temperature furnace or the use of a thin film of adhesion promoter. The resist is dispensed through filters designed to remove particles greater than $0.2\ \mu\text{m}$, and the operation must be carried out in high-grade clean-room conditions, with temperature and humidity controlled to close tolerances. A typical specification for the ambient conditions is $21^\circ\text{C} \pm 1^\circ\text{C}$, $40\% \text{ RH} \pm 2\%$. After coating, the wafers are dried by a short bake at 90°C .

Exposure

Exposure of the coated wafers through a photomask can be performed by one of three methods: the hard contact, proximity or projection methods. The methods are described in the order in which they became available to industry. Block diagrams of the three methods are shown in Fig. 7.

Hard Contact Method

By use of the hard contact method, pattern dimensions can be reproduced onto the wafer down to a linewidth accuracy of $1\ \mu\text{m}$. The method has a major disadvantage in that damage can arise to both wafer and mask when brought into contact. For VLSI work, in which mask costs are very high, the hard contact method of exposure is uneconomic.

Proximity Method

In the case of the proximity method of exposure, the mask and wafer are separated by a gap of $5\text{--}30\ \mu\text{m}$; thus, if both surfaces are sufficiently flat, damage to the mask or wafer is avoided. However, because proximity printing relies on casting a shadow of the photomask onto the wafer, the collimation of the incident illumination has to be near perfect if geometrical distortion is to be avoided. The optical equipment required to prevent this distortion is more elaborate than for contact printing and, hence, equipment costs are higher. The resolution of proximity printing is limited by Fresnel diffraction at pattern edges, and a minimum linewidth of $2\ \mu\text{m}$, at a mask-wafer separation of $5\ \mu\text{m}$, is the best available by this method.

Projection Method

Projection printing is achieved by focusing an image of the mask onto the plane of the wafer. This presents an opportunity to work with other than 1 : 1 mask-to-wafer scaling, although 1 : 1 scaling is emerging as the most popular approach. Best results are obtained using reflective optics in the projector because this avoids problems associated with the transmission of ultraviolet radiation through refractive elements. For geometries less than $2\ \mu\text{m}$, depth of focus is one of the limiting factors, demanding wafer and mask flatness to better than a few microns. Whichever exposure method is used, progressive misalignment across a wafer (called *run-out*) can occur due to the difference in thermal expansion coefficients of the mask plate glass and silicon wafer, and very close control of temperature (to within 0.5°C) must be maintained throughout the process to minimize this effect. All the exposure methods require close control of the radiation level reaching the resist since both under-exposure and over-exposure lead to poor linewidth control and detrimental effects in other processes.

Alignment

Before exposure of the coated wafer through the photomask

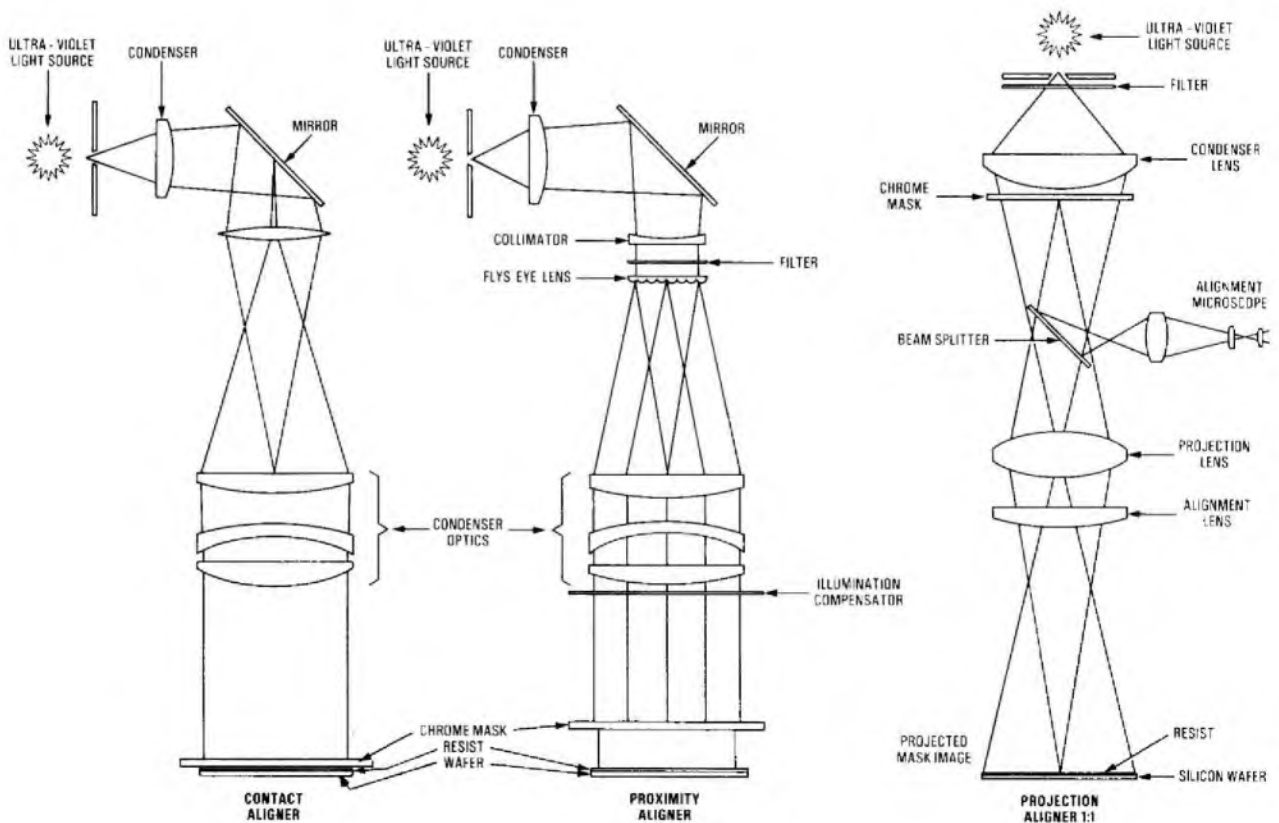

FIG. 7—Three methods of resist exposure

can take place, the mask must be accurately aligned with patterns previously etched in the wafer surface. This alignment is achieved by viewing the mask and wafer through high-powered microscopes and physically moving one with respect to the other. Keys or shapes are provided on the masks to indicate the correct alignment, and are etched into each succeeding layer on the wafer, together with the desired circuit pattern. Present design rules require placement of the mask to within $\pm 1 \mu\text{m}$ for $5 \mu\text{m}$ linewidths and better than this for finer geometries. Automatic alignment equipment is now becoming available to perform this task.

With the combination of projection printing and automatic alignment, it becomes practicable to expose only part of the wafer (for example, an array of 9 chips or even individual large chips), and then step automatically to the next array and expose that, until the whole wafer has been exposed. This process, known as *step on wafer*, with its inherent small field of view, enables better resolution for a given lens system and permits use of a times 10 reticle (avoiding the need to produce a mask containing actual device dimensions). Because the wafer is exposed in stages, it becomes possible to refocus and realign automatically before each exposure; thus errors associated with wafer bowing and mask-to-wafer run-out are reduced.

Development

Having exposed the pattern, the unwanted photoresist is dissolved away. The solvents used in this process will of course be related to the chemical composition of the chosen resist. Bath development is technically acceptable for the smallest geometries, but has been overtaken by spraying techniques since these are more easily automated for inclusion as part of a flow-line process. Given a known concentration of developer, time and temperature become the critical parameters. Negative resist suffers more distortion during development than positive resist, and the latter is preferable for very small dimensions. After development, the resist pattern is baked to harden it and to improve its resistance to attack by the etching process.

Future Developments in Lithography

The technologies described for wafer lithography all use light in the visible or near visible band. As already mentioned in the photomask section of this article, these techniques are limited by the wavelength of the incident illumination to a resolution of about $1 \mu\text{m}$. Some improvement in resolution can be obtained by working with deep ultraviolet light (wavelength of 200–260 nm) to take advantage of the improvements offered in mask making by electron-beam lithography (the lower wavelength being set by absorption of ultraviolet in optical elements of the system). Further improvements in resolution can be achieved by direct writing on the wafer using the electron beam, and this approach is being studied in the BPO Research Department by using the Cambridge Instruments EBMFI, which was installed at Martlesham in May 1980. At present, due to the long writing time involved to delineate an array of LSI chips, this is cost effective only for circuits of low complexity. Undoubtedly, these problems will be overcome and the need for conventional photomasks will disappear, but certainly the next generation of devices, based on 3–4 μm linewidths, will use the optical methods described in this article.

ETCHING OF THIN FILMS

The films required to be etched for a typical n-channel or a complementary metal oxide semiconductor (CMOS) silicon gate technology are insulating layers of silicon nitride, silicon dioxide and phosphorus-doped glass, and conducting layers of polycrystalline silicon (polysilicon) and aluminium (often an alloy of 1.5% silicon in aluminium). Typically, the insulating films are 300–800 nm thick, the polysilicon is 400 nm thick and the aluminium conductor is $1 \mu\text{m}$ thick,

Etching Techniques

The conventional way to etch the insulating layers is by a wet chemical process in which the composition of the etch is chosen

- (a) to give a reasonable etch time (about 1–10 min), and
- (b) not to attack the underlying substrate or photoresist mask.

Typical etchants for glassy layers are solutions of hydrofluoric acid, potassium hydroxide for polysilicon and phosphoric acid for aluminium. Silicon nitride has to be etched by boiling phosphoric acid, and hence an additional masking layer of oxides is required because of the inability of photoresist to withstand the etch cycle.

These wet etching technologies are still the mainstay of many process lines, but they have a number of disadvantages which become more evident as the dimensions of the circuit elements are reduced. Chief among the problems are

- (a) the isotropic nature of the etching, which is a serious problem when the width of the pattern becomes comparable with the thickness.
- (b) bubble formation in the etch solutions, which can leave bridges of material between tracks³, and
- (c) resist adhesion.

Modern spray etching facilities minimize these problems and claims have been made for some degree of anisotropy in the etch characteristics. However, a newer technique called *plasma*† etching is now tending to replace wet etching because of its inherent ability to solve all three of the above problems. With plasma etching, the active chemical species are formed by an electrical discharge in a suitable gas at low pressures, and volatile products formed by the etching reaction are pumped away by the vacuum system. It is the policy of the microelectronics division of the BPO Research Department to develop this new technology and incorporate the processes as the equipment becomes commercially available. During the last few years, plasma etch processes for nitride, polysilicon and overlay oxide have become standard features of wafer processing.

Development of Plasma Equipment

Plasma-etching machines have developed from two independent sources, and two distinct types of equipment are available: the *barrel etcher* and the *diode reactor* machines.

The Barrel Etcher Machine

The barrel etcher machine is derived from ashing machines in which an oxygen plasma is used to remove hydrocarbon residues from a sample surface. A cross-section of such a machine is shown in Fig. 8 and equipment of this type is used to remove the photoresist mask after etching is complete. The machine consists of a cylindrical quartz chamber evacuated by a rotary vacuum pump. A radio frequency (RF) voltage at 13.5 MHz is applied to external electrodes. An oxygen discharge is formed around the circumference of the chamber at a pressure of about 70 Pa. The wafers to be cleaned are stacked in a quartz boat which is placed axially in the chamber, and active oxygen species combine with carbonaceous residues to form carbon monoxide and carbon dioxide, which is pumped away.

This simple equipment was modified for etching purposes by the addition of an aluminium mesh tunnel surrounding the wafers and the use of carbon tetrafluoride gas with a small percentage of oxygen⁴. The mesh tunnel reduces the amount of charged particle bombardment (and hence the temperature) of the wafers, which enables standard photoresist masks to be used and improves the uniformity of etching. The exposed material is etched by active gaseous species containing

† A plasma is an overall electrically neutral region of ions and electrons within a gas

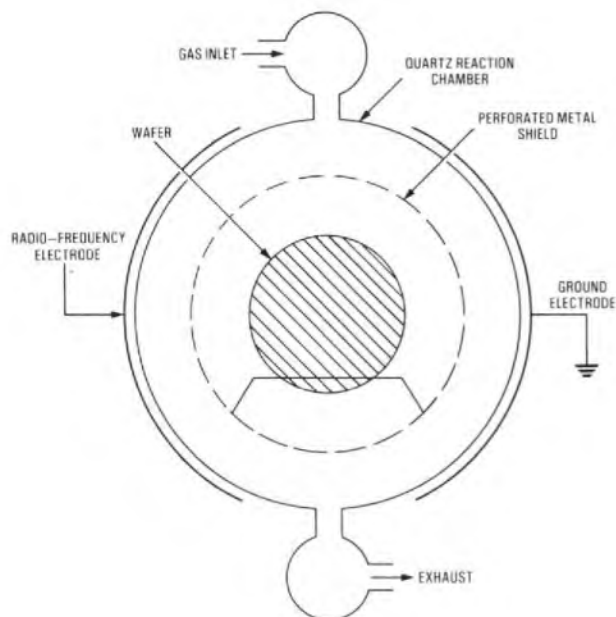

FIG. 8—Cross-section of barrel etcher

fluorine. This process quickly found favour for silicon nitride etching because it enabled a simple photoresist mask to be used instead of the additional oxide masking stages, and eliminated the potentially hazardous hot phosphoric acid etching. Similar plasma processes are also used for etching polysilicon and opening bond pad windows over aluminium in oxide passivation layers. However, this equipment has some disadvantages for VLSI circuit fabrication: firstly, lateral etching can still be a problem because it relies on diffusion of active species to the wafer surface; secondly, it is not possible to etch aluminium because aluminium fluoride is not volatile and the active chlorinated species required have too short a lifetime to diffuse to the wafers; thirdly, it is not possible to etch oxide from a silicon surface because the silicon etch rate is higher than the oxide etch rate (that is, there is no natural end-stop to the etching process).

The Diode Reactor Machine

The problems associated with the barrel etcher machine were overcome by the development of the diode reactor machine, a block diagram of which is shown in Fig. 9. The RF power is applied to an electrode situated within the vacuum chamber. The gas plasma is formed between this electrode and a water-cooled grounded surface on which the wafers rest, and the potential of the plasma can reach a value of several hundred volts with respect to the electrodes. As a consequence, there is considerable ion and electron bombardment of wafers placed on the electrodes. The equipment has been developed for etching by introducing an active gas to form volatile compounds at the surface as in the barrel etcher. The crucial advantages of this more complex equipment over the barrel etcher are

- (a) it is possible to etch aluminium because the wafers are immersed in the plasma and short lived species are formed near enough the surface to take part in the reaction,
- (b) because some chemical reactions at the surface are induced or enhanced by electron or ion bombardment, the etching of many materials becomes anisotropic due to the directional nature of the charged particle flux, and
- (c) it is also possible to etch oxide from silicon surfaces with acceptable selectivity⁵.

The anisotropic nature of aluminium etching is illustrated in

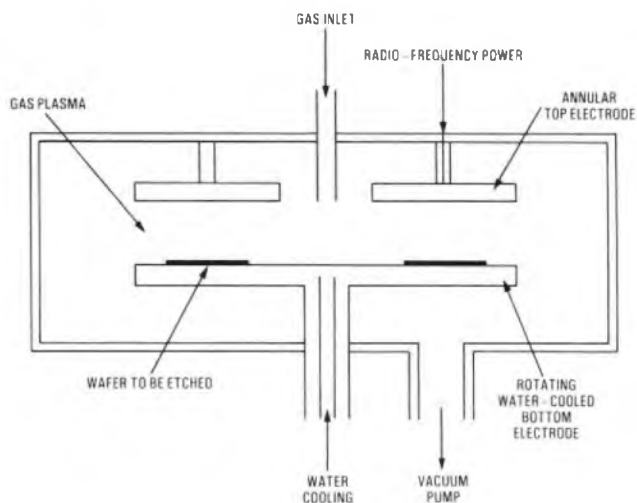

FIG. 9—Block diagram of diode reactor



FIG. 10—Plasma-etched aluminium test structure (4 μ m wide, 1 μ m thick)

Fig. 10, which shows a scanning electron micrograph (SEM)⁶; the vertical edges of an aluminium test structure on a silicon dioxide film can be seen. A typical plasma-etched conductor pattern on an IC is shown in the SEM in Fig. 11.

However, the introduction of these techniques brings with it problems unique to plasma etching. The most important of these is the comparative lack of selectivity of etching between the film required to be patterned and both the mask and the substrate. Unlike wet etching, complete selectivity is rarely attained (the only example in silicon wafer processing being oxide over aluminium), and typical selectivities lie between 5 : 1 and 20 : 1. Whether these selectivities are sufficient to make a viable process depends on other factors; for example, the degree of overetch necessary (which is determined mainly by the uniformity of film thickness and uniformity of etch rate) and the depth of substrate that can be sacrificed. A particular problem with the use of chlorinated gases to etch aluminium and polysilicon is the high etch rate of the masking photoresist; the quality of the etching depends markedly on the thickness, durability and cross-sectional profile of the resist. Difficulties in aluminium and polysilicon etching are also encountered where the surface of the wafer is steeply contoured over previously patterned layers. Both these problems illustrate the increasing interdependence of processing steps in LSI circuit fabrication.

The present processing sequence for silicon wafers uses wet

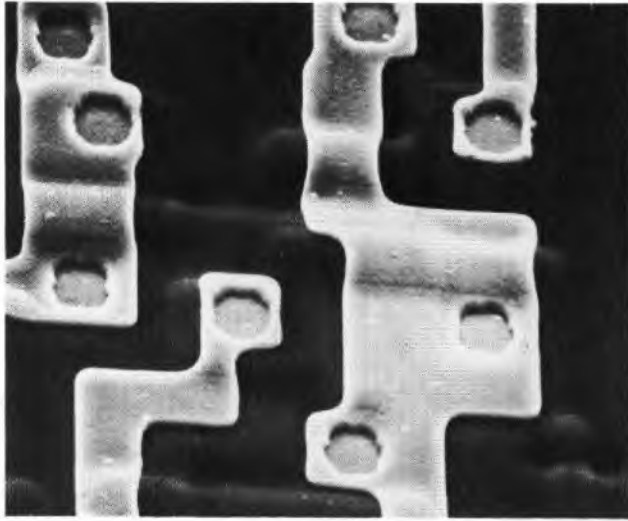

FIG. 11—Plasma-etched aluminium integrated circuit connexion pattern

etching for opening contact holes in oxide to the silicon surface and for etching aluminium tracks where the surface topology does not allow the present anisotropic plasma etching process to be used; plasma etching is used for nitride, polysilicon, and aluminium on the more planar technologies such as collector diffused isolation (CDI).

At present, work is aimed at introducing an all dry-etch processing sequence, and the two most important areas for development are the reduction of resist etch rate in the chlorine-based plasma systems (permitting wider use of the aluminium

plasma etch) and the optimization of an oxide etch process. It is expected that these plasma processes will be used to advantage in the new HMOS and CMOS technologies to be introduced during 1981.

CONCLUSIONS

This article has described just one aspect of LSI circuit manufacture and has illustrated the very exacting nature of the technology and the high capital cost of the equipment to make the processing viable. The techniques of pattern definition are constantly improving and it is apparent that the limits of optical resolution will be reached within the next few years in normal production processes. Equipment such as the electron-beam pattern generator is already being evaluated and developed to continue the trends of greater packing density and higher operating speeds beyond these limits.

ACKNOWLEDGEMENTS

The authors wish to acknowledge the contributions to this work by many colleagues in the Microelectronics and Devices Divisions of the BPO Research Department.

References

- ¹ HENDERSON, J. C., and WILSON, S. J. Design and Technology of Silicon Planar Transistors. *POEEJ*, Vol. 56, p. 238, Jan. 1964.
- ² WALKER, G. S. Computer-Aided Drawing Equipment for Integrated Circuit Manufacture. *POEEJ*, Vol. 64, p. 260, Jan. 1972.
- ³ HINES, R. E. An Improved Technique for Etching Aluminium Interconnect Patterns on Integrated Circuits. *Microelectronics and Reliability*, Vol. 10, p. 59, 1971.
- ⁴ KOMIYA, H., ABE, H., SONOBE, Y., and MATSUI, H. International Electron Devices Meeting, Washington, p. 459, 1973.
- ⁵ HEINECKE, R. A. H. Control of Relative Etch Rates of SiO_2 and Si in Plasma Etching. *Solid State Electronics*, Vol. 18, p. 1146, 1975.
- ⁶ BOOTH, R. C., and HESLOP, C. J. Application of Plasma Etching Techniques to Metal-Oxide-Semiconductor (MOS) Processing. *Thin Solid Films*, Vol. 65, p. 111, 1980.

Book Review

Telecommunication System Engineering. Roger L. Freedman. John Wiley & Sons. xxii + 480 pp. 184 ills. £17.70.

Many authors have attempted to present a comprehensive study of telecommunications system engineering in a single volume; very few of them have met with complete success. In general, the few successful books published have been by authors who have consciously restricted the scope of their study to one particular aspect of telecommunications engineering, or who have aimed their books at a specific audience.

In this book, the author claims that it is his intention to present the general engineering considerations necessary for the design of practical telecommunications networks to an audience of students, practising engineers, planners and managers; not surprisingly, he has failed to achieve this ambitious objective.

The most serious failing of the book is the balance of detail devoted to different subjects. Indeed, it is difficult to establish

the author's intentions, or the readership he was aiming at when he wrote the book. For example, the book starts with a chapter that includes a discussion on traffic engineering in which no less than 10 pages of text are devoted to tables detailing the traffic capacity of routes containing between one and 150 trunks. As the book progresses, the discussion becomes less and less detailed, until in chapter 9 the entire subject of digital transmission and switching systems is dismissed in a total of 40 pages.

It is unfortunate that the author has set himself an over-ambitious target, because the book is generally well written and illustrated, and detailed arguments are logically presented. Had the author set out to produce a textbook limited to a single subject, such as switching principles, he would probably have ended up with a successful result. As it is, the lack of balance is sufficiently serious to render this book of little value to an individual telecommunications engineer.

A. W. MUIR

System X: Subsystems

Part 5—The Subscribers' Switching Subsystem

M. G. FOXTON, B.SC.†

UDC 621.395.345

This article continues the series describing the subsystems of System X. The structure and operation of the subscriber switching subsystem are explained, showing how traffic from individual subscribers' lines is concentrated into the central digital switch.

INTRODUCTION

Previous articles have described the technical principles of System X^{1,2} and introduced the architecture of the family of System X local exchanges³. This article covers the subscribers' switching subsystem (SSS) which is used in the family of local exchanges. Its purpose is to interface directly with subscribers' lines through the main distribution frame (MDF) and to provide the necessary analogue-to-digital conversion and traffic-concentrating functions to connect subscribers' lines to a number of standard 2·048 Mbit/s time-division multiplex highways, the structure of which has previously been described⁴. The concentration is necessary to achieve a high enough channel occupancy level which will allow economical traffic switching through the digital route switch⁵.

In the local exchange overview³, two distinct versions of SSS were mentioned, an analogue and a digital version. Initial designs of System X made use of the analogue version, but in the light of recent advances in technology, a digital concentrator has been evolved as a direct replacement, and it forms the subject of this article.

The concentrator is designed to terminate 2048 subscribers' lines and concentrate the traffic onto 8 standard 2·048 Mbit/s line systems each handling 30 speech channels. A minor hardware modification is available which allows 4096 lines to be accommodated in areas with particularly low average traffic per line.

A local exchange can contain a number of concentrator modules, thus allowing the full capacity of a large local exchange to be reached. Control of each concentrator is by a common-channel signalling technique, so that any concentrator can be collocated with, or remote from, the digital route switch and processor.

FUNCTIONAL REQUIREMENTS OF DIGITAL SUBSCRIBERS' SWITCHING SUBSYSTEM

Basic Requirements

The main function of the digital subscribers' switching subsystem (DSSS) is to interface to all types of subscribers' apparatus, including coin-collecting boxes and PBXs, which currently exist in the network. It concentrates the subscribers' lines onto a smaller number of 64 kbit/s channels in such a way that it is non-blocking; that is, under fault-free conditions and given that a free channel to the digital switching subsystem or route switch exists, there are no mechanisms within the concentrator which will prevent any subscriber obtaining access to that channel. In order to achieve this, it processes both the signalling and speech information which are presented by such subscribers.

The DSSS handles the speech information by first performing a 2-wire-to-4-wire conversion so that the two directions of conversation can be separated, as shown in Fig. 1. This is necessary since the functions of coding, decoding, concentration and transmission need to operate on unidirectional information. Considering the direction of transmission from subscriber to route switch, the concentrator must sample the analogue waveform every 125 μ s (8 kHz) and encode each sample into an 8 bit digital word in accordance with CCITT* A-Law encoding requirements. The resulting 64 kbit/s digital stream is subsequently processed through a digital concentrator into a channel on a 2·048 Mbit/s line system. A complementary function in the return direction of transmission involving digital-to-analogue conversion is also provided.

In order to handle the subscribers' signalling, the concentrator must detect all line conditions and convert the information given into messages which can be sent into the software of the exchange processor for subsequent call handling. Equally, the concentrator is able to receive messages from the software and to act on these by creating the appropriate subscribers' line conditions. In particular, the concentrator is capable of:

- (a) detecting the on/off-hook line-state during all phases of a call, even in the presence of ringing current on the subscriber's line,
- (b) returning dial tone to a subscriber,
- (c) detecting dialled digits either in the form of loop-disconnect signalling (up to 20 pulses/s) or multi-frequency subscriber's signals (SSMF4),
- (d) providing ringing current on the line to operate the subscriber's bell, and
- (e) returning tones during various phases of a call.

In addition to these basic signalling functions, there are a number of additional facilities which are used where special

* CCITT—International Telegraph and Telephone Consultative Committee

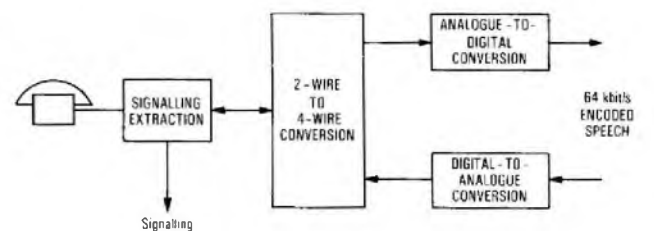

FIG. 1—Simplified speech path

† System X Development Department, Telecommunications Headquarters

features are provided for the subscriber, such as malicious-call indication equipment. For most of these facilities the concentrator acts as a simple agent to the software, either to accept a software command to generate a line signal or to detect a line condition and report that event to the software. The exceptions to this rule are subscriber's private metering and coin-collecting box charging supervision, where the concentrator carries out call timing supervision using charge-rate information provided at the beginning of each call by the exchange software.

Ancillary Requirements

The ancillary functions that are required to be handled in addition to the above are:

(a) *2.048 Mbit/s line system alarm handling.* A number of line conditions can be detected by the concentrator, and the alarms thus created are passed to the software so that appropriate maintenance action can be initiated.

(b) *Test access.* The concentrator provides metallic-pair access to all subscribers' lines in order that the maintenance staff can perform tests on the subscriber's line similar to those currently performed from a test desk. The concentrator provides access either out to the subscriber's line or into the line equipment of the exchange as requested by the maintenance staff.

(c) *Fault detection.* The concentrator is able to detect and report failures within itself. Additionally, where redundancy is incorporated, it can configure itself in such a way that it will continue to function until repairs are effected.

(d) *Fault diagnosis.* The design aim is such that faults should be diagnosed automatically to the level of a single replaceable unit.

(e) *Traffic Measurement.* Where traffic dependent mechanisms exist, the concentrator provides the administration with statistical information which enables it to monitor the quality of service provided by the concentrator. Examples of this would be the grade of service provided to subscribers on the concentrator, which is affected by either the number of SSMT4 receivers or by the number of 64 kbit/s links.

(f) *Non-System X Alarms and Keys.* Such conditions comprise 50 V power alarms, repeater-station alarms, fire alarms, and building-occupied indication. The detection of these conditions will cause not only visual and audible indications to be given, but will also result in a message being sent to the exchange processor, for passing on to the local administration centre where the appropriate maintenance action will be determined.

Remote Concentrator Requirements

It is possible for all the above requirements to be satisfied whether the digital concentrator is collocated with the route switch and the processor or remotely situated, connected as usual by 2.048 Mbit/s line systems. This implies that any signalling that needs to pass between the processor software and the concentrator hardware must be performed via the 2.048 Mbit/s line system. To achieve this, use is made of time slot 16 to carry the common-channel signalling protocols of the message transmission subsystem (MTS). Should all the transmission systems fail, resulting in a total loss of this signalling ability, the concentrator can still provide a limited service as explained later.

DESIGN CONSIDERATIONS

In addition to the normal design considerations (that is, the most economic realization maintaining adequate reliability and quality of service) two important aspects were taken into account during design.

Concentrator Module Size

The maximum number of subscribers per concentrator is determined largely by the number who will, during the busy-hour, give an average 64 kbit/s channel occupancy of 0.6–0.7 erlangs/channel (approximately 20 erlangs/line system). In applications where subscribers are predominantly residential, an occupancy of 0.02–0.03 erlangs/subscriber is to be expected; hence 1024 subscribers will generate about 20 erlangs of traffic. Because a minimum of two line systems are needed to provide security against transmission failure, a concentrator size of 2048 subscribers was chosen. However, it was recognized that in some areas, average subscriber line traffic levels would be even lower. A simple hardware modification is possible to permit 4096 total terminations.

In applications where business customers predominate, a need to cater for an average busy-hour occupancy of four times the residential average was thought necessary. This gave rise to the need to extend each concentrator module from two line systems up to a maximum of eight, giving a maximum switch capacity of 160 erlangs.

Remote Working and Isolation

As well as being capable of remote working it is required that, should a total transmission failure occur between the concentrator and its parent, some limited call-handling capability is retained by the isolated concentrator. This is limited to connecting calls between subscribers on the concentrator, with the range of facilities being reduced to simple telephone calls. Operator access and emergency services are also maintained, albeit at a minimal level, by the use of a small number of emergency junctions.

With these considerations in mind, a subsystem structure has been produced as shown in Fig. 2. It is now important to differentiate between the SSS as a whole and individual concentrators. The SSS in an exchange is capable of supporting a number of concentrator modules, each of which is able to generate about 160 erlangs of switched traffic and terminate up to 2048 subscribers' lines. The DSSS handler software running on the central processor has very little on-line processing requirement. All the software processing required to execute the call-handling functions has been delegated to microprocessors contained within each concentrator module. The role of the DSSS handler software is restricted to that of maintenance and statistics, and it acts as a communications medium between the other central software subsystems (except the call processing subsystem (CPS)) and the concentrator modules. In order to communicate with the concentrator

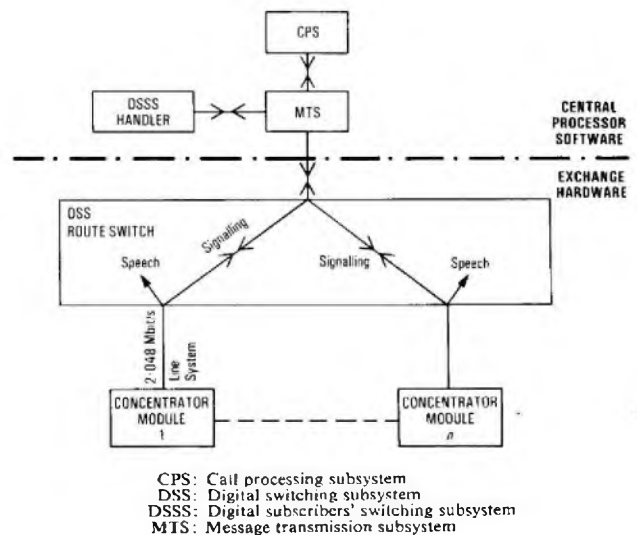
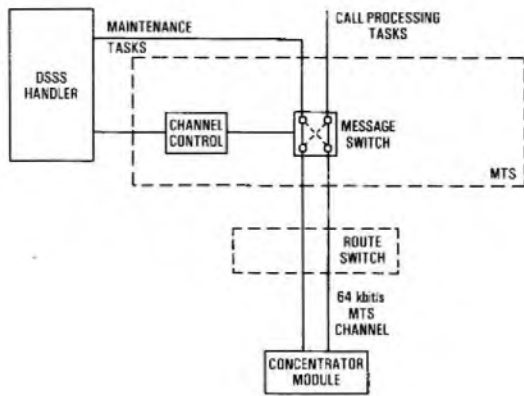

Fig. 2—Subsystem organization



DSSS: Digital subscribers' switching subsystem
 MTS: Message transmission subsystem

FIG. 3—Digital subscribers' switching subsystem usage of message transfer subsystem

modules the CPS software and the DSSS handler software use the MTS. Semi-permanent connexions through the route switch enable the signalling information to be inserted into time slot 16 alongside speech for transmission to the concentrator.

USE OF THE MESSAGE TRANSMISSION SUBSYSTEM BY THE DIGITAL SUBSCRIBERS' SWITCHING SUBSYSTEM

Communication between the concentrator module and the central processor uses the MTS. Fig. 3 shows a block diagram of the MTS link, which provides a duplicated message bearer. The MTS can provide the fan-out to allow many concentrator modules to be connected to one central processor and performs the task of routing a particular message to the appropriate concentrator. The MTS receives central processor messages in the form of tasks into its software and can transmit this information via the route switch to terminal units, two of which are contained within each concentrator module. Each terminal unit receives a 64 kbit/s bi-directional highway which is extracted from time slot 16 of a 2.048 Mbit/s line system. The two terminal units in one concentrator communicate with the central processor via different line systems to ensure continuity of control should line failure occur. The message can then be passed on to the concentrator for further processing; the techniques used to ensure the error-free transmission of these tasks were described in a previous article⁶.

When both MTS channels are working, the concentrator uses one for call handling activities and the other for maintenance purposes. The DSSS handler has responsibility for deciding the channel usage by instructing the MTS software. Only during link failure does the MTS override this mechanism, all tasks then passing along the remaining link.

RELATIONSHIP BETWEEN THE DSSS HANDLER SOFTWARE AND THE CONCENTRATOR MODULES

In order that each concentrator module can carry out its basic functions, the DSSS handler performs a number of tasks to assist it:

- (a) data record maintenance,
- (b) hardware initialization,
- (c) traffic measurement-statistics initiation and reporting,
- (d) overload control,
- (e) subscribers' private metering and coin-collecting box information control,
- (f) hardware fault reporting, and
- (g) miscellaneous hardware control.

As described in a previous article³, extensive use of data records is made to record both the maintenance states of equipment and subscribers' class-of-service information. Each concentrator module contains this information and the DSSS handler software maintains the integrity of these records. Maintenance staff can alter these records via a visual display terminal through the central processor. As well as passing this information on to the appropriate concentrator module, the software must remain a back-up copy of the database, which will be used if the volatile storage in each concentrator is corrupted in any way. A routine audit of these two data records is also performed so that any errors in the data records in each concentrator module can be identified and corrected.

Hardware initialization is required if the central processor initiates a complete software restart, or if the concentrator appears to be mishandling calls or messages. The DSSS handler software ensures that each concentrator module executes its initializing activities, and that this is performed in the correct sequence with respect to other activities.

The DSSS handler software initiates statistics measurements, which are actually performed in each concentrator module. The results of such measurements are passed back through the handler to the management statistics subsystem.

If, due to exceptional conditions, the queue lengths in the central processor become too long, the central processor can decide to suspend temporarily the processing of new call attempts until this overload condition disappears. Under these circumstances, each concentrator module needs to be instructed to stop new calls from being originated. The handler performs the role of initiating these overload control procedures in each concentrator.

The call accounting subsystem periodically provides charge-rate information to the DSSS handler software, and this is passed to each concentrator module as a data update. When calls involving subscribers' private metering or coin-collecting box charging commence, the concentrator module refers to these tables and together with timing information derived from the extracted clock of the 2.048 Mbit/s line system, it is able to deduce the metering rate and, in the case of coin-collecting boxes, interrupts speech with pay tone and checks the value of coins inserted. On completion of each call using one of these facilities, a message is sent via the handler software to the call accounting subsystem so that accountancy checks can be made.

A message originating in each concentrator module indicates when a fault has arisen. The handler software will decide what needs to be done to identify and isolate the faulty equipment and will initiate and co-ordinate any resulting fault location and diagnostic activities, together with the necessary maintenance state updates.

As mentioned earlier, there are a number of hardware functions within the concentrator modules which are not under the direct control of the SSS; for example, test access, and non-System X alarms. Operation of these functions is under the control of other software on the central processor, and the handler software acts as an interface between the concentrator and the appropriate software.

CONCENTRATOR MODULE DESIGN Architecture

The block structure of each concentrator module is shown in Fig. 4. Thirty-two subscribers' lines terminate on a line module, which is microprocessor controlled. Within this line module, analogue-to-digital conversion is performed and the resulting digitized speech is multiplexed onto a time-divided 2.048 Mbit/s highway which terminates on the concentrator switch. After concentration, the speech passes through tone generation and injection equipment, the digital line termination (DLT) and finally onto a 2.048 Mbit/s line system.

Concentrator control and subscribers' signal processing

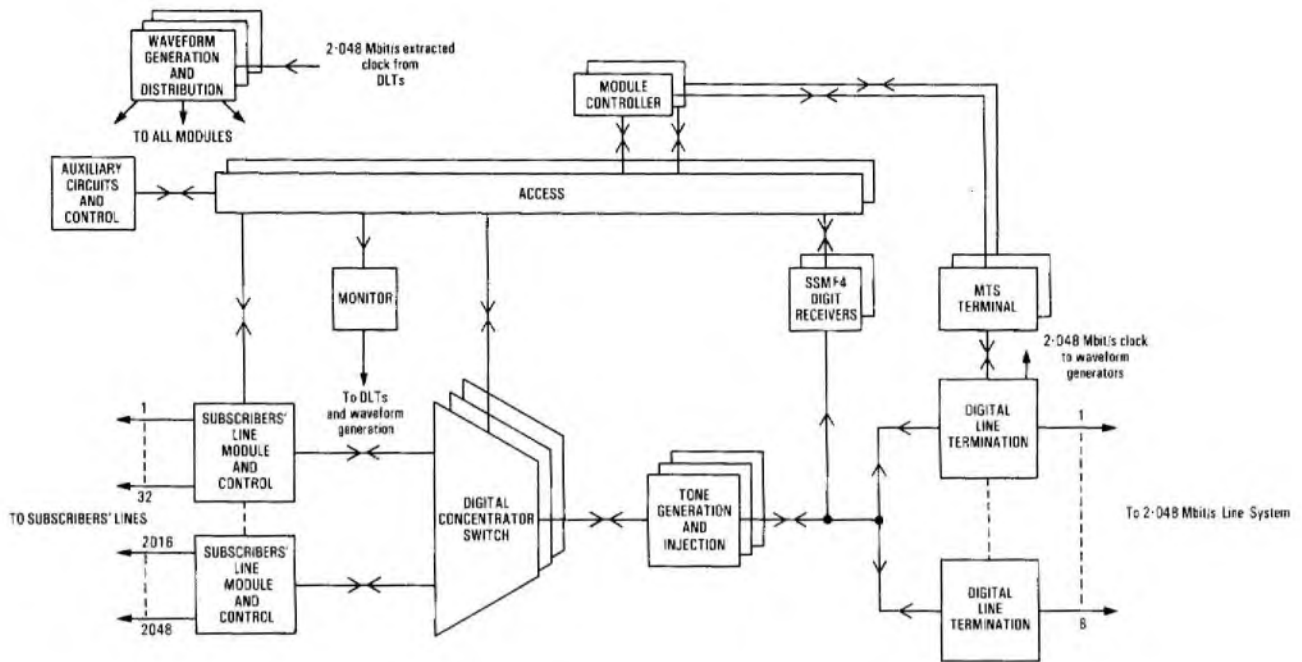

DLT: Digital line termination
 MTS: Message transmission subsystem

FIG. 4—Concentrator module architecture

are co-ordinated by the module controller, which communicates directly with the central processor by using the MTS control links in time slot 16, channel access onto the line system being provided in the DLT. Communication between the module controller and the remaining equipment is via a standard message signalling mechanism, known as *access*. Within the line module, subscribers' signalling information is extracted and passed through *access* to the module controller. The module controller is responsible for selecting free channels on the line systems, instructing the digital concentrator switch to set-up and clear connexions to subscribers and, when appropriate, co-ordinating the injection and reception of tones. Digitally generated tones and SSMF4 digit receivers are provided centrally after traffic concentration, and the module controller ensures that they are allocated and connected to subscribers' lines at the appropriate time. Any subscribers' signalling information subsequently received by the digit receivers is passed on to the central processor by the module controller.

Auxiliary circuits are provided for special subscribers' facilities (for example, subscribers' private metering) and these are serially trunked into the line circuit via the MDF. The auxiliary circuits generate and detect the line conditions, while the module controller again co-ordinates their operation with the rest of the concentrator and central processor.

With the exception of the DLTs and the waveform generators, which interface through an alarm collecting device which is known as *monitor*, all the hardware functional units in the concentrator contain a microprocessor-based controller.

All the hardware functions shown in Fig. 4 obtain their timing waveforms from a triplicated waveform generator which is itself synchronized to predetermined 2.048 Mbit/s line systems. Circuitry within the DLT recovers the 2.048 MHz clock signal from the incoming line system and this is passed to the waveform generators. In this way synchronous operation with the route switch and the rest of the network is achieved⁷.

Reliability

The subscribers' line module, handling 32 customers, is controlled by equipment which has not been replicated.

Should failures occur in this equipment, therefore, those subscribers connected to the faulty module lose the ability to make telephone calls. Similarly, up to 256 auxiliary circuits are served by common unsecured equipment. Failures here, however, would only result in the loss of the facilities provided by the auxiliary circuit. Basic telephone service would still be maintained.

The waveform generator and the digital concentrator switch are secured by triplication. Equipment connected to these units interface through a majority voting function, such that single plane failures permit the switching function to continue.

Access equipment and the module controller are duplicated; call control will be carried out on one plane only, the other plane being informed regularly of the state of all calls in progress, so that a failure in the worker will not affect any calls in progress. Maintenance activities are performed on the standby equipment and these are suspended if change-over occurs. A small triplicated security controller is employed to ensure that the duplicated security arrangements are maintained.

Detailed Description

Subscriber's Line Module

A block diagram is shown in Fig. 5. Each subscriber termin-

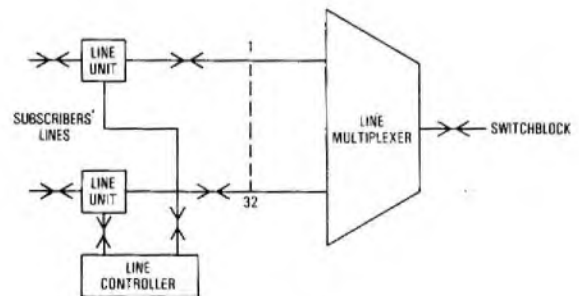

FIG. 5—Subscriber's line module structure

ates on a line unit within a line module. Signalling extraction and speech analogue-to-digital conversion are performed in the unit and are routed to the line controller and multiplexer respectively. In the multiplexer the digital information is put onto a 2·048 Mbit/s bearer for passing on to the concentrator switchblock. Time-slots 0 and 16 carry speech in the same way as all the other channels. The line controller provides the interface between the subscriber's line unit and access mechanism. The line controller is concerned with subscribers' signalling and will pass any information to the module controller, or activate the ringing current relay or operate the test access relay. A block diagram of the line circuit is shown in Fig. 6.

Metallic-pair test access to subscribers' lines is provided for maintenance purposes. This is implemented with a relay per line, activated from the line controller; a number of subscribers are commoned onto one test-access highway. Separate access to the subscriber's line and the exchange line unit is possible. A secured ringing current source is provided on a one per concentrator-module basis, and in each line unit equipment exists to cadence this supply so that the bell in the subscriber's telephone is operated. While ringing current is being passed to line, it is possible to detect a subscriber's loop by means of the ring-trip detector. Overvoltage protection needs to be provided against 250 V AC mains application and lightning strikes. In addition to this equipment, a gas-discharge tube may also be required on the MDF. The majority of subscribers' lines are fed with a constant-current supply of approximately 30 mA. Because the telephone instrument regulator is thus unable to perform its normal gain regulation, this function is undertaken by the line unit. The DC voltage measured across the subscriber's line at the exchange is used to vary the gain of the line unit. Simple make/break detectors

are provided on a one-per-line basis to perform signal extraction, and the line controller performs the necessary persistence activities to enable the appropriate software message to be sent. Two-to-four-wire conversion needs to be performed before the analogue-to-digital conversion and digital concentration. Hybrids are therefore provided on a one-per-line basis. Digital encoding is provided by sampling the analogue waveform periodically at a rate of 8 kHz and coding the amplitude into an 8 bit word. This encoding is non-linear, and conforms to the A-law recommendation of the CCITT. The decoder function performs the reverse operation.

Digital Concentrator Switchblock

Since they are all handled by the same controller, time switching, tone injection and the additional switching provided for use during concentrator isolation will all be described together. A block diagram of these functions is given in Fig. 7. Up to 2048 subscribers from 64 line modules are terminated into the switchblock on 2·048 Mbit/s serial highways. Thirty-two 8 bit speech samples are structured into a frame and, in order to perform time switching efficiently, a serial-to-parallel converter is provided so that the 8 bits of one sample are presented to the speech store coincidentally in time. The principles of time switching have already been well described in the *Journal*^{2, 3, 5}. This particular time switch also performs a concentration function since it terminates up to 2048 subscribers' channels and concentrates these onto the 256 channels which ultimately terminate on eight DLTs.

Between the time switch and the DLT, digital tone injection is performed followed by parallel-to-serial conversion. Analogue-to-digital conversion is based on the principle of sampling the speech waveforms every 125 μ s and encoding

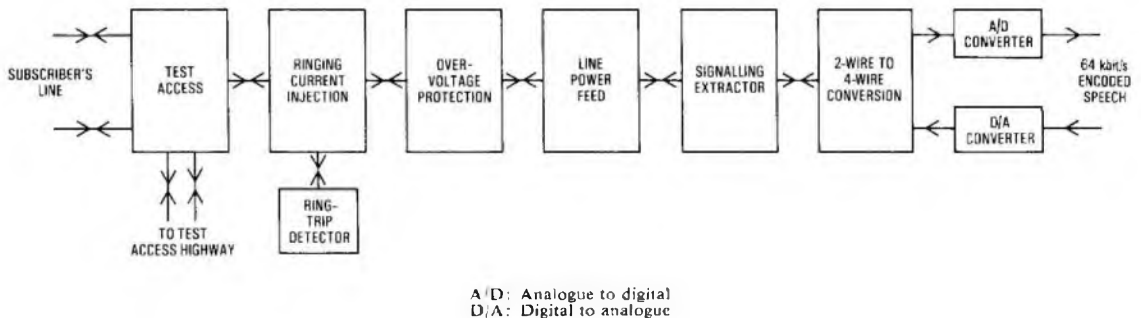

FIG. 6—Line-circuit structure

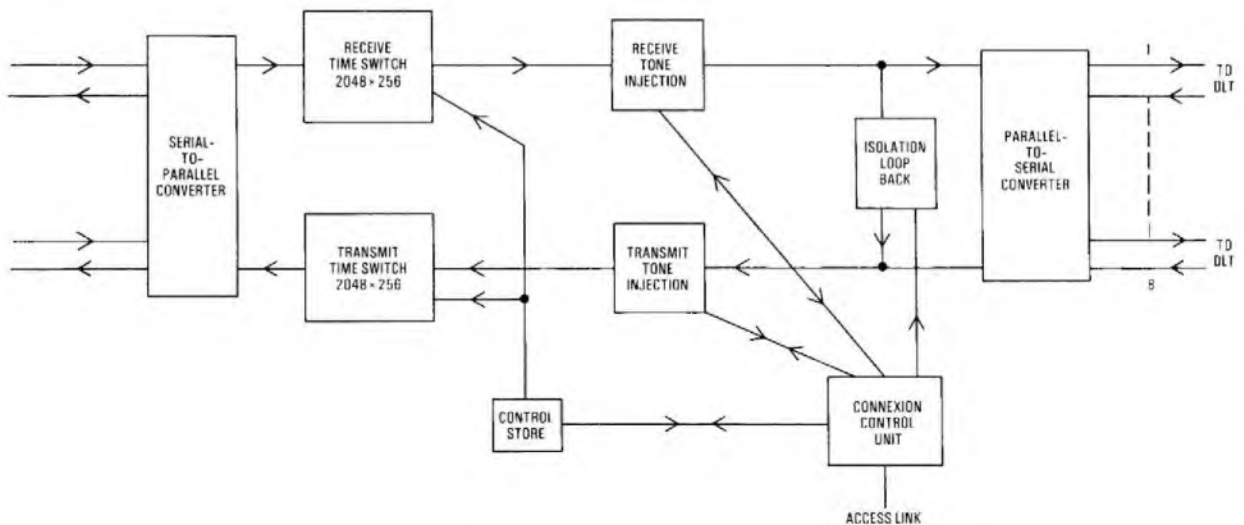

FIG. 7—Digital concentrator switch

the amplitude of each sample digitally. A tone has a waveform which repeats itself periodically and, using this same principle, a sequence of 8 bit samples, which characterize the waveshape of one complete cycle of a tone, can be stored in a memory. By accessing one sample of the sequence from the memory every 125 μ s and then cycling around the memory continuously, the tone can be digitally generated.

As mentioned earlier, should there be a total failure of all the transmission systems connecting a remote concentrator to its parent exchange, some limited call handling is possible between subscribers on the isolated unit. Since the transmission systems and their DLTs are of no use in this situation, a mechanism that is capable of by-passing this equipment is provided; this connects the receive and transmit time switches together. Because the ability to inject and detect tones is required during isolation, this loop-back is located between the tone-injection function and the DLT.

Digital Line Termination

The 2.048 Mbit/s line systems use the HDB3⁴ line code. The DLT performs any necessary conversions from this three-level signal into binary code and vice-versa. It also handles error detection on the line system and frame alignment, which have been previously described⁵.

MF4 Digit Reception

The time switch produces 256 channels, but only 240 can pass into the line system, the remaining 16 channels being overwritten in the DLT by the frame-alignment pattern in time-slot 0 and the MTS signalling in time-slot 16. Since these 16 channels cannot be used for outgoing speech, they are used internally for connexion to SSMF4 digit receivers. The detector uses a custom-designed device to detect the existence of the digitally encoded tones which are relayed to the module controller for subsequent signal processing.

Access

The line unit, the switchblock, MF4 receivers and ancillary equipment have all been designed to interface to the module controller by means of *access*. This provides a serial communication channel that operates at 1 Mbit/s and enables 8 bit control words to be passed between the module controller and an *access* user; a number of such transfers enabling a multi-word message to be transferred. Up to 64 line controllers can exist within the concentrator module and *access* provides the necessary fan-out capability. Message transfer is bit synchronous and, in order to ensure error-free communication, every bit of the sequence is returned to the originating end of the link so that a bit-by-bit check can be carried out. Should errors be found, this results in the 8 bits being repeated.

Module Controller

Two module controllers, as shown in Fig. 8, are needed so that the integrity of the concentrator can be maintained should one develop a fault. Normally, one controller, the worker, will handle all the control activities associated with call handling. The remaining controller, the standby, can accept updates of the call states from the worker and can also handle any background activities, such as routine maintenance, which may be initiated by the DSSS handler software. Each module controller comprises a central processor unit together with a memory which is split into read-only and read-write areas for programme and data storage respectively. The central processor unit is able to communicate with

(a) any of the other functional units shown in Fig. 6 by means of *access* (each controller only communicates through one plane of *access*),

(b) the software running on the central processor via an MTS control link, and

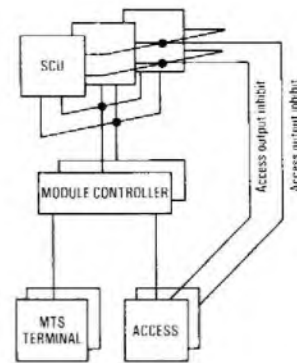

SCU: Security control unit
MTS: Message transmission subsystem

FIG. 8—Module controller and access

(c) the other module controller using a two-way communication link.

In addition to these three links, should one controller develop a fault, the integrity of the concentrator is maintained by a small triplicated security control unit (SCU) and a link between each SCU and each module controller is provided for this purpose. To assist the SCUs to maintain overall control, each controller has to send a periodic message simultaneously to all the SCUs. Provided a majority of the SCUs are satisfied that this message is being received, no action is taken. However, should at least two SCUs decide that the receipt of the last message from either controller is overdue, the appropriate unit is assumed to be faulty and, if this is the worker, the standby unit automatically takes over concentrator control. To prevent the faulty module controller from interfering with messages from the working unit, the SCUs also send signals to the standby access unit, which physically disables the outputs connecting it to the rest of the concentrator.

Should the concentrator become isolated from its parent exchange, because of a transmission failure, the module controllers will assume total control over the concentrator module. On the return to service of the transmission links, the module controllers will again adopt their normal working arrangements with the central processor.

Waveform Generator

This provides the basic 2.048 Mbit/s clock waveforms and other important timing information, such as 8 kHz frame-start signal, to units within the concentrator so that its various elements can communicate synchronously with each other. Normally these generators will themselves synchronize to the extracted clock from the DLTs. However, should the concentrator become isolated and prevent the DLTs from recovering the line system clock, the waveform generator is designed to maintain concentrator operation by providing an alternative clock reference.

Monitor

Neither the DLTs nor the waveform generator are able to communicate directly with *access*, and the monitor equipment provides an alarm reporting mechanism.

CONCLUSIONS

This article has described the subscribers' switching subsystem which serves as the concentrating stage of the System X family of local exchanges. The subsystem comprises a number of concentrators which are capable of being collocated with the parent exchange or operated remotely. The use of the concentrator on a remote basis is one way of providing a telephone service in an economical way to small communities

and also, in the early days of System X, a way of achieving widespread coverage of System X facilities. The use of digital concentrators facilitates digital transmission to subscribers, which in turn will lead to the evolution of the integrated services digital network which is based on an all-digital switching and transmission network between subscribers.

ACKNOWLEDGEMENTS

The author wishes to thank his colleagues in the British Post Office and in Standard Telephones and Cables Limited for their assistance in the preparation of this article and their contribution to the development described.

References

- 1 MARTIN, J. System X. *POEEJ*, Vol. 71, p. 221, Jan. 1979.
- 2 JONES, W. G. T., KIRTLAND, J. P., and MOORE, B. W. Principles of System X. *POEEJ*, Vol. 72, p. 75, July 1979.
- 3 OLIVER, G. P. Architecture of System X. Part 3—Local Exchanges. *POEEJ*, Vol. 73, p. 27, Apr. 1980.
- 4 VOGEL, E. C., and MCLINTOCK, R. W. 30-Channel Pulse-Code Modulation System. *POEEJ*, Vol. 71, p. 5, Apr. 1978.
- 5 RISBRIDGER, J. N. A. System X Subsystems. Part 1—The Digital Switching Subsystem. *POEEJ*, Vol. 73, p. 19, Apr. 1980.
- 6 PRICHARD, T. W. System X: Subsystems. Part 4—Common-Channel Signalling and the Message Transmission Subsystem. *POEEJ*, Vol. 73, p. 165, Oct. 1980.
- 7 BOULTER, R. A., and BUNN, W. Network Synchronization. *POEEJ*, Vol. 70, p. 21, Apr. 1977.

Record-Breaking Thrustbore

D. BRAKES†

While planning an extension to the external cable network of a satellite PABX at an RAF station in 1979, the Peterborough area RAF liaison and planning officer employed with the customer Works Group was faced with the problem of laying a cable from the PABX to a point on the opposite side of a 62 m wide concrete runway. It was estimated that a single duct of about 100mm would be required to take the cable.

Technical difficulties and operational flights at the airfield prevented open trenching across the runway, and routing the cable around the airfield's perimeter was not considered acceptable because of the distance and the cost involved. An alternative solution to the problem was to bore under the runway with a thrustboring machine. This machine, which has a long metal cylinder fitted with a nose cone, is driven by an internal piston operated by compressed air. A short-stroke hammering action propels the machine along underground; a recoil spring returns the piston for the next hammer blow.

In July 1979, a meeting attended by all the parties interested in the project was held at Peterborough General Manager's Office; later, there was a visit to the airfield site.

It was decided that a Duct No. 54 would be laid under the runway and that a 130 mm pneumatic thrustborer (a Grundomat) would be the most suitable machine for this job. A decision to purchase one was taken after consultation between the Midlands Telecommunications Region (MTR) and Telecommunications Headquarters (THQ); it was felt that, as further jobs for this machine could be envisaged, it would be more economic to buy one for use in the MTR.

The thrustborer, complete with its trailer and 25 m of air hose and control cable, was delivered in early July 1980. In addition, 2 extra 25 m lengths of hose and cable were hired from the suppliers of the machine.

Work on the runway, which the RAF authorities had agreed to close for 55 h, began at 17.00 hours on 8 August. A Davis 500 excavator was used to excavate a launch pit approximately 2 m × 5 m × 2 m deep in subsoil which comprised very densely packed clay and flint stones ranging in size from chippings to small boulders 150 mm in diameter. The actual boring commenced early on the morning of 9 August and continued throughout the day and the following night. When

22 m of the tunnel had been completed, work was stopped and the machine withdrawn so that the runway could be cleared and made safe before flying resumed at noon on 10 August.

Progress on the tunnel, about 1 m per hour, had been slow, and this was attributed to the dense subsoil. Therefore, before the runway was made available again on 22 August, the thrustborer was returned to its supplier for servicing and modification. A prolongation stud, which effectively increased the length of the thrustborer by $\frac{1}{2}$ m and helped directional control was fitted, and the nose cone on the machine replaced by a stepped chisel cone.

When work resumed on 22 August, the launch pit was enlarged slightly and a sloping ramp made at the rear to facilitate easier access and to aid duct feeding. The duct which was to be laid was secured on the rear of the thrustborer by a Tirfor winch and rope. Experience gained during the first session of boring had shown that bowing of the duct could be prevented by adding new sections which did not exceed 3–4 m in length. Shift-working also meant that the machine could be used continuously; the depth and line of the bore-hole was frequently monitored by using Locators No. 2A and No. 1B.

During the evening of 24 August, a reception pit was excavated on the opposite side of the runway to reveal the thrustborer. Measurements taken confirmed that the bore-hole was correctly aligned horizontally but not vertically. However, the difference between the starting depth of 1.7 m and the finishing depth of 1.4 m was well within the expected limits.

Before the site was vacated on 25 August, the duct line was extended to meet the existing network and a draw rope provided.

The 62 m thrustbore is understood to be the longest thrustbore to be completed by the British Post Office, and the longest to be completed by a Grundomat machine. It has been estimated that, in comparison to routing the cable around the airfield's perimeter, using the thrustbore method has resulted in a saving of £20 000 on the project.

The author would like to thank everyone who worked on the project for their enthusiasm and co-operation; in particular, the staff of the Peterborough Telephone Area, the MTR, THQ and the staff of Courtburns Ltd.

† Peterborough Telephone Area

System X: Subsystems

Part 6—Software Subsystems

J. A. ELMORE, B.ENG., C.ENG., M.I.E.E.†

UDC 621.395.34: 681.3.06

This article provides a general introduction to the software-only subsystems developed for System X exchanges. A brief insight into the telephony control functions, system overload detection and control requirements, the call accounting functions and the management information capabilities is given, together with the subsystem descriptions.

INTRODUCTION

Previous articles in this series have described the software standards¹ and the software development facilities² which define the software environment for the System X development. This article describes the wholly software subsystems; that is, those which have no hardware component. The subsystems considered are

- (a) the call processing subsystem,
- (b) the overload control subsystem,
- (c) the management statistics subsystem, and
- (d) the call accounting subsystem.

GENERAL CONSIDERATIONS

The scheduling unit of software on the processor utility (PU) is the *process*. It is therefore necessary to structure the software of a subsystem into one or more processes. The factors which need to be considered when selecting the process boundaries for a particular subsystem include

- (a) the functional split of the subsystem activities,
- (b) the ability to define simple enduring interfaces,
- (c) the likely process code size,
- (d) the security of the data, and
- (e) the effect on system performance.

The selection of optimum process boundaries is one of the most significant aspects of software-controlled systems design, since a misplaced boundary could result in an unnecessary amount of process rescheduling or, just as importantly, in a reduced capability to optimize performance by expedient use of process priorities. A multi-processor machine—that is, a machine which has more than one central processing unit (CPU) and which can, therefore, run several processes (1 per CPU) simultaneously—enables the system engineer to consider the use of process replication to improve system performance. This is achieved by having more than one process for handling a given set of functions. For example, the process which controls the set-up of calls can be replicated so that several calls can be processed simultaneously and quite independently. Replication can be achieved by having more than one process using the same code (but invariably operating with different data), or by having several copies of the code. This latter technique can be expensive with regard to storage requirements, but it has the advantage of eliminating or reducing the

system overhead due to several CPUs attempting to access the same area of store simultaneously (the phenomenon of store contention).

The operating system of the target machines is, in general, unaware of subsystems. As mentioned above, the process is the only software unit which is identifiable for scheduling on the processors and it is the passing of messages (tasks) between processes (or between the process allocator and processes for hardware interrupts) which indicates that a process has some work to perform. Each message consists of a 4–8 word task, which is linked into the receiving process' input task queue.

All of the subsystems described in this article, except for the call accounting subsystem, appear in the full range of System X exchanges. This exception is due to the fact that a subscriber charging capability is not required by the trunk and junction tandem systems. Differences do arise in the trunk exchange and local exchange versions of the subsystems due primarily to the different requirements of their respective positions in the network hierarchy; for example, the local software needs to support subscriber supplementary facilities. However, it has been a prime objective of the development to ensure that the differences between the trunk and local exchange software are kept to a minimum. This has resulted in the designs of the local and trunk software subsystems adopting the same software architecture, with minimal differences at the subsystem design level. Virtually all of the code is written in a high-level language (POCORAL), which significantly enhances subsystem (process) portability and maintenance. Some of the time-critical code, which in practice has proved to be less than 2% of the total application code, is written in the assembler language of the target machines.

In general, it has been a design aim to separate, as far as possible, the control software from the data management software. For subsystems which own large data areas this functional split has been realized by implementing separate processes or modules for these two major functions.

THE CALL PROCESSING SUBSYSTEM

The call processing subsystem (CPS) performs the major telephony functions of a telephone exchange, and controls the progress of the telephone calls through the exchange. To carry out these functions, it is necessary for the call control software to interface with the signalling and switching subsystems. These interfaces have been defined so as to maintain a standard set of messages. For example, the call control interfaces between the call processing software and the signalling subsystems (the signalling interworking sub-

† System X Development Department, Telecommunications Headquarters

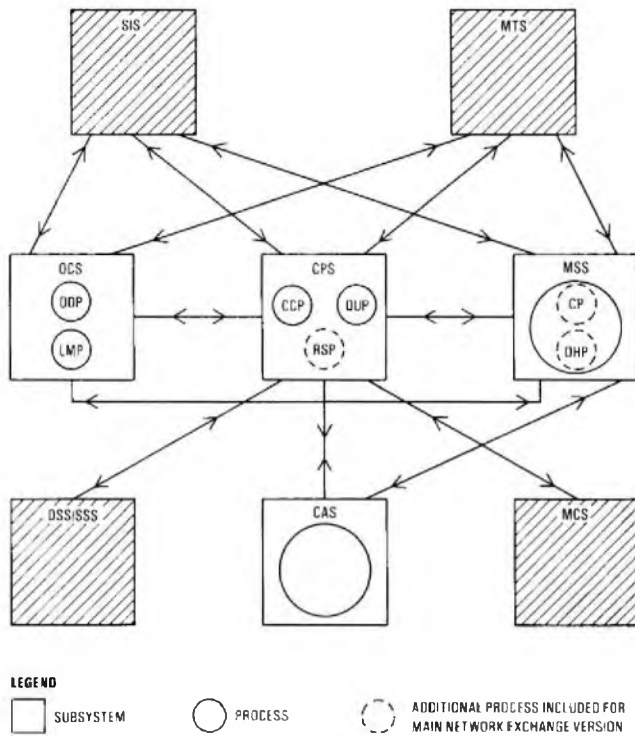

- LEGEND**
- SUBSYSTEM
 - PROCESS
 - (with dashed border) ADDITIONAL PROCESS INCLUDED FOR MAIN NETWORK EXCHANGE VERSION
- | | |
|--------------------------------------|--|
| CAS: Call accounting subsystem | MTS: Message transmission subsystem |
| CCP: Call control process | OCS: Overload control subsystem |
| CP: Control process | ODP: Overload detection process |
| CPS: Call processing subsystem | RSP: Replication synchronization process |
| DHP: Data-handling process | SJS: Signalling interworking subsystem |
| DSS: Digital switching subsystem | SSS: Subscriber switching subsystem |
| DUP: Data update process | |
| LMP: Load monitor process | |
| MCS: Maintenance control subsystem | |
| MSS: Management statistics subsystem | |

Note: Interfaces to the operating system are not included

FIG. 1—Block diagram of inter-subsystem interfaces for the CPS, OCS, MSS and the CAS

system (SIS) for old network calls and the message transmission subsystem (MTS) for new network calls) have been designed such that they share a generalized set of messages.

The subsystem process structures, together with an indication of the inter-subsystem communication paths, are shown in Fig. 1. It can be seen that the trunk version of the CPS includes the replication synchronization process, which maintains data synchronization between the replicates of the call control process. The local call control process will be replicated to increase the call-handling capability when required. To indicate the role of the CPS, an example of the message sequences between the subsystems within the main trunk exchanges for a basic call is given in Fig. 2. The inter-module communications within the call control process for the same basic call is shown in Fig. 3.

Functional Description of the CPS

The call control process provides the telephone call processing capability. The trunk exchange version can be replicated, if required; the number of replicates provided is dependent on the traffic loading of the exchange. Each replicate controls a dedicated set of routes. Consequently, the passage of a call through the exchange always involves two replicates of the call control process (controlling the incoming and outgoing circuits), and communication between them is via the task mechanism. The roles of the incoming and outgoing replicates are depicted in Fig. 3.

The incoming replicate controls the set-up phase of the call. The basic activities for a successful call are

- (a) the receipt of incoming address information (digits),

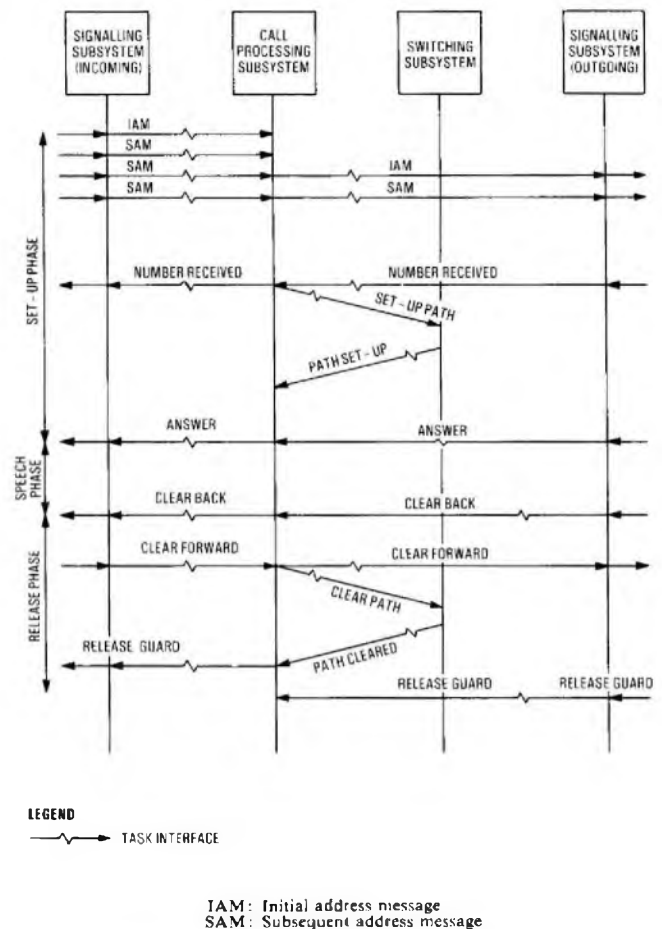

FIG. 2—Inter-subsystem message sequence chart for a typical call (trunk exchange)

- (b) the translation of the received digits and outgoing route selection when appropriate,
- (c) the generation of a message to the outgoing replicate requesting selection of a free circuit on the specified route (or a particular subscriber for a terminating local exchange),
- (d) the control of the sending of address messages to the next exchange (where appropriate), and
- (e) requesting the switching subsystem to connect a path.

The incoming replicate also controls repeat attempts, automatic re-routing, alternative routing and the application of tones. During the call set-up phase, a set-up record is allocated to the call and is held for the duration of the set-up period.

The outgoing replicate controls the supervision phase of the call. Its first involvement with the call is the receipt of the *outgoing route seize* message or the *subscriber seize* message from the incoming replicate. On receipt of this message, a call record is allocated which is preserved for the duration of the speech phase. The main functions of the outgoing replicate are

- (a) to select a free circuit on the specified outgoing route or to check that the required subscriber is free in a terminating local exchange,
- (b) to pass backward set-up messages (for example, *start sending*, *abort set-up*, *outgoing route congestion* to the incoming replicate in the trunk environment or *subscriber free* in the local environment),
- (c) to receive and act on *answer*, *clear* and *re-answer* messages, and
- (d) to supervise the release of the call, including disconnection of the switch path at the end of the call.

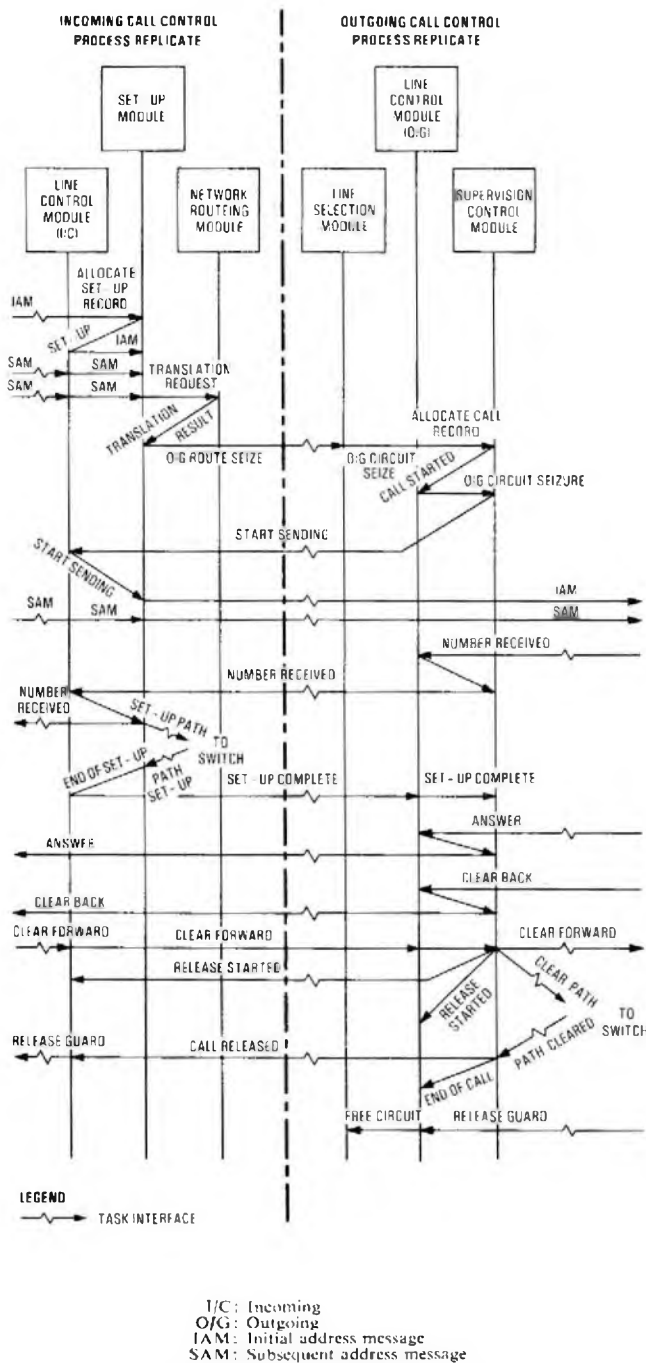

FIG. 3—Simplified message sequence chart showing communication between the call control replicates, and inter-module communication

The local exchange version of the call control process also controls the use of supplementary facilities and is responsible for providing the call accounting subsystem with the information required for charging purposes (as described later). A full range of subscriber facilities (for example, call transfer, abbreviated dialling) and administrative facilities (for example, operator override, service interception, service observations) are provided. These facilities are implemented as sub-modules of the call control process. The modular implementation provides the capability of adding new facilities with minimal change to the existing software.

The data requirements for call processing are complex. Three main data types are maintained:

(a) installation dependent read-mostly data, which is accessed by one call control process replicate only (for example route information, line-circuit information);

(b) installation dependent read-mostly data, which is accessed by all replicates of the call control process (for example, digit decodes); and

(c) read/write data private to each call control process replicate. This is the CPS working area, and contains set-up records and call records, free/busy circuit state map, time-out information, etc.

The equipment maintenance and data update functions for the resources controlled by the CPS are implemented in a separate process which is not replicable. All update and maintenance transactions are carried out under the control of the maintenance control subsystem (to be described in a later issue of the *Journal*), and are completed without interruption to the telephony functions of the exchange. The read-mostly data is secured against system faults, whereas data of a more transient nature, such as equipment maintenance states, is not. Once again the modular structure of the software allows the data management functions to be extended easily, either by the addition of new resource types or by a new set of data transactions. The secure handling of the exchange data is fundamental to the software security of the exchange and a transaction hierarchy has been defined to ensure that data integrity is maintained. This approach is maintained within the CPS by a rigid data update protocol implemented as a sequence of parent/dependent requests; this ensures that updates are performed in a logical and controlled manner.

A replication synchronization process has been developed to maintain data synchronization between the replicates of the call control process. At present, this process is required only in the trunk exchange version of the CPS.

Fault Reporting

The CPS can detect hardware faults (on circuits owned by the CPS) and software inconsistencies. The fault reporting mechanism is embodied in a separate module in each process and, therefore, does not exert an unduly large influence on the design of the telephony modules. Both hardware faults and software inconsistencies are reported to the maintenance control subsystem, which will invoke the out-of-service sequences for hardware faults or the system software security mechanisms for software faults.

Overload Control

Facilities are provided in the telephony processes of the CPS to enable the overload control subsystem (see below) to limit the number of new calls accepted by each process. Relative to other real-time exchange functions, the set-up phase for new calls requires the highest proportion of processing power. Therefore, the control of the number of calls simultaneously in the set-up phase provides a simple mechanism for dealing with exchange overload conditions. The software for call rejection, invoked during overload, has been designed to ensure that minimal processing time is required to reject new calls. This results in the demand for processing power being kept to a minimum while overload conditions prevail. A procedure for recognizing and accepting priority calls (for example, emergency calls) is included, and the overload threshold is chosen such that sufficient processor power is always available to process the priority calls.

Generation of Management Information

The CPS generates information from which traffic and network management statistics can be determined. No processing of the information is performed within the CPS: the data is collected and passed directly to the management statistics subsystem. Depending upon the category of the data, information is generated either on a per-call basis or as a *one-in-n* calls sample. Examples of the type of information generated are

- (a) the time of completion of the set-up phase,
- (b) the destination identity,
- (c) the time of answer,
- (d) the time of termination of the call,
- (e) automatic re-routing used, and
- (f) the identification of the routes to which the call was offered.

THE OVERLOAD CONTROL SUBSYSTEM

General Considerations

The function of the overload control subsystem (OCS) is to regulate the traffic handled by the exchange such that the central control does not become overloaded. Unlike earlier telephone exchange technologies, computer-controlled systems do not reject traffic by default; therefore, a new set of overload criteria is required. In the absence of suitable control mechanisms, the onset of overload in a common-control exchange results in a rapid degradation in its performance, which materializes as a sharp increase in process response times and therefore to reduced call-handling capability. All requests for processing time are in the form of tasks which are added to the target process' input queue. The effect of an increase in traffic offered to the exchange is, therefore, to extend the queuing time of the tasks before they are serviced. The task queuing time, which is a function of the input task queue length, thus becomes the main overload criterion. The system limits on the total number of tasks allowable in the system at any one time and the maximum input task queue lengths of the individual processes can be set from off-line simulation studies of system performance (measured in terms of calls handled per second for a given traffic mix, or in greater detail by individual process occupancies and response times). The on-line monitoring of these factors provides the basis of overload detection within the System X exchanges.

The rate of growth of the individual process task input queues will, for the call-handling processes, depend upon the traffic being offered to the exchange and the priority of the process itself. The higher priority processes will clear their task input queues quicker than the lower priority processes. These high priority processes will, however, be generating tasks to the other processes; therefore, a balance has to be achieved between the traffic offered to the call-handling processes and the maximum allowable queuing time of tasks to all the processes in the system. Also, it is necessary to ensure that traffic accepted by one process does not generate tasks for other processes which would be lost if any of the task input queue length limits were exceeded. In this way, telephone calls cannot be lost within the exchange, and the design ensures that, at the time of accepting a new call, sufficient processing power is available to complete the call set-up across the exchange.

Overload Detection and Workload Control

The task input queues of selected processes are monitored continually by the operating system to detect process overload. Also, periodic reports on process workloads are passed to the OCS. These reports, together with information on the currently available processing capability, measured in terms of the current level of background processing (idle time), are used to calculate a workload limit on the exchange. The method of calculating the appropriate workload limit at any instant is the same for overload caused by an excessive peak in telephony traffic being offered to the exchange, or because of a reduced processing capability due to a processor fault.

All monitored task queues have an upper and lower queue length threshold. During normal conditions, the actual task queue lengths, including the system limit on the total number of tasks present, are compared with the appropriate upper threshold. On detection of a task queue overload, the OCS will determine which processes generate tasks to the overloaded process and will direct them to reduce their workload. The

action taken at this point will depend on the processes involved; for example, the call processing processes would cease accepting new non-priority calls and, therefore, would not inject further tasks into the system. The offending task queue is then monitored until the lower threshold is reached; at this point, all communicating processes are directed to increase their workload limit. In regard to the call processing processes, this would entail setting a limit on the maximum number of calls simultaneously in the set-up phase. This will be calculated by the OCS and will normally, during the initial stages of recovery from overload, be set to a fraction, say 80%, of the normal workload.

Periodically, information is passed to the OCS on the amount of spare processing capacity available and the amount of work accepted and rejected during the measurement period. This information, which is used by the OCS to tune the individual workload limits of the processes to the prevailing conditions, ensures that the workload is raised, in a controlled manner, to the design optimum as quickly as possible.

Subsystem Structure

The OCS consists of two processes: the overload detection process and the load monitor process.

The overload detection process is a very high priority process, which is responsible for receiving and taking action on overload and underload information generated by the operating system. This process identifies the processes which have caused the overload and requests them to immediately reduce their individual workloads. Also, on detection of underload, the overload detection process calculates the new workload limits for the affected processes.

The load monitor process ensures that the exchange is working at the optimum level during normal (non-overload) periods. Periodically, this process receives information on the amount of background processing being performed and the level of work being accepted and rejected by a number of selected processes in the exchange. This data is used by the load monitor process to calculate the workload limits for each of these target processes. By this means, no work is rejected while spare processing capacity is available. During the period between the detection of overload and the corresponding, subsequent underload condition, the load monitor process inhibits the workload calculation algorithms; therefore it cannot change the workload limits of the affected processes. The load monitor process is a very low priority process.

Management Information and Update Mechanism

Whenever an overload occurs, the identity of the overloaded process, or system limit, is sent to the management statistics subsystem by the overload detection process. Periodic counts of rejected calls are also sent to the management statistics subsystem by the load monitor process.

An interface is provided, via the maintenance control subsystem, over which the monitoring period of the load monitor process and the minimum spare processing capacity limit can be updated.

THE MANAGEMENT STATISTICS SUBSYSTEM

General Requirements

Information on the performance of telecommunications networks and traffic patterns is of paramount importance if the controlling administration is to achieve the correct balance between the grade and quality of service offered to its customers and the optimal use of exchange equipment and line plant. The introduction of stored-program-controlled exchanges has provided the facilities to monitor exchange performance and traffic patterns to a much higher degree than has been possible with the distributed control step-by-step exchange types. System X will provide further capability for the

generation of network statistics. All telephony and maintenance subsystems within the System X exchanges generate information on their own performance and, where appropriate, on the telephony characteristics of the exchange. This information is passed to the management statistics subsystem (MSS) for collation and onward transmission to the local administration centre. Some examples of the information generated have been included in the subsystem descriptions given above. Table 1 presents a typical set of local and main network exchange statistics.

TABLE 1
Typical Statistics Generated by the Management Statistics Subsystem

Subscriber-Related Statistics	Network-Related Statistics	Exchange-Equipment-Related Statistics
Subscriber traffic intensity Subscriber call counts Charge-related call counts PBX overflow counts	Call sample analysis Call failure analysis Traffic destination analysis Route traffic intensity Alternative routing analysis Old network (SIS) traffic New network (MTS) traffic	Switch congestion Spare CPU power Duration of overload Rejected call counts

SIS: Signalling interworking subsystem
MTS: Message transmission subsystem
CPU: Central processing unit

Subsystem Structure and Description of Operation

The local exchange version of the MSS is implemented as a single process. However, the trunk version has been configured into two processes to improve the data-handling capability. The control process, which is of low priority, schedules the measurements to be made and controls the outputting of the measurement results. The high priority data-handling process receives the raw data from the other subsystems and updates the measurement data area. At present, the MSS is capable of taking over 30 different measurements, and each of these measurements is implemented as a separate module within the data-handling process. Introduction of new measurements is achieved by the addition of further measurement modules, and by updating the control process data tables.

The measurement schedule, which is secured against system faults, dictates which measurements shall be active during the next measurement period. Data for the schedule is provided over the man-machine interface (via the maintenance control subsystem) and a special command language for updating the schedule has been devised. On receipt of a request for a new measurement, the MSS will assess the extra storage and processing power required and reject the request if insufficient resources are available. Extra care is taken to ensure the integrity of the measurements under abnormal operating conditions; for example, processor overload. During overload, the OCS may reduce the workload limit of the MSS. Under these conditions, the number of active measurements is reduced to an acceptable level. If the overload is of short duration, the least important measurements are suspended, but if the overload persists, then these measurements are abandoned.

The output from the MSS is in either binary or alphanumeric form. The binary output option is used for the bulk transmission of data to the local administration centre (LAC), where it is stored for further off-line processing. The alphanumeric option is provided to enable direct access to the data held within the MSS. Not all measurement data is directly accessible, since this requires some on-line processing by the MSS. Call failure analysis and average route traffic intensity are

examples of the type of measurements which can be accessed directly.

THE CALL ACCOUNTING SUBSYSTEM

The call accounting subsystem (CAS) performs all the charging functions for the System X family of exchanges and generates the information from which customers' bills can be produced. The billing data is fully secured against all types of hardware and software faults, and the achievement of the data security requirements has been the main objective of the design of the subsystem. The CAS is a single process subsystem, which has been implemented in a highly modular fashion with separate modules for charging and the generation of itemized call records, data manipulation and fault reporting.

The CAS Functions and Data

Calls are charged on the basis of

- (a) the charged terminal's class of service,
- (b) the radial distance of the call,
- (c) the duration of the call,
- (d) the time of the day, and
- (e) whether the call is a basic call or whether one or more supplementary facilities have been used.

Information on the time of answer and time of clear, together with the tariff group of the charged subscriber, the charging method to be used (that is, fixed-fee or charge-band) and whether a supplementary facility has been used is passed to the CAS by the CPS. Call charges are then calculated on the basis of the elapsed time of the call and not the more traditional time-pulse based method. (Note that, since periodic meter pulses are required for calls involving coin-collecting boxes or from subscribers with private meters, charging for these calls is handled by the subscriber switching subsystem (SSS). Charge-rate information is given to the SSS by the CAS and updated every half-hour. At the end of each call the SSS reports the charge it has accumulated for the call to the CAS for validation and recording.) A tariff program is provided for each combination of charge-band and tariff group for each day of the week, and extra tariff programs can be inserted for special days. Each of these programs includes the time for which a particular tariff rate is in force.

A subscriber's bill can be presented as a single accumulated number of units (bulk billing), fully itemized on a per-call basis, or as a combination of bulk units and itemized call entries. The call types to be itemized can be selected by the subscriber or the administration. These may include international calls, non-local calls and calls of greater than a specified number of units. All calls involving supplementary facilities are itemized.

Two main data areas are maintained within the CAS, these are:

- (a) the call record link-list (a record is held for each call for the call duration), and
- (b) a fully-secured data area, which is resident within magnetic-bubble memory. This data area contains the data equivalent to the subscribers' meters of the current exchanges and the charge rate data, which includes tariff group data, coin-collecting box information, etc. used for calculating call charges.

The security of the data is of paramount importance; therefore, the sharing of data between software modules is kept to an absolute minimum. The use of two bubble memory modules, each of which contains a copy of the data described in (b) above, is necessary to meet the very stringent security requirements.

Billing information is generally stored in bubble memory and forwarded on request to the LAC, but owing to the amount of information generated for itemized calls an indi-

vidual record for each of these calls is sent to the LAC when the call terminates. The CAS does not produce bills. Bills are generated at a billing centre on data processing machines controlled by the Data Processing Executive of the BPO.

Fault Reporting and Management Statistics

All fault reports are generated by a single module within the call charging process. These reports are sent to the MCS for action.

The CAS generates information for the MSS, from which call charge statistics can be calculated. During a measurement period, a table is generated by the CAS which, at the end of the period, will contain the accumulated units per charge band for each tariff group.

CONCLUSION

This article has given only a brief description of the software subsystems. The majority of System X subsystems have a software component, and the enhanced flexibility afforded by software implementation is central to the evolutionary potential of the new generation of telecommunications systems. Reference has been made to the system engineering

aspects of real-time software design. This is still a relatively new engineering discipline but, to date, the software has been performed, on the test beds and in the first public installation, without any major problems emerging. This demonstrates the value of the rigid set of software standards and design rules, and the off-line support facilities, which have enabled a high standard of software production to be achieved.

ACKNOWLEDGEMENTS

Thanks are due to all the engineers, both within the BPO and the UK firms participating in the manufacture of System X, who have contributed to the development of the subsystems described in this article.

References

- ¹ COOPER, T. R., and HELLEUR, R. J. System X Software Engineering. *POEEJ*, Vol. 72, p. 240, Jan. 1980.
- ² LOOME, S. R. System X: Design and Support, Part 3—Software Development Facilities. *POEEJ*, Vol. 73, p. 47, Apr. 1980.
- ³ WALSH, A. A. Architecture of System X, Part 4—The Local Administration Centre. *POEEJ*, Vol. 73, p. 36, Apr. 1980.

Post Office Press Notice

PLANS TO BOOST OFFICE COMMUNICATIONS

Plans to simplify electronic message transfer between offices were announced recently.

The principal object of these plans is the development of an electronic black box which will enable many different kinds of text-handling machines (that is, Telex, facsimile, word processor, visual display unit, teletypewriter, or Prestel set) to communicate with each other. In the first phase of development, Logica Ltd., a firm of computer and communication consultants, has been awarded a £145 000 contract for studies aimed at producing, during 1981, a specification for a prototype device. The firm will also outline objectives and procedures for field trials of the device and find organizations willing to take part in the trials.

To enable otherwise incompatible machines to communicate with each other, the device would function as a protocol converter, translating one machine's "language" into a form understood by the other. To do this it would act as a gateway, channelling messages between a user's machines and the network over which they are sent. It could work like this:

- Office A, equipped with only Telex machines, wishes to send a message to office B, which has only facsimile equipment.
- The message is typed out on A's Telex machine and then stored electronically in its communicating black box.
- Office A calls up office B by telephone, and their black boxes are connected together over the telephone link.
- A's device converts its stored message into a form suitable for the telephone and sends it to B's black box, which stores it.
- The receiving device converts the message into the

appropriate language for facsimile and arranges for it to be printed out on B's machine.

The devices would not be restricted to the telephone network. They would be able to send messages just as readily over the Telex network, or over the new packet-switched service which has just started in a pre-operational phase between London, Reading and Bristol and which will cover the entire country by the end of this year.

Logica is now seeking companies which would be willing to take part in trials of a black box communications device. In the first instance, these organizations will be invited to discuss with Logica the particular communication problems and kinds of protocol conversion most frequently encountered in day-to-day business affairs. This should enable Logica to produce specifications for an initial device capable of the limited protocol conversions that would satisfy this most frequent need. Reducing the initial range of the device in this way would reduce development problems, simplify operating procedures and make for greater use during the trials.

As part of the project, Logica will be looking at ways of achieving greater standardization of the procedures, protocols, form designs and other operating parameters of office text-handling machines. Such standardization would assist users by reducing the scope and complexity of protocol conversion; it would also give a lead to industry in equipment design.

If the initial exploratory phase is successful in producing a practicable specification, British Telecom will be able to place contracts with industry for the development and production of prototype devices and subsequently embark on trials in about a dozen participating organizations.

Margins of Safety in Design

D. G. CLOW, C.ENG., F.I.MECH.E., F.R.MET.S.†

UDC 624.046

This article discusses the reliability of mechanical components and assemblies and the need to provide a reserve of strength over and above that required to resist the expected loading, thus ensuring economic, serviceable and safe designs.

INTRODUCTION

In design, it is very unlikely that either the strength of a structure or the loads applied to it can be known precisely. In this context, the term *structure* refers to any engineering component or assembly designed to resist externally-applied or internally-generated forces. Thus, a mechanism such as a gearbox, or a static framework such as a radio tower or a telephone pole can equally be defined as structures which must withstand forces of considerable magnitude and for which the provision of adequate strength dominates the design process.

Because of doubts about the exact nature of either strength or loading, a reserve of strength over that required to resist the nominal calculated loading is always provided. The selection of the appropriate margin of safety is fundamental in design because failure to select a suitable level of reserve can lead to designs that are either unreliable or unsafe, or uneconomic and inefficient.

In recent years, the civil, structural and mechanical engineering professions have paid much attention to the critical examination of structural integrity. This action has been stimulated by some dramatic and well-publicised failures, increased economic pressures towards efficient design and a greater concern for human safety. The development of powerful analytical techniques and the much improved methods of monitoring structural performance have greatly facilitated this re-evaluation.

One effect of the renewed interest in margins of safety has been the introduction of a variety of approaches which have gradually displaced the former simple *factor of safety* concept. For example, a structural framework designed in steel is now based on a noticeably different and more traditional safety philosophy than that for a comparable framework designed in reinforced concrete.

In general, a margin of safety is necessary to give protection against areas of ignorance in the entire process of design, fabrication, construction and use of a component or system. There are many different areas in which both strength and loading are likely to vary, and an appreciation of all the significant variables is important for ensuring the safety of structures.

TERMINOLOGY AND DEFINITIONS

The margin of safety can be achieved in a mechanical system by factoring the expected maximum loading to obtain the design load; this is termed the *load factor* approach. Alternatively, the strength of a system can be explicitly

increased by the use of a strength factor, or implicitly by limiting the maximum stress allowed. The reserve of strength may also be obtained by a combination of these factors.

More traditionally, usage referred to the *factor of safety*, which is defined either as

$$\frac{\text{load to cause failure}}{\text{maximum design load}} \text{ or } \frac{\text{stress at failure}}{\text{maximum working stress}}$$

Historically, it was the use of cast iron as a material for girders in the nineteenth century which first caused the development of the concept of a "factor of safety". The propensity for cast iron to fail without warning, and the possible presence of hidden flaws in castings, stimulated the provision of a generous factor of safety on the load required to break a beam. (The breaking load was determined by a series of tests on sample beams.)

As methods of analysis were developed and more predictable materials became available the values of the factor of safety were reduced, although not without incident when the margins were trimmed too far. It also became possible to analyse structures in a more detailed manner, and the use of a global factor of safety for a structure gave way to factors of safety which were based on stresses in different parts of the structure; thus, struts, beams, tie-bars, bolts etc were treated individually, and this enabled each component part of a complex assembly to approach optimum strength.

Any engineering structure will fail if the appropriate conditions obtain; what the designer would prefer is an indication of the risk of failure for a given set of circumstances. To predict statistically the probability of failure, it is necessary to describe all major variations of strength and load by probability distributions; the probability of failure can then be determined as a complex statistical exercise. But, because of the lack of adequate data, such an ideal situation rarely prevails. Nevertheless, recent safety approaches have introduced statistical concepts at a number of points; an important example of this is the *limit state* method, which was first used for structural concrete design and which is now spreading to other fields.

The definitions given earlier referred to the term *failure*. This is taken to mean complete collapse or disintegration; for example, when a lifting rope snaps or a telephone pole breaks. This catastrophic condition is the most important for the consideration of safety; in limit state design, this failure condition is known as the *ultimate limit state*.

† Transmission Department, Telecommunications Headquarters

Designers are equally concerned with a condition which usually occurs, though not always, before final failure; that is, when a structure becomes unfit for its intended purpose. A simple example is a D-shackle used in lifting tackle; if this became deformed enough to prevent withdrawal of the pin, it would render the shackle useless (but not unsafe) long before final failure occurred. A more complex example is a building frame which becomes distorted to the extent that partitions crack and doors jam in their frames. Such conditions, often known as the *serviceability limit states*, are inconvenient rather than unsafe.

There are some conditions when unserviceability coincides with failure. This applies when brittle materials are involved because failure is then likely to occur with little or no forewarning in the form of visible structural distress. Examples of failure in structures constructed in brittle and ductile materials are shown in Fig. 1.

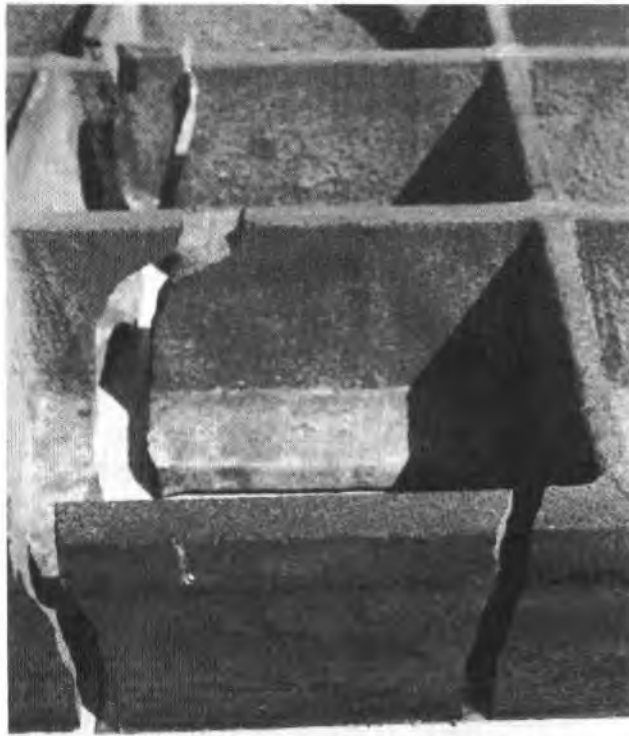

(a) Brittle structure



(b) Ductile structure

Notes: Fig. 1(a) shows a damaged cast-iron frame of a joint box cover; no deformation of the material could be detected prior to failure. Fig. 1(b) shows the result of a destructive test on a derrick used for mast construction; large deformation of the structure gave ample warning of overloading well before failure occurred.

FIG. 1—Examples of brittle and ductile failure

VARIATION IN STRENGTH

The strength side of the safety equation can be considered at three levels: the basic material properties, the behaviour of a single component, and the response of a complete assembly of parts.

Material Properties

All engineering materials exhibit variation in properties from sample to sample. The following discussion will concentrate on variation in strength, as this is usually the most important in a safety analysis. There is a close link between the cost and the control of the strength variation of materials; highly predictable materials are generally more expensive because of the very close control which is required during production.

For most materials, a frequency histogram of the results of tests to destruction of a large number of samples will follow, with acceptable approximation, the Gaussian distribution curve. Such a curve is useful in that, for a particular batch of material, it becomes possible to evaluate the mean strength and standard deviation, and a value for the probability of any particular threshold of strength being reached can be derived. Examples of strength distribution curves for various materials are shown in Fig. 2. However, traditionally, the designer has not had the data available to provide an indication of material variability because the various material specifications have tended to give minimum strength criteria only. An example of this is the British Standard for structural steel, which gives minimum yield and tensile strength values. However, recent British Standards for structural concrete have moved away from a minimum strength basis to incorporate a statistical description of strength.

Although material variations cannot be ignored, the total variation of strength for a modern manufactured material is likely to be relatively small. But this is not the case for a natural material such as timber, and especially so for an item like a telephone pole, which is only lightly processed; the strength variation then becomes a very significant factor in the safety analysis.

Mention has already been made of the significance of ductility, or lack of it, in material behaviour. When materials are known to be basically brittle (for example, materials such as ceramics or cast iron) then products using such materials are designed with this condition in mind; thus, tensile stresses will be kept low and impact loading minimized. However, if a normally ductile material becomes embrittled in service, then the dangers can be great. This state could occur as a result of fatigue or low temperature embrittlement.

Component Parts

So far in this article materials have been considered in the form supplied by the producer. However, when material is fabricated into a usable component, it is inevitable that some of the basic material properties will not be fully available. To limit the discussion, only the case of the strength properties of parts of a structural framework will be considered here.

Areas in which the effective component strength will be less, and sometimes very much less, than the basic material strength include steel members in tension or compression, and bolted or welded connexions.

Although the tensile strength of steel is high, its full potential in tension members (ties) is very difficult to use because of the problem of designing efficient end terminations at the points where the loads are transferred from the tie to other parts of the structure.

The mode of failure of components subject to compressive force is dependent on the geometry of the item. A short stout object will fail in pure shear and the compressive strength of the material will be fully utilized. At the other extreme, a long

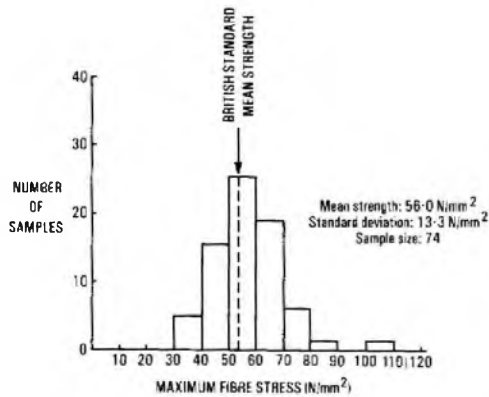

(a) Variation of maximum fibre stress of a batch of Scots pine telephone poles

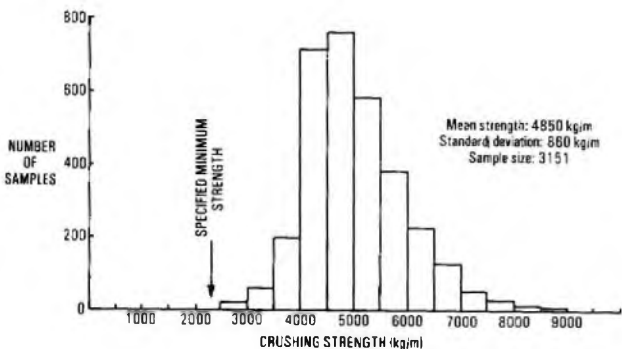

(b) Variation of crushing strength of BPO earthenware Ducts No. 15

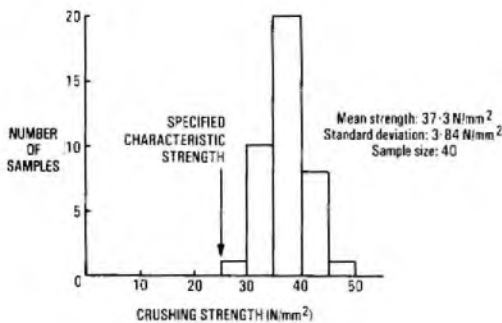

(c) Variation of Grade 25 concrete test-cube strength for a batch of concrete used at the BPO satellite earth-station, Madley

FIG. 2—Histograms of strength distribution for given materials

slender member will suffer an instability failure by crippling (buckling) because the member flexes in a sideways direction, which results in a dramatic and sudden reduction in the load the strut could resist.

Connexions pose other problems. It is not difficult to visualize that the forces to be transmitted by an ordinary multi-bolted connexion will not be evenly distributed between all the bolts; indeed, if such a joint is dismantled after use, several of the bolts are often found to be deformed. Even with a single-bolted connexion the stresses in the bolt are still rather indeterminate as the bolt is subjected to a combination of shear, tensile and bearing stresses.

Welding is another form of connexion about which there is considerable uncertainty as to its efficiency; low allowable

stresses are used even for tightly-controlled welds. Inadequate welding can produce embrittlement of the steel in the heat-affected zones adjacent to the weld itself; this embrittlement can result in cracks being formed, which provide a source of potential larger-scale failure. The heat input during the welding process can produce distortion of the object being welded, and heavy locked-in residual stresses can result as the assembly cools. It follows that, when the safety of lives or plant is at stake, welding is a process which requires careful control at all stages and is therefore an expensive process.

The last aspect to be considered under this heading is a particularly difficult one because it concerns the actual distribution of stress in a component. Conventional stress analysis yields average stresses in different parts of a structure, but much higher, albeit very localized, stresses can occur. These areas of stress concentration are set up when a structure is loaded at points where changes in profile or thickness occur. What happens in practice in a normally-ductile material is that local yielding of the metal takes place in the areas of high stress; this has the effect of redistributing the stresses to produce a more uniform sharing of load throughout a cross-section. Even so, the stresses will be higher around a stress concentration, even if yielding has taken place.

Assemblies

Insufficient attention is often paid to the behaviour of complete assemblies. This neglect was highlighted, for example, by the Ronan Point flats disaster in which damage caused by an explosion in one flat resulted in the progressive collapse of a substantial part of the whole structure. On the other hand, many buildings have suffered massive damage without totally collapsing. It is now generally recognized that, where safety is of paramount importance, structures should fail-safe; that is, a major component can be lost without catastrophic failure occurring. Such an approach avoids the need for very high safety margins on single components.

VARIATION IN LOADS

The discussion given in this article has so far been limited to one side of the safety equation, namely that of the strength available to resist applied forces. These applied forces are equally subject to doubts about their magnitude. For convenience, these forces can be divided into *dead* and *live* loads. Typical examples of dead loads are static items such as filing cabinets or exchange equipment racks installed on the floor of a building. The wheel of a vehicle passing over a man-hole cover applies a live load to that cover; the characteristic of a live load is that the forces applied by that load to a support will exceed its weight by a factor which could be large.

A special case of live loading is that of fluctuating loads which can give rise to load magnification by setting a structure into mechanical resonance. The amplitudes of vibration can build up to a destructive level unless the energy input is dissipated by damping.

INFLUENCE OF USE

There are many ways in which the initial strength of an assembly can deteriorate in service; these include loss of material through decay, wear and corrosion, also fatigue and other long-term changes in material properties. In some circumstances, the deterioration will not be apparent on inspection; it is, therefore, most important to allow for such effects when safety levels are set.

It is estimated that approximately 3 out of 4 engineering failures in metals and plastics occur as a result of fatigue, which can reduce the strength of a material to a value as small as a quarter of its strength under static load conditions.

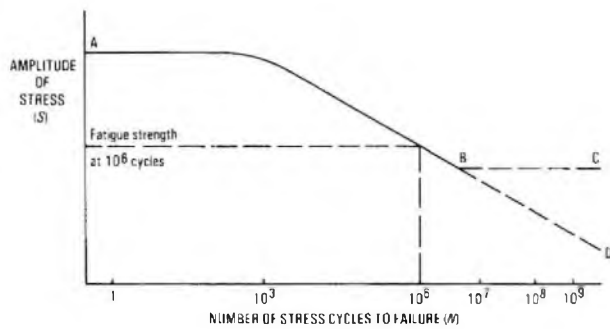

Note: Curve ABC applies to materials possessing a fatigue limit

FIG. 3—Typical fatigue/life curves showing relationship between stress magnitude and a number of stress cycles

Fatigue failures, which can occur under the influence of repeated loading, are characterized by a brittle type of fracture. The rate of embrittlement is a function of the number of cycles of stressing, N , experienced by the component, and the magnitude of the stressing, S . As a result, a large number of cycles of low stress magnitude can produce the same effect as a few cycles of much higher magnitude; this effect can be seen in the typical S/N curves shown in Fig. 3. A number of important materials exhibit the property of a fatigue or endurance limit; that is, a level of stress below which fatigue failure will not occur. For example, structural steel has an indefinite fatigue life if the stress does not exceed about 100 N/mm^2 .

In recent years, the engineering profession has become very aware of the economic cost of frictional wear of moving parts and deterioration due to corrosion or decay, because these factors can lead to equipment being scrapped before it is technologically obsolescent. There is a clear advantage from the point-of-view of safety in producing designs in which the effects of wear and corrosion can be readily detected. Visibility of distress prior to failure is a valuable asset in other respects for it provides an early warning of impending trouble and, in such cases, lower safety margins can be adopted than for situations where failure could occur without warning.

Casual modifications are a particular problem. The ill-considered removal or insertion of an additional component can sometimes cause a large redistribution of forces in a structure. The efforts of a designer and a fabricator to achieve high-quality welds throughout a structure can be negated by an apparently innocuous weld which is poorly done and which introduces a weak point in the structure; equally, a small hole drilled in a highly-stressed area of a brittle material can have serious results by introducing a high stress concentration. Many other problems can arise when a user undertakes even minor modification to an item without realizing the wider significance of the change.

OTHER FACTORS

At this juncture it is important to place the many uncertainties in strength and loading in perspective. In practice, the majority of major failures in engineering do not result from deficiencies in materials or assemblies, but from human error and omission, whether culpable or not.

Designers are not infallible, and there are many traps for the unwary. It is not uncommon to find that inappropriate or misunderstood theory has been used to justify a design. Many errors at the design stage can be identified by having checks carried out by engineers who have not been closely involved in the original design and who can apply a fresh outlook to the design and analysis work.

Errors do occur during manufacture, although quality assurance techniques should reduce such errors to a minimum. The standard of quality assurance has a major bearing on safety; there is no point in reducing the cost of quality

assurance work if safety margins have to be increased to compensate for the greater risk of poor manufacture or construction.

Some allowance must be made for such matters as inadvertent overloading, and even deliberate misuse. Because of the nature of fatigue deterioration, the effect of overstress may not become apparent until premature failure occurs at a later date, and the innocent user suffers.

SETTING THE LEVEL OF A SAFETY MARGIN

It will have become evident from the preceding discussion that there are very many opportunities for both strength and loading to differ from that assumed by a designer. The magnitude of the variations under each heading is likely to be dependent on the application. For example, the strength of wooden poles of a given size in a batch is likely to be distributed over a much wider range than would the strengths in a batch of steel poles. The dead weight of equipment put on a radio mast is likely to be much closer to the predicted range than would be the loading on the floor of a general-purpose building. Equally, the degree of knowledge of the nature of the variation of each factor varies. The maximum weight of a water storage tank is well defined, but the forces applied to a wall-mounted telephone change-giving machine are likely to be ill-defined, and subject to the vagaries of impatient users or acts of vandalism.

In view of the many variables is it then possible to produce meaningful margins of safety? The answer is obviously 'yes'. But how then can the margins be set?

The first and most useful input consists of the accumulated body of past experience and the evidence of failure or lack of failure. The evidence of lack of failure is somewhat inconclusive, since it is not clear if success is the result of optimum design or over-design.

Because failures, when they do occur, are expensive and sometimes distressing, there is a tendency not to benefit from them. A failure not fully analysed is no more than a monument to past failings; but a failure analysed is a valuable source of information for improving safety in the future.

The second source of data is the result of experimental work, which throws light on the behaviour of structures or the nature of the applied loading. Recent computing techniques have facilitated detailed theoretical analyses, and these have been matched by improved transducers and data processing equipment, which have made the gathering of information on the actual behaviour of structures relatively easy to attain.

With so many possible sources of variation it is inevitable that there will be circumstances, albeit very rare, when failure will occur. The situation is indicated in Fig. 4, in which all the variables are brought together into approximately Gaussian curves for strength and loads respectively. Inevitably, the curves overlap slightly and it is within this area that overloading could combine with understrength to cause failure. However, there are very few instances in practice where such probability curves can be drawn realistically.

A considerable amount of effort is being put into reliability analyses in engineering to effect a balance between economics and safety. In a world in which resources are finite this balance is most important, but it is not easy to resolve. Where risk to life is not involved, a reliability analysis can attempt to quantify the cost of failure; for example, the replacement cost of the failed component or structure, the estimated loss of revenue and the consequent overhead charges. This type of analysis becomes more problematic when there is risk to life and limb. Factual data can still be used and attempts are made to assess the cost of injury or death by using data such as the prevailing levels of damages or compensation awarded in the courts, the loss of the productive capacity of a trained person, insurance costs etc. But there is a reluctance to pursue this approach because there is a general unwillingness to face up to the undeniable fact that risks are an inescapable facet of

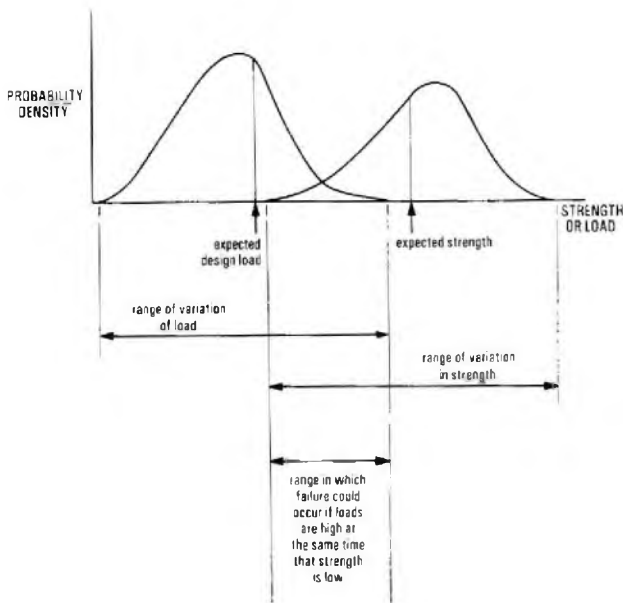

FIG. 4—Representation of the notional risk of failure for any practical structure

TABLE 1
Comparative Annual Probability of Death due to Accidents

Activity	Annual Risk per Person
Mountaineering	3×10^{-3}
Air travel (crew)	1×10^{-3}
Coal mining	3×10^{-4}
Car travel	2×10^{-4}
Construction site	2×10^{-4}
Air travel (passenger)	1×10^{-4}
Home accidents (to able-bodied persons)	4×10^{-5}
Manufacturing	4×10^{-5}
Structural failure	1×10^{-7}

human existence. Although the topic is difficult to quantify, in practice, most people have an intuitive measure of what is an acceptable or unacceptable degree of risk for various occupations or activities.

Examples of typical fatality risks are listed in Table 1; these statistics should be regarded with some caution as the data is difficult to acquire and interpret.

APPLICATIONS

The following examples briefly illustrate the wide variety of approach necessary in the determination of appropriate safety margins for some items of the BPO's external plant.

Lifting Ropes

At first sight, very high factors of safety appear to be used for steel-wire ropes. However, as these factors are based on the weight of the items being lifted, an allowance is necessary to cater for acceleration and deceleration of the load. In addition, a running rope suffers from fatigue failure of the strands caused by the fluctuations in tension and the stressing

caused when running over sheaves of pulleys or winch drums. When the rope flexes, individual strands rub against each other and wear occurs; corrosion of the strands is another hazard. In such circumstances, high load factors of safety are used; for example, a load factor of 5 is used for equipment-lifting and a factor of 10 for man-lifting operations.

Microwave Radio Towers

The main load on a microwave radio tower is the action of the wind. For a given probability of occurrence, wind speeds, like wave heights and flood levels, become higher the longer the period of time considered. What the designer requires the user to specify in these circumstances is the likely life of a structure; design can then proceed with rational safety margins. Most telecommunications masts and towers are designed to withstand the once-in-50 year wind speed, so that excessive deflections, which might cause serious loss of radio signal strength, do not occur and so that the recommended safety levels given in the relevant British Standards are preserved.

The limiting strength of a tower usually applies to members in compression; a factor of 1.7 is generally applied to the calculated load at the maximum design wind speed.

Manhole Covers

The maximum load applied by a single wheel of all normal road vehicles at rest is currently 5 t; yet the current design criterion for heavy duty covers aims for a minimum breaking load of 60 t, which gives a load factor of 12. The reasons for such a high margin are many; they include the suddenly-applied load when a vehicle wheel travels over the cover, road surface imperfections which impart a vertical acceleration to the vehicle wheel and suspension, wheel loads exceeding the legal maximum, accelerations resulting from out-of-balance wheels and wear on the cover seatings. The actual load factor is therefore much less than 12 and probably reduces to 2 in the worst case.

Telephone Poles

The main loads on poles result from wind and ice, wire or cable tensions and, significant for smaller diameter poles, the impact load which would be applied if a linesman should fall from his working position but is then arrested by his safety belt.

The strength of a given pole is not at all clearly defined; there is a wide scatter about the mean strength of a batch of poles, even if they have originated from the same forest (see Fig. 2(a)). Being lightly-processed, pole diameters vary appreciably. Defects, such as knots and shakes, which are usually present in the timber, may affect strength; timber is also subject to decay. Fortunately, these factors are statistically independent variables.

A most important factor in setting safety margins for pole design is the long history of the satisfactory use of poles and the large number in use at any one time: currently the BPO has about 4.5 million poles in use in the UK telecommunications network.

Present practice is based on a factor of safety of about 4 on the mean strength of poles as given in the appropriate British Standard. Sensitivity tests are undertaken to ensure that pole strengths on the tail of the strength distribution curve are still adequate to give safe working conditions, even when some decay is present.

Fall Arrestor Attachments

Fall arrestors are used in a number of circumstances where staff are working at a height in locations where the use of access ladders and platforms is impractical; the workman would wear a safety harness attached to a rope with a fall

arrestor device connected at some point. There are two main types of fall arrestor systems: in the first type, the rope is fixed, and the man's harness is attached directly to the arrestor, which normally runs freely up and down a fixed rope; in the second type, the harness is fixed to the end of a rope that is paid out from a drum in the fall arrestor device. Either system must be attached to an adequately strong part of the fixed structure. The characteristic of both types of arrestor is that a sudden movement, such as that which would occur if a person started to fall, causes the device to lock quickly and hold the person on the rope. If such a fall does occur, then a sudden force is applied to the supporting structure that could well exceed the person's weight by a large factor (Fig.5).

The BPO has examined many devices and has pioneered the investigation into the impact forces which are possible†. As a result of this experimental work, the person's weight (taken as 115 kg) is now multiplied by a factor of 10, and this value is taken as the maximum design load. The actual breaking load of the attachment will be even greater than this design load by whatever safety margin is applicable in the appropriate British Standard.

† CLOW, D. G., MELLING, R. J., and ALDOU, D. R. Measurements in the Establishing of Safe Construction Techniques. *Proc BSSM/ICE*. Joint Conference on Measurements in Civil Engineering. Newcastle-upon-Tyne, 1977.

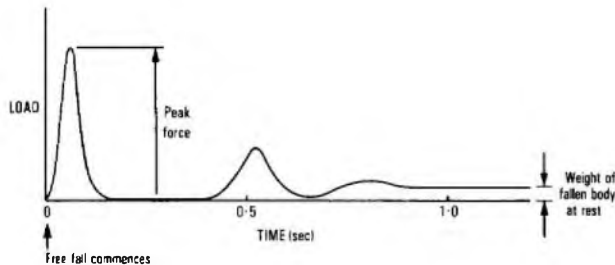

FIG. 5—Forces acting on a fall-arrestor support imposed by a falling test load

Reinforced Concrete Structures

The revised British Standard (CP110) for design in structural concrete introduced (for the first time in a UK design code) the application of limit-state design. The two limit states—ultimate and serviceability—have already been mentioned. Loads and strengths in limit-state design are defined, as far as is possible with the data available, in terms of *characteristic* loads and strengths. Concrete strength is given in terms of *characteristic strength*, which is defined as “that value of strength below which 5% of the population of all possible strength measurements of the specified concrete are expected to fall” and is numerically equal to

$$(\text{mean strength} - 1.64 \times \sigma),$$

where σ is the standard deviation.

As there is less statistical data available for loads, some simplification has been necessary to produce characteristic loads. The loading on the structure is split into dead, imposed and wind loads; partial safety factors are used to take into account the differing degrees of variability of each type of loading. There are many possible combinations of factors. For example, the design load for one of the serviceability states is as follows:

$$\text{design load} = (\text{design dead load} \times 1.0) + (\text{design imposed load} \times 0.8) + (\text{design wind load} \times 0.8).$$

It may be noted that all such attempts to produce designs on a more rational basis have complicated the designer's task; the hope is that this penalty will be offset by more reliable and economic structures.

CONCLUSIONS

This article has shown that the judicious choice of safety margins is of fundamental importance to sound engineering practice. The topic is complex and many areas are open to debate and further study.

The examples given in this article indicate that the achievement of safe, economic equipment can be obtained only from a sound theoretical appreciation of material, machine and structure behaviour, and from a realistic understanding of the vicissitudes which the equipment will undergo in production and use.

Book Review

Semiconductor Pulse and Switching Circuits. Santokh S. Basi. John Wiley & Sons. xiii + 538. 252 ills. £10.50.

In his introduction to the book the author indicates that it is his intention to cover the subject comprehensively and to provide an introductory course specially for technicians. If these limitations are accepted, then the book achieves its aims relatively well: the author explains every area very well, sticks to basics and does not resort to complex mathematics. Although the book is relatively long and rather exhaustive examples are given throughout, the presentation of the material is good. The book is also very readable.

The principal criticism of the book is that, while the author claims to provide a comprehensive coverage of the subject, in

the final chapters he runs up against the problem of all authors of this topic; that is, how to cover the vast subject matter of integrated logic circuits and applications.

The reader must accept that the main theme of the book is the basic principles and operation of discrete circuit elements, while the coverage accorded to logic and integrated circuit techniques is limited to an introduction to the subject.

The author and the publishers obviously see an opening for this textbook, even though its subject matter has been extensively covered in similar works. While they have no doubt done a good job, it is doubtful whether the author's contention can be accepted that more has been achieved in this book than in previous publications; some have certainly been more concise.

A. R. POTTER

The CCITT No. 6 Common-Channel Signalling System

P. J. WALKER, M.A.(CANTAB.), C.ENG., M.I.E.E., and D. R. BALLINGER, B.SC.†

UDC 621.395.34: 621.394.4

The introduction of stored-program control switching systems into the international network in recent years has allowed the adoption of fast inter-processor signalling using common-channel principles. This article provides an introduction to the CCITT No. 6 international common-channel signalling system, which has been provided at Thames International Gateway Exchange in London.*

INTRODUCTION

Since the early days of telephony in the nineteenth century, signalling has been required to transfer call-control information between exchanges in the telephone network. Initially, this signalling was very simple, with most of the information being conveyed verbally. However, introduction of semi-automatic and automatic networks, based on electromechanical switching techniques, led to the development of various signalling systems suitable for the needs of these networks. These signalling systems are now well established and, in general, make use of direct-current, voice-frequency or multi-frequency signals, transmitted on the circuits involved in a particular call¹.

It has been realized for many years that a possible alternative to these within-channel systems is the use of a single common channel to transfer all signalling information between two exchanges. The application of computer technology to the control of telephone switching, and the development of transmission and modulation systems that are able to carry high-speed serial binary data, have allowed the common-channel concept to become both a practical and a rational method of signalling.

COMMON-CHANNEL SIGNALLING

A distinction should be drawn between true common-channel signalling systems and separate-channel signalling systems. In the latter systems, a separate channel is used to convey the signalling information for a group of circuits, but the channel is divided, using time- or frequency-division techniques, so that each circuit has a discrete nominated signalling path. The time-slot 16 signalling method used on 30-channel pulse-code modulation (PCM) systems can be classed as a separate-channel signalling system. In common-channel signalling systems, however, all circuits signal over the same path, using the first available information slot, and therefore require a label within the signal message to identify the circuit to which the message refers. Because the signalling link uses high-speed data transmission, the signals must be formatted as serial binary data messages. The transmission time of each of these messages is very short and so the information transfer could be subject to errors caused by noise and short breaks in transmission on the data link. Therefore, error detection and correction systems are required in all common-channel signalling systems.

In addition, if large numbers of circuits were totally

dependent on one data link for their correct operation, it would be a security hazard. Consequently, a common-channel signalling system must secure the signalling link through the provision of alternative signalling paths. In its simplest form, more than one signalling link may be provided between the two exchanges. However, a more elegant method to ensure the signalling is by using non-associated signalling methods, in which the signals are sent over an alternative link to a third exchange and then passed to the destination exchange over a second signalling link, as shown in Fig. 1. The third exchange, known as a *signal transfer point* (STP), takes no part in switching the call and need not be an exchange

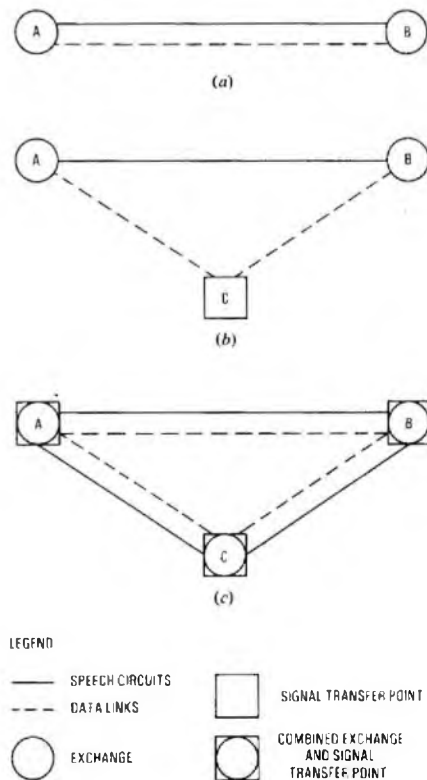

(a) Associated working
(b) Non-associated working
(c) Network with mixed associated and non-associated working

FIG. 1—Associated and non-associated modes of working

† Exchange Systems Department, Telecommunications Headquarters

* CCITT—International Telegraph and Telephone Consultative Committee

at all. Hence, it can be seen that a network of signalling links can be built-up which is divorced from the speech network it controls. Such a network also allows the transfer of information other than telephone call control signals. For example, a network management centre could pass messages to and from other centres and remote exchanges. In this type of operation, the signalling network operates in a manner analogous to a packet-switched data network.

From the foregoing, it can be seen that much of the complexity of common-channel signalling systems arises not from the telephone signals, but from the way signals, in the form of data messages, are transferred from one exchange to the next. These signalling systems can be functionally divided into message transfer functions which are responsible for delivering the messages, and user functions such as telephone call control and network management which are the end users of the messages transferred.

Two common-channel signalling systems are being introduced by the British Post Office (BPO). The CCITT No. 6 signalling system is already in service for intercontinental telephone traffic, while the CCITT No. 7 system is being developed for applications in digital networks, both national and international, and can be used for both telephone and circuit-switched data. The CCITT No. 7 system will also be used in integrated services digital networks. The BPO intends to use a national sub-set of the CCITT No. 7 system between System X exchanges in the UK national network^{2,3}.

History of CCITT No. 6

In the early-1960s, the CCITT became aware of the signalling limitations and high line-termination costs of the CCITT No. 4 and No. 5 signalling systems⁴ and started to study the possibility of using common-channel techniques. Initial studies investigated the use of a common-channel for the line signals, in conjunction with multi-frequency inter-register signalling. Accelerating development of stored-program control (SPC) switching systems in the mid-1960s allowed a complete common-channel system for both line and register signals to be ultimately adopted. An interim specification for the system was first published following the fourth Plenary Assembly of the CCITT in 1968, in the White Book, the system being designated *CCITT Signalling System No. 6*⁵. This was the first time a signalling system had been completely specified within the CCITT.

Following the White Book specification, the system was the subject of an international field trial, in which the BPO participated using a processor-controlled extension to the Wood Street TXK2 International Exchange⁶. Following the field trial, a number of changes were made for the Green Book specification published in 1972⁴. The Orange Book specification of 1976⁷ contained further changes, including the specification of a version for use on digital transmission links, and forms the basis for the implementation of a number of designs of CCITT No. 6 signalling systems. In the light of this design experience, additional changes have been made for the 1980 specification.

The system first entered public service in the international network in July 1978 between the United States, Australia and Japan. Service between the UK and the United States commenced in January 1980.

Advantages of CCITT No. 6

The particular features of the CCITT No. 6 system giving advantages over existing international signalling systems can be summarized as follows:

(a) Use of a serial binary data link is a rational method of transferring information between SPC exchanges, which already process information internally in binary form.

(b) It is potentially a lower cost system when the line termination equipment savings exceed the costs of provision of

the data links and signalling terminal equipment.

(c) The signal capacity allows a larger range of telephone signals to be established than with earlier signalling systems.

(d) The system can be used over both satellite and cable bothway circuits, including those derived from circuit multiplication systems, and contains control information concerning the use of satellite circuits and echo suppressors.

(e) The high basic signalling speed, coupled with the ability to work in either *en bloc* or overlap signalling modes, provides the potential for a reduction in post-dialling delay.

(f) Signalling via the common channel removes the possibility of interference between answer signals and the initial burst of speech.

(g) Signal capacity has been allocated for network maintenance functions and the future addition of network management functions.

SYSTEM STRUCTURE

CCITT No. 6 can be divided into message transfer functions and user functions. The message transfer functions can be further divided into 4 hierarchical parts:

- Part 1—The modem;
- Part 2—Data link control;
- Part 3—Message handling;
- Part 4—Signalling network security.

Part 4, among other functions, transmits system control signal units (SCUs) to other exchanges to co-ordinate the reconfiguration of the signalling network. These signals are sent over the message transfer system as regular CCITT No. 6 messages. The Part 4 function is, therefore, also a user function in its own right. The division of the message transfer functions into parts is not formalized in the CCITT specification, but is similar to the formal division of CCITT No. 7 into *levels* and has been introduced here to clarify the system description.

Four user functions are included in CCITT No. 6; these are:

(a) telephony functions, responsible for the control of telephone calls and individual speech circuits, in conjunction with the exchange call-processing functions;

(b) signalling network security functions, which are also part of the message transfer functions;

(c) network maintenance functions, responsible for groups of speech circuits, in particular automatic recovery following failures of SPC exchanges in the network; and

(d) network management functions, which are not yet specified in detail, but will be responsible for passing information and commands concerning routes, traffic flow and routing arrangements.

It is not possible to give a detailed description of all these functions in this article, but the following provides enough background for comparison with other common-channel systems. A diagram of the system structure is shown in Fig. 2.

Message Transfer Functions

Although the CCITT No. 6 signalling system has been specified in both analogue and digital forms, only the former is in use today and is described here.

Part 1—The Modem

The modem modulates and demodulates the serial binary data sent to and received from the data link. The data link operates at a rate of 2400 bit/s, employing 4-phase phase-shift-keying of the type also used for the BPO Datel 2412 service⁸. The modem maintains bit synchronism, and also provides clock pulses derived from the incoming bit stream and an alarm if the received data carrier disappears.

Part 2—Data Link Control

The data streams sent and received by a signalling terminal are

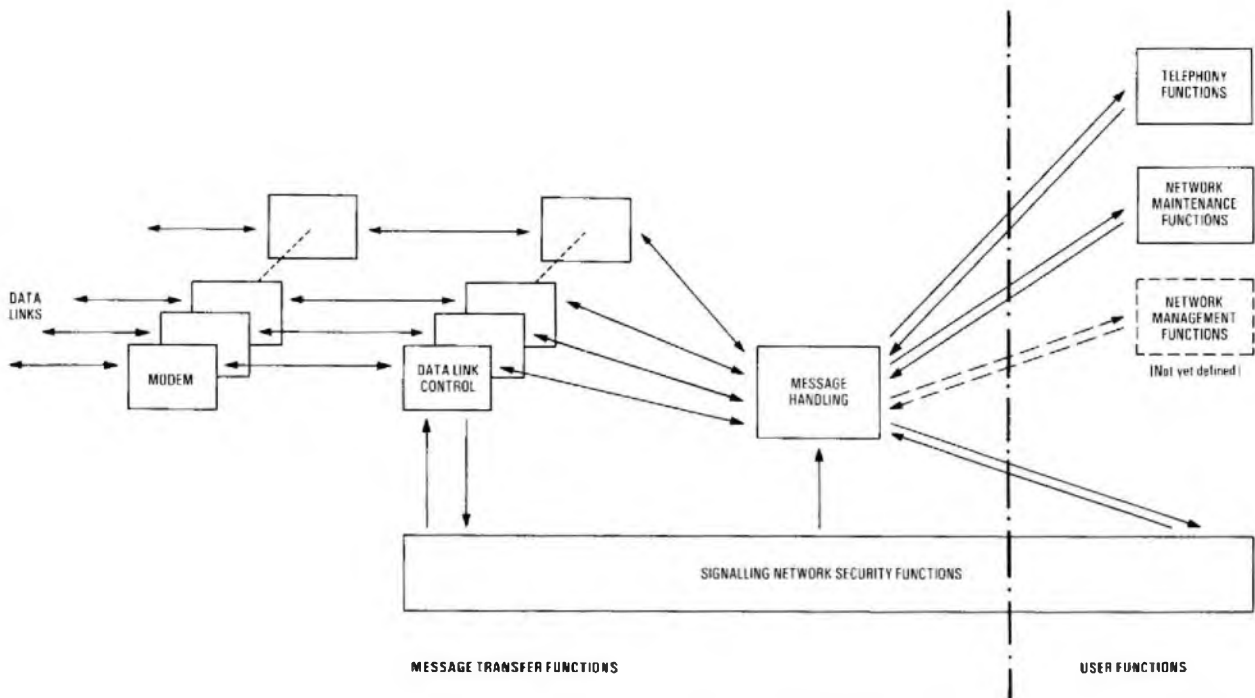

FIG. 2—Functional structure of the CCITT No. 6 system

structured into signal units (SUs) and blocks. Each SU comprises 28 bits, the first 20 of which are used for information and the last 8 are check bits. These check bits are generated from a cyclic polynomial function of the information bits and, decoded at the incoming end, can detect virtually all SU errors.

Each block comprises 12 SUs. The first 11 SUs are used for carrying messages, but if no message is waiting to be sent, synchronization signal units (SYUs) are transmitted. The twelfth signal unit is the acknowledgement signal unit (ACU), and this forms part of the error control system. When a block has been received, the results of the check-bit error check on the first 11 SUs are coded into the ACU of one of the blocks about to be transmitted. When the ACU is received at the other end, it indicates, for a certain block, whether the information has been correctly received. If there were errors in the original signals, error correction is provided by retransmission of the affected signals.

The correlation between ACUs and the blocks they acknowledge is provided by a system of block sequence numbering within each ACU. Consequently, each signalling terminal has to store all transmitted SUs until they are positively acknowledged. In addition, a terminal may have to queue signals before transmission because the signalling demand varies instantaneously. The queuing control gives priority to certain signals (for example, *answer* and those waiting for retransmission) to ensure that these suffer the minimum delay.

Synchronization control is also included in the Part 2 function. When a signalling link is started or restarted, each end has to delineate the boundaries of the SUs and blocks within the bit stream. SU synchronization is attained by continuously comparing the bit stream with a fixed bit pattern within the SYU. Block synchronization is then attained by searching for an ACU. Following this, the block sequence numbering is commenced. Finally, the error rate performance is checked during a suitable proving period before the link is taken into service.

Complete failure of a data link can be detected by the Part 2 functions. A failure of the receive stream is detected by one of two methods:

- (a) unrecoverable loss of block synchronization, and
- (b) excessive error rate.

On detection of a failure of the receive stream, the Part 4 function is informed, which then sends change-over signals to the other end to ensure bidirectional recognition of the failure.

The data-link error rate is continuously monitored, and the criterion for unsatisfactory performance is a function of both error rate and the period for which it persists. This allows recognition of a complete failure within 350 ms, but at the same time permits moderate bursts of errors to be tolerated without the link being declared unusable. For stable operation, the monitor requires the long-term error rate to remain below 0.2%. When a link is considered unusable, the Part 4 functions are informed, so that the signalling information can be changed over to an alternative path.

Part 3—Message Handling

The message handling function works in 3 ways:

- (a) incoming messages are routed to the required user function;
- (b) outgoing messages are routed to the required data link; and
- (c) incoming messages using the exchange as an STP are detected and routed out again on the appropriate data link with label translation as required.

Incoming messages are processed by analysing the header code, which is the first part of the 20 information bits. Further analysis of other information may be required; in the case of STP messages, the label must be analysed to determine the required onward routing and outgoing label. Processing of outgoing messages is simpler. The required data link for a given signalling stream is defined by the Part 4 functions and is updated by those functions whenever a signalling network reconfiguration takes place.

Part 4—Signalling Network Security

The method of securing a given signalling link depends on bilateral or multilateral agreements between the countries concerned, but the overall aims and method of operation are the same. The signalling link that is normally carrying the signalling traffic between two exchanges is termed the *regular*

link, and this would normally be supplemented by one or more reserve links. This group of links is known as the *link-set* between the two exchanges. The reserve link(s) may be either:

- (a) a synchronized reserve, where the link is kept synchronized ready to take the signalling load whenever required, or
- (b) a non-synchronized reserve, where the link is disconnected from its modems and must be prepared and synchronized before use.

At present, only synchronized links are in use in the international networks, although several administrations have the capability of providing non-synchronized reserve links. A link-set in general consists of two synchronized links: a regular and a reserve. A variation of the same arrangement is the load-sharing mode, where each of these links normally takes half the signalling traffic, but either can take all the traffic when the other fails.

Non-synchronized reserve links have advantages if they can be used for other purposes when not required for signalling. For example, the link could be used as a speech circuit and earn revenue, but with the possible disadvantage that a call could be in progress at the time it is required, thus preventing its use as a signalling link. Another possibility is that the reserve link could be associated with a spare trunk in a TASI† system; a TASI channel would be connected only when the data carrier is activated.

An alternative strategy is to secure a signalling link using two other link-sets in the quasi-associated method of operation. This is very economical, but requires the agreement of a third country. For small groups of circuits, quasi-association could be used as the normal signalling path because a regular link might be uneconomic.

Whatever the method of operation, the signalling network security functions communicate with other functions as follows:

- (a) The data link control (Part 2) sends information on the status of each data link as detected from the incoming bit stream.
- (b) Commands are sent to the data link control to start or stop a signalling link.
- (c) Instructions are sent to the message handling function (Part 3) to alter the current routing of outgoing messages when a reconfiguration has been determined.
- (d) The signalling network security as a user function interchanges SCUs with other exchanges in the network. This ensures that the bidirectional capability of each link is known by both exchanges and, hence, allows cooperative reconfigurations of the signalling network according to pre-determined agreements. Other SCUs, known as *signalling network manage-*

ment signals, inform an exchange of the status of remote parts of the signalling network, which might be required for quasi-associated signal routings.

(e) Part 4 instructs the exchanges call-processing functions to block traffic routes if there are no signalling paths available because of multiple faults.

The internal logic of the signalling network security functions operates at three hierarchical levels:

- (a) at the link level, for the starting and stopping of links and the necessary redirection of signalling traffic,
- (b) at the link-set level, to ensure whenever possible that at least one working link exists in every link-set, and
- (c) at the signalling route level, to ensure that, for every group of speech circuits, the signalling passes through the network using the optimum path.

Telephony User Functions

The telephony user functions are responsible for the setting-up and supervision of telephone calls, and make use of signals corresponding to most of the traditional telephone signals. These are sent as messages on the common-channel signalling link under the control of the message transfer functions. Each telephone message requires a header code (5 bit) to indicate that it is a telephone message of a particular type. It must also carry an 11 bit label to indicate the speech circuit to which it refers. Allowing for the normal 8 check bits, this leaves only 4 bits from the 28 bit signal unit to carry the actual identity of the signal being transferred; for example, *clearforward* or *digit 3*. To overcome this problem, CCITT No. 6 user functions can code messages using one or more SUs in tandem. Messages using only one SU are known as *lone signal units* (LSUs), while those using two or more are known as *multi-unit messages* (MUMs). The advantage of MUMs is that the 11 bit label is sent in only the initial SU and the header code for a subsequent SU is only 2 bits, thus allowing a large information carrying capacity. The format of the LSU and the MUM is shown in Fig. 3.

The telephony user functions make use of MUMs by sending much, if not all, of the call address information in one MUM known as the *initial address message* (IAM). This can include up to 16 address digits: the country code, the national number and the stop signal. In addition, the IAM includes information such as the language or discriminating digit, and indications of transit or terminal call, echo suppressor inclusion, and satellite link inclusion. In cases where only part of the address information is sent in the IAM (the so-called *overlap* signalling mode), subsequent address messages are sent forward (as LSUs or MUMs) when the digits are ready for transmission.

All other telephone signals are transmitted as LSUs. By using four header codes and the 4 bit information field, a

† TASI—Time assignment speech interpolation

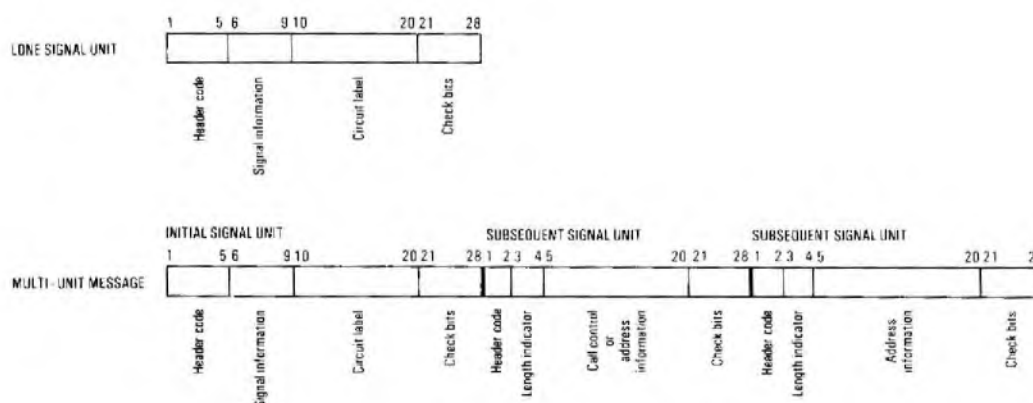

FIG. 3—Format of typical CCITT No. 6 messages

capacity of 64 messages is produced, of which 34 are currently allocated. These can be classified into five types of message:

- (a) call supervisory signals, such as *clear forward* or *answer, charge*;
- (b) circuit supervisory signals, such as *blocking*;
- (c) backward address complete signals, such as *address complete, subscriber free, charge*;
- (d) backward unsuccessful call signals, such as *subscriber busy* or *national network congestion*; and
- (e) signals required because of irregularities in the message transfer functions, such as *confusion* or *message refusal*.

All common-channel signalling systems working in an analogue environment have one disadvantage compared with in-channel signalling systems. Because the call-set-up information is not passed over the speech circuit, a call could be set up on a discontinuous circuit. To overcome this, the CCITT No. 6 system includes a continuity check of the speech path at the start of each call. At the same time as the IAM is being sent on the common channel, a 2000 Hz continuity check tone is transmitted on the speech circuit. When the IAM has been received at the incoming end, a loop is applied between the transmit and receive pairs of the 4-wire circuit allowing the tone to return to the outgoing end. On receipt of the check tone at the outgoing end, the tone is removed and a *continuity* signal sent over the common channel instructing the incoming end to remove the loop, thereby allowing the normal call set-up to proceed.

A significant drawback in the CCITT No. 6 system is that the necessary, or sometimes superfluous, retransmissions on the signalling link can cause the order of telephone signals to be disturbed, or result in signals being received twice. The logic of the telephony functions has, therefore, to include *reasonableness checks* on each received signal to overcome any apparently illogical signal sequence. To aid this process, all subsequent address messages (SAMs) include a sequence number in the header code to ensure that address digits are assembled in the correct order. In other cases, the illogical signal is discarded or, in the most difficult circumstances, the call is released. In more modern common-channel signalling systems, a pre-requisite for the design of the message transfer functions has been that the user functions should be immune to any irregularities on the signalling link, thus allowing the reasonableness checks to be largely dispensed with.

Fig. 4 shows the signalling sequence on a typical interna-

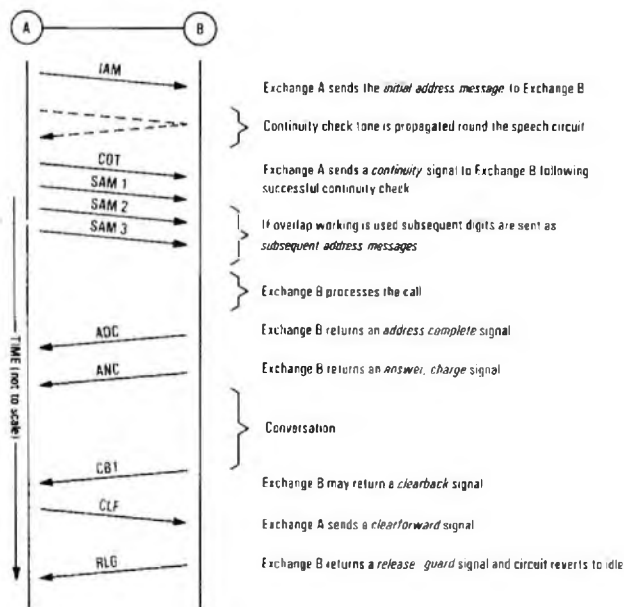

FIG. 4—Typical call set-up procedure

tional call using the CCITT No. 6 system. There is no separate seizing signal because the IAM implies the seizure of the indicated circuit. Following the IAM, the continuity check sequence takes place. (If this is unsuccessful, a second attempt is made to establish the call on another circuit, while the original circuit is subjected to a second continuity check. If this also fails, the circuit is blocked.) If the IAM does not contain the complete sequence of address digits, one or more SAMs are sent as the digits become available from the preceding exchange. On completion of the call set-up procedure, the incoming exchange returns either one of the *address complete* signals, or one of the *call unsuccessful* signals. In the former case, the routing information at each exchange can be erased and the speech connexion completed. In the latter case, the call may be re-attempted on another circuit, or a tone or equivalent signal is returned to the calling party. When the called party answers, the priority signal *answer, charge* is transmitted, causing the international accounting and the metering of the calling party to commence. At the end of the call, the circuit returns to the idle condition after exchange of the *clearforward* and *release guard* signals. In the case shown in Fig. 4, the called party clears first, so this sequence is preceded by the transmission of the *clearback* signal.

BPO IMPLEMENTATION OF CCITT NO. 6

International service using CCITT No. 6 signalling is currently provided on the Thames International Switching Centre (ISC), Phase 2. This exchange, installed by Thorn-Ericsson Ltd., is of the L. M. Ericsson AKE 132 type and is known as *TXK6* within the BPO. It uses SPC, with three duplicated processors working in a multi-processing configuration. A miniature electro-mechanical matrix switch, known as the *code switch*, is used as the analogue switchblock. All the software for switching, signalling and call processing resides in the main central processors, but in the case of CCITT No. 6, a number of front-end mini-computers are provided to carry out most of the Part 1 and 2 message transfer functions. The exception to this is that the message buffers, which require considerable storage, are in the main data stores of the central processors. This hierarchical configuration allows the processing load of maintaining data link protocols to be deloaded from the main processors.

System Development

From quite early in the development phase, it became clear that several countries had different interpretations of parts of the Orange Book CCITT No. 6 specification and, even when the interpretation was the same, there was no guarantee of total compatibility. It was necessary to liaise with all the other countries implementing CCITT No. 6 to ensure that compatibility would be achieved; this was complicated because some CCITT No. 6 equipment in the network conformed to the older Green Book specification, and used a different and partly incompatible synchronization procedure.

A further activity during this period was the specification and performance of engineering compatibility tests. These have been designed to prove compatibility between different implementations of CCITT No. 6 before public service is commenced. These tests are expected to be carried out as each new exchange system enters the network and, to aid commissioning staff, a set of test schedules has been informally published by the CCITT.

System Administration and Operation

The implementation of CCITT No. 6 service requires that a number of inter-administration agreements are made, over and above those normally required for an international signalling relationship. In general, these relate to the structure of the signalling network, and the various assignments agreed

will define the pre-determined signalling reconfigurations that take place on failure or after a manual request.

Where quasi-associated and STP working is used, more than two administrations will be involved in the provision of a signalling relationship and a more integrated multi-lateral approach may be necessary. Because a number of different implementations of the CCITT No. 6 system have been designed, there will inevitably be some detailed differences in their behaviour. While these should not in any way affect their interworking ability, they may give rise to some operational or administrative restrictions that must be taken into account.

It is expected that the nature of the system will affect the administrative functions for the provision, operation and maintenance of international service. In particular, the traditional tasks of network and traffic planning, circuit provision, trunking and grading, together with switching and transmission maintenance, need to take account of the changes that the CCITT No. 6 system brings to the signalling environment.

System Maintenance

The CCITT has specified a number of maintenance facilities to be provided at ISCs using the CCITT No. 6 system. These cover data-link error-rate testing facilities, together with various maintenance alerts that should be given when failure conditions occur. Additional maintenance facilities, such as system monitoring and signalling terminal diagnostics, together with maintenance facilities for the processors on which the system software is run, may also be provided.

In-service experience is expected to show that short-term data-link failures (because of noise etc.) will be the cause of most interruptions to CCITT No. 6 signalling. However, these will not require any maintenance action because the signalling should be secured by one or more reserve links and, on cessation of the circuit noise, the data link will be taken back into service. Where a data link is suffering from permanent failure or a long-term high error rate, transmission checks, and possibly signalling terminal testing, will be required. Transmission checks will also be required when the

telephony functions indicate that a particular speech circuit is not passing the continuity test.

Unlike earlier international signalling systems, it is not possible to monitor directly the signalling on a particular circuit, or to generate dummy signals to prove the circuit. Control and supervision of the system must be exercised by maintenance staff entirely through the processors themselves and, hence, all necessary procedures must be built-in. These will include a mandatory facility for manually-initiated continuity test calls on individual speech circuits.

CONCLUSION

The CCITT No. 6 system is the first common-channel signalling system to be used in the international network. It is expected that the introduction of this complex system, after a gestation period lasting for a decade, will significantly improve the service on international telephone routes. The CCITT No. 6 system has also laid the foundations for improved common-channel signalling systems, which will be used in the digital networks of the future.

References

- 1 WELCH, S. Signalling in Telecommunications Networks. Peter Peregrinus Ltd., 1979.
- 2 JONES, W. G. T., KIRTLAND, J. P., and MOORE, B. W. Principles of System X. *POEEJ*, Vol. 72, p. 75, July 1979.
- 3 PRICHARD, T. W. System X: Subsystems, Part 4—Common-Channel Signalling and the Message Transmission Subsystem. *POEEJ*, Vol. 73, p. 165, Oct. 1980.
- 4 Specifications of Signalling Systems Nos. 4, 5 and 6. CCITT Green Book, Vol. VI-2.
- 5 Specification of Signalling System No. 6. CCITT White Book, Vol. VI.
- 6 FRENCH, J. A. T. United Kingdom Participation in the Field Trial of CCITT Signalling System No. 6. *ITU Telecommunication Journal*, Vol. 41, p. 133, Feb. 1974.
- 7 Specification of Signalling System No. 6. CCITT Orange Book, Vol. VI-2.
- 8 BIGGS, R. W. A New Modem for the Datel 2412 Service: Datel Modem No. 12B. *POEEJ*, Vol. 70, p. 185, Oct. 1977.

Book Review

Principles of Digital Communications. G. T. Marshall, PH.D.
McGraw-Hill. xi + 170 pp. 59 ills. Paperback: £5.50.

The author is a Principal Lecturer at the Polytechnic of North London and the book is based on undergraduate courses that he teaches there.

The book starts with a very basic introduction to communication systems, which assumes little knowledge of the subject on the part of the reader. Subsequent chapters introduce the concepts of information theory and some of the basic techniques for coding analogue signals into a digital format for transmission.

A useful feature of the text is the way in which basic theory is related to practical systems, although some of the systems described are not the most up-to-date of those in use today. For example, the pulse-code modulation encoders described seem quite antiquated by modern standards; nevertheless, they do illustrate the important principles which are involved and which are the theme of the book throughout. In the section dealing with modern digital communications systems no mention is made of equipments forming part of the digital hierarchy based on 2 Mbit/s that has been adopted by

administrations throughout Europe. This seems to be a rather important omission. Baseband transmission systems and the relative merits of the various carrier-borne digital-transmission systems are described. The final chapters discuss complete digital communication networks, including circuit, message and packet-switching techniques, and the various possibilities that exist for switching messages through them; basic theory is also introduced.

There are a considerable number of illustrations which help in the general understanding of the text, and a number of worked examples are given. Further problems for the reader to solve appear at the end of each chapter, together with answers and some explanations. A short list of references, which guide the reader to sources of more detailed information, and a brief description of their usefulness also appear at the end of the book.

Overall, the book is very readable and seems well suited as an introductory work for the undergraduate scholar that the author has in mind. However, anyone requiring more specialized information, including more rigorous treatment of the theory or more detailed descriptions of practical systems, should look elsewhere.

R. W. McLINTOCK and B. N. KEARSEY

UXD5: A Small Digital-Switching Telephone Exchange for Rural Communities

Part 1—General Description

J. R. W. AMES, B.SC., M.SC., C.ENG., M.I.E.E., M. J. ELSDEN, B.SC., M. W. HILL, M.SC., C.ENG., M.I.E.E., and P. A. TRUDGETT, B.SC., M.SC., PH.D., C.ENG., M.I.E.E.†

UDC 621.395.2: 621.374

The UXD5 is a high-technology, digital-switching telephone exchange designed for use in rural areas where telephone penetration is small. The design of the UXD5 is based on the Monarch 120 PABX¹ and is intended as a replacement for Strowger Unit Automatic Exchanges at present installed in the UK telephone network. This part of the article gives a general description of the UXD5 design and its application; Part 2 will describe the system software and operational aspects.

INTRODUCTION

Rural areas have always presented particular problems for telephone operating administrations. Scattered communities with low telephone penetration, often coupled with adverse terrain, lead to difficulty in offering an economic and reliable service. In the early days of the UK telephone network, service was provided by small manual boards, usually sited at the local Post Office. During the 1930s it became apparent that these manual boards were becoming increasingly uneconomic, therefore the British Post Office (BPO) introduced a family of small Strowger exchanges to cater for the needs of small rural communities. These exchanges, designated *Unit Automatic Exchanges* (UAXs), were constructed from a series of standard cabinets housed in standard buildings. The standard design of these exchanges led to low installation costs and high reliability, and these exchanges offered to the rural subscriber a service comparable with that available in towns and cities.

UAXs still form a large part of the BPO network in rural areas, having been modified for trunk dialling from 1969. There are over 2000 exchanges in the UK network with less than 400 lines, a high proportion of which are of the UAX type. Scotland has a particularly large number of small exchanges, over 600 of which have less than 200 lines. Many of these small exchanges are now over 40 years old and are reaching the end of their service lives.

Modernization of the BPO network is based on the System X family of exchanges; it is the intention of the BPO to replace all Strowger exchanges by the turn of the century. Initial development of the modernization programme has necessarily been concentrated on the larger exchanges and, therefore, an interim programme is required for the replacement of UAXs; in particular, the replacement of UAX12s. The cost of developing a new small exchange would be very high, and low equipment quantities would lead to high production costs. These costs have, however, been reduced substantially by adopting a new exchange design based on an existing system which is scheduled for bulk production; that is, the Monarch 120 PABX¹, which can be adapted with minimum design change to fulfil the operating requirements of a UAX12.

In early-1978, a feasibility study indicated that modification of the Monarch 120 system to provide the facilities of a UAX12 would be possible, and recommended that a model

be built for trial in the public telephone network. A feasibility trial model entered service at Glenkindie, near Aberdeen, on the 31 July 1979. The trial has been successful, and production of the system, known as *Unit Exchange Digital No. 5* (UXD5), is scheduled to commence in 1981.

BACKGROUND TO THE DEVELOPMENT OF THE UXD5

The UAX12 is the smallest of the unit Strowger exchanges still in use; there are over 200 in service, mostly situated in Scotland. Initially, the UAX12 was designed to cater for 100 terminations (subscribers plus junctions), but later development permitted extension to 160 subscribers. Switching is centred on pre-2000 selectors, which act as group selectors for junction calls and as final selectors for terminating calls.

The basic UAX12 exchange is housed in three types of standard unit, designated *A*, *B* and *C*. The *A* and *B* units contain line circuits, subscribers' meters, line finders and selectors; the *C* unit contains the main distribution frame (MDF) and common equipment. Other units, housing junction and coin-and-fee checking relay-sets, have been added to provide trunk dialling facilities. Junctions carry mixed level 1, 9 and 0 traffic; a discriminating digit is used to segregate ordinary and coin-collecting box (CCB) level 0 traffic at the group switching centre (GSC). A typical exchange of 90 lines comprises a suite of racks approximately 4 m long and 1.8 m high.

Investigation into possible methods of replacing the ageing UAX12 installations included the possibility of using concentrators or network amalgamation. However, it became apparent that the cost involved in changing the established network in remote areas would be substantial. Therefore, the BPO decided to develop a replacement system based on the design of the Monarch 120 PABX.

The Monarch 120 system is the new standard rental-range PABX which has been developed by the BPO in conjunction with UK telecommunications manufacturers. The system caters for a maximum of 120 dial or keyphone extensions, which is approximately the correct size for a UAX12 replacement. The Monarch 120 system offers many of the facilities needed on a public exchange and its microprocessor control² has an inherent flexibility, a feature that has eased the modification process.

The UXD5 feasibility trial model was developed to demonstrate that a small public exchange, based on the Monarch 120 design, could be built with minimum change to the basic

† Messrs Ames, Hill and Trudgett are with the Research Department, Telecommunications Headquarters. Mr Elsdon is with the Exchange System Department, Telecommunications Headquarters

design. The design of the UXD5 was concentrated on meeting 4 main objectives:

- (a) that the exchange would be capable of operating in the same network configuration as a UAX12;
- (b) that, for ease of installation, the system would be of unit design;
- (c) that, for ease of maintenance, the equipment would be provided with advanced diagnostic facilities; and
- (d) that the system design would be flexible to enable the provision of advanced facilities, should they be required.

ADAPTATION OF THE MONARCH 120 PABX AS A PUBLIC EXCHANGE

Originally conceived as a PABX, the Monarch 120 lacks certain features normally required for the public network. The main areas that required modification were

- (a) availability performance and power supply arrangements,
- (b) call-charging facilities,
- (c) junction signalling facilities, and
- (d) operation of CCB services.

Availability Performance and Power Supply

The reliability of the Monarch 120 system depends on the correct operation of the control shelf and the mains power shelf. A failure in either of these subsystems could disable the whole, or a substantial part, of the exchange. Theoretical calculations have indicated that the mean-time-between-failures (MTBF) of the exchange due to either of these causes is approximately 3-5 years, excluding failure of the mains supply. While this value of MTBF is appropriate for a small PABX in an office environment, it is not suitable for a remote unattended public exchange; a MTBF in excess of 50 years is required in this application.

For the UXD5 exchange, an increase of MTBF to approximately 100 years has been obtained by duplication of the control shelves and by introducing DC-DC converters operating from a standard -50 V supply, which removes direct reliance on the public mains supply. One control shelf acts in a standby mode and is activated on detection of a fault in the working control shelf, thereby maintaining service until the faulty control shelf is repaired. Use of the DC-DC converters allows a small area of the exchange to be powered from each converter so that, in the event of a converter failure, service to only a limited number of subscribers is affected.

Call Charging

The Monarch 120 system offers a selective call-logging facility which does not meet the requirements for public network call-timing and charging. At the time of the UXD5 development the billing arrangements for System X had not been finalized, so it was therefore decided to develop the hardware and software required to operate standard subscribers' meters in the usual manner. Charging operates in exactly the same way as a UAX exchange by using local-call timing (LCT) and metering-over-junction (MOJ) pulses from the parent GSC. However, the UXD5 system has been designed so that a billing system providing System X data can be easily attached at a later date.

Junction Signalling

There is no provision in the Monarch 120 system for public network signals such as MOJ, trunk offer (TKO), and manual hold because the exchange interfaces only with public exchange lines. Hardware and software have therefore been developed to interwork with existing loop disconnect (LD), SSDC2 and SSAC8 signalling systems. A circuit is being

developed which, with the aid of a single-chip microprocessor, will be able to work to a wide range of DC signalling systems, including those mentioned above.

Description of the UXD5 software and system operation will be the subject of Part 2 of this article, which will be published in the April 1981 issue of the *Journal*.

Operation of Coin-Collecting-Box Services

No provision was needed in the Monarch 120 system for the control of CCBs. A self-contained CCB for use in the low-revenue areas serviced by UXD5 exchanges is not likely to be available for some time, so a special line unit has been developed to handle coin-pulse signals and to control the coin slots of existing pay-on-answer CCBs. Use of this line unit, plus additions to the exchange software, enables UXD5 exchanges to perform the standard coin-and-fee-checking process without the addition of any further hardware.

UXD5 SYSTEM ORGANIZATION

A system block diagram of the UXD5 is shown in Fig. 1. To take advantage of common volume production and to minimize design work, the UXD5 design uses, wherever possible, equipment produced for the Monarch 120 system.

Line Shelves

The line shelves and backplanes of the UXD5 are identical to those used in the Monarch 120 system. The line cards interface with customers' 2-wire lines and provide digital speech and signalling, at 72 kbit/s, to and from the shelf multiplexers; the signalling and speech are separated in the shelf multiplexers. A line card contains 4 subscribers' line circuits.

The MDF incorporates gas-discharge protection devices on each line to prevent lightning surge voltages being passed to the digital circuits.

The line shelves house the line units designed for use with CCB lines and junction signalling cards; receivers for multi-frequency signalling (SSMF4) telephones can also be accommodated on the line shelves. Monarch 120 multiplexers are used to multiplex the digitally encoded speech from the 32 ports on a line shelf onto a single 2.048 Mbit/s highway and to perform demultiplexing in the opposite direction of transmission. The digitally encoded signalling to and from the 32 ports on a line shelf is carried on a pair of 256 kbit/s highways, one for each direction of transmission.

The line shelves also accommodate a test line unit, which provides facilities for the automatic routine testing of the digital circuitry associated with each line and junction card, as well as much of the control shelves; the test line unit design is the same as that used for the Monarch 120 system.

Control Shelves

Although the control shelves use a high proportion of Monarch 120 circuit cards, the backplane wiring has been modified to allow duplication of the control shelves to meet the availability requirements. Only one of the control shelves is active at a time; the other control shelf is operated in an idle mode, in which it executes a program that checks for faults in its own equipment. The idle shelf takes over the control of the exchange automatically should a fault be detected in the active unit.

Each control shelf includes a change-over card specially designed for the UXD5. These cards incorporate tri-state buffers which pass clock waveforms, signalling and digitally encoded speech from the operational control shelf to the ribbon cables which interconnect the line and control shelves. The change-over cards on the control shelves are interconnected in such a fashion that only one shelf can have

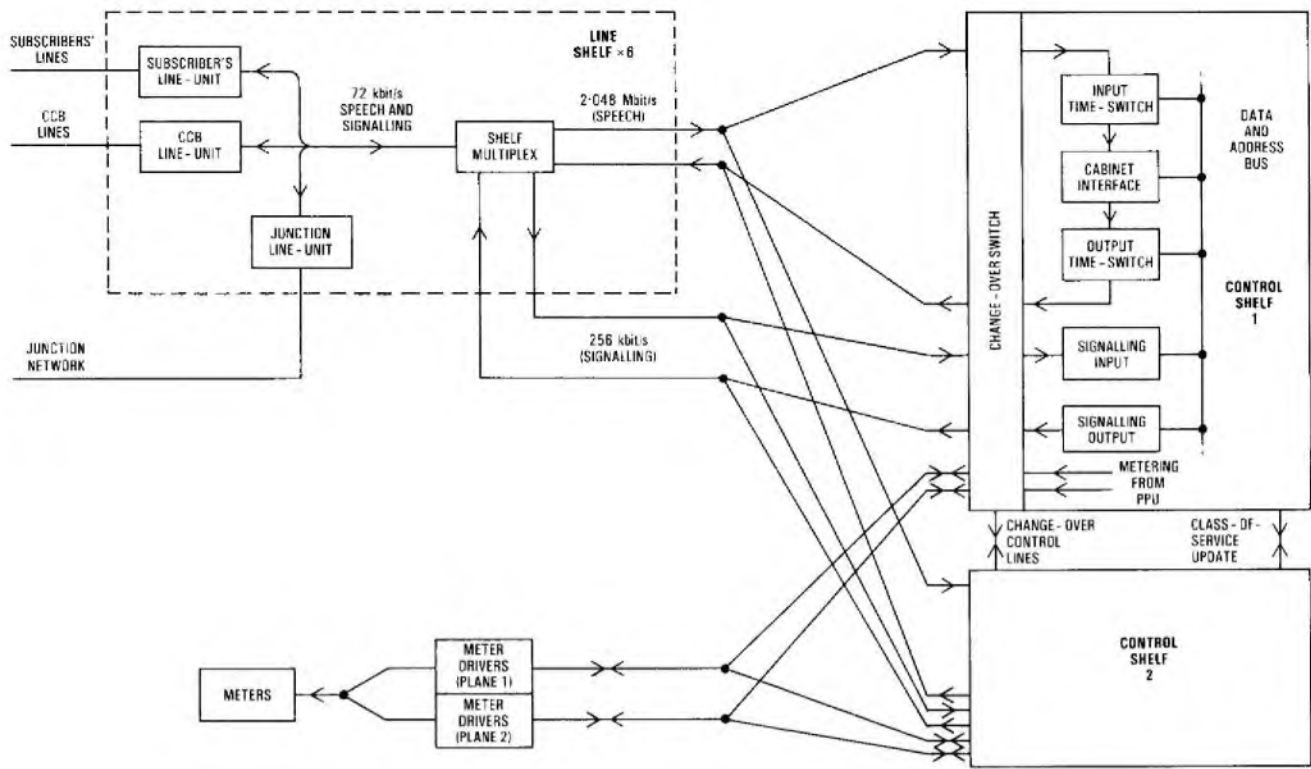

FIG. 1—Block diagram of the UXD5

access to the line shelves at any one time. If a fault is detected on the working control shelf, an output from the processor circuitry, known as the *watchdog*¹, causes the change-over card to initiate a change-over to the idle control shelf, but with loss of calls in progress. A routine change-over between control shelves is also made approximately every 24 h, but at a time when no calls are in progress.

A data link is provided between the two control shelves so that changes (such as class-of-service state) made to the database in one shelf can be passed automatically to the other shelf.

Digitally encoded speech from the shelf multiplexers is applied to non-blocking time-switches designed for the Monarch 120 system. The time-switch inputs include signals from a digital tones card and a conference unit (currently used in the UXD5 for various standard functions such as tone test and pay tone), as well as signals from the 6 line shelves. Similarly, signalling from the shelf multiplexers is applied to a signalling input card on each control shelf, which is scanned by the processors for signalling information. A signalling output card interfaces between signalling from the processors and the line shelves.

The provision of public network signalling and metering has placed an additional scanning load on the central processor unit (CPU); to assist with this load, a pre-processor unit (PPU) has been introduced on each control shelf. Both processors use the same design of board, the differences being implemented by means of links. In each case, an 8085 microprocessor provides the processing power and is provided with an attendant watchdog circuit, random access memory (RAM), read-only memory (ROM) and serial data-handling devices (universal synchronous/asynchronous receiver/transmitter (USART)). Alphanumeric displays on the front of the board are used to provide limited diagnostic information.

Primarily, the PPU handles junction scanning and dialled digit reception, for which a scan every 8 ms is required; the CPU deals with a slower (128 ms) scan used for the detection of subscribers' loop conditions and for the handling of call-processing routines. The use of two processors was necessary

to handle the volume of processing work and to provide sufficient serial USART links for purposes such as metering, without requiring major redesign of the Monarch 120 processor board.

The two processors on each control shelf are arranged to use common data and address busses. The PPU has priority and can interrupt the CPU by use of a *hold* signal.

The main program is held on two ROM cards, each capable of storing 48 kbytes² of information; 16 kbytes of RAM is also provided. Both types of storage use the same cards as those used in the Monarch 120 system.

Metering

The meter-driver cards are driven from the PPU over duplicated serial data links controlled by USARTs and are accessible by either control shelf.

Each meter-driver card controls the operation of up to 60 meters. The card carries a single-chip microcomputer (Intel 8748), which receives a request to operate a meter, checks the message, holds the meter operated for the appropriate length of time and checks that the meter is being correctly driven. Relay driver integrated circuits are used to interface between the low voltage microcomputer and the meters, which operate from the - 50 V battery.

Up to 4 meter-driver cards can be connected to a bus, which carries messages to and from the PPU. When a meter is to be operated, an 8 bit serial message is sent to the bus by the PPU, the first 2 bits of which identify the driver card. The microcomputers on each of the 4 cards receive the message, but action is taken only on the card addressed by the first 2 bits. The remaining 6 bits of the message identify the meter that is to be operated. The microprocessor decodes the message and first checks the electrical conditions at the meter terminals to confirm that the meter is not already operated. If this test is successful, a signal is sent to the appropriate meter driver to operate the meter and the conditions are again checked, this time to ensure that the meter has been driven correctly. After a period of 150 ms, the meter is

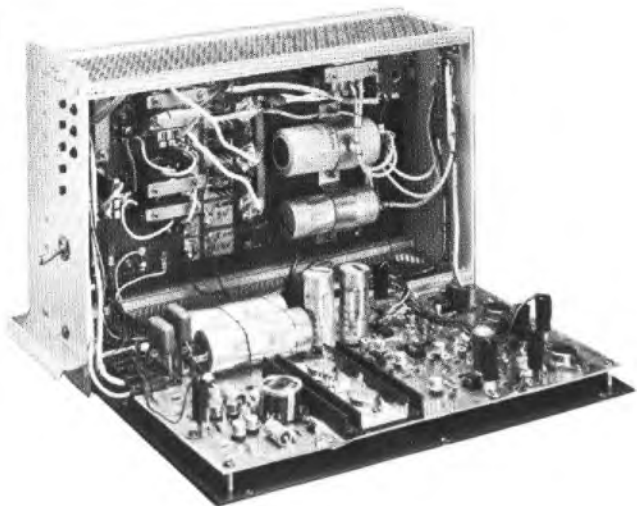

FIG. 2—DC-DC converter

released and a final check is performed to ensure that the meter is no longer operated. Finally, if all of the checks are successful, the microprocessor returns a copy of the original message to the exchange PPU via the bus to verify that a meter pulse has been applied.

The entire meter-driver structure is duplicated (as shown in Fig. 1). In the event of a fault on an operational meter-driver card (detected by a wrong or missing reply message), no further messages are sent to that card. Further requests to operate one of the 60 meters thereby affected are routed by the PPU via the second bus to the duplicate standby card, and an alarm is generated. In the unlikely event of a failure in the standby card, no further attempt is made to charge any of the 60 affected customers until maintenance action is taken. At intervals of 24 h, the functions of worker and standby meter-driver cards are interchanged to ensure that hidden faults have not developed in the standby unit.

Power Supplies

The control and line shelves are powered from specially designed high-efficiency DC-DC converters (see Fig. 2), each providing up to 100 W of power from the exchange battery at voltages suitable to drive the digital circuitry. For example, each control shelf is provided with a dedicated DC-DC converter which provides 54 W at +5 V, 2 W at +12 V and 3 W at -12 V at an overall efficiency of 80%. The power requirements of the digital circuits used for metering are provided from the control-shelf converters.

One DC-DC converter is provided for each pair of line shelves; by this means, only partial loss of service occurs under fault conditions. The DC-DC converters use switching techniques and ferrite components for efficiency; the converters are also designed to achieve high availability.

The power consumption of a 100-line UXD5 is 250 W with no traffic, and 330 W when 14 calls are in progress.

PHYSICAL REALIZATION OF THE UXD5

The 150-line exchange is contained in two cabinets, secured together to give an overall size of 1114 mm × 595 mm × 2130 mm. The cabinets are designated *A* and *B* respectively, and contain standard-size shelves which accommodate equipment cards of 318 mm × 203 mm. The equipment cards are interconnected by means of a backplane in which wiring is wrapped automatically during production. A front view of the cabinets (with covers removed) is given in Fig. 3.

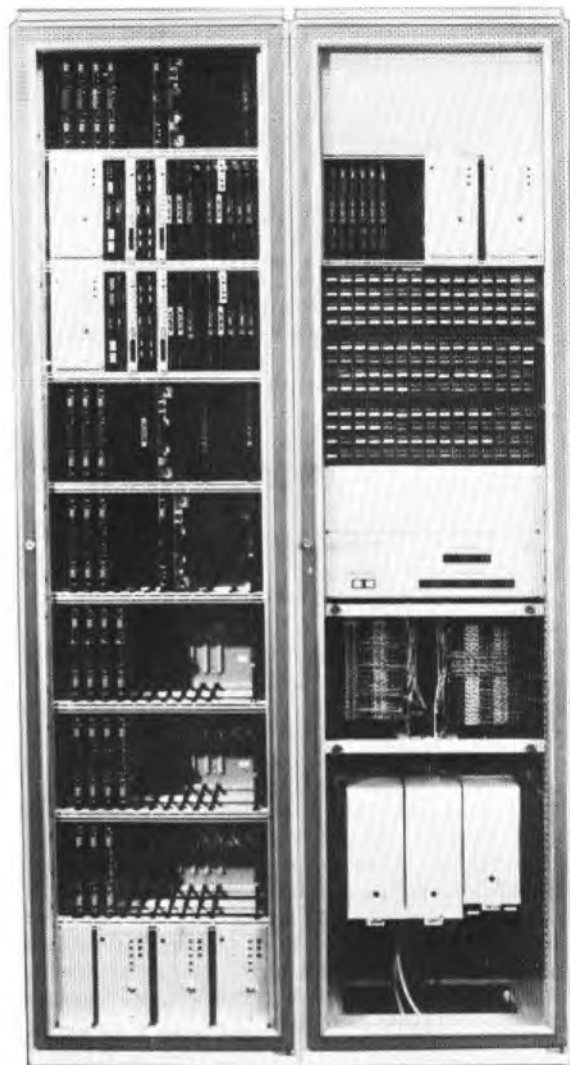

FIG. 3—Front view of the UXD5 equipment cabinets

A-Cabinet Equipment

The A-cabinet (shown on the left-hand side of Fig. 3) houses two more shelves than a Monarch 120 cabinet. The second shelf position contains the duplicate control shelf, and an extra line shelf is installed at the top of the cabinet to provide facilities for an extra 24 customers' lines and 8 junction circuits. The extra line shelf uses a spare time-switch port provided in the Monarch 120. At the bottom of the cabinet are 3 line shelf DC-DC converters, mounted in slide-in-units, and a Ringer No. 13A, also mounted in a matching slide-in-unit.

B-Cabinet Equipment

The B-cabinet (shown on the right-hand side of Fig. 3) houses equipment required to connect the UXD5 to the existing network; that is, the equipment that enables the UXD5 to operate as a direct functional replacement for a UAX12. The cabinet houses subscribers' meters and their associated duplicated driver cards, an alarm panel, the MDF, miscellaneous relay-sets and the 50 V power distribution fuses.

Three pairs of meter-driver cards are contained in a standard shelf; connexion is made to the meter panels below by multi-way ribbon cable terminated with plugs and sockets. The meters are arranged in 3 panels, each holding 60 meters in four rows of 15.

Below the meters is the alarm panel and associated indi-

indicator lamps, which report the status of the exchange. Also provided on the panel are buttons to reset the meter-driver cards after maintenance work; switches are provided which disable the alarm indicators while the lamps are tested.

The compact MDF is built from the recently introduced Jacks, Test No. 39 and No. 40. Each block carries 100 pairs; those on the line side of the exchange are protected by gas-discharge tubes. An intermediate distribution frame is not required since directory-number to equipment-number translation is performed by the exchange software and the exchange is not sensitive to the distribution of traffic load between the line units or shelves. Therefore, line pairs are jumpered from the line side of the MDF directly to the exchange side, where terminations are arranged in equipment number order. Direct test access to each line is available at the MDF as each pair can be split by a specially designed plug inserted in the terminal block.

Power from the exchange battery enters the UXD5 at the bottom of the B-cabinet and is distributed as required via fuses. Indications of fuse failure are connected through the processor in the A-cabinet and an alarm is raised when a fuse fails.

Finally, space is provided for up to 3 jack-in relay-sets. A WB700 receiver is provided to receive local call-timing pulses from the controlling GSC. To allow full flexibility of use, all connexions to the relay-set sockets appear on a miscellaneous connexion strip mounted in the rear of the cabinet.

FACILITIES

The UXD5 provides normal Strowger facilities, with UAX12 variations such as combined level 1, 9 and 0 junction working, trombone junction testing and remote test number.

Loop disconnect, SSDC2 and SSAC8 facilities are available for junction signalling; the resistance limit for incoming loop-disconnect signalling is 2000 Ω . All level 1, 9 and 0 traffic is routed to the parent GSC, and side routeings are available on level 8. The numbering range used on trial models has generally conformed with the UAX12 numbering scheme; however, UXD5 is capable of operating within a linked-numbering scheme.

The traffic capacity of the exchange is limited by the number of call records to 23 erlangs while providing a grade-of-service of 0.01. The occupancy of the control sets a limit of 1700 busy-hour call attempts. However, the time-switch is non-blocking, and has no effect on traffic capacity.

The transmission aspects of the system have been designed, as far as possible, to keep speech levels at the GSC similar to those from a UAX12. There are, however, two restraints

upon transmission through the exchange. Firstly, the incoming analogue signal must be adjusted to ensure that the signal presented to the CODEC does not cause overloading; secondly, since UXD5 is 4-wire switched, the 4-wire loop must be unconditionally stable.

The exchange uses a 25 mA constant-current feed on subscribers' lines and, as the telephone regulator is inoperative at this level of current, a gain adjustment is provided on the line card to cater for short lines of up to 4 dB line loss and long lines up to 10 dB loss. Service can be provided to long lines exceeding 10 dB loss by using a modified line-card. At present, the DC signalling limit for subscribers' lines is 1500 Ω , excluding the telephone instrument.

Subscribers' class-of-service status is stored in the exchange configuration database, which can be read and modified using a teletype. Access to the database is restricted by means of passwords. New lines can be provided simply by plugging-in extra line cards, providing MDF jumpering and activating the lines in the database. Maintenance and diagnostic facilities can be accessed using the same teletype, and will generally isolate faults down to card level. However, as these automatic tests are not absolutely certain of isolating all faults, confirmation by maintenance staff is required. Results from the tests are stored in a fault record, which can be read as required by maintenance staff. The diagnostic facilities also allow the maintenance staff to run particular tests on suspect equipment.

Initially, production UXD5 exchanges will be provided with adaptors for 16 shared-service lines, but the space occupied by the adaptors will possibly be needed for new equipment providing advanced facilities as shared service is phased out.

FEASIBILITY STUDY TRIAL

The UAX12 site chosen for the feasibility study is at Glenkindie, in the Aberdeen area. The exchange serves a rural community and has 93 exclusive lines, 3 CCBs, and 8 bothway junctions to the GSC at Alford. The connexions include both very short lines and some lines which are beyond the present transmission limits, but which are within proposed new limits.

For the purposes of the feasibility study, the existing UAX12 is retained on site, although some rearrangement of the UAX12 racks was necessary to accommodate both exchanges in the existing building (see Fig. 4). The ability to locate both exchanges in the one room indicates just how small the UXD5 is in relation to its predecessor.

A multiple relay switch is provided so that either the UXD5 or the UAX12 can be connected to provide service. The UAX12 is returned to service automatically should the UXD5

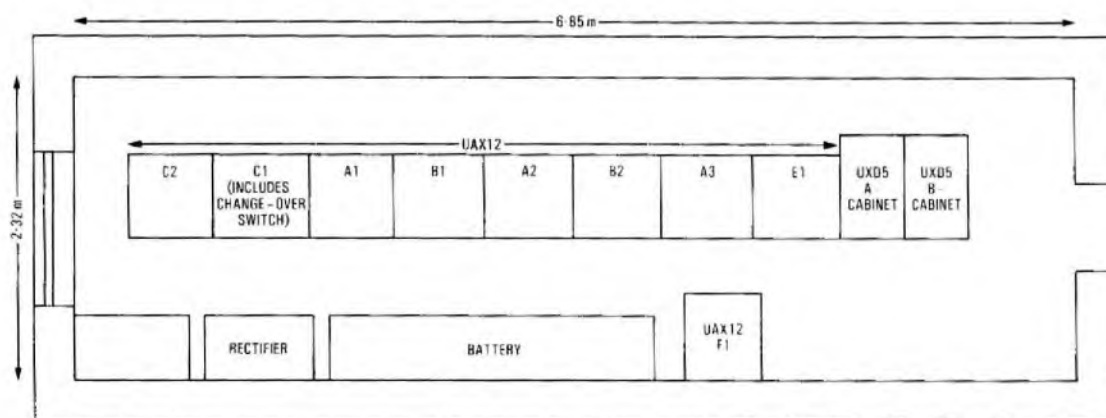

FIG. 4—Equipment layout for the feasibility study trial at the Glenkindie exchange

be rendered inoperable by failure of both control shelves or by failure of the power to one of the DC-DC converters supplying the line shelves.

For the feasibility study trial, it was necessary to increase the capacity of the exchange batteries to supply the joint power demand when the UXD5 carries no traffic and the UAX12 carries all traffic. If the mains supply fails for longer than 5 min, the UXD5 is switched off to conserve battery power. In this case, the UAX12 provides service. Urgent alarms in the UXD5, or a change-over to the UAX12, are signalled remotely by a change to the number unobtainable (NU) tone on the alarm-test number.

The trial was started on 31 July 1979. Some initial deficiencies were discovered during the early stages of the trial, but these have been easily corrected. In particular, the need to reduce the susceptibility of the line cards to lightning was highlighted, and improved protection was provided and will be provided on all future models.

FURTHER DEVELOPMENT OF UXD5

The BPO is now producing a further 12 exchanges for laboratory and network trials. These are based on the Glenkindie design, but some minor changes have been implemented as a result of experience with the trial model. Nine of these exchanges are being installed in the Dundee and Edinburgh telephone areas for evaluation trials.

A contract has been placed with Plessey Telecommunication Ltd (PTL) for industrialization of UXD5 design and the production of a number of prototype exchanges. It is expected that production exchanges will become available during 1981. A joint BPO/PTL study has been set up to identify possible enhancements for both the home and export markets. A substantial export market currently exists for a very small exchange of this type, and the initial phase of the study included an assessment of export requirements.

Further development of UXD5 is envisaged in the following areas:

(a) To reap maximum benefit from export opportunities and for additional flexibility within the home market, it is proposed to increase the maximum size of UXD5 to 600 lines.

(b) Consideration is being given to the development of additional services; namely, abbreviated dialling, automatic advice of call duration and charge, automatic alarm-call, call barring, call diversion, call-waiting indication, repeat last call

and 3-party calling. The Monarch 120 system offers a range of supplementary services which will form the basis for equivalent facilities on UXD5.

(c) Advanced signalling development is in hand to provide CCITT R2 signalling and direct connexion to 30-channel pulse-code modulation systems. In addition, the development of common-channel signalling is under consideration.

(d) The design is being enhanced to provide advanced service facilities, including remote print-outs and remote interrogation of maintenance and diagnostics. Advanced traffic-recording facilities are being considered for development at a later stage.

(e) An itemized billing system is under development, and remote read-out facilities for both bulk and itemized billing systems will be provided.

SUMMARY

The UXD5 is a small, high-technology telephone exchange designed for use in rural areas. It is of extremely economic design due to its commonality with the Monarch 120 PABX; approximately 75% of the cards in a fully equipped UXD5 are the same as those used in the Monarch 120 system. The design is highly flexible as the exchange is software controlled, and a high availability is offered due to duplication of the control and switching equipment.

The unit design of UXD5 leads to ease of installation, and sophisticated diagnostic facilities are provided to assist maintenance.

A feasibility trial of UXD5 has indicated that the system has considerable potential and an additional 9 models are now being installed in the BPO network for further evaluation of the design.

The design of UXD5 is now being enhanced for export purposes and to provide advanced facilities for the home market. Production exchanges are scheduled to be available during 1981.

References

¹ POTTER, A. R. Monarch 120—A New Digital PABX. *POEEJ*, Vol. 73, p. 14, Apr. 1980.

² TONGE, J. D., GAUNT, D. L., and KENDALL, J. P. Programmable Logic and Microprocessors. *POEEJ*, Vol. 70, p. 136, Oct. 1977.

³ WALTERS, R. E., PARK, I. D. C., and COLLINS, P. E. Microprocessor Software Development for a Small Telephone Exchange. *Microsoftware*, SERT Symposium 1980.

Prestel Comes to Wales

P. L. BUSHELL and M. CLEMITSON†

When public service for Prestel, the British Post Office's (BPO's) view-data service opened in London in September 1979, ambitious plans had already been made to extend it by the end of 1980 to a further 18 major conurbations, including Cardiff, so that Prestel would be available to around 60% of the UK telephone population on a local call basis.

The heart of the system at each information retrieval centre (IRC) is two 208-port GEC 4082 mini-computers using 70 Mbyte disc drive storage. Customers' equipment consists of a modified television set (though some terminals intended for business use do not have television reception) equipped with additional decoding and identifier electronics, an autodialler

and an integral modem. Access from customers' telephone installations is via the public-switched telephone network to Modems No. 20 at the IRC. Data transmission is asynchronous duplex at 1200 bit/s from the IRC to the customer, and 75 bit/s in the reverse direction. Alternatively, where an IRC is not initially justified on traffic or other grounds, a local call area can be served by Dataplex from a suitable IRC. Dataplex 3, which has superseded Dataplex No. 2 for all new work, is based on the Multiplexor No. 3A using statistical time-division techniques with Modems No. 11 over high-speed bearer circuits.

In the case of Cardiff, it was decided to open an IRC which would initially serve, by Dataplex, Bristol and Bournemouth, part of the South West Telecommunications Board, and

† Wales and the Marches Telecommunications Board

Belfast, part of the Northern Ireland Postal and Telecommunications Board. Plans to serve other locations in Wales and the Marches Telecommunications Board (WMTB) by Dataplex, such as Swansea, Shrewsbury and Colwyn Bay, already exist for when Prestel's traffic increases and the service expands.

Planning for the Cardiff computers started in 1978. An area of 275 m² was earmarked in Stadium House, a 15 storey tower block extension to Cardiff auto-manual centre/group switching centre (AMC/GSC). Ultimately the AMC/GSC will house a digital main network switching centre, a digital local exchange and a TXE4 local exchange unit. In addition, an adjacent area of 116 m² was earmarked for the regional Prestel centre (RPC) to house Prestel's engineering, marketing, finance and operational staff. Contracts were let for the raised flooring, false ceiling, and air-handling units essential to a computer installation.

The names chosen for the 2 computers were DYLAN and MEGAN; names, or other identities, are necessary so that customers can easily ascertain for billing and other operational reasons which computer has been accessed. DYLAN was allocated to Cardiff 389111 and MEGAN to 380111. Rather than switch 100 or so erlangs through several stages, the computers were trunked off levels 389 and 380 in Cardiff (Strowger) main exchange to modems in the IRC via interface relay-sets. The interface relay-sets provide supervisory (ringing, transmission bridge, etc.) conditions, and absorb up to 2 digits. In addition, the relay-set responds to 33 k Ω loop backward-busy signals from the Control Unit No. 30A associated with each Modem No. 20 (backward-busy being required to remove a faulty modem or computer-port from service). The use of digit absorbing relay-sets in this way allows the access to be transparent to any future changes such as TXE4/TXD modernization.

Installation of 250 modems in 22 control racks in Stadium House and the associated relay-sets in Cardiff main exchange commenced in late 1979. Racks were also installed to house the viewdata access monitor and priority incident reporting equipment (VAMPIRE) and the responsive automatic dial-out line equipment (RADLE). In addition, one rack containing modems for the registration visual display units, RPC answering machines and other miscellaneous equipment was specially constructed for use by RPC operational staff. The 2 computers were delivered in late July, and the Bristol Dataplex equipment at the beginning of September. Computer disc storage is six 70 Mbyte drives per computer: 2 are for administrative use and system control; the remaining 4 contain the database of 250 000 frames. Plans exist to enhance this initially to 375 000 frames by installation of a further 2 disc drives; the Cardiff installation has been equipped with a total of 8 drives per computer in readiness for this enhancement. After installation, the modems and control units, including an essential modification for interworking to VAMPIRE, and the interface relay-sets were tested by Cardiff area engineering staff; the computers were acceptance tested by Telecommunications Headquarters (THQ) systems evaluation staff and computer operations staff from Prestel headquarters. This was followed by an overall end-to-end test by RPC operational staff.

Dataplex is the preferred method for serving remote sites but, owing to equipment shortage, an early decision was taken

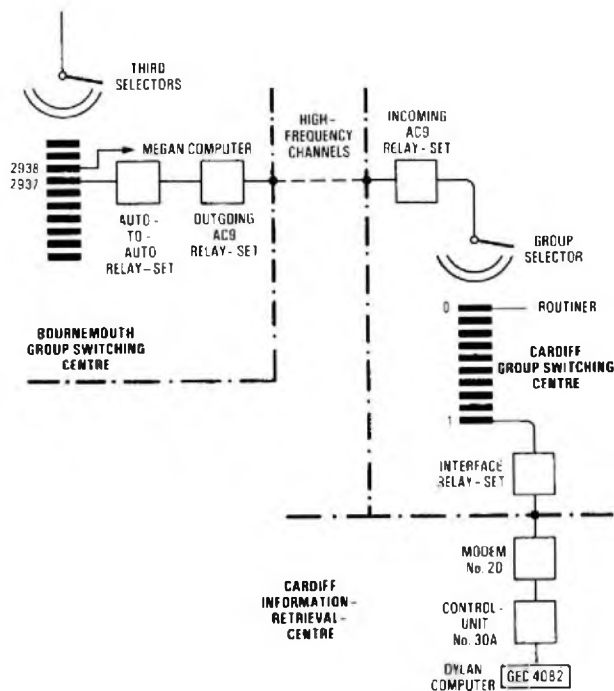

Fig. 1—Access from Bournemouth to Cardiff information retrieval centre

to serve Bournemouth, exceptionally, by discrete high frequency (HF) traffic circuits from Cardiff. During computer outages, backward busying conditions are automatically applied, and this posed a problem of overloading the HF group repeater equipment with high levels of 2280 Hz AC9 supervisory tone. Various possibilities were considered to overcome the difficulty. The solution adopted was to interpose a rank of group selectors at the Cardiff end, and re-strap the interface relay-sets to absorb only 1 digit (see Fig. 1). Backward busying then busies only the local Cardiff group selector outlets. An additional advantage of this is that routiner access to monitor the serviceability of the route becomes possible.

An eleventh-hour delay arose from problems at the central Prestel update-centre computer (UDC) with the software needed to allow the UDC to keep the database updated at a total of 16 satellite computers (5 provincial IRC's with 2 computers and the 6 computers comprising the London IRC). However, by rapidly rewriting the software and switching the UDC function to another computer with an enlarged core store, these problems were overcome. When the Cardiff IRC opened, it initially served Cardiff, Bristol and Bournemouth with only DYLAN computer; the first public customer was registered onto the system on 3 October 1980.

In conclusion, the writers would like to acknowledge the efforts of those in the Cardiff Telephone Area, WMTB Headquarters, THQ and Prestel headquarters who helped to bring Prestel to Wales.

British Telecom Research Laboratories on Show

UDC 621.3.007

British Telecom Research Laboratories, the research centre of the British Post Office (BPO), revived an old Dollis Hill tradition, where open days were held every three years from 1933-1966 (except during the war years), when the first open day at Martlesham was held in September 1980. Some 1500 guests visited the centre; the visitors included representatives of the press and broadcast authorities, government, industry, universities, public corporations, customers and senior BPO staff. There were 20 major exhibits, which covered a representative cross-section of the work in hand at Martlesham.

This Journal has published an article† that briefly described the role and function of the BPO Research Centre. This present article expands that previous coverage by providing a fuller description of the work being undertaken at the Telecom Research Laboratories, including brief reports on 4 particular aspects of work; namely, optical-fibre submarine cable systems, slow-scan television, an automatic voice-response announcement system and electronic telephones.

Because the information given in this article was contributed by many authors who, in turn, have reported on the work done by other colleagues, no author credits are given.



The reception marquee at Martlesham

INTRODUCTION

The Telecom Research Laboratories of the British Post Office (BPO) are widely recognized as one of the world's leading telecommunications research establishments. Their role is to reinforce the vast high-technology enterprise of the BPO and to provide support for UK Industry in the quest for exportable products.

A previous article† has described the basic functions of research in the BPO, the scale of effort employed and the management of projects. These matters are reviewed briefly to set the scene for description of the work performed at Martlesham.

The activity of BPO research is strictly purposeful and commercially oriented. The prime objective is better service at lower cost to customers. The range of activity extends from basic research to demonstrating the practical feasibility of new systems and services.

The competence, professionalism and dedication of its staff is the greatest asset of the BPO's research activity. In terms of staff, the BPO employs one professional research engineer for each £4.5 M of income. The annual budget for research is about 0.66 per cent of the BPO's total income.

Telecommunications is a world-wide activity, and the BPO research staff play a large part in the work of committees that function under the aegis of the International Telecommunication Union.

The need for research into unexplored territory in search of

solutions to practical problems and the seeking of knowledge to allow effective exploitation of new phenomena must, in some measure, remove research activity from the more transient constraints of the market place. Nevertheless, the research programme is continually reviewed and remoulded to keep in step with the needs of an active, growing and evolving business.

RESEARCH WORK AT MARTLESHAM

The scope of work at Martlesham is wide, and involves many disciplines. Most of it falls into two broad categories. First there is applied research, covering new materials and their application to devices such as transistors, lasers and micro-technology. Techniques have to be developed for producing the devices, and laboratories with special environmental conditions, such as a dust-free atmosphere at controlled temperature and humidity, are needed for this exacting work.

The second category covers communications system research and advanced development. This explores new methods of transmission, faster and more efficient switching and signalling techniques for the next generation of telephone exchanges, and new ideas for telephone services.

Work in these two broad categories is mutually interactive. For example, systems research engineers may foresee the need for a new device likely to be required in the network some time ahead. The appropriate Divisions in Research Department then initiate the necessary research and co-ordinate progress to achieve the target.

A good illustration of this co-operation is in the field of integrated circuit design and fabrication. Planar technology now makes it possible to construct many thousand individual transistors by combining them in a tiny chip of silicon. The Technology Divisions' capability in integrated circuits is exploited by Transmission and Switching Divisions. Work done in this field at Martlesham is having a major impact on concepts of system design.

The research work of the BPO is described in many articles in the technical press, and results are published as papers in learned journals and at international conferences. About 100 Research Department Reports are printed and published at Martlesham each year for distribution within the BPO, Government departments and other organizations.

Most investigations must be customer oriented and are undertaken only if a clear economic advantage is likely to result. The aims are better services and a wider range of

† AYERS, E. W. Research at Martlesham. *POEEJ*, Vol. 71, p. 44, Apr. 1978

facilities available to customers. Thus much of the research and development effort is aimed at providing the ability to build a future telecommunications system that uses computer-controlled digital switching exchanges served by a digital transmission network: this system is being developed jointly with British industry under the title *System X*.

System X will be more reliable and cheaper to maintain. It will provide a wider range of facilities to customers, enabling them, for example, to bar all incoming or outgoing calls, divert calls to another telephone, transfer calls, or hold three-way conversations. These and many other options would be initiated by the customer directly, using his own telephone. Among the items which Research Department is contributing to System X are automatic voice-guidance systems and software support facilities for the wide range of control programs which are needed. A special computer language has been developed for these programs.

A new building houses special test facilities for evaluating new exchange designs.

To provide experience of some of the problems likely to arise with computer-controlled exchanges, an experimental exchange, named *Pathfinder*, has been designed and built, and is providing full service to about 140 Research Department staff. Although very small, the exchange has been designed so that up to 2000 customers could be connected. It provides the standard facilities offered by present-day exchanges and offers advanced facilities by drawing upon the support of larger processors at a higher level in the network.

One of the design objectives of *Pathfinder* was to offer the advantages of stored-program-control at low cost and at the high reliability required for public service. *Pathfinder* is now allowing early experience to be gained of some of the problems which will arise from commissioning and operating these new types of telephone exchange.

Another switching project is the development of a new small PABX, in which stored-program-control and digital switching techniques have been combined to produce a very versatile and economic unit. This PABX, named *Monarch 120*, is being developed in collaboration with industry to BPO designs and will provide service for up to 120 extension telephones. Although a separate development, it is of course fully compatible with System X as well as with all existing exchanges. Production units are now in public service.

The penetration of large-scale integrated circuits, such as microprocessors and semiconductor memories, into telephone exchanges and other equipment has created new reliability assurance problems, demanding the use of powerful computer-driven test equipment for characterization and test-program generation. At the same time, life-tests, encapsulation and materials studies, and the failure analysis of many other types of integrated circuit, including hybrids, are needed in order to protect the network from high failure rates both in the short and long-term. Close collaboration is maintained with both the component and equipment-supplying industries.

The optical communications project is concerned with the study and development of optical-fibre transmission systems, in which hundreds of telephone conversations are carried as beams of light through strands of special glass no thicker than a human hair. The work ranges from fundamental studies of materials properties for optical detectors, lasers and low-loss fibres to the assembly and demonstration of working systems. In 1977, two such systems were demonstrated; the systems are routed from Martlesham to Kesgrave and Ipswich, and carry 120 and 1920 telephone circuits respectively. The experience gained by work on these systems led to orders for the first

production systems, which are now entering service.

At present, work is aimed at very high performance, high-capacity systems operating at several hundred megabits per second for intercity or undersea use, and at very simple yet effective systems for applications as diverse as Confravision, Business Systems and Cable TV.

Prestel, a BPO invention, is a computer-based information retrieval system, using the telephone in conjunction with a modified domestic TV set, which is both economical and capable of general use. Prestel is interactive, so that users may respond to the information supplied by the computer or enter their own data. Hence, the system lends itself to communication between the deaf, education in the home and a host of other applications; for example, ordering goods and services from the home or office. Public service was first made available in London in March 1979 and a full public service commenced in September 1979, the first of its kind in the world.

Research into future generations of Prestel has continued at Martlesham and has led to the announcement in March 1980 of 'Picture Prestel'. This development enables a colour picture to be reproduced on a Prestel page: the service is seen as having long-term commercial importance in areas such as mail ordering.

The BPO has been actively involved for many years in the development of satellite communications and submarine cable systems. Some satellite work continues at Martlesham, where a fully steerable 6 m diameter aerial is available. For many years the BPO has co-operated very closely with industry on the development of submarine cable systems and work is now in hand on the design of high bit rate optical-fibre submarine systems for use in the late-1980s. The BPO also operates a fleet of cable ships to maintain its extensive submarine cable network, and specialized marine equipment has been developed to speed up and make safer the cable repair operations.

Problems are bound to arise when customers need to interact with a complicated telecommunications system, whether the customer is a user of a simple domestic telephone or is involved with a business system incorporating visual displays and complex keyboards. Investigations into these problems are often described as *human factors* research and can embrace equipment design, environmental conditions, workspace design, procedures and instructions. The staff engaged on such research must have a knowledge of the ergonomic, psychological and physiological limitations of human beings, together with an understanding of the electrical and mechanical characteristics of both old and new telecommunications equipment. An important area of human factors research is in evaluating various aids which might help to meet the special telecommunications needs of handicapped people.

In common with many other administrations, the BPO is progressively introducing new ranges of telephone sets. In the research and development laboratories, more advanced designs are evolving which make increasing use of silicon integrated-circuit technology. Some of these incorporate a microprocessor to provide facilities and services which would previously have been judged uneconomic or impracticable. Future designs, perhaps making use of visual displays and increased-artificial intelligence, could provide advanced features that will make the present day telephone appear as rudimentary as an adding machine is to a modern computer.

As examples of the activities of the Telecom Research Laboratories, a brief description of 4 particular aspects of work at present in hand are given.

OPTICAL-FIBRE SUBMARINE CABLE SYSTEMS

INTRODUCTION

Vast potential bandwidth coupled with small size make optical fibre cables an attractive proposition for the future international communications network. Comparative cost studies show that long-wavelength optical-fibre submarine cable systems should be significantly cheaper than equivalent analogue systems employing conventional submarine cables. Considerable effort is therefore being directed, both in the UK and abroad, to the development of optical-fibre submarine cable systems for service in the 1980s and beyond.

SYSTEM CONSIDERATIONS

At present, two possible windows in the optical-fibre spectrum exist for submarine system applications. These are located at $1.3 \mu\text{m}$ and $1.55 \mu\text{m}$, where low loss and low dispersion can be achieved, leading to potential repeater spacings in the order of 50–100 km, compared with just over 6 km for the 45 MHz coaxial cable system. A major advantage of the optical-fibre system is that a number of fibres can be incorporated into the cable and the equivalent number of regenerative repeaters provided in the repeater housing, thereby enabling a range of system capacities to be achieved using a single basic cable and repeater design.

The choice of data rate is dictated by market requirements and available technology. Consideration must also be given to the established CCITT digital hierarchy which specifies 140 Mbit/s at the fourth order. Current development is based on the early realization of a 280 Mbit/s system; that is, 2×140 Mbit/s.

In addition to the transmission of required traffic information, further capacity must be provided for such purposes as timing recovery, error detection, system supervision, telemetering and provision of engineering speaker circuits. This is achieved by the use of redundancy in the line code and, for optical-fibre submarine cable systems, a 7B8B code has been selected, leading to a system signalling rate of 325 Mbauds.

REPEATER TECHNOLOGY

A PIN-FET detector is being used as the optical receiver in preference to an avalanche photo-diode. Current development work for long-wave operation is based on the use of GaInAs and GaInAsP diodes on GaAs or InP substrates coupled with a GaAs MESFET in a hybrid package.

For the optical transmitter, development centres on stripe-geometry heterostructure lasers using GaInAsP/InP materials systems. It is hoped that development of narrow-stripe lasers will lead to the availability of long-wavelength low-threshold sources.

The transition from conventional analogue to digital optical-fibre systems entails an increase in the number of active components by at least an order of magnitude. To provide this degree of complexity, and to achieve the necessary effective bandwidth and long-term reliability, an integrated-circuit approach has been adopted for the non-optical portions of the repeater. High reliability is further ensured by using the BPO silicon bi-polar technology, which has a long established history of reliability in conventional submarine systems.

OPTICAL-FIBRE SUBMARINE CABLE

The optical-fibre submarine cable is required to house up to 12 separate fibres that must operate for many years without significant change in their transmission characteristics in the extremely harsh environment offered by the ocean depths. The optical-fibre cable must also be capable of being buried to

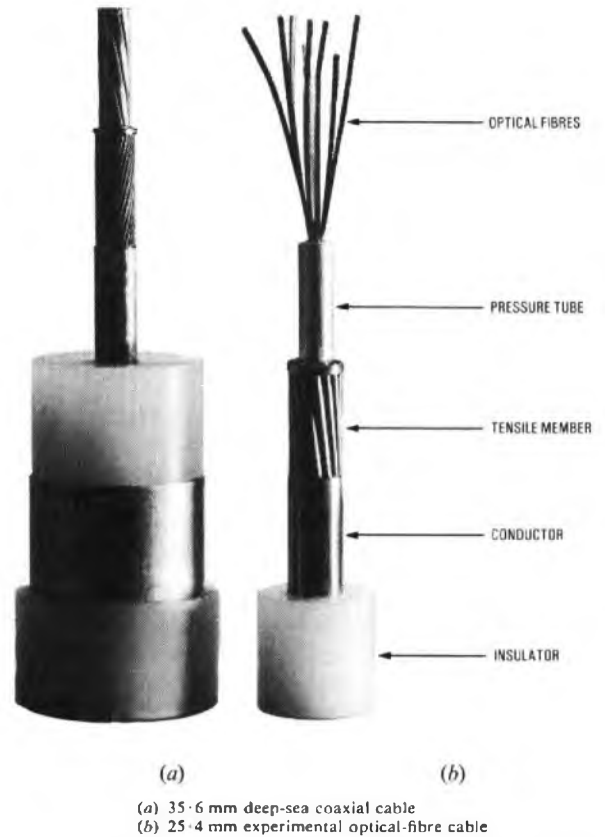

Comparison of coaxial and optical-fibre submarine cables

provide protection against anchors and fishing trawls, but must also be capable of recovery for repair purposes. In addition to the optical path, a metallic conductor must be provided to feed power to the repeaters.

The necessary isolation of the fibres from sea-bottom pressures is achieved by housing them loosely in a pressure-resistant metallic tube. Tensile strength is obtained by overlaying steel strands, and the composite metallic structure also provides the necessary power-feed path. Electrical insulation is by means of an overall polyethylene extrusion. For shallow-water applications, additional mechanical protection is provided by steel armouring wires.

The optical-fibre submarine cable has been developed by STC Ltd. Full mechanical, environmental and optical evaluation of the cable properties is now in hand using the specialized test facilities at the Martlesham site.

INSTALLATION AND MAINTENANCE OF OPTICAL-FIBRE SUBMARINE CABLES

Extensive development is in hand to ensure that the necessary shipboard equipment is available for laying, burying and recovering the optical-fibre submarine cables of the future.

Many new and difficult problems need to be resolved to ensure the satisfactory jointing of optical-fibre cables, particularly under the adverse environmental conditions imposed by a cable ship operating in rough weather conditions. Major problems also remain to be solved in locating system faults, both from the terminal stations and from the cable ship once a cable has been recovered. In the cases where cables are buried, good accuracy of location is imperative if repairs are to be made quickly and economically.

THE FUTURE

Although many problems remain to be solved, there is little doubt that optical-fibre submarine cable systems offer the potential for almost unlimited bandwidths for international

communications at extremely competitive rates. A promising portent for the future has been the successful demonstration of a trial system developed by STC Ltd and installed by the BPO Cable Ship *Iris* in Loch Fyne.

THE INTELLIGENT TELEPHONE

In recent years, the BPO Research Department, along with other telecommunications organizations, has been examining the design of new electronic telephones, which it is hoped will begin to replace existing designs during the early-1980s. These will eventually appear to the customer as push-button tone-caller instruments; the customer will not be aware that the functions inside the telephone instrument are performed by electronic circuits.

The advantages of electronic telephones to the customer lie mainly in the areas of styling, the potential for extra facilities and improved quality of performance (although the latter is so heavily dependent on the performance of the telephone network that its impact is likely to be small). The telecommunications administration, however, benefits from: the higher reliability of the new telephones which, despite a slightly higher purchase cost, yield a lower in-service cost; a new flexibility in design, which can be turned to a market advantage; and from the enormous potential for further development that is inherent in the use of integrated circuits.

At the present time, there are, worldwide, two mainstreams of development in electronic telephones. The first uses three integrated circuits to handle separately the speech transmission, signalling and tone-calling functions. The other approach combines all three functions on a single circuit. At first sight, the latter approach seems more elegant and cost effective, yet it has still seemed worthwhile investigating the evolutionary potential of the 3-chip approach because the means to achieve the objectives are available here and now. The public is becoming used to electronic equipment of steadily increasing power and complexity for the same price; if the telephone is to live up to the expectations of customers in the 1980s, it must follow this trend and perform more than the basic functions. A first step is to provide more customer facilities, either by giving the customer access to an intelligent processor-controlled exchange, such as a System X exchange, or by

providing the telephone with its own intelligence or, in some cases, by doing both. Intelligence in the telephone is now quite feasible thanks to the cheap, single-chip microprocessor. Telephones are already being manufactured which contain microprocessors, but to date, most, if not all, have had the microprocessor added to the basic telephone to provide, for example, a large telephone-number memory. Although the method of adding the microprocessor has sometimes been very elegant, such telephones have, understandably, sought to make the best possible use of the powerful yet relatively costly microprocessor and this approach has resulted in fairly expensive facility models. But, as the cost of microprocessors is reduced, will they be associated only with expensive facility telephones, or should they become an integral part of the basic telephone? Recent work in the BPO has been trying to answer these questions.

Push button telephones, which produce 10 impulses/s loop-disconnect signalling and have a tone caller, are natural subjects for microprocessor operation. The microprocessor responds to depressions of the push buttons and controls the sending of signalling digits to the exchange while, on calling, it generates different tones and tone sequences, as required. The necessary software uses only a modest proportion of the available program space in a small single-chip microprocessor. If the microprocessor is expensive, and if it also carries the overhead of a mains power unit, then even this modest use would be precluded by the cost. However, if its cost becomes comparable with that of the two integrated circuits which it replaces, and if by using low-power technology it can be



An experimental microprocessor telephone. (On this model, the sounds made by the tone-caller can be varied by pressing buttons on the keypad.)



Mr. George Jefferson, Chairman British Telecom, trying out an experimental telephone

powered from a telephone line, then the picture becomes quite different. During the course of the investigation carried out by the BPO it has been established that

(a) small microprocessors, which meet both the cost and power requirements, are already available,

(b) new devices are in immediate prospect which are even more attractive, and

(c) the use of a microprocessor to provide telephone signalling, calling and logic functions is quite feasible and can be achieved with program space to spare.

Some of the microprocessor-controlled telephones which were displayed utilized an n-channel metal-oxide semiconductor (NMOS) microcomputer with an ultra-violet erasable program memory which, because of its relatively high power consumption, was mains powered. No apology was needed for this situation as this is still the penalty which must be paid for ease of programming in experimental and prototype stages. That this is only a stepping-stone to a more satisfactory solution was, however, amply demonstrated by two telephones which, because they used low-power complementary metal-oxide semiconductor (CMOS) technology, were entirely powered via the connexion lines. The first of these instruments used a Texas Instruments TMS 1000C microcomputer to provide signalling in either 10 impulses/s loop-disconnect or MF4 modes, a 22-digit last-number re-dial store and a 16-digit notepad memory store, which could also be used as a single-number store.

The tone-caller waveforms were also generated by the microcomputer, and both volume and timbre were selectable by means of appropriate push buttons. The TMS 1000C is a CMOS version of the TMS 1000 and the example used was the result of a co-operative development between the BPO and Texas Instruments. It is an example of how modest enhancements may be introduced to a telephone for minimal additional cost.

The second example used an ITT SAA 6002 microcomputer which provided, in addition to 10 impulses/s dialling, ten 16-digit number stores, last number re-dial and single-button

access to 4 emergency or commonly-used numbers. An 8-digit liquid-crystal display was driven directly by the micro-computer and displayed both stored and dialled numbers. The display also provided time-of-day and stopwatch functions and could be used to display cost information, although, for technical reasons, this was not demonstrated. This latter instrument was clearly in the de-luxe bracket and would cost more to manufacture than the first example, but the technology to make it is available now.

Whether future telephones will incorporate mask-programmed microcomputers or dedicated integrated circuits that perform similar functions is still an open question. But there can be little doubt that during the 1980s telephones will become available, at low cost, that incorporate significant processing power.

When viewing the two models described above, it is easy to be attracted by the extra facilities offered by the second version and to forget that it is the simple version that is most immediately important. There is a market for advanced-facility telephones but, at the present time, it is small when compared with the requirement for cheap, basic telephones that can offer many options to a telecommunications administration. Some examples that illustrate the potential are:

(a) a telephone that recognises whether it is connected to an exchange equipped to receive loop-disconnect or MF4 signalling and responds appropriately,

(b) a telephone that provides single-button access to the facilities offered by exchanges such as System X, and

(c) a telephone that will test itself on command from the telephone exchange.

There are many other possibilities; most leave sufficient processing power to provide some extra facilities for the customer at little or no extra cost to the administration.

It is not yet clear which of these ideas will be taken into development, but it seems likely that the microprocessor, which is intruding into so many places, may become an integral part of even the basic telephone within the next few years.

AUTOMATIC VOICE-RESPONSE FROM TELEPHONE EXCHANGES: VOICEDATA

INTRODUCTION

The automatic announcement subsystem (AAS) developed for System X provides spoken responses to assist subscribers to use the exchange facilities. It represents a revolutionary improvement over the tones traditionally used to advise subscribers of the progress of their calls. This, however, is only the beginning of a whole new range of telephone services that exploit the capabilities of automatic voice-response from telephone exchanges. The term *voicedata* has been coined to describe the new facility. Two *voicedata* services now being developed are voice-store-and-forward (VSF) services and an interactive recorded-information service (IRIS).

INTERACTIVE RECORDED-INFORMATION SERVICES

Information services are already available from the telephone. The most popular of these, the speaking clock, received 431 million calls during 1979. Techniques developed for the AAS make it feasible to offer a far wider range of spoken information and to enable subscribers to specify the precise item of

information required by using their telephone dial or keypad; for example, a user could dial his required departure time when using a train timetable service. Studies at the Research Centre are devoted to designing equipment and investigating the implementation of such services. The equipment encodes the speech waveform using delta modulation or adaptive differential pulse-code modulation at 32 kbit/s, stores it in solid state or magnetic disc memory, and retrieves it in response to subscribers' signals.

For second-generation equipment, speech synthesis techniques are being investigated which offer a reduced data rate of 4 kbit/s and, hence, reduced storage cost. Speech quality is lower than that achieved by digital recording, but there is no objective measure to indicate the level of quality that is acceptable for a given application. The thrust of this work, therefore, is to improve overall speech fidelity and, in parallel, to sponsor studies of those characteristics that contribute to perceived speech quality. Other research work being sponsored aims to develop algorithms that synthesise speech directly from text, so that announcements can be created simply by typing in the required wording.

VOICE-STORE-AND-FORWARD SERVICES

System X offers many useful supplementary services such as code calling, reminder calls and call diversion. A very useful addition to this range might be voice store-and-forward services, which enable a caller to record a spoken message for later delivery. The simplest of these services would allow a caller to record a message when the called number is engaged or if there was no reply. Measurements indicate that 28 per cent of all calls suffer this fate, so this alone would be an extremely valuable service. However, if equipment to store voice messages is available, other new and useful services may be provided. For example, a *voicegram* service that records a subscriber's message and passes it on to a specified telephone number at a specified time—a kind of electronic mail that requires no special terminals, just the ordinary telephone. Voice-store-and-forward services must be offered as an

integrated part of the telephone service and, to this end, equipment is being developed to allow the technical and human factors to be assessed. A voice-storage subsystem using computer magnetic-disc stores will provide the basic capability to store messages. Application programs then have to be developed to provide the various facilities for recording messages, scanning through a message list, deleting and saving messages. Interaction with other supplementary services must be considered.

CONCLUSION

The automatic announcement subsystem gives the telephone exchange a voice. It heralds a number of new services that use voice guidance and voice messages to make the telephone more useable and more useful.

SLOW-SCAN TELEVISION

In the constant search for new ways of using the huge asset represented by the thousands of kilometres of buried cable, the BPO Research Department has developed a slow-scan television system, by means of which television pictures can be transmitted over normal telephone lines. Such a system is ideally suited to situations in which it is sufficient to send either a single still picture or a sequence of frozen pictures every few seconds or minutes.

A block diagram of the equipment is shown in Fig. 1. A single image from the camera is captured in differential pulse-code modulation (DPCM) digital form in a picture store at the transmitter; a data link (usually an ordinary telephone circuit with data modems at each end) is used to transfer the digital picture information to an identical store at the receiving terminal, where it is decoded and displayed on a television screen. The length of time taken to transmit the picture depends on two factors:

- the number of elements in the picture (that is, its resolution), and
- the operating digit rate of the data link in kilobits/second.

The system which was exhibited had a store of 290×256 elements and used 4 bits for each element. The corresponding transmission times for different data-link digit rates are shown in Table 1.

Studies are continuing into methods of extending the basic idea. Fig. 2 shows a block diagram of some of these extensions.

Movement detection can be accomplished by means of an extra circuit which detects any significant change in a designated area of the picture. Such a facility is particularly useful in situations where closed-circuit television is being

TABLE 1
Transmission Times and Types of Circuits

Data Rate (kbit/s)	Transmission Time (s)	Type of Circuit	Modem Cost
2.4	120	Dial-up	Low
4.8	60	Dial-up or private circuit	Medium
9.6	30	Private circuit (equalized)	High
48	5	Local/junction private circuit	Low/medium
64	4	System X speech path	Low

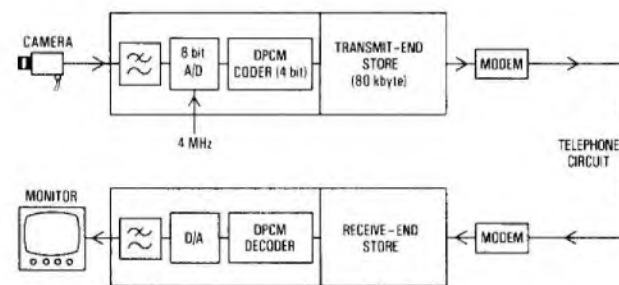

DPCM: Differential pulse-code modulation
A/D: Analogue to digital D/A: Digital to analogue

FIG. 1—Basic slow-scan television system

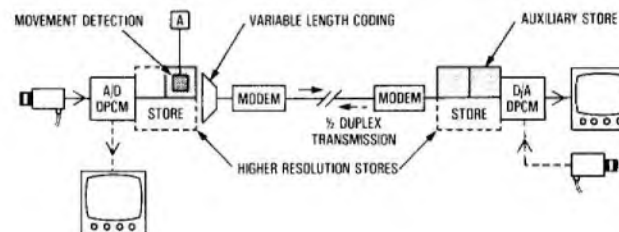

DPCM: Differential pulse-code modulation
A/D: Analogue to digital D/A: Digital to analogue

FIG. 2—Future development of slow-scan television

used for surveillance. When a movement is detected, the picture freezes and an alarm is triggered.

Transmission times can be reduced by up to 50 per cent by the use of variable-length coding. The 4 bit DPCM word is statistically coded. This simple modification is particularly advantageous for textual matter.

By using an auxiliary store, the change-over in pictures, instead of being gradual as new information arrives in the store, can be made when the picture is complete. Alternatively, the picture may be changed at the operator's instigation.

To approach the resolving capability of the camera and monitor, a picture of at least 512×512 elements is needed. A system is being developed to do this at the expense of longer transmission times.

A switched transceiver, for two-way communication is also being developed.

The Hollow Pole

D. CLARK, DIP.E.E., C.ENG., M.I.E.E.†

UDC 621.315.66

New designs of telephone poles are being introduced into the British Post Office local distribution network to connect dropwires to customers' premises. The poles are hollow and all construction work is carried out at ground level; access to the top of the pole is gained by the use of special purpose tools. The design concept greatly enhances the safety of staff because they do not have to climb the poles, and reliability of an installation is improved because the material used for the construction is more durable than wood, the traditional material used for poles.

INTRODUCTION

The British Post Office (BPO), in common with many other telephone administrations throughout the world, uses a large number of wooden poles to support overhead cables and dropwires. The practice of using wooden poles is long established and dates from the very beginning of the provision of the telegraph service. During the last 100 years or so there have been many changes in the scale and type of communication services, but the use of the wooden pole has not altered dramatically as a consequence. Furthermore, those changes which have occurred in overhead construction (for example, open-wire routes have given way to insulated multipair aerial cables) have had only a minor impact on the use of wooden poles; the main changes have been the use of smaller poles and redesigned pole fittings.

Provided that care is taken over the choice of species of timber and its preservation, wood is a very durable substance which has good strength characteristics. The average life of a wooden pole in the BPO telephone network is 44 years, but there are poles which have been in service for over 80 years. It might therefore seem strange at first sight to want to find an alternative to a well used and proven product.

The BPO has sought for many years to find an alternative to the use of wood for telephone poles; the motivation has been

- (a) to reduce dependence on imported products,
- (b) to overcome the difficulty of obtaining timber of the required quality,
- (c) to achieve a reduction in the weight of telephone poles, and
- (d) to develop easier and safer methods of installation.

A glass pole was patented by a German inventor at the turn of the century, but this idea failed due to manufacturing difficulties and the inherent brittleness of the material.

Cast iron poles were used around 1920 but, owing to a spectacular failure of a route, were withdrawn. In the late 1940s, the BPO installed some 50 000 sheet-steel poles, made in the form of truncated cones that fitted one inside the other. Although some of these poles exist today they were generally less durable than wood, more expensive, difficult to test and suffered from unsightly rust streaks resulting from attachments on the pole. Until recently, no material has really challenged wood, although some countries do use sheet-steel poles as a direct replacement, and in a conventional manner.

HOLLOW POLE CONCEPT

In 1972, the BPO's Experimental Changes of Practice Committee No. 1 expressed concern over the number of staff injured as a result of accidents involving telephone poles, and

asked if safer methods of using poles could be devised. As a result of this request, the whole of the BPO's works practices surrounding the use of poles was examined and, from this study, it was concluded that safety could only be improved if climbing was reduced or eliminated. It was also concluded that if the pole did not have to be climbed, the importance of routine pole testing would be much reduced. (As well as the need to test a pole every time it is climbed, the BPO carry out routine testing on all their wooden poles once every 6 years.) Therefore, a reduction in pole-climbing activity offered the prospect of a safer working environment and a saving in costs. From these conclusions, the hollow pole concept was derived. A view of a hollow pole is shown in Fig. 1.

In the BPO external cable network, only a small percentage of cables are carried overhead. However, the final connexion to the customer is an overhead cable (known as a *dropwire*) in about 60% of all cases. It was in this area that the study was



FIG. 1—The hollow pole

† Transmission Department, Telecommunications Headquarters

concentrated; the object was to eliminate pole climbing when making the final connexion, thus creating a significant improvement in safety.

The point in the external network where the final connexion to the customer is made is called the *distribution point* (DP). A DP may be sited underground or overhead. An overhead DP usually consists of a wooden pole fed by an underground cable which is terminated at the top of the pole. A dropwire is run from the termination via a ring at the pole top (to anchor the tensioning clamp) to a customer's premises, where the dropwire is anchored to an external bracket (via another tensioning clamp) and then led into the premises, where it is terminated.

The hollow pole system eliminates all work at the top of the pole; the underground cable is led into the pole below ground level and brought up the inside of the pole and terminated 1.5 m above ground level. Dropwires enter the top of the pole and are run down the inside to be anchored to a special ring and terminated to the feed cable (see Figs. 2 and 3).



FIG. 2—Dropwire entering pole top

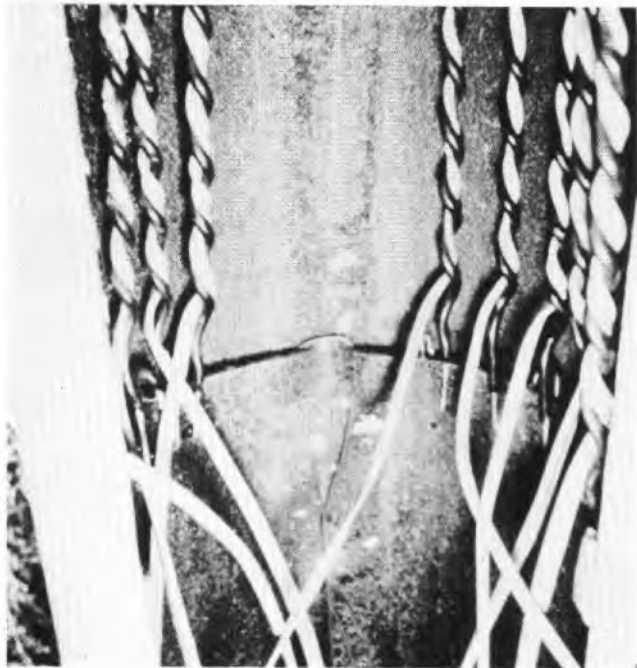

FIG. 3—Dropwire anchored to C-ring

DESIGN AND CONSTRUCTION OF THE HOLLOW POLE

In determining the design and the choice of materials for the hollow pole the following were considered to be essential requirements:

- (a) the pole had to support a working load of 1.4 kN applied 600 mm from the top of the pole in one direction,
- (b) the strength safety-factor had to be at least 2.5 : 1,
- (c) the overall length of the pole was to be 8.5 m,
- (d) the weight of the pole was not to exceed 75 kg,
- (e) the door opening was to be 2.6 m from the pole butt to the base of the door, thus giving a convenient working height when the pole was in position,
- (f) the inside and outside surfaces of the pole had to be smooth and free from sharp edges, and
- (g) any temporary deflection, with a load of 455 N applied 100 mm from the top of the pole, was not to exceed 180 mm.

The initial cost of a wooden pole is very low, and it is inconceivable that any fabricated pole could compete on a first-cost basis. However, the problems associated with the wooden pole system over the average life of a DP installation are such as to permit the use of other pole materials if there is a distinct advantage over the conventional pole on a whole-life costing basis. Only two basic materials meet the specification and cost requirements: glass-reinforced plastic (GRP) and mild steel; for the latter, protection against the effects of corrosion is necessary. In neither the GRP nor the steel situations was it easy to achieve the appropriate balance between cost and performance.

Using GRP, effective utilization of the expensive glass-fibre reinforcing material is critical and there has been, and still is, scope for individual manufacturers to develop new glass lay-up formations and pole production techniques. It is therefore likely that future costs will be reduced.

In the use of steel, the anti-corrosion system is the principle determinate of cost, and a balance has to be reached between first cost and pole life. Although the safety aspect of a pole which does not have to be climbed is marginal, a rusty pole would be unsightly.

A not insignificant aspect of this new development is that it is anticipated that the hollow pole system will be more acceptable aesthetically, especially in modern housing estates. In such situations, the pole shape is likely to match that of modern lighting columns; the availability of 3 different shapes of hollow pole will facilitate the matching of such installations. The pole-head assembly of the hollow pole is a neat arrangement when compared with the often untidy construction detail which can result from the use of a conventional wooden DP pole.

At present, only one shape of hollow pole constructed in GRP has proved successful; this pole has a circular cross-section and is tapered continuously throughout its length. However, hollow poles constructed from steel are available in two shapes:

- (a) octagonal cross-section (the pole is tapered continuously throughout its length), and
- (b) circular cross-section (the pole is constructed from two parallel-sided sections of different diameter, the larger diameter section is used as the base of the pole).

All designs of hollow pole have 4 cable-entry holes, spaced at 90° intervals and 1 m from the butt, and a door whose base is 2.6 m from the butt. At a point 3 m from the pole butt, inside the pole, a stainless-steel C-ring is fitted. This ring is fitted horizontally and, apart from its attachment point, has a clearance of 6 mm from the inside wall of the pole. A mushroom-shaped cap (made of GRP) is fitted at the top of the pole to provide a smooth cable-entry point. A C-ring (with dropwire clamps fitted) and cap are shown in Fig. 4.



FIG. 4—Pole cap and C-ring

The methods of construction for the different types of pole are as follows:

(a) The octagonal-shaped steel pole is made in a large knife press, which forms each side longitudinally. On the last pressing, sufficient space is left for the knife to be removed; the gap is then closed and welded together.

(b) The tubular-shape steel pole is made from two different size tubes which are jointed by bellng out the end of the smaller tube into a cone shape and then reducing the end of the larger tube over the cone; the joint is then welded to improve appearance.

(c) The GRP pole is made by laying glass fibres onto a mandrel, which is then placed inside a mould and spun. When the speed is sufficiently high, the fibres are thrown onto the inside of the mould and the mandrel removed. Resin and hardner are then introduced and the mould is heated and allowed to cure while still rotating.

The GRP pole is protected by a layer of resin, applied at the time of manufacture; no other treatment is necessary.

Protection of the steel poles is carried out in one of two ways:

(a) a pole is galvanised inside and out and a bitumastic paint is then added inside and out at the butt end for a length of 2 m, or

(b) aluminium is sprayed on the outside and an epoxy paint is applied on the inside. As before, the butt end is treated with a bitumastic paint.

USE OF THE HOLLOW POLE

As stated previously, hollow poles are used only as overhead DPs. The provisions of a dropwire from a customer's premises to a hollow pole is now described.

A number of new tools and a set of standard duct rods are required for the rigging operation. A sash line, a rigging head, a weight and a pulley are shown in Fig. 5. The sash line has two small hooks fitted at each end; the weight is fitted with a spring clip; the pulley is of standard design, but is made of plastic (polycarbonate). The rigging head has a brass end, which can be screwed on to a duct rod, a fixed pulley and a joint between the two ends. The joint in the rigging head will only operate in one direction through 90°. The weight, sash line and rigging head are assembled as shown in Fig. 6. The fixed pulley allows the sash line to move freely under the action of the weight and, during rigging, the weight is held close to the pulley. The whole rigging-head assembly is connected to a duct rod and then pushed through the door opening (the sash line is held to prevent the weight moving away from the pulley). As each rod end is reached, another rod is added until the rigging head and weight emerge from the pole cap (see Fig. 7). The rods can now be rotated to align the weight in the correct direction. By paying-out the sash line, the weight will fall to the ground,

where it is removed. By holding both ends of the sash line, the rods can be withdrawn and, once the rigging head is free from the door opening, can be detached from the sash line. A bracket and pulley are attached to the customer's premises; a draw rope is threaded through the pulley. This draw rope is used to tow dropwire from a dispenser through the pulley and over to the pole. After ensuring that there is enough slack in the draw rope, a dropwire clamp is attached at the bracket at the house. By using the sash line, the dropwire can be pulled over the pole cap into the pole. When it is safe to do so, the dropwire is tensioned by hand against the house bracket and clamp.



FIG. 5—Special tools



FIG. 6—Rigging assembly

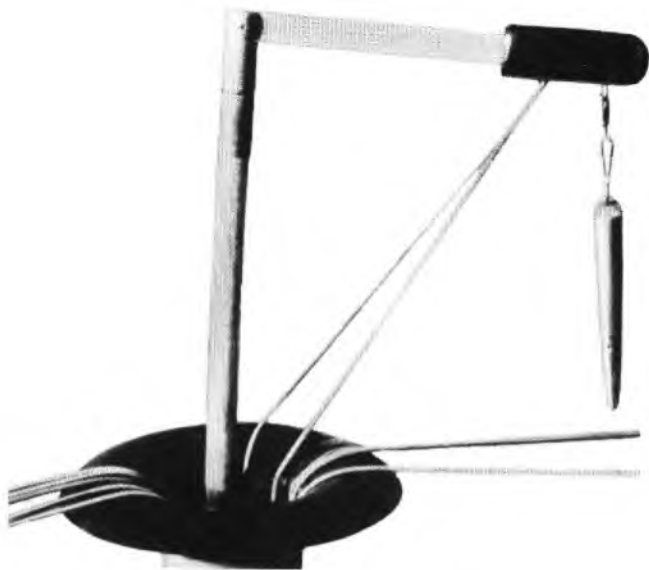

FIG. 7—Rigging assembly emerging from pole top

The special clamp (Clamp Dropwire No. 6, shown in Fig. 4) is attached to the wire and then fitted to the C-ring; the clamp

has been designed to include a self-locking action to prevent the clamp being released from the ring accidentally. The dropwire is then terminated onto the feed cable, and the whole termination assembly is placed back inside the pole. Termination at the customer's end follows normal practice.

CONCLUSIONS

This article has described briefly a new method for the overhead distribution of dropwires. The trials of the method have proved satisfactory, and experience is being gained of a potentially much safer system. Apart from greater safety, the hollow pole offers a more pleasing appearance, simpler working methods, an enclosed jointing point and a construction practice more in keeping with modern telecommunications. As a result of increased production of hollow poles there is the prospect that there will be economic benefit to be derived by the use of the design.

Although there is not the same need for using hollow poles in line-of-route situations, this aspect is being examined. Other possible uses of hollow poles are to house such plant as loading coils and pulse-code modulation regenerators or cable joints.

The BPO will use hollow poles constructed from GRP and steel, but it is expected that the production advantages of GRP will, in a few years time, result in the steel poles being phased out.

Post Office Press Notices

FOURTH TV NETWORK GETS A BOOST FROM BRITISH TELECOM

Vital links for Britain's new independent television channel—due to open in Autumn 1982—have been assured by a £7.5M equipment and cable order by British Telecom.

GEC is to supply all the associated long-haul microwave radio-relay links which distribute television signals. A contract has also been placed for £2.5M worth of coaxial cable to connect the links to network centres; Pirelli General in Southampton and Telephone Cables Ltd. of Dagenham will supply the cable.

The microwave links are part of a permanent national network operated by British Telecom and used by the BBC and IBA. The network connects the broadcasters' studios and control centres with the transmitters all over the country. It also serves the BBC and IBA when overseas television transmissions are fed into this country via Eurovision and international satellites.

Since the earliest days of television in the 1930s, there has been a close link between British Telecom and the broadcasters. As a result, British Telecom has provided a number of essential services unknown to most viewers. For instance, British Telecom performs the task of switching between local productions and networked programmes (such as News at Ten), so that viewers see uninterrupted programming. The efficiency and split-second timing of this switching means that the average viewer never even notices the switching operations, even though 40 000 are performed each year.

Another British Telecom service to broadcasters is the provision of facilities for outside broadcasts. A team of engineers ensure that TV signals are carried from the camera site to the nearest point in the television transmission network. This is done either by setting up cable links or, if microwave radio is used, by small portable dish aerials sited along the route.

FIRST MARITIME AERIAL AT GOONHILLY

British Telecom has placed a contract worth £2½M with Marconi Communication Systems Ltd. (MCSL) for the provision of a steerable dish aerial and for super-high-frequency radio equipment, as part of British Telecom's first maritime aerial system, which will be sited at Goonhilly Downs, Cornwall. Under the contract, MCSL will provide about half the equipment required for the new aerial system, and tenders are at present being sought for the telephone and Telex transmission and switching equipment needed to complete the system. The aerial itself—the smallest at Goonhilly—is to be constructed by Toronto Iron Works of Canada; it will have a diameter of 13.7 m.

Work started in October 1979 and is due to be finished by November 1981, in readiness for the aerial to come into service during the summer of 1982; its completion will herald the start of a new era in ship-to-shore communications. The new aerial will be used for access to the satellite system to be established by the International Maritime Satellite Organization (INMARSAT), in which Britain has an 11% share.

The first satellites in the INMARSAT series are due to be launched this year and, when complete, the system will give total maritime coverage. The satellites will provide a much better quality of service than the existing high-frequency systems, and bring quicker and more reliable communication.

The new Goonhilly aerial will be pointed towards the INMARSAT satellite over the Atlantic region. At present, only about 400 ships of the world's merchant fleet are equipped to make use of satellite communications. But, when enough satellite capacity is achieved by the mid-1980's, it is expected that more than 2000 ships will use the service.

System X: The Role of the Switching Systems Test Facility

A. THOMAS, M.Sc.†

UDC 621.395.345

Part of the development of System X exchanges has been the provision by the British Post Office of a test centre to provide facilities for the development testing of equipment and to give support to field operations. This article explains the role of the test centre, describes the facilities provided and gives examples of the work performed.

INTRODUCTION

System X is a family of new switching and associated systems that use micro-electronic technology, integrated digital switching and transmission, stored-program control (software) and common-channel signalling. Compared with other exchange designs, System X represents a radical new design, provides new customers' facilities, new administrative facilities, new working practices and improved performance. System X will be used in many situations; for example, as local, tandem, trunk and international exchanges, and for operator and administration centres. The new equipment must work with the wide variety of switching, transmission and signalling equipment in the existing network, and it must be possible for the administration to perform all the servicing, operational and management procedures necessary to operate the network efficiently. The switching systems test facility (SSTF) has been established to provide the facilities necessary for proving the correct working of System X, its correct interworking as a new network and its interaction with the existing network, for proving operational procedures and for providing field support.

By providing a single test centre, it has been economically viable to equip the centre with a comprehensive set of tools. An explanation of the role of the test facility and a description of the tools provided form the subject of this article.

THE FUNCTIONS OF THE SSTF

The prime purpose of the SSTF is to ease the transition of System X from development to operational use. The tasks of the SSTF therefore range from development testing, where the facility has a part to play in the design validation process, to providing assistance as required to the operational units. One of the tasks that embodies both these aspects is testing new issues of hardware and software before they are released to the field.

Design Validation Testing

Design validation is the procedure that has to be performed to ensure that equipment described in the full documentation set meets all the requirements and operates, as intended, in the environment for which it was designed. For a complex system, such as a System X switching system, design validation is a progressive process. Performing tests on models is part of this process and is itself progressive. In the early stages of development a great deal of useful information can be obtained with relatively unsophisticated facilities. One of the main requirements at this stage is the need for fast communication between the model and the development team. For the development of System X, this testing started on the subsystem feasibility

models (SSFMs), where tests on individual subsystems are performed. System aspects are first checked on system feasibility models (SFM). The SSFMs and SFMs are sited at the premises of firms participating in the development and manufacturing of System X.

As the tests progress and the interactions studied become more complex, so the facilities required become more sophisticated, and the need for fast communication is not so important because the problems found take longer to solve. By having a number of systems under one roof, as at the SSTF, it allows the cost of the testing to be spread over all the models, and therefore it is possible to provide facilities which would be too expensive to provide on a per-SFM site basis. Also, having an example of each member of the System X family in the same building eases interworking testing. Therefore, because of the facilities available at the SSTF, more sophisticated and rigorous tests can be performed.

Testing New Issues of Software

Software is never perfect. Because of its complex nature, many combinations of events are possible in the software and it is not possible to test them all. Operational software will therefore contain hidden design deficiencies. These design deficiencies will become apparent, and manifest themselves as misoperation of the software, when a new combination of circumstances is met. The removal of the design deficiency involves re-writing the software. A number of these corrections is collected together to form a new issue. The new issue of software must be tested thoroughly before it is released for use in the field, for it is always possible that another design deficiency has been inserted during the correction process.

Although there are many off-line testing facilities available to the software engineer on the software development facilities, because of the complex interactions between software and hardware, the final tests have to be performed on real exchange hardware in an appropriate environment. This task will be performed at the SSTF.

Another reason for producing a new issue of software is that for marketing reasons it has been decided to add a new facility. Again, the same arguments apply and require that the new issue be tested thoroughly at the SSTF before being released for service.

Testing Up-Dates to Hardware

A similar argument can be applied to the hardware as was applied to the software. Therefore modifications will be occasionally required to the hardware of in-service installations. The significant modifications, together with the instructions for applying them, will be tested at the SSTF before they are released.

Maintenance Support and Back-Up

The System X exchanges have a number of in-built facilities to

† System X Development Department, Telecommunications Headquarters

aid the local maintenance staff and, in most cases, these will prove to be more than adequate. However, it is possible that faults or service difficulties will arise for which the local maintenance organization will not be able to find a solution, and will therefore need assistance. This assistance can be given through established procedures by the staff at the SSTF, who are in an ideal position to provide this assistance because of their practical knowledge of the systems, the facilities at their disposal, and their close contact with the development teams.

The models, together with the other facilities, can be used for investigating obscure faults or service difficulties. Several techniques can be used on the SSTF models which could not be used for in-service installations because of the effect they would have on service. These investigations can help to locate faults and provide valuable information for the Correction Function. The Correction Function is a small dedicated group, who are part of the development team, responsible for effecting quick clearance of faults.

Under normal procedures it is the role of the Correction Function to provide a temporary solution, known as a *patch*, for these special problems. A patch is a small piece of software which can be inserted in an in-service system to overcome a difficulty. A strict record of these patches has to be kept and they have to be tested on the SSTF before they are released. The patch has only a short life and would be replaced by the next issue of software.

In an emergency, the SSTF would be at the centre of the activity to provide a quick solution to enable service to be restored.

The staff of the SSTF will provide a special investigation unit for the location of obscure faults. The investigation will be

conducted on site or by use of data links to the exchange in question to obtain relevant print-outs at the SSTF.

The other main area of support is the proving of operational techniques and procedures before they are used in the field. All the work at the SSTF has to be closely co-ordinated with the launch programme of System X so that the right support is given at the right time.

A DESCRIPTION OF THE TEST FACILITY

To demonstrate the potential and capabilities of the SSTF a brief description of the building and the testing tools is given below.

The Building

The SSTF is accommodated in a building which was designed specifically for the purpose. The building has a gross floor area of 3800 m², divided into a two-storey office block, and a single-storey equipment area. The office block provides accommodation for 60 persons (permanent staff, participating firms' staff, and visitors), a conference room, two discussion rooms, a clerical office, a mess-room and a first-aid room. The equipment block has 5 test-bed areas totalling 1600 m² which can be further divided by demountable partitions, a demonstration room, a 50 V power plant and battery rooms, and a plant room. The layout of the building is shown in Fig. 1.

To provide a stable test environment, the equipment area has air temperature control. Air flow is from a plenum above the ceiling to return ducts under the corridors. Fig. 2 shows a cross-section through the equipment area. A 50 V DC supply is distributed from a standard TE Power Plant No. 233 to fuse boards placed at intervals in the test-bed areas. Cabling is

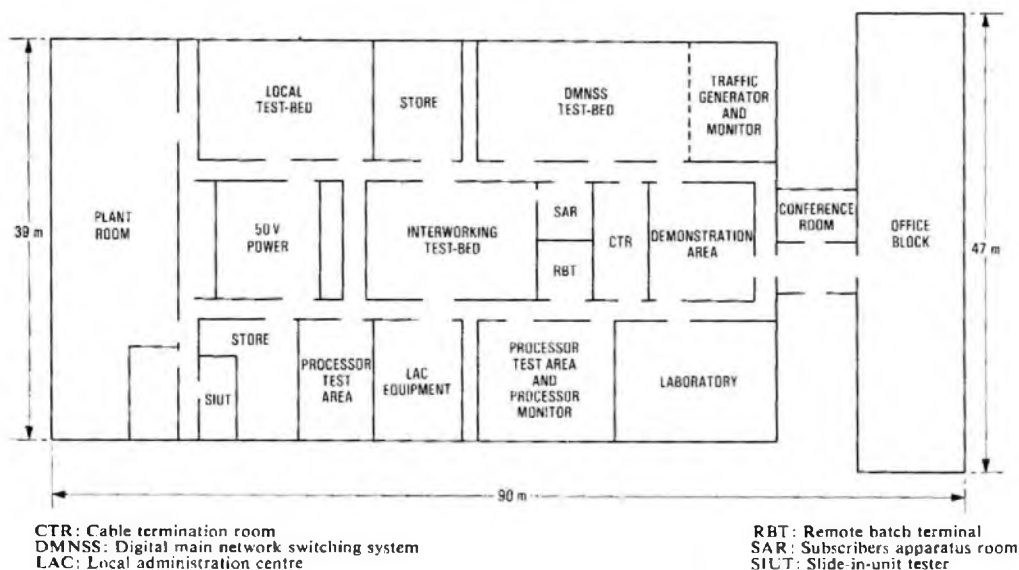

FIG. 1—Layout of the SSTF building

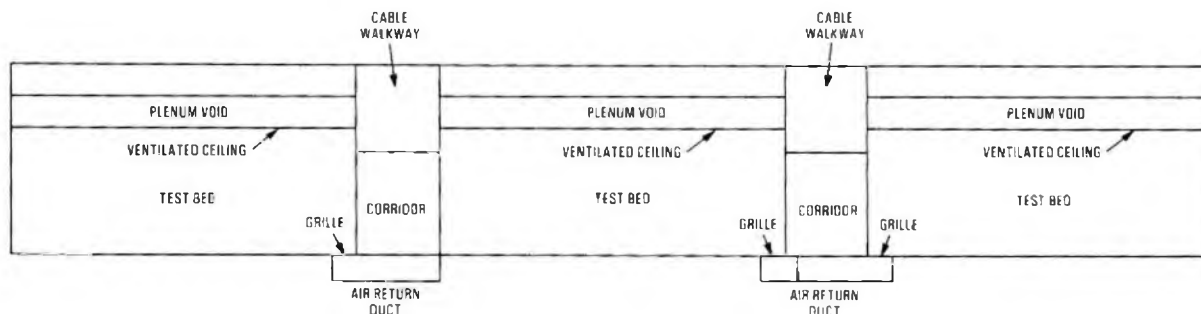

FIG. 2—Cross-section of the SSTF equipment block

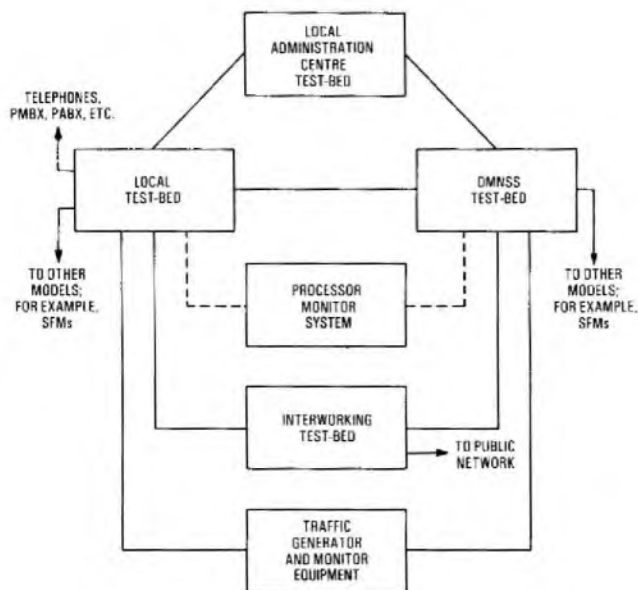

FIG. 3—Interconnexion of models and facilities

carried in a cabling walkway above the corridors, and this also houses the power busbars. There is easy access for equipment from outside the building and between test-bed areas.

All systems and test facilities are connected to analogue and digital interconnexion frames; by this means different system configurations can be set up easily. Fig. 3 shows the interconnexions of the models and facilities.

System X Systems

A model of each member of the System X family will be installed at the SSTF. The first models to be installed are a digital main network switching system² (DMNSS), a medium local exchange³ (MLE) and a local administration centre⁴ (LAC).

The DMNSS model is configured to handle approximately 200 erlangs of traffic in analogue or digital form. The model has some features of a large system, which enables the processor and the software to be monitored under higher simulated loads.

The present local exchange model is equipped to handle 960 subscribers, and digital and analogue junctions. It will be extended at a later date to prove in-service extension techniques, and to model in skeleton form the larger exchanges to be installed in the network.

The LAC model is in two parts: the work position, including the terminals, is installed in office-type accommodation in the office block, while the processor and associated equipment are installed in the equipment block. In addition to testing the LAC and its interworking with the other systems, the model will be used for ergonomic studies in connexion with the work positions.

Traffic Generator and Monitor Equipment

The traffic generator and monitor equipment provide facilities to detect design deficiencies, to monitor the effect of maintenance or modification procedures and to gain experience of a system carrying variable, controllable, realistic loads under normal conditions and simulated fault conditions. It generates calls on the incoming circuits of a system, receives calls from the outgoing circuits of a system, monitors for correct operation (including timing), detects any mis-operations, continuously checks the transmission path while the call is held, and produces a comprehensive analysis of the calls at the end of a run or at specified intervals.

The holding times and the call-interval times have negative exponential distributions, and both are variable. It is possible, through the man-machine interface, to group circuits into routes, and to load specific circuit groups, both incoming and outgoing. To simulate different exchange types in the existing network, incoming circuit selection can be random or sequential with a fixed start. Different call sequence types can be specified, and these are selected at random.

A number of interface units have been developed. For subscriber working there is loop-disconnect or Multi-Frequency No. 4 signalling. A pulse-code modulation line unit is provided which provides signalling for all 30 channels in time-slot 16 and provides line management. Interface units for other signalling types are now being developed and will be available shortly; these units will accommodate DC2, AC8 and AC9 signalling.

A block diagram of the traffic generator and monitor equipment is given in Fig. 4.

A more detailed description of the traffic generator and monitor equipment will be the subject of a future article in the *Journal*.

The Processor Monitor System

The processor monitor system was developed and built for the testing of the processor subsystem during the development phase, and is available for monitoring the processors controlling the models, and so forms an important part of the SSTF installation. It allows the performance of the processor, and hence all applications of software, to be measured without affecting that performance.

The system consists of a number of modules. Each module can be controlled manually or by a computer. Within the constraints of the system parameters, there is complete flexibility on how the modules are configured; the particular configuration is dependent upon the test being performed. The modules available are interface units (for matching the system to the processor), 16 bit and 32 bit comparators, 16 bit and 32 bit within-range detectors, sampling registers, programmable counters and timers, and a general-purpose logic unit. The modules can be interrogated by the computer, which can also set registers within the modules.

The controlling computer has a disc system for storing the data obtained. If desired, the data can be analysed and presented either in tabular form or as a histogram.

By using the processor monitor system, it is possible to identify many different events occurring within the processor. Having identified one or more events, it is possible to count the number of times they occur within a period specified at run-time, and measure their duration or the interval between their occurrence. All measurements can be repeated automatically under the control of the computer, the number of repeats being specified by the user at run-time.

Interworking Test-Bed

To enable the testing of signalling interworking, routing protocols and administrative facilities between System X exchanges and the present network, a representative sample of the existing systems has been installed. A list of the systems installed is given in Table 1. These systems, although they have a very small traffic-handling capacity, are trunked as complete systems within a proper numbering scheme. To give an indication of the size of this installation a floor plan of the interworking test-bed is shown in Fig. 5.

Analogue and digital transmission systems have also been provided, together with a larger variety of customer terminals.

Ancillary Facilities

A remote batch terminal (RBT) gives access to the software development utilities; in particular, to the software master library, from which current versions of the software can be obtained. An RBT is a computer-controlled data terminal

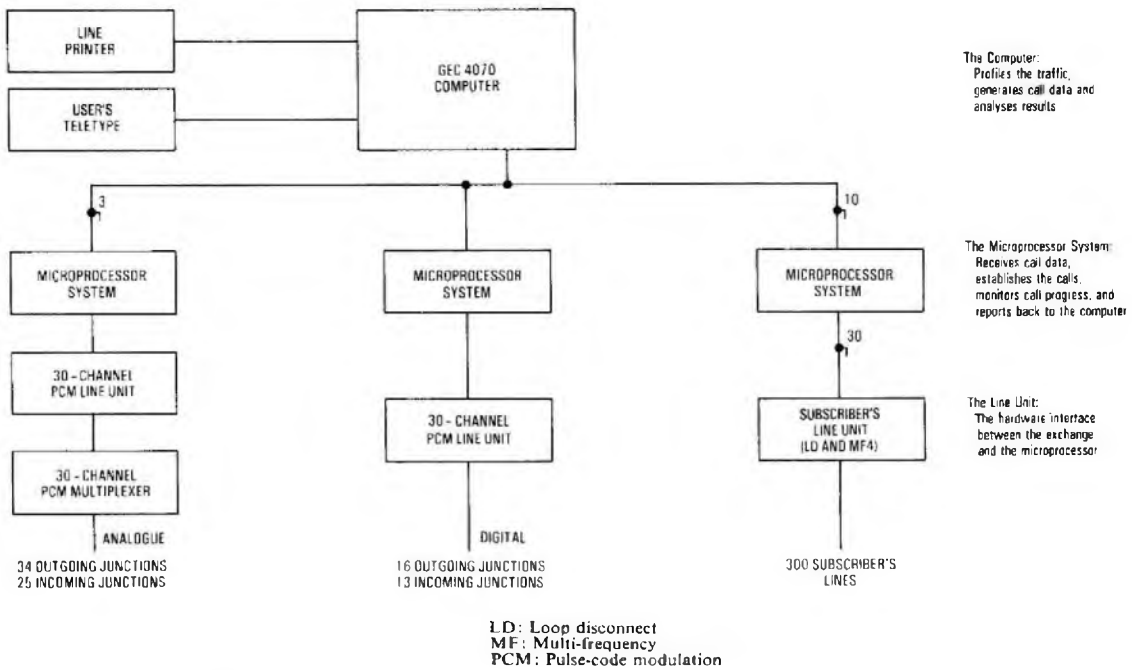

FIG. 4—Block diagram of the traffic generator and monitor equipment

TABLE 1
Systems Installed in the Interworking Test-Bed

Exchange Type	Exchange Code
Strowger	UAX12
	UAX13
	TXS (local non-director) TXS (local director) TXS (group switching centre)
Crossbar	TXK1 (local) TXK1 (group switching centre)
Reed relay	TXE2
Manual board	AMC/SCS (sleeve control) AMC/CSS1 (cordless)
Private manual branch exchange	PMBX2 PMBX3 PMBX4
Private automatic branch exchange	PABX1 PABX5
Test position	Trunk/local

which provides a wide range of facilities.

An obvious requirement is the need for documentation. At the SSTF there is a documentation office, which contains copies of all the released documents. Much of this documentation is on micro-film.

In addition, there is a whole range of testers, including test-call senders and a hardware message generator which is used for loading the processors.

EXAMPLES OF TESTS

To give an impression of what can be achieved at the SSTF with the facilities provided, three examples from the test programme are now described.

Checking Billing Information

It is essential that the billing information provided by a local exchange is correct. It is therefore necessary for the British Post Office to be able to perform tests to ensure that the billing system is reliable. To do this it must be possible to generate a

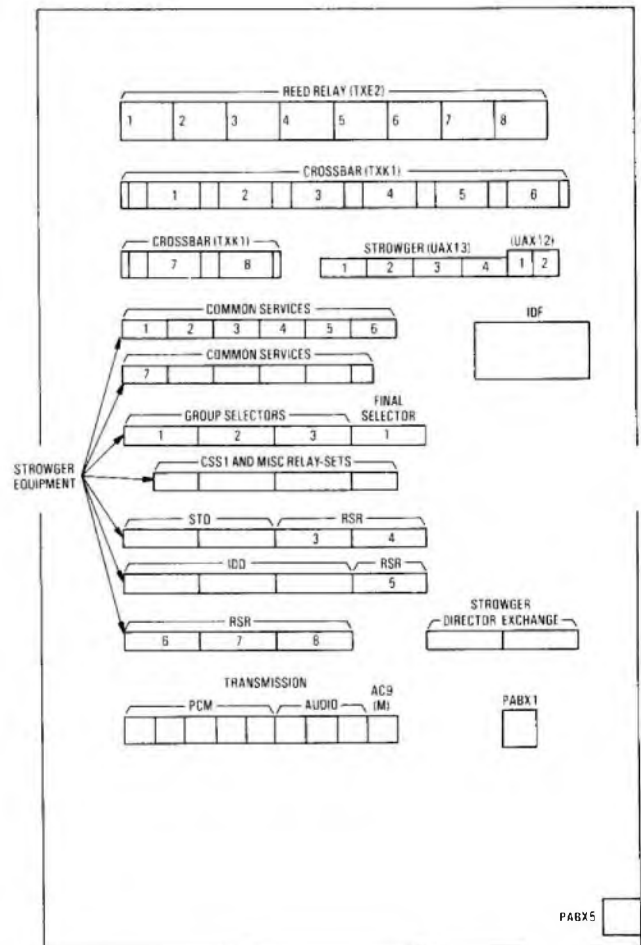

- CSS: Cordless switchboard system
- IDD: International direct dialling
- IDF: Intermediate distribution frame
- PCM: Pulse-code modulation
- RSR: Relay-set rack
- STD: Subscribers trunk dialling
- TXE: Electronic exchange
- TXK: Crossbar exchange
- UAX: Unit automatic exchange

FIG. 5—Interworking test-bed floor plan

known traffic load; that is, for specific subscribers' lines, calls with known routing digits and known duration, including unsuccessful calls, and calls that are aborted. There has to be a check that the calls were set-up as intended. The billing information is then obtained from the system, and bills generated and checked against manually produced bills from the original data. The test must be repeatable.

The traffic generator and monitor equipment provides the repeatable specified load, including the unsuccessful and aborted calls; it also monitors the calls and provides a check that the run went as intended.

On-Line Extension

For any switching system to be viable it must be possible to increase its traffic capacity without any deterioration in service while the extension is being performed. To check the extension procedures, the traffic generator and monitor equipment is connected to supply a representative load. It is also programmed to give a periodic print-out of the fault analysis. The system is then extended according to the agreed procedure. Any deterioration during the extension will be detected by the traffic generator and monitor equipment.

Software Optimization

Software optimization in this instance means reducing the time for a particular piece of software to run. For the optimization process to be effective, the development effort has to be directed to those areas of the code which run most frequently on the processor and which occupy an excessive amount of processing capacity. The facilities at the SSTF provide the right tools to perform this function. The code is run on a real processor, driving a real system, which is carrying a realistic load provided by the traffic generator and monitor equipment. For large loads, the hardware message generator provides a base load, with the traffic generator and monitor equipment providing the final measureable amount. The processor

monitor can be used to measure the performance of the processor subsystem without affecting its performance. The code will therefore behave exactly as it will in service. The processor monitor can identify not only the process which occupies most of the processor time, but also the module within that process which runs most frequently. Further resolution can be obtained down to individual lines of code, if required. It is therefore possible, using the facilities provided at the SSTF, to direct effort to where it can be most profitably spent in improving the software.

CONCLUSIONS

This article has shown the variety of facilities that go to make the SSTF. A considerable investment in terms of men and money was needed to make it possible. This investment will be justified as the SSTF serves its main function of easing the transition of System X from development to operational use.

ACKNOWLEDGEMENTS

The provision of the SSTF and all its facilities has been a team effort. The author would like to take this opportunity to thank all members of that team for their contribution. Thanks are also due to the staff from Eastern Telecommunications Board for their invaluable assistance in the provision of the interworking test bed.

References

- ¹ LOOME, S. R. System X: Design and Support. Part 3—Software Development Facilities. *POEEJ*, Vol. 73, p. 47, Apr. 1980.
- ² VANNER, N. J. Architecture of System X. Part 2—The Digital Trunk Exchange. *POEEJ*, Vol. 72, p. 142, Oct. 1979.
- ³ OLIVER, G. P. Architecture of System X. Part 3—Local Exchanges. *POEEJ*, Vol. 73, p. 27, Apr. 1980.
- ⁴ WALSH, A. A. Architecture of System X. Part 4—The Local Administration Centre. *POEEJ*, Vol. 73, p. 36, Apr. 1980.

Book Review

Technician Mathematics 2. M. G. Page. Cassell Ltd. v + 346 pp. 122 ills. £4.00.

The author states that this book has been written to cover all the objectives in any unit being studied in a programme leading to an award of the Technician Education Council (TEC) bearing a title of, or similar to, Mathematics Level II. He also says that, in particular, the book covers the units Mathematics 1 (U75/012), Mathematics 2A (U75/038) and Mathematics 2B (U75/039). The latter statement is correct, although there are a few small discrepancies, but I doubt his wisdom in making the former statement, since there is a number of objectives in other Mathematics Level II units (for example, U76/032 and U76/033) which do not appear in the text.

The book is divided into two main parts. Part A contains material required by all students of level II mathematics and consists of sections on computation (calculators, logarithms and slide rules), statistics (frequency diagrams, mean, mode, median, standard deviation and distribution), graphs (straight line and in solution of equations), geometry (areas, volumes, frustra and centroids) and trigonometry (trigonometrical ratios of angles up to and over 90°, sine and cosine rules, graphs of trigonometrical functions). Part B contains material

required by students progressing to level III and consists of sections on statistics (including standard deviation and normal distribution), algebra (quadratic and cubic equations and progressions), trigonometry (equations and combinations of waves) and calculus (differential and integral).

This is a well written book with many good illustrations and a wealth of worked and unworked examples; but I feel it would have benefited if some effort had been made to isolate important statements, terms, definitions and examples from the main text so that the student would find it easier to absorb the content, to refer back, and to revise.

There are two points which puzzle me. Firstly, why has the author used the formula $y = ax + b$ for a straight line graph when the TEC objectives use $y = mx + c$? Secondly, why has the author used A as the constant of integration whereas no other source at which I have looked does so. Furthermore, on page 337, whilst working out the value of area A , he changes, without explanation, to the use of C as the constant, which I feel could lead to some confusion.

To sum up, Mr Page has produced a book which explains the subject well and which should prove a useful reference source for students of level II mathematics and help them in their progress to level III.

R. SUTTON

Character Coding for Text Communication

Part 2—The Development of Practical Standards

A.J. WHALL, B.SC., M.I.E.E.†

UDC 681.304: 621.397.12

Part 1 of this article gave a brief outline of the history of character code standards and the motivation for the development of new standards. It also briefly described the basic techniques available for extending the coding capabilities of the 7 bit code. Part 2 of the article deals with the development of practical standards for the new services.

THE ISO STANDARD

The general object of the character coding work within the International Standards Organization (ISO) has been to produce an umbrella standard³ catering for the requirements of all text communications systems and services. This search led to the adoption of certain assumptions about the use of the standard and also pointed the way towards its structuring. The standard consists of a general-purpose character set, catering for the widest possible range of systems using languages based on the Latin alphabet. Provision is made for future extensions to the standard to cater for languages not based on the Latin alphabet, and also for specialized text communications systems; for example, specific scientific bibliographic.

The major assumptions on which the standard was developed were as follows.

(a) The character code will be used for communication between terminals or terminal systems; internal machine codes are not necessarily the same as those transmitted over telecommunications networks. Terminal systems in this context may be a local cluster of terminals within an office building, or a complete service with information broadcast between computers and terminals; for example, Teletext.

(b) Store-to-store operation is assumed between terminals.

(c) The concept of fallback representation is very important because the comprehensive nature of the standard makes it likely that many printing and visual display devices will be incapable of presenting the repertoire in its entirety. When a character received from line cannot be presented exactly, a fallback presentation is shown in its stead; examples are shown in Fig. 6. Where no approximate rendition is possible, an ultimate fallback is shown; for example, ■ or -. Fallback does not affect the form in which the information is stored in the terminal. Information can therefore be output from the store either using fallback presentations in the case of, say, an English terminal receiving from Germany or, if a printwheel having the German character set is available, the information

† System Evaluation and Standards Department, Telecommunications Headquarters

CHARACTER	POSSIBLE FALLBACK
ä	a
l	l (Capital l overstruck with -)
ø	o (O overstruck with x)

FIG. 6—Possible fallback representations

can be printed out in its correct form—the choice is left to the user.

(d) To facilitate the requirements of assumption (a), the concept of a coding interface has been introduced. This is not a physical location, but is an imaginary surface at which the communication code is specified. It is an extremely useful concept, allowing the boundaries, within which the communication code applies, to be readily delineated. Fig. 7 shows the

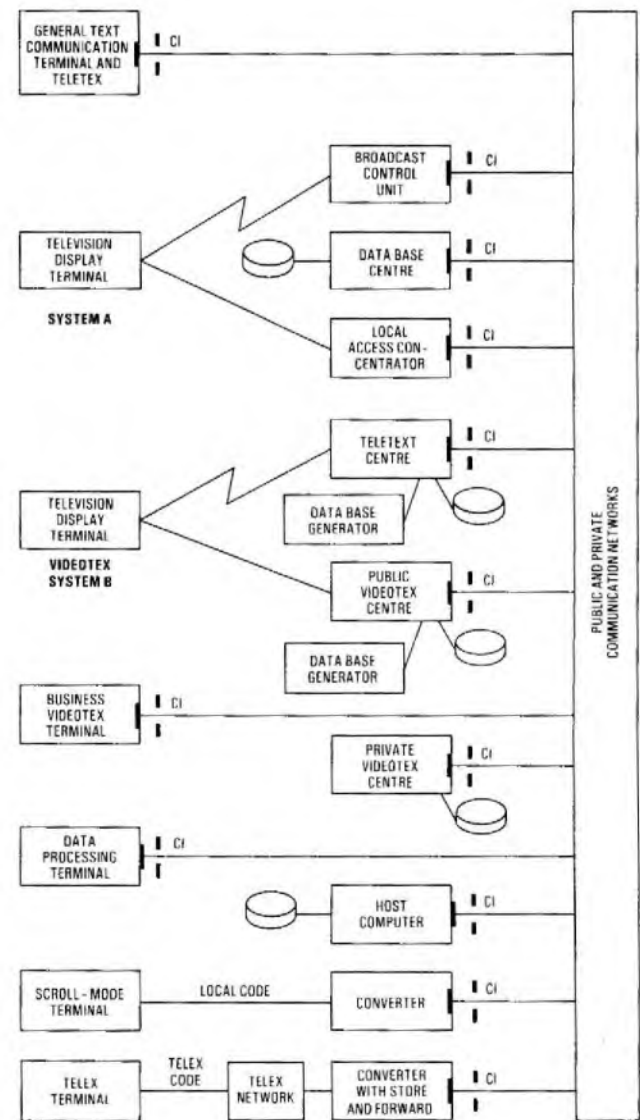

CI—coding interface

FIG. 7—Overall view of general text communication services

scenario of general text communication, and illustrates clearly the coding interfaces and the application of the terminal system concept to the broadcast information services (Teletext).

CHARACTER REPERTOIRE

The first task of the ISO Working Group was to collate a repertoire of graphic characters used in all known languages based on the Latin alphabet and then select those that were relevant to general text communication. The first of these tasks was considerably eased by the availability of a study of European languages based on the Latin alphabet carried out in 1977 at Rennes University⁴. This report indicates that some 192 special linguistic symbols are required in addition to the 52 capital and small letters. The frequency of use of special characters is indicated for each language. In general, the Western European languages have a moderate requirement for special symbols and the frequency of usage tends to be around the 2-5% range. Moreover, many of the accented letters are common to a number of countries; for example, á is used in 14 languages. On the other hand, Czechoslovakia requires 18 special letters for the Czech and Slovak languages and the average frequency of occurrence is 10-14%.

From the Rennes report and other contributions submitted, it was decided that a total of 14 diacritical marks are required to accent basic letters of the alphabet. The range of accented letters is shown in Fig. 8. In addition, for the special linguistic symbols, the basic requirements for arithmetic, punctuation, currency and miscellaneous symbols were determined by means of questionnaires to national administrations; these concerned their requirements for typewriter keyboards and for general text communication use. The total repertoire of characters to be coded was thus established at 333, including diacritical marks imaged as separate characters. This repertoire will cater for the requirements of some 40 languages and dialects, including Esperanto, Lettish, Wendish and others.

CHARACTER CODING METHOD

Having quickly established the order of magnitude of the repertoire, detailed consideration was given to the choice of a suitable coding method. A total of 14 different proposals⁵ were put forward for consideration by the committee; these proposals were all variations on, or combinations of, the 4 basic code extension schemes outlined in Part 1 of this article. To give adequate consideration to so many proposals and the various supporting documents was clearly an onerous task, and the standard that finally emerges will represent the distillation of much intense debate and incorporate the compromises that are the essence of standardization.

The direct coding (substitution) method found little support within the committee for the reasons that were mentioned in Part 1 of this article; the debate settled on the choice between the direct coding method using G2 and G3 supplementary sets of characters, and the composition method of coding using a primary (G0) set of basic characters together with a single supplementary (G2) set of special characters. Those countries favouring the UK Videotex/Teletext system tended to argue for the direct coding method. Countries having more interest in the Teletex service, together with those countries favouring the French Antiope/Telctel Videotex system, tended to argue for the composition coding method. Within the CCIR†, CCITT*, CEPT‡ and EBU**, much the same sort of discussions on coding method were taking place.

By May 1979, the debate appeared to be deadlocked. With time at a premium because of the closeness of the CCITT

BASIC LETTER	ACUTE ACCENT	GRAVE ACCENT	CIRCUMFLEX ACCENT	DIARESIS OR UMLAUT MARK	TILDE	CARON	BREVE	DOUBLE ACUTE ACCENT	RING	DOT	UMLAUT MARK	MACRON	CEDILLA	ODONEK
a A	á À	â Á	ã Ä	ä Å	ā	č	ç	â	ā	·	ä	ā	ã	ā
b B														
c C	ć		č								č		ç	
d D														
e E	é	è	ê	ë							ë	ē	ẽ	ē
f F														
g G	ğ		g								g			
h H			h											
i I	í	ì	î	ï							ï	ī		ī
j J			ĵ											
k K														ķ
l L	ł													ļ
m M														
n N	ñ				ñ	ň								ñ
o O	ó	ò	ô	ö	õ			õ			ö	ō	õ	ō
p P														
q Q														
r R	ř													ŗ
s S	š		š											š
t T														ţ
u U	ú	ù	û	ü	ű		ü	ū	ū		ü	ū	ū	ū
v V														
w W			ŵ											
x X														
y Y	ÿ		ÿ											ÿ
z Z	ž													ž

FIG. 8—Use of diacritical marks

Plenary Assembly, coupled with the widespread desire to reach agreements in this study period, a compromise solution was earnestly sought. It was at this point that the concept of the coding interface assumed great importance. By conceiving the whole of the Teletext system(s) as terminal systems, within which coding arrangements could be arranged independently from the telecommunication network codes, it became possible to separate the discussions on coding for Videotex and Teletex from the discussions on Teletext coding requirements. A common coding scheme for Teletex and Videotex was sought by some countries, but not universally supported.

It was finally agreed to adopt the principles of composition coding for both Videotex and Teletex services, but not necessarily with identical code tables. Coding for the broadcast information services could then be studied further in the relevant committees without delaying the work on Videotex and Teletex. This decoupling of the broadcast services enables composition coding to be adopted for Videotex without sacrificing compatibility with existing services; for example, Prestel. This is illustrated in Fig. 9 where communication between the CEEFAX/ORACLE Centre and the television set can use direct coding which suits the properties of the transmission medium, whereas all communication with the Prestel computer can use the composition coding method. As long as the repertoires of characters to be transmitted are compatible, the terminal requirements are simplified. In practice, by ensuring that the present UK Prestel Teletext repertoire and basic (G0) set are a subset of the standard then, although direct coding is used, the UK systems are completely upwards compatible with the standard. Because present terminals cannot display accented letters etc., the gateway computers could generate suitable fallback representations in interworking situations. If it is ever necessary to include accented letters as a basic feature of the UK system, then this can be done in a manner which does not affect the operation of existing terminals. The concept of fallback presentation allows interworking by providing suitable standardized fallback conversions within terminals or at gateway exchanges as appropriate.

Fig. 10 shows the primary set of graphic characters for text communication, together with SPACE and DELETE. In compiling

† CCIR—International Radio Consultative Committee
 * CCITT—International Telegraph and Telephone Consultative Committee
 ‡ CEPT—Conference of European Posts and Telecommunications
 ** EBU—European Broadcasting Union

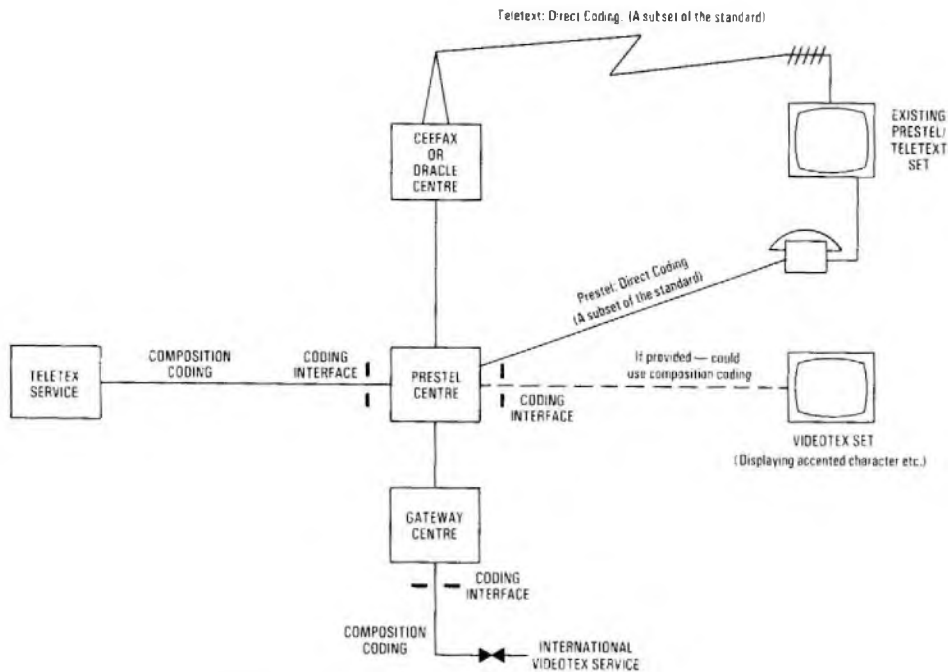

FIG. 9—Combined use of composition and direct coding

b_7, b_6	b_5	b_4	b_3	b_2	b_1	b_0	
0 0	0 0	0 0	0 0	0 1	1 1	1 1	
0 0	0 0	0 1	1 1	0 0	0 1	1 1	
0 0	0 1	0 1	0 1	0 1	0 1	0 1	
0 0	0 0	0 0	0 0				SP @ P p
0 0	0 0	1 1					! A O a q
0 0	0 1	0 2					" 2 B R b r
0 0	0 1	1 3					3 C S c s
0 1	0 0	4					4 D T d t
0 1	0 1	5					% 5 E U e u
0 1	1 0	6					6 F V f v
0 1	1 1	7					' 7 G W g w
1 0	0 0	8					l 8 H X h x
1 0	0 1	9					l 9 I Y i y
1 0	1 0	10					* : J Z j z
1 0	1 1	11					+ ; K l k l
1 1	0 0	12					, < L \ l
1 1	0 1	13					- = M m
1 1	1 0	14					. > N ^ n ~
1 1	1 1	15					/ ? D @ DEL

① When interworking with Videotex, this code shall have the meaning delimiter Coding represented by bit combinations 2/1 to 7/14 of a 7 bit or 8 bit code (in an 8 bit code, additional bit $b_8 = 0$)

FIG. 10—Primary set of graphic characters for text communication

b_7, b_6	b_5	b_4	b_3	b_2	b_1	b_0	
0 0	0 0	0 0	0 1	1 1	1 1	1 1	
0 0	0 0	0 1	1 1	0 0	0 1	1 1	
0 0	0 1	0 1	0 1	0 1	0 1	0 1	
0 0	0 0	0 0					° — Ω X
0 0	0 0	1 1					ı ± \ ı Å æ
0 0	0 1	0 2					¢ 2 / 0 ı
0 0	0 1	1 3					ı 3 ^ ı §
0 1	0 0	4					\$ x ~ ı ı
0 1	0 1	5					ı ı ı ı
0 1	1 0	6					# ı ı ı ı
0 1	1 1	7					§ . ı ı ı ı
1 0	0 0	8					ı ı ı ı
1 0	0 1	9					ı ı ı ı
1 0	1 0	10					ı ı ı ı
1 0	1 1	11					<< >> ı ı ı ı
1 1	0 0	12					ı ı ı ı
1 1	0 1	13					ı ı ı ı
1 1	1 0	14					ı ı ı ı
1 1	1 1	15					ı ı ı ı

② When a distinction needs to be made between diaeresis and umlaut, this code should represent umlaut

Coding represented by bit combinations 2/1 to 7/14 of a 7 bit or 8 bit code (in an 8 bit code, additional bit $b_8 = 1$)

FIG. 11—Supplementary set of graphic characters for text communication

this table, every effort was made to allocate fully the code table positions; however, to ensure compatibility with existing equipment, it was necessary to leave certain code positions empty. It can be seen from a comparison with Part 1 of this article that the primary set is essentially a subset of the International Alphabet No. 5 (IA5) with the addition of the footnote.

The supplementary set of graphic characters for text communication is illustrated in Fig. 11. It is not intended to

describe the symbols in detail in this article, but merely to point out certain features of the tables. Whenever possible, similar characters are grouped together. Column 4 contains the non-spacing accent symbols which, when combined with basic letters from the G0 set, produce the accented letters. Columns 6 and 7 contain the upper and lower case versions of the European special linguistic symbols. These two columns neatly illustrate the lengths to which the committees went to ensure that all Latin alphabet languages are catered for. The

Greenlandic K (7/0) was included after a particularly conscientious committee member had produced a cutting from a Greenland newspaper (with a circulation of a few thousand copies) as evidence of the need for the character, even though the Danish delegation reported that the letter is, by official edict, no longer used. However, it was felt that, for bibliographic work, the character might still be useful and so it was included in the repertoire. The blank spaces in column 5 are reserved for future standardization. Columns 2 and 3 are used for currency, arithmetic, punctuation and other miscellaneous symbols.

The ISO standard is equally applicable in both 7 bit and 8 bit environments: in the 7 bit case, characters from the supplementary set (G2) are preceded by SS2; in the 8 bit case, the supplementary set is coded as the right-hand half of the code table (10/1 to 15/14). Separate parts of the standard define the repertoires and coding of control functions for document interchange (Teletex and similar applications), and for screen-based information retrieval systems (Videotex applications).

In theory, the use of composition coding with two tables of 94 characters allows many thousands of combined characters to be transmitted. In practice, therefore, rules must be established to cope with such characters, particularly in applications where a fixed repertoire of character shapes is likely to be stored in the terminal; for example, in raster-scan systems.

At the present stage of work, the standard caters for only languages based on the Latin alphabet. It is intended that further sections to be discussed and agreed in the future will deal with other languages (for example, Greek, Arabic, Cyrillic etc.) and also with the specialist scientific applications. These other national and/or application-oriented sets of characters will be designated and invoked singly or in pairs, as appropriate. This open-ended approach to the scope of the standard has greatly eased the work, enabling it to be tackled in manageable units.

THE CCITT VIDEOTEX AND TELETEX RECOMMENDATIONS

The Recommendations, which were placed before the Plenary Assembly of CCITT in the autumn of 1980, were developed in close collaboration with the ISO. The degree of co-operation and liaison between the many standardization organizations serving the broadcasters, telecommunications organizations and computer manufacturers has made the progress of the work very rapid compared with the many years of debate before the IA5 was finally agreed. In practical terms, this liaison has meant that the ISO working group members have participated in the work of the CCITT study groups and vice versa.

THE VIDEOTEX RECOMMENDATION

The Recommendation⁶ is based on a 7 bit code structure because of the existing systems which use simple parity checking for error detection in the local link from the computer to terminal. The graphic character repertoire is a subset of the ISO repertoire and thus the Videotex primary (G0) set is as Fig. 10, with blanks at 5/11 to 5/14, 7/11, 7/13 and 7/14. The supplementary (G2) set is as Fig. 11 with 5/1 blank.

The definition and coding of the picture-element character set used for the construction of maps, logos and simple pictures in Videotex is defined in the Recommendation, in conformance with the code extension principles outlined in this article. Also included in the Videotex recommendation is an example of a system for picture drawing using geometric primitives transmitted to the terminal as commands to be processed by a microprocessor within the terminal. Further options to be standardized include photographic coding techniques and the so called *dynamically redefinable character*

sets (DRCS) option, whereby the dot patterns corresponding to pre-defined shapes (for example, electronic circuit elements, special timetable symbols, etc.) are loaded into the terminal read-write memory and subsequently invoked by way of appropriately designated G0, G1, G2 or G3 sets.

THE TELETEX RECOMMENDATION

The Teletex service is defined⁷ in terms of synchronous store-to-store communication, for which simple parity check error detection systems are not appropriate. The character code for Teletex is, therefore, based on an 8 bit code structure, with the primary set as shown in the left-hand half of the code table and the supplementary set is placed in the right-hand half (See Fig. 12). The repertoire differs from the Videotex set in that the arrows (10/12 to 10/15), delete (7/15) and the high bar (13/10) are not required for Teletex. However, square brackets (5/11 and 5/13) are required.

FUTURE DEVELOPMENTS

During the coming four-year study period, the CCITT activity will be directed towards service integration: firstly, to permit interworking between Videotex, Teletex and facsimile equipments and, secondly, to produce standards which could enable, for example, the inclusion of a facsimile capability within the Teletex service for the purpose of transmitting company logos, signatures etc. Within the ISO an increasing emphasis will be placed on the development of suitable coding standards to permit the development of text processing facilities.

Both the CCITT and the ISO can be expected to give consideration to the needs of the non-latin alphabet-based languages and specialist applications such as bibliography.

b ₇	b ₆	b ₅	b ₄	b ₃	b ₂	b ₁	b ₀	00	01	02	03	04	05	06	07	08	09	10	11	12	13	14	15	
0	0	0	0	0	0	0	0																	
0	0	0	0	0	0	1	1																	
0	0	0	1	1	0	0	1																	
0	0	1	0	1	0	1	0																	
0	0	1	0	0	0	0	0																	
0	0	1	0	0	1	0	0																	
0	0	1	0	1	0	0	0																	
0	0	1	0	1	0	1	0																	
0	0	1	1	0	0	0	0																	
0	0	1	1	0	1	0	0																	
0	0	1	1	0	1	1	0																	
0	0	1	1	1	0	0	0																	
0	0	1	1	1	0	1	0																	
0	0	1	1	1	1	0	0																	
0	0	1	1	1	1	1	0																	
1	1	1	1	1	1	1	1																	

- ① When interworking with Videotex, this code shall have the meaning delimiter
- ② When a distinction needs to be made between diaeresis and umlaut, this code should represent umlaut

FIG. 12—Basic code table for the Teletex service

CONCLUSION

This article has given an insight into the background to the development of a family of character coding standards for the new generation of text communication systems and services. The coding for graphic characters has been described because it illustrates the similarities between the services more than does the coding of control functions which, although based on the same broad principles, tends to be more dependent on the implementation.

In the past, the growth of telecommunications networks and services has tended to be regulated by technological development. This situation is changing rapidly with the introduction of the microcomputer, so that today almost any conceivable facility or service is technically possible and the restricting factors tend to be economic. Standardization permits the economies of large-scale manufacture to be fully exploited, and opens up services to much larger markets. It is for this reason that the timely development of standards is crucial to

(Editor's Note: Since this article was drafted, the Plenary Assembly of the CCITT has agreed all the Teletex and Videotex recommendations.)

the success of text communications services in the coming years.

ACKNOWLEDGEMENTS

The author acknowledges the co-operation and advice of colleagues in Research Department and Product Development Division, Marketing Executive.

References

- ³ Coded Character Set for Text Communication. ISO. Draft Proposal 6937.
- ⁴ Problemes Linguistiques du Teletexte Etude des Langues Europeennes Utilisant l'Alphabet Latin—Rapport Final. CCETT Rennes, July 1977.
- ⁵ MCGREGOR ROSS, H. Character Sets for Communication of Text. Report prepared for Commission of the European Communities.
- ⁶ CCITT Draft Recommendation S.g.
- ⁷ CCITT Draft Recommendation S.f.

Book Reviews

Digital Techniques and Systems. D. C. Green. Pitman Books Ltd. x + 182 pp. 223 ills. £4.95.

This book sets out to provide a fairly comprehensive coverage of the basic techniques used in modern digital circuitry and the elementary principles of data communications. It covers the whole syllabus of the Technician Education Council (TEC) Digital Techniques III and Transmission Systems III half-units. The author has assumed that the reader will possess a knowledge of electronics and telecommunications transmission techniques equivalent to that reached by the TEC level II units, and of Electronics II and Transmission Systems II and integrated circuits.

The book is divided into ten chapters: six of these cover digital techniques, and the remainder data communications. Each chapter contains a number of worked examples and a selection of exercises at the end, some of which have been taken from past City and Guilds examination papers. Chapter 1 provides an introduction to some of the uses of digital techniques, chapters 2 and 3 cover logic gates and introduce the various logic families (for example, transistor-transistor logic, complementary metal-oxide semiconductor etc.); chapters 4 to 6 deal with flip-flops, counters and ferrite-core stores.

The subject of data communication is limited to a discussion of the transmission of data over telephone lines. Chapter 7 explains why modems are used by considering the effect of a transmission line on the propagation of pulses. Chapters 8 and 9 cover modulation techniques and provide some examples of typical data circuits containing modems, multiplexers and concentrators; pulse-code modulation is discussed in the final chapter.

On the whole, the book is relatively easy to follow, although a few subjects would benefit from more explanation. However, as it seems likely that the book will be generally used for lectures, this should not present a problem.

I. P. BELL

IEEE Recommended Practice for Emergency and Standby Power Systems for Industrial and Commercial Applications. IEEE. John Wiley & Sons Ltd. 208 pp. 80 ills. £5.00.

This volume presents the recommended principles and practice for selecting, installing and maintaining emergency and standby power plant in the USA. The widespread use of long overhead power lines for both high-voltage and medium-voltage feeders makes the distribution system in North America much more vulnerable to weather and lightning

hazards than it would be in smaller countries where mainly underground systems are provided.

After a list of definitions, about one-third of the book is devoted to a thorough discourse of general guide lines, in which the effects of supply outages, interruptions and transients such as surges, sags, impulses and noise are related to various user needs. The factors which a user should consider for differing degrees of interruption in the fields of lighting, lifts, factory processing, environmental conditioning, fire protection, life support systems, communications and data processing are conveniently summarized in a table showing tolerable durations of failure and standby system justification. The section on data processing is particularly apt, since it highlights the vulnerability of computers not only to electrical transients, but also to cooling-plant failures; figure 4 in the book shows an envelope of voltage-time tolerances which the IEEE recommends should be the design goal of energy conscious computer manufacturers.

The choice of systems and hardware is covered in the next section of the book. The merits of diesel engines, gas turbines, mobile generators, fly-wheel motor alternators, two and three-machine continuity sets and battery standby systems are compared and outline costs given. A number of battery-inverter and uninterruptible power system configurations are outlined with accompanying output voltage oscillograms. Although the question of reliability is touched upon, very little information is provided about either the mean time between failures of public utility electricity supplies, or about the various standby systems covered. The benefits of dual standby systems and parallel redundancy of the major items of power plant are not emphasised; it would therefore be necessary for a non-expert user to follow up the extensive references and bibliographies listed in the book. The reader's attention is drawn to the need for reliable starting and operation of standby plant, but the crucial importance of good design in common control and monitoring circuits has been omitted. Basic schedules of maintenance tasks and their frequencies, and the various methods of electrical and physical protection are given. Grounding or earthing, both in principle and in practice, is covered in some detail with generous illustrations and diagrams. However, safe current and voltage limits are not given, possibly because of the different requirements of the supply companies.

It is pointed out in the book that, while all users of electricity desire perfect frequency, voltage stability and reliability at all times, these conditions cannot be realized in practice. Although based on American practice, this book gives the larger power user a list of factors and references which he should consider in order to safeguard his operational needs and obligations.

I. G. WHITE

System X: Design and Support

Part 6—Design Rules

J. L. SWAFFIELD, B.SC., C.ENG., M.I.E.E.†

UDC 621.395.34

In formulating a new design of telecommunications equipment, a designer is constrained by many factors; for example, operational and performance requirements, environmental conditions, the state of technology, interworking and compatibility aspects. For System X, a project which has involved the efforts of a multi-disciplined team of engineers drawn from UK industry and the British Post Office, very precise design rules were agreed by all participants in the project. This article gives an insight into the design rules for the System X hardware and the control procedures which have been established to maintain the integrity of equipment performance and reliability.

INTRODUCTION

The concept of employing numerous small teams of engineers on a development project instead of one large team has obvious advantages: engineers can be permanently retained on their specialisms and, because more engineers can be employed on a project, the time scale of the development programme is shortened. But if the problem of control and co-ordination, inherent in a project organized along these lines, is not resolved, these advantages may be negated. It is in this context that design rules are important: for these rules serve as guide-lines for the engineering design teams working on the project, and ensure that common standards of design—a basic principle of the System X equipment structure—are maintained. In addition, these design rules ease maintenance and repair work; aid installation, extensions, and production and testing; limit costs; and enhance reliability.

HARDWARE DESIGN RULES

The collaborative development agreement between the British Post Office (BPO) and the 3 companies—STC, GEC, and Plessey—jointly designing and manufacturing System X has strongly influenced the compilation of the design rules for the System X project. In its practical application, this has meant that no design rule can be accepted until it has been extensively discussed and agreed by the BPO and the companies participating in the System X project.

The need for information transfer has also influenced the formulation of these design rules. Each of the firms participating in the System X project has the capability to manufacture complete exchange systems; therefore, relevant information must be exchanged so that a subsystem designed by one firm can be manufactured by another¹.

Hardware design rules are contained in documents which cover the following areas:

- (a) a list of components which have been approved for use in System X;
- (b) design rules for printed-wiring boards;
- (c) design rules for the wiring of shelf backplanes;
- (d) circuit design rules (that is, how the various components should be interconnected, decoupled, derated etc.);
- (e) a set of documents describing completely each component on the approved list and giving such information as performance, quality assurance, dimensions and manufacturing sources;

† System X Development Department, Telecommunications Headquarters

- (f) rules for the low-voltage distribution within racks and for 50 V distribution within a System X installation; and
- (g) rules for the use of the equipment practice.

THE STANDARD LISTS OF COMPONENTS

The standard lists of components identify the electrical components approved for use in System X. The types of components listed range from resistors to memory and microprocessor devices. At present, 400 passive and 200 active devices are listed, a small number for a project as large as System X.

The number and variety of components on the list have been deliberately restricted. This policy, strongly upheld by the BPO, is considered to have a number of advantages. For example: larger orders for a particular type of component can be placed and lower prices obtained; the variety of spares stocked by the BPO and its contractors is reduced; the likelihood of components on the lists becoming obsolescent is lessened; the total amount of documentation is reduced; and finally, fewer component-testing methods are required.

An extremely good case must be presented before a new component is listed. However, once it has been decided that a new component should be placed on the list, the procedure for achieving this is straight-forward. The head of the team working on the particular subsystem involved submits his request, together with all the relevant information on the component, to the BPO's standards group. The type of information submitted to the standards group could show, for example, that no device or alternative to it is already listed; that there are at least 2 suppliers of the device; that the device is not unreliable; that the device has British Standard or BPO specifications; that the device consumes less power than an alternative one, and so forth. The request is then considered by a multilateral group, which comprises members of the BPO and the firms participating in the System X project: if accepted, the component is placed on the appropriate list. Occasionally, the standard lists are examined critically with the object of eliminating any devices which are no longer required.

In a field of technology as fluid as that of modern electronic components, designers must be made aware of the suitability of components during the development phase of a project. To this end, a scheme for classifying the acceptability status of components has been introduced. The scheme consists of an alphanumeric range of codes. The numeric code bestows

grades of status on components which vary from

(a) full approval (no restrictions are placed on the use of the component), to

(b) banned status (the equipment must be redesigned).

In between the two extremes are other grades of status; for example, obsolescent (a component can be used in existing designs but should be designed out at a future date).

The alpha character is available as a further means of clarifying status or as notes for information. Every component used on System X has been given a status code, which is updated should the need arise.

DESIGN RULES FOR PRINTED-WIRING BOARDS

Printed-wiring boards (PWBs) range in complexity from those having broad, widely spaced conductors on only one side, to those having narrow, closely spaced conductors on a number of thin sheets of laminate sandwiched together to form multilayers; the multilayers are interconnected by plated-through holes, which are small holes in the laminate having a very thin plating of copper on the sides which are connected to conductors on the surfaces.

Initially, double-sided boards (with conductors on both sides) with plated-through holes were used for System X. But multilayer techniques have been adopted in the more recent designs of slide-in-units (SIUs) and backplanes. The conductor width and spacing for the design of System X PWBs range from 0.5 mm minimum for boards mounting mostly discrete components (that is, resistors, transistors) to 0.3 mm for boards mounting rows of dual-in-line integrated circuits. All of these boards are made from epoxide-woven glass-fabric copper-clad laminated sheet, to specification BS4584 Part 3, and have a nominal thickness of 1.6 mm; the copper foil has a minimum thickness of 35 μm .

The size of the PWBs used in System X is 286 \times 345 mm. The PWB mounts many 16-pin dual-in-line packs in rows. Of course, mixtures of dual-in-line packs (14, 16, 22, 24, 40-pin) and discrete components are found on many boards, especially those providing a partly analogue function.

Design rules which designate certain edge connector contacts for particular uses (for example, derived power-supplies, earths, -50 V) and which lay down a standard conductive pattern for an earth (0 V) and +5 V power supply matrices have also been set out for designers.

Each component occupies a certain amount of PWB area and each has its leads in particular positions. Design rules for the former, called *court areas*, and for the latter, called *component mounting spans*, have been included to enable the layout designer, by means of computer-aided design (CAD)² techniques, to partition the PWB and to place the holes, leads and conductors.

Design rules for automatic component insertion and for the avoidance of solder bridging between conductors during flow-soldering operations have been laid down to aid production.

WIRING DESIGN RULES FOR SHELF BACKPLANE

Since the mid-1960s, wire-wrapping has steadily gained in popularity over solder terminations as a termination method. Introduced into the British telecommunications industry on a large scale in crossbar exchanges, wire-wrapping has remained substantially unchanged up to the present time.

Wire-wrapping relies on a post, used for terminating the wire, having at least 2 sharp edges: the wire is positioned

against the post and wrapped around it under tension to produce a cold-weld contact at the sharp edges. Generally, nominally square cross-section posts are used because the inherent symmetry gives more reliable and easily achieved wire-wraps.

All within-shelf backplane connexions on System X equipment are wire-wrapped and up to 3 individual wires can be terminated on the same post.

A special tool, known as a *gun*, is used for wire-wrapping. The gun is placed over a post and an insulated wire is inserted; when triggered, the gun strips the insulation and, at the correct amount of tension, spins the bare wire around the post.

Although wire-wrapping guns have been improved since they were introduced, their basic design has not been changed. The only real innovation which has been introduced recently in their application has been the addition of a terminal locator. The terminal locator, controlled by a sequencing program, indicates the next position to be wire-wrapped, but the operator still has to feed in the wire and position and operate the gun.

In the USA, and increasingly in Europe, fully automatic machines which can run virtually unattended and which give wire-wrapping rates of over 1000 wires per hour (that is, 2 wire-wraps per wire times 1000) have been introduced over the last 10 years. A number of these fully-automatic machines have been purchased for use on System X equipment, though manual wire-wrapping can still be used if necessary.

Design rules have been set down for shelf wiring; they cover areas such as the number of turns of wire for each wrap, the number of wires that can be terminated on one post, the number of wires that can be run between rows of posts, sizes of wires, crosstalk limitation, and areas where wiring is not permitted.

Special consideration has also been given to the termination of coaxial cables, which cannot be wire-wrapped, and to twisted pair cable and shelf power wiring, which cannot be automatically wrapped.

Some difficulty has been experienced in formulating a set of compatible design rules for automatic and manual wiring. The greatest obstacle in resolving this problem has been the BPO's criterion that all shelves of a particular type manufactured by the companies participating in the System X project must have identical wiring. (This criteria is echoed throughout System X design to ensure that the same items (for example, equipped shelf) from different factories will not only look the same but, more important, will be electrically identical.)

Finally, guide-lines, such as those for choosing simple wiring patterns in preference to more difficult patterns, have been written into the design rules to aid efficient manufacture.

RACK CABLING DESIGN RULES

The application of miniaturization techniques in telecommunications equipment designs has resulted in more lines being packed into less space; the advantages of equipment miniaturization are obvious, but there are also disadvantages which may be less apparent.

Although the space required for telecommunications equipment has decreased considerably over the years, the associated cables or wires have not decreased in number or size by more than a factor of two or three. A major consideration in formulating design rules for System X was cable congestion. This has been alleviated as follows:

(a) rules or guide-lines have been drawn-up to inform system designers of the mix of cables that can be accommodated and the order in which they must be fitted.

(b) the System X equipment practice (Tep-1H)³ is so designed that the main cable channels on each side of the

rack are shared with those of the adjacent racks, and

(c) the number of cables that can be plugged onto the front and rear plug-in connector fields, or to SIUs, has been stipulated.

The total capacity of a rack main-cable channel (one per side) is 94 or 147 16-pair cables, depending on whether the rack is 520 mm deep or 630 mm deep. For System X, the rack height is 2164 mm, which gives accommodation for a maximum of 6 shelves. The Tep-1H equipment practice also has the facility to accommodate overhead and/or underfloor cabling.

CIRCUIT DESIGN RULES

Circuit design rules have been established that place constraints on the designer's use of components. Some of these design rules are mandatory; some are purely advisory. They have been set out in a document which is divided into sections, each of which covers a particular family of components; for example, resistors, delay lines, low-power Schottky transistor-transistor logic (LSTTL) or microprocessors. A further section on interconnexion design rules covers the requirements for connecting components together; for example, SIUs to SIUs, shelves to shelves and racks to racks. For a family of devices, each dedicated section covers the following areas:

- (a) the calculation of the power dissipation of individual devices,
- (b) the determination of the derating of the component performance specification to be applied, if any,
- (c) how the design should aid the testing of an SIU,
- (d) any special mounting arrangements required (for example, the mounting of high dissipation resistors off the surface of a PWB),
- (e) any restrictions to the application to which a device can be put (for example, the use of electrolytic capacitors because of deterioration during storage),
- (f) the loading capability of a device (for example, information on maximum output current of integrated circuits),
- (g) the maximum operating junction temperatures of semi-conductors,
- (h) the connexion of unused logic gate inputs and outputs (for example, connexions to earth and other inputs) to ensure that no extraneous condition is present that could upset the logic and that the state giving least power dissipation is defined,
- (i) the need for buffer stages in certain device applications that drive signals to another SIUs,
- (j) additional design information which is not in the device specification,
- (k) the effects of load capacitance on propagation delay,
- (l) when and how much power supply decoupling is required,

(m) when it is necessary to fit heat sinks, and

(n) design rules regarding the maximum interconnexion lengths between devices, use of twisted pairs, noise immunity, and the types of driver/receiver combinations to be used for particular applications.

The importance of the above rules lies in the fact that they enable common standards of design to be adopted, thus ensuring uniform high quality and reliability.

STANDARD CIRCUITS

System X has been designed to common standards, and it is the aim of the BPO to extend this philosophy where it proves feasible to do so.

In addition to the common design rules, whenever a group of components on a PWB form a circuit to perform a certain function which may have applications elsewhere (for example, a crystal oscillator circuit, or an on-card power supply), it should be assessed as a standard circuit and documented separately. The advantages of doing this are:

- (a) the need for additional component types to be added to the approval list is lessened;
- (b) maintenance staff have a smaller variety of functional blocks to maintain;
- (c) new designs can incorporate existing functional blocks, and thus design time can be saved; and
- (d) modules of SIU test programmes can be standardized and, because the design is well tried and tested, this should cause fewer problems than a completely new design.

CONCLUSION

This article has recorded the considerations that led to the establishment of design rules for the System X hardware and has given examples of their application.

ACKNOWLEDGEMENT

The author wishes to thank his colleagues for their help in the preparation of this article.

References

- ¹ SHEEKEY, B., and MILWAY, N. R. P. System X: Design and Support, Part 5—Change Control and Documentation Database. *POEEJ*, Vol. 73, p. 104, July 1980.
- ² HORTH, P. J., and REYNOLDS, R. A. System X: Design and Support, Part 2—Computer-Aided Design. *POEEJ*, Vol. 72, p. 234, Jan. 1980.
- ³ HARVEY, D. G. W. A New Equipment Practice for Exchange Switching Equipment and other Applications: Tep-1H. *POEEJ*, Vol. 73, p. 171, Oct. 1980.

Institution of Post Office Electrical Engineers

General Secretary: Mr. R. E. Farr, THQ/TE/SESS.3, Room 1156, 207 Old Street, London EC1V 9PS; Tel: 01-739 3464, Extn. 7223
(Membership and other local enquiries should be directed to the appropriate Local-Centre Secretary as listed in the October 1980 issue)

PROPOSED CHANGES TO RULES 33 AND 34

The number of objections received by the due date to the proposed changes to Rules 33 and 34 was 78. In accordance with the existing Rule 33, which will now continue to apply, the changes will not be implemented. Council will reconsider its proposals and it is likely that new proposals will be put to the membership with other proposed rule changes consequential upon Post Office separation during 1981. An apology is due to members of the London Centre, many of whom did not receive details of the proposed changes until after the closing date for objections, because of a failure in the distribution arrangements. More time will be allowed for objections on future occasions to ensure that this situation does not arise again. Members may rest assured that rule changes would not be implemented where there has been a clear case of disenfranchisement such as this, even without the required number of objections.

The Council of the Institution has decided to defer the proposed changes of the title of the Institution and of the *Journal*, originally contemplated for April 1981. Proposals will be put to the membership in due course.

THE FEDERATION OF TELECOMMUNICATIONS ENGINEERS OF THE EUROPEAN COMMUNITY (FITCE)

A final attempt is being made to reach a compromise agreement with FITCE on the conditions under which IPOEE members may join the Federation. Members will be advised of the outcome as soon as possible.

R. E. FARR
Secretary

IPOEE CENTRAL LIBRARY

The books listed below have been added to the IPOEE library since the publication of the 1974 Library Catalogue. Any member who does not have a copy of the catalogue can obtain one on loan from The Librarian, IPOEE, 2-12 Gresham Street, London EC2V 7AG. Library requisition forms are available from the Librarian, from local-centre and Associate Section centre secretaries and representatives. The form should be sent to the Librarian. A self-addressed label must be enclosed.

5310 *Mechanical Science for Technicians*. I. McDonagh (1979)

This book makes use of worked examples, which are integrated with the text, to relate the principles under discussion to their practical applications. It covers the content of the TEC standard unit Mechanical Science III.

5311 *Microprocessors for Hobbyists*. R. Coles (1979)

This book, which is based on a series in *Practical Electronics*, is an introduction to this challenging field, and should appeal to both computer and electronics hobbyists.

5312 *Transmission Networks and Circuits*. R. V. Buckley (1979)

The contents of this book cover transmission line theory from

first principles without the use of Maxwell's equations, leading up to the network equivalent of a line. By this means the author presents a logical follow-up to the study of networks in general, including circuit theorems and asymmetrical circuits, matched to image and iterative impedance and insertion loss.

5313 *Optical Fibre Communications*. Edited by M. J. Howes and D. V. Morgan (1980)

The use of glass fibres as a medium for transmission lines in optical communication systems has reached the stage where systems are being constructed and evaluated. This book is about the history and development of glass fibres; it includes a chapter written by Dr. J. E. Midwinter and Dr. I. Garrett of the British Post Office's Research Department.

5314 *The Nuclear Power Decisions*. R. Williams (1980)

Nuclear power is a highly controversial and even emotive issue but, because of its political-economic and technical complexity, it is little understood by those not directly involved in its operation. This book examines and documents the major British decisions which have been taken in the nuclear field, and argues that the subject has not been fully understood by many of the decision makers.

5315 *The Big Bang*. J. Silk (USA, 1980)

Written for non-specialists, this book describes the contemporary achievements in astronomy, cosmology and astrophysics which have allowed science to describe, with some degree of certainty, the origin and evolution of the universe.

5316 *The History of the Telescope*. H. C. King (USA, 1979)

This book, although unconventional, is a definitive history which tells the story of not only the early inventors and astronomers, but also the instrument makers and the instruments.

5317 *The Architecture of Microcomputers*. S. E. Greenfield (USA, 1980)

This publication seeks to communicate the basic principles of microcomputer architecture in such a way that it is of relevance to both theoretician and the microcomputer user. By concentrating on principles rather than the operations of specific types of microcomputers, the book offers a good general grounding in this increasingly important field.

5318 *Visual Display Terminals*. A. Cakir, D. J. Hart, and T. F. Stewart (1980)

This book is a standard work covering all aspects of visual display terminals, including health and safety, ergonomics, workplace design and task organization.

5319 *Semiconductor Devices and Integrated Electronics*. A. G. Milnes (USA, 1980)

This is a comprehensive digest and reference book which carries diode and transistor theory beyond introductory level and which touches on a wider range of semiconductor-device principles and applications.

R. CROSS
Librarian

Notes and Comments

CHANGE OF ADDRESS OF EDITORIAL OFFICE

The Editorial office of the *Journal* is now located in Room 704, Lutyens House, Finsbury Circus, London EC2M 7LY and the telephone number for general enquiries is 01-357 4313. Please note that the Sales office of the *Journal* is still located at 2-12 Gresham Street, London EC2V 7AG.

CONTRIBUTIONS TO THE JOURNAL

Contributions to the *POEEJ* are always welcome. In particular, the Board of Editors would like to reaffirm its desire to continue to receive contributions from Regions and Areas, and from those Headquarters departments that are traditionally modest about their work.

Anyone who feels that he or she could contribute an article (short or long) of technical, managerial or general interest to engineers in the Post Office is invited to contact the Managing Editor at the address given below. The editors will always be pleased to give advice and try to arrange for help with the preparation of an article, if needed.

GUIDANCE FOR AUTHORS

Some guiding notes are available to authors to help them prepare manuscripts of *Journal* articles in a way that will assist in securing uniformity of presentation, simplify the work of the *Journal*'s editors, printer and illustrators, and help ensure that authors' wishes are easily interpreted. Any author preparing an article is invited to write to the Managing Editor, at the address given below, to obtain a copy.

All contributions to the *Journal*, including those for Associate Section Notes, must be typed, with double spacing between lines, on one side only of each sheet of paper.

As a guide, there are about 750 words to a page, allowing for illustrations, and the average length of an article is about 6 pages, although shorter articles are welcome. Contributions should preferably be illustrated by photographs, diagrams or sketches. Each circuit diagram or sketch should be drawn on a separate sheet of paper; neat sketches are all that is required. Photographs should be clear and sharply focused. Prints should preferably be glossy and should be unmounted, any notes or captions being written on a separate sheet of paper. Good colour prints and slides can be accepted for black-and-white reproduction. Negatives are not required.

It is important that approval for publication is given at organizational level 5 (that is, at General Manager/Regional

Controller/THQ Head of Division level) and authors should seek approval, through supervising officers if appropriate, before submitting manuscripts.

Contributions should be sent to the Managing Editor, *The Post Office Electrical Engineers' Journal*, NEP 12, Room 704, Lutyens House, Finsbury Circus, London EC2M 7LY.

CORRECTION

High-Speed Digital Transmission in the British Post Office Coaxial Network

As pointed out by Mr. G. S. Mills of Colchester, the presence of two serious errors in Fig. 6 on p. 147 of the October 1980 issue of the *Journal* greatly confuses the understanding of the test method. The errors are:

(a) The position of the fault impedance was transposed. Such a fault can, of course, only be detected when present in the pair under test.

(b) The link between the receiver and the oscilloscope was omitted.

Apologies are offered for any confusion that may have been caused and a corrected diagram is reproduced below.

The opportunity has also been taken to make it clear that the connexion between the connector and the transition unit is a metal plate.

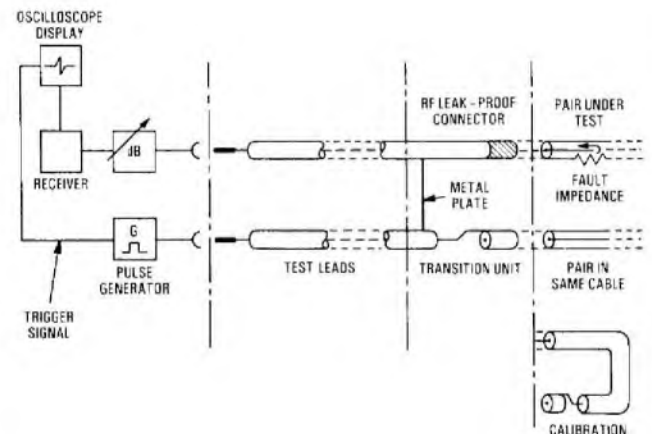

Associate Section Notes

BELFAST

The reorganization of the centre's committee at the beginning of last season resulted in an upsurge of activity during the year. A visit early in the year to the new Cregagh TXE4 telephone exchange proved to be so popular that two additional visits had to be arranged to satisfy the demand. This visit was followed by another to the STC factory at Monkstown to see the TXE manufacturing process.

Technical quizzes also figured prominently during the season, and 5 teams contested the centre championship; but stiff opposition in the Regional Quiz prevented a repeat of our team's success of last year at this level. The friendly quiz,

which took place between the new centre, Downpatrick, and our team, is now likely to become an annual event.

Earlier in the year, 4 lectures were given at the centre: *Prestel*, given by Mr. J. B. Millar of the Northern Ireland Telecommunications Board; *MAC*, given by Mr. D. Doherty of the Belfast Telephone Area; *System X*, given by Mr. B. Somerset of the Technical Training College, Stone; and *A Modern Approach to Engineering Training*, given by Mr. M. Thompson of the Technical Training College, Stone.

The satisfactory level of attendance last year has given the committee encouragement for the new season, the first meeting of which was held last September.

D. McLAUGHLIN

LUTON

The centre's programme since the annual general meeting has been reasonably full and well supported.

The centre's summer season opened with a lecture by Fred Darrell on the *Canadian Post Office*. Subsequently, members visited the US air-force base at Alconbury, where they were able to view closely a *Phantom* aeroplane; an open-cast coal mine; and the Bristol model railway exhibition, which has now become an annual event. In addition, an evening visit was arranged to the permanent model railway exhibition at Pendon museum near Didcot in Oxfordshire. After being

shown static and working models, our party was shown a new model which was being constructed. When completed, this new model will represent a section of railway landscape reproduced in every detail, and it will be one of the largest in OO scale. The detail, especially of the model buildings, was much admired by everybody, even those who had no special interest in modelling.

Intended activities for the future include talks on the *Swiss railway system*, and *amateur radio*, and visits to Lotus cars, the Road Research Laboratory and Bracknell weather centre.

P. R. OSBORNE.

Post Office Press Notice

NEW DIAL-UP DATA SERVICE WITH FULL DUPLEX

A new service for sending data over the public switched telephone network (PSTN), providing simultaneous both-way transmission at 4 times the speed previously available, has been successfully launched by British Telecom.

Known as Datel 1200 Duplex, the new service offers full duplex data transmission at 1200 bit/s over single exchange-line connexions to the PSTN. Until now, this facility has been available on dial-up only in the Datel 200 service, which provides full duplex transmission at up to 300 bit/s. All other duplex transmission requires private circuits, or 2 exchange line connexions to the modem.

The new facility will offer customers many new applications for two-way data transfer not practicable at the lower bit rate. Examples include on-line graphics, software development, and advanced financial programs. By providing data transmission at 4 times the speed previously possible, the new service offers prospects of reduced call charges or the ability to send a greatly increased volume of data for the same call charge.

Datel 1200 Duplex is based on a proprietary modem (modulator/demodulator) which broadly meets recommen-

dation V22B of the International Telegraph and Telephone Consultative Committee (CCITT). The Datel 1200 Duplex was the subject of a detailed trial last year.

The modem offers a wide range of test facilities to enable customers to diagnose faults directly. Pushing test buttons on the modem generates a test pattern of data which can be circulated within the modem itself or sent down the line to the distant modem and back to provide a check of the full transmission circuit.

Although there is as yet no formal agreement with other countries under which an international Datel 1200 Duplex service is available, customers of the inland service may use the new modem for full duplex data transfer on international dial-up connexions, provided the distant modem is compatible, and the other telephone company, or administration, agrees.

The new service is the first step in a phased introduction of Datel services providing full duplex transmission at 1200 bit/s with a range of customer facilities. British Telecom is now evaluating tenders for a contract to develop a full facility modem, providing full duplex data transmission over the PSTN or private circuits at 1200 bit/s, but falling back to 600 bit/s where the higher speed may not be wholly successful.

Forthcoming Conferences

Further details can be obtained from the conference department of the organizing body.

Institution of Electrical Engineers, Savoy Place, London WC2R 0BL.
Telephone: 01-240 1871

Telecommunication Transmission

17-20 March 1981
Institution of Electrical Engineers

Antennas and Propagation

13-16 April 1981
University of York

International Telecommunications Energy Conference

19-21 May 1981
Royal Lancaster Hotel, London

Software Engineering for Telecommunication Switching Systems

20-24 July 1981
University of Warwick

Electronic Design Automation

1-4 September 1981
University of Sussex

POEEJ: SUBSCRIPTION ORDER FORM

Those wishing to subscribe to *The Post Office Electrical Engineers' Journal* can do so by completing the relevant section of the order form below. British Post Office (BPO) staff should complete the upper section and send it to their local *POEEJ* agent or, in case of doubt, to the address shown; non-BPO staff should complete the lower section. A photocopy of this form is acceptable.

SUBSCRIPTION ORDER (BPO STAFF)

To: The Local Agent (*POEEJ*), or
The Post Office Electrical Engineers' Journal (Sales),
2-12 Gresham Street, London EC2V 7AG.

The Post Office Electrical Engineers' Journal:
Authority for Deduction from Pay

Please arrange for me to receive *The Post Office Electrical Engineers' Journal*. I have completed the form opposite authorizing deductions from pay to cover the special annual subscription of £1.92.

I,
(name in full, surname first in block capitals), authorize the deduction from my salary or wages, until further notice, of the sum of 16p per month/4p per week for 48 weeks for payment to the Managing Editor, *The Post Office Electrical Engineers' Journal*, on my behalf.

Date Signature

Date Signature

Name and initials (in block capitals) Rank

Official address

Official address

Rank Pay No.

Area/Dept.

YEARLY SUBSCRIPTION ORDER (NON-BPO STAFF)

To: *The Post Office Electrical Engineers' Journal* (Sales),
2-12 Gresham Street, London EC2V 7AG.

Name

Please supply 4 quarterly issues of *The Post Office Electrical Engineers' Journal*. I enclose a cheque/postal order for the sum of £5.20 (Canada and the USA: \$12) to cover the yearly subscription.

Address

(Cheques and postal orders, payable to "*The POEE Journal*", should be crossed "& Co." and enclosed with the order. Cash should not be sent through the post.)

Please state with which issue you wish your subscription to commence (April, July, October or January).....

The Post Office Electrical Engineers' Journal

Copyright

The entire contents of this *Journal* are covered by general copyright, and special permission is necessary for reprinting long extracts, but editors are welcome to use not more than one-third of any article, provided that credit is given at the beginning or end, thus: "From *The Post Office Electrical Engineers' Journal*".

The Board of Editors is not responsible for the statements made nor the opinions expressed in any of the articles or correspondence in this *Journal*, unless any such statement is made specifically by the Board.

Remittances

Remittances for all items (except binding) should be made payable to "*The POEE Journal*" and should be crossed "& Co."

Advertisements

All enquiries relating to advertisement space reservations, copy, proofs, etc. should be addressed to Mr. N. G. Crump, The Advertisement Manager, *Post Office Electrical Engineers' Journal*, Room 506D, 2-12 Gresham Street, London EC2V 7AG (Telephone: 01-357 2089).

Subscriptions and Back Numbers

The *Journal* is published quarterly in April, July, October and January, at 80p per copy (£1.30 per copy including postage and packaging); annual subscription: £5.20; Canada and the USA: \$12.00.

The price to British Post Office staff is 48p per copy.

Back numbers will be supplied if available, price 80p (£1.30 including postage and packaging). At present, copies are available of all issues from April 1974 to date with the exception of the April and October 1975 and April 1976 issues.

Orders, by post only, should be addressed to *The Post Office Electrical Engineers' Journal*, 2-12 Gresham Street, London EC2V 7AG.

Employees of the British Post Office can obtain the *Journal* through local agents.

Distribution and Sales

Correspondence relating to the distribution and sale of the *Journal* should be addressed to *The Post Office Electrical Engineers' Journal* (Sales), 2-12 Gresham Street, London EC2V 7AG.

Communications

With the exceptions indicated above, all communications should be addressed to the Managing Editor, *The Post Office Electrical Engineers' Journal*, NEP12, Room 704, Lutvens House, Finsbury Circus, London EC2M 7LY (Telephone: 01-357 4313).

Model-Answer Books

Books of model answers to certain of the City and Guilds of London Institute examinations in telecommunications are published by the Board of Editors. Copies of the syllabi and question papers are not sold by *The Post Office Electrical Engineers' Journal*, but may be purchased from the Sales Department, City and Guilds of London Institute, 76 Portland Place, London W1N 4AA.

Binding

Readers can have their copies bound at a cost of £7.50, including return postage, by sending the complete set of parts, with a remittance, to Press Binders Ltd., 4 Iliffe Yard, London SE17 3QA.

INDEX TO ADVERTISERS

Advertisements

Communications, advertisement copy, etc., should be addressed to Mr. N. G. Crump, The Advertisement Manager, *POEEJ*, Room 506D, 2-12 Gresham Street, London, EC2V 7AG (Tel: 01-357 2089).

No responsibility is accepted by the Journal for any of the private or trade advertisements included in this publication.

Area Intertrade Ltd.	3
C P Developments	8
Dale Electric of GB Ltd.	8
Ferranti Ltd.	6
GEC Telecommunications Ltd.	2
Herman Smith Ltd.	1
Open University	4
Plessey Communications and Data Systems Ltd.	9
Siemens Ltd.	10
Southway Electronics Ltd.	5
Terracom	7
Watford Control Instruments Ltd.	8

IPOEE CENTRAL LIBRARY

Any member who does not have a copy of the catalogue can obtain one on loan from the Librarian, IPOEE, 2-12 Gresham Street, London EC2V 7AG. Library requisition forms are also available from the Librarian, from honorary local-centre secretaries, and from Associate Section centre secretaries and representatives.

Alternatively, the panel below, or a photocopy, can be used (only by members) to borrow any book listed in the catalogue or in the updating lists published in recent issues of the *POEEJ*. The form should be sent to the Librarian at the address above; a self-addressed label must be enclosed.

IPOEE Central Library
LIBRARY REQUISITION FORM

*For use only by members of the Institution of Post Office
Electrical Engineers*

Author

Title

.....

Catalogue No..... Date.....

Name

Official Address.....

Good things come in little packages!

In a telephone exchange, the layout and equipment racking makes it extremely tricky to fault find with the conventional oscilloscope. The SCOPPLE (designed & developed by Southways in conjunction with STC) is effectively a mini scope, with the time-base frozen, it will display AC or DC voltages in 2 ranges, ie $\pm 12V$ $\pm 50V$ on a bright green LED display with a red LED to indicate centre zero. Pulses down to 1 Mille/Sec can be seen in the normal mode or for fleeting pulses, a storage mode can be switched in. — The Post Office tried it, and they found it so useful they gave it a number PO Tester 286A

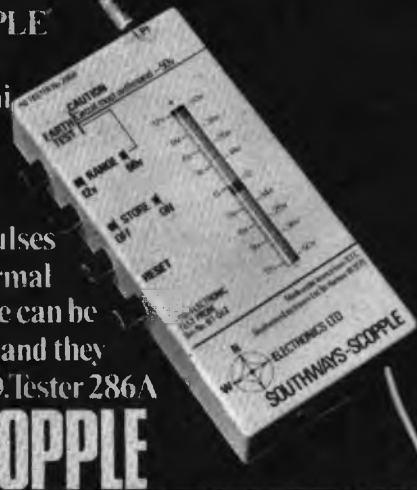

THE SOUTHWAYS SCOPPLE

We design, develop and manufacture electronic testing equipment for use in the tele-communications industry. P.O. Approved.



ELECTRONICS LTD.
Horsecroft Place, Harlow Essex.
Telephone (0279) 413179

SOUTHWAYS

Please send further information about the Scopple

Name

Address

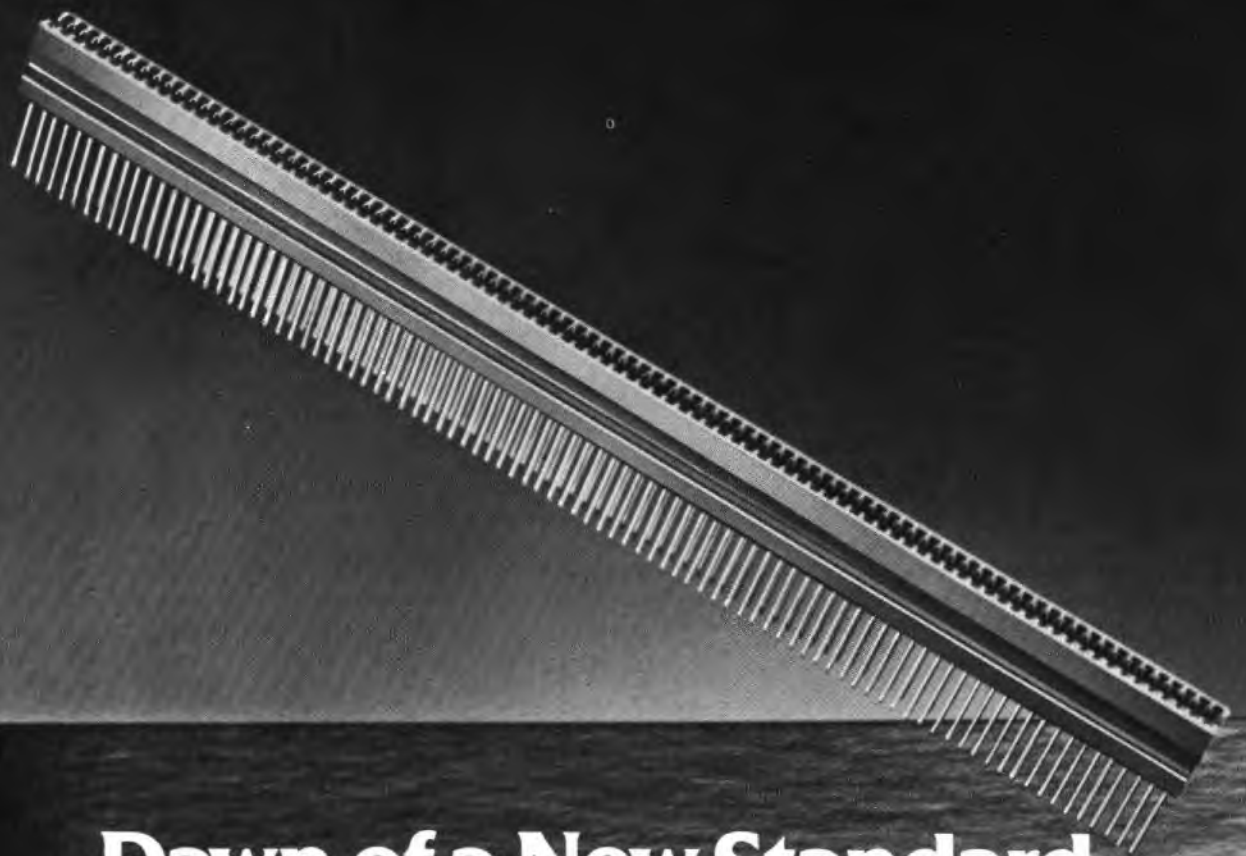

Dawn of a New Standard.

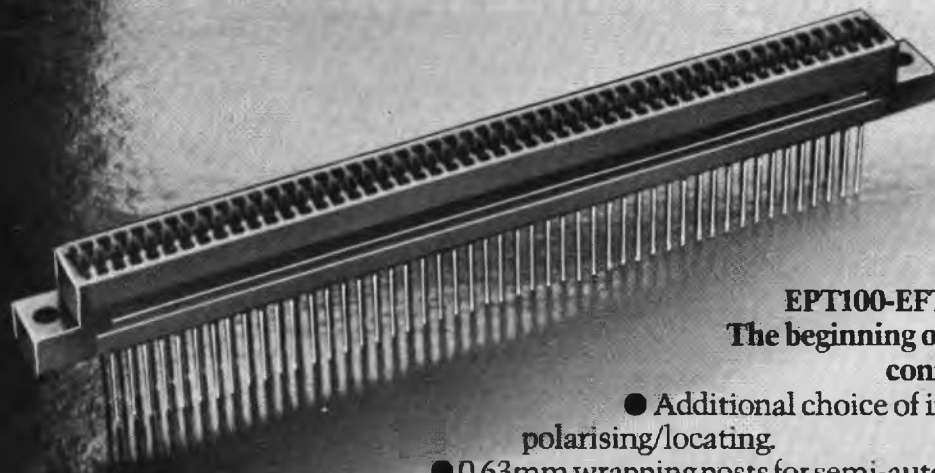

EPT100-EFT100 (2.54 mm pitch)
The beginning of even better Ferranti connectors.

- Additional choice of in-between contact polarising/locating.
- 0.63mm wrapping posts for semi-automatic wire wrapping.
- Increased temperature range: -55°C to $+125^{\circ}\text{C}$.
- 5 amps rating at 25°C .
- New polarising key with wire insert for positive retention.
- EFT connector compatible with HE.901 specification.
- EPT connector compatible with BS.9520 specification.
- Ferranti have approval for the 206D connector to Spec D 2343 and .100" Pitch connectors to Spec D 2552.

Contact: Connector Sales, Ferranti Limited,
Professional Components Department, Dunsinane Avenue, Dundee
DD2 3PN, Scotland. Telephone: 0382 89321 Telex: 76166

FERRANTI
Connector Capability

THE MICROWAVE RADIO FOR EVERY USE

Selected by British Post Office Again!

Also by Post and Telegraph, Ireland; LGT, France ; Telecoms Australia, and others.

Frequency Agility

The TCM-6 is tunable across each band from 1.7 to 15.35 GHz. Change bands by plug-in RF module replacement.

Full Performance

Color video with FM or digital subcarrier channels, 1800 FDM voice channels, 34 Mb/s digital data or wideband radar video.

Proven Operation

More than 2000 TCM-6 radios are used worldwide, from arctic to desert, by major television and telecommunications administrations.

Fixed Link or Portable

Simplex, duplex and diversity operation in tripod, tower or rack mount configuration.



Loral Corporation

for stable ac voltage

...the world
talks to
Watford Control

Watford Control Instruments Ltd
Riverside Rd Watford WD1 4HZ England
Telephone Watford (0923) 41313
Telex 261739

Electromechanical ranges

Widest stabiliser choice in Europe, and still growing! Ratings from 250VA to 1300kVA three phase, with high and low voltage options and no less than 8 swing ranges.

Solid state ac voltage stabilisers

Our latest solid state technology brings even lower distortion and higher accuracy. Ratings from 22VA to 75kVA, single or three phase, with new wide swing and low-cost open OEM options.

Low-cost voltage compensators

3 step AVC auto transformers with zero voltage switching, in ratings up to 10kVA. Hold output voltages to within $\pm 6\%$ or $\pm 10\%$ of nominal.

New filter option

Transient voltage attenuation can be added to all our stabilisers.

Uninterruptible power supplies

New rectifier/charger, battery pack and inverter sets that keep vital ac power supplies stabilised to specification, even if the mains fails! Three models, from 500VA to 2kVA rating.

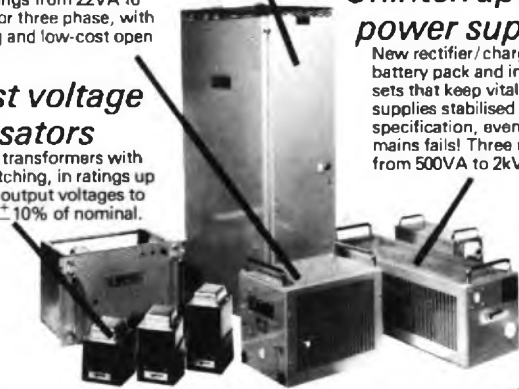

Daylight conditions at the press of a button.

Stem-Lite

The high intensity floodlighting system needed by the emergency services to provide high intensity illumination, even at night, at the scenes of fires, road accidents and other major incidents.

Stem-Lite is the world's most advanced, high performance vehicle-mounted floodlight that gives near daylight conditions at the press of a button, improving the safety and efficiency of emergency personnel.

The complete system retracts into a 380mm x 450mm housing



DALE

EMERGENCY PRODUCTS DIVISION,
Osprey Margaret's Road Industrial Estate, Scarborough,
North Yorkshire YO11 2YH, U.K. Telephone: 0723 71371 Telex: 52163.

- Beacon rises above obstructions to give increased, advance warning.
- Extendable mast rises automatically to 2.5 metres above the vehicle.
- Two levels of floodlighting intensity available. The 2000 watts from the halogen lamps provides near-daylight illumination up to a radius of 33 metres.
- Optional illumination identification signs.

QUALITY

RELIABILITY

POST OFFICE and MoD STANDARDS

FOR FIVE YEARS WE HAVE WORKED TO THIS POLICY

- P. C. B. ASSEMBLY
- ARTWORK DESIGN
- TEST FACILITY AVAILABLE
- DESIGN MICROPROCESSOR AND DISCRETE LOGIC
- PRIORITY SERVICE WHEN TIME MATTERS

Telephone Telex or Write for Brochure

C P Developments

VERNON BUILDING, WESTBOURNE STREET,
HIGH WYCOMBE, BUCKS. HP11 2PX
TEL: HIGH WYCOMBE 448888 TELEX: 837225

TEP-1 (E)*

*For the
racking practice*

PLESSEY

makes perfect

The new TEP-1 (E) practice calls for a complete new racking system, with structural members manufactured from stainless steel pressings. Plessey are fully tooled up and already in production. Indeed, Plessey can now meet the requirements of any manufacturer working to the new practice specifications and offer competitive delivery times and pricing.

Before you are committed to expensive tooling costs and the prices imposed by short runs, have a word with Plessey at Beeston. Our commitment to TEP-1 (E) practice could well be a help to you.

Ring Andrew Riddle on Ext. 4602.



PLESSEY
telecommunications

Plessey Communications and Data Systems Limited,
Beeston, Nottingham, United Kingdom NG9 1LA.
Telephone Nottingham (0602) 254831 Telex 37468.

*Registered trademark The Post Office

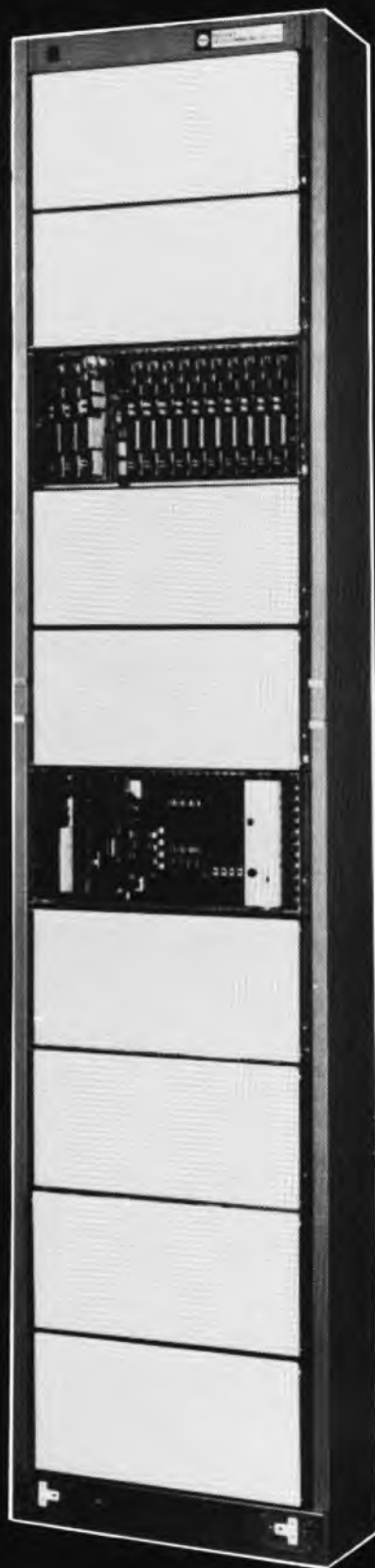

*All the elements of the TEP-1 (E)
racking are available from Plessey.*

SIEMENS

Compact, reliable connectors. Approved for use on TEP.IE.*

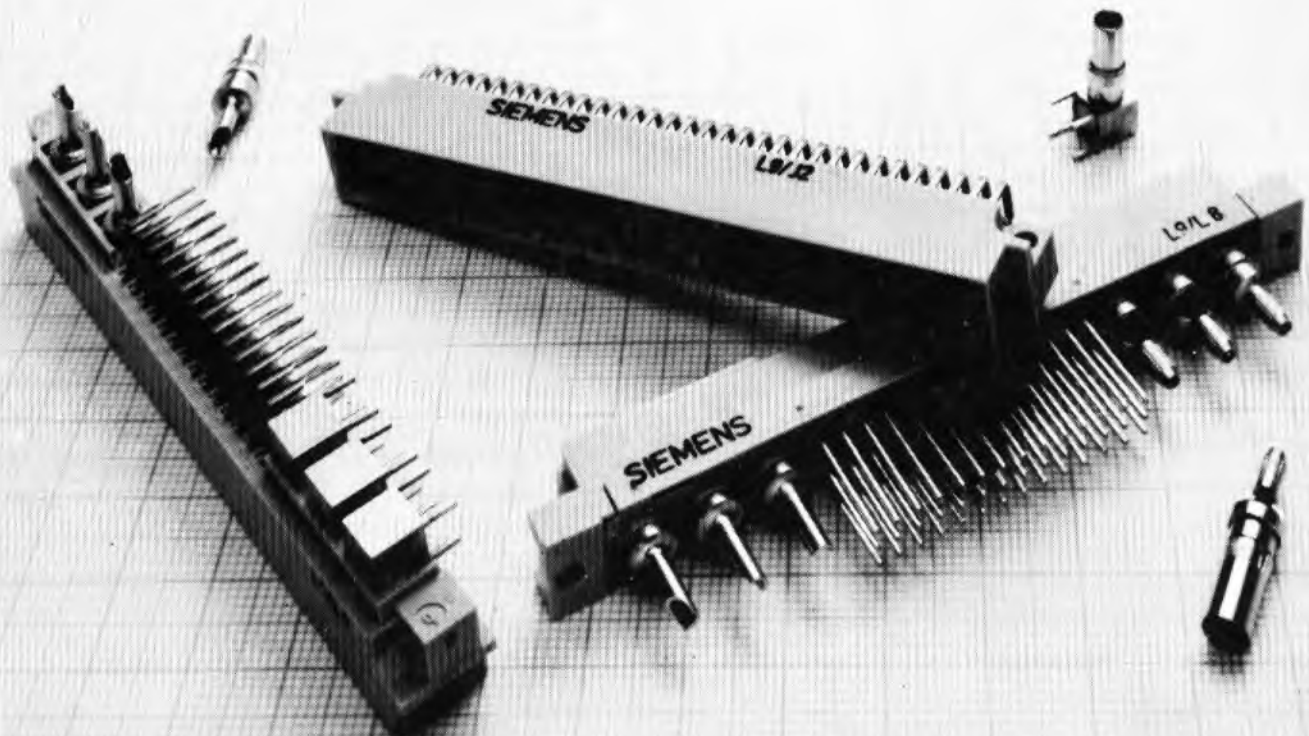

Designed for conditions encountered at speeds in excess of Mach 2, Siemens connectors are the vital links upon which the reliability of today's most sophisticated electronic systems depends. In the continuing development and improvement of our connector ranges, reliability, cost reduction, and space saving are major considerations. Siemens connectors comply with standards specific to communications, electronics and data processing. Two-part connectors are made

according to DIN 41612 and IEC 130-14 standards, with VG95324 military approval, and, therefore meet the demanding environmental requirements of military and avionic systems. These two-part connectors have also been approved by the major UK Government contractors.

Siemens Limited, Siemens House, Windmill Road, Sunbury-on-Thames, Middlesex TW16 7HS.
Telephone: Sunbury (09327) 85691
Telex: 8951091

In the world of electronic components Siemens has the answer.

* Registered trade mark of the Post Office