

The Post Office Electrical Engineers' Journal

*Mr. R. A. Roe.
P.E. 21*

VOL 72 PART 1 APRIL 1979



THE POST OFFICE ELECTRICAL ENGINEERS' JOURNAL

VOL 72 PART 1 APRIL 1979

Contents

Editorial	1
System X and the Evolving UK Telecommunications Network L. R. F. Harris and E. Davis	2
Conclusions from the Empress Digital Tandem Exchange Field Trial B. R. Kerswell and W. G. T. Jones	9
The Electret: A Possible Replacement for the Carbon Microphone R. R. Walker and A. J. Morgan	15
Semiconductor Laser Development and Production	19
Main Transmission Network: Planning of Digital Transmission Systems D. J. Beckley	27
A Standard Control System for Thyristor Rectifiers J. P. Henderson	36
Operational Experience and Evaluation of the British Post Office Experimental Packet-Switched Service P. D. G. Marlow-Mann	43
A New Mobile Unit for the Radiophone Service: Development of a 55-Channel Unit D. G. Wood	50
Use of Single-Channel-per-Carrier Terminal Equipment at Satellite System Earth Stations S. A. Foulkes and A. J. Keane	54
STEMSS: Satellite Telegraph Engineering and Management Switching System P. A. Carruthers, S. L. Biggs and R. G. K. Gorvin	59
A New Telecommunications System for the Greater Manchester Police Authority D. H. Wilkinson	66
Institution of Post Office Electrical Engineers	67
Notes and Comments	68
The Associate Section National Committee Report	69
Associate Section Notes	69
Forthcoming Conferences	70
Post Office Press Notice	66
Book Reviews	8, 26, 42

Published in April, July, October and January by *The Post Office Electrical Engineers' Journal*,
2-12 Gresham Street, London EC2V 7AG.

Price: 55p (80p including postage and packaging). Orders by post only.

Annual subscription (including postage and packaging): home and overseas £3.20.
(Canada and the USA \$6.50.)

Price to British Post Office staff: 36p.

© 1979: The Institution of Post Office Electrical Engineers.

Approved Components

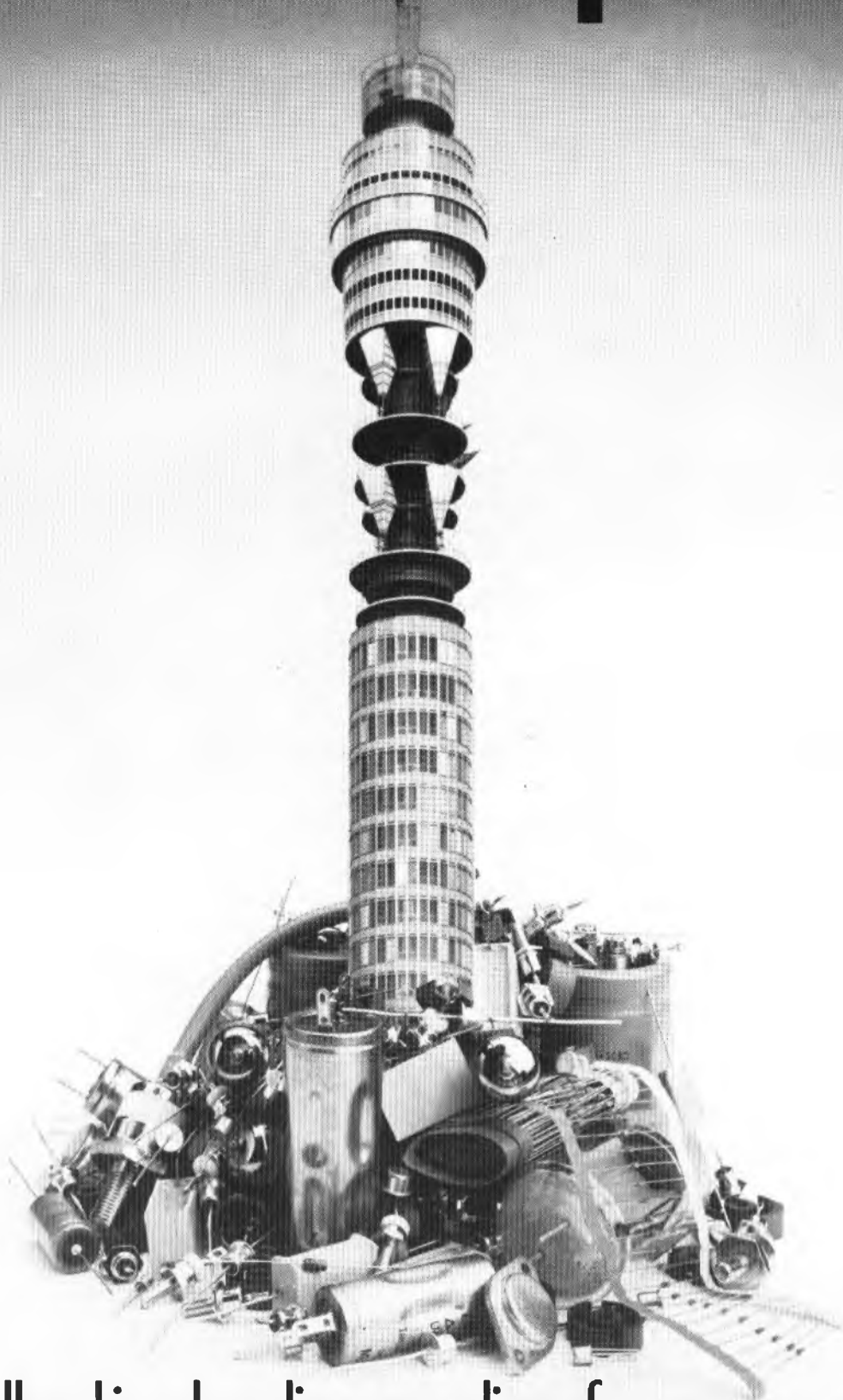

Mullard is a leading supplier of components
used by the Post Office



Mullard Limited, Mullard House,
Torrington Place, London WC1E 7HD.
Telephone: 01-580 6633
Telex: 264341

Mullard



Mullard manufacture and market electronic components under the Mullard, Philips and Signetics Brands.

The GEC 746 puts Jackie Kawalski in touch with room 137 or her boyfriend.

Whether the call is to the same building or a different continent, it begins and ends with the familiar telephone.

The GEC 746 table telephone incorporates the latest technology associated with a rotary dial signalling instrument and is suitable for reliable operation in a wide range of climatic and environmental conditions.

All component parts can be easily replaced and the telephone which includes automatic volume regulation as a standard feature, can be provided with a wide range of optional facilities to give maximum operational flexibility.

The GEC 746 is a highly reliable telephone which is ruggedly constructed in tough high-impact plastic.

Whether the call is to the same building or a different continent The GEC 746 is an aesthetically pleasing telephone available in a range of seven colours and is equally at home in a domestic or business environment.



GEC

Telecommunications

GEC manufacture telephones for world markets: table and wall-mounting models, pushbutton telephones, switching telephone systems, and subscribers carrier equipment.

CF 8

GEC Telecommunications Limited

Telephone Division, Whinbank Road, Aycliffe, Co. Durham, England. A Management Company of The General Electric Co. Ltd., of England.

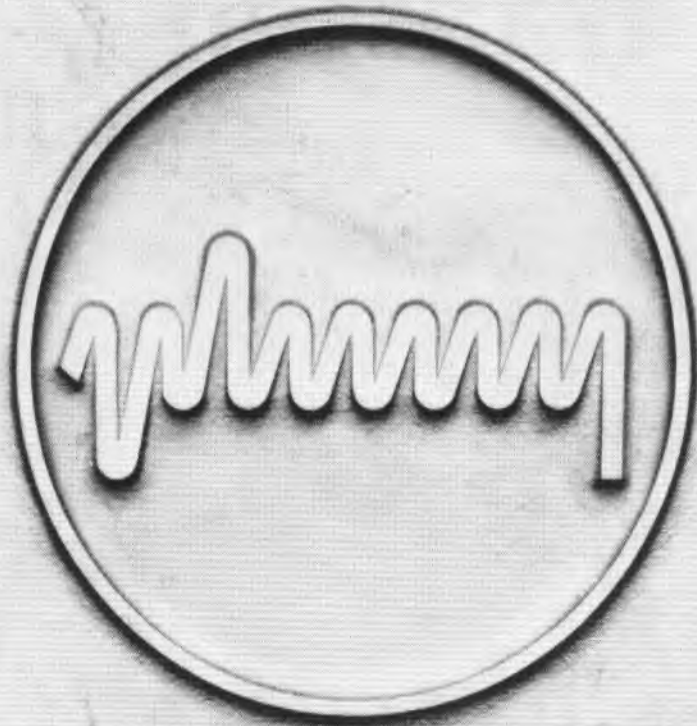

PLESSEY

**world-wide leadership
in telecommunications
and electronics**

Plessey Telecommunications Limited
Edge Lane, Liverpool, England L7 9NW
Telephone: Liverpool (051) 228 4830 Telex: 629267

A Thorn Ericsson PABX can provide over twenty aids * to efficient communications. Here is one of them

Automatic Transfer

After an incoming call has been routed to an extension by the operator, the extension can transfer the call automatically to another extension by use of the service button on the instrument. To avoid a 'lost' call, special safeguards have been built into the system.



For optimum efficiency and maximum flexibility

A Thorn Ericsson PABX can be built up with extra lines, extensions or facilities as traffic needs increase.

Planning ahead with a Thorn Ericsson 561 or 562 PABX will give you that efficiency and flexibility that is a real investment.

Contact: PABX Division, Thorn Ericsson Telecommunications (Sales) Ltd., Viking House, Foundry Lane, Horsham, Sussex. Telephone Horsham 641 66.

* *Other facilities available include: Barred Extensions (stops unauthorised calls), Hold for Enquiry, Repeated Enquiry, Camp-on Busy, Call Announcing, Trunk Offering, Parking Incoming calls, Automatic Transfer, Night Service (Three methods), Inter PABX connexion (Private wires), Group Calling, Direct Dialling-in, Automatic Call Back and many more*

SAVE TIME. Simply clip this coupon to your letter heading and send to **Thorn Ericsson, Freepost, Horsham, Sussex.**

No stamp needed

Name _____

Please arrange for me to have:
details of PABX's

A technical adviser (appointment)

A Demonstration of PABX

**THORN
ERICSSON**



The Post Office Electrical Engineers' Journal

BOARD OF EDITORS

J. F. P. Thomas, B.SC., C.ENG., M.I.E.E., Chairman

A. J. Barnard, C.ENG., M.I.E.E.

K. Chinner

C. E. Clinch, B.SC.(ENG.), C.ENG., F.I.MECH.E., F.I.E.E., F.S.S.

E. Davis, C.ENG., M.I.E.E.

R. C. Taylor

G. White, B.SC., PH.D., SEN.MEM.I.E.E.E.

Managing Editor

D. J. Holmes

Assistant Editor

A. R. Lawrence, C.ENG., M.I.E.E.E.

Secretary-Treasurer

B. Farr

EDITORIAL

The series of articles in this *Journal* describing the family of digital-switching telephone exchanges (System X) continues in this issue with the article on page 2: the article discusses the use of System X in the UK telecommunications network.

Articles scheduled for publication in future issues of this *Journal* will describe

(a) the principles of System X (including aspects related to digital switching, common-channel signalling and processor control),

(b) the architecture of System X (including description of the structure of main-centre and local exchanges),

(c) the subsystems of System X,

(d) the hardware and software technology, and

(e) the design and support of modern switching systems and the management of the System X project.

From the above, it can be seen that the *Journal* will give comprehensive coverage in its description of System X; a system that is of immense importance to the future development of the UK telecommunications network and which has the capability to compete effectively in the world's export markets.

A prime role of the *Journal* is to report on new projects in the field of telecommunications engineering. However, it is appropriate at times to report on the status of projects that have featured in past articles published in this *Journal*. Examples of such reports are included in this issue: the article on page 43 reports on the operational experience of the British Post Office experimental packet-switched service; the article on page 9 gives conclusions drawn from the Empress digital-tandem-exchange field trial.

System X and the Evolving UK Telecommunications Network

L. R. F. HARRIS, M.A., C.ENG., F.I.E.E., and E. DAVIS, C.ENG., M.I.E.E.†

UDC 621.395.34

The first article¹ about System X published in this Journal outlined the system concepts, and described the basis on which the design is being undertaken and the present position. This second article discusses, in general terms, the use of System X in the UK telecommunications network. It will be followed in future issues of this Journal by a number of articles covering the detailed design of the various types of exchange and supporting systems.

INTRODUCTION

An earlier article¹ has given a brief description of the basis and arrangement of the family of switching and associated systems known as *System X*, and has indicated the progress being made with the detailed design. Orders for early production digital trunk, junction and small local exchanges have now been placed and it is planned to have the first exchange in public service before the end of 1981.

The use of System X in the UK telecommunications network is discussed in general terms in this article. It will be followed in future issues by a number of articles covering the detailed design of the various types of exchanges and supporting systems.

EXISTING NETWORK

There are now some 25 million telephones in the UK telecommunications network, with 16 million working lines (connexions) to more than 6000 British Post Office (BPO) local telephone exchanges. These local exchanges are interconnected via some 400 higher-order exchanges (mainly group switching centres (GSCs)) and a very large number of trunk and junction lines or circuits; there are currently some 300 000 circuits in the main network and approaching one million circuits in the junction network.

All BPO telephone customers are now connected to automatic exchanges, mainly Strowger and crossbar electro-mechanical exchanges, but with a rapidly increasing number connected to reed-relay electronic exchanges. There are currently nearly 1000 small electronic exchanges (TXE2) in service, and more than 300 large electronic exchanges (TXE4) are in course of installation or on order. Nearly all customers can dial their own trunk calls; currently nearly 98% of all trunk calls from UK telephones are dialled, including about 90% of international traffic to more than 80 countries.

THE NEED FOR MODERNIZATION

In the course of its growth over a long period, the UK telecommunications network has been progressively shaped and adapted to meet customers' changing needs and to take advantage of new techniques. However, in common with other existing networks throughout the world, it suffers from a number of constraints, particularly because it is dominated by 2-wire electromechanical switching systems and a multiplicity of limited-capability inter-exchange signalling systems.

In consequence, there is a relatively long set-up time for a multi-link call through several intermediate exchanges, transmission loss varies with call routing and there are

problems of noise and distortion. Mechanical switches are prone to wear; manufacture and maintenance of equipment is highly labour intensive; and there is only limited capacity for further evolution and provision of new and enhanced services.

Much of the current equipment is out of tune with modern technology, which offers the prospect of greatly enhanced capability for new customer services and management facilities, reliability and economy. This potential is already being realized in modern PABXs, which are largely independent of the public network, and their benefits are being enjoyed by increasing numbers of business customers. Similar and more widespread benefits will become available in the public telecommunications network through System X, and are now beginning to be realized by TXE4 exchanges.

SYSTEM X NETWORK

The characteristic features of a network using System X are integrated digital switching and transmission, stored-program (software) control and common-channel signalling. The essential differences between this arrangement and that of the existing network are illustrated by Fig. 1.

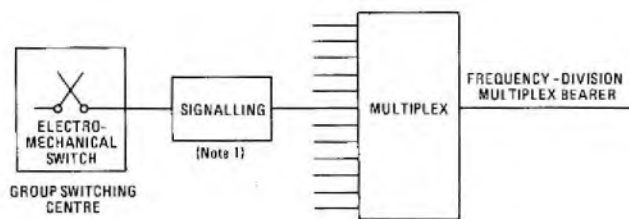

(a) Existing arrangement

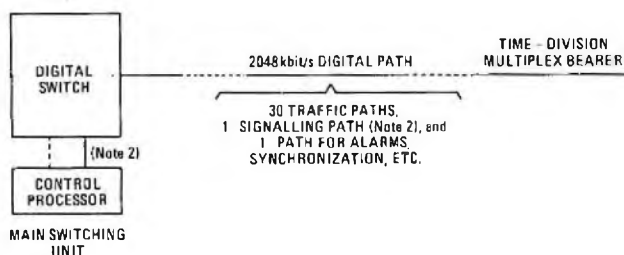

(b) Integrated switching and transmission with common-channel signalling

Notes 1: Provided on a per-circuit basis
2: Inter-processor signalling

† Telecommunications Systems Strategy Department, Telecommunications Headquarters

Integrated Switching and Transmission

Computer assisted studies² in the late 1960s by the UK Trunk Task Force (UKTTF) indicated that the most economic solution for the future main network would be to provide an integrated digital switching and transmission network—in CCITT† terminology, an integrated digital network (IDN). The studies indicated that the total main-network cost, in terms of annual charges, could be reduced by as much as 50% compared with continuing with the existing space-switching and analogue-transmission network.

The major cost savings stem from the elimination of the intermediate primary multiplexing equipment and 'per-circuit' signalling equipment at the switching/transmission interface (see Fig. 1), together with the lower manufacturing costs of electronic equipment compared with that of electromechanical equipment, the elimination of the need for a separate transit network, and reduced accommodation and maintenance charges.

Switching Centres

There will be 3 different kinds of System X switching unit for inland public switched telephone traffic, as follows:

Local Exchange Switching Unit

Each customer terminal (telephone or PBX) will be connected directly to a local switching unit (LSU) at its local exchange. The subscriber switching subsystem (SSS) of the LSU can, if required, be divorced from the exchange and out-stationed for use as a remotely-controlled subscribers' concentrator, possible uses being in sparsely-populated rural areas and in the fringes of urban areas. The System X LSU has a comprehensive routing capability for national-number-dialled calls, and will be capable of determining the charge band for all calls.

Junction Switching Unit

There will continue to be some cases, particularly in the larger conurbations, where local-number-dialled traffic is switched by junction switching units (JSU). Alternatively, the junction tandem function will be carried out at a suitable local exchange or at the parent main-network switching centre.

Main-Network Switching Unit

Main-network switching units (MSU's) will switch national-number-dialled traffic. In many cases, the MSU will also switch junction tandem traffic and is then called an *MJSU*, or, less correctly, a *digital main-network switching centre (DMNSC)*. (A 'centre' includes the power supplies, distribution and access frames etc., which are not necessarily associated with a particular unit.)

A combined main-and-local switching unit will be among the next members of the System X family of applications to be designed. In the meantime, current plans in the UK are for the GSC to be replaced by a *MJSU* and a collocated LSU.

There will also be other types of switching unit, particularly including data switching units (DSUs), which will function as special service centres for circuit-switched and packet-switched data; access to DSUs will increasingly be obtained via the general-purpose System X network, leading eventually to the integration of services on the one network, as described later in this article. Access to the international network will be obtained over the System X network via an international

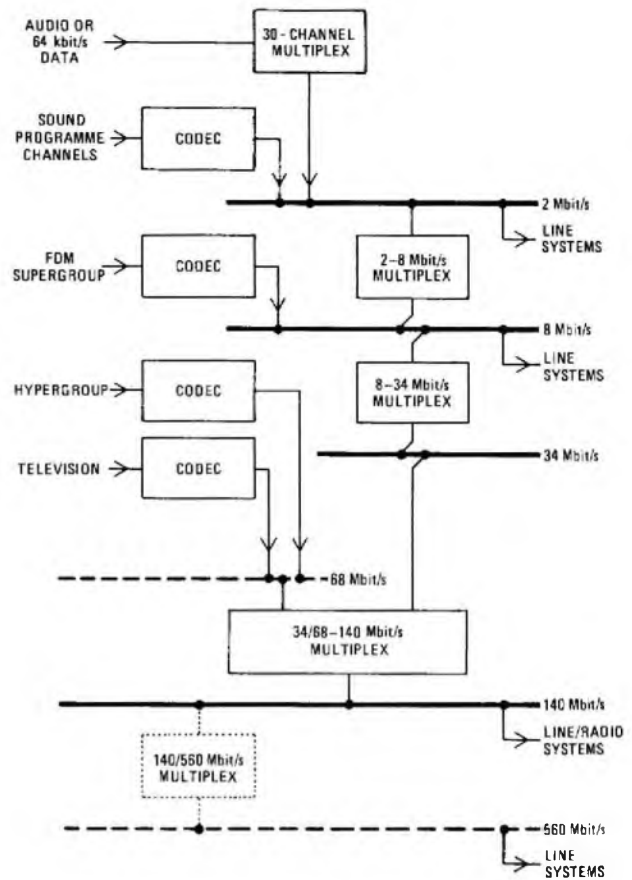

Note: CODECS are used in pairs, one at each end of a link

FIG. 2—Digital hierarchy

switching centre (ISC). A new manual board will also be designed, though System X will be capable of working satisfactorily with existing manual boards.

Transmission Systems

Although System X exchanges, with interworking equipment, can use analogue transmission equipment, studies have shown that an increased provision of digital, rather than analogue, transmission equipment from now on will give compensating savings (in the cost of interworking equipment) when System X exchanges are introduced. In consequence, there will be an acceleration of the rate of introduction of 30-channel pulse-code modulation (PCM) transmission systems in the junction network and an increasingly widespread, although initially thin, digital element in the main network.³ The digital hierarchy that will be used is shown in Fig. 2. Not shown in Fig. 2 are some intermediate developments, such as the 120 Mbit/s line system.

Traffic Routing

With the integration of digital switching and transmission, the minimum transmission module is 30 circuits; a considerable increase over the 12-circuit group, or the single circuit available on junction cables. This will result in increased traffic levels being required to justify direct optional routes. Furthermore, the routing flexibility being designed into the System X switching units and the alleviation of the transmission constraints will result in more multi-link routing than at present. If all existing main-network switching centres

† CCITT—International Telegraph and Telephone Consultative Committee

were digital and appropriate route justification standards were applied, it has been estimated that about half the main-network traffic routes (carrying about 10% of the total traffic) might no longer be economically justified.

Nevertheless, it is intended to retain a hierarchical routing structure. It eases the management of the network, guarantees a basic routing for all possible connexions between exchanges in the UK network, and thus provides an essential foundation on which a variety of routing strategies can be built. The need for the existing analogue transit network with its district switching centres (DSCs) and main switching centres (MSCs) will progressively diminish with the growth of the new digital network.

With common-channel signalling there is no need to have separate routes for different classes of traffic and this, together with the use of multi-link routings and a low-blocking, ungraded switch, will give rise to smoother traffic flows and more efficient use of plant. This, in turn, will require greater attention to the network performance under overload conditions. Digital traffic routes will need to be augmented on the basis of 30-channel modules, and such large incremental steps will make it preferable to establish high-usage primary routes, with traffic overflowing to appropriately dimensioned final routes, until there is sufficient traffic to warrant an additional module on the primary route.

Numbering

The introduction of System X will not involve any drastic changes in the numbering scheme; present strategies such as the introduction of linked numbering schemes and the elimination of code dialling will continue. However, the improved digit examination capability of System X exchanges means that numbers can be allocated in blocks of 1000 or even 100, compared with the present blocks of 10 000. This increased flexibility will relieve much of the strain on the numbering scheme and enable it to continue beyond the year 2000. For the longer term, System X will also allow the number length to be increased by one digit, giving a 10-digit national (significant) number (that is, excluding the STD prefix digit '0').

SIGNALLING

Up to the present time, the transfer of call-control information between exchanges in the UK has been effected by channel-associated signalling, in which the signals are carried by the circuits that provide the speech-path connexions. System X exchanges will have the capability of signalling over individual circuits using conventional signalling systems (including channel-associated signalling over PCM links in time-slot 16) for inter-working with existing exchanges but, within the new network, common-channel signalling will be used direct between exchange processors.

Signalling Within the New Network

Signalling information relating to calls between System X exchanges will be passed from exchange processor to exchange processor over dedicated signalling links that will each serve a large number of traffic circuits.

The use of such a message transmission subsystem (MTS), which is compatible with the CCITT Signalling System No. 7, provides capability for a very large repertoire of signals, is much faster than existing signalling, and enables signals to be transmitted inaudibly at any time during a call. It also enables inexpensive paths to be provided for network administration signals and avoids the need for a large number of per-circuit signalling terminations.

The MTS signals will normally be carried on a 64 kbit/s channel (usually time-slot 16) of a 2048 kbit/s digital path, but can, if required, be routed on frequency-division multiplex

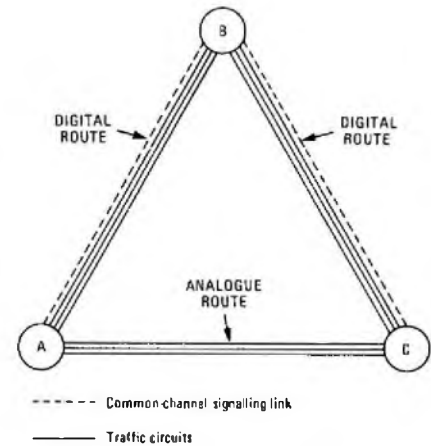

Notes: Traffic circuits A-B and B-C served by associated signalling
Traffic circuits A-C served by quasi-associated signalling via B, which acts as a signal transfer point

FIG. 3—Associated and quasi-associated signalling

(FDM) or audio transmission plant using modems. Where a traffic route on digital plant exists between two switching units, a signalling link may be provided directly, and *associated signalling* is then said to be used. Alternatively, where a traffic route exists but there is no direct digital link, or where the number of traffic circuits is small, *quasi-associated* signalling over an indirect path may be used, as illustrated in Fig. 3.

Customer Signalling

Signalling from analogue telephones and other customer apparatus to the local exchange to set up calls and control supplementary services will use CCITT-recommended multi-frequency signals (BPO Signalling System MF 4) from 12-button keypads; alternatively, 10 pulses/s loop-disconnect signals from standard dials can be used.

Consideration is being given to the signalling methods that will be used with a digital local network and customer apparatus catering for telephone, data and other services.

NETWORK SYNCHRONIZATION

In the existing network the transmission rate of PCM digital line systems is governed by a crystal oscillator clock in the multiplexer; at the receiving end of a line system the demultiplexer extracts information from the incoming signal to derive an identical clock, thus ensuring that no problems arise due to clocking differences between the two ends of the line system.

The digital transmission systems radiating from an exchange in the integrated digital switching and transmission network will be controlled by an exchange timing unit (TU). This is a reliable frequency source, but there will be minor differences between the natural frequencies of the TUs at the many exchanges in the network. However, the operating frequency will be controlled so that the mean frequency difference between any pair of TUs is zero, and the network is then said to be synchronized.

If the TUs were not synchronized, the information rate of a signal received at an exchange would be different from the rate at which the exchange could process the information and retransmit it, resulting in information being lost (if the input rate were faster) or repeated (if it were slower). Such *slip* could cause audible clicks and distortion of an analogue (for example, speech) signal, or errors in a data signal.

The need for synchronization could be avoided by the use

of high-stability free-running clocks; the choice between such a plesiochronous network and a synchronous network being dependent on a number of factors, including the quality of service to be offered to the customer, comparative costs and international implications.

Synchronization Network

For the purposes of synchronization, the UK digital switching centres will be divided into 4 hierarchical levels. The arrangement is shown in Fig. 4, level-1 being the highest in the synchronization hierarchy.

Synchronization links between TUs will either be unilateral (with control being effective only at one end) or bilateral (with control being effective at both ends). Fig. 4 shows a typical arrangement, from which it will be seen that there are unilateral links between switching centres at different levels (with the effective end at the lower level switching centre) and bilateral links between switching centres at the same level.

A single level-1 exchange with a secured local caesium frequency standard will function as the national reference-frequency exchange. Although initially it will be located at a MSU, the equipment will be capable of participating in international synchronization and, in due course, will no doubt be located at an international gateway exchange. For some years, international working on a digital basis is likely to be plesiochronous (the frequency sources being independent but maintained within defined limits), though synchronous operation is a desirable objective from a technical point of view.

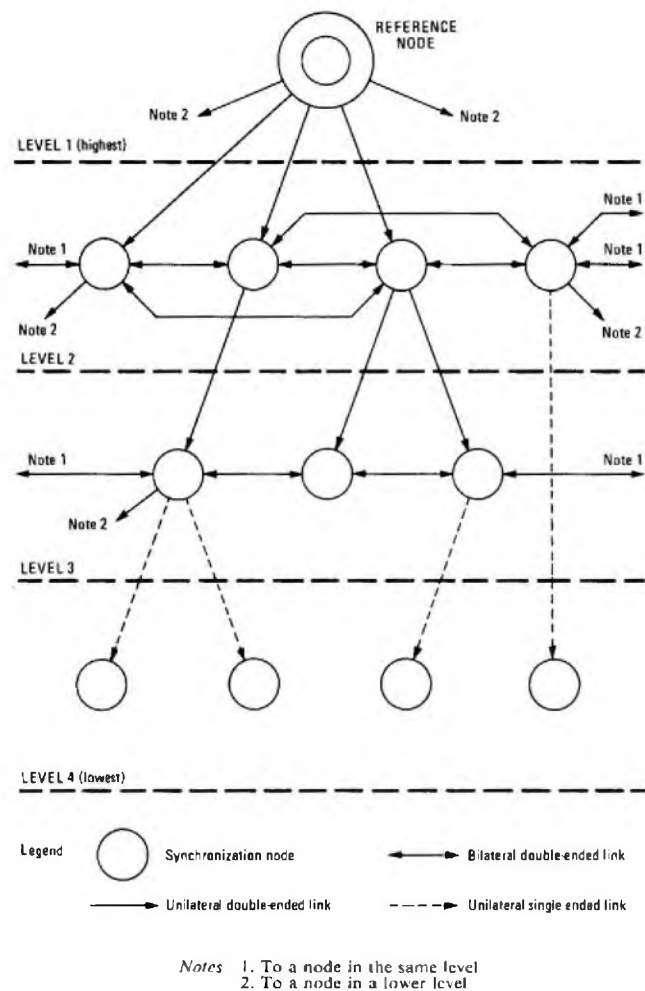

FIG. 4—Synchronization network topology

Synchronization Utility

Synchronization utility (SU) equipment at each exchange will be connected to the synchronization links (designated 2·048 Mbit/s PCM line systems or multiplexes of higher-order systems). The SU will derive information from the synchronization links to control the frequency of the exchange TU and thus maintain it in synchronism with the rest of the network.

Earlier articles^{4,5} have included a comprehensive description of the synchronization network topology, the synchronization equipment and its operation, and the national synchronization reference clock.

TRANSMISSION PERFORMANCE PLAN

Limits have been set for transmission loss and other parameters for calls routed wholly in the new network and for those passing between existing and new networks during the necessarily long conversion period.

Transmission Loss

The CCITT has established a range of preferred values for the transmission losses of national telephone networks. They are expressed in terms of *reference equivalents*, which take into account the sensitivity of the telephone instruments involved in a connexion and permit comparison of the performance of networks using instruments of different sensitivities. Summarized, the planning objectives for traffic-weighted mean overall reference equivalents (OREs) of connexions are: short-term 12·5–22·5 dB, and long-term 12·5–17·5 dB.

Telephone calls in the existing UK analogue network may be routed between local exchanges via a maximum of two terminal and either one intermediate GSC (all with 2-wire switching) or via transit switching centres (TSCs) of the 4-wire switched transit network. Under the 1960 BPO Transmission Plan⁶, the limiting nominal transmission loss between 2-wire points at the terminal local exchanges is 19 dB via the transit network and 19·5 dB via 3 GSCs, giving OREs in the range 17–32·5 dB, depending on local line loss. These losses were set taking account primarily of the stability requirements of GSC–GSC circuits and the transit network, but are nevertheless too great to give an overall performance within the preferred range.

When the new integrated digital switching and transmission network is fully established, but still with analogue transmission between the local exchange and the customers' premises, digital encoding and decoding will take place at the local exchanges, with transmission between them being over 4-wire switched digital links. Because the digital signals do not represent speech information as amplitude variations, the absolute signal levels in the digital network have no bearing on the effective transmission loss.

The digital part of a connexion between encoders and decoders (CODECs) in the new network can be effectively considered as a zero-loss 4-wire circuit (but introducing some delay) and, from consideration of stability alone, a transmission loss of 3 dB or slightly less would be achievable, between 2-wire points at the local exchange hybrid units. However, a loss of 6 dB between 2-wire points in the terminal local exchanges of a multi-link connexion has been chosen as the long-term requirement because this will give improved side-tone and echo performance and will ease connexion to international circuits. This will give OREs on national connexions in the range 4–18 dB (depending on local line loss). The minimum ORE is rather less than the 12·5 dB recommended by CCITT, and is due primarily to the high sensitivity of the UK standard telephone set. The subjective effect of such a difference at the low end of the range is not significant.

Transmission loss limits have also been set for numerous different conditions that will apply on calls routed between

the existing and new networks. In particular, the transmission implications of inserting an isolated System X local exchange with digital switching into the existing analogue network have been studied. With 2-wire transmission connexions on each side of the local exchange, a loss of 3 dB through the exchange is desirable to ease stability problems. It has been established that the preferred means of recovering the additional loss on a main network call (compared with 2-wire space-division switching) is to provide 4-wire (preferably digital) transmission on the junction connecting such a local exchange to its parent GSC. The use of gain in the LSU to offset the additional loss is not considered to be practicable. However, incorporation of gain in the all-digital version of the System X local exchange to provide line extension facilities is being pursued.

Other Parameters

Limits for other parameters of the new network have also been set, including attenuation/frequency characteristics, noise, crosstalk and various types of distortion and interference. They bear a close resemblance to those of a single 30-channel PCM system, and should result in a considerable overall improvement in the subjective performance of the network. Because of the delay necessarily introduced by digital exchanges, the echo-path delay of a connexion will be increased. However, a 6 dB network loss is sufficient to control any resulting impairment.

EXCHANGE AND NETWORK ADMINISTRATION

The administration of a group of exchanges will be controlled from a local administration centre (LAC), which provides: a control centre for maintenance; a concentration point for data being transferred between exchanges and data processing centres; and a concentration and control point for man-machine communication with the exchanges.

Functions of Local Administration Centres

The LAC combines the functions of servicing, service management, network management and call accounting.

Servicing

The servicing function includes the following tasks:

- (a) operational control of exchanges,
- (b) control of exchange maintenance,
- (c) control of circuit maintenance, and
- (d) management of the work force.

Provision is made for signalling and display of alarms from System X and other exchanges by a separate alarm system that is independent of both exchange and LAC processors. Fault reports from exchanges will be stored in the LAC processor data files for interrogation and action by the staff of the centre, details of urgent faults being printed out as soon as they are received. Facilities are provided for remote testing of main network (trunk), junction and private circuits terminating at System X exchanges.

Service Management

The LAC has the capability of controlling and changing the provision, cessation or alteration of service, including:

- (a) customers' service (for example, provision of a supplementary service such as diversion of incoming calls to another number, change of class of service from dial to keyphone),
- (b) private circuits, including the control of switching of part-time private circuits, and

(c) information services, including recorded information services and recorded announcements.

In addition, an assessment can be made of the quality of service being experienced by customers at individual System X exchanges by analysing a sample of the call records produced by the exchanges at a data-processing centre. The call records are sent to the LAC with the other administrative data, and then forwarded to the data processing centre.

Network Management

The LAC receives information on the traffic flows in the exchanges and routes under its control and provides for the maintenance of grade-of-service and short-term re-routing of traffic to relieve congestion; it also collects information for the provision of long-term traffic data for dimensioning purposes. Some of the traffic data will require processing at remote data-processing centres and will be transferred to them via the LAC.

Call Accounting

Data relating to call accounting will be sent from the local exchange to the LAC, which will separate the information from other administrative data and forward it to the billing centre.

Local Administration Centres in the Network

Each LAC will be connected to the exchanges under its control via common-channel signalling links (either direct or via main or junction switching units) for transmission of the various types of administrative data produced by the switching units and the control signals from the LAC. The various types of data collected at the LAC will be transferred to data processing centres; initially, the data will be recorded on cartridge tapes but, in the longer term, the information will be transmitted over data links.

The LACs in the network will be suitable for use by Telephone Area sales, accounts, and planning staff, and will in due course be linked to network management centres (the network management functions being vested in the LAC in the absence of a network management centre). Fig. 5 illustrates the longer-term arrangement in simplified form.

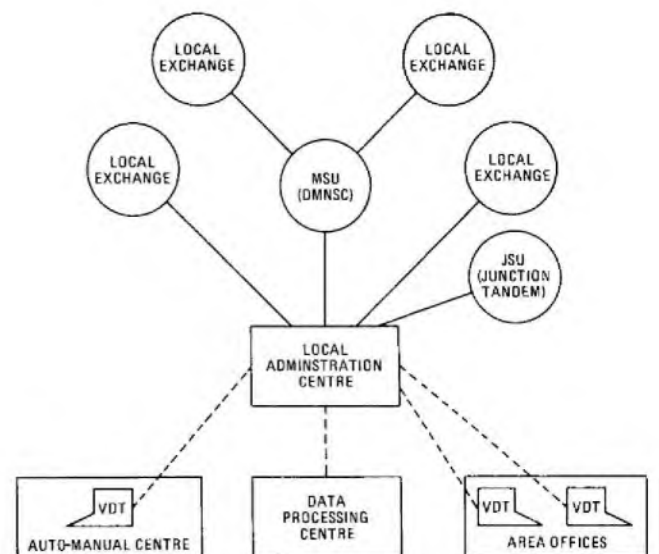

MSU: Main-network switching unit DMNSC: Digital main-network switching centre JSU: Junction switching unit VDT: Visual display terminal

FIG. 5—Network arrangement of local administration centre

BPO personnel will be able to use visual display terminals (VDTs) to obtain administrative access to System X exchanges. It is anticipated that VDTs will, in due course, be provided at Telephone Area Offices (for use by the General Manager's staff), auto-manual centres and network management centres. The functions that may be carried out using VDTs at these locations can, if required, be exercised from the LAC on an agency basis.

EVOLUTION OF THE NETWORK

The existing telecommunications network was developed for analogue telephony with approximately 3 kHz service capability (adequate for commercial speech transmission) and rather elementary call set-up procedures. Nevertheless, the network has been exploited successfully for various derived services, including such essentially digital services as Datel and, currently, Prestel (viewdata). Separate networks have, however, been provided for Telex and packet-switched data services.

With the rapidly increasing availability of digital transmission systems and the introduction of System X switching equipment, it will become progressively possible to provide 64 kbit/s switched transmission paths throughout the network, capable of catering for a wide and increasing range of services. The complete conversion of the existing network into such an integrated services digital network (ISDN) will require massive capital investment spread over many years; it will, initially, be constrained by the availability of System X equipment, while production builds up and displaces that of current, particularly electromechanical, types of exchange equipment and associated line plant.

In designing System X, network options are deliberately being created, including facilities for remote control of small exchanges and concentrators, to allow

- (a) replacement of existing exchanges (where economically justified),
- (b) extension of existing exchanges to cater for growth of requirements, and
- (c) creation of a high-capability overlay network serving customers best able to use its potential.

System X will thus be capable of being deployed in various ways under diverse conditions. Comprehensive studies are being made of the detailed way in which System X will be used to enhance the existing network, both to satisfy interim needs and work towards longer-term objectives, and a number of identifiable, but overlapping, phases in the evolution of the network are becoming apparent.

Phase 1: The Initial Phase

During the relatively-short initial phase, limited amounts only of System X equipment will become available and the services that can be offered will be very much constrained by the capabilities of the existing network. Expedients will be necessary to alleviate these constraints.

Phase 2: The Integrated Digital Network

During this longer phase, the growing penetration of System X switching equipment and digital transmission systems in the junction and main networks will allow the progressive build up of a national integrated digital network (IDN). This will make available enhanced network capabilities, but appreciable penetration will be necessary before they can be exploited effectively for the benefit of the BPO and its customers.

It will thus be important, as far as is practicable and economic, to provide digital switching and transmission plant in locations where the service benefits are most quickly available to customers, and particularly business customers, and to route calls in a way that minimizes interworking between the existing and developing new network.

During the early years of this phase the existing pattern of basic telephony and derived services will remain but there will be progressive integration of telephony and other services.

Phase 3: The Integrated Services Digital Network

The developing integrated digital network will grow progressively and to some extent concurrently into an integrated services digital network (ISDN) providing 64 kbit/s transmission capability between customers' specialized and multi-purpose terminals, with the network providing data storage and other facilities where required.

The main features of the ISDN, as viewed by the customers' terminals, are currently envisaged as being:

- (a) a transparent bothway digital transmission capability at 64 kbit/s between user terminals,
- (b) a comprehensive signalling repertoire between the customer's terminal and the network, and
- (c) the ability to associate more than one 64 kbit/s path with a customer's terminal, either to increase the digit rate further or to permit the use of two (or possibly more) services simultaneously.

Subsequent Phases

It is recognized that demand for even greater transmission capacity in the public switched network will arise in the future, particularly for visual services such as videophone and television. It is thought that, initially at least, such requirements will be met by provision of separate wideband transmission paths and switching nodes which are linked to the ISDN for control and co-ordination. If the several possible networks for the 64 kbit/s services and wideband services evolve along similar topographical lines, the resulting links and nodes may, in the final phase, be transformed into a totally integrated services network on common digital bearers.

Extending the Digital Network to Customers' Premises

During the early years of the evolution of the digital network, some customers, and particularly business customers with modern PABXs, will benefit from digital access to the network, possibly in advance of the conversion of their local exchange to System X. In such circumstances, connexion could be provided to a customer's own or a nearby System X exchange over specially adapted existing local line plant.

Many techniques are being studied throughout the world for providing digital circuits on existing local cables. Systems of particular current interest in the UK use burst-mode techniques, in which time-division-multiplex signals are transmitted in high-speed bursts in alternate directions of transmission over a single cable pair. One or more 64 kbit/s plus signalling channels can be provided on a pair while preserving the analogue circuit for normal use. Such burst-mode systems can be used in conjunction with conventional 4-wire digital multiplex systems (for example, between the exchange and local-line cabinet) both to extend the distance and to allow a group of customers to be served. Other techniques for two-way 2-wire transmission that are being studied include the use of hybrid digital terminations.

While digital systems on existing cables will be of particular value during the early years of the evolution of the network, there will inevitably be a progressive move towards more widespread use of digital working in the local network, in which optical-fibre cables will have a large part to play.

Interworking Between the New and Existing Networks

The problems of evolving from the existing to the new network are accentuated by the need for the embryo new network

to function not only in its own right but also to interwork satisfactorily with the existing network, so that full access can be maintained throughout the conversion period. Planning the evolution requires consideration of many interdependent aspects, including traffic routing, signalling, transmission network planning, the provision for new services, viable conversion strategies, simplicity of implementation and, of course, cost.

It is clear that, for a long period, many of the restrictive interworking arrangements between exchanges, and with the customers' apparatus, will persist and the service benefits obtainable with System X will be distributed unevenly throughout the network. It is thus important that System X be introduced in a way that optimizes benefits to customers, and particularly business customers, and minimizes the effects of the constraining influences of the existing network.

CUSTOMER AND ADMINISTRATION BENEFITS

The reduced capital and running costs of System X compared with existing equipment will enable the BPO to hold down charges to customers, while its enhanced and evolutionary capability, arising principally from stored-program control, common-channel signalling, and the use of new technologies, will facilitate the provision of new and improved services as the need arises.

As System X penetrates the UK network, the basic telephone service will be progressively improved by reduction in call set-up time, consistently good speech transmission, less noisy connexions and more reliable service. Similar benefits will accrue to data and other services.

More specifically, it will be possible on System X exchanges to provide a large number of supplementary telephone services. Initially, a limited number of new or improved supplementary services, some of which are already available on modern PABXs, have been identified for early provision; they include such services as abbreviated dialling, call waiting, 3-party service (for example, hold for inquiry), and transfer of calls (initially within the local-call area). The full versions of many of the supplementary services require the co-operation of two or more exchanges, not all of which may be System X (for example, transfer of calls) and some services will, there-

fore, be available in only restricted form during the early years.

With the extension of digital working to customers' apparatus and 64 kbit/s transmission through the IDN, the provision of new and improved services will be greatly facilitated. These include fast facsimile and Datel services, enhanced Prestel (viewdata) and word-processing services (such as person-to-person message services, electronic funds transfer, business data-processing, and home entertainment services), telemetry services, and still-picture/slow-scan visual services (including surveillance services).

CONCLUSION

System X has the potential to enable the BPO to hold down charges to customers, to improve existing services, and to provide an expanding range of telecommunications services in the future.

Detailed strategies for implementation of System X in the UK network are now being worked out and evaluated, with the expectation of providing, on a substantial scale, a network of System X exchanges, interconnected by digital transmission links and extending to the major conurbations by the late 1980s.

ACKNOWLEDGEMENTS

This article is based on work by the authors' many colleagues in the Telecommunications Systems Strategy Department and other Departments at Telecommunications Headquarters.

References

- ¹ MARTIN, J. System X. *POEEJ*, Vol. 71, p. 221, Jan. 1979.
- ² BREARY, D. A Long-Term Study of the United Kingdom Trunk Network. *POEEJ*, Vol. 66, p. 210, Jan. 1974.
- ³ BOAG, J. F. The End of the First PCM Era in the UK. *POEEJ*, Vol. 71, p. 2, Apr. 1978.
- ⁴ BOULTER, R. A., and BUNN, W. Network Synchronization. *POEEJ*, Vol. 70, p. 21, Apr. 1977.
- ⁵ BUNN, W. National Synchronization Reference Clock. *POEEJ*, Vol. 71, p. 132, July 1978.
- ⁶ TOBIN, W. J. E., and STRATTON, J. A New Switching and Transmission Plan for the Inland Trunk Network. *POEEJ*, Vol. 53, p. 75, July 1960.

Book Review

Introduction to Communications Engineering. R. M. Gagliardi, M.A., PH.D. J. Wiley and Sons. xi + 508 pp. 210 ills. £18.75.

The title of this book is, perhaps, rather misleading, as it is not intended as an introduction across the whole field of communication as one might have imagined. It is rather a college text book, dealing with the transmission and reception processes, no account being given of switching theory, or practical concepts of complete telecommunication networks.

Its kernel for each of the individual subjects dealt with; modulation, demodulation, baseband waveforms, encoding, etc. is the mathematical formulae for each of these processes. The physical meaning of these expressions and practical effects are touched upon, but only those who already have a considerable experience of practical design of advanced transmission systems will be able to derive the full benefit of the work.

In its approach, the book, although generalized at its theoretical level, has a somewhat radio bias in presentation. The systems terminology used is often strange and the term *Manchester Coded* signals when *return-to-zero* signals are meant, owes its antecedents, perhaps, more to the academic, rather than the American, origins of the book.

Of the 9 chapters, one is on waveform representation, 3 are devoted to transmission and reception of waveforms, 3 to digital aspects and 2 to multiplexing and timing. Following each chapter there are a number of problems set related to the contents of the chapter but, unfortunately, there are no answers given.

The book is a useful source of mathematical expressions representing transmission and reception processes and consequently would be very helpful as a basis in preparing a series of college lectures for post graduates. It is unlikely however to be of general use outside academic and specialized disciplines.

G. D. ALLERY

Conclusions from the Empress Digital Tandem Exchange Field Trial

B. R. KERSWELL, B.TECH., M.SC., C.ENG., M.I.E.E., and W. G. T. JONES, B.SC., C.ENG., M.I.E.E.†

UDC 621.376.56.001.41 : 621.395.722

An experimental digital tandem exchange, designed and built by the Research Department of the British Post Office, was in service (on a field-trial basis) to public traffic from September 1968 to May 1975. The design of the exchange is reviewed briefly in this article, with comment on the way in which the design was influenced by the technology available at that time. The operational performance of the exchange is discussed, and an analysis made of the state of the equipment at the end of the trial.

INTRODUCTION

Studies into the feasibility of digital switching, conducted by the British Post Office's (BPO's) Research Department, led to the design and construction of an experimental digital tandem exchange in the late 1960s. This exchange, although only a small model, was installed at Empress (West Kensington) exchange in London, where it became the world's first digital telephone exchange to carry public traffic. Photographs of the exchange equipment on site, and of a typical unit, are shown in Figs. 1 and 2 respectively. The Empress exchange was connected to 3 Strowger director exchanges in west London (Shepherd's Bush, Acorn and Ealing), the connexion in each

case being via two 24-channel pulse-code modulation (PCM) transmission systems. There were thus totals of 72 incoming and 72 outgoing circuits on the digital tandem exchange.

The main aims of the experiment were to demonstrate the technical feasibility and economic viability of digital switching. However, valuable subsidiary information was obtained from the field trial since the Empress exchange involved the first use by the BPO of two significant technical innovations: microelectronic integrated circuits and printed-wiring boards with plated-through holes.

A detailed description of the Empress exchange has been given in this *Journal*,¹ and this was followed some years later by an interim report on the progress of the field trial². The purpose of this present article is threefold:

- (a) to review the design of the equipment in the light of technological changes which have occurred since that time,
- (b) to consider the overall performance of the exchange during its period in public service, and
- (c) to discuss the state of the equipment at the end of the trial.

Although the equipment was designed and built by the Research Department, who performed the final on-site development and commissioning, the responsibility for running the experiment was passed to the BPO's Telecommunications Development Department. Day-to-day maintenance was performed by technicians from the London Telecommunications Region. Maintenance reports from the technicians were passed to the Development Department who, in turn, compiled periodic bulletins describing the progress of the experiment. Much of the information in this article has been obtained from a study of these bulletins, coupled with the results of a detailed examination of the equipment by Research Department staff after the exchange was taken out of service.

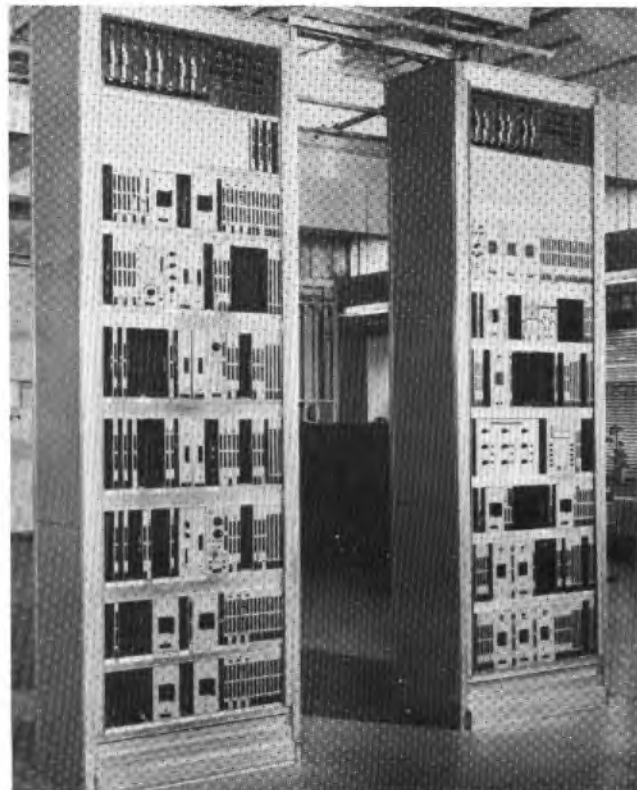

FIG. 1—Empress digital tandem exchange equipment

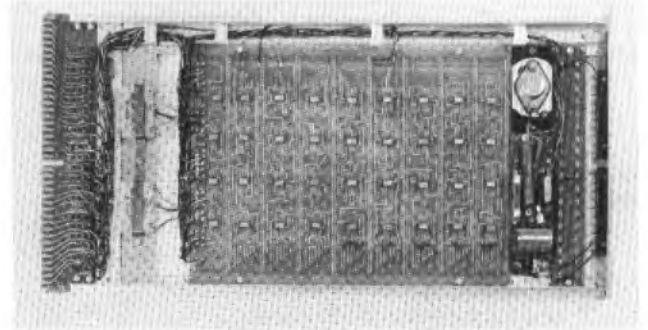

FIG. 2—Typical plug-in unit (tone generator)

PRINCIPLES OF DIGITAL SWITCHING

PCM transmission systems are now widely used by the BPO in the junction network, and work has already started on the introduction of higher-order systems into the main network. However, when the design of the Empress exchange was in progress, PCM systems were being considered only for the longer junction routes with a high rate of traffic growth. The PCM systems under development and trial at that time carried 24 channels of digitally encoded speech and used one cable pair for each direction of transmission³.

When a number of PCM line systems terminate at an exchange, the calls that pass between the systems can be converted back to the audio baseband and switched by conventional electromechanical equipment, such as Strowger or crossbar equipment. This involves demultiplexing and decoding the incoming speech, with subsequent re-encoding and multiplexing for onward transmission after switching. The process is therefore not only costly in terms of equipment but also introduces additional transmission loss, noise and distortion. The alternative is to switch the speech channels while they are still in their digitally-encoded form. Time-division multiplexed switching of PCM channels had been established as theoretically feasible by the mid-1960s, but a field trial was needed to show that reliable operation was possible in the environment of a telephone exchange.

At the inlet of a digital switch, each speech channel can be identified in space (by the PCM system on which it is carried) and in time (by the channel, or time-slot, it occupies within that PCM system). Each channel has a double appearance at the exchange's periphery since the two directions of speech are carried on separate paths. To connect a call across the exchange, it is necessary, in general, to perform switching in both time and space, as illustrated in Fig. 3. The space-switching part of the digital exchange must be capable of changing its configuration at least every time-slot ($5.2 \mu\text{s}$ for a 24-channel system). However, the particular configuration for each time-slot will recur at intervals of the PCM frame time ($125 \mu\text{s}$), assuming no changes in the routing of calls in progress. The time-switching function must selectively delay the coded-speech digits in one time-slot so that they may be released in another. For example, to connect channel 3 to channel 8 requires a delay of 5 time-slots for one direction of transmission, and a delay of 19 time-slots in the other direction.

The space-switch crosspoints and time-switch storage devices are clearly associated with the speech path. In addition, control storage is needed to ensure that the space and time switches operate appropriately in each frame, while further control logic is required to set up and clear down calls. The control information is derived from signalling on the PCM line systems. All the circuitry in a digital exchange must be accurately synchronized, and this is achieved by distributing precisely-timed waveforms from a central source within the exchange. Reliability in a digital exchange clearly

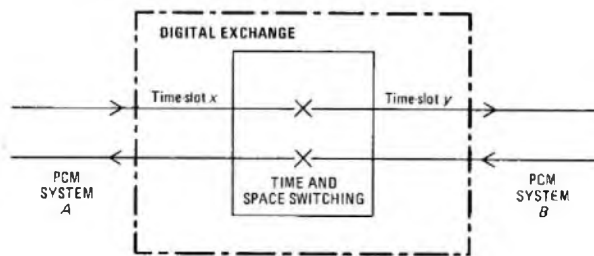

Space switching: Physical interconnexion of PCM systems
Time switching: Selective delay of coded digits in a time slot

Fig. 3—Connexion across a digital exchange (time-slot x in system A shown connected to time-slot y in system B)

needs close attention, since failure of most parts will cause the loss of at least 24 speech channels. Complete failure of the central source of exchange waveforms would put the whole exchange out of action.

This brief description of the functions of a digital switch is necessarily superficial. However, it provides sufficient background to enable examination of the way in which available technology influenced the design of the Empress exchange, and how changes might arise with present-day technology.

EFFECT OF TECHNOLOGY

When the design of the Empress exchange was originally considered, the cost, speed of operation and physical size of processors did not make them very attractive for use in controlling exchanges. In any case, the benefits offered by stored-program control were only just beginning to be appreciated. The exchange was therefore conceived as a register-controlled exchange, rather than a processor-controlled exchange. However, many parts of the exchange involved logic circuitry, for which the newly-developed integrated circuits offered considerable advantages.

It is easy to forget how rapidly technology has changed over the last 10 to 15 years, particularly in the field of microelectronics. In 1965, at the early stages of the Empress design, the available ranges of integrated circuits were studied to determine the most suitable type for use in the exchange. The diode-transistor logic (DTL) range was chosen as offering reasonable operating speed and noise immunity. The dual-in-line package had not then been introduced, and so the devices were purchased in flat-pack form and had to be welded to the printed-wiring boards. The most complex available devices contained about 6 logic gates, or 2 bistable elements, with a cost some 20 times that of their equivalent today.

As the design progressed, it was found that the timing required of signals on the transmission path through the exchange became difficult to meet using DTL devices, due to the duration and variation of their propagation delay. Fortunately, by that time, transistor-transistor logic (TTL) had become available and offered a significant speed improvement. In the final equipment, about 90% of the integrated circuits used DTL, with the remainder (where timing constraints were critical) using TTL.

The cost and speed of the integrated-circuit bistable elements made them unsuitable for use as switch-control stores or speech-path delay stores in the time switches. Cost was the main problem for the control stores, and so the cheaper alternative of ferrite-core stores was used. The actual arrays of ferrite toroids were quite small, but the size of a complete store unit increased considerably when the READ and WRITE amplifiers were added. Speed was the problem with the time-switch speech stores, and a solution was adopted using encapsulated groups of discrete diodes and capacitors.

With such expensive forms of storage, particularly in the time switches, it was clearly necessary to minimize the amount of storage required. As a result, the exchange trunking was arranged in a space-space-time-space-space array, giving a very low number of time switches. The trunking of the model is shown in Fig. 4, from which it can be seen that the time switches, or delay units, are of two types: *fixed* and *variable*. Although the construction of the two types was the same in each case, the fixed-delay time switches were much simpler to control as each always provided a delay of a fixed number of time-slots. The variable-delay units were programmable to give the delay required for a particular call, necessitating complex control circuitry.

In the years since Empress was designed, there have been dramatic changes in integrated-circuit technology, making these items suitable for all the functions of space-switch crosspoints, control stores and time-switch speech stores. The costs have fallen dramatically, particularly for storage

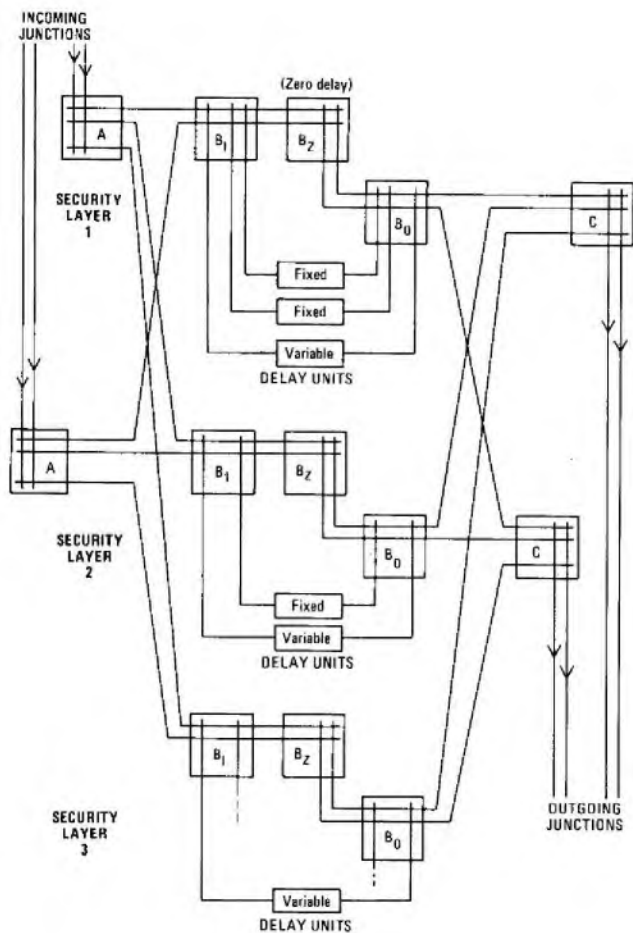

A: A-switch
 B₁: Input section of B-switch
 B₀: Output section of B-switch
 B₂: Intermediate section for connexions requiring zero delay
 C: C-switch

FIG. 4—Empress exchange trunking

devices, and a large quantity of storage can now be obtained in a single device. On the other hand, although some advances have been made in devices suitable for space-switch cross-points, progress in this area is less marked than it is in others because these components are limited in capacity by the number of leads which a single device can accommodate. The result has been a change in the balance of costs between space switching and time switching. Modern designs of trunk and tandem digital exchange thus tend to use time-space-time trunking⁴, with random-access memories for the time switches and metal-oxide-semiconductor shift registers for the control stores.

One area where technology has changed little is in the central waveform generator. The Empress design used 3 temperature-controlled quartz-crystal oscillators with majority decision on their outputs, thus ensuring correct operation even if one oscillator failed. The waveforms derived from these oscillators were distributed via a system of buffer amplifiers. The main change likely to be seen in modern designs is a reduction in the number of distributed waveforms. This arises partly from changes in methods of control and partly because it is now cheaper and simpler to derive more of the waveforms in the unit where they are needed.

OPERATIONAL EXPERIENCE

General Performance

Empress exchange was officially opened on 11 September 1968, although prior to that date the equipment had been

TABLE 1
 Traffic Carried by Delay Units

Type of Delay Unit	Percentage of Traffic Carried in Year						Predicted Traffic Distribution in a Large Exchange
	1970	1971	1972	1973	1974	1975	
Zero (i.e., traffic via B ₂ switch)	71.4	—	65.2	71.1	65.0	77.3	40
Fixed	14.9	—	23.9	22.4	25.2	18.4	
Variable	13.7	—	10.9	6.5	9.8	4.3	

operated experimentally both in the Research Department's laboratories (then at Dollis Hill) and in the Empress exchange building. At the time of the opening, the exchange was in use for only part of the day. Full-time public service was attained in December 1968 and, in June 1969, the responsibility for the equipment was handed over to the Telecommunications Development Department. The equipment was removed from public service in May 1975 as it was felt that little further information could be gained from the trial, and the space occupied by the PCM tandem exchange was needed for other purposes.

Between December 1968 and May 1975, the exchange was taken out of service only to attend to serious faults or to make modifications and, during this period, the exchange successfully handled 8 850 226 calls. Calculations had been made before the trial of the proportion of traffic which would be carried by the 3 types of delay unit (zero delay, fixed delay and variable delay). The actual traffic carried is shown in Table 1 for the years for which information is available. It can be seen that the exchange achieved its primary object of establishing the practicality of digital switching, although, in such a small model with light traffic loading, the proportion of calls handled by fixed and variable-delay units was much lower than was predicted for a large exchange.

The secondary object of the field trial was to examine how reliably the switching functions were performed using modern electronic components. Details of the problems which occurred form the remainder of this section of the article. However, before considering the faults in detail, there are two points that need to be emphasized. Firstly, the equipment was intended as a short-term feasibility trial, and its construction, carried out by the Research Department, could not be expected to reach the standards of normal production equipment. The second point is that the PCM line systems connected to the exchange were of an early prototype design and suffered from a number of problems. This applies also to the units which interfaced the line systems with the switching equipment, since these units made use of a component board from the line system. The following study therefore concentrates on the performance of the exchange's switching and control equipment only.

Reliability During the Field Trial

For convenience, the reliability of the Empress exchange has been estimated by studying the faults that occurred during each month. A preliminary study showed, not surprisingly, that, while development work continued on the exchange, the reported failure rate was high, so that the period from installation up to 1 January 1970 has been ignored. The following analysis of exchange faults covers the period 1 January 1970 to 31 July 1975, the latter being the date on which Research Department staff returned to examine the state of the exchange

TABLE 2
Details of Faults Analysed by Units and Components

Component	Unit														Totals
	Delay units	Routiner	Fault monitor	Alarms	Oscillator clock	Wave-form generator	Power equipment	Space switches	Stores	PCM-system units	Trunk units	Registers	Buffers	Other equipment	
Soldered joint		1		10						1	1	1	2		16
Wrapped joint												1			1
Welded joint			1			2									3
Plated hole	1														1
Capacitor													2		2
Diode			3	2	1										6
Transistor			2							8					10
Integrated circuit		1		1				3	1	1	2	2	4	1	16
Resistor					1										1
Fuse	2		1					2			1				6
Others	7	2	10	2	3		2	2	4	2		1	3	1	39
Intermittent faults	133	2	12		15	5	1	2	1	8	3	32	1		215
Component failures and intermittent faults	143	6	29	15	20	7	3	9	6	20	7	37	12	2	316
Total number of exchange faults	143	6	28	4	19	6	3	9	6	20	6	37	11	2	300

Note: The differences between the last two rows indicate that certain exchange faults were each associated with failure of several components

TABLE 3
Predicted and Actual Component Failures

Component	Predicted Failure Rate (/thousand/year)	Number in Exchange	Anticipated Number of Failures	Actual Number of Failures
Soldered joint	0.007	1×10^6	38	16
Wrapped joint	0.007	5.5×10^4	2	1
Welded joint	Not available	5.4×10^5	—	3
Plated hole	Not available	1.3×10^5	—	1
Capacitor	0.16	6.5×10^3	6	2
Diode	0.05	1×10^4	3	6
Transistor	0.4	6×10^2	1	10
Integrated circuit	0.7	7.7×10^3	30	16
Resistor	0.035	Not quantified	—	1

Note: Period of service = 5.5 years

after its removal from service. In this period, a total of 300 faults was recorded, of which 85 were permanent and 215 were intermittent. Permanent faults are taken at those where, after the detection of a fault, a physical cause could be found and corrected. In some instances, the analysis of these faults showed that more than one component had failed, so that the number of permanent faults reported is less than the number of component failures. Intermittent faults have been defined as those where no cause could be found for the detected fault, the apparently faulty unit being returned to service without any significant remedial action being taken.

The faults have been analysed in terms of the type of unit in which they occurred and the type of component responsible, as shown in Table 2. A plot of the total number of exchange faults each month is given in Fig. 5(a), while Figs. 5(b) and 5(c) respectively show the total numbers of permanent and intermittent faults each month. The predicted failure rate for the main components in the exchange would imply about 14 failures/year; that is, a total of 80 failures over the period of interest. The predicted and actual numbers of failures are compared in Table 3.

Specific Faults

While categorizing the faults by type of unit, it was realized that a large number of faults had occurred in the delay units. One of the variable-delay units had suffered 108 faults, although only 3 of these were permanent. The fault performance of this unit is shown in Fig. 6; it is reasonable to deduce that other systems, using similar construction techniques and

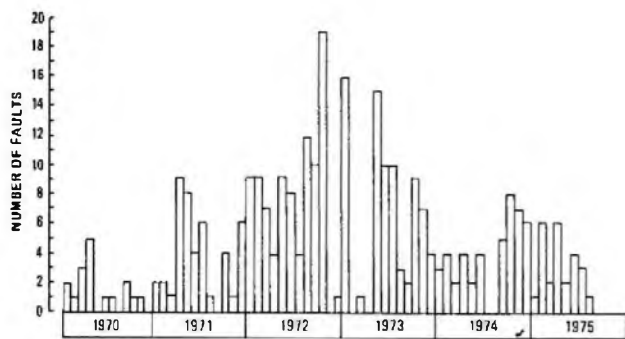

(a) Total exchange faults

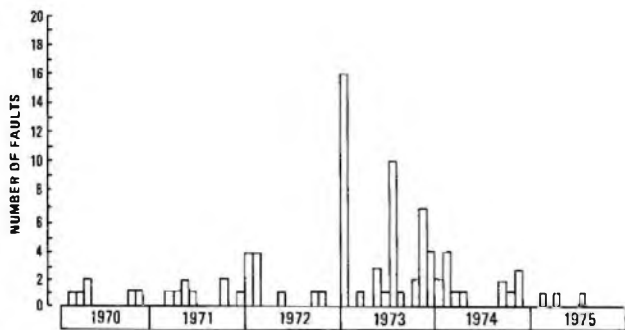

(b) Permanent faults

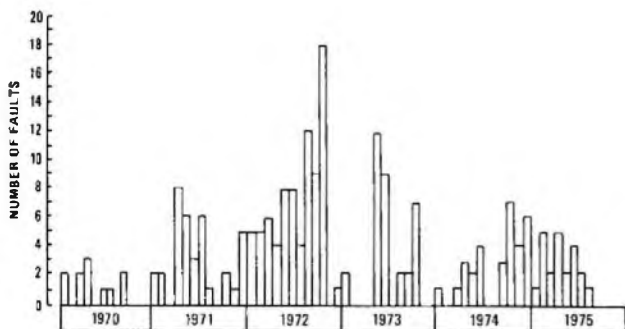

(c) Intermittent faults

FIG. 5—Analysis of exchange faults

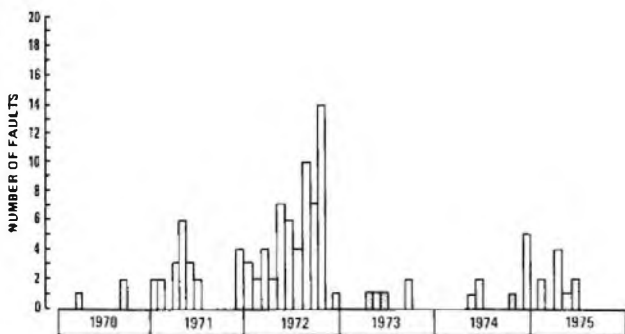

Note: Shaded areas indicate permanent faults, the remainder are intermittent faults

FIG. 6—Fault distribution for one of the variable-delay units

component technology, will also experience intermittent faults, though these faults may not be evenly distributed across the system.

Other specific faults arose during the life of the equipment, and these were most serious when they occurred in parts of the system that were provided to enhance its reliability. For example, the security of the waveform-distribution system was achieved by using triplicated waveform generators, each output being connected to 2-out-of-3 majority-decision voters to maintain the supply if one of the generators failed. However, an undetected fault in a voter circuit caused one of the waveforms to be lost when one generator was removed for a routine check. It is interesting to note that this fault occurred despite the considerable care exercised at the design stage, since the waveform-generation area was clearly critical to the operation of the whole exchange. This illustrates the difficulty of trying to anticipate every possible failure mode. Despite this, and other less serious problems, the overall reliability of the exchange was certainly good, particularly considering its experimental nature.

CONDITION AFTER THE FIELD TRIAL

After the Empress exchange had been removed from service, a two-part examination was conducted to determine the state of the equipment. The first stage involved exhaustive testing of the complete exchange *in situ*, and the second stage involved removing selected items for detailed examination in the laboratory.

Testing at the Exchange

On-site testing revealed several previously undetected faults, which may be categorized as follows (permanent faults affecting traffic-carrying capacity had been rectified in-service under normal maintenance procedures):

- (a) intermittent faults that affected traffic-carrying capacity,
- (b) intermittent faults that decreased reliability, and
- (c) permanent faults that affected the fault-reporting system.

The existence of these undetected faults demonstrates the inherently fault-tolerant nature of switching systems. It also shows the difficulty of applying thorough routine tests to a complex piece of digital equipment, unless it is removed from operational service. The Empress exchange was in fact provided with two different routine testers and many alarm lamps.

As part of the original commissioning procedure, complete measurements had been made of the propagation delays throughout the waveform-distribution system. These measurements were repeated after the field trial and, although some changes were found, it was not possible to discern an overall trend. An example of the measurements obtained for one waveform is shown in Table 4. The apparent changes during the life of the exchange were probably caused by the interchanging and replacement of the various waveform buffer-amplifiers as part of normal maintenance. The waveform timings after closure were all within the tolerances originally specified.

Measurements were also made of the operating temperature of the racks, and of the electrical noise present on the power supplies. Rack temperature was found to be generally only a few degrees Celsius above ambient, while power-supply noise did not exceed 200 mV peak-to-peak.

Laboratory Tests

After completion of the on-site testing, various units were removed for laboratory testing by the Semiconductor Reliability Division of the BPO's Research Department, and by the Materials Section of what was then called the Purchasing and Supplies Department (now called the Procurement Executive). Brief indications of the findings are given below.

TABLE 4
Waveform Measurements

Date of Measurement	Rack	Leading-Edge Propagation Delay		Pulse Width	
		Mean (ns)	Standard deviation (ns)	Mean (ns)	Standard deviation (ns)
1968	A	226.67	15.88	334.79	10.87
	B	224.17	6.19	330.36	5.14
1969	A	235.97	7.73	331.71	11.0
	B	218.93	6.92	332.07	5.62
1975	A	237.63	12.69	328.26	15.26
	B	224.64	10.44	317.74	5.58

Integrated Circuits

The propagation delay of 25 DTL devices removed from the exchange was compared with that of 12 similar devices which had been kept as spares but never used. The normalized distribution of the results is shown in Fig. 7, from which it can be seen that there is no significant difference between the used and unused devices.

Connexions

Careful inspection showed that examples of the printed-wiring-board edge-connectors, the wire-wrapped joints used for rack wiring, and the welded and soldered joints used on integrated circuits, were all sound.

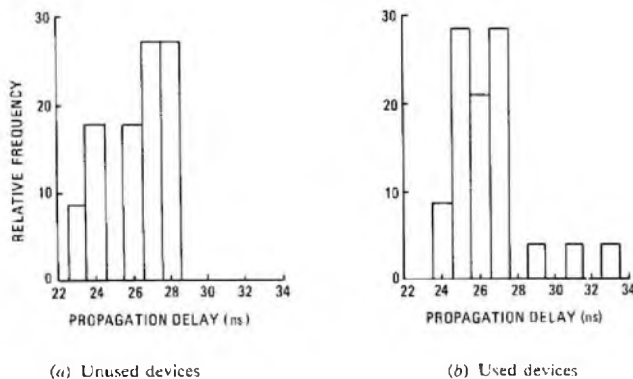

FIG. 7—Normalized propagation-delay measurements for integrated circuits

Printed-Wiring Boards

Parts of some printed-wiring boards had become soiled by airborne dust. However, measurement of the insulation resistance of one of these boards showed that the value was still acceptable. Various samples of board material were tested for inflammability, since the original specification of the material had required a certain level of flame retardancy. The tests revealed that one particular type of board material had lost its flame-retardant properties during the life of the equipment.

CONCLUSION

This article marks the closing of the first chapter in the story of digital switching. It is thus appropriate to consider not only what information was obtained from the studies described here, but also the overall contribution which the Empress exchange made, and the paths which lead from it.

The tests conducted after the closure of the exchange in fact revealed little in a positive sense. The equipment was in good condition at the end of the trial, and any changes in physical or electrical parameters were of a very minor nature. Some interesting results were obtained from studying the intermittent faults, and these are now the subject of further study in the Research Department. However, overall, the exchange-fault performance was close to that expected.

The Empress experiment undoubtedly fulfilled its primary objective of proving the technical feasibility and economic viability of digital switching. This provided an important input to the subsequent study of the trunk network by the UK Trunk Task Force,⁵ from which in turn stemmed the decision to move towards a digital trunk network. Equally encouraging was the reliability of the equipment, and the fact that it was looked after by exchange-maintenance staff with no previous experience of digital electronics. The confidence in digital switching gained from the Empress exchange has led to digital switching becoming one of the main principles of System X, the BPO's integrated digital switching and transmission system, now under development. The Empress equipment can therefore reasonably be said to have some significance in the history of telecommunications, and so it is appropriate that the hardware has now been passed to various BPO museums, and to the National Science Museum in London.

References

- 1 CHAPMAN, K. J., and HUGHES, C. J. A Field Trial of an Experimental Pulse-Code Modulation Tandem Exchange. *POEEJ*, Vol. 61, p. 186, Oct. 1968.
- 2 HARRIS, A. S. Digital Switching Systems. *POEEJ*, Vol. 65, p. 154, Oct. 1972.
- 3 BOLTON, L. J., and BENNETT, G. H. Design Features and Application of the British Post Office 24-Channel Pulse-Code Modulation System. *POEEJ*, Vol. 61, p. 95, July 1968.
- 4 PHILIP, A. S. A Multipurpose Digital Switching Subsystem. Paper 142-3, International Switching Symposium, Kyoto, 1976.
- 5 BREARY, D. A Long-Term Study of the United Kingdom Trunk Network, Parts 1 and 2. *POEEJ*, Vol. 66, p. 210, Jan. 1974, and Vol. 67, p. 37, Apr. 1974.

The Electret: A Possible Replacement for the Carbon Microphone

R. R. WALKER, B.S.C.(ENG.), C.ENG., M.I.E.E., and A. J. MORGAN.†

UDC 621.395.616.2

The British Post Office (BPO), in common with other administrations, has for some time been seeking an alternative to the carbon-granule microphone for use in telephones. This article describes the design, construction and performance of an electret microphone developed in the BPO Research Department as a possible drop-in replacement for the Transmitter Inset No. 16.

INTRODUCTION

The Rev. Henry Hunnings of Yorkshire is generally credited with the first patent, taken out in 1878, for a carbon-granule microphone. The British Post Office (BPO) Transmitter Inset No. 1, shown in Fig. 1, was a development of the Hunnings transmitter¹. The critical feature is its solid back; that is, the back electrode is flush with the back of the granule chamber. Thus, when the microphone is turned on its face there is a possibility that none of the granules will be in contact with the electrode and the microphone is open circuit. In the early part of this century there were designs of telephone in use that had handsets and used solid-back transmitters (the Edwardian instruments that are becoming fashionable again). The fact that the microphone may have been an open circuit while the handset was being picked up was of little consequence since the microphone did not form part of the signalling loop and obtained its feed current for transmission from a local battery. Signalling was, of course, provided by a magneto.

When systems that used a central battery for signalling and transmission came into use, it was necessary to use a telephone in which the microphone was likely to remain in a near-vertical plane throughout the duration of a call. The micro-

phone obtained its feed current from the central battery and also provided the loop across the line. This led to the almost universal use of "candlestick" telephones in the 1920s.

In 1929, a number of sources came up with the same solution to the problem of disconnexions: both electrodes of the microphone were immersed in the carbon granules. Fig. 2 shows a design, by Messrs. Siemens, from which the BPO Inset No. 10 was derived². In this design, the granule chamber surrounds the electrodes. This simple change made it possible to revert to telephones with handsets. There were detailed changes over the years, but basically the design of carbon microphone used by the BPO did not change until the Inset No. 16³ was introduced in 1964 (see Fig. 3) and, in slightly modified form, this is the item that is still in use today. The principle change from earlier designs that is immediately apparent is the use of hemispherical electrodes enclosing a granule chamber that is about 8 granules deep. In fact, a vast amount of theoretical study and practical experience went into the design of this microphone, which resulted in significantly improved performance.

† Research Department, Telecommunications Headquarters

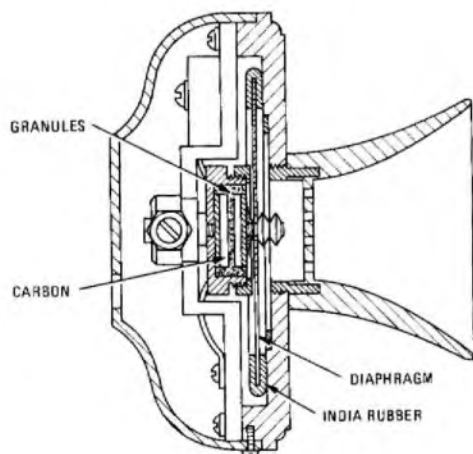

FIG. 1—Solid-back transmitter (BPO Transmitter Inset No. 1)

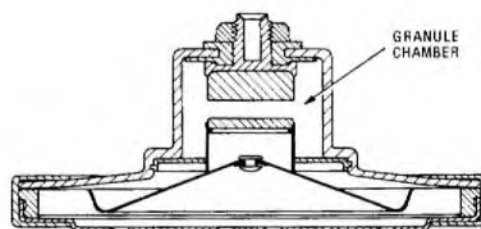

FIG. 2—Siemens transmitter—1929

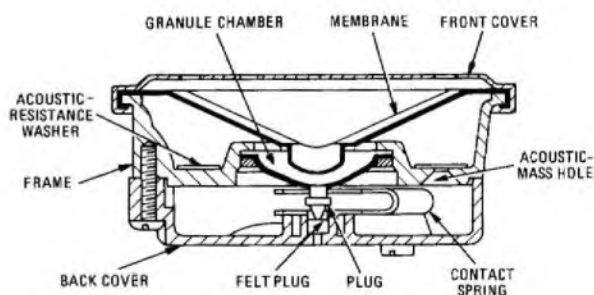

FIG. 3—Transmitter Inset No. 16, Mark I

Although the microphonic action of granular carbon has been the subject of study for as long as anyone can remember, the present position is that no one theory of operation has gained universal acceptance. Also, full explanations do not appear to be available for the various degradations in performance to which carbon microphones are prone: increase in noise, loss of sensitivity, and change of resistance. The authors can only offer their personal opinion that the full electrochemistry of carbon granules has yet to be discovered.

PERFORMANCE OF CARBON MICROPHONES

Over the years, many articles have been published, in this *Journal* and elsewhere, on the performance of carbon microphones^{4,5,6,7}. By the nature of its operation, a variable-resistance microphone causes non-linear distortion, and microphonic action of the carbon adds its own contribution to this. Non-linear distortion has become an accepted part of the performance of carbon microphones, but there are other characteristics that cause more trouble. The sensitivity increases with increasing feed current, therefore the microphone gives greater output on short lines. There is a wide spread to all the characteristics, which also change with time. Finally, the microphone generates noise and can become increasingly noisy with age and use, although specimens in carefully controlled experiments have also been known to become less noisy with use.

It is perhaps too well known that carbon microphones cause noise. This makes it difficult to be sure of microphone fault statistics. A customer may complain of noise on the telephone. When the complaint is investigated, the noise is not found; it has cured itself. The source of this intermittent noise could have been in the exchange, or in the line plant, or it could have been in the telephone. So the prudent maintenance engineer changes the microphone. Why not? The item is cheap, much cheaper than the cost of another maintenance visit.

But, with all these disadvantages, the carbon microphone is still in almost universal use because it is the only suitable microphone that does not require an amplifier in the telephone. It is cheap and it is robust. Yet the BPO, in common with most other administrations, has for some time been seeking a replacement for the carbon microphone.

The replacement must operate satisfactorily for very long periods, sometimes under arduous conditions of temperature and humidity, and it must include an amplifier. It is this last condition that has been the stumbling block because there does not appear to be any way of making a microphone plus amplifier for the same price as a carbon microphone.

The first step is to distinguish two different applications for linear microphones in telephones. Firstly, the drop-in replacement with a linear microphone and its amplifier in a similar case to that of the particular carbon microphone in use: this can be used to replace existing microphones in telephones, and to equip new production, without any other alteration to the telephone or to the rest of the system. Secondly, the use of a linear microphone in completely new designs of electronic telephone containing integrated circuits (ICs) that perform many other functions.

In the second case, the economics of a linear microphone may be fairly straightforward because the necessary amplifier can form part of one of the ICs at little extra cost. Moreover, a carbon microphone is likely to be out of place in an electronic environment. But the drop-in replacement can be difficult to justify until account is taken of the maintenance costs incurred by carbon microphones. There is, too, an unquantifiable benefit to be gained from increased customer satisfaction from improved transmission performance and fewer faults.

So, a replacement for the carbon microphone may be justifiable, provided that the replacement is cheap and highly reliable.

CHOICE OF A NEW MICROPHONE

There is no perfect microphone for telephony. The feasibility of designs employing electrodynamic (moving coil and moving iron), piezo-electric and electret elements has been demonstrated^{8,9,10}. A particular design using an electret is described in this article, both because the item has been developed by the BPO Research Department and because its principles may be less generally understood. Before giving that description, however, it should be mentioned that there is another new microphone just coming out of the research phase in many laboratories; this device uses a piezo-electric foil as a diaphragm. The foil is polyvinylidene difluoride (PVDF). It may prove more suitable than electrets for other forms of transducer (receivers, keypads) and, so far, no failure mechanism has been discovered for it.

But, to return to the electret; its merits as a microphone include:

- (a) simplicity of construction,
- (b) low cost,
- (c) relatively high output,
- (d) low diaphragm mass, and therefore insensitivity to handling noises on telephone handsets,
- (e) easy control of parameters, and
- (f) mechanical robustness.

THE ELECTRET MICROPHONE

An electret is a material which, after receiving an electrical charge, retains that charge (or a proportion of it). The term was coined many years ago by Oliver Heaviside, who saw the properties of an electret as being analogous to those of a permanent magnet, despite the fact that no practical electrets could at that time be demonstrated.

Electrets can now be made using polymer films only a few micrometres thick, ideally suited for use as a microphone diaphragm. The simplified cross-sectional diagram, Fig. 4, shows that a microphone using the electret principle is essentially a very simple device comprising a metallized electret diaphragm located a defined distance (in this instance $\approx 70 \mu\text{m}$) in front of a conducting backplate. In operation it closely resembles a capacitor microphone, but without the need for an external polarizing voltage.

Operating Principles

The electret charge, q_e , has associated with it a capacitance to ground, C_e , and an equivalent polarizing voltage, V_e , related according to the equation

$$V_e = q_e/C_e$$

The proximity of the electret film to the backplate results in a modification of capacitance C_e determined by the distance d between the backplate and the electret film. Flexure of the electret film, which is also the microphone diaphragm, results

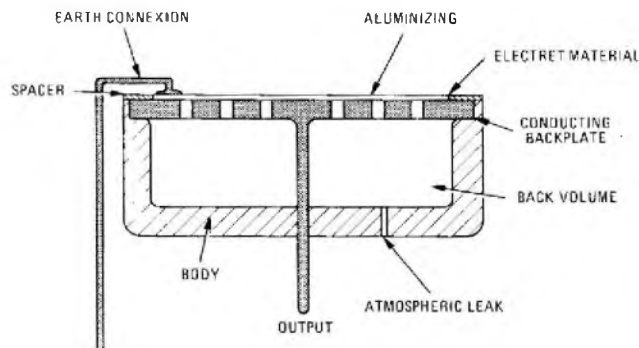

FIG. 4—Basic form of electret microphone

in the value of C_e changing in sympathy with the movement of the diaphragm, which is of the order of nanometres. There is a corresponding change in voltage V_e , which appears as an EMF in series with a capacitance. It is necessary to pre-stress the diaphragm in order to oppose the electrostatic attraction which exists between it and the back plate. A *back volume* of air is also included to provide compliance, against which the diaphragm acts under the influence of a sound wave.

Since the charge and the capacitance are both proportional to the area of the diaphragm, V_e and changes in V_e are, to a first order, independent of the diaphragm area.

Microphone Construction

The success of an electret microphone hinges on its design and the assembly techniques employed, and of paramount importance is the electret itself. There are, at present, 4 main methods of charging an electret.

The Thermo-Charging Process

In the thermo-charging process, the film is placed between two electrodes and heated almost to softening point as the voltage across the electrodes is increased. This is followed by a controlled cooling cycle.

The Electron-Beam Method

In the electron-beam method, the film is charged by electron bombardment.

The Corona-Discharge Process

In the corona-discharge process, the film is subjected to corona from appropriately shaped electrodes.

The Knife-Edge Method

In the knife-edge method, the film passes in intimate contact with a knife edge. This injects charge directly by virtue of the high electric field existing across the film.

Evidence to date suggests that all of these methods give good results, but research is continuing at the BPO Research Centre and elsewhere into the physics of electrets in order to produce a better product. The BPO has chosen to use the knife-edge charging method because it can be carried out continuously at room temperature and requires no special conditions, such as high vacuum. Fig. 5 shows the uncharged film from the supply spool being passed slowly over the knife edge, which is maintained at a potential of about 700 V and then taken up on the take-up spool drum. The film is $12.7 \mu\text{m}$ thick FEP Teflon, aluminized on one surface. The design of the charging machine is such that the aluminized surface is kept in contact with earthed rollers, and on take-up the charged surface comes into contact with the earthed aluminized surface. This allows any unwanted electrostatic charge to leak away, leaving only the electret charge; the potential is now about 250 V.

The construction of the microphone achieves repeatable

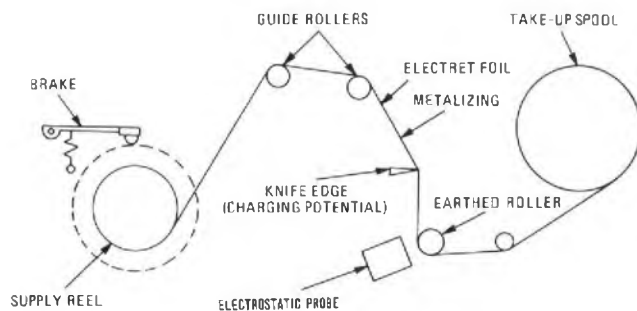

FIG. 5—Block diagram of knife-edge charging apparatus

dimensional and electroacoustic performance, long-term stability and ease of manufacture. Of particular interest is the method of locating and protecting the electret film. The metallized side of the film is cemented onto a brass ring using a cyanoacrylate adhesive and is held against the backplate by the fitting of the conductive body moulding. The backplate is moulded from conductive polypropylene and has on its front face a number of small pimples and an annular knife edge, both of very closely controlled dimensions. The knife edge, in conjunction with the brass ring, ensures uniform tensioning of the film, and the pimples serve to maintain a constant distance between the film and the backplate.

Studies into the behaviour of electret materials indicate that, if protection from extremes of heat and humidity is provided, the lifetime can be very long indeed. In practical terms, only the humidity need be considered because the upper temperature ranges necessary to shorten the life would result in damage to other parts of the telephone. Effective protection has been incorporated in a simple and inexpensive manner using a Melinex moisture-barrier in front of the aluminized surface of the diaphragm.

Microphone Size

Electret microphones can be made quite small and most of the work by the BPO Research Department has been concentrated on designs of 15 mm diameter. There is, however, some evidence to suggest that an increase in size to about

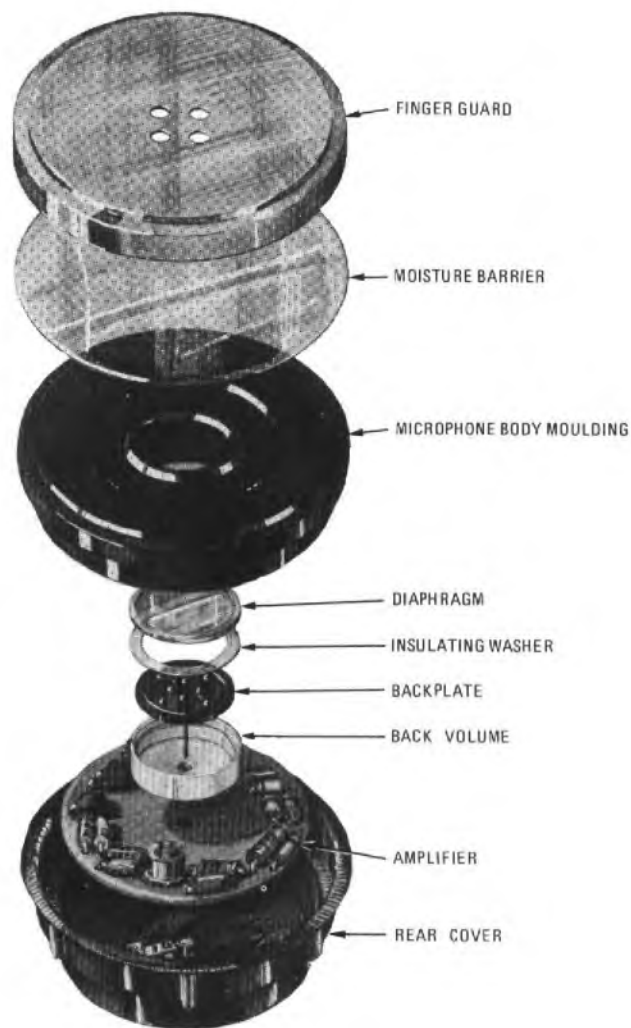

FIG. 6—Electret microphone (Drop-in replacement for Transmitter Inset No. 16)

25 mm diameter could be advantageous because this gives higher capacitance and, therefore, lower impedance; increasing the size of the electret does not necessarily increase its sensitivity.

Microphone Amplifier

The output of the electret microphone is some 20 dB below that of a typical carbon-granule microphone and so compensating amplification has to be provided. The impedance of the microphone demands the use of an amplifier with an input impedance of the order of 10 M Ω . This is most readily achieved using a field-effect transistor (FET) input stage, although bipolar designs can be used. The input stage is followed by further amplification, which can form part of a comprehensive electronic transmission circuit in a telephone. Alternatively, the complete unit of microphone plus amplifier can be made as a physical and electrical drop-in replacement for a carbon microphone for use in existing designs of telephone. Performance details presented here refer to a microphone of this type.

A complete microphone, made up as a drop-in replacement for the Inset 16, is shown in Fig. 6. There are two points of special interest in the construction of the microphone: the microphone body moulding is made of conductive polypropylene, and forms one connexion to the electret; the amplifier uses discrete components rather than an I.C.

During the course of research and development on this microphone, the construction of the amplifier and its associated components (poling bridge, surge protection) has come full circle. It started in discrete components; then an IC was specially designed and constructed at the BPO Research Department for the application. But it was not possible to include some of the larger capacitors and higher-dissipation resistors on the chip, and it became apparent that the entire circuit was more expensive than the original breadboard. So thick-film circuits were investigated and models made. But, in the end, the design reverted to discrete components because this form of construction appeared to offer the least costly solution.

If this microphone is adopted for large-scale production it may well be that alternative forms of construction will be adopted for the amplifier.

Performance

One of the attractions of the electret microphone is that it is relatively easy to control the frequency response characteristic, by both electro-acoustic and electrical means. The frequency response curve shown in Fig. 7 is the mean, with standard deviations superimposed, of 6 drop-in replacement electret microphones measured in a standard telephone handset in accordance with internationally agreed standards. The limits to which these microphones were designed, which differ slightly from those currently employed, are also shown.

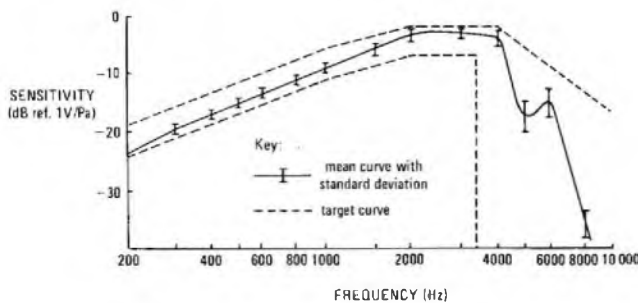

Fig. 7—Sensitivity/frequency-characteristic of the Mark 3 electret microphone

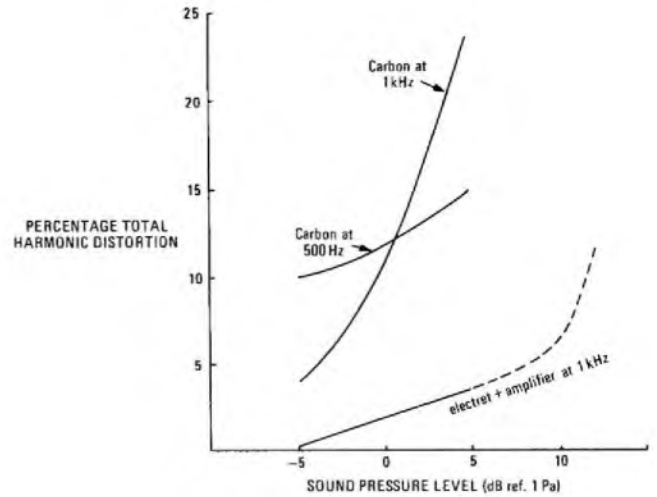

Fig. 8—Harmonic distortion produced by carbon and electret microphones

In addition to the good control of frequency response, distortion is greatly reduced by using an electret in place of a carbon microphone, as is shown in Fig. 8. Other characteristics of this microphone are given below.

- (a) Noise level: -80 dB (ref 1 V psophometrically weighted).
- (b) Operating current range: 10–110 mA.
- (c) Output impedance: 80 Ω (nominal at 1 kHz).

LONG-TERM STABILITY

As mentioned, it is of paramount importance that any replacement for the carbon microphone has extremely good reliability. The design described here has been subjected to extensive and severe environmental tests and has proved entirely satisfactory.

CONCLUSION

The move away from carbon microphones in telephones is gathering momentum throughout the world. Designs are now available that offer more stable characteristics, less distortion and improved reliability; the latter is the vital ingredient in a cost-effective solution. For the immediate future the electret is a strong contender. It remains to be seen whether, in the longer term, PVDF foil microphones offer significant advantages.

References

- 1 ATKINSON, J. *Telephony*, Vol. 1. Sir Isaac Pitman and Sons, London 1948.
- 2 ALDRIDGE, A. J., BARNES, E. J., and FOULGER, E. A New CB Microtelephone. *POEEJ*, Vol. 22, p. 185, Oct. 1929.
- 3 BEADLE, A. C., and HARVEY, F. J. A New Carbon Transmitter—Transmitter Inset No. 16. *POEEJ*, Vol. 58, p. 102, July 1965.
- 4 McMILLAN, D. Some Performance Characteristics of the Subscriber's Telephone Transmitter. *POEEJ*, Vol. 28, p. 167, Oct. 1935.
- 5 McMILLAN, D. The Telephone Transmitter: A Suggested Theory of Operation. *POEEJ*, Vol. 31, p. 167, Oct. 1938.
- 6 MEANS, D. R. T1 Carbon Transmitter Model for Use in Computer-Aided Analysis of Telephone Set Transmission Characteristics. *BSTJ*, Vol. 54, p. 1301, Sept. 1975.
- 7 GLEISS, N. Carbon Microphones and Linear Microphones—A Comparison. *Tele*, No. 4, p. 1, 1975.
- 8 SESSLER, G. M., and WEST, J. E. Electret Transducers: A Review. *Journal of the Acoustical Society of America*, Vol. 53, p. 1589, June 1973.
- 9 WADA, Y., and HAYAKAWA, R. Piezo-electricity of Polymers. *Japanese Journal of Applied Physics*, Vol. 15, p. 2041, Nov. 1976.
- 10 HEDMAN, J. The Electret Microphone—A New Microphone for Telephony. *Tele*, No. 1, p. 49, 1976.

Semiconductor Laser Development and Production

UDC 621.375.826: 621.382.2

This article first appeared in the 'Post Office Research Review', a publication issued by the British Post Office (BPO) Research Department. The article describes the work of the BPO Research Department on semiconductor lasers in support of the development of optical-fibre transmission systems.

In consideration of the fact that the information given in this article was contributed by many authors who, in turn, have also reported on the work done in this field by other colleagues, no author credit is given.

INTRODUCTION

In the British Post Office (BPO), optical-fibre transmission systems are moving very rapidly from the laboratory experimental stage to the first operational trials prior to entering production. Two classes of system are emerging: an 8 Mbit/s 120-channel system¹ aimed primarily at the junction network with repeater separations of 15 km or, more usually, between buildings up to 15 km apart; and a 140 Mbit/s 1920-channel system for operation in the main network with repeater spacings of 10 km. The 140 Mbit/s system requires a laser, whereas the 8 Mbit/s system can use either a laser or a light-emitting diode (LED): the choice between them is a complex one involving balancing the additional complexity and probable expense of the laser source against the additional performance (typically 10 dB in power) that it offers. There is also intense interest in LED sources of various designs for more general use in the ultra-cheap fibre systems that are expected to become possible following the build-up of production for the first systems; these could conceivably open new markets by offering cheap wideband transmission to the customer.

Also in the research phase is a new generation of sources and detectors for operation at 1300 nm fabricated with an indium-gallium-arsenide-phosphide (InGaAsP) active layer on indium-phosphide (InP) substrates. In this wavelength region, fibre losses are minimal; values of 0.5 dB/km have been obtained (1.7 dB/km at 900 nm). Also, the first-order fibre material dispersion goes through zero, offering the prospect of very high performance systems with exceptional repeater separations of 40 km or more if the materials problems in their manufacture can be solved. Both lasers and LEDs will probably find wide application at the longer wavelength, since the linewidth/materials dispersion limitation at 900 nm wavelength has been greatly reduced.

The work of the BPO Research Department on semiconductor lasers in support of the optical communications project is outlined in this article. The aim of the technology effort on materials and devices is to provide new types of devices for experimental work on system development. The reliability studies on the other hand aim to evaluate (and help to improve) the commercial devices which will eventually be used in the field.

LASER DESIGN

In 1970, the advent of the double-heterostructure (DH) gallium-aluminium-arsenide (GaAlAs) laser gave the possibility of stable continuous room-temperature operation of semiconductor lasers for the first time. Since then, the major research effort around the world has gone into modifying this basic structure to produce devices best suited to the needs of optical-fibre systems in terms of drive power, modulation performance, spectral characteristics, coupling efficiencies into fibres, and reliability. The DH laser consists, to take a specific example, of a thin (0.1-0.3 μm) layer of GaAlAs,

the active region in which light is generated, sandwiched between, typically, 1 μm thick layers of n-type and p-type GaAlAs. The structure is grown epitaxially on a GaAs substrate and a final GaAs contacting layer is usually added to the sandwich. Additionally, the lateral extent of the current flow can be restricted by proton isolation to between 4 and 20 μm in the case shown in Fig. 1, and yields a 'stripe-geometry' structure. The GaAlAs layers confine the injected carriers, so that light is generated only within the active region. A 'buffer' layer of GaAs is sometimes included to isolate the laser from any defects present in the substrate.

Above a critical current, known as the *threshold current*, laser action occurs and light is amplified in the plane of the layer structure. The end faces of the laser, which are produced by cleaving, act as semi-reflecting mirrors so that sufficient feedback is achieved to sustain laser action. The sandwich structure also forms a slab optical waveguide in the plane of the layers, which dramatically reduces the optical diffraction losses that would otherwise occur from such a narrow light-emitting active region. Unlike other types of laser where the output is highly collimated, light emitted from such a source is fairly divergent (up to $\pm 30^\circ$) perpendicular to the layer structure because of the very narrow source dimension. Continuous operation at temperatures up to 100°C is possible with stripe-geometry GaAlAs lasers on a suitable heat sink. The small size of the semiconductor laser is evident from Fig. 2.

Provided that a sufficient step in aluminium concentration is maintained between the layers, the emission wavelength can be varied between about 800 and 900 nm by incorporating aluminium into the active region. More recently, double-heterostructure devices operating close to 1.06 μm have been

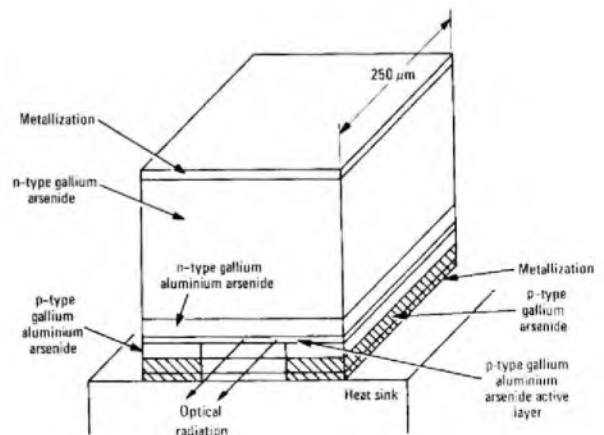

Note: Proton-bombarded isolated regions are shown hatched

FIG. 1—A stripe-geometry double-heterostructure laser

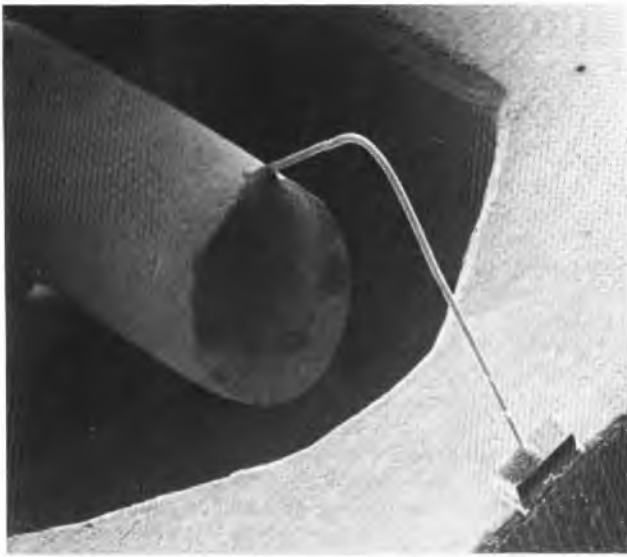

FIG. 2—Laser bonded onto a heat sink

reported, made in sandwich structures of GaAsSb (gallium arsenide antimonide)/AlGaAsSb and also of InP/InGaAsP, where emission wavelengths of up to $1.6 \mu\text{m}$ are possible. Continuous wave (CW) operation of an InP/InGaAsP laser at $1.3 \mu\text{m}$ has recently been demonstrated at the BPO Research Department.

Development has concentrated on the realization of a low-threshold-current version of the standard stripe-geometry laser with proton isolation, by optimizing the proton penetration into the layers and the stripe width, and also minimizing lasing cavity length. Calculations have shown that minimum threshold currents can be achieved when the proton isolation does not penetrate the active layer (shallow isolation) and when the stripe width is in the range $3\text{--}7 \mu\text{m}$. Additionally, shortening the length of the lasing cavity from $400 \mu\text{m}$ to $100 \mu\text{m}$ can reduce typical lasing threshold currents from 120 mA to 40 mA for epitaxial layer structures routinely available. It is predicted that, with epitaxial wafers having active layer thicknesses very close to $0.1 \mu\text{m}$ and also with rear facet reflective mirrors added, threshold currents as low as 10 mA should be possible. Devices with threshold currents in the region of 20 mA at room temperature have already been produced, in line with the calculations made. Such lasers have a high potential for use in optical-fibre systems, not only because their much lower operating currents enable simpler drive circuits to be designed, but also because of their transverse mode stability and transient behaviour: these points will be discussed fully later in this article in a section on output characteristics.

MATERIALS REQUIREMENTS

Until recently, the only system of any practical value for the fabrication of double-heterostructure lasers was the GaAs/Ga_xAl_{1-x}As system. It can be grown successfully as a single crystal because aluminium and gallium (quite fortuitously) have approximately the same atomic radius and therefore the crystal lattice spacing of Ga_xAl_{1-x}As is a fairly good fit to that of GaAs for all values of x . Good lattice matching is an essential requirement for any system in which different materials are grown as part of the same single crystal (hetero-epitaxy).

To move to a different emission wavelength (for example, to exploit the more favourable properties of the optical transmission medium at $1.3 \mu\text{m}$) advantage can be taken of the almost total mutual miscibility of III-V semiconductors in the solid state and produce a ternary composition tailored to have exactly the right band-gap by preparing a solid solution

of two binary semiconductors having band gaps respectively greater and smaller than the required value. For example, a band gap corresponding to $1.3 \mu\text{m}$ emission can be obtained by suitably choosing x in the In_xGa_{1-x}As system. However the active layer must, again, be capable of being grown epitaxially on a readily available substrate and, in order to meet the lattice-matching requirement for epitaxial growth, the system must be given an additional degree of freedom by introducing a fourth component (in this case, phosphorus). The quaternary system In_xGa_{1-x}As_yP_{1-y} offers, in principle, one composition that is

- (a) lattice-matched to InP, and
- (b) emits laser radiation at the required wavelength.

An active layer of the correct quaternary composition can therefore be sandwiched between optically-confining layers of InP, the whole structure being grown on an InP substrate. Thus, whatever method is chosen for growing the laser structure must offer good control over the compositional parameters x and y as well as over the thickness of the layers. The method must also allow each layer to be doped with the requisite amount of n-type or p-type impurity and it must produce material as free as possible from all other chemical impurities and from crystal defects.

GROWTH METHODS

The growth method which, so far, has most consistently yielded hetero-epitaxial structures of laser quality is liquid-phase epitaxy (LPE), which is an extension and elaboration of the oldest crystal-growing technique—growth from supersaturated solutions (see Figs. 3 and 4). It was first applied by Nelson in 1963 to the growth of GaAs from solution in liquid gallium, and is now used throughout the world in a number of variants that differ in degree of refinement but not in principle. The widely adopted 'saturation slice' variant, which is favoured by the BPO, elegantly avoids the need for a detailed and exact knowledge of the relevant solubility values. To grow a ternary (Ga_xAl_{1-x}As) layer, the BPO choose the Ga:Al ratio in the melt, shown in Fig. 5(a) as point A, and this melt is allowed to saturate itself with GaAs at the chosen growth temperature T_L ; the liquid composition travels towards the GaAs point until it meets the limiting solubility curve corresponding to T_L . Thus, the melt automatically acquires the exact composition for the stipulated growth temperature (point L). By slightly cooling the melt L, a supersaturation is produced which causes solid material to crystallize on to the substrate (conjugate point S). The required value of x is achieved simply by adjusting the position of



FIG. 3—Liquid-phase epitaxy kit

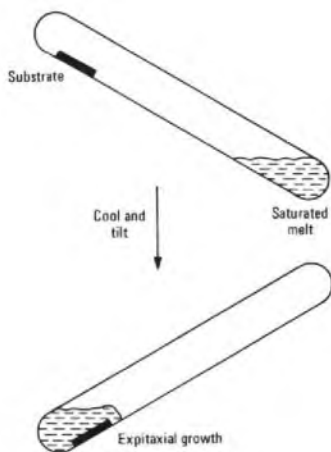
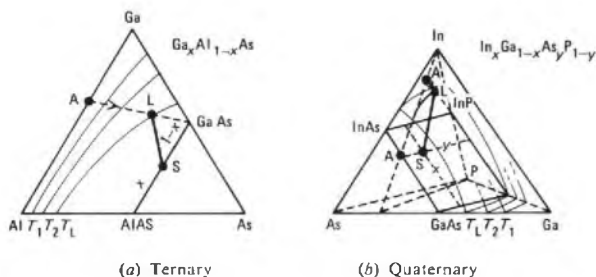
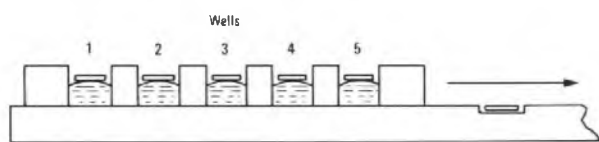

FIG. 4—Principle of LPE growth



Note: The pairs of points (L, S) represent conjugate liquid and solid composition
 FIG. 5—Solubility diagrams for ternary and quaternary systems



Note: Wells 1, 3 and 5 contain gallium, gallium arsenide and dopants; wells 2 and 4 contain gallium, aluminium, gallium arsenide and dopants

FIG. 6—Growth of multilayer structures

point A on the Ga-Al axis. In the case of a quaternary layer (see Fig. 5(b)), both x and y must be controlled and two adjustments are needed: the ratio of InAs to GaAs in the starting mixture (point A), which fixes the arsenic to gallium ratio; and the ratio of this mixture to the solvent indium (point A'), which determines the amount of phosphorus taken up by the melt when the charge is allowed to saturate itself with InP (point L). A slight drop in temperature then produces a solid of the conjugate composition S. Unfortunately, the x and y adjustments needed to control lattice parameter and band gap are not independent, but the trial-and-error approach to the optimum melt composition converges fairly rapidly.

To grow multilayer structures such as GaAs/GaAlAs, the various solutions with their saturation slices floating on top are placed in the wells of a graphite block (see Fig. 6), accurately machined to slide over another graphite block fitted with a shallow recess for the substrate. The whole assembly is held at 1100 K in an atmosphere of pure hydrogen to equilibrate the melts with their saturation slices and then the system is cooled by a few degrees to generate a supersaturation in each melt. It is important to be able to control the degree of supersaturation, so that the epitaxial layers can be grown slowly or rapidly at will and their homogeneity and flatness

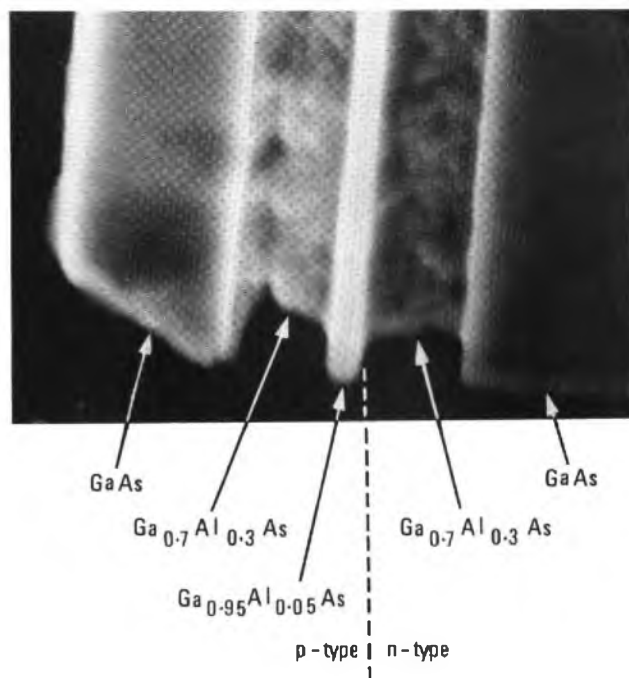

FIG. 7—Cross-section of a 5-layer laser structure as viewed in the scanning electron microscope

controlled. In practice, the excess of supersaturation is allowed to decay away by inserting an appropriate delay before the substrate is brought into contact with the melt by moving the slider.

The melts are about 3 mm deep by 2 cm² in area, weighing 3 g. They contain about 200 mg of GaAs and enough dopant, either tin (n-type) or germanium (p-type) to give each layer the required carrier density. Layer thickness can be controlled to 0.1 μ m or less for the active layer and 3 μ m for the buffer layer by accurately controlling the stability of the temperature profile to ± 1 K and its uniformity to ± 0.2 K at the operating temperature of 1100 K. Extreme purity of the atmosphere, boat, and other parts of the furnace must be maintained. Traces of oxygen, hydrocarbons, or nitrogen produce spurious solid phases on the surface of the melts which interfere with growth and can degrade the product either catastrophically or in less easily recognized ways.

The ultimate test of a successful growth run is, of course, the fabrication of good lasers, but this procedure is of little help to the materials growers because it is slow as well as having only a moderate diagnostic value. A broad range of characterization techniques is needed, especially during the 'learning' period, to monitor the 13 properties of the structure which can be specified by the designer (5 thicknesses, 5 doping levels, and 3 gallium-to-aluminium ratios) and also those properties which are known to influence device behaviour in a less easily quantifiable way—lattice defects, lattice matching, surface morphology, and luminescence efficiency. The ultimate aim of the materials assessment programme is to ensure that only satisfactory material is sent forward for laser fabrication, faulty material being intercepted and the fault diagnosed.

Typical materials assessment results are shown in the accompanying illustrations. The 5-layer structure can be revealed by examining a cleaved and preferentially etched cross-section in the scanning electron microscope (see Fig. 7), or by determining the carrier concentration profile electrochemically (see Fig. 8). X-ray double-crystal rocking curves give a sensitive indication of residual lattice parameter mismatch between the layers (see Fig. 9), and of the resulting curvature of the sample. X-ray Lang topographs can distin-

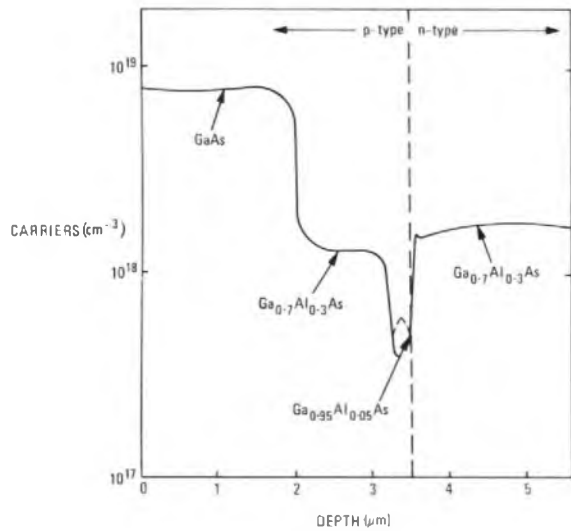

FIG. 8—Carrier concentration profile (electrochemical)

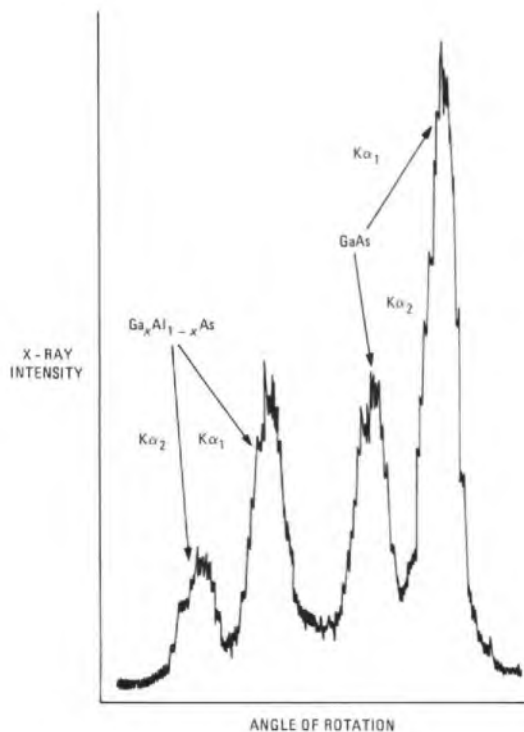

FIG. 9—X-ray double-crystal rocking curve

guish layers of good crystallographic quality from those showing 'slip' and other defects (see Fig. 10). The elemental composition of compound semiconductors is conveniently and non-destructively monitored by electron microprobe analysis, as shown by the line scans of the gallium (lower) and indium (upper) concentrations in a layer of $\text{In}_x\text{Ga}_{1-x}\text{As}_y\text{P}_{1-y}$ on InP (see Fig. 11).

NEWER GROWTH METHODS

Exploratory research on two methods of growing epitaxial layers is in progress in the BPO Research Department. Both methods are flexible, and applicable to various types of device: their suitability for laser fabrication specifically is being examined.

Double-heterostructure lasers with very low threshold currents have recently been fabricated in the USA from



FIG. 10—X-ray Lang topographs showing layers of high and low crystallographic quality respectively on substrates of similar quality

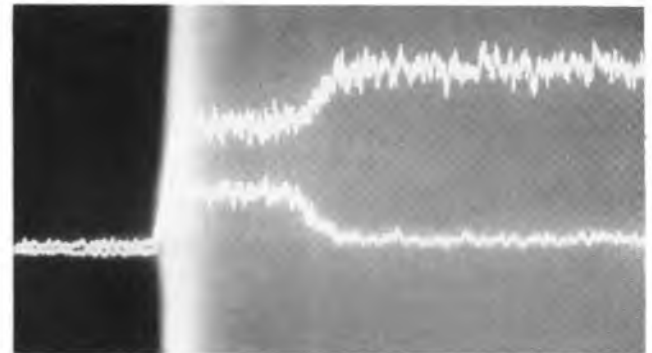

FIG. 11—Electron microprobe line scans

epitaxial structures grown by metal-organic chemical vapour deposition (MO-CVD). In this method, the layers are grown by decomposing gaseous compounds, metal alkyls or hydrides of the constituent elements on the substrate, supported on a radio frequency heated susceptor in a cold-walled quartz reactor; the doping elements are also introduced in the form of metal alkyls or hydrides. The method is undoubtedly very interesting and may eventually establish itself as a production method, but it is important to stress that high-quality layers with internal efficiencies as high as those of the best layers grown by LPE have so far been obtained only in one or two of the leading laboratories.

Another new growth method is molecular beam epitaxy (MBE), which has a number of advantages associated with the fact that growth takes place in ultra-high vacuum. Thus, the method offers very precise control over layer thickness and doping profile and large uniform areas can readily be grown. Furthermore, the properties of the growing interface can be monitored *in situ* by various ultra-high frequency surface analytical techniques. Despite the relatively small scale of the effort devoted to MBE, very interesting new, as well as existing, device structures have been grown, exploiting the special features of the method. But, so far, even the leading workers in this field have failed to produce GaAlAs double-heterostructure lasers of acceptable quality, in sharp contrast with the excellent properties of their microwave devices and their unipolar and bipolar transistors. An MBE kit is shown in Fig. 12.

DEVICE FABRICATION

Fabrication technology is aimed at being uncomplicated and using as many routine GaAs processing steps as possible.

Because the basic properties of the device are instilled into the wafer during the epitaxial-growth sequence, fabrication involves, broadly, device area definition and contacting processes only. Area definition is carried out using proton

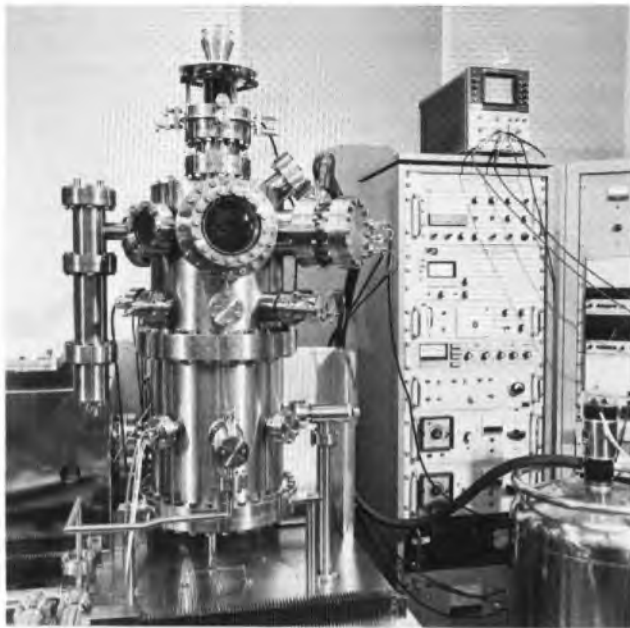

FIG. 12—Molecular beam epitaxy kit

isolation technology, originally developed within the BPO Research Department for GaAs IMPATT diode isolation. For lasers, electroplated gold stripes of various widths (in the range 2–20 μm , depending on the need) are formed on the titanium-gold (TiAu) metallized p-side of the epitaxial wafer in photoresist-defined stripe regions. The electroplated gold has to exceed some minimum thickness to prevent proton damage of the stripe region, and this is achieved by controlled plating of the gold through and over the photoresist to obtain any value of stripe width between the standard widths available on the photoresist mask. Lateral scattering of protons under the mask is also taken into account in calculating the required electroplated gold mask width required. Precise control of proton penetration has been found to be necessary, especially for narrow ($<10 \mu\text{m}$) stripes. As the proton front penetrates within 1 μm of the active region, and as the stripe width narrows, there is a tendency for the lasing light-output/current curves to become non-linear or 'kinky'.

Proton bombardment is carried out with a Van de Graaff accelerator using H_3^+ ions that dissociate at the GaAs surface into 3 equal-energy protons. In this way, a supply of, say, 200 keV protons can be obtained using an accelerator which is designed for higher energy operation. In practice, incident proton energies of $<400 \text{ keV}$ are required, corresponding to a mean range of up to 4 μm in GaAs, as the active layer is buried typically 2–3 μm from the p surface of the epitaxial wafer. Channelling of the proton beam is eliminated by a slight misorientation of the (100)GaAs wafer with respect to the incident beam.

After proton bombardment, all metallization is removed and the n-side of the wafer is thinned chemically to leave the total wafer thickness in the range 60–100 μm , so that high yields can be obtained during the cleaving of short-cavity lasers.

After chemical thinning, AuGe is alloyed to form an ohmic contact to the n-side, and then a titanium-palladium-gold (TiPdAu) Schottky barrier contact is applied to the p-side, giving a specific contact resistivity of less than $10^{-4} \Omega \text{ cm}^2$. Doping of the p-GaAs capping layer with Ge to a level close to 10^{19} cm^{-3} during epitaxial growth eliminates the need for a surface top-up zinc diffusion. Cleaving and scribing operations can then be performed to produce individual devices, which can be bonded with indium onto gold-plated headers. By using the method of supporting the wafer on a



Note: The plating is about 12 μm thick

FIG. 13—Gold-plated individual heat sink, after replating, with photoresist still in place

'tacky' backing affixed to a tensioned plastic sheet during the diamond 'nicking' and cleaving operation, it is possible to cleave 100 μm long cavity devices with a very high yield when the wafer thickness is 70 μm or less.

One development currently in progress is the formation of integral plated-up heat sinks as one way of removing the indium bond from close proximity to the p-side of the chip. There is a tendency for InAu intermetallic compounds to form and produce voids, especially under operating conditions at slightly elevated temperatures, which increases the thermal resistance. When the indium is in close proximity to the p-side of the chip, this increase can be very serious in limiting elevated temperature lifetimes under CW operational conditions. Fig. 13 shows a plated-up heat sink, formed by electroplating gold uniformly over the p-metallization of a wafer, masking with photoresist, and etching the unmasked areas followed by re-plating (with the photoresist still in place) to improve the edge profile of the heat sink. In this way, it is possible to obtain efficient heat sinking to within a few micrometers of the ends of the laser cavity and, because there is no metal overhang with this method, there is no interference with the light emitted from the ends of the lasing cavity.

LASER CHARACTERISTICS

The criterion by which these lasers are judged is their suitability for proposed civil optical-fibre transmission systems. Two regimes of use are envisaged: the first around 8 Mbit/s (and possibly 34 Mbit/s), where LEDs can compete with lasers because fibre dispersion does not necessarily dominate in the systems use envisaged; the second at 140 Mbit/s and above, where a laser is required in the 900 nm region and where its transient and spectral characteristics have to be controlled.

At around 8 Mbit/s it is envisaged that sources and regenerators will be located in exchange buildings where adequate power is available. Thus the potential of the laser lies in its higher power output capability and also, if laser operating currents are in the range 50–100 mA, its ability to operate on half-width return-to-zero current pulses using simple mean-power feedback control. Such drive conditions should enhance laser lifetime by a factor of 4 above the values normally quoted for CW operation of the device.

Devices with characteristics similar to that shown in Fig. 14 have been used without intermediate regenerators in the mode described above over the 13 km Martlesham to Ipswich optical-fibre link at 8 Mbit/s, and shown to be very suitable.

Measurements have also been made to determine the suitability of this type of device in high-bit-rate optical-fibre

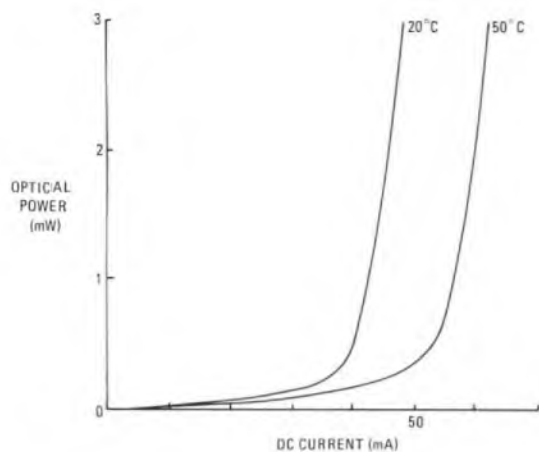
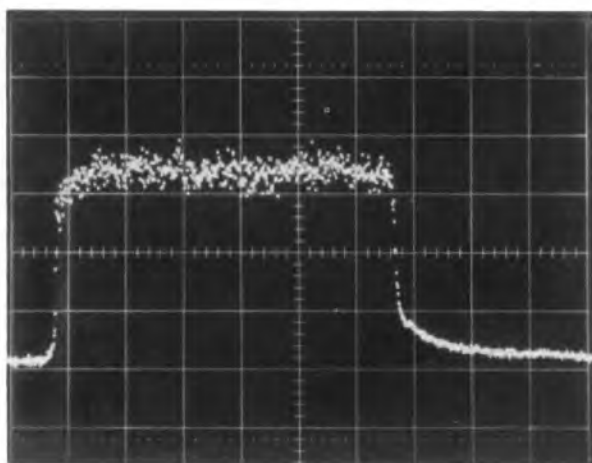

FIG. 14—Continuous wave characteristics of a laser with a $4.4 \mu\text{m}$ wide stripe and a $96 \mu\text{m}$ long cavity



Note: Time scale is 5 ns per division

FIG. 15—Optical pulse response at a peak power of 3 mW

communication systems. Lasers with a cavity length of $100 \mu\text{m}$ and stripe width of $4.4 \mu\text{m}$, having threshold currents of 35–50 mA at 20°C , have been studied in this respect. The light/current characteristics of such lasers are linear up to at least 3 mW with a differential power efficiency of up to 60%, whereas wider stripes often exhibit non-linearities at lower power levels and, as a result, have a lower differential power efficiency.

The devices studied exhibit a lowest-order transverse mode (that is, a single-lobed intensity profile) in the plane of an active layer, $5\text{--}9 \mu\text{m}$ wide. The polar diagrams of the emitted light, measured in the planes parallel and perpendicular to the active layer, are both single-lobed with angular half-widths of approximately 20° and 40° respectively.

Transient response studies have been made with lasers pulsed from a DC bias level approximately 10 mA below threshold. The current pulses have a risetime of less than 0.5 ns and an amplitude adjusted to give a peak power of 3 mW. The light pulses were detected (Fig. 15) with a high-speed silicon avalanche photodiode and displayed on a sampling oscilloscope, the combined risetime being less than 0.3 ns.

High-frequency ($\approx 0.5\text{--}1$ GHz) damped oscillations (relaxation oscillations), normally associated with driving a semiconductor laser from below threshold, are seen to be absent. Such oscillations interfere with the laser output pulse height and position when the bit rate approaches the oscillation frequency.

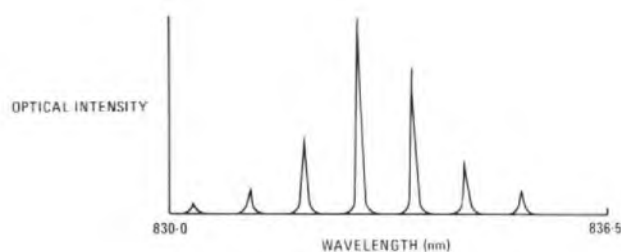

(a) Continuous-wave optical spectrum at optical power output of 3 mW

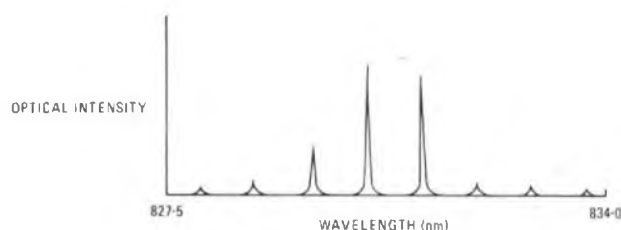

(b) Time-resolved pulse spectrum measured after 1 ns on a pulse having a peak optical power output of 3 mW

FIG. 16—Optical spectra

The absence of relaxation oscillations is a common feature of all the lasers studied having a stripe width of $4.4 \mu\text{m}$. In devices having wider stripes, the relaxation oscillations are either absent or completely damped within 1 ns of the leading edge of the optical pulse. The high level of broadband intensity noise evident from Fig. 15 is observed under DC and pulse-modulation conditions on all lasers studied having a stripe width of $4.4 \mu\text{m}$, the wider-stripe devices exhibiting significantly less noise. With the laser operating at an output power of 3 mW, the optical power signal-to-noise ratio in a bandwidth of 350 MHz, as determined from the RMS noise on the photocurrent of the monitoring photodiode, was approximately 22 dB in the worst case. This should result in a negligible penalty in the receiver sensitivity of optical communication systems having bandwidths of up to 350 MHz.

Typically, these lasers emit power into several longitudinal modes, the modes and their separation being determined by the cavity length. For lasers with a cavity about $100 \mu\text{m}$ long, the longitudinal mode separation is about 1 nm.

Time-resolved measurements of the optical spectrum showed that the signal-to-noise ratio of an isolated longitudinal mode was very much smaller than the corresponding value for the total output of the laser, suggesting that the noise is the partition noise that occurs when a photon can be stimulated into one of a number of lasing modes.

Optical spectra of the lasers have also been measured under steady current pulse conditions. The steady current spectrum of one laser (cavity length $96 \mu\text{m}$) at an output power of 3 mW and the time-resolved spectrum of the same laser measured 1 ns from the onset of an optical pulse having a peak power of 3 mW are shown in Figs. 16(a) and 16(b) respectively. In the latter measurement, the laser was biased approximately 10 mA below threshold. The lack of any significant spectral broadening as a result of pulse modulation is consistent with the absence of relaxation oscillations in the optical transient response. Based on considerations of the material dispersion alone, lasers having the optical time-resolved pulse spectrum shown would be suitable for use in 140 Mbit/s optical fibre communications systems having a repeater separation of at least 15 km and also, if operated with a reduced pulse width, for 280 Mbit/s systems with repeater separation in excess of 10 km.

In summary, the low threshold currents, linearity, and

absence of relaxation oscillations in the transient response of the short-cavity narrow-stripe GaAs/GaAlAs lasers described make them particularly interesting as sources for high-bit-rate optical communications systems. Devices having threshold currents below 50 mA offer the possibility of modulation at 140 Mbit/s with a zero bias current, leading to reductions in power consumption and to simplification of the feedback circuit necessary for laser level control. In addition, operation of the laser with a zero-bias current will result in an improvement of the laser reliability if the residual degradation mechanisms are associated with the flow of current through the device rather than the peak optical flux density at the facets

RELIABILITY

A major problem in the past has been the unreliability of semiconductor lasers and LEDs. The potential operational lives of these devices have gradually been increasing as some of the reasons for failure have been discovered and overcome. To date, the majority of work around the world has been on GaAlAs devices, but early work on the newer InGaAsP lasers is showing that there are some problems here also.

The problems of improving laser lifetime have turned out to be markedly different from those normally encountered in semiconductor devices. Whereas, in the main, failures of semiconductor components have been associated with the surface of the chip and its passivating oxide and may be aggravated by current flow, temperature, and moisture, failures of GaAlAs lasers have been associated with processes within the semiconductor chip. Dislocations threading through the active layer have been shown to increase their length in the presence of the high rate of carrier recombination, which leads to a localized reduction of the efficiency of light generation and hence an increase in laser threshold current. The effect can occur in periods ranging from a few hours to several thousand hours. Strict quality control of the grown epitaxial wafer can now eliminate this and similar problems: GaAlAs devices have now been operated for several years without failing, although, in general, the threshold current does increase. A realistic state-of-the-art figure at present is 0.5–1.0% increase in threshold per thousand hours for

room-temperature operation. Hence, failure is gradual, the end-of-life being determined by the margins of current supply to drive the laser allowed by the system design engineer. For example, if a 50% increase in threshold can be catered for, which can be regarded as acceptable in practice, then a 1% per 1000 h increase in threshold is equivalent to 50 000 h (6 years) of continuous operational use.

Another early problem was that strain, introduced during device fabrication and bonding stages, could result in early failure. This is the reason why semiconductor laser chips are almost universally bonded down with a very 'soft' indium solder, which melts at 156°C.

Because of the long device life now possible at room temperature from GaAlAs lasers, effort in the BPO Research Department has concentrated on exploring means of accelerating operational failure. Temperature and also current have been examined as overstress parameters (see Fig. 17). Temperature overstress has been limited to 90°C by the presence of indium but, even at this temperature, metallization problems begin to dominate internal laser-chip degradation processes. The thermal resistance of the device is seen to increase by a factor of 2 or 3 over periods of several hundred hours of operation at 90°C, sometimes saturating at a higher value. The observed increase in thermal resistance is related to the formation of In/Au intermetallic compounds during device operation; these compounds form granular structures, which may be responsible for the worsening thermal properties. These changes are accelerated by current flow as well as by temperature, so that at 90°C the thermal resistance changes can be slower by a factor of 10 when no current is passed. The threshold current for lasing is sensitive to temperature, changing by 1–2% per °C, and, hence, high device-thermal-resistance causes serious problems in maintaining stable laser operation, particularly at high ambient temperatures (device operation at up to 50°C would be preferred for some BPO applications).

In order to measure the internal degradation of the laser chip in the presence of a deteriorating thermal resistance, pulsed, low-duty-factor measurements of device characteristics can be made. In addition, to reveal the effects of temperature overstress alone on degradation, devices have been tested in the LED mode by operating them at currents just below the room-temperature threshold at all stress temperatures. This precludes the identification of degradation mechanisms associated with high optical flux densities but, with the application of dielectric coatings to protect the output facets from attack, catastrophic disintegration (burn-off) of these facets due to the high power density incident on them is thought to be controllable. Pulsed degradation rates for CW operated

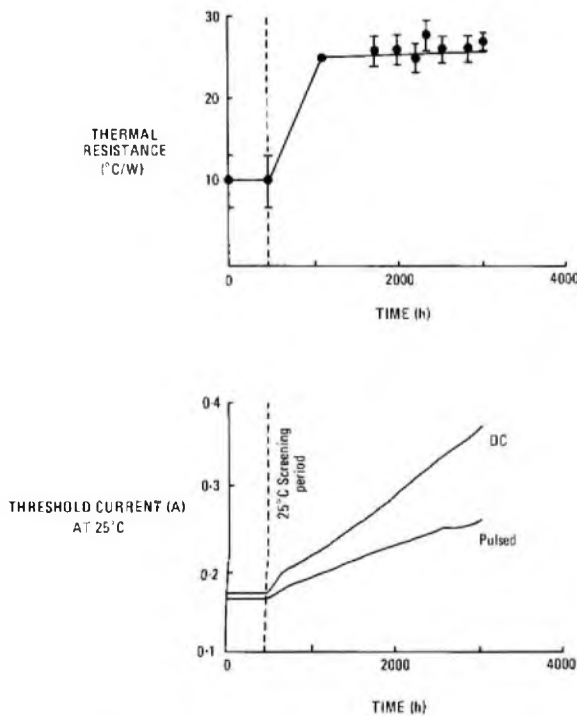

FIG. 17—Thermal resistance and threshold current increase (measured at 25°C) with time for a laser operated at 90°C

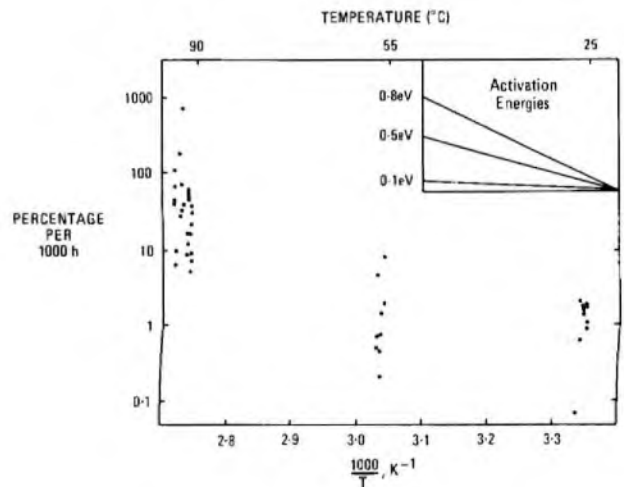

FIG. 18—Laser degradation rates (in terms of percentage change in pulsed threshold measured at 25°C) as a function of temperature

devices at 25, 55 and 90°C are shown in Fig. 18. The scatter in results is higher at the higher temperature and analysis of the distribution indicates that a different degradation mechanism is dominating at elevated temperatures. Clearly, this prohibits conventional Arrhenius extrapolations for this type of device and this is confirmed by photoluminescence assessment of working devices. This technique allows the uniformity and efficiency of the active region to be spatially assessed and shows that devices operated at 90°C often degrade in a non-uniform way, whereas no such non-uniformities have been observed after room-temperature operation.

Current overstress, to date, has not yielded any consistent results. Thus, it is evident that a viable accelerated test for predicting the operational lives of this type of laser is not yet available. Such a test remains a prime aim of degradation studies, as continuing long-period testing under operational conditions is not acceptable as a means of validating device performance. It is hoped that experience with GaAlAs devices will lead to a much quicker understanding of the reliability problems of InGaAsP devices as they begin to appear.

CONCLUSION

The semiconductor laser is still developing, and it is not clear yet what device configurations will eventually be chosen. However, satisfactory versions of the laser itself are now appearing, and there is a real need, in parallel with pushing ahead with further development, to put the laser chip itself into the most practical environment for use with fibre systems. To this end, studies of the methods of coupling the laser output most effectively into the transmission fibre are now beginning in earnest. The feasibility of incorporating the laser within a hybrid package to enable it to be driven more effectively at higher modulation rates is also being investigated.

References

¹ BRACE, D. J., and RAVENSCROFT, I. A. Optical-Fibre Transmission Systems: The 8.448 Mbit/s Feasibility Trial. *POEEJ*, Vol. 70, p. 146, Oct. 1977.

² BERRY, R. W., and RAVENSCROFT, I. A. Optical-Fibre Transmission Systems: The 140 Mbit/s Feasibility Trial. *POEEJ*, Vol. 70, p. 261, Jan. 1978.

Book Review

World Communication: Threat or Promise? C. Cherry. John Wiley & Sons Ltd. xiv + 229 pp. 48 ills. £11.00 (Hardback); £4.75 (Paperback).

This is a revised edition of a book first published in 1971. In his "Apology and Acknowledgement", Professor Cherry claims no more than that it is a modest attempt to bridge the chasm between the technical experts on one bank, and humanists on the other. This has become a popular activity with writers fascinated by the political and social implications of telecommunications, but Professor Cherry is not only one of the originators of the genre, he is still one of the most thought provoking.

Not surprisingly, Professor Cherry does not attempt to offer a universal reply to the question posed in the title of his book. Concepts and actions which might be regarded as good or progressive in Western eyes may be quite alien to the cultures of the emerging nations. Communications do not really help the Western world to know these peoples better. Images of their lives and thoughts pass through many stages of selection and presentation before they reach our newspapers and television screens. Admittedly, the telephone differs fundamentally from the mass broadcasting forms of communications, although both spring from the same basic technologies, in that a telephone conversation is not merely an exchange of messages but implies some commitment to a revelation of personal character and opinion. But even then, the international telephone service does not make the world our village for, at best, we cannot expect to get to "know" more than one or two hundred people in this way.

However, Professor Cherry believes that global communications can bring benefits, both by facilitating the establishment of international institutions and by permitting the decentralization of some functions. There are now over 2600 specialized international organizations gradually building a federalism, not of states but of areas of interest. They are defining and tackling large numbers of problems that go beyond national frontiers, and gradually building a trust in institutions, which is an essential part of the infrastructure of modern civilization; they could not operate without modern communications.

These are but a few of the many strands in Professor Cherry's argument. Along the way, the reader is presented with a wide variety of fascinating information. Did you know, for instance, that the habit of buying books and borrowing from public libraries increased sharply after sound broadcasting started in the early 1920s and increased sharply again when television took off in the early 1950s? Or that two-thirds of the population of the USA knew of President Kennedy's assassination within half an hour of its occurrence? Why is the USA so advanced in its use of the telephone but (comparatively) laggardly in its use of Telex?

This book will not help anyone to solve a technical problem or pass an examination. It is, however, recommended to all who wish to reflect on the social consequences of their activities, and particularly to those of us who feel tempted to utter a few amateur sociological musings as a preface to our lectures. Is the world our village? Does global communication promote international accord? Professor Cherry brings a sharp pin to these bubbles.

D. WRAY

Main Transmission Network: Planning of Digital Transmission Systems

D. J. BECKLEY, C.ENG., M.I.E.E.†

UDC 621.394.4: 681.327.8

This article briefly reviews the types of transmission media used in the British Post Office (BPO) main transmission network at the present time, and discusses the considerations and plans for the introduction of digital transmission systems into this network. The article describes the growth and extent of the main network and the application of digital systems in the provision of an integrated network of digital-switched exchanges and digital line systems.

INTRODUCTION

During the last 15–20 years, there has been enormous world-wide interest in the exploitation of digital technology for both switching and transmission, and there is little doubt that this technology will be used in most public telephone networks within the next decade, if it has not already been. In the British Post Office (BPO), initial interest found its most practical realization in the form of 24-channel pulse-code modulation (PCM) systems on symmetrical pair audio cables in the junction network¹, but right from the early days, the BPO has envisaged an integrated network of digital switching and transmission.

Interest in such a network was confirmed in 1967 by the setting-up of the UK Trunk Task Force (UKTTF)², whose commitment was to study the long-term telecommunications requirements of the society of the future, the technologies likely to be available, and the cost of meeting those requirements with the various technologies identified. One conclusion of the UKTTF was that service, operational and economic benefits would derive from the use of digital forms of transmission in the UK main network irrespective of the type of switching system adopted, provided that a satisfactory repertoire of transmission systems of different capacities was available. Another conclusion was that, once a digital transmission network had been established, considerable advantage could be gained from the adoption of digital switching at group switching centres (GSCs). Following the UKTTF activities, the Advisory Group on System Definition (AGSD) was set-up to define the operational requirements for the network as a whole, with a view to the design of a family of digital switching units, which are now embraced within the generic description of *System X*. It is against this background that digital transmission systems are being introduced to the BPO main network.

An important advantage of digital transmission is that it can be used for all services; for example, telephony, telegraphy, television and data transmission. However, as will be indicated later, digital transmission is not compatible with analogue transmission systems at transmission multiplex levels; this aspect is a significant operational disadvantage.

This article briefly reviews the growth and extent of the BPO main transmission network and indicates the progress and complexities of introducing digital transmission systems and the likely use of these systems for the various services.

THE MAIN TRANSMISSION NETWORK

The BPO main transmission network³ comprises the cable and radio systems used to provide circuits between GSCs and between GSCs and higher-order exchanges in the switching hierarchy; also between international frontier stations (sub-

marine cable and satellite terminal stations) and international switching centres (ISCs). The majority of plant used for the main network comprises high-capacity systems on coaxial cables and micro-wave radio-relay links, the latter also being used for television links for the UK Broadcasting Authorities, Confravision services and very-high-speed data services.

Over the years, there has been a steady increase in the circuit capacity of transmission systems in the main network; this increase is in keeping with the traffic demand and the advances in technology. Initially, all of these systems employed frequency-division multiplex (FDM) techniques, which were first developed for use on lightly-loaded balanced-pair cables to provide carrier channels (to a maximum of 4)⁴, in addition to an audio-frequency bearer circuit. Although these early systems were used quite extensively, a truly national FDM network did not emerge until the arrival of the 12-circuit carrier systems⁵, which were installed in the late 1930s and early 1940s, using two 24-pair balanced-pair cables, one for each direction of transmission. This network extended from Truro in the South West to Inverness in the North, and formed the foundation for the high-frequency (HF) network as it is today. This network was later (1945–1955) enhanced to provide 24 circuits per two pairs, and some 60-circuit systems were installed. But, by that time, the advance of technology and economic factors favoured coaxial cable systems, and no more advances were made with balanced-pair carrier systems. The 12-circuit and 24-circuit network has, however, given noble service, and it is only in recent times that plans have been made to withdraw the equipment from use. As will be indicated later in this article, the cables will be used for digital transmission.

Coaxial cable systems were first introduced⁶ into the network in the late 1930s and early 1940s, but it was not until the 1950s and 1960s that provision of these gained momentum and they became the dominant medium for main network circuit provision for relatively-short as well as long-distance circuits.

Because of the cost of in-band (and more especially out-band) signalling systems, economics had, until the late 1960s, favoured the use of audio circuits on balanced-pair cables for short-distance circuits, and an extensive network of such cables has been installed. In many cases, these audio cables have been designed to cater for junction as well as trunk traffic, and many are already being used for PCM applications, or are planned for use in the future.

The development of the microwave-radio element⁷ of the main network owes its origin to the expansion of the broadcast television and international services, with which it is largely concerned, and has grown rapidly since the late 1940s.

Until 1968, the planning of all cables for the main network was concentrated in Telecommunications Headquarters but, at that time, the decision was made to delegate to Regions the responsibility for audio cables, irrespective of their use.

† Network Planning Department, Telecommunications Headquarters

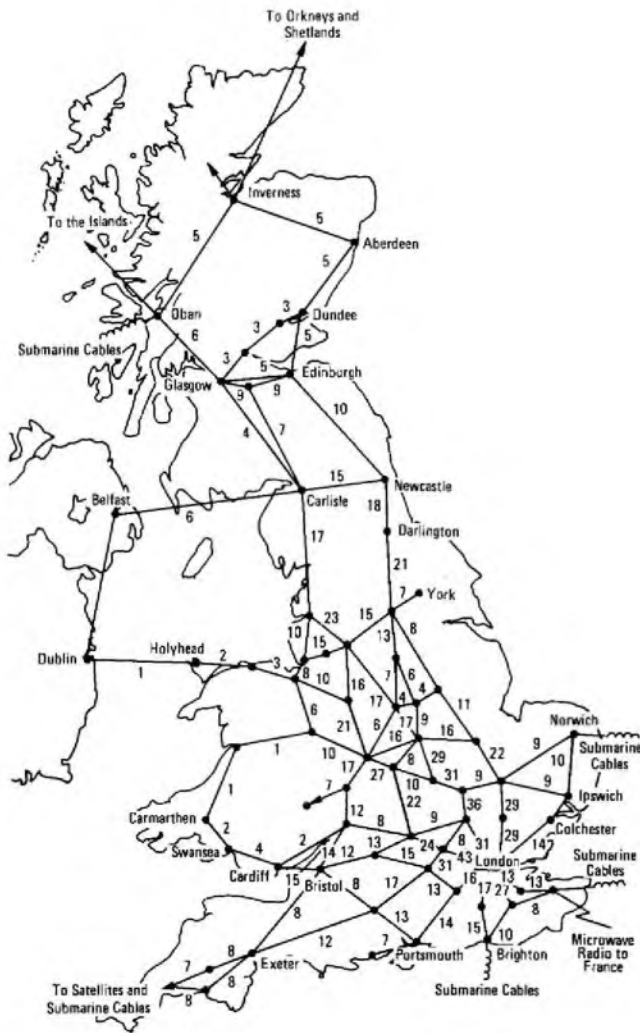

Note: Circuit quantities indicated represent thousands of circuits

FIG. 1—Major trunk-traffic links

Telecommunications Headquarters retained the responsibility for the planning of the HF network, which serves the main arteries of the network. Although HF plant is dominant, a significant proportion of main network circuits are routed on audio plant, see Table 1. The present circuit capacity of the main network is indicated in Fig. 1.

REVIEW OF THE USE OF FDM SYSTEMS IN THE NETWORK

HF systems are provided only when the number of circuits required is sufficiently large to justify them; where it is not, main network circuits are integrated with junction circuits and carried on junction plant, either audio or PCM. For the HF network, as elsewhere, it is the practice to select the most economic system for a particular route; the choice of system is dependent upon route distance, the annual increment of circuit growth, the suitability of available systems, the ability to exploit existing plant, and the transmission requirements. The decision may also be influenced by other considerations; for example, the security of the network, which must be planned to provide diversity of routings to minimize the effects of system failures. During the last decade, a substantial network of spare capacity has been provided for use in the event of failures. The network is known as the *service protection network* (SPN) and this will be discussed later in this article.

TABLE 1
Main Network Circuits (Including Private Circuits)

Transmission Media	Total Circuits	
	Installed	Planned
	1978-79	1982-83
HF FDM Systems	313 000	413 500
Higher-Order TDM Systems	200	13 600
Audio Plant	14 600	14 500
24-Circuit PCM on Audio Plant	41 200	49 300
30-Circuit PCM on Audio Plant	1800	15 500

Notes: Of the total circuits routed on HF plant and shown for 1978-79 and 1982-83, 24 000 and 30 000 respectively are routed wholly or partly on microwave radio

Circuits required between UK international switching centres and UK frontier stations correspond to approximately 20 000 and 36 000 circuits respectively for 1978-79 and 1982-83. They are all planned to be routed on HF plant, and are additional to the totals shown above

TABLE 2
Coaxial Cable Systems at Present Installed in the BPO Main Network

Frequency	Circuit Capacity	Remarks
1.3 MHz	300	Obsolescent
2.6 MHz	600	Obsolescent
4.0 MHz	960	Obsolescent
12.0 MHz	2700	
60.0 MHz	10 800	
120 Mbit/s	1680	

In the past, the technological advances made in an environment of continuing expansion (which has of course influenced the pace of technical advance), have led to a widening of the range of systems available to the planning engineer. As might be expected, the economic aspects vary quite considerably from route to route and, in the network, there is a wide and more or less continuous spectrum of application for systems. However, it is not possible or economic to keep a very wide range of facilities available because there will be insufficient demand to keep production lines in operation. Thus, the trend has been towards adding higher-capacity systems to the repertoire and removing the small-capacity systems from the lower end of the scale.

Table 2 lists the coaxial cable systems that are now installed in the main network, and indicates those that are now obsolescent. The largest systems (that is, 60 MHz systems⁸), are just entering the network at the beginning of the digital era. Two points are worthy of note. The first is that advances in technology have progressively made it possible to re-exploit cable assets to greater advantage than was envisaged when they were first installed; secondly, the existence of these very considerable assets places constraints on the design objectives for new systems. Table 3 gives a statistical picture of the main network as it has been planned for 1978 at the beginning of the digital transmission era, and at 1982, the latest date for which firm plans have been made.

Before considering the requirements for digital systems, it will be useful to reflect on the way in which exploitation of the various FDM systems has progressed. In the early days of carrier telephony, it was not uncommon to de-multiplex to audio at an intermediate point on-route in order to obtain an economic 'fill' of the group capacity (that is, channel fill of groups). Early coaxial systems were permanently cabled down to the group level (60-108 kHz), which was the only flexibility point. In the 1950s, new systems were

TABLE 3
Main Network Statistics

Plant/Circuits	Installed	Planned
	1978-79	1982-83
Hypergroups	1395	1589
Working Supergroups	9300	10 700
Working Groups	30 200	37 500
12 MHz Line Systems	590	673
4 MHz Line Systems	1260	1316
120/140 Mbit/s Systems	7	101
8 Mbit/s Systems	—	144
Tube Kilometres of 2·6/9·5 mm Coaxial Cable	41 300	41 400
Tube Kilometres of 1·2/4·4 mm Coaxial Cable	154 300	160 000
Main Network Circuits (including private circuits) on HF FDM	313 000	413 500
Main Network Circuits (including private circuits) on TDM	200	13 600
Main Network Circuits (including private circuits) on Audio Plant	57 600	79 300
48 kHz Wideband Circuits on HF FDM	679	1042
240 kHz Wideband Circuits on HF FDM	137	198
Radio Channel Hops* for 960-channel Telephony Systems	760	760
Radio Channel Hops* for Television	412	439
Radio Channel Hops* for 1800-channel Telephony	411	426
Radio Channel Hops* for Miscellaneous Services	90	90
Radio Channel Kilometres for Telephony (960/1800 Channels)	47 000	47 000
Radio Channel Kilometres for Television	16 200	17 500
Radio Channel Kilometres for Miscellaneous Services	3500	3500
Average Length (km) of 12 MHz Line Systems	67	65
Average Length (km) of 4 MHz Line Systems	42	42
Average Length (km) of 120/140 Mbit/s Systems	28	37
Average Length (km) of 8 Mbit/s Systems	—	32

*—Unidirectional

provided with flexibility at the supergroup level (312–552 kHz). In the 1960s, flexibility was also provided at the hypergroup level (312–4028 kHz). These facilities have led to the setting-up of longer links of increased modular size: first groups, then supergroups and now hypergroups. At the same time, HF systems have become more and more economically attractive for short-distance use, and this has led to the provision of shorter links of all modular sizes. Thus, as the network has developed, the spectrum of modular sizes has increased and we now have hypergroup links as short as 10 km and as long as 600 km; 20 years ago, the range was 50–200 km. An important consideration in the network has been the ability to achieve satisfactory fills of the modular sizes without installing excessive connecting equipment at group and supergroup levels, which is costly to provide, involves more effort in circuit provision and maintenance, and adds to transmission

impairments such as noise, group-delay and attenuation distortion. In fact, as the network has developed, its performance has been improved, not only because technical advances have been achieved, but also because the size of the network has made it possible to exploit the facilities to greater advantage. Optimization has enabled economies, technical improvement and operational advantages.

The Service Protection Network

During the last decade, a substantial element of spare capacity has been provided in the main network for the protection of high-capacity FDM line transmission systems. Microwave radio-relay systems are provided with protection channels, which can be used to restore line systems. Overall, the spare cable capacity amounts to about 10% of the traffic-carrying capacity, and is primarily used for the protection of the inland network. The capacity is largely in terms of dedicated 4 MHz and 12 MHz coaxial cable systems though, in some cases, spare 4 MHz bands in 12 MHz systems have been allocated. To enable radio protection channels to be used for line system restoration purposes, it has been necessary to provide extensions from terminal radio stations to city centre terminals.

International services are catered for by the international protection network (IPN), which comprises a somewhat larger proportion of spare capacity between international switching centres (ISCs) and international frontier stations (submarine cable and satellite terminals) to ensure that international services are not disrupted by inland failures.

With the establishment of a digital network, which is not compatible with the analogue network, it will be necessary to establish a separate protection network, both for inland and overseas circuits. As yet planned, the proportion of capacity on digital plant is not significant, but the time will soon arrive when spare digital capacity must be provided to deal with transmission failures, and outline plans have already been prepared.

PLANNING OF THE MAIN TRANSMISSION NETWORK

The planning of the BPO main transmission network is organized in annual cycles, commencing with the publication of the annual schedule of circuit estimates (ASCE). Currently, the ASCE covers a period of 5 years, the first-year quantities being the circuits which will be set up in the year following publication, and for which plant will have been provided under earlier forecasts and plans. Processing of the data and determination of the annual programme of transmission works occupies 9 months, following which, tenders are sought and contracts are placed for the plant and equipment required.

It is the normal practice to plan new line systems or radio transmission systems on the basis of the fifth year of the ASCE (that is, 4 years in advance of completion of the transmission systems), this allows one year for circuit provision. Terminal equipments are planned with one year less lead time.

In keeping with the plan to change-over progressively from analogue to digital forms of transmission for network growth in a period of 8–10 years starting in 1978, the first 30-channel digital line systems for the main network were planned in 1974 and will be brought into use under the 1978/79 annual programme of transmission works. Current plans extend to 1982, and include 5 cycles of digital planning. As explained earlier, the network of FDM systems has reached a well-developed stage, and nearly all the main network switching centres are connected by higher-order transmission systems (that is, 4, 12 or 60 MHz systems). These systems are exploited to provide both short-distance and long-distance links, the modular sizes of which depend upon growth requirement. To

avoid excessive intermediate multiplexing equipment costs, the modular sizes are chosen to suit growth, though this inevitably means less flexibility. One of the features of this approach is that, in the arteries of the network, there exist along the same route (perhaps in the same cable or system) both short-distance and long-distance hypergroups and supergroups, the short-distance links usually being co-terminal with the 2 nodes which they connect. It is always possible to interconnect short-distance routes to serve distant centres, but it is possible to use spare capacity in the long-distance systems for short-distance use only by introducing intermediate multiplexing on route; that is, converting to short-distance use. In general, there will be no relationship between the dates of saturation of the long- and short-distance elements, which will occur randomly. In the planning process, longer-distance systems are set-up whenever possible, satisfactory fills (that is, the use of capacity) being achieved by transferring groups from tandem-connected short-distance links. The capacity thus freed is available for growth on shorter-distance routes and, in effect, long-distance systems are introduced without noticeable loss of flexibility.

In all these processes, circuits are planned with the object of meeting minimum standards of diversity to guard against plant failures. Currently, traffic routes of more than 12 circuits have a minimum diversity of 2, and are split such that no more than two-thirds of circuits are carried on a single transmission system, which may be a cable or radio link. Where only cables are available, the transmission systems used for the diverse circuit routings are, in most cases, in separate cables.

DIGITAL DEVELOPMENT PROGRAMME

In 1973, following the publication of the report of the UKTTF, the BPO Management Board endorsed the recommendation that planning of the main network should move towards the use of digital transmission, and preliminary plans were made for the development of a suitable range of systems.

A digital multiplex hierarchy is decided, in the first instance, by the design of the primary multiplex group assembly. Initial work in the development of PCM systems was concentrated in the USA where, as elsewhere, the initial impetus came from the possibility of deriving significant economic advantages from the use of PCM on audio cables. This work was mirrored in the BPO, which was amongst the first telecommunications administrations in the world to develop a PCM system for operational use¹. The BPO system, like the American system, provided 24 channels, though there were a

number of important design differences between the 2 systems (particularly in the coding law and the frame structure) that would have prevented their use for international links. But, in the event, after considerable debate in the forum of the International Telegraph and Telephone Consultative Committee (CCITT), 2 designs were standardized⁹; a 30-channel design based on a new coding law (A law) and a 24-channel design based on the Bell System coding law (μ law). The original American design had to be modified for international as well as long-distance use in the USA. North American countries and Japan have adopted the 24-channel assembly, whereas all European and many other countries have adopted the 30-channel assembly. It was against this background that decisions had to be made for the development of a range of digital transmission systems for the BPO network¹⁰, to satisfy both main and junction network requirements. A comparison of the American and European FDM and TDM multiplex levels is given in Table 4.

Ideally, from the planning standpoint, a complete range of digital transmission systems would have been available from the start, but this would have been too demanding of research and development resources; therefore, it was necessary to spread the development programme over a number of years. Three phases of development were envisaged.

Phase 1

The immediate objectives were the development of a 30-channel primary multiplex equipment and associated line system for use on audio cables^{11, 12}, and a medium-capacity digital system for use on coaxial cable. These systems were intended to fulfil, respectively, the role of the 24-channel PCM systems on junction cables and the medium-capacity FDM system requirements provided on coaxial cables; thus enabling a start to be made in creating a digital network capability as quickly as possible. At that time, the CCITT had not decided on the hierarchical levels above the second level, and it became necessary for the BPO to decide upon the digit rate of a suitable coaxial cable system in advance of CCITT recommendations. In the event, and after considering the available information on cable performance and taking into account the power-feeding limits in the BPO network, 120 Mbit/s was chosen as the digit rate for the coaxial cable system¹³. Thus, the 30-channel primary multiplex and the associated 2 Mbit/s digital line systems, together with the 120 Mbit/s coaxial line system and the associated 2/8 and 8/120 Mbit/s multiplex equipment, formed the first of the 3 phases of the development programme, details of which are

TABLE 4
Multiplexing Structure

Multi-plexing Level	Digital (Time-Division Multiplexing)		Analogue (Frequency-Division Multiplexing)	
	North America	Europe	UK	Other European Countries
First Order	1·544 Mbit/s (24 channels) Primary block μ law encoding	2·048 Mbit/s (30 channels) Primary block A law encoding	60–108 kHz (12 channels) Group	60–108 kHz (12 channels) Group
Second Order	6·312 Mbit/s (96 channels)	8·448 Mbit/s (120 channels)	312–552 kHz (60 channels) Supergroup	312–552 kHz (60 channels) Supergroup
Third Order	44·736 Mbit/s (672 channels) or 32·064 Mbit/s (480 channels)	34·368 Mbit/s (480 channels)	312–4028 kHz (900 channels) Hypergroup (note)	812–2044 kHz (300 channels) Mastergroup
Fourth Order	274·176 Mbit/s (4032 channels)	139·264 Mbit/s (1920 channels)	—	8516–12 388 kHz (900 channels) Super Mastergroup

Note: In North America the multiplexing level is 60–2788 kHz or 564–3084 kHz (600 channels) Mastergroup

TABLE 5
Development Programme

Phase	Equipment/Systems	Ready for Service Date
1	2 Mbit/s DLS 120 Mbit/s DLS Multiplex Equipment up to 120 Mbit/s (2, 8 and 120 Mbit/s)	December 1978 (In service)
2	11 GHz Radio System 140 Mbit/s DLS 8 Mbit/s DLS (on Carrier Cable) 8/34 Mbit/s and 34/68/140 Mbit/s Multiplex Equipments Supergroup codec	April 1982
3	Hypergroup codec Optical-Fibre Systems: 8 Mbit/s 140 Mbit/s 565 Mbit/s	April 1983 1984 1984 1988

DLS: Digital line system

given in Table 5. An important feature of this programme was the need to utilize existing assets to the maximum; for example, for the 2 Mbit/s system, it was essential that it should be able to operate over the same cables as those being used for the 24-channel system, with the same regenerator spacings and with the regenerators housed in the same cases. Similarly, the 120 Mbit/s system had to be capable of using existing coaxial cables, with regenerators housed in the cases used for intermediate repeaters for 12 MHz line systems¹⁵, and using the same power-feeding stations.

Phase 2

The second phase of development was seen as extending the range of systems to capitalize on existing assets within the scope of existing technology, and moving rapidly towards the CCITT assemblies. It had been realized that the CCITT might, and in all probability would, recommend third and fourth multiplexing levels which did not harmonize with the 120 Mbit/s rate, and, in the event, the 34 Mbit/s and 140 Mbit/s rates respectively were chosen. By that time, more research had been carried out into the potential of various line codes as well as coaxial cable characteristics, and it was realized that, with 2 km spacing of regenerators, a transfer rate of 140 Mbit/s could be achieved. This is an acceptable if not highly satisfactory modular size, though of course it represents a reduction from the capacity achieved per pair of coaxial tubes compared with the 12 MHz analogue system (1920 circuits as against 2700 circuits).

Having settled the higher levels of the multiplex structure, it became possible to consider the design parameters for other systems, notably microwave radio-relay systems and higher-capacity cable systems. The BPO decided that the 11 GHz radio band should be exploited to give six bothway 140 Mbit/s channels, which would be used in a 1 + 5 (1 protection and 5 operational channels) arrangement, and that a 140 Mbit/s coaxial cable system would be needed to extend the radio channels into city centres. At the same time, it was envisaged that there would be a need for interface facilities to enable digital line capacity to carry analogue circuits without demultiplexing to audio. As a result, supergroup and a hypergroup encoder/decoder (codec) equipment is now being developed, the latter under the third phase of the programme. A pair of supergroup codecs will allow a supergroup to be carried by an 8 Mbit/s digital path, but this represents a poor utilization of the digital capacity (60 circuits instead of 120 circuits); however, it will be advantageous in situations where contiguity of the same type of plant cannot be achieved. The hypergroup codec is less inefficient (840 circuits instead of

900 circuits) and will provide 14 supergroups on a 68 Mbit/s stream.

Finally, an important element of the second phase is the 8 Mbit/s system, which is being designed for use on the network of balanced-pair cables which were used for the 24-circuit carrier systems. The regenerators and power-feeding stations will have a maximum spacing of 3.5 km and 40 km respectively. The 24-circuit carrier intermediate stations were spaced at a maximum of 25 km, and many of these will be re-used as power-feeding stations. However, the cables will now be used for much shorter links than was the case for the carrier systems and will be connected to a number of small group switching centres (GSCs), allowing many carrier intermediate stations to be vacated. Intermediate regenerators not located at power-feeding stations will be housed in cases located in manholes.

Phase 3

In 1973, when the development programme was being drawn-up, circuit demands were still buoyant and actual growth matched forecast growth. At that time, almost all cable system growth in the FDM network was met by using 12 MHz systems, and it was foreseen that, unless a high-capacity digital system was developed, there would be a massive demand for new cables in the early 1980s. (This forecast considered the limited circuit-capacity capable of being provided by 11 GHz radio links and that a 140 Mbit/s digital system on coaxial cable would only have two-thirds of the circuit capacity of a 12 MHz system.)

It was not known whether cables that were already installed had adequate performance characteristics to support higher digital rates. Also, there were doubts related to the technology of the day and of power requirements for the regenerators. Preliminary research and development work was set in train for a 565 Mbit/s coaxial cable system but, by the time the initial phases of this work had been completed, there had been a significant fall in demand arising from the business recession, and it was recognized that the massive demand for new cable would not now arise as early as had been expected. In addition, progress had been made in the development of optical fibres¹⁶⁻²⁴, and it was evident that optical-fibre transmission systems would be available in advance of the situation where coaxial cables would be required in large numbers because of the limited capacity of 140 Mbit/s systems. In consequence, research and development work for a high-capacity digital system on coaxial cable has been reduced in priority and work is now continuing at a reduced pace.

Another development that has been reduced in priority is that for 19 GHz radio links. These will provide 8 channels of 140 Mbit/s using intermediate stations at 6-16 km intervals, depending on the mean value of rain attenuation and the radio-frequency plan adopted. The aerials will probably be mounted on buildings or on masts about 30 m high (about the height of lamp standards used on highways).

Work on the development on a millimetric long-distance waveguide system²⁵⁻²⁷, using 120 Mbit/s channels, had reached an advanced stage with the completion of a field trial installation between Martlesham and Wickham Market. Preliminary plans were made to install a waveguide between Bristol and Reading but this was cancelled when the cost of the considerable redevelopment work to provide 140 Mbit/s channels instead of 120 Mbit/s had been reassessed. Other considerations that influenced the decision included the progress of optical-fibre transmission systems and the reduced forecast in respect of traffic demands.

Estimates of the relative cost of the various systems that have been considered are given in Fig. 2. The associated economic studies which have formed the basis for the information given in Fig. 2 are, of necessity, speculative in nature and are based on assumptions which may, in the event, prove

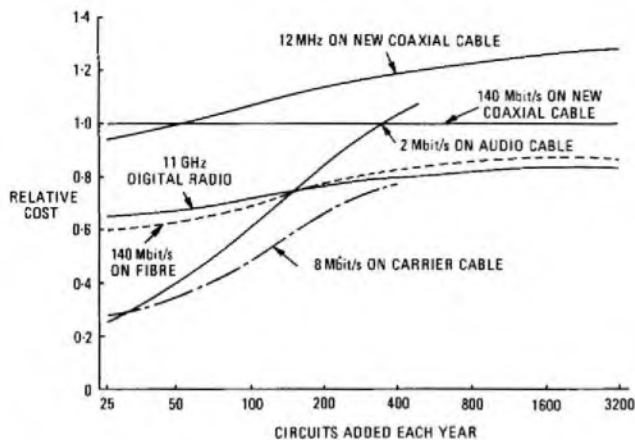

Note: 8 Mbit/s gives 2400 circuits total capacity; that is, 120 circuits per annum for 20 years
 11 GHz gives 5×1920 circuits total capacity; that is, up to 480 circuits per annum for 20 years

FIG. 2—Estimates of the relative cost of transmission systems for a 100 km route

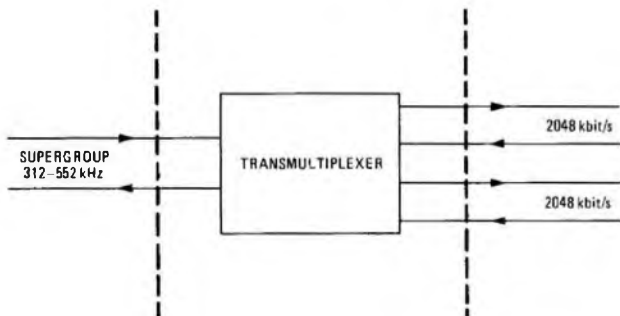

FIG. 3—Interconnexion of a transmultiplexer between FDM and TDM interfaces

to be wrong. But decisions can be made only in the light of the best and most recent knowledge; if, for example, optical-fibre transmission systems turn out to be significantly more costly than present knowledge suggests, then a decisive change in direction will be necessary, more especially to step-up the pace on projects which have been slowed down. However, the trend of research and development work related to optical fibre systems is towards higher capacity and cheaper systems, and it seems unlikely that such a change of course will be necessary. Indeed, it is quite possible that when production of optical-fibre systems is well established, it will be more economical to provide them than to re-equip existing coaxial cables. In this regard, the BPO is in a particularly fortunate position; most other administrations lay their long-distance cables directly in the ground whereas the BPO draws cables into ducts, which can easily be re-utilized. As matters stand, the use of optical fibres should enable greater exploitation of duct capacity.

Finally, it should be mentioned that there has been an increasing interest in the forum of the CCITT in the possibility of a device known as a *transmultiplexer*, which is intended to enable interconnexion of analogue and digital plant at higher multiplex levels. The use of a supergroup transmultiplexer is illustrated in Fig. 3, which shows the interconnexion of two 2 Mbit/s digital paths and a supergroup. The advantages of a transmultiplexer are that it:

(a) avoids the need for costly FDM and time-division multiplex (TDM) primary multiplexing equipment or, alternatively, of the advanced provision of line/radio capacity,

(b) uses the assigned frequency spectrum and bit rates to maximum efficiency (that is, as if FDM and TDM primary multiplexing were used),

(c) can incorporate signalling conversion, which may be advantageous where out-band signalling is employed,

(d) requires less space than would the equivalent multiplexing equipment, and

(e) could be installed at short notice for expediencies.

The disadvantages are that it:

(a) may be a costly device if produced in small quantities (more than offsetting (a) above), and

(b) does not provide an overall digital facility (that is, it is not transparent to digital data, and does not provide a message-transfer system capability using the 30-channel (2 Mbit/s) signalling time-slot facility).

If developed, the transmultiplexer would be likely to find only transitory use in the BPO main network since, under the present planning policy, digital transmission will soon penetrate the whole of the network and problems of contiguity will be of limited duration. As with the supergroup codec, a transmultiplexer would be an expedient device.

PROGRESS IN INTRODUCING DIGITAL TRANSMISSION SYSTEMS INTO THE NETWORK

The economic introduction of digital transmission systems poses considerable problems, simply because the interface between the 2 media (FDM and TDM) carries a heavy penalty. The flexibility of the network cannot be exploited to anything like the same extent and, in the early stages of development, digital systems can be exploited economically only for circuits between the nodes to which the systems are connected. Also, there are problems related to the much larger modular size (30 channels) of the primary multiplexing group, which leads to difficulties of achieving satisfactory fills and diversity. Therefore, to create a digital overlay economically, it must be introduced where there is comparatively high growth and a requirement for short links which can then be interconnected; these conditions exist in the dense parts of the network. The Midlands area of the UK provides the best springboard for digital network development, and the early systems are being installed there. The stages of the development of the digital network at intervals up to 1982 and the expected further progress in 1983 are shown in Figs. 4-6. A limiting factor in the early planning years has been the non-availability of a range of systems. In the first 3 years of planning, 120 Mbit/s systems were the only available higher-order systems, and a total of 88 of these have now been planned to be in service by mid 1982. From the planning standpoint, it was disappointing not to have had the option of using 8 Mbit/s systems, which offer valuable flexibility, during the very early years. Notwithstanding the limitations, very satisfactory progress is being made not only in the extent of the digital network, but also in the achievement of good fills. The embryonic digital facilities will soon expand to the remainder of the network and the 8-10 year objective is likely to be achieved except, perhaps, in the remote parts of the network, where



FIG. 4—Digital transmission network at 1978/79

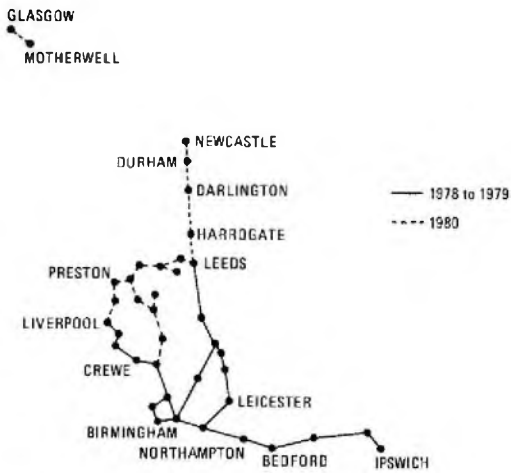

Fig. 5—Digital transmission network as planned for 1980



Fig. 6—Digital transmission network as planned for 1982-1983

growth is slow and where spare analogue capacity may last for a considerable time. Rapid progress will be made in the main inter-city routes by using the 11 GHz radio links, thus extending the network significantly in distance. In-filling with short-distance systems will follow.

Provision of new analogue systems for growth of the inland network has been brought to a close, and it is the spare

capacity of existing systems that will be used for further analogue circuit growth until about 1988, by which time approximately 35-40% of inland circuits will be on digital plant. This digital element will form a sound foundation for the introduction of digital switching systems during the 1980s.

SIGNALLING IMPLICATIONS IN TRANSMISSION PLANNING

In planning for growth of the analogue network, very little special attention to signalling aspects was necessary, since the majority of circuits in the HF network employ in-band signalling, which can be planned independently of transmission. The few cases where requirements dictated otherwise (for example, out-band signalling) were dealt with easily. This freed transmission planning from the obligation to take account of circuit details such as direction (incoming, outgoing or bothway), a factor which has significant implications in a digital environment since the 30-channel PCM multiplex equipment incorporates signalling cards.

In a wholly digital transmission network, the same freedoms would apply as for a wholly analogue network, but in a mixed network of digital and analogue systems there is the added complication that the signalling requirements cannot be determined until decisions have been made on the type of plant to be used.

Therefore, to ensure proper planning of signalling aspects, it has been necessary to make extensive changes in the transmission computer planning systems. Whereas it was previously necessary to plan only enough transmission-system and terminal-equipment capacity to meet the total circuit requirements, it is now necessary to allocate circuits to that capacity and to determine the signalling requirements accordingly. This has repercussions in utilization, since use of the transmission network must now more nearly keep to the detailed plans.

PLANNING FOR SERVICES OTHER THAN THE PUBLIC SWITCHED TELEPHONE NETWORK

This article has, so far, described only the provision of plant for the inland public switched telephone network (PSTN), which dominates the requirements for transmission capacity. Other requirements for plant are those for the provision of

- (a) capacity for inland extensions and international circuits,
- (b) video circuits,
- (c) sound programme circuits,
- (d) telegraph circuits,
- (e) speech-band and wideband private circuits, and
- (f) digital data circuits.

International Circuits

About 20% of network capacity is provided for international circuits. This capacity is used between international frontier stations and ISCs; all ISCs are located in London. The frontier stations are, for the most part, located on the East Anglian coast, or in the South East and South West England. All plant requirements are for analogue capacity, though provisional plans are being made to make digital capacity available between London and the satellite terminal at Madley for the European communications satellite (ECS) project. Until 10 years ago, the inland capacity requirements for international services were relatively small, and it was the practice to provide dedicated supergroups that were routed on hypergroups provided for the general network. However, in recent times, the requirements have been large enough to justify dedicated hypergroups for the international services. Future requirements for analogue capacity are likely to be

provided over digital plant using hypergroup codecs at frontier stations and the ISC terminals.

Video Circuits

Video circuits are mainly provided for the Broadcasting Authorities and are, in all cases, routed on microwave radio-relay links for the long-distance elements. Cable sections are used only for short distance links and for links between radio terminals and renters' premises. The radio capacity provided for video circuits is equivalent to about 6% of the transmission network. It is likely that, in future, many of the requirements will be provided on digital plant: in some cases, the renter will be provided with a digital link over which will be transmitted signals that are generated in digital form at the studio; in others, analogue-to-digital converters may be used, located at a renters' premises or at the BPO television network switching centre. Enquiries have already been received from one renter for an extensive digital network, and it seems possible that, within a decade, most video requirements will be on digital plant. Satisfactory colour picture quality can be achieved with a digital stream of 68 Mbit/s, though techniques are under study for reducing this digital rate. Whatever the outcome, it is clear that video signals will be transmitted over digital transmission paths.

Sound Programme Circuits

The majority of sound programme circuits are for the Broadcasting Authorities, and for many years the circuits have been provided on audio plant or phantom circuits of carrier cables. During the last decade, there has been an increase in the use of carrier programme equipment to carry circuits on standard 12-circuit carrier groups. The facility is provided by disabling a number of telephone channels (depending upon the bandwidth required) and allocating the frequency spectrum to the programme circuit. In the digital era, a somewhat similar principle will be used, whereby a number of 64 kbit/s time-slots normally used for telephone channels in a 30-channel TDM group will be allocated to the programme circuit. As yet, however, international standards have to be defined on the bit rates required and the coding law. Currently, there are plans to use some proprietary equipment that can provide 6 programme channels, each of 15 kHz bandwidth, using a 2 Mbit/s digital block. However, until international standards are defined, it is unlikely that rapid progress will be made towards the ultimate goal of carrying digital programme circuits on the digital plant provided for telephony.

Telegraph Circuits

For many years, telegraph circuits have been routed on audio channels, initially using amplitude-modulated multi-channel voice-frequency telegraph (MCVFT) and, more recently, frequency-shift voice-frequency telegraph (FSVFT) equipment. In the early 1970s, a feasibility study and field trial were conducted of high-capacity systems that provided 184 telegraph channels over a 1.5 Mbit/s digital line system (DLS) normally provided for PCM telephony²⁸. In 1974, following satisfactory conclusion of the trial, an initial order was placed for production equipment and, since that date, equipment providing a total of 17 000 bothway channels has been ordered; of these, 3200 are now in service. The 184 channel system can be used with 1.5 or 2 Mbit/s digital paths and has now been adopted as the main multiplexing system to be used for Telex customers' lines. To maintain service in the event of line failures, 2 independently-routed DLSs are normally provided, on a main and stand-by basis.

More recently, a speech-band TDM system has been purchased for international use and this provides 46 telegraph channels over a 2400 bit/s link provided by a data modem.

The economics of this system are ideal for long-distance high-capacity routes, where the cost of the bearer is high in relation to the cost of the terminal equipment, as is the case by international circuits.

Private Circuits

Speech-band private circuits providing speech and data facilities comprise about 15% of main network transmission requirements and are currently routed over HF channels or audio plant, depending on plant availability and circuit length. Private HF circuits of 48 kHz or 240 kHz bandwidth (commonly known as *wideband circuits*) are also available for providing high-speed data facilities and/or 12 or 60 speech-band channels respectively on equipment located in customers' premises.

In the junction network, speech-band private circuits can be routed over 24-channel PCM systems and, in the immediate future, routings will also be made on the 30-channel systems being introduced, both in the junction and the main networks. It is possible that 2 Mbit/s links will be extended into customers' premises to provide private 30-channel PCM groups.

In the longer term, in the era of integrated digital transmission and switching, it is envisaged that private circuits will be carried on 2 Mbit/s links, brought together at the 64 kbit/s level by means of semi-permanent connexions set up through the digital switch block of digital main network switching centres (DMNSCs) and possibly at digital local exchanges (DLEs), to provide end-to-end private circuits capable of exploiting the 64 kbit/s capacity for speech or high-speed data purposes. Such an arrangement is expected not only to provide data facilities additional to those currently offered, but also to permit significant improvements to be made in private-circuit procedural arrangements and provision timescales.

Digital Data Circuits

Demands for the BPO experimental packet-switched data service (EPSS)¹⁹⁻³³ have been satisfied by the use of 48 kbit/s modems operating over group paths of FDM systems. Future services will exploit digital transmission capacity, and plans have been made to provide a transmission network of 2 Mbit/s links in the main network for these services.

THE FUTURE

This article has indicated that the impetus for the introduction of digital transmission systems was to achieve a reduction of circuit cost in an analogue switching environment, but that the most important cost advantages lie in a digitally switched environment. It is likely that over the next 10-15 years a substantial proportion of main network switching units will be converted to digital switching or have digital switching elements. It is unlikely that these units will be served wholly by digital transmission plant from the outset, and analogue-to-digital interface equipment will be necessary for some of the circuits required to provide the range of traffic routes. Nevertheless, the aim must be to provide digital transmission to the maximum extent possible to serve these digital exchanges.

During the same period, there will be a rapid growth of requirements for digital transmission capacity for essentially digital services, more particularly high-speed digital data services, but there will also be a rising demand for digital transmission capacity where superior technical quality can be obtained, notably for sound-programme and video circuits. The overall trend will be towards the recovery of analogue capacity and its replacement by digital plant, though whether analogue systems will be replaced before they reach the end of their useful lives remains to be seen. What is clear is that, in the long run, all of these services will be closely integrated, using the same transmission systems and perhaps the same

switching facilities, but full integration is likely to be a slow process. A key element in all this is the development of the digital transmission network.

CONCLUSION

As was foreseen, the decision to change from analogue to digital transmission has posed problems in the planning of the BPO main network. Although interfacing equipments can be used they are expensive or pose other problems, and the fact has to be faced that the two forms of transmission are basically incompatible. This presents a challenge to planning engineers, compounded by the difficulties in reaching judgement on the time to allow for development, manufacture and installation of new equipment and systems. Basically, a new network has to be built with all that this implies by way of economics, loss of flexibility, and evolutionary benefits, though the last two are less marked in a digital network.

One of the penalties of digital transmission is that it is more demanding of spectrum, and this has repercussions on the available capacity of media in the network today (that is, cable—both balanced-pair and coaxial—and radio). Optical-fibre transmission systems, will, however, restore the balance, and the main network of the future will be at least as economical, flexible and rugged as the analogue network of today. It will certainly be no more difficult to plan, especially in an era of digital switching. It is in a mixed analogue/digital network that most problems arise in planning for growth, but at the half-way stage in the 8–10 year change-over period, it is possible to say that these difficulties can be overcome economically.

ACKNOWLEDGEMENTS

The author acknowledges the assistance of his many colleagues in various Departments of Telecommunications Headquarters in the preparation of this article.

References

- 1 BOLTON, L. J., and BENNETT, G. H. Design Features and Application of the British Post Office 24-Channel Pulse-Code Modulation System. *POEEJ*, Vol. 61, p. 95, July 1968.
- 2 BREARY, D. A Long-Term Study of the United Kingdom Trunk Network, Parts 1 and 2. *POEEJ*, Vol. 66, p. 210, Jan. 1974, and Vol. 67, p. 37, Apr. 1974.
- 3 BOAG, J. F., and SEWTER, J. B. The Design and Planning of the Main Transmission Network. *POEEJ*, Vol. 64, p. 16, Apr. 1971.
- 4 HALSEY, R. J., and MILLAR, D. P. M. Carrier System No. 4. *POEEJ*, Vol. 29, p. 294, Jan. 1937.
- 5 LITTLE, G. J. S. Twelve-Circuit Carrier Telephone Systems. *IPOEE*, Printed Paper No. 167, 1938.
- 6 MUMFORD, A. H. The London-Birmingham Coaxial Cable System. *IPOEE*, Printed Paper No. 164, 1938.
- 7 MARTIN ROYLE, R. D., DUDLEY, L. W., and FEVIN, R. J. A Review of the British Post Office Microwave Radio-Relay Network, Parts 1, 2 and 3. *POEEJ*, Vol. 69, pp. 162 and 224, Oct. 1976 and Jan. 1977 and Vol. 70, p. 45, Apr. 1977.

8 The 60 MHz FDM Transmission System. *POEEJ*, Special Issue, Vol. 66, Oct. 1973.

9 BOAG, J. F. The End of the First Pulse-Code Modulation Era in the UK. *POEEJ*, Vol. 71, p. 2, Apr. 1978.

10 BENNETT, G. H. Developments in Digital Transmission. *POEEJ*, Vol. 68, p. 243, Jan. 1976.

11 VOGEL, E. C., and McLINTOCK, R. W. 30-Channel Pulse-Code Modulation System. Part 1—Multiplex Equipment. *POEEJ*, Vol. 71, p. 5, Apr. 1978.

12 WHETTER, J., and RICHMAN, N. J. 30-Channel Pulse-Code Modulation System. Part 2—2.048 Mbit/s Digital Line System. *POEEJ*, Vol. 71, p. 82, July 1978.

13 SCHICKNER, M. J., and ZICK, L. C. Development of a 120 Mbit/s Digital Line System, Parts 1 and 2. *POEEJ*, Vol. 69, pp. 154 and 217, Oct. 1976 and Jan. 1977.

14 BRIGHAM, E. R., SNAITH, M. J., and WILCOX, D. M. Multiplexing for a Digital Main Network. *POEEJ*, Vol. 69, p. 93, July 1976.

15 MILLER, J. R., and GIPP, J. A. L. Recent Developments in FDM Transistor Line Systems. *POEEJ*, Vol. 63, p. 234, Jan. 1971.

16 ROBERTS, F. F. Optical-Fibre Telecommunications Transmission Systems. *POEEJ*, Vol. 67, p. 32, Apr. 1974.

17 BEALES, K. J., MIDWINTER, J. E., NEWNS, G. R., and DAY, C. R. Materials and Fibre for Optical Transmission Systems. *POEEJ*, Vol. 67, p. 80, July 1974.

18 DYOTT, R. B. The Optical Fibre as a Transmission Line. *POEEJ*, Vol. 67, p. 164, Oct. 1974.

19 NEWMAN, D. H. Sources for Optical-Fibre Transmission Systems. *POEEJ*, Vol. 67, p. 208, Jan. 1975.

20 MATTHEWS, M. R., and SMITH, D. R. Photodiodes for Optical-Fibre Transmission Systems. *POEEJ*, Vol. 67, p. 213, Jan. 1975.

21 TURNER, R. J. Preliminary Engineering Design of Digital Transmission Systems Using Optical Fibre. *POEEJ*, Vol. 68, p. 7, Apr. 1975.

22 RAVENSCROFT, I. A. Feasibility Trial of Optical-Fibre Transmission System. *POEEJ*, Vol. 70, p. 119, July 1977.

23 MIDWINTER, J. E. Optical-Fibre Transmission Systems: Overview of Present Work. *POEEJ*, Vol. 70, p. 144, Oct. 1977.

24 BERRY, R. W., and RAVENSCROFT, I. A. Optical-Fibre Transmission Systems: The 140 Mbit/s Feasibility Trial. *POEEJ*, Vol. 70, p. 261, Jan. 1978.

25 MERLO, D. The Millimetric Waveguide System: The Current Situation. *POEEJ*, Vol. 69, p. 34, Apr. 1976.

26 RITCHIE, W. K., and ROWLANDS, C. E. The Millimetric Waveguide System: The Design, Production and Installation of the Waveguide. *POEEJ*, Vol. 69, p. 79, July 1976.

27 RAVENSCROFT, I. A. The Millimetric Waveguide System: Terminal and Repeater Equipment. *POEEJ*, Vol. 69, p. 250, Jan. 1977.

28 SKINGLE, G. D. Time-Division Multiplex for Telex-Customers' Lines. *POEEJ*, Vol. 68, p. 84, July 1975.

29 BELTON, R. C., and SMITH, M. A. Introduction to the British Post Office Experimental Packet-Switching Service (EPSS). *POEEJ*, Vol. 66, p. 216, Jan. 1974.

30 HADLEY, D. E., and MEDCRAFT, D. W. F. Experimental Packet-Switched Data-Transmission Service: Network Design and Implementation. *POEEJ*, Vol. 67, p. 88, July 1974.

31 NEIL, W., SPOONER, M. J., and WILSON, E. J. Experimental Packet-Switched Service: Procedures and Protocols. Parts 1, 2 and 3. *POEEJ*, Vol. 67, p. 232, Jan. 1975, and Vol. 68, pp. 22 and 110, Apr. and July 1975.

32 GARDNER, A. J., and SANDUM, K. N. Experimental Packet-Switched Service: Routing of Packets. *POEEJ*, Vol. 68, p. 235, Jan. 1976.

33 BURGESS, M. J., and LOCKWOOD, J. A. Experimental Packet-Switched Service: The Customers and their Packet Terminals. *POEEJ*, Vol. 69, p. 122, July 1976.

A Standard Control System for Thyristor Rectifiers

J. P. HENDERSON, B.Sc.†

UDC 621.314.6: 621.382.334

Thyristor controlled rectifiers are now included in the range of power plants available to the British Post Office. 50 V modular power-plants use thyristor rectifiers in a range of sizes from 500–5000 A. This article describes the design aspects of the rectifier equipment and the operation of the control system.

INTRODUCTION

The British Post Office (BPO) has recently introduced into service a range of thyristor rectifiers that provide outputs of 500–5000 A at 50 V DC.

These rectifiers all use the same basic power circuit, and a standard control-system has been developed which can be used without modification in any size of rectifier. This article describes the background to the development of this equipment and the working of the power and control circuits.

THE POWER PLANT No. 233

In 1972, the BPO introduced into service a modular power-plant, the Power Plant No. 233; its design philosophy was described in detail in earlier articles in this *Journal*^{1,2}. A block diagram of the basic system is shown in Fig. 1. Two types of rectifier are used: the Rectifier No. 126 is provided as a standby unit, and provides spare capacity in the event of failure of an associated Rectifier No. 127.

† Operational Programming Department, Telecommunications Headquarters

The Rectifier No. 127 contains two separate units; a main rectifier section, which provides an output of 51.5 V DC; and an auxiliary rectifier, which provides an output of 5.3 V DC. The main rectifier supplies the equipment load and float-charges the battery by working in series with the auxiliary rectifier. Together they maintain a total float voltage across the battery of 56.8 V.

The range of Rectifiers No. 126 and 127 introduced initially provided outputs between 50–300 A at 51.5 V DC. These rectifiers used conventional techniques of transductor control. In this method, saturable reactors (transductors) on the primary side of a mains transformer control the voltage applied to the transformer, and, hence, the rectifier output. Rectification is provided by silicon diodes connected in a 3-phase bridge circuit on the secondary side of the transformer. This approach is satisfactory for outputs up to 300 A, but above this value several factors militate against the use of transductors. In particular, the size, weight and audible noise generated by large transductors can be troublesome. However, the major factor which led to the adoption of thyristor control, rather than transductor control, was the need to use 12-pulse rectification. Rectifiers draw their current from the mains supply in pulses; the number of pulses of current drawn from the supply in one cycle is referred to as the *pulse number* of the rectifier. Transductor rectifiers using 3-phase bridge rectifiers are *6-pulse rectifiers*. The current pulses drawn from the mains supply cause distortion of the mains voltage. Because of this, the Electricity Council places limits³ on the level of harmonic currents which may be drawn from the supply. These limits restrict the total amount of load which may be connected in the form of 6-pulse rectifiers at a given site. To overcome this limitation, the larger rectifiers, in the range 500–5000 A, use 12-pulse rectification. Twelve-pulse rectifiers produce higher-order harmonics than 6-pulse rectifiers, and the specified limits of harmonic current at these higher frequencies allow a greater total load to be connected.

The complexity of 12-pulse working makes the use of transductor control uneconomical in comparison with the use of thyristors. An additional attraction of using thyristors is that they allow a far greater opportunity for standardization in both the power and control circuitry. Standardization in its turn can reduce development and production costs and simplify maintenance procedures.

THE POWER CIRCUIT

The basic power circuit used in the main rectifier section of a Rectifier No. 127 (output, 500–5000 A) is shown in Fig. 2. The main rectifier operates as a 12-pulse rectifier. For simplicity of description in this article, the auxiliary rectifier circuitry is omitted from Fig. 2. Because of its much lower rating, the auxiliary rectifier can function as a 6-pulse rectifier, and can be regarded as half the circuit for the 12-pulse design. It contains one transformer and 6 thyristors. Both the main and auxiliary rectifier use the same control system as described later in this article.

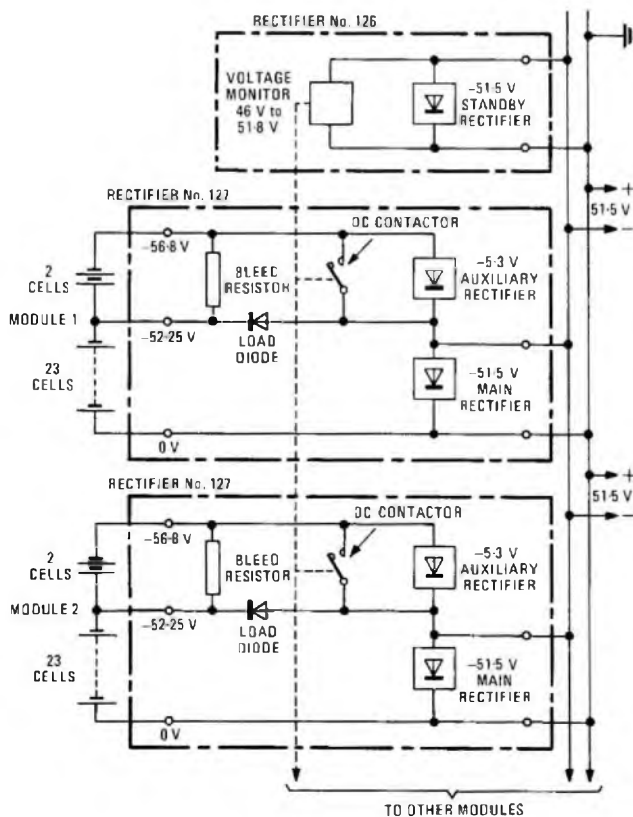

FIG. 1—Modular power plant (–50 V)

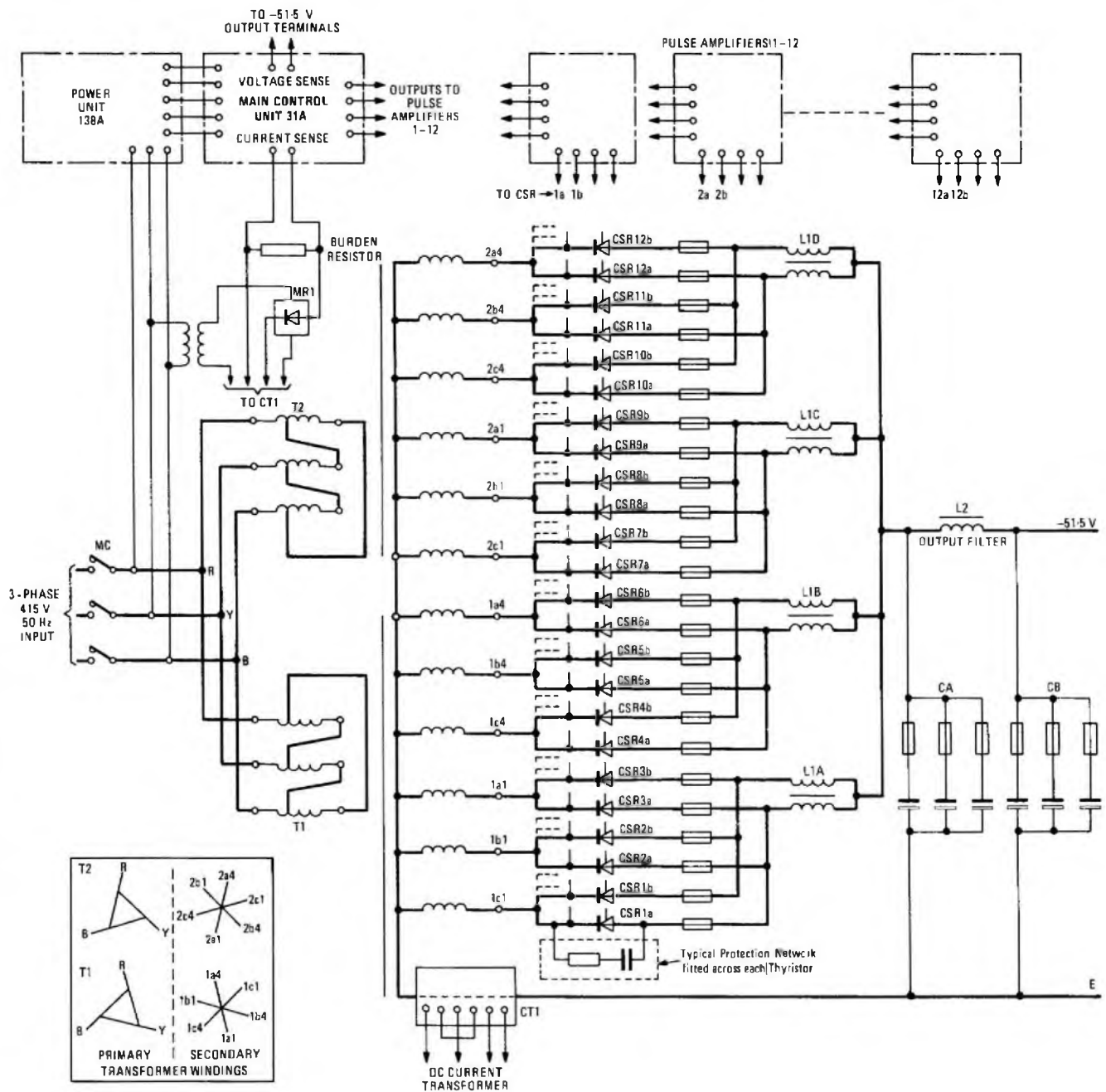

FIG. 2—Thyristor-rectifier circuit arrangement for outputs of 500–5000 A

The operation of the main rectifier is as follows. The 3-phase mains supply feeds transformers T1 and T2. Each transformer has 6 secondary windings. Transformers T1 and T2 are constructed in an identical fashion except that the taps in the primary windings of transformer T1 are linked in the opposite sense to those of T2. This introduces a phase shift of 30° between the 2 groups of secondary windings. When the secondary windings are connected together, as shown in Fig. 2, twelve single-phase outputs are available, each displaced by 30° .

Star groups made up of 3 windings, each displaced by 120° , are commoned via the thyristors CSR 1–12 into 4 first-stage chokes (chokes L1A–D). These chokes serve 3 functions:

(a) Firstly, the chokes enable the voltage at the commoning point of each group of 3 thyristors to be different. This

enables the periods of conduction of thyristors in each of the 4 groups to overlap. The current supplied by the rectifier at any instant is therefore shared by 4 thyristors, with a consequent reduction in individual thyristor ratings.

(b) The second function of the chokes is to promote good current sharing when thyristors have to be used in parallel. For the larger rectifiers, it is not easy to obtain single thyristors with an adequate rating. Therefore, up to 4 thyristors have to be used in parallel for each of the 12 secondary phases. If these thyristors are connected directly in parallel they will not share the current equally because of the wide spread of parameters of the devices. A separate choke winding is therefore provided for each group of 3 thyristors, and the additional impedance of the winding determines the current each device carries. Fig. 2 illustrates the case where two thyristors are used in parallel; for example, thyristors CSR1a and CSR1b each have a separate winding on choke L1A.

(c) The final function of the chokes is to act as smoothing chokes in the first stage of the inductive/capacitive power filter. The capacitor banks CA and CB are made up of parallel combinations of 10 000 μF capacitors. Typically, the larger rectifiers require up to 400 000 μF to reduce the noise level at the output of the rectifier to the required level of better than 1.5 mV (psophometrically weighted).

A Control Unit No. 31A (described later in the article) monitors the rectifier output voltage and current, and provides firing pulses to the pulse amplifiers. The pulse amplifiers supply the firing pulses at a suitable level to trigger the thyristors. The DC current transformer operates on transducer principles and supplies the control unit with a voltage proportional to the current supplied by the rectifier. The output voltage is monitored directly.

CONTROL-SYSTEM Design Considerations

The realization of a standard power-circuit for both the main and auxiliary rectifiers led to consideration being given to the possibility of developing a standard control-circuit which could be used in any rectifier in the range 500–5000 A. However, in specifying a common control-circuit, there were constraints not applicable to control systems designed for one specific size of rectifier. The control circuit had to perform in a stable manner in every size of rectifier and had to take account of the differing gains of these rectifiers. (The gain of the power circuit may be considered as the change in output voltage for a given change in firing angle of the thyristor, and this changes with each size of rectifiers because the parameters of the various wound components in the power circuits change.) Nevertheless, the decision was made to use the same control circuit to control either the main or the auxiliary rectifiers in all sizes of rectifier. The control circuit is, therefore, capable of controlling two different rectifiers of widely differing output characteristics, as described later.

In addition to these restrictions, there were other problems related to the way in which the rectifiers were to be used in the overall power system. The rectifier not only supplies current to the exchange equipment, which presents a varying load, but also floats the exchange battery at a constant voltage. The impedance of the battery is a complex quantity which can vary with the age of the battery, the state of charge, battery size and type of construction. At present, this impedance cannot be adequately defined for all battery conditions and therefore it is not possible to predict precisely at the design stage the performance of the rectifier for all system conditions.

The action of the main and auxiliary rectifiers working in series results in considerable interaction between them and achieving stable operation under all operating conditions can present problems. If the public mains supply to a telephone exchange fails, the rectifiers will operate from an engine-driven alternator. This introduces not only the need for the rectifier to function with a supply of varying frequency but also introduces additional control loops. The rectifier control-system must maintain stable operation when working in series with the engine's mechanical speed-governing system and the alternator's voltage control system. It was therefore an important part of the development programme to prove that the control system functioned in a stable fashion under all possible operating conditions.

Circuit Description

The control system comprises two components: the Control Unit No. 31A, which controls the rectifier output characteristics and provides low-level firing pulses; and the Pulse Amplifier No. 1A, which converts these pulses to a level suitable for firing the thyristors.

CONTROL UNIT 31A

The Control Unit No. 31A is shown in Fig. 3. The unit comprises 2 printed-wiring boards mounted on a common chassis. The control unit may be plugged into any size of



(a) Pulse Amplifiers No. 1A

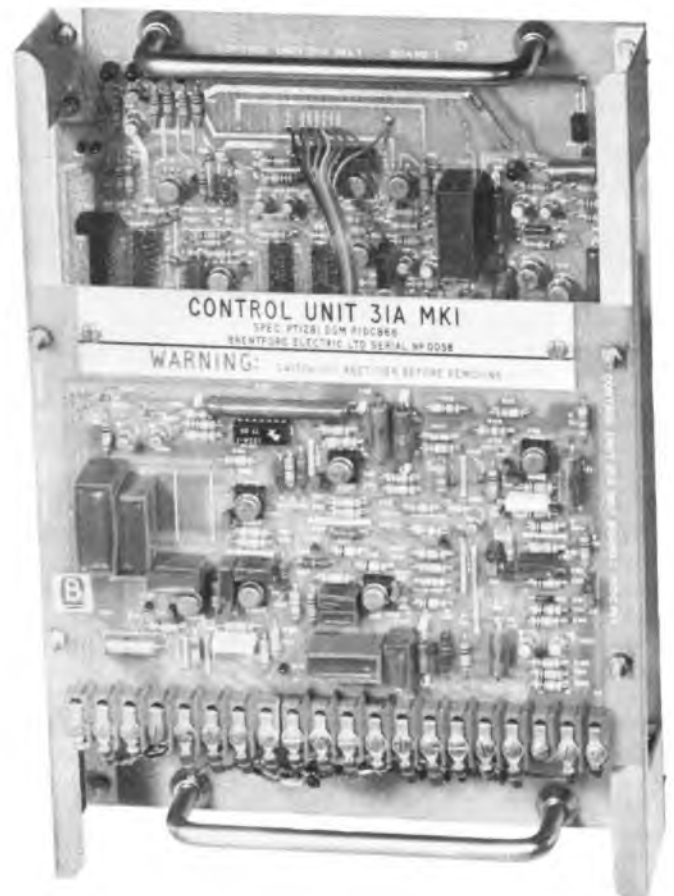

(b) Control Unit No. 31A

FIG. 3—Pulse Amplifiers and Control Unit

rectifier by means of two 40-way connectors and will control either the main or the auxiliary rectifiers. The smaller of the 2 printed-wiring boards, the voltage/current control board, carries mainly linear devices and determines the output characteristics of the rectifier. The larger printed-wiring board, the digital board, carries mainly digital integrated circuits and generates the firing pulses for the 12 thyristors. The firing pulses produced by the digital board are phase-shifted to control the rectifier output under the command of the control board.

The Voltage/Current Control Board

The voltage/current control board receives output voltage and current sense signals from the rectifier power circuit and processes these signals to produce the necessary rectifier output characteristics. The output from the board is a DC voltage that varies over the range 0–5 V and this voltage determines the phase of the firing pulses produced by the digital board and, hence, the rectifier output voltage. The control board produces the rectifier characteristics illustrated in Fig. 4.

The mode of operation of the control circuit is determined when the control unit is plugged into either the main or auxiliary positions in the rectifier. Links on the 40-way sockets in the rectifier modify the arrangement of the circuitry to give the appropriate characteristics. Block diagrams of the circuit configurations are shown in Fig. 5. When the control circuit is in the auxiliary position, the rectifier provides a regulated 5.3 V DC output, with a constant-current characteristic above 100% full-load current down to full short-circuit conditions. During initial charging of the battery the output of the auxiliary rectifier has to be boosted to 15.5 V DC to provide an adequate charging current. Altering the position of a float/boost link in the auxiliary rectifier provides a signal to the control circuit to increase the output voltage.

In contrast, the main rectifier requires a constant-voltage characteristic from no load to 100% and a constant power overload above this down to an output voltage of 42 V. To ensure that when rectifiers are operating in parallel they share the load current in a stable manner, there is a small slope in the constant voltage characteristic between no load and full load. To achieve these characteristics, the control board monitors both output voltage and current. The voltage-feedback signal does not vary with rectifier size but the current feedback signal must be suitably scaled down so that the control board detects the same range of input signals and

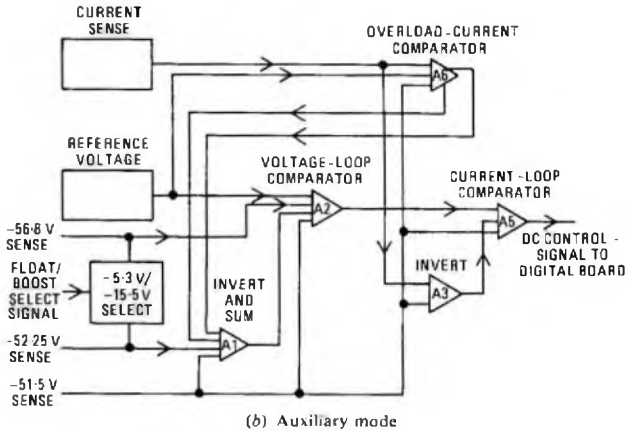
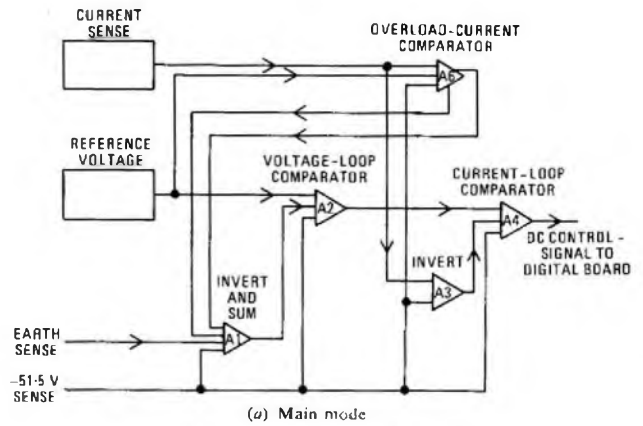

FIG. 5—Block diagrams of the control board in the main and auxiliary modes of operation

therefore produces the same output characteristics for all sizes of rectifiers.

The current-feedback signal from the power circuit is derived from a DC current transformer, which is mounted in the common-earth side of the main-transformer secondary windings, as shown in Fig. 2. The DC current transformer burden resistors for each different size of rectifier are arranged so that, no matter what the rating of rectifier, the output from the circuit is a DC voltage that varies linearly from 0 V at no load, to 5 V at 100% load current.

The two different configurations of operational amplifiers required to produce different rectifier characteristics are shown in Fig. 5. Operational amplifiers A1, A2, A3 and A6 are used in both modes. Amplifier A4 is used in the main mode only, and amplifier A5 is used in the auxiliary mode only.

An important function of the control board is to ensure that all sizes of rectifier are stable; in this respect, the overall gain of the rectifier control system is an important factor.

The problem of differing gains of rectifiers (as mentioned earlier) is overcome by providing a 'gain' resistor, mounted in each rectifier, which is connected into the control circuit via the 40-way connectors. The resistor is inserted between the output of the control board and the input to the digital board. In this position, the resistor provides compensation so that the overall gain around the loop containing the control board—gain resistor—digital board—rectifier power-circuit, remains constant. The constant loop-gain ensures that all rectifiers behave in a similar way, no matter what their size. In practice, it is sufficient to determine a single value of resistor for each size of rectifier. Once this value has been chosen, additional adjustments to cater for the variation in parameters of individual rectifiers of the same size are not required.

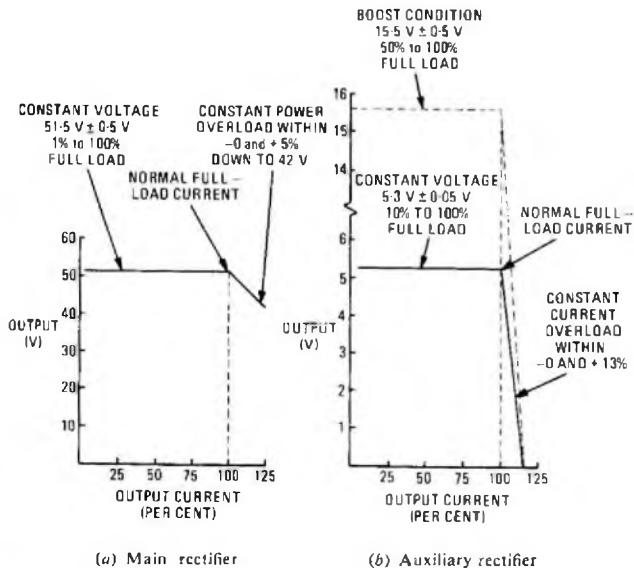

FIG. 4—Rectifier output characteristics

The Digital Board

The function of the digital board is to provide firing pulses to the 12 thyristors in the power circuit. The output voltage of the rectifier is controlled by varying the timing of these firing pulses with respect to the phase of the public mains supply or standby supply. The 0-5 V output voltage of the control board is used by the digital board to determine the timing of the firing pulses (0 V represents minimum output while 5 V represents maximum output).

To fire the thyristors, the digital board must produce 12 output-pulses, one for each thyristor. These firing pulses must each have a 30° phase shift between them to correspond to the 30° shift between the phases to which the thyristors are connected. When the rectifier output is changed, the timing of all firing pulses has to be advanced or retarded simultaneously.

A further requirement of the digital board is to ensure that firing pulses are applied to the thyristors only when they are forward biased. Damage can result if pulses are applied when the thyristors are reverse biased. The thyristors are forward biased for 180° of each cycle, but the rectifier design restricts the range over which firing pulses may be applied to 150° . The relationship between the firing pulses and the voltages applied the thyristors is shown in Fig. 6.

Several problems must be considered when designing a circuit to provide the firing pulses:

(a) Any departures from a precise 30° phase-shift between consecutive firing pulses will give rise to undesirable sub-harmonics in the rectifier output voltage. This would make it difficult to achieve the low psophometric-noise-levels demanded of power supplies for telecommunications equipment.

(b) The timing of the firing pulses must remain locked in phase with the supply voltage to maintain a constant output voltage. As an example of how accurate this locking process must be, consider the main rectifier output voltage which has to be controlled between 51 V and 52 V: once connected to a battery, a relatively small change in output voltage can easily cause a swing in output current from no load to full load. A change of approximately 1 V in the output voltage of the rectifier corresponds to a phase-shift in firing angle of only $1-2^\circ$. This change would be sufficient to swing the output from no load to full load. Thus, it is clear that the timing of firing pulses must be extremely precise if large swings in output current and voltage are to be avoided.

This problem becomes more severe when the rectifier is fed from a supply of varying frequency, such as an engine-driven alternator. In this case, the control system must maintain the timing of firing pulses despite rapid changes in frequency of the AC supply during load changes.

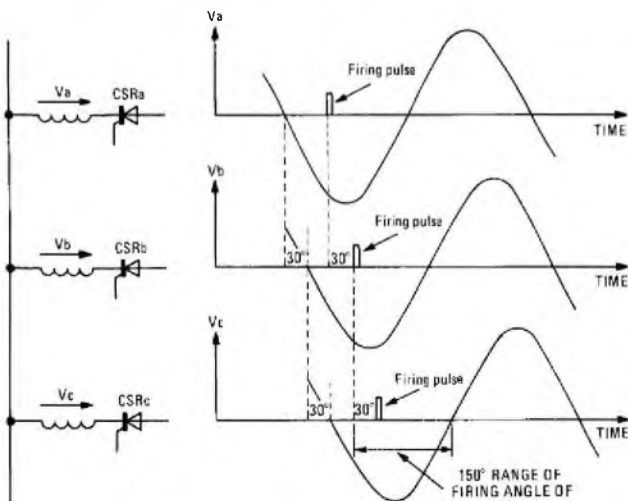

FIG. 6—Relationship between the voltage waveforms applied to the thyristors and the thyristor firing pulses for a 12-pulse rectifier

The majority of proprietary thyristor rectifiers utilize analogue circuitry for the production of firing pulses. However, in this application, it was decided that the use of digital techniques was more appropriate to achieve the desired degree of accuracy in the timing of the firing pulses. Furthermore, the use of digital circuitry offers the opportunity for simplification in the construction of the control unit at some future date when suitable large-scale integrated circuits become available to carry out various circuit functions.

A block diagram of the circuit arrangement of the digital board is given in Fig. 7. The circuitry can best be described in terms of 3 functional blocks³.

The Supply-Frequency-Locked Reference Signal Generator

A reference signal indicating the phase of the AC supply is obtained via an isolating transformer. Unwanted noise on this signal is filtered out by two stages of filtering and the signal is then converted to a square wave by a zero-crossing detector. This signal is used as a reference for a phase-locked loop, which produces an output at 12 times the supply frequency and which is locked in phase to the supply frequency. This 600 Hz signal is fed to the clock input of a 6 bit shift register; the 50 Hz square wave is fed to the serial input. The parallel output of the shift register is then six 50 Hz square waves, each phase-shifted from the next by 30° . A further 6 signals are produced by inverting these outputs. In this way, 12 reference signals are available which represent the phases of the voltages applied to each of the 12 thyristors. The accuracy with which the reference signals remain locked to the AC supply depends on the ability of the phase-locked loop to follow changes in the supply frequency.

Two of the 12 reference signals are fed into logic gates to produce a signal at twice the supply frequency. This signal is used to reset an integrator circuit which has a constant voltage input, thereby producing a ramp signal at twice the supply frequency and locked in phase with it. This ramp signal is fed to the phase-controlled signal generator.

Phase-Controlled Signal Generator

The ramp signal from the control board is compared with the DC control signal, resulting in a signal of rectangular waveform whose mark-to-space ratio depends on the level of the DC control signal. This signal is gated by the appropriate reference signals to produce a square wave at the supply frequency which is phase-shifted by the DC control signal. The range over which this square wave can be phase shifted is limited to 150° . The firing pulses are derived from this square wave, and their range of movement is, therefore, limited to 150° .

The phase-shifted square wave serves as a reference to a second phase-locked loop. Again, the output of this circuit is at 12 times the supply frequency and locked in phase with it. Therefore, the output consists of a 600 Hz square wave which can be phase-shifted by 150° . The parallel outputs of the divide-by-12 counter of the phase-locked loop are used to generate address signals for the thyristors. These address signals comprise 12 different combinations of binary signals on 4 lines and are used to identify each thyristor in turn.

The Signal Processor

The first operation of the signal processor is to compare, in a multiplexor circuit, the thyristor address signal with the fixed reference signals from the supply-frequency-locked reference signal generator. This gives a logic one output if the address signal for a particular thyristor occurs within the permitted firing zone defined by its associated reference signal. The circuit inhibits any firing pulses which occur outside of the permitted firing zone.

The logic one signal is used to gate the phase-shifted 600 Hz signal and, provided that a logic one signal is present, this signal is passed to the demultiplexor.

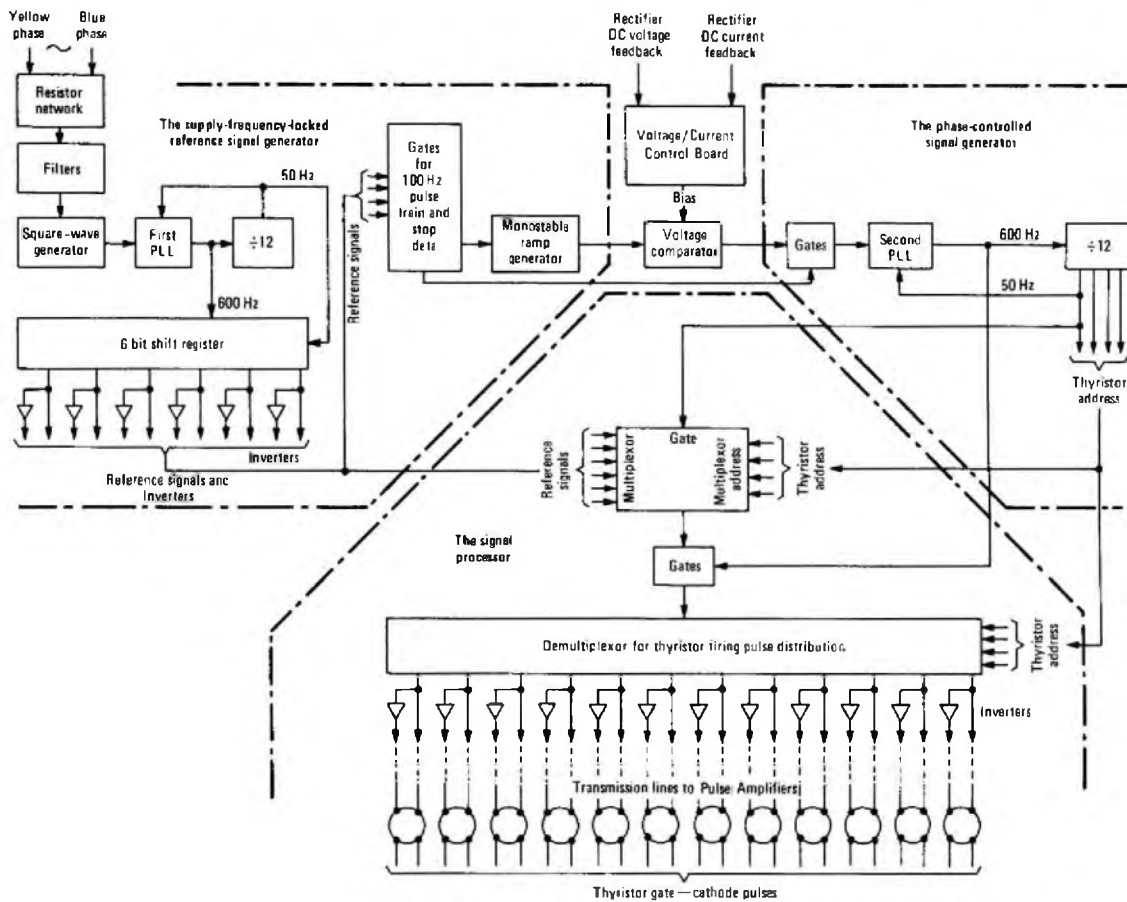

PLL: Phase-locked loop

FIG. 7—The digital board

The demultiplexer receives the phase-shifted 600 Hz signal and also the thyristor *address* signal. It processes these signals and distributes the 600 Hz phase-shifted signal over 12 separate outputs, as dictated by the *address* signal, such that each individual output produces pulses at 50 Hz.

These output pulses are all displaced from each other by 30°, and all are phase-shifted with respect to the incoming supply by the DC control voltage. The 12 output pulses, together with their complements, the need for which is described later, are fed to 12 pulse amplifiers.

THE PULSE AMPLIFIER No. 1A

The output pulses from the Control Unit No. 31A are produced by transistor-transistor logic circuits and are therefore of limited power. Pulse amplifiers are required to provide the following functions.

The firing pulse required by the thyristor is a current pulse of 80 μ s duration with an amplitude of about 1 A. The larger rectifiers in the range use up to 4 thyristors in parallel for each of the 12 phases. Therefore, the amplifier must be capable of simultaneously driving 4 thyristor gate circuits.

The firing pulses are applied between the gate and cathode of each thyristor. It can be seen from Fig. 2 that the cathodes of the thyristors can be at different potentials because they are separated by choke windings. The pulses produced by the control unit are all produced with respect to the same common power-rail of the control unit. The output of the control unit cannot therefore be connected directly to the thyristors as this would short together all the thyristor cathodes. Therefore the pulse amplifier must provide isolation between the input and output pulses.

It is important to avoid pick-up between adjacent firing

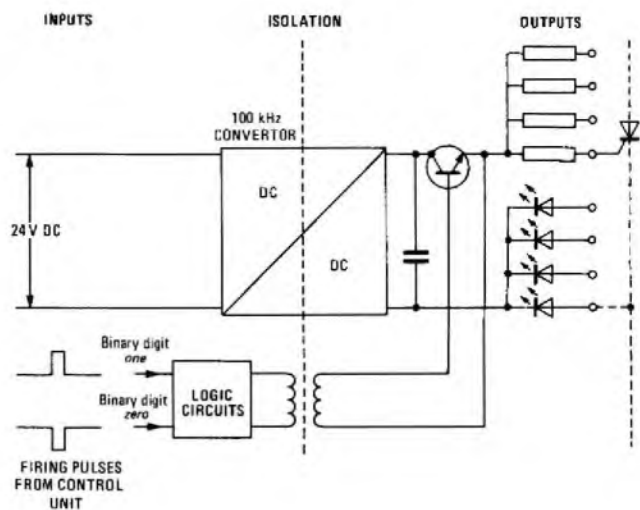

FIG. 8—Block diagram of Pulse Amplifier No. 1A

circuits otherwise thyristors may be fired at the wrong time. The firing circuits must also be immune to electrical noise generated by external events which could also cause thyristors to be fired.

A block diagram of the basic elements of the pulse amplifier is given in Fig. 8. All the pulse amplifiers in the rectifier are fed from a common 24 V power rail and this supplies a simple 100 kHz DC-DC converter. The transformer in the converter provides isolation between the input supplies and the output

pulses. The output of the converter charges a reservoir capacitor which is discharged through the thyristor gate circuit via a switching transistor in response to the input signal from the control unit. The reservoir capacitor stores sufficient energy to fire 4 thyristors simultaneously. The pulse amplifier has 4 pairs of outputs and a light-emitting diode (LED) is provided in series with each. The LEDs light up when the associated output is being used.

Pick-up between the gate circuits is minimized by mounting the pulse amplifiers as close as possible to the thyristors they are to fire. The leads carrying the high-power firing pulse can then be kept very short. The pulse-amplifier circuit is mounted in a metal can to provide electrical screening. There remains the possibility of pick-up in the relatively long leads which carry the low-power firing pulse from the control unit to the pulse amplifier. This problem is overcome by coding the firing pulses from the control unit. The pulse amplifier is supplied with two firing pulses, one being the inverse of the other. Logic circuitry in the pulse amplifier checks for the presence of both signals before triggering the output pulse. This procedure provides good immunity to common mode interference with the input signals to the pulse amplifiers.

CONCLUSION

The first prototype thyristor rectifier was installed in late 1975. Since that date, about 250 rectifiers have been installed, and there have been no instances of rectifier instability caused

by the wide range of combinations of batteries and AC supplies, either from the mains or engine-alternator sets. The viability of using large-scale integrated circuits to simplify the control system has been investigated but, at present, this cannot be justified on economic grounds.

ACKNOWLEDGEMENTS

The initial design and development of the rectifier power and control circuits was carried out by Brentford Electric Ltd., and the author acknowledges their help and that of his colleagues in the Operational Programming Department of Telecommunication Headquarters in providing the information on which this article is based.

References

- ¹ PINE, R. Telecommunications Power Supplies—The Next Decade. Part 1. *POEEJ*, Vol. 64, p. 2, Apr. 1971.
- ² HUMPHREYS, S. F. Telecommunications Power Supplies—The Next Decade. Part 3. *POEEJ*, Vol. 64, p. 164, Oct. 1971.
- ³ Limits for Harmonics in the United Kingdom Electricity Supply System. The Electricity Council Chief Engineers Conference, Engineering Recommendation G5/3.
- ⁴ SPOONER, F. E. A Standard Thyristor Firing System Integrated into the New Universal Post Office (Modular) Power Plant No. 233. IEE Conference, Power Electronics—Power Semiconductors and their Applications. London, 3–5 Dec. 1974.

Book Review

Technician Workshop Processes and Materials 1. C. R. Shotbolt, C.ENG., F.I.PROD.E., M.I.MECH.E., M.I.Q.A., M.A.S.Q.C. Cassell and Co. Ltd. (Cassells TEC series). 206 pp. 179 ills. £3.00.

This book provides excellent coverage for the new Technician Education Council (TEC) level 1 Workshop Processes and Materials mechanical engineering standard unit TEC U75/001. In it, the author sets out to explain workshop principles rather than practice but, when necessary, supplements his explanation by examples of the industrial use of materials and processes. Both the metric and imperial systems of units are discussed in the chapters on measurements and screwcutting techniques and, in this respect, it is gratifying to note the author recognises the need for mechanics to be adaptable to both systems. Particularly useful are the safety notes shown in bold print. These cover such topics as operator safety, care of machinery, machining operations and hints and suggestions to assist the mechanic. Although questions are helpful to the student at the end of each chapter, it would have been more useful if model answers had also been included—probably not directly after the questions but perhaps in a separate section at the end of the book. An index would also be of value.

Most British Post Office Telecommunications students will follow the Materials and Workshop Practice standard unit TEC U75/002, which is oriented towards electrical engi-

neering. The book also adequately covers the mechanical engineering content of this unit, but does not set out to cover in detail the electrical aspects of machine shop practice. Passing reference only is made of electrical hazards in the machine shop and the causes and treatment of electric shock. The general objectives that are not covered but form part of the TEC U75/002 unit include aspects on safety matters with particular emphasis on good electrical engineering practice, the treatment of accidents caused by electric shock and the principles of establishing good electrical connexions by means of solder, crimp and wrapped joints. A single text book covering both units TEC U75/001 and 002 would satisfy the needs of a wider range of students and, it would seem, that with minor additions to the book, this could be achieved.

As a frequently used reference book, there is a need to improve the paper cover binding as, in the reviewer's copy, this soon became detached. The illustrations are mostly line drawings and are adequately detailed, generally appearing where they should, on the same page as the reference.

A well written book presented in a logical manner and recommended to students following the Workshop Processes and Materials unit. It would be of lesser value to those students taking the electrical engineering oriented unit, Material and Workshop Practice, because details on electrical safety and electrical connexions are not sufficiently covered.

D. C. WELLER

Operational Experience and Evaluation of the British Post Office Experimental Packet-Switched Service

P. D. G. MARLOW-MANN, C.ENG., M.I.E.R.E., A.M.B.I.M.†

UDC 621.394.4: 681.32: 681.3.08

This article reports on the operational experience gained from the Experimental Packet-Switched Service, the problems encountered are discussed and the results of tests carried out are detailed.

INTRODUCTION

The British Post Office (BPO) officially started its 2-year experiment in packet switching in April 1977 with the formal opening of the Experimental Packet-Switched Service (EPSS). However, by phasing the introduction of hardware and software over the preceding 18 months, a temporary service was provided; this enabled customers to develop, and gain operating experience of, their systems. The run up to the actual opening, and the subsequent 18 months of in-service operating experience, has provided the BPO with much useful information on the problems of implementing and operating a packet-switched network; it has also afforded the opportunity to evaluate network performance under controlled conditions. This article reviews the major findings from this period.

† Network Planning Department, Telecommunications Headquarters

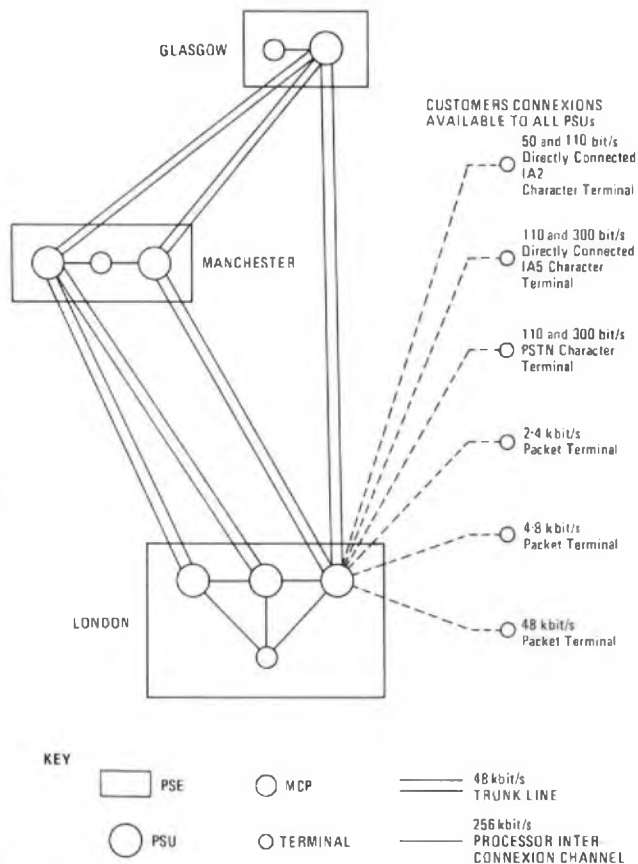

IA—International Alphabet
FIG. 1—EPSS network topology

PRESENT NETWORK

The EPSS network has been fully described in previous articles^{1,2}, but for completeness, a broad outline of the present network, including changes recently made, is given below.

The EPSS network comprises 3 packet-switching exchanges (PSEs), one each at London, Manchester and Glasgow. Each PSE consists of a number of fully-interconnected sub-units—packet-switching units (PSUs)—and a monitor and control point (MCP) for network control. Both PSUs and MCPs are based on standard commercial mini-computers (Ferranti Argus 700E), although the microprocessor-based packet line cards for customer interface were a special development. Three PSUs are provided at London, fully duplicated for security, and working in the hot-standby mode; the 2 PSUs at Manchester, and the one Glasgow PSU, are unduplicated or single units. Originally, it was planned to equip the Glasgow PSE with 2 PSUs, but there was insufficient customer demand and one of the units was transferred to London for development, test and experimental purposes. The 3 PSE, 6 PSU network is partially interconnected by 48 kbit/s trunks, and customer access to the PSEs is gained by use of conventional Datal services. Both packet and character terminal operation can be catered for. Packet terminals operate at digit rates of 2.4 kbit/s, 4.8 kbit/s or 48 kbit/s, and can choose either a standard or a simplified protocol working³; the options are specified when the terminal is initially connected to the network. Character terminals gain access at digit rates of 50 bit/s, 110 bit/s and 300 bit/s over directly-connected telegraph or telephone private circuits, or via the public switched telephone network (PSTN). EPSS protocols were developed specifically for the experiment in advance of international standards, with which they are not compatible. Fig. 1 shows the topology of the EPSS network, and Fig. 2 a general view of the London PSE.



FIG. 2—General view of London PSE

OPERATING EXPERIENCE PRIOR TO OPENING DAY

To enable customers to connect their terminals to the network as soon as possible, it was decided in the Autumn of 1975 to introduce a provisional service on a phased basis, as modules of software were proved functionally viable. It was necessary to retain enough PSUs and associated hardware at the contractor's works to form a test configuration for factory acceptance testing and software development purposes. However, by careful re-organization, sufficient equipment was made available and installed at the London, Manchester and Glasgow PSEs to form an embryonic network. Many customers' terminal installations were not ready for connexion to the network and therefore competition for the limited number of access ports initially available was not immediately a problem; but customer scheduling was necessary later, and some customers were parented on remote PSUs by means of tariff T circuits provided on an expedient basis.

The software modules comprising the advance EPSS software system, although basically correct, required further development work to enhance their resilience to incorrect or unexpected events, and to eradicate faults brought on by various combinations of circumstances. Since customers were using the network to develop their terminal software, they were producing just the fault conditions to which the PSE software was most vulnerable, and PSU failures in the early days were frequent. For the first software system brought into service, the average PSU failure rate was one fault every 90 min.

An unfortunate consequence of giving advance service to customers under these conditions was that the relatively poor performance gave rise to criticism, but as factory development continued, the software systems improved, and service to customers became progressively more acceptable. By the time the penultimate software system was released, improvements were such that it was decided in April 1977 to declare the formal start to the EPSS. During this early phase, assured service rose from 4 h/d at the beginning to 8 h/d, 5 days a week; during these times, all major failures would be attended to. The network was, however, available for use during other times on an unassured basis; that is, any major failure would not necessarily be dealt with immediately.

PROBLEMS DURING PROVISIONAL SERVICE

One of the first problems encountered in trying to provide advance service concerned network control. For the designed system, the operator interface for inserting or changing either customer or network parameters is via the MCP. Since MCP hardware and software were not available until the later phases of implementation, all communication with the network had to be achieved on a direct interface with the individual PSUs, using a special test and support program that accepted suitably coded parameters. Although the lack of plain English translation made interpretation difficult, and the facilities offered were not as comprehensive, it was, however, found that, after familiarity had been gained, the method had the advantage of being faster in its application than the MCP system that replaced it.

Similarly, because training, documentation, and network administration were all structured for final system operation, the development of separate interim procedures required much co-operation and adaptability from local staff. Since software and network configuration changes occurred frequently, and had to be implemented concurrently at 3 different locations, it was essential to ensure strict adherence to formal procedures. *Ad hoc* operational and maintenance procedures had to be designed, documented and implemented very quickly, and it soon became necessary to co-ordinate these aspects from one central point. To illustrate the complexity of this function, at one time, a restart of a failed PSU entailed selecting the correct information from 12 different operating

configurations and 2 different software systems. Unless operating and maintenance procedures are adequately defined, and site organization formalized, restoration of service in the confusion that could follow a system failure would be anything but smooth.

Frequent intermittent failures of the packet line cards (PLCs) terminating customer's lines on the PSU were experienced during these early stages, and this was eventually found to be the result of fretting corrosion⁴. Fretting corrosion is the build up of contact resistance, caused by the slight motion between materials due to small temperature fluctuations. This was found to be present in the connexions of the programmable read-only memories (PROMs) holding the microprograms for the microprocessors to the PLCs. These PROMs operate at a high temperature and, during the development phase, used a plug-and-socket arrangement to facilitate replacement. This combination led to the failure of the PLC after periods of typically 2-3 d operation. Although various techniques of lubrication were tested by the contractor, with limited success, a full cure was obtained only by replacing all sockets with a later type using gold inlaid contacts.

Power at all sites was taken from the essential services supplies, which incorporate a diesel generator to guard against the effect of mains failure. Unfortunately, the essential services supply change-over arrangements at each site have to be routinized at intervals, resulting in a break in supplies of between 200 ms and 20 s, depending on local power distribution arrangements; this causes a failure of the complete PSE, both on initial change-over and again on restoration of the normal supply. In cases where a true no-break AC essential services supply does not exist, and DC-AC inverters are not provided, it would be better to power the equipment from the mains, with fall-back to the essential services supply only when there is a real mains failure. This would avoid failures of the PSE when routines are carried out. However, an analysis of the mains supply failure record should be made during the planning stage, since experience has shown that some supplies can be subject to a high fault rate. Provision of inverters at the London PSE, powered from the -50 V exchange battery, overcame the problem at that site, and arrangements to have power routines performed outside assured hours of service have reduced the problem at the other sites.

Another major operational difficulty of this period centred around the magnetic drums used for storing system information, and the statistical and billing records. The EPSS was designed for each PSU to have access to 2 drums, working in a master/slave (hot-standby) mode. Due to the skeletal state of the network, only one drum per PSE was available initially and the resulting vulnerability soon became apparent—following a drum failure, records were queued within the PSU occupying the spare working area, eventually causing the complete failure of the PSE. Temporary solutions to this problem involved software modifications to by-pass the drums at the expense of losing records, but despite this, obscure problems persisted until the final network configuration was achieved.

This experience indicated that maintaining a master/slave configuration was essential to the security of the Glasgow PSE when it was reduced to a single PSU. Because information is passed between major software modules at packet level, it was possible to adapt the network configuration to allow either the 2 Manchester drums to work in a master/slave mode and be accessed also by the Glasgow PSU, or for one of the Manchester drums to be paired with the single drum at Glasgow. Drum information is transmitted in normal packet format over the 48 kbit/s inter-PSE trunks, alongside other network traffic; although the latter option places more reliance on the trunk routes between Manchester and Glasgow (since all master records have to be continually copied onto the slave drum), it has proved useful in avoiding the effect of

Manchester power breaks, which would otherwise have caused the Glasgow PSE to fail through lack of access to a drum.

OPERATING EXPERIENCE SINCE THE OPENING OF SERVICE

After the acceptance of the final software system, the remaining equipment was released from the factory and introduced into service. This allowed the network to be configured into its designed state which, together with operation of the accepted software, improved the service to customers and allowed network measurements to take place on a valid basis.

Four phases in the development of the EPSS can thus be traced as follows:

- (a) provisional service before the opening of the EPSS (from November 1975);
- (b) service using penultimate system software and reduced network equipment (25 April 1977);
- (c) service using final system software (from 21 November 1977);
- (d) introduction of full network facilities including dual system operation at London (from 27 February 1978).

NETWORK PERFORMANCE

Fig. 3 shows the average weekly total network availability (TNA) during assured hours, and the corresponding average weekly PSU failure rate from opening of service in April 1977. It became apparent during the early days of the experiment that PSU failure rate was not a good measure of network performance, since one long-duration hardware fault could have a greater effect on service than a large number of quickly reloadable software failures. Nevertheless, a loose correlation between failure rate, reflecting fault probability, and TNA, representing fault effect, is readily apparent from Fig. 3.

A disadvantage of using TNA to express network performance is that it does not provide a meaningful representation of service as seen by a particular group of customers. This is because the failure of, say, the Glasgow PSU does not affect customers on other PSUs unless they were working to a Glasgow customer; any transit calls in progress via the Glasgow PSU are automatically re-routed. Consequently, availability targets are expressed and measured on an individual PSU basis and, using an interpretation of the specified design parameters, availability targets for a full 168 h week have been set at 99.93% and 99.80% for duplicated and single PSUs, respectively. This means that, to meet target limits, the down time must be less than 7 min for a duplicated PSU, or 20 min for a single PSU, during a 24 h day, 7 d week. During the 40 weeks of service since implementation of the final network configuration, this target has been met for 72% of the time by duplicated PSUs, and for 80% of the time by single PSUs.

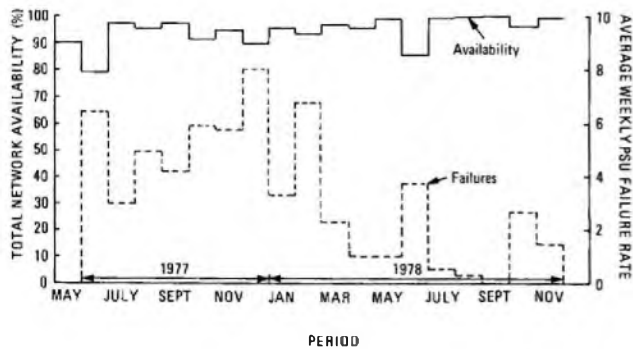

Fig. 3—Variation of TNA and PSU failure rate

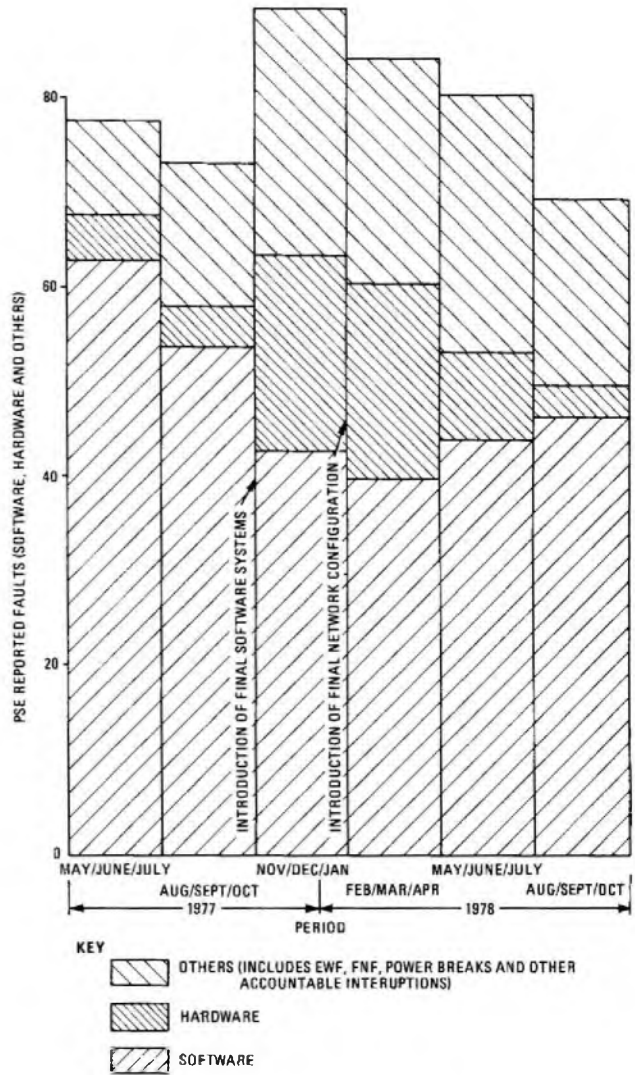

Fig. 4—Variation in reported PSE faults

The effect of the greater reliability of duplicated PSUs on network security is clearly seen on the TNA graph from February 1978 onwards, when duplicated PSUs were introduced.

Fig. 4 categorizes the faults affecting exchange switching equipment. This shows a distinct improvement in software performance after the introduction of the final system software and, again, after the introduction of duplicated processor operation at London. The increase in attributable faults from November 1977 is due to the increased implementation activity while hardware, software and network configuration changes were taking place. It has been found that a similar unsettled phase followed every new software implementation or network change during the experiment irrespective of how much pre-introduction testing was carried out, or how many precautions were taken. Similarly, the increase in hardware faults during this period was due to the teething problems arising from the introduction of new switching units into service, and use for the first time of hardware facilities required for duplicated processor operation. The number of true faults was certainly less than the totals indicated in Fig. 4, because the graph shows reported, not proved, faults; it also includes repetitive failures due to the same cause, and faults that would not affect service availability.

Figs. 5 and 6 illustrate the network usage during the period

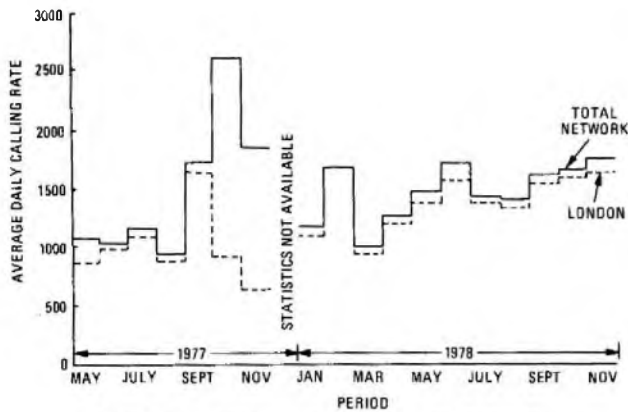

FIG. 5—Variation in average daily calling rate

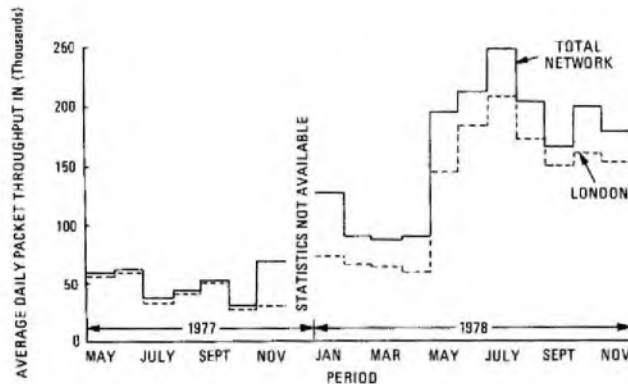

FIG. 6—Variation in daily packet throughput

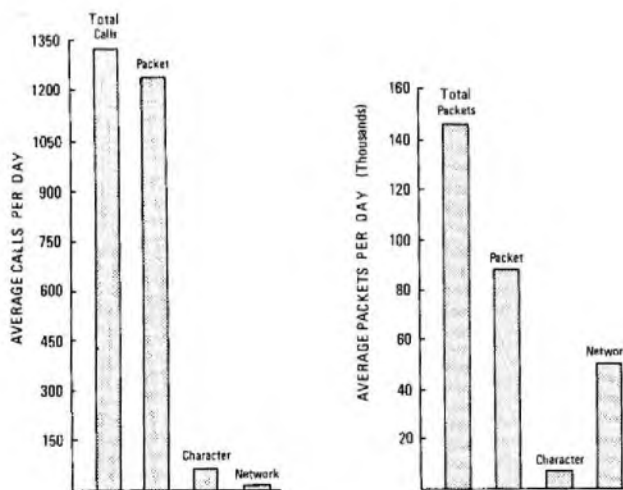

FIG. 7—Distribution of calls and packets by terminal type

of formal service. With a few exceptions, due to special tests being carried out at other exchanges, most of the traffic originates from customers parented on the London PSE. Peaks in traffic levels are predominantly the result of BPO tests and experiments, with the exception of the period around June 1978, which was due to increased customer activity in preparation for a customer/BPO organized demonstration of the uses of packet switching.

Fig. 7 illustrates the distribution of calls and packets generated by packet, character and network terminals. Network terminals comprise all the internal network virtual terminals; for example, the MCP, the drum, and the statistics collector. It should be noted that approximately 60% of calls/d are the routine polling calls made by 2 packet terminals to verify the correct functioning of their line and the availability

of the PSE. These calls could be considered non-valid traffic because it is unlikely that they would be generated on a true revenue-earning network. Also of note is the high proportion of packets generated by network terminals, and the correspondingly low number of calls, since these are normally left permanently established.

Traffic levels and general usage of the network has been disappointingly low, due possibly to the experimental nature of participants' interests. However, with the stable network, a general increase in traffic levels is detectable as more applications are run on a routine basis. Examples of present usage are: time-sharing services run by the universities, their many users utilizing the EPSS to access host computers; and daily file transfers carried out by the National Girobank.

EPSS PROTOCOLS

Although a detailed evaluation of EPSS protocols is beyond the scope of this article, the main criticisms made of the BPO protocol specifications, which affected character and packet terminal operation, are outlined below.

By far the greatest difficulty experienced with character terminals accessing the EPSS over the PSTN arose because only one attempt at the EPSS address selection phase was possible. Failure for whatever reason (called-customer busy, incorrect selection etc.) resulted in release of both the EPSS and PSTN connexions and required the calling customer to re-dial through the PSTN and repeat a lengthy validation and log-on sequence. Software changes have now been made so that, normally, only the EPSS portion of the call is cleared.

Other areas for suggested improvements included: more specific service signals; faster echo response; use of an escape character to clear the call, which would avoid the need to provide a separate BREAK key; and selectable padding on carriage return flyback to avoid overprinting on certain types of terminals.

Difficulties concerning the specific shortcomings of EPSS protocols affecting character terminals were found, of which the following serves as an example. Once a call originating packet (COP) has been sent, no further packet is delivered on that call until the called terminal has returned the first response packet (FRP). Since this condition also applies to a clear packet, if there is no one available at the receiving character terminal to return the FRP (as in the case of an unattended Telex terminal), it would be held in the *busy* condition, even after the calling terminal has released his portion of the call and would remain in that state until human intervention restored it to the *free* condition.

Comment by packet terminal users on operational difficulties tended to be less than those from users of character terminals, since any inconsistencies experienced would be programmed into the packet terminal implementation, and the annoyance factor therefore becomes less apparent. However, the use of *packet hold* applied during the periods when terminals or the PSE were unable to handle further traffic gave rise to considerable discussion. It was felt that *packet hold* (the time during which the PSE stored packets) should be greater than the present 2 s maximum, and also allow for the traffic differentials of the various line speeds. It was also considered that *packet hold* should be selectively applied by the PSE to those terminals causing the congestion, rather than global application of the condition to all customers.

The experience gained in the design and operation of EPSS protocols has, nevertheless, enabled the BPO to make valuable contributions to the study and design of international standards for packet protocols, and to identify the facilities likely to be of most importance to customers on new systems.

SYSTEM OPERATING EXPERIENCE

Many lessons have been learnt from the implementation and

operation of the EPSS. The following examples are selected for their importance and, with the current spate of computer network implementation, their applicability at this time.

System Security

Especially during the early phases of the EPSS, system security would have been enhanced if automatic system restart had been incorporated in the original system specification. This, coupled with an automatic log of system failure parameters, would have eased problems of providing 24 h service, without resorting to continuous cover by trained staff. Remote reload from a continuously manned site is an alternative solution to the problem.

MCP Man-Machine Interface

Operational experience has indicated that the ergonomics of the MCP man-machine interface could be improved. Interaction is presently carried out via a visual display unit (VDU), using a network control language of formatted commands in plain English. Although commands can be abbreviated, input is still cumbersome and could be further simplified, preferably by having an additional alternative format for the input of commands.

The advantage of this becomes apparent when the following example is considered. The provision of a new terminal with the present method requires 17 separate commands in the form: *CHange: TERminal: T12345: RATE: TO: 1: FROm: 0*, where the upper case characters represent the abbreviated command and all after *T12345* is different for each of the 17 commands. The whole operation takes 10-15 min, which compares unfavourably with the 1-2 min required before the introduction of the MCP, when each command was represented by a group of suitably coded characters. Consequently, the provision of an alternative facility to input parameters in a continuous string in fixed format, with mnemonic codes either omitted or in a highly abbreviated state, would result in a considerable saving in time, without loss of security.

Although an alternative input would have its advantages, output in plain English should still be retained. However, experience has shown that the use of mimic diagrams to replace tabulated data would provide a clearer representation of outputted information.

Two other facilities that, in retrospect, could usefully have been included in MCP implementation are:

- (a) the ability to transmit and receive messages in packet form from one MCP to other MCPs and to customers, and
- (b) the ability to use the MCP to examine and, via suitable interlocks, change the contents of a PSU core store; this would enable software support to be carried out from remote locations, with the consequential saving in time and improved service cover.

Network Control

Network control was found to be a very important aspect of the EPSS implementation and operation, and a hierarchical chain of command was established. At the lowest level, individual PSEs were responsible for the day-to-day operation of their own exchange. The next level allowed for one PSE to be nominated as system control on a rota basis. This function was to provide a single interface between Telecommunications Headquarters (THQ) and the PSEs, and to give the maximum autonomy for local arrangements. In practice, with the small network for the EPSS, this function is not formally used, since it has been found practical to work directly to all sites. The final level in the chain consisted of the THQ groups controlling the experiment; here it was found necessary to establish one central function that could co-ordinate the interests of all groups and provide the interface to the PSE. A computer-based system for holding and distributing network control information was considered, but this proved unnecessary for the scale of the experiment and a conventional paper-based system was implemented. However,

for a larger network, a computer-oriented system should be considered to cope with complexity of holding the necessary database of system parameters.

Accommodation

Although the EPSS was designed to operate in a standard telecommunications environment, it was found necessary to adopt a computer operations approach to site organization, and PSEs had to be supplied with the appropriate data-handling equipment. System security, in particular, received special attention, with master system tapes held in secure locations, and with operating tapes and information fully catalogued.

NETWORK EXPERIMENTS

Once the network had been configured into its final designed state, and operating performance had stabilized, a programme of experiments was carried out. These experiments used the test and experimental PSU, configured and connected via normal customer access ports to the London PSE, to appear as a traffic source of 10 customers (see Fig. 8). This traffic source used call-generation software originally developed for factory acceptance testing, which allowed a distribution of calls with known and controlled characteristics to be established through the network. One of the facilities of the programme enabled very accurate packet counts and time measurements to be made to an accuracy of ± 1 ms.

For these experiments, a distribution of calls was established, representing the maximum designed steady-state load that could be carried by a PSU for an indefinite period. This load was defined as unity and, by altering a master timer in the traffic-generating PSU, the frequency of call and packet generation could be varied. This allowed the PSU to be subjected to different traffic levels, referred to as multiples of steady-state traffic loading or, for convenience, load factor.

Fig. 9(a) illustrates the effect that various traffic levels have on packet throughput for short (16-byte) packets, and

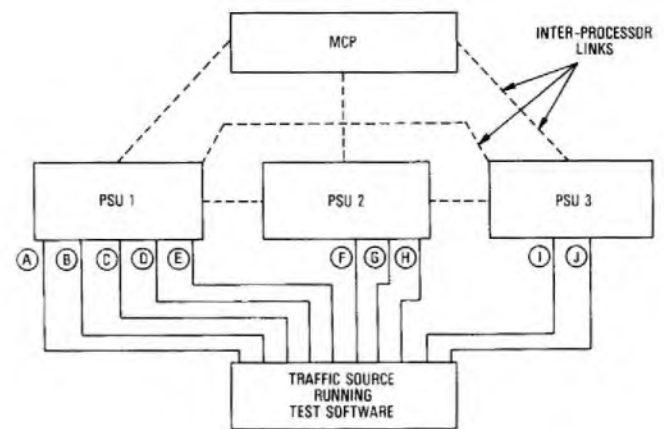

TEST CUSTOMER	(A)	48 k bit/s packet working
" "	(B)	2.4 k bit/s packet working
" "	(C)	2.4 k bit/s packet working
" "	(D)	48 k bit/s packet working
" "	(E)	110 k bit/s character working, PSTN access
" "	(F)	48 k bit/s packet working
" "	(G)	2.4 k bit/s packet working
" "	(H)	110 bit/s character working, PSTN access
" "	(I)	2.4 k bit/s packet working
" "	(J)	110 bit/s character working, direct access

FIG. 8—Test configuration for London PSE

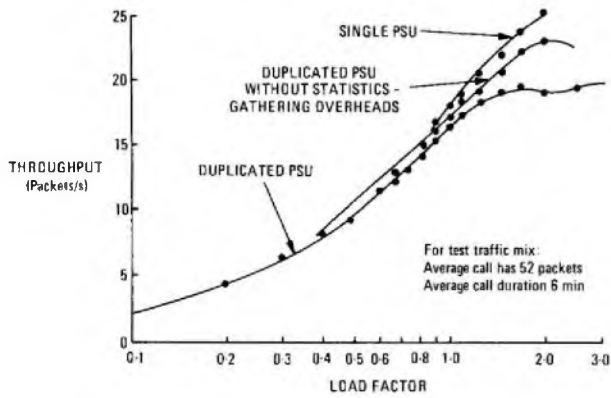

(a) Throughput with packet length of 16 bytes

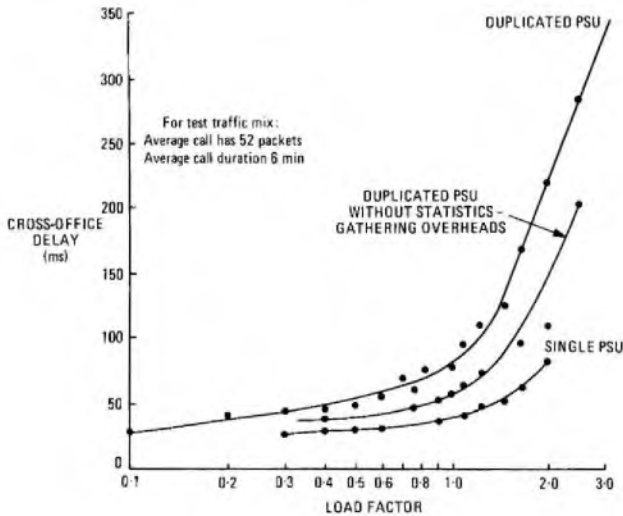

(b) Cross-office delay with packet length of 16 bytes

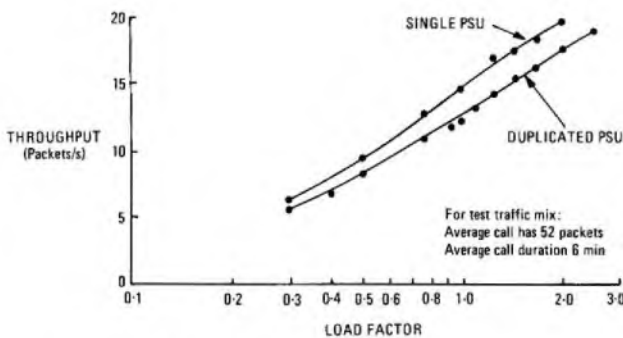

(c) Throughput with packet length of 255 bytes

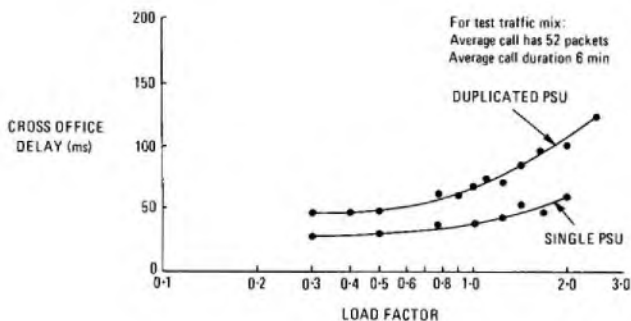

(d) Cross-office delay with packet length of 255 bytes

FIG. 9—Variation of throughput and cross-office delay with load factor

Fig. 9(b) shows the corresponding effect on the time taken to switch the packet across the PSU (cross-office delay). Graphs for both throughput and cross-office delay exhibit the typical curves produced by a processor-controlled switch. It can clearly be seen that a linear relationship exists between throughput and PSU loading, until processor utilization approaches 100% and queues start to build up. The effect of queue formation is more apparent on cross-office delay, and a steep exponential curve is produced as the processor becomes fully utilized. Further increase in traffic levels only adds to the queues, causing a greater cross-office delay and consequential fall in throughput.

Throughput, in the series of experiments described in this article, is defined as the number of packets/s switched by a PSU. Previous EPSS results published for throughput have been quoted in terms of packets handled per second by a PSU. Since every packet switched represents 2 packets (one received and then retransmitted), results quoted here are half those expressed as packets handled.

In theory, throughput should eventually stabilize at a constant level or decline slightly, but in practice, actual throughput is affected by sub-functions within the software system. This is well demonstrated by the kinks in duplicated PSU throughput graphs in Fig. 9(a) where, having reached a maximum, the throughput starts to reduce. However, because of the high traffic levels being presented to it, the processor shuts down the statistics-collection sub-function, and the extra processing resources thus released are used to provide a further improvement in throughput.

Figs. 9(c) and 9(d) illustrate results from the same series of experiments, but using a maximum packet length of 255 bytes: similar shaped curves are obtained. The minimal effect due to different packet lengths was anticipated, since only the header of the packet containing addressing and facility information is processed, the variable-length message portion being held in a working area of core store. In the previous experiment, the effect of loading the PSU with short packets caused processor utilization to become the limiting factor; with longer packet lengths requiring more storage, however, it is the lack of dynamic work space (DWS)—conceptually, the spare operating area from which space is allocated for the temporary storage of packet data—that the PSU encounters first. The effect of this is more significant: rather than just cause delays, the lack of resources causes the PSU to prevent further input of traffic by the extension of *packet hold* to customers. It was these conditions, in conjunction with limitations of the test software, that prevented tests with higher traffic levels being run, and the throughput possible on shorter packet lengths being reached. Total transmission time for a packet comprises cross-office delay and the transmission time of the packet on the link, the latter being a function of packet length. Because of the greater transmission time for long packet lengths, a reduction in the number of packets being presented to the PSU, and consequently a reduction in throughput compared with short packet lengths occurs for any given load. Cross-office delays, however, remain in the same order, since DWS resources are the limiting factor and queues will not have been formed.

Also demonstrated in Figs. 9(a) to 9(d) is the relationship between duplicated and single PSUs, and the effect of the statistics-gathering overheads. Penalties are incurred with duplicated-processor working, since information must be copied from the on-line half of the PSU to the standby to keep the standby half of the PSU updated and ready for immediate takeover. The effect of the extra processing, and the reduction in DWS caused by the additional software, is clearly represented by the reduced throughput and greater delays of the duplicated processor, compared with the single processor. Similarly, the improvement in throughput and cross-office time by relieving a PSU of the overheads of gathering statistical information is clearly indicated in these graphs. Experience has shown that many of the statistics on the EPSS are being

collected in too much detail; a better balance between information gathered and the resources necessary to obtain it could be achieved, with a consequential improvement in performance.

Measurements for combined call set-up and call clear-down times gave an average for a duplicated PSU of 77 ms, and for a single PSU of 63 ms, for a call where both calling and called parties are connected to the same PSU. For calls between different PSUs in the same PSE, the figures were 107 ms for a duplicated PSU, and 79 ms for a single PSU; this reflects the extra processing, transmission, and packet-handling delays. Although it was not possible to measure the components of call set-up and clear-down separately, a theoretical treatment indicates that those processes should be symmetrical.

A full description of standard and simplified protocols has been published in a previous issue of the *Journal*³, but, essentially, standard protocol allows interruption of a transmitted packet to return the acknowledgement for a correctly received packet, and thus allows further transmission. With simplified protocol, interruption of packets cannot be made, and return of the acknowledgement must await completion of a packet; transmission of further packets therefore bears an equivalent delay. The advantage of standard protocol should, therefore, be to produce a higher throughput under full-duplex, high-utilization conditions. This is borne out in all cases for a 48 kbit/s line (approximately 6% improvement in throughput using standard, instead of simplified, protocol at all packet lengths) and is marginally better for longer packet lengths at 2.4 kbit/s (approximately 3% improvement in throughput using standard, instead of simplified, protocol); however, a timing interaction within the PSU reverses this situation for short packets at this speed.

Table 1 illustrates the values of line utilization possible with EPSS protocols. At relatively long packet lengths, line utilization is always greater than with short packet lengths, because the overheads of the 5-byte header and the 2-byte error-checking codes have a more significant effect on packets with a short data field: 43% overhead on information transfer rate for a 16-byte packet compared with 3% for a 255-byte packet. Also, for the shorter packet lengths, there are a greater number of packets handled for a given information throughput and, consequently, the processing and packet-handling overheads are greater.

Line utilization for a 48 kbit/s terminal is greatly reduced at short packet lengths, since a continuous packet stream at this rate represents a load of approximately 260 packets/s, presented to a PSU whose maximum packet handling capability is about 20 packets/s. At longer packet lengths, where the load is reduced to about 23 packets/s, a more realistic line utilization ensues, but this shows that the performance of high-speed lines, in particular, is very much dependent on the overall traffic load being handled by the PSU.

However, this result, and the others reported here, should be considered in terms of normal customer usage. It is highly unlikely that a continuous stream of partially-filled packets would be transmitted on the same call, because tariff structures and normal efficiency constraints lead to most transmissions being made with a maximum packet fill. Neither is line utilization on its own necessarily of primary importance to customers; the information transfer rate, the efficiency of terminal usage and the improvement in facilities are factors likely to have a more significant influence on customer decisions. Even using Datel services, some loss of line efficiency must result, either from the error protection codes normally used, or from the penalty of retransmissions. However, the

TABLE 1
Comparison of Line Utilization using EPSS Protocols at Different Packet Lengths

Protocol		Line Utilization (%)	
		Packet length 16 bytes	Packet length 255 bytes
Standard	2.4 kbit/s	25.6	91.1
	48 kbit/s	2.7	66.2
Simplified	2.4 kbit/s	26.7	88.9
	48 kbit/s	2.6	62.6

results from these tests indicate that on the EPSS network a 2.4 kbit/s terminal can gain the benefits of a packet switched system with no significant loss of transmission efficiency whereas, for 48 kbit/s terminals, the benefits are achieved at the expense of a noticeable reduction in line utilization.

It has been found that a true analysis of system performance can be made only under controlled conditions, and the interpretation of the results obtained from the experiments carried out on the EPSS has enabled the peculiarities resulting from system design to be appreciated. Most processor-controlled switching systems involve such a complexity of interrelated events that, even if an extremely sophisticated theoretical treatment or mathematical modelling was carried out, it is unlikely that all aspects could be accurately predicted.

CONCLUSIONS

The EPSS was established with 3 main aims:

- (a) to allow the BPO and customers to assess the economic and technical viability of packet switching;
- (b) to enable a decision to be made on provision of packet switching facilities in future data services; and
- (c) to enable operational experience to be gained, and to assist in formulating tariff and traffic-design principles.

The recent decision to provide a National Packet Switched Service (NPSS) to supersede the EPSS indicates that the aims of points (a) and (b) have now been met. This article has recorded some of the main findings from those aspects concerned with the third aim. There is still scope for further studies; nevertheless, it is hoped that the experience gained from the EPSS to date will be of use to those planning or implementing a packet switched network.

ACKNOWLEDGEMENT

The author wishes to acknowledge the assistance of colleagues in THQ Departments (TD9 and NP4) in the preparation of this article.

References

- ¹ BELTON, R. C., and SMITH, M. A. Introduction to the British Post Office Experimental Packet-Switching Service (EPSS). *POEEJ*, Vol. 66, p. 216, Jan. 1974.
- ² HADLEY, D. E., and MEDCRAFT, D. W. F. Experimental Packet-Switched Data-Transmission Service: Network Design and Implementation. *POEEJ*, Vol. 67, p. 88, July 1974.
- ³ NEIL, W., SPOONER, M. J., and WILSON, E. J. Experimental Packet-Switched Service: Procedures and Protocols, Part 2—Transmission Procedures. *POEEJ*, Vol. 68, p. 22, Apr. 1975.
- ⁴ BOCK, E. M., and WHITLEY, J. H. Fretting Corrosion in Electrical Contacts. Proceeding of the HOLM Seminar on Electrical Contacts, Illinois Institute of Technology, 1974.

A New Mobile Equipment for the Radiophone Service: Development of a 55-Channel Mobile

D. G. WOOD†

UDC 621.396.6: 621.395.4

After outlining the development of the British Post Office Radiophone services, this article discusses the deficiencies of the existing 10-channel mobile equipment, describes the new 55-channel mobile and indicates the improvements that the new mobile will bring to the Radiophone customer.

INTRODUCTION

The British Post Office (BPO) Radiophone service is a means of providing access to the public switched telephone network (PSTN) for customers on the move. The customer is connected to the PSTN by a telephone operator at a Radiophone controlling exchange, via a radio channel to a fixed base station and a 4-wire circuit to the exchange. Each customer is equipped with a mobile radiotelephone equipment (referred to in this article as a *mobile*).

The original London Radiophone service, introduced in 1965¹, was replaced by an improved service, designated *System 3*, in 1972. A total of thirty-seven 25 kHz spaced, 2-frequency, very-high-frequency (VHF) radio channels were allocated for use on the new service. These consisted of one control channel, used for signalling to a mobile customer

that a call was being held by the Radiophone operator, and 36 traffic channels used for speech communication. At that time, mobile equipments of 10-channel capacity were available in quantity for private mobile radio systems, and these were adopted as the standard for the BPO service. The 10 channels, with which each mobile was equipped, comprised the control channel and a group of 9 traffic channels. The 36 traffic channels were arranged in 5 groups of 9 channels, designated *L1, L2, L3, L4, L5*, with some of the channels shared by more than one group; each group was expected to cater for up to 350 mobile customers. These aspects were described in an earlier article².

The *System 3* Radiophone service was introduced in the South Lancashire area in 1973 to replace the original Radiophone service³ (opened there in 1959), and has since been introduced in 6 new areas. The number of mobiles operating on the service has grown from about 1000 in mid-1973 when only London was operational, to about 6000 at present (1978) in the 8 Radiophone areas. Fig. 1 shows the service area coverage of the 8 Radiophone areas, and also a breakdown of the numbers of mobiles licensed in each area.

In 1973, another eighteen 25 kHz spaced, 2-frequency radio channels were made available for use on the *System 3* service and plans were made for a further 3 groups of channels to be introduced in London. This allowed the expected capacity of the London Radiophone service to be increased from 1750 to about 3000 mobiles.

CHANNELLING CONSTRAINTS OF THE 10-CHANNEL MOBILE

Limited Channel Availability

Even with a further 18 traffic channels added to the service, it was obvious that the London Radiophone area would exhaust the available capacity within a very few years. Because of the limited frequency spectrum allocated for mobile radio, it was likely to be several years before more channels might be made available for Radiophone use. It was therefore necessary to seek ways of increasing the channel loading as much as possible, without causing a significant degradation of the grade of service.

A traffic study was made in 1974 and it was found that, if all mobiles could select any one of the 54 traffic channels instead of being restricted to 9, the average number of mobiles per channel capable of being carried by a Radiophone service could be increased by 30%. The service would then be able to grow for a longer period before overall system capacity was reached, even if some 10-channel mobiles were still present on the service.

Roaming-Access Requirements

One of the facilities of the Radiophone service that is particularly attractive to the mobile user is *roaming*; that is, the ability to make or receive calls in other Radiophone areas in the UK. But, as expansion of the *System 3* service into the

† Telecommunications Development Department, Telecommunications Headquarters

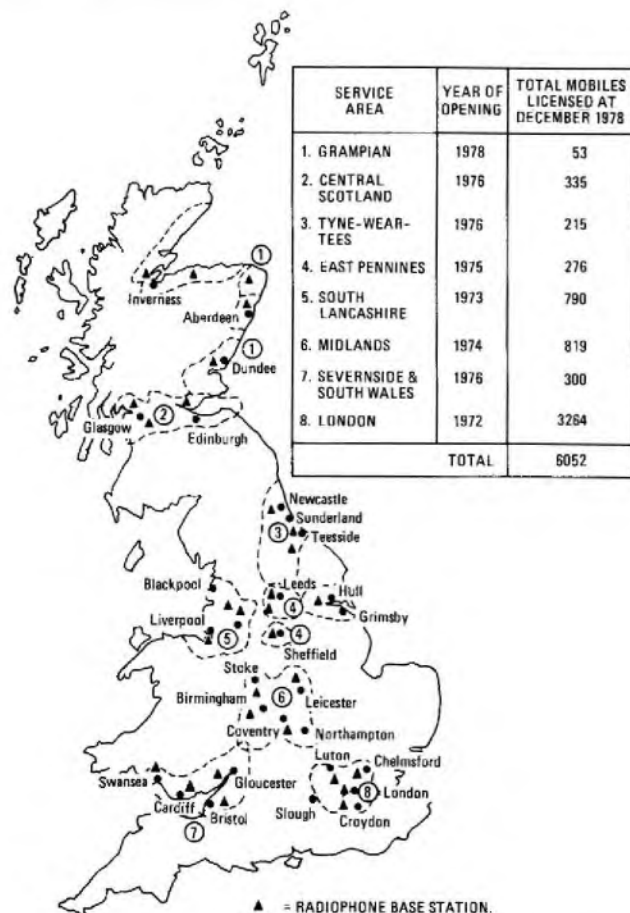

FIG. 1—Service area coverage and breakdown of numbers of mobiles licensed in the 8 Radiophone areas

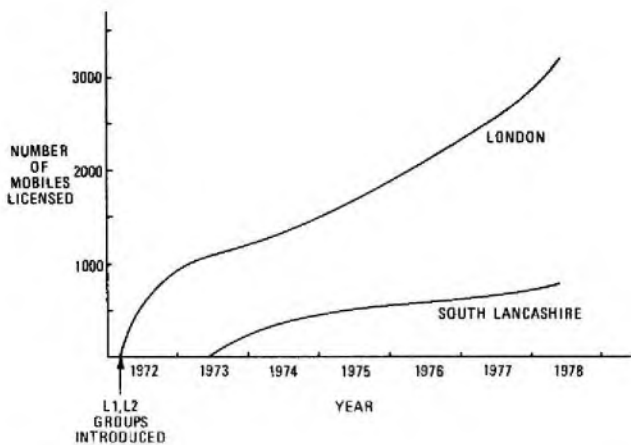

FIG. 2—Comparison of growth of numbers of mobiles licensed in London and South Lancashire (System 3)

provincial areas commenced, the difficulties in providing the roaming facility proved one of the major drawbacks of the 10-channel mobile. Each time a new group of channels was introduced in London, roaming access for the mobiles associated with that group had to be made available at each provincial area base station. By the time the South Lancashire Radiophone service opened in 1973, the London Radiophone service was growing rapidly and had expanded to 5 channel groups. Fig. 2 compares the growth of the London service with that of South Lancashire—a typical provincial area. It was not possible to open with the same first channel group as that used in London (channel group L1) because this would almost completely bar roaming access in South Lancashire for mobiles of the other London channel groups (L2–L5) due to the necessarily limited sharing of channels between groups.

It was therefore necessary to produce a separate channelling arrangement for provincial area groups (designated *P1*, *P2*, etc.) from that used for the London expansion programme. This proved to be a considerable task and was based on provision of roaming access for all 5 London groups operational at that time. After the extra 18 radio channels had been allocated, however, it became virtually impossible to provide roaming access for the added London channel groups (L6, L7, L8) in the provincial areas, because of the limited growth in these areas; provision of additional channel equipment would have been necessary just to accept traffic from roaming London mobiles. This would have been very costly and the equipment would have been severely under-used.

NEED FOR A 55-CHANNEL MOBILE

It became clear that the continued use of the 10-channel mobile would cause increasing difficulties in planning channel allocations for growth in all Radiophone areas, and would restrict the capacity of those services. The need was therefore identified for a mobile that could select any one of the 55 channels available on the Radiophone service.

The facilities of such a mobile had to be defined, taking into account that this equipment would have access to many more channels than its 10-channel counterpart. It was also desirable that, as far as possible, the mobile should be designed to interface with the existing System 3 service. In particular, signalling and radio requirements should be taken into account so that the mobile could be introduced without modification of existing Radiophone equipment.

The first problem was that manual channel-selection, as used on the 10-channel mobile, would not be suitable for a mobile with a much greater channel access capability, and it was concluded that some form of automatic channel-selection was essential. Additionally, the provision of separate sets of

crystals for the fifty-five 2-frequency channels was undesirable, because of the large amount of extra space required to locate them. Both of these considerations led to the need for a synthesized signal source with rapid switching times, to allow each of the pairs of frequencies to be selected and generated in sequence during the automatic channel-selection procedure. The problem was presented to interested mobile manufacturers. It was found that a 55-channel mobile, operating on these principles, could be produced, and work went ahead to prepare a specification. A prototype was developed and type-approval was completed in mid-1976.

AUTOMATIC CHANNEL-SELECTION AND CALLING

The 10-channel mobile identifies a free traffic channel by absence of a carrier signal at the receiver input when that channel is selected. If a carrier signal is present, a CHANNEL ENGAGED lamp glows when that channel is manually selected by the user. With this type of indication, the user must have a chart to indicate which channels are available at the particular base station considered the most suitable for his location. This arrangement is not suitable for a system of automatic channel-selection. Since all 55 radio channels are not available at every base station, nor indeed in every Radiophone area, it was necessary to define a positive means of identifying a free channel for the new mobile.

A system of *marking* free channels was defined, and this was the one major variation from the existing system interface. Under this marking arrangement, free channels at each base station in a Radiophone area transmit the channel carrier, modulated with a *marking* signal. The mobile searches automatically through the 54 traffic channels until it finds one with the *marking* signal modulation, and this channel is used to set up the connexion via the operator. It was decided that every base station within a Radiophone area would present the same *marking* signal, but that adjacent areas would present different *marking* signals. Thus, by providing a MARKING SIGNAL SELECTION control, the user could preselect the Radiophone area into which he wished to call.

The mobile could now select a free channel automatically, and determine into which Radiophone area the call was to be directed. The problem remained, however, that the first free channel found during a search is not necessarily the most suitable one available. The mobile needed to be capable of selecting the free channel with the strongest carrier signal. To do this, the mobile searches through the 54 traffic channels, measuring the signal strength of those carrying the *marking* signal, and continually updates a store with the identity of the channel having the highest signal strength measured so far. At the end of a search, the mobile returns to the channel whose identity is stored and, if the *marking* signal is still present, sets up a call over that channel. A minimum is set for a signal strength considered *reasonable* for channel selection (the *R*-level) and, by finding the channel with the best signal strength, the mobile user is assured of the best service available at that time and location. To avoid searching through all traffic channels when the mobile is located close to a base station, an upper threshold (the *P*-level) is specified, such that any marked free channel, with a signal strength above the *P*-level, is given *priority* and selected immediately, without the need for the search to be completed.

Fig. 3 shows a simplified flow diagram for the automatic-channel-selection-and-calling procedure finally specified for the new mobile. Automatic channel-selection is initiated by the user lifting the handset from its rest. A visual indication is given that searching is in progress; this is a SEARCHING lamp, which lights when the handset is removed from its rest and is extinguished when a channel has been successfully selected. Having completed the automatic channel search, and ensured that the *marking* signal is still present on the selected channel, the mobile sends automatically the appro-

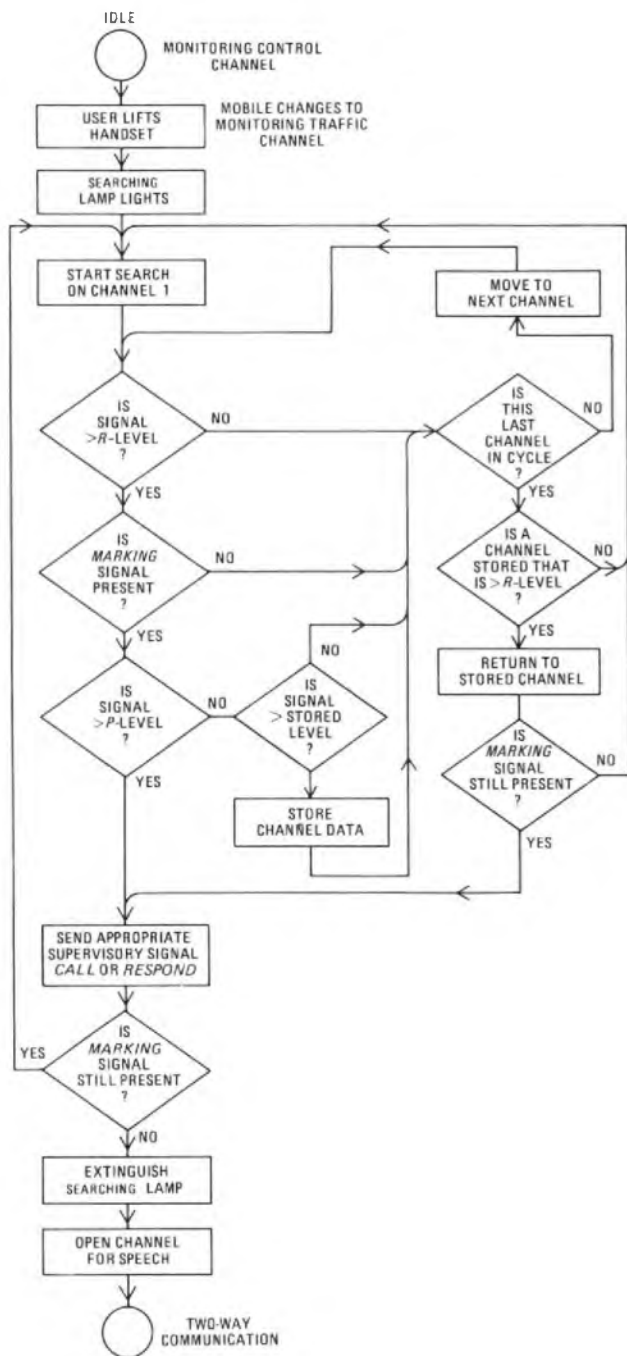

Fig. 3—Simplified flow diagram for automatic-channel-selection-and-calling sequence

appropriate supervisory signal; the signal sent depends on whether the mobile user is originating a call (*call* signal), or answering a call from a Radiophone operator (*respond* signal). After transmission of the supervisory signal, the mobile reverts to the receive mode and checks that the *marking* signal modulation has been removed from the base station carrier, which indicates that the channel has been busied by the exchange in response to the mobile signal. If the *marking* signal modulation is still present, or the carrier has been removed, the mobile resets and repeats the channel search sequence. If the channel has been busied, the mobile opens the transmission path to allow the user to proceed with 2-way communication.

Signalling and Operational Details

The *marking* signal used to modulate the transmitted carrier of a free traffic channel consists of 2 audio tones, transmitted



Fig. 4—Control box for the 55-channel mobile

simultaneously. The user of a 55-channel mobile can select the Radiophone area into which he wishes to call (assuming that he is in range) by setting the *MARKING* SIGNAL SELECTION control on the mobile control box (Fig. 4) to the appropriate position. This control has 6 positions, each of which sets the *marking* signal detector in the mobile to detect a particular pair of tones; the 6 positions are designated A, E, I, O, U, and X, and their associated tone frequencies are shown in Table 1. Initially, only *marking* signals A, E, and I have been allocated to Radiophone areas, the selection of signals O, U, and X being inhibited in the mobile—these have been reserved for future requirements. The allocation of the *marking* signals to the Radiophone areas is also shown in Table 1.

Initially, most of the mobiles operating on the Radiophone service will be 10-channel types; thus, as the 2 types of mobile use different channel-selection methods, it was necessary to restrict the number of channels marked for 55-channel mobile access at the base station. It was therefore decided that, initially, only one free channel per base station would be marked for 55-channel mobile access at any time. Details of the method of presenting marked channels will be given in a subsequent article.

The *R*-level is preset at $2 \mu\text{V}$ nominal, to ensure that the signals received by the mobile user on the selected channel give good communication anywhere within the coverage area of the associated base station. The *P*-level is preset at $50 \mu\text{V}$ nominal; in most cases, a signal above this level reaches the mobile from only one base station and so this must be the best channel available. Fig. 5 shows the significance of the *R*- and *P*-levels in a generalized Radiophone area.

TABLE 1
Marking Signal Details

Marking Signal Designation	Tone Frequencies (Hz)		Radiophone Areas where Allocated
	1	2	
A	2200	2000	London South Lancashire Severnside and South Wales Central Scotland
E	2200	1830	Midlands Tyne—Wear—Tees
I	2200	1670	East Pennines Grampian
O	2000	1830	} Not used at this stage
U	2000	1670	
X	1830	1670	

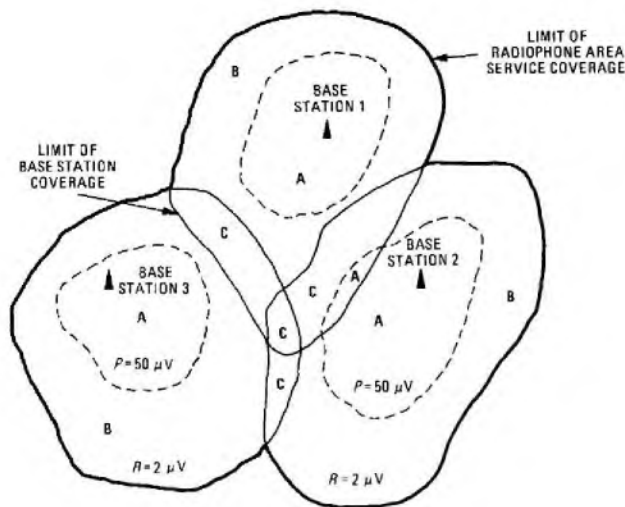

Note: In areas marked A, the mobile will select a channel with signal strength $> P$ level at the appropriate base station
 In areas marked B, the mobile will select a channel with signal strength $> R$ level but $< P$ level at the appropriate base station
 In areas marked C, the mobile will select a channel with the highest signal strength from the base stations in range

Fig. 5—Significance of P-levels and R-levels for channel selection in a generalized 3-base-station Radiophone area

The transmitter output power of the 10-channel mobile is about 10 W and this has been increased to 20 W on the 55-channel mobile. This 3 dB increase in power gives improved reliability of signal reception for the network customer, once a channel has been selected and communication established.

The maximum time taken for the mobile to complete a search through the 54 traffic channels is specified as 10 s. One 55-channel mobile equipment developed for the service uses a monitor period of about 40 ms on each channel in turn, to check for the presence of the carrier. If the carrier is present at a signal strength above the R-level, the monitor period is extended by a further 120 ms to allow sufficient time to check for the presence of the marking signal and to measure the actual signal strength of the carrier. If the marking signal is present, the appropriate action is taken by the mobile, before moving on to the next channel in the sequence. A full search over 54 channels can be completed in less than 2.5 s if the service is lightly loaded and, if the service is heavily loaded, can still be completed in less than 9 s.

IMPROVED CLEARDOWN ARRANGEMENTS

A parameter of the 10-channel mobile that has caused problems is that the *call* and *clear* supervisory signals are identical, both being a 750 ms burst of 2.4 kHz modulation on the mobile transmit carrier. When a 10-channel mobile is out of range of the base-station traffic-channel carrier, the selected channel appears to be free because carrier is not detected. If the mobile user then attempts to originate a call into the Radiophone exchange and the channel is in fact busy, the transmitted *call* signal can, in some circumstances, be received at the base station. The *call* signal then appears to the controlling operator as a false *clear* supervisory signal. A supervisory signal different from the *call* signal has therefore been specified for the *clear* signal of the 55-channel mobile, comprising a simultaneous transmission of 2.4 kHz and 2.6 kHz, the latter tone being the present *respond* signal. This is a small variation from the requirement to use the existing system interface, since it has meant only minor changes to the signal detection needs of the Radiophone exchange.

Another feature of the 10-channel mobile that can cause false supervisory signals to be presented to the controlling

operator is that transmission of a *clear* signal is possible when the carrier is no longer detected by the mobile. This is particularly troublesome if lack of carrier is due to the operator disconnecting the channel when the distant customer clears down, but before the mobile customer clears. If the channel is free when the *clear* signal is finally sent by the mobile, this appears as a false *call* supervisory to the operator. If the channel has been busied by another mobile in the meantime, the *clear* signal appears as a false *clear* supervisory signal to the operator.

To overcome this problem, a timeout is incorporated in the 55-channel mobile so that, if no carrier is detected for a period exceeding 10 s, the mobile receiver output and the mobile transmitter is completely inhibited. This inhibit condition remains operative until the handset is replaced in its rest, preventing both the mobile user from overhearing a subsequent call and the mobile from sending an unwanted *clear* signal.

SUMMARY OF IMPROVEMENTS

The 55-channel mobile offers the user the following improvements over the facilities of the 10-channel mobile:

(a) *Simplified Operating Procedure* With the introduction of automatic channel-selection and calling, it is necessary only to lift the handset from its rest and wait for the mobile to set up the connexion with the Radiophone switchboard, instead of searching manually for a free channel and then calling the exchange by depressing a CALL button.

(b) *Secure Channel Selection* The mobile uses handshaking principles to set up a connexion on a traffic channel, instead of relying on absence of carrier to indicate a free channel.

(c) *Full Channel Availability* As it has access to all 55 channels, the new mobile is more likely to be able to access a free channel under heavy traffic loading conditions and can be assured ready access to marked free channels on any System 3 Radiophone service.

(d) *Better Bothway Communication* Because the channel with the greatest signal strength is selected and because the mobile transmitter power is greater than that of the 10-channel mobile, bothway communication is improved with the 55-channel mobile.

(e) *Selection of Required Radiophone Area* A suitable free channel is selected in the required Radiophone area by setting the MARKING SIGNAL SELECTION control.

The benefits to the service in general are as follows:

(a) *Better Channel Utilization* The ability to achieve better distribution of the traffic load under busy conditions means that service capacity can be increased. It is also possible to extend the service on a gradual basis to meet the traffic loading of each base station, instead of on a block basis for each Radiophone area as a new group of channels is introduced.

(b) *Reduced Possibility of Overhearing* The introduction of the 10 s timeout reduces the possibility of overhearing when using the 55-channel mobile.

(c) *Reduced Possibility of False Supervisory Signals* The possibility of false supervisory signals being presented to the operator is reduced by: the introduction of the 2-tone *clear* signal, to distinguish it from the *call* signal; the inhibit condition to prevent transmission of a *clear* signal when no carrier is present for 10 s; and the use of handshaking principles for verification of connexion to the exchange.

CONCLUSIONS

After gaining type-approval in 1976, production was started and the 55-channel mobile was introduced in June 1977 in the London, South Lancashire and Midlands Radiophone areas. Because of the more modern technology used, including the use of the synthesizer, the overall size of the equipment



FIG. 6—Comparison of size of 10-channel and 55-channel mobiles

is reduced compared with the 10-channel mobile (see Fig. 6).

Within 12 months of the introduction of the new mobile, over 500 had been licensed for customers' use in London alone. Because of the full-channel availability of this mobile, it has been possible to extend the capacity of the London Radiophone service from 3000 to 3600 customers. By 1979, it is intended that all Radiophone areas will be equipped with the facilities needed to allow access to 55-channel mobiles. This should then encourage a considerable increase in the numbers of these mobiles licensed nationally.

FUTURE DEVELOPMENTS

The London Radiophone service has already used all available frequency spectrum; that is, all 55 radio channels on a 25 kHz channelling basis. The maximum number of mobiles capable of being carried by these channels with the present mixture of 10-channel and 55-channel mobiles is 3600. This was reached in October 1978 (account being taken of customers waiting for their mobile equipment to be installed) and necessitated closure of the London service to new customers. To satisfy further customer demand, plans to increase the utilization of the present frequency spectrum by changing from 25 kHz channelling to 12.5 kHz channelling are being considered for London, thus effectively doubling the capacity.

References

- ¹ HYATT, J. L. The London Radiophone Service. *POEEJ*, Vol. 59, p. 98, July 1966.
- ² LINNEY, P. J. An Improved Radiophone Service for London. *POEEJ*, Vol. 65, p. 98, July 1972.
- ³ ARMAN, L. T., and MELLER, V. C. The South Lancashire Radiophone Service. *POEEJ*, Vol. 52, p. 253, Jan. 1960.

Use of Single-Channel-per-Carrier Terminal Equipment at Satellite System Earth Stations

S. A. FOULKES and A. J. KEANE., C.ENG., M.I.E.R.E.†

UDC 621.396.946: 621.396.721

The use of standard frequency-division-multiplex/frequency-modulated carriers for the majority of the traffic routes operated via INTELSAT satellites is satisfactory except for those routes on which only a few channels are required. In such cases, the system is inefficient in its use of satellite power and bandwidth, and costly in terms of the equipment required at the earth stations. The article describes a single-channel-per-carrier equipment which obviates these disadvantages.

INTRODUCTION

The majority of telephone traffic routed to and from the UK via INTELSAT satellites is assembled in blocks of frequency-division-multiplex (FDM) channels, which are frequency modulated (FM) on carriers. The circuit capacity of carriers available at present is from 12–1872 telephone channels in bandwidths of 1.25–36 MHz respectively. Each earth station transmits one or more carriers, on which all outgoing telephone channels are assembled; incoming channels are derived from a carrier received from each of the earth stations to which a communications link is established. Using this system, the cost per telephone channel is greater for small capacity carriers because the cost of the earth-station equipment required to transmit or receive a 12-channel carrier is not much less than that required to transmit or receive much larger capacity carriers. The effective cost per channel is further increased when all the channels on a carrier are not used (that is, when the carrier is not fully loaded). In practice, the FDM/FM system is inefficient for earth stations that require only a few circuits, perhaps just a single circuit in the case of

some countries. In this situation, not only is the per-channel capital cost of the earth-station equipment high, but the satellite is also used inefficiently because the allocated bandwidth for the carrier is greater than is needed.

The cost penalty for lightly-loaded routes has already been reduced by the introduction, in the Atlantic Ocean region, of a system that enables earth stations to share a pool of satellite circuits. In this system, known as *single-channel-per-carrier pulse-code-modulation multiple-access demand-assignment equipment* (SPADE),* each telephone channel is modulated on a separate carrier frequency, which is assigned on demand to provide a connexion only for the duration of the call. Cost savings are achieved because much of the equipment is common to all channels in each SPADE terminal, and additional circuits to any country in the network can be introduced at relatively low cost. However, the SPADE system is rather complex and this, together with its high initial capital cost, deters many smaller countries from adopting it. A simpler system, the single-channel-per-carrier (SCPC) system, has been developed; this system is similar to SPADE,

† Telecommunications Development Department, Telecommunications Headquarters

* HALL, G. C. Single-Channel-per-Carrier Pulse-Code-Modulation Multiple-Access Demand-Assignment Equipment (SPADE) for Satellite Communications. *POEEJ*, Vol. 65, p. 42, Apr. 1974.

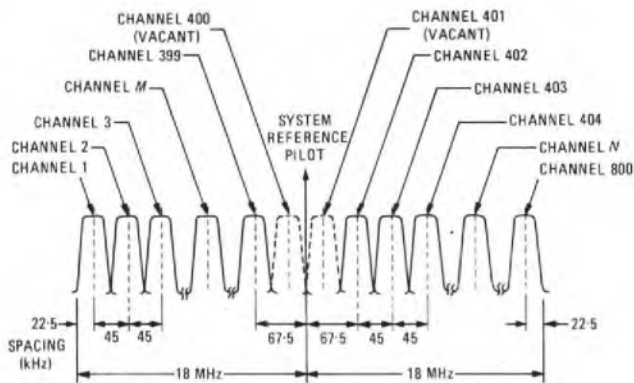
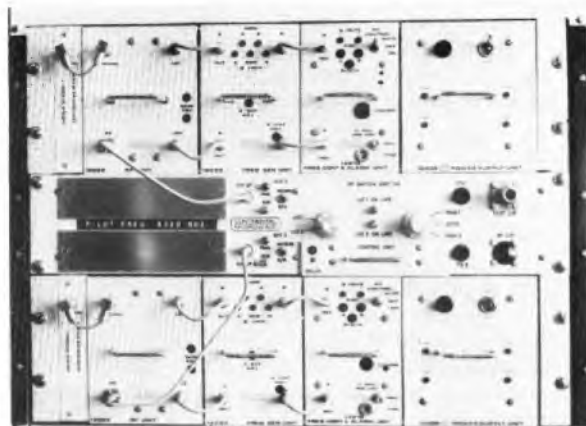

FIG. 1—SCPC frequency plan for full transponder operation



(a) Up-converters



FIG. 2—The SCPC terminal equipment

but it provides pre-assigned, rather than demand-assigned, circuits. Therefore, the requirement for processor control is eliminated and the complexity of the system is greatly reduced. This article describes the SCPC system and, in particular, the equipment which has been supplied by Digital Communications, USA and installed at the British Post Office (BPO) satellite earth stations at Goonhilly Downs in Cornwall, and at Madley in Herefordshire.

THE SCPC SYSTEM

The INTELSAT IVA satellites, to which aerials at both Goonhilly and Madley earth stations currently operate, comprise a number of transponders, each with a usable bandwidth of 36 MHz. Each transponder receives carriers transmitted from earth terminals at frequencies in the 6 GHz band; after amplification and frequency translation, the carriers are retransmitted to earth in the 4 GHz band. One transponder is allocated to the SCPC system; the 36 MHz bandwidth is divided into 45 kHz slots, each slot corresponding to a single one-way channel. Thus, if the total transponder bandwidth is used, 800 channels can be accommodated (see Fig. 1). In practice, to prevent mutual interference with the mid-band system pilot the 2 centre channels are not used, thus the number of available telephone channels is reduced to 798. If traffic does not warrant the allocation of the whole 36 MHz transponder bandwidth to the SCPC service, the unoccupied part of the transponder bandwidth can be used for other services.

Each earth station in the SCPC system has a set of terminal equipment (see Fig. 2) that comprises channel units, common equipment, and frequency up-converters and down-converters (see Fig. 3). In the transmit direction, each channel unit converts an analogue voice signal into a digital code, which

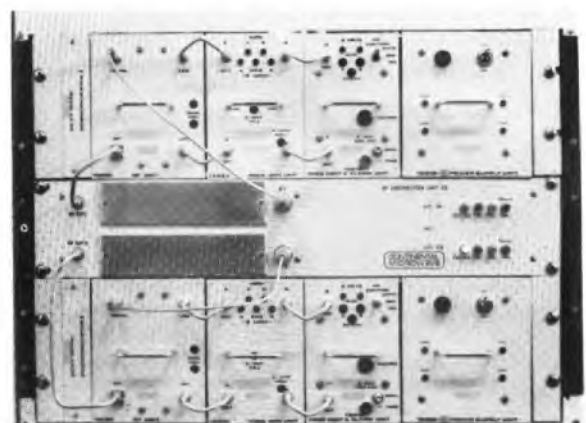

(b) Down-converters

FIG. 3—Frequency converters

is combined with synchronization data from a transmit synchronizer, and modulates the composite signal on a 46 MHz carrier. This carrier is controlled by a voice-activated switch, which allows the carrier to be transmitted only when speech is present. In this way, a considerable saving of earth station output power is achieved and, even more important, satellite output power is conserved. The 46 MHz carrier is mixed with the output of a pre-set frequency synthesizer to convert the frequency of the carrier to the required position in the intermediate-frequency (IF) band of 70 ± 18 MHz.

In the receive direction, the process is reversed; the carrier is changed in the IF sub-system from an IF in the 70 MHz band to an IF in the 46 MHz band. The carrier is then converted to a frequency of 24.012 MHz by mixing it with the output of a pre-set frequency synthesizer prior to demodulation and decoding. Any SCPC carrier frequency can be pre-assigned to transmit or receive information and, unlike the SPADE system, there is no necessity for a fixed frequency separation between the transmit and receive channels of a particular circuit.

The SCPC equipment uses common oscillators and amplifiers which are shared by all the channel units in the terminal and, since failure of any part of this equipment would cause a disruption of service, full redundancy is provided. Equipment is also provided to combine the outputs of all the individual channel units into one path and to present each channel-unit input with the complete receive spectrum.

The output from the SCPC terminal, which consists of individual carriers in the range 70 ± 18 MHz, passes to an up-converter, which translates the frequency of these carriers into the 6 GHz band for transmission to the satellite. The receive system reverses this process and, in addition, carries out the automatic frequency-control (AFC) and automatic gain-control (AGC) functions.

One earth station in the SCPC network transmits a reference pilot, which is used by all earth stations in the SCPC network for AFC and AGC of the received carriers. Two earth stations have facilities for generating this pilot and, in the event of a pilot failure at the nominated reference station, the second earth station takes over the role of generating the pilot. Pilot restoration is not automatic, and so failure may lead to a short interruption of service.

Since the analogue voice signal is digitally encoded prior to modulation at a rate of 64 kbit/s, the SCPC system is easily adaptable for the transmission and reception of medium-speed data. This mode of operation permits standard data channels (at input rates of 48 and 50 kbit/s) to be carried and, after the addition of an error-correcting code, these are transmitted at a rate of 64 or 66.66 kbit/s respectively. (Data rates of 56 kbit/s can also be conveyed using a less powerful error-correcting code but, at present, the BPO does not operate such circuits via SCPC.)

THE SCPC EQUIPMENT

This article has discussed the advantages of SCPC over FDM/FM for low-capacity routes and has described the

SCPC network in general terms. The sections which follow cover, in more detail, the working of some of the equipment used in a typical SCPC terminal; a block diagram of an SCPC terminal is given in Fig. 4. The equipment described is that in use at the BPO Goonhilly and Madley earth stations. Other administrations may use SCPC equipment obtained from different manufacturers than the BPO, but the principles of operation are the same.

The Channel Unit

As already mentioned, an SCPC channel can be used for conveying either voice or data and it is usual for an SCPC terminal to be provided with channel units of both types, using one set of common equipment. Two channel units, each providing the transmit and receive functions of a particular circuit, are housed in a single shelf and each channel rack in an SCPC terminal has facilities to accommodate up to 8 shelves. The voice-channel unit comprises the following units: a pulse-code-modulation (PCM) encoder and decoder; transmit and receive synchronizers; PSK modulator and demodulator; and transmit and receive frequency synthesizers.

SCPC Transmit Equipment

In the transmit direction, the analogue voice signal (frequency range 300–3400 Hz) is fed into a PCM codec where, in a 7 bit A-law encoder, it is converted into a 56 kbit/s digital stream and forwarded to the transmit synchronizer. In the transmit synchronizer, the digital stream is fed in parallel to

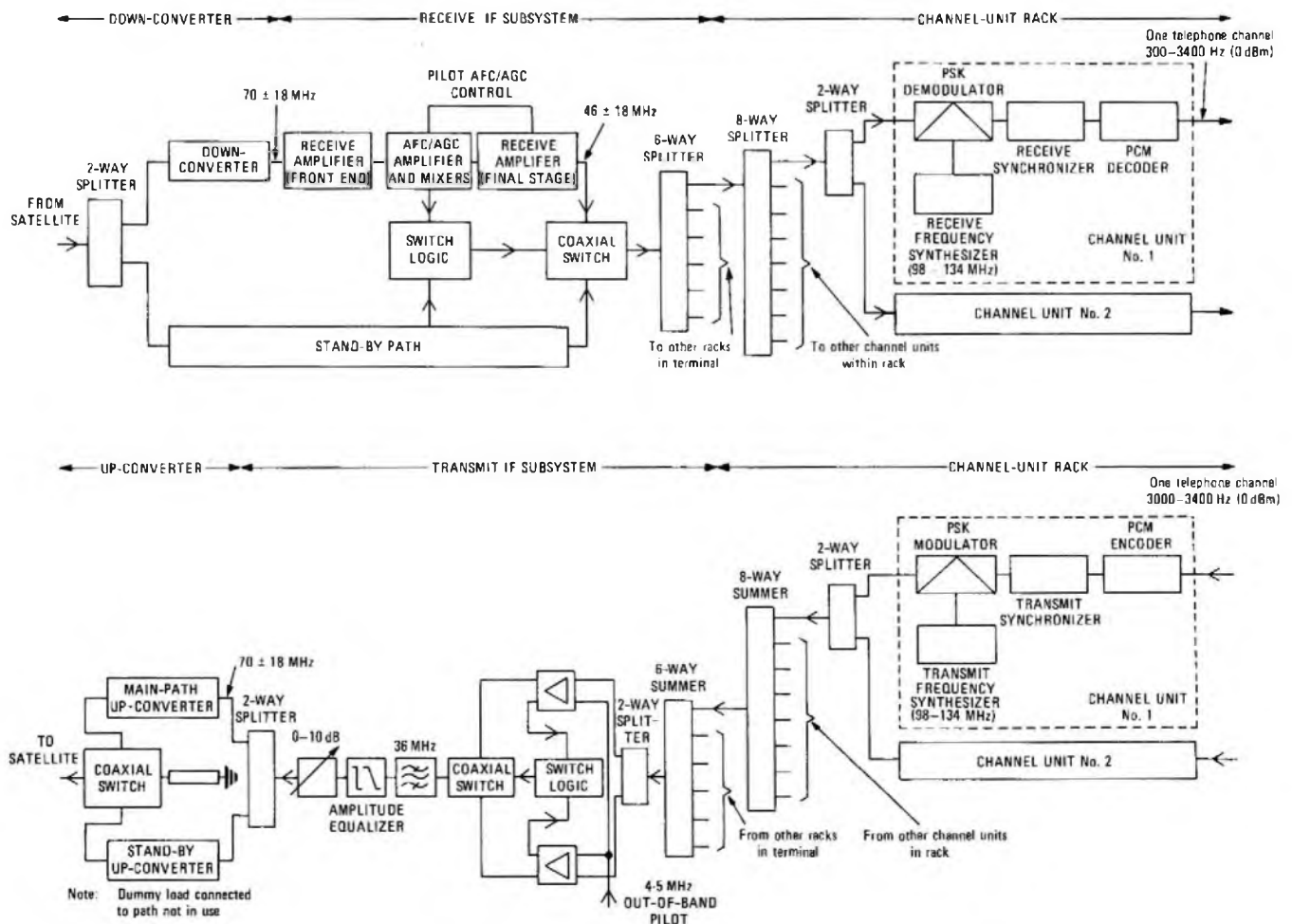

FIG. 4—Block diagram of a typical SCPC terminal

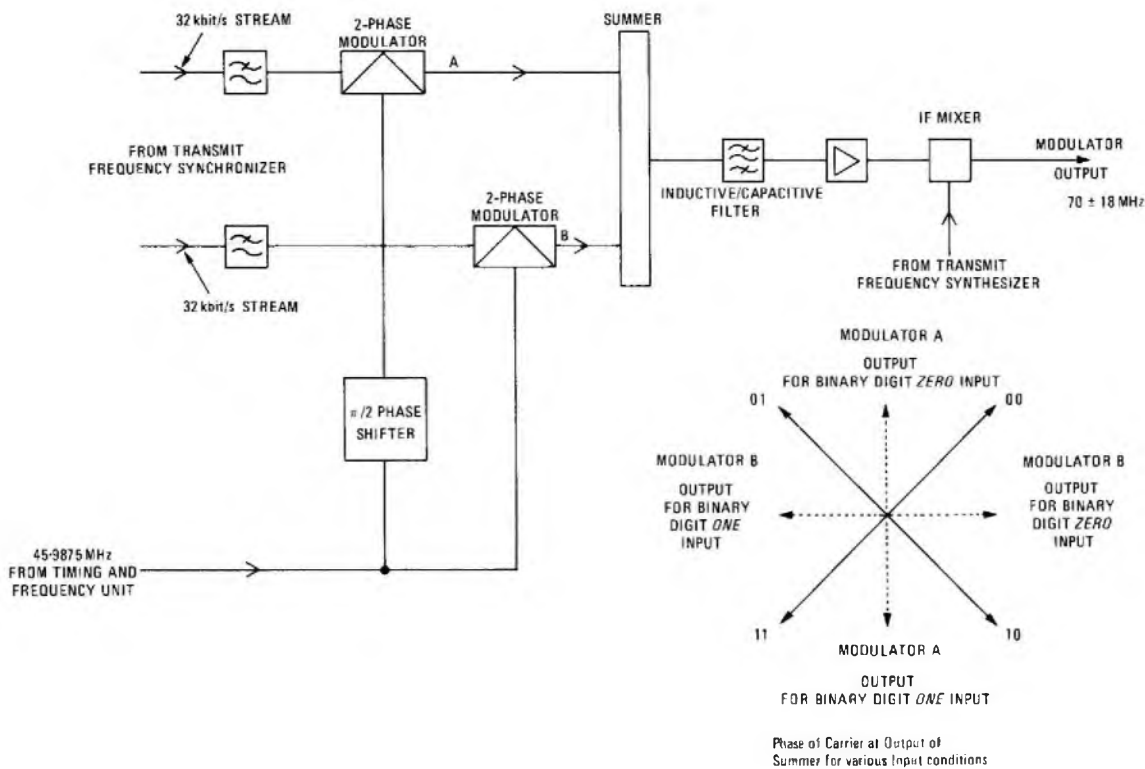

FIG. 5—Block diagram of a 4-phase modulator

a speech detector, which controls a voice-activated switch, and to a delay line in the main speech path, which delays the speech for a fixed period. This delay prevents speech-clipping by the voice-activated switch and enables a 60 bit preamble sequence, which aids carrier and clock recovery in the demodulator, to be injected in front of the digital-encoded speech.

The transmit synchronizer also injects two 16 bit synchronization words into the digital stream every 4 ms. These *start-of-message* words are used at the receive terminal of the SCPC system to provide PCM frame synchronization and to resolve phase ambiguities in the recovered 4-phase PSK carrier. The combination of the *start-of-message* words with the 56 kbit/s preamble and the voice data results in an output rate of 64 kbit/s, which is forwarded to the PSK modulator as 2 parallel 32 kbit/s streams.

To produce the 4-phase PSK modulated carrier, the 2 digital streams are clocked alternately into separate 2-phase modulators, which are driven by quadrature components of the 46 MHz carrier frequency (see Fig. 5). Depending on the particular combination of bits present at any given instant at the inputs to the 2-phase modulators, the outputs, when linearly summed, assume one of the 4 possible states, as shown in Fig. 5. A simple inductive-capacitive filter is used to suppress harmonics generated during the PSK modulation process, and the 46 MHz PSK carrier is then mixed with a signal from the transmit frequency synthesizer (in the range 98–134 MHz) to generate one of the possible 798 channel IFs in the range 70 ± 18 MHz. Before being taken to the IF subsystem, the output of the PSK modulator is summed with all the other PSK modulator outputs from the same rack.

SCPC Receive Equipment

The receive channel unit is used to receive and demodulate the incoming signals and, basically, the process of the transmit unit is reversed. The complete receive spectrum, which appears from the IF subsystem in the range $46 \pm$

18 MHz, is fed to each channel unit and mixed with the output of the receive synthesizer, whose frequency is set to down-convert the required carrier to 24.012 MHz. This signal is then mixed with the output of a 23.5 MHz crystal-controlled oscillator to produce a 512 kHz carrier, which is passed via a 38 kHz bandpass filter to the PSK demodulator.

The PSK demodulator demodulates the carrier to produce 2 parallel 32 kbit/s streams and, at the same time, recovers a reference timing-signal which ensures that both the transmit and receive earth-stations are processing the digital streams at the same rate. Following demodulation, the synchronization data provided by the transmitting earth-station is removed in the receive synchronizer, this data having been used in this unit to remove any phase or interleaving ambiguity from the received digital streams. The reassembled voice-data and associated timing signals are then passed to the PCM codec (decoder section) where the digital encoding process is reversed to produce an analogue signal in the range 300–3400 Hz.

Medium-Speed Data Transmission

To convert the channel unit to the medium-speed data mode of transmission (48 or 50 kbit/s), the transmit and receive synchronizer units are removed, and the PCM codec is replaced by a data codec and an interface module. The interface module provides the correct impedance and levels to match data modems having interface parameters in accordance with CCITT† Recommendation V35. The interface module also includes a scrambler/descrambler using a 20 bit shift register and half-adder to ensure that data transitions appear at the data codec input under all conditions.

At Goonhilly and Madley, each data-channel interface module is connected to a BPO Modem No. 8, which scrambles and band restricts the digital data signals received from the SCPC terminal. A BPO Modem No. 9 is then used to trans-

† CCITT—International Telegraph and Telephone Consultative Committee

late the data to the basic group frequency band (60–108 kHz) for transmission over the terrestrial link. This process is reversed for the transmit direction through the SCPC terminal.

The data codec (encoder section) receives a scrambled digital data stream at 48 or 50 kbit/s from the interface module. This is fed into a 3 bit shift register which is latched every third digit to produce 3 parallel digital streams, each at one-third of the shift register input rate. The parallel data streams are clocked into a parity generator which generates parity bits, also at one-third of the bit rate at the shift register input. The 3 data streams, together with the parity digital stream, are recombined in a digital commutator to produce 2 data streams at the PSK modulator input, each at two-thirds of the encoder input binary digit rate. Since the encoder input digit rate is three-quarters of the total digit rate at the encoder output (that is, for a 48 kbit/s data input the digit rate at the PSK modulator input is 64 kbit/s), the unit is referred to as a *three-quarter rate codec*. Data transmissions at 56 kbit/s can be accommodated using a seven-eighth rate codec, again producing an output of 64 kbit/s.

In the receive section of the data codec, the inherent phase ambiguity of the quadrature PSK signal is resolved and the decoder receives 4 parallel data streams, each at one-quarter of the 64 kbit/s received data rate. Three of the four digital streams are clocked into 21 bit shift registers; the fourth (parity) digital stream is compared with parity check outputs from these shift registers. Correction pulses are generated for erroneous data bits and the corrected data sequences are recombined and passed to the interface module for descrambling and interfacing with the BPO modems. This forward-error-correcting system ensures an output digit error rate of better than 1 in 10^7 , at a threshold corresponding to an uncorrected error rate of 1 in 10^4 .

The SCPC Terminal Common-Equipment

The equipment described above modulates and demodulates the analogue voice signals or the data signals and converts them to or from a particular position in the IF bands. The remaining common equipment can be divided into 2 sections: the IF subsystem, which performs various operations on the IF spectrum; and the timing and frequency unit, which generates the reference frequencies used throughout the system.

The functions of the IF subsystem are summarized as

- (a) combining the outputs from the channel-unit racks (and the 70 MHz pilot if required) into a single radio-frequency spectrum centred on 70 MHz, (the terminals installed at Goonhilly and Madley have a maximum capacity of 96 channels),
- (b) accepting a received spectrum containing many individual carriers and a reference pilot centred on 70 MHz, and frequency translating the spectrum to a band centred on 46 MHz before distribution to each channel unit rack, and
- (c) providing AFC and AGC of the received spectrum, using the received pilot signal as a reference.

In the transmit direction, (see Fig. 4) the SCPC spectrum centred on 70 MHz is split into 2 paths which feed 2 amplifiers to provide full redundancy for the only active element in the transmit IF subsystem. The signal is amplified and combined with a 4.5 MHz out-of-band reference signal, the sole purpose of which is to monitor the status of the amplifiers. If this signal is not detected at the output of the amplifier in use, a changeover to the stand-by amplifier is initiated. The amplified signal passes through a 36 MHz bandpass filter where unwanted out-of-band signals are rejected, and to an amplitude equalizer which levels the transmit spectrum across the band to ensure that all channels are transmitted at the same power. A variable 0–10 dB attenuator is provided which enables the output level of the transmit spectrum to be adjusted before

it is again split into 2 paths and fed to separate up-converters, which are configured in a redundant mode of operation.

In the receive direction, each of 2 down-converters feeds an independent receive IF subsystem. Full redundancy is provided by using a failure-detection circuit to initiate switch-over if the system pilot is not detected in the on-line transmission path but is present in the stand-by path. Each path provides an AFC and AGC loop. The operation of the AFC in the IF subsystem involves 2 mixing processes which results in the centre frequency of the received SCPC spectrum being translated from 70 MHz to 46 MHz. The AFC loop has a pull-in range of ± 40 kHz and centres the received spectrum on the system pilot; the AFC is designed to operate without disruption in the event of a system pilot failure lasting up to 4 s. The AGC loop operates over a dynamic range of 14 dB and uses the system pilot power level as a reference. The outputs of 2 independent receive IF subsystems, centred on 46 MHz, are fed to a coaxial switch, which is controlled by the failure-detection circuit, and thence to a divider network for distribution to the channel unit racks.

Up-Converters and Down-Converters

The up-converters and down-converters are basically frequency translators: the up-converter is used in the transmit direction to translate the IF spectrum centred on 70 MHz to a similar spectrum centred on a frequency in the 6 GHz transmit band; the down-converter is used in the receive direction to translate the spectrum of carriers centred on a frequency in the 4 GHz region, received from the satellite, to a similar spectrum centred on 70 MHz. The up-converters and down-converters are identical to those used with FM/FDM carriers except that, since the frequency band being translated comprises many individual carriers spaced only 45 kHz apart, they operate to more stringent frequency stability limits. For example, in the transmit direction, the maximum carrier frequency variation that can be tolerated is 250 Hz, whereas for FDM/FM carriers, variations in excess of 80 kHz are permissible. Dependent on traffic requirements, the full 36 MHz transponder bandwidth may not be used, so a filter is included in the up-converter to prevent any unwanted transmissions outside the bandwidth allocated to the SCPC carrier.

CONCLUSION

Single-channel-per-carrier equipment has been installed and successfully brought into operation in the BPO satellite earth stations at Goonhilly and Madley. These large BPO Standard A type earth stations, employing aerial reflectors having diameters of about 30 m, also use FDM/FM carriers efficiently to carry heavy international traffic streams between main communication centres. However, in recent years, the need has been recognized for developing countries to satisfy their small international traffic needs via communication satellites, and an increasing number of Standard B type earth stations, typically having aerial diameters of about 12 m, are being allowed to operate to INTELSAT satellites. To achieve compatibility between Standard A and Standard B stations and to make the most efficient use of satellite bandwidth and power, it has been made mandatory for the small Standard B earth stations to use only SCPC/PSK or SCPC/PCM/PSK transmissions.

For the small capacity user, the cost advantage of SCPC transmissions compared with that of FDM/FM systems, and the equipment simplicity compared with SPADE, makes SCPC operation particularly attractive. As more Standard B earth stations access the INTELSAT system, there is no doubt that the use of SCPC equipment in both Standard A and Standard B earth stations will considerably increase.

STEMSS: Satellite Telegraph Engineering and Management Switching System

P. A. CARRUTHERS, B.TECH., S. L. BIGGS and R. G. K. GORVIN†

UDC 621.396.946: 621.394.34

This article describes equipment developed by the British Post Office to meet the switching requirements of the international telegraph engineering service network used for the control of the satellite communication links provided by aeriels 1 and 2 at the Madley earth station.

INTRODUCTION

The engineering service circuits for satellite communication links form a private network over which all earth stations working to a particular satellite can communicate. The network, which comprises telephony and telegraph systems, is used for the interchange of information relating to system management and performance statistics. This article describes the functions of the satellite telegraph engineering and management switching system (STEMSS), which has been developed by the British Post Office (BPO) for use at the Madley earth station.

The telegraph system, which operates with a modulation rate of 50 bauds and uses the International Alphabet No. 2, has a traffic capacity of 15 erlangs.

To conserve channel capacity, a shared send-path system is used, in which each earth station normally has a dedicated receive circuit, but has several earth station destinations on each send path. This is illustrated in Fig. 1. The signalling system is based on CCITT* Recommendation U1, with the addition of a message header to indicate the station required.

A block diagram of the STEMSS engineering service circuits at Madley and the interconnexion arrangements between the Madley and Goonhilly earth stations is shown in Fig. 2. In addition to the teleprinter circuits between the earth stations, unidirectional trunk circuits are used for the interworking arrangements between the 2 stations.

† Telecommunications Development Department, Telecommunications Headquarters

* International Telegraph and Telephone Consultative Committee

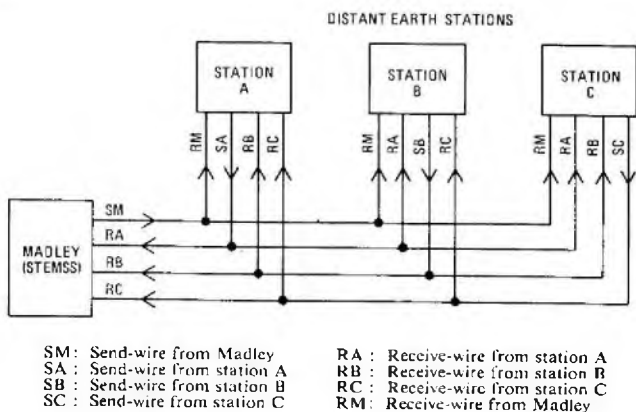

Fig. 1—Shared send-wire working

FACILITIES

The STEMSS equipment is provided with 108 ports, which can be connected to satellite routes, to trunks to Goonhilly, or to teleprinter ports which can provide a variety of functions. Basically, the system operates as a concentrator in which one of many engineering service circuits routed on satellite links can be connected to a small number of teleprinters or trunk routes.

Outgoing calls can be originated from any of the teleprinters at Madley or Goonhilly to any other teleprinter extension, or to any satellite station. To give the necessary system flexibility, circuit routing information is stored in a 'look-up' table, which can be amended using a system teleprinter.

Fifteen simultaneous calls are possible on the system. The earth-station or route selection codes received at Madley are decoded, and only the codes *MDMD*, *GHGH* and *RRRR* are accepted as valid calls to be processed. All other codes are rejected. The circuit receive-wire (R-wire) port number is given a *busy* status and the connecting circuit is released to accept the next call.

Calls having the selection code *MDMD* are routed to the first of 3 teleprinters (termed an *A type* teleprinter) that is free; such calls are answered manually by operating staff at Madley. An operator can connect additional teleprinters at Madley or Goonhilly, or other satellite routes, up to a maximum of 4 ports, to form a conference call. Calls can be transferred from an *A type* teleprinter to one designated a *B type* for fault clearing and maintenance purposes. Calls having the code *GHGH* are routed automatically to Goonhilly over tie circuits connected to teleprinters (termed *B + type*) which are situated in the telecommunications operational control centre (TOCC). Calls received at Madley which bear the selection code *RRRR* are routed via tie circuits to Goonhilly, where they are re-routed to the Atlantic Ocean region satellite link.

As the Madley earth-station does not have an operating staff on duty at night, a facility is provided on the STEMSS rack where, by operating a key, calls for Madley (code *MDMD*) are re-routed to an *A + type* teleprinter at Goonhilly. An *A type* teleprinter at Madley operates as a monitor during the call and provides a copy of any messages passed.

SWITCHING PRINCIPLES

The STEMSS switch operates in a fully element-by-element regenerative manner, using the time-division principle. A frame of 1.25 ms duration is used, the frame being divided into fifteen 62.5 μs time slots and one 312.5 μs time slot. The frame format is shown in Fig. 3. A central-processor instruction cycle time of 0.5 μs allows 119 instructions to be executed in a 62.5 μs time-slot, and 618 in the 312.5 μs time-slot.

The first 15 time-slots are used as connecting circuits, thus

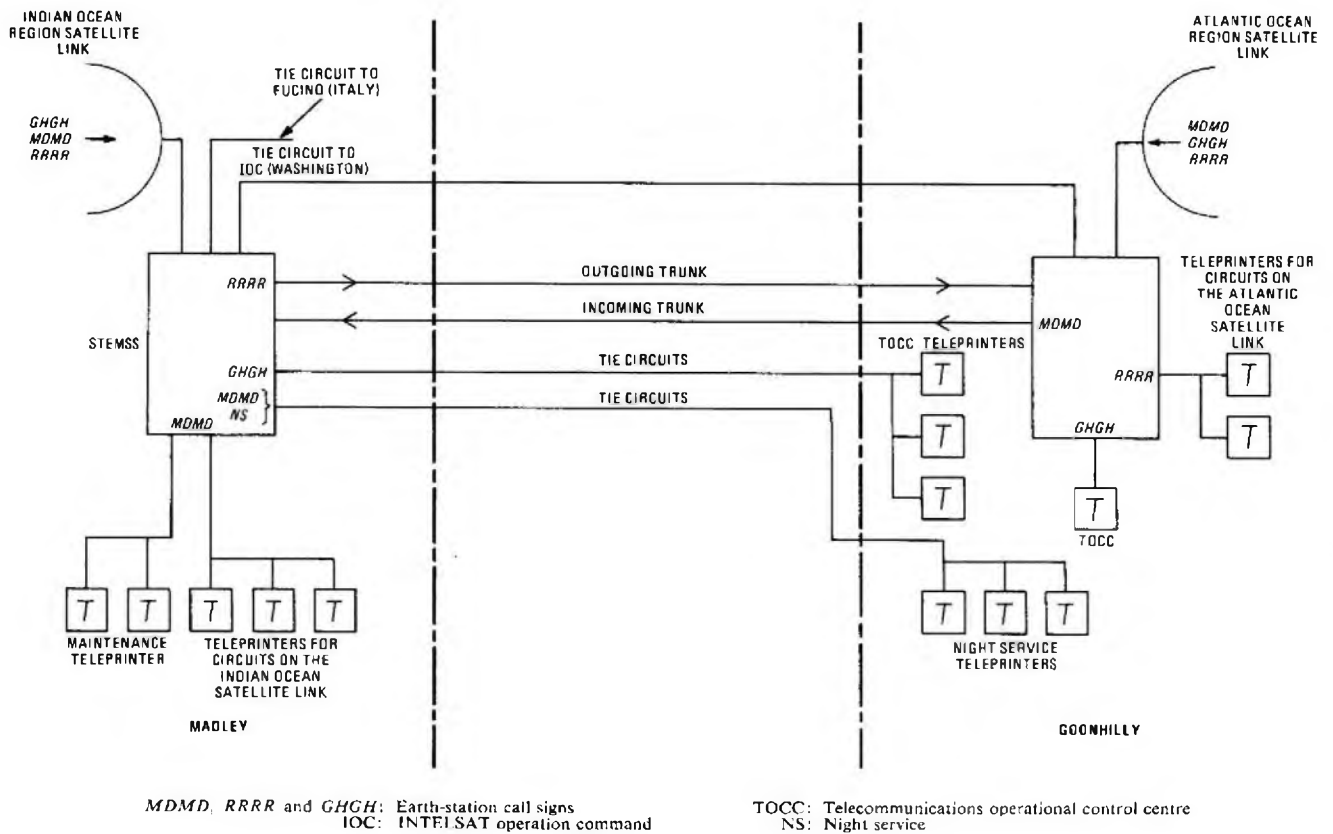

FIG. 2—Block diagram of engineering service circuit arrangement

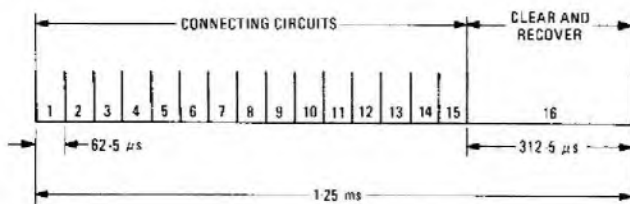

FIG. 3—Frame format

allowing 15 simultaneous calls to be established. Each connecting circuit is capable of processing a call and has a 16-word page of random-access memory (RAM) associated with it. Each connecting circuit has access to all normal programs, which are stored in common read-only-memory (ROM) storage; when a connecting circuit is not in use, a scan program is run which scans all ports in search of a call. The page of RAM associated with each time-slot is used for storing transient information relating to the call being processed; for example, the program page and counter settings which indicate the point at which the program will continue in the next time frame, and the port address of parties on the call.

The 312.5 μs time-slot is used for the clearing of completed calls established by other time-slots and for the recovery of the system under transient fault or power-failure conditions.

The change-over from time-slot to time-slot and frame-to-frame is synchronized using clock pulses from the central processing unit (CPU). The time-slots are counted using a register; this register is used to address the associated page of RAM.

The time-division concept results, effectively, in there being 16 independent processors running in parallel although, in reality, each shares the same program and CPU resources.

PORT NUMBERING AND STATUS ALLOCATION

An 8 bit port-address field is used; this gives a theoretical maximum of 256 different ports. In practice, however, only 108 ports are used. To simplify decoding, the numbering range is sub-divided on the basis of port type; the division is shown in Table 1. Each port consists of a send (S) and receive (R) wire but, as many satellite routes share the same S-wire, the S-wire number refers to the R-wire port number with which it forms a physical pair.

Each port has associated with it, on a distributed basis, a 4 bit word of RAM, which is used to indicate the port status. The status indicates whether a port is *busy* or *free*, and is used for the timing of clearing conditions and recovery. The time-slot processing the call sets the initial status, which is then monitored and processed by the clearing time-slot. The various status words and their functions are shown in Table 2. The status of an S-wire is ascertained by checking the status of its associated R-wires.

TABLE 1
Port Numbering Scheme

Port Number	Designation
0000 XXXX	Multiple-input satellite routes
0XXX XXXX	Satellite routes
1000 XXXX	A + type teleprinter circuits
1001 XXXX	A type teleprinter circuits
1010 XXXX	B type teleprinter circuits
1011 XXXX	B + type teleprinter circuits
1100 XXXX	Incoming trunks
1101 XXXX	Outgoing trunks
1110 XXXX	Spare
1111 XXXX	Port not in use

Notes: The lower 4 bit indicate the port numbers 1-16.
An X indicates that the binary state is not significant to the numbering scheme.

The 4 bit status word forms the lower half of an 8 bit data stream used for transmitting information to and from the line interface units. The upper 4 bit are used for indicating or setting the line condition. The allocation of the upper 4 bit is shown in Table 3.

TABLE 2
Status Allocation

Status Code	Status Code Function	Status Word
Spare	Spare	0 0 0 0
BAT	<i>Busy after 30 s.</i> These 3 status words are used to operate a 30 s timer. The status is incremented to the <i>BFT</i> status	0 0 0 1 0 0 1 0 0 0 1 1
BFT	<i>Busy for them.</i> A call that is not for Madley results in the Madley incoming port being set to <i>BFT</i> . These 4 status words are used to time 400-600 ms of positive clearing. The port is then incremented to the <i>free</i> status	0 1 0 0 0 1 0 1 0 1 1 0 0 1 1 1
F F'	<i>Free status.</i> Indicating that a port is free; the port <i>F</i> and <i>F'</i> status are used to run a 1.6 s timer. A port with a free status and a negative potential (calling) line condition that is maintained for 1.6 s has its status set to <i>BAT</i> . This ensures that, if all connecting circuits are in use, an incoming call results in the port being set <i>BAT</i>	1 0 0 0 1 0 0 1
BFU	<i>Busy for us.</i> Calls in progress for Madley have their status set to <i>BFU</i> . The last bit of the status word alternates under the control of a clock pulse and permits automatic recovery	1 0 1 0 1 0 1 1
FAF	<i>Free after 5 s.</i> On cleardown of a call, the clearing condition is sent for 5 s before a port is set free. These 3 status words are used to operate a 5 s timer; on time-out, the port is set <i>BFT</i>	1 1 0 0 1 1 0 1 1 1 1 0
N	<i>Not used.</i> This status indicates that a port is out of service.	1 1 1 1

ROUTING TABLE

All circuit routing information and codes for satellite destinations are stored in an alterable non-volatile RAM look-up table. The look-up table is divided into 2 parts and covers 4 pages of RAM (a page of RAM comprises 256 x 8 bit bytes).

In *Look-up Table 1*, the entries are indexed under the R-wire port numbers, which range from hexadecimal (H00) to hexadecimal (H7F) (a total of 128 locations). Of these, the first 16 ports are for multiple input routes. The port number is used to address one row of locations in each of the 4 columns (pages). During an outgoing satellite-route call, columns 3 and 4 are hunted to find the destination code selected, and the port S-wire number is found by projecting back to column 1 on the same row (PC setting). If the route is a multi-input satellite route there will be more than one destination code on each R-wire, and columns 3 and 4 will contain F/S? The hunt for the destination code will then continue into *Look-Up Table 2*, where column 1 will contain the port R-wire number. This is then used to re-address *Look-Up Table 1* to find the S-wire number.

TABLE 3

Allocation of Binary Digits for the Setting or Identification of Line Conditions

R-Wire Line Condition	Register-IP Word
Earth or disconnection	0 0 1 1 XXXX
Positive potential	1 0 1 1 XXXX
Negative potential	0 1 1 1 XXXX
S-Wire Line Condition	Register-OP Word
Positive potential	1 1 1 0 XXXX
Negative potential	0 0 0 0 XXXX

Note: The lower 4 bits of each register indicate the status (see Table 2).

TABLE 4
Routing Tables

Look-Up Table 1				
Page Number	Column 1	Column 2	Column 3	Column 4
Port Number (PC Setting)	S-Wire Number	Auxiliary Word	First Satellite Character	Second Satellite Character
0000 0000	XXXX XXXX	0000 0001	F/S	?
0001 0000	XXXX XXXX	0000 0001	O	R
0111 1111	XXXX XXXX	0000 0001	R	J
Look-Up Table 2				
Page Number	Column 1	Column 2	Column 3	Column 4
PC Setting	Port Number	Auxiliary Word	First Satellite Character	Second Satellite Character
1000 0000	0000 0000	0000 0000	C	S
1000 0001	0000 0000	0000 0001	B	S

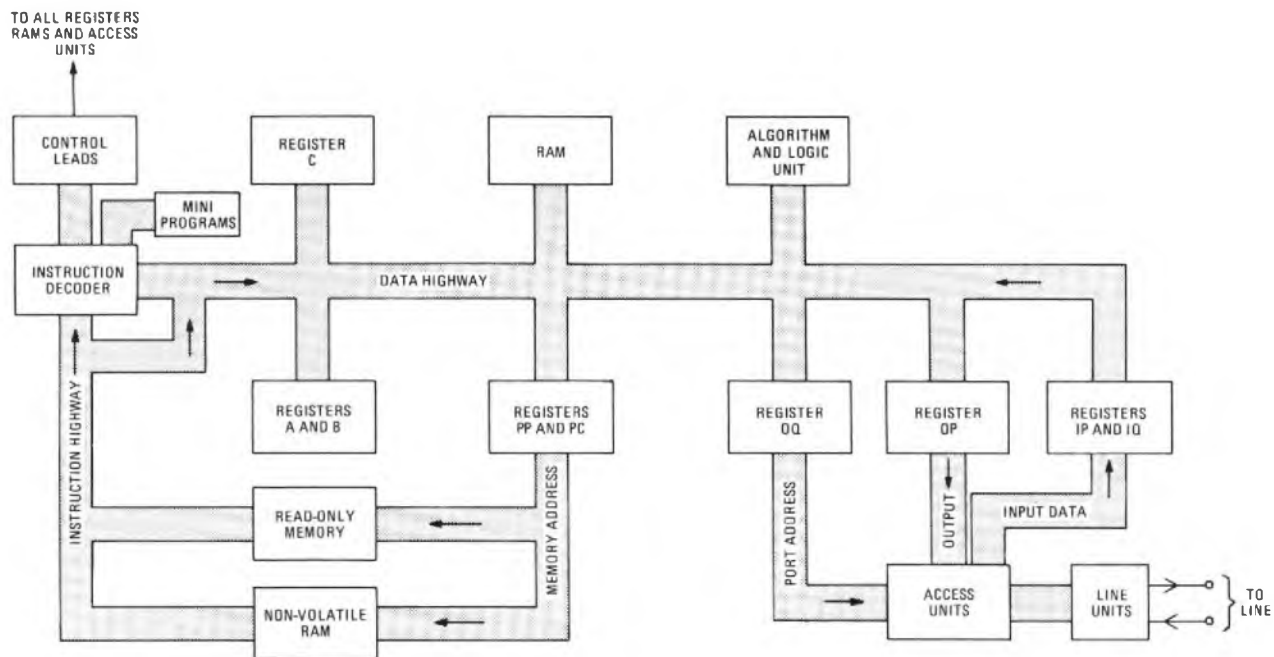

FIG. 4—Block diagram of the STEMSS architecture

SYSTEM SECURITY

It is essential that, under power failure or other fault conditions, the system restores to service without manual intervention. To achieve this objective, a combination of hardware and software techniques has been used.

The CPU is designed to ensure that, if a time-slot ends without a STOP instruction being decoded, the program-count register will reset automatically to zero. This action, coupled with a JUMP instruction (which results in a program jump if register C (see Fig. 4) addresses time-slot 16), ensures that programs are run in the correct time-slots automatically.

In a power-fail recovery situation, given normal line conditions, any status other than the status *busy for us* will eventually increment to the *free* status. Any port that is erroneously set to status *busy for us* is not as easily recovered because, to all intents and purposes, the port is busy with a call in progress. To cater for this possibility and to allow recovery to take place, 2 status words are used to indicate the status *busy for us*. These status words are held in register IQ (see Fig. 4). The bits of this register, with the exception of the last bit, are permanently strapped to binary state *zero* or *one*. The last bit is strapped to the CPU clock pulse and is changing its state continually. The contents of register IQ are loaded into the port-status store at least once every 26 s during the processing of a call. The recovery-program checks once every 26 s that the current status word *busy for us*, stored in register IQ, matches that set for the port. If it does not, then the port is recovered. The comparison is achieved using a hardware window-comparator coupled to the jump selector on the CPU. Hence, use of a conditional JUMP instruction tests if a busy port needs recovering.

STEMSS EQUIPMENT

Transmission within the STEMSS is at the 12 V level. A 4-wire circuit arrangement is used, the receive circuit being looped and provided with a metallic return path to earth at the sending end. The STEMSS equipment is mounted on a 62-type rack (see Fig. 5) and is powered by a DC-DC converter, which supplies ± 5 V logic and 12 V signalling potentials; the converter operates from the station 28 V supply.

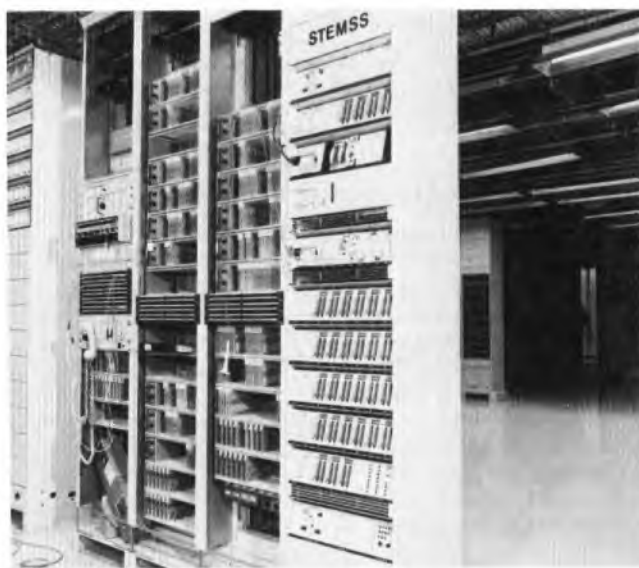

FIG. 5—STEMSS equipment

The 12 V-80 V converters used to drive the teleprinters are mounted on a rack near to the main equipment and are powered by 2 DC converters (BPO code, Converter 12A) connected in parallel; these also supply the signalling potentials for the associated telegraph systems. The teleprinters are controlled by signalling units (BPO code, TG 2388), which are private-wire units having a signalling interface that conforms to CCITT recommendation U1. These signalling units enable a break interrupt to be transmitted after a call has been established, thus enabling recall of the processor and the further processing of the call. The teleprinters used are the BPO type-15B, which operate at 50 bauds and are powered from the AC mains supply.

HARDWARE

The STEMSS hardware is centred round the BPO Telegraph Processing System No. 1, which was developed initially as a

Private Automatic Telegraph Branch Exchange. The system comprises a CPU, ROM, RAM and processor access units. For use with the STEMSS, the CPU instruction set was modified, and 2 additional hardware units developed: a complementary metal-oxide semiconductor (CMOS) non-volatile RAM unit, which enables flexible routing facilities; and a low-voltage line unit for interfacing with the 12 V transmission system. (See Acknowledgement.)

The Central Processing Unit

The central processing unit (CPU) is based on transistor-transistor logic (TTL) design that allows a fast instruction cycle time; the CPU is, essentially, an 8 bit device, the main data highway and working registers being 8 bit wide. However, when required, it can manipulate data in units of 4 bit.

The instructions are decoded by the processor in parallel form; most of the instructions are one or two bytes in length. Some instructions give rise to several micro-instructions, which are known as *mini-programs*. Mini-programs are executed under the control of a separate program counter, and the instructions are stored in ROMs within the CPU. Mini-programs are used for performing tasks of a simple but repetitive nature, and they have a maximum length of 16 instructions.

The 8 bit byte format accommodates a maximum of 256 different instructions, the function of each being determined by the decoding ROMs in the CPU.

The STEMSS has 128 instructions; these can be split into groups such as data transfer, input/output, mini-programs and jump instructions.

The processor consists of an 8 MHz quartz crystal oscillator, from which are derived all the CPU and memory timings, 11 working registers, 2 logical gates for NAND and EXNOR functions, character send and receive algorithms, and a data highway consisting of 8 leads which is connected between the registers and the RAM, as shown in Fig. 4.

Registers PC, PP, A, B, C, OP, OQ and the RAM can send and receive data from the main data-highway; registers IP, IQ and the lower bits of the decode register, register D, can only send data to the main data-highway.

Registers A, PC and C can be incremented. Register PC, which is used as the program counter, increments automatically at the end of each instruction, the program memory is addressed on a page basis, register PP addresses the page of memory, and register PC points to one of the 256 words on the page.

The upper 4 bits of register C are used to allocate 1 page of RAM per time-slot, giving a maximum of 16 pages; the lower 4 bits can be used to address any word of RAM on the current page, giving a maximum of 16 words per page.

Registers OQ and OP are output registers and are connected to an 8-lead address highway; a separate address is associated with each port. Four of the address leads are used for setting the status of the call and the remaining 4 leads are used for setting the required line conditions. Register IP is an input register having 4 leads for examining the status of the call: the remaining 4 leads are used to examine the incoming line conditions.

The CPU has 2 hard-wired algorithms which are used for the sending and receiving of characters using registers A and B. The receive algorithm converts the serial telegraph signal received by register B into a parallel form and can also be used to regenerate a character. The send algorithm converts the stored word in parallel form to a serial telegraph signal, complete with a STOP and START element.

The instructions for the processor are stored on 4 ROM units; each unit can hold 1 kbyte, each of 8 bit.

Access Unit

The access unit acts as an interface between the ports and the processor. Each unit serves up to 12 individual ports and

comprises an 8-lead address highway, a 4-lead highway for data input and output, 24 outgoing latches for maintaining the line conditions on the 2 outgoing leads, and a 4 bit read/write memory associated with each port.

The required port address is connected to the 8-lead address highway via register OQ, which enables the 4 bit read/write and input/output leads. The 4 bit read/write memory is used to store the status of the port; that is, whether the port status is *busy for them, busy for us, or free*. The condition of the output leads and the status conditions are loaded into register OP and, on receipt of a strobe pulse, are clocked into the appropriate latches. The input conditions of the port and the status of the line are loaded into register IP, where these conditions can be examined.

Low-Voltage Line Units

The low-voltage line units provide the interface between the STEMSS rack and the transmission equipment.

The R-wire circuit converts the 12 V line signals to a pair of complementary binary outputs, which are interpreted by the processor as a positive, negative or disconnected line condition. The circuit is electrically isolated from line by a pair of opto-couplers preceded by a filter circuit, which also forms the line termination. The filter is designed to introduce a small amount of distortion into the circuit so that the transitional overlaps of the complementary outputs are never in the binary *one* condition at the same instant. The opto-couplers are followed by a transistor stage and a MOS inverter which, together, form a TTL-compatible output to the access unit. A light-emitting diode (LED) is provided to indicate the presence of negative polarity and signals on the line.

The S-wire circuit is provided with 2 transistor amplifier stages because the output from the access unit is not TTL compatible, and these provide the input to the line driver, which is an integrated circuit. The line output potentials are clamped by Zener diodes to protect the line driver from any excessive voltage induced on the line. The send circuit is also provided with an LED indication of negative potential to line.

The front plate of the 12-module low-voltage line unit is fitted with U-links, which can be removed to isolate the line from the STEMSS equipment. The U-links also form a cross-connection point for the temporary rearrangement of circuits, and they provide access points for monitoring purposes and the measurement of line currents.

Non-Volatile RAM Unit

The non-volatile RAM unit uses ultra-low-power static CMOS RAMs, arranged as 256×4 bit words. These devices are ideally suited for battery-supported retention of data in the event of power failure, and are guaranteed to retain data down to a supply voltage of 2 V. The secure supply (+5 V) is fed from the +12 V supply, via a voltage regulator and connected across it is a 9 V nickel-cadmium battery. On failure of the +12 V or +5 V supply, the non-volatile RAM unit is disabled immediately, and the secure supply fed from the battery. When fully charged, the battery enables the data to be retained for at least 72 h. The STEMSS rack is equipped with 2 identical non-volatile RAM units, one designated as the main and the other the stand-by; the use of these units is controlled by the positions of manually-operated keys.

Writing data into the non-volatile RAM units is a hardware and software operation, the data is written into the stand-by unit. Each unit has a lockable manually-operated READ/WRITE key, which is normally operated to the READ position; if any update of information is required, the stand-by unit key is operated to the WRITE position. After the data has been checked, it can be transferred into the main unit without interruption of service.

The unit is connected to the main ROM highway, and is addressed using registers PP and PC. The 16 bit address highway is allocated as follows: 6 bit are used for unit enable; 2 bit are used for page enable; and 8 bit from register PC are shared for addressing or writing data into the non-volatile RAMs. Connected to the address highway are 2 latches that, on a command from the processor, latch the contents on the highway. At other times the contents contain the required address.

SOFTWARE DEVELOPMENT

The design of the software which, for the complete system, has a program capacity of 5 kbytes, was achieved in 3 phases: the system-definition phase, the preparation of algorithm level flow charts, and the preparation of instruction-code flow charts.

The system-definition phase involved the analysis of the basic system requirements and identification of problems to be solved and the sub-division of program requirements into functional blocks. A block diagram of the STEMSS software program structure is given in Fig. 6.

The facilities of each program block were defined and the RAM storage necessary for communications between blocks was allocated. Areas in which sub-routines could be used were defined. Total program size was limited by the hardware, and maximum use had to be made of available program space so that functions such as *sending a printed response* were made into an independent block utilized by all other blocks. In certain instances, the time to perform a function was limited and programs using the least number of instructions were necessary.

Each major block was then further divided and a block diagram outlining the function was prepared. An algorithm level flow chart was produced which defined the logic and techniques for executing the function. This flow chart was then converted into machine code.

The software program assembly was achieved in 4 stages, each stage being essentially self-contained. In this way, system

complexity was increased progressively (that is, the next program-assembly stage was undertaken only when the preceding stage had been proved to work).

The first stage of program assembly allowed the recognition of a call request and the return of a *proceed* printed response; this permitted the checking of the hardware and the basic system principles. Most of the instruction set was used in these programs.

The second stage enabled a call to be set up between normal extensions and for the exchange of messages. Conference, transfer and party-identification facilities could also be tested at this stage.

In the third stage, incoming satellite and trunk calls were tested, together with the night-service options.

In the final stage, programs were tested for the entering of routing information into the non-volatile RAM unit, establishing an outgoing satellite call, and system clear and recovery operations. In this stage, the processor was run in its normal multiple time-slot mode.

Software Program Blocks

Several words of RAM are used for the same purpose in each of the blocks, and these are referred to as *global flags*. The 16 words of RAM are numbered from M0-M15 (the M indicates a RAM word).

The most important global flags are M0-M3, which are used for storing the port numbers on a call. Flags M4 and M5 are used for indicating night service and to allow interrupts on certain ports to be ignored. M8 is used for selecting the desired printed response, and flags M14 and M15 store the program-page and program-count settings.

During the call-connected phase, all ports on a call are checked continuously for interrupts. During other processing phases, or combination of phases which could last longer than 5 s, ports on a call are also tested for interrupts. In this case, however, interrupts from printer ports are ignored, and only satellite routes are cleared down. A brief explanation of each of the main software program blocks is given below.

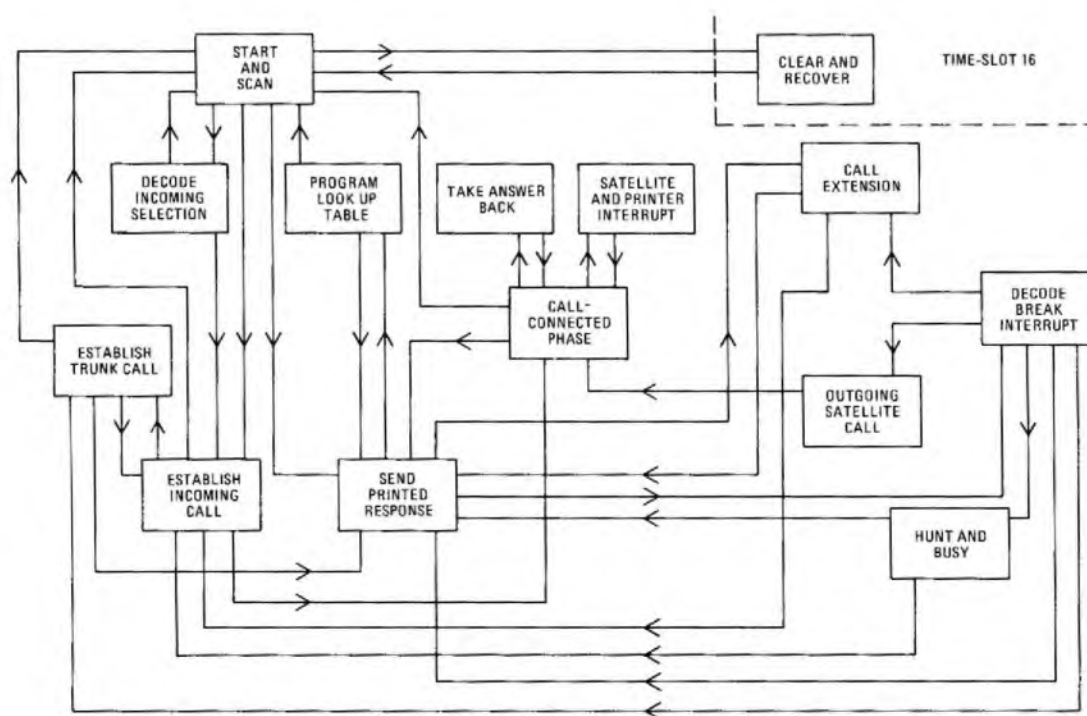

FIG. 6—STEMSS software program structure

Start-and-Scan Program

The start-and-scan block is a looped program, and connecting circuits not actively processing a call spend their time in this phase. All the 256 port numbers available in the 8 bit port number are scanned. Each port is addressed in turn and its status determined. A check is made for night-service conditions and of the R-wire for a calling condition, and various words of RAM are set. The type of port is decoded and the program jumps to other program blocks as appropriate.

Send-Printed-Response Program

The send-printed-response program enables printed responses to be returned during the processing of a call, controlled by the setting of the response decision flag. The printed words include: PROCED; BUSY; NO RESPONSE; and READY.

Decode-Break-Interrupt Program

The decode-break-interrupt program block decodes the selection from a teleprinter port, and may be used to set up a call initially, or to further process an established call. The selection must be in a certain format, the first 4 similar letters indicating the requirement such as conference, transfer, clearing down, clearing a conference or access to the non-volatile RAM look-up table. The selection letters are followed either by figures or letters to indicate the extension or satellite route to be connected.

Decode-Incoming-Selection Program

The decode-incoming-selection program block decodes the incoming selection from a satellite route and accepts only predetermined codes; all other characters received result in the circuit status being set *busy for them*, and the call is ignored.

Call-Extension Program

The call-extension program block is used to connect a printer port to another printer port and uses a look-up table to convert the 2 digit extension number to the port number.

Establish-Incoming-Call and Establish-Trunk-Call Programs

According to the incoming satellite code selected, these program blocks route a call to a particular type of teleprinter at Madley or Goonhilly.

Hunt-and-Busy Program

The hunt-and-busy program block processes an outgoing call from a teleprinter port at Madley and initiates seizure of a teleprinter at TOCC.

Outgoing-Satellite-Call Program

The main function of the outgoing-satellite-call program block is to find the correct S-wire and R-wire from the non-volatile RAM look-up table and transmit the selection format over the satellite route.

Call-Connected-Phase Program

When a call has been established, the processor, while servicing that particular time slot, remains in the call-connected phase. All characters received from any one port are regenerated and sent to all other ports connected on the call. Up to 4 ports can be connected together as a conference and, when night service is required, the monitor printers also receive messages.

Satellite-and-Printer-Interrupt Program

The satellite-and-printer-interrupt program recognizes interrupts and enables satellite routes to be cleared.

Take-Answer-Back Program

The take-answer-back program provides the facility that enables all parties on a call to be identified. A request for identity initiated by a teleprinter results in the answer-back codes of other teleprinters being taken in turn.

Clear-and-Recover Program

The clear-and-recover program runs in the clearing time-slot only, and enables recovery and clearing to take place automatically.

Look-Up Table Program

The look-up table program allows access and control of the main system routing tables from any teleprinter port.

Information can be transferred automatically from the standby to the main NV RAM unit. All information entered is verified and error messages are given under fault conditions.

RELIABILITY AND MAINTENANCE

Equipment reliability and availability are regarded as extremely important design criteria. All components used in the STEMSS are of high reliability. All major units are duplicated on a cold stand-by basis. It has been calculated that major system failure could occur once every 5 years but, over a 10 year period, assuming change-over to stand-by within 1 h, system availability is 99.997%.

Hardware and software maintenance aids are provided to simplify the location and clearance of faults. Line monitoring and interception facilities are provided on the line units to allow all circuits to be cross-connected and monitored as required.

CONCLUSIONS

The software has been designed to be as flexible as possible and could be tailored with a minimum of effort to meet the individual requirement of other earth stations' systems. The system could be used as a telegraph private-circuit concentrator system.

The project has demonstrated the advantages of having a modular family of hardware units which, by developing additional hardware and new software, can perform many functions. Using this concept, it has been possible to meet the costs and time scales set for the STEMSS project.

A second STEMSS system has been ordered by the BPO to provide a dedicated communications network on the Indian Ocean region for use by the Madley telecommunications operational control centre. The equipment will be mounted on the same rack at Madley as the engineering service circuits, but will have 48 circuits and be completely self contained.

ACKNOWLEDGEMENT

The authors wish to acknowledge the work of Mr R. Wilkins of the BPO Telecommunications Development Department who was responsible for the design of the PATBX.

A New Telecommunications System for the Greater Manchester Police Authority

D. H. WILKINSON, B.SC., C.ENG., M.I.E.E.†

In April 1977, approval was given for a new telecommunications system to serve the Greater Manchester Police Authority (GMPA). The new network, which was to replace a fragmented system inherited when the Police Authority was formed from the Manchester and Salford, part of the Cheshire and part of the Lancashire constabularies, was required to be operational by 1 October 1978. Manchester Central Area Customer-Works Group was charged with planning the system, based on GMPA requirements, and co-ordinating the British Post Office (BPO) effort in the 3 Manchester Telephone Areas.

The GMPA had decided that the hub of the network would be an IBM 3750 PABX with approximately 1000 extensions serving police and local-government establishments throughout Greater Manchester. The PABX was to be housed in the new GMPA headquarters, situated some 5 km west of the existing headquarters in the city centre. Because the new headquarters was not purpose-built, extensive building alterations were required and took place at the same time as the installation and commissioning of the IBM 3750. Close liaison was required between the GMPA, the City Architects, the building contractors and the BPO.

Only 320 extensions were to be internal to the new headquarters; the remainder would be amplified external extensions serving 24 locations in Manchester. In addition, access to 12 remote PABXs of various types would be given by inter-switchboard circuits. The IBM 3750 would be serviced by 96 exchange lines and 74 direct-dialling-in (DDI) lines.

For security reasons, the new headquarters was to be linked to 2 different Manchester Area director exchanges by 3 separate cables in 2 separate duct routes. All circuits to and from the PABX were to be distributed over the 3 cables such that

no large concentration of circuits to any one location would occur in one cable. The last cable was pulled in and terminated in June 1978, by which time the Transmission-Construction Group had installed amplifiers at various exchanges throughout the Manchester Central Area. The fitting of multi-frequency keyphones at police stations was undertaken by the Customer-Works Groups in the 3 Manchester Telephone Areas. The external extensions and private circuits had then to be lined-up by the Customer-Works Private-Circuit Group.

Due to building delays at the new police headquarters and a new police divisional headquarters, although the first extensions were handed over to the Authority on 15 September 1978, the final one was not commissioned until 29 January 1979. During this period, the old and the new systems had to be interconnected by inter-switchboard circuits, and no disruption of the normal 24-hour police communications systems was allowed.

The area Traffic Division had not only to arrange operator training and customer education, but also the provision of recorded announcements as various police stations transferred from their old telephone numbers to the new one. In particular, the Manchester telephone directories had to contain both old and new numbers and a message telling customers when each was to be used.

Manchester Central Area Power Group took responsibility for acceptance testing the standby battery and rotary inverter which was required because the PABX had direct-dialling-in lines.

The job, the largest ever undertaken by Manchester Central Customer-Works Group to date, was successfully completed on time to the credit of everyone involved in the GMPA, the BPO and the firm of contractors.

The performance of this expensive and important new installation is being monitored by the GMPA and the Manchester Central Area with considerable interest.

† Manchester Central Telephone Area

Post Office Press Notice

UK PERMANENT PACKET-SWITCHED DATA SERVICE

The decision to go ahead with Britain's permanent packet-switched data service (PSS) has been taken by the British Post Office (BPO). The service is due to come into operation later in 1979 and PSS will follow the existing experimental packet-switched service (EPSS), which has now been working for 2 years. It is being provided as part of the BPO's massive £1000M-a-year investment programme, amounting to more than £3M every working day, under which the BPO caters for growth and provides for future services.

Based on CCITT Recommendations adopted or proposed as the international standards for public packet-switched services, PSS would also give UK users access to international data links using this form of switching. In particular, it will be connected to IPSS, the international packet-switched service shortly to be set up across the Atlantic, and to

Euronet, the European Economic Community's database-access network due to come into operation this year.

The switches to be used for PSS have been selected and a contract for their supply is now being negotiated with Plessey Controls Ltd. Under the contract, Plessey will install the equipment in 1979 to permit the first customers to be connected before the end of the year.

At the start, PSS will be based on 9 packet-switching exchanges, to be sited in London, Birmingham, Bristol, Cambridge, Edinburgh, Glasgow, Leeds, Manchester, and Reading. These will be interconnected by 48 kHz circuits operating at 48 kbit/s. This initial network would be expanded as necessary to meet future growth.

Discussions with potential users are continuing and will now be centred on mutually determining acceptable tariffs. This will enable users to plan optimum use of the network. Final details of facilities and tariffs are to be announced later.

Institution of Post Office Electrical Engineers

General Secretary: Mr. R. E. Farr, THQ/NP9.5.4, Room S04, River Plate House, Finsbury Circus, London EC2M 7LY; Tel.: 01-432 1954
(Membership and other local enquiries should be directed to the appropriate Local Centre Secretary (see *POEEJ*, Vol. 71, p. 210, Oct. 1978)).

INSTITUTION MEDAL AWARDS 1977-78

An Institution Senior Silver Medal has been awarded to Mr. J. W. Young for his paper *Time for Network Planning*. This somewhat controversial paper, which explores the opportunities open to planners to think afresh with the introduction of digital switching and transmission, was highly regarded by the Papers Selection and Editing Committee of Council and has stimulated a lively interest wherever it has been read.

Institution Field Medals, intended for papers on field subjects, primarily of Regional interest, have been awarded as follows:

to Mr. M. F. Arnold for his paper *Improvements in Repair Service Controls*,
to Mr. M. W. Bayley for his paper *Repair Service Controls*,
to Messrs. B. H. House, E. Hall and E. E. J. Huggins for their paper *Test Equipment Design in the SETR*.

The medals will be presented at the Institution's Annual General Meeting at the Institution of Electrical Engineers, London, on 2 May 1979.

RETIRED MEMBERS

The following members, who retired during 1978, have retained their membership of the Institution under Rule 11(a).

F. Kinston, 50 St. George's Avenue, Wolstanton, Newcastle-under-Lyme, Staffs., ST5 8DH.

A. G. Humphrey, 6 Aspin Park Road, Knarcsborough, HG5 8HF.

J. R. Deag, 2 The Furlong, Yarnfield, Stone, Staffs., ST15 0PE.

R. B. Guile, 14 Cumberland Crescent, Chapelton, Sheffield, S30 4TA.

W. Greaves, 81 Clarence Road, Handsworth, Birmingham, B21 0EP.

A. E. Marks,

G. E. Gill, 71 Heston Road, Hounslow, Middlesex, TW5 0QW.

J. Pritchett, 2 Linfields, Little Chalfont, Amersham, Bucks., HP7 9QH.

W. Corrin, Schoolbury Meadows, Grove Lane, Chalfont St. Peter, Bucks.

R. J. Harris, 14 Acomb Gardens, Newcastle upon Tyne, NE5 2RY.

R. W. de Nicolas, 47 Roe Lane, Newcastle-under-Lyme, Staffs., ST5 37H.

J. W. Bearon, Lyton, Buttertons Lane, Oakhanger, Crewe, Cheshire, CW1 1UX.

D. C. Walker, 9 The Mount, Rickmansworth, Herts., ND3 4DW.

O. W. Warne, 41 Dilly Lane, Barton-on-Sea, New Milton, Hants.

C. C. Pikett, 21 Melton Road, Tollerton, Notts., NG12 4FL.

J. A. Robinson, 214 Brookside, Carlisle, Cumbria, CA2 7JU.

A. V. Smith, 17 Heathfield Avenue, Ilkeston, Derbyshire.

G. V. Short, Fernleigh, East End, Bergholt, Colchester, Essex.

A. J. H. Burton, 40 Tithe Walk, Mill Hill, London, NW7 2QA.

P. J. W. Clarke, 41 Royal Avenue, Tonbridge, Kent, TN9 2DB.

A. H. Hunt, Lindum, 53 Louth Road, Horncastle, Lincs., LN9 5EH.

R. C. Barker, 86 Ellesmere Road, London, NW10 1JS.

N. Gandon, 2 Undercliffe Rise, Ilkley, West Yorkshire, LS29 8QF.

T. A. Barker, 25 Parkside Place, Leeds, LS6 4NX.

T. J. Morgan, 17 Court Close, Patcham, Brighton, BN1 8VG.

T. E. Smith, 219 Holyhead Road, Handsworth, Birmingham, B21 0AS.

IPOEE CENTRAL LIBRARY

The following books have been added to the IPOEE Library since the publication of the 1974 Library Catalogue. Any member who does not have a copy of the catalogue can obtain one from the Librarian, IPOEE, 2-12 Gresham Street, London, EC2V 7AG. Library requisition forms are also available from the Librarian, from local-centre secretaries, and from Associate Section local-centre secretaries and representatives and, also appear from time to time in the *Journal*.

5259 *Submarine Telecommunication and Power Cables*. C. C. Barnes (1977).

This IEE book covers the development, manufacture and installation of submarine cables. A number of projects around the world are reviewed and extensive references are provided for all aspects of the work.

5260 *Telecommunication Networks*. Editor: J. Flood (1976).
Reviewed in *POEEJ*, p. 249, Vol. 69, Jan. 1977.

5261 *Integrated Circuits: A User's Handbook*. M. M. Cirovic (USA, 1977).

This book is a detailed and practical user's guide which describes the operation and application of integrated circuits for all aspects of electronics.

5262 *Building Technology Vol. 1*.

5263 *Building Technology Vol. 2*. J. Bowyer (1978).

Although designed specifically for Technician Education Council courses, these books should appeal to the do-it-yourself enthusiast and anyone else who would like a basic knowledge of building construction techniques. Subjects such as planning regulations, preparation and materials, as well as actual construction are covered in plain language with numerous illustrations.

5264 *Data Communications*. D. R. Doll (USA, 1978).

This book explains the basic technology and structure of data-communication systems and includes details of facilities, networks and system design.

5265 *Logical Design Using Integrated Circuits*. W. D. Becher (USA, 1977).

A concise, practical textbook which describes the essential principles underlying the logical design of digital integrated-circuit systems. No technical background beyond a familiarity with ordinary algebra is required.

5266 *Repairing Pocket Transistor Radios*. I. R. Sinclair (1977).

Many thousands (possibly millions) of pocket transistor radios have been abandoned in the last two decades because of faults which did not justify costly repair. This book, for the handyman or enthusiast, shows how to locate and rectify faults using only simple tools.

5267 *Op-Amps—Their Principles and Applications*. J. B. Dance (1978).

This book is intended for the technician or home constructor who requires sufficient information about operational amplifiers to use them in conventional circuits without making a thorough study of the subject. The text is written in non-mathematical style and is directed specifically at the non-academic reader.

5268 *Rotating Electric Machinery and Transformer Technology*. D. V. Richardson (USA, 1978).

This book is a comprehensive review of rotating electrical machinery, covering DC and AC motors, generators and transformers. The various types of machinery are considered in both technical and practical application form; also included are such topics as design, machine selection, machine efficiency, efficiency measurement, operation and control.

5269 *Solid-State Electronics*. L. E. Murr (USA, 1978).

The principles and applications of solid-state electronic devices are presented in this book, with emphasis on the physical and chemical properties of their basis materials. The topics are covered chronologically with regard to the development of electronic properties, from electrons through to atoms, molecules and solid crystals.

5270 *Industrial Electronics*. N. Morris (1978).

This book has been written to meet the electronics requirements for technicians in both certificate and diploma courses. There is a broad coverage of devices and circuits, including diodes, rectifiers, bipolar and field-effect transistors, thyristors, integrated circuits, optoelectronics, pulse-shaping circuits, digital electronics, stabilized power supplies, oscilloscopes and digital instruments.

5271 *Electromagnetism for Engineers*. P. Hammond (1978).

This book is an introduction to electromagnetic theory and requires only a knowledge of basic mathematics.

5272 *Basic Integrated-Circuit Engineering*. D. J. Hamilton and W. G. Howard (USA, 1975).

Integrated-circuit engineering is introduced in this book, with emphasis on fabrication techniques and their relevance to device behaviour. Applications employing linear and digital circuits are demonstrated.

5273 *Private Electronic Switching Systems*. IEE (1978).

Reviewed in *POEEJ*, p. 220, Vol. 71, Jan. 1979.

5274 *Inventor and Entrepreneur: Recollections of Werner von Siemens* (Germany, 1966).

Werner von Siemens (1816–1892) is probably best remembered as the elder brother of Sir William Siemens, but, as this book reveals, he was a great engineer and industrialist in his own right. His major contribution was the discovery of the dynamo-electrical principle which led ultimately to the large-scale generation of electrical power, although this achievement was in fact only a small part of his work.

5275 *A Structured Programming Approach to Data*. D. Coleman (1978).

The problems and excessive costs of program maintenance have led to the development of structured programming techniques. This text introduces and explains the principal structuring concepts and relates them to many different programming applications.

5276 *A First Course in Computer Technology*. M. G. Hartley and M. Healy (1978).

This book has been written specifically for students commencing the study of computers and computing. It is an introductory work aimed at providing a broad understanding of how a computer works, and thus covers a number of disciplines, ranging from mathematics to electrical engineering.

Notes and Comments

ABBREVIATION OF "BINARY DIGIT"

The use of the word *bit* as a noun in place of *binary digit* has now become so widespread that the Editors have decided to adopt the abbreviation. However, the standard of using the singular to represent a unit will be followed.

PUBLICATION OF CORRESPONDENCE

The Board of Editors would like to publish correspondence on engineering, technical or other aspects of articles published in the *Journal*, or on related topics. Letters of sufficient interest will be published under Notes and Comments.

Letters intended for publication should be sent to the Managing Editor, *The Post Office Electrical Engineers' Journal*, NP 10.1.4, Room S 08, River Plate House, Finsbury Circus, London EC2M 7LY.

CONTRIBUTIONS TO THE JOURNAL

Contributions to the *POEEJ* are always welcome. In particular, the Board of Editors would like to reaffirm its desire to continue to receive contributions from Regions and Areas, and from those Headquarters departments that are traditionally modest about their work.

Anyone who feels that he or she could contribute an article (short or long) of technical, managerial or general interest to engineers in the Post Office is invited to contact the Managing Editor at the address given below. The editors will always be pleased to give advice and try to arrange for help with the preparation of an article, if needed.

GUIDANCE FOR AUTHORS

Some guiding notes are available to authors to help them prepare manuscripts of *Journal* articles in a way that will assist in securing uniformity of presentation, simplify the work of the *Journal's* editors, printer and illustrators, and help ensure that authors' wishes are easily interpreted. Any author preparing an article is invited to write to the Managing Editor, at the address given below, to obtain a copy.

All contributions to the *Journal*, including those for Associate Section Notes, must be typed, with double spacing between lines, on one side only of each sheet of paper.

As a guide, there are about 750 words to a page, allowing for illustrations, and the average length of an article is about 6 pages, although shorter articles are welcome. Contributions should preferably be illustrated by photographs, diagrams or sketches. Each circuit diagram or sketch should be drawn on a separate sheet of paper; neat sketches are all that is required. Photographs should be clear and sharply focused. Prints should preferably be glossy and should be unmounted, any notes or captions being written on a separate sheet of paper. Good colour prints and slides can be accepted for black-and-white reproduction. Negatives are not required.

It is important that approval for publication is given at organizational level 5 (that is, at General Manager/Regional Controller/THQ Head of Division level) and authors should seek approval, through supervising officers if appropriate, before submitting manuscripts.

Contributions should be sent to the Managing Editor, *The Post Office Electrical Engineers' Journal*, NP 10.1.4, Room S 08, River Plate House, Finsbury Circus, London EC2M 7LY.

The Associate Section National Committee Report

THE COTSWOLD TROPHY

There are 4 entries for the 1979 competition for the Cotswold Trophy, which is awarded annually to the centre adjudged to have best furthered the aims of the Associate Section of the Institution. The entrants are the Midland Region, Salisbury, Chester and London South Area centres. The winner will be decided on the basis of one vote per region, and the trophy presented at the National Quiz Final at the Institution of Electrical Engineers, London, on 20 April 1979.

MEMBERSHIP FORMS

I now have a supply of membership forms, presented to the Associate Section by the senior section Council. These forms are available from me, c/o M2.3, 34 Castle Street, Salisbury SP1 1BW (Telephone: Salisbury 27996). Apparently,

in the past, centres have experienced problems in obtaining new forms and I hope that these will now be resolved.

YEAR PLANNER

A proposition was put forward at the last meeting of the committee to produce an Associate Section diary. This idea was subsequently changed to a Year Planner type diary. At the moment, I am trying to determine the price of such an item, which will include an information section and envelopes to hold such items as pass cards and credit cards. It is hoped that there will be a good response from members, as larger orders give cheaper prices. The folder will be for all time and the planner changed each year.

M. E. DIBDEN
General Secretary

Associate Section Notes

INVERNESS CENTRE

Our 1978-79 session opened in October with a visit to A. I. Welders Ltd. in Inverness. In November we had an interesting illustrated talk on *Oil Development*, and in December a most enjoyable talk about *System X*. Attendance at these 3 meetings was well up on previous years.

After successes against Edinburgh and Aberdeen, the Inverness quiz team, comprising P. M. Bisset, J. Fulton, A. MacKenzie, J. Ogilvie, D. Ross and R. G. Swanson (Captain), narrowly beat Dundee in December to win the Scottish Quiz final. At the time of writing, our next match will be against the London Telecommunications Region in the National Quiz.

R. G. SWANSON

IPSWICH CENTRE

The Centre has had *engineering* as its theme for the past few months. Our first visit after the annual general meeting was to Fords at Dagenham. This gave a good insight into the construction of that everyday item, the car.

A visit to the Post Office Railway in London proved to be excellent, with guides explaining in great detail how the railway functioned and how, thanks to help from London underground railway experts, it was designed and maintained. It boasts 50 years without serious mishap.

Railways stayed in mind when our members visited the Research Department of British Rail at Derby to see the advanced passenger train (an APT name).

Electrical and mechanical engineering were covered by a lecture, given at the local technical college, on *Nuclear Power* and how it affects our lives.

The following months see a slight variation on our theme, with talks by two of our members; one on hand weapons through the ages and the other on tanks and modern warfare.

Social events include a cheese and wine evening, which will include a wine competition to give our members a chance to show off their expertise in the art of winemaking. To round off the session, there will be a dinner-dance.

K. R. PHILLIPS

LUTON CENTRE

At a recent meeting, the present Honorary Secretary resigned due to pending promotion and Mr. W. H. Webb was elected to the office. 1978 was quite a successful year as far as visits were concerned, with all visits being oversubscribed. Further interest has been generated in the Centre's activities, resulting in a steady influx of new members.

Future visits have been arranged to Texas Instruments,

Vauxhall Motors Truck Division, the Post Office Cable-Ship Depot and the Post Office Research Centre at Martlesham. In addition, visits to a coal mine and to the Radio Astronomy Centre at Cambridge have been proposed.

W. H. WEBB

NOTTINGHAM CENTRE

The Centre's programme of visits continued on 30 July when two coaches took members and guests on a family outing to a military air pageant at the Shuttleworth Collection, Old Warden. Despite inclement weather, a good flying display was enjoyed by all. In September, a party of 20 members travelled to Oldham to visit the Ferranti Electronic Components Division, and saw a wide variety of semiconductor "chips" in various stages of manufacture. This was followed on 26 October with a visit by 52 members and guests to the International Motor Show at Birmingham. Luck was on our side, for there were no massive queues to enter the show. An evening visit to the Unigate Stilton cheese factory at Harby took place in November, where the whole process of cheese-making was seen, and the results sampled afterwards. In December, a small party was shown round the Central Fire Station at Nottingham following which the party enjoyed sandwiches and a pint in the station club.

Our quiz team were at work again in December, when they played Swansea via a landline link in the first heat of the National Quiz. A low-scoring match produced disappointment for us when we lost 25½ points to 21.

Two of our committee members, Mr. M. P. Melbourne and Mr. G. Fotheringham entertained members in January with a talk and slide show on their visit to Nepal in 1977. The slides included excellent views of the Kathmandu Valley and the Himalayan mountain range.

M. RUSH

NORTHERN IRELAND CENTRE

The final of the regional technical quiz was held at Ballymena in December when Belfast section defeated the Londonderry section. The winners of that match went on to meet Guildford in the first round of the National Quiz in January. After several changes of lead, Guildford were the eventual winners by 31½ points to 28½. Despite losing, the Belfast team had a most enjoyable visit to Guildford, all the more so for the excellent hospitality of the home team. In a friendly quiz against the Technical Training College, Stone, the Belfast team held their own in the early stages, but the college team drew away to a comfortable win in the later stages.

D. McLAUGHLIN

Forthcoming Conferences

Further details can be obtained from the conference department of the organizing body.

Institution of Electronic and Radio Engineers, 99 Gower Street, London WC1E 6AZ. Telephone: 01-388 3071

Television Measurement

21-23 May 1979
The Commonwealth Institute, London

Video and Data Recording

24-27 July 1979
The University of Southampton

Land Mobile Radio

4-7 September 1979
The University of Lancaster

Institution of Mechanical Engineers, 1 Birdcage Walk, London SW1H 9JJ. Telephone: 01-839 1211

International Progress in Postal Mechanization

6-8 November 1979
The Institution of Mechanical Engineers, London.

Institution of Electrical Engineers, Savoy Place, London WC2R 0BL. Telephone: 01-240 1871

Electronic Test and Measuring Instrumentation

19-21 June 1979
Wembley Conference Centre

Computer-Aided Design and Manufacture of Electronic Components, Circuits and Systems

3-5 July 1979
University of Sussex

† *Submarine Telecommunications Systems*

26-29 February 1980
The Institution of Electrical Engineers, London
Papers: Synopsis by 23 April 1979; final by 10 September 1979.

† *Communications 80: Communications Equipment and Systems*

15-18 April 1980
National Exhibition Centre, Birmingham
Papers: Synopsis by 21 May 1979; final by 29 October 1979.

Secretariat 1980 International Zurich Seminar, Miss D. Hugg, Dept. ENF, BBC Brown, Boveri and Co. Ltd., CH-5401 Baden, Switzerland. Telephone: +41-56-299038.

† *International Zurich Seminar on Digital Communications (Digital Transmission in Wireless Systems)*

4-6 March 1980
Swiss Federal Institute of Technology
Papers: Summary by 17 July 1979; final by 30 December 1979

† New or revised information

The Post Office Electrical Engineers' Journal

Copyright

The entire contents of this *Journal* are covered by general copyright, and special permission is necessary for reprinting long extracts, but editors are welcome to use not more than one-third of any article, provided that credit is given at the beginning or end, thus: "From *The Post Office Electrical Engineers' Journal*".

The Board of Editors is not responsible for the statements made nor the opinions expressed in any of the articles or correspondence in this *Journal*, unless any such statement is made specifically by the Board.

Subscriptions and Back Numbers

The *Journal* is published quarterly in April, July, October and January, at 55p per copy (80p per copy including postage and packaging); annual subscription: £3.20; Canada and the USA: \$6.50.

The price to British Post Office staff is 36p per copy.

Back numbers will be supplied if available, price 55p (80p including postage and packaging). At present, copies are available of all issues from April 1974 to date with the exception of the April and October 1975 issues; copies of the July 1970 and April and October 1973 issues are also still available.

Orders, by post only, should be addressed to *The Post Office Electrical Engineers' Journal*, 2-12 Gresham Street, London EC2V 7AG.

Employees of the British Post Office can obtain the *Journal* through local agents.

Binding

Readers can have their copies bound at a cost of £5.25, including return postage, by sending the complete set of parts, with a remittance, to Press Binders Ltd., 4 Iliffe Yard, London SE17 3QA.

Remittances

Remittances for all items (except binding) should be made payable to "*The POEE Journal*" and should be crossed "& Co."

Advertisements

All enquiries relating to advertisement space reservations should be addressed to Mrs. S. Underwood, Advertisement Manager, The Kemps Group, Forge House, Bell Lane, Brightwell-cum-Sotwell, Wallingford, Oxon. (Telephone: 0491 35448 or 0491 39370).

Advertisement copy should be addressed to the Managing Editor, *The Post Office Electrical Engineers' Journal*, NP 10.1.4, Room S 08, River Plate House, Finsbury Circus, London EC2M 7LY.

Distribution and Sales

Correspondence relating to the distribution and sale of the *Journal* should be addressed to *The Post Office Electrical Engineers' Journal* (Sales), 2-12 Gresham Street, London EC2V 7AG.

Communications

With the exceptions indicated above, all communications should be addressed to the Managing Editor, *The Post Office Electrical Engineers' Journal*, NP 10.1.4, Room S 08, River Plate House, Finsbury Circus, London EC2M 7LY (telephone 01-432 4840).

Model-Answer Books

Books of model answers to certain of the City and Guilds of London Institute examinations in telecommunications are published by the Board of Editors. Copies of the syllabi and question papers are not sold by *The Post Office Electrical Engineers' Journal*, but may be purchased from the Department of Technology, City and Guilds of London Institute, 76 Portland Place, London W1N 4AA.

Advertisements

Communications, advertisement copy, etc., should be addressed as shown on p. 70.

No responsibility is accepted by the Journal for any of the private or trade advertisements included in this publication.

ERA Ltd.	5	Northeast Electronics	8
GEC Telecommunications	2	Plessey Telecommunications Ltd.	3
Mullard Ltd.	1	R.F. Components Ltd.	5
Niphan Ltd.	7	Standard Telephones and Cables Ltd.	6
		Thorn Ericsson	4

<h1 style="text-align: center; margin: 0;">R. F.</h1> <h2 style="text-align: center; margin: 0;">COMPONENTS</h2>	<p style="text-align: center;">Relays & Switches</p> <p style="text-align: center;">2—30 way XY Matrix 0—18 GHz</p> <p style="text-align: center;">Remote or Manual</p>	<p style="text-align: center;">R. F. COMPONENTS</p> <p style="text-align: center;"><i>Trading as</i> HERCOAX LTD., PLUMPTON HOUSE, PLUMPTON ROAD, HODDESDON, HERTS, EN11 0EB ENGLAND</p> <p style="text-align: center;">Tel: HODDESDON 63603 Telex: HERCO 265849</p>
--	--	--

Master the Micro



The MP Experimenter microprocessor teaching system is designed to teach engineers about microcomputers at their own pace at work or at home. Using a proven step-by-step procedure, the course takes the student from an understanding of digital logic and computer arithmetic to working with a hypothetical microcomputer and finally, the 8080 microprocessor. For further information contact:

ERA
COMPUTERS AND
AUTOMATION

ERA Computers and Automation
Electrical Research Association Ltd.,
Cleeve Road,
Leatherhead,
Surrey KT22 7SA
Telephone:
Leatherhead (03723) 74151

IPOEE CENTRAL LIBRARY

Any member who does not have a copy of the catalogue can obtain one from the Librarian, IPOEE, 2-12 Gresham Street, London EC2V 7AG. Library requisition forms are also available from the Librarian, from honorary local-centre secretaries, and from Associate Section centre secretaries and representatives.

Alternatively, the panel below, or a photocopy, can be used (only by members) to borrow any book listed in the catalogue or in the updating lists published in recent issues of the *POEEJ*. The form should be sent to the Librarian at the address above; a self-addressed label must be enclosed.

IPOEE Central Library

LIBRARY REQUISITION FORM

*For use only by members of the Institution of Post Office
Electrical Engineers*

Author

Title

.....

Catalogue No. Date

Name

Official Address



We haven't seen some of our finest work for over 20 years.

When an intercontinental telecommunications link is laid at great depth, it's rather important to know that nothing will go wrong with it.

Because apart from the fact that communications suffer, it's not that easy to get the repair man in.

STC have an incredible reputation for reliability. Some of our earliest undersea repeaters have already been operating for over twenty years without attention.

Perhaps this is why STC is the world's leading supplier of undersea

communication systems, with capacities ranging up to 5,520 circuits, over some 80,000 nautical miles of cable, and linking 34 countries.

And submarine systems is only one aspect of STC's world capability in the development and manufacture of advanced telecommunications systems worldwide.

Standard Telephones and Cables Limited STC House, 190 Strand, London WC2R 1DU Telephone: 01-836 8055 Telex: 22385

Standard Telephones and Cables Limited

A British Company of **ITT**

NEW FROM **NIPHAN**

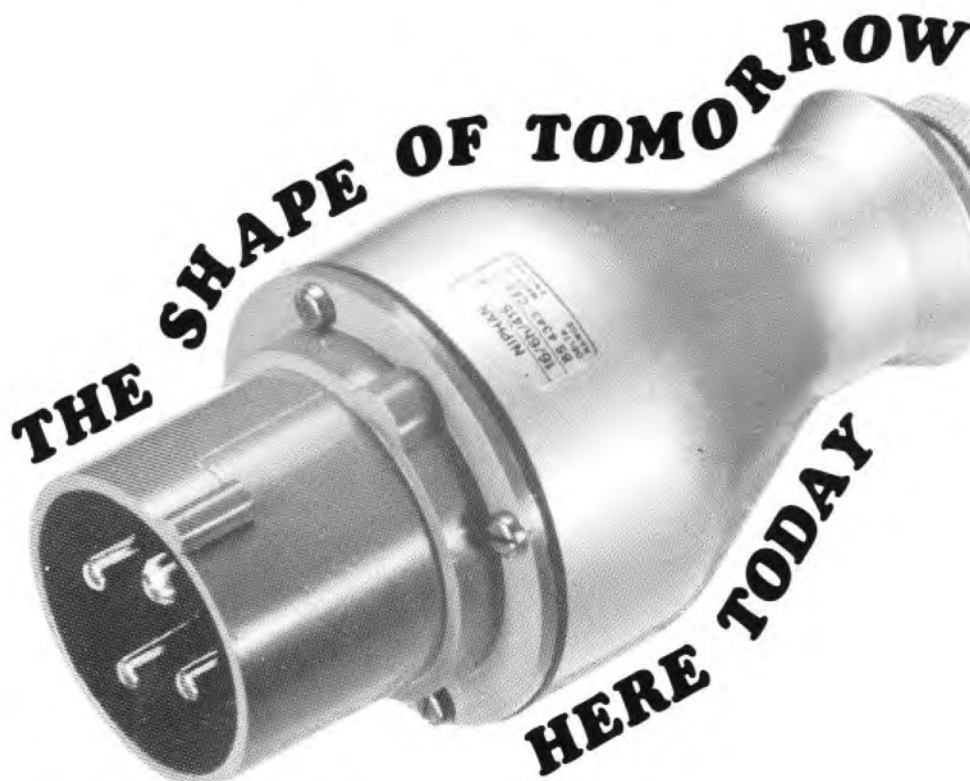

Industrial Metal-clad Plugs Sockets and Couplings

- Robust housing suitable for industrial environments
- Colour coded in accordance with BS4343 (CEE17)
- Available from our authorized distributor network

NIPHAN DELTA

Niphan Limited

310 Merton Road London SW18 5AA

Telephone: 01-874 6622 PBX

Telegrams: NIPHAN LONDON SW18

Please send for our free illustrated brochure

Name _____

Address _____

The new, intelligent Model 2760 by Northeast Electronics is a signalling problem-solver that locates trouble areas quickly to keep revenue-producing telephone systems operating efficiently with minimum downtime. It has the brains to detect, store and display full sequences of digits and codes for register and line signalling, in both forward and reverse directions. This compact, easy-to-operate instrument is so versatile it outperforms anything else available today.

The genius has a built-in memory, a microprocessor and the ability to perform a broad range of test functions. It has plug-in capability and can handle many signalling

systems including R2/MFC, MF2, E & M or Loop DP, AC9, AC11, 3825 Hz SF. Model 2760 is modularly expandable and future plug-ins for R1/CCITT 5, Touch-Tone[®] plus other signalling systems will include programmable senders and receivers.

A dual display shows as many as 16 digits/codes and up to 240 digits/codes per call can be captured in memory and recalled for use. The instrument can be bridged anywhere on 2, 4, or 6-wire circuits without disturbing normal service.

In addition to routine maintenance and service observing functions, the 2760 can be used to detect fraudulent use of the telephone network and to test systems to their marginal limits.

The genius is ready to go to work for you and help improve toll call completion, increase revenue, and make maintenance easier and faster. For full details, call or write today: A. W. Hart, Eurep Ltd., P. O. Box 1, Chepstow, Gwent NP6 5XQ, UK, Tel. Chepstow 5614/5870, Telex 49280 Severn Chepstow.

NORTHEAST ELECTRONICS Division of **nt** northern telecom

The genius can solve your toughest signalling problems.

