

RA ROE

THE POST OFFICE *C. Roe*  
ELECTRICAL ENGINEERS'  
JOURNAL



## CONTENTS

|  | Page                                      |
|--|---|
| MUSEUM RADIO TOWER   |   |
| H. Knee, E.R.D., A.M.I.E.E., and F. G. Balcombe, Assoc.I.E.E.....  | 73  |
| AN INTERNATIONAL EXPERIMENT IN FREQUENCY COMPARISON  |   |
| R. L. Corke, A.M.I.E.E.....  | 80  |
| LOCAL-CALL TIMING AT NON-DIRECTOR TELEPHONE EXCHANGES  |   |
| B. D. Gorton.....  | 83  |
| SUBSCRIBER TRUNK DIALLING AT NON-DIRECTOR SATELLITE TELEPHONE EXCHANGES  |   |
| R. H. G. Kearsley-Brown, A.M.I.E.E., A.M.Brit.I.R.E., and B. D. Gorton.....  | 86  |
| IMPROVEMENTS IN INSTALLATION METHODS FOR TELEPHONE EXCHANGES   |   |
| W. G. Roberts, A.M.I.E.E., and C. S. Mills.....  | 92  |
| THE INTERIM MEETING OF C.C.I.R. STUDY GROUP IV—SPACE SYSTEMS AND RADIO<br>ASTRONOMY, WASHINGTON, D.C., MARCH, 1962 .....                                 | 96  |
| SATELLITE COMMUNICATION SYSTEMS  |   |
| W. J. Bray, M.Sc.(Eng.), M.I.E.E.....  | 97  |
| EQUIPMENT AND TESTING FACILITIES AT THE EXPERIMENTAL SATELLITE GROUND<br>STATION, GOONHILLY DOWNS, CORNWALL—F. J. D. Taylor, O.B.E., B.Sc., M.I.E.E..... | 105                                       |
| ENGINEERING ASPECTS OF DEPRECIATION ACCOUNTING   |   |
| R. G. Gaut.....  | 113                                       |
| ELECTROLYTIC CAPACITORS AND THEIR RELIABILITY  |   |
| A. A. New, M.Sc., F.R.I.C., A.Inst.P.....  | 115                                       |
| ON PROGRAMMING COMPUTERS   |   |
| F. J. M. Laver, B.Sc., M.I.E.E.....  | 125                                       |
| DISMANTLING THE LONG-WAVE MASTS AT LEAFIELD RADIO STATION  |   |
| D. E. Watt-Carter, A.M.I.E.E.....  | 129                                       |
| NOTES AND COMMENTS.....  | 132                                       |
| INSTITUTION OF POST OFFICE ELECTRICAL ENGINEERS.....   | 134                                       |
| REGIONAL NOTES.....  | 136                                       |
| ASSOCIATE SECTION NOTES.....   | 138                                       |
| STAFF CHANGES.....   | 141                                       |
| BOOK REVIEWS.....  | 82, 95, 104, 112, 124, 135, 137, 140, 144 |

Price 2s. 6d. (Post Paid 3s. 6d.)

Published in April, July, October and January by *The Post Office Electrical Engineers' Journal*,  
G.P.O., 2-12 Gresham Street, London, E.C.2.

Annual Subscription (post paid): Home and Overseas, 14s. (Canada and U.S.A., 2 dollars 25 cents).

# THE POST OFFICE ELECTRICAL ENGINEERS' JOURNAL

Vol. 55 Part 2

JULY 1962

## Museum Radio Tower

H. KNEE, E.R.D., A.M.I.E.E., and F. G. BALCOMBE, Assoc.I.E.E.†

U.D.C. 624.97:621.396.67

A tower 600 ft high is being built adjacent to Museum telephone exchange in London to support aerials for a number of microwave radio links to serve some of the principal trunk routes from London. The height of the tower was determined by the need to provide transmission paths clear of obstructions, such as other tall buildings, and the opportunity is being taken to provide public observation galleries together with a restaurant and refreshment bars near the top of the tower.

### INTRODUCTION

**A** FAMILIAR landmark in the Tottenham Court Road area of London is the lattice radio tower situated on the rooftop of Museum telephone exchange. The number of aerials for new services it could accommodate is limited, and even the existing transmission paths are in danger of being obstructed by new tall buildings in the London area. A new permanent 600 ft-high radio tower, now under construction on an adjacent site and estimated to be ready for the installation of equipment by June 1963, is described below.

### GENERAL CONSIDERATIONS

In 1954, consideration of the expected growth of the trunk telephone and television network between London and the provinces in the following 20 years led to a proposal for a system of broad-band microwave radio links as a means of providing a considerable part of that growth. The routes from London to Birmingham, Portsmouth, Bristol, Norwich, Brighton and Dover were cited as examples for which such a system would probably be suitable. Two possibilities were considered. Either a ring of radio stations could be built in the outskirts and the broad-band links extended to central London by cable, or a single radio station could be built near the centre. The use of a ring of stations would involve no special technical difficulties, but if a central station were chosen the rapid growth of tall buildings in and around the centre of London would make a specially tall building necessary to provide adequate ground and obstacle clearance for the radio paths in the directions required.

There are over 200 buildings, either existing or proposed, in the central area of London that have a height of 100 ft or more, and of these about 50 are, or will be, 200 ft or more high, 20 will be 300 ft or higher,

and at least one, on the Albert Embankment, will rise to 400 ft. Obstructions near the straight line from a transmitter aerial to receiver aerial are not only capable of causing loss of received signal power but also generate unwanted reflected signals that give rise to unacceptable distortion of the signals being transmitted. The additional clearance that must be allowed depends on the radio frequency used, the position of the obstacle in the path and the prevailing atmospheric conditions. For example, if an obstruction exists midway between transmitting and receiving aerials 30 miles apart and working on a frequency of 2 Gc/s, the minimum clearance needed above the obstacle will vary with atmospheric conditions from 50–150 ft, approximately.

For a tower in central London the aerials need to be significantly higher than is usual in microwave-radio practice in which the aerials are normally mounted on a tower or mast some 50–300 ft high and the equipment is housed in an adjacent building after the manner of a cable repeater station, the equipment being connected to the aerials by waveguides or, occasionally, by cables. The waveguide, however, has its limitations; its transmission loss is significant, and its irregularities and imperfections all contribute to distortion in multi-channel systems by giving rise to echoes and so to intermodulation between channels. Therefore, with aerials at abnormal heights, the directly-associated radio equipment must also be housed aloft to limit the length of the feeder, and the tower then becomes a much more massive structure.

The proposal for a high tower in central London was preferred to the scheme for a ring of suburban stations, partly on cost, partly on the elimination of the traffic problem created by cable-laying, but not least on the impracticability of finding a number of suitable high-ground sites around London. The decision taken, the siting was no serious problem: Museum telephone exchange is the focal point both of the telecommunications system and of the network of vision cables in London, space was available for the tower in a yard off Cleveland Mews, and the design and constructional problems could be solved along with the pending extension to the Museum telephone exchange. With a tower on this site the aerial centres need to be some 375–470 ft above ground level according to route and frequency. Naturally, other sites were considered, and the planning

† Mr. Knee is in the Exchange Equipment and Accommodation Branch, and Mr. Balcombe is in the Inland Radio Planning and Provision Branch, E-in-C.'s Office.



was not in reality as straightforward as set down here, but after many rebuffs and adjustments the conclusions reached were those described above.

A building significantly taller than its fellows acquires a special interest, and amenities for the public have been included at the top of the tower, bringing the height up to about 600 ft. A short lattice-steel tower to carry additional aerials is to be placed on top of the concrete structure.

#### BASIC DESIGN AND CONSTRUCTIONAL FEATURES

The aerials at Museum, needed to meet the rapidly-expanding demand for transmission links, require a cylindrical space of about 52 ft in outside diameter and 110 ft in height. The whole of this aerial-gallery section must be situated between 365 ft and 475 ft above ground level, and a circular shape is necessary so that links may be provided in any azimuthal direction. The horns and paraboloids are mounted towards the outer edge of the aerial galleries, whilst the centre space is occupied

by a 22 ft-diameter reinforced-concrete hollow shaft around which the tower is constructed. This shaft has a wall varying in thickness from top to bottom and, besides providing the tower with structural strength and stability, it accommodates the lifts and emergency staircase, ventilation ducts, a large number of cables and all the usual services (water, electricity, sanitation) except gas.

Below the open aerial-galleries are floors, clad in stainless steel and glass, carrying the radio equipment and the ventilation plant. All the equipment and aerial floors, and, above these, the public floors, including a restaurant, refreshment bars and observation galleries, are constructed of reinforced concrete cantilevered out from the centre shaft. To maintain consistency of form with maximum visual slenderness and to ensure minimum wind-resistance, the circular shape dictated by the aerials has been followed throughout. The general form of the tower is shown in the elevation drawing in Fig. 1 (a) and in the photograph of the model in Fig. 1 (b).

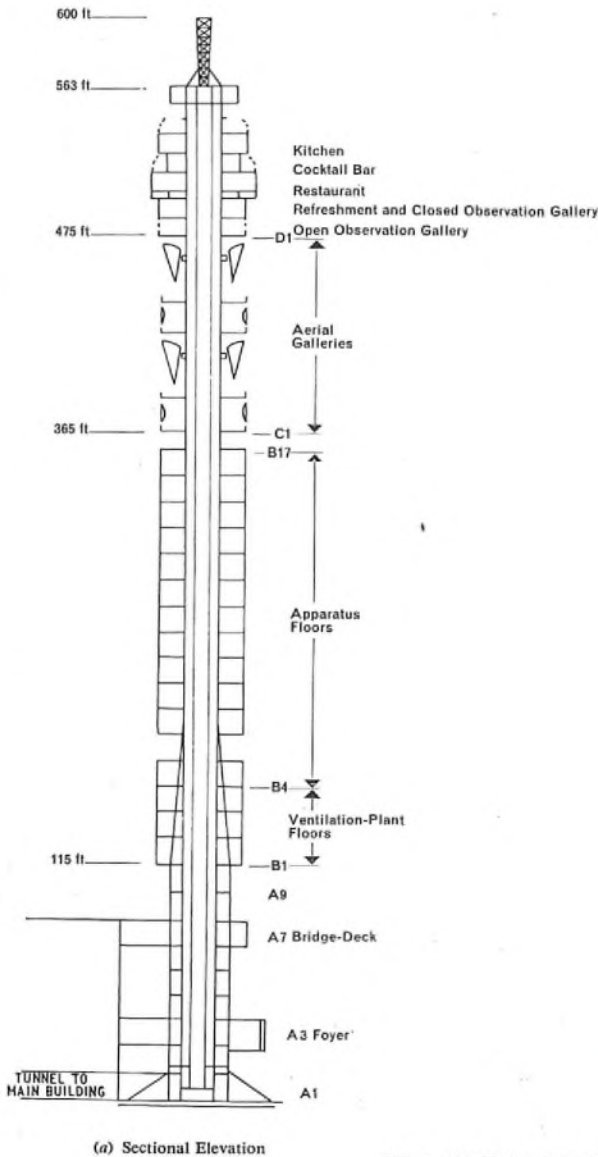

(a) Sectional Elevation

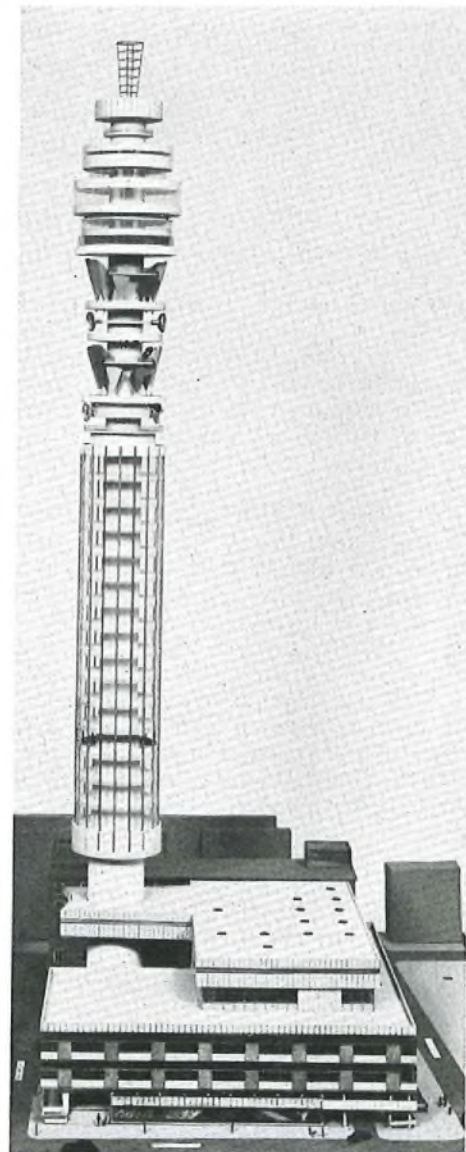

(b) Photograph of Model

FIG. 1—MUSEUM RADIO TOWER



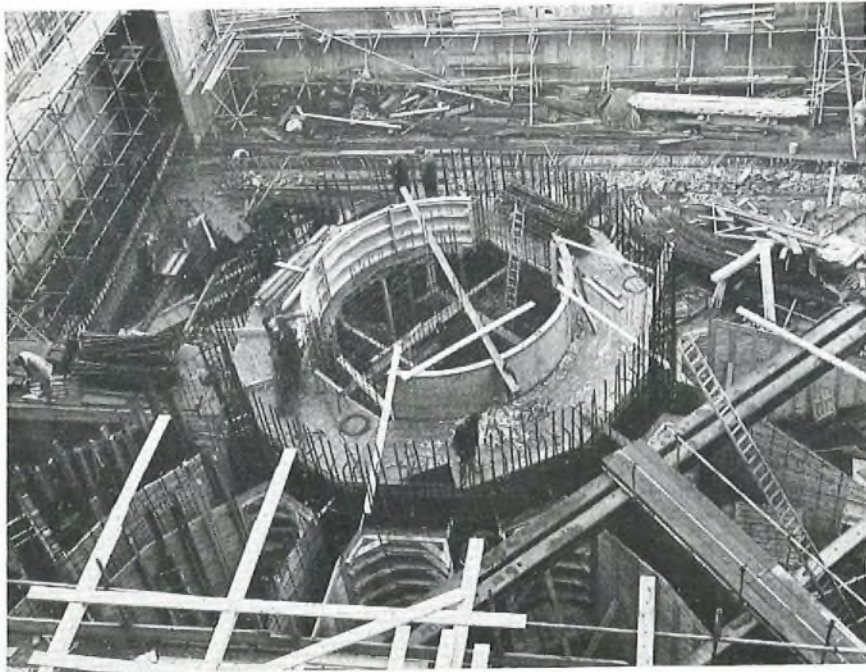

FIG. 2—WORK IN PROGRESS ON TOWER FOUNDATIONS

The tower, which will be about 560 ft to the top of the lift-motor room and will weigh some 13,000 tons, rises from a reinforced concrete truncated pyramid 90 ft square and 22 ft deep, built on a post-stressed concrete foundation raft constructed on blue-clay subsoil. Work on the tower foundation is illustrated in Fig. 2, and the progress on the tower early in May is shown in Fig. 3. Tall towers are susceptible to deformation due to wind pressures and non-uniform temperature changes brought about by solar heating. It is important, however, that aerial alignment with distant stations should be preserved, since the half-power widths of some of the radio beams used are less than one degree, and to permit angular movement would cause serious loss of signal power at the distant station. A deviation of not more than 20 minutes of arc has, therefore, been specified for the top of the structure. To assist in providing this degree of stability the diameter of the shaft, for the lower 200 ft, increases to 35 ft.

Further stability is provided by the bridge-deck that connects the tower to the main building at a height of 80 ft above the ground. This bridge will transmit an expected wind force of 600 tons to the main building, which is strengthened to support it, but at the same time there will be no resistance to vertical movement of the tower caused by the inevitable settling of the foundations and shrinkage of the structure. It is expected that wind pressures may deflect the top of the tower by as much as 15 in., and an elliptical movement 2 in. by 1 in. may result from solar heating, but the effect of such movements on the received signal power of the most sensitive microwave radio systems will only be about  $\frac{1}{2}$  db.

A building 600 ft high can be expected to receive a number of lightning strokes each year, and means must be provided for these to be harmlessly dissipated to earth. In this tower, reliance on the traditional copper-tape conductors for lightning protection has been dispensed with, and the steel reinforcement of the tower is being used to provide a path to earth for lightning discharges.

A main air termination (lightning rod) will be provided at the highest point of the tower, with secondary terminations placed at four points on the periphery at three other levels. These terminations will be electrically connected to the steel reinforcement bars, all of which will be joined together by welded joints. All other steelwork such as aerial supports, apparatus racks, lift guides, cable bearers, ventilation ducts and emergency staircases will be bonded to the vertical reinforcement rods that will themselves be connected to the earth-electrode system at the base of the structure. This consists of eight rods driven through 2 in. tubes cast in the foundation concrete and penetrating into the blue-clay subsoil. The tubes are arranged in two rings of four, the earth rods of each ring being connected by 1 in. copper tapes with interconnexion between the rings.

#### ACCOMMODATION PROVIDED

The tower can be divided conveniently into four main sections, as

follows:

(i) The lowest portion from the foundation slab up to the first equipment floor. This portion passes through

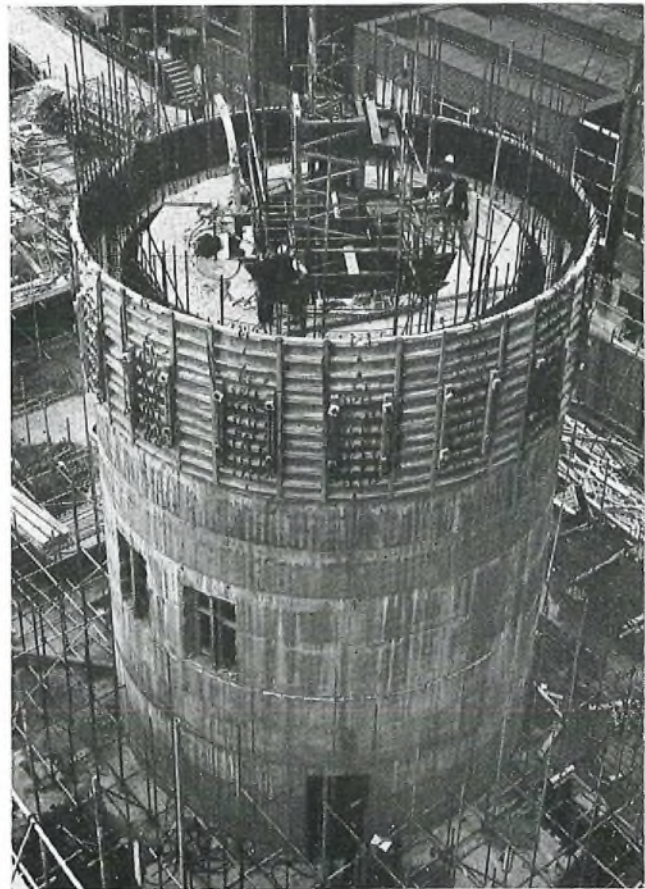

FIG. 3—PROGRESS OF TOWER BY MAY 1962



the bridge-deck and is split into nine A levels.

(ii) The next section comprising all the equipment and ventilation-plant floors (B1-17).

(iii) The aerial galleries (C1-6).

(iv) The topmost section that includes the restaurant and public galleries (D1-5) and, above these, the lift-motor room surmounted by the 40 ft-high lattice-steel mast.

#### The A Levels

From the A1 level, which is at the foundation slab of the tower, an access tunnel runs to the basement of the adjacent telephone-exchange and repeater-station building. This is about  $7\frac{1}{2}$  ft square in cross-section, and is intended primarily as a cabling tunnel with adequate access for staff.

The A2 level, or lower-ground-floor, is the general yard and car-park level on the Cleveland Mews side of the site. The whole of this area immediately surrounding the tower will be roofed over by the public entrance way and by the foyer at the next level, A3.

The general public will gain admittance to the top section of the tower through the foyer, which will have a ticket office and a waiting area with display facilities, seats, cloakrooms and a suite of public telephones.

The bridge-deck referred to earlier will be at level A7, and this, in addition to adding stability to the tower, will provide access from the main building at 4th-floor level for cables, staff and special visitors. It will also contain a cinema with seating for 53 people, along with a dark room, film store and an exhibition foyer.

Within the external walls of the tower pedestal, levels A2-9 inclusive will all be similar to each other and are essentially a structural requirement. In this section the external diameter of the tower will be 35 ft. The outer wall will be 2 ft thick and the central shaft, although still having a 20 ft internal diameter, will have a wall only 6 in. thick. Apart from their structural function, the narrow annular floors in the A levels may be useful for storage space or as working platforms during cabling operations.

#### The B Levels

Referring to Fig. 1 (a) it will be seen that there will be 16 floors available in the main section of the tower. Owing to the method of construction, however, the bottom five floors will be of substantially smaller floor area than the remainder, but it so happens that these narrow floors will be suitable for the main ventilation plant, which will be accommodated on the three bottom floors, B1-3. Moreover, exhaust air from the ventilation system has to be released at the B1 level and it will be expedient to do this through louvres in the floor.

The whole of the B section of the tower, with the exception of the B5 level, will be glazed with anti-sun glass and provided with sun-breakers to restrict solar-heat gain. For aesthetic considerations the glazing of the B5 level will either be omitted or set back so as to provide a break in the continuity of the outline, thus balancing the sculptural effect of the open aerial-galleries higher up.

Levels B6-16 inclusive will each have a floor area of something over 1,500 ft<sup>2</sup>, and are designed to accommodate radio and line equipment. There will be some welfare facilities on every third floor. A typical layout, showing the radial disposition of the apparatus racks, is illustrated in Fig. 4. Structurally all these floors will be

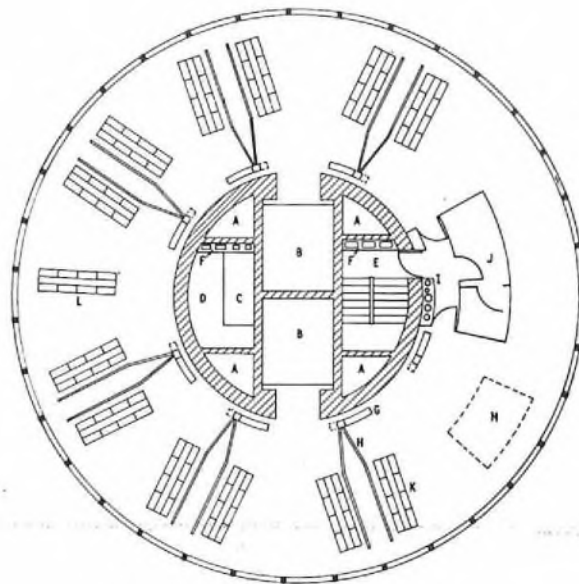

FIG. 4—TYPICAL LAYOUT OF APPARATUS FLOOR AND CENTRAL SHAFT

similar, but, because of Post Office requirements, there will be a difference in the upper floors that is of interest. As all the waveguides from the aerial galleries above will be brought down through slots in the apparatus floors close to the centre shaft, the maximum concentration of waveguides will occur at the ceiling of B16, the number diminishing progressively at lower levels as the waveguides are diverted to the various equipment floors. This means that at floor B16 there will be seven slots each 4 ft long and 8 in. wide, situated close to and encompassing the shaft, on a circle 78 ft in circumference (see Fig. 4). To give adequate strength under these conditions, at a point where the bending moment of the cantilevered floors is greatest, it will be necessary to thicken the five upper floors with a 2 ft square cross-section annular ring of reinforced concrete where the floors join the shaft.

Level B17, which will have a reduced diameter of 41 ft, is primarily intended as a point at which waveguides from the aerial galleries can be re-routed into the appropriate slots to serve the apparatus floors below. It will also contain window-cleaning equipment that can be lowered by power-operated machinery down guides, attached to the glazing bars all round the outer circumference, to the windows of the apparatus floors below.

#### The C Levels

The outline of the C levels will be as shown in Fig. 1 (a). The shaft in this part of the tower will have an outside diameter of 22 ft, and the galleries will be similar in construction to the lower B-level floors with waveguide slots but without reinforcing rings, and carrying a 4 ft-high parapet wall. The floors will be perforated to accept the aerial fixings estimated to be required and will allow a limited amount of further perforation. At this windy elevation the outer parapet walls will be needed at least as much for safety's sake as to give a pleasing

appearance to the distant eye, while the maintenance of the front surfaces of the aerials presents an interesting but not unduly formidable problem in access engineering.

### Aerials

The numbers and disposition of the aerials are settled by the following considerations. The frequency allocations for microwave radio-relay links\* are such that four heavily-loaded routes can be terminated at a single station. There will thus be four directions of radiation from Museum tower to its neighbouring stations. Each direction will be able to carry a number of broad-band channels in each of the 2, 4 and 6 Gc/s frequency bands, and the 11 Gc/s band is expected to come into use later. In addition, short spur routes from the tower can also be accommodated.

In planning, provision has been made for the ultimate installation of two large horn-reflector aerials, about 27 ft long, two smaller ones about 15 ft long and two 12 ft diameter parabolic dishes in each of four principal directions for the main routes. There will also be accommodation for a further ten 8 ft dishes for spur routes not yet allocated, and for a number of 4 ft dishes for other services.

The aerials must be so disposed in the galleries that there will be no reflective obstructions in the immediate vicinity within an angle of  $45^\circ$  to the beam axis, measured from the edges of the apertures, and, as measured from the upper rim of the horn aerials, the angle of clearance must be  $85^\circ$ . This is to avoid coupling between aerials or within the systems using any one aerial and to avoid the retransmission of reflected, and therefore delayed, signals that would give rise to distortion and crosstalk at the receiver. Next, there must be facilities for tilting and panning† each radio beam to enable the optimum direction of radiation to be achieved and, finally, the installation of the aerials must not be too difficult or dangerous a task to undertake in the centre of a city, nor must the operation of adding aerials at a later stage interfere with the working of those already installed.

A solution to the problem of erection has been found wherein the larger aerials will be manufactured in units of the maximum size permitted by the lift system and assembled on site. The aerials will, in general, be mounted with their weight taken on the gallery floors and the wind loads taken by strutting back to the core. The adjustment will normally be permanent and effected by built-in or removable cradles and adjustable braces. Waveguides and cable feeders will be taken back to the core and then down to floor B17 to enter the correct slot for the radio equipment below. The horns will be of the multi-frequency bipolar type and will carry their branching units directly underneath them. These units will be the transducers connecting the rectangular guides of systems with different frequencies and different wave polarizations to the circular throat of the horn, and will themselves be approximately 20 ft long.

Aerials for spur routes and other services will take up the gallery spaces between the main-route aerials and will also occupy the small butterfly-wing mezzanine galleries shown at about mid-horn level in Fig. 1 (b).

### The D Levels

As a spectacular and novel contribution to the amenities of London, members of the public will be admitted to the D-level section of the tower, which will be by far the tallest building in the capital. This section,

all levels of which will be reached by express lifts from the foyer, has been designed to provide suitable facilities for approximately 500 visitors. Access between floors will be by way of a broad staircase.

**D1 Level.** The D1 level will be the public observation gallery situated immediately above the aerial galleries at about 475 ft above the ground. It will be open to the sky except for a protective mesh above the parapet wall. It will be provided with telescopes, and not only will it be a useful vantage point from which to view or photograph the London scene but it will also serve as a collection and evacuation area should any emergency arise affecting the public floors above.

There will be a fire break in the escape staircase at this point.

**D2 Level.** A combined light-refreshment bar and closed observation gallery will be incorporated in the D2 level. There will be some seating accommodation, and meteorological instruments and charts will be on view.

**D3 Level.** The restaurant floor, D3, will have seating accommodation for 100 diners. Their tables will be placed near the windows on an 11 ft-wide strip of floor that will slowly revolve, completing two or three circuits in about an hour, the drive being by electric motor through a rack and pinion or a wire rope. As the restaurant floor will be wider than the remainder of the tower and as the windows will be mounted on the moving floor, the diners will be able to enjoy an uninterrupted panoramic view of London as the restaurant rotates.

A weather seal will be provided between the tops of the moving windows and the fixed frame by means of a lip dipping into a continuous trough filled with oil.

The layout of the restaurant is shown in Fig. 5.

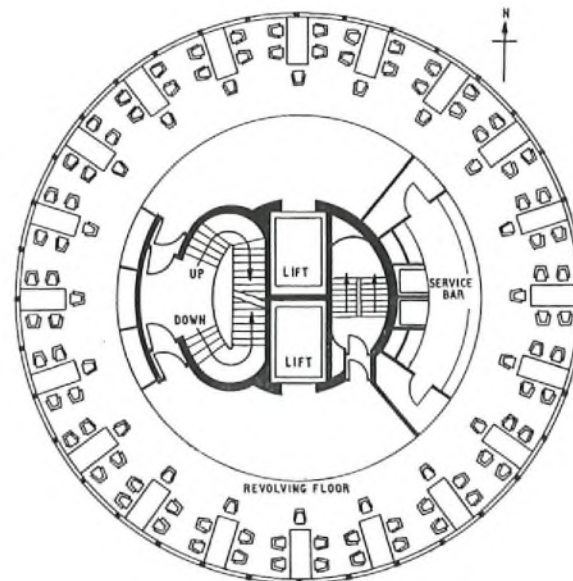

FIG. 5—LAYOUT OF RESTAURANT

**D4 Level.** The D4 level will accommodate the cocktail bar and cloakrooms for patrons of the restaurant. The layout can be seen by reference to Fig. 6. Note the

\* BRAY, W. J. Standardization of International Microwave Radio Relay Systems. *Proceedings I.E.E.*, Paper No. 3412E, Mar. 1961 (Vol. 108, Part B, p. 180).

† Panning—adjusting the horizontal direction of the radio beam.



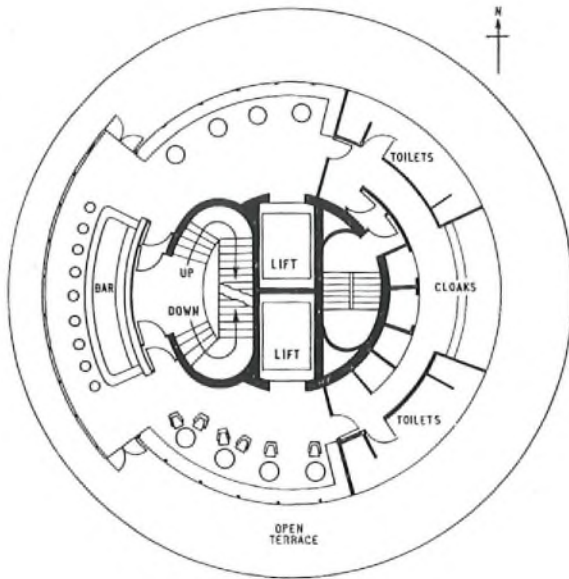

FIG. 6—LAYOUT OF COCKTAIL BAR

broad staircase leading down to the restaurant and the open terrace that will provide yet another observation point. There will also be public telephones on this floor.

*D5 Level.* The topmost floor of the public section, D5, will contain the kitchen quarters. All the facilities needed for storing, preparing and cooking the first-class fare that will be served in the restaurant below, together with complete welfare accommodation for the chefs and their assistants, will be provided here. Electricity will be used for cooking, the use of other fuels for this purpose being precluded for reasons of safety. There will be two service lifts linking the kitchens with the three public floors below at which refreshments will be obtainable.

Above the top of the kitchen floor, the shaft rises a further 17 ft, allowing for lift "over-run," to the floor of the lift-motor room. The latter will house not only the lift motors and associated gear but also water tanks for domestic services.

#### POWER SUPPLIES, LIGHTING AND VENTILATION

Power supplies will be derived from the main building extension wherein duplicate 11 kV main supplies will be provided. These will be transformed to (nominally) 415/240 volts by duplicate sets of transformers each comprising two 1,250 kVA dry-type transformers. Standby plant for essential services will consist of five 500 kVA diesel-alternator sets, all automatically started on mains failure.

The tower load of approximately 900 kW will be fed from the medium-voltage switchboard in the new building extension. Three separate distributions will provide short-break, long-break and non-essential supplies, respectively, for telecommunications equipment, selected accommodation services, and remaining accommodation services not essential in the event of extended supply failure.

Main distribution from the medium-voltage switchboard will be by ducted multi-core cables connected at the base of the tower to three rising busbar systems in metal trunking. The distribution has been designed to keep voltage drop to a practical minimum and cater for linear expansion of the rising busbars.

#### Lighting

Lighting in the tower will be mainly fluorescent and, on equipment floors, it will be arranged radially to conform with the apparatus layout. Periphery lighting will be provided internally at appropriate levels for both functional and aesthetic purposes. The design will provide for a degree of lighting to be maintained at all working levels, if required, between dusk and midnight, so that an evenly illuminated exterior will be presented. Filament lighting will be installed on the staircase and other access ways within the shaft. As far as possible Post Office standard lighting fittings will be used except in special areas such as the restaurant, public corridors and the entrance foyer, in which the lighting will be part of the general decor. Aircraft warning lights will be provided to the requirements of the Ministry of Aviation.

Emergency lighting of the staircase and public areas will be supplied from a battery designed to cover a period of three hours, and a proportion of the apparatus lighting will be fed from the long-break supply to provide emergency lighting for working purposes during extended supply failure.

#### Air-conditioning

It is intended to provide two air-conditioning plants in the tower, one to serve the apparatus floors B4-16 and the other to serve the public floors D1-5. Initially, the plant serving the apparatus floors will provide high-velocity ventilation only, facilities being provided for adding refrigeration plant at a later date. Three floors, B1, B2, and B3, have been allocated to house the ventilation and refrigeration plant. The capacity of the ventilation plant will be approximately 60,000 ft<sup>3</sup>/min, this being split between two half-duty plants. Air will be taken in through louvres in the side of floor B1, the intake fans (about 70 h.p. each) being housed on floor B2. The air will be cleaned by means of two electrostatic filters on this floor before being circulated to the apparatus floors through two vertical structural ducts inside the shaft of the tower. On each apparatus floor an annular supply duct will be connected to the vertical ducts and air will be fed into the room through diffusers. An annular extract duct will also be provided on each floor.

Where possible, extraction will be direct from the radio-apparatus cabinets. These extract ducts will discharge into a further two vertical structural ducts leading to 75 h.p. extraction fans situated on floor B3. Facilities will be provided for recirculation of part of the air, the design requirement being to maintain the room ambient temperature at not more than 10°F above the outside ambient temperature.

Fan horse-powers are high because the permissible size of the main ducts necessitates a high air velocity (3,000 ft/min). Special expansion boxes with sound attenuation will be provided at the junctions with the room ductwork, which will work at about 1,000 ft/min. Silencers will also be provided for the intake and exhaust at B1 level.

When the installed radio-apparatus load grows to about 75 kW it will be necessary to install refrigeration plant to cool the air in order to maintain satisfactory conditions for the staff. The total installed refrigeration capacity will be 160 tons\* of refrigeration divided between two half-duty plants. Because of space restrictions four quarter-duty compressors (each of about 40 h.p.) will

\* 1 ton = 12,000 B.t.u./hour.

be used. These will be located on floor B1 in an annular space only 5 ft wide and of outside diameter 31 ft. The plants will be of the direct-expansion type, the air coolers being located in the supply ducts on floor B2. The evaporative condensers will be housed on floor B3. The plant will then be able to deal with a total apparatus dissipation of 250 kW (up to 45 kW per floor on certain floors) and a total solar gain of 115 kW.

#### LIFTS

##### *Basic Requirements*

The lifts in the tower will be required to carry:

- (a) the public to the high-level observation floors,
- (b) customers to the restaurant,
- (c) Post Office staff and official visitors to the operational floors and aerial galleries,
- (d) supplies to, and refuse from, the kitchen,
- (e) racks of equipment to the operational floors,
- (f) aerial sections to the aerial galleries, and
- (g) maintenance staff and their equipment to all floors.

Service will thus be required to all 29 floors, including the four aerial galleries.

##### *Design Considerations*

*Size.* It was considered that two lifts at least would be necessary to provide an adequate and reliable service.

The lift wells have to be incorporated within the central concrete shaft, which has a minimum internal diameter of 20 ft. As the stairs and service ducts will also have to be accommodated within this shaft the space available for the two lift wells is limited to 18 ft by 6 ft 6 in. This in turn limits the lift-car size to 6 ft 3 in. by 4 ft 6 in. The number of passengers that can be carried in a car of this size is 15, and this gives a contract load of 2,250 lb, which is adequate for the heaviest equipment to be carried. The normal car height of about 7 ft is insufficient for accommodating large aerial sections, and an internal height of 12 ft has been allowed. To preserve normal car proportions when carrying passengers a removable ceiling at a height of about 7 ft will be provided.

For structural reasons the clear size of the landing entrances has had to be limited to 3 ft 6 in. wide by 6 ft 9 in. high.

*Speed.* It was originally thought that a speed of 700 ft/min would give both a reasonable time for the journey from the ground floor to the public observation gallery and adequate passenger-handling capacity. The depth of the lift pit and the top over-run clearances were determined from this speed. Subsequently, a decision to increase the number of public floors by adding floors for restaurant, kitchen and other services increased the lift travel to 525 ft and appreciably increased the prospective lift traffic. It was therefore decided to increase the speed to 1,000 ft/min, which is the highest speed used in this country. This gives a top-to-bottom journey time of 34 seconds. The lift pit having already been constructed it has been necessary to make special arrangements to

ensure that the lift car cannot in any circumstances approach the lowest floor at a speed exceeding 850 ft/min, which is the maximum speed allowed for a 700 ft/min lift.

*Type of Control.* Dual, directional, collective control has been adopted. In this system an UP or a DOWN call can be registered at any landing. The lift car will answer in order all calls in the direction for which the car is set to travel and then reverse to answer all calls in the opposite direction. With "attendant" control, facilities are provided to bypass all intermediate-landing calls when it is necessary for a full car to make a fast run from ground to top floors or vice versa.

There is no interconnexion between the lifts and each operates independently of the other.

*Lift Machines.* Gearless d.c. lift-motors will be used, with the driving sheaves mounted directly on the motor shafts. Each motor will be supplied by a motor-generator, and field-control of the generator output, using the Ward-Leonard principle, will give automatic control of acceleration, running and slowing.

*Ropes.* Each car and counterweight will be directly suspended from six wire-ropes that will be double wrapped round the driving sheave and an auxiliary pulley to give adequate tractive effort. Compensating ropes will be fitted beneath.

#### MISCELLANEOUS FACILITIES

As this will be the tallest building in London certain scientific bodies have expressed the wish to be granted facilities to mount instruments on it. Foremost amongst these bodies is the Meteorological Office, whose intention is to install the following equipment:

(a) A storm-warning radar scanner and an anemometer at the top of the lattice mast; these unfortunately will have to be removed should this position be required for a Post Office aerial at any time in the future.

(b) Solarimeters and radiation recorders near the top, and thermometers, and humidity and fog recorders at four points up the tower.

These instruments will be arranged for remote reading at a common point, and a suitable display unit will be on view to the public in the observation gallery.

The Building Research Station also is arranging to install pressure-plate anemometers and strain gauges at various points on the structure.

Lastly, University College, London, are providing resistance thermometers that project into the atmosphere at various levels up the tower in connexion with their research work on the climate of London.

#### ACKNOWLEDGEMENTS

The tower was designed by the Chief Architect's Division, Ministry of Works, to whom the authors are indebted for the architectural and structural details. The authors also wish to acknowledge the assistance given by colleagues in the Engineering Department.



# An International Experiment in Frequency Comparison

R. L. CORKE, A.M.I.E.E.†

U.D.C. 529,786:621.317.361

In the autumn of 1959 the Post Office co-operated with the Cruft Laboratory at Harvard University and the United States Signal Corps in the comparison of the phase of signals from the high-power 16 kc/s transmitter at Rugby, the measurements being made at Banbury and at Cambridge, Massachusetts, U.S.A., some 3,000 miles away. One object of the experiment was to find the probable accuracy of frequency comparisons at large distances. An accuracy of about 2 parts in  $10^{11}$  can be expected for a 24-hour period of measurement.

## INTRODUCTION

THE powerful 16 kc/s transmitter GBR at Rugby has virtually a world-wide range as a telegraph transmitter. Its carrier frequency has been controlled by a master crystal oscillator since 1954 and this oscillator also controls the MSF\* standard-frequency transmissions at 60 kc/s, 2.5, 5, and 10 Mc/s. These MSF transmissions are calibrated by the National Physical Laboratory (N.P.L.) by comparison with the caesium resonator at Teddington. Thus, the GBR transmissions have the same frequency calibration. The master oscillator at Rugby is highly stable and is occasionally adjusted by minute amounts so that its frequency is kept very close indeed to its correct value. Today, the accuracy is such that the transmitted frequencies rarely depart by more than 2 parts in  $10^{10}$  from a declared value relative to the N.P.L. caesium resonator.

Signals from GBR arriving at a distant point on the Earth's surface carry the N.P.L. frequency calibration with an accuracy disturbed only by the effects of propagation on the phase of the signals. An experiment<sup>1</sup> was conducted in September and October, 1959, jointly by Cruft Laboratory of Harvard University, the United States Signal Corps and the British Post Office in an endeavour to discover how much error would be introduced by propagation effects over a radio path of 3,000 miles at carrier frequencies of 16 kc/s.

The method of measurement was to compare the phase of the received GBR carrier with a highly-stable local reference situated at Banbury, Oxfordshire, 24 miles from the transmitter, and, at the same time, to compare the phase of the carrier as received at Cambridge, Massachusetts, U.S.A., with a similar stable reference. The information gathered from this experiment was to prove valuable for later work in connexion with comparisons of the U.S.A. and United Kingdom standards of time and frequency. These are now continuously compared by means of two transmissions, one from Rugby at 16 kc/s and the other from a similar high-power station, NBA, situated in the Panama Canal Zone and transmitting at 18 kc/s.

The frequency stability of both the GBR and NBA transmitters is of the same high order, and mutual comparisons can be made in Europe and in America in such a way that the basic standards of frequency and of time intervals in these continents can be compared continuously, the accuracy of measurement being probably better than 2 parts in  $10^{11}$ .

In addition to the use of transmissions from controlled very-low-frequency (v.l.f.) stations for the purpose outlined above, it has been found possible to navigate aircraft<sup>2</sup> with an inaccuracy of only a few kilometres at great distances from the transmitters by comparing the phase of the distant transmitter with a reference standard oscillator borne by the aircraft. These navigational facilities, as well as those for comparing frequency and time interval, are available from a radio transmitter that is used for commercial traffic and has no special modification except the provision of a very stable carrier source.

## PROPAGATION EFFECTS

A much-simplified idea of the way propagation changes occur can be obtained by making the assumption that the radio waves are propagated along a path bounded by the Earth and by a conducting layer of gas high in the atmosphere where it is ionized by the sun's radiation. During the night ionization is less active and the effective height of the layer tends to rise, so that when the majority of the radio path is in darkness the apparent length of the radio path is longer than in daylight conditions.

Assume that phase-measuring equipment is set up close to the transmitter and able to measure the phase of the received carrier by reference to a stable local oscillator. If there is an identical receiving equipment at a distance, and if both local oscillators can be regarded as being absolutely stable and in all ways identical, the difference between the phase records taken at the two receiving stations would be the phase changes introduced in propagation between the transmitter and the more distant receiver.

In the experiment it was found that during the night the apparent phase of the received signal at the distant station tended to lag by about  $180^\circ$  at 16 kc/s, indicating an increase of propagation time of about  $30\mu\text{s}$  or, alternatively, an increase in the effective length of the radio path of half a wave-length. If a frequency measurement were made during a period that covered the transition from day to night or from night to day over the path, and if frequency were measured by counting the number of cycles in a given time, the half-cycle gained or lost due to propagation effects would constitute an error which, if the measuring time were brief, could be very large. For example, even if the measurement were made by counting cycles continuously for a period of about five hours (20,000 seconds) the error caused during a light-to-dark transition would be as much as 6 parts in  $10^9$ .

Fortunately, it was found that the propagation effects at very low frequencies are reproduced quite accurately from day to day, and, if a measurement is made over a period of 24 hours, the errors in propagation are nearly eliminated. It has been demonstrated that, for navigational purposes, the diurnal phase characteristic is so consistent that corrections can be made to the received phase to obtain good accuracy in position finding. In the Banbury-Harvard experiment, it was shown that

† Post Office Research Station.

\* MSF—the call sign of the transmitter used for the standard frequency service.



during the measurements in the autumn of 1959 the likely error in a 24-hour measurement, over a distance of 3,000 miles, was no more than about 2 parts in  $10^{11}$ , and this is the probable accuracy with which standards of frequency can be compared using v.l.f. transmission between the United Kingdom and the U.S.A.

#### EXPERIMENTAL METHODS

In the previous section it was assumed that the local phase references at the two receiving points would be absolutely stable and remain with the same relative phase throughout the experiment; this is not possible in practice. Another method would be to use two transmitters, one at each end of the path, and to monitor both transmissions at both ends and assume that propagation effects would be identical for both signals. At the time of the experiment, however, no American v.l.f. station was sufficiently stable in frequency, and the experiment necessarily had to be conducted by providing, at the two receiving points, local oscillators having the best available long-term stability. The oscillators used were "Atomichrons".<sup>3,4</sup> Two of these caesium-controlled oscillators were set up, together with phase recording equipment, at the Post Office monitoring station at Banbury, Oxfordshire by Dr. G. M. R. Winkler of the United States Signal Corps Laboratories, Fort Monmouth, New Jersey, with the assistance of the Post Office staff. Similar apparatus was used at the Cruft Laboratory at Harvard under the direction of Professor J. A. Pierce.

The Atomichron is a caesium-beam-controlled oscillator in which a quartz oscillator having a frequency of about 5 Mc/s is servo-controlled relative to a transition frequency of the caesium atoms. The short-term stability of such a device is likely to be somewhat inferior to that of a good quartz-controlled oscillator because of the servo action, but its long-term stability can be of a very high order, since the frequency is fundamentally dependent on a basic atomic behaviour that is unaffected by pressure and temperature and is only disturbed by magnetic fields, which can easily be measured and allowed for.

The phase-measuring equipment must have a long time-constant, perhaps of the order of 1 minute, in order that the record should not be influenced by short-term effects such as the reception of keyed-carrier morse signals. Thus, any small short-term instability of the Atomichron is probably unimportant in this application.

At Banbury, the Atomichron was used to drive a frequency synthesizer that produced an output of very nearly 16 kc/s. The GBR signal from a fixed-tune transistor-type receiver was arranged to brighten the trace of an oscilloscope for a period of  $5\mu\text{s}$  at each successive peak of the carrier. The X deflexion of this trace was under the control of the 16 kc/s supply from the Atomichron and synthesizer. A slow-moving photographic film, moving at a constant rate across the field of a camera focused on the trace, recorded the trace position and, in effect, the time of arrival of each element of the trace.

If the frequency of both the Atomichron output and of GBR were exactly the same at all times, the trace so recorded on the film would run parallel to the direction of film travel. Any relative change of phase between the two signals would cause a displacement of the trace either to the right or to the left, so that a uniform difference of frequency between the two would produce

a diagonal trace on the film, the slope of the trace being a measure of the frequency difference between the two. Accurate time markers were impressed on the photographic record to enable frequencies to be measured with precision and to enable the record taken at Banbury to be compared with that made at the same time at Harvard, where the equipment was almost identical with that at Banbury.

#### RESULTS

The figure shows the results obtained during September, 1959, from the records made at Banbury and at Cambridge, Massachusetts. The curve derived from

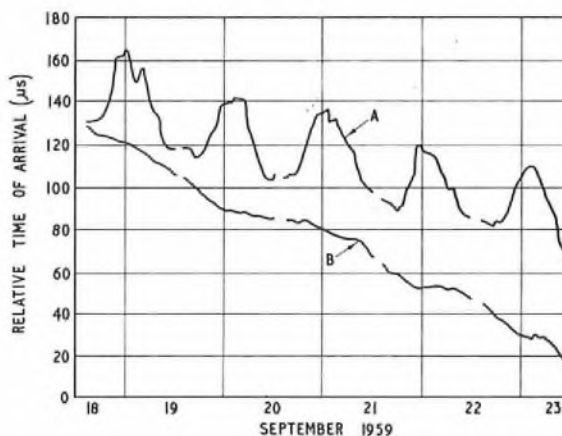

Curve A refers to Cambridge, Massachusetts, U.S.A.  
Curve B refers to Banbury, England

#### OBSERVED PHASE VARIATIONS

results at Banbury represents a small, roughly sinusoidal, component combined with a linear variation, and this curve expresses the variation of phase of the signals received from GBR compared with the Atomichron at Banbury for the days of the month shown. The vertical scale is expressed in microseconds and this may be converted easily into cycles or degrees by remembering that the GBR carrier at 16 kc/s occupies  $62.5\mu\text{s}$  per cycle. The sinusoidal component has a peak amplitude of about 5 or  $6\mu\text{s}$ , and the slope of the phase characteristic varies from about zero at some points on the curve to about  $60\mu\text{s}$  if the trend continued for about 24 hours. Thus, the changes of relative frequency between GBR and the Banbury Atomichron during the period shown in the figure were from about zero to roughly 6 in  $10^{10}$ , with a mean difference of 2 parts in  $10^{10}$ , the mean difference being the linear component of the curve.

The Harvard results, also shown in the figure, illustrate that, during the period of measurement, the diurnal change was about  $30\mu\text{s}$  and that the maximum delay occurred during the time when darkness prevailed over the Atlantic ocean. The figure also shows that the mean slopes of the two curves are different, indicating that the two Atomichrons differed in frequency though this amount was no more than 1 or 2 parts in  $10^{10}$ . There is some correlation between the peaks and dips of the Banbury curve and those measured at Harvard, and it could be inferred from this that the Rugby oscillator was varying slightly in a nearly diurnal manner.

A statistical analysis by Professor Pierce of the results obtained during September and October 1959 shows that

the day-to-day fluctuations of transmission times between Rugby and Harvard were about  $2\mu\text{s}$  and the consequential error in frequency would be about 2 parts in  $10^{11}$  for a period of 24 hours.

Since the experiment described above was performed, the United States Navy Station Transmitter, NBA, in the Panama Canal Zone has been frequency stabilized, and reciprocal measurements made since then between the United Kingdom and the U.S.A., using both transmitters GBR and NBA, give results that seem to confirm the probable uncertainty arrived at as a result of the Banbury-Harvard tests, namely 2 parts in  $10^{11}$  for a period of 24 hours, and this figure is probably the best accuracy through the medium of v.l.f. transmissions for comparing international standards of frequency.

#### CONCLUSION

In conclusion, it is of interest to mention that the time-signal services of the United Kingdom and the U.S.A. are now individually related to the standard-frequency services in such a way that the time signals not only represent accurate time intervals but the particular markers of time also accurately represent specific moments of time or epoch, and the relative accuracy of the two systems in the United Kingdom and the

U.S.A. for time-signal emission is such that the instants of emission probably differ by no more than 1 ms. This co-ordination of the time and frequency services has provided an important basis for a common working reference of time which may be used, for example, for tracking and plotting with accuracy the paths of satellites as they pass over from one continent to another.

#### ACKNOWLEDGEMENTS

Acknowledgement is made of the way Mr. W. N. Genna and the staff of the Post Office measuring station at Banbury provided facilities and gave enthusiastic support to the experiment and to Dr. Winkler during his stay at Banbury.

#### References

- <sup>1</sup> PIERCE, J. A., WINKLER, G. M. R., and CORKE, R. L. The GBR Experiment. *Nature*, Vol. 187, p. 914, 10 Sept. 1960.
- <sup>2</sup> BLACKBAND, W. T. Effects of Ionosphere on V.H.F. Navigational Aids. *Journal of Research*, Vol. 65D, p. 575. Nov.-Dec. 1961, National Bureau of Standards, U.S.A.
- <sup>3</sup> MCCOUBREY, A. O. The Atomichron—An Atomic Frequency Standard: Physical Foundation. *I.R.E. National Convention Record*, Part 1, p. 10, 1958.
- <sup>4</sup> MAINBERGER, W., and ORENBERG, A. The Atomichron—An Atomic Frequency Standard: Operation and Performance. *I.R.E. National Convention Record*, Part 1, p. 14, 1958.

## Book Review

“Electrical Theory on the Giorgi System.” P. Cornelius. Translated from the Dutch by L. J. Jolley, Ph.D. Cleaver-Hume Press, Ltd. x + 187 pp. 28 ill. 32s.

This book is an attempt to develop electric field theory from first principles using mathematical forms which are likely to be more familiar to the engineer and the technician than those traditionally used in books with the more academic approach and intended for students of pure theoretical physics. With the same group of readers in mind the author also seeks to make such abstract concepts as field strength and flux more readily understandable by considering them as analogous to the more practically-based concepts of electromotive force and current. The author further makes it clear that he is addressing readers who regard mathematics and theoretical treatment in general, primarily as tools for making calculations of direct practical interest to the engineer and technician. At the same time he hopes that his treatment of the subject will still be of value to those with an academic interest in theoretical physics, who, accordingly, look upon mathematical expression and field theory as means of acquiring a deeper and more thorough grasp of fundamental principles.

Accordingly, the treatment commences with Ohm's Law and its interpretation in terms of vector algebra, so that from the outset the equations involving potential difference and current are in the same form as those traditionally used when applying vector algebra to electric and magnetic fields. After developing these ideas simply but thoroughly the author passes immediately to a discussion of the significance of capacitance in electric fields and, in particular, the role of capacitance as a means of storing energy in electrical form. The concept of self-inductance is then introduced as a means of storing energy in magnetic form. Proceeding in this way, electromagnetic theory is developed on a strong practical basis in terms of energy storage and transmission, and the natural dissipation of such energy when current flows in resistive components. As a result the way is opened for an early consideration of Maxwell's Laws and some of their theoretical consequences.

In the early part of the treatment the use of specific units is avoided and the author quite deliberately emphasizes that the equations which emerge from these conceptions represent relations between fundamental variables—and these relations are independent of the system of units employed. He indicates how the equations need to be modified—merely by introducing appropriate purely numerical factors—in order that they shall be meaningful when using a specific system of units. The author is also at some pains to make clear exactly how it is that the numerical factors  $2\pi$  and  $4\pi$  arise as a result of purely geometrical requirements when spatial relations are concerned.

By considering the nature and magnitude of the mechanical forces acting on bodies subject to the effect of electric and magnetic fields, the author demonstrates the convenience of adopting the M.K.S. unit of force—the newton. It is accordingly an obvious advantage to define the volt and the ampere so that the following relation holds between the energy units of mechanics, electromagnetism and heat:

$$\begin{aligned} 1 \text{ newton metre} &= 1 \text{ volt ampere second} \\ &= 1 \text{ watt second} \\ &= 1 \text{ joule.} \end{aligned}$$

Having developed electrical field theory and related it to the Giorgi System of units, the author devotes the remaining half of his book to a detailed discussion of a selection of interesting electrical theoretical problems illustrating the practical advantages of his treatment. These problems include a number of subjects of particular interest to the telecommunications engineer such as: long conductors, plane progressive wave, wave resistance in a vacuum, radio-receiving aerials, the magnetic circuit and the transformer, electric and magnetic polarization, and permanent magnets.

The book will be found interesting, stimulating and useful to the student who wants to obtain a more thorough understanding of the significance of electromagnetic theory as a branch of theoretical physics but who, at the same time, wants to use the equations developed by this theory as powerful tools to make practical calculations about the transmission of energy.

F. C. M.



# Local-Call Timing at Non-Director Telephone Exchanges

B. D. GORTON†

U.D.C. 621.395.361.1:621.395.722

A new local-call timer for use at non-director telephone exchanges has been introduced. In addition to timing the call, the new circuit is designed to terminate metering and effect the forcible release of all automatic equipment following it in the switching train if the called subscriber's line is held for a period related to the rate of metering. The circuit may be connected in the uniselector grading or between subsequent ranks of switches. By splitting the P-wire circuit, the new timer eliminates double connexions, which might otherwise have been caused by excessive P-wire resistance.

## INTRODUCTION

LOCAL-CALL timing<sup>1</sup> was introduced concurrently with subscriber trunk dialling (S.T.D.) at Bristol in December, 1958, and is being applied throughout the country. The timing circuit employed at the outset was very simple, comprising a Post Office Type 2 uniselector as the pulse-counting device and one controlling relay. Early experience with S.T.D., however, indicated a need to provide the following additional facilities:

- (a) means of forcing the release of a call if the called subscriber's line is held,
- (b) means of splitting the P-wire circuit to prevent double connexions, and
- (c) a design permitting local-call timers to be fitted in one of two positions, as required.

It was convenient to provide all of these facilities by a new design of local-call timer.

The original timing circuit was succeeded by another that incorporated a forcible-release facility, but this timer is to be superseded by a circuit that, in addition to providing forcible release, is so designed that it may be inserted at alternative points in the switching train, the location depending on the trunking scheme of the exchange concerned. This arrangement will ensure that a minimum number of timers is used in a particular installation. The new timer also splits the P-wire circuit.

## NECESSITY FOR FORCIBLE-RELEASE FACILITY

In automatic telephone switching systems of the British Post Office it has been the practice for the release of a connexion to be controlled by the calling subscriber, and until this release took place the called subscriber could neither originate nor receive other calls. The called subscriber's line could thus be held accidentally, by failure of the calling subscriber to replace his telephone handset properly, or deliberately, if the calling subscriber had malicious intentions. A fault could also prevent the call being released. From the engineering point of view the holding of automatic apparatus (and, in some instances, junctions) not in use for conversational purposes was accepted as more economic than providing automatic means for their disconnexion in the above circumstances.

The incidence of calls resulting in the called subscriber's line being held unnecessarily (a circumstance usually

referred to as "called subscriber held"—C.S.H.) was the subject of many investigations with the object of determining whether any action to effect the forcible release of such calls could be justified. At the time many exchanges had full-time engineering attendance, and patrol staff could restore service to a subscriber whose line was held. At unattended exchanges, however, the cost of restoring service was high because it was necessary for an engineer to visit the exchange to clear the connexion.

At non-director exchanges a C.S.H. condition is indicated by a lamp signal at the final selector, and it seemed reasonable to force the release of the connexion at that point. However, the large number of final selectors involved would have made such a scheme costly, and it was not therefore adopted. Further action was deferred and only reconsidered after S.T.D. had been introduced, because, not only was the called subscriber held, but the local-call timer circuit still functioned and metering continued at regular intervals although the called subscriber had replaced his handset.

## REASONS FOR INCORPORATING FORCIBLE-RELEASE FACILITY IN LOCAL-CALL TIMER

The present circumstances differ in two respects from those obtaining previously. Firstly, with all previous schemes, forcible release resulted in the calling loop seizing another selector. However, with shared-service lines, which call by applying earth potential to the line, a looped line would not result in another selector being seized, the final-selector multiple would be unguarded and incoming calls to either of the sharing subscribers, although ineffective, would result in false metering. The second difference is that the local-call timer is so located in the selector train that the quantity of timers required is approximately one third to one half of the number of final selectors in the exchange. Thus, taking advantage of this circumstance, inclusion of the forcible-release facility in the local-call timer avoids modification of existing equipment, and the number of points at which the facility is required can be reduced.

Earlier proposals made use of common equipment which could only deal with one circuit at a time; this had the inevitable result that a wide variation in the delay period could occur, and metering might continue for some time after the called subscriber had replaced his handset. The new circuit gives individual control of the delay period, using a ratchet relay,<sup>2</sup> provided for timing calls, to time the delay period before forcible release is effected.

The new timer may be connected between ranks of selectors (1st and 2nd) or in the uniselector grading (Fig. 1). The latter position usually results in a more economical arrangement, but at a few of the larger exchanges the alternative position is less costly: hence the need for a timer that may be installed in either position. However, if the equipment is connected in the uniselector grading it is necessary to prevent local-call timing on levels 1 and 0, and this is done by means of a vertical marking bank and wiper on the associated 1st selector. If the timer is associated with the subscribers' 1st

† Telephone Exchange Systems Developments Branch, E.-in-C.'s Office.

<sup>1</sup> ELLIS, D. R. B., and GORTON, B. D. Local-Call Timers. *P.O.E.E.J.*, Vol. 51, p. 333, Jan. 1959.

<sup>2</sup> MANNING, D. J. The Post Office Type 1 Ratchet Relay. *P.O.E.E.J.*, Vol. 53, p. 154, Oct. 1960.



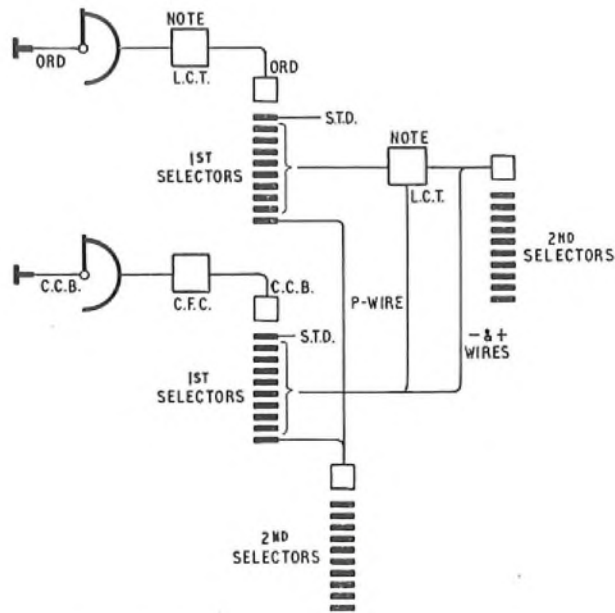

ORD.—Ordinary. C.C.B.—Coin box. L.C.T.—Local-call timer. C.F.C.—Coin and fee checking equipment  
Note: Alternative positions for local-call timer

FIG. 1—TRUNKING ARRANGEMENTS FOR LOCAL-CALL TIMING

selector there is the added advantage that on junction calls only one timer, that at the originating exchange, is brought into use. This is, however, dependent on the location of the timers at the terminating exchange.

The advantages of incorporating the forcible-release facility in the local-call timer can be summarized as follows:

(a) Service is restored promptly to the called subscriber, and it is more difficult for a subscriber maliciously to prevent competitors in business (e.g. bookmakers or taxi-service proprietors) from receiving incoming calls, because the called line will be released after 3–6 minutes when the full tariff applies and 12–24 minutes during the reduced-rate period.

(b) Equipment that formerly would have been held is released to traffic and thus, in conjunction with local-call timing itself, there is a possibility of reduced switch provision.

(c) Any junctions that would have been held are returned to traffic.

(d) Current consumption is reduced.

(e) At unattended exchanges it is unnecessary for an engineer to visit the exchange to restore service to called subscribers who would previously have demanded attention. Since more and more exchanges are unattended outside the normal hours of duty this should show considerable savings.

(f) The time taken tracing a call back to identify the calling subscriber is also reduced.

#### DESCRIPTION OF NEW CIRCUIT

The additional facilities provided by the new circuit, compared with the preceding types of local-call timer, are as follows:

- (a) Detection of a C.S.H. connexion and
  - (i) forcible release of all equipment following the local-call timer in the selector train, thus restoring service to the called subscriber,
  - (ii) cessation of periodic metering after a delay period

related to the rate of metering and not less than one periodic metering cycle,

(iii) return of number-unobtainable tone to the calling-subscriber's line, and

(iv) operation of an alarm and lamp to indicate that the connexion has been forcibly released.

(b) The P-wire circuit is split to overcome the problem of double switching due to excessive P-wire resistance. This is effective on levels 2–9 if the timer is connected between 1st and 2nd selectors, and on all levels if the timer is connected in the uniselector grading.

(c) The circuit is busied to further traffic in the event of the pulse-counting device (ratchet relay) failing to restore to a home position when a call is released.

(d) Fast guard\* is provided. This facility is only effective if the local-call timer is connected in the uniselector grading, but in that position the fast-guard earth will permit any exchange to be converted to 1,000-ohm line working when S.T.D. is introduced. To date this has not been possible at pre-2,000-type exchanges.

#### Circuit Operation

When the circuit (Fig. 2) is seized, relay RD operates in series with relay A of the associated group selector, and a contact of relay RD connects earth to the incoming P-wires. Relay PA, which is connected to the outgoing P-wire, operates when relay B of the group selector operates. Relay RD is then short-circuited, the guard on the incoming P-wires is taken over by relay PA, and the circuit is prepared for metering. Nothing further happens until the call is cleared or metering takes place.

The metering process commences with the receipt of a meter pulse of +50 volts from the auto-auto relay-set or final selector when the called subscriber answers. This pulse operates relay LM which, with relay PA operated, repeats the meter pulse to the calling subscriber's meter. On local levels relay LM also operates relay H via the shelf strap or via the vertical marking bank and wiper of the associated 1st selector. The use of the vertical marking bank enables operation of the timer to be restricted to the appropriate levels (e.g. 2–9). Relay LM releases when the initial meter pulse terminates, and is followed by the release of relay PA.

Pulses of –50 volts from a common supply are converted to earth pulses by a relay, TP (not shown in Fig. 2), to step the ratchet relays of a shelf of timers. When relay TP operates, the ratchet-relay magnet is operated via contact H6. After the 10th supply pulse has been disconnected the cams are at position 10 and as a result the R.R.S springs are operated. Relay LM re-operates with the ratchet relay to the 11th supply pulse, and applies a further meter pulse to the calling subscriber's meter. Counting in this manner continues for the remainder of the call and an additional meter pulse is connected on receipt of every subsequent 11th pulse. The frequency of the repeated metering depends upon the rate of the pulses from the common supply, this rate being determined by the tariff in force.

Whenever a local-call meter-pulse is produced relay RD examines the direction of the line current. The relay operates only if the called subscriber has replaced his handset, i.e. the direction of the line current has reverted to normal. At the end of the meter pulse, relay LM

\* Fast guard—if switching equipment is connected to subscribers' lines of high resistance it is necessary for earth potential to be applied to the P-wire more quickly than is required with lines of lower resistance.

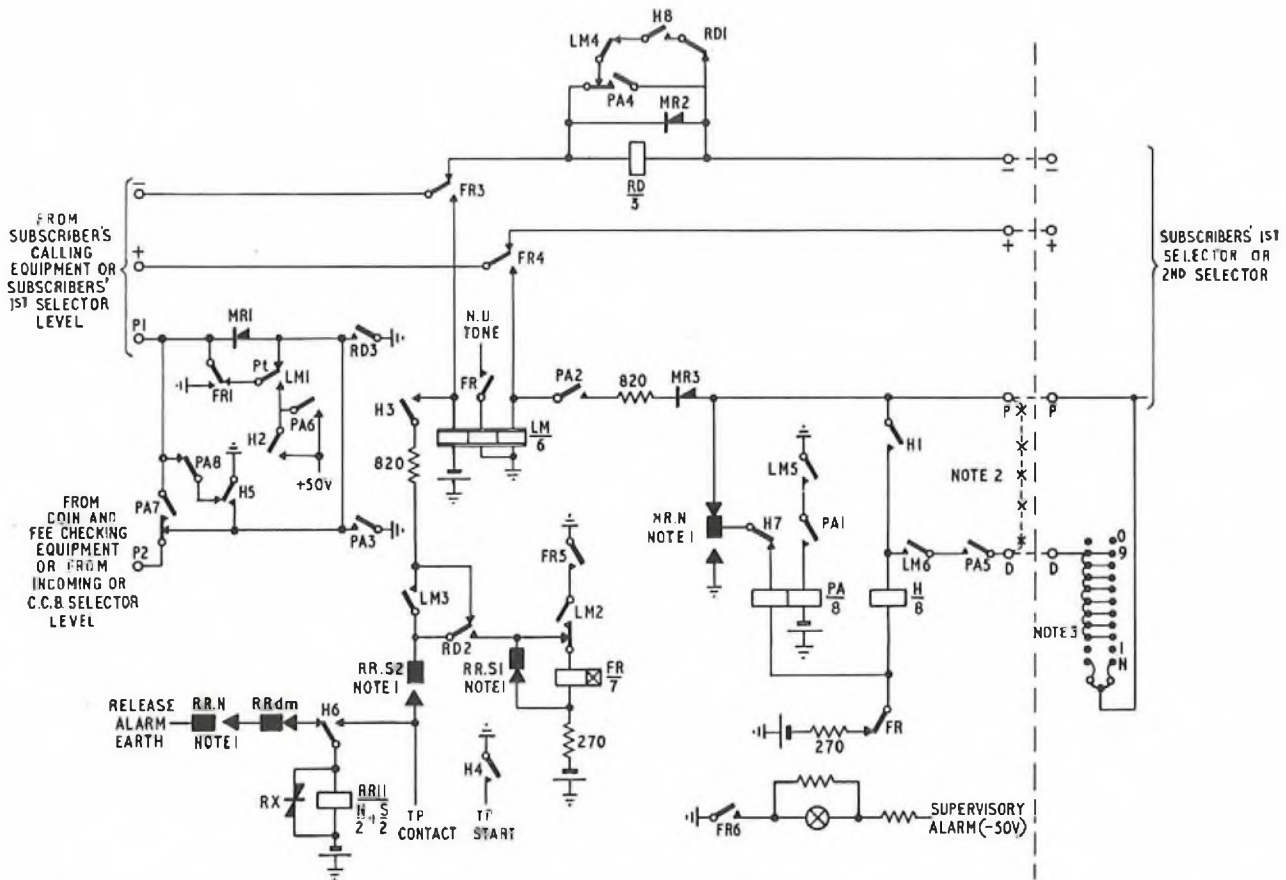

Notes: 1 The ratchet-relay N springs operate from step 1 to step 10 and the S springs operate on step 10.  
 2 Terminal P is strapped to terminal D if the local-call timer is associated

with a 2nd selector.  
 3 Vertical marking banks are provided only on subscribers' 1st selectors.

FIG. 2—CIRCUIT OF LOCAL-CALL TIMER

releases, whereas relay RD holds for as long as the called subscriber's line is held. However, if the calling subscriber does not release the connexion during a further metering cycle, the forcible-release relay FR is operated instead of the subscriber's meter. Contacts of relay FR then release equipment following the timer, stop the timing, return number-unobtainable tone to the caller and complete the circuit of the C.S.H. lamp and alarm. The circuit remains in this state until either the calling subscriber clears or the maintenance staff deal with the situation.

If the timing circuit is located between selector levels it will not encounter trunk-call meter-pulses, but if it is connected in the unselector grading the circuit acts as a P-wire link-circuit repeating all meter pulses received from trunk equipment. Whenever the equipment is released a short "open period" always occurs to allow the release of switching relays in preceding circuits.

In early S.T.D. installations, the Post Office Type 2 unselector was used as the counting device, and in the event of its failing to restore to a home position the circuit was not guarded against seizure. The new circuit, however, remains guarded in these circumstances and thus eliminates some loss of revenue and removes a cause of discrepancy in centralized service-observation records.

#### Split P-Wire Circuit

In large installations the P-wire resistance may be sufficient to permit double connexions to occur in certain circumstances. This arises from the potential drop along

a P-wire when current is being drawn through it by a unselector when hunting over an engaged outlet. This potential drop may then be sufficient to allow another selector stepping simultaneously to switch to the engaged circuit, and a double connexion results. To avoid excessive P-wire resistance careful planning of exchange layouts is necessary, but by providing a split P-wire the timer circuit gives greater scope in the layout of equipment to engineers planning installations of S.T.D. equipment and subsequent extensions. If the timer circuit is connected in the unselector grading the P-wire resistance is at a minimum.

It is interesting to note that if the timer is associated with a selector which is also accessible from incoming or coin-box groups of selectors, the split in the P-wire would result in the bank multiple being unguarded when the associated selector is seized by local subscribers. To prevent this the P-wire from the incoming and other groups is arranged not to by-pass the circuit as do the negative and positive wires. The arrangement is shown in Fig. 1.

#### CONCLUSIONS

Two years experience with local-call timing showed that additional facilities were required. The provision of these facilities so increased the cost that it was necessary to produce a timer that could be connected in the most economical point in the selector train in any given exchange and which could be moved later if circumstances warranted it.



# Subscriber Trunk Dialling at Non-Director Satellite Telephone Exchanges

R. H. G. KEARSLEY-BROWN, A.M.I.E.E., A.M.Brit.I.R.E., and B. D. GORTON†

U.D.C. 621.395.374

The need to provide facilities for subscriber trunk dialling at satellite exchanges made it necessary to examine the possible methods of giving the requisite service. This investigation is discussed and the arrangements finally adopted are described. These arrangements enable facilities to be provided similar to those at a non-director main exchange.

## INTRODUCTION

IN the United Kingdom three main types of satellite exchange exist, namely: the discriminating-selector-repeater (D.S.R.) satellite, the 2,000-type-discriminator satellite and the group-selector satellite.<sup>1</sup> A single solution to the problem of providing facilities for subscriber trunk dialling (S.T.D.) at these three types of exchange is not practicable, and two methods have therefore been developed, one applicable to D.S.R. and 2,000-type discriminator exchanges, and the other to group-selector satellites. There are other types of satellite exchange, such as the switching-selector-repeater type or the Siemens No. 16, but these are dealt with individually as the need arises.

Subscribers connected to satellite exchanges are given facilities for trunk dialling similar to those provided at main exchanges. Ancillary S.T.D. features, such as local-call timing and pay-on-answer coin-box working, are also provided, and level-1 codes for manual-board services are being introduced.

## DISCRIMINATING-SELECTOR-REPEATER SATELLITE EXCHANGES

### *Existing Arrangements*

The D.S.R. type of satellite exchange was originally designed to function as part of a multi-exchange area with a local linked-numbering scheme. At a satellite without S.T.D., subscriber-dialled calls are normally limited to those for which one unit fee is charged, and higher-charge calls are routed via the manual board associated with the main exchange. The D.S.R. incorporates a transmission bridge suited to these requirements, and provides for pulse repetition, single-fee metering and manual hold without the need for separate relay-sets.

### *Possibilities of Providing S.T.D.*

The D.S.R. is unsuitable in its original form for subscriber dialling to exchanges beyond the single-fee metering range but, because it provides for auto-auto dialling, it could, with very little modification, give local discrimination and switch S.T.D. calls via a level-0 group of junctions to register-translators at the main exchange. With such an arrangement, however, it is not easy to devise a suitable scheme for periodic metering. It would be possible to provide S.T.D. meter-pulse-supply equipment at each satellite and select the appropriate metering rate either locally or by means of signals

from the main-exchange register-translators. Such a metering scheme would, however, be uneconomic.

A more attractive arrangement would be to transmit metering pulses of the requisite periodicity over the junction in use for the call concerned, provided that this could be done without causing objectionable interference. A system such as this, known as metering over junctions (M.O.J.), has therefore been developed for satellite exchanges and has also been successfully adapted for use at director and remote non-director exchanges. Meter pulses in the form of momentary line reversals are transmitted over the junction concerned whilst conversation is in progress.<sup>2</sup>

During the development of the M.O.J. system it was found that, to avoid noise, transformer-type bridges were needed at both ends of junctions over which metering pulses were to be transmitted. To incorporate such a bridge in an existing D.S.R. is, however, impracticable. The use of separate M.O.J. relay-sets on level 0 would be possible, but this would introduce a second transmission bridge, with attendant signalling distortion. Furthermore, it would be necessary to convert the meter pulses received over the junction into meter pulses that could be passed through the D.S.R. to operate the calling-subscriber's meter. The D.S.R. is a 100-outlet selector and employs forward holding, so the difficulty can be readily appreciated. It was therefore decided that the D.S.R. should only be required to detect the S.T.D. prefix-digit 0, and an associated auxiliary hunter would be used to gain access to a group of S.T.D. junctions.

### *Arrangements Adopted*

As shown in Fig. 1, a separate group of junctions to the group switching centre (G.S.C.) is provided for S.T.D. calls. Each junction has a special type of relay-set at the outgoing end and terminates on a register-access relay-set at the G.S.C. In addition to its normal controlling function, the register-access relay-set returns periodic metering signals over its associated junction; the outgoing relay-set accepts these signals and repeats them as normal P-wire meter pulses.

Access to the S.T.D. junctions is obtained via an auxiliary junction-hunter associated with each D.S.R. If the first digit dialled is 0 the call is recognized by the D.S.R. as a trunk call, and receipt of that digit causes the auxiliary junction-hunter to search for a free relay-set during the inter-digital pause. Having effected this level discrimination, the D.S.R. has no further function and is released when switching takes place.

The register hunter at the main exchange must also search for a free register during the first inter-digital pause but, since there is a possibility of the second pulse train being dialled before the register-access relay-set is associated with a register, the second pulse train is temporarily stored in the register-access equipment.

When the call matures and the called subscriber

†Telephone Exchange Systems Developments Branch, E.-in-C.'s Office.



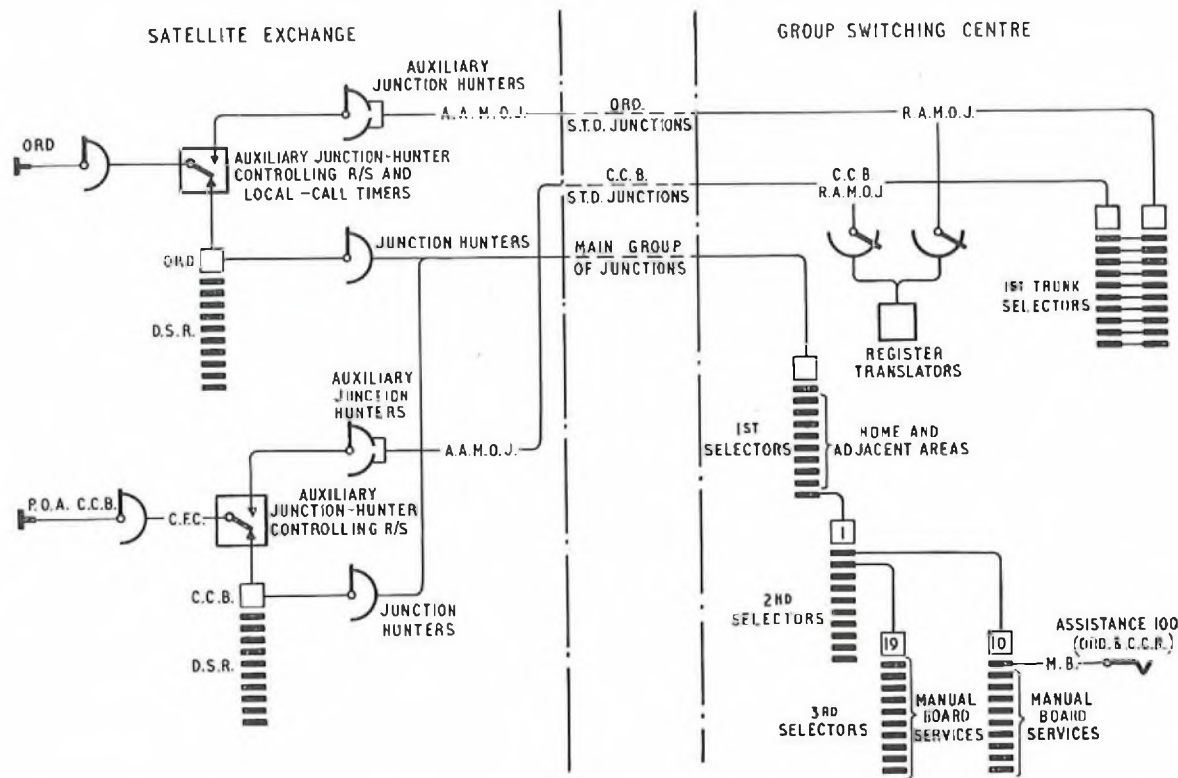

C.F.C.—Coin and fee checking equipment. A.A.M.O.J.—Auto-auto relay-set with metering over junction. R.A.M.O.J.—Register-access relay-set with metering over junction. M.B.—Manual-board relay-set. P.O.A.—Pay on answer. Ordinary (ORD) and coin-box (C.C.B.) groups of S.T.D. junctions and register-access relay-sets are provided to give flexibility in tariff arrangements.

FIG. 1.—TRUNKING OF S.T.D. AND LEVEL-1 CALLS AT D.S.R. SATELLITE EXCHANGE

answers, periodic metering signals are returned over the junction to the satellite exchange. The periodicity of these signals depends on the charge rate for the call. The maximum pulsing rate is of the order of one signal per second, so that limited international subscriber dialling<sup>2</sup> can be introduced without alteration to the equipment.

#### Manual-Board Assistance Calls

As at other types of exchange, it is necessary to bring the new assistance code 100 into use prior to the introduction of S.T.D. at a D.S.R. satellite exchange. Several methods of doing so were devised, but the subsequent extension of the use of level 1 to include services other than assistance resulted in the arrangement shown in Fig. 1 being adopted as standard.

On receipt of the initial digit 1, the D.S.R. at the satellite exchange and the incoming selector at the main exchange step in unison; the D.S.R. is arranged to give junction discrimination on this level and to route the call over the main group of junctions. The remaining digits step the 2nd and 3rd selectors at the main exchange to obtain access to the appropriate manual-board relay-set. Relay-sets that absorb the second digit 0 are, however, provided if the codes 101-109 are not used. Manual hold is given in the normal manner for remote working by returning a -50-volt signal on the positive wire of the junction.

#### Coin-Box Working

For an auto-answer call originating from a pay-on-answer coin box, the facilities given are similar to

\*Audit signal—a signal enabling the operator to recheck the amount of money inserted in the coin box during a call.

those for an ordinary call. Means of barring trunk calls are not normally required and have not been provided.

Assistance calls originating from pay-on-answer coin boxes require circuits having newly-developed signalling techniques. To indicate to an operator that a call is from a pay-on-answer coin box, a tone is automatically applied when she answers the call, and control of the coin box via the coin and fee checking (C.F.C.) relay-set is provided.

In the original design of C.F.C. equipment for non-director main exchanges control is given by means of an answering-reversal signal from the manual-board relay-set. Such a signal could not, however, be used to control, over the main group of junctions, a coin box connected to a satellite exchange because (a) metering would result and (b) the D.S.R. could not repeat the control signals to the C.F.C. relay-set unless a major modification of the D.S.R. circuit were made. To overcome these difficulties, non-metering +50-volt signals are passed in the following sequence over the main group of junctions to give coin-box identification and control. The first signal, which is automatically transmitted when the operator answers, calls for coin-box identification tone. Operation of the RING ANSWER key cuts off the tone; a second operation of the key causes the coin slots to open, and subsequent operations cause audit signals\* to be transmitted from the C.F.C. relay-set to the operator.

With this method of working it is possible to use a common group of level-1 junctions to serve ordinary subscribers as well as pay-on-answer coin-box subscribers. A C.F.C. relay-set incorporating the features discussed has been developed for use at satellite

exchanges and has now been adopted as standard for all types of exchange.

It has been necessary to make simultaneous provision for both pre-payment and pay-on-answer coin boxes to enable satisfactory service to be given whilst the change-over of coin boxes takes place. The pre-payment coin-box group of D.S.R.s retains the present assistance code 0 and the original trunking. A lamp signal is given at the manual board to indicate that the call originates from a pre-payment coin box. While pre-payment coin boxes remain, it is necessary to retain the coin-box 0-level group of junctions to the manual board and to bar coin-box users from level 1, so preventing them from gaining access to ordinary subscribers' assistance relay-sets by dialling 100 while coins are in suspension in the coin box.

#### Local-Call Timing

Changes in the method of charging for calls have made it necessary to apply periodic metering to local calls as well as to trunk calls, and the equipment necessary to do this is incorporated in the relay-set that controls the auxiliary junction-hunter. Unless precautions are taken to prevent it, the local-call timer will continue its function of timing and metering if the calling subscriber fails to clear or if a line fault holds the line relay controlling the call. The local-call timing element has therefore been designed to stop timing and metering if, after the called subscriber has cleared, his line is held for a period related to the rate of metering in progress.

#### Access to Home and Adjacent Charging Groups

At all types of satellite exchange where S.T.D. is introduced, access to the home charging group outside the linked-numbering scheme is via level 8 at the main exchange. Access to adjacent charging groups is via level 9.

#### Circuit Description

The D.S.R. is a 100-outlet selector with only three wipers and this precludes the use of 4th-wire metering, because it would be necessary to modify much old equipment from forward to backward holding on level 0 to retain a maximum availability of 10.

Because of these difficulties it was decided to provide an auxiliary (trunk) junction hunter for each D.S.R. to give access to the auto-auto relay-sets. By this means the availability is also increased, with a consequent reduction in the number of S.T.D. junctions needed.

Local-call timers are required only for local calls originated by ordinary subscribers, because, for coin-box calls, the C.F.C. equipment also provides local-call timing. For D.S.R.s serving pay-on-answer coin boxes it is necessary for the outgoing speech wires to be connected so that signals intended for the control of the C.F.C. relay-set may by-pass the transmission bridge. On many old D.S.R.s the transmission-bridge capacitors are mounted on the rack and the modification can therefore be made without disturbing the selectors.

The auxiliary-junction-hunter circuits with local-call timing also provide for the forcible release of all automatic equipment forward of the auxiliary equipment whenever the called subscriber's line is held after he has cleared for a period related to the rate of metering. Prior to the introduction of S.T.D. the called-subscriber-held (C.S.H.) condition is indicated by a lamp on the

D.S.R. and an alarm is given if the call is not released within a predetermined period. It is thus possible to extend the C.S.H. signal to the auxiliary-junction-hunter circuit.

At 4th-wire earth-metering D.S.R. exchanges it is essential to release the meter after its initial operation to permit its further operation by subsequent meter pulses. Having modified the meter circuit it is necessary to produce the initial meter pulse within the local-call timing-element and to prevent flashing by the called subscriber from causing false metering.

*Trunk Calls.* When 0 is dialled as the first digit the D.S.R. steps to that level and the wipers step to contact 1. Earth connected to the PI bank is then routed to the auxiliary equipment to operate relay B (Fig. 2) to cause the auxiliary junction-hunter to search for a free M.O.J. relay-set. Earth testing similar to that used in sub-

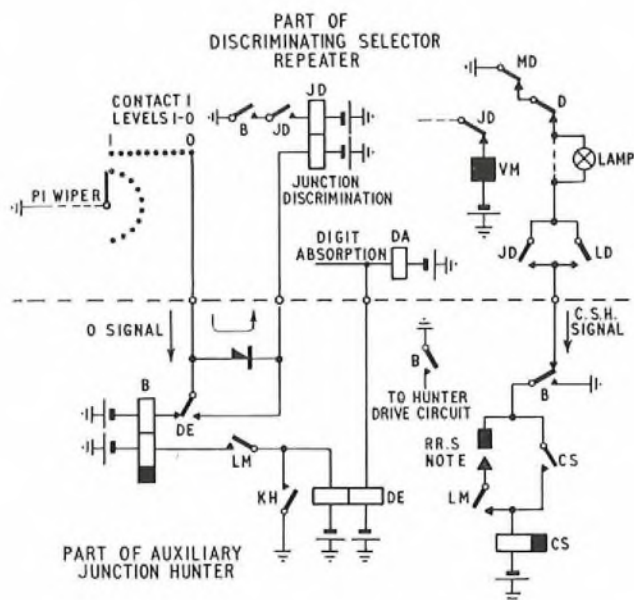

Note: This contact operates on step 10 of the ratchet relay.

FIG. 2—METHOD OF OBTAINING LEVEL 0 DISCRIMINATION AND CALLED-SUBSCRIBER-HELD SIGNAL FROM D.S.R.

scribers' unselector calling equipment is employed, and when switching takes place the D.S.R. is released; seizure of the register-access relay-set at the group switching centre then follows and the remaining digits of the national number are repeated by the M.O.J. relay-set.

When the called subscriber answers, the reversal of line polarity by the distant equipment causes an initial meter pulse to be given. This and subsequent meter pulses take the form of line reversals of approximately standard meter-pulse duration and are converted to +50-volt pulses to operate the calling-subscriber's meter. At 4th-wire earth-metering exchanges a further conversion takes place in the controlling relay-set to provide the requisite pulses.

From Fig. 2 it will be seen that the junction-discrimination relay, JD, operates with relay B via a rectifier and prevents the vertical magnet of the D.S.R. being energized whilst the wipers are still in the bank, when the selector is released after switching occurs.

When 0 is dialled as a second digit the call is not routed to trunk equipment, because local or junction discrimination, or digit absorption, must have taken



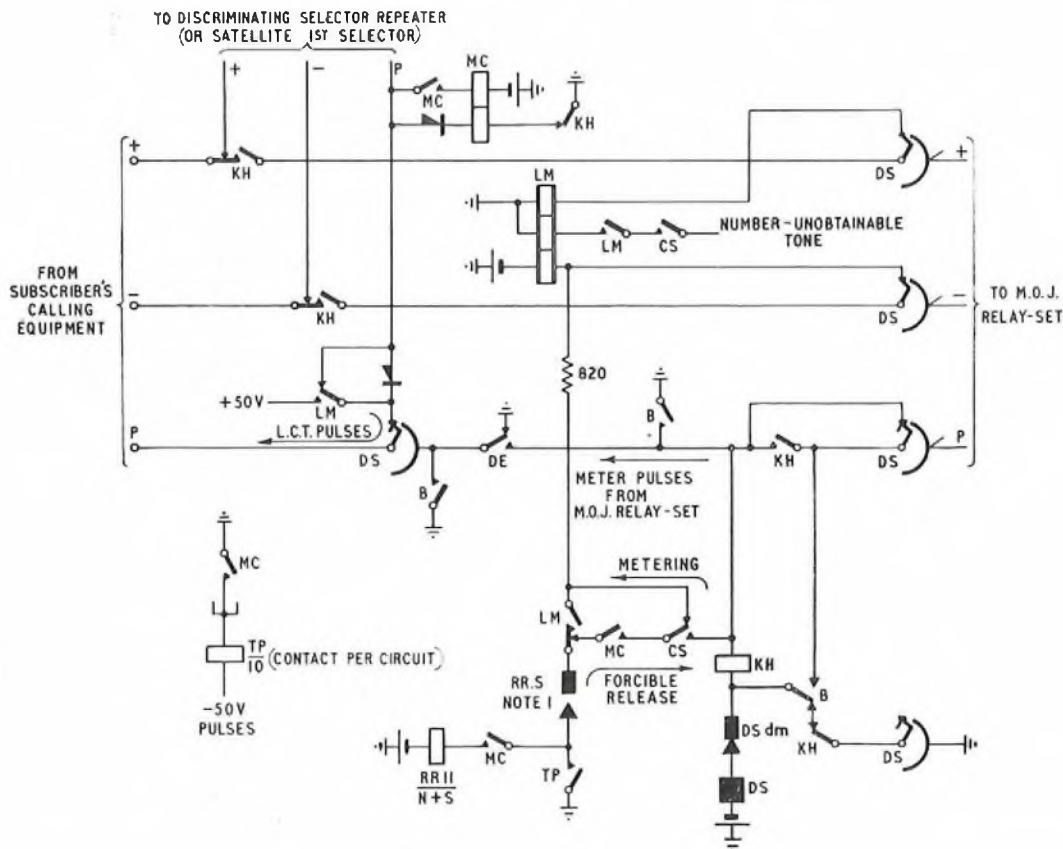

- Notes:
1. This contact operates on step 10 of the ratchet relay.
  2. The forcible-release circuit is not required for auxiliary junction-hunters available to coin-box subscribers.
  3. This diagram should be read in conjunction with Fig. 2.

FIG. 3—BASIC CIRCUIT OF AUXILIARY JUNCTION-HUNTER AT POSITIVE-BATTERY-METERING EXCHANGES

place with the first digit. On any such call the operation of relay B is prevented and the hunter cannot drive. If a digit is absorbed, relay DA in the D.S.R. operates in parallel with relay DE in the auxiliary-junction-hunter circuit to isolate relay B.

**Local Calls.** Calls from ordinary subscribers bring the timing circuit into operation when the called subscriber answers (see Fig. 3). The initial meter pulse, which, for earth-metering equipment, is produced within the circuit, operates the calling subscriber's meter and relay MC. This relay controls the ratchet-relay stepping and homing circuits.

Pulses of -50-volts from the common supply are converted to earth pulses by shelf-relay TP to step the ratchet relays (RR) of a shelf of circuits. After the 10th supply pulse the cams of the ratchet relay are at position 10 and the RR.S springs are operated. When the 11th supply pulse arrives, relay LM operates in parallel with the ratchet relay and a further meter pulse is applied to the calling subscriber's meter. This cycle is repeated for the duration of the call and a further meter pulse is applied on receipt of every 11th pulse.

In addition to controlling metering, relay LM also connects relay CS to the C.S.H. lead, as shown in Fig. 2, but the relay operates only if the called subscriber is in fact held. Relay LM releases at the end of each meter pulse, but relay CS continues to hold for as long as the called subscriber remains held. If the calling subscriber does not release the call during the next metering cycle, forcible release occurs in place of

metering. Relay KH operates instead of relay LM and releases the D.S.R., connects relay LM to the subscriber's loop and also prevents further metering. Timing is also stopped when earth is first disconnected from the P-wire of the releasing selector. Operation of relay LM returns number-unobtainable tone to the calling line, and relay B ensures that the circuit remains held in the event of further dialling by the subscriber, as only a clear will release the equipment. A lamp indication and delayed alarm are also provided.

Release from any type of call or forcible-release results in a short "open period" occurring to permit the subscriber's K relay to release. After this the circuit remains guarded until any mechanism taken into use has restored to its home position.

#### 2,000-TYPE-DISCRIMINATOR SATELLITE EXCHANGES

The problems of providing facilities for S.T.D. at 2,000-type-discriminator satellite exchanges are similar to those at D.S.R. satellites and the same solutions have been adopted. Optional connexions have been included in the circuits developed for D.S.R. satellites with +50-volt metering to make the circuits equally suitable for 2,000-type-discriminator satellites. Slight modifications to the discriminator are required to enable it to recognize an initial digit 0 as indicating an S.T.D. call and to enable it to accept level-1 codes.

The design of the satellite 1st selector used with the 2,000-type discriminator would permit 4th-wire metering from the M.O.J. relay-set if the availability on level 0

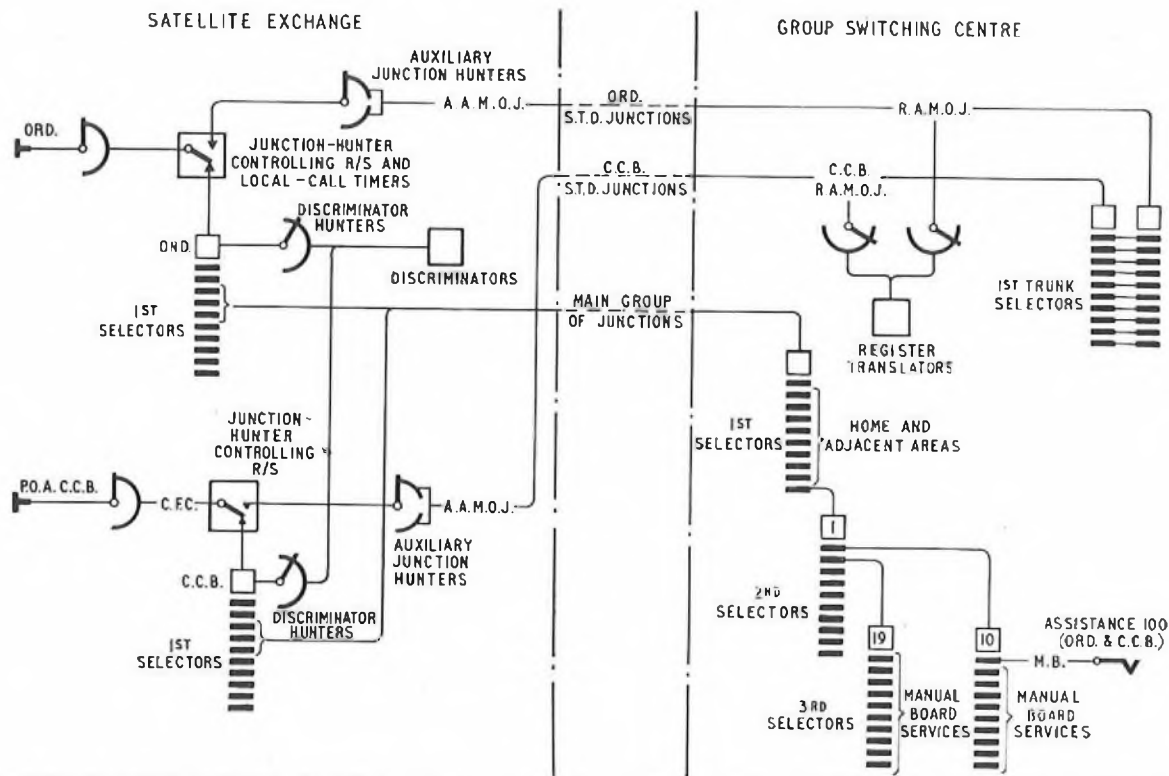

C.F.C.—Coin and fee checking equipment. A.A.M.O.J.—Auto-auto relay-set with metering over junction. R.A.M.O.J.—Register-access relay-set with metering over junction. P.O.A.—Pay on answer. M.B.—Manual-board relay-set.

The arrangements for S.T.D. are similar to those at a D.S.R. satellite exchange, and level-1 calls are routed via the main group of junctions to the group switching centre.

FIG. 4—TRUNKING ARRANGEMENTS AT 2,000-TYPE-DISCRIMINATOR SATELLITE EXCHANGE

were halved, but due to the design of the equipment the discriminator could be held for longer periods, and as a result more discriminators would be needed to carry the traffic. Two transmission bridges would also be in circuit at the originating exchange during trunk calls. For these reasons, and in the interest of standardization it was decided to use the same type of auxiliary junction-hunters as at D.S.R. exchanges, as shown in Fig. 4.

#### Circuit Operation

At 2,000-type-discriminator exchanges, when 0 is dialled as the first digit, the pulse train steps the C uniselector in the discriminator to operate a relay STD on the 10th step when relay C releases. Operation of the STD relay causes the operation of relay B in the hunter circuit (Fig. 3) to bring about the search for a free circuit to trunk equipment. Relay KH operates to release the satellite 1st selector and discriminator and to seize the auto-auto relay-set.

The circuit operations that take place when the called subscriber answers are similar to those described for D.S.R. exchanges.

#### GROUP-SELECTOR SATELLITE EXCHANGES

Group-selector satellite exchanges are more adaptable than any other type of satellite, and can be readily modified to suit the new conditions. Level 0 gives access to a group of S.T.D. junctions to the main exchange via M.O.J. relay-sets of the same design as those used for D.S.R. satellite exchanges. The trunking arrangements for levels 1 and 0 at a group-selector satellite are shown in Fig. 5.

#### Level-1 Calls

Prior to the introduction of the code 100 for assistance, level 1 was spare. The level is taken into use by providing a level-1 group of junctions to the main exchange via relay-sets with facilities for manual hold, single-fee metering, and relaying C.F.C. control signals. The manual-hold signal is standard, and the +50-volt sequential signal described earlier is used for coin-box identification and control. The junctions terminate on 2nd selectors at the main exchange to give access via 3rd selectors to the manual-board and other level-1 services.

#### Coin-Box Working

Levels 1-9 of the pay-on-answer coin-box group of 1st selectors are commoned to levels of the ordinary subscribers' group of selectors, and combined working is adopted. Level 0 is segregated to give flexibility of tariff.

Calls from pay-on-answer coin boxes to manual-board services are recognized in the same way as at D.S.R. exchanges. No modification of selectors is required.

During the change-over period from pre-payment to pay-on-answer coin boxes, level 0 of the pre-payment coin-box group of 1st selectors remains undisturbed, and the existing coin-box group of junctions gives access to the manual board, with lamp discrimination.

#### Local-Call Timing

As shown in Fig. 5, local-call timers in the form of separate relay-sets are either associated with 1st selectors or connected to working levels 2-9 of the 1st selectors. In



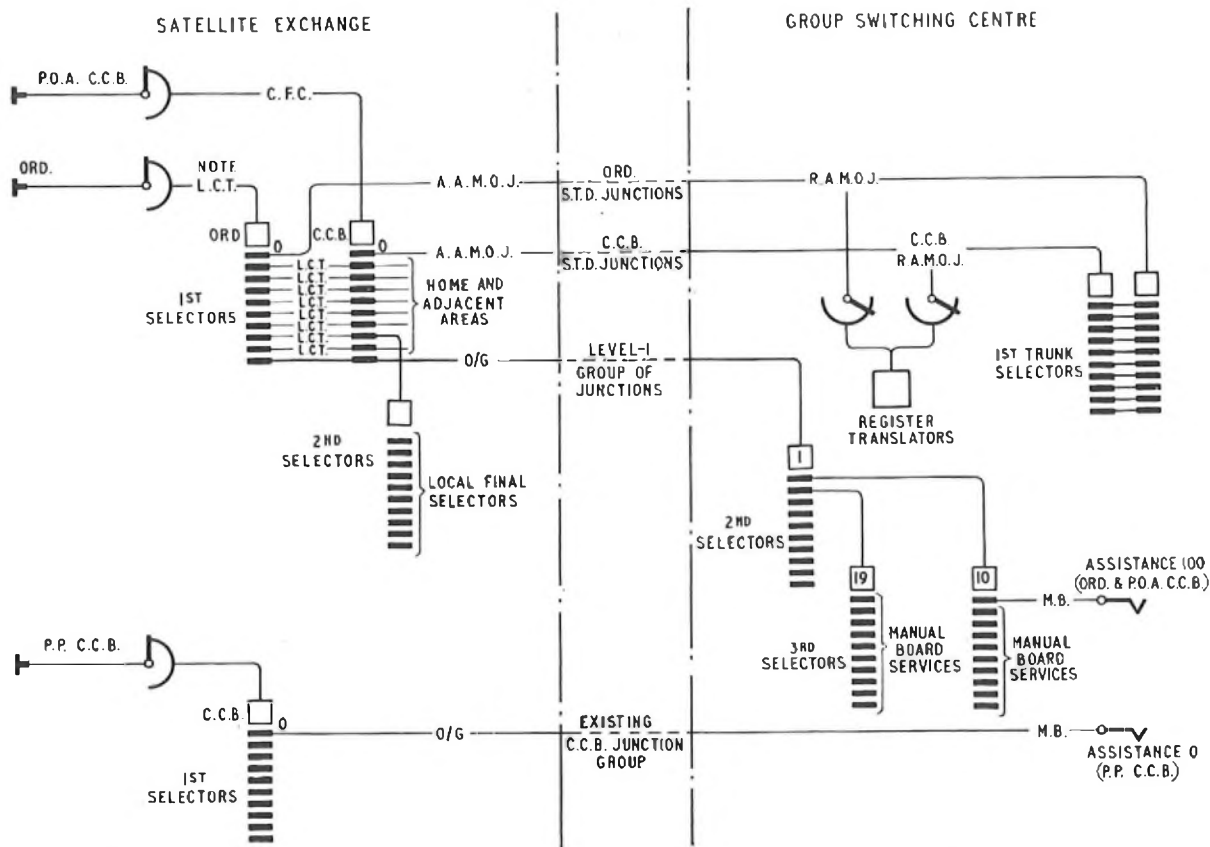

P.O.A.—Pay on answer. P.P.—Pre-payment. A.A.M.O.J.—Auto-auto relay-set with metering over junction. R.A.M.O.J.—Register-access relay-set with metering over junction. L.C.T.—Local-call timer. M.B.—Manual-board relay-set. O/G.—Outgoing relay-set. Note: Alternative positions for local-call timer. Manual-board traffic from ordinary subscribers and pay-on-answer coin boxes is combined at the satellite and connected via a common group of level-1 junctions.

FIG. 5—TRUNKING ARRANGEMENTS AT GROUP-SELECTOR SATELLITE EXCHANGE

addition to timing local calls, the circuit gives individual control of the delay period before forcible release is applied if the called-subscriber's equipment is held.

#### Circuit Arrangement

The provision of facilities for S.T.D. at group-selector satellite exchanges is relatively simple, because backward holding is employed and it is possible to use level 0 to obtain access to trunk equipment. It is also possible to use the local-call timer already developed for main exchanges.<sup>1</sup> The auto-auto relay-set for accepting metering-over-junction signals has already been mentioned and is necessarily a new design for satellites in general.

#### NEW SATELLITE EXCHANGES DESIGNED FOR S.T.D.

For new satellite exchanges it is highly desirable that the first switching stage should not have a transmission bridge. The group-selector satellite exchange meets this

requirement and is suitable for use at reasonable distances from the main exchange.

If discrimination is included in a new design of satellite exchange it might be desirable to use only junction hunters on outgoing calls from the exchange and bring the 1st selectors into use solely for local calls. By this means the number of 1st selectors at the satellite exchange would be reduced to about a third of the number otherwise required. A scheme based on these principles is being examined.

#### References

- <sup>1</sup>TOBIN, W. J. E., and BIRCH, S. Satellite Exchange Working in Non-Director Multi-Exchange Systems. *P.O.E.E.J.*, Vol. 46, p. 1, Apr. 1953.
- <sup>2</sup>HEPTINSTALL, D. L., and RYAN, W. A. Metering over Junctions. *P.O.E.E.J.*, Vol. 51, p. 335, Jan. 1959.
- <sup>3</sup>MAURER, C. J. Dialling of International Trunk Telephone Calls by United Kingdom Subscribers. *P.O.E.E.J.*, Vol. 54, p. 92, July 1961.
- <sup>4</sup>GORTON, B. D. A Local-Call Timer for Non-Director Exchanges. (In this issue of the *P.O.E.E.J.*)

# Improvements in Installation Methods for Telephone Exchanges

W. G. ROBERTS, A.M.I.E.E., and C. S. MILLS†

U.D.C. 621.395.722.005

Conventional methods of installing telephone exchange equipment have largely been accepted as adequate and effective, but the increasing costs of labour and the need for speedier provision have focused attention on the possibilities of new techniques. The changes already being introduced are described.

## INTRODUCTION

ATTENTION has been given in the past few years to the possibilities of achieving economies by adopting revised equipment layouts for telephone exchanges, and some savings have been effected by the more useful employment of floor space. These changes are independent of those introduced by exchange design based on the unit method<sup>1</sup> of equipment layout which does not aim specifically at direct economies but is intended to facilitate the replacement of equipment when this becomes necessary, and, in addition, to ensure effective overall equipment layouts in buildings provided initially to cater for requirements based on a short planning period.

It was apparent, however, that there was also scope for direct savings in the use of new installation methods, and some success has already been achieved, whilst a review of current practices is continuing. A number of new installation methods are described below.

## SECURING CABLES TO RUNWAYS

Over-ceiling cabling,<sup>2</sup> which has recently been introduced, will facilitate and cheapen cabling in single-storey buildings. For multi-storey buildings, where cables have to be run within the apparatus room, a number of ideas are being investigated with the object of reducing the labour expenditure on the lacing of cables.

Three different methods of securing cables have been developed and are now being used with marked success on horizontal cable runs.

### Cable Clips

Cable clips are available in a range of sizes suitable for holding one, two or three layers of cables of appropriate diameters, the largest clip taking six layers of three 200-wire cables. Fig. 1 shows a typical cable formation, with the cables clipped into position.

The clip is made of 16 S.W.G. mild steel 1 in. wide (Fig. 2). The upper portion is U-shaped to hold the cables, and is spot-welded to a lower bracket that fits fairly tightly on to the rectangular cross-sectional slats of the cable runway but is not fixed to them. The arms of the upper portion are  $5\frac{1}{8}$  in. long, allowing cables to be laid to a depth of approximately 6 in.

To ensure that the cables retain their formation, lacing is necessary on horizontal bends from the slat preceding the bend to the slat following it. Lacing is also required on the two horizontal-runway slats before and after a vertical section, and where cables drop off to feed racks and frames. Clips are satisfactory where there is a small

† Mr. Roberts was formerly in the Exchange Equipment and Accommodation Branch, E.-in-C.'s Office, but is now in the Engineering Branch, Home Counties Region. Mr. Mills is in the Exchange Equipment and Accommodation Branch, E.-in-C.'s Office.

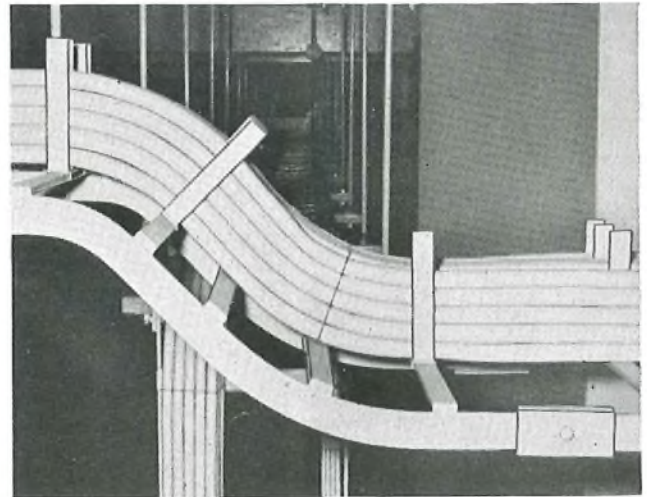

FIG. 1—USE OF CABLE CLIPS

change in the level of the runway, but lacing is necessary at the slat on the bend (Fig. 1).

The clips are normally placed at every third slat and a measure of interlocking of the outer cables is provided by staggering the positions of the clips, the clip formation being repeated along the runway. In large formations of cables, only the outer cables are clipped, leaving a central trough where clips are unnecessary. Where the height of the cross-section of a cable formation varies, additional clips are provided on intermediate slats to preserve the correct cross-section of the formation.

Where the cables cross a runway at an angle, as may occur over an intermediate distribution frame (I.D.F.), the clips are set at the appropriate angle by twisting their vertical members to prevent the sides of the clips from cutting into the cable sheath.

The quantity and location of the clips is dependent largely upon local requirements and, within prescribed limits, their positioning is a matter for determination on site.

Cable with an additional layer of cotton braid is somewhat firmer than that without, but clips used in associa-

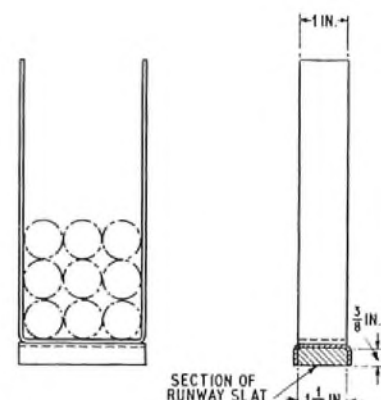

FIG. 2—SKETCH OF CABLE CLIP



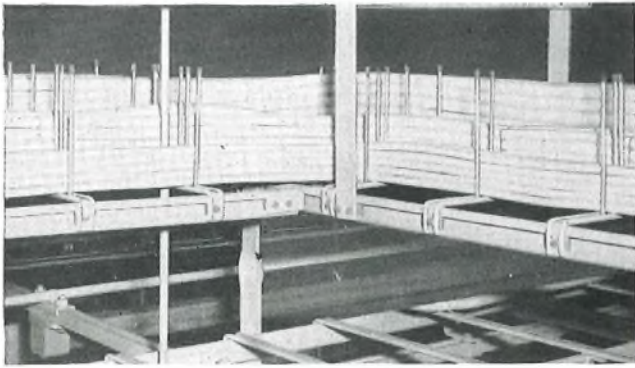
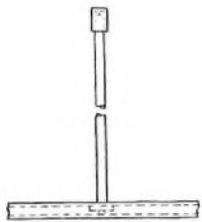

FIG. 3—USE OF CABLE PINS DEVELOPED FOR A PARTICULAR TYPE OF RACKING

tion with both types of cable have given equally successful results.

#### Cable Pins

To take advantage of the cable-clip principle, a cable pin has been designed that can be used in conjunction with a different type of cable racking. Fig. 3 shows cable racking of this type and illustrates the use of the cable pin, which consists of a  $\frac{3}{16}$  in. diameter mild-steel rod,  $6\frac{1}{2}$  in. long, threaded at one end and slotted at the other. It is attached to the runway by means of an oval base plate drilled and tapped to take the threaded end of the pin. The base plate is placed inside a cable-rack slat



CABLE-PIN NUT



The cable-pin nut is inserted between the flanges of the cable-runway slat and locked in the required position by tightening the pin.

FIG. 4—SKETCH OF CABLE PIN SHOWING METHOD OF FIXING TO SLAT

on horizontal bends. Where the outer cables tend to lift out of formation, lacing-twine ties are made over the cables between pins.

Another design of pin, used in a similar manner to that described above, has been developed for use with the more widely used runway slats of rectangular cross-section. The pin, which is shown in Fig. 5, is of  $\frac{1}{8}$  in. diameter mild steel and is produced in three lengths. It is firmly fixed to a cable slat by means of a small clamp so designed that it will not damage a cable sheath in contact with it.

With clips or pins of any one of the forms described, the recently-introduced practice of tying cables of 31 wires or less into bundles remains satisfactory, the

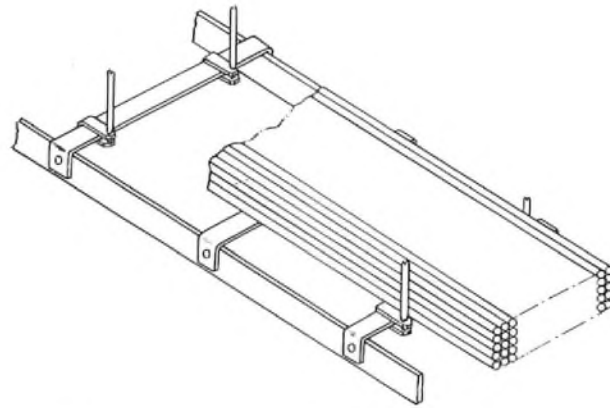

FIG. 5—USE OF CABLE PINS WITH RECTANGULAR CROSS-SECTIONAL CABLE RACKING

resultant bundles, which do not exceed 2 in. in diameter, being treated as a single cable.

The overall economics of the use of cable clips or pins have not yet been finally determined and will depend upon the production costs of the final designs and the increased speed of cable installation, which should improve as further experience in the use of clips or pins is gained. It is already apparent, however, that they save much time in cabling and this is itself of considerable value apart from the savings of manpower that result.

#### TROUGHING

To check the possibilities of troughing, which, although attractive, has so far appeared to be too expensive, a field trial is being made of troughing of a new design. The basic principle is the use of a number of small open troughs running horizontally over, and supported by, the equipment racks. Cables are laid in these troughs and laced only on the vertical drops between the troughing and the equipment.

#### ADHESIVES FOR CABLE FORMATIONS

The use of adhesives has been considered for securing cables in position on both horizontal and vertical cable runs, but no suitable technique has yet been found. The problems posed are the adverse effect of the adhesives on the cable sheath, the setting time, which slows the installation process, and the likely difficulty of recovering cables when necessary.

#### INTER-FLOOR CABLING

The conventional method of feeding cables between floors is to run large numbers of cables through a common hole to a point above the tops of the racks, before turning them horizontally to feed the separate racks or frames.

An appreciable saving in the quantity of cable required would result from feeding cables from the tops of lower-floor racks or frames directly through the floor to the feet of upper-floor racks or frames. Due to the difficulty of planning the locations of the requisite holes sufficiently early to avoid difficulties in the building operations, the arrangement may largely be restricted to I.D.F.s situated on an upper apparatus floor, although feeding to a suite of, say, meter racks via a series of floor holes would lead to appreciable economies and is a desirable objective.

To date, inter-floor cabling of the type mentioned

above has been used only at a few selected installations for main distribution frame (M.D.F.) and I.D.F. cables. As, in those instances, the terminating capacities per vertical of the M.D.F. and I.D.F. were identical, it was usually possible to arrange for the cables from three M.D.F. verticals to feed through a floor hole to the three I.D.F. verticals immediately above. The problem is slightly more difficult with the new designs of M.D.F.<sup>3</sup> and I.D.F. which will be used at all new installations, since the terminating capacities per vertical are not the same, but it is only necessary that groups of cables of appropriate sizes should be collected from the frames or equipment on the lower floor and fed through a series of small holes located under the vertical jumpering side of an I.D.F. on the floor above.

The standard design of cable hole and packing was regarded as inappropriate and too expensive for use with a larger number of smaller holes and it is intended to use an asbestos pipe, with an internal diameter of 10 in., cast into the floor slab during building operations. The pipe will project 2 in. above the finished floor surface and be closed by a split asbestos cap cut to fit closely around the cables and secured to the projecting portion of the pipe by a metal band. The lower end of the pipe will be closed by an asbestos or similar sheet fixed to the ceiling. Over that portion of the floor reserved for an I.D.F. extension, the pipes would be provided at the building stage, but the upper section of the pipe would then finish at floor level and be enlarged to take a wooden bung. On extension of the frame, the bung can be replaced by a further short section of pipe, thus providing a through hole similar to those existing. Sketches of the proposed arrangements are shown in Fig. 6.

The holes will be provided on the basis of one per four I.D.F. verticals and be so placed that the incoming cables all turn in one direction before being led up the verticals, thus avoiding as far as possible the formation of dust traps.

#### RACKING SUPPORTS AND FIXINGS

Examples of changes that have been recommended for the structures provided to secure distribution frames, equipment racks, travelling-ladder tracks, cable racking, busbars, etc., are described below.

##### *Distribution-Frame Footings*

The new types of distribution frame are designed to be free standing, and the footings do not require to be encased in concrete as did the footings of earlier designs. The concreting was intended to facilitate cleaning, but the free-standing types of frame now adopted do not cause any difficulty in cleaning and are very much simpler to install.

##### *Rack Floor Fixings*

The use of masonry nails for fixing racks to the floor was considered, but rejected because of the possibility of damage to the equipment on the bottom shelf of the rack as the nails were being driven home. In addition, the advent of concrete floors without screed made the proposal still less attractive, due to the likelihood of encountering aggregate.

The use of non-slip pads fitted to the bases of the racks to prevent lateral movement was also considered, but did not prove satisfactory, due mainly to the unevenness of the floor surfaces.

Following tests, coach screws fixed into drilled and

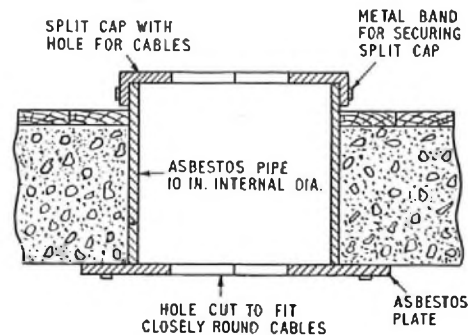

(a) Section of Hole for Feeding to Equipped Vertical of Intermediate Distribution Frame.

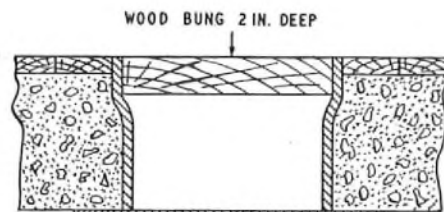

(b) Section of Sealed Hole in Area Reserved for Extension of Intermediate Distribution Frame.

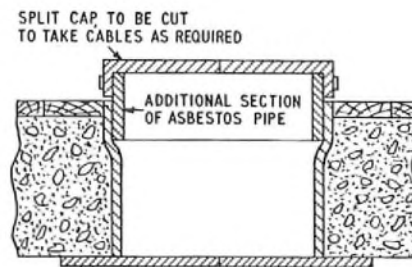

(c) Section Showing Arrangement for Feeding to Vertical of Intermediate Distribution Frame when Frame is Extended.

FIG. 6—PROPOSED METHOD OF PROVIDING CABLE HOLES FOR INTER-FLOOR CABLING TO INTERMEDIATE DISTRIBUTION FRAME

plugged holes were shown to be satisfactory for non-screeded as well as for screeded floors, and it has been accepted that the quantity provided may be reduced to one coach screw per rack (instead of three per rack as hitherto), the outer holes in the base of the rack being used for the end racks of a suite. For single racks, two coach screws will be provided, one in each of the outer holes. To assist installation, additional screws may be provided for racks erected singly initially but which will eventually form part of a suite.

##### *Ceiling Struts*

A tubular strut has been devised that overcomes the difficulty previously experienced of fitting factory-produced struts on site where the dimensions, due to the normal building tolerances, may not be precisely as shown in the plans.

The device consists of a tube of  $1\frac{3}{4}$  in. outside diameter that can be readily cut to the required length on site and bolted at each end to angled cast lugs (Fig. 7). The strut is then fitted in position, usually being fixed to ceiling beams, and provides a rigid support at an angle of  $45^\circ$ . The use of this form of strut avoids the need for the manufacture of specially-dimensioned struts, or their fabrication on site, an operation that can involve bending fairly heavy channel-iron.



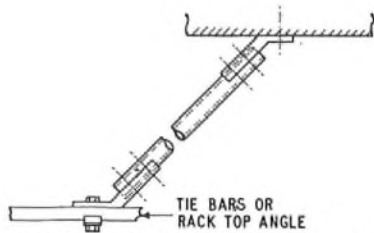

FIG. 7—TUBULAR STRUT FOR APPARATUS-RACK SUPPORT

### Ceiling Fixings

To provide readily-available ceiling fixings for equipment and cable-runway supports, it was a standard requirement that beams in apparatus rooms should be fitted with hollow tubes or that auxiliary girders should be provided. The difficulty of specifying the position of such fixings sufficiently early during the planning of the building resulted in a change to the provision of a 3 ft spaced grid of tapped ceiling-sockets over the whole of the apparatus-room ceiling. The loading of each socket was limited to 100 lb, and the need for load spreading which this limit imposed, coupled with the frequent requirement to strap two or more sockets in order to obtain a vertical fixing in the required position, resulted in a large amount of unsightly and costly overhead ironwork.

Considerable simplification of this structure was shown to be practicable, and in particular a revision of the ceiling-socket loadings was agreed whereby, without the overall ceiling loading being increased, individual sockets were allowed to carry 500 lb, subject to limitations regarding the loading of sockets close together.

For new buildings, an overall grid of ceiling sockets will not be provided, because it has been found that for the grids of ceiling sockets already provided, usually only some 5–10 per cent of the sockets were used, and their provision was sometimes troublesome to builders. New installations will make greater use of wall fixings and temporary floor-supports where no racks are provided initially. It will also be necessary for some ceiling fixings to be specially made at the equipment installation stage, but it is not expected that the number of such fixings will exceed 2 per cent of the total of ceiling sockets previously provided.

Ceilings fixings were used extensively near distribution

frames, where the distances to be spanned by the tie-bars were greater than those encountered within the suites of racks. Standard twin tie-bars, each of 1 in.  $\times$   $\frac{3}{8}$  in. mild steel, are adequate for unsupported span lengths of up to approximately 5 ft, but larger-sized tie-bars will be used for longer spans, thus avoiding the provision of a number of ceiling fixing points near frames and over wide end-gangways. It is considered that an overall simplification of installation methods will result, and the cost should be no more and may eventually prove less. The introduction of the unit layout of equipment was a major factor in determining this line of action, since it materially reduces the number of floor supports required, particularly in floor areas which, if not so impeded, might be useful for maintenance purposes.

### CONCLUSION

The increasing cost of labour and materials in the provision of telephone exchange equipment has emphasized the need to review installation methods that have become general during the past years. The introduction of new methods has resulted in worthwhile economies without reducing the efficiency and effectiveness of installation standards.

### ACKNOWLEDGEMENTS

The cable clips illustrated in Fig. 1 and 2 were developed by Ericsson Telephones, Ltd. The cable pins shown in Fig. 3 and 4 were developed by the General Electric Co., Ltd., and those in Fig. 5 by Associated Electrical Industries, Ltd.

The authors are indebted to the telephone exchange equipment manufacturers for their close co-operation in the work described, to colleagues in the Telegraph Branch, E.-in-C.'s Office, for their co-operation in the extensive trial of the Ericsson-type cable clip in Fleet Automatic Telex Exchange, and to the Ministry of Works.

### References

- <sup>1</sup> LAWRENCE, J. P. The Unit Method of Automatic Telephone Exchange Design. *P.O.E.E.J.*, Vol. 54, p. 14, Apr. 1961.
- <sup>2</sup> ROBERTS, W. G., and POVEY, J. A. Over-Ceiling Cabling for Telephone Exchanges. *P.O.E.E.J.*, Vol. 54, p. 82, July 1961.
- <sup>3</sup> HIX, K. W. The Telephone Exchange Main Distribution Frame. *P.O.E.E.J.*, Vol. 53, p. 226, Jan. 1961.

## Book Review

“An Introduction to Computational Methods.” K. A. Redish, B.Sc. The English Universities Press, Ltd. xii + 211 pp. 28 ill. 30s.

This book is written for students and for people who have occasional need for computing. The latter requirement has led to a preference for methods which are easier to understand, even though the arithmetic may be a little more laborious. The mathematical level is, apart from the occasional use of matrices, G.C.E. Advanced Level or a little above.

There is an excellent introductory chapter dealing, in particular, with a practical approach to the handling of rounding-off errors. The rest of the book covers most of the usual problems: simultaneous linear equations, non-linear equations in one or more variables, finite differences,

interpolation, differentiation and integration, differential equations. A chapter on miscellanea touches on such things as approximating functions, latent roots, summation of series. Throughout the book there are detailed references to one or more of about a dozen standard texts. The examples in the book cover the various points in great detail with plenty of numerical working; the user should have no difficulty in following the process being explained.

The reviewer disagrees strongly with treating the “Method of False Position” as a first-order process: taking the two latest points, rather than the first and latest, converts it into a second-order process almost as powerful as Newton’s Method and preferable in the many cases where calculation of the derivative is impractical. Apart from this, the book is an excellent introductory text.

W.E.T.

# The Interim Meeting of C.C.I.R. Study Group IV—Space Systems and Radio Astronomy, Washington, D.C., March 1962

U.D.C. 061.3:621.396.946 + 523.164

**A**T the IXth Plenary Assembly of the C.C.I.R.,\* Los Angeles,† 1959, the work of some of the Study Groups was revised because of changing emphasis and of the need to take account of developments in the new field of space communications. Study Group IV was reconstituted and given the task of dealing with space systems and radio astronomy, its new terms of reference being:

“To study technical questions regarding systems of telecommunications with and between locations in space and questions relating to radio-astronomy.”

Professor I. Ranzi (Italy) was elected the International Chairman and Mr. W. Klein (Switzerland) the Vice-Chairman of the Study Group.

The first meeting of the Study Group, an Interim Meeting, was held in Washington, D.C., 12–23 March 1962, preparatory to the Xth Plenary Assembly of the C.C.I.R., New Delhi, January 1963. Since it was the first International Telecommunication Union meeting to deal in any detail with the technical aspects of space communication systems, its deliberations were of considerable interest and importance to the designers of such systems. This is exemplified by the attendance; there were present 162 delegates from 28 countries, while many international bodies, including the International Astronautical Federation, the Inter-Union Committee for Frequency Allocations for Radio Astronomy and Space Science, the World Meteorological Organization and the International Astronomical Union were also represented. The meeting was opened by the Honourable Lyndon B. Johnson, Vice-President of the United States.

A total of 62 contributions were submitted before the meeting; these included papers from Canada, France, Federal Republic of Germany, Japan, the United Kingdom, U.S.A. and the U.S.S.R. The work was divided between five groups dealing respectively with:

- (i) telecommunications between fixed earth-stations using earth satellites as relays and direct broadcasting from earth satellites,
- (ii) technical characteristics of earth-space and space-space telecommunication systems,
- (iii) satellite systems for navigation and meteorology,
- (iv) radio-astronomy, and
- (v) radio propagation and noise.

Since this was the first meeting of the reconstituted Study Group, rapid progress in the new field was not possible. Nevertheless, several draft recommendations and reports were approved. These represent a partial answer to some of the many questions posed. They are of considerable interest and importance to the designers

\* C.C.I.R.—International Radio Consultative Committee.

† The IXth Plenary Assembly of the C.C.I.R., Los Angeles, April 1959. *P.O.E.E.J.*, Vol. 52, p. 101, July 1959.

‡ C.C.I.T.T.—International Telegraph and Telephone Consultative Committee.

§ C.M.T.T.—Joint C.C.I.R./C.C.I.T.T. Committee for the Long-Distance Transmission of Television.

and users of satellite systems, and should provide a good start for the next meeting of the Study Group which will take place immediately before the Xth Plenary Assembly.

One report considers the propagation and other factors which determine the most suitable frequency ranges for space services, including satellite communications. This, and a companion report, concludes that the optimum frequency range at the present time is 1–10 Gc/s, although the later use of higher frequencies is not precluded.

In an examination of the problem of finding frequency space for satellite communication systems in the range 1–10 Gc/s it was concluded that the best prospects were on the basis of frequency sharing between communication satellite systems and line-of-sight radio-relay systems. It was agreed that such sharing would necessitate some limitation of the transmitter powers of satellites and of radio-relay systems in order to avoid mutual interference, and that these aspects will also need to be examined by C.C.I.R. Study Group IX which deals with radio-relay systems.

The considerations relating to radio-frequency channelling arrangements for satellite communication systems were examined with particular reference to an example of a possible r.f. channelling arrangement with shared use (by satellite and line-of-sight radio-relay systems) of the 4 and 6 Gc/s radio-relay system bands as submitted by the United Kingdom. It was concluded that:

“It is of the utmost importance for the future of satellite communications that there should be early international agreement on radio-frequency channelling plans for such systems. Attention is also drawn to the need for an internationally agreed procedure for the assignment of channels for specific systems.”

Progress was made in the preparation of provisional performance objectives for satellite communication systems in respect of the signal-to-noise ratio for multi-channel telephony and monochrome television. These performance objectives will have to be considered by the C.C.I.T.T.‡ and the C.M.T.T.§ To permit of the international exchange of television signals, up to and including the 625-line standard, it was recommended that satellite communication systems should be designed to provide a 5 Mc/s video bandwidth.

Draft Recommendations were prepared on the preferred frequency bands for the tracking, telemetry and telecommand facilities to be provided in operational satellite communication systems and the radio-frequency channelling arrangements required for these purposes.

In conclusion it can be said that, although a useful foundation for the design of operational satellite communication systems has been laid, much remains to be done before the Xth Plenary Meeting of the C.C.I.R. in 1963.

C.F.B.



# Satellite Communication Systems

W. J. BRAY, M.Sc.(Eng.), M.I.E.E.†

U.D.C. 621.391.1:621.396.934

The characteristics and potentialities of satellite communication systems, and the types of satellites and satellite orbits which could be used for such systems, are briefly considered. A possible satellite communication system is then described. Some indications are given of the part the United Kingdom is playing in experimental and development work, and of the international planning that will be necessary for the operation of world-wide systems.

## INTRODUCTION

SATELLITE communication systems are technically feasible and show promise of providing, in quantity and with good reliability and quality, inter-continental circuits for telephony, telegraphy, data transmission and television. Such systems are of considerable interest to the British Post Office in view of its responsibilities for world-wide communications. It is perhaps true to say that in no other field of communications are so many complex technical, operational, economic and international aspects involved; on the other hand, the facilities offered by a successful satellite communication system might well be such as to justify every effort to solve the many outstanding problems.

The present article discusses some of the characteristics and planning problems of satellite communication systems, the studies being made in this field by the Post Office in co-operation with the Ministry of Aviation, and the work of the International Radio Consultative Committee (C.C.I.R.) on space systems. Reference is also made to the recent Commonwealth Conference on Satellite Communications held in London during March and April 1962. The design of the Post Office experimental satellite ground station at Goonhilly Downs, Cornwall, is briefly discussed, and its role in the development of satellite communication systems is considered. The research and experimental aspects, and the transatlantic satellite tests—Projects TELSTAR and RELAY—to be carried out this year, are described in a companion article in this Journal.<sup>1</sup>

## CHARACTERISTICS OF SATELLITE COMMUNICATION SYSTEMS

Communication satellites of large traffic capacity are likely to be of the active type, in which signals transmitted on a given frequency from one of a group of ground stations are received and amplified in a satellite, and then re-transmitted on a different frequency back to another ground station in the group. It thus becomes possible to use line-of-sight propagation paths between ground stations and satellites; this will, for the first time, allow radio waves in the spectrum between about 1,000 and 10,000 Mc/s to be used for long-distance point-to-point inter-continental communication. The transmission capacity that could be provided on each radio carrier in this part of the spectrum would be adequate for a thousand or more telephone channels or a television channel; each telephone channel could, alternatively, provide some 20 telegraph channels. More than one world-wide system, each providing a thousand or more telephone

channels and one or two television channels, would be possible.

The large potential capacity and flexibility of satellite communication systems could be of considerable value for meeting the expanding demand for world-wide telephonic and telegraphic communication facilities. The number of telephones in use in the world is increasing rapidly and to keep pace with this growth the capacity of the world arteries of communication must increase accordingly. The development of international subscriber dialling will further stimulate this demand.

Most of the world's television receivers are in North America and Europe but as yet there is no "real-time" television link between these regions, although each contains extensive internal television networks. Television services are developing rapidly in many other parts of the world and a world television network could be of cultural, economic and political significance. Closed-circuit television links, i.e. for private as distinct from broadcast use, are already being provided in some countries, and requirements for inter-continental circuits of this type and for high-speed data transmission may arise. Satellite communication systems would appear to offer the most promising technical solution in sight for the achievement of world-wide television relaying networks.

## COMPARISON WITH OTHER INTER-CONTINENTAL TRANSMISSION SYSTEMS

The high-frequency (3–30 Mc/s) radio systems at present used for long-distance inter-continental communication suffer, at times, from poor-quality transmission and are of limited reliability. Furthermore, the high-frequency band is severely congested and any appreciable expansion of the number of services would be impracticable. Communication satellites would enable radio to be used for long-distance communication in a part of the spectrum, 1,000–10,000 Mc/s, free from such limitations and with scope for a large increase in the traffic capacity.

Submarine repeatered cable systems at present carry up to some 100 telephone channels over long distances and there is no doubt that in the future larger numbers of telephone channels, and perhaps real-time television, will be possible. Nevertheless, the capacity of long-distance submarine repeatered cables seems unlikely to approach that offered by satellite communication systems for some time.

A distinctive feature of satellite communication systems is that they could provide multi-station operation, whereby a number of ground stations within a given zone on the Earth's surface could all be connected to one another via a single satellite. Furthermore, the total capacity of the system could be shared between the ground stations according to traffic requirements, and the system could readily be adapted to cater for changes in these requirements, within the limit of the capacity of the satellite.

## CONSIDERATIONS RELATING TO TYPE OF SATELLITE ORBIT

The orientation, height and form, i.e. whether elliptical or circular, of satellite orbits used for satellite communi-

†Space Communication Systems Branch, E.-in-C.'s Office.

<sup>1</sup>TAYLOR, F. J. D. Equipment and Testing Facilities at the Experimental Satellite Ground Station, Goonhilly Downs, Cornwall. (In this issue of the *P.O.E.E.J.*)

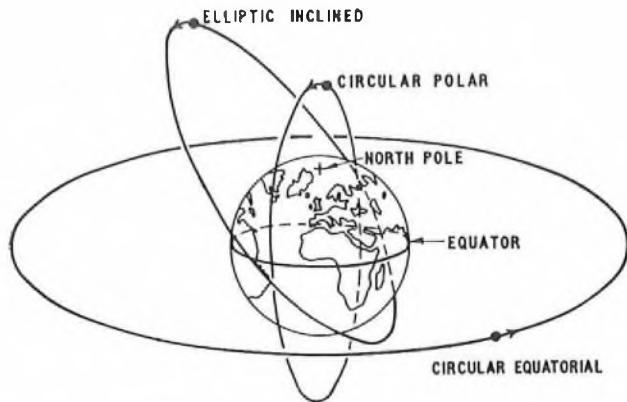

FIG. 1.—TYPICAL COMMUNICATION SATELLITE ORBITS

cation systems (see Fig. 1) will considerably influence the system design, performance and cost.

Elliptic orbits have advantages in certain situations, especially when coverage is required only over particular parts of the Earth; they may enable a given launcher to put a given payload into a higher-altitude orbit (at the apogee) than with a circular orbit. However, elliptical orbits are considered less suitable than circular orbits for systems providing world-wide coverage and using attitude-stabilized station-keeping satellites.

One distinction between equatorial orbits and polar (or highly-inclined) orbits is that, with the former, each satellite would track repetitively over the same part of the Earth's surface whereas, with the latter, each satellite would track over different parts of the Earth during each successive transit, due to the Earth's rotation. Each system may have special merits for particular applications but it is to be noted that the tracking problem at all ground stations would be considerably simplified by the use of satellites in equatorial orbits, since each satellite follows virtually the same track as the others on each successive transit. Furthermore, by using west-to-east orbits in the equatorial plane, advantage could be gained by using the rotational velocity of the Earth to launch greater payloads into orbit.

The effective period of an orbit, i.e. the time taken for one satellite to make a complete revolution round the earth, increases progressively with the orbit height. Equatorial orbits have the same periods as polar orbits of the same height, relative to an observer in space. With equatorial orbits, however, it is often more convenient to refer to the period relative to an observer on the Earth's surface. This, of course, involves more than a complete revolution in space if, as would normally be the case, the satellite travels in the same direction of rotation as the Earth. These relations are shown in the table.

Relation between Height and Period for Satellites in Circular Equatorial West-to-East Orbits

| Orbit Height<br>in Statute Miles | Period in Hours |                 |
|----------------------------------|-----------------|-----------------|
|                                  | True Period     | Observed Period |
| 1,000                            | 2.0             | 2.2             |
| 6,410                            | 6.0             | 8.0             |
| 8,610                            | 8.0             | 12.0            |
| 10,000                           | 9.3             | 16.3            |
| 22,300                           | 24.0            | Infinite        |

The equatorial orbit at 22,300 statute miles (s.m.)

height is known as the "synchronous" orbit since, in this case, a satellite travelling in the same direction as the Earth appears to be stationary to an observer on the Earth, i.e. the true period is 24 hours and the observed period is infinite. Orbits at 6,410 s.m. and 8,610 s.m. height are of interest as an observer on Earth would see a given satellite three and two times each day, respectively, at the same local times each day.

The greater heights of orbit are advantageous from the aspect of communications coverage as the number of satellites required for a world-wide service is thereby reduced, e.g. three satellites in the synchronous orbit could provide almost complete world-wide coverage except for the polar regions. However, for a given payload, the size and cost of the rocket launcher increases with the height of the orbit to be achieved. It by no means follows that the highest orbit, i.e. the 22,300 s.m. synchronous orbit, would necessarily be the most economical for a world-wide system. Furthermore, with the synchronous system, the transmission delay from ground to satellite and back to ground would amount to about 0.27 second, and this may well present serious difficulties for public telephony when two such satellite links are connected in tandem for calls between, say, the United Kingdom and Australia.

Another factor influencing the choice of orbital height is the presence of the Van Allen radiation belt of high-energy protons and electrons in that part of space surrounding low-altitude regions of the Earth. Such radiation may cause damage to solar cells or other solid-state devices used in active satellites, unless the orbits are suitably chosen and the solid-state devices are made as radiation-resistant as possible.

#### PASSIVE AND ACTIVE SATELLITES

Each of the basic types of satellite communication system referred to above could, in principle, use either passive satellites, such as the Project-ECHO balloon in which the satellite merely reflects or scatters the radio-wave energy incident upon it, or active repeater satellites incorporating receivers, transmitters and a source of power. The signals received from passive satellites are attenuated according to the fourth power of the distance and are extremely weak for orbital heights above a thousand miles or so unless very high-power transmitters and very large aeriels are used at the ground stations. On the other hand, heights of several thousand miles are desirable in order to reduce the number of satellites required for world-wide coverage. In view of these conflicting requirements, and the need to avoid the use of high-power ground-station transmitters in frequency bands shared with other radio services, active satellites are preferred to passive satellites for high-capacity systems providing a thousand or more telephone channels or a television channel.

Passive systems using large numbers of thin metallic dipoles in an orbital belt round the earth (Project WEST-FORD) have been proposed. These have not only the disadvantages common to all passive systems but also other disadvantages resulting from the rapidly fluctuating character of the received signal and the limited transmission bandwidth that is possible. The point has also been made by scientists that such belts could cause difficulty for both optical and radio astronomy.

#### STATION-KEEPING AND RANDOM SATELLITES

In some systems the satellites would "keep station,"



i.e. they would be controlled to have the same orbital period and to maintain prescribed positions in orbit. Such systems, of which the synchronous-orbit system is a particular case, would enable world-wide coverage to be obtained with a smaller number of satellites than if a random distribution of satellites were employed. A satellite orbit is affected to a small degree by several influences, such as those due to the non-uniformity of the Earth's gravitational field and solar-radiation pressure, which gradually affect the period and height of the orbit and, therefore, the relative positions of the satellites in orbit. Station-keeping may be achieved by means of jets which, on command by radio links from a ground station, emit from time to time small quantities of gas from a reservoir in the satellite, the thrusts thus imparted being such as to correct the satellite's velocity and direction of motion as necessary. In the interests of long life and reliability it is clearly important with such systems to choose orbits which minimize the amount of correction required; in this connexion the circular equatorial orbit offers advantages over circular polar and elliptical orbits.

A system using randomly distributed satellites could well require some 50 or more satellites for a world-wide service in order to ensure that there is only a very small percentage of time, of the order of 0.1 per cent, when no satellites are mutually visible to co-operating ground stations. A system using random satellites may also present considerable operational problems when large numbers of ground stations are involved. However, such satellites would be simpler than station-keeping satellites and may have a longer life and greater reliability.

#### *Satellite-Attitude Stabilization*

Directive aerials on satellites could be used to reduce the satellite and ground-station transmitter powers required for a given overall system performance, the directivity being such as to include the area of the Earth visible from a satellite. The use of directional aerials requires that the satellite attitude be stabilized, generally in such a manner that the aerial-beam direction points continuously at the centre of the Earth. Such attitude stabilization could be achieved by active means, e.g. by the gas jets referred to above in conjunction with infrared horizon-sensors, or by semi-passive means using the torque created by the gradient of the Earth's gravitational field. Either system adds to the complexity of the equipment in the satellite and may therefore reduce reliability; in this connexion the passive system may offer advantages in view of its greater simplicity. It also seems desirable, other factors permitting, to choose orbits such as the circular equatorial orbit which simplify the problem of satellite-attitude stabilization.

#### A POSSIBLE SATELLITE COMMUNICATION SYSTEM

The following example of a possible satellite communication system is based on the joint theoretical studies carried out by the Post Office and the Ministry of Aviation (Royal Aircraft Establishment, Farnborough). In these joint studies the Post Office has been concerned primarily with communication aspects and the Ministry of Aviation with the launching vehicle and satellite design. Before considering the design it must be emphasized that many major problems (involving a great deal of research, experiment and development) would have to be solved before an operational system could be achieved. At this stage it can be considered only as a potential design objective and further experience may well neces-

sitate major changes.

In this example 12 active, station-keeping, satellites would be deployed with uniform spacing in a circular equatorial west-to-east orbit at a height of about 8,610 s.m. (see Fig. 2). The effective, or observed, orbital

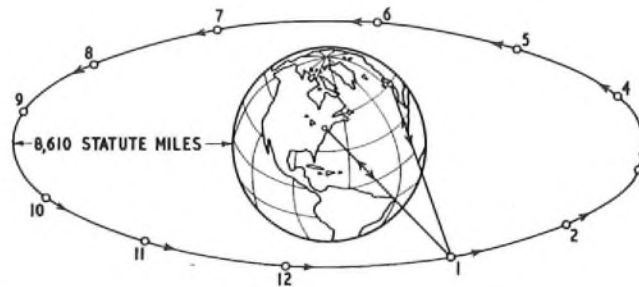

FIG. 2—CIRCULAR EQUATORIAL ORBIT SYSTEM

period is assumed to be adjusted to 12 hours with fair accuracy, each satellite being seen by an observer on Earth twice per day at very nearly the same local time each day; the true orbital period is then 8 hours, corresponding to three orbits per day, as shown in the table. The study indicates that, by using a high-precision launching technique and control-jets on the satellites, the errors in angular separation of the satellites need not exceed a few degrees over periods of several years.

The satellites might transmit on a frequency of the order of 4,000 Mc/s and the ground stations on a frequency of the order of 6,000 Mc/s. Initially such a system might provide up to some 1,200 unidirectional telephone channels, i.e. 600 circuits, and a 5 Mc/s-wide television channel. Later this capacity might perhaps be doubled by using a heavier satellite and a launching vehicle of more advanced design. Using frequency-modulation techniques, the radio-frequency bandwidth required would be of the order of 50 Mc/s in each band on the basis of the typical transmitter powers and aerial gains referred to below. All the satellites could use the same radio-frequency channels in each band since sufficient discrimination between satellites would be obtained from the highly directive aerials used at the ground stations.

For telephony, a single transmission from the satellite would carry all the 1,200 telephone channels, the aerial beam width being wide enough to cover the zone of the Earth's surface visible from the satellite. Each ground station within this zone would receive the transmission and extract from it the particular telephone channels it required. In the upward direction, the total bandwidth of about 50 Mc/s would be divided into a number of sub-channels so that each ground station could transmit its outgoing telephone channels on a different frequency. Each ground station would thus accommodate one or more blocks of, say, 24 or 120 telephone channels. Wide-deviation frequency-modulation could be used for the downward transmission, and narrow-deviation frequency-modulation for the upward transmission in each sub-channel.

In the satellite, the transmissions received from the various ground stations in a given zone would be demodulated to the baseband\* and then reassembled into a

\* Baseband—the baseband of a radio-relay system may be defined as the frequency band at the input and output of the system which is occupied by the multi-channel telephony, television or telegraphy signals and any pilots or other signals transmitted by the system.

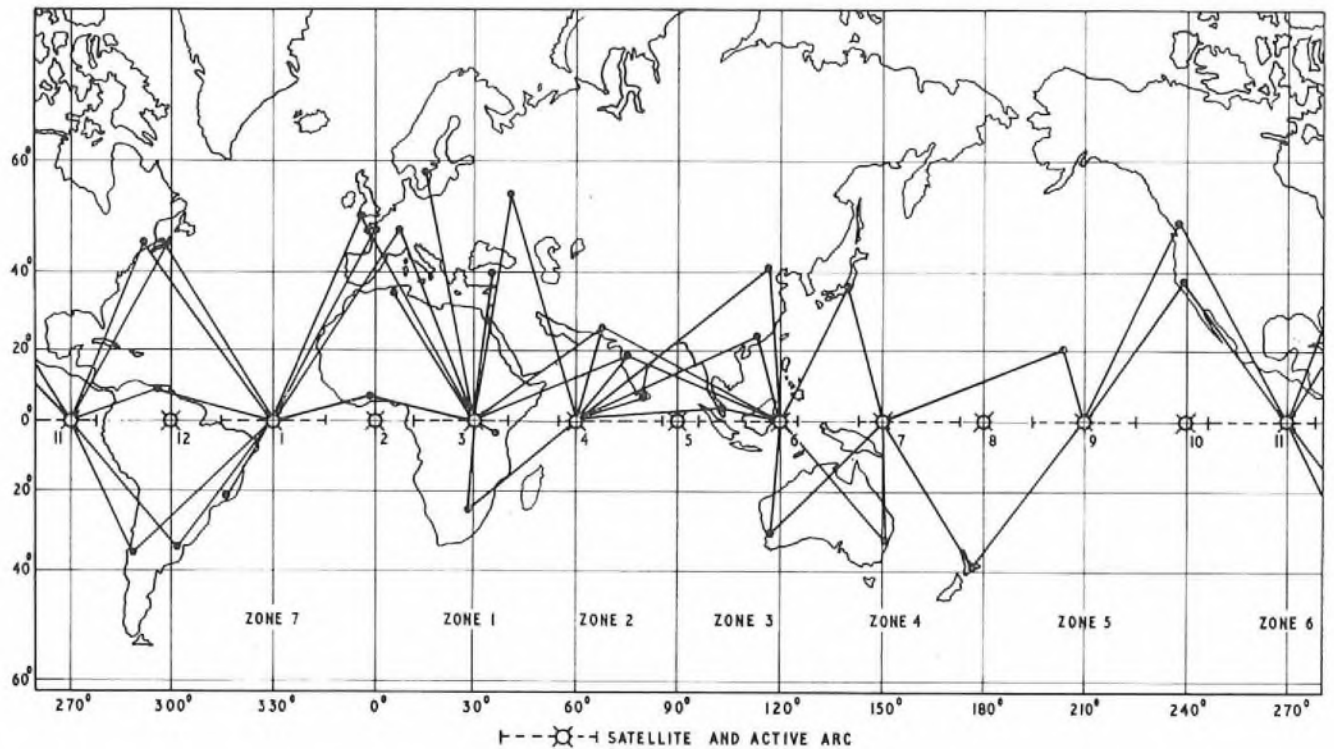

FIG. 3—REPRESENTATIVE LINKS FOR CIRCULAR EQUATORIAL ORBIT SYSTEM

single wide-baseband signal which modulates the satellite transmitter.

The satellite would be available to all ground stations within the zone and the arrangements outlined above would enable telephony circuits to be established between any pair of these ground stations, thus providing for multi-station operation.

For the system described, world-wide communication would be possible using seven such zones more or less uniformly spaced round the equator. Fig. 3 shows the zones and representative links that could be established. Each satellite would pass through each of the seven zones in turn in the course of its 12-hour effective period of orbit. To provide a simple and convenient operational plan, an "active arc" would be designated in each zone, its position being so determined that it is fully visible to the greatest number of ground stations in the zone. The lengths of an active arc would be slightly more than the spacing between adjacent satellites so that one satellite is always to be found within an active arc. All ground stations within a zone make use of a satellite while it is traversing the associated active arc.

As one satellite leaves the end of an active arc, the next satellite will be entering the arc, and the ground stations will switch from the first to the second satellite at this time. This switching would take place regularly at hourly intervals. The need for exact synchronization of switching could be avoided by arranging for all ground stations, while continuing to work to the first satellite, to commence dual transmissions to the second satellite within a short but defined period before switching is due to take place. At the end of this period all stations would be transmitting to both satellites simultaneously but the ground station output signals would continue to be taken from the first satellite. Transfer of the received signal from the first to the second satellite could then take place

independently at each ground station, a further short defined period being allotted for this operation. In this manner uninterrupted communication would be maintained between all ground stations.

The zones referred to above would overlap and, in general, a ground station would be able to utilize two active arcs, one to the east and one to the west. All the ground stations within a zone would be in communication with each other via a single-hop link utilizing one satellite. Communication between ground stations in different zones would be made via ground interconnecting stations and would involve at least a two-hop satellite link.

A system of the type described would use satellite transmitter powers of a few watts and aerial gains of some 15 db. High-capacity ground stations accommodating blocks of 120 telephone circuits and a television channel would use steerable aerials some 85 ft in diameter, with gains of about 60 db and beam widths of about  $0.1^\circ$ ; smaller ground stations accommodating blocks of 24 telephone circuits would use aerials 30 ft in diameter. Ground-station transmitter powers would be of the order of 1 kW.

A typical ground station of such a system might employ three operational aerials each with its associated transmitter and receiver. Two of these would be in use tracking those satellites traversing the active arcs to the east and to the west. The third would be used to establish connexion with the satellite next required before it entered the active arc, so that switch-over from one satellite to the next could be effected without interruption.

A satellite communication system of the type described might be used to provide circuits for world-wide telephony, telegraphy and data transmission; it could also provide facilities for television relaying. For the latter purpose the zoning principle would be particularly useful,



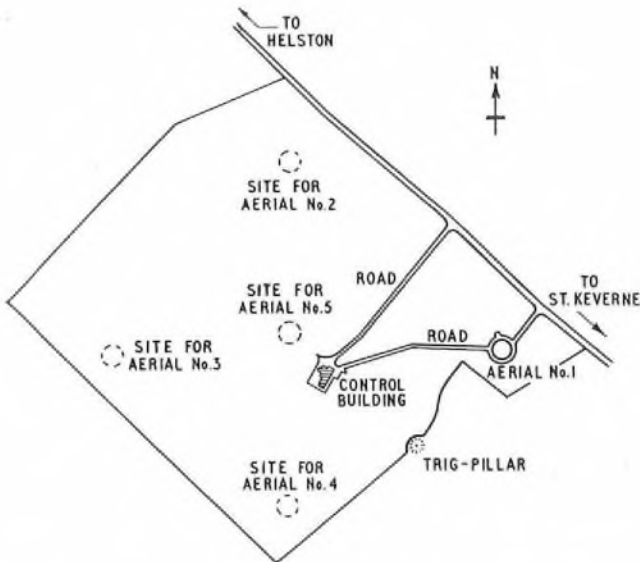

FIG. 4—SIMPLIFIED SITE-PLAN OF GOONHILLY RADIO STATION

since each zone of some 4.5 hours time difference corresponds approximately to a convenient maximum difference of time which could normally be accommodated for live television broadcasts. Each zone could, if desired, accommodate a different television program; on the other hand, world-wide television links could be established via ground interconnexion stations.

Among the advantages of such a system may be cited the following:

- (a) Continuous world-wide coverage up to at least 55°, and limited coverage up to 60°, north and south latitudes.
- (b) Large telephone-circuit capacity with considerable flexibility for traffic routing, and sizes, numbers and locations of ground stations.
- (c) Most inter-continental telephone connexions could be provided with delays not exceeding 0.25 second for

two satellite links in tandem and this would probably be acceptable for public telephony.

(d) Failure of a satellite would not cause continuous interruption of communication, e.g. less than one hour in 12 hours.

(e) Initial, or additional, satellites could be put into orbit to provide added capacity on heavy-traffic routes, e.g. the North Atlantic route, at peak traffic periods.

(f) Suitability for multi-zone television relaying with different programs, if required, in each zone.

#### THE POST OFFICE EXPERIMENTAL SATELLITE GROUND STATION

The early accumulation of experimental information on the performance of communication satellites is of great importance to the designers of a system for commercial operation. To facilitate this end, in February 1961, the United Kingdom and U.S.A. Governments prepared and signed a Memorandum of Understanding regarding collaboration between the British Post Office and the United States National Aeronautics and Space Administration (N.A.S.A.) on the testing of experimental satellites to be launched by N.A.S.A. for communication purposes. The first phase of the tests covers Projects TELSTAR and RELAY (both using active satellites), referred to in a companion article in this Journal.<sup>1</sup>

The understanding with the United States covers the full interchange of technical information, makes clear that the collaboration is in respect of experimental tests only and is not concerned with commercial exploitation, and does not preclude the use of the Post Office experimental ground station for tests outside the co-operative projects outlined. Similar agreements between the United States and France, Federal Republic of Germany, Italy and Brazil have since been made.

In order to carry out the tests, the Post Office has built an experimental satellite ground-station at Goonhilly Downs, Cornwall (see Figs. 4 and 5). The site, approximately 800 yards square, was chosen as being particularly suitable for the transatlantic path in view of its westerly location; also its latitude is convenient for satellites in

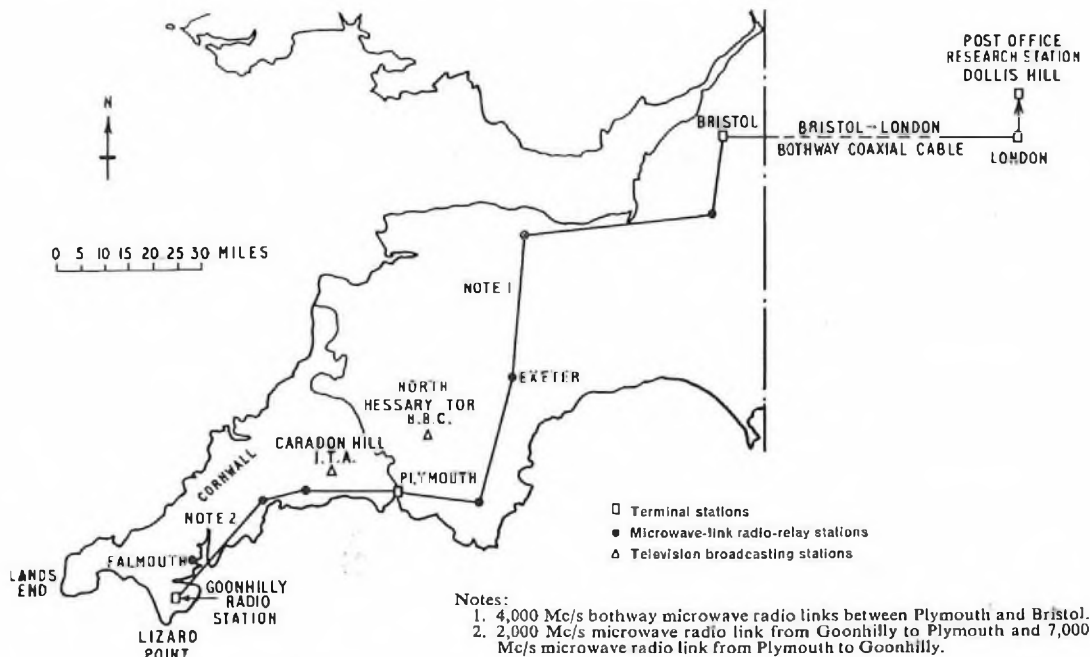

FIG. 5—VIDEO LINKS ASSOCIATED WITH GOONHILLY RADIO STATION

equatorial orbits. It is remote from the majority of microwave links in the United Kingdom, so that frequency-sharing with such links is facilitated. The horizon angles are predominantly negative with a maximum positive value of about  $0.5^\circ$ , so that satellite orbits involving low angles of elevation could be used. The main station building is located near the centre of the site, the aerial being close to one corner. The site is large enough to accommodate additional aerials.

The station is at present being equipped for participation in Projects TELSTAR and RELAY; the facilities provided include the following:

(a) An 85 ft diameter parabolic-reflector aerial with ability to steer over the whole hemisphere above the horizontal plane.

(b) Means for steering the aerial automatically from predicted orbital data.

(c) A 5 kW transmitter operating at 6,390 Mc/s for Project TELSTAR.

(d) A 10 kW transmitter operating at 1,725 Mc/s for Project RELAY.

(e) Low-noise receiving equipment for the 4,170 Mc/s signals from the satellites.

(f) Terminal equipment for transmission and reception of multi-channel telephone and television signals.

(g) Video and multi-channel telephone links to the trunk network (see Fig. 5).

The steerable dish aerial, Fig. 6, is designed for operation up to at least 8,000 Mc/s. Since the TELSTAR and RELAY satellites will move fairly rapidly across the sky—the maximum period of visibility between the United Kingdom and American ground stations will be only some 30 minutes—the aerial is required to track a moving satellite to within a few minutes of arc. The aerial rotates as a whole on a turntable to provide changes in azimuth, and the dish is rotated about a hori-

zontal axis for elevation changes. In addition, small variations (up to a degree) of beam direction are possible by remotely-controlled movement of the feed at the focus of the dish.

Since the aerial is not protected by a radome, stability under high-wind conditions is achieved by a heavy, sturdy, construction using reinforced concrete supporting members, and powerful driving motors. The weight of the movable part of the aerial structure is some 870 tons, and the structure is designed to operate in wind velocities up to 65 mile/h. The aerial will be steered primarily on the basis of predicted orbital information derived from the N.A.S.A. world-wide network of "Minitrack" stations, one of which is operated by the Department of Scientific and Industrial Research at Winkfield, near Slough. In addition, manual control, and, later, an automatic "lock-on" control, operating from a radio beacon on the satellite, are being provided.

In the main building (Fig. 7), from which all experiments are to be controlled, the principal rooms are equipped with:

- (i) control and experimental apparatus,
- (ii) computer and data-processing equipment,
- (iii) telegraph equipment,
- (iv) aerial-steering equipment,
- (v) aerial-steering console, and
- (vi) auxiliary test apparatus, including telecine equipment.

It is of interest to note that the Goonhilly radio station will have been built and equipped within one year of obtaining access to the site, and that virtually all the equipment provided, including the large steerable aerial, is of British design and manufacture. The aerial design is the copyright of Husband & Co.

The station has been planned and equipped, not only for participation in the initial experimental Projects TELSTAR and RELAY but also to be suitable for modification and extension as required for later experiments and for a wide range of satellite-system studies. The aim has been to provide considerable flexibility in the equipment design, together with accommodation and services capable of expansion to meet future needs, including the possibility of operational use at a later date. It will certainly play a very important part in the acquisition of the technical information and experience needed for the design and construction of a successful operational satellite communication system.

#### INTERNATIONAL PLANNING

##### *International Telecommunication Union*

The success of satellite communications will depend in large measure on the effectiveness with which the international planning is carried out. In this, the International Telecommunication Union (I.T.U.) assisted by its advisory committees, the International Radio Consultative Committee (C.C.I.R.) and the Inter-

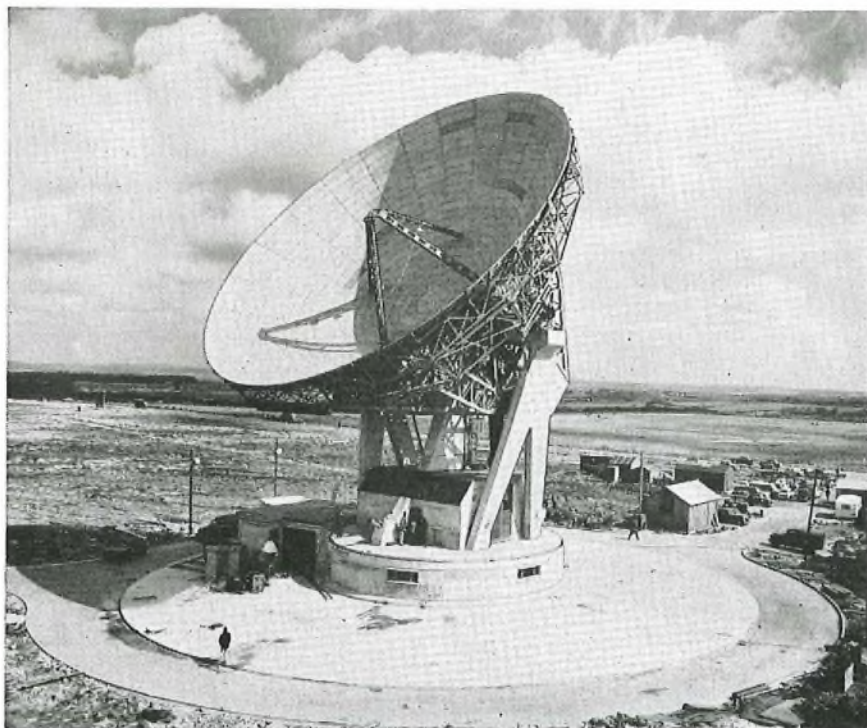
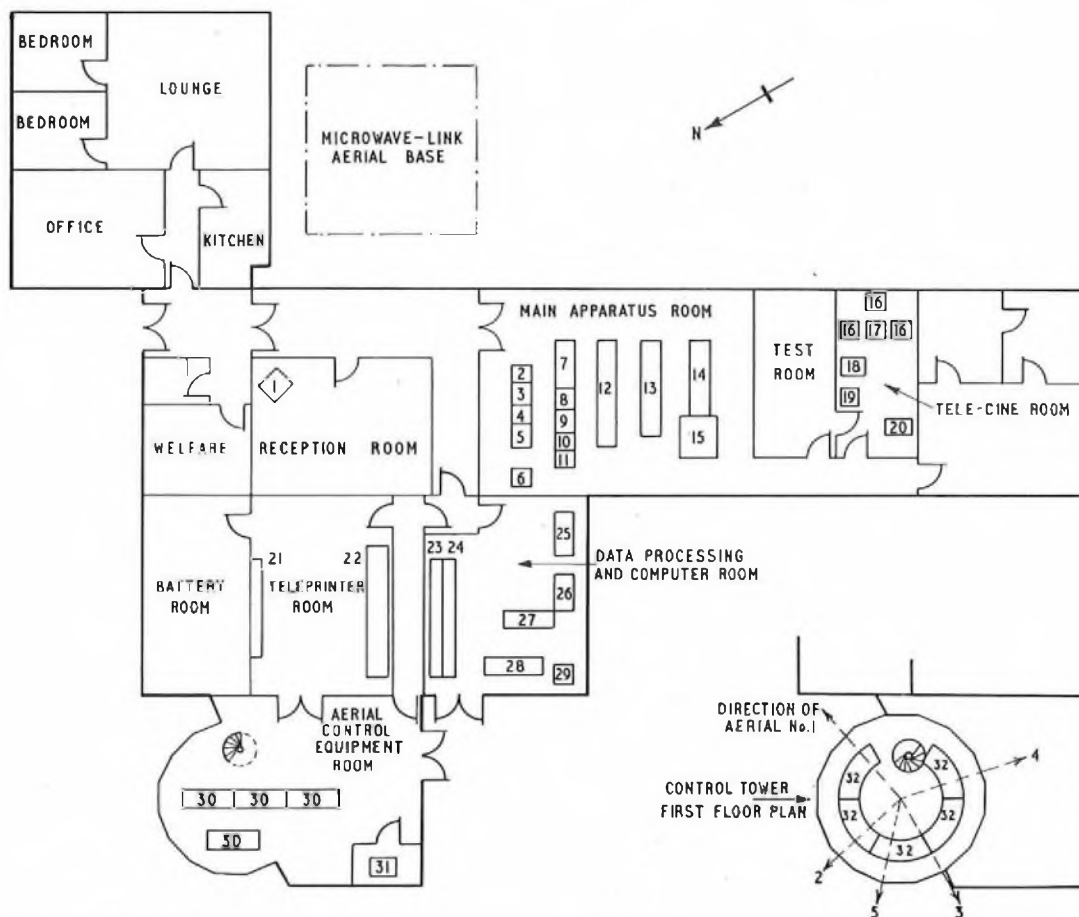
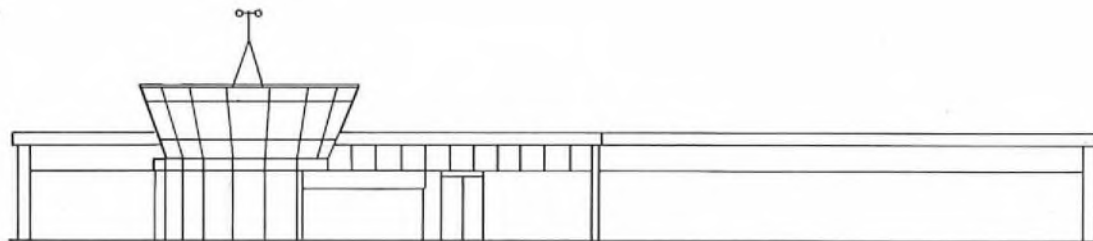

FIG. 6—GOONHILLY RADIO STATION STEERABLE AERIAL





1. Television-picture monitors.
2. Controller-of-experiments position.
3. Circuit-switching position.
4. Beam-swinging control position.
5. Transmitter and receiver supervising position.
6. Private automatic branch exchange switchboard.
7. Microwave-link equipment.
8. Waveform-correction apparatus.
9. Time equipment.
10. Experiment switching apparatus.
11. Direct pick-up television receiver.
12. Baseband and r.f. equipment.
13. Miscellaneous test equipment.
14. Multi-channel telephony carrier terminal.
15. Internal cabling distribution frame.
16. Telecine projectors.
17. Television camera.
18. Telecine apparatus racks.
19. Meteorological recording equipment.
20. Private automatic branch exchange switching equipment.
21. Power switchboard.
22. Telegraph equipment.
23. Aerial steering control tape readers.
24. Aerial steering control data recorders.
25. Reproducers.
26. Keyboard table.
27. Paper-tape station.
28. Computer.
29. Battery charger.
30. Aerial control equipment.
31. Temperature-controlled crystal clock.
32. Aerial control consoles.

FIG. 7—APPARATUS LAYOUT OF GOONHILLY RADIO STATION

national Telegraph and Telephone Consultative Committee (C.C.I.T.T.), will have a major role to play.

At this stage the most important aspect is the question of frequency bands to be used. The range 1,000–10,000 Mc/s is already being used for a variety of radio services, some of which, such as high-power radar and tropospheric-scatter services, would be incompatible with satellite systems. In fact, at the last Administrative

Radio Conference (Geneva, 1959), at which the whole frequency range from 10 kc/s–40,000 Mc/s was allotted to the various types of service, the band, 1,000–10,000 Mc/s was more or less used up for other services, only a few allocations being made for space research. However, it was proposed that an Extraordinary Administrative Radio Conference (E.A.R.C.) be held in 1963 to consider frequency allocations for space systems. The work

to be done at the E.A.R.C. will clearly lay the foundations on which such systems will be built.

At the C.C.I.R. Study Group IV Interim Meeting held in Washington,<sup>2</sup> 12-23 March 1962, a start was made on the preparation of draft recommendations regarding frequency usage and transmission performance.

#### *Conference of European Postal and Telecommunication Administrations*

The Conference of European Postal and Telecommunication Administrations (C.E.P.T.) at its meeting in Torquay, 1961, established a Working Group, "Telecommunications by Artificial Satellites," under the chairmanship of the United Kingdom to consider the problems of, and exchange views on, the development of satellite communications from the point of view of the European countries. This working group met in London, in November 1961, for a preliminary exchange of views, and the corresponding Radio Working Group of C.E.P.T. met in Rome, in January and February 1961, to consider frequency allocations for satellite communication systems.

#### *Commonwealth Satellite Communications Conference*

The Commonwealth Satellite Communications Conference, which met in London, 28 March-13 April 1962, to consider the technical and economic aspects of satellite communication systems, was attended by representatives from Australia, Britain, Canada, Ceylon, Ghana, India, New Zealand, Nigeria, Pakistan, Sierra Leone, and the Federation of Rhodesia and Nyasaland. In his welcoming address to delegates the Postmaster-General, the Rt. Hon. Reginald Bevins, M.P., pointed out that developments in the field of communication satellites were such that it was appropriate for Commonwealth Governments to give early consideration to the great potentialities of such systems. Sir Ronald German, C.M.G., Director-General of the British Post Office, was unanimously elected chairman of the Conference.

The Conference, which was of an exploratory character, concluded that satellite communication systems are technically feasible although a great deal of research and experimental work, which would take some years, would be required before a satisfactory commercial system could be established, and recommended that such work should continue to be actively pursued in Commonwealth countries. The Conference gave detailed consideration to the needs of Commonwealth communications and recognized the advantages of a satellite system using active, station-keeping, attitude-stabilized satellites in an equatorial orbit in the height range of 5,000 to 10,000 miles, i.e. similar to that described as an example in this

<sup>2</sup> The Interim Meeting of C.C.I.R. Study Group IV—Space Systems and Radio Astronomy, Washington, D.C., March 1962. (In this issue of the *P.O.E.E.J.*)

article. The need to serve as large a number of countries as possible with maximum flexibility was recognized. It was recommended that there should be early discussions with the United States and European countries, in the hope that such co-operation would lead to a pooling of effort and thereby achieve the best world-wide system of satellite communications. This recommendation is entirely in line with the United Nations General Assembly Resolution of December 1961, which expressed the view that communication by means of satellites should be available to the nations of the world on a global and non-discriminatory basis.

The conference forecast a very bright future for the growth of telephone and telex communications, and felt that a global satellite communication system could well become financially profitable within a few years of establishment. The possibilities of television relays, especially between countries with comparatively small time differentials, were also thought to be bright. At the same time it was recognized that satellite communications and submarine telephone-cable systems would be complementary to one another.

The Report of the Conference, which was agreed unanimously, is being submitted to the Commonwealth Governments.

The opportunity was taken during the Conference to show the visitors the progress which had been achieved at the Goonhilly Radio Station. The delegates made the journey in a chartered aeroplane (London Airport to the Royal Naval Air Station at Culdrose, Cornwall), and expressed great interest in the equipment of the new station and in the progress which had been achieved.

#### CONCLUSION

It will be evident from the foregoing that the Post Office, in co-operation with the Ministry of Aviation and other Government Departments, is taking an active part in the study and development of satellite communication systems. This work includes system planning and technical studies, related to the international regulatory aspects of satellite communications, by the Space Communication Systems Branch of the Post Office, and also research and experimental work by the Post Office Research Station, which will be of vital importance as a basis for the design of future operational systems.

Valuable contributions to this work are being made by the team of engineers from Australia, Canada and New Zealand, shortly to be joined by engineers from other Commonwealth countries, now co-operating with the British Post Office.

Quite apart from the interest of this fascinating new development in communications technology, those concerned have the reward of participation in what may well be one of the most significant experiments of our time in international co-operation for peaceful purposes.

---

## Book Received

"Learning Morse." Thirteenth edition. H. F. Smith. Published for *Wireless World* by Iliffe Books, Ltd. 20 pp. 6 ill. 1s. 6d. (1s. 10d. post paid).

This is a newly-revised edition of a booklet intended as a guide for those persons wishing to master the international signal code. It gives methods of learning the code, key

manipulation and practice, and also gives details of equipment, including a practice set with a transistor oscillator. The international Morse code is given in full and the revised Q code, which was approved at the 1959 Geneva Telecommunication Conference and came into operation during 1961, is also included. The booklet ends with a series of practice code groups and rhythmic groups.



# Equipment and Testing Facilities at the Experimental Satellite Ground Station, Goonhilly Downs, Cornwall

F. J. D. TAYLOR, O.B.E., B.Sc., M.I.E.E.†

U.D.C. 621.396.7:621.396.934

The large steerable aerial and associated equipment at the Goonhilly satellite ground station have been provided initially for research and experimental studies connected with satellite communication systems, and, in particular, in connexion with Projects TELSTAR and RELAY. An outline is given of the equipment provided, some of its special features, and the tests to be made with it as part of Projects TELSTAR and RELAY.

## INTRODUCTION

THE experimental satellite ground station at Goonhilly Downs, Cornwall, has been so designed that it will be suitable, with appropriate equipment modification, for any foreseeable research and experimental satellite communication studies that many be required.<sup>1</sup> The main elements are a large steerable aerial, accommodation for experimental equipment and facilities for connexion to the trunk network.

The dimensional tolerances, stability and steerability of the aerial are such that it may be employed at frequencies up to at least 8,000 Mc/s and may be used to follow satellites at heights above about 300 miles.

The equipment provided initially for the station is that required for experiments in connexion with Projects TELSTAR and RELAY, which involve active satellites to be launched by the National Aeronautics and Space Administration (N.A.S.A.) of the U.S.A. during the summer of 1962. The present article discusses the following aspects of the equipment provided and the tests to be carried out:

(a) The large steerable aerial, and the means for steering it and for testing its performance.

(b) The special demands that communication via active satellites impose upon transmission equipment at an experimental ground station.

(c) The transmission characteristics for Projects TELSTAR and RELAY.

(d) The experimental ground-station transmission equipment.

(e) The tests to be carried out as part of Projects TELSTAR and RELAY.

It will be appreciated that, in an article of this compass, it is not possible to do more than give an outline of these aspects.

## THE STEERABLE AERIAL

A simplified drawing of the steerable aerial is given in Fig. 1. The reflecting surface is a paraboloid of revolution having an aperture 85 ft in diameter, the focus being in the aperture plane. The use of an aerial feed in the aperture plane is important and, with suitable design of the feed itself, noise picked up from the ground via the minor lobes of the radiation diagram is minimized. The reflector mounting is pivoted on a horizontal axis supported high above a horizontal turntable some 40 ft in diameter. Azimuth movement is effected by rotation of the turntable about its vertical axis, while change of elevation is obtained by rotating a vertical screw which passes through a nut, the nut being attached to the reflector mount by a connecting rod.

At the foot of the turntable there is a room containing

†Post Office Research Station.

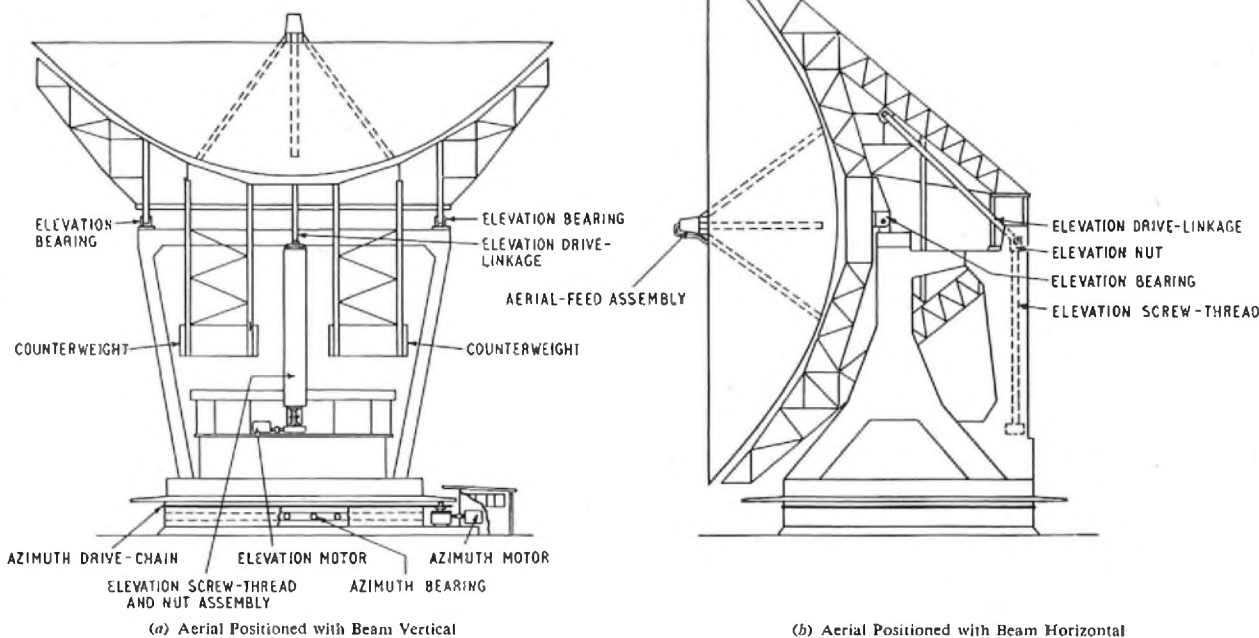

FIG. 1.—OUTLINE DRAWING OF GOONHILLY STEERABLE AERIAL.



FIG. 2—COMPUTER ROOM AT GOONHILLY

two Ward-Leonard electrical systems; these produce d.c. supplies for variable-speed motors which provide the azimuth and elevation drives. Rotation of the aerial in azimuth is effected by means of a loop of chain which embraces a motor-drive sprocket, tensioning sprockets and the periphery of the turntable. Movement of the reflector is restricted mechanically to:

- (a)  $0^{\circ}$  to  $100^{\circ}$  elevation above the horizontal, and
- (b)  $\pm 250^{\circ}$  azimuth about a line from the reflector centre to true south.

Fixed on both the azimuth and elevation axes there are digital shaft-angle encoders which provide an indication of the bearing of the axes relative to the above-mentioned datum angles.

For the accommodation of apparatus that must be very close to the aerial feed, two cabins have been constructed immediately behind the reflector, while the turntable itself supports a large room containing high-power transmitting and other equipment. Within the apparatus room on the turntable there is a central cylindrical structure that holds the loops of cable providing flexible connexions between equipment in the main station building and that on the movable structure.

The total weight of the rotating structure is some 870 tons and the total maximum motor-drive power is 200 h.p. Drive power and the rigidity of the aerial structure are such that it will maintain the necessary high degree of beam-pointing accuracy at wind speeds up to some 65 mile/h while tracking at angular velocities of up to at least one degree per second. The aerial design is the copyright of Husband & Co.

#### *Steering the Reflector*

For Projects TELSTAR and RELAY, prediction of the orbital elements of the satellite paths is being effected at the Goddard Space Flight Center in Maryland, U.S.A., on the basis of radio observations at "Minitrack" stations throughout the world, one such station being at Winkfield, England. At Goddard Space Flight Center a computer will be used to determine, some 24 hours in advance, the position of the satellite relative to various

ground stations, including Goonhilly. The orbital data will be transmitted in digital form, by teleprinter private-wire to Goonhilly, as distances to the satellite in Cartesian coordinates, i.e. in directions corresponding to true north, true east and the local vertical. To save computer and transmission time the data will be supplied at 1-minute intervals and for precise times in "Universal Time 2".

At Goonhilly, the received data will be processed in a computer (Fig. 2), the output of which is a punched paper-tape carrying in digital form:

(a) the azimuth and elevation bearings of the satellite at 1-second intervals, and

(b) changes of bearing at 0.2-second intervals.

The computer also corrects the bearings for small changes of wave direction due to refraction in the atmosphere, and allows for any

systematic steering errors. Means are also provided for the determination of true distance from the station to the satellite and of the magnitude of Doppler shift.

To steer the aerial, the steering tape is placed in a tape reader which controls the aerial-drive mechanism. Initiation of steering is effected when there is coincidence between the start time, as described in digital code on the tape, and the output from a master time equipment (Fig. 3).

The output of the tape reader is fed via a store to a digital arithmetic unit which processes the information and generates two signals representing the required azimuth and elevation bearing at each one-fiftieth of a second. The subsequent processes of azimuth and elevation control are identical, so that only one, the elevation drive, is considered here by way of example. The demanded position signal is compared in a comparator unit with the actual position as described by the shaft-angle encoder on the elevation axis. Any difference will be transmitted as an error signal to a converter which provides an analogue output, i.e. one in which the output level is proportional to the magnitude of the error. This is used to control the appropriate Ward-Leonard set, which produces a d.c. output to drive the elevation motor by an amount sufficient to reduce towards zero the difference between the demanded and actual elevation bearings.

For test purposes, and whenever the aerial is required to be set to a pre-determined rest position, it will be necessary to have an alternative to tape control. A manually-operated aerial-steering facility is provided for this purpose, and signals representing adjustable magnitudes of azimuth and elevation drive can be fed directly into the arithmetic unit. The aerial-steering console (see Fig. 4) will also serve as a point at which the correct operation of the aerial can be observed and at which certain steering corrections, discussed later, can be inserted.

#### *Radio-Beam Swinging*

If the orbital data, the aerial-steering mechanisms and



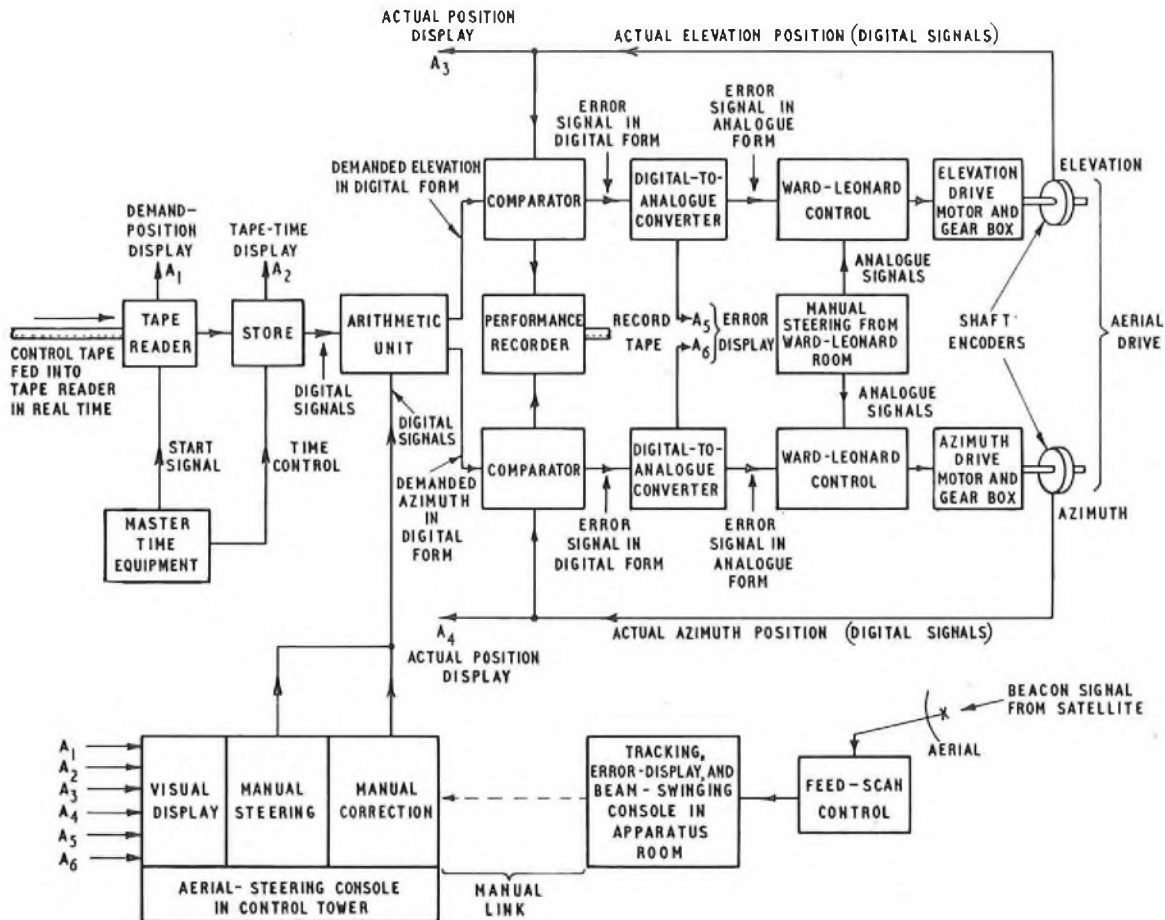

FIG. 3—SIMPLIFIED BLOCK-SCHEMATIC DIAGRAM OF THE AERIAL-STEERING SYSTEM

the aerial feed were all perfect, the axis of the paraboloid reflector and the electrical axis of the radio beam would be coincident and the radio beam would intercept the satellite. However, the radio beam is very narrow—only some 9 minutes of arc at 6,000 Mc/s—so quite small imperfections could cause the beam to miss the satellite altogether. Means are therefore provided for making



FIG. 4—AERIAL-STEERING CONSOLE

small relative movements between the axis of the reflector and the axis of the beam. The satellites of both the TELSTAR and RELAY projects will emit a continuous-wave (c.w.) beacon signal at 4,080 Mc/s as well as a communications signal at about 4,170 Mc/s; this beacon signal can be used to determine any offset between the axis of the reflector and the line from the station to the satellite. Prior to the time when reception of the beacon signal is expected the radio beam will be given a spiral scanning motion, i.e. it will be made to "look" for the satellite. Any discrepancy in bearing will be measured and a correction made to the aerial-steering instructions. Once the satellite is "on beam" it will still be necessary to watch for any drift and this will be done by giving the beam a small continuous conical scan.

Both the spiral and conical scans are effected by moving the feed at the focus of the dish (see Fig. 5), the scan amplitudes being approximately  $1^\circ$  and  $0.06^\circ$ , respectively. Display of difference of relative bearing is effected on cathode-ray tubes and corrections may be applied at the aerial-steering console in terms of digital signals injected into the arithmetic unit.

#### Testing the Aerial Performance

Facilities are provided at Leswidien, some 21 miles from Goonhilly, for low-power radio transmission or reception in order that measurements of the aerial gain and radiation diagram may be made. In addition, the station at Leswidien includes "satellite simulators", i.e. transponders corresponding electrically to the

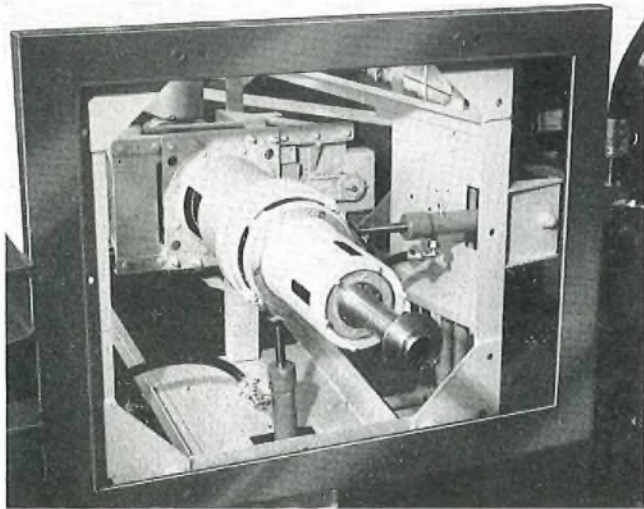

FIG. 5—AERIAL-FEED SCANNING MECHANISM

satellites, so that loop transmission tests can be made.

Tests of the tracking characteristics of the aerial, including measurements of any errors of alignment of the electrical and mechanical axes, can be made using the most powerful of the radio stars, Cassiopeia A, the direction of which is very accurately known at any given time.

#### A SATELLITE GROUND STATION TRANSMISSION EQUIPMENT

The transmission equipment provided at a satellite ground station must resemble in principle but not in scale that at terminal stations of conventional line-of-sight microwave radio systems. Indeed, a transoceanic path via an active satellite is but a two-hop microwave radio link. It is instructive, however, to consider the differences between the two techniques. A satellite communication system differs from a conventional radio-relay system in the following respects:

- (a) The use of steerable rather than fixed aerials.
- (b) The use of high-power transmission, i.e. kilowatts instead of a few watts.
- (c) The generation and reception of radio waves having circular rather than linear polarization.
- (d) A received carrier power of the order of only micro-microwatts.
- (e) An extremely low ratio of received carrier power relative to the noise power in the receiver r.f. and i.f. pass bands.
- (f) The presence of a Doppler frequency shift.

#### TRANSMISSION CHARACTERISTICS FOR PROJECTS TELSTAR AND RELAY

Projects TELSTAR and RELAY both use active satellites, i.e. incorporating radio receiving and transmitting equipment, with transmitter powers of a few watts, there being very little aerial directivity or gain in the satellites. Both satellites are to be launched in elliptical orbits at about  $50^\circ$  to the equator, the maximum height being some 3,000 statute miles, and the orbital period about  $2\frac{1}{2}$  hours. The maximum period of mutual visibility between the U.S.A. and the United Kingdom ground-stations will be some 30 minutes.

\*Baseband—The baseband is the frequency band, at the input and output of the system, which is occupied by the multi-channel telephony, television, or telegraphy signals and any pilot or other signals transmitted by the system.

The ground-to-satellite radio-frequencies for Projects TELSTAR and RELAY are, respectively, close to 6,390 and 1,725 Mc/s but, when two-way rather than one-way transmission is being effected, the carrier frequencies will be offset from these values by a few megacycles per second. For both projects the satellite-to-ground radio-frequency is approximately 4,170 Mc/s though, again, slightly offset from this value when two-way transmission is being undertaken. Wave polarization is right-hand circular from ground to satellite, and left-hand circular in the reverse direction of transmission.

For both projects the nominal baseband\* is up to 5 Mc/s. For one-way television transmission the video baseband is up to 3 Mc/s, the sound channel being transmitted as a frequency-modulation of a sub-carrier at 4.5 Mc/s. The baseband for one-way tests of multi-channel telephony is 60–2,540 kc/s, while for two-way telephony demonstrations it may be either 12–60 kc/s or 60–108 kc/s.

#### GOONHILLY TRANSMISSION EQUIPMENT

A simplified block-schematic diagram of the transmission equipment at Goonhilly is shown as Fig. 6; it outlines the equipment from the baseband input to the r.f. output and from the r.f. input to the baseband output.

Transmission both to and from a satellite will employ frequency-modulation and, because of the low ratio of carrier-power to noise power, the deviations will be greatly in excess of those used in conventional microwave line-of-sight systems.

Signals at baseband frequency will be applied, after any required pre-emphasis, to a frequency-modulator having a carrier of some 70 Mc/s, and the resulting i.f. signal will be transmitted over a coaxial pair from the control building to the turntable cabin. Here it will be raised to the appropriate r.f. and, after amplification, applied to the input of a high-power transmitter. Waveguide will carry the signals up from the turntable cabin to the dual (send and receive) aerial feed.

As previously mentioned, two signals will be received from a satellite: a c.w. beacon signal at about 4,080 Mc/s and a communications signal in the form of a wide-deviation of a carrier centred on about 4,170 Mc/s. The incoming signals will pass from the dual aerial feed by waveguide to one of the apparatus cabins immediately behind the reflector. Here they will be separated and the communications signal amplified; they will then recombine and pass down to the turntable cabin. After further processing, the communications and beacon signals will again be separated and transmitted in the 70 Mc/s i.f. range over coaxial cables to the control building.

At the control building the received communications signal will be demodulated in a f.m. demodulator and the baseband signal recovered. The beacon signal will be applied to a "beacon receiver," the principal function of which is to assist in correcting any difference between the arrival angle of the beacon signal and the bearing angle of the aerial.

#### 70 Mc/s Modulator

The 70 Mc/s modulator is basically of a type designed earlier by the Research Branch for experimental microwave line-of-sight systems. Facilities are provided so that when demonstrating two-way telephony the carrier frequency can be changed from 70 Mc/s to a somewhat lower figure. This shift enables the satellite to accom-



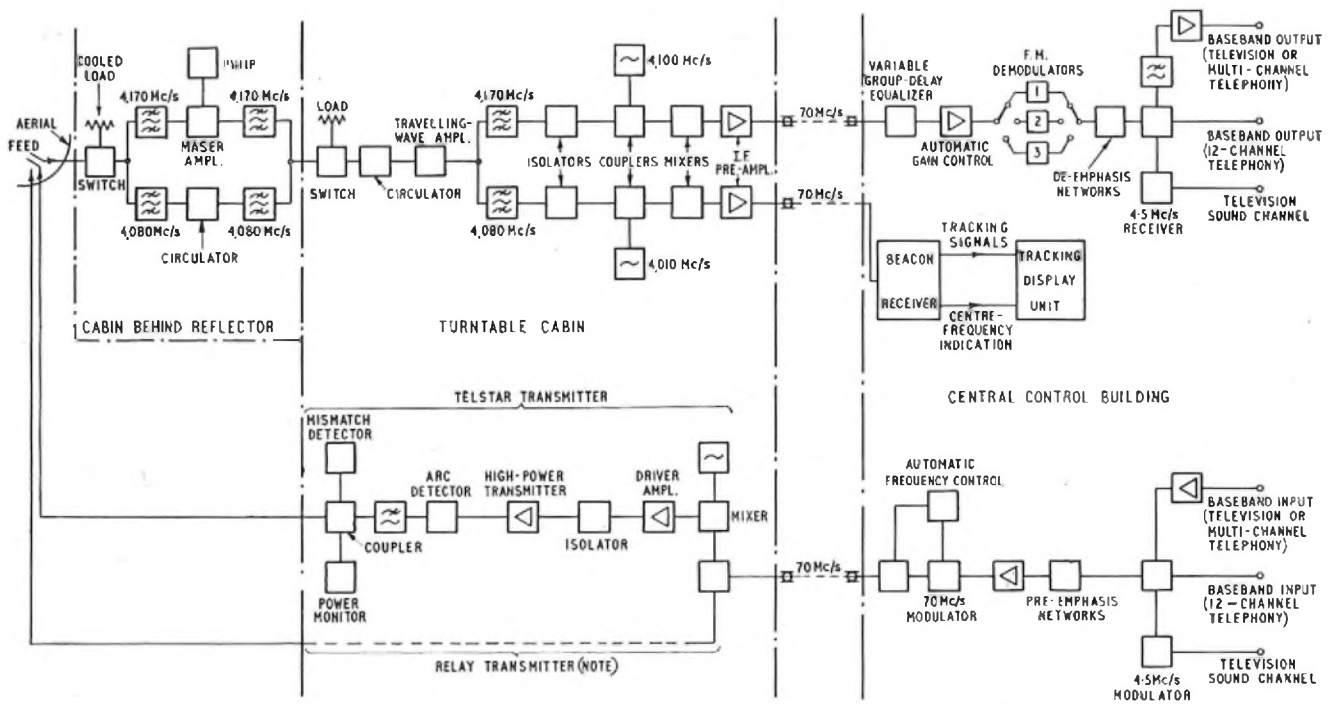

Note: The RELAY transmitter is, in general, similar to the TELSTAR transmitter

FIG. 6—SIMPLIFIED BLOCK-SCHEMATIC DIAGRAM OF THE GOONHILLY GROUND-STATION TRANSMISSION EQUIPMENT

modate east-west and west-east transmissions simultaneously, depending upon the character of the input signal and the nature of the test.

#### Transmitter-Drive Equipment

As Projects TELSTAR and RELAY use different frequencies for ground-to-satellite transmission, two independent transmitter-drive equipments have been provided for shifting the signals from i.f. to r.f. and raising them to a level suitable for application to the high-power transmitters. They both are, respectively, modifications of commercial equipments as used in microwave line-of-sight systems employing the 2,000 Mc/s and 6,000 Mc/s bands.

#### High-Power Transmitters

Microwave transmitters providing c.w. powers of several kilowatts are relatively novel and for this application two completely new valves have had to be designed, developed and constructed. For the RELAY transmitter a klystron has been made in the U.S.A., and this produces an output of some 10 kW at about 1,725 Mc/s. For the TELSTAR transmitter (Fig. 7) the Services Electronic Research Laboratory have provided a travelling-wave valve capable of producing an output power of more than 5 kW at 6,390 Mc/s; this is a considerable achievement.

The power-supply equipment to feed these high-power transmitting valves is complex; d.c. potentials up to some 35 kV are involved, and dissipations are such as to require the use of liquid cooling systems with associated heat exchangers.

#### Aerial Feeds

Two aerial feeds, each for transmission and reception, are provided, one being appropriate to the TELSTAR (Fig. 8), and the other to the RELAY radio frequencies.

One or other is mounted at the reflector focus depending upon which satellite system is under test. Either feed fits into the permanently-mounted electromechanical structure which provides the beam-scanning facility.

For the RELAY feed the ratio of received and transmitted frequencies is such that "waveguide-beyond cut-off" techniques can be used to provide a diplexing

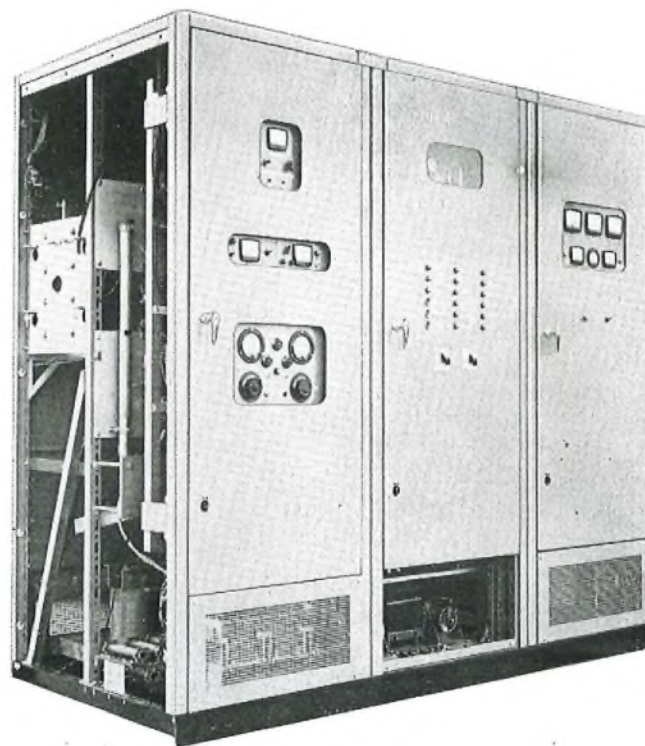

FIG. 7—TELSTAR HIGH-POWER TRANSMITTER

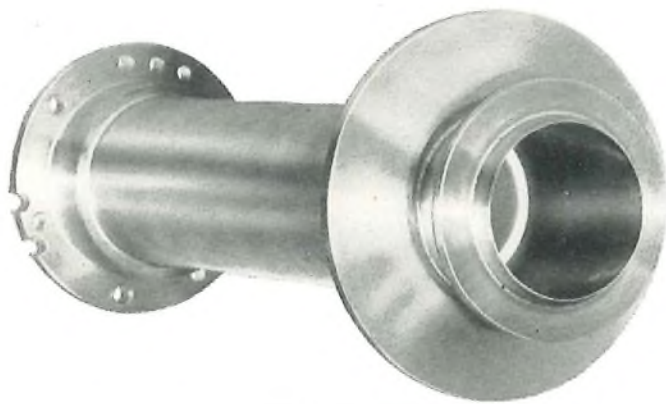

FIG. 8—TELSTAR DUAL AERIAL-FEED

facility; for the TELSTAR feed this ratio is too small and a separate diplexer has been provided. A diplexer ensures that only a negligibly small part of the transmitted energy enters the receive-signal path.

Transmission to and from the aerial feeds is by way of rectangular waveguide operated in the dominant mode. The feeds, therefore, have to convert signals from linear to circular polarization in the transmitting direction and from circular to linear polarization in the receiving direction.

#### Maser Amplifier

The power level of the communications signal received

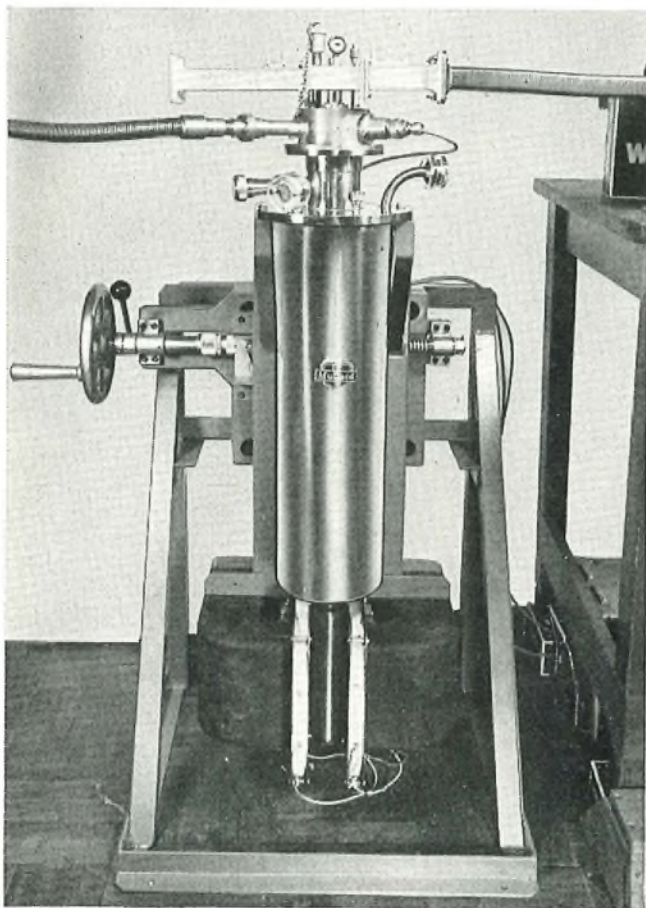

FIG. 9—THE GOONHILLY MASER AMPLIFIER

from a satellite is so low and the r.f. bandwidth so wide that even were a low-noise travelling-wave amplifier used to raise its level the signal energy would be swamped by the noise generated in the valve. Use has therefore been made of the quietest of all microwave amplifiers—the maser<sup>2</sup> (Fig. 9).

No attempt will be made here to describe the operation of this device; it is sufficient to say that the critical element is a ruby crystal on which rests a structure for decreasing the wave velocity in the presence of a strong magnetic field. The maser is operated at liquid-helium temperature—in this instance, only about 2°C above the absolute zero of -273°C. The liquid-helium container is itself surrounded by a jacket containing liquid nitrogen (-196°C).

An interesting feature of the maser and associated plant is that it allows for the movement of 100° as the reflector tilts. Also, there are two designs of maser available; in one, the magnetic field is provided by a permanent magnet, while in the other it is generated by a coil at liquid-helium temperature and carrying a current that, once started, continues indefinitely without need for a source of e.m.f.

Helium is an expensive commodity so, as it boils, the gas must be collected and stored ready for re-liquefaction. This has involved the provision of gas-storage facilities and a compressor so that cylinders of helium gas under high pressure can be transported to a re-liquefying centre.

The maser used in this installation was designed and constructed by the Mullard Research Laboratory.

#### Receivers

One receiver provided is of the frequency-modulation negative-feedback type, the object being to reduce the noise bandwidth, and hence lower the f.m. threshold level, by reducing the deviation of the signal. The method was first proposed by Chaffee in 1939<sup>3</sup> but does not appear to have had any application until the advent of experimental satellite communication systems. A block schematic of the particular receiver employed is given in Fig. 10. Briefly, the f.m. signal at 70 Mc/s is

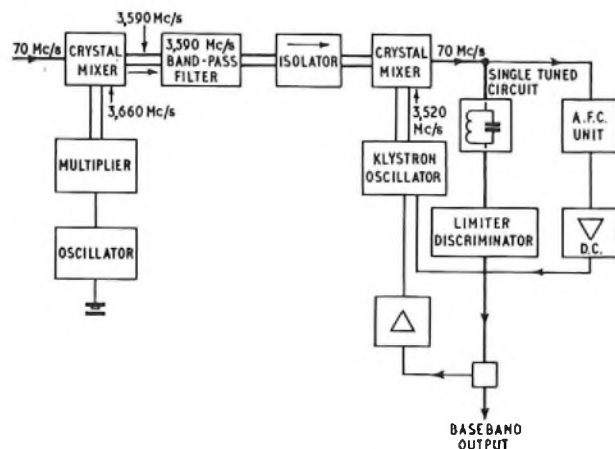

FIG. 10—SIMPLIFIED BLOCK-SCHEMATIC DIAGRAM OF THE FREQUENCY-MODULATION NEGATIVE-FEEDBACK RECEIVER

frequency-changed to 3,590 Mc/s and then applied to a crystal mixer driven by a klystron operating at 3,520 Mc/s. This klystron is suitable for large-deviation linear frequency-modulation. The 70 Mc/s signal from the mixer is filtered by a circuit having a noise bandwidth of



about 10 Mc/s and then demodulated. The derived baseband signal is applied to the reflector of the klystron driving the mixer. F.M. negative-feedback occurs by subtraction of the deviations of the incoming and local-oscillator signals. In brief, the action of the receiver can be regarded as involving the tracking of the instantaneous frequency of the incoming signal and limiting the noise bandwidth by means of a filter of narrower pass-band than that occupied by the whole deviation range of the r.f. carrier.

Alternative designs of receiver are also provided, including one employing a variable-bandwidth dynamic-selection demodulator. This design incorporates a tuned-circuit, of narrower bandwidth than that occupied by the r.f. signal, the resonant frequency being adjusted automatically to follow the frequency of maximum side-band energy. In addition, the bandwidth of the tuned-circuit is made a function of the signal level, the bandwidth being greatest when the signal is a maximum. Thus the threshold margin is maintained at the highest practicable level for the available received-signal level.

#### Auxiliary Facilities

The power of the main transmitters is sufficient to necessitate automatic shut-down in the event of certain abnormalities, such as the initiation of an electric arc in a waveguide run, or of a serious output-impedance mismatch occurring, for example, due to a waveguide fault. Continuous monitoring of the transmitter power is essential in the context of propagation measurements. For the TELSTAR transmitter, when the station is operating in the two-way telephony mode, there is a further requirement that the transmitter output power be varied in accordance with the distance from the station to the satellite; this is in order that the signals received at the satellite simultaneously from two co-operating ground stations can be maintained closely alike.

Facilities are provided so that a low-level sample of the transmitted r.f. signal can be reduced to the base-band; this serves as a valuable check on the operation of the transmitting-equipment chain and also facilitates comparison when the transmitted signals are also being received from the satellite. It is of interest to observe that whenever the station is transmitting in the one-way

mode it can always receive its own signals back from the satellite; this means that even when, for example, it is transmitting to a distant ground station via a satellite it can monitor its signals as relayed from space: further, a satellite can be used for local loop tests at times when there is no mutual visibility with a co-operating ground station.

#### Control Consoles

The short period of visibility of a satellite, coupled with the complexities inherent in a transmission path of variable parameters, makes it essential to effect all control and adjustments rapidly and unambiguously. To ensure that this is so, a suite of control consoles has been provided. Fig. 11 (a) and (b) show these consoles, which have been installed at Goonhilly as a continuous suite. In operation they are occupied by the Controller of Experiments, the Test-Switching Operator, the Beam-Swinging Operator, and the Transmitter and Receiver Control Operator.

#### TESTING THE SATELLITE COMMUNICATION SYSTEM

The tests which can be applied to the satellite communication system may be considered as falling into two categories: those necessary to confirm that the performance of the ground-station equipment meets the requirements and those necessary to determine the electrical characteristics of a system embracing ground stations and satellites. The second category can be subdivided into objective tests, involving the measurement of physical quantities, and subjective tests, necessitating personal assessments of overall performance. Demonstrations are by-products of subjective tests.

Measuring equipment has been provided to meet the following classes of objective-system tests:

- (i) Insertion gain stability.
- (ii) Selective fading.
- (iii) Noise.
- (iv) Television transmission characteristics.
- (v) Baseband, i.f. and r.f. transmission characteristics.
- (vi) Sent and received carrier power.
- (vii) Doppler shift.
- (viii) Receive system noise-temperature.

The communication system to be measured is unusual

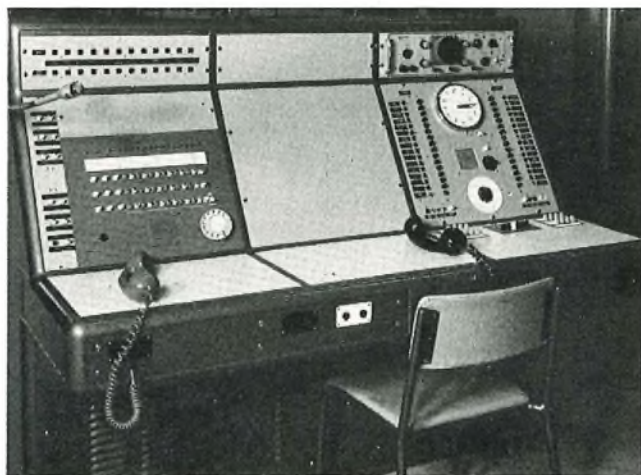

(a)

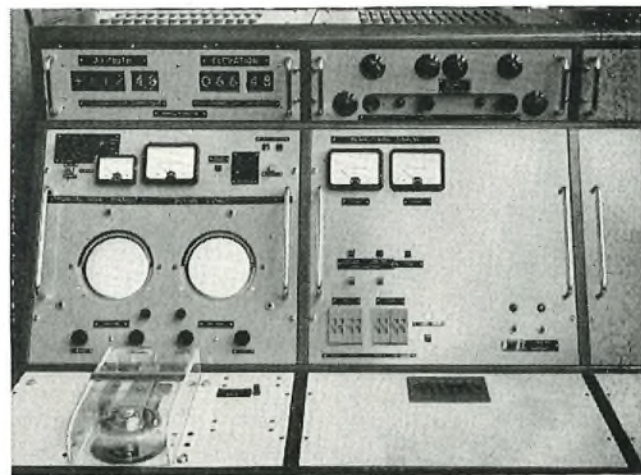

(b)

FIG. 11—CONTROL CONSOLES IN THE MAIN STATION BUILDING

in that the propagation loss is a slowly varying quantity; the gains of the satellite aerials vary with their aspect relative to the ground, there are time-variable small errors of the ground-antenna beam-bearing relative to the direction to the satellite, and there is a time-varying Doppler shift. In order that system performance can be analysed it follows that quantities must be measured either continuously or at short intervals of time. Initially, much use will be made of continuously-running chart records, though it is recognized that the analysis of the total available data presents a formidable task. To reduce the burden of data analysis, arrangements have been made to provide digital data-logging equipment; when this becomes available measurements will be sampled at 1-second intervals and, after analogue-to-digital conversion, recorded on punched tape. By suitable programming it will be possible to effect analysis by applying the tapes to a computer.

A further complication arises in that, because it is essential to gather data as quickly as possible, several different tests must be made during every scheduled "mutual-visibility" or "local visibility" passage of a satellite. To facilitate this, particularly when testing in collaboration with a remote ground station, equipment has been provided for switching rapidly from one test program to another. Appropriate test equipments and station apparatus are lined-up prior to a session of experiments and connected to a test-switching console. At prearranged times the operator has merely to operate keys to associate test equipment and apparatus.

For subjective telephony tests, terminal equipment has been provided so that 12 two-way telephone circuits may be set up. For subjective television tests, 21-inch picture monitors have been provided for viewing, while for transmission there are the alternatives of (a) telecine equipment capable of scanning slides or motion-picture film; (b) direct pick-up of material broadcast by the British Broadcasting Corporation and the Independent Television Authority, and (c) program material provided by the studios of the broadcasting organizations and transmitted by line and microwave radio-link to Goonhilly. When transmitting in the loop conditions,

i.e. Goonhilly-satellite-Goonhilly, the 405-line television standard will be used. However, when transmitting television to, or receiving television from, the U.S.A. the 525-line, 60 fields/second standard will be used; this has led to some degree of complication for multi-standard equipments have had to be provided, and standards-conversion equipment must be used if the transmitted or received pictures are at any time displayed to the public over national television broadcast networks.

#### CONCLUSION

In an article of this nature and scope it is not practicable to do more than outline the wide range of equipment that has been provided at Goonhilly. Nevertheless, it is hoped that the reader will have gained some impression of the facilities, why they have been provided, and how they work.

#### ACKNOWLEDGEMENTS

In only a very little over 12 months the apparatus described in this article has been designed, constructed, installed and tested. It will be clear that this has involved great and sustained effort by many. The provision of the steerable aerial to the design of a Consulting Engineer and the general planning of the Goonhilly Station was the responsibility of the Space Communication Systems Branch, Engineering Department. Responsibility for the communications equipment and testing facilities described in this article fell to the author's colleagues at the Post Office Research Station, but it is acknowledged with great appreciation that their task would have been impossible without the unfailing support and great effort provided by many elements of the British telecommunications industry and by Post Office staff in the South Western Region.

#### References

<sup>1</sup> BRAY, W. J. Satellite Communication Systems. (In this issue of the *P.O.E.E.J.*)

<sup>2</sup> The Principles and Possible Application of some Amplifiers of Low Intrinsic Noise. *P.O.E.E.J.*, Vol. 52, p. 212, Oct. 1959.

<sup>3</sup> CHAFFEE, J. G. The Application of Negative-Feedback to Frequency Modulation Systems. *Bell System Technical Journal*, Vol. 18, p. 404, July 1939.

## Book Review

"Electronics: A Bibliographical Guide." C. K. Moore, B.Sc., and K. J. Spencer, A.L.A. Macdonald & Co. (Publishers), Ltd. xvii + 411 pp. 65s.

The term "electronics" now covers a wide range of subjects which find application in many fields. Originally used with reference to thermionic valves, vacuum or gas-filled, and to devices incorporating them, it now embraces also solid-state devices, such as transistors, which use material having special semi-conducting properties, and devices utilizing special dielectric, photoelectric, magnetic and electroluminescent properties. The rate of production of technical literature on electronics is very large and the task of assembling all the important information on some particular aspect can be formidable even though the aspect be narrowly defined.

The authors have sought to provide a guide to assist the searcher, and in this they have certainly succeeded. The technical subject-matter is arranged in 67 sections, in U.D.C.

order, which are preceded by a special section on reference media. This section contains nearly 300 entries grouped under 13 headings, such as Bibliographies, Information Services, Patents and Trade Marks, Progress Reviews and Technical Foreign Dictionaries.

The books, periodicals and reports listed in the technical sections were, in the main, published between 1945 and 1959 but important publications of earlier dates have also been included, e.g. in Radio Astronomy the first item is Jansky's paper in *Proceedings I.R.E.* for December 1932. For each item there is shown the number of references included and the time period covered by them. A short commentary is also given for each item, and many of these refer as much to the scope of the bibliography given in the item as to the technical content of the item. The book is thus truly a guide to bibliography and it provides a good starting point for any new investigation in electronics. It should also be a very useful tool for librarians and information officers.

H. D. B.



# Engineering Aspects of Depreciation Accounting

R. G. GAUT†

U.D.C. 657.372.3:383/4.001.2

The part engineering estimates of plant life play in the assessment of the annual depreciation contribution in the Post Office Commercial Accounts is examined, and a brief survey is given of the changes in the method of calculating depreciation introduced by the 1955 White Paper "Report on Post Office Development and Finance." Estimation of the mean service life of plant requires mortality records extending retrospectively for many years; these are rarely available for Post Office plant, and records established for other purposes have to be adapted and used in support of engineering judgement. The use of these estimates of mean service life to produce an equated depreciation rate applicable to a plant group as a whole is briefly described. Some implications of a change in procedure that removes the restriction previously placed on the use of the annual depreciation payments to finance new capital expenditure are examined, and the increased importance is stressed of the engineering appreciation of depreciation accounting consequent upon the change of status proposed in the 1960 Post Office Bill.

FEW words have been subjected to more definition than "depreciation," and, even when considered in the context of engineering economics, the interpretation of the word can be coloured to reflect the views of the user and the needs of the argument he advances.

In the British Post Office there are two applications in which depreciation plays an important part. These are in the annual Commercial Accounts and in the economic studies that are used as a guide in long-term planning and in selecting the most economical of a number of alternative methods of providing a particular service or facility.

In the Commercial Accounts the annual depreciation contribution is one of the major items on the expenditure side of the telephone account, amounting to some 25 per cent of the total and being exceeded only by expenditure on salaries and wages. In economic studies of the use of plant, depreciation is one of the annual charges that make up the cost of a project, and its magnitude and incidence can be a major factor in deciding which is the more economical of alternative courses of action.

In the Telephone Income and Expenditure account of the Post Office Commercial Accounts the annual expenditure on depreciation is shown separated into two components. One of these components, amounting in 1959-60 to some £35 million, is assessed in relation to the historical cost of the plant, and the other is shown as a supplementary provision intended to go some way towards compensating for the increase in price levels that has taken place during the current life-cycle of the plant.

†Mr. Gaut is the Post Office Liaison Officer, War Office. He was formerly in the Exchange Equipment and Accommodation Branch, E.-in-C.'s Office.

\*Equated life and equated residual value—each plant group is made up of different types of plant that may have differing average lives and residual values. To obtain life and residual-value figures applicable to the plant group as a whole, weighted figures are assessed that take account of the life, residual value and current replacement cost of each component. The results of these assessments are known as the "equated life" and "equated residual value" of the plant group.

‡Equated depreciation rate—the rate applied to a plant group as a whole to calculate the annual depreciation contribution.

§Sinking-fund method—a method of replacing the initial capital cost of plant by equal annual contributions spread over the life of the plant, assuming that these annual contributions attract compound interest.

The historical cost component is calculated by aggregating the depreciation charges applicable to each plant group and, for this purpose, it is necessary to know the retrospective annual capital expenditure on each plant group, its equated life,\* and its equated residual value.\* Information on historical capital expenditure is available from the ledgers of the Accountant General's Department of the Post Office, and the mean-life and residual-value data are based on recommendations of the Post Office Committee on Lives of Plant and Depreciation, which includes representatives from the Accountant General's Department and the Engineering Department.

Assessments of average lives and residual values are made for the various types of plant included in each plant group, and then, by estimating the current replacement cost of each type of plant included in the group, equated mean lives and residual values can be determined that are applicable to the plant group as a whole. These data are used to calculate the equated depreciation rate‡ applied to the historical cost of the plant, as recorded in the ledgers, to produce the annual depreciation payment.

It is the responsibility of the engineer to assess the mean lives and residual values to be assigned to the various types of plant and to provide guidance on the weighting to be used in assessing equated depreciation rates for plant groups that contain components having different average lives. To make realistic assessments of the mean plant lives to be applied to existing plant, it is necessary to observe the lives achieved by retired items. It does not necessarily follow that the future life achievements will always follow the pattern shown in the past, but where such records are available the experience and critical judgment of the engineer offer the best available guidance towards correctly forecasting the expected service life of existing and future plant.

Ideally, for the assessment of mean service life, plant mortality records are required for each plant item that give details of the date the item was purchased and the date it was recovered. Few records of this type are maintained in the Post Office, and existing records have to be adapted and new records reconstructed to apply established life-assessment methods. The records have to show the past plant additions and recoveries, either in numbers or in terms of money, year by year, for a period longer than the mean life of the plant. In the past, this information has not always been readily available as it has been found that either the records have not been preserved for the requisite period, or that they are in a form unsuitable for application to life assessment. For some plant groups where life assessments have been particularly speculative because of the absence of historical records, new records are being introduced that in future years will provide the information on which realistic life assessments can be made.

In economic cost studies depreciation is assessed as an annual charge which will amortize the historical cost of the plant over its life. For convenience of producing a constant annual charge for interest and depreciation taken together, the engineer normally uses the sinking-fund method,§ whereas for accounting purposes, for

which each year's depreciation is considered as a separate entity, it is usually more convenient to use the straight-line method.\* The average plant life used in calculating the depreciation rate used for accounting purposes is not necessarily the life used in economic cost studies as these may involve using plant under conditions in which it would not be correct to assume average lives. For each application the engineer must use his judgment in assessing the life most appropriate to the conditions under which the plant is being used.

The 1955 White Paper on Post Office Development and Finance† made important changes in the method of calculating the annual depreciation charge and made provision for an annual supplementary contribution that was intended to represent what, in the opinion of the Post Office, was a fair estimate of the additional amount required to make the total provision in any year reflect the current value of the assets in that year. This change was made with the object of putting Post Office finances on a sounder economic footing, and it was intended that the tariff charged to customers should contain an increment that reflected, at current price levels, the value of the assets consumed during the year.

The controversy on the ethics of paying depreciation on replacement rather than on historical costs has been long, and the outcome indecisive, but whatever arguments are advanced in support of the former it must be admitted that once the historical cost is abandoned the authentic basis is lost, as the capital sum representing the current cost from which the annual depreciation is calculated must, of necessity, be partly estimated and may change from year to year.

For a period prior to 1955-56 the Post Office accounting system was so arranged that the aggregate amount of money paid in depreciation over the average life of a particular plant item was greater than its historical cost, but generally much less than its replacement cost; the effect of the 1955-56 change is to make the aggregate depreciation payments approach more closely to the replacement cost than they did previously.

The change in method of calculating the supplementary depreciation contribution requires the annual reassessment of the current capital value of each plant group, and engineering advice has been sought so that this can be made as realistic as possible. Information is available on the changes in price levels for stores, equipment, and contract works, and also for the changes in the average man-hour rate for Post Office labour. From these data a series of price indexes is computed that can be applied to historical costs to convert them to current costs.

The use of the price-index method of assessing current capital value is well authenticated in modern accounting, but its application to telecommunication plant is not altogether satisfactory, and for certain plant groups it may result in appreciable discrepancies between the calculated and the true replacement cost. These discrepancies arise when telephone plant is replaced at the end of its life, because renewals are seldom of the "like-for-like" type.

During the course of a normal life cycle there are continuing technical changes to plant, improved and

more economical methods of handling telephone and telegraph traffic are devised, and new installation practices and mechanical aids increase the productivity of Post Office staff. Price indexes based on material and labour costs do not make full allowance for changes of this type and, as a result, it is probable that some plant groups are being over-depreciated. Exceptionally, no supplementary depreciation is charged against trunk underground plant because it is recognized that technical advances in trunk-circuit provision have more than compensated for the general increase in price levels, with the result that the cost of a modern trunk circuit is less than the cost of a trunk circuit provided a life cycle earlier. For other types of plant, engineers are examining the problem of assessing a current replacement cost that makes due allowance for technical and productivity changes, but it is doubtful whether compensating adjustments can be built into the existing price-index structure. An alternative method of assessing current capital value that, it is claimed, makes due allowance for modern materials, techniques, productivity, and facilities, has been proposed and is being examined by the Lives-of-Plant Committee.

Subsequent to the change in the basis of assessment of the supplementary depreciation contribution introduced by the 1955 White Paper, the Post Office and Telegraph (Money) Bill of 1957 abolished the long-standing separation of Post Office finances into Vote and Loan components. Under the old arrangements capital expenditure on new works was financed out of new loan, and capital expenditure on renewals was voted out of the balance of the depreciation fund. This required segregation of costs between new works and renewals and introduced accounting complications in apportioning expenditure on capital works that included both new and renewal components. Under the new procedure, authority for all capital expenditure is voted, and the annual depreciation contribution that was formerly credited to the depreciation account, is now "ploughed back" into the business and used to finance new capital expenditure of any type. The balance in any year between the total capital expenditure and the annual depreciation contribution is met by a new loan.

To the engineer, the present concept is liable to introduce conflicting loyalties. On the one hand it appears that the right thing to do is to retain plant for as long as is economical and, provided that depreciation is based on the historical capital cost, this results in the annual depreciation payment being a minimum, with consequential tariff advantages to customers. On the other hand, although a higher annual depreciation payment, due either to current cost depreciation or to a more ambitious replacement policy, will lead to higher tariffs, some compensation will arise from a reduction in the amount of new money raised by loan, with consequential savings in interest payments at times when interest rates are high.

In the past, little information has been available on the engineering aspects of depreciation accounting and plant-life assessment, but the change of status introduced by the Post Office Bill of 1960 will make a full understanding of the basic principles even more important than it was before if maximum advantage is to be gained from the long awaited freedom from some aspects of Treasury control that the new Bill is designed to give.

\*Straight-line method—a method of replacing the initial capital cost by annual contributions spread over the life of the plant assuming that the annual contributions attract simple interest.

†Report on Post Office Development and Finance. Her Majesty's Stationery Office, Oct. 1955.



# Electrolytic Capacitors and Their Reliability

A. A. NEW, M.Sc., F.R.I.C., A.Inst.P.†

U.D.C. 621.319.45

The origin and development of electrolytic capacitors are briefly reviewed. The principles of operation of electrolytic capacitors are discussed, and the various types at present available are described and their properties considered. Failure rates, calculated from accelerated life tests, are given for certain types of capacitors, and recommendations are made for improving the reliability of electrolytic capacitors in service. Conclusions are drawn as to the suitability of electrolytic capacitors for use in telecommunication equipment.

## ORIGIN AND DEVELOPMENT

THE idea of forming an insulating film on a metal electrode to make a capacitor is generally attributed to Wheatstone in 1855, but the idea of the electrolytic capacitor arose in Germany some 20 years later.<sup>1</sup>

The precursor of the modern electrolytic capacitor, consisting of two aluminium-sheet electrodes immersed in an electrolyte consisting of a solution of ammonium borate in a glycerine-water mixture appears to have originated about 1908, and in that year an important step in the reduction in size of such capacitors was made by constructing the anodes of thin sheets, rolling them up into cylindrical form and placing them in containers of the same shape. However, the more bulky form persisted for many years after this.

## PRINCIPLES OF OPERATION

### Essential Parts of an Electrolytic Capacitor

The essential parts of an electrolytic capacitor are:

(a) A metal anode (the positive electrode) made from a film-forming metal.

(b) A very thin oxide film produced electrolytically on the anode, the film constituting the dielectric. The thickness of the film, coupled with its medium permittivity, is the main reason for the high capacitance per unit volume.

(c) An electrolyte suited to the anode metal and characteristics required. The electrolyte is the true negative electrode.

(d) A second electrode, commonly called the "cathode" but really a member for making contact with the electrolyte.

(e) A spacing layer to keep apart the anode and "cathode" that are normally in the form of thin foils. This spacer usually consists of two layers of tissue paper. This helps to prevent the possibility of short-circuits if the thin oxide film is temporarily damaged.

(f) A case to hold items (a)-(e).

(g) Leads or tabs connected at one end to an electrode and at the other to the external wires or tags which form the terminals of the capacitor.

(h) Insulating seals to prevent loss of the electrolyte or its liquid constituents and also to hold the leads rigidly.

The general construction of an aluminium foil or tantalum-foil electrolytic capacitor is shown in Fig. 1.

### Electrodes and Formation of Insulating Film

Aluminium, tantalum, zirconium, niobium, hafnium, tungsten, bismuth and antimony all form anodic oxide films by an electrolytic "forming" process,<sup>2</sup> but only aluminium and tantalum are at present used to make electrolytic capacitors on a commercial scale. Extensive

†Post Office Research Station.

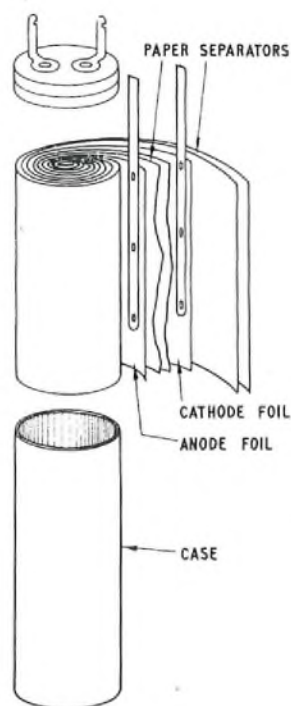

The paper separators are often omitted in small tantalum capacitors

FIG. 1—ALUMINIUM-FOIL OR TANTALUM-FOIL ELECTROLYTIC CAPACITOR

research is being carried out on zirconium and niobium, and experimental capacitors have been made successfully, but so far there is no commercial production. The principal problem appears to be to obtain metal of a sufficiently high degree of purity. None of the other metals mentioned has yet yielded a practicable electrolytic capacitor.

The films consist of substantially pure oxide of the anode metal (e.g.  $\gamma\text{Al}_2\text{O}_3$  or  $\text{Ta}_2\text{O}_5$ ) with a possible content of adsorbed water or entrapped electrolyte ions in the more porous ones. The films are mainly amorphous and glassy in structure, showing interference colours characteristic of the thickness and refractive index of the film. At very high magnifications the anodic films on aluminium are seen to have a fine cell structure in which each individual cell bulges into the electrolyte on one side and into the metal on the other.<sup>3,4</sup> The differences in electrical behaviour seem to arise largely from (a) the degree of compactness or porosity of the films and (b) the occurrence of localized defects of the film structure or the presence of foreign particles.

All of these metals form thin oxide films on their surfaces when in contact with air, but for various reasons these films are not ideal as capacitor dielectrics, and generally speaking are removed chemically at an early stage in the manufacture of capacitors (aluminium in contact with water forms a film of boehmite, a hydrated aluminium oxide<sup>5</sup>). These compact anode films can be made practically free from defects while still being extremely thin (about 3 ångströms/volt of formation)

and can withstand very high electric stresses (e.g. 500 volts/micron) that in some instances approach the intrinsic dielectric strength of the oxide— $10^4$  volts/micron. The permittivity is about 8.4–10 for aluminium, 27–28 for tantalum and 41 for niobium.

To make a capacitor, the thoroughly-cleaned metal foil is placed in a suitable electrolyte and connected to the positive terminal of a source of direct current. A cathode connected to the negative side of the same supply completes the circuit. Electrolysis of the water in the electrolyte takes place, and the oxygen combines rapidly with the anode metal to form the surface layer of oxide, with nearly 100 per cent efficiency in the case of pure metal anodes.<sup>2</sup> As the oxide film is a dielectric and practically non-conducting, the current falls rapidly, and, as the film thickens, the potential across the film rises until it is approximately the same as that of the supply.\*

The foil is then removed from the electrolyte, washed to free it from the forming electrolyte, cut to appropriate length if it has been made in a continuous process, connected by some form of crimping or welding to a lead-out tab or wire of the same metal, and wound up with a similar-sized piece of untreated foil (the "cathode") and the separating papers. In very small capacitors the "cathode" foil may be omitted and the case used as the "cathode." The paper acts both as a mechanical separator and as an absorbent reservoir for the working (filling) electrolyte with which the unit is now impregnated; sometimes it is vacuum impregnated. Since in the cutting and in the crimping of the anode connexion small areas of the oxide film become broken, a further forming process is given, after which the unit is sealed up in its container.

The normal commercial practice, where thousands of capacitors are made every day, is to use a continuous anodizing machine in which the foil is drawn into a bath and wound back and forth many times under the surface of the forming electrolyte before being drawn out, washed with sprays, and wound into a coil.

#### *Self-Healing Property and Formation of Gas*

If during its life the oxide film is punctured or cracked, the voltage across the capacitor causes a local current to flow that in turn leads to a local growth of oxide film, thus giving the capacitor a self-healing property.

Both this and the very small steady leakage current cause electrolysis of water in the electrolyte, so that oxygen and hydrogen gases are evolved in proportion to the total electric charge that has passed. Some of the oxygen combines with the anode in the self-healing process, but the remainder, plus the hydrogen, accumulates as a gas and, if a suitable vent has been provided, leaks away. If the capacitor is completely sealed, an internal gas pressure may build up, causing the seals to bulge and leading to an explosion in extreme instances if the current is considerable. With modern types of capacitor, and particularly if the voltage is low, the leakage current is so small that the gas pressure is very slight.

#### *Deforming of Electrolytic Capacitors*

If an aluminium electrolytic capacitor is without a polarizing voltage for a long time (say 6 months) its insulation resistance drops, and it is said to have "deformed." If the normal voltage is switched on suddenly, the initial current for the first few minutes is very much higher than normal, and in some circumstances may cause breakdown by evolution of heat. This can be

avoided either by deliberately "reforming" with a current-limiting resistor in circuit before the capacitor is re-used or by having such a series resistor permanently wired-in if the circuit conditions can tolerate this.

### ALUMINIUM ELECTROLYTIC CAPACITORS

#### *Polarized and Non-Polarized Types*

The normal electrolytic capacitor is polarized and the voltage must be applied in one sense only, otherwise the dielectric layer will be damaged and the rush of current may cause the capacitor to break down. Non-polarized or "reversible" types are, however, available in which both foils have been anodized; the same effect can be obtained by connecting two similar polarized capacitors in series in opposite senses. The resulting capacitance is, however, only about a half or a quarter, respectively, of the normal capacitance per unit volume.

#### *Ripple Voltage*

It often happens in practice that the voltage across a capacitor contains both d.c. and a.c. components. Ripple ratings vary greatly with individual types of capacitor and should never be exceeded. In particular, (a) the sum of the d.c. voltage and the peak a.c. voltage should never exceed the d.c. rating, and (b) the ripple current should never reach the point where the heat generated by it (on account of the high  $\tan \delta$ †) cannot readily be dissipated without raising the temperature of the capacitor above its maximum rated value.

#### *Capacitance Range*

In general, aluminium electrolytic capacitors are made with capacitances in the range 1–10,000  $\mu\text{F}$ , but sub-miniature types are made with capacitances as low as 0.1  $\mu\text{F}$ . There is not much point in lower capacitances, because they fall well within the range of paper capacitors, which have both small physical size and a considerably lower  $\tan \delta$  than the corresponding electrolytic type. Special electrolytic capacitors are made with capacitances as high as 100,000  $\mu\text{F}$  or more, and, by paralleling, any capacitance can be achieved. The dielectric film has low losses over wide frequency and temperature ranges, but it is in series with the electrolyte, which has a substantial resistance. This causes the relatively high values of the  $\tan \delta$  characteristic of electrolytic capacitors. At high frequencies the impedance is mainly resistive and inductive.

#### *Voltage Range*

The higher the voltage at which an electrolytic capacitor has been formed the thicker the oxide film, and, of course, the lower the capacitance. Up to certain limits the thicker the film the higher the working voltage it will withstand without breakdown. The maximum voltage that a single film of aluminium oxide will withstand is in the order of 600 volts d.c., but the working voltage has to be lower for two reasons: firstly, because scintillation (the formation of numerous minute sparks on the surface of the film corresponding to self-healing failures) commences at about this level (various manufacturers quote from 500–600 volts as the maximum surge voltage of their 500-volt working capacitors) and causes both

\* With aluminium this self-stopping effect is characteristic of solutions of borate or boric acid, tartrate, phosphate, etc. With electrolytes that can dissolve the film at an appreciable rate, such as sulphuric, phosphoric, or oxalic acid solutions, porous films are formed which grow at almost constant voltage to thicknesses of many microns.

†  $\tan \delta$ —tangent of dielectric loss angle, often erroneously called "power factor".



loud noise in circuits and, if prolonged or if the scintillation voltage is exceeded, the possibility of breakdown. Secondly, the leakage current rises disproportionately rapidly with increasing voltage and effectively sets a working limit. There is often a distinct knee in the current/voltage curve well below the rated working voltage, and for long life it is recommended that the capacitor should work at about this point, which is usually about two-thirds of the rated voltage. No hard-and-fast rule can be made because manufacturers employ different ratios between forming voltage and rated voltage for different types.

At the lower end of the range some capacitors are rated as low as 1 volt, but it is doubtful whether there is really such a thing as a 1-volt electrolytic capacitor. This is because a film is always formed on aluminium in the presence of oxygen and water, and while there is some controversy about the exact voltage to which it corresponds, this is probably of the order of a few volts.

#### Plain-Foil, Etched-Foil, and Metallized-Fabric Types

So far it has been assumed that only plain foils are used, but the demand for more capacitance in even less volume has led to two developments. Firstly, by etching the anode foil (Fig. 2) prior to assembly its true surface can

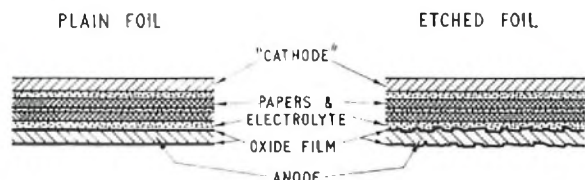

FIG. 2—PLAIN-FOIL AND ETCHED-FOIL CONSTRUCTION

be increased some five or more times over its superficial area, a ratio called the "etch factor." However, since nearly all the resistive component of  $\tan \delta$  is derived from the resistivity of the electrolyte, it is obvious that, if the capacitance is increased several times by greatly increasing the effective area of the foil without increasing the conductance of the electrolyte, the  $\tan \delta$  value must inevitably be increased in a similar ratio (since  $\tan \delta = \omega CR$ ). Still greater surfaces can be obtained by using cotton fabric metallized with aluminium by means of a metallizing gun, and it is claimed that an effective area of at least 10 times the superficial area can be obtained by this method when the capacitor is formed at 550 volts d.c.

#### TANTALUM ELECTROLYTIC CAPACITORS

##### General Properties

Tantalum and tantalum-oxide film are much more inert materials chemically than aluminium and its oxide film, and for this reason would be expected to make more stable and reliable capacitor units. This inertness also makes possible a much wider choice in the range of electrolytes used, one of the common electrolytes being moderately-strong sulphuric acid (which makes it possible to use such capacitors over a wide temperature range). Others are lithium-chloride solution and variants of the borate solutions used with aluminium anodes.

Under equal conditions the leakage current is generally lower than that of the average-quality aluminium electrolytic capacitor.

##### Capacitance and Voltage Range

As tantalum oxide has a considerably higher permit-

tivity (about 28) than aluminium oxide (about 9-10), tantalum capacitors can be smaller than their aluminium equivalents. The range of polarized-foil-type tantalum capacitors at present available is from about 10  $\mu\text{F}$  for 150-volt d.c. working to 200  $\mu\text{F}$  for 6-volt d.c. working. The smallest capacitance thought worth while is about 0.15  $\mu\text{F}$ . The above includes both plain-foil and etched-foil types, but there is no tantalum-on-fabric type.

##### Sintered-Anode Tantalum Electrolytics

A type which at present is limited to tantalum is that which employs a sintered anode. Tantalum powder of predetermined particle size is compacted to form a pellet which is then sintered so that particles join together without melting, and the pellet remains porous. In this, as in most other tantalum electrolytic capacitors, the case, which forms the cathode connexion, is usually of silver. The sintered-pellet form of construction results in a very high ratio of capacitance to volume and a low inductance.

#### DRY ELECTROLYTIC CAPACITORS AND OXIDE-FILM CAPACITORS PREPARED ELECTROLYTICALLY

##### "Wet" and "Dry" Electrolytic Capacitors

Early types of electrolytic capacitors in glass battery or aquarium jars had considerable excess liquid electrolyte, and it was essential to keep them upright. The next "wet" type was formed by replacing the jars by cylindrical or rectangular aluminium cans and using seals that enabled the capacitor to be used in any position. Leakage and creeping of electrolyte were often a trouble with these types, and to avoid such difficulties the present so-called "dry" types were evolved. These are not really dry since they still use liquid electrolytes and do contain a certain amount of water, but aluminium electrolytic capacitors are, in general, free from leakage of liquid electrolyte. This has been achieved by reducing the amount of electrolyte in a capacitor to the absolute minimum consistent with efficient operation, by increasing the viscosity of the electrolyte in some instances, and by the use of absorbent papers between the electrodes to form a reservoir for the electrolyte.

##### Electrolytically-Prepared Oxide-Film Capacitors

Since it is the oxide film only that is the dielectric in an electrolytic capacitor, efforts have been made to produce a capacitor without the electrolyte but with the same capacitance per unit volume as the corresponding electrolytic type, by washing and drying the anodized aluminium after the film has been formed and adding another electrode by evaporating a thin layer of metal, e.g. aluminium, on to it.

Two different processes have been used for making the aluminium-oxide film. At the Electrical Research Association this has been done, using voltages up to 750 volts, by constant-current formation in a saturated solution of boric acid containing a little sodium borate. The process has been quite successful in producing capacitors with working voltages up to 100 volts and  $\tan \delta$  less than 0.01 at 250 c/s, as long as the unit is kept dry. At ordinary humidities  $\tan \delta$  is in the order of 0.05-0.08. Batches of capacitors of this type have been made and exhibited at various exhibitions. An alternative way of forming the film is to anodize it in molten sodium nitrate, sodium nitrite, or mixtures of the two, and again complete the capacitor by evaporating a counter-electrode of aluminium on to the oxide film. This method is being studied at the Post Office Research Station.

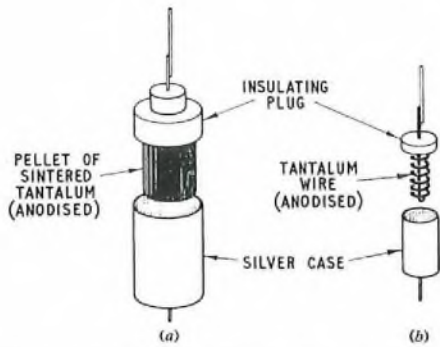

(a) Sintered-Tantalum-Pellet Capacitor (Wet Electrolyte) or "Solid" Tantalum Capacitor (Pellet Impregnated with Manganese Dioxide and Contact Provided to Case)  
(b) Coiled-Wire Tantalum Capacitor (Wet Electrolyte or Manganese Dioxide Types)

FIG. 3—CONSTRUCTION OF TANTALUM CAPACITORS

*Solid Tantalum Capacitor (Tantalum-Pellet Manganese-Dioxide Capacitor)*

A further type<sup>6</sup> of truly dry capacitor based on an anodically-formed oxide film on tantalum is just beginning to come on to the market in this country, but has been available for some time in the U.S.A. In this type an anodized tantalum pellet is formed in much the same way as in the manufacture of the pellet-type tantalum electrolytic capacitor (a coiled-wire-anode type is also

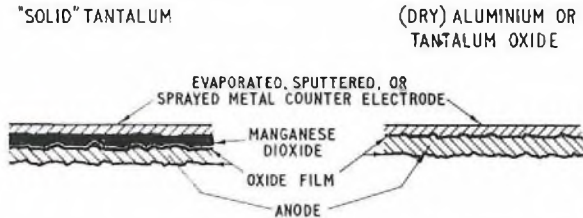
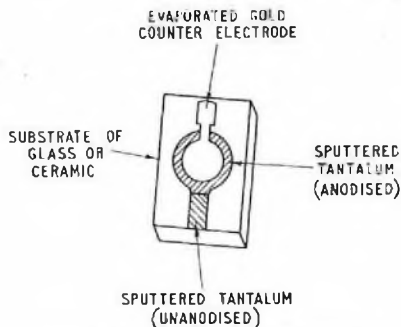

FIG. 4—"SOLID" TANTALUM AND "DRY" ALUMINIUM OR TANTALUM-OXIDE CAPACITOR CONSTRUCTION

made). After washing away the electrolyte the pellet is vacuum-impregnated with a strong solution of manganese nitrate, dried, and heated to decompose the manganese nitrate to manganese dioxide. This process may be repeated several times. After this a contact coating that may consist of graphite, silver, etc., is applied to the manganese dioxide to complete the capacitor unit.

It was at one time claimed that the manganese dioxide performed the same healing function for the tantalum-oxide that takes place with the wet electrolytes when a voltage is applied, the suggestion being that when a fault appeared in the tantalum-oxide film the exposed tantalum metal was reoxidized from the manganese



This type can also be based on aluminium

FIG. 5—TANTALUM "PRINTED" CAPACITOR (BERRY AND SLOAN EXPERIMENTAL TYPE)

dioxide. There has been considerable controversy, but it seems rather doubtful whether the above process does in fact take place. However, the capacitors undoubtedly work over a temperature range of  $-55^{\circ}\text{C}$  to  $+120^{\circ}\text{C}$  with comparatively small capacitance change (about 15 per cent between the above limits). In general  $\tan \delta$  at 50 c/s is about 0.01-0.03 over the above temperature range and the inductance is very low. The development is too recent for much information to be available on reliability and stability. Most manufacturers limit the working voltage to 35 volts but a few types have working voltages up to 75 volts.

CONSTRUCTION OF TANTALUM ELECTROLYTIC CAPACITORS

The construction of the types of tantalum electrolytic capacitors referred to in the previous paragraphs is shown diagrammatically in Fig. 3 and 4. A further type, the Berry and Sloan experimental printed capacitor,<sup>7</sup> is shown in Fig. 5. Many minor variants of the arrangements shown are, however, in use.

CHARACTERISTICS OF ELECTROLYTIC CAPACITORS

Some characteristic curves of various types of electrolytic capacitors are shown in Fig. 6-10. These curves indicate the order of values characteristic of capacitors of about 10-35  $\mu\text{F}$  and 20-50-volt working voltage. Very small capacitors of low working voltage often give poorer values.

*Insulance Change with Temperature (Fig. 6)*

The insulance\* is greatly influenced by the choice of working voltage. To some extent the lower the applied voltage the higher the insulance, but if the voltage is too low deforming may occur.

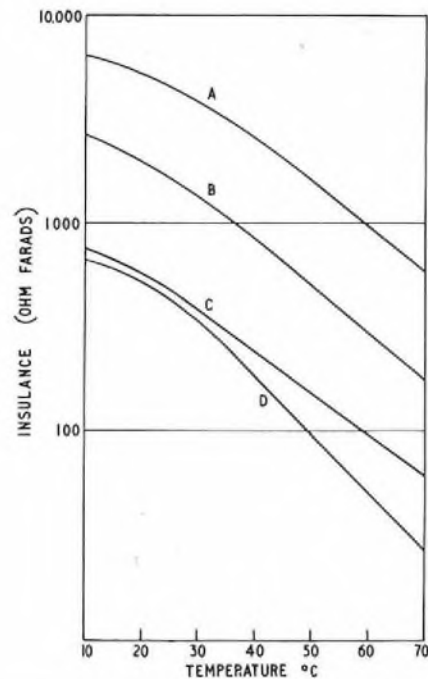

A = Best (wet) aluminium-foil capacitor or best (wet) tantalum-foil or pellet capacitor  
B = Tantalum-foil capacitor.  
C = Solid tantalum (dry) capacitor.  
D = Ordinary (wet) aluminium capacitor

FIG. 6—CHANGE OF INSULANCE WITH TEMPERATURE

\* Insulance in this context is defined as the product of the insulation resistance and the capacitance and is expressed in ohm-farads.



**Capacitance Change with Temperature (Fig. 7)**

The differences in capacitance change with temperature arise mainly from the small contribution to the capacitance of the liquid electrolyte.

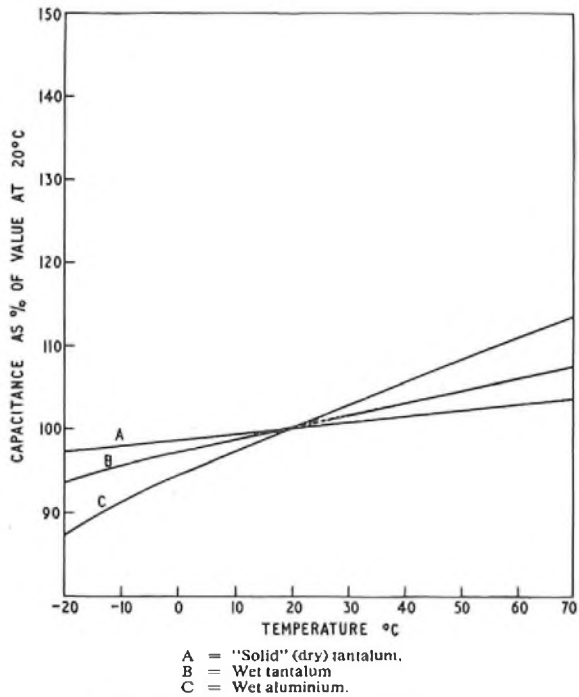

FIG. 7—CHANGE OF CAPACITANCE WITH TEMPERATURE

**Change of  $\tan \delta$  with Temperature (Fig. 8)**

Nearly all the resistive component of  $\tan \delta$  arises from the resistivity of the electrolyte, and this in turn is greatly affected by the viscosity of the electrolyte at the temperature concerned. Some aluminium electrolytic capacitors have lower values of  $\tan \delta$  at low temperatures than

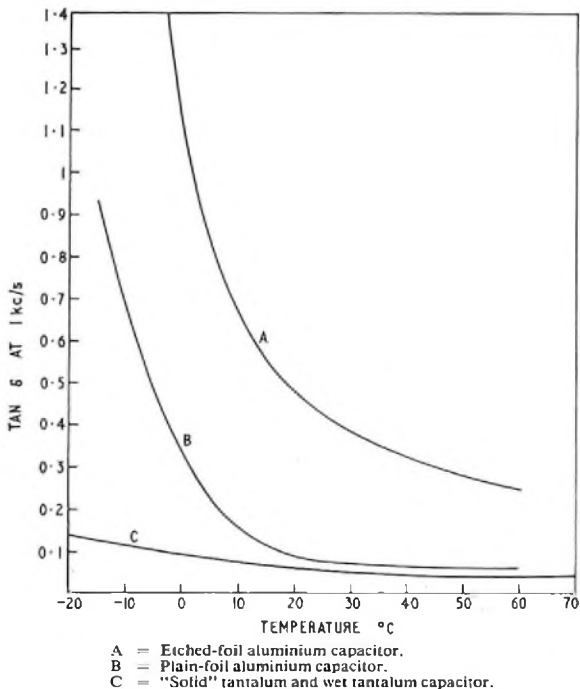

FIG. 8—CHANGE OF  $\tan \delta$  WITH TEMPERATURE

those shown in Fig. 8 because their electrolytes contain liquids, such as alcohol, that have very low freezing points. Their use, however, restricts the upper temperature limit.

Very small low-voltage electrolytic capacitors usually have higher values of  $\tan \delta$  than those shown in Fig. 8.

**Variation of Impedance with Frequency (Fig. 9)**

Above about 100 kc/s–1 Mc/s, the impedance is mainly resistive and inductive due to the configuration. Special designs are available that keep the inductance to a minimum.

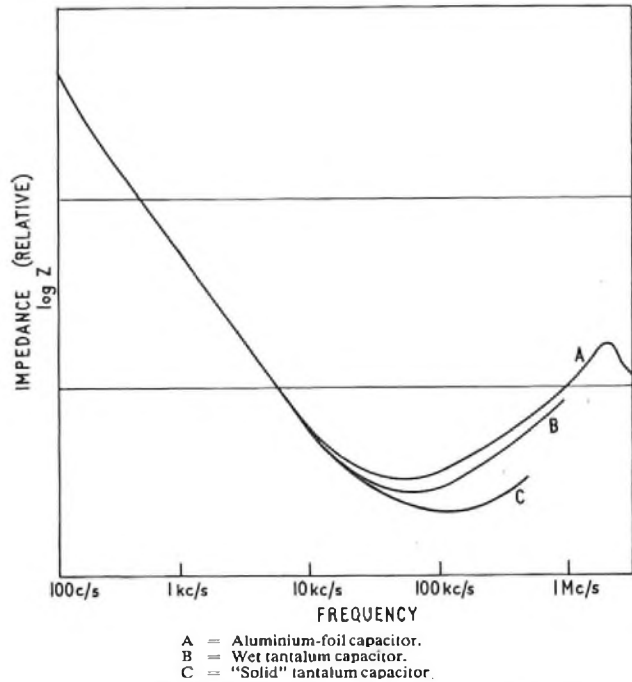

FIG. 9—VARIATION OF IMPEDANCE WITH FREQUENCY

**Leakage Recovery After a Long Idling Period (3 to 12 months) (Fig. 10)**

Liability to failure may arise if electrolytic capacitors,

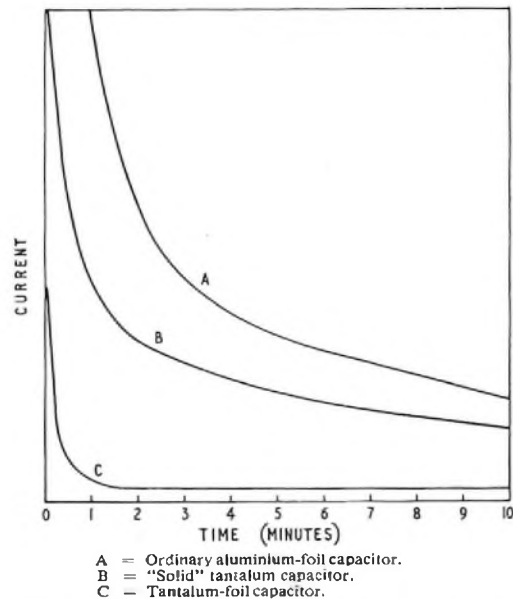

FIG. 10—LEAKAGE RECOVERY AFTER A LONG IDLING PERIOD

particularly aluminium types, are allowed to idle for a long time and are then abruptly switched to full voltage without first reforming or using a current-limiting series resistor.

#### RELIABILITY OF ELECTROLYTIC CAPACITORS

##### *Increased Need for Small Capacitors*

Transistors use smaller currents and voltages than valves, and so components whose size is governed by power dissipation or electric strength of the dielectric can be made smaller, but paper capacitors cannot be made smaller unless thinner paper becomes available. Furthermore, transistors, being relatively low-impedance components, require capacitances larger than those used with valves.

Of the alternatives to paper capacitors, electrolytic capacitors offer the greatest advantage in size, and, for equal capacitances, aluminium electrolytic capacitors have a substantial advantage in price. This, however, is dependent on the electrolytic capacitor having adequate reliability and length of life for the equipments envisaged, though it does allow for a higher price than usual for special designs of electrolytic capacitor of high reliability.

##### *Mechanisms of Failure of Electrolytic Capacitors*

Electrolytic capacitors have not had a good reputation for reliability in the past, the principal failure mechanisms that have been noted being:

- (a) Corrosion of electrodes.
- (b) Leakage of liquid electrolyte with or without corrosion of external leads.
- (c) Corrosion of internal connecting tab by spacing material.
- (d) Bulging or bursting due to internal evolution of gas.
- (e) Formation of oxide film at one of the metal-to-metal joints leading to a rising series resistance increasing the value of  $\tan \delta$  and, ultimately, to disconnection.
- (f) Drying out of the electrolyte of the capacitor due to vapour diffusion through the sealing material of the capacitor or loss of water from the electrolyte by electrolysis, leading to loss of capacitance and rise in  $\tan \delta$  (the converse of this is the diffusion of moisture into capacitors through the sealing material in very damp atmospheres, leading to electrolyte leakage).
- (g) Gradual growth in thickness of the oxide film leading to reduced capacitance.
- (h) "Field recrystallization" occurring in tantalum electrolytic capacitors at high (e.g. over 100°C) temperatures and high electric stresses. Starting from minute nuclei, the amorphous oxide film is replaced by crystalline tantalum pentoxide.<sup>2</sup> This process is accompanied by increased leakage current.

Of the above, (a) is very rarely met nowadays; so is (b) except with small tantalum electrolytic capacitors. A number of instances of (c) have been met in the last 5 years, but these have occurred with specific insulating materials. A few examples of (d) do occur but mainly in connexion with high temperatures and high voltages, neither likely in transistor circuits. When (a)–(d) have been eliminated, fairly large-scale life-tests carried out over the last 8 years indicate that most capacitors which reach a long useful life will ultimately fail by (f) or (g) but that before they have a chance to live this long useful life many of them will be eliminated by mechanism (e), the formation of oxide films at various crimped or pressed joints. Failure by (f) is deferred by the use of purer anode

metals, which reduce both the electrolysis of water and the need for a gas-leakage mechanism.

It is reasonable to infer from the above that, with mechanisms (a)–(d) eliminated, aluminium electrolytic capacitors could be greatly improved in reliability if constructed with continuous metallic connexion ("true metallic bonding" or "interatomic bonding") from each terminal wire through to the anode or cathode as necessary, and that the improved life and reliability would be of the order required in many kinds of transistor circuit. Any process that produces a true continuous metallic connexion may well be usable, but one that has been examined in this respect is cold welding.

Two methods are available for determining the suitability of such processes. The first is to make up substantial numbers of capacitors using the process to be tested and to submit them to a life test or accelerated life test, followed by dissection to determine whether any failures were in fact at metal-to-metal joints. This is the only ultimate proof but entails considerable delays before information is available and action can be taken. The alternative at present is to prepare metallographical sections of the type of joints under consideration both before and after annealing. The untreated sample shows the crystal structure associated with each originally separate piece of metal, while the annealed sample shows crystal growth across the boundaries if a true interatomic bond has been formed. Fig. 11 shows examples of such sections of aluminium joints formed by the cold-welding process.

##### *Recommendations for Making Aluminium Electrolytic Capacitors with Improved Reliability*

To obtain high reliability, electrolytic capacitors for use in transmission equipment should be of types specially made and approved for the purpose. The principles involved in the following clauses (except (h)) have been included in the Post Office specification for electrolytic capacitors.

- (a) Capacitors should be accepted only from manufacturers whose capacitors have previously been subjected to life tests by the Post Office and found satisfactory.
- (b) No metal except aluminium should be used inside the case of the capacitor, and the electrode foils and internal connecting leads should be of aluminium of not less than 99.99 per cent purity. The foils should be at least 0.0018 in. thick.
- (c) A sample of electrolyte taken from the capacitor should not contain more than 10 parts per million (by weight) of halide or sulphate radicals.
- (d) No insulating or packing materials should be used in the construction of the capacitors except paper, polythene, neoprene, epoxy resins, or other materials specially approved for the purpose.
- (e) All electrical connexions inside the capacitor should be made by a method that has been proved to produce a continuous metallic connexion. Up to the present only the cold-welding process has been approved.
- (f) During manufacture, the internal unit of the capacitors should not be touched with the bare fingers.
- (g) The leakage current measured at, or corrected to, 20°C should be such that 15 minutes after connexion to a source of the nominal rated voltage the product of the insulation resistance and the nominal capacitance should be at least 5,000 ohm-farads.
- (h) The leakage current measured at 85°C, 15 minutes after connexion to a source of the nominal rated voltage, should not exceed five times that measured as in (g).



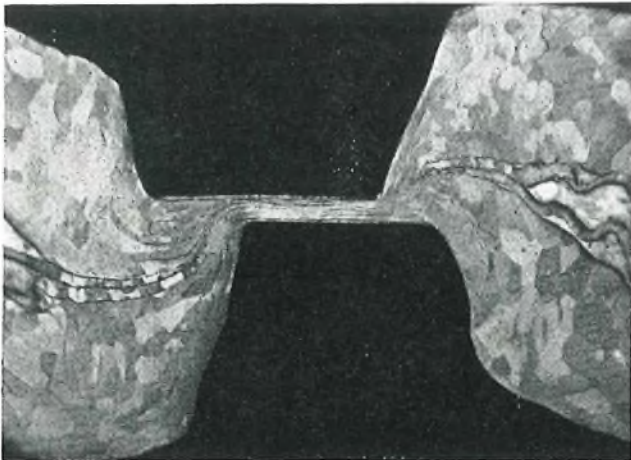

(a) Anodized Aluminium Foil after Cold Pressure Welding

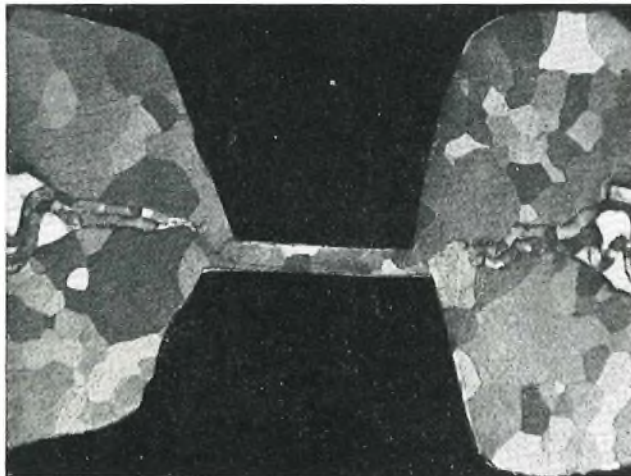

(b) Anodized Aluminium Foil after Cold Pressure Welding and Annealing

FIG. 11—COLD-WELDED JOINTS OF ALUMINIUM

(i) The case of the capacitor, if of metal, should be covered by an insulating sleeve.

(j) The sealing of the capacitors should be capable of withstanding the following test: A capacitor should be immersed in water and the pressure reduced to 660 mm of mercury and held at this value for 5 minutes. The pressure should then be restored to standard for 5 minutes. The capacitor should then be removed from the water and, after 24 hours at standard conditions for recovery, it should meet the requirements of paragraph (g) above.

The above principles have been discussed with several manufacturers, some of whom are willing to work to them, and a few types of capacitors have been received containing cold-welded joints. Several manufacturers have submitted samples claimed to meet all the above clauses with the exception of cold welding, and these have been submitted to accelerated life tests the provisional results of which are discussed later.

*Recommendations Regarding the Use of Electrolytic Capacitors (with Particular Reference to Aluminium Electrolytic Capacitors)*

The voltage applied during working should be such that the leakage current is small consistent with the capacitor performing in the desired manner. This generally

means working the capacitor at about 50–80 per cent of its rated voltage. If possible, the manufacturer's opinion should be sought. The voltage applied should not be liable to surges or to occasional sustained periods of higher voltage.

The ambient temperature should be kept as low as possible, but not below the lower temperature limit for the type of capacitor.

Where appropriate two capacitors of the same working voltage should be connected in parallel to reduce the probability of complete failure by disconnection.

The metal case of the capacitor is sometimes not connected to either terminal. It should either be left disconnected, or connected to the negative terminal. It must not be connected to the positive terminal or to a source of positive potential.

With most aluminium electrolytic capacitors the insulation resistance drops considerably during protracted periods (of months or years) without voltage applied. The insulation resistance can be restored quite rapidly, but to avoid overheating in the first few minutes of voltage reapplication the capacitor should either be deliberately reformed, or used with a suitable current-limiting series-resistor in the circuit.

ACCELERATED LIFE TESTING OF ELECTROLYTIC CAPACITORS

The acceleration of life testing of electrolytic capacitors is complicated by the variety of failure mechanisms possible. Corrosion of electrodes or connecting tabs are chemical or electrochemical processes. Many chemical processes are accelerated two to three times by raising the temperature 10°C, and electrochemical processes are usually accelerated in proportion to the leakage current, which in turn can be increased by raising the voltage, but it is undesirable to increase this above the rated working voltage. Experimental work on a number of different types has given evidence that supports these principles, with failure-rate/temperature coefficients of 1.6–2.1 (with a mean of 1.9) per 10°C rise in the range 40–60°C. This is applicable to failure by corrosion of foils and corrosion of connecting tabs.

Failure by direct leakage of liquid electrolyte is rather erratic in behaviour. Its rate is accelerated by rise in temperature, but no specific range of values has been determined for it; fortunately, if failure is going to take place by this mechanism, it usually does so fairly quickly and the arbitrary assumption of a doubling of the rate per 10°C rise in temperature for short accelerated life tests of the order of 3–12 months with a temperature range of 20–60°C is probably adequate.

Bulging or bursting due to evolution of gas occurs mainly in connexion with high-voltage capacitors, particularly if used at the top of their temperature range; if the leakage-current and the gas-leakage rates are known they can be related, through Faraday's laws and the mechanical properties of the sealing materials, to these effects.

The formation of oxide films at crimped joints and the loss of moisture by vapour diffusion both cause a steady rise in  $\tan \delta$ , the former resulting ultimately in disconnection. The loss of moisture by vapour diffusion or electrolysis also causes a steady decrease in capacitance. Where direct measurements of moisture loss are not available it is difficult to distinguish between these effects and those due to a gradual thickening of the oxide film.

The rate of diffusion of moisture vapour out of an electrolytic capacitor is proportional to the difference



between the internal and external moisture-vapour pressures. To calculate the expected life of the capacitor from a life test accelerated by raised temperature and controlled humidity, a knowledge of these pressures, the total moisture content of the capacitor, how the vapour pressures vary with temperature and concentration, and the diffusion factor for the seal must be obtained. While not impossible, the calculation is complicated and several important parts of the data are rarely available.

However, the curves of capacitance and  $\tan \delta$  with life are often so near to straight lines when plotted on semi-logarithmic paper that the extrapolation principle can be used with success; individual acceleration factors can be calculated by comparing such curves at different temperatures.

A short-circuit or a disconnexion provides a sharp definition of the end-of-life of a component, but a slowly drifting capacitance or  $\tan \delta$  calls for some arbitrary definition of end-of-life, and it has been assumed here that useful life ends when the capacitance has been halved or doubled, or when  $\tan \delta$  has risen to some predetermined value. The fixing of this value is a very arbitrary matter because of (a) the wide range of maximum values that circuits "just tolerate", and (b) the fact that the numerical value of  $\tan \delta$  may vary by as much as a factor of 3:1 or more between 0°C and 40°C.

From many discussions with circuit engineers the only generalized definition that has emerged is that the impedance of a capacitor should not be more than doubled "under the worst working conditions" due solely to the change in  $\tan \delta$ , when compared with that calculated from the nominal capacitance alone. This occurs at  $\tan \delta = 1.73$ . Since  $\tan \delta$ , in general, is highest at the lower end of the operating temperature range this is considered to apply to 30°C for hearing aids, 40°C for telecommunication apparatus, and 0°C for external unattended repeaters, etc. To enable rapid assessments to be made from results at 40–60° for aluminium capacitors the values can be rounded off to:

|  |                 |
|--|-----------------|
| Hearing aids and telecommunication apparatus | 1.7 at 40–60° C |
| Unattended repeaters and similar items       | 0.7 at 40–60° C |

These criteria have been used in calculating the results shown in Tables 1–8. Since there is such a variety of requirement, however, attention is drawn in the notes associated with the tables to those capacitors whose life has terminated due to high  $\tan \delta$ . In all instances the test frequency was 1 kc/s. Where it is the 50 c/s value that is of importance to designers, it should be noted that  $\tan \delta$  values are often three to six times lower, with a corresponding considerable effect on what constitutes the end-of-life with respect to  $\tan \delta$ .

#### Results of some Accelerated Life Tests on Various Types of Electrolytic Capacitors

A considerable number of batches of electrolytic capacitors have been examined in the Post Office Research Station in the last 10 years by means of life tests and accelerated life tests, the results of some of which are summarized in Tables 1–8.

The life tests were carried out on batches of about 10 each at more than one temperature. Ten units are about the minimum to give useful information about the basic failure mechanism (or mechanisms), but are insufficient statistically to give reliable information about manu-

facturing faults occurring randomly. In order to improve the significance of the results the calculations have in general been made with respect to all the samples of a type lumped together, with each group weighted for the life it is considered to have had by the acceleration factor. Where a specific acceleration factor was not known a factor of  $\times 2$  per 10°C was used. For example, if 6 out of 10 fail in 4 years at 60°C, i.e. 15 per cent per annum for 4 years at 60°C, and if 1 out of 10 fails in 4 years at 40°C, i.e. 2.5 per cent per annum for 4 years at 40°C, then combining these,  $(6 + 1) 100 / (10 \times 4 \times 2^2) + (10 \times 4 \times 1) = 3.5$  per cent per year for 10 years at 40°C.

Where the results would be excessively weighted by a very high proportion of failures at high temperatures and calculation was being made for milder conditions where life was 20 years or more, the group with the highest acceleration has been omitted from the calculation or its effect adjusted. Preferably, acceleration factors of 4–10 have been used (the highest being 16), but it is thought reasonable to use an acceleration factor of up to five with an extrapolation factor of up to five giving a combined factor of up to  $\times 25$ . The considerations involved have been discussed by the author elsewhere.<sup>8</sup>

In the tables the calculated percentage failure rates per year are shown in the columns headed "Rate." The estimated lengths of time (in years) during which such failure rates would be applicable are indicated in the column headed "Time." After such periods the failure rates would rise. The estimated lengths of time (in years) for half the individual capacitors in each population to fail are shown in the columns headed "Half-Life." In most instances these half-life times have been obtained by extrapolation.

The type of capacitor is indicated in the first column of each table by the letters P, E, F or S as follows: P—plain foil, E—etched foil, F—metallized fabric, S—sintered pellet.

TABLE 1  
Percentage Failure Rates per year of 50-Volt Aluminium-Foil Electrolytic Capacitors Manufactured in 1952–53 (Length of Accelerated Life Tests: 2 Years)

| Type | Manu-<br>facturer | 20°C |      | 40°C |      | 60°C |      | 85°C |      |
|------|-------------------|------|------|------|------|------|------|------|------|
|      |                   | Rate | Time | Rate | Time | Rate | Time | Rate | Time |
| 1E   | A                 | 0.2  | >20  | 0.7  | 5.6  | 2.8  | 1.4  | —    | —    |
| 2P   | B                 | 1.6  | >20  | 6.4  | 5.6  | 26   | 1.4  | —    | —    |
| 3P   | C                 | 1.0  | >20  | 3.9  | 5.6  | 16   | 1.4  | —    | —    |
| 4P   | D                 | 3.1  | >20  | 12.5 | 5.6  | 50   | 1.4  | —    | —    |
| 5P   | D                 | 3.0  | >20  | 12.1 | 5.6  | 48   | 1.4  | —    | —    |
| 6P   | D                 | 1.5  | >20  | 6.1  | 5.6  | 24   | 1.4  | —    | —    |
| 7P   | D                 | 1.7  | 13   | 6.5  | 3.3  | 27   | 0.8  | —    | —    |
| 8E   | E                 | 0.8† | 8    | 1.7† | 8.0  | 2.0  | 4.8  | 11   | 1.2  |
| 9P   | E                 | 0.3  | 13   | 1.1  | 3.3  | 4.4  | 0.8  | —    | —    |
| 10P  | E                 | 2.5  | 20   | 8.0  | 4.9  | 32   | 1.2  | 80*  | 0.3  |

#### Notes:

1. Where the calculated result suggests more than 100 per cent failures the actual result for that temperature has been substituted, as indicated thus:\*
2. Where the results would be heavily weighted by groups having acceleration factors greater than 10, these groups have been omitted from the calculation, as indicated thus:†.

Considering 40° as a reasonable environmental working temperature for electrolytic capacitors and the probable approximate working temperature of transistor circuits, it was considered that types of capacitors with failure rates greater than about 1 per cent per annum at



40°C were of no interest for telecommunication purposes. Types 1 and 9 were felt to be of interest as a basis from which a reliable aluminium electrolytic capacitor might be developed. Type 8, by the same maker as type 9, was more difficult to assess because, with the limited number of samples used, the results were disproportionately affected by the results of the 85°C test. It was decided to continue the accelerated life test with types 1 and 9, the results being shown in Table 2.

TABLE 2

Percentage Failure Rate per Year during Accelerated Life Test Continued for 7 years, and Calculated Rates if there had been no Disconnexions

| Type | Manu-<br>facturer | 20°C  |      |           | 40°C |      |           | 60°C |      |           |
|------|-------------------|-------|------|-----------|------|------|-----------|------|------|-----------|
|      |                   | Rate  | Time | Half-Life | Rate | Time | Half-Life | Rate | Time | Half-Life |
| 1E   | A                 | 0.13  | >20  | >30       | 0.5  | 20   | >20       | 2.0  | 5.0  | —         |
| 9P   | E                 | 0.15  | >20  | >30       | 0.6  | 18   | >30       | 2.4  | 4.5  | —         |
| 1E   | A                 | <0.03 | >30  | >30       | <0.1 | 20   | >20       | <0.4 | 5.0  | —         |
| 9P   | E                 | <0.03 | >30  | >30       | <0.1 | 18   | >30       | <0.5 | 4.5  | —         |

Notes:

- The limited number of failures occurring in the tests referred to in the first two lines of Table 2 were open-circuits due to the formation of anodic oxide film at joints. If there had been no such failures the calculated failure rates would have been as shown in the third and fourth lines of the table.
- The type 1 capacitor has an etched anode and hence is smaller than type 9, but has a much higher  $\tan \delta$  (4–10 times).
- The type 1 capacitor is approaching the end of its life by its basic failure mechanisms (loss of capacitance and rise of  $\tan \delta$ ) if used in a circuit where 50 per cent loss of capacitance is equivalent to failure. The type 9 capacitor, whose basic failure mechanism is the same, is much further away from general failure of this kind.

After actual life conditions in hearing aids (0.5 year shelf-life and 1 year working life) the percentage failure rates per year for types 12A and 15E were 0.7 and 0.1, respectively. The periods during which such rates would be applicable are 1 year for type 12A and 1.8 years for type 15E, though for the latter type the rate would rise to 2–5 per cent in 2–3 years but would later fall to 1–2 per cent at 5 years. A larger sample of type 12A capacitors taken after 1–8 years' working life gave a percentage failure rate per year of 0.2. In this instance, and for the 15E type, the results were based on an examination of the samples at the end of the period indicated.

Calculated failure rates such as some of those quoted in Tables 1–8 must not be taken as precise statements, but on the other hand they are somewhat more than a mere indication of the order of figures involved. The only precise statement of the reliability of a component is that given by a complete failure curve or failure-rate curve (or tables that convey the same information) based on a large number of units.

Electrolytic capacitors are among the more difficult components to deal with in this way because of the number

TABLE 3

Percentage Failure Rates per Year of 2–6-Volt Sub-Miniature Aluminium Electrolytic Capacitors Manufactured during 1957 and Life-Tested for 6 Months–2 Years.

| Type | Manu-<br>facturer | 20°C |      |           | 40°C |      |           | 60°C |      |           |
|------|-------------------|------|------|-----------|------|------|-----------|------|------|-----------|
|      |                   | Rate | Time | Half-Life | Rate | Time | Half-Life | Rate | Time | Half-Life |
| 11   | A                 | <5   | 2.4  | 10        | <20  | 0.6  | 5         | —    | —    | —         |
| 12   | A                 | 0.8  | 13   | >20       | 3    | 3.4  | 12        | 10   | 0.8  | 3         |
| 13   | B                 | 1.3  | 12   | >20       | 5    | 3    | 6         | —    | —    | —         |
| 14   | D                 | 1.3  | 4    | 15        | 5    | 1.2  | 5         | 20   | 0.3  | 3         |
| 15   | E                 | 1.3  | 5    | 16        | 5    | 1.2  | 4         | 20   | 0.3  | 3         |
| 16   | G                 | 1.3  | 3    | —         | 5    | 1    | 3         | —    | —    | —         |

TABLE 4

Percentage Failure Rates per Year of 350–500-Volt Aluminium Electrolytic Capacitors Manufactured in 1955, Based on Life Tests of about 4 Years' Duration

| Type | Manu-<br>facturer | 40°C |      |           | 70°C |      |           | 85°C |      |           |
|------|-------------------|------|------|-----------|------|------|-----------|------|------|-----------|
|      |                   | Rate | Time | Half-Life | Rate | Time | Half-Life | Rate | Time | Half-Life |
| 17F  | A                 | 1.5  | 7    | —         | 10   | 3    | —         | —    | —    | 0.3       |
| 18P  | A                 | 7    | 3    | 5         | —    | —    | 0.3       | —    | —    | 0.3       |
| 19E  | B                 | 7    | 3    | 5         | —    | —    | 0.3       | —    | —    | 0.3       |
| 20E  | B                 | <5   | 3    | 5         | —    | —    | 0.3       | —    | —    | 0.3       |
| 21E  | C                 | 7    | 3    | 2.4       | —    | —    | 1.2       | —    | —    | 0.3       |
| 22E  | C                 | 2    | 15   | —         | 10   | 3    | —         | 24   | 3    | 2         |
| 23E  | D                 | 1.5  | 16   | —         | 10   | 3    | —         | 8    | 3    | —         |
| 24E  | D                 | 13   | 3    | 6         | —    | —    | 1.4       | —    | —    | 1.0       |
| 25E  | E                 | <0.5 | 16   | >20       | <3.3 | 3    | —         | —    | —    | 1.1       |
| 26P  | E                 | <3.5 | 3    | 8         | —    | —    | 0.3       | 0.3  | —    | 0.3       |
| 27E  | E                 | 0.6  | 13   | >20       | 7    | 3    | 5         | —    | —    | 2         |
| 28E  | E                 | 0.6  | 13   | —         | 3.3  | 3    | —         | —    | —    | 0.3       |

Note: The failure rates have been calculated mainly as follows. 70°C and 85°C: on the test at these temperatures only. 40°C: from a weighted average of results at 40°C and 70°C using what acceleration factor seemed reasonable, usually  $\times 2$  per 10°C. 20°C: from weighted averages of results at 20°C and 40°C (and with 70°C results if necessary).

Some adjustments were made where it was obvious that, due to an insufficiently large sample, a disproportionately large or small number of manufacturing faults had affected the figure.

TABLE 5

Percentage Failure Rates per Year of Aluminium Electrolytic Capacitors Manufactured in 1958–1960. Based on Life Tests and Accelerated Life Tests of 1–3 Years

| Type | Manu-<br>facturer | $\mu\text{F}/\text{cm}^3$ | Voltage | 40°C |      |           |
|------|-------------------|---------------------------|---------|------|------|-----------|
|      |                   |                           |         | Rate | Time | Half-Life |
| 46E* | A                 | 7.3                       | 10      | 0.8  | 7    | 10        |
| 47E  | A                 | 3.9                       | 50      | <2.0 | 10   | >20       |
| 48E* | A                 | 5.3                       | 12      | <2.4 | 5.3  | 12        |
| 49E  | A                 | 6.3                       | 25      | <2.4 | 5.3  | 20–25     |
| 50E* | A                 | 16                        | 6       | 4.8  | 4.8  | 7         |
| 51E* | A                 | 14                        | 3       | 2.6  | 5.0  | 6         |
| 52E  | D                 | 8.5                       | 15      | 0.8  | 6.7  | >20       |
| 53E  | D                 | 3.5                       | 30      | 1.8  | 6.5  | >20       |
| 54P  | E                 | 2.2                       | 25      | <1.1 | 4.4  | >20       |
| 55P  | E                 | 0.3                       | 25      | <1.1 | 4.4  | >20       |
| 56P  | J                 | 0.5                       | 50      | <1.6 | 3.1  | —         |

Notes:

- A number of other types (indicated thus\*) manufactured during this period were also tested but were found to have higher failure rates than the above due to loss of capacitance. At 60°C the capacitance would be reduced by two-thirds.
- The half-lives at 40°C were based on extrapolations.

TABLE 6

Percentage Failure Rates per Year of 25–100-Volt Tantalum Electrolytic Capacitors Manufactured in 1954

| Type | Manu-<br>facturer | 40°C |      |           | 60°C |      |           | 85°C |      |           |
|------|-------------------|------|------|-----------|------|------|-----------|------|------|-----------|
|      |                   | Rate | Time | Half-Life | Rate | Time | Half-Life | Rate | Time | Half-Life |
| 29S  | A                 | 0.8  | 8    | —         | 3    | 2    | —         | 10   | 2    | —         |
| 30E  | E                 | 0.4  | >20  | >20       | 1.7  | 6    | —         | 10   | 1    | —         |
| 31E  | H                 | 4.0  | 4    | —         | 17   | 1    | —         | —    | —    | —         |

Note: Earlier batches of type 29 had much higher failure rates due to manufacturing faults.

of different failure mechanisms involved and because of the varied acceleration factors arising in accelerated life tests on them.

Failure rates are meaningless unless accompanied by the length of time to which they refer (given in the tables in the columns headed "time"). The half-life or time to 50 per cent failures is usually considered a late stage in the useful life of a batch of components, but when taken with

TABLE 7  
Percentage Failure Rates per Year of 25-70-Volt Tantalum Electrolytic Capacitors Manufactured during or after 1958

| Type | Manu-<br>facturer | $\mu\text{F}/\text{cm}^3$ | 20°C |      |           | 40°C |      |           | 60°C |      |           |
|------|-------------------|---------------------------|------|------|-----------|------|------|-----------|------|------|-----------|
|      |                   |                           | Rate | Time | Half-Life | Rate | Time | Half-Life | Rate | Time | Half-Life |
| 32S  | A                 | 23                        | 25   | 4    | —         | 100  | 1.0  | 0.5       | —    | —    | —         |
| 33S  | A                 | 16                        | 13   | 4    | —         | 50   | 1.0  | 1.0       | —    | —    | —         |
| 34S  | A                 | 59                        | 6.2  | 9.6  | —         | 25   | 2.4  | 2.0       | —    | —    | —         |
| 35S  | A                 | 23                        | 0.6  | 19   | 20        | 2.4  | 4.8  | —         | 9.6  | 1.2  | —         |
| 36E  | E                 | 13                        | <0.3 | >20  | >20       | <1.2 | 10   | —         | <4.8 | 2.5  | —         |
| 37E  | H                 | 11                        | 7.0  | 14   | —         | 28   | 3.6  | —         | —    | —    | —         |
| 38E  | H                 | 16                        | 4.4  | 19   | —         | 18   | 4.8  | —         | —    | —    | —         |
| 39E  | H                 | 86                        | 0.6  | >20  | >20       | 2.4  | 6.4  | —         | 9.6  | 1.6  | —         |

TABLE 8  
Percentage Failure Rates per Year of 1.5-6-Volt Tantalum Electrolytic Capacitors Manufactured in 1955-59

| Type | Manu-<br>facturer | 20°C |      |           | 40°C |      |           | 60°C |      |           |
|------|-------------------|------|------|-----------|------|------|-----------|------|------|-----------|
|      |                   | Rate | Time | Half-Life | Rate | Time | Half-Life | Rate | Time | Half-Life |
| 40E  | A                 | 100  | 1    | 0.5       | —    | —    | —         | —    | —    | —         |
| 41E  | H                 | 3    | 8    | 20        | 13   | 2    | 20        | —    | —    | —         |
| 42E  | H                 | 13   | 4    | —         | 50   | 1    | 1         | 100  | 0.5  | —         |
| 43E  | H                 | 4    | 4    | —         | 16   | 1    | 5         | 50   | 0.5  | —         |
| 44E  | H                 | 3    | 19   | —         | 12   | 5    | —         | 50   | 1.2  | —         |
| 45E  | H                 | 0.3  | 19   | 20        | 1.2  | 5    | —         | 5    | 1.3  | —         |

the other two figures gives in many instances as useful an approximation to the full failure rate as can be conveyed by three parameters only.

The principles and the difficulties involved have been discussed by the writer elsewhere.<sup>8,9</sup>

#### CONCLUSIONS

As a result of the tests made, and upon which the tables are based, the following conclusions can be drawn:

(a) Accelerated life tests confirm the popular impression that in general (i.e. without choosing specific types) electrolytic capacitors of the last decade have only a moderate reliability.

(b) Several manufacturers make a good aluminium unit apart from the methods used for making connexion between the electrodes and the external terminals. However, the best of these if used continuously at about 40°C may give 20-year lives with average failure rates of the order of  $\frac{1}{2}$  per cent per year.

(c) If a uniformly satisfactory connexion could be incorporated in the types referred to in (b), 20-year lives at 40°C with failure rates not higher than 0.1 per cent per

year should be possible, which should make them acceptable for telecommunication equipment.

(d) A method that has been shown to give a continuous metallic connexion (interatomic bond) is the cold-welding process. However, any other process that could be proved to produce the same effect would be acceptable.

(e) Nearly all of the tantalum anodes examined were of good quality. The numerous failures of some types of tantalum capacitors were due mainly to poor sealing techniques and manufacturing faults.

(f) If satisfactory methods of sealing tantalum capacitors are used and manufacturing faults eliminated, several types of such capacitors would be expected to have the reliability necessary for telecommunication equipment.

#### References

- <sup>1</sup>DUMMER, G. W. A. Fixed Capacitors (Pitman, 1956).
- <sup>2</sup>YOUNG, L. Anodic Oxide Films (Academic Press, 1961).
- <sup>3</sup>KELLER, F., HUNTER, M. S., and ROBINSON, D. L. Structural Features of Oxide Coatings on Aluminium. *Journal of the Electro-Chemical Society*, Vol. 100, p. 411, Sept. 1953.
- <sup>4</sup>FRANKLIN, R. W. Structure of Non-Porous Anodic Films on Aluminium. *Nature*, Vol. 180, p. 1,470, Dec. 1957.
- <sup>5</sup>HART, R. K. A Study of Boehmite Formations on Aluminium Surfaces by Electronic Diffraction. *Transactions of the Faraday Society*, Vol. 50, p. 269, Mar. 1954.
- <sup>6</sup>MCLEAN, D. A., and POWER, F. S. Tantalum Solid Electrolytic Capacitors. *Proceedings I.R.E.*, Vol. 44, p. 872, July 1956.
- <sup>7</sup>BERRY, R. W., and SLOAN, D. J. Tantalum Printed Capacitors. *Proceedings I.R.E.*, Vol. 47, p. 1,070, June 1959.
- <sup>8</sup>NEW, A. A. Principles of Acceleration of Life Tests of Electronic Components. International Conference on Components and Materials used in Electronic Engineering, London, June 1961.
- <sup>9</sup>NEW, A. A. Component Reliability in Post Office Equipment. *P.O.E.E.J.*, Vol. 54, p. 40, Apr. 1961.
- <sup>10</sup>MARGOLIS, D. S., and COZENS, J. H. Electrolytic Capacitors. *A.T.E. Journal*, Vol. 15, p. 245, July 1959.

## Book Review

"The Use of Semiconductor Devices." Published by the Electronic Valve and Semiconductor Manufacturers' Association ("VASCA"), London. 64 pp. 12 ill. 2s.

This booklet is written by an association of fourteen manufacturers of semiconductor devices and is intended primarily as a guide to equipment designers in choosing correct operating conditions for semiconductor devices. The first chapter, therefore, describes the general features of semiconductor devices, defines ratings and characteristics, and deals with the three systems of ratings which are now in use. Chapter 2 deals with semiconductor diodes; it describes

Zener, tunnel, variable capacitance and microwave diodes in addition to small-signal and power diodes. A section on four-layer two-terminal switches is also included. Chapter 3 summarizes the circuit properties of junction transistors, including high-power, high-frequency and switching applications, and two short chapters follow dealing with photo-sensitive devices and controlled rectifiers.

Many semiconductor devices can be damaged by energies which seem very small, and the use of correct principles in circuit design is of great importance in obtaining the high reliability of which semiconductor devices are capable. The booklet provides a valuable service to circuit designers, and contains a surprisingly large amount of information in spite of its small size.

H.G.B.



# On Programming Computers

F. J. M. LAVER, B.Sc., M.I.E.E.†

U.D.C. 681.142

Computers cannot think, they can only do what they are told to do, and then only within certain limits. The instructions given to computers must, therefore, be accurate, and the problems to be solved or the process to be performed must be within the capabilities of the machine. This article reviews the various ways in which computer programs are compiled and presented to these machines.

## INTRODUCTION

IN the decade or so since the first electronic computers came into use much has been written to describe how they work and what they can do. Those interested will know that computers can take in numerical data, store it, put it through long sequences of arithmetical operations, re-arrange it and put out the results; and that all this takes place under automatic control and at a very high speed.<sup>1</sup> No more need be said on these topics for the purpose of this article, which is to review the ways in which work is presented to computers—the ways in which men communicate instructions to these machines.

### *Instructions for a Computer*

A computer is a general-purpose machine, so general-purpose in fact that it can do next to nothing by itself; but as long ago as 1843 Lady Lovelace wrote: "It can do whatever we know how to order it to perform."<sup>2</sup> Two consequences follow. The first is that we must ourselves know how to solve the problems, or perform the processes, that the machine is to undertake. Computers do not relieve us of the need to think; only of the drudgery of producing masses of particular results from our general solutions. However, this is no small matter for, to quote again: "... what discouragement does the perspective of a long and arid computation cast into the mind . . .". The second consequence is that we must know how to give orders to computers.

The actions of an electronic computer are controlled by electrical signals which open, close, inhibit or enable the gate circuits that regulate its various internal circulations of pulses. The signals that set these gates are themselves derived by decoding pulse patterns which are held in a particular register in the control unit of the computer. A typical computer can perform 50 or more different basic operations: add, subtract, read in a number, print out a number, and so on; each such operation has its own distinctive pulse pattern. These patterns constitute the "instructions" to perform the corresponding operations. The pulse pattern for an instruction can be directly represented by a group of binary digits, using digit 1 for each pulse and digit 0 for each gap, but for brevity it is usually represented outside the computer by a related group of decimal digits, or letters, according to some code.

A computer instruction consists of:

- (a) a "function" part, which specifies the action (operation) required, and
- (b) one or more "address" parts, specifying which compartments (locations) in the computer's store will supply data for the operation or receive its result.

For example, the National-Elliott 803B computer, installed at the Post Office Research Station, Dollis Hill, for general use by the Engineering Department, has one-address instructions, such as 04 2385 which means "Add to the number already in the accumulator register of the arithmetic unit the number now being held in location 2385 (i.e. compartment number 2385) of the store, leaving the result in the accumulator." On the other hand, one large business machine has three-address instructions, for instance DS, A, B, C which means "Subtract from the number in location A the number in location B and place the result in location C, treating these numbers as decimal numbers." However, the difference between computers with different numbers of addresses in their instructions is one of detailed design and does not affect the basic methods of preparing work for the machine.

### *Programming*

In obeying one instruction a computer executes one simple operation; but to complete a useful computation it must perform several such operations in turn, and these are specified in a list of instructions known as the program. Different computations will, of course, need different programs, but the same program can be used again and again to repeat the same computation with different data.

The first stage then, in preparing a computer program, is to break down the required computation into a series of simple arithmetical steps. These are specified by their corresponding computer instructions. The programmer writes out a list of instructions, in the order in which they are to be obeyed, and this list is the program. The written program must now be reproduced in a form that the computer can accept. Taking in programs is one of the very few things that computers can do by themselves, for they have short fixed programs permanently built in for this purpose. Most often the written program is given to the operator of a keyboard punch, who copies it into a length of perforated paper tape, or into a pack of punched cards. The program tape or cards are then read by the computer, and their contents are translated into pulse patterns and recorded in its main store. The machine is now ready to perform the computation, so the data are fed in (also on punched tape or punched cards), and the computer obtains instructions one by one from its store until the program has been completed. The whole process is shown diagrammatically in Fig. 1 for a computer which has paper tape as its input and output media.

### MACHINE CODE

Outside the computer a program consists of a list of figure or letter groups, each group representing one instruction, i.e. one elementary step in the computation. Inside the computer the program consists of groups of binary digits held in the store, to be used, group by group, for decoding in the control unit. As an example,

† Organization (Complements) Branch, E.-in-C.'s Office.

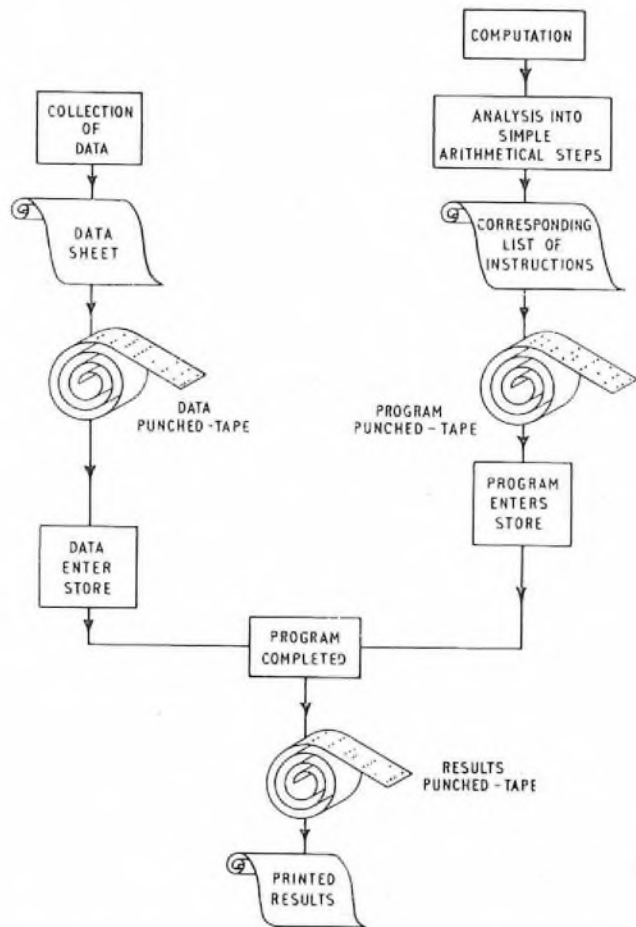

FIG. 1—BLOCK SCHEMATIC DIAGRAM OF PREPARATION FOR CONTROL OF A COMPUTER

consider the Engineering Department's machine. The short piece of program which follows instructs this machine to add together the numbers held in locations 2384 and 2385 of its store, and place their sum in location 2386.

| Instruction | Effect  |
|-------------|---|
| 30 2384     | Machine copies the number in location 2384 into the accumulator, replacing what was there before. |
| 04 2385     | Machine adds the number in location 2385 to the number in the accumulator.                        |
| 20 2386     | Machine copies the sum from the accumulator into location 2386, replacing what was there before.  |

Because in the preceding example the instructions are in the form in which they enter the computer, they are said to be in "machine code."

The example is ridiculously brief, for practical programs contain from several hundreds to many thousands of machine-coded instructions. Nevertheless, it serves to illustrate some general points, including the following ones:

(a) One instruction covers only one very small stage in the computation, for computers take much smaller steps than those natural to human thought.

(b) The codes used in the function parts of instructions are not self-evident; the Engineering Department's computer has 56 different codes for its programmers to memorize, and some larger machines have as many as 200.

(c) The computer operates with the numbers held in specified locations in its store; the programmer has, therefore, to keep a meticulous account of the changing contents of all locations used by his program, including those used to store the program itself.

These three points explain why writing computer programs in machine code is a slow and painstaking business, and why lengthy checks are necessary to eliminate programming errors. Again, the programmer has to ensure that none of the numbers occurring in his calculation exceeds the capacity of the computer, usually some 10 to 12 decimal digits; this he does by careful scaling of his quantities. It may take a man three or four weeks to learn to program in machine code, and twice as many months of full-time programming to become proficient. Machine-code programming has, therefore, tended to be a job for specialists.

#### AUTOCODE

About five or six years ago it had become evident that much of the work of programming was pure routine and that it might well be undertaken by the computers themselves. Some of the pioneering work along these lines was done at Manchester University, where the term "autocoding" was coined. Autocoding provides a way of stating programs which is much nearer to that commonly used to deal with computations than is machine code: in the jargon of the trade it is "problem-oriented" rather than "computer-oriented." The Engineering Department's computer can be programmed in Elliott Autocode, and in this autocode the single autocode statement  $A = B + C$  parallels the three machine-coded instructions given above, for it specifies that the numbers in locations B and C should be added and their sum placed in location A. The following are some further examples of autocode statements:

| Statement            | Effect  |
|----------------------|---|
| $A = B - C$          | Machine subtracts C from B, placing the result in A.                            |
| $A = \text{SQRT } B$ | Machine extracts the square root of B, placing the result in A.                 |
| $A = \text{SIN } B$  | Machine evaluates sine B, placing the result in A.                              |
| READ A               | Machine reads the next number from the input tape, and stores it in location A. |

There are just over 50 different standard statements in Elliott Autocode, and, in relation to the three difficulties of machine-code programming mentioned earlier:

(a) one autocode statement covers a more significant step in the computation.

(b) the form of the statements is mnemonic, for they resemble the language of algebra, and

(c) the programmer need take account only of those locations in the store that he has distinguished by letters (e.g. A, B, C above), for the detailed assignment of A, B, C, etc., to locations and the arrangements for storing the program itself are made automatically by the computer.

As a result, programming in Elliott Autocode can be learned in two or three days, after which it is quite feasible for computer users to write their own programs with little or no specialist help.

A program in autocode consists of a list of mnemonic statements, and cannot be directly used to control a computer. It is first necessary to convert the autocode statements into their equivalents in machine code, and usually one statement in autocode gives rise to several



machine-code instructions. The conversion is done by a preliminary run on the computer, during which it is controlled by a translator program called a "compiler": the autocode statements are the input data, and the result is the corresponding program in machine code.

Programming in autocode, therefore, comprises the following stages:

(i) Analysing the problem and reducing it to a complete sequence of simple arithmetical steps.

(ii) Expressing this sequence by a series of autocode statements.

(iii) Punching the autocode program into paper tape or punched cards.

(iv) Loading the computer with the compiler program supplied by the manufacturer, and feeding in the autocode program as data; the computer then automatically punches out a machine-code program.

This process is shown in Fig. 2. It may appear to be rather elaborate, but it is much quicker than writing in machine-code and takes place once only when the program is first written; the machine-coded program is

preserved and used thereafter whenever the computation is to be repeated. Again, the ordinary user is concerned only with stages 1 and 2, for the remaining stages are handled by trained machine operators.

#### UNIVERSAL AUTOCODES

An autocode, such as Elliott 803 Autocode, can only be used with a small number of different computers—usually the different models made by one manufacturer. Someone who wishes to use several machines has, therefore, to learn several different autocodes, and there would be advantages in a universal autocode, if one could be devised. There are, however, some practical difficulties.

(a) Autocodes are problem-oriented to make them more convenient to use, and this means that an autocode which is designed for mathematical problems tends to be clumsy or unfamiliar for business processes.

(b) Opinions differ about the range of facilities that should be offered by an autocode: the wider the range the more difficult it is to write the compiler program, and the slower the process of translation. These differences of opinion inevitably increase when the specification of a universal autocode is discussed.

(c) If a common standard were accepted, each manufacturer would have to write compiler programs for his own range of computers. This is no quick or easy task, and most manufacturers have already invested substantial sums in producing compilers for their own autocodes.

Despite these difficulties two universal autocodes have been proposed, one for mathematics and one for clerical work.

#### Algol

The universal autocode proposed for mathematics is called Algol,<sup>3,4,5</sup> which is an acronym derived from ALGOrithmic Oriented Language. Thus Algol is an autocode, i.e. a programming language, oriented to the programming of algorithms, an algorithm being a concise statement of the steps to be taken, or the rules to be followed, to solve some mathematical problem. Algol grew out of informal discussions between American and European mathematicians in 1958, and has since been developed more formally at conferences which have included representatives from Denmark, France, Germany, Holland, Switzerland, the United Kingdom and the United States.

Algol, like some of the manufacturer's autocodes, uses algebraic symbols to state the procedures of a calculation, but, unlike most autocodes, it is free from certain arbitrary restrictions. For instance, some autocodes restrict the programmer to two operands in arithmetical operations; thus he can write

$$A = B + C$$

but not  $A = B + C + D$

To add three numbers he must write

$$A = B + C$$

$$A = A + D$$

where the second statement means: "make the new value of A equal to its old value (i.e. B + C) plus D". In Algol, on the other hand, it is possible to write

$$A = B + C + D + E + \dots$$

or  $A = B \times C / D + E$

or even more complex expressions. This greater freedom of expression in Algol has been won quite simply—by definition! For Algol is declared to be independent of the limitations imposed by any computer. In this way the

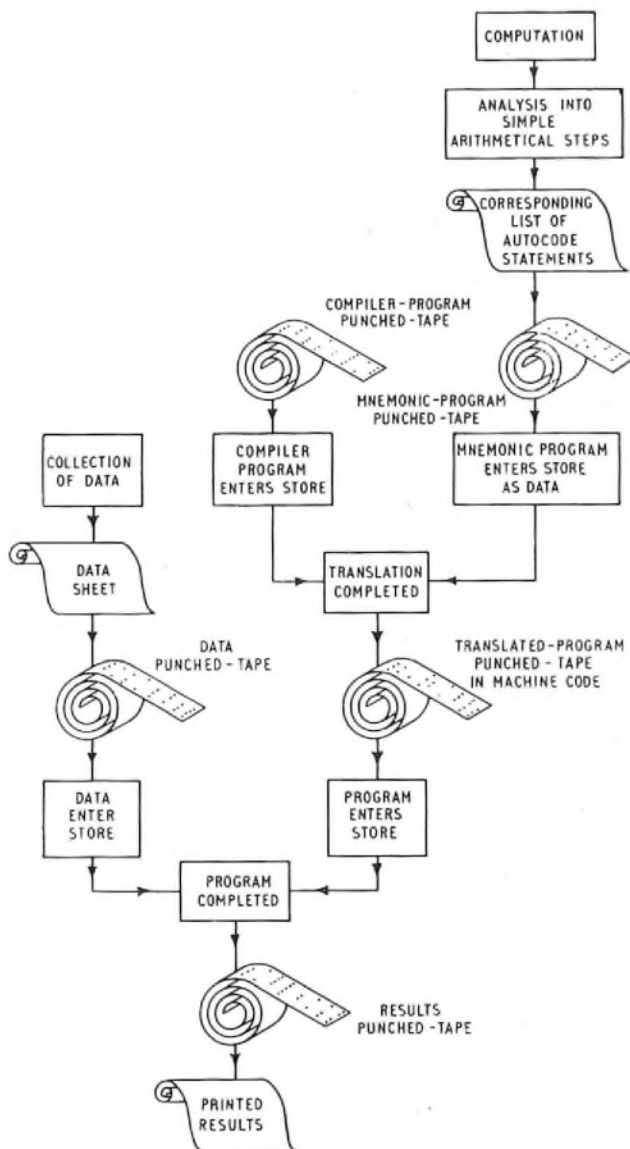

FIG. 2—BLOCK SCHEMATIC DIAGRAM OF PROGRAMMING A COMPUTER IN AUTOCODE

difficulties have been transferred from the users of Algol to the writers of the compiler programs used for translating it into the machine codes of the various computers.

So far, few Algol compiler programs have been written and thoroughly tested so that experience in the use of Algol is limited; but it is already proving valuable by enabling mathematical programmers to communicate with each other in print. Previously, the publication of programs was not worthwhile because only the few who had learned that particular machine-code or autocode could read them. Algol provides a programming Esperanto, and for this reason alone its use seems certain to increase. Algol can be used for communication even before compiler programs are available, for programmers can themselves translate it "by hand" into the particular machine-code or autocode of their own computers. An example of a simple program in Algol is given in the Appendix.

### Cobol

The acronym Cobol<sup>6,7</sup> derives from COmmon Business Oriented Language. Cobol is wholly American in origin, for it was produced in 1960 by a committee of computer manufacturers and users set up by the U.S. Department of Defense; this department continues to sponsor its development and use. The most obvious difference between Algol and Cobol is that, whereas Algol uses algebraic notation, Cobol statements express their procedures in plain English, although with certain restrictions on the choice of words and on their arrangement. For example, to calculate net pay as the product of rate and hours less tax, a programmer might write in Algol:

$$p = r \times h - t$$

but in Cobol:

NET-PAY EQUALS RATE TIMES HOURS  
MINUS TAX.

Cobol is less widely accepted than Algol, and among the reasons for this are:

- (a) clerical processes have not been analysed and generalized to the same degree as mathematical ones,
- (b) business terms have not been standardized,
- (c) Cobol has had less time for development and few compiler programs are available,
- (d) Cobol has no international status, and
- (e) the belief that programs written in an autocode are less efficient (take longer to run) than those written in a machine-code, and inefficiency is less tolerable in business than in mathematical work.

The first and last of these points call for comment. Thus, it has become clear that the use of computers for clerical work involves a much more analytical approach to office work, and that the key to success is the generalization and standardization of such basic business procedures as retrieving information from files, keeping records up to date, sorting and regrouping records, and producing reports.

Efficiency is more essential in business programs than in mathematical ones because a business program may be used week in week out to process hundreds of thousands of items, whereas a mathematical program may be used less than a dozen times. Again, a business user most often expects his computer to reduce costs, and is keenly interested in its processing rate, whereas a mathematician commonly uses a computer to set himself free from tedious arithmetic and speed is not his dominant criterion. However, it is by no means certain that programming in

autocode is an inefficient practice. It is probably true that programmers as adept as those who write the autocode compiler programs could beat the products of their own compilers, but most programmers will not rise to this class. Moreover, the use of autocode offers compensatory savings, for the cost of preparing and maintaining the programs for a large business computer may exceed the capital cost of the machine, and autocode can considerably reduce the programming cost by reducing the man-hours, the calibre, and the training of the staff required.

### AUTOMATIC PROGRAMMING

The use of an autocode relieves the programmer of the drudgery of expressing himself in machine language, but he is still required to state his program in exhaustive detail.

The next step would be for the computer to operate from a broad description of the problem to be solved or a general indication of the results required. There have been some developments in this direction, but at this early stage these have taken the form of demonstration pieces rather than usable methods of automatic programming. For example, a program has been written which enabled a computer to solve simple problems in plane geometry (at about the General Certificate of Education Ordinary Level); the computer reached its solutions by trial and error procedures, working backward from the required result to the premisses.

Some early consideration has also been given to the writing of "learning" programs, by the using of which a computer would recognize those of its attempted solutions that brought it most near to its goal; these it would record for future use with similar problems, so "learning" from its experience. The hub of this approach is the assessment of progress towards the set goals, and this involves either establishing suitable criteria, or using a human teacher to judge the computer's early efforts and "reward" or "punish" it accordingly. Eventually, a computer so programmed might use its accumulated experience to attempt problems whose solutions were unknown, rather than to fill in the proofs of known or predicted results.

This work may seem somewhat academic, but it could prove to be invaluable in business applications. For example, it is often necessary to attempt to retrieve a record from a large file on the basis of an incomplete or partially incorrect inquiry. A skilled filing clerk, or a library assistant, may succeed by using his experience of similar searches to prompt alternative lines of approach; and so could a computer controlled by a learning program. This technique is being studied for such computer applications as searching the patent libraries, language translation, medical diagnosis, traffic control, transport scheduling, and the optimization of industrial plant operations, for these are all activities for which no one can state precise solutions that could be programmed in the ordinary way.

### References

- <sup>1</sup>LAVER, F. J. M. An Introduction to Electronic Computer Systems for Office Use. *P.O.E.E.J.*, Vol. 52, p. 13, Apr. 1959.
- <sup>2</sup>ADA AUGUSTA, Countess of Lovelace. Translator's Notes to: MENABREA, L. F. Sketch of the Analytical Engine Invented by Charles Babbage, Esq. *Taylor's Scientific Memoirs*, 1843 (Vol. III p. 666).
- <sup>3</sup>Report on the Algorithmic Language ALGOL 60. *Communications of the Association for Computing Machinery*, Vol. 3, p. 299, May 1960.



<sup>4</sup>WOODGER, M. An Introduction to ALGOL 60. *Computer Journal*, Vol. 3, p. 67, July 1960.

<sup>5</sup>SCHWARZ, H. R. An Introduction to ALGOL 60. *Communications of the Association for Computing Machinery*, Vol. 5, p. 82, Feb. 1962.

<sup>6</sup>Report to the Conference on Data Systems Languages, including Revised Specifications for a Common Business Oriented Language (COBOL) for Programming Electronic Digital Computers. U.S. Government Printing Office, June 1961.

<sup>7</sup>MACKINSON, T. N. COBOL: A Sample Problem. *Communications of the Association for Computing Machinery*, Vol. 4, p. 340, Aug. 1961.

## APPENDIX

### Program Example in ALGOL

#### Problem

Tabulate, to six significant figures, the real roots of the quadratic equation

$$ax^2 + bx + c = 0,$$

for the values of  $a, b, c$ , punched in sequence into an input-data

tape. Any imaginary roots should be noted by printing: "Roots are Imaginary."

#### Analysis

The roots of the equation are given by the well-known formula

$$x = \frac{-b \pm \sqrt{b^2 - 4ac}}{2a},$$

but for computation it is convenient to re-arrange this to

$$x = -\frac{b}{2a} \pm \sqrt{\left(\frac{b}{2a}\right)^2 - \frac{c}{a}}.$$

The roots are imaginary when the quantity under the square-root sign is negative, i.e. when  $\left(\frac{b}{2a}\right)^2$  is less than  $\frac{c}{a}$ .

#### Program

Algol does not include any standard instructions for the input or output of data, but in the following example "read", "print", and "line" have been adopted for these purposes.

The program is shown in the left-hand column; the notes in the right-hand column are purely for explanation, and would not normally be written.

| Program   | Notes   |
|---|---|
| <b>begin</b>  | Start of program.   |
| <b>real</b> $a, b, c$ , Root 1, Root 2;   | Tells the compiler program that $a, b, c$ , Root 1 and Root 2 will be used to represent real number variables.                      |
| <b>Input:</b> <b>read</b> ( $a, b, c$ );  | Reads the next three numbers from the input tape and sets variables $a, b, c$ , to their values.                                    |
| <b>if</b> ( $b/2 \times a$ ) $\uparrow$ 2 > $c/a$ <b>then</b><br>Root 1 = $-b/2 \times a + \text{sqrt}[(b/2 \times a) \uparrow 2 - c/a]$<br>Root 2 = $-b/2 \times a - \text{sqrt}[(b/2 \times a) \uparrow 2 - c/a]$ | Tests for imaginary roots and calculates real roots. " $\uparrow$ 2" means "raised to the power 2", and "sqrt" means "square root." |
| <b>else go to</b> Imroot;   | Proceed direct to instruction labelled "Imroot."  |
| <b>print</b> (Root 1, Root 2) as (+3d.3d2s);  | +3d.3d2s shows the format required for the results, namely: sign, 3 integer digits, decimal point, 3 fractional digits, 2 spaces.   |
| <b>lines</b> 2;   | Insert 2 line spaces in printed results.  |
| <b>go to</b> Input;   | Return to the instruction labelled "Input" to read in the next set of data.   |
| <b>Imroot:</b> <b>print label</b> ("Roots are Imaginary");  | Print the text contained in the brackets.   |
| <b>lines</b> 2;   | Insert 2 line spaces in printed results.  |
| <b>go to</b> Input;   | Return to the instruction labelled "Input" to read in the next set of data.   |
| <b>end</b>  | End of program.   |

## Dismantling the Long-Wave Masts at Leafield Radio Station

D. E. WATT-CARTER, A.M.I.E.E.†

U.D.C. 624.97.059.6 : 621.396.67

As part of a redevelopment scheme for Leafield Radio Station the long-wave aerial system is being dismantled. Recovery of the 10 305 ft reinforced-concrete masts forming part of the installation presented unusual problems, and the way in which these are being overcome so as to facilitate the subsequent disposal of the masts is described.

### INTRODUCTION

LEAFIELD Radio Station came into being in 1912 as part of a chain of 10 long-wave radio stations that were to be built in various parts of the British Empire. This project, known as the Imperial Scheme, never progressed beyond this initial point due to the

rapid developments in short-wave radio techniques. The Post Office took over the installation in 1914 from Marconi's Wireless Telegraph Co., Ltd., and, after using it as an interception station during the first world war, brought it into service as a transmitting station in 1921 using first Poulsen Arc and, since 1928, valve transmitters. A large proportion of the press telegraph traffic outgoing from this country to Europe and the rest of the world has been transmitted from Leafield, some of it on long-wave transmissions, but increasingly over the years by short waves.

† Overseas Radio Planning and Provision Branch, E.-in-C.'s Office.

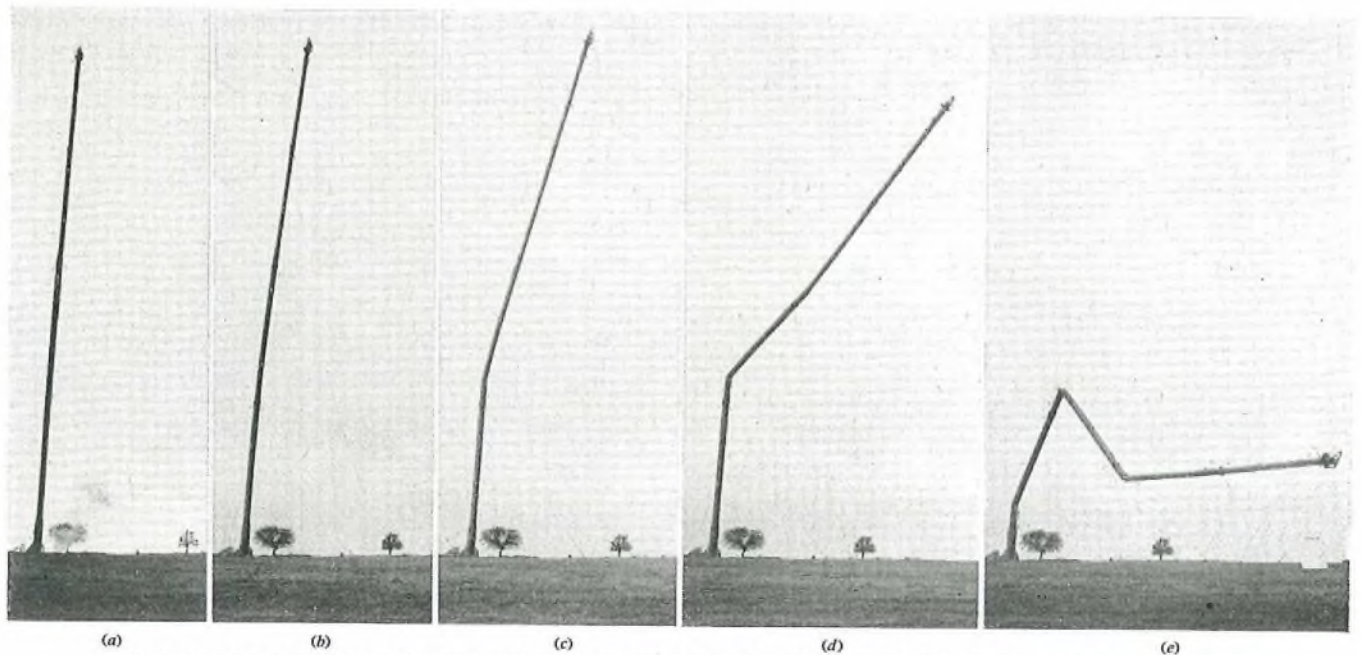

(a) Start of fall, earth surrounding base being blasted; (b) After 3.2 seconds; (c) After 7.3 seconds; (d) After 10.4 seconds; (e) After 12.2 seconds.

FIG. 1—PATTERN OF FAILURE OF FIRST MAST

The long-wave era at Leafield came to an end early in 1961 and the three long-wave transmitters ceased operation after 33 years of continuous service. The station site is being extended and redeveloped on modern lines as a high-frequency transmitting station, and the long-wave aerials are being dismantled to make way for high-frequency aerial systems.

#### CONSTRUCTION OF LONG-WAVE MASTS

A prominent feature of the station is the group of 10 305 ft masts, visible for miles to Cotswold travellers, that formed part of the original installation. These masts, of somewhat unusual construction, were originally of tubular-steel form, with a 2 ft 6 in. diameter up to a height of 170 ft and a 2 ft diameter thereafter, fabricated from half-tubular 10 ft sections of flanged  $\frac{3}{8}$  in. thick steel plate bolted together. Each mast weighed about 20 tons, was solidly bolted to a concrete foundation 8 ft square by 6 ft deep and weighing 25 tons, and was held upright by four stays at each of four levels.

The exteriors of the masts were protected by painting them periodically, using a bosun's chair suspended from the mast head. Although access to the interiors was possible through manholes in the bases, working conditions were very restricted and unpleasant, and in consequence any maintenance of the interior surfaces was extremely difficult.

The masts were examined thoroughly in 1942 when fairly extensive corrosion was discovered, particularly where the tubular sections had been bent to form the horizontal flanges. The masts were judged to be unsafe and, because it would have been difficult to replace them at that time, the decision was taken to safeguard them by encasing them in a reinforced-concrete shell that would, if necessary, stand on its own and permit the original structure to disintegrate. This interesting and, it is

\* HARDING, J. P., and HARMON, J. F. The Reconstruction of Leafield Long-Wave Radio Masts. *P.O.E.E.J.*, Vol. 40, pp. 1 and 63, Apr. and July 1947.

thought, unique feat of structural engineering has been fully described elsewhere.\* The concrete shell varies in thickness from 6–8 in., and up to 10  $\frac{1}{2}$  in. diameter reinforcing bars are used in the lower sections. In all, some 70 yd<sup>3</sup> of concrete and over 3 tons of reinforcing material were used in each mast. The present masts each weigh about 75 tons and the enlarged foundations 85 tons.

#### FELLING THE MASTS

From the recovery point of view the combination of steel and concrete of the reconstructed masts is more than usually difficult to destroy. The essential aim is to fell each mast in such a manner that as much of it as possible ends in the horizontal position, so as to facilitate subsequent break-up and disposal. To overturn the structure completely by uprooting its foundation after loosening the surrounding soil by explosives appeared just possible on a preliminary study, but experience with the first mast proved that the strength of the mast section was inadequate to exert the necessary overturning moment. A satisfactory alternative is to leave the block undisturbed and to induce a fracture as near the base as possible. The junction of the mast with its base is a comparatively strong



FIG. 2—FIRST MAST HITTING GROUND



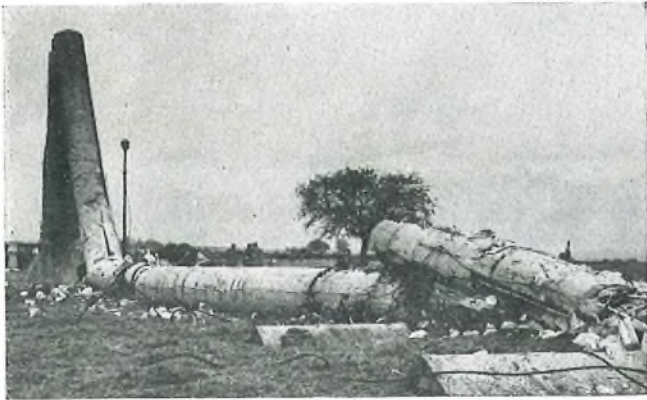

FIG. 3—FIRST MAST AFTER FALL

reinforced-concrete pyramidal section 20 ft in height, and if the mast were allowed to fall freely fracture would clearly occur somewhat higher than this, leaving an intractable "stump" to be contended with subsequently.

For the second fall, therefore, attempts were made to weaken this pyramid sufficiently to induce a fracture near ground level. The reinforcing rods on the side remote from the fall were first bared by small explosive charges and then severed by oxy-acetylene flamecutting. Eleven holes were drilled into the heart of the concrete facing the fall and explosive charges totalling 2 lb were inserted. The four stays holding the mast against the chosen line of fall were gathered together at the top-stay anchor-block and held there by a single  $1\frac{1}{2}$  in. link chain. A 2 oz explosive charge of polar ammon gelignite was inserted in one of the links, enclosed by two steel plates, and bound in. On the side of the fall the second stay 170 ft above ground was lengthened by adding a spare stay and attached to a tractor some 600 ft away. If the mast were plumb a pull at this point of some 3-5 tons, depending upon the state of the original steel mast, would be needed to induce a fracture.

The sequence of events immediately before the actual fall was, first to take up the load on the tractor, then to

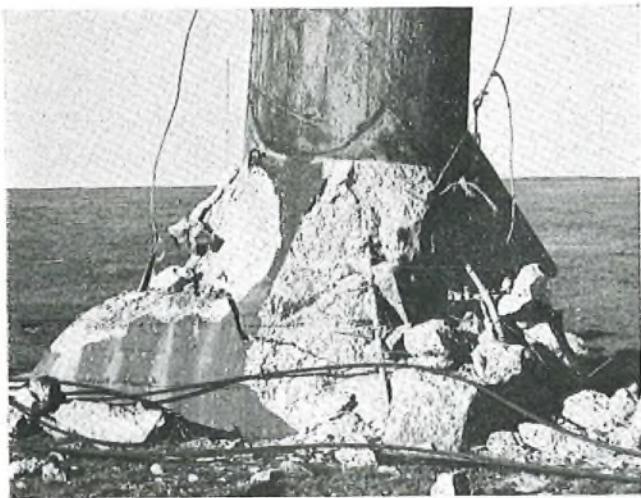

FIG. 4—BASE OF SECOND MAST AFTER FALL

explode the charge in the chain link, followed within 2 or 3 seconds by the explosion of the mast-base charge.

The pattern of failure of the first mast, which was followed closely by that of the second, is clearly visible in Fig. 1. Initial failure occurred at 100 ft above ground after about 7 seconds, followed at 10 seconds by a secondary break at 180 ft. The upper half remained intact until hitting the ground at 14 seconds (Fig. 2). The terminal velocity was estimated as well over 100 m.p.h. and caused extensive shattering of the concrete shell and almost complete collapse of the original steel cylinder. The last main fracture to occur at 30 ft was clearly caused by the refusal of the reinforcing rods at the original break to part, the upper section dragging the lower section down. The lower half collapsed concertina-fashion, and although disintegration was less complete the shell was fissured longitudinally and shaken partly free of the core (Fig. 3).

The attempt to cause a fracture nearer the base was thus only partly successful, as although the concrete pyramid was cracked over the whole cross-section (Fig. 4) the inner core still held firm.

The procedure for the third attempt was therefore

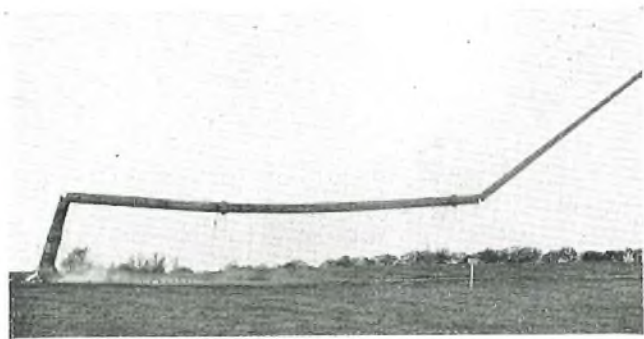

FIG. 5—THIRD MAST JUST BEFORE HITTING GROUND

varied in certain respects. In the first place all 10 reinforcing bars within the pyramidal base were exposed by near-surface shot blasting and severed by flamecutting. Secondly, explosive charges were distributed around three sides of the pyramid, and the explosion penetrated closer to the steel core than on the previous occasion. Then, during the actual felling, the tractor pull was exerted at the first stay-point 90 ft above ground in an effort to avoid the initial break at 100 ft. These changes produced a completely successful operation. The initial fracture occurred at 30 ft and, apart from the secondary failure at 180 ft, resulted in a comparatively clean fall. Fig. 5 shows the mast just before hitting the ground.

After some initial resistance the "stump" was dragged over by the momentum of the upper section and the ring of 12  $1\frac{3}{4}$  in. diameter bolts securing the steel mast shell to its original foundation all failed in tension, giving a clean break at ground level.

The original mast appeared to be in quite a good state of preservation throughout its length and had undoubtedly retained a high proportion of its original strength. The disintegration that occurs on impact with the ground will greatly assist disposal and quite a high proportion of steel will be recoverable as scrap.

## Notes and Comments

### Birthday Honours

The Board of Editors offers congratulations to the following engineers honoured by Her Majesty the Queen in the Birthday Honours List:

|                             |                  |                            |  |
|-----------------------------|------------------|----------------------------|--|
| Cambridge Telephone Area .. | C. Riley ..      | Area Engineer ..           | Member of the Most Excellent Order of the British Empire |
| Engineering Department..    | C. J. Cameron .. | Assistant Staff Engineer.. | Imperial Service Order                                   |
| Engineering Department..    | J. E. Haworth .. | Senior Executive ..        | Member of the Most Excellent Order of the British Empire |
| London Postal Region ..     | W. D. McLaren .. | Manager of the Post ..     | Member of the Most Excellent Order of the British Empire |
|                             |                  | Office Railway             |  |
| North West Area, London     |                  |                            |  |
| Telecommunications Region   | G. L. Chilton .. | Inspector ..               | British Empire Medal                                     |

### Recent Awards

The Board notes with pleasure the following awards:

|               |                  |                          |  |
|---------------|------------------|--------------------------|--|
| Edinburgh..   | W. Carlyle ..    | Youth-in-Training ..     | Royal Humane Society Testimonial on Parchment, for rescuing a boy from drowning. |
| Lancaster ..  | W. Fisher ..     | Technician, Class IIA .. | Royal Humane Society Testimonial on Vellum, for rescuing a boy from drowning.    |
| Portsmouth .. | J. E. Jarrett .. | Technical Officer ..     | Royal Humane Society Testimonial on Vellum, for rescuing a youth from the sea.   |

### Retirement of Mr. W. S. Procter, O.B.E., M.I.E.E., F.S.R.E.

Mr. W. S. Procter, O.B.E., who retired as Chief Regional Engineer, London Telecommunications Region, on 30 April, was born at Halifax, Yorkshire, on 22 April 1900. He entered the Post Office as a Youth in September 1914. After a short period of service in the R.N.V.R., he



became a Temporary Inspector in 1923 on his transfer to the Research Station, Dollis Hill, where he was engaged on loading and final tests on audio trunk cables.

In 1926, he became a Probationary Assistant Engineer

(old style) and the following year was transferred to the Technical Section of the old North Western District at Preston, Lancashire. January 1929 saw him back in London in the Telephone Section of the Engineering Department where he was engaged in the preparation and production of Technical Instructions (now Engineering Instructions). From 1931 to 1934, he was Assistant Editor of this Journal. He was promoted to Executive Engineer (old style) in 1933.

In January 1933 he was transferred to Dundee, Angus, as Sectional Engineer and, later, he became the first Area Engineer in the new Dundee Telephone Area on the introduction of Regional organization to Scotland. He was promoted to Regional Engineer in January 1938, and was posted to Post Office Headquarters, Edinburgh, where he was concerned with the planning and provision of defence communication requirements throughout Scotland.

In January 1945 he was appointed Telephone Manager, Glasgow, and after 3 years there he came to London in January 1948, on his promotion to Chief Regional Engineer.

A man of wide and varied experience, he always kept his feet on the ground. His deep understanding of human behaviour, his kindness, and his cheerful unruffled disposition will long be remembered by those who worked closely with him. His many friends in the Post Office and in the telephone industry, as well as the many who know of him through his association with the late T. E. Herbert in the authorship of their text book on telephony, wish him long life, health, and happiness in his retirement.

G.S.B.

### S. J. Edwards, A.M.I.E.E.

Mr. S. J. Edwards, who has been appointed Chief Regional Engineer, London Telecommunications Region, entered the service in 1931 as a Probationary Inspector, having completed an apprenticeship at H.M. Dockyard, Portsmouth. After a period as an outstationed Inspector



at Bideford, he joined the Superintending Engineer's Office at Bristol and was engaged on local-line planning until 1936 when he became Probationary Assistant Engineer (old style). He then joined the Bristol Telephone Area, in charge of maintenance, in time to take part in the closing stages of the "Bristol Maintenance Experiment", which was one of the early field trials leading to our present-day maintenance procedures. He remained in Bristol throughout the war and was concerned with the maintenance of the many defence installations, and also with the repair of the heavy blitz damage.

Returning to Regional Headquarters in 1946, he became Efficiency Engineer, covering a duty which also included running the Regional Engineering Training School. His interest in education led him to undertake the organization of telecommunications courses at the Merchant Venturers Technical College, where he also lectured. Always interested in the sporting and social activities of staff, he played an active part in the Bristol Area Sports and Social Association, serving as secretary and as chairman.



Exchanging the West Country for East Anglia he was appointed Telephone Manager, Cambridge, in 1954, a post which he left, after making many friends, in 1960 when he became Telephone Manager, Brighton. During this period he was also a member of the Working Party on Engineering Accommodation, and immediately before his recent appointment he undertook instructor's duties at the Post Office Management Training Centre. His friends wish him every success in his new appointment.  
G.C.G.

**M. F. Holmes, B.Sc.(Hons.)**

Mr. M. F. Holmes was appointed to the post of Senior Principal Scientific Officer in the Thermionics Division of Research Branch in April, 1962. A Yorkshireman, educated at Leeds University, he took an honours degree in physics and stayed on for a further year to take a Diploma in Education. He decided then that teaching was not his line of country and entered the Civil Service



by Open Competition. His experience has been a wide one covering service on both traffic and engineering sides. In 1944 he was transferred to Research Branch and started the work on thermionic valves that has occupied his attention ever since.

He was a founder member of the Thermionics Group set up in 1946 to develop long-life valves for use in submerged repeaters, and this gave him wide scope for both his scientific background and organizing ability. His first important task was to recognize the potential life-span of valves from short-term tests, and the methods that he devised in those early days are still used to-day in the selection of valves for the Commonwealth cable scheme. The success of these methods is evidenced by the very few "incidents" that have occurred in some 30 million valve-hours experienced so far in British Post Office underwater-repeater working. Mr. Holmes has since worked on a variety of problems associated with thermionic emission and has become an authority on the plethora of causes leading to deleterious changes in valve characteristics. On the engineering side he has had charge of the valve production plant at the Post Office Research Station, Dollis Hill, and has been responsible for producing more than half of all valves at present working underwater in British Post Office schemes. For the past two years Mr. Holmes has served as Secretary to the Co-ordinated Valve Development (C.V.D.) Research Advisory Panel on general-purpose valves.

His many friends wish him well in his new appointment.  
G.H.M.

**Board of Editors**

The Council of the Institution has appointed Mr. E. J. Markby a member of the Board of Editors in place of Mr. G. J. Millen, who recently completed his term of office as a member of Council.

**Reprint of Articles from the Special S.T.D. Issue of the Journal (Vol. 51, Part 4, Jan. 1959)**

A reprint of selected articles from the special subscriber trunk dialling issue of the Journal (Vol. 51, Part 4, Jan. 1959) has been produced. This 32-page reprint, price

2s. 6d. (3s. post paid) per copy, contains some notes drawing attention to developments that have taken place since the original publication of the selected articles and which affect the information contained in these articles. The articles in the reprint are as follows:

The General Plan for Subscriber Trunk Dialling.  
Controlling Register-Translators, Part 1—General Principles and Facilities.  
Local Register for Director Exchanges.  
Periodic Metering.  
Local-Call Timers.  
Metering over Junctions.

Subscribers' Private Meter Equipment.

Members of the London Centre, Associate Section, should order their copies from the London Centre secretary and local secretaries. Other Post Office readers should order their copies from the Journal local agents. For all other readers, orders and remittances, which should be made payable to "*The P.O.E.E. Journal*" and crossed "& Co", should be sent to *The Post Office Electrical Engineers' Journal*, G.P.O., 2-12 Gresham Street, London, E.C.2.

Early ordering is advised as the number of copies is limited.

---

## Institution of Post Office Electrical Engineers

### Results of Essay Competition, 1961-62

A prize of £6 6s. and an Institution Certificate have been awarded to the following competitor in respect of the essay named:

R. Bayfield, Technical Officer, Brighton. "The M.K.S. System of Electrical Units."

Prizes of £3 3s. each and Institution Certificates have been awarded to the following four competitors:

K. Hounsell, Technical Officer, Folkestone. "A Look at Eurovision."

R. J. Thorogood, Leading Technical Officer, London Telecommunications Region. "The Highgate Wood Experiment."

D. A. Hill, Technical Officer, Skegness. "Maintenance and its Organization."

E. R. Harrington, Technical Officer, Engineering Department (Test and Inspection Branch). "Inspection of the Lightweight Submarine Telephone Cable."

Institution Certificates of Merit have been awarded to:

P. Morrison, Technician I, Bletchley Park. "Engineering—Recruiting and Training."

F. E. Butler, Technical Officer, Rotherham. "The Economic Nature of the Post Office Engineering Department in the Framework of Postwar Commerce."

F. C. Reading, Technician I, London Telecommunications Region. "Subscriber Trunk Dialling."

D. W. J. Smith, Technician I, Bletchley Park. "Pinus Sylvestris."

R. J. Boon, Technical Officer, Cardiff. "Abetting the Bookmakers."

The Council of the Institution records its appreciation to Messrs. E. W. Anderson, W. B. Jago and C. Grant, who kindly undertook to adjudicate upon the essays entered for the competition.

*N.B.—Particulars of the next competition, entry for which closes on 31 December 1962, will be published later.*

### Institution Field Medal Awards, 1960-61 Session

In addition to the Institution Senior and Junior silver and bronze medals, up to three bronze medals, the Field Medals, are awarded annually for the best papers read at meetings of the Institution on field subjects primarily of Regional interest.

Field Medals were awarded to the following authors for papers read during the 1960-61 session:

R. Corbishley and D. J. Marsland, Manchester (North Western Region). "The Effects of New Methods and Materials on Local-Line Planning."

S. A. Downing, Cambridge (Home Counties Region). "Provision of Telephone Exchange Accommodation."

J. E. Dadswell, Aberdeen (Scotland). "Some Aspects of Supervision."

The Council of the Institution is indebted to Mr. J. Stratton, Chairman of the Paper Selection Committee of Council, for the following précis of the medal-winning papers.

### *The Effects of New Methods and Materials on Local-Line Planning*

In this paper the authors have made a bold attempt to cover a very wide field—the changing balance between cabinets and pillars, the consequences of the introduction of the 700-type telephone, aspects of shared-service schemes, line connectors, the use of new types of cable, and many other items of real and immediate interest to the local-line planning engineer.

But even with this wealth of information they have managed, most successfully, to maintain clarity and a logical approach. The relegation of matters of detail—various factual tables and companion charts—into a series of appendices, and the provision of a comprehensive series of diagrams and graphs is of great assistance in this respect.

The paper illustrates clearly how the local-line planning engineer, by maintaining a lively interest in the development of new ideas and new materials, and being prepared to employ them in a fairly widespread application in his own areas of operations, can achieve worth-while economies.

### *Provision of Telephone Exchange Accommodation*

The author, in this paper also, deals with a subject which presents a very wide range of problems. To make a detailed survey, from the preliminary stages, even before a spot on the map has been selected for a new exchange building, to the point where the building is completed and awaits the equipment and cable installation parties, is an ambitious project. Even so, the paper presents the material in an orderly fashion, giving due consideration to the difficulties which arise at each stage and describing the procedures adopted to ensure a satisfactory result.

The provision of new exchange accommodation, beginning with the search for a suitable and economic site right through to the determination of small detailed requirements in the structure itself, has to be approached with a multiplicity of alternatives in mind, and the paper illustrates how such alternatives are considered in a particular Region.

If any adverse criticism may be voiced, it is that such is the scope of the subject that rather too much has been attempted in one paper. The many problems associated with site selection and the practical difficulties involved in the erection of a satisfactory exchange building would provide subject matter for separate papers.

### *Some Aspects of Supervision*

This is an extremely well-constructed paper on an unusual subject, and one which is worthy of close attention and



consideration by all supervising officers who have not had the opportunity of attending management courses, either within the Post Office training scheme or at the many technical colleges carrying such courses.

The efficiency of any large organization depends as much on human relationships as upon technical "know-how"—a factor seldom sufficiently appreciated.

The objection is often heard that management and supervision training merely states the obvious, but attempts to justify itself by clouding the issues with the adoption of apparently profound phraseology. The same objections might be raised in connexion with this paper and there may be a small grain of truth in the allegation. But it is the obvious which is so seldom taken to apply to the reader himself. If all staff in supervisory capacities read, read again and re-read this paper, indulging in a little critical self-examination at the same time, it might be that some of the less able supervisors might begin to recognize themselves and decide to attempt to rectify their methods. If so, the paper will have been of value.

S. WELCH,  
*General Secretary.*

### 1961 Supplement to the Library Catalogue

A supplement listing books added to the Library since the issue of the 1958 Library Catalogue has been prepared. Copies are available from Honorary Local Secretaries.

#### Additions to the Library

Library requisition forms are available from Honorary Local Secretaries, from Associate Section Centre Secretaries and representatives, and from the Librarian, I.P.O.E.E., G.P.O., 2-12 Gresham Street, London, E.C.2.

2669 *Automobile Fault Tracing*. S. Abbey (Brit. 1961).

A practical handbook for service mechanics and owner-drivers.

2670 *Basics of Fractional Horsepower Motors and Repair*. G. Schweitzer (Amer. 1960).

Gives a working explanation of principles of operation, and presents basic procedures for servicing and maintaining them.

2671 *Sound and Television Broadcasting. General Principles*. K. R. Sturley (Brit. 1961).

A B.B.C. engineering training manual for new recruits to the B.B.C.—readily understood by those having G.C.E. level of education.

2672 *Essentials of Heat*. O. M. White (Brit. 1961).

Emphasizes practical applications, and is appropriate to G.C.E. A level of education.

2673 *The Business of Management*. R. Falk (Brit. 1961).

The author does not claim this book to be a textbook or manual: it is an attempt to help the thinking of those who feel that management is worth thinking about.

2674 *The World of Leonardo da Vinci*. I. B. Hart (Brit. 1961). Presents da Vinci against the background of the world in which he lived.

2675 *Radio for Examinations*. H. I. F. Peel (Brit. 1961).

An attempt to cover the essential requirements for radio examinations.

2676 *Radio Today*. D. K. McCleery (Brit. 1961).

Covers the types of thermionic valves and transistors, and their functions, in transmitting and receiving apparatus, types of such equipment and appropriate aerial arrays, and details of the latest practice, suggesting possible future developments.

W. D. FLORENCE,  
*Librarian.*

## Book Review

"Selected Scientific Papers." Balthasar van de Pol. Edited by H. Bremmer and C. J. Bouwkamp. North-Holland Publishing Company, Amsterdam. Vol. I and II: xv + 1,338 pp. £6 13s.

With the passing of Balthasar van de Pol in October 1959 there died one of the great men of telecommunications, and one whose reputation extends far beyond into electrical physics, mathematics, and elsewhere. In this publication of a selection of his scientific papers one finds, within the compass of two volumes, a collection which is quite amazing in its breadth and depth, and which, if studied only for a few moments, tells one a great deal about the man who wrote them. The papers cover a span of over 40 years and are in Dutch, English, French, or German. They range over a great variety of subjects: from studies of radio-wave propagation and oscillation generators, including the heart, to a classical dissertation on the principles of frequency modulation; and a lecture on music and the theory of numbers which even a non-musician like the reviewer finds interesting. The collection also includes a considerable number of papers on pure mathematics.

Although most of the papers are mathematical some are entirely descriptive and many of them will be understood by those whose mathematical equipment is not very extensive. This is because van de Pol, although he usually wrote in a language other than his mother tongue, attached great importance to writing clearly and to the point. Indeed he often used to emphasize the time and care needed to do so by quoting the case of the man who wrote: "My dear Mother, I am sending you this letter because I have not enough time to write a postcard."

These two volumes of van de Pol's collected works are interesting in several ways: they tell us so much about the

man and his life. We see unfolding the science of radio communication, with which he was largely concerned, and we are perhaps led to read papers that would otherwise never have come to our notice. For example, one rather interesting and very early paper is "The Production and Measurement of Short Continuous Electromagnetic Waves" written while van de Pol was at the Cavendish Laboratory, communicated by J. J. Thomson and published in the *Philosophical Magazine* in July 1919. This paper, unlike many others, is entirely non-mathematical and describes how using a triode valve in association with "Lecher wires" (open-wire transmission lines), waves as short as 3.65 metres were generated—a surprising achievement in view of the early date and fact that the valve used appears to have been worked under normal space-charge conditions. On the other hand one of the last papers is "On Series of the Reciprocals of the Jacobian Theta Functions" published posthumously in the *Proceedings of the Academy of Sciences*, Amsterdam 1960.

One paper which, in the reviewer's opinion, should not have been included is a report of a sub-sub-committee (*sic*) of the International Radio Conference, Madrid, 1932,—a sub-sub-committee composed of T. L. Eckersley, J. H. Dellinger, Ph. de Corbeiller, and van de Pol, who was chairman. The report is merely a series of curves based on data derived from various sources and acknowledged as such. Van de Pol's stature is such that it does not need to be boosted by such trivial material.

The reviewer feels that these "Selected Scientific Papers" will be very interesting to anyone who had the pleasure of knowing van de Pol, and they are a fitting tribute to a great man. But it is doubtful whether they will serve any useful purpose as a textbook. However, that clearly is not the publisher's intention.

H.S.

## Regional Notes

### Wales and Border Counties

#### PAY-ON-ANSWER COIN BOXES—MOBILE DEMONSTRATION UNIT

Because of difficulties in getting suitable accommodation in the centre of the city of Chester to give demonstrations of the new-type pay-on-answer coin-box a mobile demonstration unit was designed, based on an unequipped mobile automatic exchange trailer van. The unit was parked in a public car park near the centre of the city and was visited by about 2,200 people during the fortnight demonstration period.

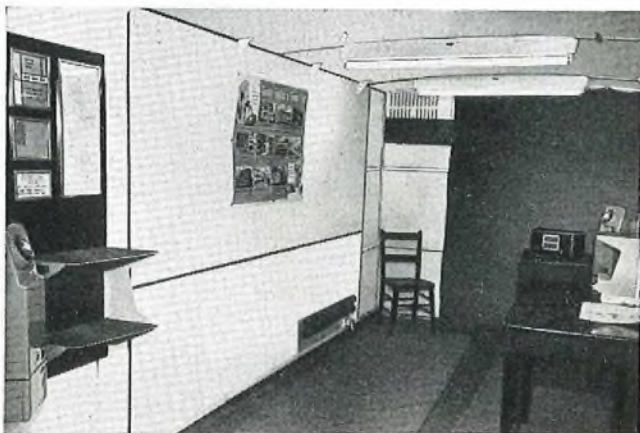

THE INTERIOR OF THE MOBILE DEMONSTRATION UNIT

The van was approximately 17 ft 6 in.  $\times$  8 ft, with the floor level about 3 ft. above ground-level. Steps were provided to give access to the van and were covered by a canopy. Steps and canopy were made by local contractors. The inside, shown in the photograph, was panelled with hardboard and the mains supply for the fluorescent lighting, etc., was obtained by tapping off a nearby electric-light standard. An amplifier-loudspeaker unit was coupled to the telephone circuit of one of the coin-boxes and this proved to be very useful for demonstrating pay tone to the visitors.

It is proposed to use the unit at other centres in the Area to give demonstrations of pay-on-answer coin-boxes prior to their introduction.

K.G.

### North-Eastern Region

#### TWO-MOTION SWITCH-CLEANING APPARATUS

A very useful aid in cleaning switching equipment has been constructed at Newcastle on Tyne in collaboration with Telephone Exchange Standards and Maintenance Branch, Engineering Department, and the Regional Headquarters. The item consists of an air-compressor unit and a dust-proof compartment with an outlet into the atmosphere outside the apparatus room. The equipment to be cleaned is placed on a turntable in the dust-proof compartment which is then closed. The operator's hand gains access via a sleeved entry to a pressure gun, which is served by the air compressor, and this enables loose dust and dirt to be blown from the equipment. The compartment is illuminated by an internal lamp so that the cleaning can be clearly observed. The item being cleaned can be rotated as required by an external control. The unit is trolley-mounted and can be readily moved to each working site as required.

Results of the trial in Newcastle are very promising; the equipment gives a short treatment which leaves the equipment in an immaculate condition without the necessity for the final relay-contact cleaning.

A.E.T.

### Northern Ireland

#### WARPED CASE OF A TELEPHONE 706

Thermo-plastic materials are susceptible to softening by excessive heat. This was amply demonstrated by a recent fault which occurred in the Belfast Telephone Area. A black telephone No. 706 was found to have surface damage where exposed to sunlight which entered the room via a Flemish glass window.

The Materials Section of the Tests and Inspection Branch, Engineering Department, says that the design of Flemish glass is such that a series of lenses is formed in the glass. Consequently, the sun's rays have been focused at various points on the telephone and, coupled with the heat absorption property of a black body, have caused local high temperatures which have been greater than the softening point of the acrylic moulding material. The Subscribers' Apparatus and Miscellaneous Services Branch, Engineering Department, are aware of the fault and specify that telephones should be at least 2 ft 6 in. to 3 ft away from this type of glass.

H.G.

### Midland Region

#### A TELEVISION INTERFERENCE PROBLEM AT PETERBOROUGH

Prior to October 1959, Peterborough and its environs received its television programmes from Sutton Coldfield (channel 4) and Lichfield (channel 8) at signal strengths varying from 50 to 100  $\mu\text{V}/\text{m}$ . There was often severe fading, particularly on channel 8 signals from Lichfield.

On 5 October 1959 the B.B.C. opened its Morborne Hill transmitter on channel 5. This station, which is situated approximately 6 miles to the south-west of Peterborough, provides a serviceable signal to an area bounded by a line of roughly 30 miles radius from the transmitter.

On 27 October 1959 the I.T.A. opened its East Anglia transmitter at Mendlesham in Suffolk, on channel 11. This station, sited some 66 miles to the south-east of Peterborough provides that city with an acceptable picture when interference is absent, and reception is much better than that previously obtained from Lichfield. The average strength of the received signal is of the order of 250  $\mu\text{V}/\text{m}$ . The aerials of both of the new stations are horizontally polarized.

The introduction of these two stations had two immediate effects:

(i) The reduction of the number of normal television-interference complaints to manageable proportions, almost overnight.

(ii) The creation of a major interference problem.

The interference problem created is one of local-oscillator radiation from television receivers, mainly at second harmonic frequency, which emanates from receivers and receiving aerials in approximately equal proportions. All the affected receivers were tuned to channel 11.

Television receivers responsible for the trouble fall into two main categories:

(a) Sets with British Radio Equipment Manufacturers' Association (B.R.E.M.A.) standard intermediate frequencies which are tuned to channel 5. The second harmonic of the local oscillator causes the interference.

(b) Sets with 16 and 19.5 Mc/s intermediate frequencies which are tuned to channel 8, the local oscillator causing the interference by radiating the fundamental frequency. In



isolated places in the north of the Telephone Area, where it is possible to view on channels 2 and 11, some third harmonic radiation has caused trouble with sets having intermediate frequencies of 16 and 19.5 Mc/s.

The interference manifests itself, generally, as a moving pattern (often described as lace-curtain effect) over the viewer's screen, its severity being dependent upon three factors:

- (a) The strength of the wanted signal.
- (b) The strength of the radiation.
- (c) The distance from the source to the viewer's receiver.

At its worst the interference has been known to turn the viewer's screen peak white.

The interference is most prevalent when sets are installed back to back and the two aeriols are on a common chimney stack (e.g. semi-detached houses) or when the channel 11 receiving aeriols are pointing in the same direction and in line.

During the first 2 years of the life of the channel 5 and 11 transmitting stations the Telephone Manager received 3,250 complaints of interference with the reception of channel 11 programmes and, during the ensuing investigations, found over 1,400 offending television receivers, 1,250 of which had B.R.E.M.A. standard intermediate frequencies. Tests carried out by the Post Office staff with a television receiver complying with the radiation limits of British Standard Specification, B.S.S. 905, have made it clear that many television receivers do not comply with B.S.S. 905 and that if they did, the problem at Peterborough would have been very much smaller. Most of the complaints were in Peterborough City, which has a population of 57,000, approximately 15,000 of whom are licence holders.

The complexity of the problem was such that, at one stage during 1960, several cases were under investigation on which six, seven or eight sources had been found. Conversely sets were also found which were affecting viewers as much as 400 yd away and, thus, marring the viewing of small districts. Investigations were further hampered by the fact that over 90 per cent of the complainants quoted evenings only as the times the interference prevailed.

There were two possible means of solving the problem.

(a) The erection of a new I.T.A. station operating on another Band III channel.

(b) Local action at the source.

Since (a) would be a long-term remedy, (b) was left as the only solution to the problem.

Although some of the more modern models of television sets have lent themselves to reduction of the radiation by additional screening, by fitting wave traps on the Band I section of the turret tuner or by reducing the oscillator drive voltage, the general remedy has been to retune the intermediate-frequency stages 1-2 Mc/s higher or 1 Mc/s lower than standard, so that the interfering signal falls outside the channel 11 acceptance band. It is hoped that if a new station is eventually provided to serve this area that channels 10 and 12 will not be used.

This work of re-alignment, which has been carried out by the radio dealers, calls for specialized equipment and some skill, and has, consequently, been done with varying degrees of success. The main fault with this remedy is that, due to the inherent instability of the average commercial television

set, the oscillator frequency tends to drift over a period of time and cases are already known where sets have been the cause of interference more than once due to this cause.

With this type of complaint the function of the radio-interference investigation staff is to trace all possible sources and to advise on remedial action. Early in 1960 manufacturers' technical representatives were also invited to the area to study the conditions and to consider the problem. The majority agreed to advise dealers on the re-alignment procedure already mentioned. Thus the Area staffs' task was to trace the hundreds of sources known to exist. The staff also undertook, to save work at a later date, to check sets after modification.

Before the opening of these two new transmitters, which were to serve the Peterborough district, a reduction in numbers of complaints had been expected because of the increased signal strengths at which programmes were to be received. The possibility of over-staffing on interference work was in mind. However, this was not so due solely to this local-oscillator radiation problem. The many months needed to train an interference investigation officer has been an obstacle to dealing with the problem as expeditiously as we should have wished.

The number of investigation officers available was five, one outstationed at Boston, and as there was no possibility of being able to increase this number quickly, the chief problem was to devise an efficient working scheme to tackle the heavy influx of cases in the winter of 1959-60 and again in the autumn and winter of 1960-61. After much trial and error the following method was instituted.

The Peterborough City area, from which about 60 per cent of the complaints were received, was split into four sectors, one to each investigation officer, each sector being again split into four sub-sections. Investigations of complaints in one sub-section were then carried out during one week to the exclusion of the remainder of that territory. This sub-section was then left for a month. Experience had shown that it took from one to four weeks to get a set modified and it was found to be pointless to visit an area again until most of the offending receivers found had been attended to. This put a strain on the relationship between the investigation group and the general public, but the majority agreed with the procedure when the points were explained.

The problem at Peterborough is now reasonably well under control but it will be a long time before this type of interference becomes only a minor problem. It is evident that it will never be completely eradicated. The extent and severity of the interference in well-populated areas and dormitory areas must also give rise to concern in the industry as a whole in view of the rise in the number of television stations in this country. The only real solution to this type of problem is for the receivers to be designed so that radiation from television receivers is reduced well below the levels which exist at the present time.

During the months from April to November 1961 valuable assistance in locating and clearing interference, in districts in the Peterborough Telephone Area, adjacent to their own Areas was given by staff of the Leicester and Nottingham Telephone Areas and we wish to record our thanks for their help.

W.I.L. and R.R.

## Book Received

"Electrical Who's Who, 1962-63". Seventh Edition. Electrical Review Publications, Ltd. Distributed by Iliffe & Sons, Ltd. 528 pp. 45s (47s. 3d. by post).

This new edition contains about 8,000 entries covering prominent people in the electrical profession and industry.

Electrical engineers in the Post Office, the Admiralty and other Government Departments are also included. Brief biographies give particulars of education and careers.

Companies and organizations were invited to submit their own lists for inclusion in the section guide to Firms and Organizations. It is, therefore, easy to ascertain the names of the principals of a particular firm or organization and from there to refer to the biographical entries.

# Associate Section Notes

## Cornwall Centre

We were again fortunate in having Mr. Procter, O.B.E., Chief Regional Engineer, London Telecommunications Region, for our January meeting. Mr. Procter gave a paper on "Space Communications" and illustrated it by "launching" a satellite. When it was in "orbit" he beamed a microwave transmitter on to it and received the signal on a microwave receiver. This meeting was well supported by members and we were pleased to welcome the Chief Regional Engineer of the South Western Region, Mr. Moffatt, and the Regional Liaison Officer, Mr. Bayley. Mr. Procter's many friends in the Cornwall Centre would like to take this opportunity of wishing him a long and happy retirement.

In February, Mr. Longman, who is resident engineer at Hinkley Point atomic power station, gave a paper, "The Peaceful Uses of Atomic Energy." This paper was excellently illustrated with 100 coloured slides showing the Hinkley Point site from when the work started to the present time when the reactor is nearing completion. The Centre hopes to make a visit to Hinkley Point during the summer.

Mr. Warren of the Marine Biological Museum gave the Centre a paper in March entitled "Marine Life." This proved to be a most interesting paper dealing with the lives of various fish, the work of the Marine Biological Museum and the work of their laboratory ships. This paper was also illustrated by coloured films.

In March we held our annual dinner-dance at Newquay. This proved to be a great success, and our Telephone Manager, Mr. Stanbury, proposed the toast of the Cornwall Centre.

A.R.B.

## Bletchley Centre

The new year commenced with an illustrated talk by Mr. D. Carton on "Rocket Propulsion." Before giving his talk Mr. Carton appealed for everyone to keep a sharp look-out for a bald-headed man running wild with buckets of nitric acid and liquid oxygen. He then continued in a most humorous manner on the basic approach to rocket propulsion and gave quite an interesting summary on how to perform a "do-it-yourself" trip to the moon. He brought this very difficult and technical subject down to the level of the layman, giving members a thoroughly enjoyable evening.

In February, Mr. N. S. Rapley gave a talk on "Letter Sorting by Machinery." A brief examination of the problems of the postman in the sorting office and the headaches that the public present to the engineer was made before describing the machinery. An extract from the film "Machines to Move the Mail" was shown to illustrate what the future may hold for the postman and the maintenance engineer.

A talk on "Transoceanic Submarine Telephone Systems" was given by Mr. P. T. F. Kelly in March. The history and development of undersea communication up to the present day were described. Members were shown the film "Voices under the Sea," the American counterpart of the British film, "Transatlantic Link." This talk was followed by a later one in April by Messrs. Robinson, Ash and Baker on "Laying of the Transatlantic Cable."

A visit to British Railways' Wolverton works was also arranged in March, and 10 members who attended had an excellent Saturday morning tour, free of noise and busy workers. One party was fortunate to see coaches of the Royal train.

A.J.H.

## Bangor Centre

The annual general meeting of the Centre took place on 17 May 1961. The following officers were elected: *Chairman*: Mr. R. D. Roberts; *Secretary*: Mr. R. L. Williams;

*Librarian*: Mr. V. Griffiths; *Assistant Librarian*: Mr. E. G. Rowlands; *Treasurer*: Mr. R. R. Williams; *Committee*: Messrs. C. W. Owen, T. A. Roberts, H. Williams, O. E. Jones (Internal), J. H. Davies, J. E. W. Jones, I. W. Owen, J. R. Conway (External) and H. Willington (M.T.); *Auditors*: Mr. W. Roberts and Mr. R. Elias.

It was with regret that the resignation of Mr. O. E. Jones as Secretary was accepted, and we should like to record our thanks for his enthusiastic work since the inauguration of the Centre in 1958. All members are pleased that we still have his services on the Committee, and also as the Journal agent.

Members were delighted to hear of the success of Mr. Harry Williams, Leading Technical Officer at the Holyhead repeater station, upon passing the open examination to become an Executive Engineer. While the Centre will miss Mr. Williams as a member who was ready to give a lecture and to help in any way he could, we wish him all the best for the future.

On 17 October an interesting talk was given by Mr. A. H. C. Knox, the President of the Associate Section. The subject was "Appraisements and Promotions." Members were very happy also to welcome Mr. Lamping, the Regional Liaison Officer, to the meeting at Portmadoc on 7 November. An illustrated talk was given by Mr. F. W. Coates, Resident Engineer, Central Electricity Board, Trawsfynydd, on the "Pump Storage Electric Scheme at Tanygrisiau, Blaenau Ffestiniog, Merionethshire." The Chairman thanked Mr. Coates for a very interesting talk.

About 20 members travelled by coach on the 14 November to visit the steelworks of Messrs. J. Summers & Son at Shotton, Chester. Three of the firm's guides conducted the party on a tour of the works until 4.30 p.m. Our thanks for a most enjoyable visit were conveyed to the company by our Chairman, Mr. R. D. Roberts. In the evening the party went on to Broughton, Chester, to visit the factory of de Havilland Aircraft Company and were met by Mr. Plevine. We were shown through the large factory, which was made up of several departments with each one full of interesting things to see. The company were thanked for making the visit most enjoyable.

On 23 November members were invited by Mullard, Ltd., to a film meeting held at the Town Hall, Llandudno, where two films, "Mirror in the Sky" and "Transistors," were shown and a talk was given by a representative of the firm.

On 23 January, by the kind permission of the Chief Constable, the training officer, Inspector John Hughes, of the Gwynedd Constabulary, delivered a very interesting talk on "Police Duties." The members felt that the Inspector could have gone on much further had time allowed, so it was decided to invite him again. The Chief Inspector agreed and Inspector Hughes came along once more on 20 February, when members again thoroughly enjoyed this additional lecture.

There was also a visit to the Rover car factory at Solihull, Warwickshire, on 26 April, and several members have taken advantage of the invitation extended by the University College of North Wales Engineering Society to attend lectures delivered on various subjects of interest.

A few of our members are also members of the Gwynedd Engineering Society, which draws members from all industries in North Wales. The Society hold monthly lectures and arrange visits to various places of interest. The meetings of the two Societies are held at the Lecture Room, Department of Electronics, Dean Street, Bangor.  
R.L.W.

## Chester Centre

Visits have been made during this session to Granada television studios at Manchester, Messrs. Cammell Laird's



shipyard at Birkenhead and the Central Electricity Generating Board's power station at Connah's Quay.

Two full-day visits have also been made to the Shell Oil refinery at Stanlow and the Austin Motor Company's works at Longbridge, Birmingham. Both of these visits were very interesting.

The membership has risen steadily and now exceeds 100, but in spite of this, the interest shown in the activities of the section are rather disappointing and we are hoping for better things in the future.

T.P.

#### Hereford Centre

The following officers were elected at our annual general meeting held on 27 November. *Chairman:* Mr. G. E. Jenkins; *Vice-Chairman:* Mr. E. A. Talboys; *Secretary:* Mr. F. E. R. Page; *Treasurer:* Mr. H. D. Goodman; *Committee:* Messrs. D. Preece, A. T. Daniels, C. J. Bethall, D. Booton and T. W. Wellington.

The Centre's activities to date have been as follows:

30 November: Visit to W. D. & H. O. Wills' factory at Bristol.

1 December: An invitation by the South Midlands Section of the Institution of Radio Engineers to hear "Electronic Telephone Exchanges," a paper read by Mr. J. F. Hesketh.

8 January: "Water Supplies in Kenya," by Mr. G. T. Roberts. A talk illustrated with colour slides.

23 January: "Free Speech." Ten-minute talks followed by discussion—by our own members.

14 February: Mullard Film Show.

2 March: "High-Fidelity Sound Reproduction." A demonstration by Daystroms, Gloucester.

21 March: "Optical Aids to Maintenance and Development," a paper by Messrs. E. W. Hubbard and G. L. Mack of the Telephone Exchange Standards and Maintenance Branch, Engineering Department.

We again appeal to all non-members to enrol now and assist in making this Centre a continued success.

F.E.R.P.

#### Bolton Centre

The Bolton Centre which opened in May 1961 with 13 members, has progressed slowly to a present total of 64.

The following office-bearers were elected: *Chairman:* Mr. J. Makin; *Vice-Chairman:* Mr. N. Lee; *Secretary:* Mr. A. H. Downing; *Treasurer:* Mr. M. W. Vickers; *Librarian:* Mr. A. Ryder; *Committee:* Messrs. E. Winch, J. Rigby and A. Brown. The Area Engineer, Mr. C. R. Halliday, kindly agreed to be President of the Bolton Centre.

Our first visit was in June to the port radar station, Liverpool. In August we went aboard a Manchester liner, the S.S. *Manchester Spinner*. Two parties, in September and October, enjoyed instructive trips to Leyland Motors. November found a group of members at Pilkington's, glass manufacturers at St. Helens. In December a trip to "ERNIE," the Electronic Random Number Indicating Equipment at Lytham St. Annes, was enjoyed by a mixed party. In February an enjoyable visit was made to the Automatic Telephone & Electric Co., Ltd., Liverpool, ending with excellent refreshments.

The program for speakers and papers has proved successful, though larger attendances will always be welcomed. We have had talks by Mr. Thompson, our local Senior Sales Superintendent, entitled "Domestic Installations," and by Mr. Crabtree from the North-West Electricity Board on "Up-to-date Electrical Equipment." The President of the Associate Section, Mr. A. H. C. Knox, gave an interesting talk on "Appraisements and Promotions" in January, and Mr. B. B. Gould and Mr. B. G. Woods, Telephone Exchange Systems Developments Branch and Telephone Exchange Standards and Maintenance Branch, Engineering Department, respectively, spoke on a subject of real interest to us in Bolton—"S.T.D. in Non-Director Exchanges." To complete this year's activities, we

had a film show in March, thanks to the Senior Section who allowed us to show their films at our meeting.

We look forward to the ensuing year, determined to improve on 1961.

A.H.D.

#### Bristol Centre

About 20 members of the staff of the Bristol Area and the South Western Regional Training School met on 21 March to discuss the possibility of reforming the Bristol Associate Section which became dormant 11 years ago. It was decided to form a small committee to organize an inaugural meeting. This meeting was held on 18 April and Mr. C. A. L. Nicholls, O.B.E., from Regional Headquarters, gave the opening address.

At the time of writing the Centre has enrolled about 100 members.

H.F.N.P.

#### Ayr Centre

The Centre has had a very interesting and successful session, the only fault being that the attendances could have been better. The committee would welcome any suggestions to attract a larger audience.

During the session the Centre has had the following meetings:

(i) Visit to Telephone House, Glasgow.

(ii) Visit to the Laboratory, Glenfield and Kennedy, Kilmarnock.

(iii) A talk on "Scottish Birds," by Mr. A. Bagnall.

(iv) An illustrated talk, "Communications and Forecasting," by Mr. D. Harley, Principal Scientific Officer, Meteorological Office, Prestwick.

(v) "Faraday Lecture," in St. Andrew's Hall, Glasgow.

In closing, the Committee would again draw your attention to the poor attendance at these meetings. Although the membership totals 90, the average attendance at each meeting was only 18.

J.H.

#### Edinburgh Centre

Meetings held this year have catered for a wide range of interests. Mr. D. M. Plenderleith's film show, an annual event, was well received in January. February brought Mr. W. Hetherington from Regional Headquarters, Scotland, with a lecture entitled "Transport Efficiency." This latter meeting was preceded by the presentation of an Institution Certificate of Merit to Mr. H. H. Templeton of Dunfermline, by the Chief Regional Engineer, Mr. R. J. Hines, for his entry in the 1961-62 Essay Competition. It is hoped to have Mr. Templeton present his paper on "General Observations on Telegraph Machines and Improvements in their Design" to the Centre next session.

In March, Mr. A. Davidson, also from the Regional Headquarters, Scotland, produced a vintage Rudge "Multi" motor cycle as the basis of a talk on "The History of Motor Cycling." At the April meeting, one of our members, Mr. A. G. Gilmore, took as his subject, "Tandem Working in Edinburgh."

The following office bearers have been elected for 1962-63. *Chairman:* Mr. R. P. Donaldson; *Secretary:* Mr. D. S. Henderson; *Assistant Secretary:* Mr. J. Dixon; *Treasurer:* Mr. A. G. Gilmore; *Librarian:* Mr. R. Renton; *Committee:* Mr. F. C. Baker, Mr. T. W. Henderson, Mr. W. Paterson, Mr. P. J. Peebles, Mr. A. Robertson, Mr. D. Stenhouse and Mr. D. Stewart.

D.S.H.

#### Glasgow Centre

The annual general meeting of the Centre was held in Sloans Restaurant on 6 April.

The following office bearers were elected: *Chairman:* Mr. D. Bidgood; *Vice-Chairman:* Mr. J. McCallum; *Secretary:* Mr. H. McWilliams; *Organising Secretary:* Mr. W. Fotheringham; *Treasurer:* Mr. K. Gordon; *Librarian:* Mr. J. Fuller; *Assistant Librarian:* Mr. A. C. Campbell; *Committee:* Messrs. Macnamara, Carty, Bolton, Walker,

Murray, Fraser, J. Campbell, Dick, Shanks and Fleming.

A very wide and varied program is being arranged for next year when we hope to be able to have something of interest to all branches of our membership.

With a membership of 200 and a committee of 10 it will be seen that there is quite a job to be done keeping individual members informed of all the meetings and visits which take place. Members could help by keeping in touch with any of the Committee. We endeavour to produce a letter about the meeting or visit just before it is due, and on every exchange notice board a poster is displayed for about a week before the event. Should members not receive a syllabus by the end of September they should contact a Committee member who will put things right.

The attendances this year have been up slightly, and with members' co-operation we hope it will be even better next year.

J.F.

#### Dundee Centre

The annual general meeting of the above Centre was held in the New Imperial Hotel on 3 April.

The Chairman, in his report, stated that we had had a fairly successful year with an average attendance of 23 members at meetings and visits. The financial report indicated that the Centre's bank balance was still improving in spite of increasing expenditure. The highlight of the session was the last meeting when Mr. K. F. Jalland, our Area Engineer, gave his talk on "Future Developments in the Trunk Network" and Mr. R. J. Hines, the Chief Regional Engineer, visited us in order to present our colleague, Mr. Lawson, with an Institution Certificate of Merit for his successful essay in the 1961-62 Essay Competition and the Silver Medal of the City and Guilds for his success in the "Radio C" examination. Mr. Lawson has since left us to join the Goonhilly staff as an Assistant Engineer, and the Chairman said he felt sure the Centre would endorse his thanks to Mr. Lawson who, as Treasurer, had done so much for the Centre.

After the reports were given the new office bearers and Committee were elected as follows: *Chairman*: Mr. R. L. Topping; *Secretary*: Mr. R. T. Lumsden; *Treasurer*: Mr. R. B. Duncan; *Committee*: Messrs. R. J. Hendry, R. C. Smith, G. Deuchars, D. Cook, B. D. Mackie and J. A. Glendinning; *Auditors*: Messrs. J. A. Lamb and E. McLaggen.

The proposals for next session's program include a

number of varied visits and possibly three talks. We hope to hold at least two meetings in Perth.

#### Bradford Centre

The winter session commenced in December with a talk, "Future Developments in the Bradford Area," given by our Area Engineers, Mr. E. H. Wilkinson and Mr. J. W. Barratt. Attendance was quite good and members appreciated this opportunity of finding out what the Area will look like in a few years' time.

In March we welcomed Mr. B. B. Gould and Mr. B. G. Woods, Telephone Exchange Systems Developments Branch and Telephone Exchange Standards and Maintenance Branch Engineering Department, respectively, who spoke to us about "S.T.D. in Non-Director Exchanges." This was another look into the future for most of us and we are grateful to our speakers for a most interesting evening.

The session concluded with visits to the factory of Messrs. Heinz at Wigan, and to the Wedgwood Pottery at Stoke-on-Trent.

R.C.S.

#### Hull Centre

The 1961-62 session has been fairly successful for the Hull Centre.

Aspects of S.T.D. have been covered in our varied program and were touched upon particularly in the following papers:

"The S.T.D. Coin-Box," by Mr. J. P. Allen, Regional Training School, Otley.

"Hull 'Civic' Telephone Exchange," by Mr. H. V. J. Harris, Telephone Manager, Hull.

"Hull 'Anson' Trunk-Mechanization Switching-Centre," by Mr. N. Heaton.

Members were invited to two meetings of the Hull Electronic Engineering Society entitled "Electronics in Industry" and "Future Trends in Magnetic Recording."

We have also held two film shows and the annual general meeting. The officers for 1961-62 were re-elected unanimously for the 1962-63 session.

Our thanks are extended to all those people who have helped us in various ways during the past year, particularly to Mr. Harris and Mr. Wyan for their continued help and good will.

A.B.

## Book Review

"Sound and Television Broadcasting. General Principles."

K. R. Sturley, Ph.D., B.Sc., M.I.E.E. Published for *Wireless World* by Iliffe Books, Ltd. x + 382 pp. 248 ill. 45s.

This book differs considerably from Dr. Sturley's earlier text books on "Radio Receiver Design" and "F.M. Radio"; it is one of a series of B.B.C. engineering training manuals and has been written to provide new recruits to the B.B.C. Engineering Division with the basic principles of sound and television broadcasting techniques. It is well written and pleasant to read, the treatment being largely descriptive with a considerable number of excellent diagrams. The technical level and mathematics are appropriate for students educated to G.C.E. standard.

A substantial first chapter deals in rather broad outline with the fundamental principles of sound, optics, and electricity, and their application to basic equipment used in broadcasting. The second and third chapters, covering Sound Studios and Recording and Television Studios, Telecine and Telerecording, are divided into three sections: Administrative and Staff duties, Apparatus, Tests and

Operational Procedures. As an introduction to broadcasting problems the sections on staffing and operational procedure are invaluable. In both chapters there are detailed descriptions of current equipment together with its standard of performance, both mechanically and electrically. A separate chapter on Television Outside Broadcast deals principally with the broadcaster's equipment and staffing.

Chapter 5 rather ambitiously deals with r.f. transmission, covering the design and performance of transmitters and their associated aerials and feeders for amplitude modulation in low-frequency to very-high-frequency wavebands and frequency and television modulation in the very-high-frequency band. A short section touches on the propagation characteristics at these frequencies and the chapter ends with information on monitoring, testing and performance. A final chapter entitled Line Intercommunication System discusses different transmission systems, their performance and equalization.

Students taking the City and Guilds examinations in Radio and Line Transmission will find this book excellent additional reading. The few minor errors noted and indeed expected in a new book do not detract from its value.

*I.P.O.E.E. Library No. 2671*

R.A.D.



# Staff Changes

## Promotions

| Name   | Region, etc.              | Date     | Name  | Region, etc.           | Date     |
|--|---------------------------|----------|---|------------------------|----------|
| <i>Telephone Manager to Chief Regional Engineer</i>          |                           |          | <i>Assistant Engineer to Executive Engineer—continued</i> |                        |          |
| Edwards, S. J.   | H.C. Reg. to L.T. Reg.    | 1.5.62   | Brand, A. T.  | E-in-C.O.              | 27.2.62  |
| <i>Senior Executive Engineer to Assistant Staff Engineer</i> |                           |          | Davies, A. P.   | E-in-C.O.              | 27.2.62  |
| Young, S. G.   | E-in-C.O.                 | 17.1.62  | Harrison, C. C.   | E-in-C.O.              | 27.2.62  |
| Wray, D.   | E-in-C.O.                 | 17.1.62  | Sixsmith, J.  | E-in-C.O.              | 27.2.62  |
| Harris, L. R. F.   | E-in-C.O.                 | 17.1.62  | Davis, E.   | E-in-C.O.              | 27.2.62  |
| <i>Telephone Manager to Assistant Staff Engineer</i>         |                           |          | Cumming, W. S.  | E-in-C.O.              | 27.2.62  |
| Alston, G. J.  | W.B.C. to E-in-C.O.       | 19.2.62  | Francois, R. A.   | E-in-C.O.              | 27.2.62  |
| <i>Executive Engineer to Area Engineer</i>                   |                           |          | Cooper, H. B.   | H.C. Reg. to E-in-C.O. | 27.2.62  |
| Baxter, E. C.  | L.T. Reg. to H.C. Reg.    | 8.1.62   | Todd, J. E.   | L.T. Reg.              | 16.2.62  |
| Radcliffe, C. M.   | E.T.E.                    | 18.12.61 | Gee, A. C.  | L.T. Reg.              | 16.2.62  |
| Boggis, R. J.  | E.T.E.                    | 22.1.62  | Foy, B. G.  | L. T. Reg.             | 23.2.62  |
| Whitehead, J. E.   | Scot. to N.E. Reg.        | 12.3.62  | Jeffries, G. L.   | H.C. Reg.              | 19.2.62  |
| <i>Executive Engineer to Efficiency Engineer</i>             |                           |          | McVitty, A. H.  | S.W. Reg. to E-in-C.O. | 12.3.62  |
| Kibby, R. A.   | W.B.C.                    | 30.1.62  | Thain, C. C.  | H.C. Reg. to E-in-C.O. | 19.3.62  |
| <i>Executive Engineer to Power Engineer</i>                  |                           |          | Harris, C. R. G.  | L.T. Reg. to E-in-C.O. | 12.3.62  |
| Cranston, W. D.  | S.W. Reg. to N.E. Reg.    | 19.3.62  | Hadley, D. E.   | Mid. Reg. to E-in-C.O. | 26.3.62  |
| <i>Executive Engineer to Senior Executive Engineer</i>       |                           |          | Farrow, L. A.   | H.C. Reg. to E-in-C.O. | 15.3.62  |
| Baker, H.  | E-in-C.O.                 | 12.1.62  | Richardson, G. E.   | E-in-C.O.              | 27.2.62  |
| Burton, A. J. H.   | E-in-C.O.                 | 19.1.62  | Russell, P. S.  | E-in-C.O.              | 9.4.62   |
| (in absentia)  | E-in-C.O.                 | 19.1.62  | Vogan, D. H.  | E-in-C.O.              | 26.3.62  |
| Jarvis, J. R.  | E-in-C.O.                 | 19.1.62  | Harvey, F. J.   | E-in-C.O.              | 26.3.62  |
| Chisman, S. H.   | E-in-C.O.                 | 19.1.62  | Weedon, A. F.   | E-in-C.O.              | 9.4.62   |
| Gibson, R. W.  | E-in-C.O.                 | 23.1.62  | Miller, C. B.   | E-in-C.O.              | 26.3.62  |
| Lang, W. N.  | E-in-C.O.                 | 23.1.62  | Porritt, W. R. A.   | E-in-C.O.              | 26.3.62  |
| Swann, G. F.   | E-in-C.O.                 | 23.1.62  | Notman, R. A.   | E-in-C.O.              | 26.3.62  |
| Withers, D. J.   | E.T.E.                    | 23.1.62  | Clarkstone, K. A.   | E-in-C.O.              | 26.3.62  |
| Hillen, C. F. J.   | E-in-C.O.                 | 23.1.62  | <i>Inspector to Assistant Engineer</i>                    |                        |          |
| Millar, J. B.  | E-in-C.O.                 | 23.1.62  | Jones, T. H.  | W.B.C.                 | 22.1.62  |
| Welsh, A. W.   | E-in-C.O.                 | 23.1.62  | Darch, J. H. R.   | S.W. Reg.              | 1.12.61  |
| Broadbent, E.  | E-in-C.O.                 | 30.1.62  | George, P. H.   | N.E. Reg.              | 24.1.62  |
| Meller, V. C.  | E-in-C.O.                 | 30.1.62  | Todhunter, J. S.  | N.W. Reg.              | 1.2.62   |
| Kelly, F.  | E-in-C.O.                 | 7.2.62   | Healey, C. M.   | H.C. Reg.              | 13.7.61  |
| Rimmer, E. G.  | N.W. Reg.                 | 13.2.62  | Stephens, H. E.   | H.C. Reg.              | 8.3.62   |
| Campbell, K. W.  | L.T. Reg. to Air Ministry | 1.3.62   | Fisher, W. R.   | H.C. Reg.              | 9.3.62   |
| Wheatley, S. J.  | E-in-C.O.                 | 2.3.62   | Kingswood, G. E.  | H.C. Reg.              | 8.3.62   |
| Davies, W. M.  | E-in-C.O.                 | 7.3.62   | Williams, F. G.   | L.T. Reg.              | 15.2.62  |
| Milton, A. G.  | E-in-C.O.                 | 7.3.62   | Carter, H.  | L.T. Reg.              | 15.2.62  |
| Collingwood, J. D.   | E-in-C.O.                 | 19.3.62  | Sproat, E. H.   | L.T. Reg.              | 15.2.62  |
| Purvis, C.   | E-in-C.O.                 | 19.3.62  | Cooper, F. G.   | L.T. Reg.              | 15.2.62  |
| <i>Executive Engineer (Open Competition)</i>                 |                           |          | Cockram, G. M.  | S.W. Reg.              | 26.2.62  |
| Weatherburn, R.  | E-in-C.O.                 | 13.2.62  | Bowness, G. B.  | N.E. Reg.              | 26.3.62  |
| <i>Assistant Engineer to Executive Engineer</i>              |                           |          | <i>Technical Officer to Assistant Engineer</i>            |                        |          |
| Helps, W. F.   | E-in-C.O.                 | 3.1.62   | Griffiths, J. R.  | H.C. Reg.              | 21.11.61 |
| Frecknall, F. H. L.  | E-in-C.O.                 | 3.1.62   | Burns, R.   | Scot.                  | 6.11.61  |
| Whittle, A. D.   | E-in-C.O.                 | 3.1.62   | Castledine, T.  | N.E. Reg.              | 24.1.62  |
| Taylor, N.   | E-in-C.O.                 | 3.1.62   | King, A.  | N.E. Reg.              | 24.1.62  |
| Blakey, H.   | E-in-C.O.                 | 3.1.62   | Holland, G. F. V.   | E.T.E. to E-in-C.O.    | 2.1.62   |
| Price, C. K.   | E-in-C.O.                 | 3.1.62   | Benton, A.  | E-in-C.O.              | 2.1.62   |
| Yeatman, R. A.   | H.C. Reg. to N.W. Reg.    | 15.1.62  | Debus, E. C.  | E-in-C.O.              | 2.1.62   |
| Macqueen, R. S.  | E.T.E.                    | 20.11.61 | Williams, N. L. H.  | E.T.E. to E-in-C.O.    | 2.1.62   |
| Davies, T. Y.  | W.B.C.                    | 6.11.61  | Felton, K. E.   | H.C. Reg. to E-in-C.O. | 2.1.62   |
| Wilkinson, W.  | N.W. Reg.                 | 4.12.61  | Honneyman, J. G.  | H.C. Reg. to E-in-C.O. | 2.1.62   |
| Brooks, H.   | N.W. Reg.                 | 18.12.61 | Clark, T.   | E.T.E. to E-in-C.O.    | 2.1.62   |
| Palk, E.   | H.C. Reg.                 | 1.1.62   | Howorth, P. W.  | N.W. Reg. to E-in-C.O. | 2.1.62   |
| Carr, W. G.  | Scot.                     | 18.1.62  | Heasman, C. S.  | L.T. Reg. to E-in-C.O. | 2.1.62   |
| Walker, A. E.  | E-in-C.O.                 | 18.1.62  | Mackie, R. H.   | L.T. Reg. to E-in-C.O. | 2.1.62   |
| Fox, N.  | Mid. Reg. to E-in-C.O.    | 29.1.62  | Harvey, W.  | N.W. Reg. to E-in-C.O. | 2.1.62   |
| Longden, R.  | L.T. Reg.                 | 22.1.62  | Davies, J. W.   | H.C. Reg. to E-in-C.O. | 2.1.62   |
| Branch, A. T.  | L.T. Reg. to E-in-C.O.    | 27.2.62  | Finn, F. G.   | H.C. Reg. to E-in-C.O. | 2.1.62   |
| Donaghy, R. C.   | N.W. Reg. to Scot.        | 12.2.62  | Harper, D. N.   | E-in-C.O.              | 2.1.62   |
| Manaton, R. P. C.  | S.W. Reg.                 | 12.2.62  | Copeland, A. W.   | E-in-C.O.              | 2.1.62   |
| Greenwood, E. A. J.  | H.C. Reg.                 | 29.1.62  | Dearing, C. D.  | L.T. Reg. to E-in-C.O. | 2.1.62   |
| Evans, H. W.   | E-in-C.O.                 | 27.2.62  | Wheeler, E. A. A.   | L.T. Reg. to E-in-C.O. | 2.1.62   |
| Parnham, G. E.   | E-in-C.O.                 | 27.2.62  | Jones, W. S.  | N.W. Reg. to E-in-C.O. | 2.1.62   |
| Fagg, A. G. J.   | E-in-C.O.                 | 5.3.62   | Orchard, G.   | N.W. Reg. to E-in-C.O. | 2.1.62   |
| Charlton, R. D.  | E-in-C.O.                 | 27.2.62  | Upton, P. A.  | H.C. Reg. to E-in-C.O. | 2.1.62   |
|  |                           |          | Holmes, D. J.   | S.W. Reg. to E-in-C.O. | 2.1.62   |
|  |                           |          | Jackson, J. E.  | L.T. Reg. to E-in-C.O. | 2.1.62   |
|  |                           |          | Harvey, R.  | Scot. to E-in-C.O.     | 2.1.62   |
|  |                           |          | Lamb, E. R.   | E-in-C.O.              | 2.1.62   |
|  |                           |          | McAllister, J.  | L.T. Reg. to E-in-C.O. | 2.1.62   |

Promotions—continued

| Name   | Region, etc.            | Date     | Name   | Region, etc.                       | Date     |
|--|-------------------------|----------|--|------------------------------------|----------|
| <i>Technical Officer to Assistant Engineer—continued</i> |                         |          | <i>Technical Officer to Assistant Engineer—continued</i>                   |                                    |          |
| Gorringe, C. E.  | L.T. Reg. to E.-in-C.O. | 2.1.62   | Gough, K. E.   | L.T. Reg. to E.-in-C.O.            | 29.3.62  |
| Noonan, W. P.  | E.T.E. to E.-in-C.O.    | 2.1.62   | Wood, J. A.  | H.C. Reg. to E.-in-C.O.            | 29.3.62  |
| Hudson, A. E.  | L.T. Reg. to E.-in-C.O. | 2.1.62   | Taylor, J. R.  | N.W. Reg. to E.-in-C.O.            | 29.3.62  |
| Williams, R. L.  | L.T. Reg. to E.-in-C.O. | 2.1.62   | Coates, R. J.  | E.-in-C.O.                         | 29.3.62  |
| Blackburn, P.  | E.-in-C.O.              | 2.1.62   | Gurton, K. C. S.   | L.T. Reg. to E.-in-C.O.            | 29.3.62  |
| Bullimore, A. A.   | E.-in-C.O.              | 2.1.62   | Arrowsmith, J.   | E.-in-C.O.                         | 29.3.62  |
| Harrison, J. C.  | E.-in-C.O.              | 2.1.62   | Davies, N. V.  | E.-in-C.O.                         | 29.3.62  |
| Pollock, J. A.   | L.T. Reg. to E.-in-C.O. | 2.1.62   | Richardson, J. H. M.   | E.-in-C.O.                         | 29.3.62  |
| Hornsby, G. H.   | L.T. Reg. to E.-in-C.O. | 2.1.62   | Crouch, A. C. J.   | L.T. Reg. to E.-in-C.O.            | 29.3.62  |
| Slaughter, W. G. F.                                      | L.T. Reg. to E.-in-C.O. | 2.1.62   | Lucas, D. R. H.  | E.-in-C.O.                         | 29.3.62  |
| Davis, P. J.   | N.W. Reg. to E.-in-C.O. | 2.1.62   | Wroe, C.   | E.-in-C.O.                         | 29.3.62  |
| Hodsoll, A. G.   | H.C. Reg. to E.-in-C.O. | 2.1.62   | Briggs, R. H.  | E.-in-C.O.                         | 29.3.62  |
| Fry, R. C.   | L.T. Reg. to E.-in-C.O. | 2.1.62   | Allenby, R. G.   | H.C. Reg. to E.-in-C.O.            | 29.3.62  |
| Hodgson, W. S.   | N.W. Reg. to E.-in-C.O. | 2.1.62   | Grant, D. E.   | E.-in-C.O.                         | 29.3.62  |
| Webber, D. W.  | E.-in-C.O.              | 2.1.62   | Garrett, W. F.   | E.-in-C.O.                         | 29.3.62  |
| Biss, A.   | E.-in-C.O.              | 2.1.62   | Keedy, D. J.   | Mid. Reg.                          | 9.3.62   |
| Hill, D. W.  | E.-in-C.O.              | 2.1.62   | Tildesley, W. J.   | Mid. Reg.                          | 9.3.62   |
| Grispo, G. V.  | E.-in-C.O.              | 2.1.62   | Warrington, F.   | Mid. Reg.                          | 9.3.62   |
| Garrett, W. G.   | E.-in-C.O.              | 2.1.62   | Bristowe, S.   | Mid. Reg.                          | 9.3.62   |
| Byfield, C. G.   | E.-in-C.O.              | 2.1.62   | Mummary, D. R. E.  | H.C. Reg.                          | 23.2.62  |
| Peters, D. S.  | Scot.                   | 5.1.62   | Nichols, J. W.   | H.C. Reg.                          | 23.2.62  |
| Pringle, R.  | Scot.                   | 20.12.61 | Bent, G. W.  | E.T.E.                             | 7.3.62   |
| Williams, D. G.  | W.B.C.                  | 16.1.62  | Dix, A. W.   | H.C. Reg.                          | 16.3.62  |
| Reeves, C. W.  | Mid. Reg.               | 8.12.61  | Vine, J. P.  | H.C. Reg.                          | 16.3.62  |
| Cooper, J.   | Mid. Reg.               | 8.12.61  | <i>Principal Scientific Officer to Senior Principal Scientific Officer</i> |                                    |          |
| Williams, D. J.  | Mid. Reg.               | 8.12.61  | Holmes, M. F.  | E.-in-C.O.                         | 2.4.62   |
| Deeming, W.  | Mid. Reg.               | 8.12.61  | <i>Experimental Officer to Senior Experimental Officer</i>                 |                                    |          |
| Ryan, D.   | Mid. Reg.               | 17.1.62  | Ayers, S. (Mrs.)   | E.-in-C.O.                         | 16.10.61 |
| Lewis, H. S.   | Mid. Reg.               | 17.1.62  | <i>Assistant Experimental Officer (Open Competition)</i>                   |                                    |          |
| Ritchie, D. A.   | Mid. Reg.               | 22.1.62  | Harridence, B. W.  | E.-in-C.O.                         | 2.1.62   |
| Chatburn, W. H.  | Mid. Reg.               | 17.1.62  | Geden, D.  | E.-in-C.O.                         | 4.1.62   |
| Priestley, A. G.   | W.B.C.                  | 29.12.61 | <i>Assistant Scientific (Open Competition)</i>                             |                                    |          |
| Lawrence, N. E.  | E.-in-C.O.              | 2.1.62   | Handscombe, J. L.  | E.-in-C.O.                         | 20.2.62  |
| Ford, E. H.  | N.W. Reg.               | 11.12.61 | Philpotts, A.  | E.-in-C.O.                         | 21.2.62  |
| King, G. R.  | L.T. Reg.               | 23.1.62  | Dunn, P. J.  | E.-in-C.O.                         | 20.2.62  |
| Rae, V.  | Scot.                   | 16.1.62  | Hunter, D. J. L. (Miss)  | E.-in-C.O.                         | 15.3.62  |
| Forster, C.  | N.E. Reg.               | 24.1.62  | Chapman, M. J. (Miss)  | E.-in-C.O.                         | 15.3.62  |
| Sheel, D. F.   | N.W. Reg.               | 29.1.62  | <i>Workshop Supervisor II to Technical Assistant II</i>                    |                                    |          |
| Lovett, C. W. B.   | H.C. Reg.               | 28.12.61 | Pearce, V. I. C.   | E.-in-C.O.                         | 20.3.62  |
| Lindley, H. E.   | N.W. Reg.               | 14.2.62  | <i>Workshop Supervisor III to Technical Assistant II</i>                   |                                    |          |
| Lewis, A. J.   | Mid. Reg.               | 19.2.62  | Heaven, P. S.  | E.-in-C.O. to Mid. Reg.            | 19.3.62  |
| Alker, B.  | Mid. Reg.               | 19.2.62  | <i>Mechanic-in-Charge to Technical Assistant II</i>                        |                                    |          |
| Dent, R.   | N.E. Reg.               | 22.2.62  | Hennis, F.   | H.C. Reg. to N.I.                  | 19.3.62  |
| Hayes, J.  | N.W. Reg.               | 27.2.62  | <i>Senior Draughtsman to Chief Draughtsman</i>                             |                                    |          |
| Griffith, L.   | N.W. Reg.               | 22.2.62  | Pusey, L. M.   | L.P. Reg. to E.-in-C.O.            | 1.3.62   |
| Hishon, D. R.  | H.C. Reg.               | 13.7.61  | <i>Leading Draughtsman to Senior Draughtsman</i>                           |                                    |          |
| Lockwood, J. A.  | H.C. Reg.               | 24.8.61  | Westwood, W. S.  | E.-in-C.O.                         | 30.1.62  |
| Theobald, S. E. C.                                       | H.C. Reg.               | 24.8.61  | Parrott, S. H. F.  | E.-in-C.O.                         | 19.2.62  |
| Noakes, R. A.  | H.C. Reg.               | 24.8.61  | <i>Leading Illustrator to Senior Illustrator</i>                           |                                    |          |
| Harcourt, E. N.  | H.C. Reg.               | 28.7.61  | Bulley, A. S.  | E.-in-C.O.                         | 3.1.62   |
| Rhody, C. F.   | H.C. Reg.               | 28.7.61  | <i>Draughtsman to Leading Draughtsman</i>                                  |                                    |          |
| Elvin, N. E.   | H.C. Reg.               | 24.8.61  | Penney, F. J.  | Scot.                              | 7.12.61  |
| Manton, J. H.  | Mid. Reg.               | 9.3.62   | Moyes, K. F.   | Scot.                              | 8.1.62   |
| Negus, D. E.   | L.T. Reg.               | 23.1.62  | Collins, G. H. L.  | L.T. Reg.                          | 8.1.62   |
| Gentry, S. W.  | L.T. Reg.               | 7.2.62   | Clarke, G. E. F.   | L.T. Reg.                          | 8.1.62   |
| Viney, F. R. W.  | L.T. Reg.               | 7.2.62   | Trott, C. C.   | Factories Department to E.-in-C.O. | 26.1.62  |
| Gregory, W. J.   | L.T. Reg.               | 7.2.62   | Holmes, D. G.  | Factories Department to E.-in-C.O. | 26.1.62  |
| Challinor, A. S.   | Mid. Reg.               | 15.3.62  | Ilett, D. H.   | E.-in-C.O.                         | 26.1.62  |
| Bwye, L. J.  | E.-in-C.O.              | 15.3.62  | Bissell, D. R.   | E.-in-C.O.                         | 26.1.62  |
| Collins, F. M.   | H.C. Reg.               | 20.2.62  | Halls, P. S.   | E.-in-C.O.                         | 26.1.62  |
| Vernon, L. E.  | H.C. Reg.               | 20.2.62  | Howlett, H. R.   | H.C. Reg.                          | 5.2.62   |
| Thompson, G. S.  | Mid. Reg.               | 15.3.62  | Ames, G. A.  | Factories Department               | 16.2.62  |
| Bennison, E.   | Mid. Reg.               | 15.3.62  | <i>Clerical Officer to Executive Officer</i>                               |                                    |          |
| Breheny, J. J.   | N.I.                    | 5.2.62   | Molyneux, I. V. (Mrs.)   | E.-in-C.O.                         | 31.1.62  |
| McClenaghan, S.  | N.I.                    | 22.1.62  | Winslade, H. A. J.   | E.-in-C.O.                         | 31.1.62  |
| Ess, C. E.   | H.C. Reg.               | 20.2.62  |  |                                    |          |
| Higgs, K. E.   | L.T. Reg.               | 15.2.62  |  |                                    |          |
| Bell, R. W.  | L.T. Reg.               | 15.2.62  |  |                                    |          |
| Snashall, R. F.  | L.T. Reg.               | 15.2.62  |  |                                    |          |
| Seaman, G. A.  | L.T. Reg.               | 15.2.62  |  |                                    |          |
| Glen, I. M.  | L.T. Reg.               | 15.2.62  |  |                                    |          |
| Geall, E. E.   | L.T. Reg.               | 15.2.62  |  |                                    |          |
| Bolam, G. P.   | Mid. Reg.               | 9.3.62   |  |                                    |          |
| Balment, G. T.   | S.W. Reg.               | 26.2.62  |  |                                    |          |
| Proctor, A. D. S.  | E.-in-C.O.              | 29.3.62  |  |                                    |          |
| Cliff, J.  | E.-in-C.O.              | 29.3.62  |  |                                    |          |
| Kneebone, J. C.  | E.-in-C.O.              | 29.3.62  |  |                                    |          |



**Retirements and Resignations**

| Name                             | Region, etc. | Date     | Name                                  | Region, etc. | Date    |
|----------------------------------|--------------|----------|---------------------------------------|--------------|---------|
| <i>Chief Regional Engineer</i>   |              |          | <i>Assistant Engineer—continued</i>   |              |         |
| Procter, W. S.                   | L.T. Reg.    | 30.4.62  | Taylor, A. A.                         | Mid. Reg.    | 1.2.62  |
| <i>Regional Engineer</i>         |              |          | Cowden, A.                            | N.W. Reg.    | 13.2.62 |
| O'Roark, A. F.                   | Mid. Reg.    | 31.12.61 | Hazeldean, F. E.                      | E.T.E.       | 15.2.62 |
| <i>Area Engineer</i>             |              |          | Shuff, T.                             | Mid. Reg.    | 28.2.62 |
| Bingham, J.                      | N.E. Reg.    | 26.12.61 | Hinton, H.                            | Mid. Reg.    | 3.3.62  |
| <i>Senior Executive Engineer</i> |              |          | Thornton, R.                          | N.E. Reg.    | 6.3.62  |
| Redshaw, C. C.                   | E.T.E.       | 30.12.61 | Jones, W. H.                          | S.W. Reg.    | 27.3.62 |
| Turtle, G. R.                    | E.-in-C.O.   | 28.2.62  | Feather, C.                           | N.E. Reg.    | 28.3.62 |
| <i>Executive Engineer</i>        |              |          | Ramsay, C. R.                         | N.E. Reg.    | 29.3.62 |
| Gibbs, F. J.                     | H.C. Reg.    | 6.12.61  | Hawkins, W. E.                        | H.C. Reg.    | 31.3.62 |
| Hobsbaum, J.                     | N.E. Reg.    | 28.8.61  | Storrie, A. R.                        | H.C. Reg.    | 31.3.62 |
| Smith, R.                        | N.E. Reg.    | 28.12.61 | Probert, P. E. (Resigned)             | E.-in-C.O.   | 16.3.62 |
| Parkinson, S.                    | N.W. Reg.    | 12.1.62  | Harrison, A. F. (Resigned)            | E.-in-C.O.   | 16.3.62 |
| Hay, J.                          | E.-in-C.O.   | 22.8.61  | <i>Inspector</i>                      |              |         |
| Harrison, H. W.                  | H.C. Reg.    | 14.2.62  | Stringer, G. H. J.                    | H.C. Reg.    | 31.3.62 |
| Mann, R. G.                      | E.T.E.       | 31.1.62  | <i>Senior Scientific Officer</i>      |              |         |
| Loque, J. H.                     | E.-in-C.O.   | 20.2.62  | Holloway, H. (Resigned)               | E.-in-C.O.   | 28.2.62 |
| <i>Assistant Engineer</i>        |              |          | <i>Assistant Experimental Officer</i> |              |         |
| Dunford, B. G. (Resigned)        | E.-in-C.O.   | 31.1.62  | Hodges, L. R. (Resigned)              | E.-in-C.O.   | 31.1.62 |
| Price, W. T.                     | Scot.        | 21.12.61 | <i>Assistant (Scientific)</i>         |              |         |
| King, W.                         | H.C. Reg.    | 29.12.61 | Ward, R. P. (Resigned)                | E.-in-C.O.   | 31.8.62 |
| Reeve, L. J. A.                  | Mid. Reg.    | 31.12.61 | <i>Senior Draughtsman</i>             |              |         |
| Knapp, C. R.                     | H.C. Reg.    | 31.12.61 | Brazier, C. J.                        | Mid. Reg.    | 17.3.62 |
| Seaton, W.                       | N.E. Reg.    | 1.1.62   | <i>Leading Draughtsman</i>            |              |         |
| Harrison, N. G.                  | E.-in-C.O.   | 3.1.62   | White, T. C.*                         | E.-in-C.O.   | 26.3.62 |
| Payne, N. J.                     | L.T. Reg.    | 6.1.62   | <i>Executive Officer</i>              |              |         |
| Halsall, G. H.                   | N.W. Reg.    | 10.1.62  | Paxton, W. H.                         | E.-in-C.O.   | 4.1.62  |
| Bowler, W. R.                    | E.-in-C.O.   | 18.1.62  |                                       |              |         |
| Atkins, A. L.                    | L.T. Reg.    | 31.1.62  |                                       |              |         |
| Mansfield, E. A. G.              | L.T. Reg.    | 31.1.62  |                                       |              |         |
| Hawkins, W. E.                   | H.C. Reg.    | 18.1.62  |                                       |              |         |
| Brownbridge, C. H.               | N.W. Reg.    | 31.2.62  |                                       |              |         |

\*Mr. T. C. White is continuing as a disestablished officer with H.C. Reg.

**Transfers**

| Name                             | Region, etc.                                   | Date    | Name                                  | Region, etc.                                  | Date    |
|----------------------------------|--|---------|---------------------------------------|---|---------|
| <i>Senior Executive Engineer</i> |  |         | <i>Assistant Engineer—continued</i>   |   |         |
| Breary, D.                       | E.-in-C.O. to Malaya                           | 14.1.62 | Linney, P. J.                         | E.-in-C.O. to Nigeria                         | 18.1.62 |
| Hamer, R.                        | E.-in-C.O. to Admiralty                        | 1.2.62  | Mason, D. J. H.                       | N.I. to E.-in-C.O.                            | 5.2.62  |
| Hix, K. W.                       | E.-in-C.O. to Nigeria                          | 15.3.62 | Copeland, A. W.                       | E.-in-C.O. to Hong Kong                       | 18.2.62 |
| Nicholson, T.                    | R.A.F. Stanmore to E.-in-C.O.                  | 19.3.62 | Stanley, E. R.                        | E.-in-C.O. to L.T. Reg.                       | 26.2.62 |
| <i>Executive Engineer</i>        |  |         | Cartner, J. G.                        | N.W. Reg. to Hong Kong                        | 27.2.62 |
| Crisp, A. J. E.                  | E.-in-C.O. to Ministry of Aviation             | 1.1.62  | Chesser, J.                           | L.T. Reg. to E.-in-C.O.                       | 12.3.62 |
| Foster, H. A. L.                 | Approved Employment to E.-in-C.O.              | 9.1.62  | Quested, W. G. M.                     | H.C. Reg. to E.-in-C.O.                       | 12.3.62 |
| Alva, J. G.                      | E.-in-C.O. to New South Wales                  | 23.1.62 | Herbert, T. A.                        | E.-in-C.O. to L.T. Reg.                       | 12.3.62 |
| Mitchell, F. J. H.               | Factories Department to War Office             | 1.2.62  | Coaker, E.                            | E.-in-C.O. to L.T. Reg.                       | 26.3.62 |
| Mole, H. H. R.                   | N.I. to Mechanization and Buildings Department | 5.2.62  | <i>Senior Scientific Officer</i>      |   |         |
| Haigh, B.                        | Scot. to N.E. Reg.                             | 19.2.62 | Hastie, R. A.                         | E.-in-C.O. to Accountant General's Department | 17.1.62 |
| Hayward, R. W.                   | E.-in-C.O. to H.C. Reg.                        | 1.3.62  | <i>Assistant Experimental Officer</i> |   |         |
| <i>Assistant Engineer</i>        |  |         | Houghton, G. F.                       | E.-in-C.O. to Foreign Office                  | 14.1.62 |
| Kelly, H. R. S.                  | N.I. to E.-in-C.O.                             | 8.1.62  | <i>Leading Draughtsman</i>            |   |         |
| Quartly, J. P.                   | E.-in-C.O. to S.W. Reg.                        | 8.1.62  | Mountford, E. D.                      | Factories Department to Mid. Reg.             | 1.2.62  |
| Hall, R.                         | E.-in-C.O. to L.T. Reg.                        | 15.1.62 | <i>Executive Officer</i>              |   |         |
|                                  |  |         | Hyde, C. K.                           | E.-in-C.O. to Northern Rhodesia               | 2.1.62  |

Deaths

| Name                      | Region, etc. | Date    | Name                                | Region, etc. | Date    |
|---------------------------|--------------|---------|-------------------------------------|--------------|---------|
| <i>Regional Engineer</i>  |              |         | <i>Assistant Engineer—continued</i> |              |         |
| Blake, D. E.              | W.B.C.       | 12.1.62 | Buckwell, S. C.                     | H.C. Reg.    | 9.3.62  |
| <i>Assistant Engineer</i> |              |         | Potts, C. M.                        | N.E. Reg.    | 16.3.62 |
| Smith, C. H. J.           | L.T. Reg.    | 2.1.62  | <i>Inspector</i>                    |              |         |
| Cannon, T. T.             | L.T. Reg.    | 23.1.62 | Percy, E. H.                        | N.E. Reg.    | 20.3.62 |
| McLeod, W. A. L.          | L.T. Reg.    | 30.1.62 | <i>Higher Executive Officer</i>     |              |         |
| Kirvell, F. G.            | H.C. Reg.    | 21.1.62 | Holliday, J. H.                     | E.-in-C.O.   | 11.3.62 |
| Eustace, C. G.            | E.-in-C.O.   | 4.2.62  |                                     |              |         |

Book Reviews

"Boolean Algebra and its Application to the Theory of Switching Automata" ("Algebra Booleana con Applicazioni alla Teoria degli Automatismi a Contatti"). Prof. Ing. R. Righi, Italian Ministry of Posts and Telecommunications, 1961. 532 pp. 385 ill. 3,600 lire (approx. £2 2s.).

Boolean algebra, as a concept of precise logic, is more than a century old and although originated in this country there are no modern books specifically devoted to the subject in English. Most books on computers and other machines based on logic, contain references, sometimes also a chapter on Boolean algebra, but these are merely incidental to the argument of using OR, AND and NOT elements. In this instance, Boolean algebra is the centre of teaching logic circuitry and although the text is unfamiliar to the English eye, the illustrations are international. In

fact, the 385 figures tell a good story in themselves.

The present volume is based on the original treatise "An Investigation of the Laws of Thought" and embraces the work of Nakashima and Hanzawa, of Shannon, of Shestakov and of Righi, with references to many others. It is a text book which contains lectures held at a special course at the Institute Superiore P.T. and develops, in very small steps, the full story of Boolean and of switching algebra as used in the design and development of telecommunication circuits, and of sequencing circuits in general. Higher mathematics are avoided, but the thinking is, naturally, strictly logical. A large portion of the figures are actual circuits, some for obtaining summation, others multiplication, generally in binary codes. Communication circuits are generously dealt with; some of them also feature feedback techniques.

In spite of the language problem for many English readers, the book well deserves to be known to a wide circle of telecommunication engineers. L. A. S.

BOARD OF EDITORS

- D. A. BARRON, C.B.E., M.Sc., M.I.E.E., Chairman.
- L. F. SCANTLEBURY, Whit.Sch., A.C.G.I., D.I.C., M.I.E.E.
- T. H. FLOWERS, M.B.E., B.Sc.(Eng.), M.I.E.E.
- W. J. E. TOBIN, B.Sc.(Eng.), A.C.G.I., D.I.C., M.I.E.E.
- E. J. MARKBY, A.M.I.E.E.
- D. J. HARRIS, B.Sc.(Eng.), A.M.I.E.E.
- R. F. WALDEGRAVE.
- E. DAVIS, A.M.I.E.E., Managing Editor.
- A. G. LEIGHTON, B.Sc.(Eng.), A.M.I.E.E., Deputy Managing Editor.
- J. MARTIN, B.Sc.(Eng.), A.M.I.E.E. } Assistant Editors.
- R. A. SUDELL. }
- B. FARR, A.B.I., Secretary-Treasurer.
- B. CROSS, Advertisement Manager.

Copyright

The entire contents of this Journal are covered by general copyright, and special permission is necessary for reprinting long extracts, but editors are welcome to use not more than one-third of any article, provided that credit is given at the beginning or end thus: "From *The Post Office Electrical Engineers' Journal*."

The Board of Editors is not responsible for the statements made or the opinions expressed in any of the articles in this Journal, unless such statement is made specifically by the Board.

Subscriptions and Back Numbers

The Journal is published quarterly, in April, July, October and January, price 2s. 6d. (3s. 6d. post paid) per copy or 14s. per year post paid (2 dollars 25 cents, Canada and U.S.A.). Back numbers will be supplied, if available, price 2s. 6d. (3s. 6d. post paid) per copy. Copies of the April 1959 and all earlier Journals are no longer available. Orders should be sent to *The Post Office*

*Electrical Engineers' Journal*, G.P.O., 2-12 Gresham Street, London, E.C.2.

Employees of the British Post Office can obtain the Journal through local agents.

Binding

Readers can have their copies of volumes bound at a cost of 15s. by sending the complete set of parts to the local Post Office distribution agent or to *The Post Office Electrical Engineers' Journal*, G.P.O., 2-12 Gresham Street, London, E.C.2.

Remittances

Remittances should be made payable to "*The P.O.E.E. Journal*" and should be crossed "& Co."

Advertisements

All correspondence relating to advertisement space reservations, copy, proofs, etc., should be addressed to the Advertisement Manager, *The Post Office Electrical Engineers' Journal*, G.P.O., 2-12 Gresham Street, London, E.C.2.

Communications

With the exceptions indicated above, all communications should be addressed to the Managing Editor, *The Post Office Electrical Engineers' Journal*, G.P.O., 2-12 Gresham Street, London, E.C.2. Telephone: HEADquarters 1234.

Model Answer Books

Books of model answers to certain of the City and Guilds of London Institute examinations in telecommunications are published by the Board of Editors. Details of the books available are given at the end of the Supplement to the Journal.



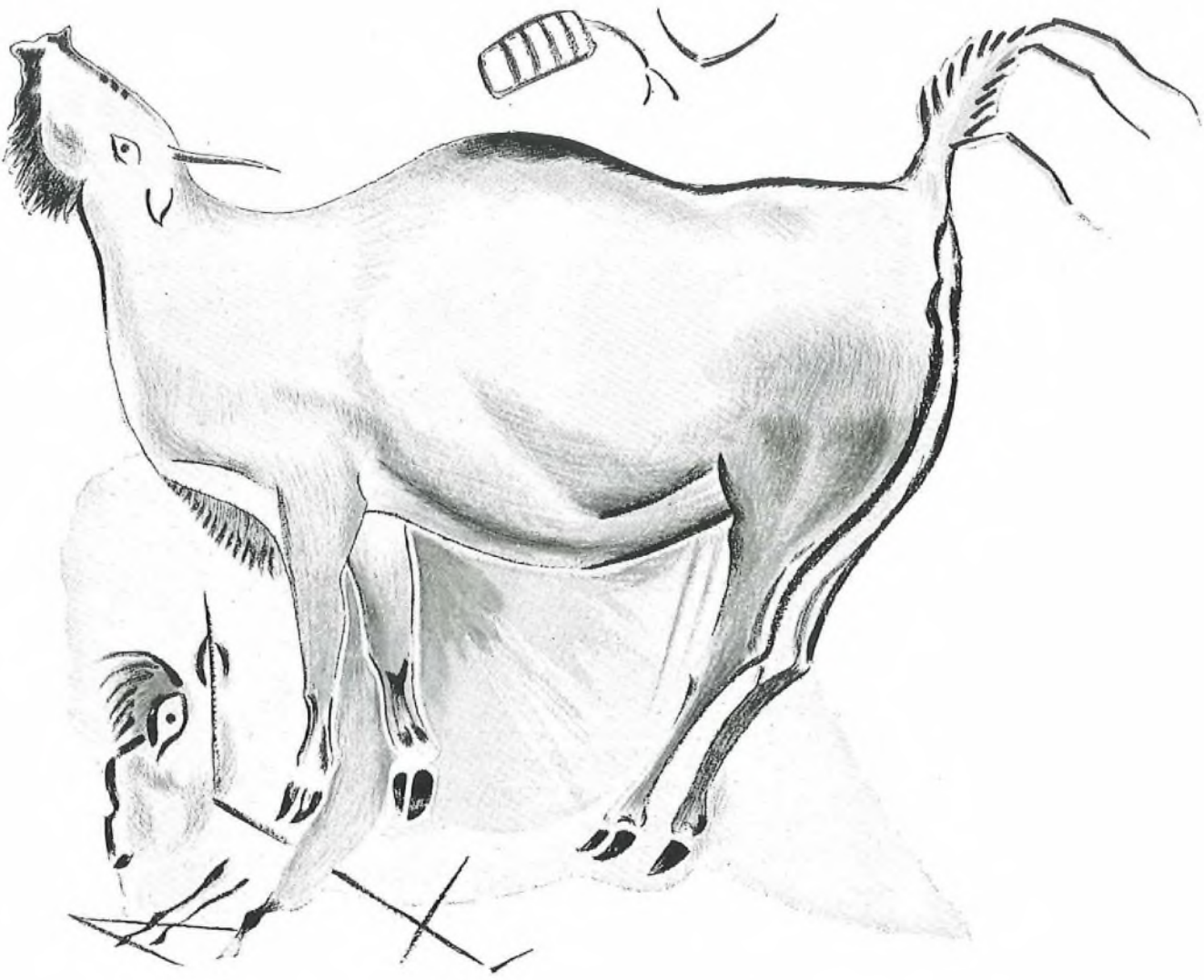

## Hidden meaning . . .

The splendid drawings in the caves of Altamira in Spain speak directly of the pleasures and preoccupations of prehistoric Magdalenian man. Discovered in 1879, they are some 25 000 years old and have been acclaimed as cave painting at its most technically accomplished stage. No less accomplished are the telecommunications systems of modern Spain, exemplified in the high technical standard of STC telephone transmission systems operating over the coaxial cable between Madrid and Barcelona and the first broadband microwave link between Madrid and Seville.

STC Transmission systems link city to city, country to country and continent to continent.



*Standard Telephones and Cables Limited*  
**TRANSMISSION SYSTEMS GROUP: NORTH WOOLWICH · LONDON, E.16**

\* for plugging, sealing, caulking

# DENSO MASTIC

THE ALL PURPOSE  
COLD APPLIED  
SEALING MEDIUM

below ground, above ground . . . or under water



**WINN & COALES LTD**

DENSO HOUSE CHAPEL ROAD  
LONDON S.E.27

Agents throughout the Commonwealth

London—Tel: GIPsy Hill 7511  
10 lines

Manchester—(Also Contracting  
Dept.) Tel: Sale 8271

Belfast—Tel: 56623

Dublin—Tel: 61768

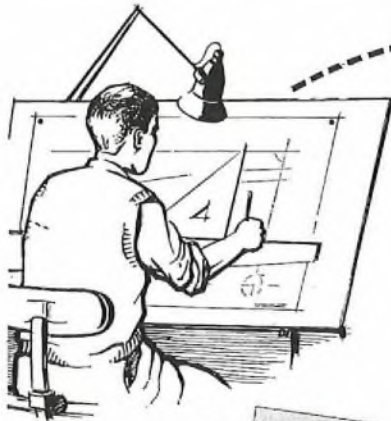

Economy begins  
at the design stage



Free  
technical  
literature

Permanent magnets, like many other aspects of technology, are making spectacular progress day by day. Remarkable economies in production can be effected if experts are consulted at the design stage. Eclipse have a highly developed research programme that makes them leaders in this field. Bring Eclipse Permanent Magnets into your preliminary design discussions—and be thankful.

**Eclipse**

**permanent magnets**



Made by the designers and manufacturers of Eclipse Permanent Magnet Chucks

JAMES NEILL & CO. (SHEFFIELD) LTD • SHEFFIELD • ENGLAND



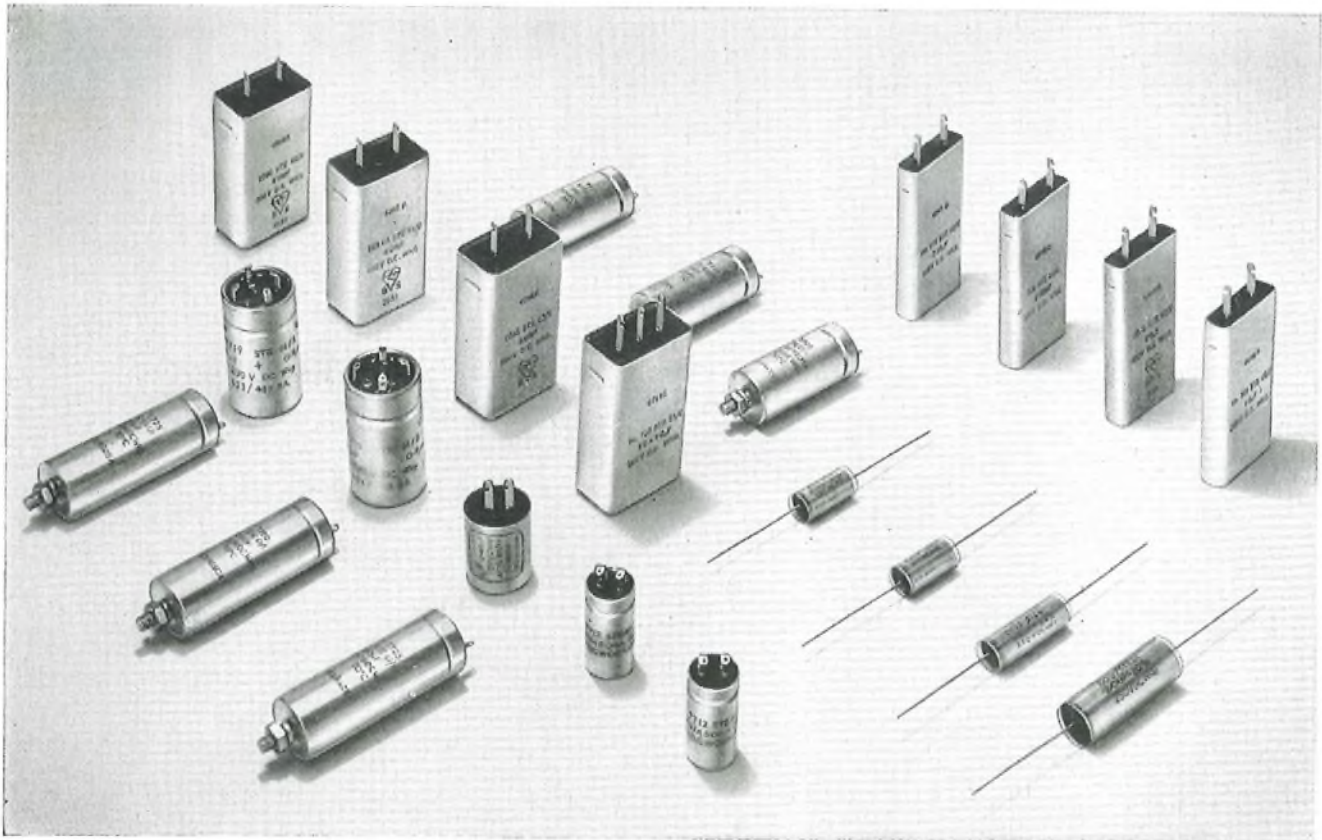

# STC BRITISH POST OFFICE TYPE CAPACITORS

| B.P.O. Number | STC Code      | B.P.O. Number | STC Code      |
|---------------|---------------|---------------|---------------|
| 94            | 453/LWA/6B    | 7710          | 453/LWA/465CA |
| 100           | 4049          | 7710 Pair     | 453/LWA/465PA |
| 101           | 4049Y         | 7711          | 453/LWA/461DA |
| 102           | 4048          | 7712          | 453/LWA/450AA |
| 102C          | 4049BA        | 7718          | 453/LWA/460CA |
| 102CA         | 4049BB        | 7719 Mk 2     | 453/LWA/453BA |
| 103C          | 4048R         | 7720          | 453/LWA/1A    |
| 103CA         | 4048P         | 7721          | 453/LWA/464AA |
| 104           | 4049H         | 7723          | 453/LWA/464BA |
| 105           | 4711C         | 7724          | 453/LWA/463AA |
| 106           | 4049V         | 7725          | 453/LWA/462BA |
| 115           | 4049B         | 7727          | 453/LWA/466DA |
| 119           | 4049C         | 8001          | 455/LWA/432CA |
| 150           | 4061B         | 8003          | 455/LWA/430CA |
| 151           | 4061F         | 8004          | 455/LWA/431CA |
| 152           | 4062          | 8005          | 455/LWA/433CA |
| 7708          | 453/LWA/461CA | 8006          | 455/LWA/434CA |
| 7708 Pair     | 453/LWA/461PA | 8007          | 455/LWA/435CA |
| 7709          | 453/LWA/461CB |               |               |

STC also manufacture the following miniature capacitors suitable for use in transistorized switching circuits:

Sintered-anode, solid electrolyte  
Tantalum

Foil-type, wet electrolyte Tantalum  
Coated foil (Stantelac)

Mica  
Polystyrene



62/5MC

*Standard Telephones and Cables Limited*

COMPONENTS GROUP

CAPACITOR DIVISION: BRIXHAM ROAD · PAIGNTON · DEVON  
LONDON SALES OFFICE: FOOTSCRAY · KENT · FOOTSCRAY 3333

# Model 40 Universal AVOMETER



Regd. Trade Mark

A self-contained multi-range a.c./d.c. instrument providing 40 ranges of direct readings of current, voltage and resistance on a 5-inch hand calibrated scale fitted with an anti-parallax mirror. Range selection is accomplished by two rotary switches, for a.c. and d.c. respectively, and a press button provides additional ranges by halving the current and voltage ranges shown on the switch knobs. Full scale deflection on voltage ranges is obtained with a consumption of 3mA. or 6mA. according to whether the press button is used or not. The total resistance of the meter is 200,000 ohms.

The instrument meets the accuracy requirements of B.S.S. 89/1954 for 5-inch scale length portable industrial instruments. It also complies with the requirements of the U.K. Air Registration Board and the Merchant Shipping (Radio) Rules 1952.

It is a robust, compact and portable instrument, and is protected by an automatic cut-out against damage through inadvertent application to overload.

Size:  $8 \times 7\frac{1}{4} \times 4\frac{1}{2}$  in. Weight:  $6\frac{1}{2}$  lb.

*A leather carrying case is available, if required.*

Power Factor and reactive kV.A. can be measured in a.c. circuits by means of an external accessory (the Universal Avometer Power Factor & Wattage Unit).

CURRENT: a.c. and d.c. 0 to 12 amps.  
VOLTAGE: a.c. and d.c. 0 to 1,200 volts.  
RESISTANCE: Up to 1 megohm.

Write for fully descriptive brochure, or for complete Catalogue of Avo Instruments.

## AVO LTD

AVOCET HOUSE · 92-96 VAUXHALL BRIDGE ROAD · LONDON · S.W.1 Telephone: VICTORIA 3404 (12 lines)



A40/8

# DRALLIM tube couplings

Illustrated is the Drallim  $\frac{1}{4}$ " O.D. tube straight coupling, one of a wide range. These are available for tube sizes from  $\frac{3}{16}$ " O.D. to  $\frac{5}{8}$ " O.D.

Tubing in nylon or polythene can be supplied to suit the above sizes.

Drallim tube couplings have absolute leak-free characteristics from high vacuum to 200 p.s.i. This is due to the Drallim captive seal union nut (cut away above).

Also available:

**P.O. pressurised cable systems comprising; Connectors Cable Air, Mountings Schrader Tee, Mountings Schrader Valve, Air Arcton Mixer, Panels Pressure Distribution, and Panels Pressure Indicating—incorporating our Multi-way Rotary Switch Valve.**

**WRITE TODAY FOR ILLUSTRATED LEAFLET No. 4/62**

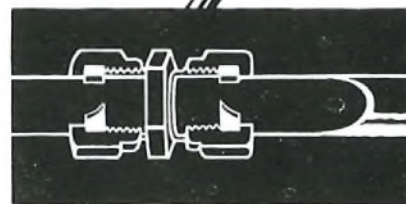

British Patent  
No. 859958



DRALLIM INDUSTRIES LTD, Bourne Works, Station Approach, Whyteleafe

Surrey. BYWOOD 2321-2



# STC

# NEW small diameter coaxial cable

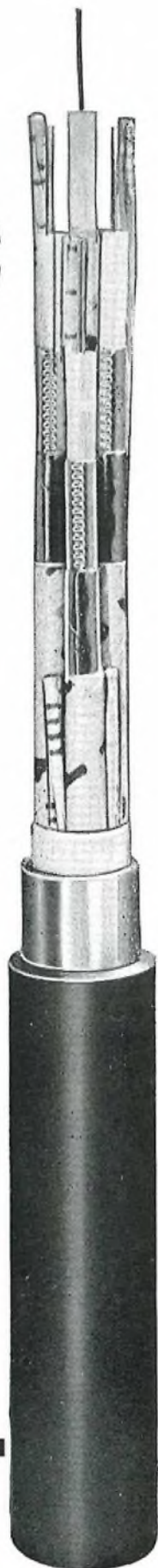

STC has designed, manufactured and installed in the London area for the British Post Office, a new, Type 174, small diameter coaxial cable. This cable is a completely new low-loss type with the centre conductors supported by means of polythene shell insulation.

The coaxial cores are within the diameter range (4,0 to 4,5 mm) recommended by the CCITT for systems intended to carry 300 telephony channels, but are of considerably higher quality. The impedance uniformity of the Type 174 small diameter coaxial cable meets, in fact, CCITT requirements for 960 channel systems on Type 375 coaxial cable, and this new, light, versatile cable can also be used for television transmission.



*Standard Telephones and Cables Limited*

TELEPHONE CABLE DIVISION: NORTH WOOLWICH · LONDON · E16

Minimum space . . . .

Minimum power consumption . . . .

Minimum maintenance . . . .



# Transistorised FMVFT

TYPE CT 24A

FOR THE PROVISION OF TELEPRINTER OR DATA TRANSMISSION CIRCUITS

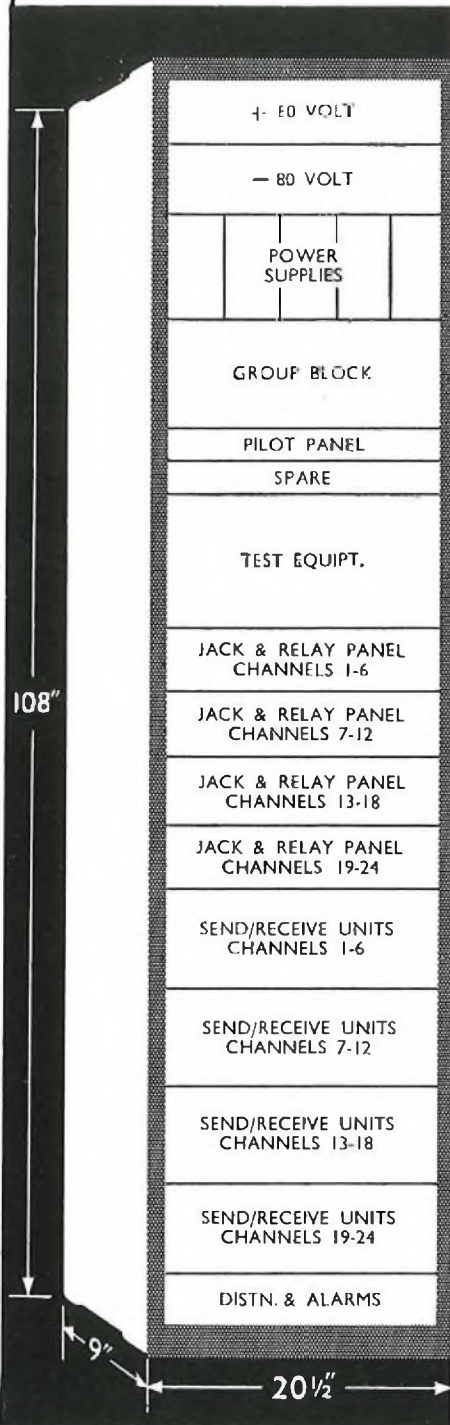

- \* CCITT standards of performance
- \* 24 channels per rackside
- \* 50 baud nominal, with operation up to 80 bauds
- \* Plug-in units
- \* Optional in-built test equipment comprising:—
  - a) Telegraph test set
  - b) Level measuring set
  - c) Frequency check unit
- \* Completely self contained with all power supplies
- \* Pilot facility 300 c/s or 3300 c/s

24 frequency modulated channels are provided in the nominal frequency band 420-3180 c/s with 120 c/s separation between adjacent channels. These are built up from 4 sub-groups of 6 channels each in the frequency band 1140-1740 c/s. Compactly assembled plug-in units use printed circuit wiring boards with small encapsulated filter and transformer units. Equipment is protected by bay covers, but test equipment and jackfields are directly accessible at centre of rack.

**Bearer Band** 300-3400 c/s  
**Deviation**  $\pm 30$  c/s from mid frequency  
**Send level range** -15 to -35 dBm  
**Receive level range** -15 to -35 dBm  
**DC lines** Send 20mA double current.  
 Receive up to 100 mA.  
 Balanced loop and neutral loop conditions on request.

**Temperature compensated**  $+ 5^{\circ}\text{C}$  to  $+ 55^{\circ}\text{C}$   
**Power supplies** 100-120v or 200-240v AC  
 (Battery operation through an inverter as optional extra).

*Details of the latest AEI Carrier Telephone and Telegraph Equipment supplied on request*

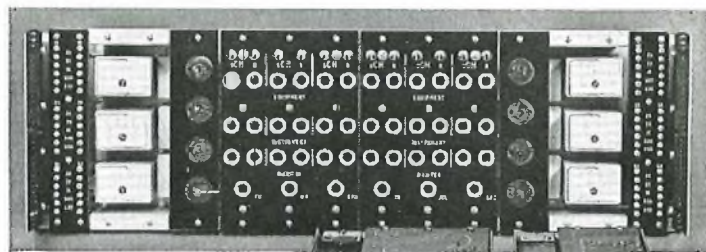

Jack and Relay Panel

Receive Unit  
and Send Unit

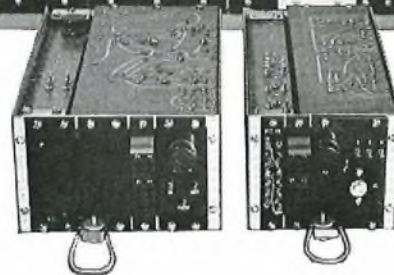

**Associated Electrical Industries Ltd**

Telecommunications Division, Transmission Department  
 Woolwich, London S.E.18, England

Cables: Sieswan London



**Aerial self-supporting***Publication H/205***Armoured and unarmoured***Publication H/100***Rural***Publication H/105*

# DISTRIBUTION CABLES FROM **STC**

These polythene insulated cables have many operational advantages over previous types of cable. For example, they may be installed in longer lengths, and the consequent reduction in the number of joints required makes them economical to use. Further, they need no processing before burial in the ground, or pulling into ducts, or suspension in the air—they are ready for immediate installation. Polythene has excellent dielectric properties, which ensure that STC distribution cables meet the most rigid installation specifications.

*Send for publications listed above*



62/5H

## *Standard Telephones and Cables Limited*

RUBBER & PLASTIC CABLE DIVISION: CORPORATION ROAD · NEWPORT · MON.

AND NOW FROM TMC ANOTHER COMPACT TRANSISTORIZED EQUIPMENT ON SHORT DELIVERY...

**speech  
+  
3 channel  
duplex  
VF telegraph**

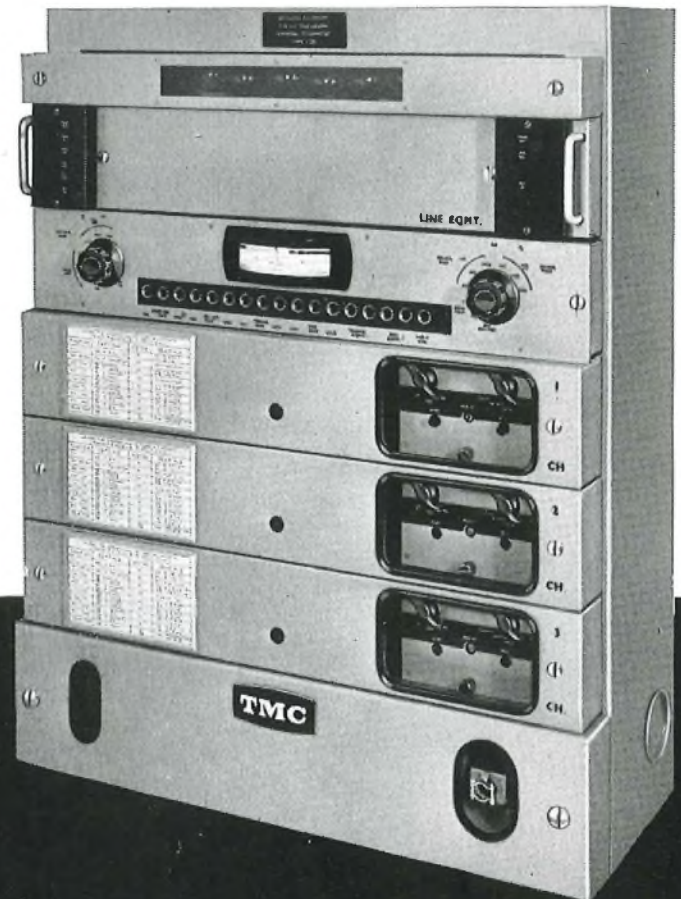

Speech bandwidth : 300-2600 c/s  
Telegraph bandwidth : 2720-3230 c/s  
Telegraph speed : 80 bauds  
Telegraph loop options : double current  
(polar)

AND  
single current  
(neutral)

## Type T3B

This compact terminal equipment provides three extra telegraph circuits without losing the speech facility and is designed for operation on a 4-wire bearer. It can be energised from a.c. mains (with the d.c. telegraph signalling supply inbuilt) or from battery supplies.

For single channel radio links, suitable radio equipment can be provided.

*We should like to explain in detail this or any other TMC equipment which will help to solve your telecommunication problem. Please write to:*

**TELEPHONE MANUFACTURING COMPANY LIMITED**  
Transmission Division, Sevenoaks Way, St. Mary Cray, Orpington, Kent. Orpington 27020

A MEMBER OF THE  GROUP OF COMPANIES

SELLING AGENTS:-

*Australia & New Zealand: Telephone Manufacturing Co. (Australasia) Pty. Ltd., Sydney, New South Wales.  
Canada & U.S.A.: Telephone Manufacturing Co. Ltd., Toronto, Canada. Also represented in other countries.*



**Aerial self-supporting***Publication H/205***Armoured and unarmoured***Publication H/100***Rural***Publication H/105*

# DISTRIBUTION CABLES FROM **STC**

These polythene insulated cables have many operational advantages over previous types of cable. For example, they may be installed in longer lengths, and the consequent reduction in the number of joints required makes them economical to use. Further, they need no processing before burial in the ground, or pulling into ducts, or suspension in the air—they are ready for immediate installation. Polythene has excellent dielectric properties, which ensure that STC distribution cables meet the most rigid installation specifications.

*Send for publications listed above*



62/5H

## *Standard Telephones and Cables Limited*

**RUBBER & PLASTIC CABLE DIVISION: CORPORATION ROAD · NEWPORT · MON.**

AND NOW FROM TMC ANOTHER COMPACT TRANSISTORIZED EQUIPMENT ON SHORT DELIVERY...

**speech  
+  
3 channel  
duplex  
VF telegraph**



Speech bandwidth : 300-2600 c/s  
Telegraph bandwidth : 2720-3230 c/s  
Telegraph speed : 80 bauds  
Telegraph loop options : double current  
(polar)

AND  
single current  
(neutral)

## Type T3B

This compact terminal equipment provides three extra telegraph circuits without losing the speech facility and is designed for operation on a 4-wire bearer. It can be energised from a.c. mains (with the d.c. telegraph signalling supply inbuilt) or from battery supplies.

For single channel radio links, suitable radio equipment can be provided.

*We should like to explain in detail this or any other TMC equipment which will help to solve your telecommunication problem. Please write to:*

**TMC**

**TELEPHONE MANUFACTURING COMPANY LIMITED**

Transmission Division, Sevenoaks Way, St. Mary Cray, Orpington, Kent. Orpington 27020

A MEMBER OF THE  GROUP OF COMPANIES

SELLING AGENTS:—

*Australia & New Zealand: Telephone Manufacturing Co. (Australasia) Pty. Ltd., Sydney, New South Wales.  
Canada & U.S.A.: Telephone Manufacturing Co. Ltd., Toronto, Canada. Also represented in other countries.*



ETELUX  
ETELUX  
ETELUX  
ETELUX  
ETELUX  
ETELUX



ETELUX  
ETELUX

## THE NEW LUXURY TELEPHONE



Manufactured exclusively by Ericsson, the Etelux is a refreshingly new concept of telephone instrument design. A great deal of thought has been devoted to the ergonomic and aesthetic problems involved in the evolution of an instrument of this nature, and among its many outstanding features is its distinctive appearance and ease with which it can be handled. It is easily convertible to wall mounting for use in kitchen, hall or any location where table space is restricted. Dial illumination, and press-button for "operator re-call" or party line working, can be provided as an optional extra. The Etelux is offered in a range of colours which have been chosen for compatibility with a wide variety of interior decor, and these are:—

Aqua Jade, Alice Blue, Dusky Pink, Rose Grey and Light Ivory. The base is Kashmir Beige, dial Silver Gilt and H.M.T. Cord Bronze Lustre.

This instrument has a technical performance equal to that of the Etelphone and can be supplied in full tropical finish.



ERICSSON TELEPHONES LIMITED • ETELCO LIMITED





These Advanced Features give the Vanguard **EXTRA PERFORMANCE**  
**UNIT PRINTED BOARD CIRCUIT ELEMENTS**

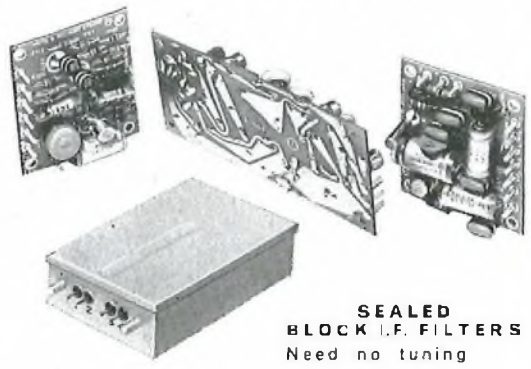

**SEALED BLOCK I.F. FILTERS**  
 Need no tuning



INTRODUCE THE  
**VANGUARD**  
 A Magnificent  
 25-Watt Transistorised  
**RADIOTELEPHONE**

**ONLY the VANGUARD has ALL these qualities**

- 25/30 & 50/60Kc/s channels
- Largely Transistorised
- Sealed Block I.F. Filters
- Printed Circuitry
- Very low Battery Drain
- All Aluminium Construction
- Dust and Weatherproof
- One—Six Channels
- 25 Watts Output
- Very Low-noise Receiver
- High Stability Mute
- 4 Watts Audio Output

Meets British, American, Canadian and Continental Specifications

**PYE TELECOMMUNICATIONS LIMITED . . . CAMBRIDGE**







**STC  
MAKES  
LIGHT  
OF THE  
JOB  
THIS  
MAKES  
FOR  
GREATER  
EFFICIENCY**

**STC LIGHTWEIGHT HEADSETS**, designed for use by private and public telephone operators and approved by the British Post Office, are fast superseding the use of the older breast type instruments.

The main advantages of this STC product are extraordinary light weight, a high degree of comfort, stability and manoeuvrability and constant level of transmission regardless of head movement. The headsets are made in black, grey or ivory nylon plastic which is virtually unbreakable.

The "Rocking Armature" principle—an important STC development in telephone receiver design—which gives improved sensitivity and frequency response has been incorporated into these instruments.

*Write for leaflet D/104*



62/1D

**Standard Telephones and Cables Limited**

TELEPHONE SWITCHING DIVISION

OAKLEIGH ROAD · NEW SOUTHGATE · LONDON · N 11

**G.E.C.**

**THE  
COMPLETE  
TELE-  
COMMUNICATIONS  
SERVICE**

**RESEARCH**

**DEVELOPMENT**

**DESIGN**

**MANUFACTURE**

**SURVEY**

**PLANNING**

**INSTALLATION**

**MAINTENANCE**

*Transmission Division*

**G.E.C. (TELECOMMUNICATIONS) LTD**

**TELEPHONE WORKS · COVENTRY · ENGLAND**

*Works at Coventry and Middlesbrough*



SPOTLIGHT  
No. 4

## INSTALLATION and MAINTENANCE

GEC have the facilities and the experience necessary for installing line, cable and radio links anywhere in the world. This service can extend from the supply of several engineers to assist customers' own staff, to complete installation and commissioning by teams composed entirely of GEC personnel. The GEC is fully aware of the general world-wide shortage of telecommunication engineers and long ago instituted facilities for customer training locally and at their own Telephone Works in Coventry.

On-site maintenance can be performed by customers' own staff with or without assistance from GEC staff or, alternatively, the Company can provide full-scale maintenance on either a short or long-term basis.

GEC maintenance engineers are available to travel anywhere at any time to assist customers with maintenance problems.

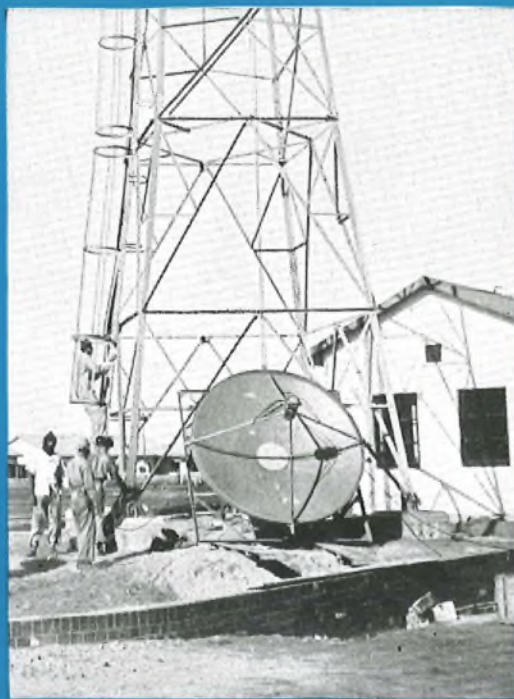

Raising the aerial at a station on a UHF radio system



Replacing a travelling wave tube in GEC SHF radio equipment

**G.E.C.**

**EVERYTHING FOR TELECOMMUNICATIONS**

# an investigation of

## SUBMARINE TELEPHONE-CABLE TERMINAL EQUIPMENT

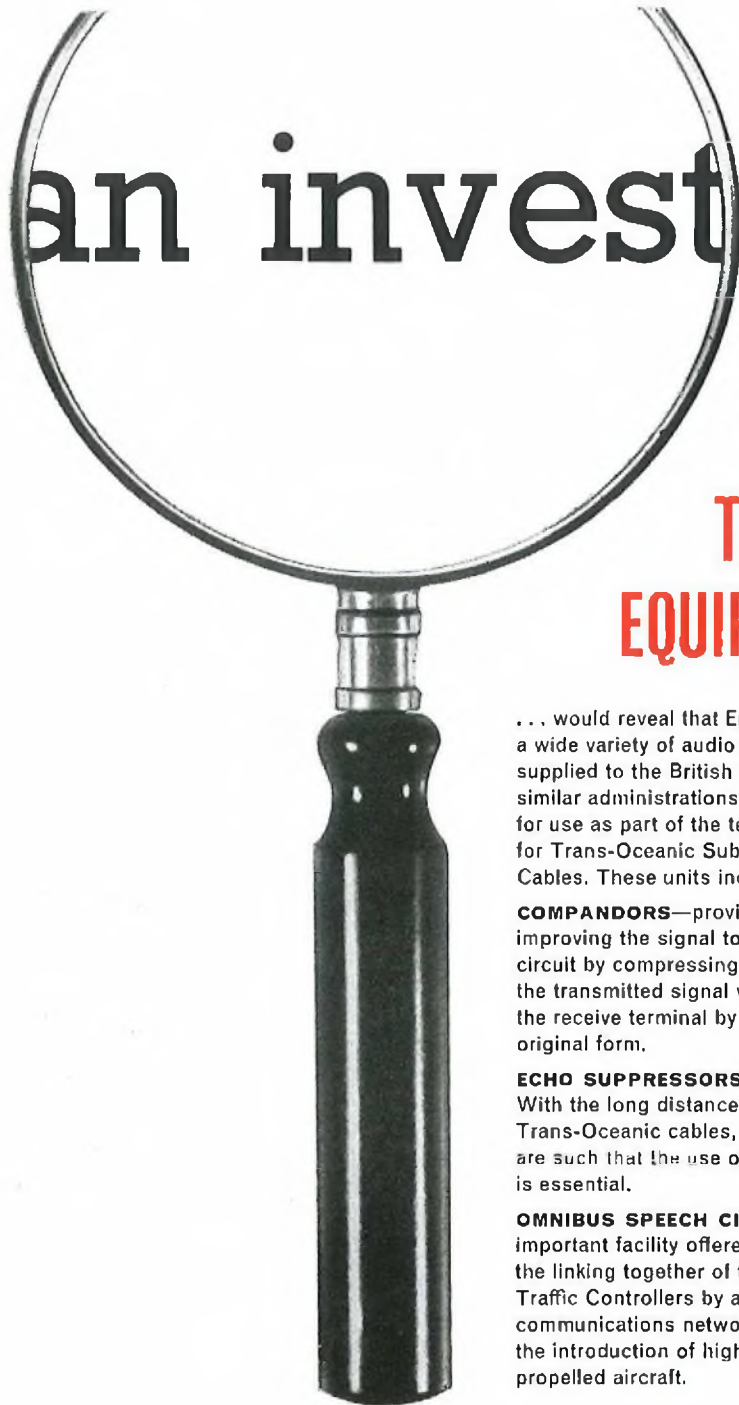

... would reveal that Ericsson manufacture a wide variety of audio units which are supplied to the British Post Office, and similar administrations throughout the world, for use as part of the terminal equipment for Trans-Oceanic Submarine Telephone Cables. These units include:—

**COMPANDORS**—providing a means of improving the signal to noise ratio of a circuit by compressing the dynamic range of the transmitted signal which is restored at the receive terminal by expansion to its original form.

**ECHO SUPPRESSORS**—(illustrated right)—With the long distances involved in Trans-Oceanic cables, transmission times are such that the use of echo-suppressors is essential.

**OMNIBUS SPEECH CIRCUITS**—A most important facility offered by these circuits is the linking together of the Oceanic Air Traffic Controllers by a very reliable communications network—so essential with the introduction of high speed jet propelled aircraft.

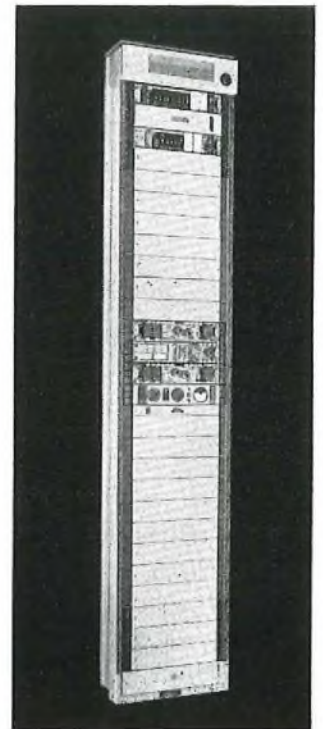

TRANS-PACIFIC SUBMARINE TELEPHONE CABLES

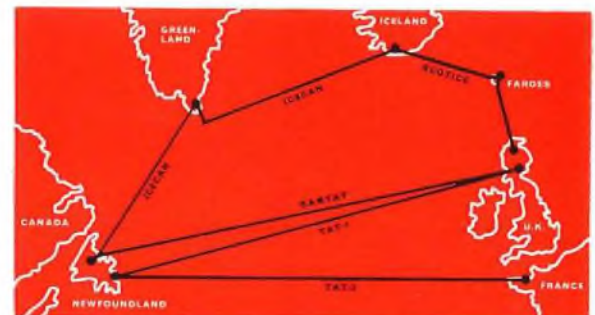

TRANS-ATLANTIC SUBMARINE TELEPHONE CABLES



**ERICSSON TELEPHONES LIMITED**  
**ETELCO LIMITED**

HEAD OFFICE: 22 LINCOLN'S INN FIELDS, LONDON, W.C.2 TEL: HOL. 6936



# STC

## COLD CATHODE INDICATOR TUBES for displaying numbers and symbols

These tubes in the STC range are intended for end-viewing and the symbol tube GS-1 is matched for seated and operating voltages with the larger number tube GN-2. The GN-2 tube directly replaces the earlier type GN-1 in all d.c. (or rectified unsmoothed a.c.) circuits and is of improved design and construction.



GN-2



GS-1



GN-3

| Abridged Data |         | Diameter (mm) | Base  | Minimum Supply Voltage (V) | Nominal Cathode Current (mA) |
|---------------|---------|---------------|-------|----------------------------|------------------------------|
| Type          | Display |               |       |                            |                              |
| GN-2          | 0-9     | 45            | B12A  | 200                        | 3.5                          |
| GN-3          | 0-9     | 28            | B13B  | 170                        | 2.0                          |
| GS-1          | + or -  | 22            | B9A/D | 200                        | 1.5                          |



92/IMS

*Standard Telephones and Cables Limited*

VALVE DIVISION: BRIXHAM ROAD · PAIGNTON · DEVON  
LONDON SALES OFFICE: FOOTSCRAY · KENT · FOOTSCRAY 3333



# FULLY TRANSISTOR

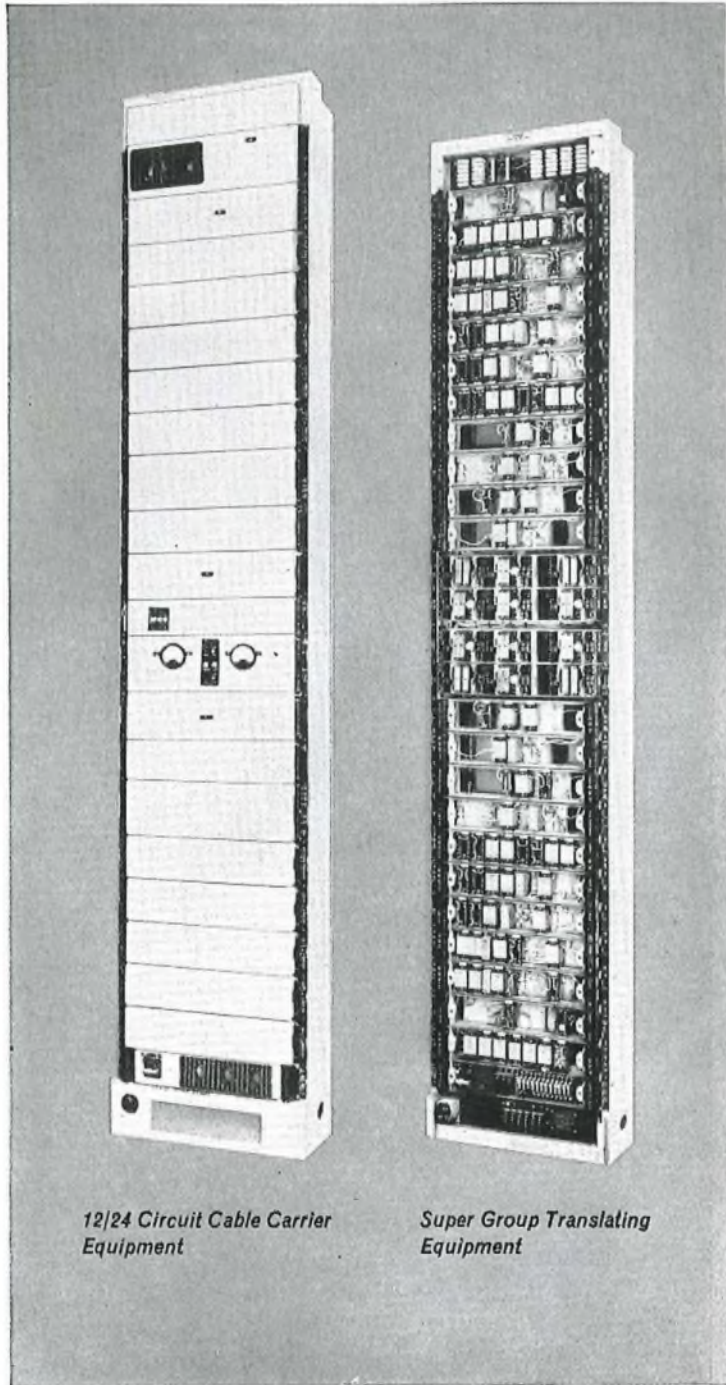

*12/24 Circuit Cable Carrier  
Equipment*

*Super Group Translating  
Equipment*



# ED TRANSMISSION EQUIPMENT

comprehensive range:



CHANNEL  
EQUIPMENT



3-CIRCUIT OPEN WIRE  
EQUIPMENT



GROUP TRANSLATING  
EQUIPMENT



12-CIRCUIT OPEN WIRE  
EQUIPMENT



SUPER GROUP  
TRANSLATING EQUIPMENT



12 AND 24-CIRCUIT CABLE  
CARRIER EQUIPMENT



FREQUENCY GENERATING  
EQUIPMENT



VOICE FREQUENCY  
TELEGRAPH EQUIPMENT



RURAL CARRIER  
EQUIPMENT



AUDIO AND MUSIC  
CIRCUIT AMPLIFIERS

experience:

8 YEARS DURING WHICH EQUIPMENT EMBODYING MORE THAN  $\frac{1}{2}$  MILLION TRANSISTORS HAS BEEN SUPPLIED.

G.E.C. transistored equipment is already operating in 22 countries ranging from Canada and Finland to Nigeria and Sudan.

**G.E.C.**

*Everything for Telecommunications*

For further information write to:

TRANSMISSION DIVISION

**G.E.C. (TELECOMMUNICATIONS) LTD**

Telephone Works, Coventry, England

Works at Coventry and Middlesbrough

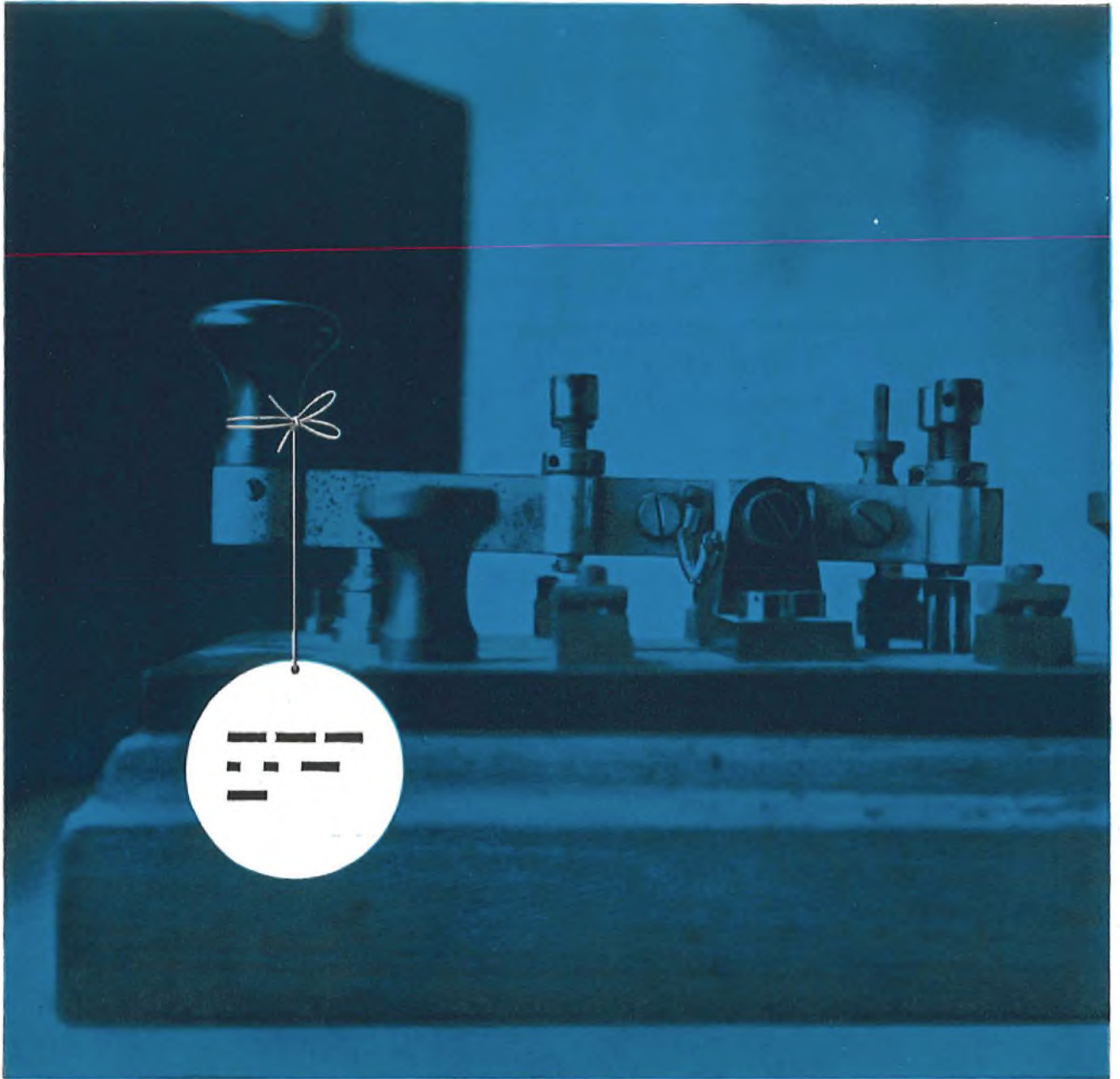

Dots and dashes . . . too slow. They're going o-u-t. FORMICA\* industrial laminates play an important part in today's fast talking telecommunications, telephone exchanges and communications satellites. Formica Limited make over 50 industrial laminate grades for industry, including specialised grades famous for their electrical properties for printed circuitry, selector bank insulation and terminal strips. With FORMICA industrial laminates goes a complete Technical Service which includes consultation, investigation, advice. Just write or ring.



Industrial laminates

\*FORMICA is a registered trade mark

Formica Ltd., De La Rue House, 84-86 Regent Street, London, W.1

BEgent 8020



# STC

# SUBMARINE CABLE

chosen for underwater communication  
systems all over the world

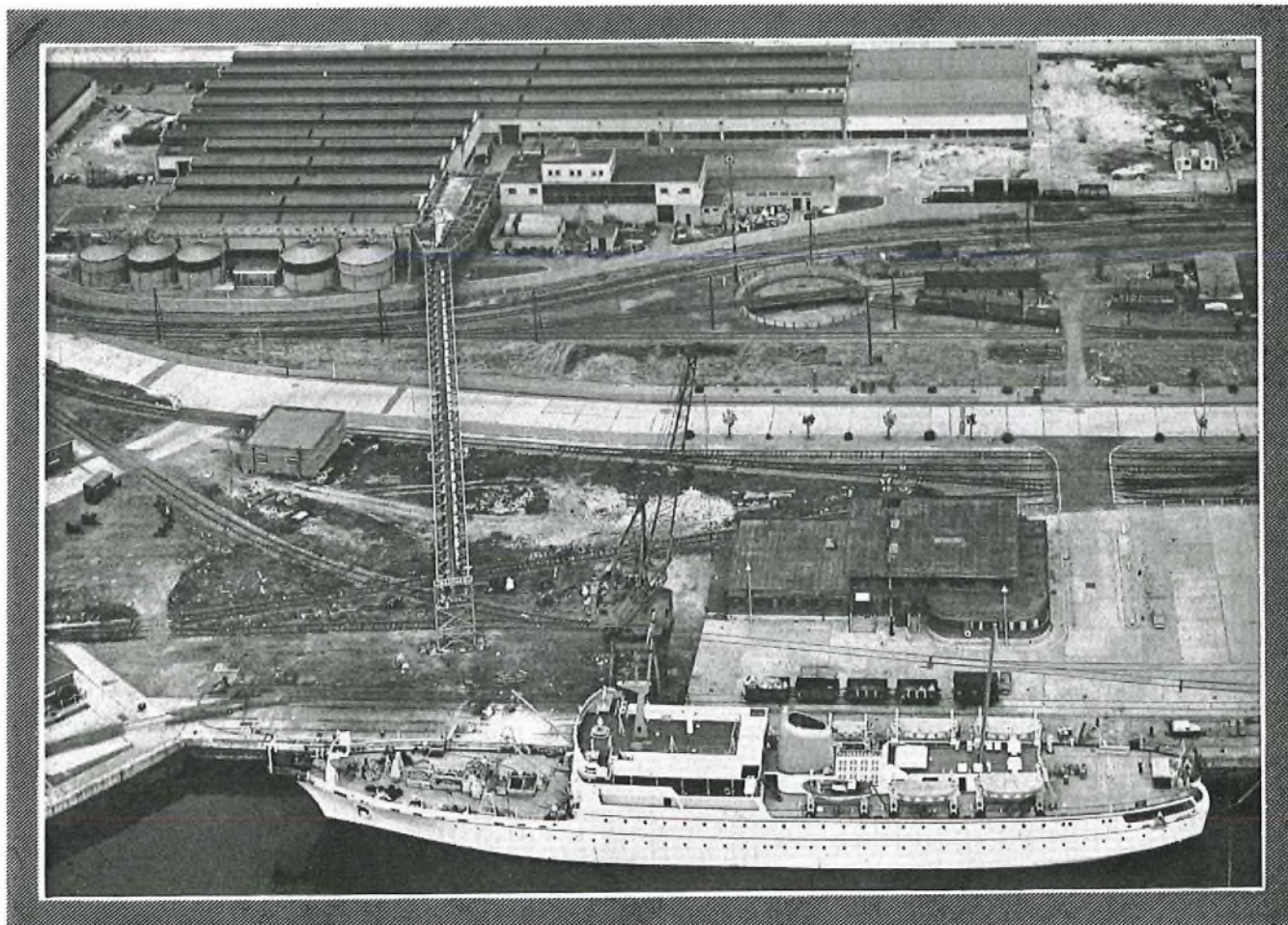

Cable & Wireless ship *Retriever* loading cable from the STC Submarine Cable factory at Southampton.

Submarine telephone cable  
on order or already  
manufactured at the STC  
Southampton factory:

|                             |       |                  |
|-----------------------------|-------|------------------|
| Commonwealth Pacific Cable  | 2 800 | } nautical miles |
| USA—Bermuda                 | 820   |                  |
| Scotland-Faroes—Iceland     | 750   |                  |
| Puerto Rico—Florida         | 715   |                  |
| UK—Sweden                   | 536   |                  |
| UK—Denmark                  | 315   |                  |
| UK—Germany No 2             | 253   |                  |
| UK—Germany No 1             | 250   |                  |
| Bournemouth—Channel Islands | 140   |                  |
| Wales—Morecambe Bay         | 75    |                  |
| Wales—Isle of Man           | 66    |                  |
| UK—Belgium                  | 61    |                  |

STC ENGINEER AND MANUFACTURE ALL TYPES OF SUBMARINE TELEPHONE AND TELEGRAPH CABLE.



62/3T

*Standard Telephones and Cables Limited*

SUBMARINE CABLE DIVISION: NEW DOCKS · SOUTHAMPTON · HANTS



# For **POTTING**



The Epoxy Resins,  
used by Whiteley  
Electrical Radio, provide  
mechanical and climatic  
protection, combined



with excellent electrical  
insulation, for equipment



used in extremes  
of temperature and  
humidity.



# or **PLOTTING**

The Radio Sonde  
enables weather forecasts  
for the upper atmosphere  
to be taken with great  
accuracy.

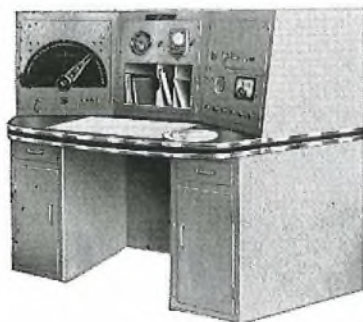
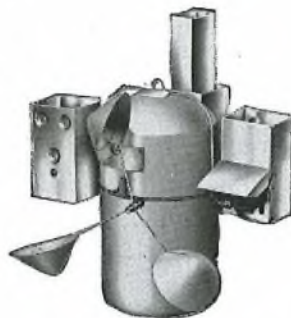

The Radio Sonde  
Ground Equipment  
enables information  
from the Radio Sonde  
to be converted into  
data on the pressure,  
temperature and  
humidity in the upper  
atmosphere.

**GET IN TOUCH WITH**

## **WHITELEY**

**WHITELEY ELECTRICAL RADIO CO LTD**  
MANSFIELD · NOTTS Tel: Mansfield 1762/5

WB166

## VALUABLE FREE BOOK

**Tells You How to Pass Your C. & G. or  
Promotion Exam. at First Attempt!**



All Post Office personnel who are anxious to obtain early promotion should at once send for a copy of our handbook "ENGINEERING OPPORTUNITIES" which, among other intensely interesting matter, describes our unique methods of preparation for the G.P.O., LIMITED COMPETITIONS for appointment as Assistant Engineer, Executive Engineer, Traffic Officer, Telecommunications Traffic Superintendent; CITY AND GUILDS EXAMINATIONS for the Telecommunication Technicians' Certificate and for individual subjects—Mathematics, Engineering Science, Engineering Drawing, Elementary Telecommunication Practice, Telecommunication Principles, Radio and Line Transmission, Telegraphy and Telephony, Line Plant Practice. It also contains details of our courses covering the City and Guilds Examinations in Electrical Engineering Practice, the Grad. Brit. I.R.E. and A.M.S.E. Examinations, in addition to a wide range of non-examination courses in all branches of engineering—Radio and Electronics, Electrical, Mechanical, etc.

We also provide tuition for the Radio Amateurs' Examination and the P.M.G. Certificates for Radio Operators, with or without Morse training. Details are given in the handbook.

**We definitely guarantee  
"NO PASS—NO FEE"**

If you intend to make the most of today's opportunities, you cannot afford to miss reading "ENGINEERING OPPORTUNITIES." It tells you everything you want to know to secure advancement, and describes many opportunities you may now be missing through lack of information. Send for your copy today—FREE and without obligation.

**BRITISH INSTITUTE  
OF ENGINEERING TECHNOLOGY**  
369 COLLEGE HOUSE,  
29-31 WRIGHT'S LANE, LONDON, W.8

# **BIET**

## **PROBLEMS IN RADIO ENGINEERING**

By E. T. A. Rapson

This is the eighth edition of this well-known textbook. It has once again been brought fully up to date. A number of early descriptive questions have been omitted and many new numerical problems have been added. A new section on transistors has also been included. Although designed particularly for the needs of the National Certificate Student in Radio Communication, it is also well-suited to the needs of those who are preparing for the examinations held by other recognized examining bodies and those engaged in private study.

15/- net.

## **SOLUTION OF PROBLEMS IN ELECTRICAL MEASUREMENTS**

By A. C. Shotton

Included in this book are problems on units and dimensions, circuit theorems, bridges and potentiometers, permanent magnet calculations, iron testing, instruments, and electronic measurements. The standard aimed at is that of the second year of a degree course but additional material covers the requirements of Higher National Certificate syllabuses.

15/- net.

## **SOLUTION OF PROBLEMS IN TELECOMMUNICATIONS AND ELECTRONICS**

By C. S. Henson

The bulk of the problems in this book have been taken from the London University Final Examinations in Telecommunications and Electronics, and from the Graduateship Examination of the Institution of Electrical Engineers in Radio Communication. The author has also given general references for further study to assist students in their reading.

27/6 net.

# **PITMAN**

PARKER ST. · KINGSWAY · LONDON · W.C.2



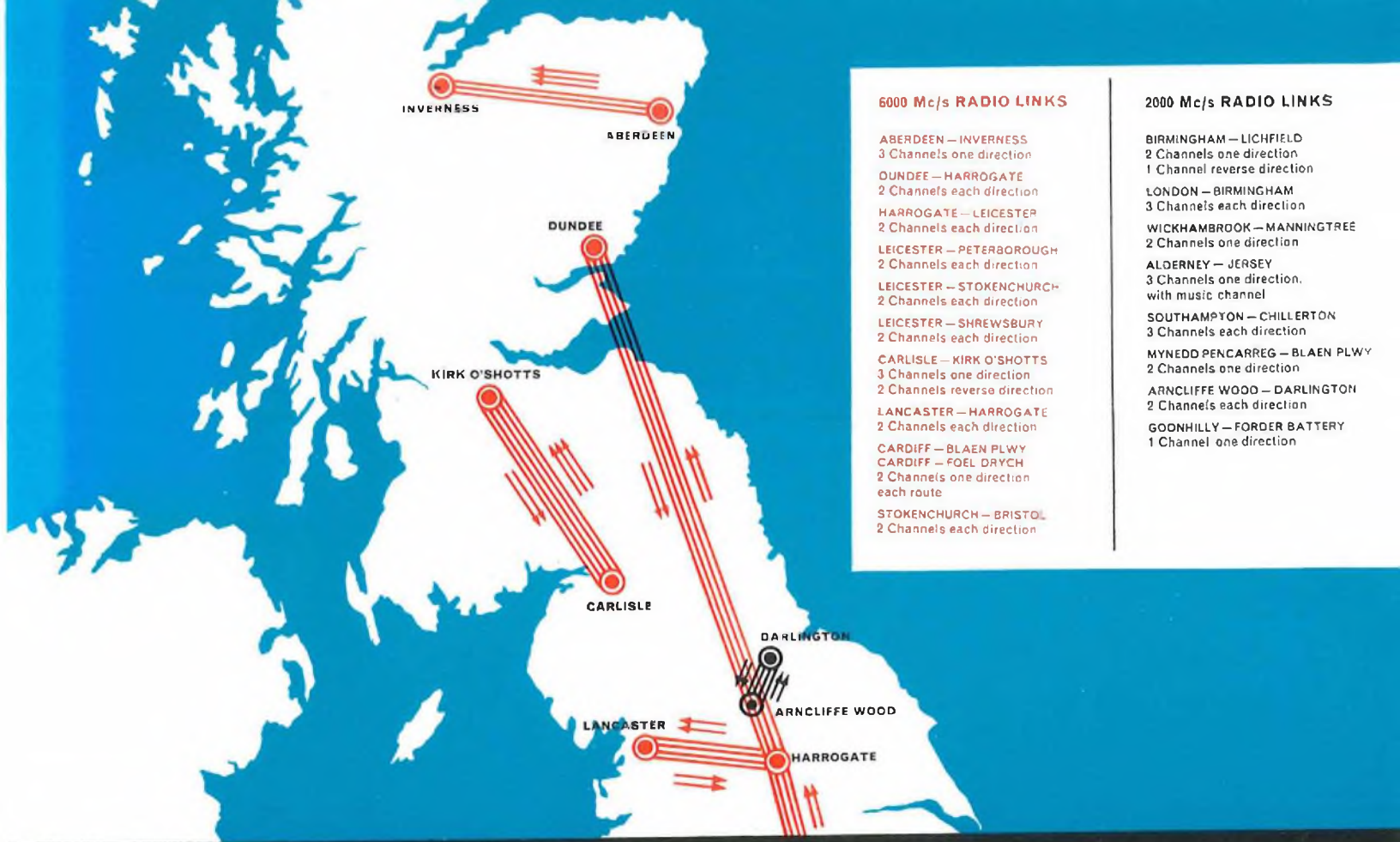

**6000 Mc/s RADIO LINKS**

- ABERDEEN — INVERNESS  
3 Channels one direction
- DUNDEE — HARROGATE  
2 Channels each direction
- HARROGATE — LEICESTER  
2 Channels each direction
- LEICESTER — PETERBOROUGH  
2 Channels each direction
- LEICESTER — STOKENCHURCH  
2 Channels each direction
- LEICESTER — SHREWSBURY  
2 Channels each direction
- CARLISLE — KIRK O'SHOTTS  
3 Channels one direction  
2 Channels reverse direction
- LANCASTER — HARROGATE  
2 Channels each direction
- CARDIFF — BLAEN PLWY  
CARDIFF — FOEL DRYCH  
2 Channels one direction  
each route
- STOKENCHURCH — BRISTOL  
2 Channels each direction

**2000 Mc/s RADIO LINKS**

- BIRMINGHAM — LICHFIELD  
2 Channels one direction  
1 Channel reverse direction
- LONDON — BIRMINGHAM  
3 Channels each direction
- WICKHAMBROOK — MANNINGTREE  
2 Channels one direction
- ALDERNEY — JERSEY  
3 Channels one direction,  
with music channel
- SOUTHAMPTON — CHILLERTON  
3 Channels each direction
- MYNEDD PENCARREG — BLAEN PLWY  
2 Channels one direction
- ARNCLIFFE WOOD — DARLINGTON  
2 Channels each direction
- GOONHILLY — FORDER BATTERY  
1 Channel one direction

**Where there are major radio communication links, then ...**

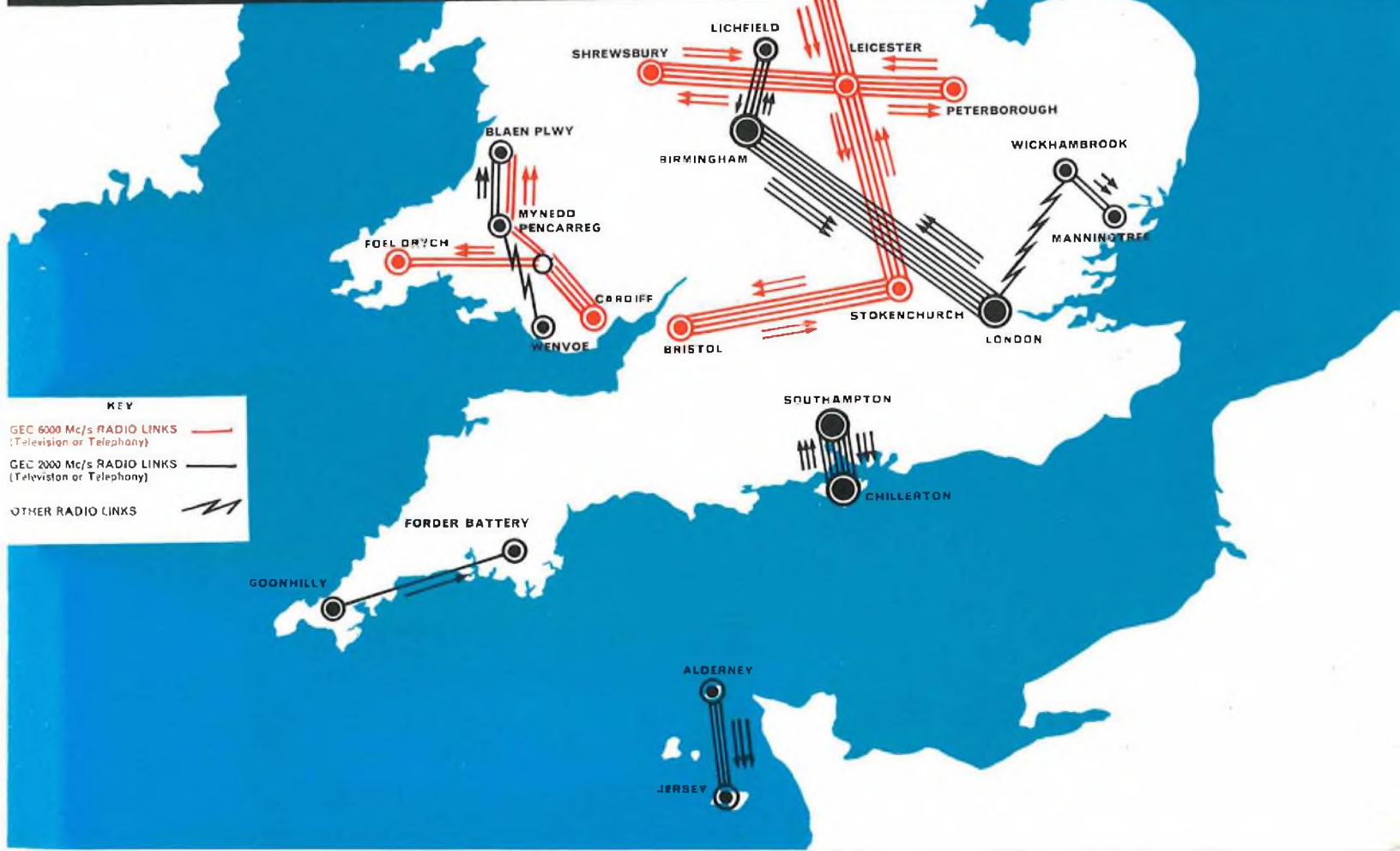

**KEY**

- 6000 Mc/s RADIO LINKS  
(Television or Telephony) — Red line with arrow
- 2000 Mc/s RADIO LINKS  
(Television or Telephony) — Black line with arrow
- OTHER RADIO LINKS — Wavy line

TRANSMISSION DIVISION  
GEC (TELECOMMUNICATIONS) LIMITED  
Telephone Works · Coventry · England  
*Works at Coventry and Middlesbrough*

**G.E.C. is behind them**

**EVERYTHING FOR  
TELECOMMUNICATIONS**

**G.E.C.**



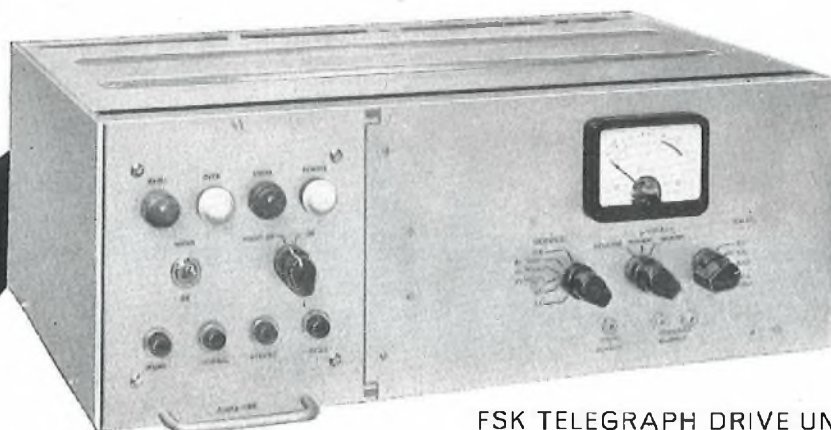

FSK TELEGRAPH DRIVE UNIT  
TYPE A.1422

# TWO NEW TRANSISTORIZED DRIVE UNITS

INDEPENDENT SIDEBAND UNIT  
TYPE A.1424

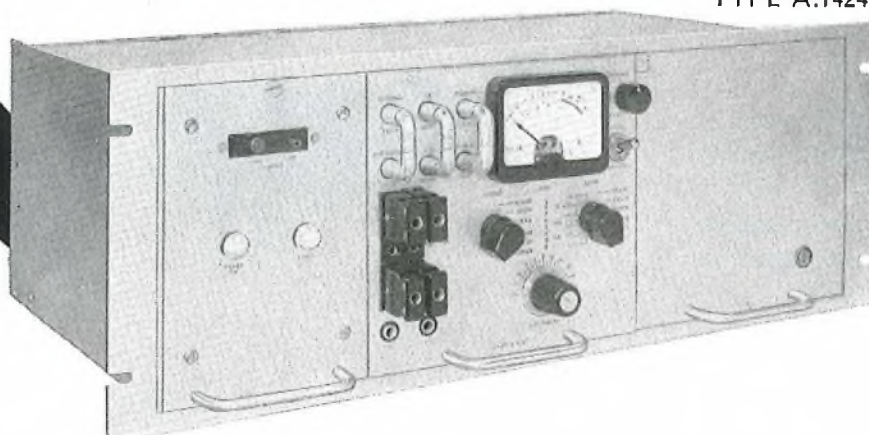

FSK TELEGRAPH DRIVE UNIT  
TYPE A.1422

The A.1422 is a telegraph drive unit with facilities for remote control, fixed or pre-set shifts, twinplex or on-off keying and monitoring for distortion measurement.

**Output** 200 mW into 72 ohms at 3.1 Mc/s.

**Emissions** A1, A2, F1, F6.

Provision is made for black and white facsimile.

**Keying Speeds** 50, 100, 200 and 300 bauds.

Meets C.C.I.R. Recommendations.  
Weight 35 lb (15.9kg.)

INDEPENDENT SIDEBAND UNIT  
TYPE A.1424

The A.1424 accepts one or two 250–6000 c/s inputs from 600-ohms lines and provides an output of 200 mW at 3.1 Mc/s for driving an ISB radio transmitter.

Remote control facilities and monitoring receiver incorporated.

**Input** –20dbm to +10dbm into 600 ohms at 250–6000 c/s.

**Output** 200 mW p.e.p. into 72 ohms at 3.094–3.106 Mc/s.

**Emissions** SSB, ISB or DSB.

Meets C.C.I.R. Recommendations.  
Weight 30 lb (13.6kg.)



62/10E

*Standard Telephones and Cables Limited*

RADIO DIVISION: OAKLEIGH ROAD • NEW SOUTHGATE • LONDON N.11

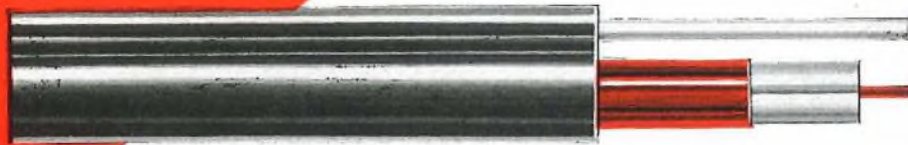

*perfect pictures and sound sense*



Quality reception of a relayed signal over land lines, audio or video, depends on the quality of the cables.

These cables are obtainable from G.E.C. (Lighting & Equipment) Ltd., Lloyd House, 2 Colmore Circus, Birmingham 4, or from Pirelli General Cable Works Ltd., Southampton.

**PIRELLI GENERAL** cables are **DEPENDABLE**

Pirelli General manufacturing techniques make available a new range of cables, which at television frequencies, have screening and radiation properties vastly superior to the double copper-wire braided screen cables previously used.

The almost perfect screening of the television circuits within the cable, and lower transmission losses than corresponding double copper braided cable, have been achieved by producing a co-axial cable insulated with solid or low-loss foam polythene, and having an outer conductor of thin wall welded copper with either a straight or corrugated profile.

The secret behind the success of this new Pirelli General cable is the company's masterly application of continuous welding techniques.

**PIRELLI GENERAL**



*best way to buy*

PIRELLI GENERAL CABLE WORKS LIMITED • SOUTHAMPTON & EASTLEIGH



# SILVER STAR

## encapsulated

# CAPACITORS

Recent additions to the range of JMC Silver Star precision silvered-mica capacitors are four synthetic resin encapsulated types. The encapsulation technique, in conjunction with Silver Star fired construction, ensures outstanding long-term and cyclic stability.

The square sectioned A15E and A25E have been designed specially for transistorised circuitry, while the C22E and C33E have been developed for use in filters and other professional equipment. All are ideal for use on printed circuits.

- ★ Fired construction
- ★ Exceptional long term and cyclic stabilities
- ★ Service temperature range  $-55^{\circ}\text{C}$  to  $+100^{\circ}\text{C}$
- ★ Synthetic resin encapsulated
- ★ Excellent humidity resistance
- ★ Low power factor and high insulation resistance
- ★ Remarkably small size
- ★ Precise body dimensions
- ★ Ideal for printed circuitry

Dimensions and capacitance ranges of each type are given below:

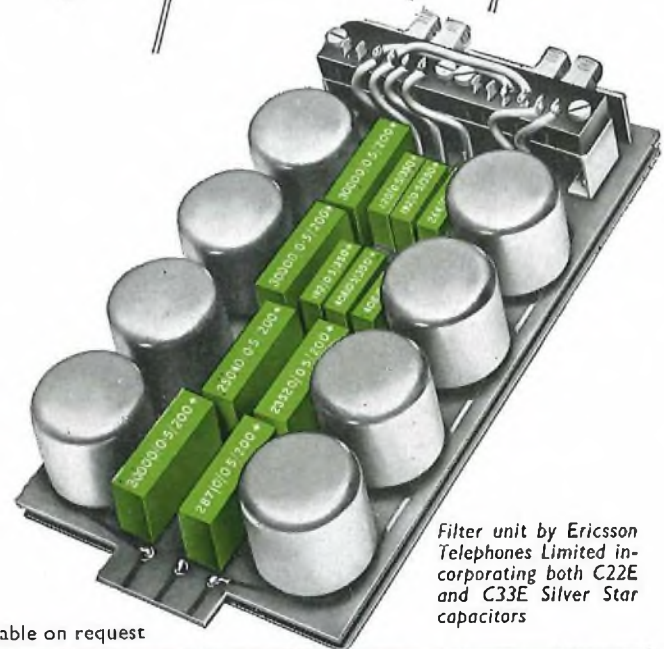
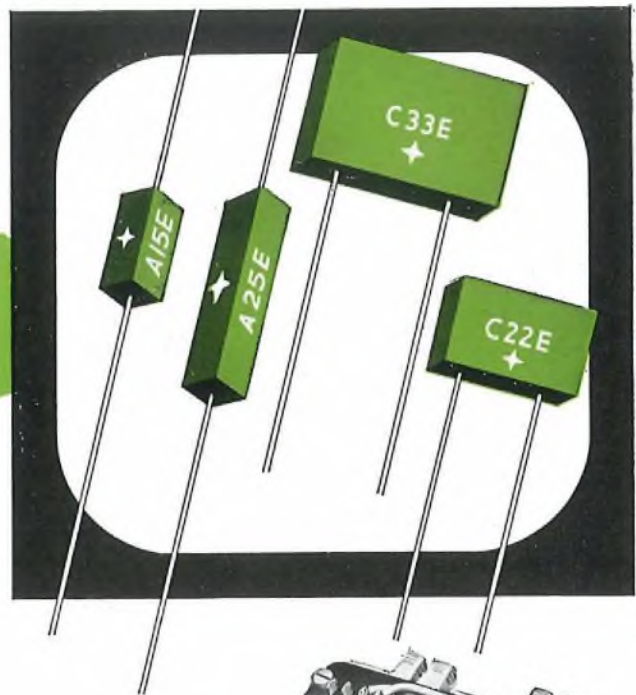

Filter unit by Ericsson Telephones Limited incorporating both C22E and C33E Silver Star capacitors

Data sheets available on request

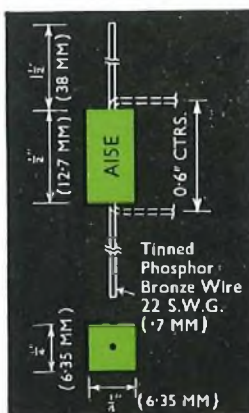

Capacitance Range  
33 to 6,000  $\mu\text{F}$ .  
Minimum Tolerance  
(above 100  $\mu\text{F}$ )  $\pm 2\%$   
(below 100  $\mu\text{F}$ )  $\pm 2 \mu\text{F}$ .

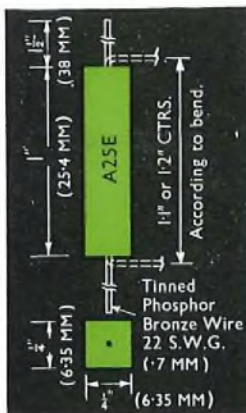

Capacitance Range  
6,000 to 20,000  $\mu\text{F}$ .  
Minimum Tolerance  $\pm 1\%$

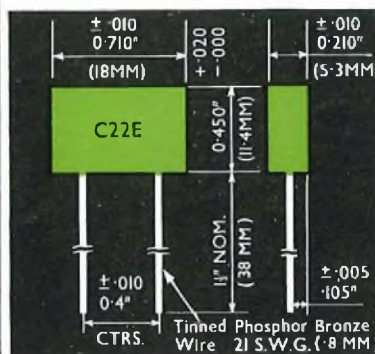

Capacitance Range  
200 volts peak working  
750 to 3,300  $\mu\text{F}$   
350 volts peak working  
5 to 2,000  $\mu\text{F}$ .  
Minimum Tolerance: (above 200  $\mu\text{F}$ )  $\pm 0.5\%$ ; (below 200  $\mu\text{F}$ )  $\pm 1 \mu\text{F}$

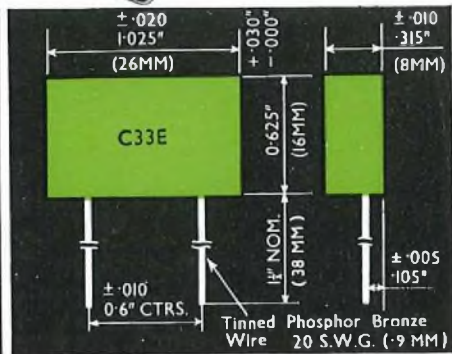

Capacitance Range  
200 volts peak working  
7,500 to 33,000  $\mu\text{F}$   
350 volts peak working  
300 to 20,000  $\mu\text{F}$

These are only four types from the wide range of JMC Silver Star <sup>(R)</sup> capacitors

**Johnson  Matthey**

**JOHNSON, MATTHEY & CO., LIMITED**  
73-83 Hatton Garden, London, E.C.1. Telephone: Holborn 6989  
Vittoria Street, Birmingham, 1 Telephone: Central 8004  
75-79 Eyre Street, Sheffield, 1 Telephone: 29212



# TELEPHONE CABLES LIMITED

are especially pleased when they are called in at the earliest stages of a project—whether it be a country-wide telecommunication scheme, a complete sound or television network, or an exchange cable distribution scheme. Their advice will enable your requirements to be carried out speedily, efficiently, and at minimum cost without unnecessary interference to your existing system. TCL are specialists in the manufacture and installation of telephone cables and in the design of cable networks. In conjunction with their associated companies, TCL are able to design, manufacture and install a complete system for telecommunication projects anywhere in the world.

TELEPHONE CABLES LIMITED, DAGENHAM, ENGLAND • TELEPHONE DOMINION 6611 • CABLES DRYCORE DAGENHAM

call in  
TCL experience  
at the  
start

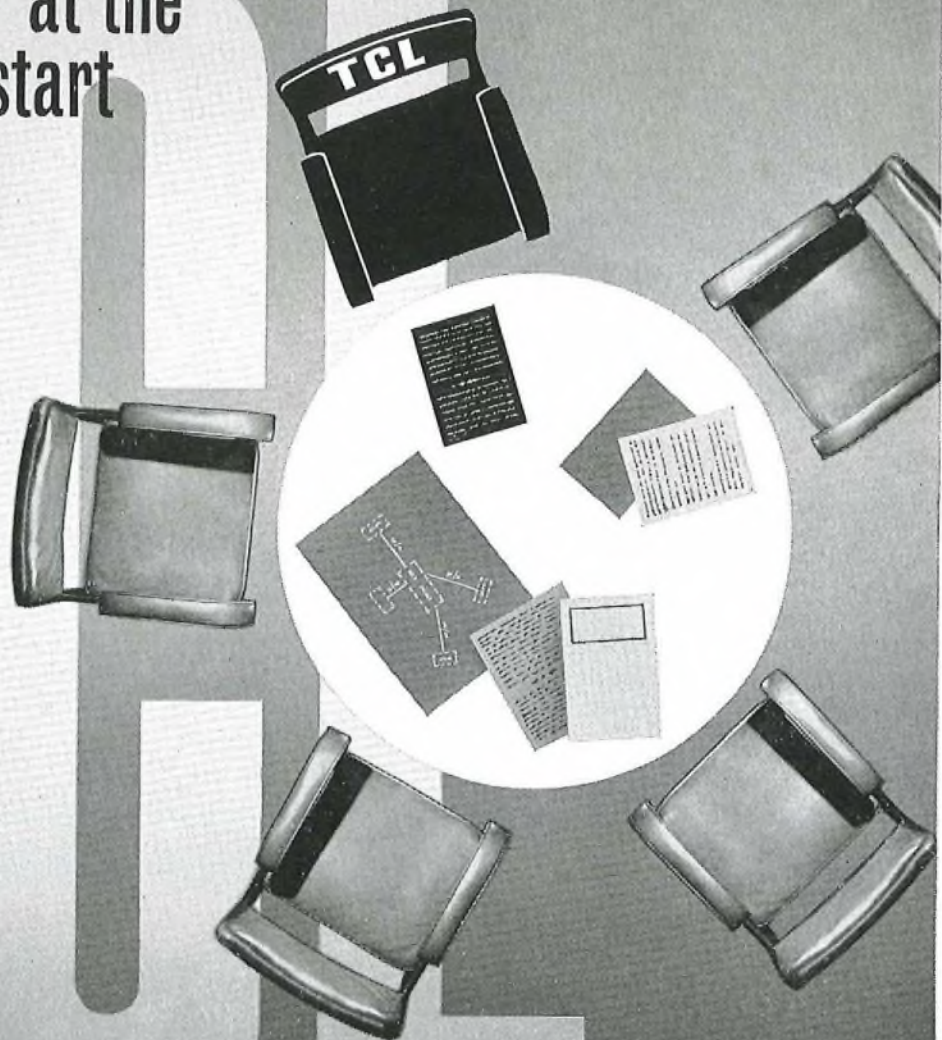

THE ORGANISATION WITH 125 YEARS' EXPERIENCE



Light on Site with  
PROPAGAS Propane



# PROPAGAS

PROPANE

**PRECISION FUEL**

Wherever the job, whatever the conditions, PROPAGAS Propane with its complete reliability, availability, simplicity and economy of operation is unequalled for floodlighting and emergency lighting. PROPAGAS is playing a major part in construction work all over the country.

**for floodlights**

PROPAGAS propane and BOTTOGAS butane are the Precision Fuels for industrial furnaces, the glass industry, radiant heaters, air heaters, bitumen and mastic heating, blow torches, fork lift trucks, agriculture.

*PROPAGAS propane and BOTTOGAS butane come from the British Refineries of the Shell and BP Groups. They are backed by a nationwide distribution service and technical resources second to none.*

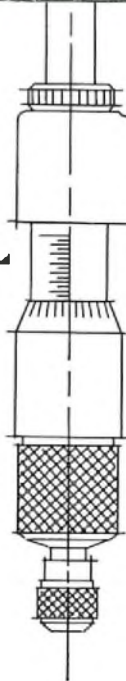

3990



**Gases**



**Shell-Mex and B.P. Gases Limited**  
(Reg'd users of Trade Marks)

Shell-Mex House, Strand, London WC2 Phone: TEMple Bar 1234

# NEW MARCONI 'SOLID STATE' AUTOPLEX

The most advanced error correcting telegraph equipment in existence

## ERROR PROOF HF TRAFFIC

**WITH**

40% less capital cost per channel

75% reduction in size

75% reduction in weight

90% reduction in power consumption

**PLUS**

Considerable savings in manpower, spares and maintenance

- \* One cabinet houses equipment for two 2-channel circuits which may be operated as one 4-channel circuit
- \* Modular construction means greater reliability and greatly simplified maintenance
- \* *Built-in* character storage for 4 or 8 character repetition cycle
- \* Fully automatic phasing including rephasing in traffic with no loss or duplication of characters
- \* Average rephasing time in traffic 4 seconds
- \* Mis-routing of sub-channels is impossible even with sub-division on all channels
- \* Error rate improvement factor of 100-10,000

\* **FERRITRANSISTORIZED** code converters and stores surpass fully transistorized designs by significant reduction in power and saving in space.

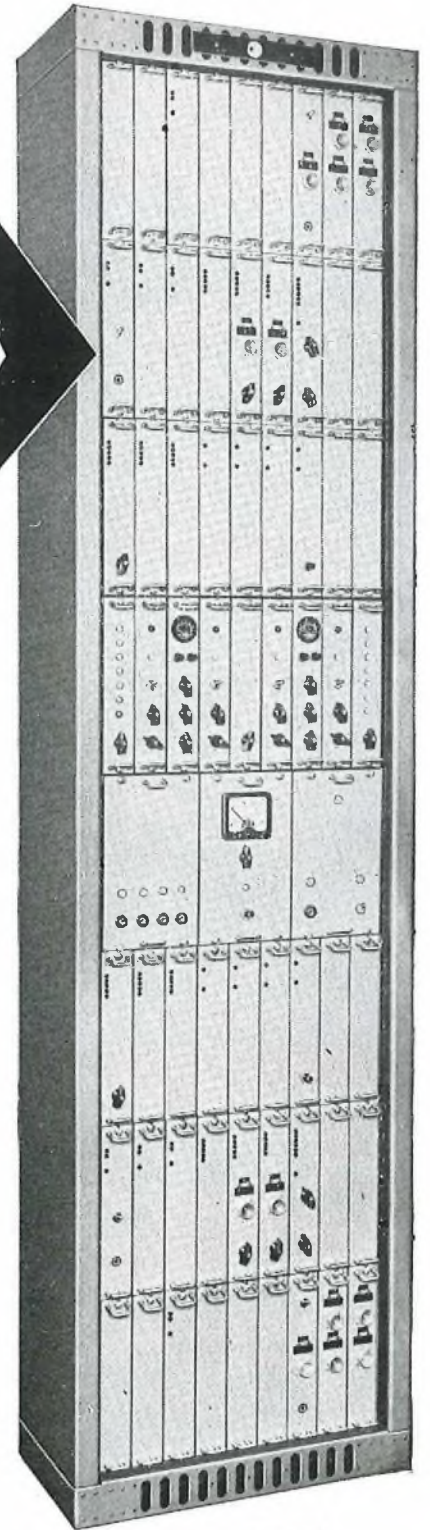

## MARCONI SOLID STATE AUTOPLEX

accurate ERROR CORRECTION MULTIPLEX TELEGRAPH SYSTEMS

MARCONI'S WIRELESS TELEGRAPH COMPANY LIMITED · CHELMSFORD · ESSEX · ENGLAND



# Telephones made from 'Diakon' retain their attractive appearance through years of use



Telephones designed and manufactured by Ericsson Telephones Ltd., Beeston, Nottingham, with cases, handsets and transparent dials made from 'Diakon' I.C.I. acrylic polymer.

'Diakon' acrylic polymer was chosen for these modern telephones because mouldings made from 'Diakon' polymer have so many advantages:—

- no change in surface finish or mechanical properties with age
- good heat stability and high heat distortion temperature
- low water absorption
- resistance to staining by nicotine, lipstick and polishes
- lightness in weight
- wide range of colours which will not fade

Find out more about 'Diakon' polymer, and its many uses in the telecommunications, electric and electronics fields, from your local I.C.I. Sales Office.

**'DIAKON' POLYMER**

*'Diakon' is the registered trade mark for the acrylic polymer manufactured by I.C.I.*



DN 29

IMPERIAL CHEMICAL INDUSTRIES LIMITED · LONDON · S.W.1



# These are PAINTON 'MULTICON' PLUGS & SOCKETS



The table below gives the **minimum** information you should have about them. **Maximum** information available in Catalogue form. Please send for your copy.

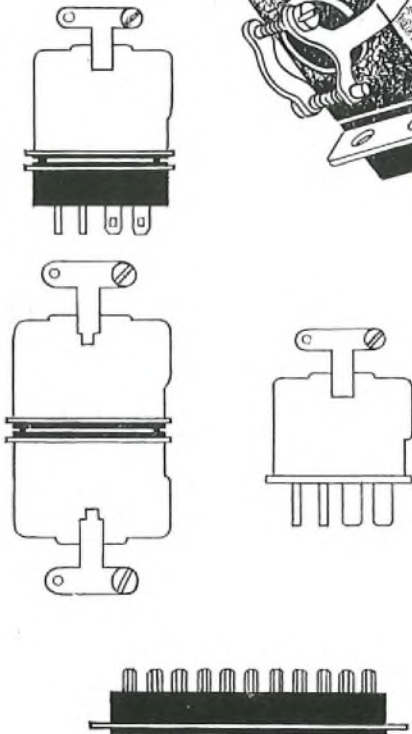

|                            | MULTICON                               | HEAVY DUTY MULTICON             |
|----------------------------|--|---------------------------------|
| SIZES                      | 2, 4, 6, 8, 10, 12, 18, 24 and 33 pole | 4, 6, 8, 12, 18, 24 and 33 pole |
| WORKING VOLTAGE            | 1000V                                  |                                 |
| VOLTAGE PROOF              | 2.5 KV BETWEEN CONTACTS                |                                 |
| CURRENT RATING             | 5 AMPS PER CONTACT                     |                                 |
| AVERAGE CONTACT RESISTANCE | LESS THAN 0.002 OHM                    |                                 |

and these are  
HEAVY  
DUTY  
MULTICONS



HEAVY DUTY MULTICONS are specially designed for applications requiring components of unusually robust construction.

*Delivery of both types of Multicon is good.*

## Painton

& CO. LIMITED

KINGSTHORPE · NORTHAMPTON

Tel: 34251 (10 lines) Grams: 'Ceil' Northampton Telex: 31576

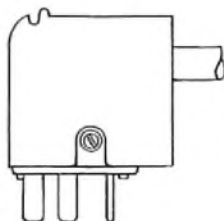



# Telcon Metals

for miniaturised, switching pulsing and control circuits

Telcon Metals manufacture magnetic materials of very high permeability and low loss in the form of toroidal cores, and these are ideally suitable for use in transformers for miniaturised circuits, for transducers in magnetic amplifiers, for switching cores in computers and logic circuits.

## SUPERMUMETAL

**MUMETAL**—alloys with Very high permeability. High impedance. Low losses—Iron & Copper

## H.S. ALLOY

High speed switching material

## H.C.R. ALLOY

A rectangular hysteresis loop alloy for medium power applications. For .001 ins. tape  $\frac{B_{rem}}{B_{sat}}$  ratio is 0.99

## ORTHOMUMETAL

A rectangular hysteresis loop alloy with very high permeability for high gain low power applications.

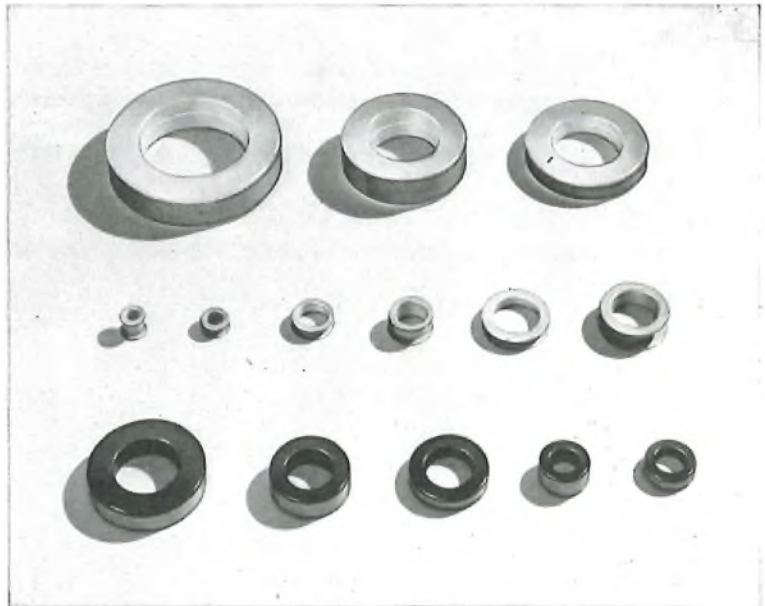

*A selection of our cores*

Further details from

**TELCON METALS LTD** PO BOX No. 12 · MANOR ROYAL · CRAWLEY · SUSSEX

Telephone: Crawley 28800. Telex: 8748. Telegrams: Telcon, Crawley, Telex.

Member of the **BICC** group of companies



G.N.T. 5-Unit Transmitter Model 20



G.N.T. Two-Level Line Commutator

# G.N.T.

## INSTRUMENTS

- Complete range of Wheatstone equipment
- Complete range of special Morse training equipment
- G.N.T. 5-unit Transmitters with one or two sensing heads
- G.N.T. Converters for Morse or Cable Code to 5-Unit or 5-Unit to Morse or Cable Code
- G.N.T. Tape Readers for 5, 6, 7 or 8 Unit Tape

# GREAT NORTHERN TELEGRAPH WORKS

4 SYDHAVN PLADS  
COPENHAGEN DENMARK

LONDON OFFICE:  
5 ST HELENS PLACE EC3



*Typical Type C12G  
terminal rackside*

**T**  
**TH**  
**FO**

As pa  
progr  
Type  
will b  
and E  
and S

# **TYPE CM**

**THE MODERN TRANSMISSION EQUIPMENT PRACTICE**

**AUTOMATI**





# TYPE CM CARRIER

## THE CHOICE OF BRITISH RAILWAYS

### FOR THE NORTH EASTERN REGION

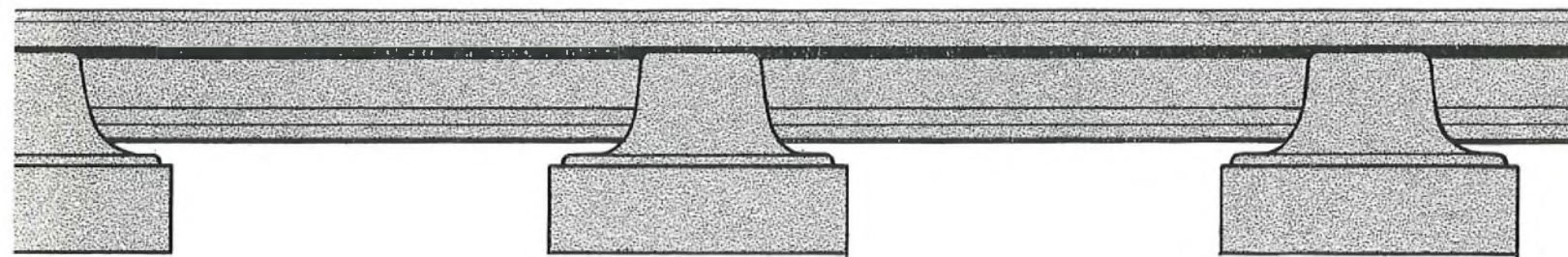

Part of the British Railways modernisation programme in the North Eastern Region, Type CM, the modern transmission equipment, is installed on the main line between York and London and on routes to Middlesbrough and Middlesbrough.

The types of equipment being supplied are :—

- R300A** - A 300-channel multiplex system for use on microwave radio links.
- C120A** - A 120-channel cable carrier system for use on a single small coaxial tube.
- C12G** - A 12-channel cable carrier system for use on a balanced pair.

All these systems are fully transistorised.



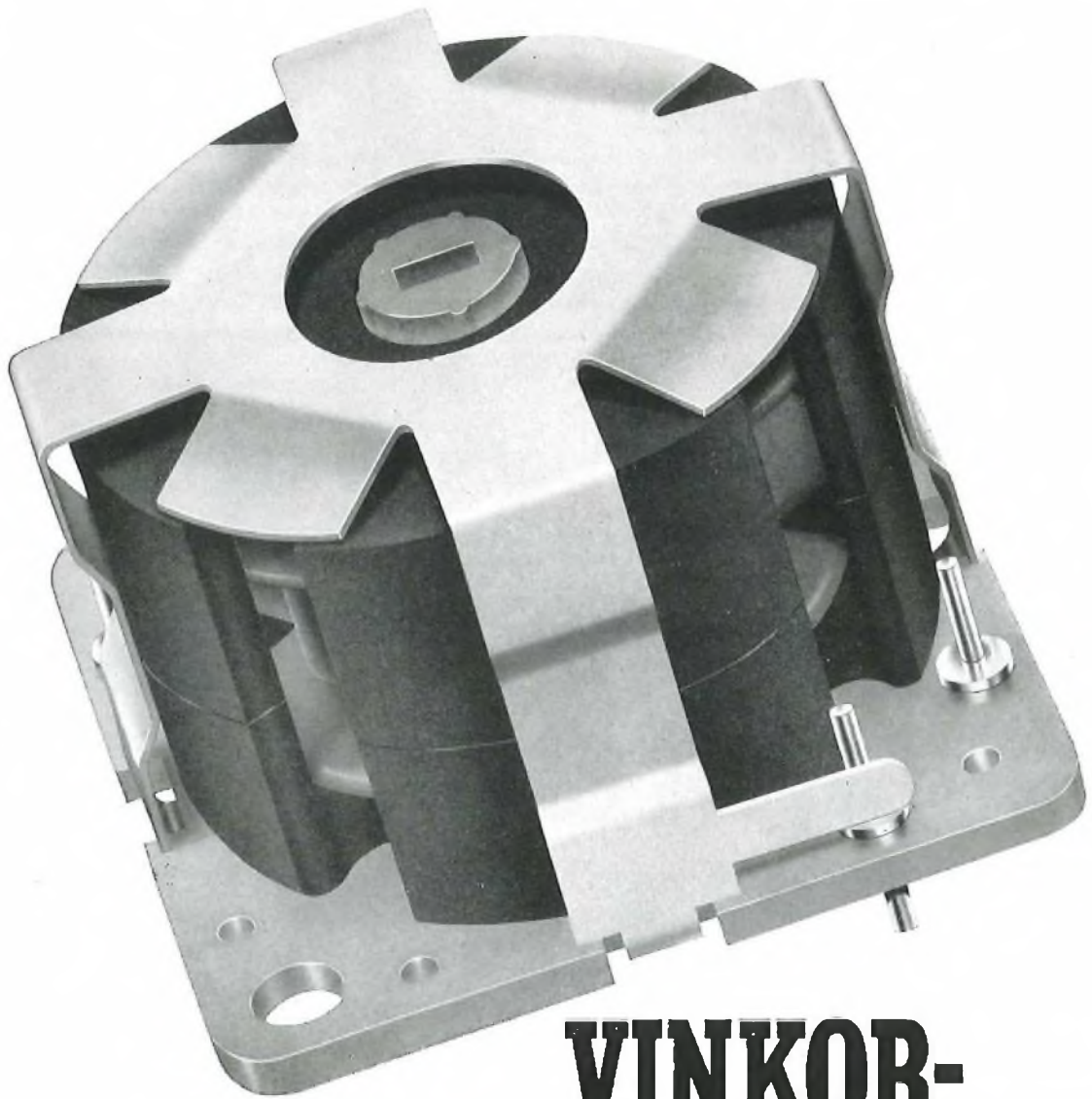

# VINKOR-

**WITH NEW CLIP MOUNTING...**

**SAVES SPACE**—One-third reduction in height

**SAVES WEIGHT**—Approx. 50% reduction

**SAVES TIME**—Easier assembly

**SAVES MONEY**—Simplified construction

Vinkors with the new clip mounting are offered as an alternative to the standard range of Vinkors.

The new clips show a marked reduction in both size and weight and are ideal for applications requiring a simple but effective mounting arrangement.

Where maximum stability is of prime importance, the standard range of Vinkor is still the recommended choice.

Full technical details of both clip and standard housing Vinkors are available on request to Mullard House. Please quote reference Z/1004/7

**Mullard VINKOR ADJUSTABLE POT CORE ASSEMBLIES**

MULLARD LIMITED, COMPONENT DIVISION,  
MULLARD HOUSE, TORRINGTON PLACE,  
LONDON, W.C.1. LAngham 6633



MC1004





# WESTINGHOUSE

*terminating and monitoring  
cubicles and repeater power  
supplies for submarine cables*

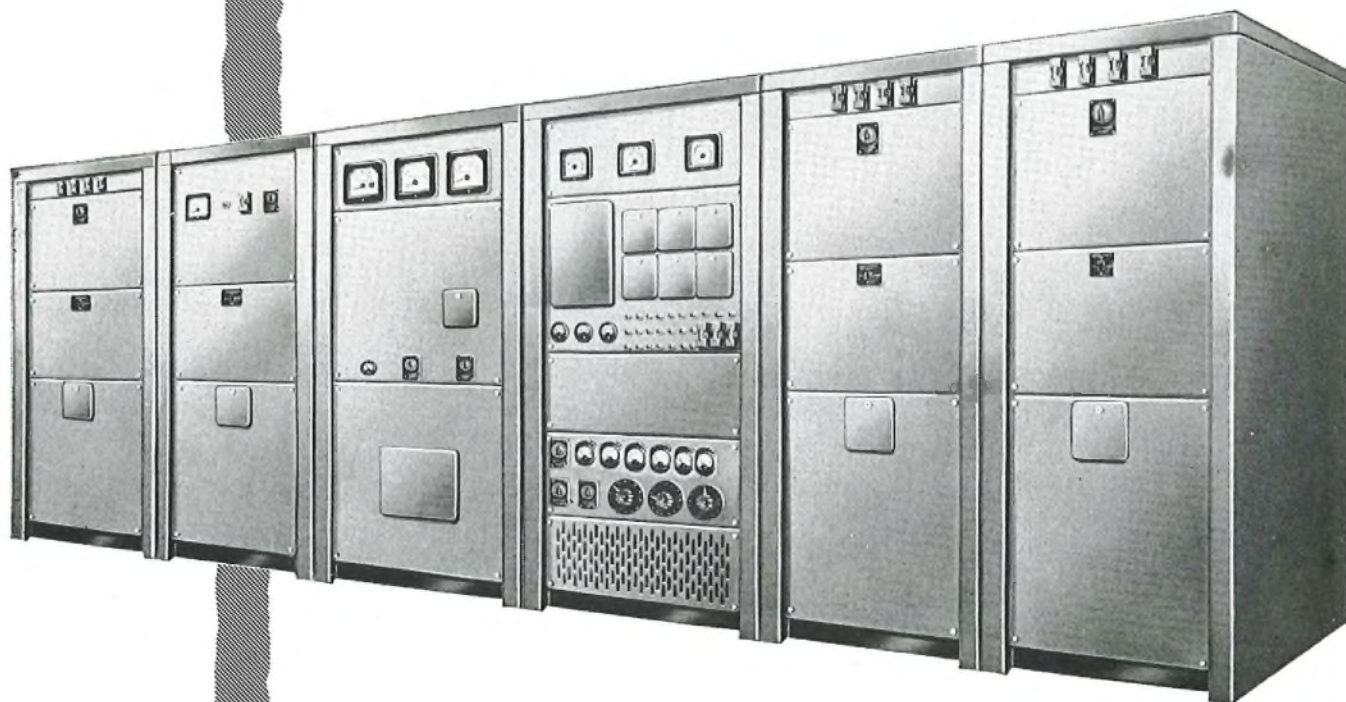

The repeaters are fed with constant current from one or both ends of a link. Extremely close limits of current stability are achieved under all combinations of load and wide fluctuations of input voltage and frequency. Owing to enormous distances between terminating stations, cable power input voltages up to 15kV are quite common.

Westinghouse have supplied cable power feed equipments for Anglo-Swedish, Bermuda-Manahawkin, and Oban-Cornerbrook submerged cables. In addition to these, similar equipments are being manufactured for the Commonwealth Pacific link incorporating Sydney, Auckland, Suva, Hawaii, Vancouver and Port Alberni. Special equipments of a similar kind have also been supplied for cable laying ships "Monarch" and "Alert" and a cable power feed equipment is now under construction for the Cable and Wireless Ship No. 1305.

*For further details write to Special Products, Rectifier Division, Dept. P.O. 7/62.*

**WESTINGHOUSE BRAKE AND SIGNAL CO. LTD**

**82 YORK WAY • KING'S CROSS • LONDON N.1. TER 6432**

WHEN LENGTHS OF DEEP SEA CABLE ARE HANDLED ABOARD H.M.T.S. MONARCH

*Preformed*

**HOLDS  
THE  
LINE....**

*H.M.T.S. Monarch which has laid the deep sea telephone cable to Canada as part of a projected Commonwealth round-the-world link-up. Photograph by courtesy of H.M. Postmaster-General.*

... because the unique Helical gripping of PREFORMED Dead Ends\* gives low localised stress. It holds the extra high tensile steel core of this revolutionary type cable through five slip surfaces without damaging the polythene sheath. This is an outstanding example of the extreme holding power of PREFORMED Dead Ends. Easily and quickly applied—PREFORMED Dead Ends are the discerning engineers choice.

Other Preformed Products Include:

**LINE GUARDS**—for conductor protection at insulators

**LINE SPLICES**—full tension joints

**PATCH RODS**—for repair of strands

**GUY GRIP Dead Ends**—the most economical way of making-off stays

**ARMOR GRIP SUSPENSION ASSEMBLY**—a revolutionary suspension clamp

**SPLICE SHUNTS**—for overheated joints

**BUNDLED CONDUCTOR SPACER UNITS**—the best twin conductor spacer

\*Patent Application Number 817535

Send for Technical Brochure available in ENGLISH, FRENCH, GERMAN or SPANISH

**PREFORMED LINE PRODUCTS**

(GREAT BRITAIN) LIMITED

ANDOVER · HAMPSHIRE · ENGLAND · TELEPHONE · ANDOVER 4045

Other products mentioned are covered by patent and patent application Nos. 817055, 817534, 805333, 817643, 817644, 788908, 817585

Agents in Countries Throughout the World

Manufactured under licence from PREFORMED LINE PRODUCTS CO., CLEVELAND, OHIO, U.S.A.

M.P. 8677





# SPECIALISTS IN REPEATERED SUBMARINE TELEPHONE CABLE SYSTEMS

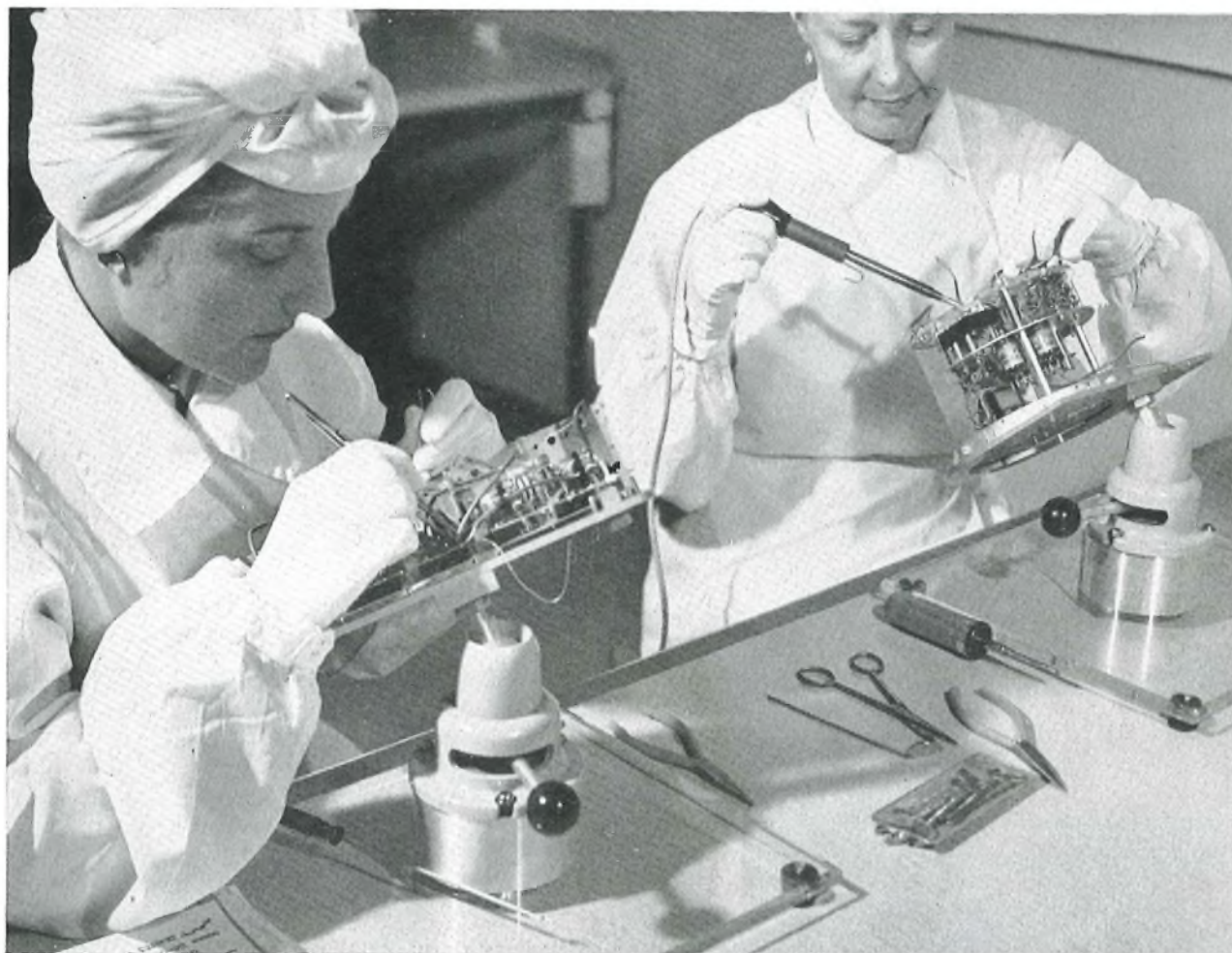

*Wiring and assembly of units for Submerged Repeater*

Submarine Cables Ltd., specialise in complete submarine telephone cable systems—cable, submerged repeaters, cable laying and terminal equipment.

Submarine Cables Ltd. developed the new unarmoured (lightweight) cable designed by the British Post Office and the Company's factory at Greenwich has supplied this type of cable for the first Commonwealth link (called CANTAT) between Scotland and Canada, to the order of the Canadian Overseas Telecommunication Corporation and Cable and Wireless Ltd. Their Repeater Division at Erith, Kent, has made the submerged repeaters for the CANTAT extension from Newfoundland up the St. Lawrence River, to the order of the Canadian Overseas Telecommunication Corporation.

Submarine Cables Ltd., backed by over a hundred years of experience, are in a position to give expert technical advice on any submarine-cable telecommunications problem.

## SUBMARINE CABLES LIMITED

*Owned jointly by Associated Electrical Industries Ltd. and British Insulated Callender's Cables Ltd.*

HEAD OFFICE: Mercury House, Theobald's Road, London WC1 · Telephone: HOLborn 8711 · Telegrams: Talsiem, London, Westcent. · Cablegrams: Talsiem London WC1 WORKS: Telcon Works, Greenwich: Ocean Works, Erith, Kent.

# ADCOLA

Patented Soldering  
(Royal Trade Mark)

## SOLDERING INSTRUMENTS and EQUIPMENT

Illustrated  
L64  $\frac{3}{16}$ " DETACHABLE  
BIT MODEL IN  
PROTECTIVE  
SHIELD L700  
FITTED WITH  
ACCESSORIES FOR  
BIT CLEANING, ETC.

ALL VOLT RANGES  
6/7 to 230/250 VOLTS

British and Foreign  
Patents and Registered  
designs

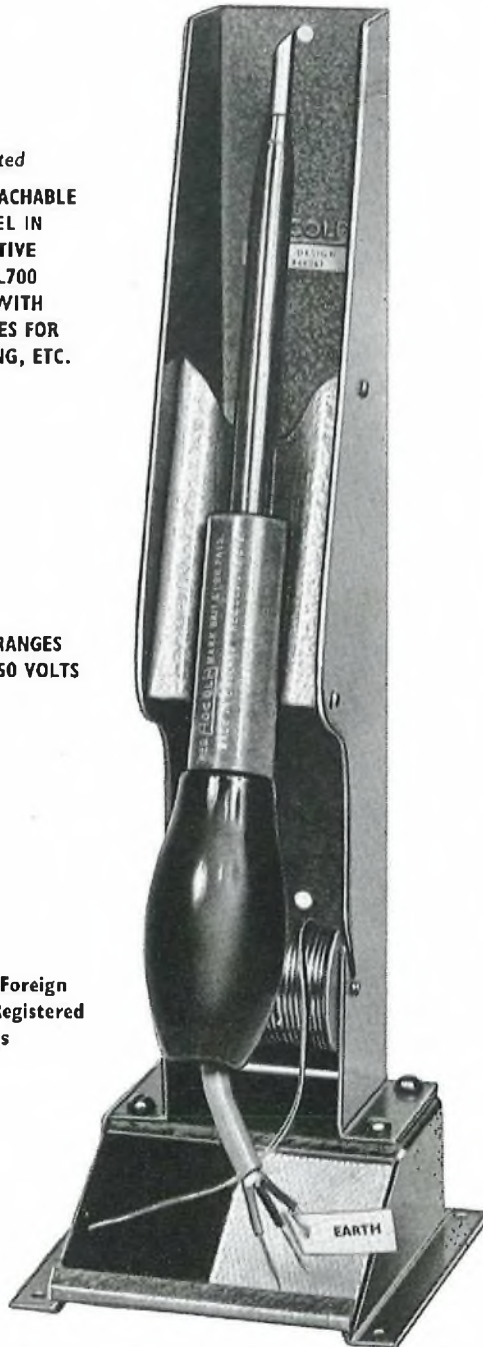

For further information and full illustrated catalogue apply head office

### ADCOLA PRODUCTS LIMITED

ADCOLA HOUSE, GAUDEN ROAD,  
LONDON, S.W.4

Telephones:  
MACaulay 3101 and 4272

Telegrams:  
SOLJOINT, LONDON, S.W.4

## MODEL ANSWER BOOKS

CITY AND GUILDS OF LONDON INSTITUTE  
TELECOMMUNICATION TECHNICIANS' COURSE

TELECOMMUNICATION  
PRINCIPLES A

TELECOMMUNICATION  
PRINCIPLES B

Price 7s. 6d. each. Post Paid 8s.

The following two model answer books, although published for the old Telecommunications Engineering Course, are still useful and are offered at a considerably reduced price.

TELEPHONE EXCHANGE SYSTEMS I

(Telephony and Telegraphy A, Telephony B)

TELEGRAPHY II

(Telegraphy B, Telegraphy C)

Price 2s. each. Post Paid 2s. 6d.

Orders to

The Post Office Electrical Engineers' Journal  
G.P.O., 2-12 Gresham Street, London, E.C.2

## The CARPO GRAMME GAUGE

for  
accurate  
measurement  
of tension  
on Contacts,  
Relays,  
Switchgear,  
etc.

INCORPORATES MAXIMUM  
READING INDICATOR AT  
NO EXTRA COST

The Carpo Standard Model incorporates both tolerance indicators and maximum reading indicator, allowing an accurate reading to be taken when the gauge itself is not visible. A robust but highly sensitive instrument acting in both directions. The 5 gramme model has jewelled movement. Two models cover ten pressure ranges.

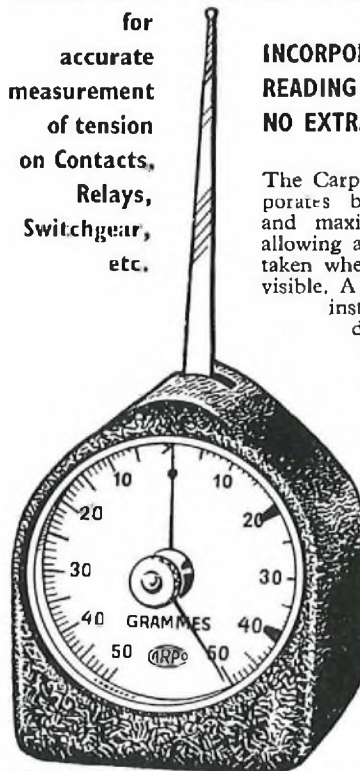

Made under  
licence from Cortrex  
5 GRAMME MODEL  
£3 15 0  
SMALL MODELS:  
£3 10 0 and £3 15 0  
LARGE MODELS:  
£7 15 0 and £9 15 0  
Special discounts for  
large quantities

Write or 'phone for  
illustrated leaflet

OBTAINABLE FROM  
**J. P. FILHOL LTD.** MILLERS ROAD, WARWICK  
TELEPHONE: WARWICK 559  
MANUFACTURERS OF JEWEL BEARINGS AND PRECISION TURNED PARTS



# FLUSH MOUNTING RESETTABLE METERS

This 3 figure meter as adopted for subscriber trunk dialling is an example from a complete range of electro-mechanical counters. Manual and electrical reset types for indication, pre-determined counting, printing and readout are available.



THE STONEBRIDGE ELECTRICAL CO. LTD.

6 QUEEN ANNE'S GATE • LONDON, S.W.1 Telephone: TRAFalgar 1444

CONTROLS & INSTRUMENTS

**STONEBRIDGE**

Agents and Licensees in U.K. for 'SODECO' Geneva

*Ernest Turner*

## Electrical Measuring Instruments

Ideally matching contemporary panel design, the Ernest Turner Model 703, illustrated here, is enhanced by the flush-fitting surround. A high degree of accuracy is adequately supported by the easy-to-read scale and clean dial layout. Full details of the range of rectangular electrical measuring instruments and flush mountings are contained in Leaflets 85/G and 85/AF, available on request.

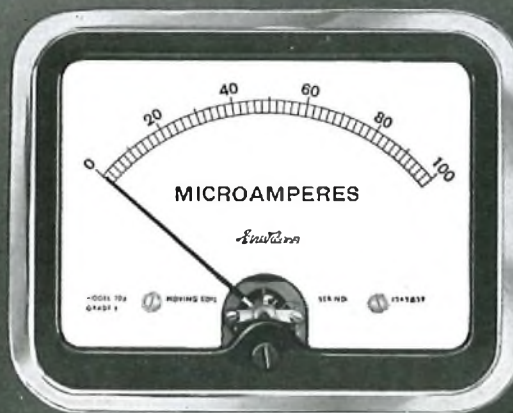

**Ernest Turner Electrical Instruments Ltd**  
HIGH WYCOMBE • BUCKINGHAMSHIRE • ENGLAND

## INDEX TO ADVERTISERS

|   | PAGE                 |   | PAGE                       |
|---|----------------------|---|----------------------------|
| Adcola Products, Ltd. . . . .                         | 38                   | Oxley Developments Co., Ltd. . . . .                  | 40                         |
| Associated Electrical Industries, Ltd. . . . .        | 6, 41                | Painton & Co., Ltd. . . . .                           | 30                         |
| Automatic Telephone & Electric Co., Ltd. . . . .      | 32-33                | Pirelli General Cable Works, Ltd. . . . .             | 24                         |
| Avon, Ltd. . . . .                                    | 4                    | Pitman, Sir Isaac, & Sons, Ltd. . . . .               | 20                         |
| British Institute of Engineering Technology . . . . . | 20                   | Preformed Line Products (Great Britain), Ltd. . . . . | 36                         |
| Drallim Industries, Ltd. . . . .                      | 4                    | Pye Telecommunications, Ltd. . . . .                  | 10                         |
| Ericsson Telephones, Ltd. . . . .                     | 9, 14                | Shell-Mex & B.P. Gases, Ltd. . . . .                  | 27                         |
| Filhol, J. P., Ltd. . . . .                           | 38                   | Standard Telephones & Cables, Ltd. . . . .            | 1, 3, 5, 7, 11, 15, 19, 23 |
| Formica, Ltd. . . . .                                 | 18                   | Stonebridge Electrical Co., Ltd., The . . . . .       | 39                         |
| G.E.C. (Telecommunications), Ltd. . . . .             | 12-13, 16-17, 21, 22 | Submarine Cables, Ltd. . . . .                        | 37                         |
| Great Northern Telegraph Co., Ltd. . . . .            | 31                   | Telcon Metals, Ltd. . . . .                           | 31                         |
| Imperial Chemical Industries, Ltd. . . . .            | 29                   | Telephone Cables, Ltd. . . . .                        | 26                         |
| Johnson, Matthey & Co., Ltd. . . . .                  | 25                   | Telephone Manufacturing Co., Ltd. . . . .             | 8                          |
| Mallory Batteries, Ltd. . . . .                       | 42                   | Turner, Ernest, Electrical Instruments, Ltd. . . . .  | 39                         |
| Marconi's Wireless Telegraph Co., Ltd. . . . .        | 28                   | Westinghouse Brake & Signal Co., Ltd. . . . .         | 35                         |
| Mullard, Ltd. . . . .                                 | 34                   | Whiteley Electrical Radio Co., Ltd. . . . .           | 20                         |
| Neill, James, & Co. (Sheffield), Ltd. . . . .         | 2                    | Winn & Coales, Ltd. . . . .                           | 2                          |

British scientists have constructed instruments for three vital experiments in the first British satellite recently launched by the Americans. The total weight of these equipments will make a payload of 20lbs.

## The First Anglo-American 'Ariel' Satellite

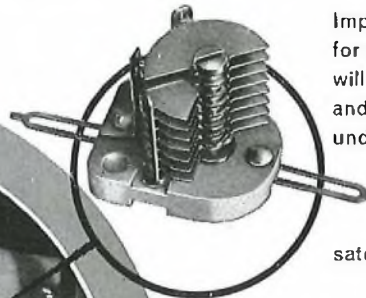
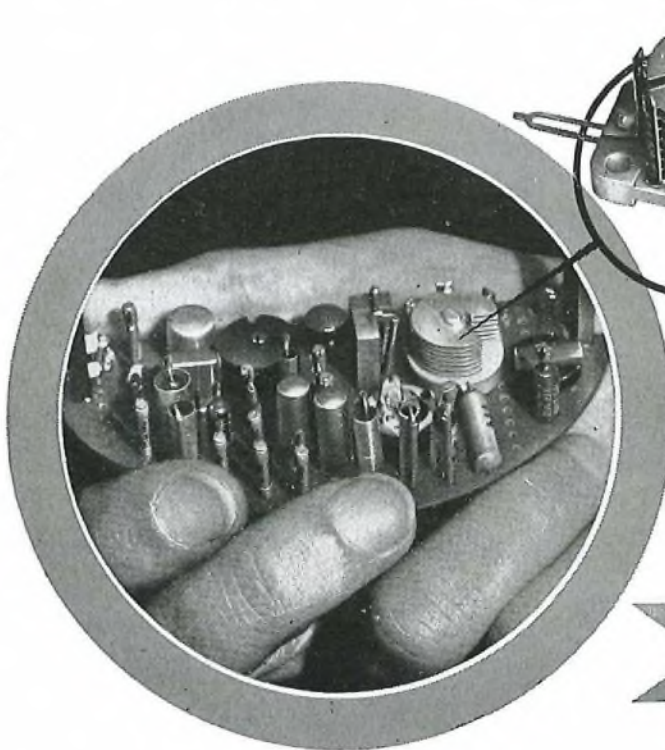

Imperial College, London have provided equipment for the study of Cosmic rays. Ionospheric studies will be carried out by University College, London and The University of Birmingham. The latter under the direction of Professor J. Sayers have contributed an instrument for the study of the free electron population density in space and of the electrostatic potential of the satellite vehicle relative to its space environment.

We at Oxley's are proud that our trimmer capacitors and barb insulators have been chosen by Professor J. Sayers' team for use in their project. The trimmer capacitors are used in a radio frequency bridge circuit upon which the experiment to measure electron density is based. It is, therefore, essential that component stability under adverse environmental conditions is maintained in order that accuracy of scientific measurements is in no way altered.

**For full technical information for these and other Oxley products, write to:**

# OXLEY

**OXLEY DEVELOPMENTS COMPANY LTD.**  
ULVERSTON LANCASHIRE  
Telephone : Ulverston 3306 Cables : Oxley, Ulverston



The steady advance in automatic long-distance telephone communications was emphasized when A.E.I. equipment was put into service for the 'senderization' of the Winnipeg (Manitoba) and Edmonton (Alberta) Automatic Toll Exchanges. The automatic translation and routing equipment which comprise an A.E.I. 'Senderization' installation represents another great step forward in the elimination of operators for handling long-distance calls. In terms of service advantages, it can be compared with the advance that took place with the introduction of automatic exchanges to handle local calls.

Similar equipment later manufactured for Halifax, Nova Scotia, provided yet another link between the main switching centres in Canada, and in turn with the whole American continent.

▼ Sender

Translator ►

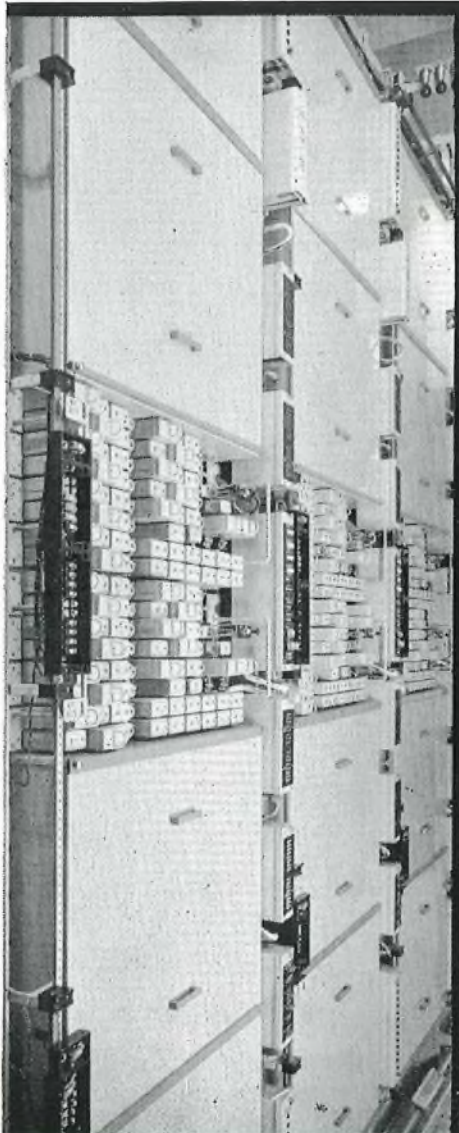

Long  
distance  
dialling  
with

**AEI**

*Senderization*

*Features include:*

- A common translator handling a maximum of 25,000 calls per hour;
- Automatic alternative routing, providing a maximum of six routes;
- High-speed multi-frequency signalling;
- Digit deletion, code conversion and prefixing to cater for all routing requirements;
- Traffic measurement on any route or group of routes.

The continuous process of research and development which produces such equipment keeps the name of A.E.I. in the forefront of Telecommunications.

**AEI**

**Associated Electrical Industries Ltd.  
Telecommunications Division**

Woolwich, London, S.E.18



Mallory not only build unique 'Sound Power' into their batteries— they've solved the problem of keeping it there. Mallory battery cell cases play no part in the electro-chemical process: they resist corrosion, protect cell materials. Double seals, specially moulded gaskets, new sealing techniques also help to make Mallory batteries leakproof. These and other original features help to underwrite the claim— Mallory batteries are the greatest dry cell development for more than eighty years. They are fadeproof not only on the shelf but on the job. They offer a constant voltage discharge over a very long life to all manufacturers who wish to miniaturise their products and retain full 'Sound Power'.

# Mallory batteries

## do not leak

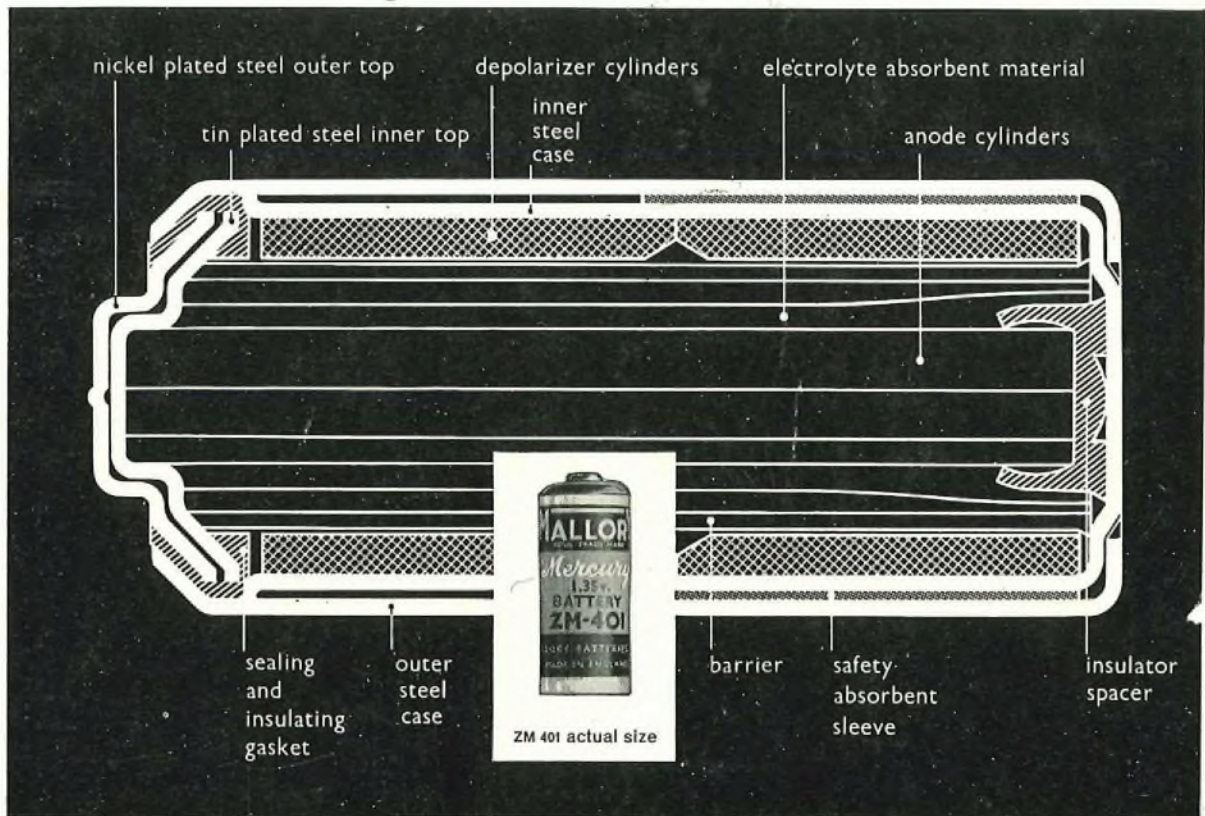

Manufacturers are advised to consult Mallory at the design stage so that full benefit can be gained from the world's most space-saving source of power.

Please write for literature to

**Mallory Batteries Limited,**  
33 Duke Street, London W1



*miniature batteries for powerful applications*