

THE POST OFFICE ELECTRICAL ENGINEERS' JOURNAL

VOL. 40

JULY 1947

PART 2

CONTENTS

| | PAGE |
|---|------------------|
| THE ANGLO-GERMAN SUBMARINE CABLE SCHEME—H. Williams, A.C.G.I., M.I.E.E., and R. J. Halsey, B.Sc.(Eng.), A.C.G.I., D.I.C., A.M.I.E.E. | 49 |
| THROUGH-GROUP WORKING IN THE COAXIAL CABLE NETWORK—Part 1—Performance Requirements—C. F. Floyd, M.A., A.M.I.E.E. | 57 |
| THE RECONSTRUCTION OF TEN 305-FT. TUBULAR STEEL RADIO MASTS IN REINFORCED CONCRETE—Part 2—Constructional Methods—J. P. Harding, B.Sc.(Eng.), A. M. Inst.C.E., A.M.I.E.E., and J. F. Harmon | 63 |
| THE INTRODUCTION OF MANUAL SWITCHING OF TELEPRINTER CIRCUITS IN THE PUBLIC TELEGRAPH SERVICE—Part 1—The Teleprinter Switching Network—H. E. Wilcockson, A.M.I.E.E., and C. W. A. Mitchell, A.M.I.E.E. | 69 |
| THE PREDICTION OF OPTIMUM WORKING FREQUENCIES FOR SHORT WAVE RADIO CIRCUITS—H. Stanesby, M.I.E.E., and G. H. M. Gleadle, M.Sc.(Eng.), A.M.I.E.E. | 76 |
| TENSION LIMITING GEAR FOR A POWER-DRIVEN WINCH—L. L. Hall, A.I.E.E., A.I.R.E., and D. E. Watt-Carter, A.M.I.E.E. | 80 |
| NOTES AND COMMENTS | 84 |
| INSTITUTION'S LIBRARY | 85 |
| REGIONAL NOTES | 87 |
| JUNIOR SECTION NOTES | 93 |
| STAFF CHANGES | 95 |
| BOOK REVIEWS | 56, 68, 75, & 83 |

Price 1/- net

THE INSTITUTION OF POST OFFICE ELECTRICAL ENGINEERS

DECADE SWITCH

*A Precision Component Embodying
All The Best Design Features*

Very low contact resistance. Sturdy action.
Positive location. Twelve positions—providing two extra contacts
—30° angular spacing simplifies dial calibration
Two types available—416A (Shorting) and 416B
(Non-Shorting).
Can also be supplied in banked units of two or more switches
PRICES ON APPLICATION

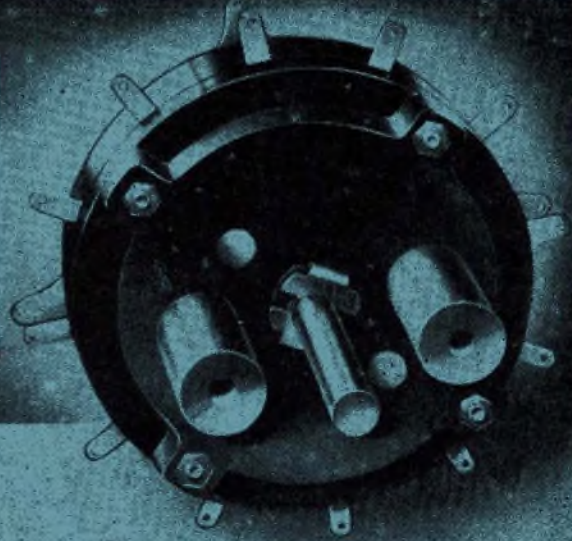

G.E.C.

PRECISION CONTROLS FOR COMMUNICATIONS & MEASURING EQUIPMENT

SALFORD ELECTRICAL INSTRUMENTS LTD.
PEEL WORKS SALFORD 3
Phone: BLA. 6688 (6 lines) Grams & Cables "Sparkless, Manchester"
Proprietors: **THE GENERAL ELECTRIC CO. LTD.** England

EDISWAN

TELEPHONE LINE PROTECTORS.

FOR THE PROTECTION OF LINES OF COMMUNICATION
FROM SURGES INDUCED BY LIGHTNING OR FAULTS
ON NEIGHBOURING POWER LINES.

Ediswan Telephone Line Protectors have now been in commission for nearly twenty years. They have proved their worth in all parts of the world and are being called for and installed in ever increasing numbers.

Many thousands were employed during the war years for the protection of vital lines of communication and were eminently successful. Reports of their outstanding merit and successful operation continue to reach us and in recent years they have proved of particular interest for protection against surges caused by lightning discharges.

Continued research has enabled us to patent a further improvement which removes any suggestion of delay in operation.

Further information and prices on application.

THE EDISON SWAN ELECTRIC CO., LTD. 
155 CHARING CROSS ROAD, LONDON, W.C.2

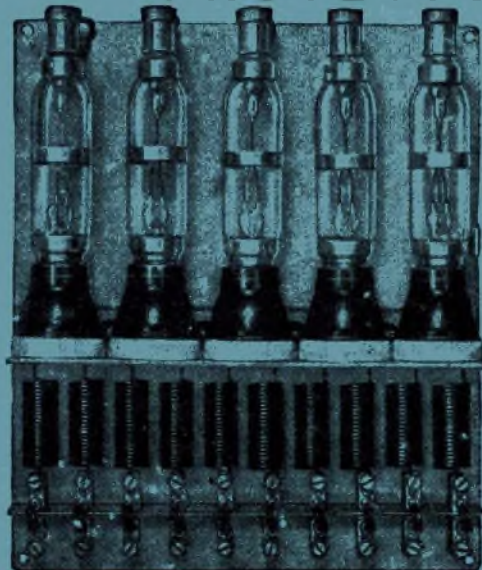

Prov. Patent
25850/45.

5-circuit
panel for
overhead
lines incor-
porating
choke
coils, spark
caps, etc.

T. 2.2

THE POST OFFICE ELECTRICAL ENGINEERS' JOURNAL

Vol. XL

July, 1947

Part II

The Anglo-German Submarine Cable Scheme

H. WILLIAMS, A.C.G.I., M.I.E.E., and
R. J. HALSEY, B.Sc. (Eng.), A.C.G.I., D.I.C., A.M.I.E.E.

U.D.C. 621.395.5 621.394.5

To provide military circuits direct to Germany the Post Office laid in September, 1945, a coaxial cable between Lowestoft and Borkum. Initially this provided 6 duplex telegraph channels, increased shortly afterwards by one speech channel which could also be used for 18-channel V.F. telegraphy. In June, 1946, a submerged repeater was inserted in this cable and terminal equipment installed at the two ends which increased the capacity of the cable to five speech circuits any of which could be used for 18-channel V.F. telegraphy.

Introduction.

THE normal method of provision of circuits from this country to Germany involves transit through Holland or Belgium. The distances are such that until now it has never been feasible to provide direct circuits. To provide military circuits directly to Germany the Post Office undertook the scheme to be described. Suitable landing points, involving connecting circuits to the inland networks were Lowestoft on the English side and Borkum, an island off the N.W. coast of Germany. The final scheme included the provision of a submerged repeater, but to bridge the time when this could be provided temporary schemes were made use of, and the cable laid without the repeater.

The Lowestoft-Borkum cable was laid therefore between 13th September, 1945, and 20th October, 1945. Owing to its length (approx. 196.7 miles) it had to be laid in a number of separate portions, the two ships taking part being H.M.T.S. *Ariel* and H.M.T.S. *Bullhead*. The cable is of the coaxial type used in a number of our submarine cables, for instance the Anglo-Dutch Nos. 4 and 5 cables, except that the dielectric is polythene.^{1, 2} At Borkum the repeater station is close to the beach and submarine cable as landed from the ship was carried directly into the station. At Lowestoft, where the repeater station is a little over $\frac{1}{2}$ mile from the beach, special lead covered submarine type core was laid between the station and the beach in advance of the laying of the main cable. In view of the high attenuation at the low frequencies used on the cable it was necessary to take special precautions against mains interference and radio interference in this section, and consequently an insulated outer conductor type was adopted and a layer of polythene approximately 0.1 inch thick was extruded over the outer conductor and then the lead sheath extruded over the whole. To make the best use of the cable, which, being in stock could be provided relatively quickly, it was decided to proceed in three stages.

- Stage 1, the provision of six duplex telegraph channels only.
- Stage 2, the provision of one 4-wire speech or 18-channel V.F.T. circuit in addition to that provided on stage 1, and
- Stage 3, the provision of five speech circuits, any one of which could be used for 18-channel voice-frequency telegraphy, which necessitated the laying of a submerged repeater.

STAGES 1 AND 2.

The equipment for Stage 1 is shown in the lower section of Fig. 1, as it was arranged to work two Army 3-channel duplex voice-frequency telegraph systems over the cable. The telegraph terminal equipment was installed in London and in Hamburg. The frequency range for the Army 3-channel duplex systems when combined is in one direction 420-1,020 c/s and in the return direction 1380-1980 c/s. The two land sections, therefore, were normal 4-wire speech circuits and the equipment was combined at the two coastal repeater stations by directional filters so as to work over the single cable. This equipment was required urgently and consequently special terminal equipment installed at the repeater stations was built up from existing equipment and was mainly standard Post Office amplifiers and filters from Army type voice-frequency telegraph repeaters. Stage 2 was also required urgently, and this also was therefore built up as far as possible from available standard equipment. It will be seen from Fig. 1 that filters were inserted to separate the band of frequencies used for the 6-channel voice frequency telegraph systems from the frequency spectrum above this, and the second circuit was provided by transmitting in the frequency band 3.4-6 kc/s in the direction Lowestoft-Borkum and in the frequency band 9.9-12.5 kc/s in the direction Borkum-Lowestoft. These frequencies correspond to those used on the Army 1+4 Carrier System³ and for Stage 2 one terminal of this system was provided at Lowestoft and Borkum. Special directional filters were built and the remainder of the equipment provided by the use of the standard P.O. Amplifier No. 35, amplifiers from 3-channel open

¹ P.O.E.E.J., Vol. 30, p. 222.

² J.I.E.E., Vol. 91, p. 218.

³ P.O.E.E.J., Vol. 38, p. 1.

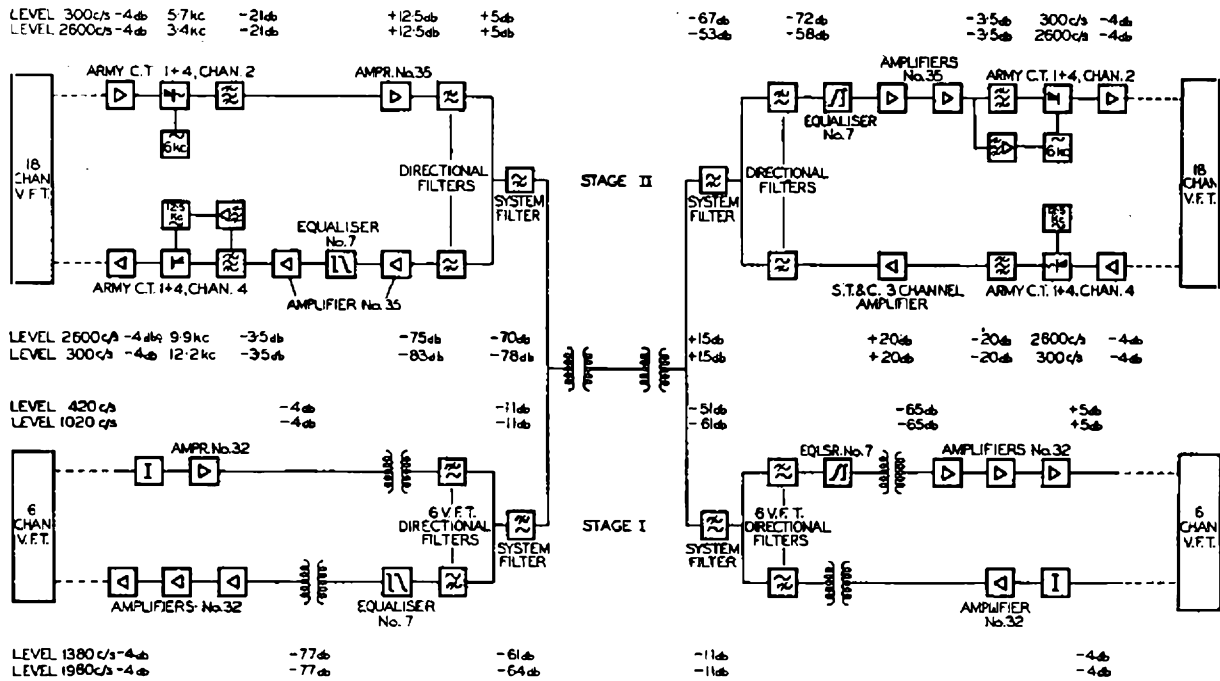

FIG. 1.—6-CHANNEL V.F.T. AND 18-CHANNEL V.F.T.; STAGES 1 AND 2.

wire systems, and equalisers made up from 12-channel and 3-channel open wire units.

The additional circuit so provided was capable of carrying either speech or one 18-channel V.F. telegraph system and it was used for the latter purpose. The Army 1+4 system is not synchronised, arrangements being provided for periodic check and adjustment. In view of the importance of the circuits, however, it was thought advisable to synchronise the two ends. This was done by transmitting at low level the 6 kc/s carrier in one direction and the 12.5 kc/s carrier in the return direction. These were filtered out at the receiving ends and used to lock the local oscillators.

STAGE 3—THE FINAL SCHEME.

In the third and final stage, five telephone circuits are provided between Lowestoft and Borkum using channel equipment of a Carrier System No. 7⁴ (Channels 8-12 only), special group modulating equipment and one submerged repeater. The five channels are first assembled in the frequency range 60-80 kc/s (inverted sidebands) in the No. 7 equipment and are translated to the frequency ranges 0-20 and 24-44 kc/s (erect sidebands), using group carrier frequencies of 80 and 104 kc/s respectively, for the two directions of transmission. The higher frequency band is transmitted over the cable from Borkum to Lowestoft and the attenuation at 44 kc/s is such that, with a 10 watt transmitting amplifier at Borkum a maximum gain of 75 db is required in the submerged repeater. The lower frequency band is not amplified in the submerged repeater and since the cable attenuation at 20 kc/s is 112 db a 100 watt transmitting amplifier is necessary at Lowestoft.

⁴ P.O.E.E.J., Vol. 34, pp. 101 and 161.

General Arrangement.

A simplified block schematic diagram of the scheme is shown in Fig. 2. The group and line equipments only are included, both input and output being in the range 60-80 kc/s, at levels -37 db and -8 db respectively, from the standard channel equipment.

Fig. 3 shows the cable attenuation over the working frequency ranges; the working levels (relative to the 2-wire input) for the extreme frequencies in the two directions of transmission are included in Fig. 2.

The line frequencies employed in the system are so low and the cable attenuations involved are so great that the elimination of crosstalk and external interference and the realisation of design attenuations in the terminal equipment require very careful attention. In high frequency systems these requirements are now normally provided for by making the construction "coaxial" throughout, each unit being arranged as an expanded bulge in the coaxial cabling; the screens then form part of the transmission circuit, must fully enclose the internal elements and must be thick enough to give the desired degree of shielding. In the present scheme, this technique is only partially effective as the necessary screen thickness would be excessive; although filters and equalisers have been assembled in containers of this type designed for higher frequencies, the amplifiers are of comparatively open construction. The full attenuation of the filters is realised and freedom from interference by earth currents is ensured by the use of double-screened transformers. These introduce high series impedances in the earth circuits, thereby greatly reducing the circulating currents which would otherwise flow via the outer coaxial conductor, the cable sheath and the repeater station earth connections. The outer coaxial structure generally is insulated from the panels and

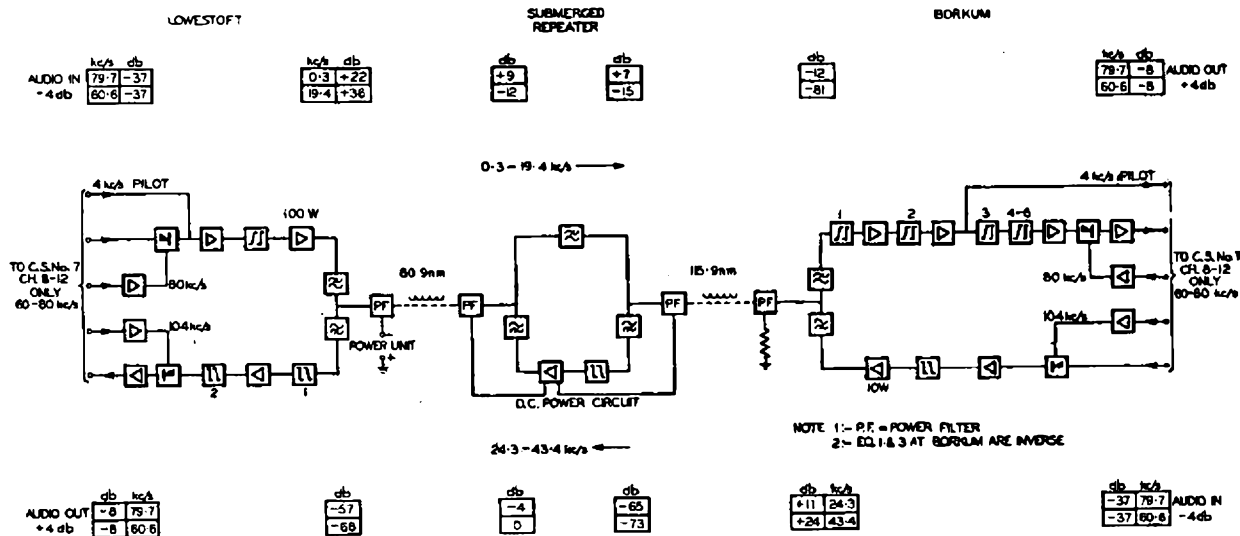

FIG. 2.—BLOCK SCHEMATIC DIAGRAM OF STAGE 3, THE FINAL SCHEME.

racking and in no case is it permissible to make more than one earth connection to any continuous run of coaxial cable or structure between double-screened transformers.

Terminal Equipment at Lowestoft.

Apart from the standard channel equipment, the apparatus at Lowestoft is mounted on three 10 ft. 6 in. bays as follows:—

- (i) Group equipment
- (ii) Transmit amplifiers
- (iii) Cable termination and submerged repeater power supply.

Group Equipment Bay. The group frequency-changers include conventional ring modulators, the group carrier supplies (80 and 104 kc/s) being taken directly from the channel frequency generating bay of the No. 7 equipment via special carrier amplifiers. In the transmit direction the gain necessary prior to the main 100 watt transmitting amplifier is provided by a standard P.O. Amplifier No. 35—a negative feedback music amplifier having a gain of 50 db. Between this and the 100 watt amplifier a transmitting equaliser

giving about 12 db of pre-equalisation is fitted. In the receive direction the equalisation partly precedes and partly follows the first receiving amplifier; both the amplifiers in this path are to a standard design giving 65 db gain with three valves.

The directional filters are constructed in multi-unit containers with air-cored toroidal inductors and mica capacitors having foil electrodes. It has long been the practice to avoid the use of ferromagnetic cores in directional filters on account of the intermodulation which occurs in such cores; it is now known that in extreme conditions such as exist in the present scheme, silvered mica capacitors likewise cause excessive non-linearity and must be avoided.

To synchronise the carrier generating equipment at Borkum a 4 kc/s pilot tone is transmitted over the cable from Lowestoft. It is introduced at the output of the group modulator at a level approximately 5 db below the channel relative level.

Spare amplifiers with U-link switching facilities are provided at all points in the terminal equipment.

100 Watt Transmitting Amplifiers. The use of 100 watt transmitting amplifiers in multi-channel carrier submarine cable schemes has been usual since about 1938⁵; such amplifiers have been driven from the normal 130 volt anode supply. The present scheme is the first in which 100 watt amplifiers have been used; at this power a substantially higher anode voltage is essential. The design of the present amplifier is such that, for the first time with a high grade negative feedback amplifier, it is possible to operate the output stage in Class AB push-pull. Feedback is applied from the line side of the output transformer to the grid of the input valve, so that the output signal is adequately free from distortion; the signals in each output valve, however, are not free from distortion, but the distortion products so arising cancel one another in the output circuit. In earlier feedback amplifiers of this type, Class A conditions have always been used and each half of the output stage has been,

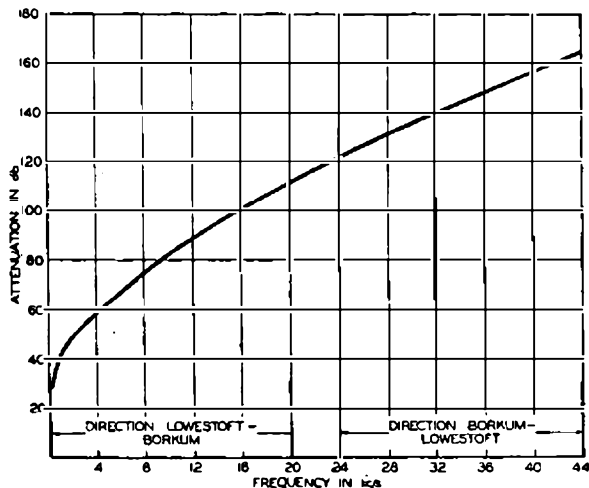

FIG. 3.—CABLE ATTENUATION.

⁵ P.O.E.E.J., Vol. 35, pp. 79 and 121.

effectively, separately freed from distortion products ; the 10 watt amplifiers used at Borkum operate in this way.

The circuit diagram of the 100 watt amplifier is shown in Fig. 4. The input stage consists of a single

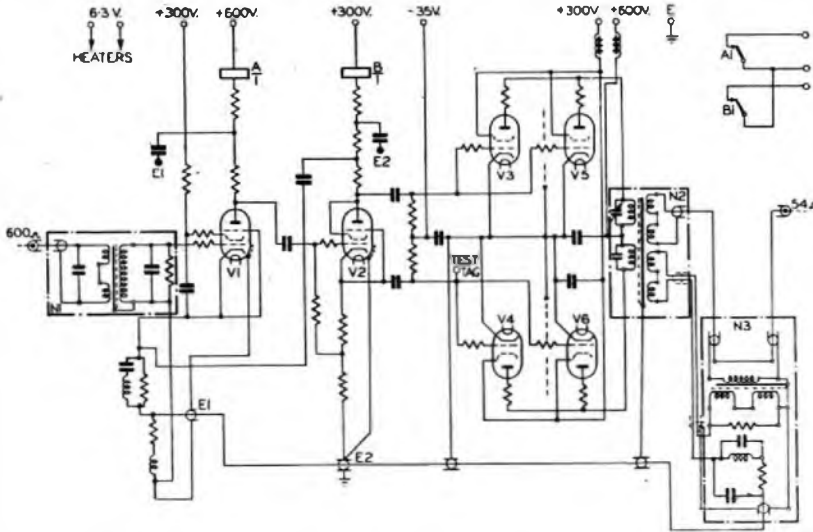

FIG. 4.—CIRCUIT SCHEMATIC OF 100W TRANSMITTING AMPLIFIER.

CV 1065 (H.F. pentode) and is followed by a phase-splitting valve of the same type. The output stage consists of four output tetrodes type CV 124 (RCA 807) in parallel push-pull with anode and screen voltages of 600 and 300 respectively. The feedback voltage is derived partly from an additional winding on the output transformer and partly from a current transformer in series with the line ; the amount of feedback is about 30 db. A complicated network is included in the feedback circuit to control the loop gain at frequencies outside the working band in such a way as to give maximum stability against oscillation.⁶ This control is supplemented by auxiliary feedback in the cathode circuit of the first stage.

Working and spare amplifiers, each with its own power unit operated from A.C. supply mains and fully screened change-over facilities, are provided on the amplifier bay which is shown in Fig. 5. The "bay" is, in reality, a cubicle occupying the same floor space and of the same height as a standard bay. A photograph of an amplifier with cover removed is shown in Fig. 6. The removal of any main cover exposing dangerous voltages cuts off the power supply.

Each power unit provides three separate rectified supplies, +600 and +300 volts for the anode and screen circuits and -35 volts for grid bias of the output valves. These supplies are so interconnected that failure of one or more supplies cannot cause damage to the valves.

Submerged Repeater Power Supply and Cable Termination. Although the power unit for the submerged repeater is at Lowestoft, the power circuit is concerned with Borkum also, as a direct current of 0.63 amp. is fed right through the cable, with an

earth return circuit. The power unit, which gives a constant-current supply, has its negative terminal connected to the centre conductor of the cable at Lowestoft, via an iron-cored choke in the D.C. feed panel, its positive terminal being connected to earth. At Borkum, the corresponding D.C. feed choke is connected to earth via a 95Ω resistor which increases the voltage at the repeater to 250 volts for the H.T. supply. Each of these chokes is effectively shunted across the signal path and is subjected to the full output of the transmitting amplifier. In these circumstances the choke at

Lowestoft is responsible for the majority of the non-linear interference present in the system and special care was required in the design to keep this within tolerable limits.

The general arrangement of the submerged repeater power supply is shown in Fig. 7. At Lowestoft, the positive pole of the power unit is connected to earth via a length of insulated 4-core submarine telegraph cable and a sea earth plate about 1 mile from the cable. This aims at avoiding electrolytic corrosion where the current leaves the cable armouring by ensuring that little current returns by this route.

A photograph of the cable termination and power supply unit is shown in Fig. 8. The cable terminating box is on the left, the power feed unit is mounted in a similar box on the right ; covers are, of course, removed in the photograph. The cable termination is fully screened. It includes a coaxial choke (i.e. a choke wound with coaxial pair) in series with the

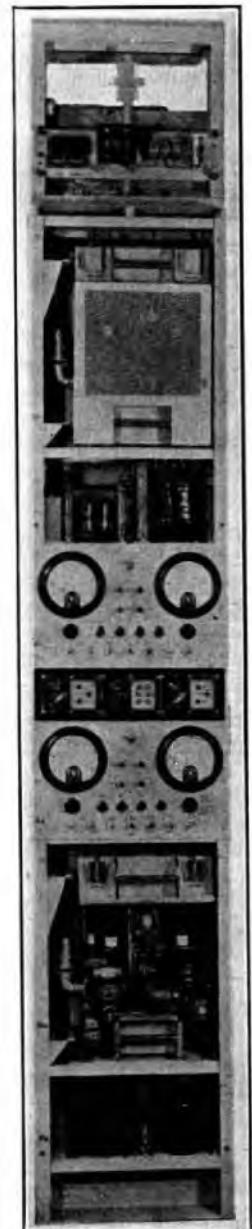

FIG. 5.—100 W AMPLIFIER BAY (FRONT).

* B.S.T.J., Vol. 19, p. 421.

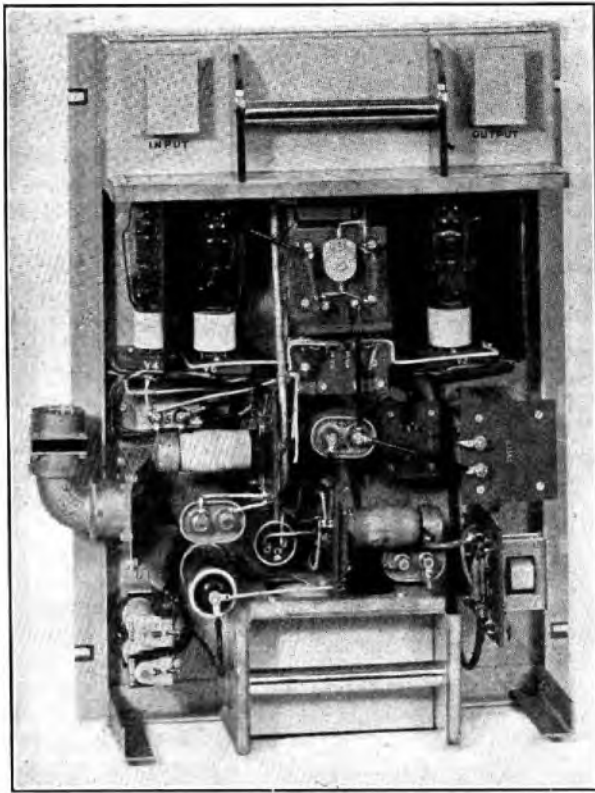

FIG. 6.—100W AMPLIFIER. 300 c/s—30 kc/s.

cable ; this is now a well-tried device for reducing high frequency currents circulating via the earth connections and is complementary to the double-screened transformers already mentioned. In the present scheme the liability of the system to interference is increased by the presence of the extended earth connection for the submerged repeater power supply and great care with the earthing and decoupling arrangements has been necessary.

To avoid damaging the valve heaters in the event of an earth fault on the Borkum side of the repeater, the power supply is derived from a constant-current source which delivers 0.63 amperes over a wide range of cable resistance and all normal variations of supply voltage ; the constant-current source is a bank of six beam tetrodes in parallel. The principle of the arrangement is based on the fact that the anode current of a tetrode (the line current in the present instance) is determined almost entirely by the screen voltage. This is maintained constant at 240 volts by voltage-stabilising gas discharge tubes.

This precaution by itself proved inadequate under the existing abnormal variations in the mains supply voltage at Lowestoft and it was necessary to add a refinement whereby any tendency for the anode current to change is compensated by a change in the grid-bias voltage.

Line current alarms are provided as follows :—

- (a) High and low current alarms at 650 and 610 mA respectively,
- (b) Very high current alarm at 750 mA. This causes the power supply to be switched off automatically and cannot operate by reason of a line fault owing to the controlling action of the constant current device, but only because of an internal fault in the power unit.

In addition an alarm is given if the cable resistance departs from its normal value by more than about 10 per cent, the power supply again being switched off automatically.

Terminal Equipment at Borkum.

All equipment at Borkum is mounted on 6 ft. bays owing to restricted room height. In addition to the channel equipment there are three bays as follows :—

- (i) Transmit bay,
- (ii) Receive bay,
- (iii) Cable Termination bay.

The current arrangements are generally the same as at Lowestoft except that :—

- (a) the transmit and receive frequency bands are interchanged,
- (b) the transmitting amplifier has an output of only 10 watts and is operated from normal repeater station power supplies,
- (c) the carrier generating equipment is synchronised by the incoming 4 kc/s pilot,
- (d) there is no submerged repeater power unit ; a load resistor in the power circuit is provided to give 250 volts H.T. at the submerged repeater,
- (e) a special crystal filter is necessary to suppress the group carrier frequency which is only 300 c/s removed from the signal frequencies of Channel 8.

The process of line equalisation at Borkum is rendered more difficult by the fact that no residual loss is permissible in the first equaliser owing to the low receiving level at 20 kc/s. Since an equaliser with zero residual loss cannot be made to match the cable reasonably, Receive Equaliser No. 1 is made to reduce the level range with zero loss at 20 kc/s without

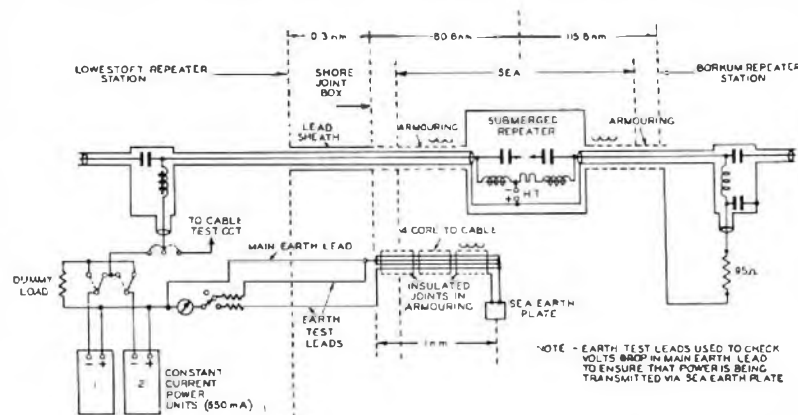

FIG. 7.—POWER SUPPLY TO SUBMERGED REPEATER.

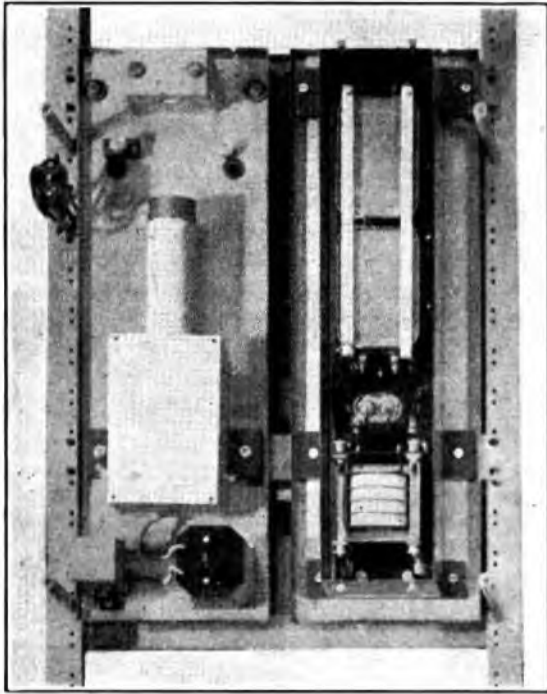

FIG. 8.—CABLE TERMINATION AND POWER SUPPLY UNIT.

reference to the cable characteristics. Receive Equaliser No. 3, which has an exact inverse characteristic, is then used to cancel the effect of Receive Equaliser No. 1, the true equalisation of the system being dependent on Receive Equalisers Nos. 2, 4, 5 and 6.

Submerged Repeater.

Mechanically, the case of submerged repeater is practically identical with that in the Anglo-Irish cable.⁷ There is one important difference; the dielectric of the Anglo-German cable is polythene whereas that of the Anglo-Irish cable is paragutta. It was at first thought that a plain substitution of polythene for paragutta would be satisfactory but it was found that the gland nuts would not remain tight owing to a slight cold flow of the polythene. After some difficulty the problem was solved by the development of a process for bonding polythene to the metal in much the same way as rubber and iron can be bonded.⁸ A direct bond is not possible, but indirect bonding via a layer of polyisobutylene and polystyrene seems to be quite satisfactory. In the present repeater this bonding is carried out inside the original

⁷ *P.O.E.E. J.*, Vol. 37, p. 33.
⁸ British Patent Application 31422/46.

gland; for future applications a new gland is being designed.

As it was necessary to use existing repeater cases, and as the filters for the present repeater are much larger than those in the Anglo-Irish scheme (the cut-off frequencies are about 22 kc/s against about 300 kc/s), some drastic modifications in the design were essential. First, it was decided not to incorporate valve switching but to rely on single selected valves in each stage; second, at the low frequencies and narrow band width concerned the requisite gain could be obtained with two stages only; finally, the resilient mountings for the amplifier were omitted. Confidence in a non-switched valve arrangement has been engendered by experience with the Anglo-Irish repeater, which, after three years, is still operating with the original valves, and on extended valve life tests in the laboratory.

A photograph of the inner unit of the repeater is shown in Fig. 9; the amplifier is mounted in the two containers with perforated covers. The amplifier circuit is shown in Fig. 10; the characteristics of the feedback loop are carefully controlled up to at least 600 kc/s and the phase margin against oscillation is fairly constant at about 45° at all frequencies between the highest working frequency (44 kc/s) and 600 kc/s.

The two valves employed are CV 1065, as in the earlier submerged repeater, but the anode voltage has been increased to 250 volts, each valve taking 6 mA.

The gain of the amplifier is 75 db and the overload point is about +26 db. Since the relative level at the output is 0 db on each channel and since, in a five-channel amplifier, a margin of about 16 db is necessary between the channel level and the overload point,⁹ there exists a further margin of about 10 db for errors in line-up and for valve deterioration.

The overall gain frequency characteristics of the repeater, in the two directions of transmission are shown in Fig. 11. Only third and higher order modulation products can cause interference between channels, but since an appropriate test would require the application of two tones to the system, it is more

⁹ *B.S.T.J.*, Vol. 18, p. 645.

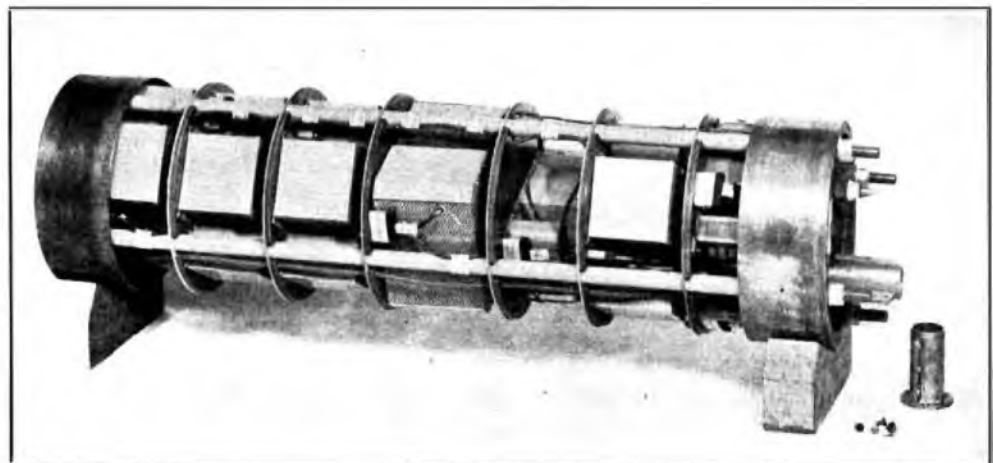

FIG. 9.—SUBMERGED REPEATER—INNER UNIT.

convenient to rely on a measurement of second harmonic as a routine check on the non-linearity of the repeater. Facilities are therefore provided to trans-

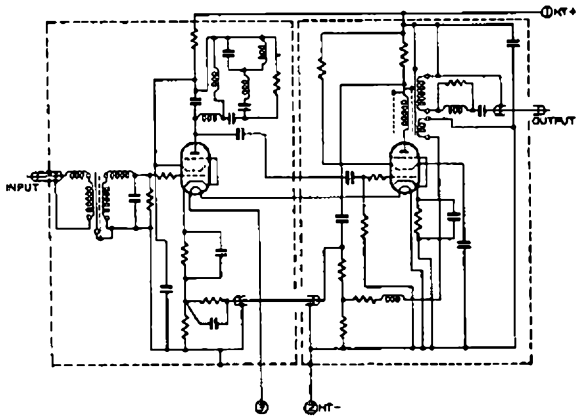

FIG. 10.—CIRCUIT SCHEMATIC OF SUBMERGED REPEATER.

mit a frequency of 24.5 kc/s to line at a level of +35 db (by sending 500 c/s on Channel 8 at Borkum) and to measure the received levels of 24.5 and 49 kc/s at Lowestoft.

Installation of Terminal Equipment.

The terminal equipment at Lowestoft and Borkum was installed by officers of the Transmission and Lines and Research Branches of the Engineer-in-Chief's Office with co-operation from the Eastern Region and the Rhine Army. This installation and local testing was completed prior to the laying of the submerged repeater.

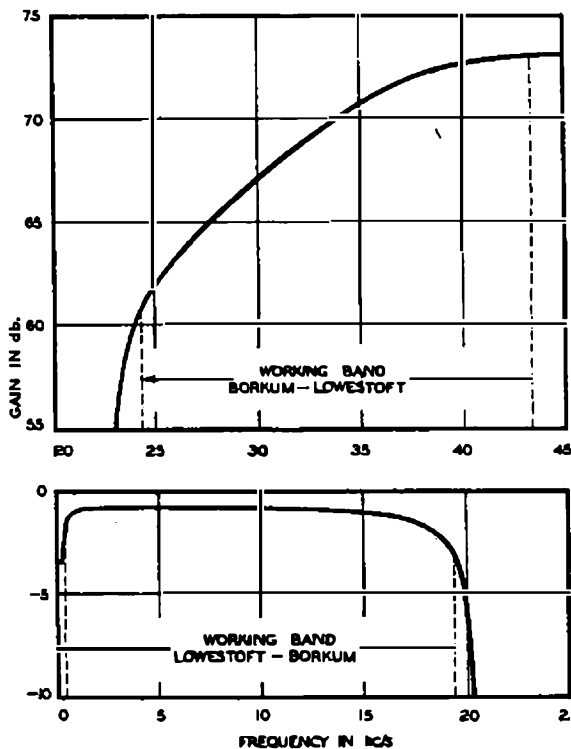

FIG. 11.—INSERTION GAIN OF SUBMERGED REPEATER.

Repeater Laying Operation.

Two repeaters were taken aboard H.M.T.S. *Iris* which located the cable and cut it at a point 80.9 n.m. (by cable resistance) from Lowestoft on June 29th, 1946, at about 06.30 hours B.S.T. Measurements of capacitance, conductor resistance and insulation resistance were made from the ship in both directions and Lowestoft made impedance-frequency measurements. A new length of cable, about 0.1 n.m. was jointed to the Borkum side, making a total length of 196.8 n.m. between Lowestoft and Borkum Repeater Stations. The Borkum cable was then jointed to the repeater at the jointing chamber.

The inner conductor only of the Lowestoft cable was also jointed to the repeater and the power switched on. The terminal resistance at Borkum was adjusted to give 250 volts D.C. at the repeater. Transmission measurements were then made and showed the position of the repeater to be satisfactory; a test was also made for harmonic production. The power was then switched off, the joint completed on the Lowestoft side and the two cables lashed together. Transmission was again checked from end to end and the power switched off.

The repeater was then lowered in a horizontal position over the side; simultaneously the cables were lowered on ropes passing over the bow sheaves. All ropes were cut away when the repeater reached the sea bed, the laying operation being completed at 18.30 hours B.S.T.

During the operation contact was maintained between *Iris* and Lowestoft using the ship's radio and a "Mobile Coast Station" at Lowestoft. Borkum was able to receive both *Iris* and Lowestoft on a communication receiver.

The jointing operations were carried out in calm weather but conditions were deteriorating by the time the repeater was ready for lowering. The North Sea at this point is 17 fathoms deep and the bed consists mainly of gravel.

Overall Tests.

Wide-band line-up measurements, or what would normally be called the "high-frequency" line-up, were made in both directions, although the term is rather inappropriate in a system transmitting frequencies as low as 300 c/s. For sending conditions appropriate to the nominal relative levels, Fig. 12 shows

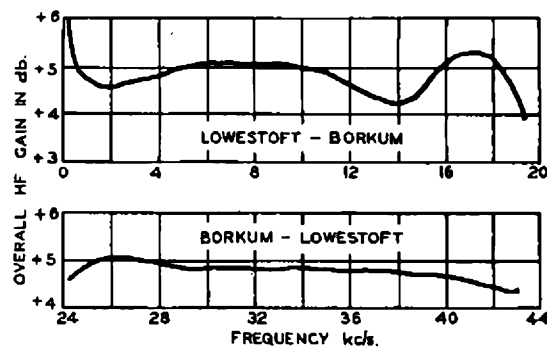

FIG. 12.—H.F. GAIN/FREQUENCY CHARACTERISTICS.

the output levels at the output of the final receive amplifier at the distant station. For a cable having

an attenuation of 166 db at the highest working frequency, attenuation ranges of 62 db and 42 db in the two bands and four pairs of directional filters, these results can be considered as very satisfactory.

The system having been lined-up in July 1946, it is of interest to note that in January 1947 the overall attenuation of the cable at 24.5 kc/s had decreased by about 2 db or 1.6 per cent due to the change in temperature; the harmonic generation in the repeater had also increased to an extent corresponding to an increase in level at the repeater of about 1 db.

Channel Frequency Response. The overall response of Channels 8 and 12 of the Carrier System No. 7 are shown in Fig. 13. Channel 8 (76–80 kc/s) is trans-

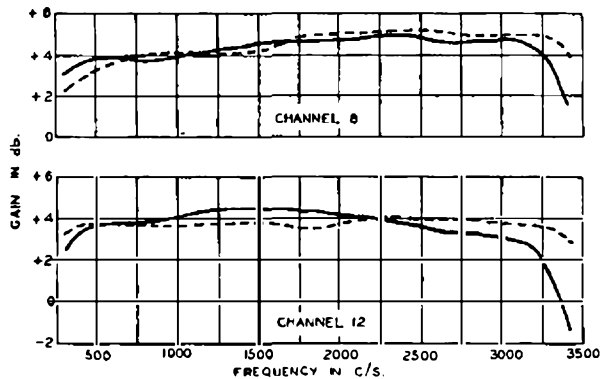

FIG. 13.—OVERALL GAIN/FREQUENCY RESPONSE OF CHANNELS.

mitted as 24–28 kc/s, i.e. adjacent to the directional filter cut-off, from Borkum to Lowestoft and in the audio-frequency range from Lowestoft to Borkum. Channel 12 (60–64 kc/s) is transmitted as 16–20 kc/s, i.e. adjacent to the directional filter cut-off, from Lowestoft to Borkum. These represent the worst conditions and the frequency response of each intermediate channel is better than that of Channels 8 and 12.

Crosstalk and Noise. With all channels idle, the noise level was measured at the channel terminals (+4 db relative level). The psophometric potential

difference varied between 0.9 and 1.1 mV at Lowestoft and between 0.35 and 1.3 mV at Borkum, corresponding to a worst value of about 0.8 mV at a point of 0 db relative level.

Non-linear interference between channels on the system was tested by sending tones on one or more channels at appropriate levels. In no instance did the total noise P.D. at the channel terminal exceed 1.5 mV, i.e. under 1 mV at a point of 0 db relative level.

For convenience, crosstalk between channels was again measured with a psophometer with two disturbing speakers each maintaining a level 4 db below R.T.P. at points of 0 db relative level. The highest level of interference measured under these conditions was 1.7 mV at the channel terminal; most of this was due to residual noise.

Acknowledgments.

The Anglo-German cable scheme, particularly the final stage, was engineered and installed at what was, for the magnitude of the work involved, very short notice. That the work was completed to schedule is a tribute to the willingness and co-operation of many officers in various parts of the Post Office Engineering organisation. The general scheme was planned by the Transmission and Lines Branch, all special equipment being provided by the Research Branch where the work of several groups dealing with specialised designs and practices had to be co-ordinated. Radio Branch assisted with the provision of crystal filters and also the mobile radio station which enabled contact with *Iris* to be maintained and the Test and Inspection Branch carried out all measurements on the cable. In connection with the laying operation of the submerged repeater very close liaison with the Submarine Branch was essential and their willing co-operation both at Headquarters and aboard *Iris* is gratefully acknowledged.

Finally, thanks are due to those members of the British Army of the Rhine who fed and otherwise cared for those officers who were called upon to install and test the terminal equipment at Borkum.

Book Review

"Electrical Testing for Practical Engineers." G. W. Stubbings, B.Sc., F.Inst.P., A.M.I.E.E. 261 pp. E. & F. N. Spon, Ltd. 12s. 6d.

During recent years a considerable number of books have been published dealing with specific phases of electrical work and catering for the "practical engineer" whose main desire is to know what to do rather than the theoretical reasons for doing it.

The present book is in this category; its subject is the simple electrical testing that installation and maintenance engineers may be called on to do. It is eminently practical, it eschews mathematics and does not attempt proof of the formulæ or methods recommended.

After a brief introductory chapter, the book goes on to describe the various types of electrical instruments and testing gear with their particular uses and the method of making voltage, current, power, insulation resistance, etc., measurements. The tests necessary on a new wiring installation are given in a useful chapter, another covers the tracing of wiring faults, while three-phase testing, in particular, is dealt with in a third. Further subjects included are testing instruments and switchgear, relays and relay connections.

The final chapter deals with insulation resistance and temperature "on site" tests of electrical machines, the measurement of slip, etc., and ends with a brief reference to the location of armature faults.

The book is well and clearly printed and altogether one that should be valuable to those to whom it is specially addressed.

H. R. M.

Through-Group Working in the Coaxial Cable Network

C. F. FLOYD, M.A., A.M.I.E.E.

U.D.C. 621.395.44 621.395.5 621.392.52

Part I.—Performance Requirements

Blocks of long trunk circuits may have to run over several coaxial cable systems in series, or may leave the main route at points of system interconnection. Through-group working enables this to be done economically in blocks of 12 circuits without reduction to audio frequencies. Part I of this article deals with the performance requirements; Part II will describe a typical installation.

Introduction.

MULTI-CHANNEL coaxial cable transmission has been standardised in this country for the provision of really large blocks of trunk circuits between major telephone centres. As distances between adjacent trunk traffic centres seldom exceed, say, 125 miles, the circuit requirements are likely to take the form indicated in Fig. 1. In this diagram A, B, C and D are large

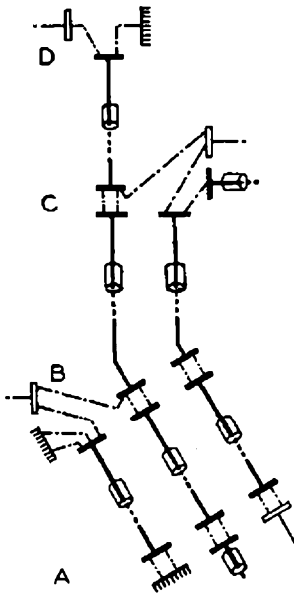

- A, B, C, D TERMINAL REPEATER STATIONS AND CENTRES OF TRUNK TRAFFIC CONCENTRATION
- COAXIAL SYSTEM WITH THROUGH-GROUP TERMINATIONS
- 12 CHANNEL CARRIER SYSTEMS WITH THROUGH-GROUP CONNECTIONS
- AUDIO CIRCUIT TERMINATIONS

FIG. 1.—A TYPICAL SECTION OF A COAXIAL TRUNK NETWORK WITH THROUGH-GROUP WORKING.

centres of telephone traffic which require interconnection by a substantial number of trunk circuits provided over coaxial cable systems. To give such a service there must be sufficient flexibility to set-up blocks of circuits between major centres and, at the same time, to provide spur connections to smaller towns off the main route. At such points as A, B, C or D it must therefore be possible to deal with circuits in any one of three ways: (a) to extract them at audio frequencies, (b) to extend them over 12-channel spurs, or (c) to continue them over other coaxial systems.

These conditions could be met if all channels on each coaxial system were transferred to audio frequencies at the points A, B, C and D: but as each pair of coaxial tubes may be carrying as many as 600 telephone circuits a large amount of frequency translating equipment would be involved in every interconnection process. A more satisfactory method, where circuit routing in multiples of twelve can be justified, is to employ through-group working for conditions (b) and (c) and so avoid translations to audio frequency at intermediate points. This results in economy of equipment, improved transmission characteristics, and greater flexibility in setting-up long trunk circuits which run over several coaxial systems in series.

The Basic 60-108 kc/s Group.

To appreciate the advantages of through-group working it is necessary to examine briefly the process by which individual telephone channels are assembled via channel, group and supergroup translating stages before transmission at high frequencies over a coaxial cable. Fig. 2 shows this in simplified form for a part of one supergroup. The other supergroups, which are merely indicated in the diagram, are substantially similar. At the transmit terminal, which employs modulation processes, the direction of transmission is from left to right. At a receive terminal, involving demodulation, it is from right to left. It will be seen that when the circuits start from, or return to, audio frequencies, triple modulation is employed as this permits simplification of the frequency translating equipment design and enables a terminal to consist of a number of standardised bay assemblies.

The frequency bands allocated to each translating stage of modern coaxial, 12- or 24-channel installations, have been made the subject of international agreement, and all equipment in use in this country, designed since 1938, ensures that all 12-channel groups in any of these systems shall pass through the 48 kc/s wide basic-group frequency band, 60-108 kc/s. This standardisation at once opened the way to the possibility of setting-up trunk circuits in multiples of twelve by linking 12-channel groups in successive coaxial systems at the basic-group frequency band without reduction to audio frequencies. As a result, only two out of the three frequency translating processes in a complete coaxial terminal would be employed at the adjacent ends of two wideband carrier systems which were to be interconnected. Such through-group working was proposed in 1940, but it has only recently become possible to use it extensively in the trunk network.

Advantages of Through-group Working.

The advantages of through-group working may be summarised as:—

(1) Coaxial cable systems and 12-channel routes can be conveniently made to operate together as one carrier trunk network. For example, the heaviest traffic routes can employ coaxial systems, and 12-channel cables can then provide spurs from suitable distribution points.

(2) There is a considerable saving of expensive equipment. The channel translating bays represent, in current coaxial designs, the bulk of a complete coaxial terminal, because a separate modulator-filter unit is necessary for each individual channel. In the group and supergroup stages each frequency trans-

(4) The labour involved in setting-up large blocks of circuits is reduced, and a high degree of flexibility is achieved. All 12-channel groups in a multi-channel carrier terminal station, whether derived from coaxial, 12- or 24-channel systems, can be brought out to a group distribution frame for circuit routing. Although the wiring on this G.D.F. is not quite so straightforward as audio circuit jumpering—as it is sometimes necessary to interpose either an attenuator or a high performance bandpass filter in the link circuit—a given block of circuits can still be routed with less labour. For example, the many single-pair jumpers necessary to route twelve 4-wire circuits on an audio distribution frame would be replaced by four separate coaxial leads.

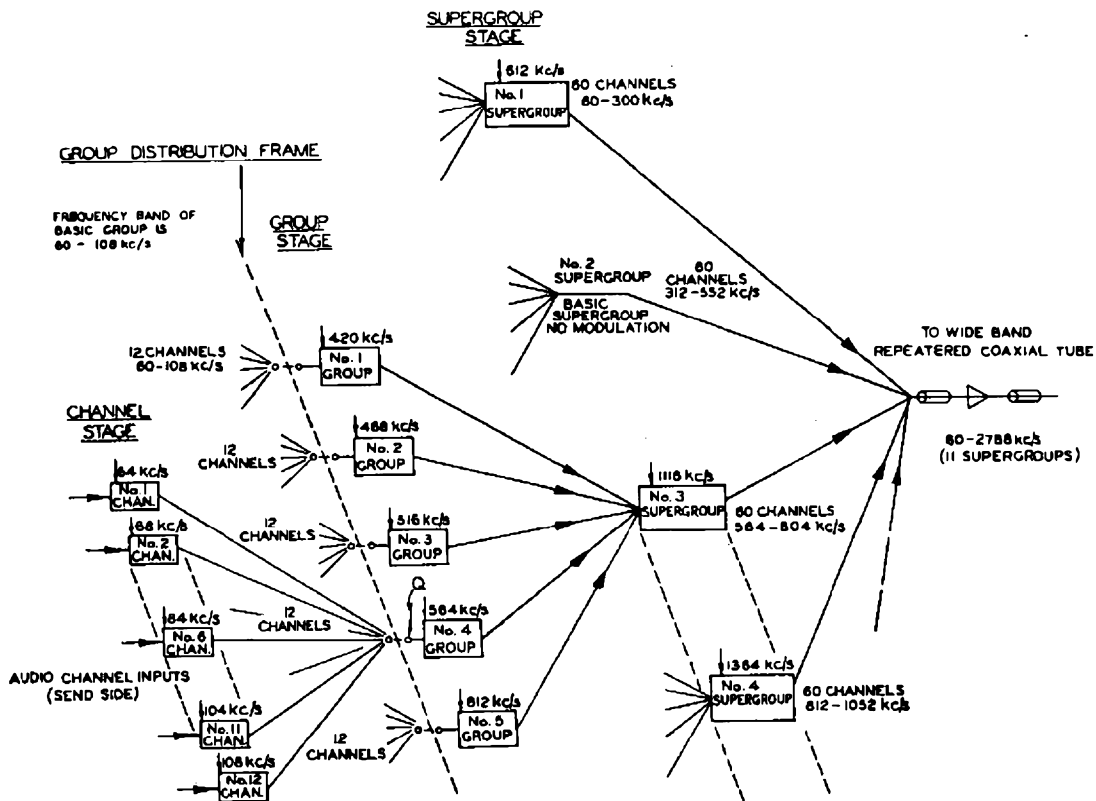

FIG. 2.—METHOD OF ASSEMBLING CHANNELS IN WIDEBAND FREQUENCY SPECTRUM IN COAXIAL SYSTEMS.

lating unit carries 12 or 60 channels respectively and consequently these two stages involve considerably less equipment.

(3) The transmission characteristics of long trunk channels are greatly improved. It is in the channel translating equipment that individual channel pass-bands are most liable to amplitude-frequency distortion and adjacent channel interference, and it is to assist in these factors that expensive quartz crystal filters are generally employed in channel bays in this country. Through-group working enables the number of frequency translations necessary at the channel stage in each direction of a single trunk circuit to be reduced to the ideal minimum of one at each terminal.

Adjacent-Group Interference.

There are, therefore, important advantages to justify using the principle of through-group working in linking the various coaxial and 12-channel carrier systems in a trunk network. Its general application is straightforward, however, only if all the signal frequencies in each group connected to the G.D.F. are strictly confined to within the band of the twelve wanted channels, namely 60 to 108 kc/s. If a group has been derived by supergroup and group demodulation from a supergroup on a previous system, it will have had neighbouring groups immediately adjacent to it in the frequency spectrum on at least one, and probably both, sides. Unless all vestiges of signals from these adjacent groups be removed from the

edges of the wanted group frequency band before transmission to another outgoing group, they will be carried over the through-group link and may appear as adjacent-group interference in the outgoing system.

This is illustrated in Fig. 3 which shows, as an

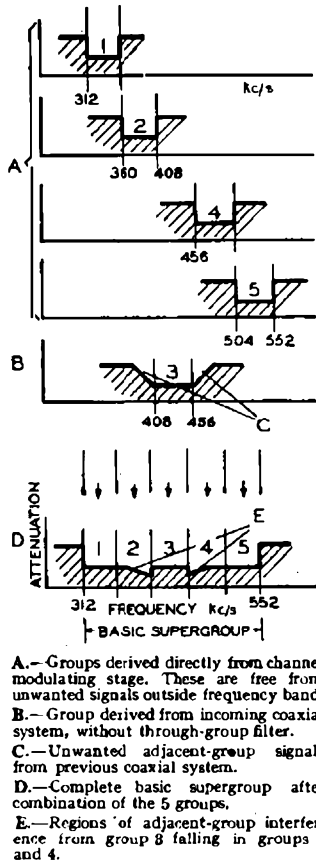

FIG. 3.—ILLUSTRATION OF ADJACENT-GROUP INTERFERENCE IN A "SEND" COAXIAL TERMINAL.

example, the condition which would arise if one such group, already obtained by demodulation in the terminal of an incoming coaxial system, were directly connected to form a group in an outgoing coaxial supergroup. (These signal conditions appertain to the point Q in Fig. 2.) At the top of the diagram are the frequency spectra of five separate 12-channel groups as they would appear after group modulation on the outgoing system. Nos. 1, 2, 4 and 5 are assumed to have been derived from neighbouring channel modulating stages and have, therefore, precisely defined frequency bands 48 kc/s wide with no vestiges of signals on the outer edges. The signal band of group No. 3 is shown as if it had originated as a group from another coaxial system and, if there were no additional filtering, it would have an attenuation-frequency characteristic with the sloping flanks indicated. These represent diminishing vestiges of signals from the groups originally adjacent to this signal-group in the previous system and, when the frequency spectra of the five groups are joined together to form a basic supergroup as in the lower part of Fig. 3, signal energy from these vestiges will

fall into the portions of the frequency spectrum proper to the adjacent groups, Nos. 2 and 4. Although the group bandpass filter following the group modulator will have further attenuated the unwanted signals these will still cause adjacent group interference, and it will be most serious in the channels at the group edges.

Adjacent group interference can be avoided only by ensuring that the signal transmission band present in each group intended for continuation over an outgoing coaxial system is restricted to within the range 60 to 108 kc/s, and that any signals outside this pass-band are attenuated by not less than, say, 70 db. relatively to it.

Such a high discrimination against unwanted adjacent group signals may already exist in groups from some sources. For example, in Fig. 3 groups of channels obtained from the output of a coaxial terminal channel modulating stage—that is, at the transmit end of the first coaxial system in a trunk line—are free from any unwanted signal vestiges. Through-group filters are, in fact, never necessary between the channel and group stages in a coaxial terminal, because the set of twelve channel filters taken together is designed to have an envelope characteristic which provides the necessary freedom from, or suppression of, unwanted signals. Since the essence of through-group working is the omission of the channel translating stages at points of connection of two systems, means must be introduced to remove the adjacent-group vestiges, and so avoid the interference shown in Fig. 3. This is done by providing a high performance bandpass filter, known as a through-group filter, in each group-to-group circuit connection, so that the signal band of the group entering the outgoing coaxial system shall be free from adjacent group signals. A further important function of the through-group filter is to provide adequate suppression (not less than 20 db.) of the 60 kc/s pilot incoming from a 12-channel line.

Comparison between Group-to-channel and Group-to-group Connections.

It is worth examining more closely the frequency bands which occur during demodulation in a coaxial terminal. Fig. 4 shows, for comparison, the signal-frequency spectra associated with the two possible methods of terminating a group of twelve channels at the receive end of a coaxial system. These are by group-to-channel and group-to-group connections. The arrows show direction of transmission, starting from the top, and the process is as follows.

A supergroup, comprising 5 groups of 12 channels each, is first selected from the full coaxial transmission spectrum by a supergroup filter. This is a coil-condenser filter and it leaves vestiges of the signals from adjacent supergroups at each end of its passband owing to the sloping flanks of its attenuation characteristic. This is shown in the diagram (after demodulation to the basic supergroup) by the discrimination curve *abcd*.

The signal band now passes to the group translating stage where it is split into its five constituent groups by the five group bandpass filters. There are no

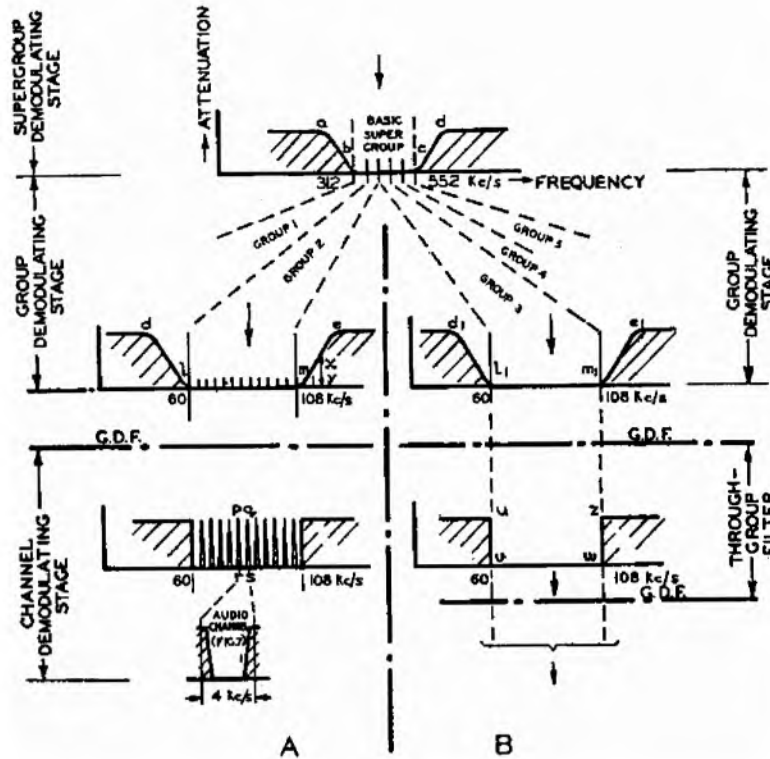

FIG. 4.—SIGNAL FREQUENCY BANDS IN DEMODULATING STAGES OF A COAXIAL TERMINAL.

frequency gaps between the passbands of adjacent group filters: and, also, they have attenuation characteristics closely resembling those of the supergroup filter, with similar sloping flanks just outside the passband range. Each filter is followed by a group demodulator which transfers the signal band to the basic-group range 60 to 108 kc/s. At this point, all five groups are connected independently by coaxial feeders to the group distribution frame. Groups Nos. 2 and 3 only are shown in full in Fig. 4. At the sending end of a coaxial system the signals follow through the same processes in the reverse order.

Now the frequency response of the complete band of signals which appears on such a basic-group outlet takes the form *dlme*, which is a replica of the discrimination characteristic of the group bandpass filter preceding the group demodulator. The wanted 12-channel band, 60 to 108 kc/s, is represented by *lm*. On each side of it are flanks *dl* and *me* of rapidly increasing attenuation which, however, cannot rise sufficiently steeply to prevent the passage of vestiges of signals from adjacent groups: for example, the third channel on the upper adjacent group is attenuated relatively to the wanted-group channels by the amount *xy* in the figure.

The group can now be connected either to a channel translating stage and so be demodulated to twelve separate channels, or it can be joined at the basic-group frequency band to an outgoing system. In the former case, a set of twelve channel filters will separate

the individual channels before demodulation and each of these filters is endowed with the highly selective characteristic *pqrs* to avoid adjacent channel interference. As can be seen from the diagram, they also effectively suppress the unwanted adjacent group vestiges *dl* and *me*. There is thus no need for any additional filtering between the group and channel translating stages, and this is the normal condition for which a coaxial terminal is designed.

In the second case, where the group is to be continued over another system as in the right-hand side of the figure, the unwanted adjacent group vestiges *dl* and *me* cannot be allowed to remain, for, after being further attenuated in the group modulator bandpass filter they will overlap on to the frequency bands of the adjacent groups in this new system, as has already been shown in Fig. 3. Therefore in such group-to-group connections extra selectivity is provided by through group filters mounted adjacent to the G.D.F. and these give the required discrimination characteristic *uvws*, which removes all signals outside the basic-group range.

Various Arrangements of Group-to-group Connections.

A high performance through-group filter is always necessary in group-to-group connections between coaxial systems if complete interchangeability of groups is required. Careful consideration of Fig. 5

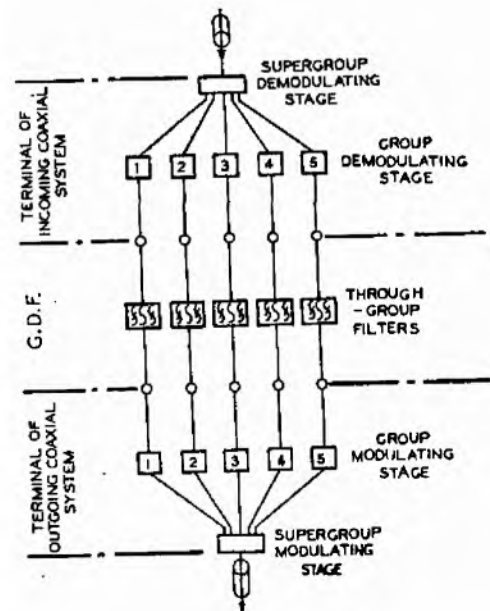

FIG. 5.—THROUGH-GROUP WORKING FOR A COMPLETE SUPERGROUP IN UNDISTURBED ORDER.

will show that if a complete supergroup-set of five groups from system A is connected in undisturbed order to a corresponding set of five outgoing groups on system B, even if these are transmitted on a supergroup of different frequency, the adjacent group interference conditions are less severe than those of Fig. 3. Clearly, the adjacent group vestiges carried over by, say, No. 3 group would be signals from the upper and lower channels of groups 2 and 4 respectively, and if allowed to remain as unwanted vestiges on group 3, these would fall back on to the paths of their originating signals in groups 2 and 4 in coaxial system B. Ideally, therefore, through-group filters appear unnecessary in this arrangement as far as crosstalk elimination is concerned. In practice, there would be some amplitude distortion and this would be affected by the phase differences which would almost inevitably occur between the various intergroup connections. Nevertheless, a through-group filter suitable for this case could be theoretically allowed to have lower discrimination than that intended for the general condition, except on groups 1 and 5, which would be subject to adjacent-group interference from neighbouring supergroups.

If several supergroup-sets of groups can be continued without disturbing either group or supergroup order, groups 1 and 5 will require no more selectivity than do Nos. 2, 3 and 4, as adjacent supergroup interference will also consist of "like signals." When the supergroup order is changed, the groups 1 and 5 will require high performance through-group filters despite the 8 kc/s gap in the interference created by the frequency space between the supergroups (see Fig. 2).

It can be seen, therefore, that there is always some advantage to be gained from routing through-group connections in undisturbed order whenever possible.

Fig. 6 illustrates a part of a more complicated

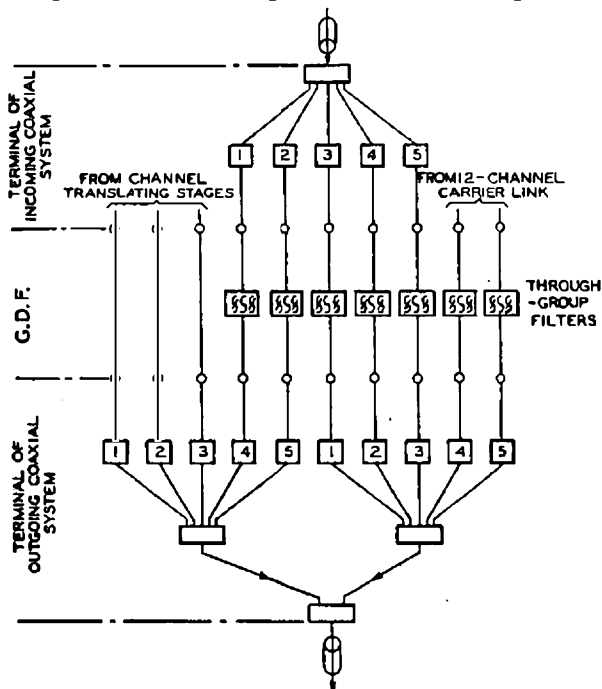

FIG. 6.—GENERAL EXAMPLE OF THROUGH-GROUP WORKING.

through-group terminal station, where group order is changed and spur connections are also made to a 12-channel carrier system. High performance through-group filters are, of course, necessary between groups on the coaxial systems. Consideration of the group signal-frequency bands which occur in the 12-channel Carrier System No. 7 would make it appear that high performance through-group filters are not theoretically essential in all examples of carrier-to-coaxial group connections. The filter might perhaps be omitted, for example, without detrimental effect on signal quality when a coaxial group is connected to a 12-channel carrier link for demodulation at the far end to audio frequencies: it would have to be included, however, if the link were connected instead to another coaxial group. When such cases arise it must be remembered that double modulation is normally employed in Carrier System No. 7 and this, in a send terminal, leads to the presence of signals which can be interpreted as adjacent-group vestiges. It is therefore standard practice at present to insert a through-group filter in all types of through-group connection.

The Performance Necessary in the Through-group Filter.

The most difficult condition of adjacent-group interference can occur when complete freedom of inter-group working between two coaxial systems is desired. The near channels in the unwanted adjacent groups may then arrive at the G.D.F. with a relative test level almost equal to that of the wanted channels, so that the through-group filter must provide the full discrimination necessary to avoid interference. Experience has shown that this should be set to a minimum of 70 db. for good quality circuits. In the passband, 60–108 kc/s, the filter cannot be allowed to introduce more than a small variation in the frequency attenuation characteristic, a desirable limit being ± 0.3 db.

Since the internationally-agreed frequency framework for coaxial terminal equipment allows no frequency gap between adjacent groups, the filter designer appears to have a problem impossible of solution. Fortunately, in practice there is a small gap of some 700 c/s, due to two factors.

Firstly, the frequency response characteristic of any individual channel does not completely fill its 4 kc/s wide frequency allocation, because the exact shape of this curve (Fig. 7) is a compromise between the limitations of channel crystal filter design and avoidance of channel interference. Secondly, a favourable psophometric weighting allowance is available because the average subscriber using the normal hand-micro-telephone experiences greatly reduced sensitivity to frequencies below 200 c/s and above 3,500 c/s. The effect of this response variation is interpreted electrically by the well-known psophometric weighting curve. These two factors together make the design of the through-group filter practicable, because as a result the limits of the interfering signal levels in the unwanted channels can be defined by the curves shown as dotted lines in Fig. 8. The necessary through-group filter discrimination can therefore be obtained as long as the filter characteristic remains above these limits.

The compilation of the exact specification for a through-group filter is involved. The fact that several similar filters may have to operate in tandem in a long trunk circuit is a factor of the utmost

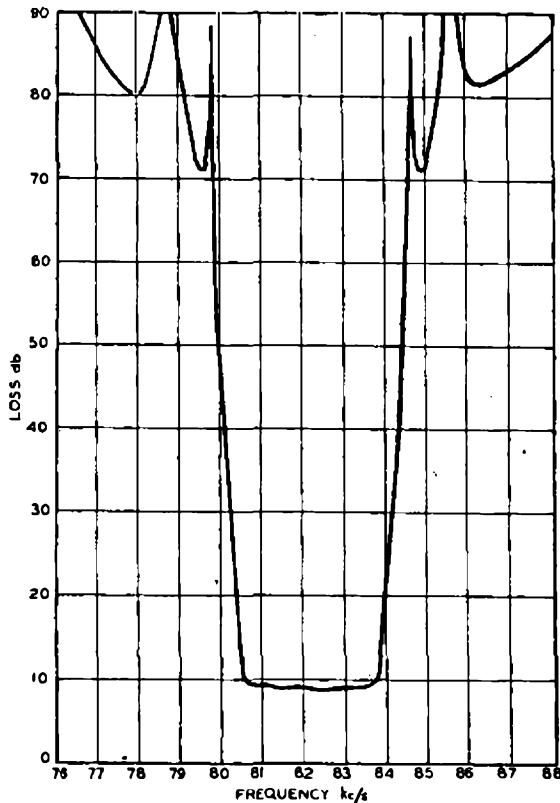

FIG. 7.—CHARACTERISTICS OF A TYPICAL PARALLELED CHANNEL FILTER.

importance as deviations from the ideal performance, particularly in the passband, will be additive. The attenuation characteristics of the group and channel bandpass filters are important factors as these control the range and relative levels of frequencies to be suppressed. The effect of temperature, ageing, and possibly humidity, on the filter components cannot be neglected, nor can the permissible deviations in the passband.

This specification can, at present, be met only by a relatively complex crystal filter consisting of high-pass and low-pass sections built to operate in series as a single unit. The attenuation frequency characteristic of such a filter is shown in Fig. 8: this filter has

already been described in this Journal.¹ It is designed to operate between 75 ohm terminations, and attention must therefore be paid to the impedances presented by associated equipment connected to the G.D.F.

Through-group filters have a passband loss built out to 29 db. which accords with the level difference standardised between corresponding send and receive connection points on a G.D.F. If a through-group connection is made without the insertion of a filter, a 29 db. attenuator should be included in the circuit to give the necessary level correction.

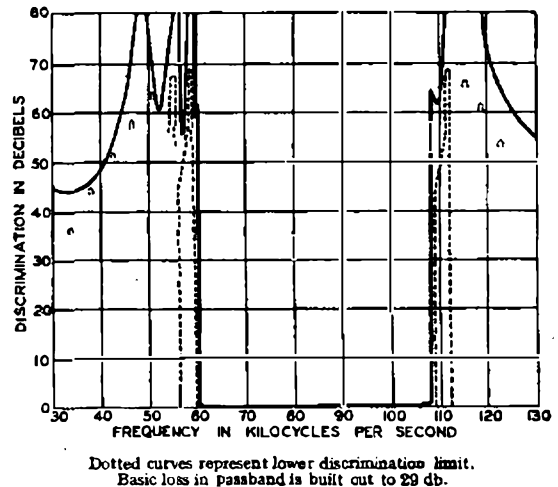

FIG. 8.—DISCRIMINATION OF THROUGH-GROUP FILTER.

Future Developments and Through-supergroup Working.

It is probable that, as the coaxial cable network expands, through-supergroup working will be required, whereby blocks of sixty channels will be interconnected between coaxial systems at the basic supergroup frequency band, 312 to 552 kc/s. The associated transmission problems are similar to those described for through-group working, but the difficulties encountered in the design of the necessary through-supergroup filters are increased by the higher frequencies and wider passband involved. The solution of this problem will bring within sight that ideal of coaxial cable transmission engineers, a system in which any supergroup can be blocked, filtered, and re-introduced at its line transmission frequency.

¹ "Crystal Filters," Part 4, R. L. Corke, *P.O.E.E.J.*, October, 1945, Vol. 38, Part 3.

The Reconstruction of Ten 305-ft. Tubular Steel Radio Masts in Reinforced Concrete

J. P. HARDING,
B.Sc.(Eng.), A.M.Inst.C.E., A.M.I.E.E.
and J. F. HARMON

U.D.C. 621.315.668.3 : 621.396.67

Part 2.—Constructional Methods

The second part of this article describes the means used for obtaining access to the masts and details the organisation and constructional methods employed on site.

Organisation of Work.

TO gain access to the masts for working purposes suspended cages were used as shown in Fig. 1 and described later in detail. Two such cages were employed, one on each of two masts,

in the delivery of certain manufactured items and other wartime problems, the whole of the ground work was completed before the cages were ready for their first ascent. ■

To accelerate the overhead work by working on masts other than the two from which cages were

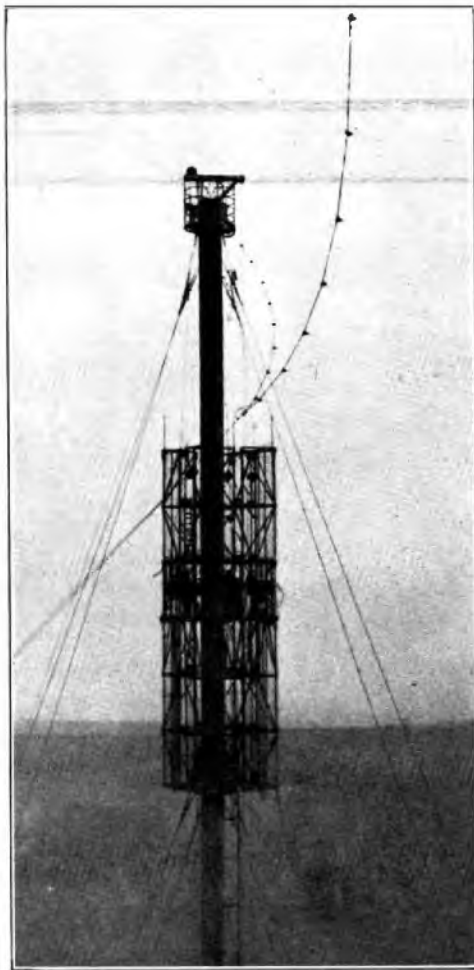

FIG. 1.—ARRANGEMENT OF WORKING CAGE.

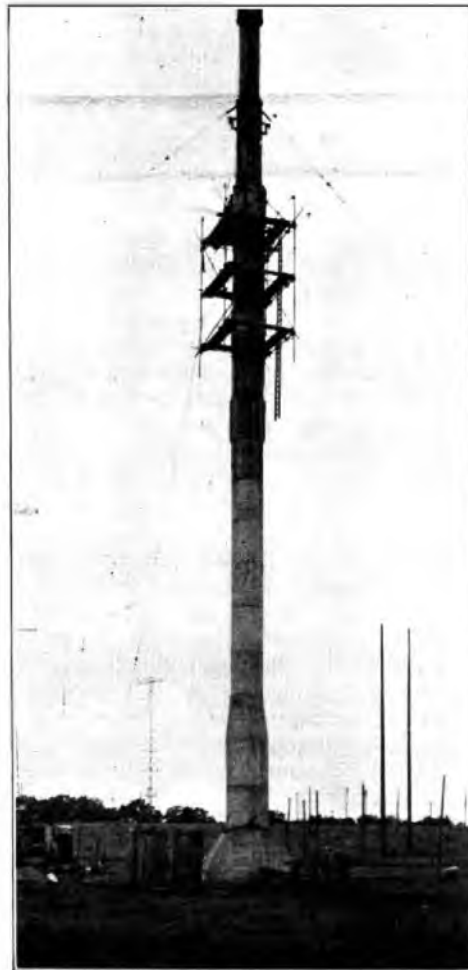

FIG. 2.—LIGHT SUSPENDED PLATFORM.

which enabled the ten masts to be reconstructed in pairs. The intended working arrangements were to form three working gangs including the necessary craftsmen. One gang was to be employed in each of the working cages and the third used for carrying out foundation and other ground work preparatory to suspension of the cages. This scheme was implemented as far as possible but, owing to delays

suspended, scaffolding was erected experimentally to a height of about 50 ft. This course proved expensive and not particularly secure and was discontinued. A more satisfactory alternative was found in the use of a light suspended platform (Fig. 2) which was hoisted from winches anchored on the ground. This cage was successfully used up to the 90 ft. level (the 1st stay level). The main erecting cages were then

brought into use at the 90-ft. level on subsequent masts which resulted in a considerable saving of time.

Working Cages and Hoists.

The cages (Fig. 1) were 40 ft. in height, 10 ft. square in plan and constructed from angle iron in four vertical sections, the separate sections being bolted together by long bolts through hard wood spacing blocks. With this construction it was possible to pass existing stays when ascending and new stays and bridles when descending by removal and refitting of the hard wood blocks. Four winches, at first hand driven, but later each powered by 1 H.P. electric motors, were located in each corner of the cage. The cage was suspended from the mast by four steel wire ropes secured at their upper ends by shackles to the existing mast sections and at their lower ends by coiling around the winch drums. The cage could thus be raised or lowered by operation of the winches. Including equipment and stores, a cage complete weighed between 7 and 8 tons—a load which it would not have been prudent to suspend from the top of a mast at the outset in view of the known unsound condition of the latter. The cages were therefore first suspended at about 140 ft. (after having reconstructed the mast up to 90 ft. using the light platform) when work proceeded to that level, i.e. 140 ft. Temporary fixings were then made by additional wire rope strops secured to the mast by shackles and the weight of the cage transferred to these. The main steel cables from the winches were then carried to and secured at a higher level on the mast when work could again continue. Care was taken that only the vertical and not the circumferential flanges of the existing mast sections were used for this purpose. After reconstruction, the cage was lowered from the top of the mast to the bottom in one operation which necessitated the accommodation of 300 ft. of rope on the winches. The cages were provided with six working platforms, a wooden ladder set in one corner being used for men to pass from one platform to another. The cage was enclosed in stout wire mesh which gave good mechanical protection. Additionally, by earthing the entire cage at all times by a trailing lead, the mesh also served as an efficient screen against the strong electric fields in the upper parts of the mast.

A travelling hoist of $\frac{1}{2}$ ton capacity (see Fig. 3) was used for carrying up men and materials to the working levels. The hoist was suspended from a wire rope passing over a pulley fixed at the top of the mast. The existing pulleys for the main hoists, although of sufficient capacity, were not used on account of their uncertain condition. A 10 H.P. electric winch on the ground was used as the source of power. The hoist was tapered in its lower section and fitted with a removable floor through which mixed concrete could be delivered. The hoist was arranged to pass up into one corner of the erecting cage and was guided in its movement up and down the mast by a stout wooden lath conveniently attached to the mast by use of the embedded eyelets through which the hand rails were to be subsequently threaded.

Concrete.

The specification for the work permitted the application of concrete by the Gunité or other spraying process or by the use of external shuttering. The successful tenderer adopted the latter alternative and the work was carried out by this means using repetition steel shuttering. Rapid hardening cement in accordance with B.S. 12 (1940) was used throughout. For all foundation work and the resurfacing of stay blocks the mix specified was 1:2:4, the sand being graded from $\frac{3}{16}$ in. to fines and the coarse aggregate $\frac{3}{4}$ in. to $\frac{1}{16}$ in. For the mast sections up to 90 ft. the mix was 1:1 $\frac{1}{2}$:3, the sizes of sand and aggregate being as before. For work beyond the 90 ft. level, at which the annular thickness of



FIG. 3.—TRAVELLING HOIST.

concrete reduces from 8 in. to 6 in., a smaller maximum size of aggregate was necessary to pass readily the restricted space (about 1 $\frac{1}{2}$ in.) between the outer edge of the circumferential flange of the mast and the inside of the shutter.¹ For this work the same mix (of 1:1 $\frac{1}{2}$:3) was employed but the aggregate was graded from $\frac{3}{4}$ in. to $\frac{3}{16}$ in. The quality of the sand and aggregate called for was in accordance with the recommendations of the "Code of Practice for Reinforced Concrete."² The mini-

¹ An aggregate graded to a maximum size of $\frac{3}{4}$ in. is one which will pass a $\frac{3}{4}$ -in. sieve, but such an aggregate may contain particles up to perhaps 1 $\frac{1}{2}$ in. long which have passed through the sieve lengthwise.

² "Recommendations for a Code of Practice for the use of Reinforced Concrete in Buildings." H.M. Stationery Office (Jan. 1934).

imum compressive strength (works cube test) specified was 3500 lb/sq. in. at 7 days.

For the foundation work the slump was maintained between 2 and 3 in. for which the appropriate water content is about 5.8 gallons per cubic ft. of cement. For the lower mast sections, using the aggregate graded up to $\frac{3}{4}$ in., experiment showed that a satisfactory consistency for the work was reached at slump values of between 3 and 4 in. corresponding to a water content of about 6.2 gallons per cubic ft. of cement.³ The fineness modulus of the aggregate was approximately 5.0 for this material and 4.4 for that graded up to $\frac{3}{4}$ in.. A small increase in the water content was needed to maintain the same values of slump with the finer aggregate. The initial setting time of the concrete is about 30 minutes after the addition of water and it was ensured that hoisting, placing and tamping were carried out within this period. (When working in hot weather only 20 minutes was allowed.)

Shutters were allowed to be struck 48 hours after completion of concreting but no loads were permitted to be borne by any embedded fittings (e.g. stay fittings or mast head details) until the elapse of 72 hours after placing of concrete. At intervals the usual 6-in. test cubes were filled at random during the course of the work to ensure the minimum compressive strength of 3,500 lb. per sq. in. called for in the specification.

Reinforcement.

Reinforcement was supplied in the longest trade lengths available (40-45 ft.) and was screwed and bent where necessary on site. After removal of the appropriate bolts in the circumferential flanges, the reinforcing rods could be threaded into position through the bolt holes. The stirrups were preformed on site in two halves and were threaded over the reinforcing rods as the latter were positioned. Short tails were left on each stirrup to loop around the first bar of the opposite half-section so maintaining continuity. Where the section of the mast was variable, e.g. at taper sections, stirrups were formed after the reinforcing rods had been erected using $\frac{1}{2}$ -in. diameter material spaced at 9-in. centres instead of $\frac{3}{4}$ -in. rod at 12-in. centres, the thinner rod being easier to bend in the confined space available.

Reinforcing rods were joined (for reasons discussed in Part I) by malleable cast iron couplings. After positioning of the rods and stirrups, wire ties were employed to maintain all in position during concreting.

Foundation Work.

The existing foundations, 8 ft. square, were to be extended by an additional 3 ft. on each side. In view of the age and uncertain condition of the existing concrete in an original foundation, the excavation was carried out in three sections, each excavated section being filled in with concrete before commencing the next. As a further precaution, trench screws were used to support the sides of the old foundations until

concrete was placed, which provided some safeguard against movement and possible disintegration of the concrete foundation under heeling of the mast. So that stirruping could be continuous, a sufficient length of rod was allowed to project from each completed section for coiling around the main reinforcing rods in the subsequent sections.

Reconstruction of Stay Anchor Blocks.

It has been mentioned that the existing stay anchor blocks were to be strengthened and used for securing the new stays. Excavation of the ground and "picking" of the exposed surface of the existing blocks showed both concrete and the embedded steel to be in fair condition. The weight of concrete in the blocks (between 8 and 12 tons according to position) was sufficient for the new loading after reconstruction but, in view of the embedded "hairpin" of 1-in. rod, there was a possibility that under load this might be dislodged and pulled out of the concrete if the block were cracked or otherwise in bad condition. The blocks were therefore strengthened by a 6-9-in. capping of new concrete, suitably reinforced, extending over the surface and sides of the block to a depth of 18 in. The function of the capping was to bind together all parts of the anchor block and thus prevent local cracking and perhaps eventual failure.

Concreting of Mast Sections and Renewal of Stays.

After completion of the foundation, stirrups were fitted for the base taper section and shutters erected. The change from the square section of the foundation to the round section of the existing mast was carried out by wooden shuttering, provision being made for retention of the manhole entrance by inclusion of a shaped aperture in the concrete base through which a man could pass. To enable the concrete to be placed and tamped effectively the upper boards in the shutter were at first omitted and later replaced as the level of the concrete increased. After striking this shutter, the steel repetition shutters for the uniform mast sections were fitted. The shutters were 5 ft. long and constructed in 4 sections by bolting through vertical flanges. Spigot and socket joints were used to provide satisfactory alignment for consecutive lifts of concrete. Suitable slots were cut in the shutters for insertion of the hand rail eyelets. Spacing details were fitted during filling to maintain accurately the shutters at a constant distance from the surface of the existing mast. At the stayed levels wooden shutters were used which could be suitably formed and cut to allow of the necessary projection of the embedded fittings. Similarly, wooden shutters were most convenient for the taper section of the masts at 170 ft. and for work at the mast head.

At each stayed level the embedded fittings for attachment of the new stays were set about 2 ft. below the point at which the old stays were secured to the mast. The procedure was then to set up the new stay attachment in position just beneath the existing stays and complete concrete work to a point immediately under the stays, thus embedding the new stay attachment in position. After the hardening period (of 72

³ The quantities of water quoted are for materials gauged dry. Correction was made for the moisture content and bulking of aggregate and sand.

hours) the new stays could be fitted to the mast and the change made from the old to the new stays. Using special lined grips (carpenter's stoppers) able to bite directly on to the old stay a few feet above the rigging screw and connected via reduction tackle to the embedded member in the anchor block, the load was removed from the rigging screw and chain in series. A movement of the stay of about $\frac{1}{4}$ in. gave sufficient freedom to allow the upper pin of the rigging screw to be driven out when the latter could be removed. The new stay, already secured to the mast at its upper end and terminated at its lower by a new rigging screw (6 of which were purchased for the changing of stays), was then offered to a convenient link in the chain when, by adjustment of the rigging screw, load could be transferred to the new stay. Opposite stays were tightened simultaneously which avoided an unbalanced load on the mast. When, by measurement of the sighting intercept,⁴ the new stays were seen to be nearing the requisite tension, the reduction tackle maintaining tension in the old stays was slackened and the mast left under control of the new stays. The latter were then finally adjusted to their appropriate



FIG. 4.—STAY-SIGHTING DEVICE.

⁴ The sighting intercept is the intercept between the projection on the mast of the tangent to the stay at the stay anchor and the point of attachment of the stay to the mast. A simple mathematical expression may be deduced in which the intercept may be expressed in terms of the tension in the stay.

intercept and the old stays recovered. Although a reasonable estimate of the sighting intercept and, therefore, of the tension in a stay, could be obtained by eye while standing at the stay anchor block, a special device was constructed by which a more accurate determination was possible. The stay sighting device (shown in use in Fig. 4) consists of a stout wooden section, 3 ft. long provided with a suitable lining at each end for clamping to the stay rope and fitted with front and back sights. The line connecting the sights was arranged to be accurately parallel to the stay rope when the device was clamped in position. A sighting mark was painted on the mast at a distance⁵ below the upper fixing of the stay equal to the calculated intercept required. The appropriate tension in the stay was then known to be reached when this mark was observed through the sighting device. The final adjustment of stay tensions was carried out under calm conditions.

Procedure at the Mast Head.

As the concrete work proceeded towards the top of the mast, the erecting cage being raised during the process, modification of the method previously adopted for changing of stays was necessary since the reinforcing rods to be positioned in conjunction with the stay fitting also served as anchorage for the main jib and required to be set up simultaneously with the latter. It was first necessary to transfer the aerial halyard from its attachment at the top of the mast to a temporary position lower down. The operation was carried out during normal transmission as follows. Using a wire rope grip, a bite was taken on the triatic at C (Fig. 5a) when, by slackening the triatic from the ground and simultaneously drawing up the tackle between B and C, a position as shown in (Fig. 5b) was

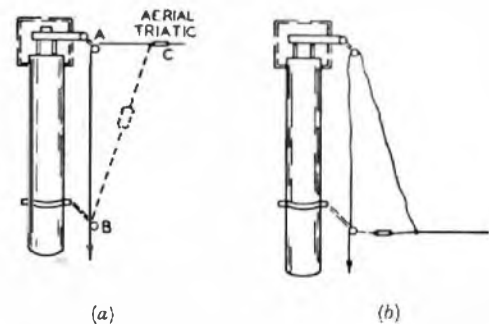

FIG. 5.—LOWERING OF AERIAL HALYARD PULLEY.

reached. At this point the halyard could be transferred from the upper to the lower pulley when tensioning the halyard from the ground relieved the load from the tackle which could then be recovered. Temporary stays, made up from lengths of recovered stays, were terminated around the concrete section of the mast about 20 ft. beneath the mast head, wood slats being used to protect the surface of the concrete. A wire rope stop was made fast around the slats to prevent them slipping downwards. Having transferred the load from the existing to the temporary

⁵ A small correction may be made, if thought necessary, for the distance between the sighting line and the stay rope.

stays in the same way that stays were changed at the lower levels, the original top stays could be recovered allowing unobstructed working facilities at the top of the mast. Using an oxy-acetylene flame the mast head was now stripped of fittings including the aerial supports, working platform, chequer plates, hand rails and access ladders. The jib for the man-hoist was not removed at this stage so that men could descend by it.

rods, the positioning of the top stay attachment and hand rail terminations and the recovery of the old jib and fittings and substitution of the new. Having the new man-hoist in use after this work, the remaining operations were to complete the concrete work, set the hinged cover at the top of the mast and fit the new mast head details such as chequered floor plates, guard railings and aerial pulley fittings. Finally, the new top stays were erected (after expiry of the necessary hardening period for the concrete), the temporary stays recovered and the aerial halyard transferred from its temporary to its permanent position at the top of the mast. The ropes supporting the main erecting cage were then transferred to a suitable fixing at the mast head. As the cage was lowered the hand rail strands were threaded through the projecting eyelets and the strand finally tensioned. The appearance of a completed mast is shown in Fig. 6.

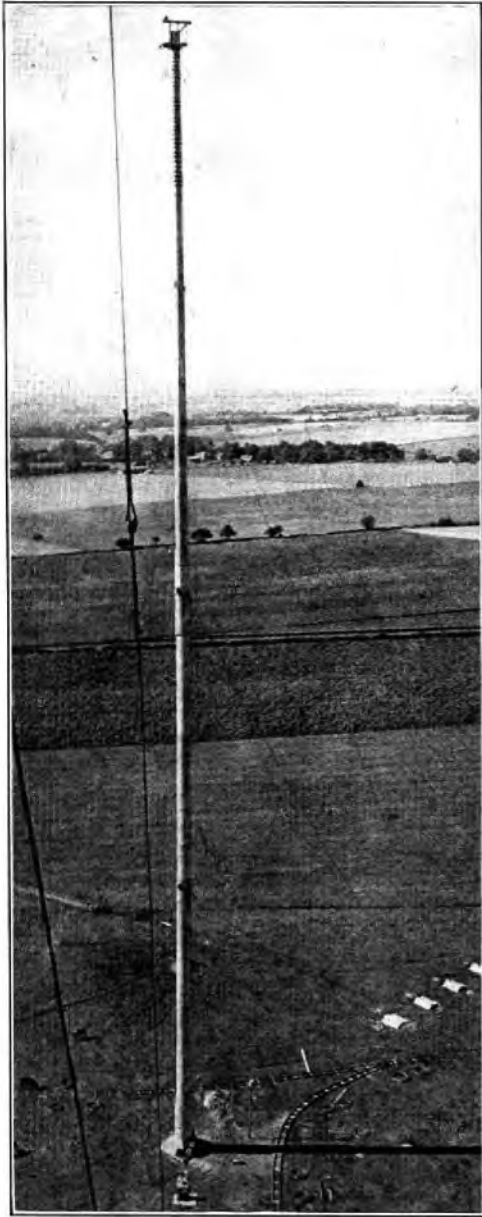

FIG. 6.—COMPLETED MAST.

The work had then to be organised in such a way that a minimum number of operations was needed to effect the change-over from the old to the new man-hoist, during which period ascent and descent were not possible. Since the new jib and man-hoist rely for part anchorage on certain reinforcing bars, the operations involved (which were completed in 6-8 hours) were the setting up and screwing in of 8 reinforcing

Straightening of Existing Masts.

Certain of the existing masts were considerably twisted and crooked, particularly in their upper sections (see Fig. 7). Calculation showed that it would be reasonably safe to attempt to straighten the worst sections by the judicious adjustment of stays

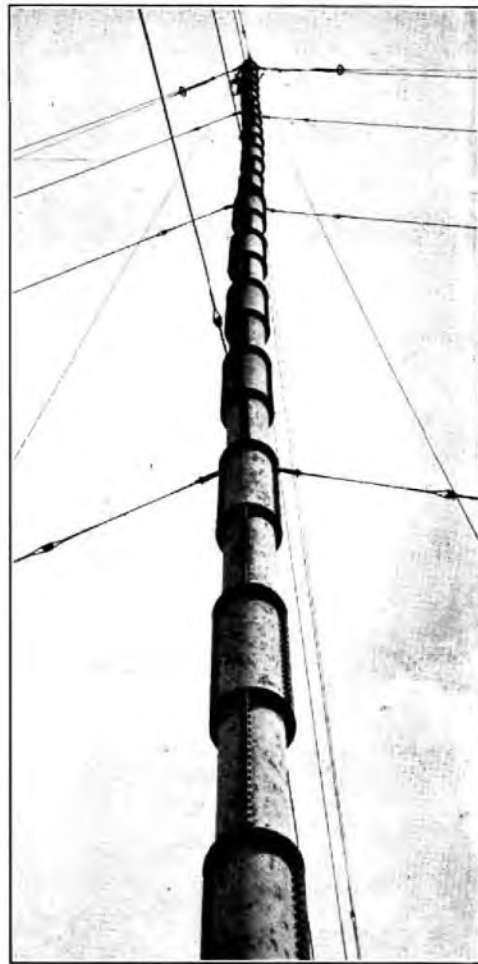

FIG. 7.—EXISTING MAST SHOWING TWIST IN UPPER SECTIONS.

and the fitting and tensioning of temporary stays at selected levels. This was successfully carried out while sighting from two theodolites arranged in directions at right angles to each other. To reduce the risk of collapse, the whole of the reinforcing rods were first set up and loosely terminated to allow small deflections of the mast but to restrain it against failure of a corroded section. Straightening in the lowest sections was first made and the mast concreted over the straightened sections. After hardening, the sections above could be similarly corrected and concreted. In certain cases a slight over-correction was intentionally made to allow for elastic return, when the stored energy due to deformation would be redistributed within the finished reinforced concrete.

Inspection.

A recent inspection of the surface of masts made eighteen months after completion, during which time the structures had been exposed to high winds, revealed no cracks or defects. A survey of the initial tensions in all stays showed only small departures (10 per cent.) from the tensions as set up on completion of each mast. This variation was probably due to slight longitudinal shrinkage of the mast and perhaps a small bedding down of the strands of the stay ropes despite the pre-stressing applied before erection.

Conclusion.

Work was commenced in April, 1943, and was con-

tinued until October of that year when operations were suspended during the winter months. Work was resumed again during April, 1944, and concluded by the following October.

All work was completed without serious accident and, except for one minor mishap in which a transmission was interrupted for 28 minutes, the whole of the reconstruction including all work at the mast head was carried through without interruption to service.

The cost of the work amounted to about 40 per cent of that which would have been involved for replacement of the masts by new steel structures. Further, the concrete surface of the reconstructed masts will require negligible maintenance attention and avoid the usual biennial expenditure for the painting of steel structures.

The design and drawings were prepared by the Post Office Engineering Department, and the work carried out by Messrs. John Mowlem and Company Limited.

Acknowledgments.

The authors wish to acknowledge the work of Mr. J. J. Edwards and other members of the P.O. Eng. Dept. Special thanks are also due to Messrs. J. T. Horn and A. R. Burton of Messrs. John Mowlem and Company Ltd., who organised and carried out the work, including the design of the erection cages.

Book Review

"The Story of the Telephone." J. H. Robertson. 299 pp. Pitman 10s. 6d.

The author of this book makes it clear that he is a political journalist and that the book has been written at the request of the Telecommunication Engineering and Manufacturing Association. The engineer will not find much to interest him from the technical aspect. On the contrary, however, he will find a great deal of well-written and interesting information, particularly concerning past history.

The general theme is the great part played by manufacturers in raising the standard of efficiency of the British telephone system and that of the countries which have adopted British standards.

Post Office engineers may consider that their own contribution has been understated, but they may temper such disappointment with the knowledge that the volume is written from the manufacturers' angle.

The book opens with the oft-told story of Graham Bell, Watson, Elisha Gray and the contribution to the art by Mr. Strowger; thereafter the reader is taken in an engrossing manner through early development stages and the transfer to the state of the National Telephone Co. and a number of municipal undertakings. The author

with the aid of extracts from correspondence, interviews and official documents, vividly portrays to the reader the intrigue and procrastination which occurred and the vicissitudes encountered during the period following and leads up to the implementation of the Bridgeman Committee's recommendations from which time the record is one of progressive improvement resulting from the more intimate relationship between the administration and the manufacturers summed up later by the author on page 281:—

"That is the true, welcome and enduring relationship which exists between the Post Office and the Industry. It maintains its strength because it is founded on years of shared enterprise and endeavour."

The author has very clearly told the reasons for the adoption by Great Britain of the Strowger System and the subsequent inclusion of the "director"; the development of carrier and coaxial working and the impact of the war on the industry are described.

Altogether a very interesting and readable volume.

C. W. B.

The Introduction of Manual Switching of Teleprinter Circuits in the Public Telegraph Service

H.E. WILCOCKSON, A.M.I.E.E.
C. W. A. MITCHELL, A.M.I.E.E.

J.D.C. 621.394.74 :621.394.3

Part I. The Teleprinter Switching Network

The first part of this article outlines the reasons for the introduction of a teleprinter intercommunication system for the Public Telegraph Service, with switching on a manual basis, and describes the switching network provided, and the programme of conversion involved. The second part will deal with the physical and circuit features of the equipment employed.

Introduction.

THIS article is intended to describe not only the Teleprinter Manual Switching (T.M.S.) system employed for the public telegraph service and the equipment provided, but also to outline the reason for its introduction and to set the whole project in its correct perspective against the background of war, which both fostered and hampered its introduction.

Firstly, it is necessary to stress that but for the war, manual switching would never have been applied to the network, since the system of automatic switching, which had been designed and subjected to satisfactory large-scale field trials prior to the outbreak of hostilities, would have been operative. This automatism scheme was, however, suspended at the outbreak of war and thus, during the early war years, the telegraph traffic continued to be handled over the existing network of point-to-point circuits, augmented as far as possible to meet the steadily increasing traffic, the trend of which is shown in Fig. 1.

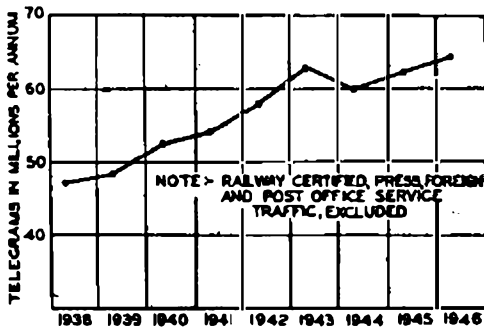

FIG. 1.—PUBLIC TELEGRAPH TRAFFIC.

With this method of working, a high proportion of the total traffic was dealt with at the Zone Centres, but the loss of the telegraph instrument rooms at the C.T.O., Liverpool, Bristol and Birmingham during the 1940/41 blitz, rendered it necessary as a matter of urgency to deconcentrate the telegraph traffic away from the large and vulnerable towns. Under the deconcentration scheme many additional Area Centres were set up, and arranged in "triangles" of three, each triangle having at one or other of the area centres concerned teleprinter point-to-point connections to all other "triangles." The scheme was brought into effect during the summer and autumn of 1941, and although successful in relieving

the zone centres of a considerable volume of traffic, it resulted in a substantial increase in the number of retransmissions per telegram, with consequent increase both in staff hours and transit time.

The immediate problem of security being resolved, attention was next directed to a means for restoring the quality of service without a corresponding increase in man-power requirements. A reduction in the number of retransmissions by the introduction of switching methods was adjudged to provide the most promising solution, the basis of the switching scheme proposed being the connection of all outlets from a particular "triangle" to all other "triangles" via a switchboard, thus eliminating the need for retransmissions at the intermediate area centre to which these outlets were connected.

At the outset, therefore, the switching scheme was designed primarily as a means of teleprinter communication between area centres only, and some thought was given to the location of the necessary switchboards at appropriate area centres. Study of the equipment requirements showed, however, that more efficient utilisation could be achieved by installing the switching centres at certain selected zone centres, such that, provided the switching equipment was sited in accommodation not more vulnerable than the V.F. equipment, adequate safeguards against dislocation of the service by air attack could be obtained. The decision was taken, therefore, to site the switchboards at selected zone centres, of which there were ultimately to be six, and for the purpose of a field trial to install suites of five positions in protected accommodation in the basements of the H.P.O.s at Birmingham and Leeds.

The urgency of the scheme necessitated the avoidance of any delay which the design and provision of special switchboards would have involved, consequently the type of switchboard used by the armed forces on the Defence Teleprinter Network (D.T.N.)¹ was adopted for the field trials with only such modifications as were necessary to meet the differing technical requirements of the Public Service. Although by this means the utmost expedition was achieved in providing and installing the field trial and subsequent equipment, the P.O. Factories Department, which undertook the manufacture of the equipment, was already fully engaged in the supply of D.T.N. switchboard equipment to meet the ever-growing demands of the fighting services, and the authors desire to place on record their wholehearted appreciation of the

¹ I.P.O.E.E. Printed Paper No. 189.

good services provided both by the staff and works personnel of the Factories Department, under difficult conditions, in meeting these joint requirements, the measure of which is given by the curves in Fig. 2.

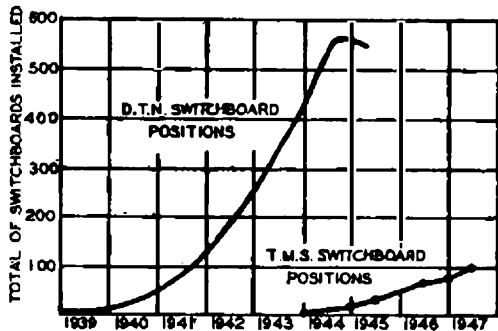

FIG. 2.—D.T.N. AND T.M.S. SWITCHBOARD PROVISION.

The five-position suites at Birmingham and Leeds, comprising the field trial equipment, were brought into service on January 14th, 1944, and from the outset provided a satisfactory service, and afforded a material reduction in retransmissions. Further improvements in the service were expected as more offices were connected, and hence the extension of the switching system to the telegraph network as a whole, by appropriate stages, each of which would contribute its quota to the improvement of the national service, was approved.

It should perhaps be recorded for those readers not familiar with teleprinter switching systems that the circuits terminated at these switchboards are suitable only for the transmission of telegraph traffic and that demands are passed to switchboards by teleprinter messages.

ROUTING OF TELEGRAPH TRAFFIC *Point-to-Point Working.*

A brief description of the arrangements in force at the outbreak of war, and after deconcentration, are given below to provide an appreciation of the problems affecting the introduction of manual switching.

The number of telegraph offices at which telegrams may be handed in is approximately 14,000, varying in size from small Post Offices to the C.T.O. in London. It follows that it was and is quite impracticable to provide direct circuits between all telegraph offices, or even all large offices, hence for telegraphic communication purposes the country was divided into 11 zones, each of which was divided into areas, and sub-divided into groups. Small telegraph offices known as minor offices were connected to their group centre, which acted as the transmitting office for all such minor office traffic. Similarly, the area centre acted as a transmitting office for all group centres in its area, and the zone centre for its area centres. Direct telegraph circuits were provided interconnecting all zone centres (excepting Belfast, which had connection to only seven zone centres), and in addition, where traffic justified their provision, between zone centres and area centres in other zones, or between area centres. Fig. 3 (a) shows an arrangement of zones and areas illustrating the foregoing principles, and also the trend in the immediate pre-war years to concentrate more traffic on the zone centres, by reduction of the number of area centres and connecting group centres to zone centres direct. The technical arrangements adopted to provide the teleprinter point-to-point circuits concerned have been the subject of previous articles^{2,3,4} and will not be described here.

² P.O.E.E. Journal, Vol. 25, pp. 8.
³ P.O.E.E. Journal, Vol. 26, pp. 163.
⁴ P.O.E.E. Journal, Vol. 28, pp. 182.

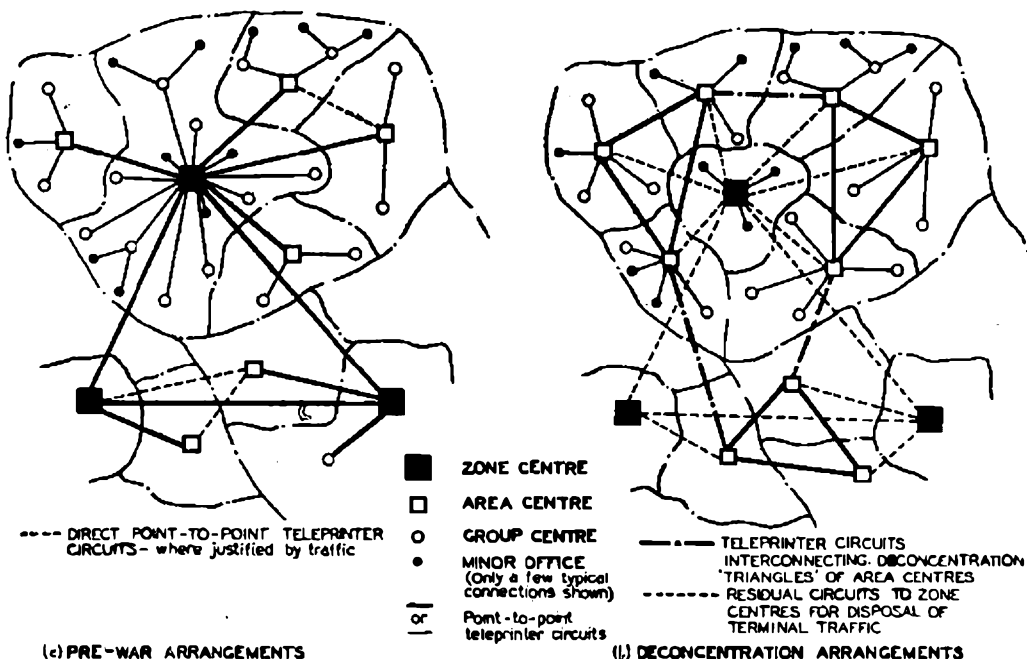

FIG. 3.—TYPICAL ROUTING OF POINT-TO-POINT TELEPRINTER CIRCUITS.

The foregoing covers the purely telegraphic network, but the description would not be complete without reference to the phonogram service and telephone-telegraph system, which together contribute some 40 per cent. of the traffic to be handled by the Inland Service. Telegrams handed in by telephone may be received either from telephone subscribers or from call offices or kiosks, this service being known as phonograms, or from small Post Offices from which the telegram traffic does not justify the provision of teleprinters, this service being known as telephone-telegrams. The centre at which this telephone traffic is received, and at which special phonogram and T.T. positions are provided and staffed, is known as the "appointed office," and has at least group centre status. Thus onward transmission from the appointed office is nearly always by teleprinter.

The net effect of the point-to-point system of working above described was that a large volume of traffic was concentrated at the zone centre, and although this resulted in efficient utilisation of the main links, an obvious drawback was that a large proportion of the traffic was subject to one or more retransmissions before reaching the objective office. As telegrams have to be circulated for distribution at each transmitting point, and then lined up for onward transmission over the next link, an appreciable aggregate delay was thereby incurred, and additional staff and apparatus costs were clearly involved.

Deconcentration Arrangements.

As the name implies, the primary objective of the deconcentration scheme was to re-route the telegraph traffic to relieve the vulnerable zone centres of as much transit traffic as possible and thus to safeguard the network against dislocation by air attack. This was achieved by creating many additional area centres, and grouping these in "triangles" of threes, each "triangle" having, at one or other of the three offices concerned, teleprinter outlets to all other triangles. Furthermore, group centres previously connected directly to zone centres were reconnected on outlying area centres wherever practicable. Fig. 3 (b) illustrates the principle of the arrangements made, and shows, clearly the cost involved in the form of additional retransmissions to secure the necessary safeguards.

Manual Switching—Initial Routing Arrangements.

At the outset the Teleprinter Manual Switching scheme was designed primarily as a means of communication between area centres, thus eliminating the retransmission required at intermediate area centres under deconcentration arrangements. Each area centre was to have bothway routes to two, or sometimes three, switching centres, of which there were to be six, located at selected zone centres, and connected each to each by inter-switchboard circuits. Exceptionally, a few large group centres were to be connected to the switching network, generally by a bothway route to the parent switchboard only.

With these arrangements, not more than two switchboards were involved in setting up any connection, and the traffic from area centres requiring two switching operations, particularly in the early

stages of the scheme with only two or three switchboards opened, and few group centres connected, would be small. In the ultimate, however, with all switching centres opened, a fair proportion of area centre traffic and a large proportion of group centre traffic would require two switchings, although no real difficulty was expected, as most of the traffic over the D.T.N. network was being similarly routed without difficulty.

Experience during the earlier stages of the scheme showed, however, that the operator output on calls routed through two switchboards was considerably lower than on calls through only one switchboard, the normal tendency towards which was increased somewhat by the effect of the occasional connection of follow-on calls to inter-switchboard circuits which had not been cleared at the distant end, resulting in delays in answering at the second switchboard, as well as misrouted calls. This difficulty was ameliorated by modifying the inter-switchboard circuits to unidirectional working, but to provide a positive solution the design and provision of inter-switchboard line equipment to give full automatic signalling facilities was put in hand. It was also observed, in connection with the use of bothway teleprinter extension circuits from the switchboards, that operators dealing with outgoing calls resented the connection of incoming calls, and therefore tended to hold connections irregularly until ready to originate the next call.

These factors, taken in conjunction with a proposal to extend the number of group centres to be connected to the switching network, led to the design of modified routing arrangements employing unidirectional circuits.

Manual Switching—Modified Routing Arrangements.

The modified scheme for routing the switched traffic over unidirectional circuits, and via only one switchboard, is illustrated in Fig. 4, from which it

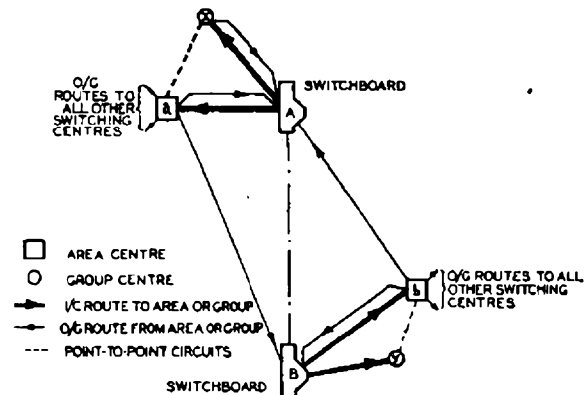

FIG. 4.—TYPICAL SWITCHING ARRANGEMENTS, USING UNIDIRECTIONAL CIRCUITS.

will be seen that all switchboard routes (with minor exceptions) are divided into incoming and outgoing circuits, and that each office will receive its incoming traffic over the only incoming route provided, namely from the parent switchboard. For outgoing traffic all area centres will have at least one circuit to every switchboard. Thus, from Fig. 4 it will be seen that

a call from a to b will be routed a-B-b, whereas a call from b to a will be routed b-A-a. Calls from area centres to group centres will be similarly routed via the home switchboard of the objective centre, e.g. b-B-y, b-A-x. The routing of outgoing traffic from group centres will vary according to its volume; at the smaller group centres point-to-point circuits will be provided to the home area centre over which all outgoing traffic will be routed for retransmission over the switching network, whereas the larger group centres will have in addition to the point-to-point route, outgoing switching circuits to the home switchboard, and to other switchboards where justified by traffic. These arrangements are typified in Fig. 4 by group centres y and x respectively.

The routing of switched public traffic via two switchboards has thus been eliminated, but a small number of unidirectional inter-switchboard circuits have been retained in use, for the routing of service traffic. Later, the use of double switched connections for a limited amount of public traffic, to meet special cases where on balance a service advantage is realised, is a possibility, and has not been precluded by the technical arrangements made.

The use of a small number of bothway teleprinter extension circuits for special purposes will of course continue, mainly for the provision of service and maintenance facilities, as follows:—

- (a) *Enquiry Circuits.* These circuits are provided for dealing with enquiry traffic, and terminate on "EQ" teleprinter positions located near the switchboard positions.
- (b) *Speaker Signalling Circuits.* With the introduction of manual switching, the speaker circuits provided on control boards in instrument rooms for use by the commercial staff in the setting up of special circuits and so on, have been converted from direct to switching circuits, with consequent economy in the use of V.F. channels. These "Z" circuits appear as bothway circuits on the switchboard, and are terminated on special equipment at the control boards.

Transmission Limits.

Allowing for a factor of safety which will ensure satisfactory operation of a teleprinter under average maintenance conditions, the switching circuits have been arranged to ensure that on any switched connection the number of V.F. channels in tandem should not exceed three, when the distortion introduced by any physical section of the connection is negligible.

Teleprinter extension circuits (switchboard to area or group centre teleprinter) are either a combination of physical line and V.F. channels, or are wholly physical. In the former case, the physical section must not exceed the limiting distance for negligible distortion, given in Column 4 of Table 1, whereas in the latter case the limits in Column 3 of Table 1 are applicable, and as the distortion may not then be negligible, not more than 2 V.F. channels in tandem may be employed on connections including such circuits.

The limits quoted in Table 1 have been determined with specific regard to the method of working employed on the T.M.S. network, i.e. 2-wire simplex, using double-current signalling.

TABLE 1.
T.M.S. Network-Limiting Distances for Physical Extension Circuits.

| Type of Circuit | Conductors Used (Note 1) | Limiting Distances (Miles) | |
|---|--|-------------------------------|--|
| | | For a circuit wholly physical | For a physical extn. from a V.F. channel |
| (1) | (2) | (3) | (4) |
| 2-wire simplex, non-relayed | Star Quad, Twin, or Multiple Twin 10, 20 or 40 lb. Single Screen, 40 or 70 lb. | 20 | 10 |
| | | 40 | 35 |
| 2-wire simplex, relayed. (Relay 299 or Standard BN) | Star Quad, Twin, or Multiple Twin 10, 20 or 40 lb. Single Screen, 40 or 70 lb. | 45 | 20 |
| | | 90 | 75 |
| 2-loop simplex, relayed. (Relay 299) | Star Quad, Twin, or Multiple Twin 10, 20 or 40 lb. | 90 | 35 |

NOTE 1.—The limits quoted for Twin or Multiple Twin cables apply to side and phantom circuits.

Circuit Provision.

The T.M.S. network was necessarily planned to operate on a "no-delay" basis, delay working being incompatible with the objective of improving the over-all grade of service. Considering the groups of unidirectional circuits from switchboards to area or group centres, the circuit provision is determined by the season busy-hour traffic (calculated in T.U.'s), in accordance with the table employed for manually selected "no-delay" telephone junctions. The inter-switchboard circuit provision is similarly determined. The circuit provision for the unidirectional routes from area or group centres to switchboards is determined on a different basis, however, as the telegrams are lined up for onward transmission and manual selection of circuits is not involved. The circuits are provided on an occupied time basis to meet an operator output of 45 telegrams hourly, the average call duration time being 1 minute.

To meet conditions where congestion may exceptionally arise on individual routes outgoing from switchboards, the operating instructions ensure that if the second attempt to secure connection by a forwarding office is ineffective, then the call will be routed on an overflow basis to a teleprinter position at the switching centre concerned for subsequent retransmission. Experience has shown that the amount of overflow traffic, with the above circuit provision, is very small.

CONVERSION PROGRAMME

General.

As an ultimate nation-wide teleprinter manual switching-network was under consideration at the planning stage, and the prevailing war-time limitations regarding the supply of equipment and availability of installation staff had to be kept in mind,

it was envisaged that the switching system should be introduced by a succession of stages, each stage being self-sufficient, and comprising basically the connection of a "triangle" of area centres to the switching network, together with circuits from other area or zone centres working to that triangle. The programme thus provided for ready adjustment to meet unforeseeable contingencies, with a maximum of flexibility in securing the earliest practicable completion date.

The initial programme provided for 15 separate stages to obtain completion of the network, the necessity for the provision and opening to service of the six switching centres arising as follows:—

| Switching Centre. | Stage. |
|-------------------|--------|
| Birmingham | 1 |
| Leeds | 2 |
| Manchester | 8 |
| Bristol | 10 |
| Glasgow | 12 |
| London | |

In addition to the requirements for the manual switchboard installations, the conversion programme also called for the installation of extension teleprinter positions at the various centres connected to the switchboards, and for the necessary provision and rearrangement of V.F. systems to meet the revised line network. To deal in any detail with this latter aspect would perhaps be outside the scope of this article, nevertheless it will be clear that careful planning and close control were necessary to ensure

the fulfilment of programme dates while, at the same time, maintaining continuity of service.

A brief review of the progress made with the conversion programme and the results obtained follows. It will be noted that in the event a number of stages have been merged to accelerate the programme, and two stages (5 and 9) deferred for later introduction.

Initial Arrangements.

Stage 1 of the conversion was based on the provision of full switching facilities to the Derby-Leicester-Nottingham triangle of area centres, with switchboard installations (using Switchboards, Teleprinter No. 17) at Birmingham and Leeds. Peterborough, for security reasons, and exceptionally the large group centres of Rugby and Coventry, were also connected as fully switched offices. The remaining group centres in the triangle continued to work to their home area centres over point-to-point teleprinter circuits, as illustrated in the inset to Fig. 5. From this figure, the line network for Stage 1, comprising 200 working circuits, may be discriminated. The outlets from the switching network providing access to the unconverted portion of the existing network are also shown in tabular form in Fig. 5. The extension teleprinter circuits installed at these "partially switched" centres were, of course, of the same design as those provided at the fully switched offices, as described later.

After a period of operation with dummy traffic for the purpose of staff training, the trial network was opened for live traffic on January 14th, 1944. Special

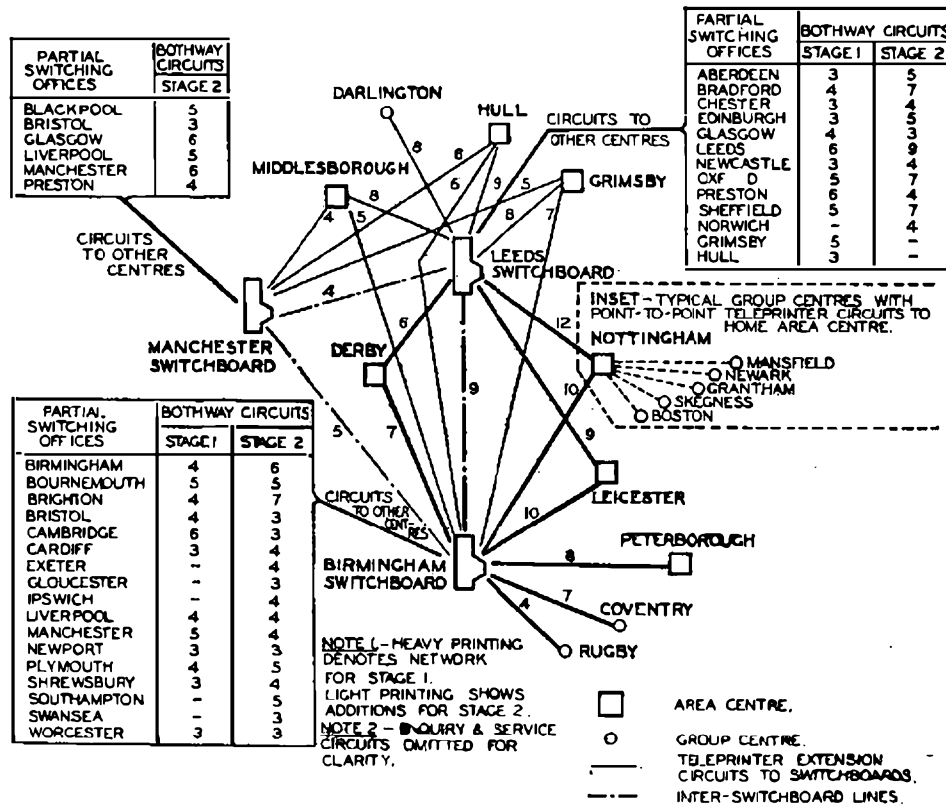

FIG. 5.—LINE NETWORK FOR INITIAL STAGES.

traffic returns were taken during the first few months of working, and showed that the average transit time per telegram from the full switching offices had been improved by approximately 20 per cent., and the number of RQs (service messages regarding apparent errors in received telegrams) had been reduced by nearly 50 per cent. The number of retransmissions saved was estimated at 0.8 per telegram. Still further improvements in service were confidently expected as more offices were connected to the network.

Stage 2 Arrangements.

For Stage 2, a third switchboard installation (Manchester) was opened, and the Hull-Grimsby-Middlesbrough area centres, and Darlington group centre added to the switching network as fully switched offices. Additional partially switched offices were also connected to the network, which is shown in Fig. 5. The total of working circuits was increased to 359, and of switchboard positions to 20.

By reason of the different operating procedure employed on the T.M.S network, compared with the D.T.N., it was found during the initial trial that a slight risk was incurred of duplicate connections being established (1 in 1,172 messages), an occurrence which can cause material service difficulties. To preclude such occurrences, a new cord and position circuit design was evolved, and given a field trial on an experimental suite of four positions at Manchester, which comprised the switchboard requirements at this centre for Stage 2. Opportunity was also taken to include a number of refinements in circuit design which had been developed meantime, as well as of physical details, the resulting switchboard being known as the Switchboard, Teleprinter, No. 17A.

The Stage 2 network was opened for service on December 31st, 1944, with satisfactory results; the automatic "engaged-test" facility incorporated in the Manchester switchboard was proved to be completely effective in preventing duplicate connections, whatever the cause.

Arrangements for Stages 3 and 4.

The combined Stages 3 and 4, opened for service on June 17th, 1945, brought the total of fully-switched offices connected to the switching network to 20, and the total of bothway circuits in use to 546.

Extension of the equipment at the three existing switching centres was necessary, the number of positions being increased to 13, 14 and 9 at Birmingham, Leeds and Manchester respectively, and opportunity was taken to install the extended suite at Birmingham in above-ground accommodation, and thus to improve the staff working conditions.

At the completion of this phase some 28 per cent. of the total public telegraph traffic was being handled by switching means, with a substantially improved grade of service. Nevertheless, traffic observations showed that further improve-

ments could be realised by the introduction of unidirectional working, as previously described.

Arrangements for Stages 6, 7 and 8.

This phase of the switching scheme marked the general introduction of the Switchboard, Teleprinter No. 17A, and of conversion of the network to the routing of traffic over unidirectional circuits, as well as the opening of a new switching centre at Bristol. Twelve additional fully-switched offices were connected to the network, and the total of working circuits increased to 867.

The installation work involved the provision of a suite of 20 positions at Leeds, replacing the existing suite of 14 positions in refuge accommodation; of 21 positions at Birmingham, to replace the existing suite of 13 Switchboards, Teleprinter No. 17; of 12 positions at Bristol, and an extension of the Manchester suite by 9 positions (Fig. 6). Also all regions were involved in the provision of additional extension teleprinter positions, as well as the re-routing of V.F. systems to meet the revised line arrangements, illustrated by Fig. 4, and provision of new systems to cater for new offices connected to the network.

An incidental product of the revised method of working was that certain rearrangements of the switchboard face layout to give improved operating facilities were made possible, and were implemented as part of the installation work for this phase, viz. the division of the combined answering and calling jackfield, with 3-panel multiple repetition, into separate incoming and outgoing multiples, with 12- and 4-panel multiple repetition respectively. As a result, the jackfield was simplified from an operating viewpoint, and a material reduction was obtained in the overall height of the multiple field. The self-evident benefit gained by this reduction in height was supplemented, to some extent, by a saving in ineffective time as a result of the reduction in the



FIG. 6.—TELEPRINTER SWITCHBOARDS AT MANCHESTER.

number of appearances of the calling lamps, and consequent reduction in the number of cases of simultaneous answering by two or more operators.

With the introduction of this phase, the provision of equipment at the Birmingham, Leeds and Manchester switching centres catered for the ultimate requirements, and from a traffic viewpoint, all 24 area centres and a number of group centres in the zones covered by these switching centres had been provided with full switching facilities.

The modified and enlarged network was opened for service on June 23rd, 1946, and functioned satisfactorily from the outset both as regards engineering and traffic facilities.

Stage 10.

The fifth switching centre, Glasgow, with six positions, was installed for this stage, and opened for service on January 5th, 1947. The switchboard at the Bristol switching centre was also increased to 18 positions. Belfast and the area centres in the Scottish Region were given full switching facilities, the totality of working circuits being increased to 1,051.

The proportion of the total public telegraph traffic being passed over the switching network at this stage

was approximately 40 per cent., or some 70,000 telegrams daily.

Completion Stages.

The London zone was the last to be added to the switching network. Because of its magnitude (17 area centres and 54 group centres will be given switching facilities), the conversion was arranged to take place in three phases, of which the first was opened on May 11th, 1947. The remaining two phases will be completed later in the year. During this period, the few residual area centres outside the London zone not yet connected to the switching network will be added as expedient.

The number of switchboard positions installed in the C.T.O., London, to meet the phase 1 requirements, was 16. For the ultimate requirements 39 positions will be required, with a multiple capacity for 240 incoming circuits and 560 outgoing circuits.

The estimated number of switching circuits in use at the completion of the conversion programme is 1,547, with a total of 134 switchboard positions. The proportion of the public telegraph traffic passing over the switching network is estimated to reach 75 per cent. of the total.

Book Review

"Elementary Telegraphy." E. Missen, A.M.I.E.E.
George Newnes Ltd. 340 pp., 108 ill., 12s. 6d.

Modern developments in telegraph technique have necessitated a change from the traditional presentation of the subject as adopted in existing text books. Whereas rationalisation of the technique has led to simplification of practice, the translation of modern theory into a form adapted to the needs of the elementary student has not been simplified. The author of the present text book has set out to cover a first-year course in Telegraphy and it can be admitted that the satisfactory accomplishment of such an aim now has its own peculiar and not inconsiderable difficulties.

The practical descriptions of telegraph apparatus and equipment follow normal lines and call for no special comment. However, in his treatment of the theoretical side of the subject, the author can hardly be said to have achieved his intentions and serious apprehension is felt that, in the hands of an elementary student, not a few passages in the book will breed discouragement if not bewilderment. This is mainly because the author has condensed the theory rather by abbreviation than by simplification and limitation of scope resulting in an unfortunate ambiguity and lack of lucidity which is more confusing than instructive. He has also introduced in several places brief references to points quite outside the needs of an elementary student which can only add to his confusion. Added to this there are not a few inaccuracies of statement in relation to theory. Examples bearing out the foregoing points follow.

A very confusing explanation of the governing conditions on teleprinter motors is given on page 50 and an inexplicable reference to the *direction* of rotation of the governor on page 51.

A diagram illustrating the magnetic circuit of a

telegraph relay on page 100 shows reluctance in series with magnetic flux.

A treatment of filter theory in Chapter III omits any specification of the type of section dealt with and, what is worse, is not correct for a single section of the type illustrated.

A reference to "skin effect" is introduced on page 147 in relation to telegraph signal frequencies.

An ill-founded explanation of teleprinter margin is given on page 285.

Most extraordinary perhaps are two paragraphs headed "Power per Channel" and "Circuit Length Limitations" in the chapter on Voice-Frequency Telegraphy. In the first paragraph, a somewhat confused account of power levels when working on the 4-wire portion of a normal zero loss trunk telephone circuit is closed by the following sentence—"The overall transmission equivalent of the circuit is therefore $-4+4=$ zero and the overall gain 8 db."

The -4 and $+4$ refer to the normal levels at the ends of the 4-wire portion of a telephone circuit which has zero-loss between the 2-wire ends, while the author seems to have the impression that their algebraic sum gives the transmission equivalent of the 4-wire portion of the circuit.

The second paragraph purports to inter-relate the band-width of the channel filters in a multi-channel system and the maximum permissible line propagation time, from which is developed a theory for establishing the maximum possible length of a voice-frequency telegraph line. The source of such a singular fallacy is difficult to fathom but the unfortunate effect on the unsuspecting student can readily be appreciated.

The foregoing examples, which could be extended, are probably sufficient to justify a feeling of considerable doubt as to the value the book can have for the elementary student and it is much to be regretted that the author's labours in describing telegraph practice must be held to have been vitiated by his treatment of theory.

E. H. J.

The Prediction of Optimum Working Frequencies for Short Wave Radio Circuits

H. STANESBY, M.I.E.E., and
G. H. M. GLEADLE, M.Sc.(Eng.), A.M.I.E.E.

U.D.C. 621.396.11 621.396.812

A brief and comparatively non-technical account is given of the reasons why, when high frequencies are used for long-distance radio communication, the most suitable frequency depends upon the location of the terminal points and the time at which communication is desired. The method used for determining the optimum frequency is also described.

Introduction.

THIS account has been written in response to a request for a simple outline of the principles and methods used in predicting the optimum working frequencies for short wave radio circuits. It does not pretend to be exhaustive, and a list of references is given at the end for the benefit of those who would like to pursue the subject further.

The Ionosphere.

With short waves, earth absorption causes the ground wave to die away fairly rapidly as the distance from the sender increases, and long-distance transmission is possible only because of the existence of ionised layers in the upper atmosphere. The region in which these layers are located is known as the ionosphere, and short waves travel from the sender to the receiver by one hop or a series of hops from the earth to the ionosphere and back again. Thus, a knowledge of the properties of the ionosphere and its effect on radio waves is the basis of all frequency predictions.

Certain components of the radiation from the sun, and cosmic rays, are able to split loosely-bound electrons away from their parent molecules in the upper atmosphere, and so cause ionisation. The free electrons have negative charges and the molecules from which they are derived are left with positive charges. These two components are called negative and positive ions, respectively.

The ionosphere is composed of two main layers of ionisation, the E-layer at a height of about 100 km. and the F-layer at 200 to 300 km. The stratification of the ionosphere is probably due to differences in the pressure of the atmosphere at various heights and in the wavelength of radiation required to split up the molecules of the different gases, and because the various components of radiation are attenuated to differing extents as they penetrate more deeply into the earth's atmosphere.

The rate at which the ions recombine increases with pressure and is therefore more rapid at the lower levels. Thus, at night, the E-layer fades away altogether and the ionisation of the F-layer decreases considerably but does not disappear entirely. This is partly because of the slower rate of recombination of the ions at the higher levels, and, it is thought, because the ionisation in the F-layer is to some extent caused by cosmic radiation which is as intense at night as in the daytime. During the day, the F-layer splits up into two components, the F_1 - and F_2 -layers, which coalesce again at or near sunset.

Effects of the Ionosphere on a Radio Wave.

On the passage of a radio wave through the ionosphere the ions are set in motion by the electric field of the wave and become elementary currents that re-radiate the energy absorbed from the passing wave. The positive ions, however, have far greater mass than the electrons and their movement is relatively insignificant; their effect can therefore be neglected. The field re-radiated by the oscillating electrons interferes with that of the primary wave. This changes the direction of the wave front and tends to bend the wave away from regions of increasing ionisation, and finally, if the ionisation is sufficient, the wave is reflected, or more correctly, refracted, back again to the earth. In other words, the electrons reduce the refractive index in the ionosphere, and, as with light waves, the radio waves are bent away from regions of lower refractive index. If, however, the maximum density of ionisation is not high enough a wave of a given frequency will not be bent sufficiently to return to earth and it will pass right through the ionosphere. In general, waves of frequencies greater than about 50 Mc/s are rarely reflected sufficiently by the ionosphere to cause them to return to earth. The highest frequency that is reflected by a particular layer when a wave is projected vertically upwards is called the Vertical Incidence Critical Frequency (V.I.C.F.) of the layer. The V.I.C.F. for the ordinary ray for F_2 -layer reflection is written f^oF_2 .

At the lower frequencies the electrons set in oscillation by a radio wave are able to acquire larger velocities because the intervals between the reversals in sign of the field of the wave are longer; in other words the inertia of the electrons is less effective. This means that low frequencies are more easily reflected than higher frequencies. Since the angle through which a wave must be bent to prevent its passing through the ionosphere is less for oblique incidence, waves of all frequencies are more readily reflected at oblique than at vertical incidence. For a given density of ionisation, a higher frequency can therefore be reflected at oblique incidence than at vertical incidence.

The oscillating electrons not only alter the direction of the wave front but, because they collide with gas molecules from time to time, they do not re-radiate all the energy abstracted from the wave, and some of it is dissipated. In other words, the wave is attenuated in its passage through the ionosphere. Broadly speaking, this effect increases as the frequency is reduced, because, as explained above, the electrons can then

acquire larger velocities and the kinetic energy dissipated is therefore greater. However, at frequencies below about 1,000 kc/s, the presence of the earth's magnetic field reduces the attenuation below the value that it would otherwise attain; but to discuss the mechanism of this action would be beyond the scope of this survey. The main part of the attenuation of a wave occurs in the lowest layers of the ionosphere, in the D- and E-layers, where the atmosphere is relatively dense and the frequency with which collisions occur is therefore greater.

To re-capitulate, the electrons of the ionosphere set in oscillation by the passage of a radio wave alter the path of the wave and also cause attenuation. The lower frequencies are always reflected back to the earth, whereas the higher frequencies may be reflected only at oblique incidence, or not at all. The attenuation, which occurs in the lower layers of the ionosphere, becomes less and less as the frequency is increased. Thus, in choosing a frequency for a particular service, the aim is, generally speaking, to use as high a frequency as possible consistent with its being reflected back to the receiving point.

Measurement and Prediction of the Characteristics of the Ionosphere.

For the moment, attention will be confined to waves travelling in a direction perpendicular to the ionosphere, i.e., to cases of normal, or vertical incidence. In the daytime, the lower frequencies are reflected by the E-layer, but as the frequency is increased the waves penetrate more and more deeply into the layer until a frequency is reached that penetrates as far as the level of maximum ionisation. This frequency is the highest that will be reflected by the layer at vertical incidence—the Vertical Incidence Critical Frequency of the layer. Slightly higher frequencies than this will pass right through the E-layer and go on until they meet the denser F_2 -layer where they will be reflected back to earth, passing through the E-layer a second time. Still higher frequencies will be reflected only by the F_2 -layer. Finally, frequencies higher than the V.I.C.F. of the F_2 -layer will pass right through the ionosphere and will not, therefore, be returned to earth. At night-time, however, the ions of the E-layer recombine and the layer disappears, only a single F-layer remains, and the picture becomes much simpler.

Ionospheric laboratories, such as the Interservices Radio Propagation Laboratory (I.R.P.L.), have been set up in various parts of the world and regular measurements are made from which, among other quantities, the virtual heights¹ and the V.I.C.F.'s of the various layers are deduced. It is also possible to determine the highest frequencies that will be reflected by the various layers at other angles of incidence; or, in other words to determine the "Maximum Usable Frequency" (M.U.F.) for various distances between the sender and receiver. An

example of the results of virtual height and critical measurements is shown in Fig. 1.

It has been established that the densities and virtual heights of the ionospheric layers undergo fairly regular variations throughout the day, the year, and the sunspot cycle, and this makes it possible to predict the average characteristics with reasonable accuracy. Predictions for several months ahead are prepared and issued by various organisations. Certain of the

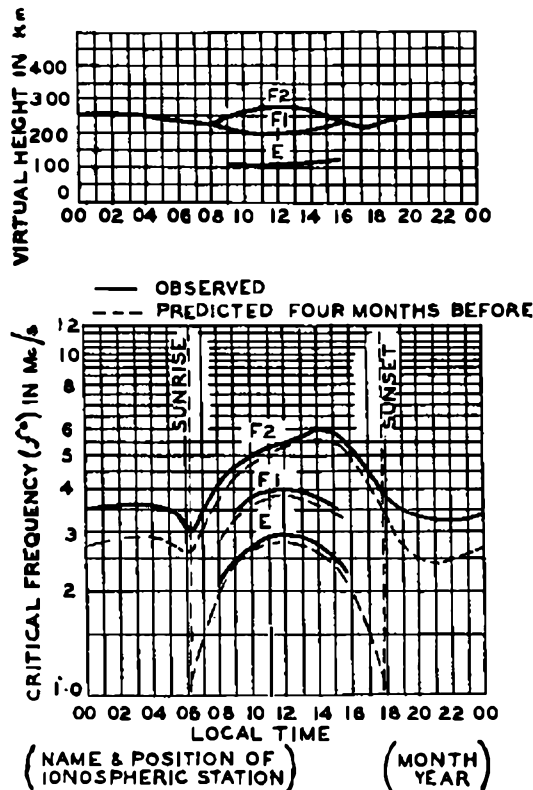

FIG. 1.—TYPICAL VIRTUAL HEIGHT AND CRITICAL FREQUENCY DATA SUPPLIED BY THE I.R.P.L.

predictions are specially prepared to facilitate the forecasting of the optimum propagation frequencies for radio circuits. One form in which the data is presented is that of a series of world contour charts showing the monthly average V.I.C.F.'s at various latitudes and local times, it being assumed that for a given local time the data is substantially independent of longitude. An example of such a chart is shown in Fig. 2. Additional predicted data is needed to convert the V.I.C.F.'s into M.U.F.'s for oblique incidence, and in one method this takes the form of a series of "M.U.F. factors" that are tabulated for various transmission distances and local times at the point of reflection. The M.U.F. is then obtained by multiplying together the appropriate V.I.C.F. and M.U.F. factor. Another method of presenting data for the forecasting of optimum frequencies is illustrated in Fig. 3 where the average monthly M.U.F.'s for a given latitude are shown for various transmission distances and local times at the point of reflection.

¹ The virtual height of a layer is that obtained by measuring the time taken for a pulse to travel vertically from the earth to the ionosphere and back again, and multiplying this time by the velocity of electromagnetic waves in vacuo. The actual velocity of propagation of a signal (group velocity) can be much smaller in the ionosphere than it would be in vacuo hence the highest point actually reached by the wave may be considerably less than the virtual height.

In practice, of course, the actual M.U.F. at any time is likely to differ slightly from the average predicted value due to statistical variations, but when auroral disturbances and certain other phenomena

reflect higher frequencies than the other layers, and since ionospheric absorption is lower the higher the frequency, it is generally more profitable to select a frequency that leads to transmission by means of

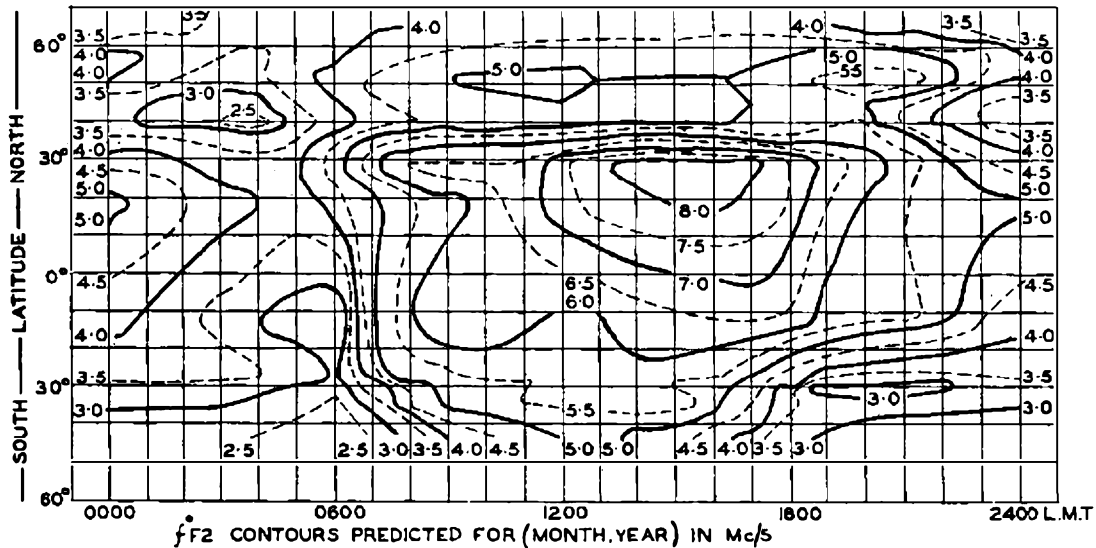
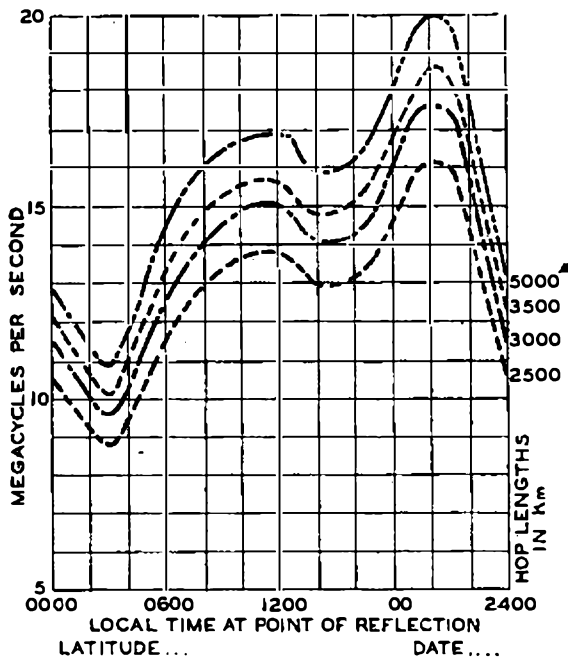

FIG. 2.—TYPICAL MONTHLY AVERAGE V.I.C.F.'S AT DIFFERENT LATITUDES AND LOCAL TIMES AS SUPPLIED BY THE N.P.L.

occur the divergencies may be considerable. Unfortunately the incidence of such disturbances cannot at present be predicted with any certainty.

Usually, for a given path, the F_2 -layer² will

reflect higher frequencies than the other layers, and since ionospheric absorption is lower the higher the frequency, it is generally more profitable to select a frequency that leads to transmission by means of



² Values shown for 5000 km. are possible on a simple ray theory, but there is insufficient data available at present to show if this is practicable.

FIG. 3.—PREDICTED CURVES OF MAXIMUM USABLE FREQUENCIES FOR GIVEN LATITUDE AND MONTH OF YEAR—AS SUPPLIED BY N.P.L.

² The term " F_2 -layer" is used to denote "F-layer at night and F_3 -layer during the daytime."

Example of Frequency Prediction.

The basic technique of frequency prediction may be illustrated by considering an example, confining attention to a particular month of the year and epoch of the sunspot cycle. The successive steps in making a prediction will be discussed briefly and then applied to a particular case. The first step is to determine the distance between the two stations. If the requisite map is available, this can be done conveniently by scaling from a Zenithal Azimuthal Graticule centred on a point near to one of the stations. Such a map gives true distances and directions from the reference point, and an example, based on London, is given in Fig. 4. The path between the two stations is then divided into the smallest practicable number of hops, bearing in mind that the longest hop via the F-layer is of the order of 3,000 km to 3,500 km. The reflection points in the ionosphere are then located at the centres of the various hops. Contour charts similar to that of Fig. 2 are used in conjunction with M.U.F. factors, or M.U.F. charts similar to that shown in Fig. 3, are employed to determine how the M.U.F. for each hop varies throughout the 24 hours. The M.U.F.'s for the various hops are then plotted against G.M.T. At any time the M.U.F. for the whole path is the lowest of the M.U.F.'s for the various hops. If data is required for a whole year it is usually sufficient to consider the winter, summer and an equinox.

An example of the use of these methods is illustrated below, for a radio circuit to the United States, September, 1946. The path is shown in Fig. 4. The length of the path is 5,280 km. and it will be

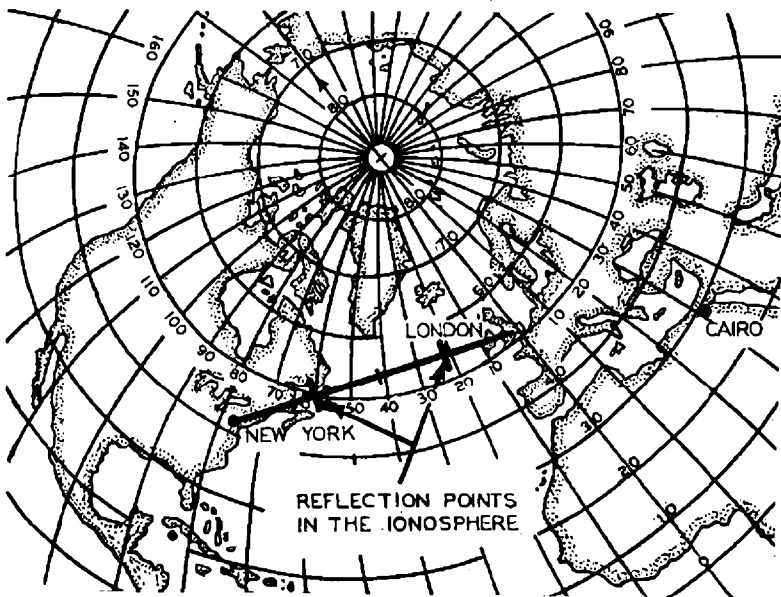

FIG. 4.—PART OF A ZENITHAL AZIMUTHAL GRATICULE BASED ON LONDON.

considered as a two-hop path. The reflection points in the ionosphere are located at 53°N , 22°W and 47°N , 59°W , and, referring all local times to G.M.T., $1\frac{1}{2}$ hours must be added to local mean time (L.M.T.) for

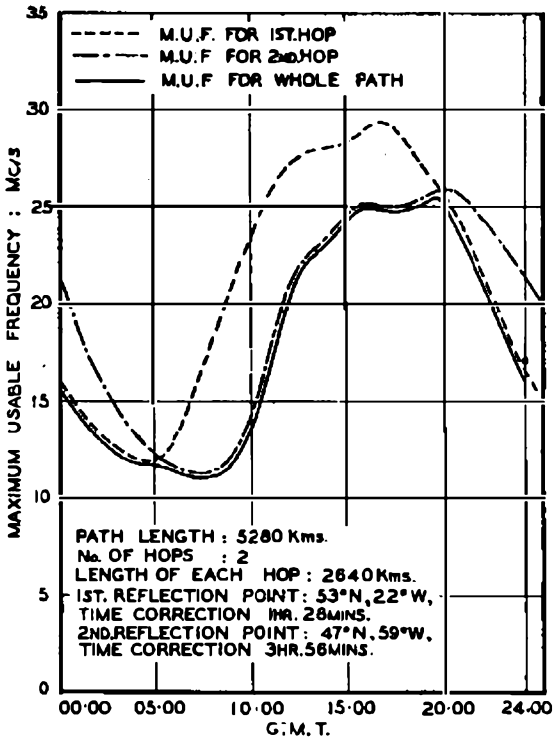

FIG. 5.—RUGBY—NEW YORK. M.U.F. FOR SEPTEMBER 1946.

the first reflection point to obtain the corresponding G.M.T., and four hours for the second reflection point. The average September M.U.F.'s for each of the two hops, and for the whole path, are shown plotted against G.M.T. in Fig. 5. The M.U.F.'s obtained in this way are average or median values. The actual M.U.F. will vary somewhat about this value and at any time it is as likely to be above the average value as below. Thus, if the average M.U.F. were used, then at those times when the actual M.U.F. was below the average, the wave would not be reflected back from the ionosphere. To overcome this it is desirable to adopt as an upper limit a frequency that is likely to be below the actual M.U.F. for at least 95 per cent. of the time. On the other hand, too drastic a reduction of frequency may cause a considerable increase in the ionospheric absorption. From considerations such as these it is usual to adopt an upper frequency limit that is

some 10 to 15 per cent. below the predicted M.U.F.

In practice, of course, the working frequency is not varied continuously to follow the M.U.F., but a few fixed frequencies are used to cover the 24-hour period. Thus, in the example considered, 10 Mc/s might be used between about 0000 and 1100, 15 Mc/s between 1100 and 1300, 20 Mc/s, from 1300 to 2100, and then 15 Mc/s again from 2100 to 2400 G.M.T.

Conclusion.

Although the prediction of optimum working frequencies has now reached a high degree of reliability, it must be remembered that it is based on the assumption of average conditions and it is not possible to give firm predictions that allow for such phenomena as ionospheric storms.

In such a short review as this, it is unfortunately impossible to describe a host of interesting phenomena associated with the ionosphere and with radio propagation, e.g., little mention has been made of the effect of the earth's magnetic field, or of the methods used for assessing the amount of absorption of the wave in the ionosphere. However, if it is desired to pursue the subject further, the references listed below might be studied with advantage.

- ¹ *Analysis of the Ionosphere*, Karl K. Darrow, Bell Telephone System Monograph, B-1241.
- ² *The Application of Ionospheric Data to Radio Communication Problems*, E. V. Appleton and W. J. G. Beynon, Proc. Phys. Soc., Lond., 1940, 62, 518.
- ³ *Radio Engineers' Handbook*, F. E. Terman, McGraw-Hill Book Co., Inc.
- ⁴ *Radio Propagation Handbook, Part I*, Interservice Radio Propagation Laboratory, National Bureau of Standards, Washington, D.C.

Tension Limiting Gear for a Power-Driven Winch

L. L. HALL, A.I.E.E., A.I.R.E., and
D. E. WATT-CARTER, A.M.I.E.E.

U.D.C. 621.863.S : 621.396.67

The design and factory testing of a device for limiting the tension in large aerial halyards during bad weather is described. It is fitted in each power-driven winch and consists of a band brake with fixed trailing and flexibly loaded leading ends. Operation is substantially independent of the coefficient of friction and speed of operation, and it can absorb high power for short periods.

Working Requirements.

FOR supporting a large aerial which had to be erected as expeditiously as possible during the war, some 600 ft. towers, which had been designed for a different system, were utilised. If the aerial had been rigidly anchored, the loading to which the towers could have been subjected under storm conditions would have been excessive, so the power-driven winches used for raising, holding and lowering the aerial had to be fitted with devices for limiting the halyard tension to 40,000 lb. With the aerial raised to the full height the halyard tension during calm weather is 20,000 lb., but this tension is considerably increased by wind pressure. It was assumed that during the worst storm which might occur at the site concerned the mean wind speed would be 70 m.p.h. but that due to superimposed gusts the wind velocity might, on occasions, rise abruptly to 110 m.p.h. at which value it might be sustained for several seconds. The winches were required to hold the aerial in winds of 70 m.p.h. (at which value the halyard tension would be 33,000 lb.) but when the wind velocity exceeded that figure, to pay out the halyards fast enough to limit the tension to 40,000 lb. and ultimately to bring the aerial to rest. The behaviour of the aerial under these storm conditions was investigated by experiments on a model, and the resulting halyard conditions which the winches had to meet are given below.

| | |
|-----------------------------|----------------------|
| Maximum halyard tension | .. 40,000 lb. |
| " " velocity | .. 21.5 ft. per sec. |
| " " acceleration | .. 12 ft./sec./sec. |
| " power to be absorbed | .. 1,290 h.p. |
| Total energy to be absorbed | .. 3,780,000 ft. lb. |
| Total halyard pay-out | .. 115 ft. |
| Duration of movement | .. 12 seconds. |

From the foregoing it is seen that the tension limiting gear had to be capable of operating quickly and absorbing a very large power. Further requirements were that the performance of the gear should not be influenced by long periods of inaction and exposure to the weather.

General Considerations.

Hydraulic, electrical and frictional methods of meeting the working requirements were considered. The first was rejected because of the instantaneous power to be dealt with and the variation of performance with temperature; the second because of the continuous expenditure of power under static conditions and the possibility of a power failure at a crucial moment—e.g. during a violent thunderstorm (the radio station is served by a single long overhead power line) but by the third method all requirements could be met.

It was therefore decided to examine the design of some form of friction brake or drive which would preserve a stable torque of predetermined value under slipping conditions. Experience had revealed the dangers inherent in the radially loaded shoe type of brake due to the difference between the coefficients of static and dynamic friction and the variation in the coefficient of dynamic friction with relative speed of the sliding surfaces. The latter point was exemplified by the experiments of Westinghouse and Galton on railway braking systems in which coefficients of friction obtainable with cast iron blocks on steel rims varied from 0.4 at low speed to 0.062 at 60 m.p.h. or with steel blocks on steel rims from 0.14 to 0.04.

The only type of friction brake which can be made substantially independent of the coefficient of friction is the flexible band brake, but only when loaded to a constant amount at the leading end. The general theory of this type of brake is well known, viz. that if the load applied to the leading end is F_1 and the coefficient of friction is μ , then the band tension F_2 at any angle θ radians from the leading end is given by $F_2 = F_1 e^{-\mu\theta}$.

For any given value of F_1 , F_2 can be reduced to a very small value by making the product $\mu\theta$ sufficiently large, and so the braking torque, which is proportional to $F_1 - F_2$, can be made substantially constant. In the case under consideration with a leading end tension of 35,000 lb., the maximum value to which it was thought advisable to allow the trailing end tension to rise, to attain satisfactory stability of braking effort, was 2,000 lbs. Thus the minimum value of $e^{-\mu\theta}$ was $35,000/2,000$ from which $\mu\theta = 2.83$. (It should be mentioned that with these values of brake band tension and zero acceleration, a halyard load of 33,000 lb. results, the difference between this and the limit of 40,000 lb. being allowed for accelerating the moving part of the winch.) The coefficient of friction obtainable between metal surfaces, as indicated above, is low and a very large angle of contact, involving several turns of the band round the brake drum, would have been required to reduce the trailing end tension to small values. However, standard brake fabrics working on steel give coefficients of friction upwards of 0.4 and accordingly an angle of contact of 7 radians would have sufficed for the above-mentioned degree of torque stability. By bifurcating the band as shown in Fig. 1 an angle of contact of about 11 radians can be conveniently obtained allowing a very stable braking effort to be obtained especially as a fabric lined brake band can be accurately bedded down by a running-in process.

A further important design consideration was the absorption of the fairly large power developed which would result in a rise in temperature of the brake drum and the working surface of the fabric. It was

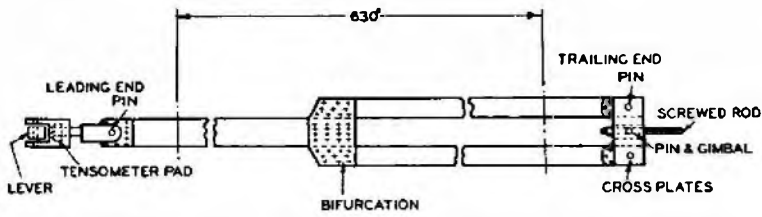

FIG. 1.—DEVELOPMENT OF BRAKE BAND SHOWING END FIXINGS.

ascertained that the upper temperature limit for the fabric, to avoid permanent deterioration in the value of the coefficient of friction, is 300°C. The heat generated would be almost entirely dissipated into the brake drum itself and accordingly the drum must either be of sufficient volume to absorb the heat without dangerous rise of temperature or else it must be cooled.

From an operational point of view the ideal position for the slipping gear is between the main power drive and the winch cable drum, since in this position the driving effort is applied via the slipping gear so that protection is afforded under all working conditions. However, the necessity for making the gear rotatable with the rest of the mechanism introduces structural complications, and in this instance, on the grounds of simplicity and the speed of production in wartime, the more orthodox arrangement of the cable drum power-driven at one end and connected to the brake at the other end by a ratchet and pawl gear, was adopted. The arrangement is shown in Figs. 2 and 3. When winding in the pawls "idle" the brake is inoperative so that, in the event of a halcyard seizure, the tension would be limited only by the

maximum torque of the power drive. Alternative means of limiting the halcyard tension under these conditions were therefore required. Under holding conditions the power drive is disconnected by a sliding pinion from the cable drum which is then held via the ratchet and pawls by the brake. When lowering, the drive unit is re-engaged for safety and fine control, and facilities for unloading the brake are required to minimise

the load on the power unit and wear on the brake.

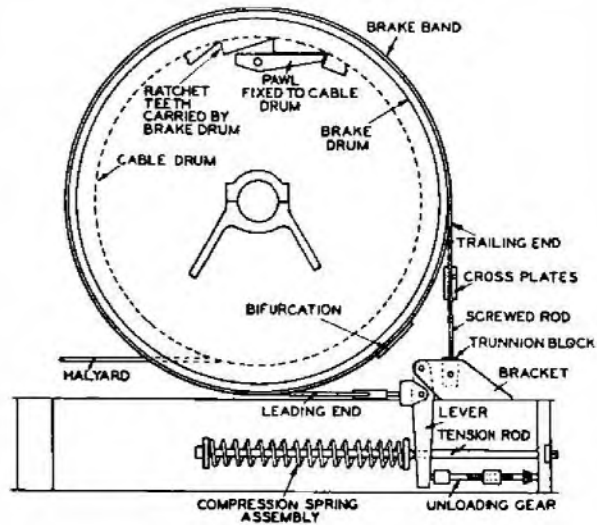

FIG. 2.—SCHEMATIC SHOWING ARRANGEMENT OF SLIPPING BRAKE.

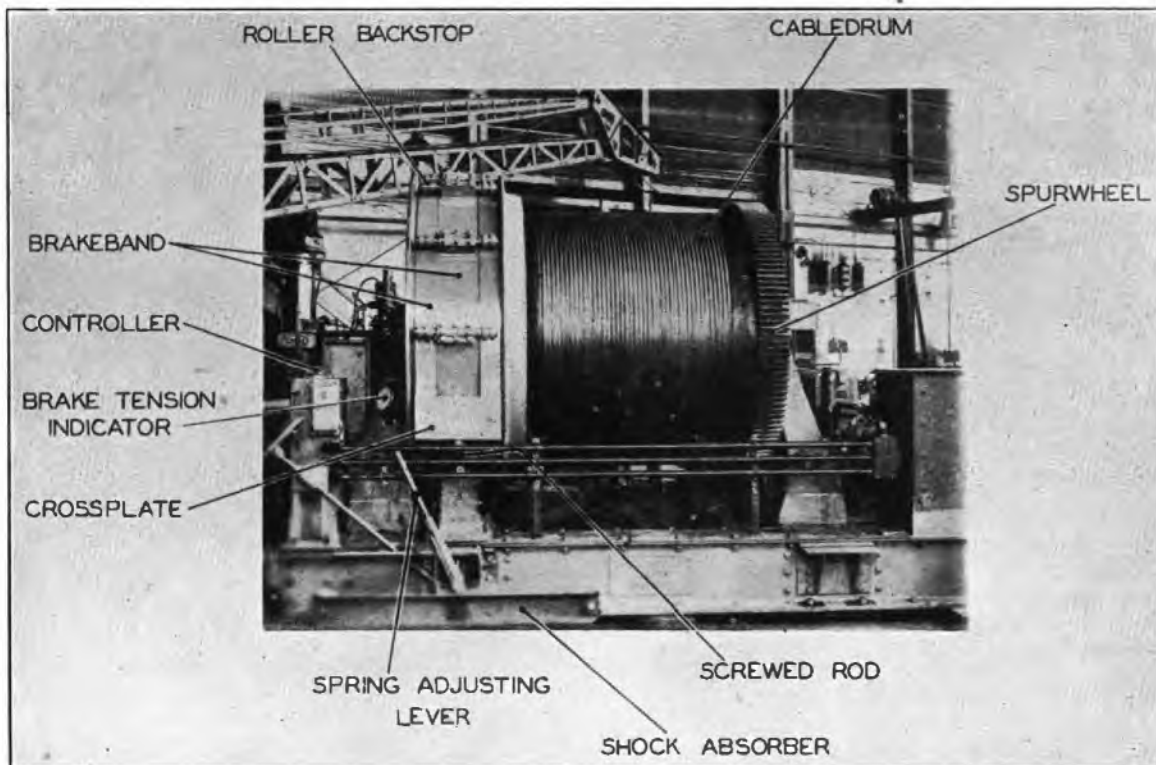

FIG. 3.—GENERAL VIEW OF BACK OF WINCH.

Design Details.

The design of the particular winches concerned was largely influenced by the availability of a sufficient number of large brake drums which had been thrown spare from another work. These drums are 6 ft. 6 in. diameter, 20 in. wide and 1½ in. thick and were incorporated in these winches without modification. The leading turn of the brake band occupies the central position of the brake drum face, being flanked on each side by the bifurcated second turn of the band (Fig. 3). To be perfectly effective the band has to be really flexible and accordingly a band of thin spring steel was demanded as the backing for the brake lining. The band used is 0.2 in. thick, and rolled to a radius somewhat larger than that of the drum. This thickness was determined by manufacturing limitations, not by stress considerations which would have been met by a thickness of half that actually used, but the flexibility achieved in the band appeared likely to produce results approaching the ideal. The power absorbing capacity of the brake fabric was given by the manufacturers as 1 h.p. per square inch indefinitely and 7 h.p. per square inch for short periods. On the assumption that practically all the power would be dissipated at the leading turn of the band the average horse-power was only 0.35 per square inch, and a detailed investigation of the temperature rise of the brake drum indicated that owing to the volume of metal in the drum, the rise would be very moderate and no special cooling would be necessary.

There is a tendency for the band to stick to the drum especially after lengthy periods of inaction, and this effect, known as stiction, temporarily destroys the action of the brake by reducing or even reversing the

normal trailing end tension. Since, however, the trailing end of the band is fixed, and the leading end is spring loaded and can, therefore, move, the band automatically frees itself after a small rotational movement of the drum by the lifting action of the end fixation. The trailing end of the band is thus put into compression and will tend to buckle, so to guard against this roller back stops, seen in Fig. 3 were provided at intervals of 30 degrees round the second turn of the band to limit the possible rise of the band from the drum to ¼ in., to reduce the unsupported length of band to a reasonable value and to transmit the lifting action rapidly towards the leading end.

The equalisation of tension in the halves of the bifurcated second turn of the brake band, irrespective of differential wear, is ensured by pin-jointed cross plates (Figs. 2 and 3), the centres of which are fixed to the winch bedplate by a screwed rod to allow for circumferential positioning of the band on the drum.

The leading end of the band is spring loaded and since the leading end tension is about 35,000 lb. the size of the springs is reduced by interposing a lever system having a mechanical advantage of 3.5. The spring flexibility is determined by the need to keep the variation of leading end tension to a minimum during movement of the band. This movement is only considerable when stiction occurs and a 1 in. movement of the springs was allowed for which, to preserve the required torque stability, required a total spring stiffness of not more than 1,000 lb. to the inch.

The spring loading and manual unloading gear (the latter merely applying a thrust on the main lever in opposition to that of the springs by a screwed rod) is shown in Fig. 4. It was felt that to cater for an

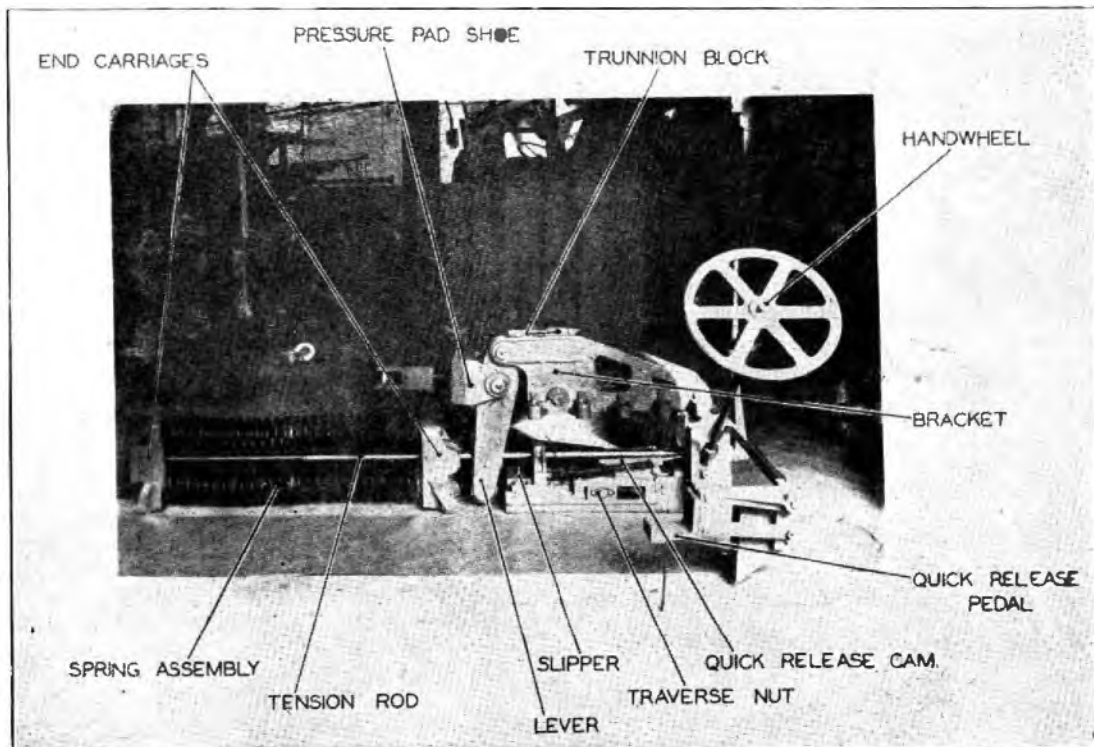

FIG. 4.—SPRING LOADING AND UNLOADING MECHANISM.

accident while the brake was partially unloaded, provision should be made for the immediate re-application of full braking torque. This was accomplished by incorporating a cam operated tripping gear in the unloading mechanism so that by depression of a pedal any unloading thrust could be released. The sudden recoil of a piece of mechanism which, prior to release, might have been applying a thrust of several hundred pounds necessitated the provision of a stout shock absorber. A hydraulic thruster was originally considered for the unloading gear but was rejected because suitable standard components were not available.

Some reliable means of indicating both the halyard tension and the available braking effort was regarded as indispensable for safe operation of the winch especially during aerial lowering. As far as the halyard is concerned the indication must be given for all halyard positions with the halyard either in motion or at rest and must not interfere with normal operations. To measure the braking effort accurately it is necessary to measure both leading and trailing end tensions, but as the latter is always small compared with the former it was considered sufficient to measure the leading end tension only. The instrument employed for tension measurement is a proprietary article made by Statimeters Ltd. and consists of a hollow rubber ring held between specially shaped steel compression plates, and connected by small bore copper tubing to a pressure gauge. The whole is filled with a mixture of glycerine and water. For the measurement of the brake band tension, the statimeter was mounted at the leading end and was calibrated to read the band tension directly. For measurement of the halyard tension, the meter was inserted in series with a pulley wheel which deflected the halyard through a known angle, and was specially calibrated to read the halyard tension directly. A continuous reading of the halyard tension was thus obtained with the halyard either at rest or in motion.

It will be recalled that the brake plays no part in the limitation of halyard tension during winding in. Accordingly an adjustable electrical contact was incorporated in the halyard tension meter, so that

when the gauge needle reaches this contact the circuit breaker feeding the electric motor is tripped. Since the gear ratio between the motor and winch cable drum is 373 : 1, the cable drum stops practically instantaneously on tripping of the circuit breaker.

Acceptance Tests and Performance in Service.

The winches were tested in pairs at the manufacturers' works prior to despatch to site. They were arranged for a back-to-back test so that the driving unit of one was tested against the braking unit of the other. The braking action in every case exhibited a gratifying smoothness and absence of stiction, but was nevertheless subject to a cyclic variation of about 1,000 lb., which in view of the accuracy with which the drums were mounted could be attributed only to inequalities in the brake drum surfaces.

The drive units and ratchet proved satisfactory, the latter being tested by impulsive loading.

Since the installation of the winches on site, the weather has never been sufficiently severe to cause the tension limiting gear to function, and owing to the war service of the aerial, no opportunity has occurred to test the brake as far as is practicable. It is unfortunately impossible to simulate the loading conditions imposed by storms. Minor defects have come to light, notably a cyclic variation in the leading end tension of one brake band of 2,500 lb. This was found to be due to buckling of the springs which caused them to foul the main tensioning rod, and thereby impose a variable spring load. It is extremely difficult to ensure even tempering of a number of large springs, but pairs can generally be matched so that tendencies to buckle can be cancelled. This was effected in the case mentioned and resulted in considerable improvement in the stability of braking torque.

Apart from these minor defects, the winches have operated satisfactorily and no doubt is felt as to the correct functioning of the tension limiting gear should the weather conditions for which they have been designed ever be experienced.

Book Review

"Philips Resistance Welding Handbook"—Philips Industrial (Philips Lamps Ltd.) 210 pp., 182 ill. 10s. 6d.

This is a first edition of a book compiled with the assistance of many experts to meet the needs of those whose interest lies in the practical application of resistance welding to aid production. It is not overburdened with theory, but a knowledge of the fundamentals of electrical engineering including electronics is essential to obtain maximum value from the book. It is also assumed that the reader has had practical experience in general engineering in order to appreciate the advantages of resistance welding methods as applied to production and so to avoid pitfalls in trying to use the process in those cases where the design is not suitable and cannot be made suitable.

The book is a very valuable addition to literature on welding and incorporates the results of war-time experience and development when resistance welding

was used to a very considerable extent, particularly in the fabrication of light steel metal parts, and flash welding was used to an extent not thought of prior to 1939.

The first three chapters are mainly descriptive and deal with spot, protection, seam, flash and butt welders. Further chapters are devoted to the use of these machines for various processes, and particulars of those processes, etc., are included. The examples of actual production jobs and the practical information on speeds of welding and electrical loads are of considerable value. There are separate chapters dealing with spot welding properties of rust-proofed mild steel, the spot welding of light alloys and the metallurgy of resistance welding. There are also chapters dealing specifically with timing devices and with electronic control of the welding process.

The book is exceedingly well produced and the many photographs and line drawings enhance its value to the general reader who is, perhaps, not intimately connected with the production aspects but who, nevertheless, wishes to keep up to date on modern production methods.

W. T. G.

Notes and Comments

Roll of Honour

The Board of Editors deeply regrets to have to record the deaths of the following members of the Engineering Department :—

| | | | |
|----------------------------|------------------|----------------------------------|-------------------------|
| Brighton Telephone Area .. | Paish, R. W. .. | Draughtsman, Class II .. | Lieut. Pioneer Corps |
| London Telecoms. Region .. | McKay, J. B. .. | Unestablished Skilled Workman | Flight Sergeant, R.A.F. |
| Norwich Telephone Area .. | Pettit, K. C. .. | Skilled Workman, Class II (A) .. | Flight Sergeant, R.A.F. |

Recent Awards

The Board of Editors has learnt with great pleasure of the honours recently conferred upon the following members of the Engineering Department :—

| | | | | |
|------------------------------|--------------------|-------------------------------|------------------------------------|--|
| Bournemouth Telephone Area | Ward, C. V. .. | Engineer .. | Captain, Royal Signals | Mentioned in Despatches |
| Bradford Telephone Area .. | Joseph, S. S. .. | Skilled Workman, Class II | Corporal, Royal Signals | Mentioned in Despatches |
| Bristol Telephone Area .. | Steadman, G. R. | Skilled Workman, Class II | Corporal, Royal Signals | Mentioned in Despatches |
| Engineering Department .. | Forster, A. E. T. | Inspector .. | Captain, R.E.M.E. | Mentioned in Despatches |
| Engineering Department .. | Mitchell, A. .. | Inspector .. | Major, Royal Signals | Mentioned in Despatches |
| Engineering Department .. | Organ, E. C. H. .. | Assistant Engineer | Lieut. Colonel, Royal Signals | Officer of the Order of the British Empire |
| Gloucester Telephone Area .. | Keeble, T. A. .. | Engineer .. | Major, Royal Signals | American Bronze Star |
| London Postal Region .. | Bush, A. .. | Skilled Workman, Class I | Chief E.R.A., R.N. | British Empire Medal |
| London Postal Region .. | Milford, A. J. .. | Skilled Workman, Class I | Chief E.R.A., R.N. | British Empire Medal |
| London Telecoms. Region .. | Dedmen, F. F. .. | Skilled Workman, Class II | L/Corporal, Royal Signals | Mentioned in Despatches |
| London Telecoms. Region .. | Head, W. H. .. | Skilled Workman, Class II | Signalman, Royal Signals | Mentioned in Despatches |
| Manchester Telephone Area | Childe, P. F. .. | Assistant Engineer | Corporal, Royal Signals | Mentioned in Despatches |
| Manchester Telephone Area | Smith, G. .. | Skilled Workman, Class II | Sergeant, Royal Signals | Mentioned in Despatches |
| Manchester Telephone Area | Wearn, R. G. O. | Engineer .. | Major, Royal Signals | American Bronze Star |
| Portsmouth Telephone Area | Evans, J. W. G. | Skilled Workman, Class II | Sergeant, Royal Signals | British Empire Medal |
| Preston Telephone Area .. | Pemberton, S. H. | Unestablished Skilled Workman | Signalman, Royal Signals | Mentioned in Despatches |
| Preston Telephone Area .. | Topping, J. H. .. | Skilled Workman, Class II | Sergeant, Royal Signals | Mentioned in Despatches |
| Swansea Telephone Area .. | De Jong, N. C. C. | Area Engineer .. | Major, General List | American Bronze Star |
| York Telephone Area .. | Cook, F. .. | Technician .. | Wt. Offr., Class II, Royal Signals | Mentioned in Despatches |

Ten Year Index

The publication of the second 10-year index, covering Volumes 29-38 of this Journal, was due in 1946 but was unavoidably postponed due to paper shortage and printing difficulties. These have now been overcome and copies of the index are being distributed free to subscribers with this issue of the Journal. Additional copies may be obtained from the

Managing Editor, the publishers or any Journal agent, price 6d. per copy.

Signals Reunion

We are advised that it is proposed to hold, in London, a reunion of former members of the Line of Communications Signals, Supplementary Reserve. All who wish to attend should communicate with Lt-Col. W. A. Peachell, O.B.E., No. 1. A.A. Mixed Signal Regiment, W6 Camp, Derwent Crescent, London, W.20.

Institution's Library

Recent additions to the Library include the following :

705 *The Electron Microscope*. Burton and Kohl (American 1946).

An introduction to its fundamental principles and applications. The book aims at presenting the physical principles upon which the operation of the electron microscope is based without any assumptions in regard to the technical knowledge of the reader. The subjects covered include vision, light, light microscopes, wave motion and media, light waves and the microscope, electromagnetic theory of light, the electron, electron emission, dual theory of light and of the electron, motion of electrons in electrical and magnetic fields, magnetic and electrostatic focussing (electron optics) electrostatic electron microscope, uses and applications of the electron microscope.

1706 *Intermediate Chemistry*. Lowry and Cavell (British 1945).

A complete textbook of chemistry for Intermediate and Higher School Certificate Examinations.

1716 *Piezoelectricity*. Cady (American 1946).

An introduction to the theory and applications of electrochemical phenomena in crystals—an excellent and comprehensive treatise.

1717 *Newnes Engineers Reference Book*. Ed. Camm (British 1946).

An up-to-date and authoritative work of reference on all branches of mechanical engineering, free from overlapping, complete and exhaustive.

1718 *Technical Drawing for Trade Students*. Forbes (British 1946).

Sound introduction to the essentials of technical drawing. Deals with basic principles and should speedily initiate the student into the rudiments of most branches of technical drawing.

1719 *Fluorescent Lighting Manual*. Amick (American 1942).

A book for all interested in the subject. Fundamental background knowledge and practical installation design and servicing information presented in simple language.

1727 *Functions of a Complex Variable*. Phillips (British 1940).

Deals with the complex variable theory and its applications so far as is commonly required for a university honours course. Its aim is to give a clear and concise account of the fundamental ideas and theorems. The chapters on conformal representation should be found especially useful to students of applied mathematics.

1728 *Worked Examples in Electrotechnology*. Pratt (British 1944).

Primary purpose is to supplement the reading of students preparing for the Preliminary and Intermediate Grade examinations of the City and Guilds of London Institute in Electrical Engineering practice. Part I of the A.M.I.E.E. examination and the Ordinary National Certificate in Electrical Engineering.

1732 *Textbook of Heat*. Noakes (British 1945).

Range and standard expected of candidates for Higher School Certificate and University Scholarship Examinations.

1733 *Mathematics for Technical Students, Part II*. Geary, Lowry, and Hayden (British 1939).

Designed to cover the second year of a three years' National Certificate Course. Sufficient solid geometry has been introduced to enable the student to solve trigonometrical problems in three dimensions and harder problems in mensuration.

1735 *Personnel Management*. Northcott (British 1945).

The importance of the human factor is stressed throughout this recent book on the principles and practices of personnel management, and aims to justify by the combination of theory and practice the acceptance of its value not only in increasing efficiency but in a better understanding of the principles of human association. The author, with long years of experience in the shaping of industrial relations, makes a useful contribution on the subjects of organisation, functions and methods in the management of a personnel department, the supply and placement of employment, selection and training, wages, education, incentives in industry, psychology of work and of the working group, joint consultation and training for personnel management.

1736 *Electromagnetic Waves*. White (British 1946).

Specially useful to university students and to those engaged on research work connected with the investigation of the upper atmosphere by wireless methods. Deals with the electromagnetic equations—Maxwell's equations, theory of Lorentz, applications of the dispersion theory, propagation in a dispersive medium with an applied magnetic field—wireless waves in the earth's atmosphere.

1737 *Mathematical Theory of Elasticity*. Sokolnikoff (American 1946).

Deals with a study of the behaviour of those substances which possess the property of recovering their size and shape when the forces producing deformations are removed, the prime concern of the mathematical theory of elasticity being to reduce to calculations the stresses and strains in an elastic body subjected to the action of a system of prescribed external forces. There are chapters on the analysis of strain, stress and stress-strain relations, and on extension, torsion and flexure of homogeneous beams.

1738 *Automobile Electrical Maintenance*. Judge (British 1943).

A practical handbook for all car owners and service and maintenance engineers. The subject of electrical faults and their remedies is given prominence throughout and the fault-finding tables included enable a quick diagnosis to be carried out.

1739 *Elementary Telegraphy*. Missen (British 1946).

Suitable for Grade I Telegraphy Syllabus of City and Guilds. Deals with the principles of the start-stop telegraph system, telegraph relays, elementary line telegraph transmission, voice frequency telegraphy, telegraph circuits and instrument room equipment, signal distortion, testing and measuring apparatus and telegraph power supplies.

1740 *Principles of Electrical Engineering*. Wall (British 1947).

A generally comprehensive account of the basic principles of the science, emphasis being placed on the identity of the principles relating to both heavy-current and light-current engineering practice. Among the subjects dealt with are fundamental units: structure of the atom—conductors and insulators—electric current and resistance;

- Coulomb's Law**—fields of electric force—potential; capacitance—dielectric constant—energy of the electric field; current distributors and networks—Wheatstone bridge; thermo-electricity—piezo electricity; electromagnetism; A.C. and A.C. power; oscillating systems; non-sinusoidal wave-forms—harmonic analysis—effect of waveform on electrical measurements; penetration of alternating magnetic flux and A.C. (skin effect); propagation of electric energy along transmission lines and cables; propagation of electromagnetic waves through space. Attention is given to simplification in methods of solution of a wide range of technical problems. New developments in application, testing and materials are taken into account. Generally, the book will be found very useful to students studying for B.Sc.(Eng.) or A.M.I.E.E. Exams.
- 1741 *Elementary Wave Mechanics*. Heitler (British, 1945).
A simple introduction to wave mechanics that can be understood by any physicist and chemist who commands an elementary knowledge of calculus and classical physics. It gives a good general account of wave mechanics and the Schrodinger equation with applications chiefly to atomic physics and spectroscopy. To illustrate the usefulness of wave mechanics for chemical problems there are two chapters on the theory of chemical bond and the quantum theory of valency.
- 1742 *The Diffraction of X-Rays and Electrons by Free Molecules*. Pirenne (British 1946).
Intended primarily to give an account of the theoretical basis of the study of X-ray diffraction by gases and of the information it has yielded about the structure of atoms and molecules. The scattering of X-rays by atoms in crystals is discussed in relation to the scattering by free atoms, and the chapter on intermolecular interferences in gases is completed by a consideration of the diffraction of X-rays by liquids. The chief aim has been to give fundamental ideas and experimental results, special attention being paid to the hypotheses and principles underlying theories, as well as to limits of validity. Mathematical formulæ and numerical data of importance have been included, but extensive mathematical developments of the theories have generally been omitted. A useful book for those doing experimental research in the field of molecular physics.
- 1743 *Pulsed Linear Networks*. Frank (American 1945).
The purpose of this book has been to analyse electrical transients in mathematical terms that are familiar to most engineers, and is done by the exclusive use of the classical method which employs conventional differential equations only. The book deals with fundamentals with little emphasis upon practical applications. The following aspects are covered—differential equations and hyperbolic functions—series networks and series-parallel networks containing resistance capacitance and inductance.
- 1744 *The Organisation of Electricity Supply in Great Britain*. Ballin. (British 1946).
A full account of growth and problems of the industry.
- 1745 *Advanced Calculus*. Stewart (British 1946).
The scope of this book is wide and includes chapters on partial differentiation, multiple integrals, functions of a complex variable, convergency, Bernoulli and gamma functions, vectors and tensors. The treatment of the processes considered is rigorous and amply illustrated by cases likely to occur in applications. A useful work for students in Honours Mathematics before specialisation in some particular branch, and much of the contents is suitable for students in General Honours or in Honours Physics. The subject matter of a first course in calculus is included and special features are the worked examples (with solutions) at the end of each chapter.
- 1746 *The Commutator Motor*. Teago (British 1946).
The author lays emphasis on the principle of energy transference which crystallises out the fundamental truths underlying the action of the induction motor in all its known forms. A detailed mathematical treatment is not aimed at. Knowledge of the general ideas embodied in the circle diagram of the ordinary induction motor is assumed. The book covers the speed control and power factor ideas, rotating magnetic fields, power factor correction (compensating commutator), the mechanism of energy transference and variable speed operation, energy transference and power factor correction (Schrage mechanism), combined speed and power factor control (Schrage mechanism), cascade operation and generator and slip power operation.
- 1747 *Ultra High Frequency Techniques*. Brainerd, etc. (American 1942).
Concerned with bases of u.h.f. techniques rather than with techniques themselves. The general level is that of senior students in electrical engineering and physics. Sufficient theoretical background is given for the various topics to make the presentations convincing and to give the student an appreciation of at least some of the possibilities which each topic offers, the difficulties which may be encountered, and the actual or potential applications. Although a reasonable mathematical background is presented, particularly in those fields such as radiation and hollow wave guides, nevertheless most of the text can be read by a person seeking specific information without involvement in the more detailed developments of the theory. Covers linear circuit analysis; fundamentals of tubes; power supplies; amplification; trigger circuits (gates), pulse sharpening circuits and oscillators; cathode ray tubes and circuits; modulation; demodulation (detection); radio receivers; transmitters; u.h.f. generators; transmission lines; radiation; propagation; hollow wave guides.
- 1748 *A First Course in Mathematics*. Baker (American 1942).
Proceeds by easy stages with a greater degree of emphasis upon vector ideas than is customary in an elementary textbook. The treatment includes trigonometric functions and vectors; numerical computation—radian measure; solution of right triangles; rotating vectors; language of algebra; linear function; simultaneous linear equations; theory of exponents; logarithms; analytical trigonometry; oblique triangles; quadratic function; complex numbers; algebraic and trigonometric equations; progressions; analytic geometry—the straight line; the conics; transformation of co-ordinates; polar co-ordinates—plane curves; three-dimensional geometry; derivatives and integrals; permutations and combinations.

L. A. CARTER,
Librarian.

Regional Notes

London Telecommunications Region

POTTERS BAR AUTOMATIC EXCHANGE

The conversion of the Potters Bar area to automatic working was completed on the 27th February, 1947, when the changeover of 2,146 subscribers from the old C.B.10 manual exchange to the new non-director automatic exchange was effected: 338 incoming and outgoing junctions were provided for the new exchange and, owing to the shortage of line plant, changeover arrangements were necessary on most of the old routes.

The exchange equipment, which is of the 2,000 type, was installed by Siemens Bros. Ltd., and is designed for an ultimate capacity of 5,000 lines with initial equipment for 3,300 lines (multiple).

Potters Bar is the manual board and maintenance control centre for Hatfield (ND), Cuffley (ND), South Mimms (U.7) and Essendon (U.13) exchanges. The manual board consists of 31 sleeve control positions and four monitors' desks.

The power plant is of the parallel battery automatic type with two batteries each of 1,100 Ah capacity.

A. W. C.
E. E. T. C.

HARROW AUTOMATIC EXCHANGE

Harrow automatic exchange was brought into service on the 12th February, 1947, when 4,500 subscribers were transferred from the old Harrow manual exchange. The equipment—of 2,000 type—was delivered to site in 1939 but owing to the outbreak of war installation was suspended and the equipment stored on site.

Early in 1941 part of the main distribution frame was transferred to the damaged Wood Street building, and some months afterwards the complete test desk and remainder of the M.D.F. were withdrawn for use at Southampton. Later, group selectors were released for installation in the new Toll A automatic exchange and final selectors and banks were transferred to the Fulham (replacement) exchange. Subsequently all this equipment was replaced and Standard Telephones & Cables Ltd. commenced installation in July, 1945.

The exchange has a capacity of 7,000 lines initially and 10,000 ultimately, and the power plant, which is of the divided battery float type, includes two batteries each of 1,200 Ah capacity. The manual board is at Byron exchange.

L. J. W. W.

NOVEL METHOD OF SHIFTING AN EXCHANGE BATTERY

An interesting piece of work was recently carried through at the Stamford Hill exchange by the L.T.R. Power Section. Rearrangement of plant necessitated shifting the exchange batteries bodily across the battery room. The batteries are of 2,100 Ah. capacity in boxes with a fully plated capacity of 3,200 Ah. It would normally be anticipated that a transfer of this sort would be carried out by cutting out the plates, emptying the boxes and moving the empty boxes to the new position and then reassembling the battery, but it was decided that in this case it was possible to shift the battery in sections without emptying the cells and incurring the considerable labour of dismantling and re-erection. In accordance with standard practice, the cells stood on



longitudinal bearers which rested on cross bearers with six cells in a group. The procedure for shifting was to support the end cells of each group against bulging as is shown in the photograph below and then to insert a heavy timber under the longitudinal bearers and to raise the unit of six cells so that the cross bearers were clear of the floor, by inserting wedges under the timbers. The timbers had been previously greased and once the cross bearers were clear of the floor, it was possible to slide the cells into their new positions and then to lower to the floor by knocking out the wedges.

The photograph makes clear the general method and shows a set of six cells in process of transfer from the old position indicated by the cells at the far end of the photograph to the new position which is indicated by the near-end cells. It will be clear that a very considerable saving was effected by the novel method.

North-Eastern Region

FLOODS IN THE CALDER VALLEY

The valley of the Calder in its early reaches is very narrow, the moorlands on either side falling steeply to the river valley from approximately 1,200 ft. A rapid thaw after a heavy snow-fall or heavy rain is liable to cause flooding of the main Halifax-Burnley road which winds its way along the valley, particularly in the Helden Bridge-Sowerby Bridge section. Roughly midway between these two places lies Mytholmroyd—a village particularly susceptible to flooding because the water from the Cragg Vale and overflow water from the Wittens Reservoir join the Calder in the centre of the village.

These notes describe the conditions which obtained at the Mytholmroyd exchange following upon the torrential rains which fell in the neighbourhood on September

19/20th, 1946, and which had disastrous effect on the village as a whole.

Mytholmroyd is a magneto exchange and as a measure of safety against flood conditions the M.D.F. is located on the first floor of the building. Unfortunately, lack of accommodation made it impossible to house the switchboard similarly. The switchroom is at the level of 2 ft. 8 in. above the level of the roadway, and the conditions may well be imagined when it is appreciated that the flood water reached the height of 2 ft. 10 in. in the switchroom, and it will not be surprising that the exchange was isolated.

The prevailing scene in the vicinity of the exchange is depicted in the photograph, but this gives little reality to



Photo—"Halifax Courier"

the surging torrent, which washed away a shop. By choosing a suitable approach the maintenance staff succeeded in wading to the marooned exchange building and found the only occupant at the time, namely the caretaker-operator, safe. The flood water had covered the keyboard and the first row of subscribers' indicators, one secondary battery, power switches and meters, but was then receding. The process of restoration was therefore proceeded with.

The switchboard was wiped reasonably dry, the power and lighting restored and hot air from a vacuum cleaner adjustment was played on to the keys and wiring. New cords were fitted and after two hours' effort a successful call to a neighbouring exchange was made. Later all wiring was separated and hot-air drying continued, and after a further six hours it was possible to report one position with six cords ready for service. The following day complete restoration was effected.

Further trouble, however, appeared later in the form of corrosion, which became apparent by a fall in insulation resistance of the wiring to the key springs. An application of an ample quantity of orthodichlorobenzene with suitable brushes, and light lubricating oil, has enabled the exchange to be kept working, pending the provision shortly of a new U.A.X. 14, viz. Calder Valley, which will take over the Luddendenfoot and Mytholmroyd exchanges. C.F.D.

STORM DAMAGE

Consequent upon the Arctic weather experienced in the North of England during the early days of February 1947, the York telephone area, in common with other Northern telephone areas, was faced with storm conditions and reacted accordingly. Due to the heavy snowdrifts and weight of snow, many exchanges were

isolated and several routes were completely broken down for upwards of 50 spans. The photographs below give an idea of the conditions experienced.



Photo—"Yorkshire Herald"

The worst effects were felt in the region of the Yorkshire Wolds, where conditions were extremely bad, with drifts as high as 18 to 20 ft. The result of this can best be imagined when it is known that bulldozers sent to clear the roads were completely enveloped in the drifts and rendered useless. Despite such conditions the work of Post Office engineers did not stop, and the linemen (construction and maintenance) and exchange maintenance men carried on under very great difficulties and with good measure of success. Large numbers of faults were caused by icing conditions and in view of the continued frost "D 8" cable was issued to gain clearances for exchange isolations.

One Wold village in particular, namely Huggate, was completely isolated by road for over a week, despite every effort on the part of the county authorities to clear even a single track through, and as a result the predicament of the village became headline news in the national Press. A mountain rescue squad of the R.A.F. was detailed to carry food to the, by now, destitute inhabitants and very manfully did they complete the task. The exchange was isolated for two days and as it is of the petrol engine-driven type, it was necessary to get the engine started and the batteries recharged. Three attempts had been made to get through, without success, and eventually a volunteer party of four, which comprised the maintenance man, a youth-in-training and two scouting members of the York exchange staff, set off to get to the exchange, if it was physically possible.

The relief party were able to go so far with vans and then did the rest of the journey on foot. The road is very undulating and varies from 50 ft. above sea level to 500 ft. at the village, the highest village in the Wolds. The distance by road from the van parking point to the exchange is six miles and due to detours because of drifts this distance was considerably increased. The four stalwarts were warned that they were not likely to get through and efforts to dissuade them from carrying on were made by the road authorities. However, they carried on and eventually reached the exchange after a great struggle. They had with them food and petrol carried in rucksacks. The villagers were amazed to see the small party and welcomed them enthusiastically, as these were the first people the villagers had seen for



Photo—"Sheffield Telegraph and Star"

a week. This tremendous effort on the part of the four concerned took place three days before the R.A.F. mountain rescue squad, with its Arctic equipment and clothing, succeeded in reaching the village.

After clearing the isolation and reporting from the exchange, a meal was prepared, generously aided by the villagers, and the return journey undertaken. Again efforts were made to persuade the four to stay in Huggate, at least for the night, but the first considerations were for the vans which it was thought would freeze up and burst the radiators, despite the use of anti-freeze mixture.

The return journey was completed successfully, despite the fact that the wind and snow had covered previous tracks, and the tired band reached York safely just after midnight.

The foregoing is a somewhat bald outline of what took place, and does not convey any real idea of conditions, which had to be seen to be believed. That the party succeeded at all is due to their grit and determination and reflects great credit on all concerned.

In the same area of the Wolds a new use for tree-cutting rods was discovered. One gang foreman was endeavouring to clear ice from the wires with this tool, when he suddenly disappeared from sight, the only indication of where he had gone being given by the top of the rod, which was sticking out of the snow. How long the foreman would have remained in the drift before being discovered is a matter for conjecture, but it could have been quite a time but for the rod.

Coastal areas were badly hit also and the Scarborough-Whitby and Scarborough-Bridlington roads were impassable and remained so for some days. Further down, on the Hull-Hornsea portion of the area, the village of Aldborough was isolated and again the first man in was the Post Office engineer on exchange maintenance, who was endeavouring to clear the exchange isolation. His greeting, however, was anything but cordial and one

faulty subscriber wanted to know why the trouble had not been cleared earlier and why the mails were late!!!
T. J.

Home Counties Region

PRECAUTIONS AGAINST FLOODS AT BRANDON CREEK (NEAR ELY) U.A.X.

The breaching of the main Cambridge-Kings Lynn road, which had formed the next line of defence to the overflow from the burst bank of the River Wissey, caused serious flooding of the Southbery Fens. Although Brandon Creek U.A.X. No. 5 is situated nearly two miles from the breach, near the junction of the Ouse and Little Ouse rivers, it was evident that the floods would reach the U.A.X. in a matter of hours. The building is of the flood type with floor built up two feet above the surrounding land, which is several feet below the normal level of the Ouse. It was decided to raise all the equipment on stayblocks to the limit of about two feet and so gain some four feet above ground level.

The power panel was turned through 90° to allow the M.D.F. to be drawn nearer to the wall to obtain enough slack in the lead-in cables to permit the M.D.F. to be raised to the maximum height. The two automatic units were lashed at the top, levered up and rested on the stay blocks. The bend in the tie cable was flattened to allow the units to go close to the ceiling. The petrol engine was unbolted from its bed and raised together with the cooling tank. Suitable flexible pipe to allow the tank to remain on the floor was not obtainable. The

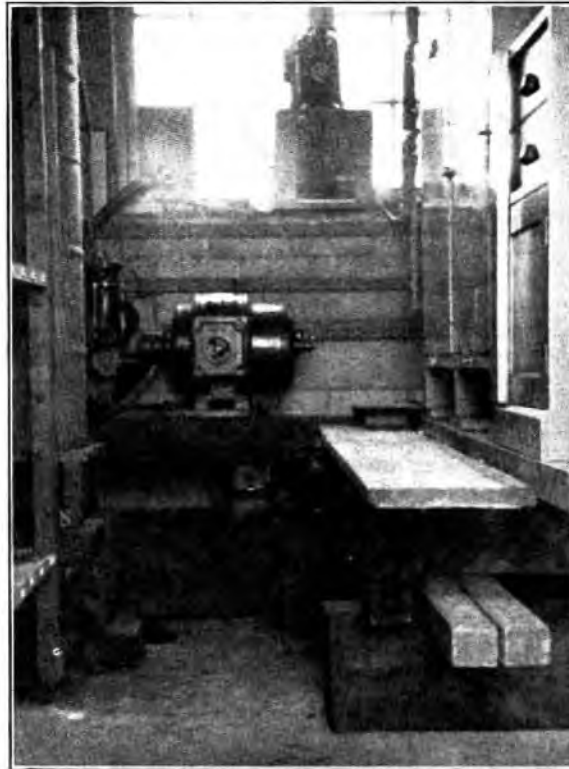

exhaust pipe was passed through the window and the outside petrol tank refixed at a higher level. Sufficient space was made available on the top tier of the battery rack to accommodate the cells from the lowest tier

and the test-set was removed to the window sill. The photograph shows the final appearance of the interior.

Boards bedded in mixture No. 2 were screwed over the outside of the Hatton vents and inside the door of the building to a height of two feet ; the entry to the cable trench was already sealed.

The water rose steadily at about half an inch per hour until it reached its peak, some three inches above the floor level of the U.A.X. None, however, found its way into the building and only a very slight seepage occurred in the cable trench. The lineman used thigh boots to reach the U.A.X. A boat was also available but was not actually required. The second photograph shows the



U.A.X. surrounded by flood water, the level being some 15 in. below the maximum height reached.

R. C. S.

Midland Region

STORM DAMAGE

The early snow caused only slight damage to external plant. The heaviest damage followed the commencement of the thaw and blizzard of the 16th March. The gale caused widespread damage to overhead routes and the flooding from the rapid thaw resulted in fairly extensive interruption of main trunk, junction and subscribers' underground cable. The plant was affected as follows. The figures represent the maximum trouble at any one time.

Isolations : 93.

Subscribers' Lines : 22,000 or approximately 8 per cent. of the total lines in the Region.

Junction and Trunk Circuits : 1,500 out of order on the 21st March.

CAVENDISH BRIDGE COLLAPSE

One victim of the March floods was the 112-year-old Cavendish Bridge which carries the London-Carlisle road (A6) over the River Trent at Shardlow, near Derby. The bridge had three arches supported on two piers built on the river bed, and the swift-flowing floodwater washed away the foundations of one pier. During the night of 21st March, two of the arches collapsed and fell into the river.

There were two main cable tracks over the bridge, one comprising a 3-way, and the other a 4-way earthenware duct. Many important trunk and junction cables were carried in these pipes, including a London-Manchester, two London-Derby, a Leicester-Nottingham and two Derby-Leicester cables. These constitute one of the main telephone and telegraph trunk routes of the

country, and their failure at a time when the administrative machine was already overtaxed would certainly have had serious consequences. The cables had a miraculous escape, however, for when the bridge collapsed the two tracks remained suspended across the breach and were practically unscathed. The photo-

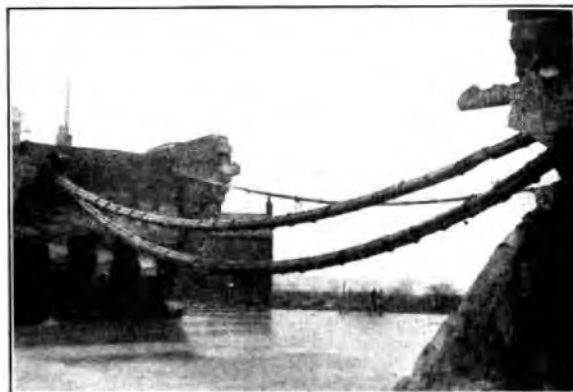

FIG. 1

graph reproduced in Fig. 1 was taken shortly after the collapse.

As soon as it became apparent that the bridge was in danger the erection of an aerial cable system was undertaken to replace the duct tracks over the river. This work was completed within a week, and a view of the aerial cable system is given in Fig. 2, which also

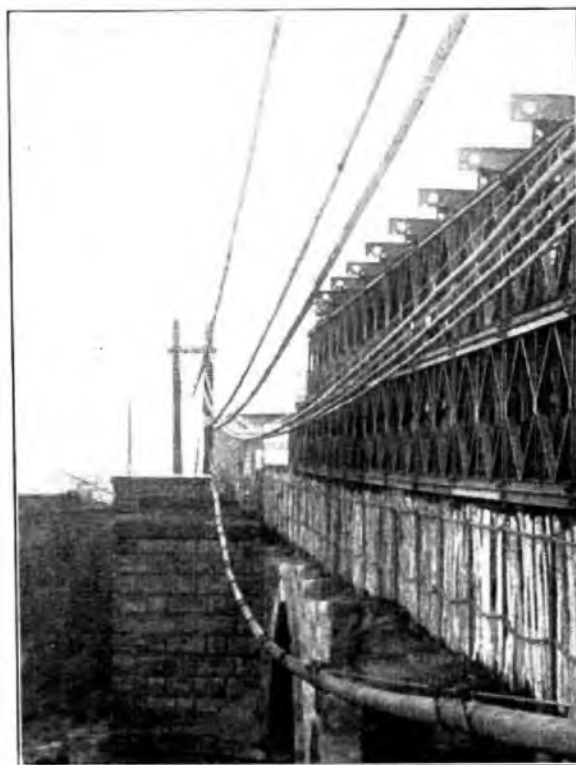

FIG. 2

shows the Bailey bridge which has now replaced the old bridge.

There are approximately 1,000 pairs in the trunk and junction cables which cross the river at this point, and it is interesting to note that there was not a single conductor or dielectric fault caused by the collapse.

W. C. W.

ARTIFICIAL TRAFFIC EQUIPMENT

The Stoke-on-Trent telephone area has been fortunate during the past 12 months in having an Artificial Traffic Equipment on field trial.

This equipment was designed by the Engineer-in-Chief's office as a means of providing a check on the service offered to subscribers. The method adopted is to pass calls through the multi-exchange area common equipment between selected calling equipments and final selector numbers, the progress of such calls being noted by various tests applied to the common equipment taken into use. The occurrence of a fault causes a lock-up of the equipment, enabling fault localisation and clearance to take place. Meters are provided to record (a) the total calls passed, and (b) the number of faults encountered. Thus, by taking monthly readings, a fault percentage for the area can be obtained, this figure serving as a useful engineering check on Service Observation percentages.

The effectiveness of the equipment is shown by the fact that, between March 1946 and March 1947, in conjunction with an energetic maintenance renewals programme, the Service Observation fault percentages decreased from approximately 14 per cent. to under

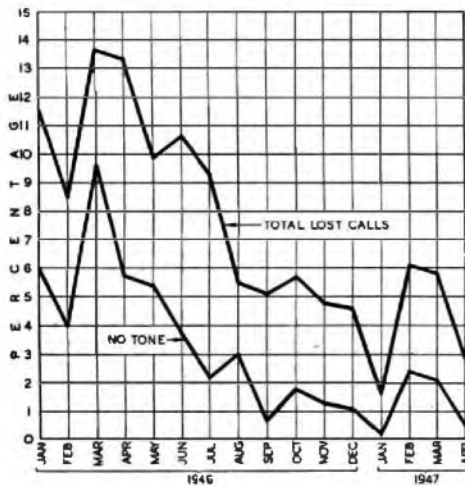

FIG. 1

5 per cent., as shown in Fig. 1. Further reduction could have been effected had it been possible to reduce the prevalence of congestion in the area, due to the abnormal increase in traffic.

The equipment has been in continuous use for the period passing up to 9,000 calls per month, and finding more faults automatically than are normally reported by the subscribers. Only three minor faults developed on the equipment itself during the year.

The equipment has been of such value to the Stoke-on-Trent area that all concerned with auto maintenance were very sorry indeed when instructions were received to send it to another area.

D. J.

GRANTHAM EXCHANGE CONVERSION TO C.B.

Owing to arctic weather conditions, Grantham was very much in the news and the town was almost inaccess-

ible by road and rail on February 12th when the telephone exchange was transferred from a C.B.S. No. 1 suite to a new C.B. suite within the same building. In spite of the vile weather 969 subscribers' circuits and 153 trunks and junctions were transferred to the new exchange at the appointed time without hitch.

The new suite shown in the photograph was built up



from recovered switchboards collected from various towns in the country and the installation was performed by local staff, including some female assistants, who were specially recruited and trained for the work. There are 20 positions, including the test position, equipped with 1,400 subscribers' calling, 1,500 subscribers' multiple, and adequate terminations to meet trunk and junction requirements. By contrast, the old suite consisted of 10 positions in a room only 24 ft. x 16 ft. so that the working conditions in the new switchroom have been materially improved.

The work generally was of a straightforward character as the new equipment was wired from the existing M. & I.D.F., the lower part of which is now retained as a separate main frame for the new exchange, but owing to limitation of space in an apparatus room (44 ft. x 20 ft.), which already contained eight bays of amplifiers with associated power panels, in addition to the equipment for the old exchange, careful planning was necessary to secure a reasonable layout of the new cables, and equipment, at the conclusion of the job. There was appreciable congestion which hindered progress with the construction work and made it difficult to maintain the existing exchange during the transition period, but the whole of the staff concerned displayed commendable zest to cope with the adverse conditions and thereby ensure a satisfactory transfer.

When the provision of the new exchange was commenced it was envisaged that it would be possible to complete an external development scheme by the transfer date but, due mainly to the adverse weather and difficulty in obtaining stores, only a portion of the scheme, including the diversion of circuits on long and exposed routes, could be accomplished. However, the work which incorporates the provision of cabinets and pillars, in accordance with present-day practice, is well in hand and by the time these notes are printed it is anticipated that Grantham will be one of the select towns without a "waiting list." A picture of a snow-clad cabinet which is the first to be installed in the Midland Region, is given.

It will no doubt be appreciated that the transfer was carried out primarily as an expedient to meet load and growth at the exchange until it becomes possible to



provide a building for a new automatic exchange, but with the facilities now available there should be a decided improvement from the service standpoint.

A. H. B.

South-Western Region

DAMAGE TO TELEPHONE PLANT BY SNOW AND ICE

Snow-storms of great severity swept the South-Western Region on the 5th March, and this coupled with a "silver thaw," resulted in widespread damage to overhead telephone plant. Breakdowns were particularly severe in exposed areas of Devon, Dorset and Somerset.

Damage was due to accumulations of ice and snow on the open wires thus resulting in the collapse of many pole routes. Formations of ice up to 5 in. in diameter were reported. Work of restoration was handicapped by roads being blocked by snow-drifts, fallen trees and poles, and many journeys on foot had to be made to reach isolated exchanges. Extensive use was made of Army D8 type wire and 70-lb. P.V.C. wire to effect temporary restorations.

Before the work had been completed a gale on 16th March, which reached a velocity of 90 miles per hour multiplied the havoc already caused; 252 exchanges were completely isolated and 76,400 subscribers' circuits were found to be faulty.

Temporary restoration of circuits involved the use of 950 miles of interruption cable (including Army D8 type wire and 70-lb. P.V.C.); 845 poles required replacement and a total of 172 tons of wire was required to repair the damage caused by the collapse of approximately 5,000 miles of wire. The labour costs involved are naturally high being of the order of 525,000 manhours which represent a cash value of approximately £64,000.

The sterling work carried out by the repair gangs under hard and adverse conditions was the subject of public acknowledgment in the local Press.

S. J. M.

Scottish Region

ICE-FILLED DUCTS

During the prolonged spell of exceptionally cold weather in January, February and March, several cases of cables frozen solid in ducts caused maintenance difficulties. Details of the worst case experienced might be of interest.

At 4.30 a.m. on Friday, 7th March, low insulation developed on a 500 pr. subscribers' cable in Coatbridge and was localised to a length of 135 yards laid in a 3-in. C.I. pipe with 18-24 in. of cover under a tarmac road. There was no spare duct available and no alternative routing for the cable. The cable could not be moved in the duct, so the ground was opened up at approximately half-way and the cable cut. This opening, carried out during Friday night, was done with hammer and jumper and severely tested the endurance of the men—the ground was frozen all the way down and a severe blizzard was blowing from the North-East.

When the pipe was cut the cable was found to be lying almost completely in ice. With much difficulty half the length of cable was drawn out but the other portion still remained immovable. A slight trickle of water was entering the manhole from the pipe so an attempt was made to loosen the cable with hot water, two 10-gallon drums of which were obtained from a local creamery. This proved unsuccessful, so also were attempts to draw out the cable using a 10-ton lorry loaded with 5 tons of sand to give road grip. As a rand digger was now available another opening was made half-way along this 52-yard section and the cable again cut, reducing the lengths to be drawn out to two, of 26 yards each. It was still found that these short lengths could not be moved and while the "rand" was employed to make a further opening at 13 yards distance, further attempts were being made to withdraw the cable. Ropes snapped like string, wire hawsers and steel suspender wires like 40-lb. bronze and not until an enormous chain was obtained on loan from a local scrap depot was the motor lorry really given its head. After no secure grip could be obtained on the cable ends pulling downhill, further attempts pulling uphill were made and finally the motor, pulling with its 5-ton load of sand on a well-sanded road, managed to withdraw one length. The other length was then tackled and 36 hours after first report of the fault the pipe was cleared and work continued normally, except for a burst water main, necessitating continual pumping, and the presence of coal gas in an adjacent manhole. Water and gas companies' workmen carried on with repairs. We were able to substitute the motor pump by a floodgate pump in time for the Sunday morning services in adjacent churches.

A. L.

Welsh and Border Counties Region

THE GREAT STORM

The "great storm" affected the Swansea telephone area much as it did most other areas, snow, gales, and floods leaving in their wake widespread damage to overhead plant which has cost many manhours and much valuable stores to repair.

Facts and figures of subscribers out of service, cable faults, trunks and junctions out of order, and exchanges isolated lose their interest when comparable statistics can be associated with almost every telephone area in

the British Isles. Out of these statistics, however, emerge happenings which may be peculiar to areas adjacent to hundreds of miles of seaboard such as South and West Wales. Following the damage to line plant after the abnormal snow and icing conditions came severe gales bringing with them brine from the sea which coated everything within reach for many miles inland. Windows and cars were soon coated with wet brine which was extremely difficult to remove. Next came the inevitable low insulation faults, and dialling over circuits of more than a few miles in length was next to impossible. Insulators, spindles, arms and poles were coated with this saline solution, and excepting washing the insulators, a change in wind direction and heavy rain was all that could be hoped for to restore normal service. Linemen were presented with an impossible task to clear all the faults, because normal insulation resistance which in this area during the winter months is between 800,000 and 900,000Ω per mile quickly dropped to 3,000Ω during the storm.

By paying particular attention to D.P.'s, cross-arm poles and other strategic points, U.A.X. junction units to parent exchanges were kept working on a skeleton basis, the insulation resistance being raised enough to permit dialling over them. The high winds were also responsible for the failure of many sleeve joints on overhead wires, and it is the considered opinion of the staff in the West Wales area, where gales of over 50 m.p.h. occur at least six times a year, that even 70-lb. wires are not heavy enough to stand the continual vibration set up by the wind, particularly where spans of necessity exceed regulation length.

The lessons learned from the storm are many, and although conditions may not obtain for many years when a technician has to hire a fishing boat in order to reach a U.A.X. to change over and charge the batteries, because roads are impassable, it is obvious that rubber-tired vehicles are useless in deep snow.

All our transport was immobilised, and the possibility of resort to tractors, "Ducks" and half-track vehicles gives us and our transport officers much room for thought.

A pool of such vehicles may be considered because even chains on rubber tyres were next to useless, and it would seem that heavy lorries capable of being readily converted to half-track caterpillar traction would be one solution of the problem.

C. G. W.

OUTLET TESTING IN AUTOMATIC EXCHANGES

During the early life of an exchange, outlet testing as a routine is not justified, but as wiring becomes old, dry joints and disconnections are liable to develop, and a relatively small number can cause a considerable deterioration of service.

Outlet testing, carried out by a test lamp, in the manner indicated in the Engineering Instructions, is a long and tedious process and to give some measure of relief a suitable circuit requiring a minimum of apparatus has been developed in the Regional Office and made up as a simple test box. The test box is used in conjunction with a spare selector which is jacked into the shelf position at the end of the bank multiple and to the wipers, and magnets of this selector leads from the test box are clipped. Continuity of the bank and grading is confirmed by lamps in the box, when associated keys are operated. The selector wipers are positioned in the bank by dialling, and progressive stepping can be obtained by dialling the "digit 1" after each outlet has been tested. An indication is also given of engaged conditions.

It would be possible to evolve a more elaborate tester but this is a matter for consideration at Headquarters. The simple test box described has, however, proved its usefulness by field trial and is well worth constructing for use until a standard item becomes available.

S. E. N.

H. L.

Junior Section Notes

Aberdeen Centre

The annual general meeting of the above centre was held on April 10th. Before the appointment of office bearers for the forthcoming year a very interesting and instructive paper on cable distribution was read by Mr. A. Birss. The following office bearers were elected:

Chairman: W. J. Cowie.
Vice-Chairman: T. I. Miller.
Secretary: C. L. Bannerman.
Librarian: J. Still.

The committee members were elected, Aberdeen 4, Inverness 2, Peterhead 1, Elgin 1, and Kirkwall 1.

The membership of the centre has now reached 165, so a better attendance at the meetings is hoped for next session.

C. L. B.

Brighton Centre

The 1946/7 session opened with a visit to the Post Office Tube Railway at Mount Pleasant, which was greatly enjoyed by all the members attending.

The winter programme consisted of a series of excellent papers covering a wide field of interest, which were greatly appreciated by our members.

The papers presented were as follows:

October 2nd, 1946. "Planning of Urban Electric Supply Networks." Mr. L. J. Simmons, A.M.I.E.E., A.M.I.I.A., Brighton Corporation Electricity Undertaking.

November 6th, 1946. "Principles of Railway

Electrical Signalling." Inspector Pantlin, Southern Railway Signals Dept.

December 4th, 1946. "Application of Auto-Telephone Apparatus, Outside the Field of Telecommunications." Mr. H. M. Wells, A.M.I.E.E., Home Counties Region. With slides and working models.

January 8th, 1947. "Operation Pluto." The Design and Manufacture of H.A.I.S. Cable. Mr. Shaw, Siemens Bros., Ltd. With slides and films.

February 5th, 1947. "Reminiscences of Telecommunications Work by the Royal Corps of Signals in the Middle East." Mr. H. M. Wells, A.M.I.E.E., Home Counties Region. With film and photographs.

March 5th, 1947. "The Teleprinter No. 3." Mr. R. F. J. Beddis. Brighton Branch. With colour film and slides.

The annual general meeting was held on April 5th, 1947, at which great appreciation was shown for the above programme. It is hoped that more offers of papers will be forthcoming for the next session from local members.

On the election of officers Mr. K. W. Chandler was elected chairman for the third successive year, together with: Mr. F. G. Anderson, Vice-Chairman; Mr. R. F. J. Beddis, Secretary; Mr. G. J. Pearce, Treasurer.

We hope that support for the branch will be as large and active as in previous years.

R. F. J. B.

Doncaster Centre

A successful and well-attended winter session ended on March 10th, when the annual general meeting was

held. The following officers were elected for the next session :

Chairman : J. Rhodes.
Secretary and Librarian : A. E. Davis.
Visits' Secretary : J. D. Hill.
Committee : J. D. Hill, J. Lawson, J. L. Ousby,
F. Hinchcliffe.

At the conclusion of this business a "five-minute paper" competition was held, in which Messrs. Taylor (Joe), Hill, Hinchcliffe, Ousby and Smith took part. The papers covered a wide field and the standard of all of them was so high that five votes were taken before the prizes were awarded as follows : 1st, F. Hinchcliffe : U.G. Cables ; 2nd, J. D. Hill : Loading of Cables.

Full advantage will be taken of the free Saturdays in planning the summer visits programme, which so far includes trips to the B.B.C. at Moorside Edge and Manchester, and the English Steel Corporation at Sheffield.
A. E. D.

London Centre

Since the last note on this Centre's activities, two papers have been read by Junior Section members.

"Radar" by D. O'R. Macnamara, a paper with a naval flavour presented in a naval fashion—comprehensive and easily understood. This paper had been read at several area meetings previously, being very popular and well received.

"12 Channel Carrier System No. 7" by J. Gregory, embraced channel and group modulation, carrier frequency generation, synchronisation and inverters and was well illustrated by slides made especially for the paper.

The Annual General Meeting was held at Faraday Building on 28th May, being honoured by the presence of the President of the Junior Section, H. R. Harbottle, O.B.E., B.Sc.(Eng.), D.F.H., M.I.E.E., and the Area Engineer of L.D. Area, E. H. Jeynes.

The annual report showed that the first post-war session of the Centre had been a very successful one and was due in no small way to the enthusiasm and drive of the retiring secretary, Mr. H. E. Williamson. The membership stood at 1,016 members for the first time for many years, the highest membership of any Junior Centre in the country.

The following central meetings have been held during the Session.

January 1946.—"The Wheatstone Bridge." H. R. Harbottle, O.B.E., B.Sc.(Eng.), D.F.H., M.I.E.E.

October 1946.—"Principles of Coaxial Cable Transmission." C. F. Floyd, M.A., A.M.I.E.E.

November 1946.—"Television." H. T. Mitchell, M.I.E.E.

December 1946.—"Kelvin—Master of Measurement." Film Show and General Meeting.

January 1947.—"The Voice of the B.B.C. in Wartime." J. H. Holmes, B.Sc., A.M.I.E.E., A.C.G.I.

February 1947.—"Radar." D. O'R. Macnamara.

March 1947.—"12 Channel Carrier System No. 7." J. Gregory.

There have been some twenty lectures and film shows given in the various areas comprising the Centre and twenty-four visits to places of interest arranged and conducted by local area committees.

The A.G.M. was followed by a meeting of the London Centre at which the President apologised for such a

boring paper but we can assure him that his well-known genial manner and method of delivery made the subject matter one of great interest and introduced many of the members to a new conception of the workings of the carbon microphone.

The following were elected as Officers and Committee for the 1947/48 session.

Chairman, Mr. E. L. Tickner ; Vice-Chairman, Mr. A. C. Welling ; Secretary, Mr. J. Gregory ; Assistant Secretary, Mr. D. E. P. Matthews ; Financial Secretary, Mr. E. Davis ; Visits Secretary, Mr. D. O'R. Macnamara ; Librarian, Mr. W. P. Skinner.

Area Representatives

Mr. W. Peck (City), Mr. L. E. J. Penney (Centre), Mr. A. C. Butcher (East), Mr. R. F. Howard (Circuit Laboratory), Mr. A. Lee (Long Distance), Mr. H. S. Ulrich (North), Mr. W. F. E. Wellar (North-West), Mr. T. Ashpool (South-East), Mr. A. L. Nickson (South-West), Mr. L. W. Kirk (South Postal), Mr. H. T. Longman (Test Section, Stud Street), Mr. S. E. Trinder (West).

The following programme has been arranged for the winter months of the 1974/48 Session.

September 1947.—"Television."

October 1947.—"Modern Local Line Development Practice."

November 1947.—"The Trend of Modern Telecommunications."

December 1947.—"Reorganisation and Telecommunications."

January 1948.—"Television."

February 1948.—"The 2,000 Type Selector and the New Standard Uniselector—Some Mechanical Developments."

March 1948.—"Impulsing."

April 1948.—"Frequency Modulation."

May 1948.—"A.G.M."

It is expected that by the time this note appears in print that the membership and programme card will be in distribution and you will be aware of the lecturers and the actual dates of the meetings. Members are asked to make every endeavour to attend the meetings and to utilise the facilities afforded by membership of the Junior Section.

J. G.

Swansea Centre

A successful winter session has been completed and the total membership has now reached 52.

The following meetings were held during the session and were well attended :

September.—"The new City and Guilds Syllabus for Telecommunications," H. Huckfield (Senior Section).

October.—"Valves and their uses," M. G. Thomas.

November.—Exhibition of technical films supplied by the Central Film Library.

January.—"Local Line Planning," E. Walters.

February.—(Meeting cancelled owing to weather conditions.)

March.—"The Cathode-Ray Oscilloscope."

April.—Annual General Meeting.

It is hoped to maintain interest during the summer months by arranging evening visits to local places of interest.
T. J. L. P.

Staff Changes

Promotions

| Name | Region | Date | Name | Region | Date |
|------------------------------------|-------------------------|---------|--------------------------------------|----------------------------------|----------|
| <i>Area Engr. to Regl. Engr.</i> | | | <i>Tech. etc. to Insp.—continued</i> | | |
| Robinson, O. D. | Mid. Reg. | 8.4.47 | Cook, G. A. | N.E. Reg. to E.-in-C.O. | 9.3.47 |
| <i>Area Engr. to T.M.</i> | | | Bordiss, H. J. K. | S.W. Reg. to E.-in-C.O. | 9.3.47 |
| Perryman, C. F. | Scot. Reg. | 19.2.47 | Agate, M. S. | E.-in-C.O. | 9.3.47 |
| <i>Asst. Eng. to Exec. Engr.</i> | | | Whitaker, T. H. | N.E. Reg. to E.-in-C.O. | 9.3.47 |
| Mew, R. J. | Test Section, London | 1.4.47 | Edgar, F. L. | E.-in-C.O. (U) | 9.3.47 |
| Rogers, H. | Test Section, London | 1.3.47 | Lockton, R. W. | Mid. Reg. to E.-in-C.O. | 9.3.47 |
| Harding, J. P. | E.-in-C.O. | 27.2.47 | Triplow, L. E. | H.C. Reg. to E.-in-C.O. | 9.3.47 |
| Wheeler, L. K. | E.-in-C.O. | 26.3.47 | Preston, A. G. | Cable Test Section to E.-in-C.O. | 9.3.47 |
| Law, H. B. | E.-in-C.O. | 26.3.47 | Baxter, B. W. | H.C. Reg. to E.-in-C.O. | 9.3.47 |
| Fryer, P. W. F. | E.-in-C.O. | 26.3.47 | Eason, D. J. | W. & B.C. Reg. to E.-in-C.O. | 30.3.47 |
| Burr, A. H. | L.P.R. to N.E.R. | 13.4.47 | Radley, M. | E.-in-C.O. (U) | 11.5.47 |
| Roy, D. W. | L.P.R. | 21.4.47 | <i>D'sman Cl. I to Senior D'sman</i> | | |
| <i>Chief. Insp. to Asst. Engr.</i> | | | Aris, F. C. | E.-in-C.O. | 20.4.47 |
| Helm, S. | E.-in-C.O. | 11.5.47 | <i>D'sman Cl. II to D'sman Cl. I</i> | | |
| <i>Tech. etc. to Insp.</i> | | | Hampton, T. E. | E.-in-C.O. | 27.9.46 |
| Flemons, J. C. | Mid. Reg. to E.-in-C.O. | 16.3.47 | Alexander, H. C. A. | E.-in-C.O. | 23.12.46 |
| Daggett, T. K. | E.-in-C.O. | 13.3.47 | Sams, E. J. | E.-in-C.O. | 23.12.46 |
| Troke, F. E. I. | L.T.R. to E.-in-C.O. | 23.3.47 | Caiger, J. E. L. | E.-in-C.O. | 27.4.47 |

Transfers

| Name | Region | Date | Name | Region | Date |
|--------------------------|---|---------|------------------------------|---|---------|
| <i>Asst. Staff Engr.</i> | | | <i>Asst. Engr.—continued</i> | | |
| Ellson, F. A. | Mid. Reg. to E.-in-C.O. | 8.4.47 | Pugh, S. E. | E.-in-C.O. to L.P.R. | 21.4.47 |
| <i>Exec. Engr.</i> | | | Short, P. | E.-in-C.O. to S.W. Reg. | 27.4.47 |
| Trott, L. J. | S.W. Reg. to E.-in-C.O. | 10.4.47 | Sawyer, R. H. W. | Scot. Reg. to H.C. Reg. | 23.5.47 |
| Clarke, A. C. W. V. | L.P. Reg. to Asst. Prin. Min. of Works | 21.4.47 | <i>Chief Insp.</i> | | |
| Hawking, W. | S.W. Reg. (loaned) to W. & B.C. Reg. | 1.5.47 | Jordan, T. | N.E. Reg. to E.-in-C.O. | 4.3.47 |
| <i>Asst. Engr.</i> | | | <i>Insp.</i> | | |
| Thomas, C. F. | L.T.R. to E.-in-C.O. | 6.3.47 | Howlett, G. R. | E.-in-C.O. to Test Section, London | 3.3.47 |
| Collins, P. T. | E.-in-C.O. to L.T.R. | 6.3.47 | Huby, T. A. | E.-in-C.O. to Test Section, London | 3.3.47 |
| Day, J. V. | N.W. Reg. to N.E. Reg. | 8.3.47 | Low, F. A. | E.-in-C.O. to N.W. Reg. | 16.3.47 |
| Williams, W. | E.-in-C.O. to N.W. Reg. | 8.3.47 | Newham, K. C. | L.T.R. to E.-in-C.O. | 14.4.47 |
| Janes, J. D. W. | E.-in-C.O. to Min. of Town and Country Planning | 15.3.47 | Robbins, R. A. D. | E.-in-C.O. to H.C. Reg. | 16.4.47 |
| Sherriff, L. | S.W. Reg. to L.T.R. | 23.3.47 | Simmonds, J. P. | E.-in-C.O. to H.C. Reg. | 27.4.47 |
| Cooper, A. B. | E.-in-C.O. to L.T.R. | 1.4.47 | Blair, G. M. | E.-in-C.O. to H.C. Reg. | 27.4.47 |
| Oldacre, A. G. | Scot. Reg. to L.T.R. | 1.4.47 | Ingram, E. A. | N.E. Reg. to E.-in C.O. | 1.5.47 |
| Gibson, J. | L.T.R. to Scot. Reg. | 8.4.47 | Wales, H. A. | E.-in-C.O. to H.C. Reg. | 11.5.47 |
| Harding, T. C. | L.T.R. to E.-in C.O. | 14.4.47 | Rudge, M. S. | E.-in-C.O. to Expl. Officer, Min. of Supply | 27.5.47 |
| | | | Saxby, F. H. | E.-in-C.O. to Mid. Reg. | 27.5.47 |

Retirements

| Name | Region | Date | Name | Region | Date |
|--------------------------|--------------------------|---------|----------------------|-----------------------|---------|
| <i>Asst. Staff Engr.</i> | | | <i>Asst. Engr.</i> | | |
| Gibson, W. W. M. | E.-in-C.O. | 28.2.47 | Stevens, F. | E.-in-C.O. | 31.3.47 |
| Eason, A. B. | E.-in-C.O. | 31.3.47 | <i>Chief Insp.</i> | | |
| <i>Exec. Eng.</i> | | | Mallows, F. J. | L.T.R. | 5.3.47 |
| Fraser, A. R. | Test Section, Birmingham | 28.2.47 | Cooper, H. G. S. | E.-in-C.O. | 31.3.47 |
| Keeble, A. G. | E.-in-C.O. | 31.3.47 | Millington, S. J. T. | Mid. Reg. | 31.3.47 |
| Stanton, E. P. | E.-in-C.O. (resigned) | 2.4.47 | <i>Insp.</i> | | |
| Sard, P. J. | L.T.R. | 24.4.47 | Keeble, W. R. | E.-in-C.O. (resigned) | 14.2.47 |
| Gunston, J. A. | L.T.R. | 30.4.47 | Sparrow, L. F. | L.T.R. | 17.3.47 |
| Maynard, H. O. | L.T.R. | 30.4.47 | Maasz, C. F. C. | H.C. Reg. | 31.3.47 |

Retirements—continued

| Name | Region | Date | Name | Region | Date |
|------------------------|-----------------------|---------|------------------------|-----------------------|---------|
| <i>Insp.—continued</i> | | | <i>Insp.—continued</i> | | |
| Hankin, B. D. | E.-in-C.O. (resigned) | 31.3.47 | Sargent, T. E. | N.Ire. Reg. | 31.5.47 |
| Frampton, A. D. | H.C. Reg. | 26.4.47 | Dickson, F. M. | N.Ire. Reg. | 31.5.47 |
| Davey, C. G. | L.T.R. | 30.4.47 | Easton, K. J. | E.-in-C.O. (resigned) | 31.5.47 |
| Williams, R. M. | E.-in-C.O. (resigned) | 30.4.47 | <i>A.R.M.T.O.</i> | | |
| Greenland, S. H. J. W. | L.T.R. | 23.5.47 | Gregson, A. | N.E. Reg. | 30.4.47 |
| Jenner, A. | H.C. Reg. | 27.5.47 | | | |

Deaths

| Name | Region | Date | Name | Region | Date |
|--------------------|-----------|---------|--------------------|-----------|---------|
| <i>Power Engr.</i> | | | <i>Chief Insp.</i> | | |
| Bawtree, K. O. | N.E. Reg. | 19.3.47 | Thompson, J. | N.W. Reg. | 13.3.47 |
| <i>Asst. Engr.</i> | | | <i>Insp.</i> | | |
| Whenmouth, H. | L.T.R. | 14.3.47 | Roberts, H. T. | L.T.R. | 14.3.47 |
| Walker, A. H. | L.T.R. | 26.3.47 | Matthews, B. T. | L.T.R. | 17.3.47 |

CLERICAL GRADES

Promotions

| Name | Region | Date | Name | Region | Date |
|---------------------------------------|------------|--------|---------------------------------------|------------|--------|
| <i>Staff Officer to Prin. Clerk</i> | | | <i>Cler. Officer to Exec. Officer</i> | | |
| Oliver, S. R. | E.-in-C.O. | 1.5.47 | Hurdle, D. F. | E.-in-C.O. | 1.1.43 |
| <i>Exec. Officer to Staff Officer</i> | | | | | |
| Warden, J. G. H. | E.-in-C.O. | 1.5.47 | | | |

Retirement

| Name | Region | Date |
|--------------------|------------|---------|
| <i>Prin. Clerk</i> | | |
| Andrews, G. C. G. | E.-in-C.O. | 30.4.47 |

BOARD OF EDITORS

- A. J. GILL, B.Sc., M.I.E.E., F.I.R.E., Chairman.
 F. E. NANCARROW, O.B.E., A.R.C.Sc., M.I.E.E.
 P. B. FROST, B.Sc., M.I.E.E.
 A. H. MUMFORD, O.B.E., B.Sc.(ENG.), M.I.E.E.
 C. W. BROWN, A.M.I.E.E.
 C. E. C. SKUSE.
 H. LEIGH, B.Sc.(ENG.), M.I.E.E., Managing Editor.
 G. E. STYLES, A.M.I.E.E.
 J. P. HARDING, B.Sc.(ENG.), } Assistant
 A.M.Inst.C.E., A.M.I.E.E. } Editors.
 A. J. BAKER, Secretary-Treasurer.

Copyright

The entire contents of this JOURNAL are covered by general copyright, and special permission is necessary for reprinting long extracts, but Editors are welcome to use not more than one-third of any article, provided credit is given at the beginning or end thus: "From the *Post Office Electrical Engineers' Journal*."

The Board of Editors is not responsible for the statements made or the opinions expressed in any of the articles in this JOURNAL, unless such statement is made specifically by the Board.

Communications

All Communications should be addressed to the Managing Editor, *P.O.E.E. Journal*, Engineer-in-Chief's Office, Alder House, Aldersgate Street, London, E.C.1. Telephone: HEADquarters 1234. Remittances should be made payable to "*The P.O.E.E. Journal*" and should be crossed "& Co."

Binding Cases

Cases for binding are available, and may be obtained from the Local Agents for 2s. Subscribers can have their copies of Volumes bound, at a cost of 7s. 6d., by sending the complete set of parts to the Local Agents or to the *P.O.E.E. Journal*, Engineer-in-Chief's Office, Alder House, Aldersgate Street, London, E.C.1. Orders for binding for Vols. 1-19 should indicate whether the original binding case with black lettering, or the later pattern with gold, is required. Cases with gold lettering are the only type stocked from Vol. 20 onwards.

Back Numbers

The price of the JOURNAL, which is published quarterly, is 1s. (1s. 3d. post free) per copy, or 5s. per annum post free. Back numbers can be supplied, subject to availability of stocks, at 1s. each (1s. 3d. post free). Orders for back numbers may be sent to the Local Agents or to the Publishers.

Advertisements

All communications relating to space reservations should be addressed to the Advertisement Editor, *P.O.E.E. Journal*, Alder House, Aldersgate Street, London, E.C.1. Communications regarding advertisement copy, proofs, etc., should be addressed to the Publishers, Messrs. Birch & Whittington (Prop. Dorling & Co. [Epsom], Ltd.), 49 Upper High Street, Epsom, Surrey.

INDEX TO ADVERTISERS

| | PAGE |
|--|-------|
| an Battery Co., Ltd., The | v |
| tinlite Limited | xiv |
| omatic Coil, Winder & Electrical Equipment Co., Ltd. | iii |
| omatic Telephone & Electric Co., Ltd. | x, xi |
| nett College, The | viii |
| ish Institute of Engineering Technology | iii |
| lin Engineering Co., Ltd. | xiii |
| ed & Co., Ltd. | vi |
| Edison Swan Electric Co., Ltd. | ii |
| ott Bros. (London), Ltd. | xix |
| sson Telephones, Ltd. | ix |
| rshed & Vignoles, Ltd. | xii |
| eral Electric Co., Ltd., The | xv |
| I. A., Ltd. | vii |
| ernational Correspondence Schools, Ltd. | iv |
| hread & Co., Ltd. | xiv |
| meko, Ltd. | xviii |
| lli-General Cable Works, Ltd. | xx |
| nan, Sir Isaac & Sons, Ltd. | viii |
| ord Electrical Instruments, Ltd. | ii |
| nens Brothers & Co., Ltd. | xvi |
| th, Frederick, & Co. | iv |
| adard Telephones and Cables, Ltd. | xvii |
| ivan, H. W., Ltd. | xx |
| ephone Manufacturing Company, Ltd. | vii |
| lor Accumulator Co., Ltd., The | xiii |
| est Turner Electrical Instruments, Ltd. | iv |
| ted Insulator Co., Ltd. | xviii |
| stinghouse Brake & Signal Co., Ltd. | iv |
| m & Coales, Ltd. | viii |

A PRACTICAL PLAN for EARLY PROMOTION



**Valuable Free Handbook Tells You
How to Pass Your C. & G.
or Promotion Exam. at First Attempt!**

All Post Office Engineering personnel who are anxious to obtain early promotion should at once send for a copy of our handbook "ENGINEERING OPPORTUNITIES," which, among other intensely interesting matter, describes our unique methods of preparation for **TECHNICAL APPOINTMENTS IN THE POST OFFICE (Assistant Engineer—New Style and Assistant Traffic Superintendent), A.M.I.E.E., CITY AND GUILDS EXAMINATIONS in Principles of Telecommunications (1-5), Radio (1-4), Telephone Exchange Systems (1-3), Telegraphy (1 and 2), Line Transmission (1 and 2), Lines Plant Practice (1 and 2), Mathematics for Telecommunications (1-5), Electrical Engineering Practice (Prelim. Inter. and Final),** and outlines a wide range of non-examination courses in all branches of **Electrical, Mechanical, Civil, Automobile, Aeronautical and Radio Engineering.**

**We definitely guarantee
"NO PASS—NO FEE"**

If you intend to make the most of to-day's opportunities, you cannot afford to miss reading "ENGINEERING OPPORTUNITIES." It tells you everything you want to know to secure advancement, and describes many opportunities you may now be missing through lack of information. Send for your copy to-day—**FREE** and without obligation.

**BRITISH INSTITUTE OF ENGINEERING TECHNOLOGY
369 SHAKESPEARE HOUSE, 17-19 STRATFORD PLACE, LONDON, W.1**

Range Model 7
Universal AvoMeter



Meters that Matter

THE world-wide use of "AVO" Instruments is striking testimony to their outstanding versatility, precision and reliability. In every sphere of electrical test work, they are appreciated for their dependable accuracy, which is often used as a standard by which other instruments are judged.

Sole Proprietors and Manufacturers
THE AUTOMATIC COIL WINDER & ELECTRICAL EQUIPMENT Co. Ltd.
Winder House, Douglas Street, London, S.W.1 Phone: VICTORIA 3404-9

..... built from
first TO LAST

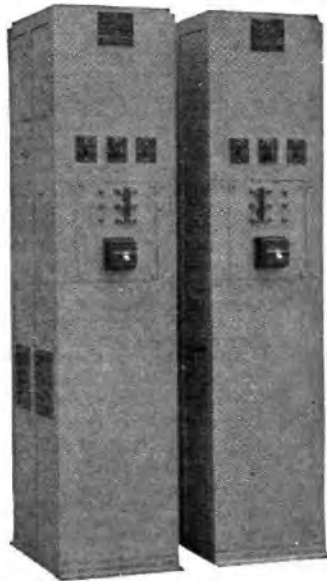

There's no doubt about it . . . experience the world over proves that Westinghouse metal rectifiers do give lasting and efficient service ; and many that were installed 17, 18, 19 and even 20 years ago are still in use and have yet to cost a penny in maintenance or replacements.

The typical equipment illustrated is for use in Repeater Stations and consists of rectifier and transformer for floating the L.T. battery, rectifier and transformer for recharging the standby battery, and rectifier and transformer for trickle-charging and standby battery, with a duplicate equipment for use with the H.T. battery.

WESTINGHOUSE
WESTALITE

METAL RECTIFIERS

*the versatile rectifiers
of outstanding reliability*

WESTINGHOUSE BRAKE & SIGNAL CO., LTD.
82 York Way, King's Cross, London, N.1

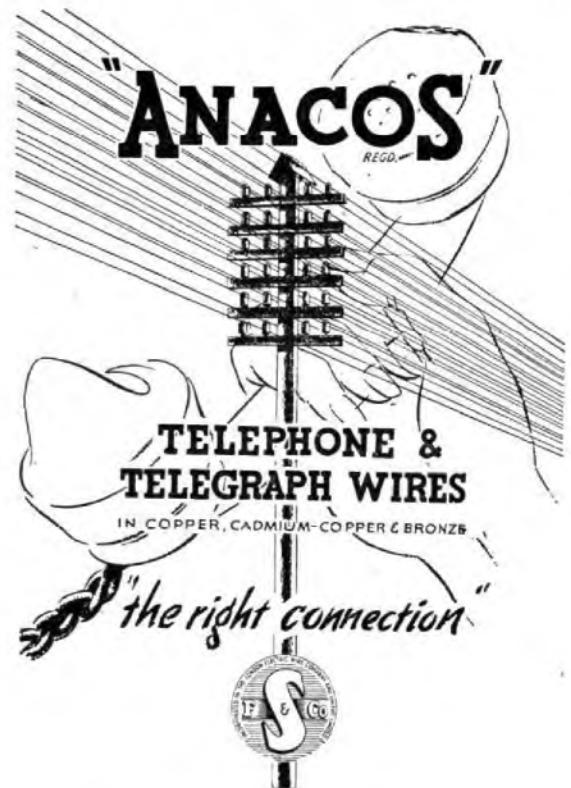

FREDERICK SMITH & COMPANY
(Incorporated in The London Electric Wire Company and Smiths, Limited)
ANACONDA WORKS, SALFORD 3, LANCS.
Phone : Blackfriars 8701 (9 lines) • Grams : "Anaconda," Manchester

SOUND INSTRUCTION by Postal Method

The I.C.S., largest school in the world devoted to spare-time training by the postal method, offers you highly specialised Courses of Instruction for the following Examinations :

**P.M.G. Certificates in Wireless Telegraphy
Associate Membership of I.E.E.**

**C. & G. Electrical Engineering Practice, Instal-
lation and Telecommunications.**

Graduateship of the B.I.R.E.

Other Courses meet the requirements of all who desire to qualify for responsible positions in Electric Power, Illumination, Heating and Traction Systems. Equally successful is our instruction for Telegraph Engineers, Radio Engineers and Radio Servicemen.

Instruction is by correspondence from textbooks specially prepared by many experts.

WRITE FOR OUR SPECIAL BOOKLET and state the particular subject or Examination in which you are interested.

..... **YOU MAY USE THIS COUPON**

International Correspondence Schools Ltd.

Dept. 108, International Buildings, Kingsway, London, W.C.2

Please send me, free of charge, your special

booklet on.....

Name..... Age.....

Address.....





15

CITY OF SOOT REBORN

'Come to the window and enjoy the view. How close the hills look — there behind St. Paul's. Queer to think that, in living memory, this was a desolate vista of soot and bricks . . .'

Not very far ahead of us now, lies the Electric Age. The era of universal, unlimited supplies of electricity. When plans of today mature, when a chain of great generating stations is feeding heat and light and power to the four corners of Britain — no city will any longer find an excuse to foul its own air with smoke and soot. Better days for all of us, then. And here in Alton, where we make the batteries for power stations all over the world, busier days than ever. Hydro-electric, Atomic, or what you will, the new power stations will all need batteries. Good batteries. The kind we have always made at Alton.

ALTON

BATTERIES OF MERIT

THE ALTON BATTERY COMPANY LTD • ALTON • HANTS
Sole Suppliers of Fuller Stationary Batteries
 Telephone: ALTON 2267 & 2268 • Telegrams: 'BATTERY, ALTON'

No. **47** TAPE MODEL
TELEPRINTER
 FOR —

RECORD COMMUNICATION —

A NEW  PRODUCT
Creed



- Printing point is in ideal position on left side.
- Last character printed is immediately visible.
- Receiving cam orientation device for obtaining optimum adjustment.
- Conforms to C.C.I.T. Recommendations.
- Tape and ink ribbon can be replenished without removing cover.
- Accessible printing unit using typewriter ink ribbon.
- Answer-back unit (20 characters).
- A cover attachment for accommodating message forms, etc., can be provided for handling heavy traffic.
- Simplified maintenance with unit construction.
- Quiet in operation.

Creed and Company Limited

TELEGRAPH HOUSE • CROYDON • ENGLAND

TELEGRAMS : "CREDO, TELEX, CROYDON."
 TELEPHONE : CROYDON 2121 (7 lines).

● CABLES : "CREDO, CROYDON."
 ● TELEX CROYDON TELEX 1082

A Typical Example of H.T.A. DESIGN

Included in the range of H.T.A. Products are Telephone Coin Collectors, Stamp Selling Machines, Autodials, Commodity Vending Machines, Coin Operated Mechanisms, Kitchen Control Units, Gas Leak Indicators and Ticket Printing and Issuing Machines of which the model illustrated is a typical example.

- ★ *This H.T.A. all-electric Ticket Issuing Machine prints and dates each ticket when coin is inserted*
Designed for selling of railway travel and platform tickets this model can be adapted for a variety of other purposes.
Tickets are printed and dated on the insertion of the appropriate coin or coins from a roll of blank paper, the size of the ticket issued being approximately 3" x 1½" x .015" thick. The machine is electrically operated and full details and specification will be supplied on request.

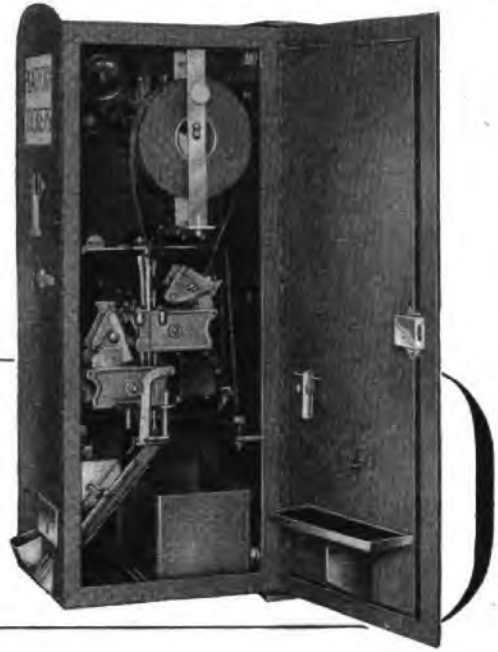

H.T.A. LIMITED

FORMERLY HALL TELEPHONE ACCESSORIES (1920) LTD
Precision Engineers & Instrument Makers
DUDDEN HILL LANE • WILLESDEN • LONDON • N. W. 10
PHONE: WILLESDEN 5141

CARPENTER

High Speed Polarised

RELAY

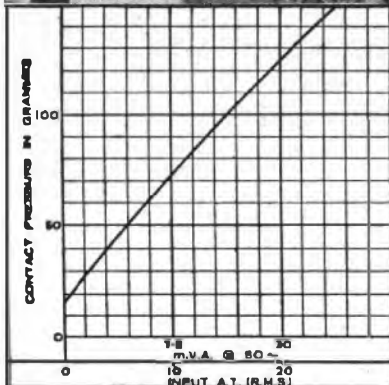
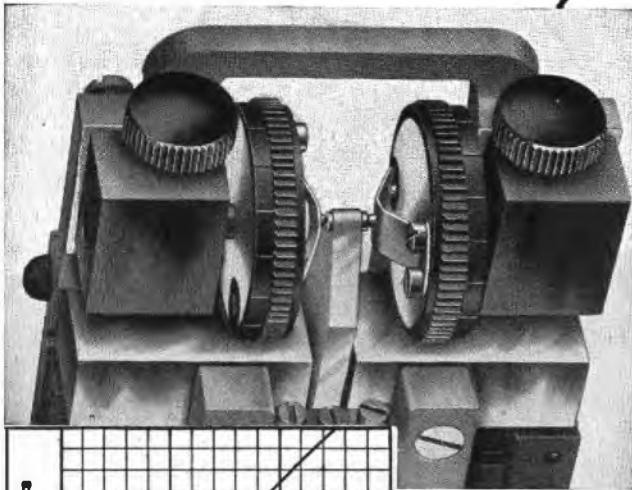

● Contact mechanism of Relay showing damped compliant mountings of side contacts.

● Graph showing contact pressures developed at 50 c/s against mVA and ampere turns input for type 3E Carpenter Relay.

The Carpenter Relay in its standard adjustment reproduces, with a 5AT input, square pulses from less than 2 milliseconds upwards with a distortion of 0.1mS, i.e., 5% for 2mS pulses or 1% at 10mS.

This unequalled performance is due to inherent features of the design of the relay, ensuring short transit time, high sensitivity and low hysteresis. There is complete absence of contact rebound at any input power and contact pressures are exceptionally high (see graph). Adjustment can be made with great ease. Moreover, since the armature is suspended at its centre of gravity, the relay has high immunity from effects of mechanical vibration and there is no positional error. Effective screening is provided against external fields. Because of these characteristics, the Carpenter Relay has many applications in the fields of measurement, speed regulation, telecontrol and the like, in addition to the obvious use in telegraph circuits; details of models suitable for such purposes will be supplied willingly on request.

DIMENSIONS IN COVER: 2½ x 1½ x 4½
WEIGHT with standard socket: 22 ozs.

Ask for booklet 1017 P.O.

TELEPHONE MANUFACTURING CO. LTD.
HOLLINGSWORTH WORKS • DULWICH • LONDON • S.E.21
Telephone: GIPsy Hill 2211 (10 lines)

TELEPHONY

Vol. 1.—Manual Switching Systems and Line Plant

By T. E. Herbert, M.I.E.E., and W. S. Procter, A.M.I.E.E. For many years the standard authority on manual telephony, this work covers the syllabus of the City and Guilds of London Institute examinations, and deals helpfully with many problems which occur in the servicing and maintenance of line plant. Second Edition. 25/- net.

Fault Localizing and Testing of Electric Mains

By F. Charles Raphael, M.I.E.E., F.I.E.S., M.Cons.E., and Charles A. Grover, M.I.E.E. 143 illustrations. 20/- net.

Electrical Wiring and Contracting

Edited by H. Marryatt, M.I.E.E., M.I.Mech.E. In seven volumes, each 10/- net.

Electric Wiring Tables

By W. Perren Maycock, M.I.E.E., and F. Charles Raphael, M.I.E.E., F.I.E.S., M.Cons.E. Waistcoat-pocket size, 5/- net.

Electric Wiring Diagrams

By W. Perren Maycock, M.I.E.E. Revised by H. C. Fabian. Third Edition. 6/- net.

PITMAN BOOKS

Pitman House, Parker St., Kingsway, London, W.C.2



**Reprinting—
Ready Shortly**

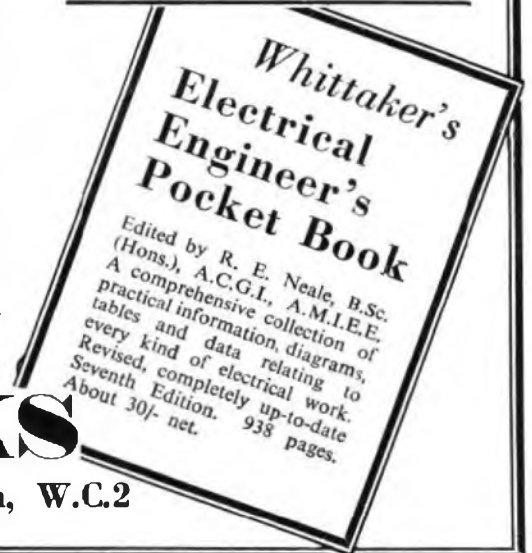

*Whittaker's
Electrical
Engineer's
Pocket Book*
Edited by R. E. Neale, B.Sc. (Hons.), A.C.G.I., A.M.I.E.E.
A comprehensive collection of practical information, diagrams, tables and data relating to every kind of electrical work. Revised, completely up-to-date. Seventh Edition. 938 pages. About 30/- net.

Denso
PERMANENTLY PLASTIC PROTECTION

SPEEDY in application

PERMANENT in protection

Write for Specification and price list
WINN & COALES LTD
TERMINAL HOUSE, GROSVENOR GARDENS, LONDON, SW.1
Telephone: Sloane 6264 Telegrams: Denselte. Sowest. London

STUDY AT HOME You Can Have a College Training For a Few Shillings Monthly **IN YOUR SPARE TIME**

FOUNDED 1900 40 YEARS OF SUCCESS

CITY and GUILDS (Telecommunication) EXAMINATIONS
To every student we send a written Guarantee of Tuition until the examination is actually passed

The most progressive and most successful Correspondence College in the world

Our tuition is so graded that each stage is reached without difficulty.
Personal attention is given to every student.
FULL PARTICULARS AND ADVICE SUPPLIED FREE.
WE TEACH BY POST IN ALL PARTS OF THE WORLD.

Dept. 24, THE BENNETT COLLEGE, SHEFFIELD

Achievement...
by
Ericsson



ERICSSON TELEPHONES LTD., Head Office: 22 Lincoln's Inn Fields, London, W.C.2

Phone: HOLborn 6936

Great Cities

JOHANNESBURG * * * * *

The story of the City of Gold is a fairy-tale which has come to life. Only a huddle of shanties and hutments almost lost in the vastness of the veldt some sixty years ago, it is to-day a huge city of gleaming skyscrapers and wide thoroughfares. Since gold was discovered in Witwatersrand in

1886 more than fifteen hundred million pounds' worth of that coveted metal has been taken from the "Ridge of White Waters." There is an equal amount, the experts say, still there for future removal. Situated nearly six thousand feet above sea level, Johannesburg's population of half-a-million is housed in fine blocks of flats and in pleasant residential suburbs. For their education an impressive university has been built, whilst religious belief has found expression in the erection of a magnificent Cathedral. The City which now bears the name of Johannes Rissik, a Surveyor-General of the Transvaal, has made almost incredible progress since the days when it was just "Ferreira's Camp."

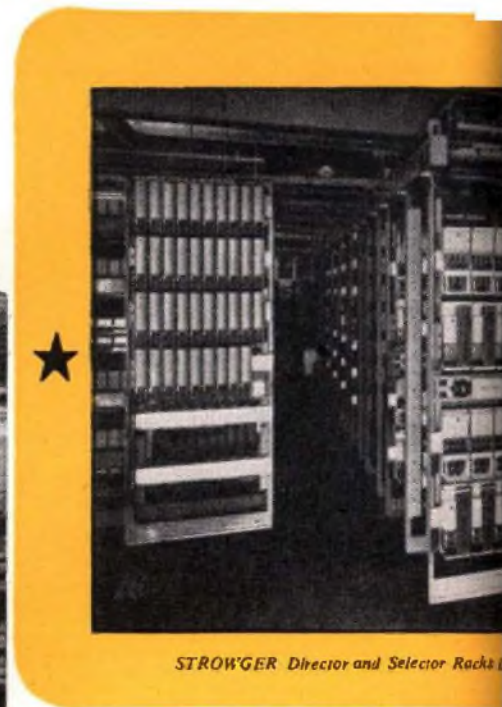

STROW'GER Director and Selector Rack



**AUTOMATIC
ELECTRIC**
MORFORD HOUSE

of the World-

rely on **STROWGER** telecommunications

In an area subject to such swift and consistent growth as Johannesburg it was essential that automatic telephone equipment initially installed should be capable of equally rapid extension to cope with a constantly increasing demand for service. In addition the importance of Johannesburg as a city merited the most efficient and up-to-date system. With these factors in mind the Department of Posts and Telegraphs of the Union of South Africa selected the Strowger Two-digit Director System and in March 1932 six automatic exchanges were completed and 25,000 lines brought into service. Since that date progressive extensions have been made and there are in operation to-date no less than twenty-eight automatic exchanges providing service over 100,000 lines. An outstanding contribution to the complete modernisation of the Witwatersrand area was the Johannesburg Trunk Exchange installed in 1936 and operating on the "on demand" principle. Except for brief periods when some of the trunk routes are operating at very heavy traffic densities "on demand" service is always provided and this is done by utilising all trunk lines in the most efficient manner. A special feature of the trunk service is the method of introducing Repeaters into long distance trunk circuits by utilising the high-bank-capacity type 32A Strowger selector to provide all ordinary cord circuits with a means of access to a group of repeaters.



Installation at Johannesburg Central Exchange

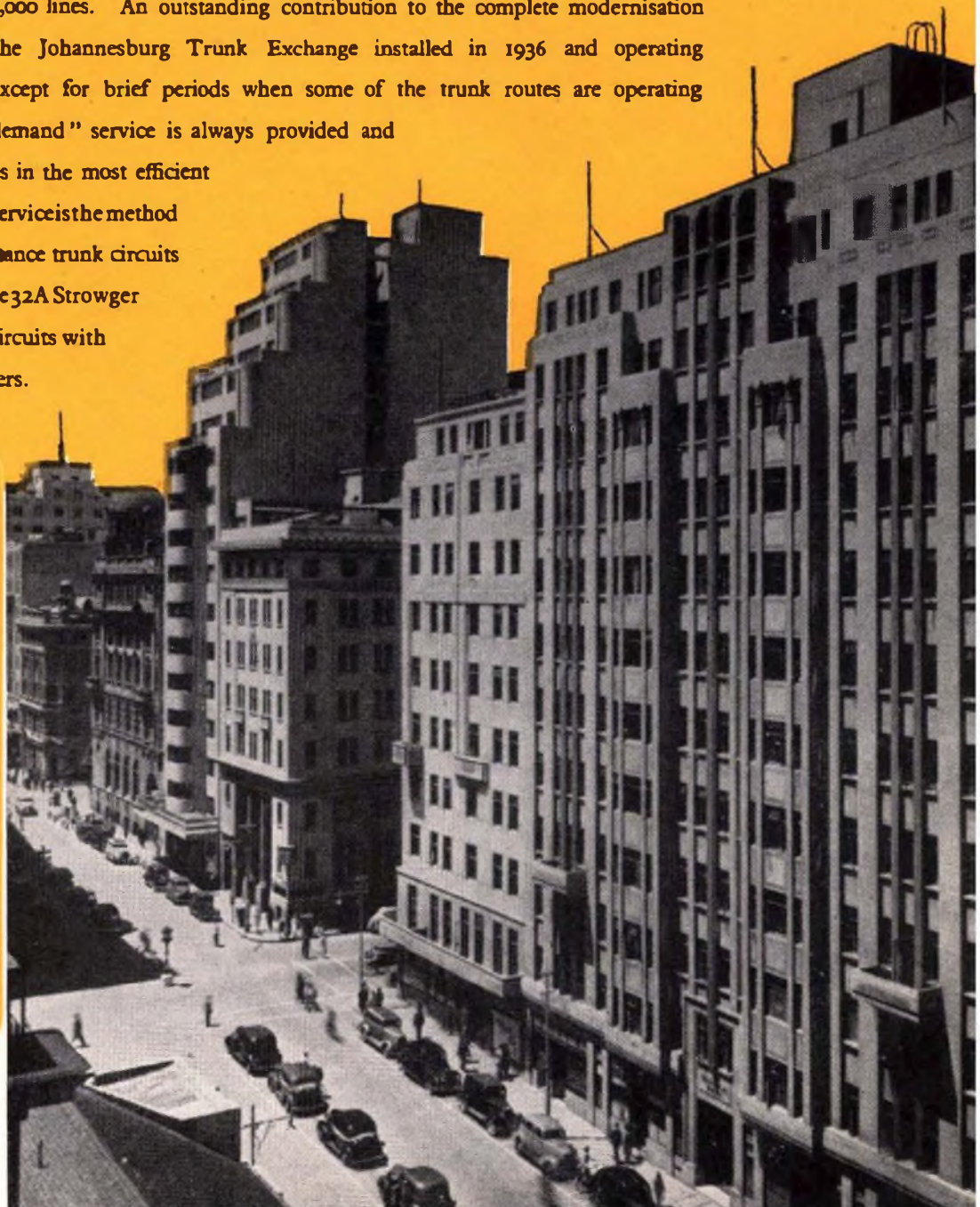

**TELEPHONE &
COMPANY LTD.**

Department :
DORFOLK ST., LONDON, W.C.2

EVERSHED RECORDERS

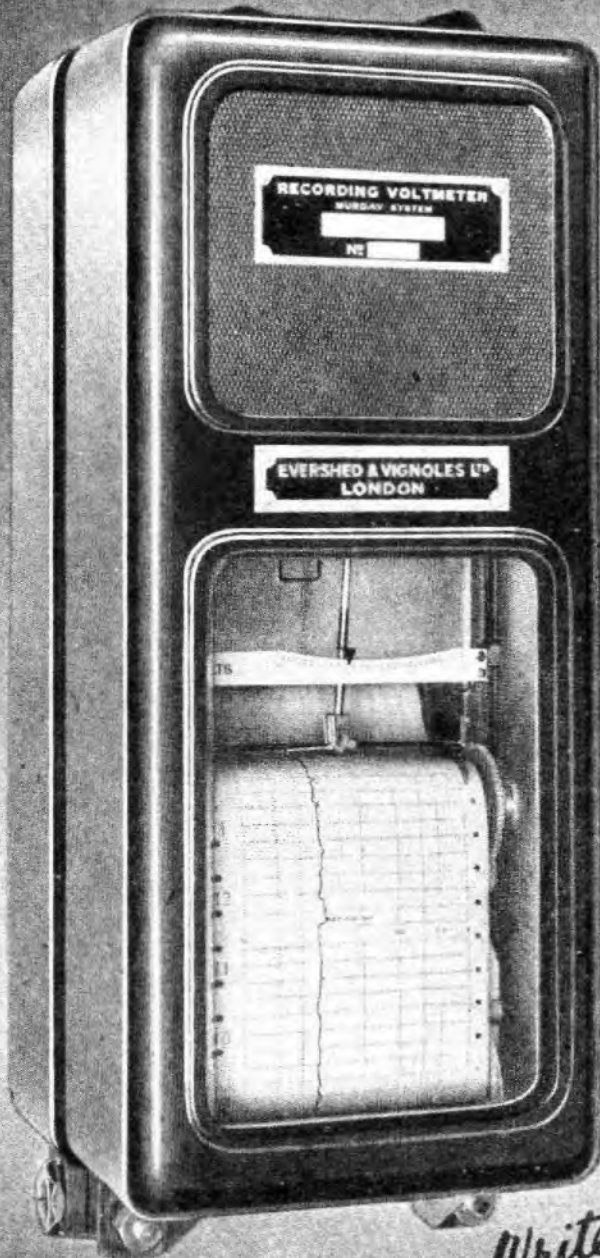

*Write for illustrated
list number 213*

EVERSHED & VIGNOLES, LTD.,
LONDON, W.4.

TELEPHONE: CHISWICK 1370 ★ TELEGRAMS: "MEGGER", CHISK, LONDON

CAPCO

REGISTERED TRADE MARK

- ▶ QUARTZ & GLASS CUTTING MACHINES
- ▶ WIRE CLEANING MACHINES
- ▶ SURFACE GRINDERS

CAPLIN ENGINEERING Co. LTD.

SOLE AGENTS : CAPCO (SALES) LTD

BEACONSFIELD ROAD, WILLESDEN,
LONDON, N.W.10

Telephone : WILlesden 0067-8
Cables : Caplinko, London

Established 1918

*For large scale
Electrical
Purposes*

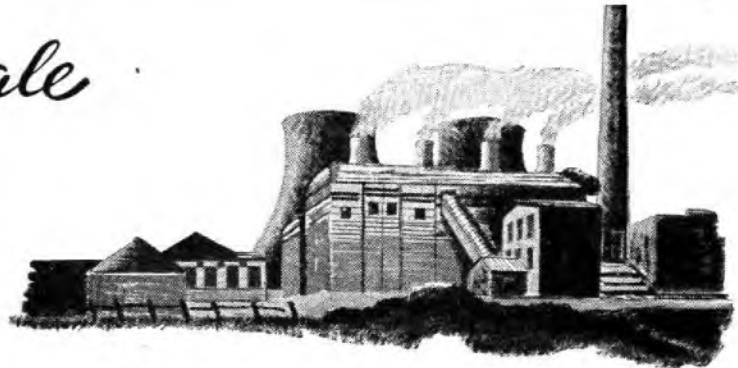

It is noteworthy where Tudor accumulators are to be found fulfilling the most important duties: over 500 British Power Stations installed Tudor. Many Tudor installations rank among the largest in the land and have an enviable reputation for long-lived reliability. No matter whether they were installed only yesterday, or over thirty

years ago—as many of them were—they are to-day functioning with consistent efficiency.

SAFETYLYTE is the Tudor Emergency Lighting System, which is automatic and instantaneous in operation. It is installed in thousands of schools, hospitals, factories and other large buildings.



TUDOR ACCUMULATORS

THE TUDOR ACCUMULATOR CO. LTD
50 GROSVENOR GARDENS, LONDON, S.W.1

AUSTINLITE

Automatic STAND-BY Power Plant

The efficiency and reliability of Austinlite generating plant has been proved all over the world—by Lighthouse and Harbour Boards, by Telephone Authorities, by Railway Companies and many other users. Austinlite emergency stand-by sets are made from $\frac{1}{4}$ kw. to 400 kw. capacity. The self-contained sets have these outstanding features:—

- Interlocked mistake-proof push-button control.
- No supervision required. Starting, assumption of load, return of load to mains supply and stopping are fully automatic.
- Load taken over within twenty seconds of the demand arising.
- Minimum maintenance—Air-cooled engine is not affected by frost and starter battery is automatically charged when the plant is operated.
- Current generated in standard supply—230 volts A.C., 50 cycles, single phase. Feeds into main lighting circuit—no special wiring required.
- Easy to install. No special foundations needed. Requires only exhaust-pipe connection to outer air.

Austinlite self-contained units are equally suitable as normal power plants for continuous use where mains supply is not available.

AVAILABLE IN TWO SIZES—AC OUTPUT VA 500 AND 1,400

A folder containing full particulars will be sent on request.

A *Chance* PRODUCT

AUSTINLITE LIMITED

Proprietors: Chance Brothers Limited. DEPT. D.D., LIGHTHOUSE WORKS, SMETHWICK, Near BIRMINGHAM. Telephone: West Bromwich 1051

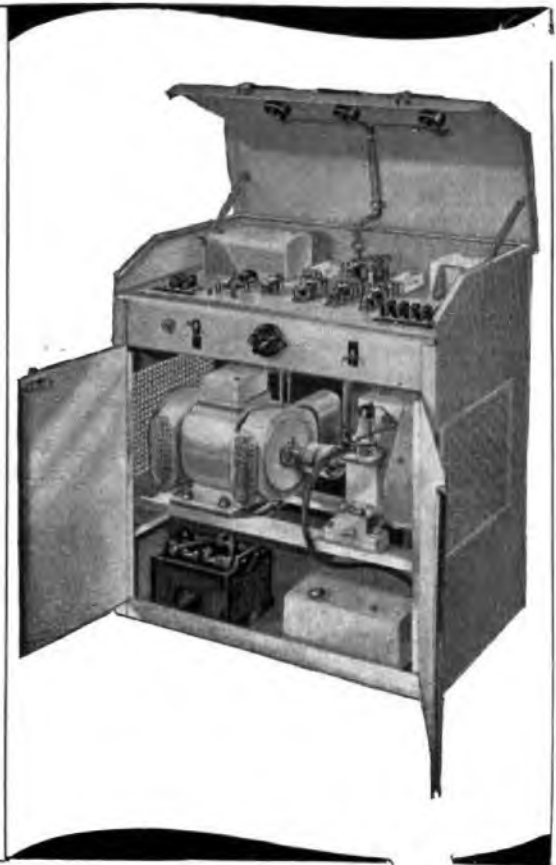

POTENTIOMETER

TYPE D-72-A

For all measurements based on potential difference

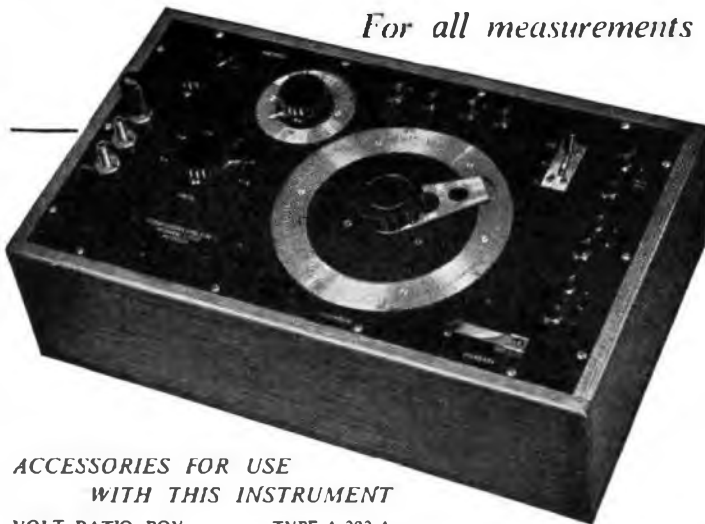

ACCESSORIES FOR USE WITH THIS INSTRUMENT

| | |
|----------------------|--------------|
| VOLT RATIO BOX | TYPE A-202-A |
| WESTON STANDARD CELL | TYPE D-113-A |
| GALVANOMETER | TYPE D-41-A |
| LAMPSTAND | TYPE D-74-A |

Measures from -0.01 volt to $+1.92$ volts on three ranges of $\times 1$, $\times 0.1$ and $\times 0.01$

Smallest subdivision on $\times 0.01$ range, 10 microvolts.

Small negative reading ensures absolute zero volts position.

Accurate current control by stud rheostat and slide wire.

Separate standard cell balancing circuit.

Terminals for two external circuits selected by switch.

MUIRHEAD

Muirhead & Company Ltd. Elmers End, Beckenham, Kent. Tel: Beckenham 0041-2.

FOR OVER 60 YEARS DESIGNERS & MAKERS OF PRECISION INSTRUMENTS

G.E.C.

Complete
Telecommunication
Equipment

Subscribers' Instruments
Automatic and Manual Exchanges
Voice-frequency and Carrier Equipment
Radio Transmitters and Receivers
Trunk and Distribution Cables
Overhead Lines
Wiring Supplies of all kinds
Loading Coils
and Testing Apparatus

for

telephone projects of all sizes are designed, manufactured and installed by the largest all-British electrical manufacturing organisation in the Empire.

THE GENERAL ELECTRIC CO. LTD. OF ENGLAND

Head Office: MAGNET HOUSE, KINGSWAY, LONDON.



TELECOMMUNICATION EQUIPMENT

*Designed for service
in all parts of the world*

By close attention to technical detail the Company has maintained its position in the forefront of Telecommunication Engineers throughout its long experience. Its products enjoy a world-wide reputation for sound design and technical excellence.

The Company undertakes the supply and installation of complete Automatic and Manual Telephone Exchanges for Public and Private service, Automatic and Manual Trunk Exchanges, all types of Telephone Cables for Trunk and Local Service, Carrier Transmission Equipment and Cables, Radio Equipments for Ships.

AUTOMATIC TELEPHONE EXCHANGES including the following types

| | |
|----------------|----------|
| Trunk | T.A.X. |
| Main | M.A.X. |
| Rural | R.A.X. |
| Unit | U.A.X. |
| Private | P.A.X. |
| Private Branch | P.A.B.X. |

MANUAL EXCHANGES of all types

CARRIER TRANSMISSION EQUIPMENT

TELEPHONE INSTRUMENTS of all types

TELEPHONE SWITCHING EQUIPMENT

PROTECTIVE DEVICES

RELAYS

TELEPHONE CABLES, WIRES & CORDS

LOADING COILS

MARINE RADIO EQUIPMENT

SHIPS' TELEGRAPHS & TELEPHONES

CELLS & BATTERIES Dry, Fluid and Inert



SIEMENS BROTHERS & CO., LIMITED
WOOLWICH · LONDON · S · E · 18

ESTABLISHED 1858

TEL: WOOLWICH 2020

Frequency Control



Developed as a result of the search for high stability in frequency control, the *Standard 4013* Type quartz crystal unit is an example of the most up-to-date practice by experts in this sphere.

The crystal is suspended in a miniature evacuated glass envelope equipped with 7 pins, in the form used in the design of midget radio valves.

Of very robust construction, these units will withstand the severe conditions of climate and mechanical shock encountered in mobile telecommunication equipment.



QUARTZ CRYSTALS

in

EVACUATED GLASS

ENVELOPES



Standard Telephones and Cables Limited

(QUARTZ CRYSTAL SECTION)

NORTH WOOLWICH · LONDON · E.16.

BLUE PRINT FOR A RED HOT BREAKDOWN

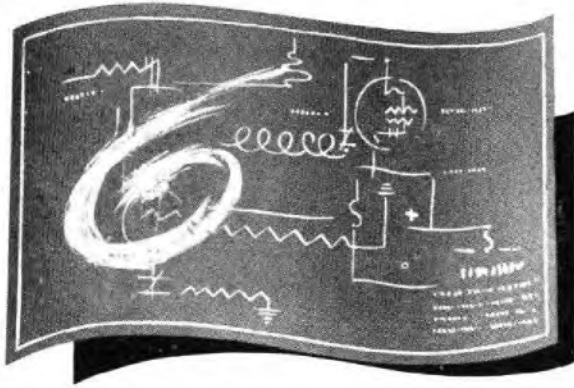

This was one of the most brilliant designs for a certain type of equipment we had ever seen. It was prepared by one of our clients for part of his postwar production. The designer knew his job from A to Z and tackled it with enthusiasm and imagination. It was fortunate however that he took the precaution of having a quiet word with our Research Dept. before going into production. We were able to suggest a real improvement by a different and special type of Input Transformer - saved him a lot of money and trouble - could we do this for you too ????

A small Input Transformer is illustrated, mumetal screened and astatically wound, giving a hum reduction of 70-80 db compared to an open type.

PARMEKO LTD.
OF LEICESTER.

MAKERS OF
TRANSFORMERS.



U.I.C Metallised Ceramics

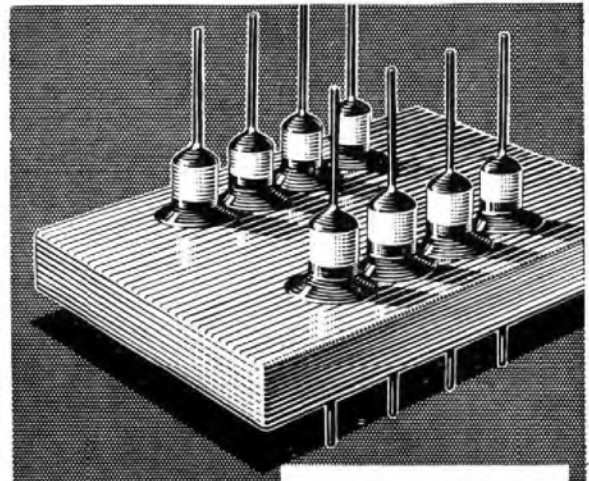

We specialise in the production of all types of Metallised Ceramic components — Hermetic Seals, Sealed Lids, Tag Boards, Bushes, Formers, etc. These are available in soldered, coppered or silvered finish, according to requirements. The suitability of any finish is a matter which we shall be pleased to discuss.

**HERMETIC SEAL
TYPE HS 421**

Flashover Voltage over outside path. 4.5 KVDC at 20° C.
Flashover Voltage over inside path 3.5 KVDC at 20° C.
Small size. Close assembly. Physically robust.



Components made to standard design or to customers' specific requirements. Write for details.

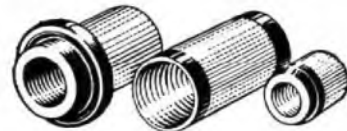

UNITED INSULATOR CO. LTD

Oakcroft Rd., Tolworth, Surbiton, Surrey

Telephone : Elmbridge 5241 Telegrams : Calanel, Surbiton

Unsurpassed In Ceramics

ELLIOTT

**TELEGRAPH
APPARATUS**

**AUTOMATIC WHEATSTONE
TELEGRAPH APPARATUS**

Comprising

**PERFORATORS, TRANSMITTERS,
RECEIVERS, SWITCHES,
TAPE GUMMING MACHINES,**

also

**INKERS, MORSE KEYS, SOUNDERS,
SOUNDER SCREENS,
GALVANOSCOPES, RELAYS,
RESISTANCES, CONDENSERS,
LIGHTNING ARRESTERS, DETECTORS,
COMMENTATORS.**

*Complete sending and
receiving station equipment*

ELLIOTT BROTHERS (LONDON) LTD
CENTURY WORKS · LEWISHAM · S.E.13

TELEPHONE CABLES

OUR LATEST BROCHURE No. 9E (1947)
IS NOW AVAILABLE, GIVING INFOR-
MATION AND SPECIFICATIONS FOR A
WIDE RANGE OF TELECOMMUNICA-
TION CABLES MANUFACTURED BY US.
COPIES WILL BE SENT ON REQUEST.

TELEPHONE
SOUTHAMPTON
2141 (5 lines)

PIRELLI-GENERAL
CABLE WORKS, Ltd., SOUTHAMPTON.

TELEGRAMS
"PIRELLI-CABLE"
SOUTHAMPTON

SULLIVAN-GRIFFITHS
DUAL DIAL NON-REACTIVE
DECADE RESISTANCES
FOR ALL FREQUENCIES
NOVEL AND PATENTED
ACCURACY BETTER THAN 0.1%

Screened Resistances of guaranteed accuracy exactly similar to our well-known Decade Resistances but specially arranged so that one box of a given number of dials gives many different values of maximum resistance. Thus a three dial box (as illustrated) may be used for instance for

three decades of Thousands, Hundreds and Tens
or three decades of Hundreds, Tens and Units
or three decades of Tens, Units and Tenths
or three decades of Units, Tenths and Hundredths

a total of 10000 ohms.
a total of 1000 ohms.
a total of 100 ohms.
a total of 10 ohms.

ALSO
RACK
MOUNTED
TO SPECIAL ORDER

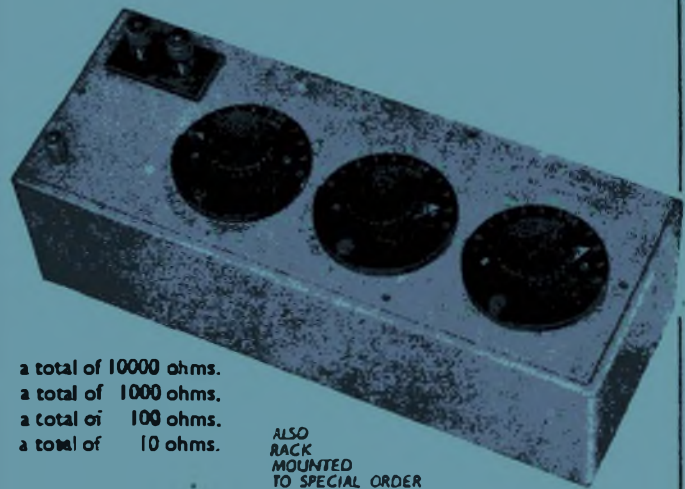

H. W. SULLIVAN
— LIMITED —

LONDON, S.E.15

Telephone: New Cross 3225 (P.B.X.)

The advantages of such a system will be obvious, for in addition to the economy involved much space is saved and the residual resistance and inductance is much reduced.

The resistances are available in 3 dial, 4 dial and 5 dial types with subdivision of 0.001% to 0.1% depending of course on the number of dials incorporated.