

THE POST OFFICE ELECTRICAL ENGINEERS' JOURNAL

VOL. 35

APRIL, 1942

PART 1

CONTENTS

	PAGE
METHODS OF GROUND WATER LOWERING—S. J. Mayo, A.M.I.E.E., and J. A. Hart	1
A SIMPLE NARROW-BAND CRYSTAL FILTER—H. Stanesby, A.M.I.E.E.	4
TEMPERATURE CONTROL FOR OSCILLATORS OF STABLE FREQUENCY—C. F. Booth, A.M.I.E.E., and F. J. M. Laver, Grad.I.E.E.	8
MODERN MATERIALS IN TELECOMMUNICATIONS—W. G. Radley, Ph.D., M.I.E.E., C. E. Richards, F.I.C., E. A. Speight, Ph.D., D.L.C., A.R.C.S., E. V. Walker, B.Sc., A.R.S.M.—Part VIb.—Contact Rectifiers and Photo-electric Cells using Semi- Conductors	15
STANDARDISATION OF WIRES USED IN TELEPHONE EXCHANGES—D. Stewart (Ericsson Telephones, Ltd.)	20
THE SUPPRESSION OF RADIO INTERFERENCE FROM ELECTRO-MEDICAL AND CERTAIN OTHER TYPES OF HIGH FREQUENCY APPARATUS—E. F. H. Gould, B.Sc., A.M.I.E.E.	23
A WIDE-RANGE BEAT FREQUENCY OSCILLATOR—R. F. J. Jarvis, Ph.D., and E. F. S. Clarke, B.Sc.	28
NOTES AND COMMENTS	36
REGIONAL NOTES	37
STAFF CHANGES	39

Price 1/- net

THE INSTITUTION OF POST OFFICE ELECTRICAL ENGINEERS

G.E.C.

CRYSTAL CALIBRATOR

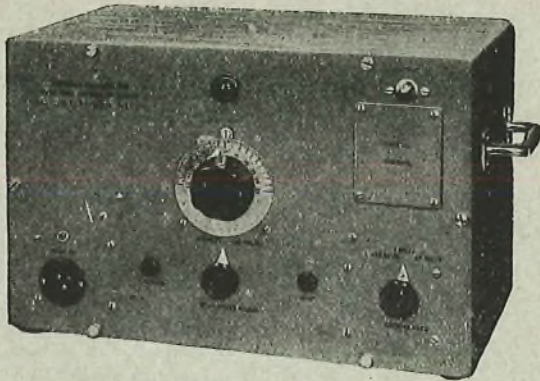

A new precision instrument for the rapid and accurate checking and adjustment of radio frequency oscillators, receivers, transmitters and similar apparatus.

It is crystal controlled and A.C. mains operated.

Ask for full information from :

SALFORD ELECTRICAL INSTRUMENTS LTD.

SALFORD. Telephone : Blackfriars 6688 (6 lines). Telegrams and Cables : "SPARKLESS, MANCHESTER"

PROPRIETORS: THE GENERAL ELECTRIC CO., LTD.

EDISWAN

TELEPHONE LINE PROTECTOR PANELS

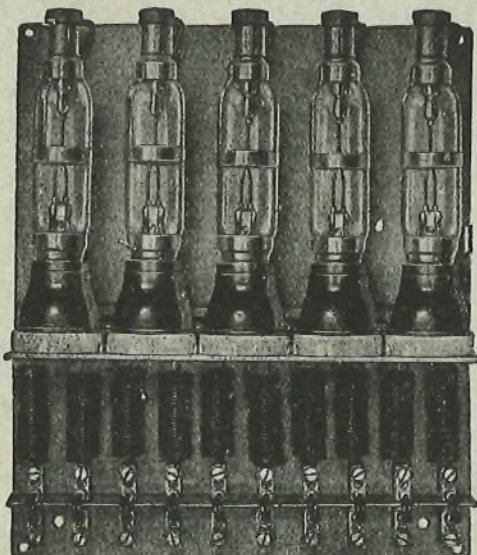

5-circuit panel for overhead lines incorporating choke coils, spark gaps, etc.

EDISWAN-SHOTTER-GREETHAM PATENT

(British Patent No. 353924)

for the protection of telephone systems against surges induced by faults on neighbouring power lines

Of the difficulties attendant upon the employment of overhead systems one of the most serious is to ensure uninterrupted working of the telephone system, by providing adequate protection against induced surges caused by switching or line faults in adjacent power lines or by lightning.

The Ediswan Patent Protectors provide the solution. They are inert at the normal working pressure of the telephone line, they keep the voltage on the line down to a pre-determined figure by providing a path of low resistance to earth whereby the surge is cleared and they again become inert immediately the surge is cleared.

They ensure simultaneous discharge of both lines and are capable of clearing heavy discharges without detriment to the system or the protector.

Ediswan Telephone Line Protectors have now been in use by Supply Companies for many years.

THE EDISON SWAN ELECTRIC CO. LTD.,  155 CHARING CROSS ROAD, LONDON, W.C.2

THE POST OFFICE ELECTRICAL ENGINEERS' JOURNAL

Vol. XXXV

April, 1942

Part I

Methods of Ground Water Lowering

U.D.C. 624.1 : 621.315.23

S. J. MAYO, A.M.I.E.E., and
J. A. HART

Methods are described by which the site of an excavation in waterlogged ground may be drained, and details given of the wellpoint system which is particularly suited to assist manhole construction in such soils. Simple plant is used enabling increased speed of manhole construction and a reduction in construction costs to be achieved.

Previous Practice.

THE construction of manholes on underground duct routes in waterlogged ground has in the past been a slow, cumbersome and costly process involving the use of close timbering, and either a tarpaulin lining with an independent sump outside the manhole excavation or a special cast-iron sump left *in situ*. The method selected has been governed by the character of the subsoil, e.g. gravel, silt or sand, by the anticipated quantity of water and by whether the flow is likely to be continuous or periodical as in excavations by the sea-shore or near tidal rivers. Running sand in particular has always presented a difficult problem, the separation of sand from the water pumped calling for special measures. The following description is typical of P.O. practice and is taken from an earlier issue¹ of this JOURNAL.

The site for the manhole was adjacent to a river estuary and water was met at 2 ft. below the surface. The excavation was close timbered, the poling boards being driven 2 to 3 ft. deeper than the excavation. As the boards were driven down, straw was packed behind them to filter out the sand from water flowing into the excavation. A cast-iron sump, set on stone pitching placed on a wooden floor and topped with a layer of fine chippings, was provided as a means of draining off the water during placing and setting of the concrete, and after the concrete had set the plug was inserted and the sump partially filled with concrete.

Recent experience has shown, however, that methods of this kind are not always successful in separating out the sand and on one particular occasion the method had to be abandoned as the withdrawal of sand with the drainage water constituted a serious risk to road and building foundations. Investigation showed that methods designed to overcome these difficulties had been used successfully in recent years both in this country and in America and, although the published information related primarily to large schemes involving extensive plant, the same principles had already been applied to the construction of telephone manholes in the U.S.A.

Ground Water Lowering Methods.

The level of the water within the site of the excavation can be lowered below the required depth of

excavation by one of the methods known as ground water lowering. A recent survey² of current practice has described three main methods of this type and in each a borehole has lowered into it a perforated tube wrapped with a fine mesh gauze. The annular space between the tube and the borehole is filled with gravel of a grade varying with the fineness of the strata in which it is installed. Each such unit forms a filter well and the effect of pumping from a number of such wells is to form a series of intersecting "cones of depression," the number of wells being so chosen and spaced that the water level is lowered to the required extent within the area surrounded by the wells.

The three main systems are:—

- (a) The shallow well system in which the degree of lowering is limited by the lift of suction pumps and is usually 15–18 ft. The well pipes are usually 6 in. dia., and the suction pipe in each is connected to a ring main served by self-priming centrifugal pumps. This system has been used in the vicinity of large power stations, gas holders, etc., without any settlement to these structures being caused.

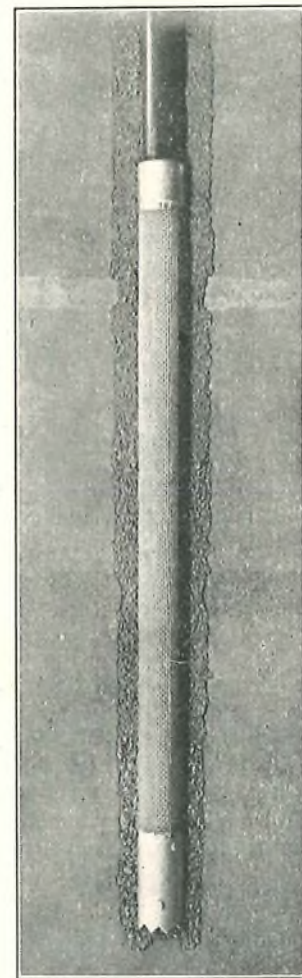

FIG. 1. — WELLPOINT
(MORETRENCH SYSTEM).

¹ P.O.E.E.J., Vol. 20, p. 288.

² Modern Processes in Support of Excavations (Harding and Glossop)—*The Engineer*, May 19th, 1939.

- (b) The deep well system in which submersible pumps are used at depths beyond the scope of suction pumps. The wells are usually 15 in. dia. with gravel filters. This system has been employed successfully in the construction of dock installations in this country and in tunnel excavation work in Holland.
- (c) The wellpoint system which has been largely developed in the U.S.A. and is stated to be based on forms of well used in tunnel construction in this country in about 1850 and on types used in the Abyssinian campaign in 1862. This system employs wellpoints spaced at 4 ft. to 6 ft. as compared with 30 ft. to 50 ft. in the shallow well system. It is particularly adaptable to trench work where the installation of wellpoints can keep pace with excavation, and to the drainage of small excavations such as telephone manholes. It is, therefore, of particular interest to telephone engineers, and a more detailed description is given below of one wellpoint system—the Moretrench system—and of its application to the P.O. construction work referred to earlier, on which more usual methods had failed.

The Wellpoint (Moretrench) System.

The wellpoint consists of a 2 in. dia. pipe carrying at its lower end a triple lap bronze gauze screen (Fig. 1) in which one fine mesh gauze is between inner and outer coarse mesh gauzes. The early wellpoints were driven into the ground and although this was fairly satisfactory in sandy soils which did not contain silt or any impervious stratum, in other soils the act of driving the wellpoint tended to compress the soil in the immediate vicinity. Consequently the passage of water to the gauze filter was impeded and the soil tended to clog the meshes of the gauze. The modern method is to "jet" the wellpoint by pumping in water from a centrifugal pump connected by hose to the top of the tube.

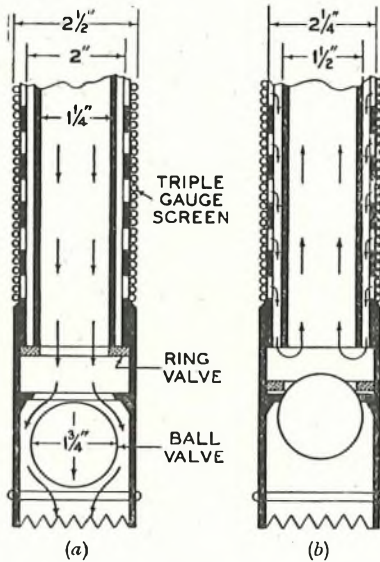

FIG. 2.—WELLPOINT SHOWING VALVE POSITIONS DURING (a) JETTING and (b) SUCTION.

The paved or other top hard surface of the ground is first broken by ordinary methods, removed from the site for the wellpoint and the tube inserted. When the pump is started water is discharged down the tube and emerges at the lower end. The water issuing from the tube is at sufficient pressure to erode the soil in the immediate vicinity and the pipe sinks under its

own weight. The end of the pipe at which the water emerges is serrated so that in resistant soils sinking of the wellpoint may be assisted by the operator rotating the tube. The serrations also have the effect of causing the water discharging from the tube end to be diverted between them so giving a more or less radial discharge which produces a greater scouring effect and consequently a larger hole than would be obtained if they were not present. To secure the use of the full quantity of "jetting" water it must be prevented from escaping through the filter screen during the jetting process and for this purpose check valves are provided inside the tube. The ring valve closes the water passage from tube to screen (Fig. 2 (a)) during jetting, and the ball valve prevents the entrance of soil (Fig. 2 (b)) subsequently during the suction stage.

When the wellpoint has been sunk to the required depth by jetting, the pump is stopped and the suspended sand and gravel settle and form a porous lining round the wellpoint screen. Any sand and gravel deposited on the ground surface by water escaping from the wellpoint hole may be shovelled back to complete the lining round the wellpoint and any deficiency should be made good from other sources. The effect of the sand and gravel refill in increasing the filter area is of considerable importance as will be seen from the following figures.

The water-passing area of a standard 2 in. wellpoint is about 300 sq. in. but with a 1 in. cavity filled with sand around the outside of a wellpoint sunk 8 ft. into the ground the outside area around the sand refill is nearly 1,400 sq. in. When, therefore, during suction the pump draws water through the wellpoint the speed of entry through this large filter area will be so small, even when the wellpoint is working at full capacity, that the movement of "fines" through the sand is eliminated.

In some soils the jetting process may not produce an adequate cavity round the wellpoint for the necessary sand refill. For example, resistant layers or lenses of clayey material may not be eroded to the same extent as the other soils encountered; on the other hand, soils containing widely diffused mixtures of clay may be penetrated so easily that little or no soil resistance is encountered during the jetting operation and the resistance at the lower

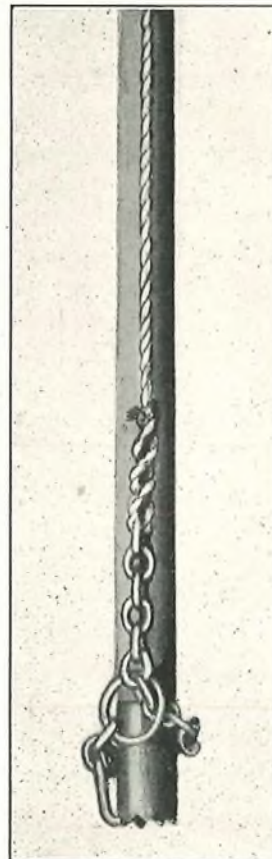

FIG. 3.—JETTING CHAIN FIXED TO WELLPOINT.

(serrated) end of the tube may not be great enough to produce radial discharge of the water, the water merely eroding the soil sufficiently to create an escape path round the wellpoint. In such soils a jetting chain is attached to the serrated end of the tube and looped round the tube body (Fig. 3), the free end being attached to a rope secured at the top of the tube. Rotation of the wellpoint tube then causes the chain to act as a cutter to enlarge the bore. Release of the rope after jetting is finished allows the chain to drop off and be hauled up before the sand refill is placed. In particularly difficult soils compressed air may also be used to assist in jetting the wellpoints, but the usual precautions necessary to safeguard foundations, etc., must be observed when pressure injection systems are used.

For the jetting of the first one or two wellpoints to be installed, water must be provided from some external source but as soon as these have been installed and they have been connected to the suction pump to commence drainage, the water drawn from them may be used for the jetting of further wellpoints. Thus, if no water source is readily available, cost need only be incurred in carting the small quantity of water required for initial jetting. After each wellpoint has been installed it is connected to a suction pump via a header main of suitable capacity and the pump is kept going to ensure that the water is below excavation level during the operations of excavation and placing and setting of the concrete.

Use of the Wellpoint System by the P.O.

The area in which the manholes were to be built consists of an alluvial flat formed by the sediment of a river and its estuary, the silting-up process still being active. The alluvium is evidently of considerable depth as borings down to 50 ft. below the river bed have been taken without reaching bottom. During such operations the composition of the alluvium has been shown to be loose stratified silting sand, quartose and fine grained, with occasional thin seams of fine gravel. The depth at which water was encountered as well as the consistency of the deposits appeared to vary considerably according to weather conditions and the state of the tide, the water frequently being only 4 ft. below the ground surface.

The manholes were to be of reinforced concrete and in two sizes, 6 ft. by 4 ft. and 10 ft. by 4 ft., the heights being 5 ft. 6 in. and 6 ft. 0 in. respectively, or more if required. The wellpoints for these manholes were 14 ft. in length and of standard 2 in. dia. To start them it was necessary on occasions to make holes 12 to 15 in. in dia. and about 2 ft. deep through the top surface. They were then jetted in, using a 3 h.p. centrifugal pump, the quantity of water required for jetting each being less than 15 gal. and sufficient water being obtained after sinking two wellpoints to supply jetting water for subsequent wellpoints. For some of the smaller manholes 4 wellpoints were found to be sufficient to keep the water below the excavation level and these were spaced one at each corner of the site. Where six were found necessary an additional one was installed midway along each of the longer sides. For the larger

manholes eight wellpoints were required. The average time taken to sink these wellpoints was 45 sec. each. Occasionally, obstructions such as tree roots and stones were met, but these could generally be removed and the excavation of fresh holes was seldom necessary.

Usually excavation for the manholes was commenced at the same time as pumping was started from the wellpoints connected to the header of a

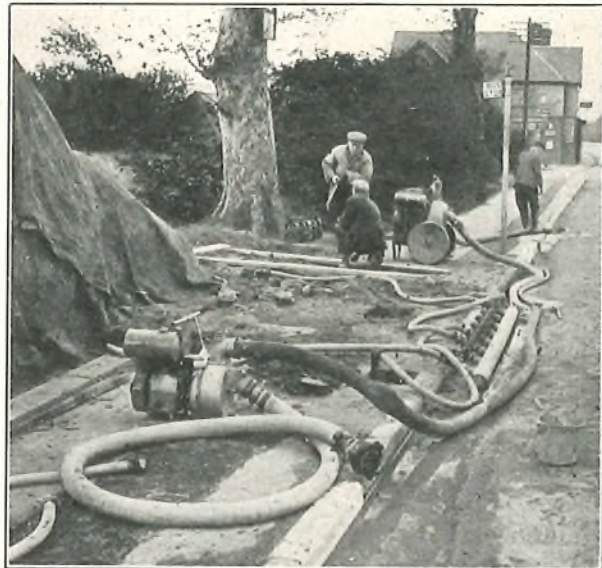

FIG. 4.—WELLPOINTS CONNECTED TO PUMP.

7 h.p. centrifugal pump (Fig. 4), and the water level was lowered with such rapidity that it was always below excavation level. Once the road or footway surface had been removed excavation was easy and the site was kept so dry and the sand compacted to such an extent within the drained area that usually



FIG. 5.—MANHOLE EXCAVATION IN WET SITUATION.

no timbering at all was necessary (Fig. 5). With the equipment described it was found possible to construct four or five manholes per week, whereas by what have previously been considered normal methods for wet

situations construction would probably have been at the rate of one manhole per week. There is, in fact, some recollection by residents in the vicinity, of manholes taking up to three weeks each to build!

Comparative Costs.

Under war conditions and with all the difficulties attendant upon the first experimental use of such a plant it was not possible to keep records of costs and performances in such a form as would enable detailed comparisons of cost per type of manhole to be extracted. The overall costs of plant hire and labour are, however, known, and from these it is estimated that the cost of building a 6 ft. by 4 ft. by 5 ft. 6 in. manhole (R.C. 1) in shifting sand with the aid of wellpoints is approximately 30 per cent. greater than the cost of building a manhole of the same size in a normal dry situation, whereas by the older methods of independent sump and hardcore drainage or C.I. sump and hardcore drainage the cost would have been about 120 per cent. greater than for a manhole in a normal dry situation. The corresponding figures

for the 10 ft. by 4 ft. by 6 ft. high manhole (R.C. 2) are 20 per cent. and 90 per cent. respectively.

Conclusion.

The extremely satisfactory practical and financial results obtained on the first experimental use of this type of plant on P.O. work indicate that considerable scope for its employment exists. The saving of time in construction and the elimination of the risks of settlement of the foundations of nearby buildings and roads are of particular importance and may well lead to the general adoption of wellpoint ground water lowering methods in waterlogged areas.

Acknowledgments.

It is desired to express our appreciation of Messrs. Blaw Knox's assistance in supplying details of the plant used in the Moretrench system, of Mr. R. V. C. Williams' (Chester Telephone Area) assistance in supplying illustrations of the plant and of assistance rendered by the Construction Branch (E. in C.O.) in the preparation of the material for this article.

A Simple Narrow-Band Crystal Filter

H. STANESBY, A.M.I.E.E.

U.D.C. 621.396.662.3

An analysis is made of a simple lattice-type band-pass filter which may be realised using two crystal resonators and two or four condensers. There is one frequency of infinite attenuation which can be located either above or below the pass-band or can be made to disappear by giving it an imaginary value; for the last condition the attenuation characteristic plotted on a logarithmic frequency scale can be made symmetrical. When quartz crystal resonators are used the maximum band-width is limited to 0.4 per cent. and the nominal characteristic impedance must usually be made higher than 10,000 ohms. The filter can be realised in the form of a π network having similar properties and requiring only one resonator, but the frequency of infinite attenuation will then be just above the pass-band.

Introduction.

IN a recent issue¹ of this JOURNAL, a lattice filter was described which, when realised in a form using four quartz resonators, passes a very narrow frequency band. The attenuation of this filter can be made to rise to very high values on both sides of the pass-band. When such a high degree of discrimination is unnecessary it is more economical to use either a simpler lattice filter² incorporating two resonators or an unbalanced equivalent which requires only one resonator. The unbalanced form is subject to greater limitations, however.

The analysis of this simpler filter given here follows, in broad outline, that in the earlier article and the same symbols are used for corresponding quantities in both. The descriptive portions are therefore abridged to save unnecessary repetition.

Analysis of Lattice Filter.

The filter is shown in lattice form in Fig. 1 with the relevant reactance and attenuation constant characteristics.

¹ P.O.E.E.J., Vol. 33, p. 176.

² This filter is referred to briefly by Mason in B.S.T.J., July, 1934, p. 413, and again by Mason and Sykes in B.S.T.J., April, 1940, p. 232.

The series and lattice arm impedances are given respectively by:—

$$Z_x = \frac{-j}{\omega C_3} \cdot \frac{\omega_1^2 - \omega^2}{\omega_2^2 - \omega^2} \dots \dots \dots (1)$$

$$Z_y = \frac{-j}{\omega C_2} \dots \dots \dots (2)$$

where $\omega_1/2\pi$ and $\omega_2/2\pi$ are the two cut-off frequencies.

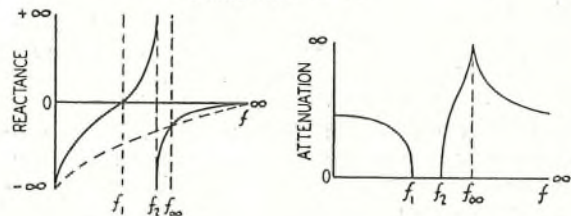
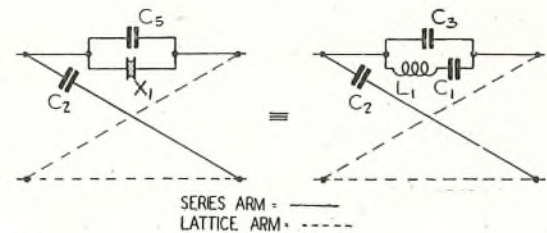

FIG. 1.—SIMPLE NARROW-BAND CRYSTAL FILTER IN LATTICE FORM, WITH REACTANCE AND ATTENUATION CHARACTERISTICS.

Characteristic Impedance.

If Z_K is the characteristic impedance then :—

$$\begin{aligned} Z_K &= \sqrt{Z_x Z_y} \\ &= \frac{-j}{\omega \sqrt{C_2 C_3}} \cdot \sqrt{\frac{\omega_1^2 - \omega^2}{\omega_2^2 - \omega^2}} \\ &= -jZ_0 \cdot \frac{\omega_2}{\omega} \sqrt{\frac{\omega_1^2 - \omega^2}{\omega_2^2 - \omega^2}} \dots \dots \dots (3) \end{aligned}$$

where the nominal image impedance Z_0 is given by :—

$$Z_0 = \frac{1}{\omega_2 \sqrt{C_2 C_3}} \dots \dots \dots (4)$$

The expression for the characteristic impedance is similar in form to that for the filter previously studied.

Propagation Constant.

If P, A and B are the propagation, attenuation and phase constants respectively then :—

$$\tanh \frac{P}{2} = \tanh \left(\frac{A}{2} + \frac{jB}{2} \right) = \sqrt{\frac{Z_x}{Z_y}}$$

Substituting for Z_x and Z_y using equations (1) and (2) :

$$\tanh \frac{P}{2} = \tanh \left(\frac{A}{2} + \frac{jB}{2} \right) = \sqrt{\frac{C_2}{C_3} \cdot \frac{\omega_1^2 - \omega^2}{\omega_2^2 - \omega^2}} \dots (5)$$

Frequency of Infinite Attenuation.

When ω assumes such a value that $\tanh (P/2)$ is unity the attenuation constant A becomes infinite. Equating (5) to unity and writing ω_∞ for ω :—

$$\sqrt{\frac{C_2}{C_3} \cdot \frac{\omega_1^2 - \omega_\infty^2}{\omega_2^2 - \omega_\infty^2}} = 1 \dots \dots \dots (6)$$

whence $\sqrt{\frac{C_2}{C_3}} = \sqrt{\frac{\omega_2^2 - \omega_\infty^2}{\omega_1^2 - \omega_\infty^2}} = m$ say $\dots \dots (7)$

As defined by the above equation m has the significance usually attributed to it in the treatment of ladder filters ; it controls the position of the

frequency of infinite attenuation³. But here m is defined uniquely by (7), regardless of whether ω_∞ is above the pass-band or not, and may assume any positive real value, whereas for a ladder filter m usually lies between zero and unity. In the present treatment as m ranges from zero to unity ω_∞ passes from ω_2 to ∞ ; when m lies between unity and ω_2/ω_1 , ω_∞ is imaginary, i.e., the attenuation constant is finite at all frequencies, and as m ranges from ω_2/ω_1 to ∞ , ω_∞ passes from 0 to ω_1 .

Calculation of Attenuation Constant.

Let :—

$$\frac{1}{p^2} = \frac{\omega_1^2 - \omega^2}{\omega_2^2 - \omega^2} \dots \dots \dots (8)$$

where ω is excluded from the interval ω_1, ω_2 , i.e., the pass-band. Respecting this restriction on the value of ω , $\frac{1}{p^2}$ will always be positive and p real.

Substituting in equation (5) using (7) and (8) and expressing A explicitly :—

$$\left. \begin{aligned} A &= 2 \tanh^{-1} \frac{m}{p} \text{ nepers } \left(0 < \frac{1}{p} < 1 \right) \\ A &= 2 \coth^{-1} \frac{m}{p} \text{ nepers } \left(\frac{1}{p} > 1 \right) \end{aligned} \right\} \dots \dots (9)$$

Curves showing the relationship between A (in decibels) and p, with m as parameter, are shown in Fig. 2. It can be shown that when $m = \sqrt{\omega_2/\omega_1}$, the attenuation constant characteristic plotted on a logarithmic frequency scale becomes symmetrical.

³ As equation (6) involves the second power of ω_∞ only, its roots are of the form $a, -a$. When a is real there will be one frequency at which the attenuation constant is infinite, but when a is imaginary there will be no real frequency of infinite attenuation.

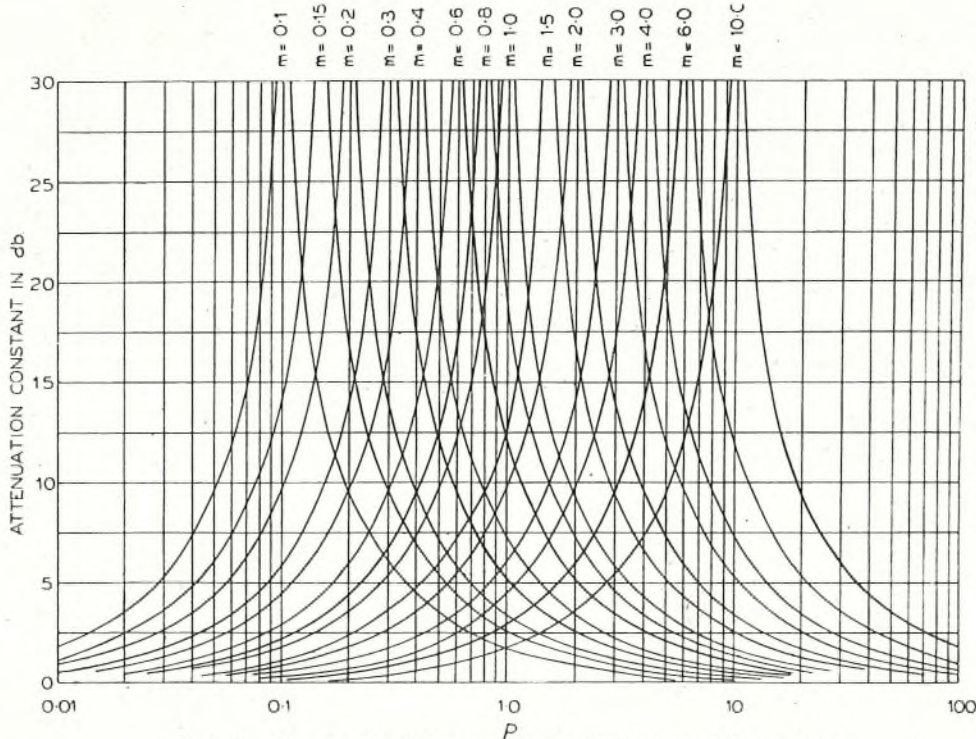

FIG. 2.—CURVES FOR COMPUTATION OF ATTENUATION CONSTANT.

Phase Constant.

If q is defined by :—

$$\frac{-1}{q^2} = \frac{\omega_1^2 - \omega^2}{\omega_2^2 - \omega^2} \quad (\omega_1 < \omega < \omega_2)$$

then, substituting q and m in equation (5) and solving, the phase constant B can be written explicitly :—

$$B = 2 \tan^{-1} \frac{m}{q} \text{ radians} \dots\dots\dots (10)$$

Values of Electrical Elements.

Combining equations (4) and (7) :—

$$C_2 = \frac{m}{\omega_2 Z_0}$$

$$C_3 = \frac{1}{\omega_2 Z_0 m}$$

and by using Foster's Theorem⁴ it can be shown that :

$$L_1 = \frac{1}{C_3 (\omega_2^2 - \omega_1^2)}$$

$$C_1 = \frac{\omega_2^2 - \omega_1^2}{\omega_1^2} \cdot C_3$$

Substituting for C_3 in the last two equations the values of the electrical elements in the lattice network are given by :—

$$L_1 = m \cdot \frac{\omega_2 Z_0}{\omega_2^2 - \omega_1^2} \dots\dots\dots (11)$$

$$C_1 = \frac{1}{m} \cdot \frac{\omega_2^2 - \omega_1^2}{\omega_1^2 \omega_2 Z_0} \dots\dots\dots (12)$$

$$C_2 = m \cdot \frac{1}{\omega_2 Z_0} \dots\dots\dots (13)$$

$$C_3 = \frac{1}{m} \cdot \frac{1}{\omega_2 Z_0} \dots\dots\dots (14)$$

Limitations Imposed by Resonators.

The use of quartz crystal resonators to replace L_1 , C_1 and part or the whole of C_3 in the series arms restricts the ratio C_1/C_3 to values below 1/125 and stray capacitances may reduce this maximum value considerably. From equations (12) and (14) :—

$$\frac{C_1}{C_3} = \frac{\omega_2^2 - \omega_1^2}{\omega_1^2} \approx \frac{2(\omega_2 - \omega_1)}{\omega_1} \quad (C_1 \ll C_3)$$

When resonators are used the bandwidth cannot therefore exceed 0.4 per cent. of the mid-band frequency. There is no restriction on the value of m . The nominal characteristic impedance will be high unless a bandwidth very much smaller than 0.4 per cent. is employed ; as this is usually undesirable, in practice Z_0 generally exceeds 10,000 ohms.

Equivalent Unbalanced Network.

An unbalanced equivalent of the lattice network is shown in Fig. 3. This can, of course, be realised only if C_2 in the lattice network is less than C_3 , i.e., m is less than unity ; but a further restriction applies if a

quartz crystal resonator is to be introduced in the series arm of the π network. Referring to Fig. 3, if a resonator is to be used the following condition must clearly be satisfied :—

$$0 < \frac{C_1}{C_3 - C_2} < \frac{1}{125}$$

Substituting using equations (12), (13), (14) and (7), this expression may be rewritten as :—

$$0 < \frac{\omega_\infty^2 - \omega_1^2}{\omega_1^2} < \frac{1}{125}$$

Finally, as $\omega_\infty^2 - \omega_1^2 \ll \omega_1^2$ this may be expressed in the form :—

$$0 < \frac{\omega_\infty - \omega_1}{\omega_1} < \frac{1}{250}$$

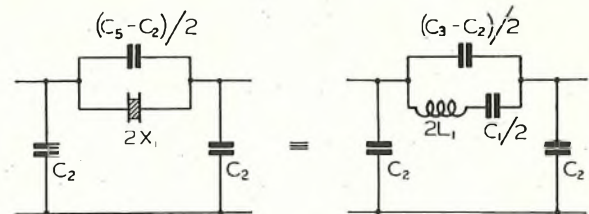

FIG. 3.—UNBALANCED EQUIVALENTS OF NETWORKS IN FIG. 1.

This indicates that ω_∞ must always be greater than ω_1 , i.e., above the pass-band, and that the interval ω_1, ω_∞ , within which ω_2 must be located, cannot exceed 0.4 per cent. of ω_1 .

Performance of Typical Filters.

Some idea of the insertion-loss characteristics that can be realised in practice may be obtained from the

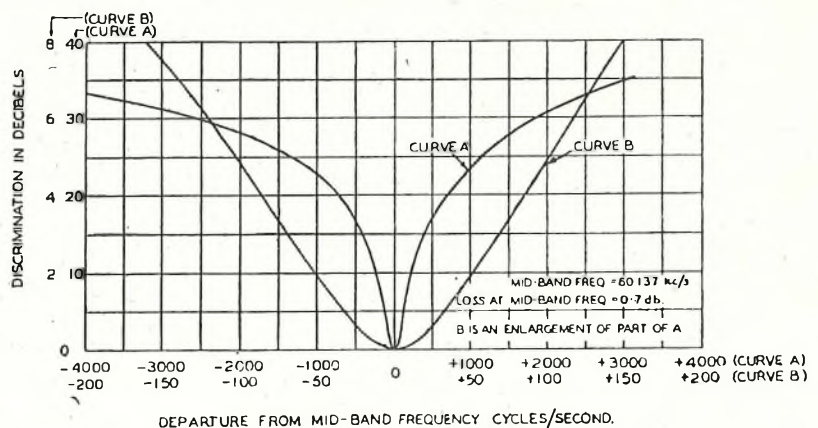

FIG. 4.—INSERTION LOSS CHARACTERISTIC OF LATTICE FILTER.

examples given below. The first two curves show the performance of lattice filters which were designed to have symmetrical characteristics by making $m = \sqrt{\omega_2/\omega_1}$. For the insertion-loss characteristic shown in Fig. 4,

$$Z_0 = 40,000 \text{ ohms, } \omega_1/2\pi = 60.099 \text{ kc/s, } \omega_2/2\pi = 60.176 \text{ kc/s}$$

⁴ B.S.T.J., Vol. 3, pp. 259-267.

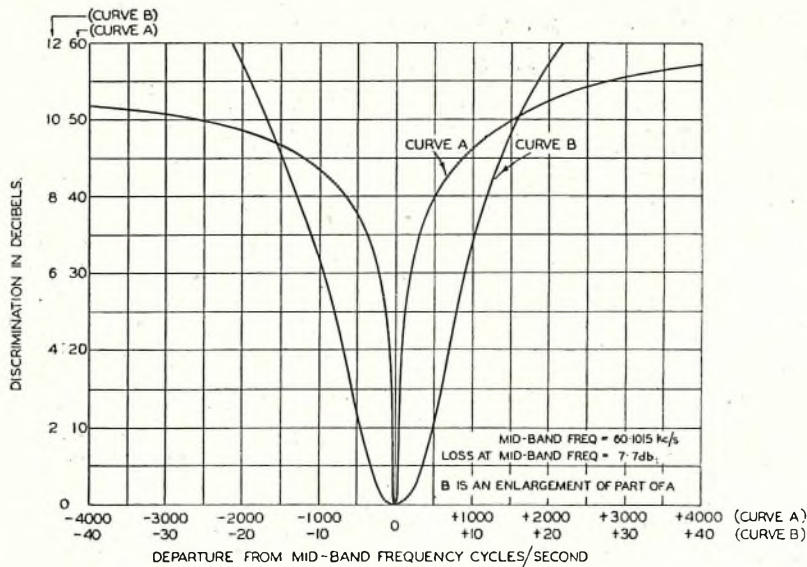

FIG. 5.—INSERTION LOSS CHARACTERISTIC OF NARROW-BAND LATTICE FILTER.

The nominal band-width is therefore 77 c/s and, although this is little more than 0.1 per cent. of the mid-band frequency, the loss in the middle of the pass-band is only 0.7 db. The characteristic shown in Fig. 5 is interesting as it shows that an extremely narrow band-width can be obtained if desired. For this filter :—

$$Z_0 = 2,570 \text{ ohms}, \omega_1/2\pi = 60.099 \text{ kc/s}, \\ \omega_2/2\pi = 60.104 \text{ kc/s}$$

The pass-band has therefore a nominal width of only 5 c/s.

Fig. 6 shows the computed and measured insertion-loss characteristics of an unbalanced section having the following parameter values :—

$$Z_0 = 10,000 \text{ ohms} \quad m = 0.882 \\ \omega_1/2\pi = 99.975 \text{ kc/s} \quad \omega_2/2\pi = 100.025 \text{ kc/s}$$

For computation the Q of the crystal was taken as 7,000 and the small discrepancy between the two characteristics appears to be mainly due to the fact that the Q was in fact rather higher. The

agreement between computation and measurement constitutes a satisfactory check of the analysis. This characteristic shows that the impossibility of removing the frequency of infinite attenuation from the immediate neighbourhood of the pass-band, when unbalanced sections are used, reduces the attenuation on the opposite side of the pass-band considerably.

Conclusions.

The filter that has been studied is capable of yielding a very narrow pass-band outside which the attenuation rises to moderately high values. It would appear to be specially suitable for reconditioning pilot or synchronising frequencies on certain carrier and radio systems. An outstanding virtue of the filter is its simplicity.

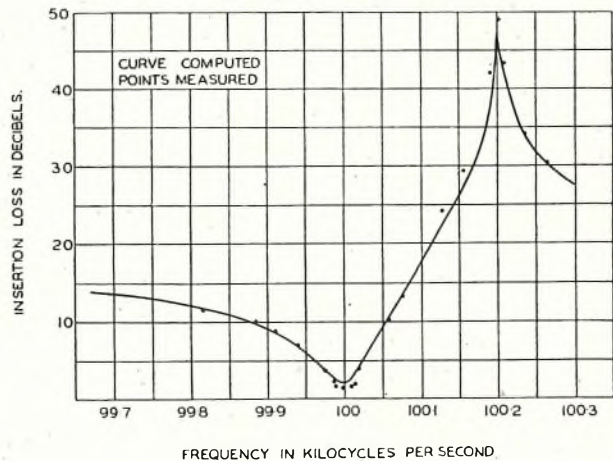

FIG. 6.—INSERTION LOSS CHARACTERISTIC OF LADDER FILTER SECTION.

Acknowledgments.

The author has pleasure in acknowledging his indebtedness to Mr. H. J. S. Mason for obtaining the measured characteristics shown in Figs. 4 to 6, and to Miss J. M. Elliott for computing data given in Figs. 2 and 6.

Temperature Control for Oscillators of Stable Frequency

C. F. BOOTH, A.M.I.E.E., and
F. J. M. LAVER, Grad.I.E.E.

U.D.C. 621.396.611.21

Details are given of thermo-sensitive devices and the associated control circuits used to maintain ovens, containing the components of the oscillating circuits of high stability oscillators, within very small temperature limits. This is followed by particulars of monitoring and alarm arrangements and some typical installations.

Introduction.

THE evolution of the modern crystal oscillator, with its stabilised maintaining circuit and closely regulated thermostat, has been a process in which the effects of temperature changes on the crystal, and of variations in the maintaining circuit have alternately been the factors which limited the frequency stability. The early types of oscillator used crystals with frequency-temperature coefficients as high as 90 parts in 10^6 per 1°C , and a close temperature control was necessary to reduce frequency changes due to variations of crystal temperature to the same order of magnitude as those due to random changes in the maintaining circuit. Then, the development and application of crystals, with frequency-temperature coefficients as low as 1×10^{-7} per 1°C , temporarily diverted attention from the improvement of thermostat design to the maintaining circuit. Recently, however, an increasing need for the highest possible degree of frequency stability has renewed the demand for an electric thermostat capable of controlling the temperature of a quartz crystal to within $\pm 0.001^\circ\text{C}$ over short periods, so that the effect of temperature changes on the crystal oscillation frequency shall not exceed $\pm 1 \times 10^{-10}$. Similar considerations affect the design of stable oscillators which use inductors and capacitors as the frequency determining elements, for of all the factors which affect the frequency stability of a master oscillator, the effects of temperature changes on the components of the oscillatory circuit are the greatest, and the most difficult to reduce by compensation. It is, therefore, necessary to control the temperature of the components of the frequency determining circuit if high frequency stability is required. The thermostats used for this purpose are often simpler than those of high grade crystal oscillators, since much larger frequency variations can usually be tolerated. Temperature control is applied to crystal and master oscillators, not to maintain a constant temperature as an end in itself, but as one of many precautions taken to improve the frequency stability. It is essential that the temperature shall be controlled accurately over short periods, but moderate temperature drifts of predictable order occurring over a long period are less important, since their effect upon the frequency of the oscillator forms only a part of the inevitable frequency drift due to other ageing processes.

Some Principles of Thermostat Design.

Electric thermostats may be either of the type in which the heat supply is varied continuously, or of the relay type, in which the heat supply changes abruptly at a particular temperature. The former type of thermostat is rarely used, so that the subsequent discussion refers primarily to the commoner

relay type. An ideal thermostat would comprise an enclosure of perfectly uniform and constant temperature. In practice several factors prevent the full realisation of this ideal, the most important of which is the cyclic temperature variation consequent upon the operation of the controlling device.

This operation is considered below for a typical electrical thermostat, represented schematically in Fig. 1. A thermo-sensitive device, which responds

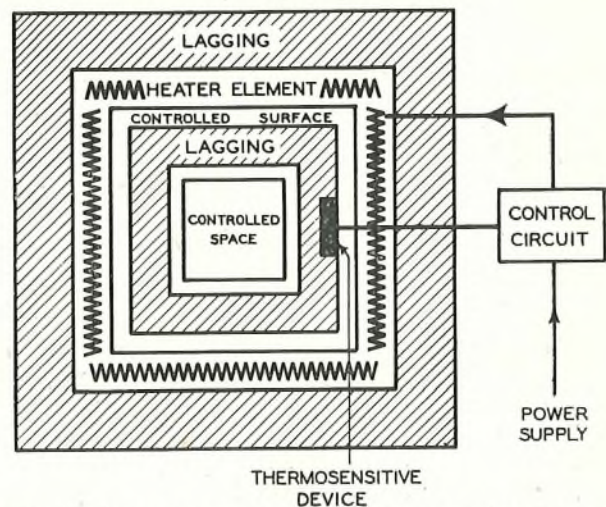

FIG. 1.—SCHEMATIC DIAGRAM OF AN ELECTRIC THERMOSTAT.

to slight changes in temperature, acts upon a control circuit which regulates the power supplied to the heater element, reducing the supply when its temperature exceeds the control value, and vice versa. Such a control combination always exhibits "backlash," that is, the temperature at which the heat supply is reduced is higher than that at which it is increased; half the difference between these temperatures is called the "operating differential" of the thermostat. In operation the temperature of the sensitive device varies cyclically by an amount approximately equal to the operating differential. A temperature constancy greater than that represented by the operating differential may be obtained by interposing some form of thermal attenuation or lagging between the sensitive device and the controlled space. The improvement so obtained depends upon the type of lagging material and upon the period of the heating cycle. The best materials are those which combine low thermal conductivity with high density and high specific heat, such as balsa wood, celotex, felt, cotton or glass wool and similar materials. The lagging is most effective when arranged in the form of layers of one of the above materials separated by layers of conducting material to equalise the heat distribution. This method of reducing the cyclic

temperature variation has the disadvantage that, due to the low conductivity and high heat capacity of the lagging, a long interval must elapse after switching on the heating supplies before thermal equilibrium is reached. The degree of attenuation is also greatest for short heat cycles, but the desirability of attempting to reduce the period of the heat cycle depends upon the type of control circuit. If mechanical devices such as contactors are used, a reduction in period increases the frequency of operation, so increasing wear, and a compromise has to be found between the degree of attenuation of the temperature cycle and reliability. With all-electric control circuits, however, no such limitations exist, so that the period may be reduced as much as possible. An approximate analysis of the factors which affect the period of the heating cycle is given in Appendix I, where it is shown that the period may be reduced by :

- (i) Use of a thermo-sensitive device and control circuit with a low operating differential.
- (ii) Close association of the heater and thermo-sensitive elements in contact with a medium of high conductivity combined with low density and low specific heat.
- (iii) Use of as high a heater power as possible.

It is not sufficient to obtain a fine control of the temperature at a single point, the walls which enclose the controlled space must be a close approach to an isothermal surface; otherwise, the temperature at different points inside the controlled space will be affected by different amounts by variations in the ambient temperature. For this reason the controlled space or oven, as it is usually called, is made as a thick-walled casting of metal of high conductivity, such as aluminium, copper or brass, and is well lagged to isolate it from the effect of ambient temperature changes. The lagging also serves to reduce the mean power which must be supplied to the heaters to maintain the temperature of the oven above that of its surroundings. The power necessary for this purpose may be estimated, to a fair approximation, from a knowledge of the conductivity, thickness and area of lagging materials, and is readily expressed by a formula of the type

$$P = \omega \frac{A\theta}{t}$$

- where P = mean heater power, watts.
 A = area of oven outer surface, sq. ins.
 θ = difference between oven and ambient temperatures, °C.
 t = lagging thickness, inches.
 ω = a constant for a particular lagging material.

The value of ω for three common lagging materials is shown below.

Celotex	Balsa Wood	Hair Felt
0.0018	0.001	0.0009

There are advantages to be gained by supplying a part of the mean heating power continuously, and by using the control circuit to regulate a part only of the full power. Such a scheme enables the load on the control circuit to be considerably reduced; and

reduces also the maximum temperature obtained by the oven under fault conditions which cause the heat supply to remain on, since the peak heater power is reduced. The extent to which permanent heat may be used, however, depends upon the range of ambient temperature over which the thermostat is required to operate. The greater this range the less the proportion of permanent heat which can be employed. Thus consider, for example, an oven controlled at 50°C, which requires a mean heater power of 9 watts when the ambient temperature is 20°C. Let this power be supplied as :

- (i) 18 watts controlled heat. 0 watts permanent heat.
 - (a) Ambient temperature 20°C. The controlled heating power will be "on" and "off" for equal periods.
 - (b) Lowest ambient temperature for which oven can be maintained at 50°C, is when the controlled heat is permanently "on," and is given by

$$50 - (50 - 20) \frac{18}{9} = -10^\circ\text{C}$$
 - (c) Highest ambient temperature for which the oven can be controlled at 50°C, is when the controlled heat is permanently "off," and is, clearly, 50°C.

To summarise :—

Control circuit load	.. 18 watts
Working range of ambient temperature	.. -10°C to 50°C

- (ii) 6 watts controlled heat. 6 watts permanent heat.
 - (a) Ambient temperature 20°C. The controlled heat will be "on" and "off" for equal periods.
 - (b) Lowest working ambient temperature.

$$= 50 - (50 - 20) \frac{12}{9} = +10^\circ\text{C}$$
 - (c) Highest working ambient temperature

$$= 50 - (50 - 20) \frac{6}{9} = 30^\circ\text{C}$$

To summarise :—

Control circuit load	.. 6 watts
Working range of ambient temperature	.. 10°C to 30°C

The price which has to be paid for the reduced working load on the control circuit is clearly demonstrated in this example, and is worked out in general terms in Appendix II. Two stages of temperature control are occasionally used to permit the use of permanent heat, and also to reduce the effect of ambient temperature variations on the temperature stability, due to the departure of the oven walls from a truly isothermal surface.

Thermo-Sensitive Devices and Control Circuits.

Bimetallic Strip Controls.—These depend upon the differential expansion of two dissimilar metals welded together to form a strip or helix, which bends or twists when heated. A simple type consists of a short cantilever of bimetallic strip the bending of which opens a pair of contacts when its temperature reaches a predetermined value. The whole device is mounted

inside an evacuated glass envelope. The control circuit is simple, the contacts being connected in series with the oven heaters as shown in Fig. 2(a). The operating differential of such a device is about $\pm 0.5^\circ\text{C}$, and the long period temperature variations

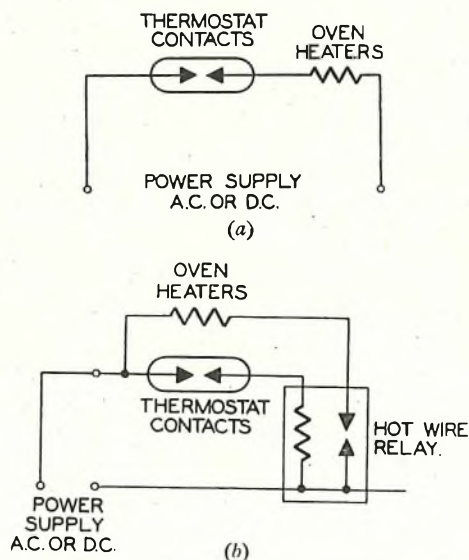

FIG. 2.—CONTROL CIRCUITS FOR BIMETALLIC THERMOSTAT.

are of the same order. A more sensitive type comprises a helix of bimetallic strip rigidly fixed at one end; the other end is fastened to a rod carrying a contact arm which engages with a fixed contact. In some designs the position of the fixed contact may be preset by an adjusting cam, so that the control temperature may be varied by a known amount over a range of some 20°C . Small permanent magnets are sometimes fixed to the contact arm and fixed contact, to ensure a rapid make and break, and to prevent chattering. The operating differential of this type may be as low as $\pm 0.1^\circ\text{C}$. The control circuit is shown in Fig. 2(b). A hot wire relay is used to reduce the contact current to 50 mA and to provide a non-inductive load. Thermostats of the bimetallic type are cheap and simple, and are suitable for use whenever a relatively crude control of temperature is all that is required. Their disadvantages are the wide manufacturing tolerances on the operating temperature of the sealed type, and an occasional tendency to fail in service by the contacts sticking open or closed, or by burning of the contacts, unless the control circuit of Fig. 2(b) is used to reduce the contact loading.

Contact Thermometer Control.—Mercury-in-glass thermometers with two or more sealed-in contacts can be used to control the temperature of an oven by the circuit shown in Fig. 3. When the temperature rises the thermometer mercury column makes a contact and applies negative bias to the valve, causing the anode circuit relay to release and disconnect the oven heat supply, and vice versa. High resistances should always be included in the thermometer circuit to limit the current carried by thermometer contacts to a value less than $5\mu\text{A}$, otherwise trouble may arise due to fouling the mercury. The anode relay should

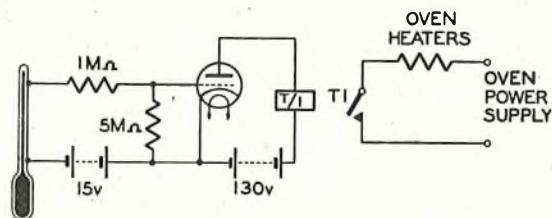

FIG. 3.—CONTROL CIRCUIT FOR CONTACT THERMOMETER.

be either of the type with a mercury switch, or with suitably heavy contacts, to handle the relatively large heater currents. The thermometers may have a sensitivity as high as 1 in. per 1°C , although 1 in. per 5°C is more commonly used, and the operating differential is of the order of $\pm 0.03^\circ\text{C}$. Thermostats of this type have given long periods of reliable service, but occasionally trouble is experienced due to capillarity and similar effects in the thermometer. The main disadvantages of this type of control are the fragility of the contact thermometer, and the effect of pressure and secular changes on the large bulbs used to obtain high sensitivity.

Two types of contact thermometer are used to control ovens which have to operate at a number of temperatures. The first type has a number of contacts provided at temperatures such as 35°C , 40°C , 45°C , 50°C , 55°C . The second type has an adjustment provided by a movable platinum contact wire fixed to a small iron rod so that the control temperature can be varied by a permanent magnet over the range 0°C to 70°C .

Resistance Bridge Control.—There are many temperature control circuits which use D.C. or A.C. bridges arranged as resistance thermometers, but the description which follows is confined to a typical example which uses a 50 c/s A.C. bridge. A full account of the design principles, and an example of this type of thermostat has been given by L. B. Turner.¹

The control circuit is shown schematically in Fig. 4, in which the two windings A and B on the

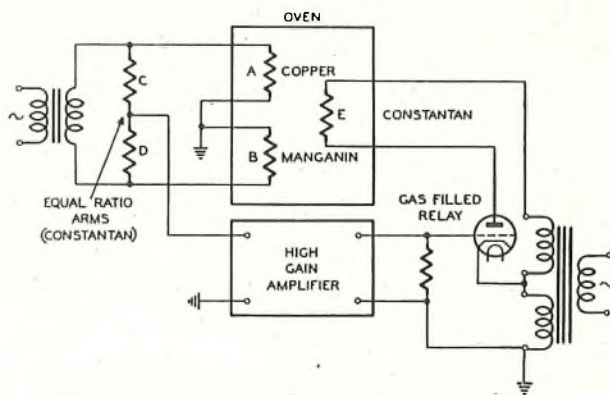

FIG. 4.—50 c/s BRIDGE CONTROL CIRCUIT.

controlled surface or oven, form with C and D a bridge. A is a copper winding of resistance-temperature coefficient 42×10^{-4} per 1°C , and B a manganin winding of resistance-temperature coefficient

¹I.E.E.J., Vol. 81, p. 399.

$<5 \times 10^{-5}$ per 1°C . The oven is wound also with a constantan heater winding E, and all three windings are in intimate thermal contact with each other and with the metallic oven surface. C and D are equal resistors of constantan wound together on a thick walled brass tube, so that the ratio of their resistances remains constant. All the windings A, B, C, D and E are wound non-inductively. The resistance of the copper winding A is chosen so that it attains the bridge balance value at the required control temperature. The bridge circuit is supplied with 50 c/s A.C., and the out-of-balance voltage is amplified and applied to the control grid of a gas-filled relay. The phase of the bridge out-of-balance voltage reverses as the resistance of A passes from a value below the balance value to one above it, and this phase reversal acts on the gas-filled relay to render it conducting when the temperature of A is below the control value and non-conducting when above it. The oven heater winding E is connected in the relay anode circuit, and a suitable alternating bias voltage is applied to the cathode, to prevent the passage of current when the bridge unbalance voltage is zero. The power dissipated in the bridge windings A and B forms the permanent heat supply, and the anode current of the gas-filled relay supplies the controlled heating power to winding E.

The operating differential of such a thermostat may be made very low by use of a suitable amplifier for the out-of-balance voltage. A voltage gain of the order of 250,000 is sufficient to achieve a differential of $\pm 0.0005^\circ\text{C}$, which corresponds to a change in the resistance of the copper winding of about $\pm 2 \times 10^{-6}$. This extremely low operating differential enables a high degree of temperature stability to be attained without the use of lagging material between the control winding and the controlled space. Consequent upon the low differential and the intimate association of windings A and E, the period of the heating cycle is of the order of a few seconds only, so that the temperature wave is severely attenuated as it passes into the interior of the oven. The long period stability of the temperature control depends principally upon the stability of the resistances in the bridge circuit. If due care is observed when winding these resistors a stability of $\pm 2 \times 10^{-5}$ should be realised over a period of years, which corresponds approximately to a temperature variation of $\pm 0.0055^\circ\text{C}$. The fact that an oven of this type does not need lagging between the controlled surface and the interior enables it rapidly to attain a thermal equilibrium; thus a typical oven may be brought from room temperature to control at 50°C within 20 minutes. This facility for quick heating is an advantage when restoring an oscillator to service after a fault; and, in conjunction with the fact that the oven control temperature may readily be adjusted by large or small amounts by shunting one of the bridge arms, makes this type of oven very suitable for measurements of crystal frequency-temperature coefficients.

Monitoring and Alarm Circuits.

Thermostats used to stabilise the frequency of oscillators are usually equipped with a more or less elaborate system of monitoring and alarm circuits, which enables the performance of the thermostat to be checked, and its failure to be indicated. The degree of elaboration of these auxiliary circuits depends upon the magnitude of the effect of a failure, and upon the consequences of the resulting frequency changes. Thus the simple thermostats used on carrier generation equipment need only have simple monitoring and alarm facilities; whereas the thermostats used with high-grade frequency standards are relatively complex.

Bimetallic Alarm Circuits.—A circuit which uses two thermostats connected in series is shown in Fig. 5. The 50°C thermostat normally controls the

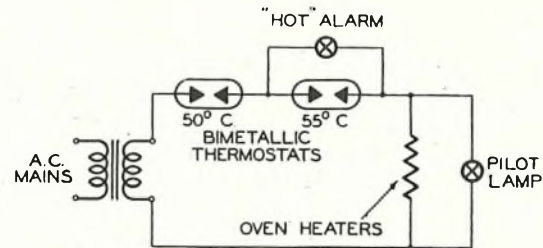

FIG. 5.—MONITORING AND ALARM CIRCUIT FOR SIMPLE BIMETALLIC THERMOSTAT.

heat supply, and its operating cycle is indicated by the pilot lamp. If the oven overheats, due to failure of the normal control, then, when its temperature reaches 55°C it is maintained at this value by the second thermostat, and the alternate flashing of the red alarm lamp and white pilot lamp indicates that a fault has occurred.

Contact Thermometer Alarms.—An auxiliary thermometer with contacts corresponding to temperatures above and below the working temperature is used for alarm purposes. Many circuits have been devised for use with such thermometers, a typical one of which is described. In this system, the temperature control circuit is duplicated throughout and the auxiliary thermometer is used to change the control from the working to the standby circuit if the oven temperature varies by more than $\pm 1^\circ\text{C}$ from its working value

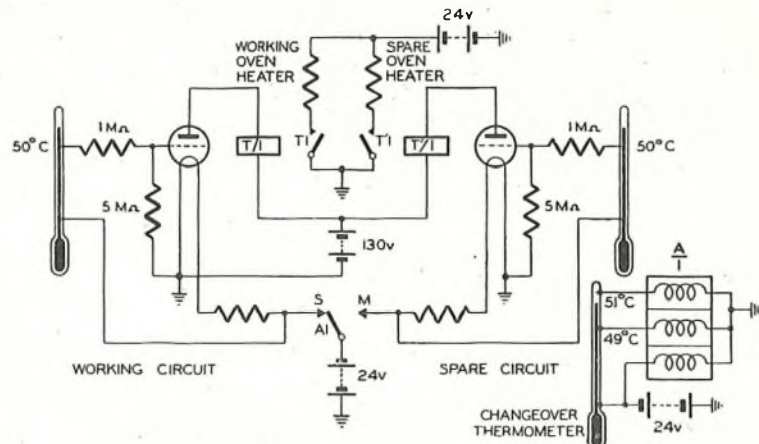

FIG. 6.—MONITORING AND ALARM CIRCUIT FOR CONTACT THERMOMETER.

The circuit, which is shown in Fig. 6, uses a balanced relay circuit operated by the auxiliary thermometer. The temperature control apparatus is completely duplicated, and the change of control temperature due to a changeover is less than 0.1°C .

Temperature Monitoring.—In the majority of oscillator applications, hot and cold alarm lamps operating at preset temperatures are the only means of temperature monitoring. When a more accurate indication is required a mercury thermometer usually suffices and provides a measurement accuracy of some $\pm 0.1^{\circ}\text{C}$. It is rarely necessary to measure accurately the absolute temperature of the thermostat; it is more important to detect small changes in that temperature, and resistance bridge thermometers may be used to measure such changes to within $\pm 0.001^{\circ}\text{C}$. Occasionally, as in the testing of a thermostat for a frequency standard, it is desirable to measure the temperature changes which will be experienced during the heating cycle by the standard crystal when mounted in the thermostat. A Y-cut crystal, of high temperature coefficient (up to $90 \times 10^{-6}/1^{\circ}\text{C}$) may be used for the measurement; it is caused to oscillate and its frequency is compared with a frequency standard. The observed frequency changes are correlated with the oven heating cycle so that the equivalent temperature changes may be estimated. The accuracy of frequency comparison, over a period of an hour or so, may be within $\pm 1 \times 10^{-8}$, corresponding to a measurement of temperature change to within $\pm 0.0002^{\circ}\text{C}$.

Some Typical Installations.

Constant Temperature Room.—A part of the Post Office primary frequency standard is housed in a cellar, the temperature of which is maintained at $25^{\circ}\text{C} \pm 0.5^{\circ}\text{C}$ by contact thermometer control.

The room, being underground is thus subject to reduced variations of ambient temperature, and is lagged on all sides with celotex to reduce the heat loss. The heating power is supplied by carbon filament lamps, and near one of these the control thermometer is placed. A fan causes a current of air to pass over the heater lamp on to the thermometer bulb. By adjustment of the relative positions of the lamp, thermometer and fan the period of the heating cycle can be varied between about 20 seconds and several hours. A period of about 5 minutes was selected for use as it gave a good compromise between excessive cyclic temperature change and unnecessary wear on the control switches. The control circuit comprises a simple valve operated relay; the valve anode circuit is supplied directly with 50 c/s A.C.

Master Oscillator Oven.—The tuned circuit components of a master oscillator are contained in a tinfoil box, the temperature of which is controlled by a bimetallic thermostat. The oven comprises two tinfoil boxes separated by a layer of celotex $\frac{3}{4}$ in. thick. The heater elements are woven asbestos resistance mats, secured in close contact with the outer wall of the inner box, and insulated from it by sheets of mica 10 mils thick. The control circuit is that of Fig. 2(b). The cyclic temperature variation of the oven is about $\pm 0.6^{\circ}\text{C}$, with a heat cycle period of 15 minutes, and the oven heats to its control temperature of 50°C in 50 minutes from switching on the power supplies.

Thermostats for Standard Tuning Forks.—The standard 1,000 c/s tuning forks, which form part of the Post Office frequency standard, are mounted in large cast bronze vessels of cylindrical shape. The outer surface of each cylinder is wound with heater windings, and its temperature is controlled by a contact thermometer, the bulb of which is

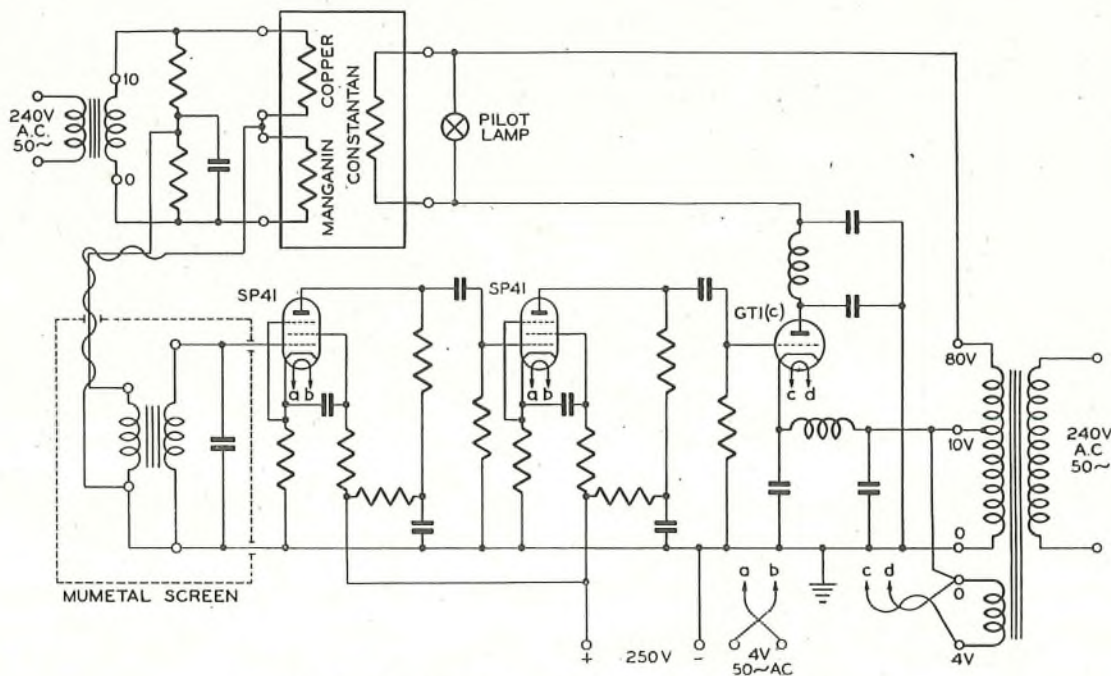

FIG. 7.—CONTROL CIRCUIT FOR BRIDGE THERMOSTAT.

placed in a hole drilled in the wall of the cylinder. The cylinder is contained in an aluminium box lagged with celotex. The control circuit is that shown in Fig. 6. The frequency-temperature coefficient of a standard fork is approximately $+6 \times 10^{-6}$ per 1°C , and since the observed cyclic frequency changes are less than 2×10^{-8} the fork temperature is presumed not to vary by more than 0.003°C . The operating differential of the control thermometer is about $\pm 0.05^\circ\text{C}$, and the period of the heating cycle 5 minutes.

Bridge Thermostat for a Standard Crystal Oscillator.—The oven consists of a heavy cast brass cylinder, having walls $\frac{1}{2}$ in. thick, with copper, constantan and manganin windings on its outer surface. The copper and manganin windings are connected in a 50 c/s A.C. bridge circuit which controls the supply of heating power to the constantan winding. The connections of the control circuit are shown in Fig. 7. The disposition of the windings on the cylinder is shown in Fig. 8; the close thermal association of the

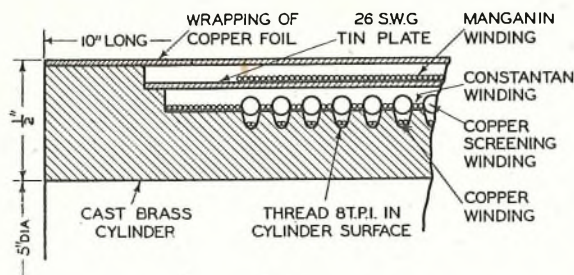

FIG. 8.—CROSS SECTION OF WINDINGS OF BRIDGE THERMOSTAT.

constantan and copper windings, coupled with low operating differential of the amplifier-thyratron combination gives a close control of temperature. The thermostat normally operates with a cyclic temperature change of $\pm 0.0005^\circ\text{C}$ on the copper winding, and with a heating cycle period of about 5 seconds. Fig. 9 shows graphically the results of

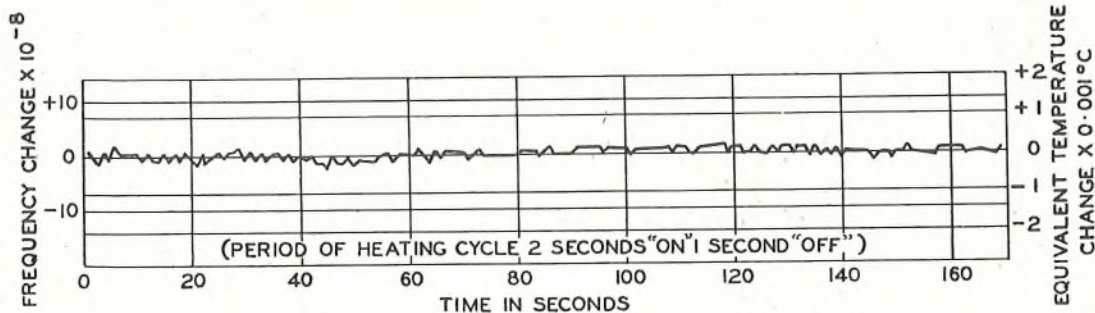

FIG. 9.—FREQUENCY OF Y-CUT CRYSTAL IN BRIDGE THERMOSTAT.

part of a test made with a Y-cut crystal, of measured frequency-temperature coefficient 72×10^{-6} per 1°C , in this oven. The portion of the test shown extends over 56 heating cycles, and it is estimated that any cyclic frequency changes are less than $\pm 2 \times 10^{-8}$, i.e., the cyclic temperature changes of the crystal were less than $\pm 0.0003^\circ\text{C}$. The cylinder is mounted inside a box lagged with balsa wood to reduce the heat loss. The control temperature is 50°C , and the

oven contains a quartz crystal frequency standard. It is estimated that the cyclic temperature variation of the crystal is less than $\pm 0.0005^\circ\text{C}$; the frequency-temperature coefficient of the crystal is less than $\pm 2 \times 10^{-7}$ per 1°C , so that the effect of temperature changes on the short period stability of the oscillator should not exceed $\pm 1 \times 10^{-10}$.

Simple Bridge Thermostat for Crystal Drive Circuits.

—The oven consists of a spun copper can, with nickel and constantan windings wound directly on its outer cylindrical surface; "pancake" windings are also fixed in contact with the end surfaces to reduce the effect of ambient temperature changes. The nickel and one of the two constantan windings are connected in a 50 c/s bridge circuit, which controls the supply of heat to the second constantan winding. The control circuit is similar to that of Fig. 7 except that the second stage of amplification is omitted. The oven is mounted inside a tin-plate box, the intervening space being lagged with cotton wool. The operating differential of a model was $\pm 0.025^\circ\text{C}$, the period of the cycle less than 2 seconds, and the oven came to its control temperature (50°C) from room temperature in 30 minutes.

Some simple modifications to the amplifier and bridge circuits are being investigated, and are expected to reduce the cyclic temperature variation to less than $\pm 0.01^\circ\text{C}$. Thus with the rapid heating cycle obtained the cyclic temperature change of the thermostat contents should not exceed $\pm 0.001^\circ\text{C}$. This type of thermostat is being developed as a cheap and reliable alternative to contact thermometer control.

APPENDIX I

Approximate Analysis of Electric Thermostat Operation.

Consider a thermostat with the following properties:

- (i) Operating differential $\pm \delta \theta^\circ\text{C}$.
- (ii) Rate of increase of temperature of heater element when "on" $h^\circ\text{C}/\text{sec}$.

- (iii) Sensitive device separated from heater element by x cms. of material of diffusivity σ , where

$$\sigma = \frac{K}{\rho C}$$

(K = conductivity, C = specific heat, ρ = density.)

Since it is not intended to derive an exact formula for the calculation of the period, but only to discover

which factors determine its magnitude, the following simplifying assumptions will be made:—

- (i) Thermostat of relay type, with equal periods of "heat on" and "heat off"—this is the normal adjustment.
- (ii) Instantaneous operation of control circuit in response to the signals from the sensitive device—in practice the operating delay is always small compared with the period.

The temperature of the heater element will rise at the rate of $h^\circ\text{C}$ per sec. when the power is switched on, and fall at the same rate when the power is off. Since the magnitude of the temperature change is small these changes may be regarded as linear, so that the temperature of the heater element will vary by $\pm \delta\phi^\circ\text{C}$ according to a triangular waveform, as

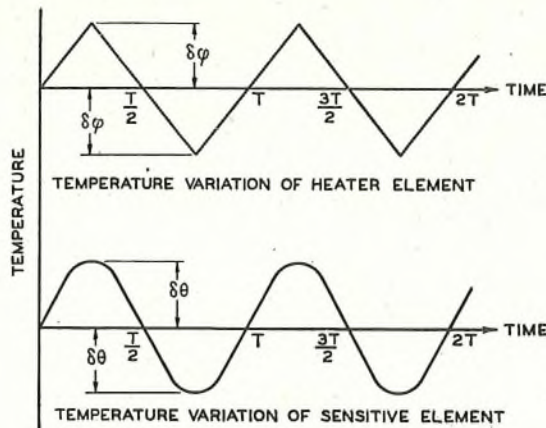

FIG. 10.—CYCLIC TEMPERATURE CHANGES IN ELECTRIC THERMOSTAT.

shown in Fig. 10. It is clear that the amplitude of this wave is given by

$$\delta\phi = h \times \frac{T}{4} \dots\dots\dots(1)$$

The variation may be analysed into the sinusoidal components shown below

$$\frac{8\delta\phi}{\pi^2} \left[\sin \frac{2\pi t}{T} + \frac{\sin \frac{6\pi t}{T}}{3^2} + \frac{\sin \frac{10\pi t}{T}}{5^2} + \dots \right]$$

This wave consists principally of the fundamental component of amplitude $8\delta\phi/\pi^2$ and without excessive error the temperature variation of the sensitive element may be assumed to be due to this component only, as shown in Fig. 10. The attenuation of the fundamental component of the temperature wave between the heater and sensitive elements is

equal to $e^{-x\sqrt{\frac{\pi}{T\sigma}}}$ so that the amplitude of the temperature cycle at the sensitive device is given by

$$\delta\theta = \frac{8\delta\phi}{\pi^2} \cdot e^{-x\sqrt{\frac{\pi}{T\sigma}}} \dots\dots\dots(2)$$

Substitute the value of ϕ from (1) into equation (2) whence

$$\delta\theta = \frac{8}{\pi^2} \left(\frac{hT}{4} \right) e^{-x\sqrt{\frac{\pi}{T\sigma}}} \dots\dots\dots(3)$$

$$\text{or } T = \frac{\pi^2 \delta\theta e^{x\sqrt{\frac{\pi}{T\sigma}}}}{2h} \dots\dots\dots(4)$$

Thus T may be reduced by reducing $\delta\theta$ or x, or by increasing σ or h.

APPENDIX II

The Effect of Permanent Heat in Reducing the Working Range of Ambient Temperature.

Consider for example, a thermostat operating at a temperature θ_T . Let the ambient temperature be θ_A , and let the mean heater power be given by $P = W(\theta_T - \theta_A)$, where W is a constant. Suppose that the mean heater power is supplied as p watts of permanent, and c watts of controlled heat.

An equal "on" and "off" heat supply cycle will be obtained when θ_A satisfies the equation

$$p + \frac{1}{2}c = W(\theta_T - \theta_A)$$

$$\text{or } \theta_A = \theta_T - (p + \frac{1}{2}c)/W.$$

If θ_A increases it will reach a value θ_A^{max} when the controlled heat is always off, after which the thermostat temperature will increase at the same rate as the ambient. θ_A^{max} is given by

$$p = W(\theta_T - \theta_A^{\text{max}})$$

$$\text{or } \theta_A^{\text{max}} = \theta_T - \frac{p}{W}$$

Similarly, if θ_A falls a value θ_A^{min} will be reached at which the controlled heat will be always on; θ_A^{min} is given by:—

$$p + c = W(\theta_T - \theta_A^{\text{min}})$$

$$\text{or } \theta_A^{\text{min}} = \theta_T - \left(\frac{p+c}{W} \right)$$

Therefore, the range of ambient temperature over which the thermostat will operate satisfactorily is

$$\theta_A^{\text{max}} - \theta_A^{\text{min}} = \left(\theta_T - \frac{p}{W} \right) - \left(\theta_T - \frac{p+c}{W} \right) = \frac{c}{W}$$

and it will, obviously, be reduced if c is reduced, so that for the maximum use of permanent heat the ambient temperature variations must be low.

BIBLIOGRAPHY

1. Thermostat design for Frequency Standards. Marrison. Proc. I.R.E. Vol. 16, July, 1928.
2. Temperature Control for Frequency Standards. Clapp. Proc. I.R.E. Vol. 18, December, 1930.
3. Crystal Oscillators for Radio Transmitters. Part IV. Booth and Dixon, J.I.E.E., Vol. 77, 1935.
4. Constant Temperature. A Study of Principles in Electric Thermostat Design. Turner, J.I.E.E., Vol. 81, 1937.
5. Factors affecting Thermostat Design. Jepson, I.E.E. Stud. Journal, Vol. 11, March, 1941.

Modern Materials in Telecommunications

U.D.C. 537.311.3:621.314.63 621.383 W. G. RADLEY, Ph.D., M.I.E.E. C. E. RICHARDS, F.I.C.
E. A. SPEIGHT, Ph.D., D.I.C., A.R.C.S. E. V. WALKER, B.Sc., A.R.S.M.

Part Vlb.—Contact Rectifiers and Photo-electric Cells using Semi-Conductors

This article describes the manufacture and properties of metal rectifiers and some of the interesting and useful photoelectric phenomena observable in semiconductors. A short account of a theory of the operation of metal rectifiers is given based on the general theory of semiconductors outlined in the previous article.

Introduction.

THE previous article described the properties of semiconductors and gave a short account of the present-day theory of these interesting materials. The applications mentioned in that article were mainly those which exploited the possibility of constructing resistors whose resistance varies with change of applied voltage or temperature. In the present article attention is devoted to the part played by semiconductors in the operation of the metal rectifier and to the photoelectric properties of certain types of semiconductor.

METAL RECTIFIERS.

Few electrical engineers have not, in one way or another, utilised the valuable properties of metal rectifiers. In the field of telecommunications alone a bewildering variety of applications for these devices has appeared in recent years and many such have already been described in this JOURNAL. For these reasons it would be superfluous to discuss the applications of metal rectifiers in any detail. It is, therefore, proposed to consider only a few interesting aspects of their history, manufacture and theory of operation.

As long ago as 1874 Braun announced the discovery that the conductivity of certain metallic sulphides appeared to depend on the direction of current flow. Nine years later Fritts commented on the strongly asymmetric conductivity of a particular selenium photoelectric cell. Subsequently such asymmetry was found to be a characteristic of many contacts between dissimilar substances but little use was made of these discoveries until the invention of the crystal detector in the early stages of radio. A further period of stagnation followed until 1926, when Grondahl announced that a plate of copper, superficially oxidised to cuprous oxide, could be used for the rectification of quite large alternating currents. Interest in the whole field of contact rectification grew rapidly and the study of copper oxide rectifiers was pursued intensively both in this country and in America. Many other rectifying combinations were examined but the only one to rival the copper oxide type was the selenium rectifier which was favoured in Germany. Nowadays it is recognised that both have their separate spheres of particular usefulness and both are manufactured on a large scale in this country.

Manufacture.

It is interesting to note that the modern rectifiers are made by processes which are fundamentally the same as those used by Grondahl and Fritts respectively. The high efficiency now attained has been achieved mainly by painstaking attention to detail and close control of the conditions at all stages in the process of manufacture.

For the copper oxide type plates, rings or discs about 1 mm. thick, of highly refined copper are heated in air to a temperature just above 1,000°C until a layer of cuprous oxide about 0.1 mm. thick has formed on the surface. The crystal structure of the oxide layer is modified by annealing processes, after which the blanks are cooled. During these treatments a thin film of black cupric oxide (CuO) forms over the underlying bright red cuprous oxide (Cu₂O). An acid treatment is then carried out to remove the cupric oxide and the cuprous oxide surface is painted with an aqueous suspension of colloidal graphite and dried. Finally a metal electrode—the “counter-electrode”—is applied by spraying, sputtering or simply pressing a soft metal plate (e.g. lead) on to the graphite surface.

Selenium rectifiers can be formed on nearly any type of metal surface, but that most commonly employed is nickel-plated steel. Black, so-called “vitreous,” selenium is applied to the base and, by heating in a hot press at about 130°C, is formed into a homogeneous, uniform layer about 0.1 mm. thick. The temperature is raised to 180–215°C, when the selenium is converted into the grey, crystalline form known as β or “metallic” selenium. A low-melting-point alloy is now sprayed on to the selenium layer to act as a counter electrode. It is found that the composition of this alloy greatly affects the efficiency of the rectifier, as also does that of the selenium. Chemically pure selenium is much less efficient than selenium to which a minute proportion of a halogen element has been added. The manufacture of the rectifier is completed by applying an electrical forming process which considerably increases the reverse resistance.

Cross-sections of typical rectifier elements would thus appear somewhat like the diagrams in Fig. 1, in

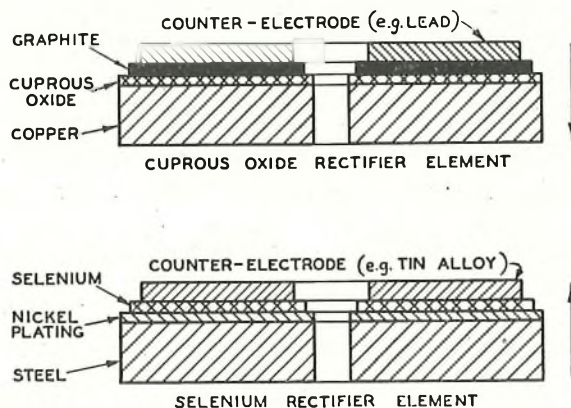

FIG. 1.—CROSS-SECTIONS OF RECTIFIER ELEMENTS
(Arrows mark conventional direction of easy current flow.)

which, however, the thicknesses of the layers have been exaggerated for clarity.

Properties.

The most important property of a rectifier is, of course, its asymmetric conductivity. If a given voltage is applied to either type of rectifier so as to produce a current flowing in the direction indicated by an arrow in Fig. 1, this current will be greater than if the same voltage is applied in the opposite sense. The low resistance direction is usually termed the "forward" direction, and the other the "reverse" direction.

In addition to changing with the sense of the applied voltage, the resistance with either direction of applied voltage also varies with the magnitude of this voltage in a manner recalling the behaviour of the first type of non-linear resistors discussed in Part VIa of this series. A typical resistance-voltage curve for a cuprous oxide rectifier is shown in Fig. 2(a), from which it will be noted that the resistance passes through a maximum value at a point corresponding to the application of a small reverse (negative) voltage. The corresponding curve for a selenium rectifier is generally similar except that, for most commercial types, the resistance maximum occurs much closer to zero voltage. The manner in which the current varies with the voltage is shown in Fig. 2(b). In this diagram the same voltage scale is used for both directions, but the reverse current scale is about 100 times that of the forward current scale.

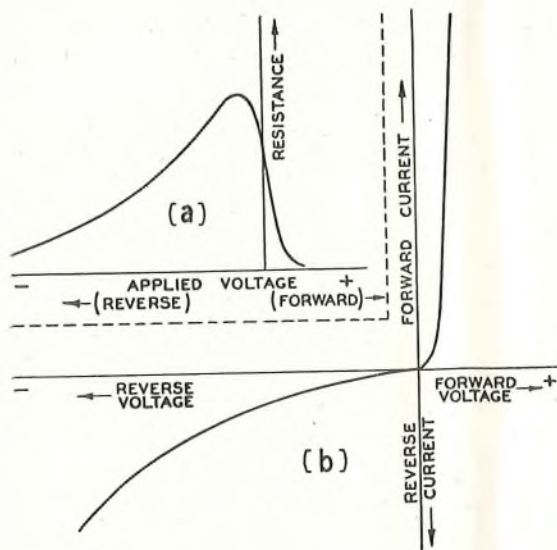

FIG. 2.—CHARACTERISTICS OF METAL RECTIFIERS.

The effect of temperature is of great importance, especially in heavy current work such as battery charging or electroplating operations. For both types of rectifier a rise in temperature reduces both the forward and the reverse resistances. (The variation is practically linear in selenium rectifiers.) It is therefore important to remember that in practice the working characteristics, and hence the losses, may differ quite appreciably from the "instantaneous" characteristics taken by the application of the testing voltage for the minimum time needed to take readings.

The manner in which the losses vary with the temperature of the rectifier is shown in Fig. 3. It will be seen that where high ambient temperatures prevail selenium rectifiers may afford a somewhat greater margin of safety than the cuprous oxide type. With both types of rectifier it is quite common to provide means of forced draught or oil cooling for the larger sizes.

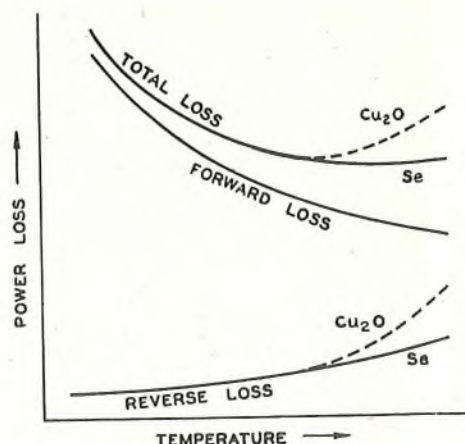

FIG. 3.—POWER LOSS—TEMPERATURE CURVES OF RECTIFIERS.

Continuous working at high temperatures in addition to reducing efficiency by increasing power loss also accelerates an irreversible ageing phenomenon which causes the forward resistance to increase and the reverse resistance to fall. This effect can, if unchecked, lead to progressive increase in both temperature and losses, with consequent rapid destruction of the rectifier.

Apart from these effects the reverse characteristics of a rectifier may change quite considerably under the application of a steady reverse voltage even if the temperature is maintained constant. The phenomenon is known as "creep," "positive" creep implying that the current increases with time and "negative" creep that it falls. In cuprous oxide rectifiers the creep is usually positive and is reversible if the rectifier is allowed to rest. In selenium rectifiers the creep may be positive or negative according to the past history of the specimen, and is not normally completely reversible. In both instances the creep in the forward direction is very small.

When rectifiers are used in speech or radio frequency circuits allowance must be made for the capacitance which is of the order of $0.02 \mu\text{F}$ per cm^2 per disc in both types. In general, a cuprous oxide rectifier having a given characteristic would contain more discs in series than an equivalent selenium rectifier, and its overall capacitance would therefore be lower.

Location of the Asymmetric Contact.

An adequate theory of the operation of the metal rectifier is obviously highly desirable whether from the purely scientific point of view or as a means to the fullest exploitation of the potentialities of an already valuable device. The particular theory now to be described is far from complete, but it can at least be said that the main principles of rectification now

appear to be well established and that there are definite indications of the directions in which final success may be sought in matters of detail.

For simplicity it is proposed to confine the discussion to cuprous oxide rectifiers and then to indicate how the theory can be applied to selenium rectifiers. Since the whole problem can be defined as the search for the cause of the asymmetric resistance-changes it will be as well to enumerate the obvious possibilities. Asymmetry between the forward and reverse resistances may arise in the following places in the rectifier :—

- (a) The copper base.
- (b) The interface between the base and the cuprous oxide layer.
- (c) The oxide layer itself.
- (d) The interface between the oxide and the counter electrode.
- (e) The counter electrode itself.

It hardly needs new experiments to prove that both the copper base and the counter electrode (including the graphite film) have resistances which are constant, show no asymmetry and are very low compared even with the forward resistance of the complete rectifier. Exhaustive tests have shown that non-linearity but no asymmetry between the forward and reverse resistances are the chief properties of the oxide layer. Altering the counter electrode changes the forward resistance somewhat but does not appreciably affect the reverse resistance, and a cuprous oxide layer sandwiched between two similar or different counter electrodes has a low resistance and no asymmetry.

The only possibility left is that the site of the rectifying action lies in the copper-cuprous oxide interface. Further, this interface must have properties different from the easily conducting interface between the cuprous oxide and the counter electrode. The truth of this conclusion was demonstrated by Schottky in experiments which revealed the distribution of potential along the thickness of rectifiers carrying current in the forward or the reverse direction. It was found that, in the forward direction, nearly the whole potential drop was distributed uniformly in the cuprous oxide layer, i.e. the resistance of this layer is nearly equal to the total forward resistance. In the reverse direction the potential drop in the oxide was relatively small and, correspondingly, the majority of the drop was either in the interface or, at most, in a very thin film of the oxide adjacent to the copper. One possible explanation of this result will now be described.

The Barrier-Layer Hypothesis.

At the time when the metal rectifier began to receive serious attention from the theoretical scientist thermionic valves were a commonplace both in the laboratory and in industry. It is probable, therefore, that modern theories of rectification owe some of their inspiration to the action of the diode valve. Possibly for this reason all the more important theories start with the assumption that between the copper and the cuprous oxide there is a thin, non-conducting region which may be either an actual physical film of highly

insulating material or some system of electric charges which behaves as such. Such an assumption also produces an explanation of the high self-capacitance of metal rectifiers and, in fact, from measurements of this capacitance the thickness of the film has been variously estimated at 10^{-6} to 10^{-3} cm. This film is usually described as the "barrier" or "blocking" layer (German: "Sperrschicht"), and, for the time being, will be considered simply as a non-conducting space.

Consider the system copper/barrier layer/cuprous oxide. Owing to the thermal energy they possess, some of the free electrons in the copper will pass through the copper surface into the barrier layer. The copper thus acquires a positive charge and a negative space charge will appear in the barrier layer or in the cuprous oxide. In the absence of any applied potential, equilibrium will be attained when the number of electrons leaving the copper in a given time is equal to the number drawn back by the electric field set up. As previously mentioned, cuprous oxide is a defect conductor and, if the barrier layer is thin enough, the escaping electrons will move into the oxide, occupying some of the hitherto empty energy levels of the impurity (excess oxygen) atoms.

Suppose, now, an external electric field is applied in a direction tending to give the copper a negative charge and the counter electrode a positive charge. As far as the copper is concerned the effect is to increase the energy of its free electrons and to reduce the existing positive charge. More electrons will thus be able to escape into the barrier layer. Simultaneously positive "holes" will move through the oxide towards the barrier layer and will there be neutralised by electrons dropping into them from the now filled impurity levels. The latter, of course, will be replenished by the electrons arriving from the copper. This process will continue as long as the external field is applied and, it will be recognised, constitutes a flow of current in the forward direction. In accordance with experimental fact it is clear that the magnitude of the current will increase rapidly as the applied voltage is raised. Since the supply of free electrons in the copper is very large the chief obstacle to the current flow at all but very low voltages will be only the resistance of the oxide film.

When the applied voltage is in the reverse direction (copper positive) the escape of electrons from the copper surface is made more difficult and may cease entirely. Any electrons in the impurity levels will tend to be drawn over into the copper and an equal number of holes to move towards the counter electrode. A current will therefore flow in the reverse direction. There are, however, very few free electrons in cuprous oxide and the only other electrons available to carry the current are those which acquire sufficient thermal energy to make the transition from a full band in the oxide to the impurity levels. These facts severely restrict the number of electrons available at any instant and the magnitude of the current is therefore much less than in the forward direction.

Although this theory is by no means faultless it has been found possible, by its aid, to derive reasonably satisfactory explanations of the shapes of the forward

and reverse characteristics, of the effects of temperature and of the existence of the resistance maximum at a small reverse voltage. Probably the most important phenomena for which the theory has not yet provided an explanation are those of creep.

All the theories are agreed that the barrier layer, if such exists, must be extremely thin. As must be admitted, possibly for this reason it has not yet been possible to demonstrate experimentally the positive reality of the layer. Nevertheless some views as to its nature may not be out of place.

As already implied, the cuprous oxide in a cuprous oxide rectifier has a relatively low resistivity—only about $1/10^5$ of that of pure cuprous oxide—and the reduced resistivity is explicable on the grounds of a small excess of oxygen. A perfectly sharp transition from this oxide to pure copper at the interface is unlikely, and there may therefore be a very thin layer of pure cuprous oxide between the two. This might, perhaps, be the actual barrier layer. Rother and Bomke have obtained some evidence in support of this view, and their picture of the interfacial structure, together with the various conductivities involved, is represented diagrammatically in Fig. 4.

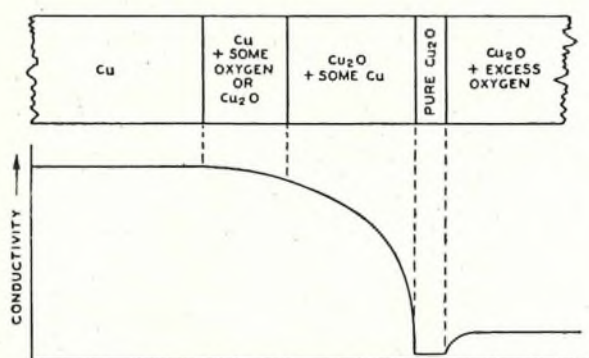

FIG. 4.—POSSIBLE STRUCTURE OF COPPER-CUPROUS OXIDE INTERFACE.

The Barrier Layer in the Selenium Rectifier.

Owing to the rather awkward chemical and optical properties of selenium it has not yet been found possible to examine the structure of selenium rectifiers in the same detail as the cuprous oxide type. There is no doubt, however, that the rectification process is fundamentally similar in both types. The existence of a barrier layer in the selenium type is therefore highly probable. The only important difference between the two types is that the barrier layer is formed differently. In the cuprous oxide type the layer is formed at some stage during the oxidation or subsequent annealing, whereas, for selenium rectifiers, it is definitely disadvantageous to permit the formation of such a layer before or during the heat-treatment of the selenium film. The barrier layer, probably a complex selenide, is therefore formed between the selenium and the counter electrode and is produced partly during the application of the latter and partly during the subsequent electrical forming process. As a result, as indicated in Fig. 1, the direction of easy current flow is opposite in sense in the two rectifiers.

PHOTOELECTRIC PHENOMENA IN SEMI-CONDUCTORS.

The Photoelectric Effect.

Fifteen or twenty years ago few people, including scientists, had seen a photoelectric cell. To-day it is an industrial device so indispensable and adaptable that even the layman is aware of many of its almost unlimited practical uses. Its present ready availability as a powerful scientific tool constitutes a debt owed by scientists mainly to one industry—the talking film—which encouraged its commercial development. It may therefore come as a surprise to many readers to learn that the fundamental effect on which the photoelectric cell is based was discovered over fifty years ago. It would be impossible in an article like this to do even partial justice to the history, the development, the theory or the practical applications of the photoelectric cell, and this will not be attempted. For this reason this section is entitled the "Photoelectric Effect." It has been introduced because the study of the effect led to most outstanding support for the quantum theory which, in turn, has resulted in striking clarification of innumerable natural phenomena.

Some important dates are worth noting. The effect may be said to have been discovered in 1887 when Hertz noticed that the spark in his resonator occurred more easily when the spark gap was illuminated by ultra-violet light than when it was not. Hallwachs, in 1888, noticed that a negatively-charged metal plate rapidly lost its charge on similar exposure but a positively-charged metal plate did not. During the next six years Elster and Geitel made an extensive study of the effect, discovered that visible light could produce it in the alkali metals and made photoelectric cells which are very similar to those of the present day.

In 1899 Lenard and J. J. Thomson independently showed that the effect was due to the emission of electrons under the influence of the light and, shortly afterwards, Lenard discovered three very important features of the effect. These were that, for light of a given wavelength, the velocity (energy) with which the electrons were emitted was independent of the intensity but varied with the frequency (colour) of the light and that the number of electrons emitted in a given time was strictly proportional to the intensity of the light.

Without making a number of dubious assumptions it is hardly possible to explain these facts on the classical wave theory of light. In 1905, however, Einstein showed that a simple explanation was easily obtained by extending Planck's views on the discontinuous nature of the processes of emission or absorption of radiant energy (*see Part V.*) to the properties of the radiation itself. According to Einstein, light consists of quanta or corpuscles of energy or "photons" which fly through space, like a hail of shot, with the velocity of light. The energy associated with each photon is $h \cdot f$ where h is Planck's constant and f the frequency of the light.

From this point of view the photoelectric effect is simply the direct transformation of light energy into mechanical energy. Suppose an electron must receive an amount of energy W before it can leave the metal. Every photon whose energy exceeds W that collides

with an electron will impart the whole of its energy to the electron. The latter may therefore be knocked out of the metal and will leave with energy E given by the equation $E = hf - W$. (*Note.*— W is not a universal constant but a characteristic of the metal known as the "work function.") This is known as Einstein's equation, and careful experiment has abundantly proved its accuracy.

Even more direct evidence for the existence of light quanta was obtained in experiments on the photoelectric effect in very fine metal dust. By the employment of a technique similar to that of Millikan's droplet method for determining the electronic charge, Meyer and Gerlach (1914) showed that emission of photoelectrons starts immediately irradiation begins, however low the intensity of the light used. This result is a necessary consequence of the quantum hypothesis but is completely opposed to the ordinary wave theory of light. According to the latter the instant of irradiation would be followed by a period (of the order of seconds) during which electrons were absorbing from the incident light the quantity of energy necessary to permit their escape from the metal.

Photoconductivity.

The photoconductive effect—the decrease in resistivity shown by many semi-conductors when exposed to light—was discovered at about the same time as the photoelectric effect in metals. For example, Willoughby Smith and May, in 1893, noticed the effect in a stick of selenium. Since that time much experimental work has been done on the cause of the effect and many practical applications for the selenium cell have been devised. It is not proposed to discuss the latter in detail, but it may not be inopportune to point out that it is incorrect to assume that the great development of the photoemissive cell has rendered the selenium cell obsolete. As will be gathered from the following discussion, it is true that the selenium cell suffers from certain defects. The magnitude of these has, however, been considerably reduced in modern cells and, by proper circuit design, their importance can be made negligible for many purposes. It is then possible fully to utilise the inherently high sensitivity of this type of cell.

It must be admitted that the theory of the photoconductive effect in selenium is far from complete owing, largely, to its complexity which arises from the occurrence, more or less simultaneously, of several distinct phenomena. The best picture of the process can be obtained by analogy with the effect in the so-called coloured alkali halides which have proved susceptible to exact experiment. It is well known that the alkali halides (e.g. sodium chloride) in the form of large crystals (e.g. rock salt) are colourless, i.e. they do not selectively absorb light in the visible part of the spectrum. Sharp, selective absorption bands are, however, found in the short-wave, ultra-violet region, e.g. at 1,600 Angstrom units (\AA) for rock salt. If light of this wavelength is applied to a rock salt crystal a new absorption band appears at 4,650 \AA , i.e. in the blue region of the spectrum, as a consequence of which the crystal acquires a yellow colour. A similar result is produced by exposing the crystals to X-rays, electron beams or the γ -radiation

from radium or, more lastingly, by heating the crystal in sodium vapour.

The ordinary colourless crystals are comparatively poor conductors and it has been shown that their conductivity is due to ionised atoms of the alkali metal or the halogen. The coloured halides, however, behave additionally as semi-conductors and, further, exhibit a photoconductive effect. It has been shown that the colour is due to the presence of free alkali metal atoms produced (by irradiation) or absorbed (from the vapour) in the crystal lattice. These atoms or "F"-centres (German: "Farbzentren") constitute a source of electrons which can become free by absorbing thermal energy or light energy and thus give rise to semiconductivity or photoconductivity respectively. On this basis the photoconductive effect strongly resembles the photoelectric effect in metals with, of course, the obvious difference that the freed electrons pass into the lattice instead of passing into the space between the electrodes. As a result the photocurrent obeys similar rules. It starts immediately when light in the new absorption band falls on the crystal and rises sharply to a constant value which is proportional to the illumination. When the latter ceases the photocurrent drops sharply to zero and the behaviour of the crystal may therefore be represented by the full-line curve of Fig. 5. (The small current flowing in the dark is ionic current plus the current due to semiconduction.)

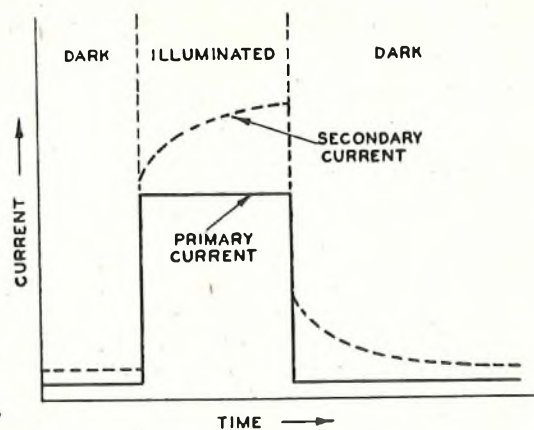

FIG. 5.—PHOTOELECTRIC EFFECT IN COLOURED ALKALI HALIDES.

This is the behaviour at room temperatures or below and the photoelectric current is termed the "primary" current. At higher temperatures the dark current is, of course, somewhat higher, but the instantaneous rise on illumination is substantially the same. If, however, the illumination is maintained for several seconds or more the photoelectric current will increase and, given time, will attain a constant total value. The total current is proportional to a lower power of the illumination than unity. This additional current, is the "secondary" photocurrent. On removing the illumination a sudden decrease occurs corresponding to the disappearance of the primary current, but some time elapses before the secondary current reaches zero. In effect there is a considerable time lag in the response and the overall result will be as in the dotted curve in Fig. 5.

Various plausible explanations for the existence of the secondary current have been advanced, but the true cause cannot yet be said to be known. Except that its response is not confined to light of one or more sharply defined wavelength ranges the selenium cell is qualitatively similar to the coloured alkali halides. The most important difference between the two is that, even at ordinary temperatures, the secondary current in the selenium cell is much greater than the primary current and, in fact, determines its practical characteristics. Its advantages are simplicity and high sensitivity, especially to light at the longer wavelengths; its disadvantages are its time lag, its departure from linearity and the variation of its sensitivity with temperature.

The Photovoltaic Effect.

If the normal solid counter electrode of a cuprous oxide rectifier is replaced by a piece of metal gauze pressed on to the oxide, and the rectifier is illuminated, a potential difference appears between the copper base and the gauze. If these are connected by an external circuit a current will flow. The direction of current flow in the external circuit is from the gauze to the copper, i.e. in the reverse direction. Including the fact that the effect is produced only by light to which the cuprous oxide is transparent there is considerable evidence that it is due to some phenomenon occurring in the so-called barrier layer. Many other combinations of metal/barrier layer/semiconductor/metal have been found to exhibit similar behaviour, which is known as the Photovoltaic Effect. (An arrangement in which the semiconductor is replaced by an electrolyte has similar properties and, in fact, some investigators prefer to restrict the use of the term to systems of this type.) Various practical photovoltaic or barrier layer photocells have been based on the effect and, since the light has to pass

through the semiconductor in order to reach the barrier layer, such cells are frequently termed "back-wall" cells.

In all these the optical absorption in the semiconductor is a disadvantage and much higher sensitivity can be attained if the light strikes the barrier layer with the minimum obstruction. This can be achieved by using a transparent counter electrode, e.g. a thin cathodically sputtered metal film and by arranging for the barrier layer to be formed between the film and the semiconductor. Commercial cuprous oxide and selenium photocells of this type are now readily available and may be termed "front-wall" cells.

Various theories have been proposed to account for the photovoltaic effect but, it must be admitted, there is, at present, too little evidence to justify accepting anyone of these in preference to the others.

Most cells of this type have a response which is confined practically to the visible part of the spectrum. In fact, by suitable design, the response can be made to approximate very closely to that of the eye. In terms of voltage the output of this type of cell is much lower than that of photoemissive cells. Amplification of the output therefore presents greater difficulties. On the other hand the internal impedance of photovoltaic cells is low. In consequence the currents generated at quite ordinary levels of illumination are sufficient to operate a robust meter without the aid of an external source of power. A simple photometer or illumination meter can thus consist merely of a photovoltaic cell and a suitable microammeter. Most photoelectric photographic exposure meters are made in this way. Where fairly high levels of illumination can be used the power output from the cell is sufficient to operate a sensitive relay directly and many alarm systems working on this principle have been devised.

Standardisation of Wires Used in Telephone Exchanges

D. STEWART (Ericsson Telephones, Ltd.)

U.D.C. 621.315.45

The author suggests that the number of types of wire used in the internal wiring of telephone exchanges could be materially reduced, without serious effect on the electrical and mechanical qualities, by the standardisation for most purposes of a 24 S.W.G. wire having a double lapping of acetylated cotton.

Introductory.

IN recent years the British Post Office has standardised telephone equipment and, to a certain extent, wires and cables, but experience under war conditions has suggested to the author that there may be scope for further standardisation of the latter.

The transmission of speech currents inside an automatic telephone exchange is over six types of wire, and although each carries the same speech currents the variation in types is apparently necessitated by the different physical conditions and, to a certain extent, the electrical requirements encountered in the components forming the switching plant (banks, switchplates, etc.). The variation takes place

in both conductor gauge and insulating material.

The six types are:—

- (1) 23 S.W.G. tinned copper, single acetylated cotton and single wool lapped (in cable).
- (2) 23 S.W.G. tinned copper, double silk and single cotton lapped, waxed.
- (3) 25 S.W.G. tinned copper, double silk and single cotton lapped, waxed.
- (4) 25 S.W.G. tinned copper, single silk and single cotton lapped, waxed.
- (5) 25 S.W.G. tinned copper, acetylated cotton single lapped and braided, waxed.
- (6) 22 S.W.G. tinned copper, wool single lapped and braided, flame-proofed.

In addition there is a large number of varieties of most of these types of wire, due to the necessity of having different coloured outer coverings for identification purposes. Fig. 1 shows where each of the types

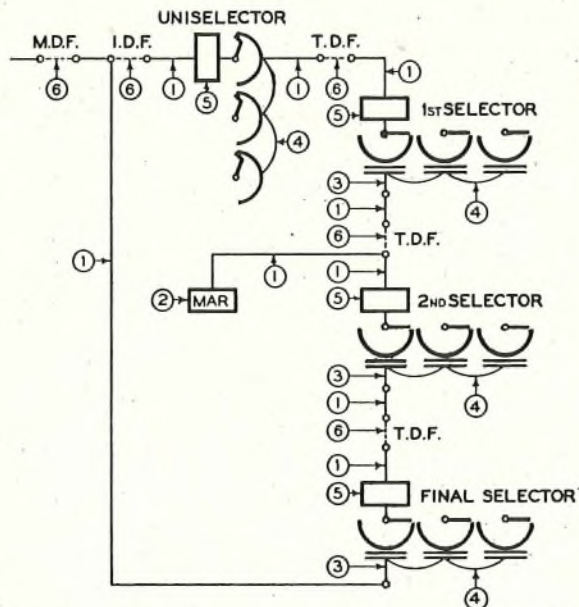

FIG. 1.—WIRE TYPES USED IN AUTOMATIC EXCHANGE TRANSMISSION CIRCUIT.

is used in the transmission circuit within an exchange.

The author's proposal is to substitute the first four types by a single standard; the sixth type, jumper wire, must necessarily be a special wire, due to the friction and strain to which it is subjected, and will not be considered further. It is also likely that the fifth type, which is used for switch and relay set plate wiring, would have to be braided for mechanical reasons, but as this point may be open to question, it has been included in the following review.

For convenience, the characteristics and uses of the five types may be summarised as follows:—

Ref. No.	Conductor	Conductor Resistance $\Omega/1,000$ yd.	Insulation	Where used	How formed
(1)	23 S.W.G. (.024 in.)	53-13	1 lapping of acetylated cotton 1 lapping of wool	Switchboard cable	Firmly laced
(2)	23 S.W.G. (.024 in.)	53-13	2 lappings of silk 1 lapping of cotton	Local cable forms on M.A.R., etc.	Firmly laced
(3)	25 S.W.G. (.020 in.)	76-53	2 lappings of silk 1 lapping of cotton	Bank multiple tails	Firmly laced
(4)	25 S.W.G. (.020 in.)	76-53	1 lapping of silk 1 lapping of cotton	Bank multiples	Air space form
(5)	25 S.W.G. (.020 in.)	76-53	1 lapping of acetylated cotton 1 braiding of acetylated cotton	Local wiring on relay sets and selectors	Laced or loose ties

From inspection of the above table, it will be observed that to provide the five types, two conductor

sizes, viz. 23 S.W.G. and 25 S.W.G., and five insulating mediums, viz. silk, cotton, wool, acetylated cotton lapping and acetylated cotton braiding, are necessary. Before suggesting a single standard to replace four or all of these five types it will be necessary to consider why they have been used in the past.

(1) 23 S.W.G. (.024 in.) *Single Acetylated Cotton and Single Wool Lapped.*

With the exception that during recent years acetylated cotton has substituted silk, this has been the standard conductor and insulation for wires in switchboard cables ever since the introduction of C.B. exchanges. Since it may be used in lengths of 90 yd. or more, conductors having a much higher resistance than that of 23 S.W.G. are not desirable.

At the ends it is formed and laced, and these forms are occasionally subjected to vibration and strains. Mechanical strength in the conductors is therefore an important consideration, and a substitute should be very little inferior in this respect.

(2) 23 S.W.G. *Double Silk and Single Cotton Lappings.*

This also has been a standard since the introduction of C.B. exchanges. Since large numbers of these wires may be laced in a cable form, inductive and contact faults may develop. Presumably this is the reason for the additional lapping of silk. There does not appear to be any objection to the use of a smaller conductor since type (3), 25 S.W.G., is used under similar conditions.

(3) 25 S.W.G. *Double Silk and Single Cotton Lappings.*

Like the previous wire, this is generally made into a laced form, so that two layers of silk are considered necessary. Under the conditions it is used, however, the space factor is a very important consideration. The space available for the cable forms is limited, and the small size of bank contact tags and the limited space between tags necessitate the use of a small gauge conductor.

(4) 25 S.W.G. *Single Silk and Single Cotton Lappings.*

Here again the space factor is important, so that 25 S.W.G. is suitable. The wires in bank multiples are, however, "air spaced" and not tightly packed as in cable forms, so that one lapping of silk is considered sufficient. A necessary qualification for a wire used on bank multiples is that it should be easy to strip.

(5) 25 S.W.G. *Single Acetylated Cotton Lapped and Acetylated Cotton Braided.*

As in types (3) and (4), the space factor is important, and in consequence 25 S.W.G. conductor has been considered necessary. These wires are made up into cable forms which have sharp bends and rest on the metal switchplate. Insulating material with a high insulation resistance and mechanical strength is therefore desirable. Two layers of acetylated cotton fulfil the first requirement, and since the outer layer is braided the second requirement is also fulfilled. It should be mentioned that type (2), 23 S.W.G., D.S., S.C., has been used for local forms on switchplates, and, so far as the author knows, without difficulty, though braided wire is undoubtedly superior.

Choice of Standard Conductor.

From the foregoing it would appear that neither 23 S.W.G. nor 25 S.W.G. would be suitable for the standard conductor since 25 S.W.G. is electrically and mechanically unsuitable for use in cable and 23 S.W.G. would be too big for bank wiring. The author suggests, however, that 24 S.W.G. would fulfil, to a large extent, the necessary requirements for both cable and bank connections. If used in cable, the resistance would only be 1Ω greater per 100 yd. than 23 S.W.G., and the adverse difference in mechanical strength would also be small. On bank connections an addition of 2 mils. to the conductor diameter should not cause any real difficulties in wiring.

With switchplates 24 S.W.G. would not be too big, since a larger size, 23 S.W.G., has already been used.

Choice of Standard Insulation.

Types (2), 23 S.W.G., D.S., S.C., and (3), 25 S.W.G., D.S., S.C., generally used in local cables, have three layers of insulating material, but the wires in switchboard cables, type (1), are usually formed under similar conditions (shelf to shelf ties, M.A.R forms, etc.), yet these wires have only two layers of insulating material. It would appear, therefore, that two layers of insulation is all that is necessary for wires which are firmly laced in local cable forms.

Type (4), used in air-space forms, and (5), used on local forms for switchplates, have only two layers. Due to conditions already mentioned, the highest grade of insulation is required on switchplate forms, and, as it is desirable to maintain this, the present insulation of type (5), acetylated cotton lap, acetylated cotton braid, should, apart from the cost aspect, form the basis of the standard. The outer layer is, however, braided, and this would prohibit its use in switchboard cables, local forms, and bank multiples on account of the additional and unnecessary costs. There would appear to be no serious objection, however, to the use of wire with a lapped outer covering for switchplate local forms (since 23 S.W.G., double silk, single cotton lapped wire has already been used), and as acetylated cotton has higher insulating and tensile strength properties than either silk or cotton, these superior qualities would compensate for the loss of one layer of insulation. A double lapping of acetylated cotton would appear to be the ideal standard. If, however, it is considered that braiding is essential to meet the conditions of switchplate wiring, a second standard would be required.

Standard Wire.

The author's suggested standard wire is therefore 24 S.W.G. (.022 in.) conductor insulated with two lappings of acetylated cotton, beeswax impregnated.

The advantages and disadvantages which would accrue from the use of this standard are as follows :—

ADVANTAGES.

- (i) The costs of cable would be reduced since there would be a saving in copper by the substitution

of .022 in. diameter for .024 in. diameter conductor. Since wool and acetylated cotton are approximately the same price the substitution of the former by the latter would not affect the costs, but, due to the superior insulating properties of acetylated cotton, a higher grade of insulation would be obtained.

- (ii) Advantages similar to the above would be obtained by substituting the standard for type (2), 23 S.W.G., D.S., S.C.
- (iii) Standard wire would tend to standardise stripping and wiring operations. This would simplify the work of the wiring staff and facilitate the training of new employees.
- (iv) It would reduce the amount of capital tied up in wire stocks, and a saving in storage capacity (bins, building accommodation, etc.), stores labour, ledger entries, etc., would be effected.

DISADVANTAGES.

- (i) The costs of bank multiples and tails would be increased, due to the increased size of conductor. The cost of double acetylated cotton insulation would be greater than the silk and cotton at present used for bank multiples.
- (ii) The substitution of a braided by a lapped acetylated cotton covering for local forms on switchplates would reduce the mechanical strength of the insulation, and in consequence the electrical efficiency might be impaired. This might necessitate a second standard wire having the outer acetylated cotton layer braided instead of lapped.
- (iii) Due to the smaller diameter conductors used in cable, the resistance of the transmission circuit inside the exchange would be slightly increased (since the longest lengths of wire are generally in cable).

Conclusion.

There are factors, such as the inherent flame extinguishing property of wool, which have not been considered in this article, and these may be sufficiently important to prevent the full degree of standardisation suggested from being achieved, but it is thought that, at any rate, some reduction in the number of types of wire could be effected. If, for example, it is not desired to introduce a new type of wire at present, there would appear to be little objection to eliminating type (2) (23 S.W.G., double silk and single cotton) and replacing it by type (5) (25 S.W.G., acetylated cotton lapped and braided) and to standardising either type (3) (25 S.W.G., double silk and single cotton) or type (4) (25 S.W.G., single silk and single cotton) for both the bank multiple wiring and the multiple tail. In this way important steps would be taken towards the ultimate goal of one type of wire for all purposes (other than power supplies) in the internal wiring of telephone exchanges.

The Suppression of Radio Interference from Electro-Medical and Certain Other Types of High Frequency Apparatus

U.D.C. 621.396.828

E. F. H. GOULD, B.Sc., A.M.I.E.E.

The author shows that the most practical method of suppressing high frequency radiation from diathermy sets, induction furnaces and eddy current heaters, etc., is by electrical screening; examples of methods of screening rooms and of screened cubicles are given.

Introduction.

THESE are certain classes of apparatus in domestic, professional and commercial use which depend for their operation upon the generation of high frequency currents. Examples of the type of apparatus concerned are violet ray treatment sets, long and short wave diathermy sets, high frequency induction furnaces and eddy current heaters. It has been estimated that before the war there were hundreds of thousands of the first type of apparatus in use in this country of which a large proportion were in the possession of private persons for treatment in their homes. The diathermy apparatus was in use for specialised surgical purposes but mainly for the treatment of rheumatism and similar complaints, and it was estimated that there were about 5,000 such sets in use. The third and fourth types of apparatus are used commercially, and in all there were probably less than 100 installations. The high frequency power used by the various equipments ranges from a few watts in the violet ray sets to hundreds of kilowatts in the electric furnaces and, as a consequence, interference with radio and communication could be expected.

Prior to the outbreak of war, interference with broadcast reception from the above-mentioned sources had not been particularly marked. This was due to the field strength from the broadcasting stations being sufficient to ensure an adequate signal to interference ratio, but a noteworthy exception was the interference caused to television reception by some types of diathermy sets, in those instances where the high frequency apparatus and the television receiver were close together. The rapid increase in the number of users of high frequency apparatus and the contemplated expansion of the television and short wave broadcasting made it necessary to find a solution to this problem.

Interference Levels from H.F. Apparatus.

Interference from violet ray sets is not usually severe owing to the low power involved and the fact that the apparatus is battery operated, but where the radiation is troublesome it can be treated in a similar manner to that described later for suppressing the radiation from other types of high frequency apparatus.

The remaining types of H.F. apparatus are mains operated, and in addition therefore to the directly radiated interference, consideration has to be given to the possibility of interference by mains-borne currents.

Experience with all types of diathermy apparatus leads to the following conclusions. Spark gap type

sets give rise to radiation which is almost continuous over a wide range of frequencies. Valve sets usually produce only harmonics of the fundamental, but other frequencies have been observed. The radiation of the fundamental (or nominal frequency) is not always the most pronounced and, lastly, that at distances greater than 25 yd. the radiation is roughly inversely proportional to the separation from the source. Typical results for long wave sets of the valve and spark gap type at a distance of 10 yd. from the set are given in Fig. 1.

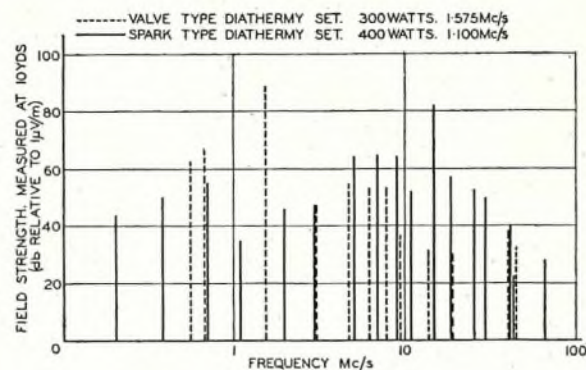

FIG. 1.—GRAPH OF FIELD STRENGTH/FREQUENCY.

As would be expected, the radiation from violet ray sets is similar in character to that arising from spark gap diathermy sets although, of course, the levels are lower due to the reduced power. The reduction in the radiation is, however, not proportional to the relative powers as the violet ray sets use an earth return for the high frequency currents and thereby cause disproportionately greater radiation.

Eddy current heaters and high frequency furnaces in most common use consist essentially of a spark gap oscillator, an inductance of which surrounds the valve being manufactured or the pot containing the charge of metal. The radiation is almost continuous over the frequency spectrum similarly to that arising from spark type diathermy sets. Typical results for a 35 kVA spark gap furnace tuned to a wavelength in the long-wave band are given in Table I, column 2. It must be remembered that the frequency of oscillation varies during the process and depends, for example, upon the weight, type and temperature of the charge of metal or in valve production upon the temperature of the electrodes of the valve in course of manufacture.

Valve-operated furnaces and eddy current heaters are less frequently met with, but are becoming more

popular. The results for an interesting case of a 120 kW furnace of this type using rectified A.C. for supplying the anodes are given in Table I, col. 3.

TABLE I
FIELD STRENGTH AT 10 YDS. (db RELATIVE TO 1 μ V/m)

Frequency in Mc/s	35 kVA Long Wave, Spark Type, H.F. Furnace	120 kW Long Wave, Valve Type, H.F. Furnace
0.21	52	76
0.49	—	> 107
0.55	—	> 119
0.6	—	> 119
0.86	—	82
1.0	49	92
2.2	—	94
3.9	—	82
6.0	65	76
9.5	62	—
11.8	67	78
15.0	49	—
19.0	61	74
25.0	49	75

The most serious interference by mains-borne H.F. currents is caused to radio receivers connected to the same electric mains, but interference can also occur due to the mains acting as an aerial. The asymmetric H.F. currents flow out along the electric conductors in parallel and return through the earth path, in this way radiating the interference.

The H.F. voltage across the mains supplying the H.F. equipment is in general of similar frequency composition to the directly radiated field from the same equipment. Typical results for spark and valve type diathermy sets are given in Table II and for a 35 kVA high frequency furnace in Table III.

TABLE II
MAINS R.F. VOLTAGE FROM DIATHERMY EQUIPMENTS

Frequency in Mc/s	Mains R.F. Voltages (db. relative 1 μ V)			
	Valve Type		Spark Type	
	Symmetric	Asymmetric	Symmetric	Asymmetric
0.21	—	—	86	84
0.5	—	—	88	86
0.7	46	45	—	—
1.45	—	—	78	88
3.0	74	59	—	—
4.0	—	—	91	86
6.6	69	76	—	—
9.0	—	—	68	85
10.6	> 112	> 112	—	—
11.0	—	—	86	106
13.0	—	—	92	> 116
20.0	—	—	60	40
21.2	79	71	—	—
24.2	75	67	—	—
25.0	—	—	70	72
30.0	44	61	—	—
45.0	35	60	—	—
64.0	46	97	—	—
69.0	47	62	—	—

TABLE III

MAINS R.F. VOLTAGE FROM 35 kVA SPARK TYPE FURNACE

Frequency Mc/s	Mains R.F. Voltage (db. relative 1 μ V)	
	Symmetric	Asymmetric
0.21	102	> 110
1.0	83	91
6.0	100	100
9.5	73	72
11.8	74	73
15.0	67	65
19.0	56	54
25.0	39	35

Methods of Suppressing the Interference.

From the manner in which this type of apparatus is used it is impossible to make it inherently non-radiating, although it has been demonstrated with violet ray sets, for example, that by a re-design of the apparatus to reduce the dimensions of the output circuit a marked reduction in the radiation can be achieved. This method has not been adopted owing to the cost. The only alternatives which would give the most general relief would be (a) to allocate certain wavelengths for the exclusive use of high frequency apparatus or (b) to enclose the equipment and everything associated with its output circuit in an earthed screen and to fit suppressors in all conductors entering or leaving the screened space.

Before the war, a proposal was made to representative users of diathermy apparatus that a band 30 kc/s wide at a mean frequency of 2.727 Mc/s and a spot frequency of 60 Mc/s should be allocated for the use of short wave diathermy apparatus. The proposal was not acceptable, the suggestion being made that it would be too costly to change the working frequency of the existing sets and modify them to ensure stability of frequency and absence of harmonics. It is interesting to note that in existing type diathermy sets frequency changes as great as 12 per cent. have been observed due to movement of patients during treatment and to the re-arrangement of the electrodes required for different treatments.

The only solution, therefore, was for the apparatus to be screened and to filter all electric conductors entering the screened space. This method is also comparatively costly and was only adopted where the users of the apparatus were troubled by interference to broadcast reception.

If the screening is to be effective it is essential that the whole of the H.F. circuit should be enclosed within a complete earthed screen, which for diathermy treatment means that the patient must be included. Although the screen need not be of continuous metal, all sections must be securely bonded together and whereas wire mesh, expanded metal or metal foil are suitable materials, metal paint is not satisfactory as the binding material in the paint insulates the particles of metal from one another. The results of tests on various materials for the screening of diathermy apparatus are given in Table IV. It will

TABLE IV

Material	Frequency Mc/s	Suppression due to Screening (db).
½-in. wire mesh	45.0	40
	0.19	64
	1.0	60
	15.0	55
¼-in. wire mesh	45.0	45
	0.15	48
½-in. wire mesh	45.0	56
Paper-back metal foil	45.0	56
½-in. steel sheet with welded seams	50.0	72
<i>Double Screening</i>		
Inner and outer, both ¼-in. wire mesh	50.0	83
Inner screen metal foil, outer screen metal faced plywood	50.0	96

be seen that for the higher frequencies the more open type mesh is less effective.

In conjunction with the screening of the apparatus all electric conductors, including telephone wires, entering the screen must be fitted with filters (close to where they enter the screen) to prevent the high frequency currents from being propagated outside the screened space. The effectiveness of the filter unit will, for any design, depend upon the impedance of the mains to which it is connected. This varies over very wide limits as will be seen from Fig. 2,

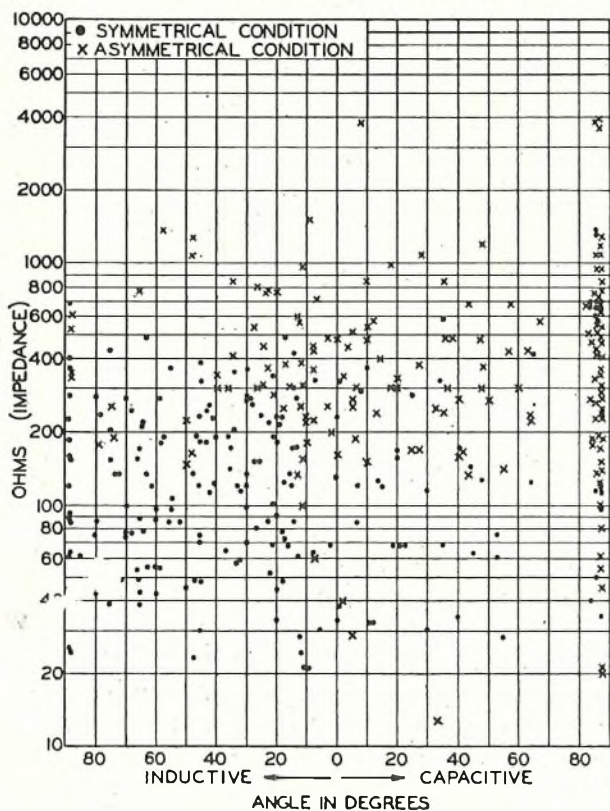

FIG. 2.—TARGET DIAGRAM OF MAINS IMPEDANCE AT 1.2 Mc/s.

for example, which gives in target diagram form the results of mains impedance measurements at 1.2 Mc/s on many typical installations. The filter must be designed to suppress symmetric as well as asymmetric components and an example of a filter recommended for general use in connection with high frequency apparatus is shown in Fig. 3. It is essential that the

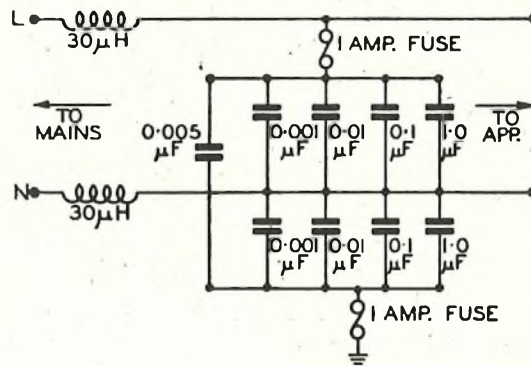

FIG. 3.—FILTER CIRCUIT FOR USE WITH HIGH FREQUENCY APPARATUS.

separate non-inductive type condensers should be used, that all leads to them should be as short as possible and that the filter should be enclosed in an earthed screening box. Other conductors which are sometimes found to enter or pass through the screened room or enclosure, for example, heating pipes or cable conduits, should be securely bonded to earth.

Practical Considerations and Examples of Screening.

From the point of view of appearance it is desirable to have the screening under the wall fabric, and if the screening is decided upon at the time the place is being built this can be done quite easily by the use of wire gauze. For an existing room the walls, floor and ceiling can be satisfactorily dealt with by paper-backed metal foil which, with suitable wall treatment afterwards, gives a pleasing appearance. A false ceiling at, say, 7 ft. or so, made of wire gauze, will enable the lighting fixture to be left outside the screen and so obviate the filtering of the conductors to them. In this connection it will often pay to re-route electric services not essential in the screened space so that they do not enter or pass through it.

Considering now, in more detail, the screening of a room during the building construction. Wire gauze should be fixed to the walls and ceiling before they are plastered and before the floor is laid. Galvanised iron wire gauze, 25 S.W.G. of ¼ in. mesh, is quite suitable and is available in rolls 6 ft. 6 in. wide at approximately 4d. per foot. An overlap of 1 in. should be allowed between adjacent strips and at the joints between walls, floor and ceiling. A soldered connection should be made every foot at the overlap joints. The plaster used for covering the screening should not have a strong alkaline reaction as this would corrode the wire gauze. Any normal finish, such as distemper, paint or wall paper, can be applied to the wall or ceiling. The doors can be covered

with metallised paper, or wire gauze can be sandwiched between two layers of wood, or the door can be covered with sheet metal or metal-faced plywood. The connection between the door screening and the rest of the screen can be made through the hinges and ball catches provided they are of non-rusting metal and unpainted. It is usually required to open the windows, and the screen should therefore take the form of a separate metal framework covered with $\frac{1}{4}$ -in. mesh wire gauze in good electrical contact with the rest of the screening. This is illustrated in Fig. 4.

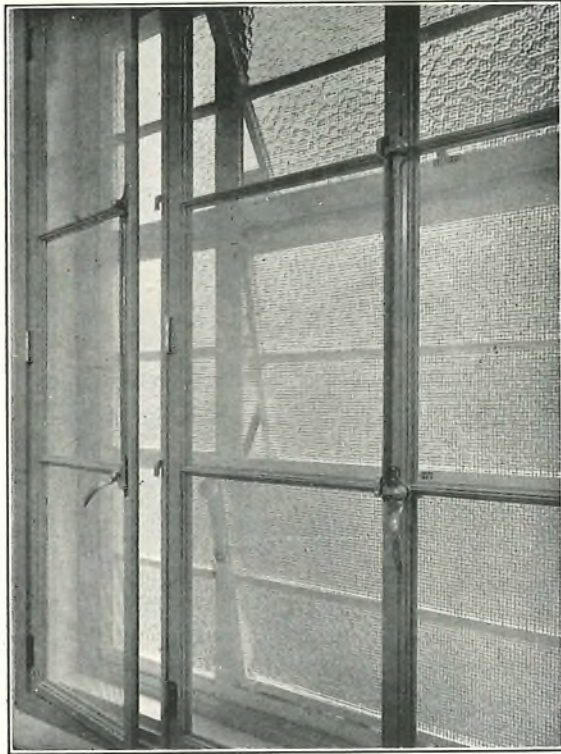

FIG. 4.—SCREENING FOR WINDOW.

If the windows are not to be opened, $\frac{1}{4}$ -in. mesh wire reinforced glass in metal frames could be used, but the standard $\frac{1}{2}$ -in. wire gauze is not suitable. A type of material which has recently come to notice and which could be used for screening window spaces, provided it is supported by a metal frame, consists of $\frac{1}{8}$ -in. mesh expanded metal embedded in a transparent material. In the sample so far examined the transparent material is inflammable and for this reason is unsuitable.

The most economical and usually the most convenient method of screening an existing room, except where tiled or painted walls are concerned, is to paper the walls and ceiling with metal foil and to treat the floor, windows and doors in a similar manner to that described above for screening a room in the course of construction. To facilitate the handling and hanging of the metal foil it is usual to use a paper-backed foil. Aluminium or zinc foil, .009 mm. thick on a 60-gramme paper back, is a commercial article obtainable in rolls 14 in. or 20 in. wide. Recently the price has

been about $2\frac{1}{2}$ d. per yd. for the narrow width and proportionally more for the wider one which should be used for preference as the number of joints in the screen is thereby reduced. All wall fittings, which would cause a gap in the screening larger than 2 in. diameter approx., should be removed and the paper hung in the same way as ordinary wall paper with the paper backing to the wall and the metal foil exposed, after which the fixtures can be replaced. Any paste, provided it is not strongly alkaline, is suitable, and at joints between adjacent strips a 2-in. wide strip of foil held in position by a wooden lath should be used to overlap the joint so as to ensure the continuity of the screen. Ordinary stuck joints are not suitable as they deteriorate in time. Metal foil strip for this purpose is obtainable but, if desired, a strip of paper-backed foil could be used, and care should be taken to see that paper backing is towards the wood lath. With regard to the floor, the wire gauze can be laid on the existing floor and covered with a material such as linoleum for mechanical protection. The contact between the wire mesh gauze and the metal foil can be secured beneath the usual wood skirting boards. The details of the method are shown diagrammatically in Fig. 5.

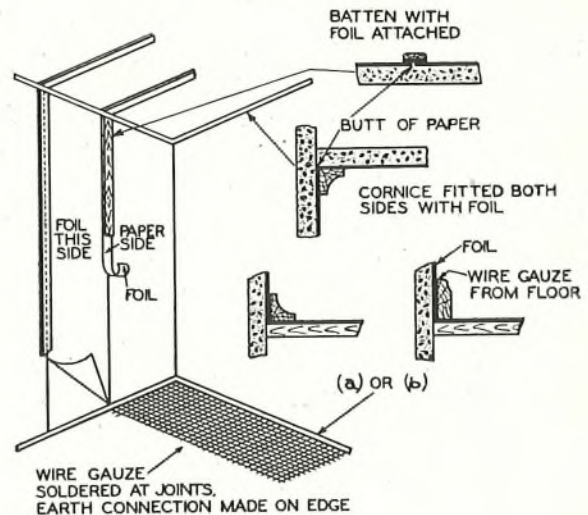

FIG. 5.—SCREENING FOR WALLS, CEILINGS AND FLOORS.

Finally the metal surface can be treated with paint or distemper for which purpose many of the well-known paint manufacturers market a suitable preparation and will readily give advice on this matter. Important points to be considered in this respect are the possibility of the paint or distemper causing chemical attack of the metal foil and the presence of grease on the foil which may affect the adhesion of the decorating material.

If the H.F. equipment is in a large room or if, for example, the doors or wall fittings are inconveniently placed it is worth while to consider screening only one corner of the room and confining the H.F. apparatus within that space. The screen must, of course, be complete, and if the corner walls are hung with paper-backed metal foil the remainder can be made in a

similar manner to that described below for a transportable screen.

It has already been indicated that the screening of an existing room may present difficulties, or it may be that the H.F. apparatus is moved from one building to another. In such circumstances a screening cubicle is the best solution.

Expanded metal of $\frac{3}{16}$ -in. mesh is suitable for screening H.F. apparatus, and for screened cubicle construction it has the advantage of being more robust than wire gauze. To ensure good electrical contact throughout, the expanded metal must be welded into a frame which is later bolted to the supporting ironwork.

A general view of a cubicle 6 ft. \times 6 ft. \times 6 ft. of $\frac{3}{16}$ -in. mesh expanded metal is shown in Fig. 6. This cubicle was made by the Expanded Metal Co. and cost approx. £25 complete with electrical fittings. Several of the electro-medical supply companies have also recently produced screened cubicles for diathermy apparatus and, in general, these are wire gauze on wood or metal frames.

Legislation to Control the possession of H.F. Apparatus.

The war, and with it the increased importance of communicating by radio with aircraft, which from the conditions of service produce only weak signals but which, moreover, it is a vital necessity should be successfully received, completely altered the aspect of this problem of interference from high frequency apparatus. In addition, the radiations from such apparatus might be used by enemy aircraft as radio beacons for navigation purposes. As an alternative to the total prohibition of the use of H.F. apparatus, it was decided to allow a proportion of the equipments to continue to operate provided certain precautions were taken to limit the radiation. For this purpose the Control of High Frequency Apparatus Order 1940 (S. R. & O. 1940, No. 1644) was made and by which it became an offence for anyone to possess high frequency apparatus after 2nd September, 1940, without a permit issued for the purpose by the Postmaster-General. Private persons or practitioners are excluded by the provision of the Order from obtaining permits, which, in brief, are restricted to hospitals or clinics receiving support from voluntary contributions, local authorities or charity, to manufacturers using such apparatus for the purpose of their business, to dealers in this class of apparatus and to laboratories used for research or instruction. Even in these categories the Postmaster-General is not obliged to grant a permit in every case, but may withhold it if it is considered that the purposes for which the Order was introduced would best be served by such a decision.

Except where the apparatus is used solely for surgical purposes or where the provision of the screening would interrupt the production of urgently needed articles, a condition of issue of the permit to possess high frequency apparatus is that it should be completely screened to the satisfaction of the Postmaster-General. Approved methods of screening high frequency apparatus are described in a pamphlet

sent with each permit and any departures therefrom must be separately approved. The pamphlet embodies in detail the screening methods dealt with generally, earlier in this article.

For the purposes of the Order, high frequency apparatus is defined as "any apparatus that generates or uses, and has a maximum output exceeding 10 W of electrical energy at a frequency exceeding 10 kc/s, not being wireless transmitting

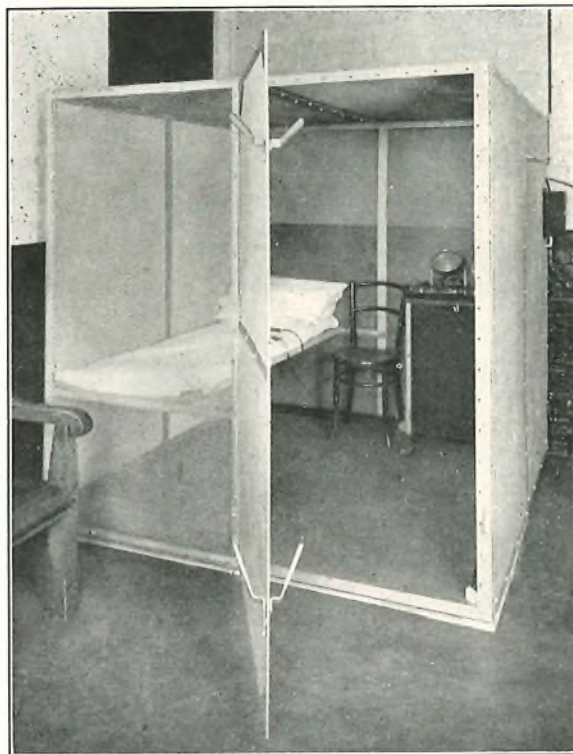

FIG. 6.—SCREENING CUBICLE OF EXPANDED METAL.

apparatus." The principal types of apparatus to which the order applies are :—

- (a) Diathermy and electro-medical apparatus using valves or spark coils, frequently known as ultra-short, or short, or long wave diathermy, surgical diathermy or therapy apparatus.
- (b) High frequency furnaces.
- (c) Eddy current heating apparatus such as is used by valve and electric lamp manufacturers.
- (d) Testing oscillators with a high frequency output exceeding 10 W.

On the other hand, it does not apply to the normal type of violet ray equipment, to X-ray apparatus, infra-red and ultra-violet ray apparatus, medical shocking coils or to wave-meters and low-powered testing oscillators such as are used by radio dealers.

Acknowledgment.—The author wishes to acknowledge the work on this subject done by his colleagues in the Radio Branch of the E. in C.'s Office engaged on the suppression of radio interference.

A Wide-range Beat Frequency Oscillator

U.D.C. 621.396.615

R. F. J. JARVIS, Ph.D., and
E. F. S. CLARKE, B.Sc.

A heterodyne oscillator is described which covers continuously the frequency range 10 c/s to nearly 4 Mc/s. This is achieved by switches controlling the oscillator frequencies, filters, and output transformers so that the whole range is obtained from one unit.

Introduction.

IN the early development of telephone line apparatus the need was felt for an oscillator covering continuously the whole audio frequency range with constant output and low harmonic content. To meet this need heterodyne or beat frequency oscillators were developed in which the whole of the audio frequency range was obtained on one dial without range switching. The output of a fixed oscillator, having a frequency of about 10 times the maximum audio frequency required, was mixed with the output of a variable oscillator and the beat note filtered by a L.P. filter and amplified. The capacitance law of the condenser in the variable frequency oscillator was arranged to give a logarithmic output frequency scale on the dial of this condenser.

When development work was started on the transmission of television signals over coaxial and balanced cables the need was soon felt for a similar oscillator covering a frequency range from 10 c/s or less up to about 4 Mc/s. Until such an oscillator was available it was necessary to use two, or sometimes three, separate oscillators to cover this range. It was appreciated that it would not be practicable to make the fixed and variable oscillators of the beat-frequency oscillator so stable that the whole range could be covered in one sweep, and that a number of fixed oscillator frequencies would be required to cover the whole range with sufficient output frequency stability. This could, however, be done by wave switches to change the oscillator frequencies and the L.P. filters, output frequencies covering the whole range thus being obtained from one unit instead of two or three. Work on the oscillator described in this article was started in 1936, some years before commercial models of similar oscillators to cover the video frequency range became available.

General Design Requirements.

A frequency range of 10 c/s to about 4 Mc/s was decided upon to meet the needs of low or high definition television. Extreme accuracy of output frequency calibration was not necessary for most of the purposes for which the oscillator was required, but good short period stability was desirable so that the output frequency could be accurately set to the required value by a multi-vibrator if necessary. As the oscillator was required primarily for measurements on lines and line apparatus, it was designed to feed a balanced-unbalanced send element for which an output of at least 15 milliwatts in 75 ohms was required. In addition to a 75-ohm impedance output it was decided to add a high impedance output for laboratory testing.

It is desirable that, when making circuit measurements, readjustment of the oscillator gain control shall not be necessary when the frequency is changed for constant reading of the send element meter. Audio frequency heterodyne oscillators have been designed in which the output is sufficiently constant with frequency to ensure this, providing a high loss is connected in the send element following the point where the effective internal E.M.F. is measured. This is necessary to ensure that this E.M.F. shall be independent of the load impedance connected to the send element. It has been found that the best method of achieving this result in a multi-range heterodyne oscillator is to employ automatic gain control to maintain the effective internal E.M.F. of the send element constant, treating the send element as part of the oscillator. Loss following the point where this E.M.F. is controlled is then unnecessary as the E.M.F. will be independent of load impedance in any case.

A heterodyne oscillator differs from a straight oscillator in that, in addition to noise and harmonics of the fundamental frequency being present in the output, there are other unwanted frequencies given by harmonics of the two beating frequencies and the sums and differences of these harmonic frequencies.

Thus if f_1 = frequency of the fixed oscillator

f_2 = frequency of the variable oscillator
and $f_2 < f_1$

the output is in the form $nf_1 + mf_2$

where n is zero or a positive integer

and m is zero or a positive or negative integer.

The desired output frequency $f_1 - f_2$ is given when $n = 1$ and $m = -1$, and harmonics of this frequency are obtained when $m = -n$.

Unwanted products, other than the beating oscillator frequencies and the sum of these frequencies, arise from harmonics in the output of the two oscillators being mixed in the frequency changer and from non-linear mixing in the frequency changer. In a double-grid frequency-changer valve, for instance, the latter arises if the grid voltage/anode current characteristics for the two grids are non-linear. It is therefore desirable for the output wave form of the two oscillators to be reasonably pure and for the frequency changer to be operated in as linear a manner as possible. The smaller the inputs to the frequency changer the more linear its operation becomes, but the signal-to-thermal noise ratio in the output also becomes smaller and the requirements regarding this ratio determine the minimum frequency changer inputs. In addition, the level of the unwanted products which come inside the output

frequency range of the oscillator can be reduced by making the ratio of the fixed oscillator frequency to the maximum output frequency as high as possible, having regard to the requirements of output frequency stability. Products which come above the maximum output frequency can be reduced to the required extent by the filter following the frequency changer. Harmonics of the fundamental frequency are, of course, also produced in the amplifier following the frequency changer and this amplifier must be designed to reduce these to a minimum.

The level of unwanted products, including valve noise, permissible in the output depends on the purpose for which the oscillator is required. Thus, in making measurements of the gain of a flat television line circuit, the total unwanted products need not be more than about 40 db. below the fundamental, whereas in making measurements on band-pass filters required for multi-channel carrier telephony they should be at least 70 db. below.

Circuit Layout.

The block schematic diagram of a beat-frequency oscillator is shown in Fig. 1. Any electrical coupling

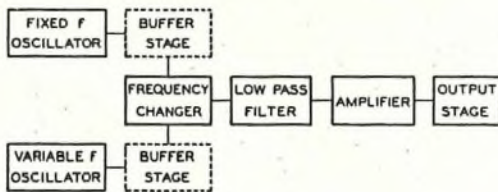

FIG. 1.—SCHEMATIC DIAGRAM OF BEAT FREQUENCY OSCILLATOR.

between the fixed and variable oscillators tends to cause the two oscillators to pull into step. This prevents the accurate setting of the "zero beat" and distorts the wave form of the difference frequency output at the low frequency end of the range. Intermediate buffer amplifier stages between the oscillators and the frequency changer have sometimes been introduced to reduce this effect, but in the oscillator described in this article the design requirements were met without introducing these.

The L.P. filter which follows the frequency changer is required to pass freely the difference frequency in the output, but to offer a high attenuation to other products having frequencies above the maximum frequency of the range, particularly the two oscillator frequencies if a balanced frequency changer is not used. The amplifier and output stages should have a level gain characteristic and deliver power to the required load with a minimum of distortion. The oscillator to be described conforms to the above fundamental circuit with the omission of buffer stages, but with provision for changing oscillator frequencies, filters and output transformers by ganged rotary switches.

Choice of Frequency Ranges and Oscillator Frequencies.

Table No. 1 shows the output frequency ranges,

and the frequency of the fixed oscillator for each range, which were finally chosen. It was originally intended to use a fixed oscillator frequency of 40 Mc/s on the highest range, but difficulty was experienced in making the oscillators sufficiently stable and 21.7 Mc/s

TABLE I
OUTPUT AND OSCILLATOR FREQUENCIES

Range	Output Frequency		Fixed Oscillator Frequency
	Maximum	Minimum	
1	100 c/s	10 c/s	2 kc/s
2	3 kc/s	100 c/s	50 kc/s
3	150 kc/s	3 kc/s	1.4 Mc/s
4	3.7 Mc/s	150 kc/s	21.7 Mc/s

was employed instead. It will be noted that on this range the ratio of fixed oscillator frequency to maximum output frequency is less than 6 to 1, whereas on the other ranges it is nearly 10 to 1 or more. With the 6 to 1 ratio the lowest spurious beat occurring in the output frequency range is that between the fourth harmonic of the fixed oscillator and the fifth harmonic of the variable oscillator. The variable oscillator frequency is always less than the fixed oscillator frequency.

The choice of the oscillator frequencies was also influenced by the design of the variable frequency oscillator as indicated later.

The Frequency Changer.

Balanced frequency changers are sometimes used in audio frequency heterodyne oscillators to reduce unwanted products to a minimum, but it was felt that the use of a balanced frequency changer in the present multi-range oscillator would be an unnecessary complication if sufficiently good performance could be obtained with the unbalanced type. A double-grid frequency-changer valve appeared to possess considerable advantages over a triode frequency changer valve, but when work on the oscillator was started the choice of suitable types of the former class was limited. In addition, they were designed primarily for use in radio receivers under different conditions from those required in the heterodyne oscillator. An octode type FC4 valve was eventually chosen for the frequency changer. An octode can be regarded as a frequency-changer valve with two "control" grids, to which the following electrodes are added:

- A screening electrode between these grids.
- A screening electrode between the second of these grids and the anode.
- An "anode" between the first input grid and the first screening grid.
- A suppressor grid between the second screening grid and the anode.

All these electrodes are in the same electron stream. Normally, the electrode (c) together with the first "control" grid and cathode form the triode beating

oscillator in a receiver, the radio signal being applied to the second "control" grid. In the present apparatus the variable frequency oscillator output is applied to the first control grid G_1 and the fixed frequency oscillator output is applied to the second control grid G_4 .

The screening grid between the control grids reduces the direct static capacitance between these grids to about $0.35\mu\text{F}$. In addition to this static capacitance coupling between the two grids there is also a second type of coupling due to the inductive effects of the common space charge stream on both electrodes. No difficulties were experienced due to coupling between the oscillators through the frequency-changer valve on the first three ranges, but on the highest frequency range some redesign of the oscillators was found necessary. With the final circuits distortion due to this coupling was found to be negligible at frequencies down to 70 kc/s.

Static characteristic curves showing the variation of the anode current of an FC4 valve with variation of the steady potential on the two control grids, G_1 and G_4 , are shown in Fig. 2 for steady potentials on the remaining electrodes having the values used in the oscillator. The approximately linear part of

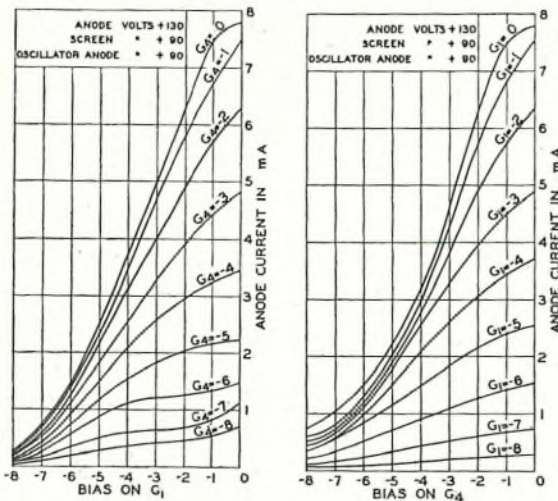

FIG. 2.—STATIC CHARACTERISTICS FOR FREQUENCY CHANGER, TYPE FC4

these curves can be represented approximately by the following relation:—

$$i_a = 0.15 (V_{G1} + 7.5) (V_{G4} + 7.7) \text{ mA.}$$

where V_{G1} = voltage on G_1

V_{G4} = voltage on G_4

and i_a = anode current.

If the potentials applied to G_1 and G_4 consist of steady components with small superimposed alternating components, $V_1 \sin \omega_1 t$ and $V_4 \sin \omega_2 t$ respectively, then the difference beat frequency component of anode current is

$$0.075 V_1 V_4 \sin (\omega_1 - \omega_2) t \text{ mA.}$$

The best values for the steady and alternating potentials on the control grids are those which give

the maximum ratio of beat frequency output signal to harmonic and noise output. The fixed and variable oscillators should be as much alike as possible, and equal outputs are desirable. The FC4 valve is well adapted to meet this condition as it has approximately equal mutual conductances on both control grids.

Preliminary tests were made at low frequencies with a harmonic analyser to determine the best operating conditions. With values of bias between about -1V and -3.5V and 1V R.M.S. sinusoidal voltages on both control grids, the second harmonic of the beat frequency was less than 0.5 per cent. of the fundamental, and the ratio of the beat-frequency output to the frequency changer valve noise output (over a 4 Mc/s band) was at least 70 db. The third harmonic output under these conditions was negligible.

The frequency changer valve is coupled to the first amplifier valve through a low-pass filter network in the anode circuit of the former valve. The maximum possible characteristic impedance of this filter was determined by the highest output frequency required and the valve capacitances and was fixed at 1500 ohms. The frequency changer valve was then operated under the following conditions:—

D.C. anode voltage = 130V.

D.C. voltage on screens and oscillator anode = 90V.

Grid bias on $G_4 = -1.4\text{V}$.

A.C. input to both control grids = 1V R.M.S.

Bias on G_1 adjusted for 0.2V beat frequency output into the 1500-ohm anode load. The value of this bias is about -2.5 to -3.2V .

The Design of the Fixed and Variable Frequency Oscillators.

As explained earlier, harmonics of the beat frequency and other unwanted products arise from harmonics of the two oscillator outputs mixing in the frequency changer. Providing one oscillator was free from harmonics it would not matter what the harmonics in the other oscillator were, and in single-range heterodyne oscillators particular attention is generally paid to the elimination of harmonics from the fixed frequency oscillator. It was not desired in the present instance, however, to introduce elaborate filtering of the output of either oscillator as good results could be obtained by making the harmonic output of both oscillators reasonably good. Thus 5 per cent. second harmonic output from each oscillator gives only 0.25 per cent. second harmonic in the beat frequency output.

It is desirable that the fixed and variable frequency oscillators should be as alike as possible, so that they should have similar variations of their frequency with external conditions such as temperature, supply voltages, etc. In any case, the frequency of both oscillators should vary as little as possible with these conditions. It was found that the required output of 1V R.M.S. from each oscillator with second harmonics of less than 5 per cent. and other harmonics correspondingly small, could be obtained from triode

oscillators employing MH 4 valves. The circuit diagram of the variable frequency oscillator is shown in Fig. 3.

The variable condenser in the variable frequency oscillator is a 1,000 $\mu\mu\text{F}$ S.L.F. air condenser on ranges 1 and 2, and a 100 $\mu\mu\text{F}$ condenser on range 3.

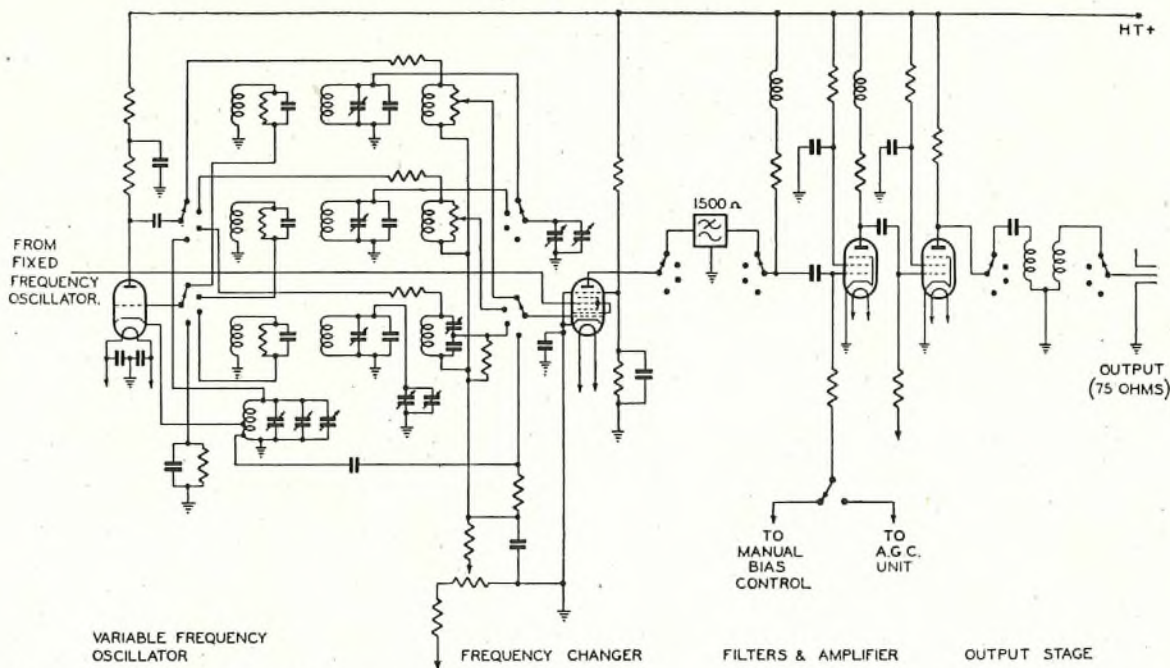

FIG. 3.—SCHEMATIC CIRCUIT DIAGRAM OF BEAT FREQUENCY OSCILLATOR (OMITTING FIXED FREQUENCY OSCILLATOR).

A separate condenser is used on range 4 with plates shaped to obtain an approximately logarithmic output frequency scale on this range. Three ganged trimmers, connected permanently in parallel with the main condensers, are provided for setting zero frequency on each range. In addition, preset air trimmer condensers are provided on all oscillator tuned circuits to facilitate initial adjustments.

The tuned circuit inductors in the fixed oscillator have the same inductances as the corresponding ones in the variable oscillator, these values being determined by the capacitances of the variable condensers, the fixed frequencies and the frequency ranges. The maximum frequency of the variable oscillator was made equal to the frequency of the fixed oscillator on each range.

Although the range of frequency on the lowest frequency variable oscillator range was made only 5 per cent. of the fixed oscillator frequency on this range, the L/C ratio and the impedance of the tuned circuits was still very high. To obtain low harmonic production it was found necessary to use a triple winding oscillator transformer in which the grid and anode windings are separate and tightly coupled to a third winding forming the tuned circuit inductor. A step-down ratio of 10:1 exists between the latter winding and the anode coil, thus considerably reducing the impedance seen from the anode circuit of the valve. A similar arrangement, with somewhat lower step-down ratios was also used on the second

and third ranges. On the fourth range a single tapped coil was used as shown in Fig. 3. Four position ganged rotary switches are used to change the oscillator ranges.

It is essential that the fixed and variable oscillators should be well screened from one another, and short

direct leads from each to the frequency changer valve are desirable. Details of the method of construction adopted to fulfil these requirements are given later.

Design of Filters.

The filters following the frequency changer must freely pass the difference frequency and provide a high attenuation at frequencies beyond the range for which they are designed, particularly at the oscillator frequencies. The maximum characteristic impedance which could be used on the fourth range was determined by the highest frequency of this range and the output capacitance of the frequency changer and the input capacitance of the first amplifier valve, stray wiring and switch capacitances being included in each case. Using these capacitances as the terminal capacitances of a simple π section filter, a characteristic impedance of 1,500 Ω was obtained as previously mentioned. It would be desirable for the coil in this filter to resonate with its own self capacitance at about 20 Mc/s, but no special precautions were taken to reduce the beating oscillator components on this range as the amplifier and output stages cut off sharply above about 4 Mc/s.

To obtain the same gain on all ranges the impedance of the filters in the other ranges was also made equal to 1,500 Ω , the filters being terminated at the output end only in this impedance. On ranges 1 and 2 simple π section filters with infinity points at the fixed oscillator frequencies were used, the self capacitance

of the inductor providing the necessary infinity point in range 2. In range 3, two sections with different infinity points were used to provide better elimination of the oscillator frequencies on this range.

The filters are completely screened, being mounted between the front panel and the vertical screen parallel to the front panel on the third shelf (Fig. 4).

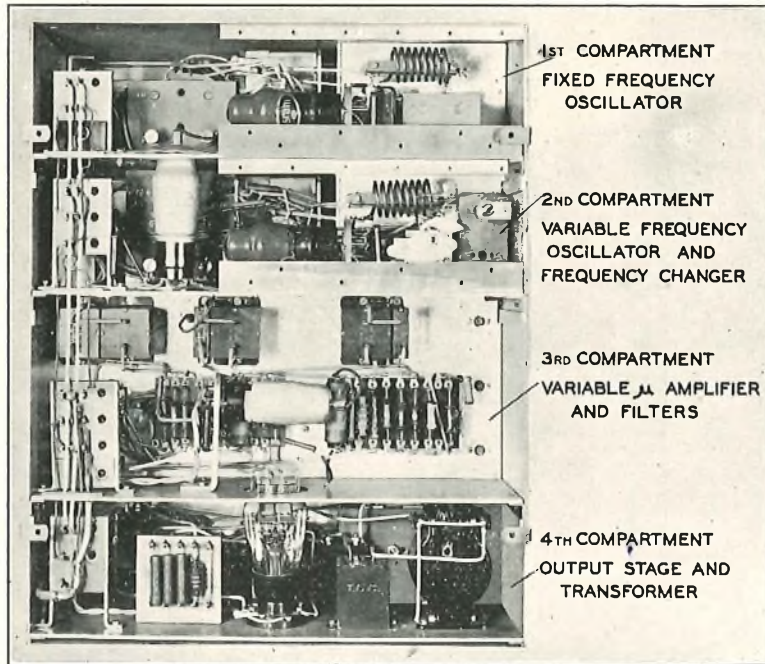

FIG. 4.—BACK VIEW—COVER AND SCREENS REMOVED.

Design of Wide-band Amplifier and Output Stage.

The beat frequency output of the frequency changer being fixed, it was necessary to introduce some method of gain control between this output and the final oscillator output to the send element. This could be done either by a variable attenuator between the frequency changer output and the input of the wide-band amplifier, or by variable attenuation following the output valve, or by a variable- μ valve in the wide-band amplifier. The last method was chosen for simplicity, but the first of these methods would be the best from the point of view of low harmonic output.

It was found that the required output to the send element of at least 1 V into 75Ω could be obtained over the frequency range from 10 c/s to about 4 Mc/s by using an A.C. V.P.1 variable- μ valve followed by a V.T.107 high slope output pentode. The anode circuit impedance of the A.C.V.P.1 valve consists of a $1,500 \Omega$ resistance and high frequency series compensating inductance. The time constants of the anode decoupling circuits of the frequency changer valve and variable- μ amplifier valve, and the time constant of the grid circuits coupling the former to the latter and the latter to the output valve, were chosen so that the rising gain at low frequencies associated with the anode decoupling circuits was partially compensated by the falling gain at low frequencies associated with the grid coupling circuit.

To avoid the use of the large electrolytic condensers required in the cathode circuits if self-biasing is used, a separate grid bias supply was used, the same stabilised 100 V supply also being used for the detector valve of the A.G.C. unit. About 30 V is applied to the log. law potentiometer which is used to vary the gain of the variable- μ valve, and this gives a total gain variation of about 40 db.

The output stage is designed to give a high impedance output across $1,500 \Omega$ in the anode circuit or a low impedance output through wide-band transformers to a 75Ω load. The two lowest frequency ranges are covered by a standard commercial type of transformer. The third range transformer (3-150 kc/s) was wound on mumetal rings and was shunt fed to avoid the saturation of the core by the direct current in the output valve. The fourth range transformer (150-4,000 kc/s) was wound on a core made up of two L-shaped 110μ dust cores.

Details of Construction.

Fig. 4 shows a back view of the oscillator, illustrating the method of construction. The complete oscillator is built up on detachable shelves which fit into a screened box, with removable back cover, fitted to the back of the panel on which the controls are mounted (Fig. 5). The fixed frequency oscillator occupies the top compartment and the variable frequency oscillator and the frequency changer the second compartment, the control grid of the frequency changer projecting into the top compartment. To avoid any slight movements of the back cover affecting the frequency of the

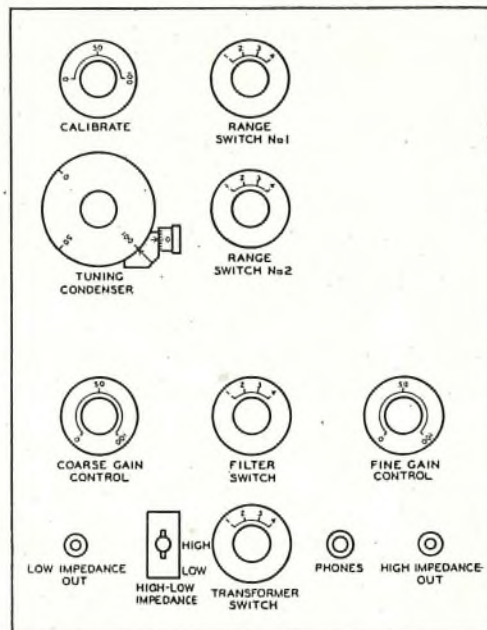

FIG. 5.—LAYOUT OF CONTROLS

oscillators, additional aluminium screens were fitted to the two shelves between the oscillating circuits and the back cover. These are shown removed in Fig. 4, only the brass angle to which they are fixed being shown.

It is essential to reduce frequency modulation caused by oscillator vibration as much as possible. Open wire coils on the fourth range were found unsatisfactory in this respect until they were clamped in two places between Keramot strips.

The preset trimmer condensers for the fourth range oscillators are mounted close to the corresponding coils, the one for the variable frequency oscillator having a slow-motion control. All the trimmers and output potentiometers for the other ranges are mounted on a single panel for each oscillator and are readily accessible. The Yaxley switches have long drive bars which permit the wafers to be mounted in convenient positions near the valve and coils.

The third compartment contains the frequency changer, filters and the variable-mu amplifier stage, and the bottom compartment contains the output stage and transformers. All supply leads are taken to tag blocks, one for each shelf, which also form convenient mountings for meter jacks provided for maintenance purposes.

Design of Power Supplies.

A stabilised 4 V heater supply is obtained from a step-down transformer of the saturated core type with a condenser in series with the primary winding. A small "compensating" transformer, connected between the primary and secondary provides a feed-back path and improves the regulation. The transformer has two secondary windings, one supplying 8.6 A at 4 V for the oscillator, amplifier valve and diode of the A.G.C. unit and the other 1 A at 4 V for the detector of the A.G.C. unit. A change of 17 per cent. in mains voltage produces a change in heater voltage of less than ± 0.5 per cent.

A stabilised H.T. supply is also essential to reduce changes of output frequency and level with mains supply changes. For the anode supply it was found best to use a single rectifier to feed two stabilising circuits. Each stabilising circuit consists of an iron barretter and two neon-tube stabilisers (Stabilisers No. 2) and provides a stabilised output of about 240 V. The change in output voltage is only ± 0.4 V for a change in supply voltage of ± 35 V. One stabiliser feeds the first three valves in the oscillator and also the A.G.C. unit, and the other stabiliser feeds the last two valves in the oscillator. Low frequency coupling between these latter valves and the earlier oscillator stages via the H.T. supply is much reduced by the use of the separate stabiliser circuits. The Stabilisers No. 2 have been found very satisfactory providing they are aged before use and not overloaded. In the present circuit they are operated with a current of about 20 mA. When used in series and with a barretter the tolerance on striking voltage is wide,

especially if a high resistance is shunted across one tube, and no trouble in this respect has been experienced.

The grid bias supply, and part of the H.T. supply for the A.G.C. detector is obtained from two half-wave metal rectifiers fed from a separate winding on the main H.T. supply transformer. This provides a smoothed output of 250 V at 10 mA. The use of metal rectifiers for the grid bias supply and valve rectifiers for the H.T. supply ensures that the grid bias voltage will be provided before the H.T. voltage. A grid bias supply voltage of 100 V is obtained from across a neon-tube type 7475 in series with 20,000 Ω . The unstabilised voltage is fed to the A.G.C. unit, which incorporates two of these tubes in series (see Fig. 8).

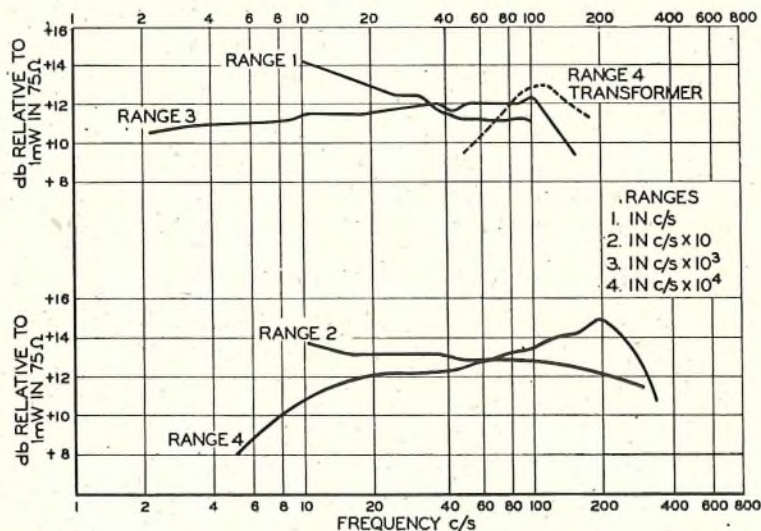

FIG. 6.—OUTPUT OF BEAT FREQUENCY OSCILLATOR.

Performance of the Oscillator.

The maximum output of the oscillator from the low impedance output into a 75 Ω load is shown as a function of frequency in Fig. 6. The change in output when the supply voltage is varied by ± 40 V is too small to measure on the normal type of output meter. The open-circuit voltage available at the high impedance socket is at least 8 V on all ranges. An approximately logarithmic variation of frequency with condenser setting is obtained on each range.

It would naturally be expected that the performance of the 4th range would not be as good as that of the lower ranges, because on the highest range the valve capacitances form a much higher percentage of the total oscillator capacitances than on the lower ranges. Even if this were not so, the absolute frequency stability in c/s would naturally be better on the lower ranges.

Even on the highest frequency range the frequency is nearly independent of mains voltage fluctuations, owing to the good stabilisation of the H.T. and L.T. supplies. On the highest range a total mains voltage variation of ± 40 V produced a change of only ± 150 c/s at 150 kc/s and ± 50 c/s at 3 Mc/s. On the lower ranges the frequency change was too low to measure with the apparatus available.

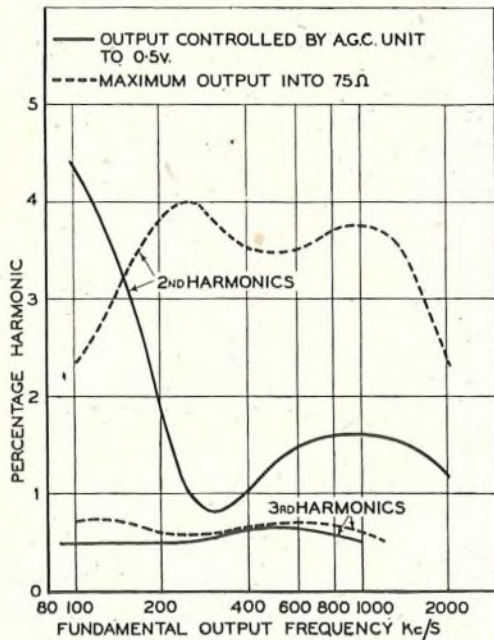

FIG. 7.—HARMONIC CONTENT IN RANGE 4 OUTPUT.

Frequency drift is only noticeable on the highest range. After first switching on from cold there is very little change for the first three minutes or so, but there is then a fairly rapid change of about 1 kc per minute for some 7 minutes. After this the change is slower and depends upon ambient temperature. During one test the change was at a uniform rate of about 1 kc per hour for a period of 4 hours.

On the highest range the calibration is not completely independent of valve changes, but this could be expected in view of the high fraction of the oscillator circuit capacitance formed by the valve capacitances. Tests were made by replacing the fixed frequency oscillator valve by valves of the same type selected at random, adjusting to "zero beat" by the controls on the variable frequency oscillator and measuring the different output frequencies for various dial settings. The largest difference in frequency recorded between any two valves was 35 kc/s at 3 Mc/s. The largest percentage difference recorded was 4.2 per cent. at the lowest frequency of 150 kc/s. When changing the fixed frequency oscillator valve it is therefore desirable to readjust the frequency to the original value. The same also applies to a lesser extent to the variable frequency oscillator valve.

The wave form of the output on the first three ranges is somewhat better than that on the highest range, probably owing to less coupling between the oscillators through the frequency changer valve and to better filtering of the oscillator harmonics prior to the frequency changer. On the lowest frequency range no departure from a purely sinusoidal output was visible on an oscillograph at frequencies down to 3 c/s. On maximum output on the second and third ranges the second harmonic output only exceeded 2 per cent. of the fundamental output at the bottom end of each range. The second and third harmonic outputs on the highest frequency range for maximum output and for an output of 0.5 V into 75 Ω , the output

being controlled at this value by the A.G.C. unit; are shown in Fig. 7.

Outside each range the oscillator frequencies naturally form the largest unwanted products in the output. On the first three ranges the oscillator frequency outputs are less than -49 db. rel. to 1 mW at maximum output. On the fourth range, at the highest frequency and maximum output the variable frequency oscillator output is -45 db. rel. to 1 mW, and the fixed frequency oscillator output is -63 db. rel. to 1 mW. A complete series of measurements of unwanted products coming inside the various frequency ranges has not yet been made. As the oscillator is varied over the first three ranges, however, no spurious beats are audible in telephones connected in the output stage. One spurious beat was just audible on the fourth range and this product was found to have a level of -72 db. rel. to the fundamental output. The total thermal noise output is naturally greatest on the highest range where the bandwidth is greatest. On this range it is -70 db. rel. to 1 mW in 75 Ω .

The A.C. mains hum level output at 50 c/s or 100 c/s is less than -48 db. rel. to 1 mW in 75 Ω .

Application of Automatic Gain Control.

At the time this oscillator was designed it was not possible to make the frequency response of the highest range output transformer quite flat. In addition, the output of the variable frequency oscillator was not quite independent of frequency on each range or exactly the same on each range. When an oscillator of this type is used for transmission measurements, the measurement can be greatly expedited if the output from the oscillator to the send element can be made independent of frequency, particularly if the effective internal E.M.F. of the send element is measured by a thermo-couple with rather sluggish response. It was thought, therefore, that it would be worth while to produce a control unit, to associate with the send element and the oscillator, to maintain the effective internal E.M.F. in the former independent of the frequency or the send element load impedance.

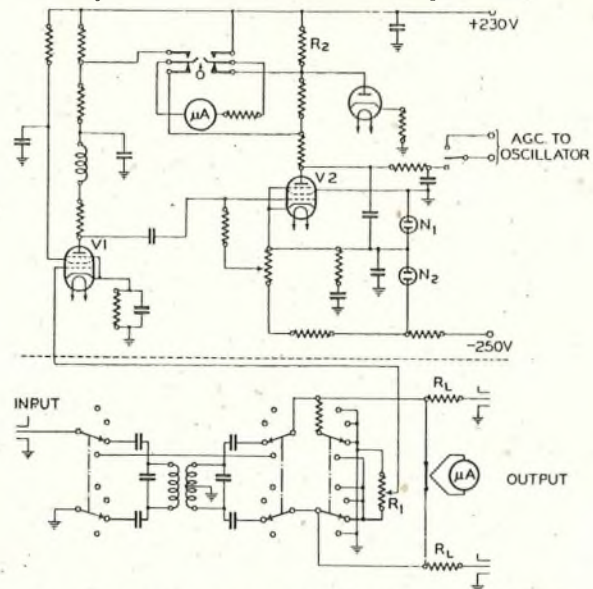

FIG. 8.—CIRCUIT DIAGRAM OF SEND ELEMENT AND A.G.C. UNIT

The circuit diagram of the send element and associated A.G.C. unit is shown in Fig. 8. The send element can be used for the measurement of balanced or unbalanced circuits, a number of transformers being provided for the former to cover the whole frequency range. The effective internal impedance of the send element is R_L in the unbalanced case and $2R_L$ in the balanced case, and the effective internal E.M.F. of the send element is the voltage across the thermo-couple. This latter voltage is maintained constant by taking a fraction of it from the potentiometer R_1 to the valve V1, which is a wide-band amplifier stage having a flat gain of about 12 db. over the whole frequency range of the oscillator. The output of about 1 V from this stage is applied to the detector valve V2. The screen grid of this valve, which is connected to earth, is maintained at a constant potential of about 100 V positive relative to the cathode by the neon-tube N_1 , and negative grid bias is derived from part of the potential drop across N_2 , both of these tubes being fed from the grid bias supply. The valve V2 acts as a square law detector and, by virtue of the amplification provided by V1 and the high value of the anode resistance R_2 (500,000 Ω) in the anode circuit of V2, there is a large change in the D.C. voltage on the anode of V2 for a small change in the voltage across the send element thermo-couple. The D.C. voltage on the anode of V2 is taken to the grid circuit of the variable mu penultimate valve of the oscillator, so that as the output of the oscillator changes the gain of this valve is automatically changed so as nearly to restore the original output.

The A.G.C. may be thrown in or out of circuit by a key arranged so that the manual gain control on the oscillator is completely out of circuit when the A.G.C. control is in operation. The level at which the voltage across the thermo-couple is maintained constant is adjustable at any value up to the maximum of which the oscillator is capable. The A.G.C. circuit will maintain the internal E.M.F. of the send element constant to within ± 0.2 db. from 20 c/s up to the maximum frequency.

Suggestions for Improvement and Comparison with Commercial Models.

As is common with apparatus of a new type, various possible improvements have become apparent during the course of development, although the oscillator in its present form is perfectly satisfactory for its original purpose, namely, transmission measurement on television circuits. For other types of work, such as the measurement of the response of filters used in carrier telephony, considerable improvement in the frequency stability of the highest frequency range is desirable. Another oscillator has since been designed particularly for this purpose, covering only the frequency range from 150 kc/s to 5 Mc/s, in which special attention has been paid to frequency stability, accuracy of calibration and freedom from noise, spurious products and harmonics in the output. In this later oscillator the temperature coefficients of

frequency of the fixed and variable oscillators have been made as low as possible and care taken to maintain their temperatures reasonably constant. The frequency of these oscillators has been made rather lower than in the present model, and acorn type valves have been used in them, so that the somewhat variable valve capacitances form a lower fraction of the total oscillator tuning capacitances. Electron coupled oscillator circuits have been used to reduce coupling between the fixed and variable oscillators which occurs in the present model via the frequency changer valve capacitances. Filter circuits have been introduced to improve the wave-form of the two inputs to the frequency changer valve to reduce harmonics and intermodulation products. A high slope low noise H.F. pentode valve has been used for the frequency changer in place of the octode used in the present oscillator, thus enabling a better signal-to-noise ratio to be obtained in the output.

After the oscillator described in the present article was completed, two commercial heterodyne oscillators, covering the frequency range from 50 c/s to 5 Mc/s, were placed on the market. One of these, an American design, has two output ranges covering 50 c/s to 40 kc/s and 10 kc/s to 5 Mc/s, the beating oscillator frequencies being about 150 kc/s and 20 Mc/s. It will be seen that the latter is nearly the same as the value used in the oscillator described in this article. The division of the 50 c/s to 5 Mc/s frequency range into only two frequency ranges is probably satisfactory for tests on circuits with nearly flat frequency response over this range, but the stability of frequency in the region from 40 to 150 kc/s would not compare with that obtained in the P.O. oscillator. In the latter only three ranges need be used to cover frequencies above 50 c/s; the lowest frequency range, which gives an output down to a frequency of only a few c/s, having been provided for special laboratory tests. The American oscillator employs a simple A.G.C. circuit, but it is stated by the makers that this only maintains the output constant to within ± 1.5 db. compared with ± 0.2 db. in the P.O. oscillator. In addition, only a high impedance output is provided, no output transformers being used. Where a low output impedance is desired, however, it may be preferable to use a cathode follower output stage in which the variation of gain with frequency will be much less than in the output transformers, and the latter, together with their associated switches, can be omitted.

Conclusions.

A four range beat-frequency oscillator, together with its associated send element and power supplies, has been produced which enables transmission measurement to be made on television circuits over the whole of the low-definition or high-definition frequency range. The oscillator is very suitable for laboratory testing, but a smaller simplified version with only two ranges, and, if possible, without A.G.C. or highly stabilised power supply circuits, is desirable for portable use.

Notes and Comments

Roll of Honour

The Board of Editors deeply regrets to have to record the deaths of the following members of the Engineering Department :—

While serving with the Armed Forces, including Home Guard

Aberdeen Telephone Area ..	Mennie, H.	Unestablished Skilled Workman	Flight-Sergeant, Royal Air Force
Belfast Telephone Area ..	Butler, C. H.	..	Unestablished Skilled Workman	Fusilier, Royal Irish Fusiliers
Belfast Telephone Area ..	Hoey, R. B. E.	..	Skilled Workman, Class II	Signalman, Royal Corps of Signals
Birmingham Telephone Area	Knight, K. E. C.	..	Unestablished Draughtsman	Captain, Royal Armoured Corps
Coventry Telephone Area ..	Fagg, M. O.	..	Draughtsman-in-Training	Ordinary Telegraphist, Royal Navy
Coventry Telephone Area ..	Worth, W. H.	..	Unestablished Skilled Workman	Lance-Bombardier, Royal Artillery
Dundee Telephone Area ..	Fyffe, C. S.	Unestablished Skilled Workman	Private, Royal Scots Fusiliers
Edinburgh Telephone Area	Duncan, D.	Unestablished Skilled Workman	Air Mechanic, 1st Class, Royal Navy
Edinburgh Telephone Area	Hogg, P. H.	..	Unestablished Skilled Workman	Signalman, Royal Corps of Signals
Edinburgh Telephone Area	Robertson, F. C.	..	Unestablished Skilled Workman	Lance - Sergeant, King's Own Scottish Borderers
Engineer-in-Chief's Office ..	Mayo, J. E.	Unestablished Skilled Workman	Leading Aircraftman, Royal Air Force
Engineer-in-Chief's Office ..	Swift, G. L.	..	Inspector	Sergeant-Pilot, Royal Air Force
Lincoln Telephone Area ..	Woodcock, G. A.	..	Unestablished Skilled Workman	Signalman, Royal Corps of Signals
London Telecommunications Region	Bayton, E. F. T.	..	Unestablished Skilled Workman	2nd Lieutenant, Royal Corps of Signals
London Telecommunications Region	Bowers, R. W.	..	Skilled Workman, Class II	Able Seaman, Royal Navy
London Telecommunications Region	Coe, A. R.	Labourer	Corporal, Royal Berkshire Regiment
London Telecommunications Region	Davis, F. E.	..	Labourer	Sergeant, Royal Air Force
London Telecommunications Region	Eddon, J. S.	..	Skilled Workman, Class II	Chief Petty Officer, Royal Navy
London Telecommunications Region	Gilliatt, L.	..	Unestablished Skilled Workman	Ordinary Seaman, Royal Navy
London Telecommunications Region	Grierson, S. K.	..	Unestablished Skilled Workman	Signaller, Royal Corps of Signals
London Telecommunications Region	Harndon, H. H. J.	Labourer	Lance-Bombardier, Royal Artillery
London Telecommunications Region	Huben, H. J.	..	Unestablished Skilled Workman	Signaller, Royal Corps of Signals
London Telecommunications Region	Miller, S. J.	Unestablished Skilled Workman	Pilot, Royal Air Force
London Telecommunications Region	Powell, C. A.	..	Unestablished Skilled Workman	Private, Royal Warwickshire Regiment
London Telecommunications Region	Woods, J. E.	..	Labourer	Fusilier, Royal Fusiliers
Manchester Telephone Area	Birtles, R. B.	..	Unestablished Skilled Workman	Sergeant-Pilot, Royal Air Force
Norwich Telephone Area ..	Bloye, E. C.	..	Unestablished Skilled Workman	Able Seaman, Royal Navy
Reading Telephone Area ..	Evans, L.	Labourer	Driver, Royal Army Service Corps
Scotland West Telephone Area	Norton, R. C.	..	Unestablished Skilled Workman	Sapper, Royal Engineers
Sheffield Telephone Area ..	Causebrook, W. C.	Skilled Workman, Class II	Sergeant, Royal Corps of Signals

Recent Awards

The Board of Editors has learnt with great pleasure that the following members of the Engineering Department have been honoured for the Services they have rendered to their country :—

While serving with the Armed Forces, including Home Guard

Bournemouth Telephone Area	Goodall, C. H. . .	Unestablished Skilled Workman . . .	Sergeant, R.A.S.C.	Distinguished Conduct Medal
Glasgow Telephone Area	Hammond, W. . .	Skilled Workman, Class I . . .	Major, Royal Corps of Signals . .	Member of the Order of the British Empire
Glasgow Telephone Area	Mooney, R. L. . .	Unestablished Skilled Workman . . .	Sergeant, R.A.F.V.R. . .	Distinguished Flying Medal
London Postal Region . .	Pidgeon, W. T. . .	Skilled Workman, Class I . . .	Chief Engine Room Artificer, Royal Navy . . .	British Empire Medal (Military Division)
Manchester Telephone Area	Birtles, R. B. . .	Unestablished Skilled Workman . . .	Sergeant-Pilot, R.A.F. . . .	Distinguished Flying Medal
Plymouth Telephone Area	Jane, A. E. . .	Unestablished Skilled Workman . . .	Home Guard . . .	British Empire Medal (Military Division)

New Year Honours

The Board of Editors offer its congratulations to the following members of the Engineering Staff whom His Majesty the King has been graciously pleased to honour in the New Year's Honours List.

To be a Member of the Most Excellent Order of the British Empire

Mr. A. E. Hayward, Assistant Engineer, Regional Director's Office, Bristol.

To be awarded the Medal of the Most Excellent Order of the British Empire

Mr. J. B. Brunton, Inspector, Wemyssfield, Kirkcaldy.

Mr. T. Dooley, Inspector, Londonderry.

Mr. M. C. Penfold, Skilled Workman, Class I, Canterbury.

Mr. F. W. Perrin, Inspector, Engineer-in-Chief's Office (E.).

Regional Notes

London Telecommunications Region

REMOVAL OF A P.M.B.X.

The 12-position C.B. No. 9 P.B.X. switchboard at the Gramophone Co.'s factory, Hayes, was removed early this year to a larger switchroom. Adoption of the normal method of duplicating the installation was not possible under existing circumstances, and it was decided to transfer the switchboard as it stood, during a week-end.

Preliminary work included the erection of a new main frame, termination of teed cables and running of switchboard cables from the frame ready for soldering to the switchboard jacks. A temporary 2-position switchboard was installed to give service to 100 of the total of 800 extensions whilst the main suite was out of use.

The switchboard was released at 5.30 p.m. on Friday, and the work of dismantling the sections was begun immediately. When the incoming cables and inter-position wiring had been disconnected, the multiple was removed from the sections, which were then conveyed about 100 yd. to the new switchroom and lined up in position. The multiple which, meanwhile, had been carefully examined, was replaced in the switchboard and reconnected. Full service was restored at 2 p.m. on Sunday.

The success of this unusual operation reflects considerable credit on the staff employed, and in this the Company's staff, who undertook the conveyance and lining up of the sections in addition to structural work, are entitled to a full share.

W.T.

TOLL B ROUTES

CONVERSION TO 7-DIGIT DIALLING

Early in January, 1940, experimental trials were carried out from Upminster, Oxshott, and Leatherhead exchanges to the 2 VF Trunk Director equipment, with a view to providing suitable Toll B routes (i.e. traffic incoming to the 10-mile circle only) with direct dialling facilities. The scheme embraced all types of manual and auto exchanges in the Toll Area for direct 7-digit dialling to London auto exchanges within the 12½-mile circle which were already available from the 2 VF Trunk Director equipment, access to the London manual exchanges being obtained via the new Toll B manual board, which will also deal with those Toll B routes remaining on a manual basis.

It is intended ultimately to provide a separate Director equipment to serve the Toll B dialling traffic, but temporarily the 2 VF Trunk Director equipment is being used. This was made possible by the deferments of the conversion of Group Centre trunk routes to 2 VF working.

Each circuit is connected to the 2 VF Trunk Director equipment via an auto-to-auto relay set and a modified first code selector. This involved the extra provision of 1,000 auto-to-auto relay sets, together with 666 junctions from the second and third code selectors to exchanges on the London network. In addition, the second and third code T.D.F.s were completely regraded and approximately 7,000 jumpers were required on the Faraday Building I.D.F.s.

Modifications have also been required at Toll B Area exchanges in order to provide loop dialling conditions on a total of 711 Toll B circuits.

To provide for an alternative access to the London auto network, most of the converted L.T.R. Toll B routes have been divided; such routes have a few circuits terminated on selectors at selected auto exchanges on the fringe of the London network. These selected exchanges, however, do not in every case afford full automatic access to the whole of the 10-mile circle, due to the limitations of multi-metering facilities or to transmission considerations.

The trials were satisfactory and in October last the transfer of Toll B circuits to 7-digit working was commenced. Completion is expected during March, 1942.

W.H.S./C.A.P.

North-Eastern Region

SUB-AQUEOUS CABLES ACROSS THE RIVER TRENT

Two cables, hessian-taped and armoured, and each consisting of 122 pairs Q.T. 20 lb. conductors have recently been laid across the tidal portion of the River Trent, a river distance of 225 yards.

The work first entailed the cutting of a trench in the river bed to a depth of 6 ft., this being the depth stipulated by the Humber Conservancy to safeguard the



possibility of interference by river traffic when anchoring. The trench was cut by a combination of a grab dredger and a scoop dredger. The grab dredger, as its name implies, is a steel grab and consists of two rows of curved tyres which are dropped into the river in the open condition. The crane has a radius of some 20 ft. and is mounted on a barge anchored fore and aft at right angles to the line of the trench (Fig. 1).

The scoop dredger is a rectangular tray 9 ft. wide with reinforced back and sides drawn backwards and forwards across the river by a steel rope terminated on a horizontal drum below the boilers of a traction engine on either side of the river. The scoop cannot throw clear the excavated material, unlike the grab which can swing this material clear of the trench and drop it in the direction of the running tide.

The approaches to the middle of the river from either side gave very little trouble, but a hard surface in the middle took some time to negotiate. During these cutting operations a tide of 4 to 6 knots was often running and at intervals it was necessary to employ the scoop dredger to take out the loose silt coming back into the trench. As soon as the grab dredger had been across the river and the scoop drawn across three or four times to remove loose silt, the scoop was uncoupled and the cables, which were already in position on the Yorkshire side, were attached to the steel rope. The first cable was drawn across in eleven and the second in twelve minutes. A trench 4 ft. deep had previously been cut into the bank on either side of the river, and the cable-laying operations were carried out at low tide. For any future tidal river crossings of this nature, the grab dredger is considered to be an indispensable machine to employ.

E. H. N. T.

North-Western Region

TEMPUS FUGIT

The flight of time and the long arm of coincidence became manifest during underground repair operations in the Liverpool Area recently. The operations in hand involved the opening of a joint in a somewhat congested manhole to replace a faulty length of cable. The sleeve was removed during the evening of Saturday, February 3rd, 1942, and when removed the jointer was heard to remark: "The old man made this joint." The name inscribed on the paper slip inside the joint was that of "the old man"—the father of the jointer carrying out the operations—and was dated December 3rd, 1903. The joint was "a beautiful joint" and, apart from accident, would have remained as such until the crack of doom.

Many other cases of the sound workmanship carried out in bygone days have been revealed from time to time, and other existing examples are worthy monuments which we moderns might very well emulate, and endeavour to retain or capture the spirit of pride in workmanship that marked so distinctly performances of the past.

Staff Changes

Promotions

Name	Region	Date	Name	Region	Date
<i>From Area Engr. to Telephone Manager</i>			<i>Clerical Officer to Tech. Asst.</i>		
Sephton, N. F.	.. Mid. Reg. to Lincoln	2.11.41	McConnell, D. A.	.. E.-in-C.O...	2.9.41
Bagley, T.	.. H.C. Reg. to Colchester..	1.1.42	<i>Mechanic Grade I to Tech. Asst.</i>		
<i>From Asst. Engr. to Exec. Engr.</i>			Dormon, A. E. .. H.C. Reg. 2.9.41		
Mellor, S. D. E.-in-C.O. to N.E. Reg.	1.1.42	<i>Skilled Workman Class I to Insp.</i>		
Alderson, J. H. E.-in-C.O.	16.2.42	Shepherd, A. M.**	.. E.-in-C.O... .. .	18.10.41
Jackson, G. Test Sectn. (Ldn.) to Mid. Reg.	14.12.41	Prain, H. E.-in-C.O.	26.10.41
Creighton, J. L. E.-in-C.O.	10.12.41	Hanna, A. M. L.T.R. to E.-in-C.O.	18.10.41
Pearce, C. A. R. L.T.R.	10.12.41	Baker, R. F. E.**	.. E.-in-C.O.	26.10.41
Storey, W. J. H.C. Reg.	14.1.42	Macdiarmid, I. F. Scot. Reg. to E.-in-C.O. . . .	26.10.41
Morley, J. E. E.-in-C.O. to S.W. Reg. . . .	6.2.42	Long, F. S.**	.. E.-in-C.O.	26.10.41
<i>From Chief Insp. to Asst. Engr.</i>			Francis, E. H. W. & B.C. Reg. to E.-in-C.O.	26.10.41
Arthur, R. Scot. Reg.	21.12.41	Awbery, W. A. W. & B.C. Reg. to E.-in-C.O.	26.10.41
Porter, W. F. L.T.R.	10.12.41	Davis, E. H. Test Section to E.-in-C.O. . . .	17.8.41
Judd, F. W. S.W. Reg. to L.T.R.	21.1.42	Jackson, J. W. & B.C. Reg. to E.-in-C.O.	23.11.41
<i>From Chief Insp. to Chief Insp. with Allowance.</i>			Dyer, E. T. Mid. Reg. to E.-in-C.O.	23.11.41
Last, S. G. H.C. Reg.	1.1.42	Saxby, F. H. Mid. Reg. to E.-in-C.O.	16.11.41
Bingham, A. H. S.W. Reg.	1.1.42	Goodall, W. G. E.-in-C.O.	14.12.41
<i>From Insp. to Chief Insp.</i>			Jones, T. J. E.-in-C.O.	14.12.41
Haddleton, P. J. L.T.R.	6.11.40	Robinson, E. L. A.**	.. E.-in-C.O.	1.1.42
Mallows, F. J. L.T.R.	23.11.41	Gray, J. A. E.-in-C.O.	1.1.42
Hutchings, E. J. L.T.R.	30.8.41	Swann, G. F. E.-in-C.O.	27.5.40
Mickler, L.** N.E. Reg.	7.11.41	Martin, A. C. H.C. Reg. to E.-in-C.O.	7.12.41
Bell, W. T. E.-in-C.O.	30.11.41	Sudell, R. A. H.C. Reg. to E.-in-C.O.	7.12.41
Crowther, L. R. N.E. Reg.	7.11.41	Flanagan, F. B. W. & B.C. Reg. to E.-in-C.O.	30.11.41
Catt, L. H. E.-in-C.O.	30.11.41	Pollock, D. R. L.T.R. to E.-in-C.O.	14.12.41
Attwood, J. W. A. E.-in-C.O.	9.11.41	Kitt, M. J. H.C. Reg. to E.-in-C.O.	23.12.41
Walters, J. R. S.W. Reg. to E.-in-C.O. . . .	16.11.41	Bond, W. W. G. S.W. Reg. to E.-in-C.O.	6.1.42
Richards, D. L. E.-in-C.O.	7.6.40	<i>Insp. to Asst. Traffic Supt.</i>		
Ricketts, N. W. J. L.T.R.	24.12.41	Burgess, A. E. E.-in-C.O. to L.T.R.	16.9.41
Carrall, T. H. N.W. Reg.	1.11.41	Richardson, C. A. E.-in-C.O. to L.T.R.	23.9.41
Sims, A. E. J.** E.-in-C.O.	21.12.41	<i>Insp. to Asst. Insp. of Traffic Class II</i>		
Lawrenson, S. E.-in-C.O.	21.12.41	Dawson, A. Gilnahirk R/S to Telecoms. Dept.	11.12.41
Turner, A. E. L.T.R. to L.P.R.	2.12.41			
Baxter, W. S. Scot. Reg.	26.12.41			
Huxley, G. F. N.W. Reg.	27.8.41			
Trueman, G. F.** N.W. Reg.	14.12.41			
Halton, T. J. V. N.W. Reg.	10.12.41			
Stevens, S. T. W. & B.C. Reg. to S.W. Reg.	4.1.42			
Smart, J. H. C. N.W. Reg.	14.12.41			

Retirements

Name	Region	Date	Name	Region	Date
<i>Chief Motor Transport Officer</i>			<i>Asst. Engr.</i>		
Hudson, A. E.-in-C.O.	31.1.42	Parker, C. N.E. Reg.	31.12.41
<i>Exec. Engr.</i>			Logan, B. G. H.C. Reg.	7.1.42
Hargreaves, T. N.W. Reg.	31.12.41	<i>Chief Insp. with Allowance.</i>		
Ireland, W. Scot. Reg.	31.12.41	Cowles, H. M. H.C. Reg.	31.12.41
Salmon, J. B. H.C. Reg.	31.12.41	Marsden, C. S.W. Reg.	31.12.41
Walton, W. E. S.W. Reg.	31.12.41	<i>Quartermaster</i>		
Hobson, J. W. N.E. Reg.	31.12.41	Mainland, L. H.M.C.S.	23.12.41
Tite, W. G. E.-in-C.O.	31.12.41			
Snell, W. S. E.-in-C.O.	15.2.42			

Transfers

Name	Region	Date	Name	Region	Date
<i>Asst. Engr.</i>			<i>Insp.</i>		
Wood, J. A. L.T.R. to E.-in-C.O.	19.11.41	Reynolds, J. Test Section to E.-in-C.O.	15.12.41
<i>Chief Insp.</i>			Cooke, E. M. E.-in-C.O. to S.W. Reg.	6.1.42
McWalter, W. V. E.-in-C.O. to Scot. Reg.	19.12.41	Carter, R. E. Test Section to E.-in-C.O.	18.1.42
			Freeman, A. W. Cable Test Section to E.-in-C.O.	18.1.42
			Sutherland, J. S. E.-in-C.O. to W. & B.C. Reg.	23.2.42
			Lane, R. W. E.-in-C.O. to W. & B.C. Reg.	23.2.42

Deaths

Name	Region	Date	Name	Region	Date
<i>Asst. Staff Engr.</i>			<i>Fourth Officer</i>		
Harrison, R. H.	E.-in-C.O.	27.1.42	Dalglish, R. J. T.	H.M.C.S.	2.1.42
<i>Asst. Engr.</i>			<i>Chief Engr.</i>		
Tregilgas, A. St.C.	N.W. Reg.	3.2.42	Borthwick, G.	H.M.C.S.	1.12.41
<i>Inspector</i>					
Wright, J. H. R.	E.-in-C.O.	16.1.42			

CLERICAL GRADES

Promotions

Name	Region	Date	Name	Region	Date
<i>From E.O. to S.O.</i>			<i>From C.O. to E.O.</i>		
Cross, A. B.	E.-in-C.O.	16.12.41	Gebbett, M. G.** (Miss)	E.-in-C.O.	16.12.41
Southgate, A. G.	E.-in-C.O.	16.12.41	Roope, D. M. (Miss)	E.-in-C.O.	12.12.41
Goodway, T. G.**	E.-in-C.O.	16.12.41	Root, J. M. (Miss)	E.-in-C.O.	16.12.41

Retirement

Name	Region	Date	Name	Region	Date
<i>Staff-Officer</i>					
Bertram, J.	E.-in-C.O.	15.12.41			

**Promoted "in absentia." All promotions "Acting."

BOARD OF EDITORS

- A. J. GILL, B.Sc., M.I.E.E., M.I.R.E., Chairman.
- F. E. NANCARROW, A.R.C.Sc., M.I.E.E.
- P. B. FROST, B.Sc., M.I.E.E.
- A. H. MUMFORD, B.Sc.(ENG.), M.I.E.E.
- C. W. BROWN, A.M.I.E.E.
- H. LEIGH, B.Sc.(ENG.), A.M.I.E.E., Acting Managing Editor.
- G. E. STYLES, A.M.I.E.E., Acting Assistant Editor.

Copyright

The entire contents of this JOURNAL are covered by general copyright, and special permission is necessary for reprinting long extracts, but Editors are welcome to use not more than one-third of any article, provided credit is given at the beginning or end thus: "From the *Post Office Electrical Engineers' Journal*."

The Board of Editors is not responsible for the statements made or the opinions expressed in any of the articles in this JOURNAL, unless such statement is made specifically by the Board.

Communications

All Communications should be addressed to the Managing Editor, *P.O.E.E. Journal*, Engineer-in-Chief's Office, Alder House, Aldersgate Street, London, E.C.1. Telephone: HEADquarters 1234. Remittances should be made payable to "*The P.O.E.E. Journal*" and should be crossed "& Co."

Binding Cases

Cases for binding are available, and may be obtained from the Local Agents for 1s. 9d. Subscribers can have their copies of Volumes bound, at a cost of 3s., by sending the complete set of parts to the Local Agents or to the *P.O.E.E. Journal*, Engineer-in-Chief's Office, Alder House, Aldersgate Street, London, E.C.1. Orders for binding for Vols. 1-19 should indicate whether the original binding case with black lettering, or the later pattern with gold, is required. Cases with gold lettering are the only type stocked from Vol. 20 onwards.

Back Numbers

The price of the JOURNAL, which is published quarterly, is 1s. (1s. 3d. post free) per copy, or 5s. per annum post free. Back numbers can be supplied, subject to availability of stocks, at 1s. each (1s. 3d. post free). Orders for back numbers may be sent to the Local Agents or to the Publishers.

Advertisements

All communications relating to space reservations should be addressed to the Advertisement Editor, *P.O.E.E. Journal*, Alder House, Aldersgate Street, London, E.C.1. Communications regarding advertisement copy, proofs, etc., should be addressed to the Publishers, Messrs. Birch & Whittington (Prop. Dorling & Co. [Epsom], Ltd.), 49 Upper High Street, Epsom, Surrey.

NOTE.—The fact that goods made of raw material in short supply owing to war conditions are advertised in this Journal should not be taken as an indication that they are necessarily available for export.

iii

'AVO'
Regd. Trade Mark

46-range Model 7
Universal AvoMeter

40-range Model 40
Universal AvoMeter

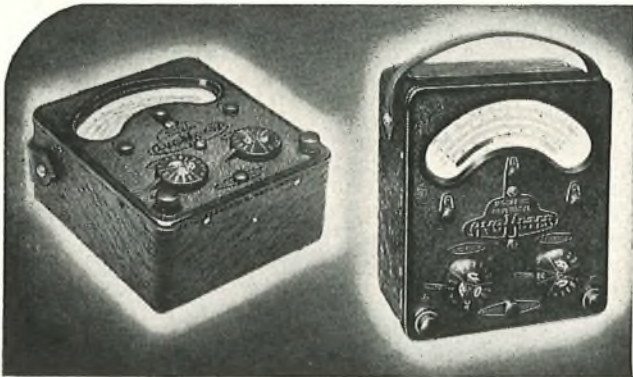

Meters that Matter

FROM years of intensive research in the design and manufacture of electrical testing equipment has grown the range of world-famous "AVO" Instruments. To-day, wherever rapid precision testing is demanded, there will be found the meters that matter—"AVO" Meters.

Sole Proprietors and Manufacturers

THE AUTOMATIC COIL WINDER & ELECTRICAL EQUIPMENT Co. Ltd.
Winder House, Douglas Street, London, S.W.1 Phone: VICTORIA 3404-7

X Make a Note of it!

PUBLICATION C-III-A

INSTRUMENT DIALS & CONTROL KNOBS

Our latest catalogue, Publication No. C-III-A, fully illustrates and describes over 60 different Dials, Drives, Scales, Knobs and Miscellaneous Parts which are of vital interest to designers and manufacturers of electrical instruments.

REMEMBER—PUBLICATION C-III-A

A copy will be supplied on request

MUIRHEAD

MUIRHEAD & CO. LTD., ELMERS END, BECKENHAM, KENT. BECKENHAM 0041-0042

FOR OVER 60 YEARS DESIGNERS AND MAKERS OF PRECISION INSTRUMENTS

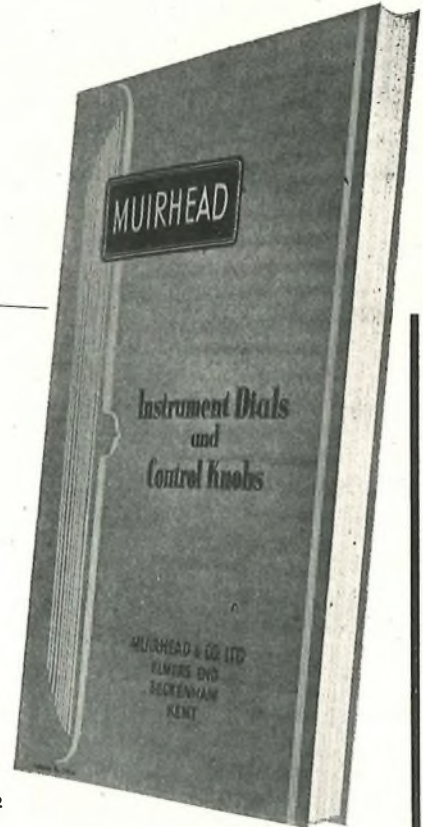



Clip-on
HERE..

Clip-on
THERE..

Clip-on
almost
EVERYWHERE



The range of the instrument is changed by a half turn of the switch.

Ranges Available	
0 — 10	— 50 amps.
0 — 20	— 100 ..
0 — 50	— 250 ..
0 — 100	— 500 ..
0 — 200	— 1000 ..

Quick
Change
to
New
Range

FERRANTI

DUAL RANGE

Clip-on AMMETER

FOR CHECKING CURRENT IN
BUSBARS, FUSES & CABLES

UP TO 2½" DIAMETER

FERRANTI LTD., HOLLINWOOD, LANCS.
London Office: Bush House, Aldwych, W.C.2.

Fl 44a

TURNER DIFFERENTIAL MILLIAMMETERS G.P.O. No. 17 & No. 18

Meet the most exacting demands for balancing currents in multiplex telegraph circuits.

— A quality product of outstanding merit —

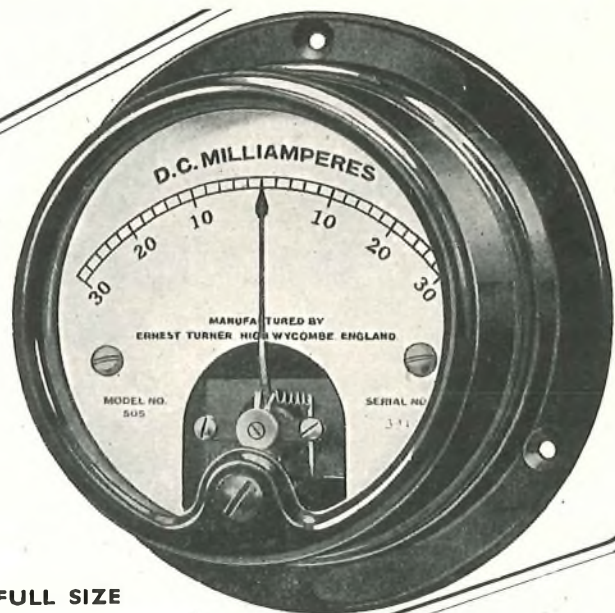

FULL SIZE

Also manufacturers of G.P.O. Detector No. 4, and a comprehensive line of instruments for precision electrical measurements.

ERNEST TURNER ELECTRICAL INSTRUMENTS, Ltd.

CHILTERN WORKS,
49-73 TOTTERIDGE AVENUE,
HIGH WYCOMBE,
BUCKS, ENGLAND

Telephone : High Wycombe 1301, 1302.
Telegrams : Gorgeous. High Wycombe.

Ericsson



MODERN TELEPHONE APPARATUS...

The new automatic telephone No. 1002 has a casework of moulded bakelite. It incorporates a sliding instruction tray and renewable writing pad. Dimensions $5\frac{1}{2} \times 9\frac{1}{4} \times 7$. Weight 6 lbs. Full particulars from makers.

ERICSSON TELEPHONES, LTD., Head Office: 56 Kingsway, London, W.C.2. Phone: HOLborn 6936

Electrical Standards for Research and Industry

Testing and Measuring Apparatus
for Communication Engineering

BRIDGES — Capacitance
Inductance
Resistance

RESISTANCES

INDUCTANCES

CONDENSERS

OSCILLATORS

WAVEMETERS

H. W. SULLIVAN
— LIMITED —

London, S.E.15

ALL TYPES — ALL FREQUENCIES — ALL ACCURACIES

Tel. New Cross 3225 (Private Branch Exchange)

Westinghouse

CONSTANT VOLTAGE RECTIFIERS

The Westinghouse "Westat" constant voltage rectifier for use with batteries, gives complete voltage stabilisation without the use of gas discharge tubes, barretters or D.C. saturated chokes. It is completely automatic in its action and many hundreds, with outputs ranging from 15 watts to 1.2 kW, are already in use.

On the right is shown one of one hundred 1.2 kW equipments, each with an output of 50/54 volts 24 amps. for float-charging a battery. Similar equipments, with an output of 80 + 80 volts 6.75 amps., are in use for power supply to V.F. telegraph systems. Below is one of twenty 50/54 volt 10 amps. equipments used for float charging.

On the left is shown one of one hundred 50/54 volt 5 amps. sets for float-charging signalling batteries. All these "Westat" equipments use the new "Westalite" rectifier.

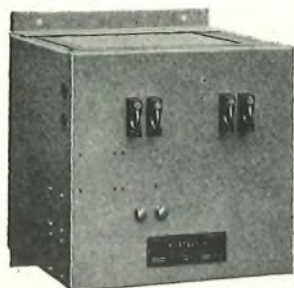

WESTAT

WESTINGHOUSE BRAKE & SIGNAL CO. LTD.
Pew Hill House, Chippenham, Wilts.

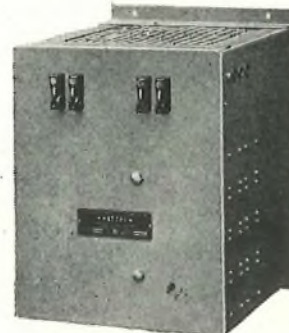
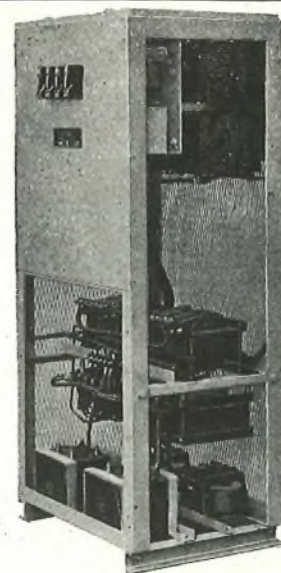

SIEMENS PRODUCTS

MADE IN ENGLAND

Contractors for the manufacture, laying and maintenance of Submarine and Land Cables for Telegraphy and the Electric Transmission of Power, for the erection and maintenance of Overland Telegraph, Telephone and Power Transmission Lines, Public and Private Telephone Exchanges and Carrier Equipment for Telephone Lines.



*Backed by over
80 years experience!*

**ELECTRIC
WIRES & CABLES**

**CABLE
JOINT BOXES**

TELEPHONE CABLES
Aerial, Underground, Submarine

**OVERHEAD
LINE MATERIAL**

CELLS & BATTERIES
Dry, Fluid & Inert

**MARINE
APPARATUS**

**ELECTRIC
LAMPS**

**PRIVATE
TELEPHONE SYSTEMS**

**PUBLIC
TELEPHONE EXCHANGES**

**ELECTRIC
TOTALISATORS**

**MEASURING & RECORDING
INSTRUMENTS**

SIEMENS BROTHERS & CO., LTD

WOOLWICH, LONDON, S. E. 18

ESTABLISHED 1858

Telephone: WOOLWICH 2020

**ELECTRICITY
METERS**

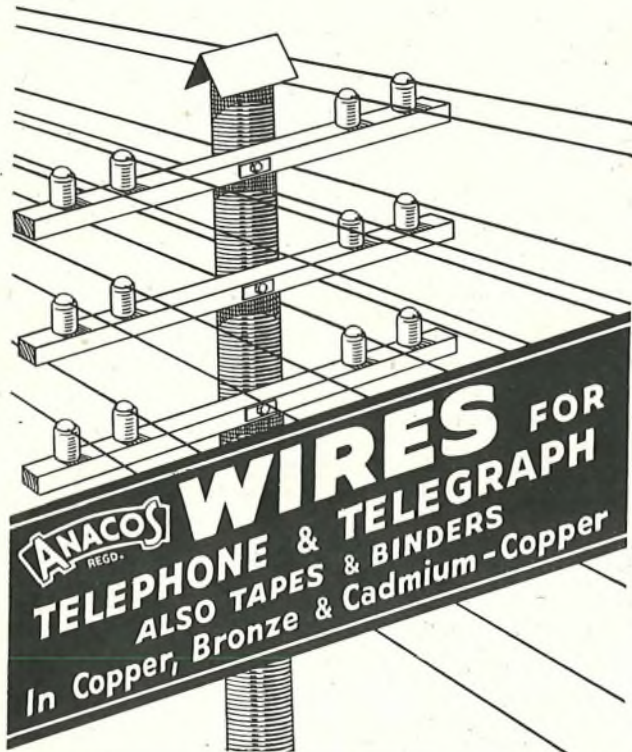

FREDERICK SMITH & CO. LTD. (Incorporated in The London Electric Wire Company and Smiths, Limited.)

ANACONDA WORKS, SALFORD, 3, LANCS.

Telephone :
BLACKFRIARS 8701 (8 lines)

Telegrams :
"ANACONDA" MANCHESTER

RAWLPLUG TOOLS

IN addition to being the manufacturers of Rawlplugs and other well-known fixing devices, the Rawlplug Co., Ltd., have for many years made a wide range of boring tools. Introduced originally to make the holes to accommodate Rawlplug Fixing devices, the range of tools has been extended year by year until to-day there is a Rawlplug boring tool suitable for boring holes of all sizes in all materials.

In order to bring Rawlplug Tools to their high standard of efficiency, thousands of pounds have been spent in research, with the result that the tools are manufactured from a special steel, produced to our own secret formula. This special steel ensures both efficiency and long life.

Write for Technical Literature.

THE RAWLPLUG CO. Ltd.
CROMWELL ROAD, LONDON, S.W.7

B245

Hall Telephone Accessories (1928) Limited

Suppliers to the British Post Office, Air Ministry, Admiralty, War Office and Foreign Government Departments.

Manufacturers of prepayment telephone multi-coin collectors, gas leak indicators, precision instruments, automatic stamp selling and ticket selling machines, automatic slot machines and fire alarm apparatus.

Registered Office :

**70, DUDDEN HILL LANE, WILLESDEN,
LONDON, N.W.10**

Tel. WILLESDEN 5141/2/3.

Also SOUTH WALES

LONDEX for RELAYS

FOR

A.C. AND D.C.

including

Time Delay Relays
and High Sensitive
Relays, silent and
reliable.



Mercury Relay
LQA

Ask for Leaflet SPN/PO



Multiple Contact
Relay LF

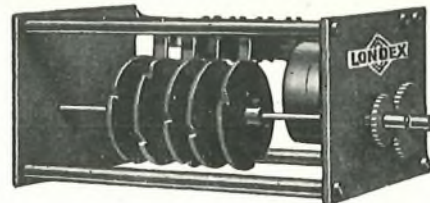

Synchronous Process Timer P.R.
with easily interchangeable gear
wheels, and up to 14 cams.

Ask for Leaflet 92

LONDEX LTD

ELECTRICAL REMOTE CONTROL
ENGINEERS & MANUFACTURERS

**ANERLEY WORKS, 207 ANERLEY ROAD
LONDON, S.E.20** Sydenham 6258/6259

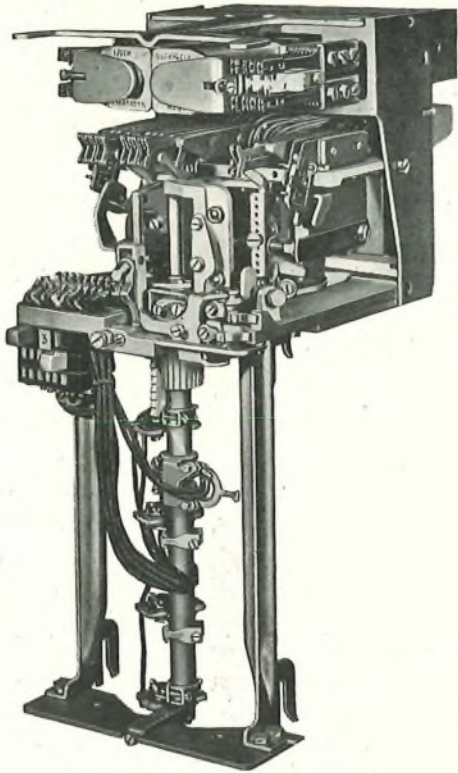

A
QUICK
“SWITCH”
FOLLOWING
A
BLITZ

**STROWGER CONTRIBUTES
 TO ONE OF BRITAIN'S
 MINOR TRIUMPHS!**

Among the stories which cannot be fully told till the war is over is that of a city's telephone service restored following damage by enemy action.

For the time-being, the city shall be nameless, and the extent of the damage must not be disclosed. It can be said, however, that by bold decision and unflagging effort, the service of a considerable number of subscribers was restored in a few weeks, when the task had appeared impossible.

The principal contributing factor was the characteristic flexibility of Strowger Automatic Telephone Exchange Equipment, which enabled apparatus manufactured for another area to be readily adapted to the needs of the “blitzed” city. Developed essentially as an amenity of civilisation, Strowger Equipment, by reason of its high operating speed and reliability, is contributing in no small measure to the evolution of the Allies' fighting machine which will bring victory to the freedom-loving nations.

AUTOMATIC TELEPHONE & ELECTRIC CO. LTD.

MELBOURNE HOUSE, ALDWYCH, W.C.2

'Phone, Temple Bar 9262 · 'Grams, "Autelco, Estrand, London"

STROWGER WORKS, LIVERPOOL, 7

'Phone, Stoneycroft 4830 · 'Grams, "Strowger, Liverpool"



*. . . high grade
manufacturers
of everything
in the
telephone
communication
field*

G.E.C.

REGD. TRADE MARK

**TELEPHONE
WORKS**

**The General Electric Co., Ltd.,
Head Office :- Magnet House,
Kingsway, London, W.C.2**



U.I.C

CONDENSERS & COMPONENTS *For Modern Radio Technique*

- 1 CERAMIC PEARL TYPE CONDENSERS
- 2 CERAMIC COIL FORMERS
- 3 SILVERED MICA (Tropical Type) CONDENSERS
- 4 POT CONDENSERS
- 5 FIXED CERAMIC CONDENSERS
- 6 CERAMIC TRIMMER CONDENSERS

Full details and advice gladly given.

CONTRACTORS TO G.P.O. & GOVERNMENT DEPARTMENTS.
ON A.I.D. APPROVED LIST.

UNITED INSULATOR CO. LTD.

12-20, LAYSTALL ST., LONDON, E.C.1

'Phone: TERminus 7383.

'Grams: "CALANEL, SMITH, LONDON."

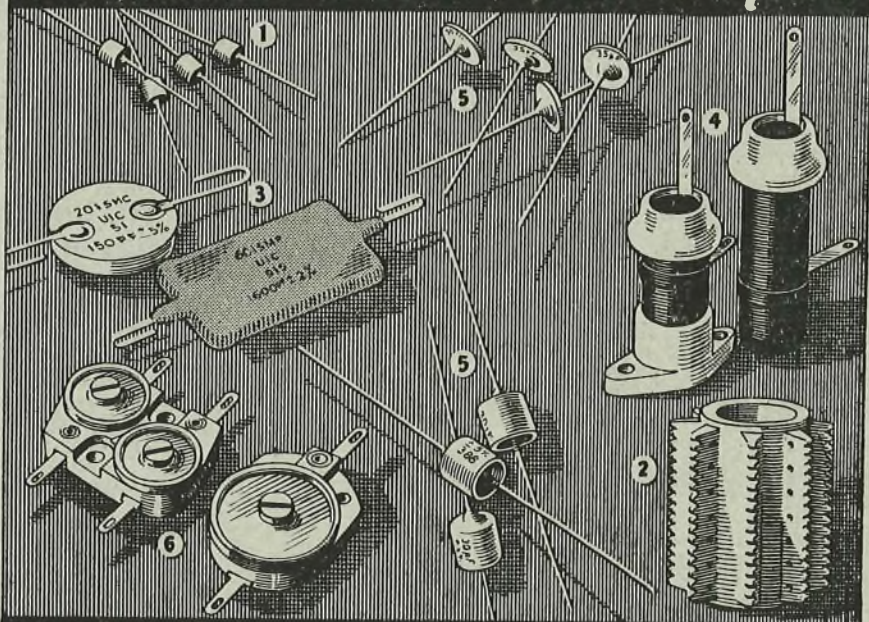

The Pioneers of Low Loss Ceramics

★
TELEGRAPH APPARATUS
MORSE *for* SYSTEMS

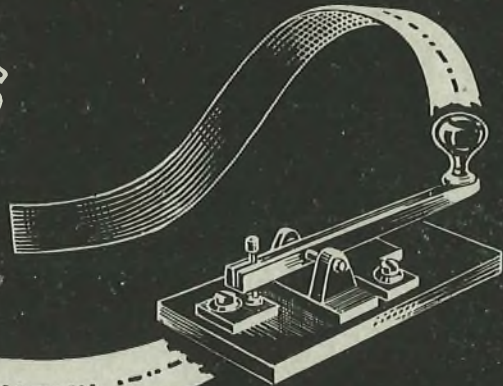

Makers of:

- GALVANOSCOPES · INKERS
- RESISTANCES · RELAYS
- SOUNDERS · DETECTORS
- KEYS · MILLIAMMETERS
- AUTOMATIC RECEIVERS
- & TRANSMITTERS ETC

Write for illustrated catalogue

ELLIOTT BROTHERS (LONDON) LTD. CENTURY WORKS, LEWISHAM, S.E.13

MAINTAINING EFFICIENCY

THE HIGH STANDARD OF EFFICIENCY
OF PIRELLI - GENERAL TELEPHONE
CABLES IS MAINTAINED BY THE
CONTINUOUS RESEARCH WORK OF
AN EXPERIENCED TECHNICAL STAFF.

TELEPHONE:
SOUTHAMPTON
2141 (5 lines).

PIRELLI-GENERAL
CABLE WORKS, Ltd., SOUTHAMPTON.

TELEGRAMS
"PICEKAYBEL"
SOUTHAMPTON."

Solder the Modern and Speedy Way!

MULTICORE

THE SOLDER WIRE WITH
3 CORES OF
NON-CORROSIVE
ERSIN FLUX

- Avoids Dry Joints
- Increases Electrical Efficiency of Joints
- Speedily makes Sound Joints on Dirty or Oxidised Surfaces
- Always Correct Proportions of Flux and Solder
- No additional Flux Required
- Low Melting Point (190° C. for 60/40 alloy)
- Approved by Air Ministry and G.P.O.
- All-British and acknowledged by the leading Manufacturers to be the finest Cored Solder in the world.



LABORATORY TESTS SHOW WHY
ERSIN MULTICORE IS SUPERIOR

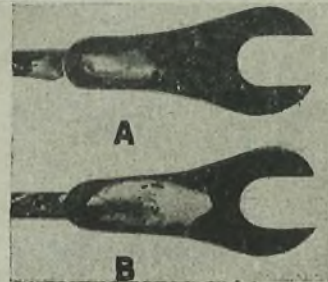

SINGLE CORE v. MULTICORE

Tag A, soldered with ordinary single core rosin solder, has fused only with copper braid, without spreading appreciably. A typical "dry joint."

Tag B, soldered with Ersin Multicore has spread evenly over both nickel and copper surfaces, including whole length of braid by capillary action, thus making a sound mechanical and electrical joint.

FREE Two informative publications on soldering have been issued by Multicore Solders Ltd. Executives are invited to send for copies and a free sample of Multicore Solder.

MULTICORE SOLDERS LTD., BUSH HOUSE, LONDON, W.C.2