

E. Simpson

THE POST OFFICE ELECTRICAL ENGINEERS' JOURNAL

VOL. 28

JULY, 1935

PART 2.

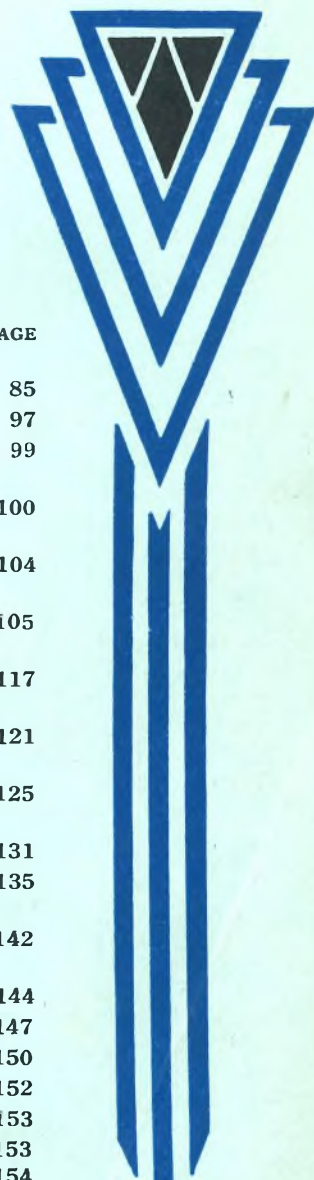
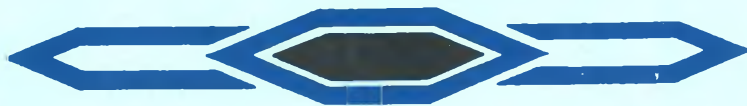

CONTENTS

	PAGE
RECENT DEVELOPMENTS IN ELECTRICAL LIGHTING—E. G. Kennard, A.M.I.E.E.	85
CROSS-TALK—S. Hanford, B.Sc., M.I.E.E.	97
TELEGRAPH AND TELEPHONE PLANT IN THE UNITED KINGDOM...	99
ELECTRIC PASSENGER LIFT IN THE G.P.O. HEADQUARTERS' BUILDING—C. W. Govett	100
THE USE OF A SURVEYOR'S LEVEL TO SOLVE AN ENGINE PROBLEM—E. J. C. Dixon, B.Sc.(Eng.), A.M.I.E.E.	104
THE UNIT AUTOMATIC EXCHANGE No. 12—C. G. Grant and E. M. Cooke	105
A METHOD OF LOCATING HIGH RESISTANCE FAULTS IN LOADED CABLES—A. Rosen, Ph.D., A.M.I.E.E.	117
ULTRA SHORT WAVE RADIO TELEPHONE CIRCUITS TO NORTHERN IRELAND—A. J. A. Gracie, B.Sc., A.M.I.E.E.	121
RECENT DEVELOPMENTS IN TELEPHONE REPEATER STATION POWER PLANT—F. W. G. Dye	125
TELEPHONE TRANSMISSION—VI.—R. M. Chamney, B.Sc., Assoc.M. Inst.C.E., A.K.C.	131
THE HOUSE EXCHANGE SYSTEM—W. Lowne and T. G. Morris ...	135
POST OFFICE TELEPHONE AND TELEGRAPH CONVENTION—B. O. Anson, M.I.E.E.	142
GAS EXPLOSIONS: PRECAUTIONARY MEASURES—P. J. Ridd, M.I.E.E.	144
LIVERPOOL NEW PARCEL POST OFFICE—R. S. Phillips, A.M.I.E.E....	147
NEWCASTLE-CARLISLE CABLE AND THE ROMAN WALL	150
BOOK REVIEW	152
NOTES AND COMMENTS	153
RETIREMENT OF MAJOR H. BROWN, O.B.E., M.I.E.E.	153
COL. A. S. ANGWIN, D.S.O., M.C., T.D., M.I.E.E.	154
J. INNES, B.Sc., M.I.E.E.	155
G. F. O'DELL, B.Sc., M.I.E.E.	155
THE INSTITUTION OF POST OFFICE ELECTRICAL ENGINEERS ...	156
LOCAL CENTRE NOTES	156
JUNIOR SECTION NOTES	156
DISTRICT NOTES	159
STAFF CHANGES	162

Price 1/- net

THE INSTITUTION OF POST OFFICE ELECTRICAL ENGINEERS



PLASTIC

PERNAX

TAPE

Is Waterproof,
Highly Insulating,
Corrosion-resisting,
Lasting and
Inexpensive.

“A Chip of the Old Block”

Is Simple to Use,
Adhesive, but
Does not soil the
fingers.
Blow-lamps not
necessary.

SOME USES.

- Insulating conductors exposed to weather to prevent Bird Contact, etc.
- Insulating joints in manholes, between lengths of PERNAX sheathed cables.
- Insulating purposes generally, where the usual type of sticky tapes have failed.

PERNAX is the only flexible insulating material that can be used in the open air without deteriorating more or less rapidly.

When first introduced it was not possible to make ordinary PERNAX TAPE (though in itself perfectly waterproof) adhesive enough to be waterproof between its lapping edges, without the use of a special adhesion process when using the tape.

Recent experiments, however, have developed PLASTIC PERNAX TAPE, whereby this difficulty has been overcome.

By lapping PLASTIC PERNAX TAPE on the cable without strain and by frictional pressure of the hand to assist adhesion a perfectly waterproof and highly insulating job will result.



(Actual photograph)

PERNAX cut away to show homogeneous result.

This should be of special value when replacing ordinary insulating tapes which have failed through moisture absorbence, perishing or unwrapping.

PLASTIC PERNAX Sealing Ends have been totally immersed in water for long periods without any loss of insulation, which is not the case with ordinary insulating tapes.

THERE IS NO OTHER INSULATING TAPE LIKE PLASTIC PERNAX
BECAUSE IT IS MADE OF PERNAX.

Manufactured only by

CROYDON CABLE WORKS LTD., MITCHAM ROAD, CROYDON.

Phone: THORNTON HEATH 2882 (4 lines).

The Home of a Great Telephone System

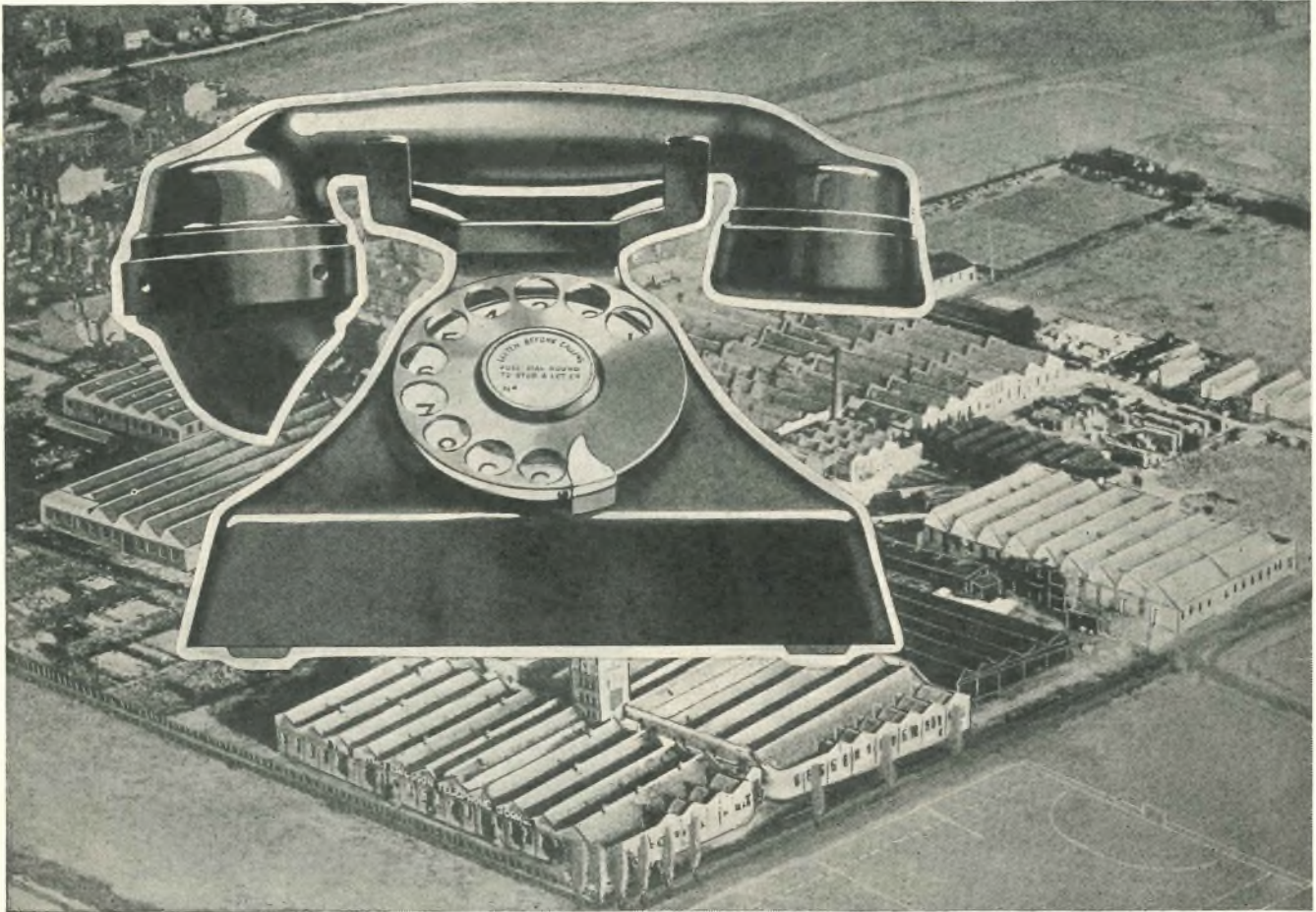

Ericsson Automatic Switch Board.

Ericsson Telephone Equipment is made at Beeston, Nottinghamshire. This fine factory keeps well ahead in telephone development and progress. A manufacturing and technical experience extending over 50 years is helping us all the time to maintain a high level of telephonic efficiency and reliability.

We manufacture, supply and instal complete automatic exchanges of the "director" and "non-director" types for any number of lines.

Informative Literature sent free.

ERICSSON TELEPHONES LIMITED

67/73, KINGSWAY, LONDON, W.C.2

Telephone: Holborn 3271/3

Works: Beeston, Notts

Ericsson

TELEPHONE
EXCHANGE
EQUIPMENT

SIEMENS

NEOPHONE

EXTENSION

TELEPHONES

*Another addition
to the
"Neophone" range.*

"NEOPHONES" of the following
types are now available :

AUTOMATIC
CENTRAL BATTERY
MAGNETO
BATTERY CALL
INTERCOMMUNICATION



"Main" Instrument.

These new extension telephones incorporate our patent anti-sidetone induction coil circuit and provide the *unrivalled transmission efficiency and superior articulation* for which the "Neophone" is noted.

The "main" instrument includes a special four position switch, supervisory signal and hand generator, a separate bell set in bakelite case (not illustrated) with terminals for the cord, battery and line connections being provided.

SIEMENS BROTHERS & CO. LTD.

WOOLWICH, LONDON, S.E.18

Telephone : Woolwich 1161



"Extension" Instrument.

SIEMENS MERCURY CONTACT RELAYS

*fulfil the
varied requirements of
Power, Alarm, Signal
and Telephone Circuits.*

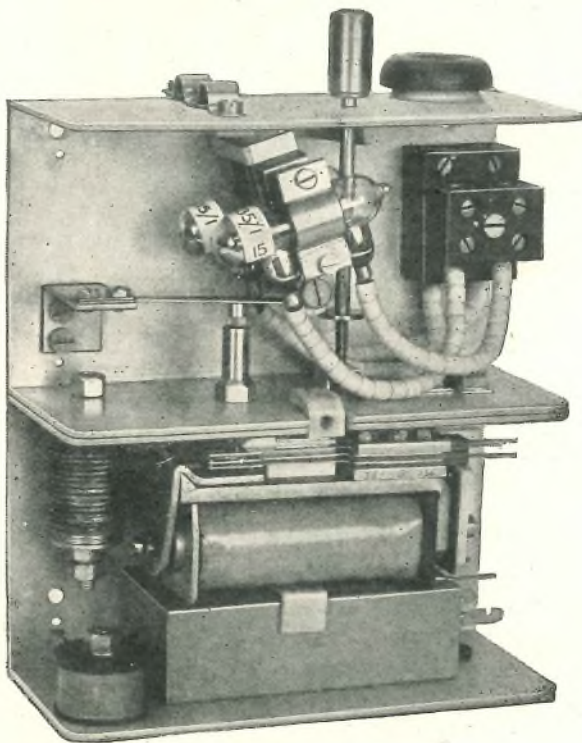

Relay with cover removed.

Provided with pressed steel case and cover for indoor use (as illustration) or cast-iron case for exposed positions.

Standardised by the
BRITISH POST OFFICE
and adopted by many other important
administrations.

Embodies the latest high-efficiency British Post Office type 3000 relay ensuring maximum reliability in operation, with minimum current.

The mercury contacts are in a separate compartment to the relay, the motion being transmitted by means of a glass rod, thus completely isolating the operating and local circuits.

Supplied for D.C. operation, or with Westinghouse Metal Rectifier for A.C. or telephone ringing currents. In the latter case a condenser can be fitted if required.

Single or double make, break, or change-over contacts for currents up to 20 amperes at 250 volts. A separate change-over spring set contact is provided in the operating compartment for signal or auxiliary circuits.

Arranged for either self restoring or hand resetting.

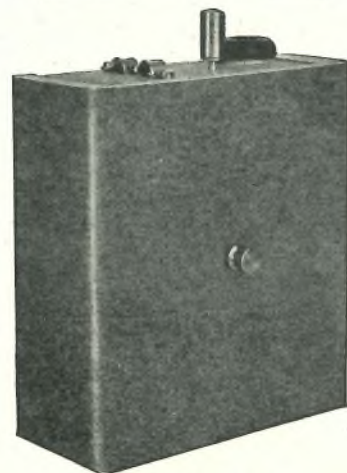

Relay with cover on.

SIEMENS BROTHERS & CO., LIMITED
WOOLWICH, LONDON, S.E.18.

Telephone: Woolwich 1161.

Johann

Automatic TRUNK

AUTOMATIC ELECTRIC COMPANY LIMITED, LIVERPOOL, is manufacturing and will shortly install an Automatic Trunk Exchange in Johannesburg. This equipment has been designed in conjunction with engineers of the South African Postal Administration and puts at the service of the trunk operator the well-proved components of Strowger Automatic Telephone Exchanges, thus bringing into long distance communications the advantages of speed, accuracy and

The intervention of the human element is still necessary for the completion of long distance connections. The automatic trunk board applies the Strowger mechanism as an essential aid to the operator, so that without a multiplicity of plugs and jacks all steps necessary for the completion of any call can be carried out from the same position. The benefit of the time saved on each position is felt not only by the subscribers but also in economies in plant.

The selector illustrated, with its 2,000 contacts, makes it possible for a group of voice current amplifiers to be made available on the board, and the economy which results from this can be attributed directly to the greatly increased bank capacity and flexibility of the 32A Strowger mechanism. This mechanism has been adopted by the B.P.O. as its future standard for all Line Finder Systems.

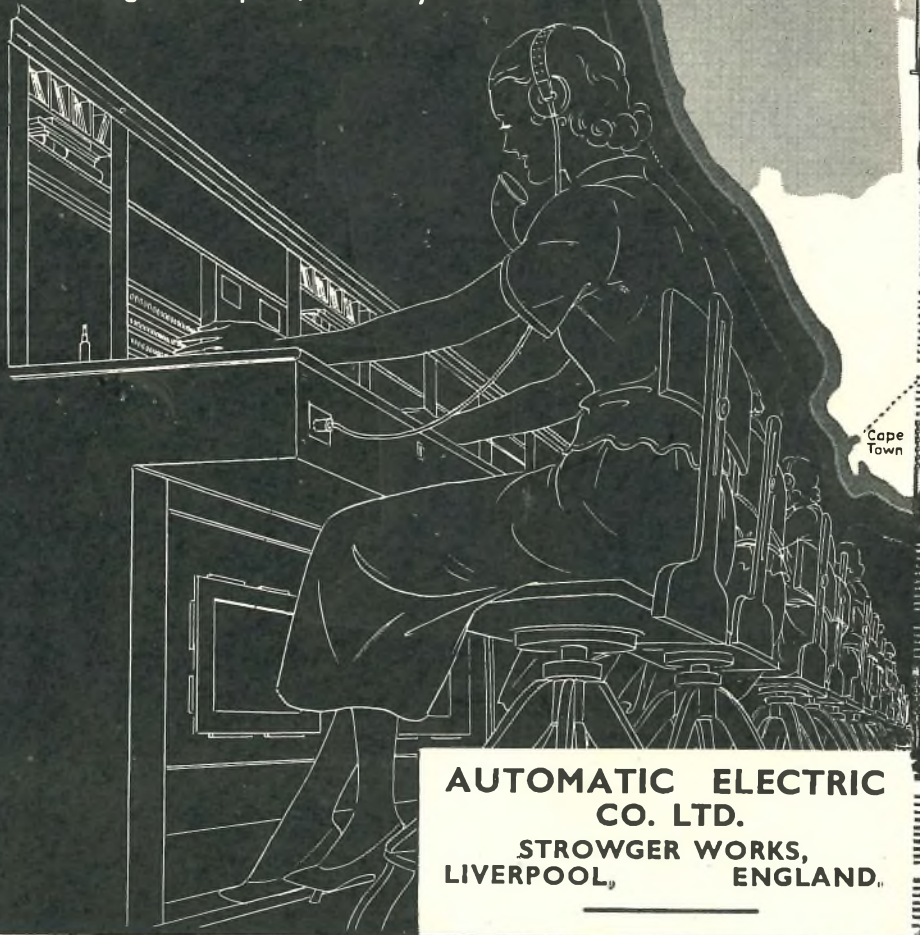

**AUTOMATIC ELECTRIC
CO. LTD.**
STROWGER WORKS,
LIVERPOOL, ENGLAND.

A triumph of STRO

STROWGER EXCHANGE

reliability which are associated with the Strowger Automatic Exchanges serving subscribers throughout the World.

The Johannesburg trunk exchange is the most important in the Union of South Africa, and automatic working has been decided upon for this centre after experience at Cape Town, with certain important modifications introduced by the Administration Engineers consequent upon this experience.

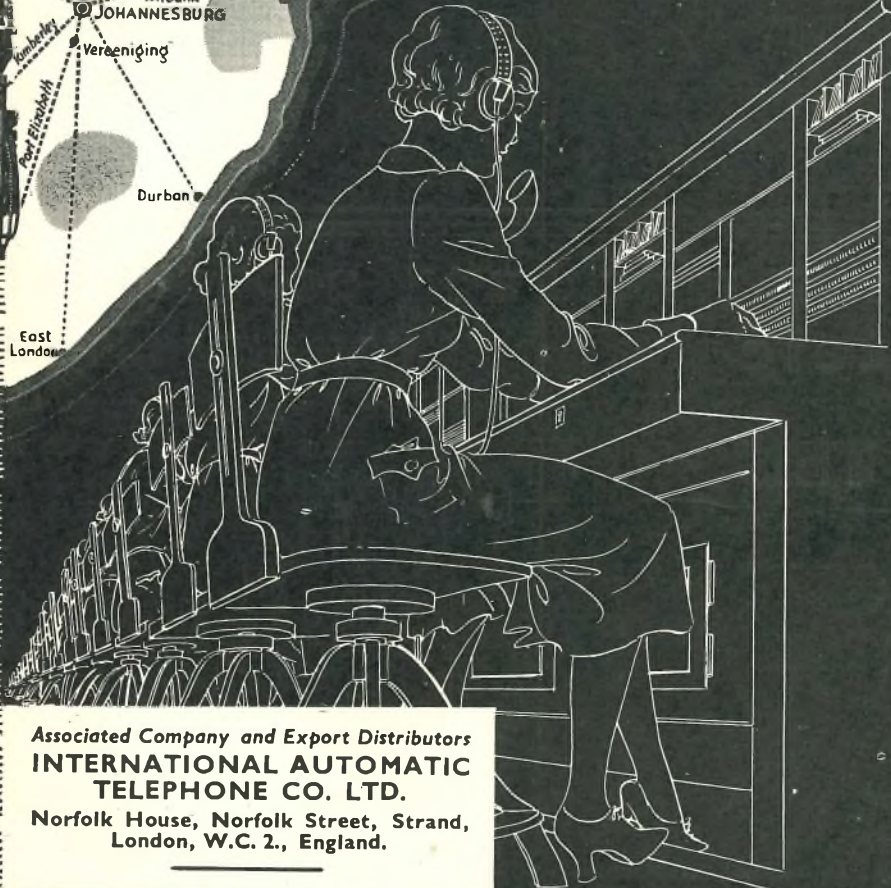
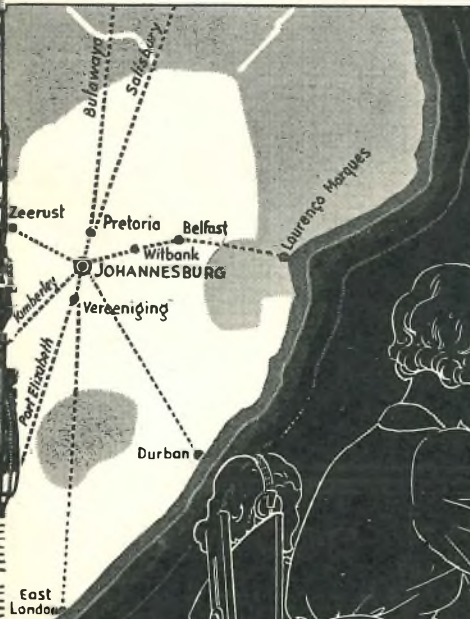

EQUIPMENT & FACILITIES.

Demand positions ..	15
Incoming positions ..	12
Long distance positions ..	4
Spare positions ..	2

Keysending for rapidity of all automatic connections.

Automatic Insertion of Amplifiers enabling the operator, by actuating a key, to insert a voice current amplifier at the appropriate gain to suit the characteristics of the trunk circuit.

Automatic Distribution of Calls and Traffic Overflow Indication.

Call Storage with Priority for Transit Calls on Automatic Trunk Selection.

Mechanical Conveyor for Tickets.

Call Timing by B.P.O. Clock No. 44.



Associated Company and Export Distributors
**INTERNATIONAL AUTOMATIC
TELEPHONE CO. LTD.**

Norfolk House, Norfolk Street, Strand,
London, W.C. 2., England.

STROWGER engineering!

THE MODERN Master of the Rolls

FIFTY YEARS' step by step research and improvement in instrument building are behind this "Modern Master of the Rolls." Accuracy to B.S.I. Specification—straight time lines and bold figures easy to read. Megger recorders are supervising, minute by minute, daily operations in mine, power-house and factory. Write for Publication X 213 — a profusely illustrated and informative brochure just off the press

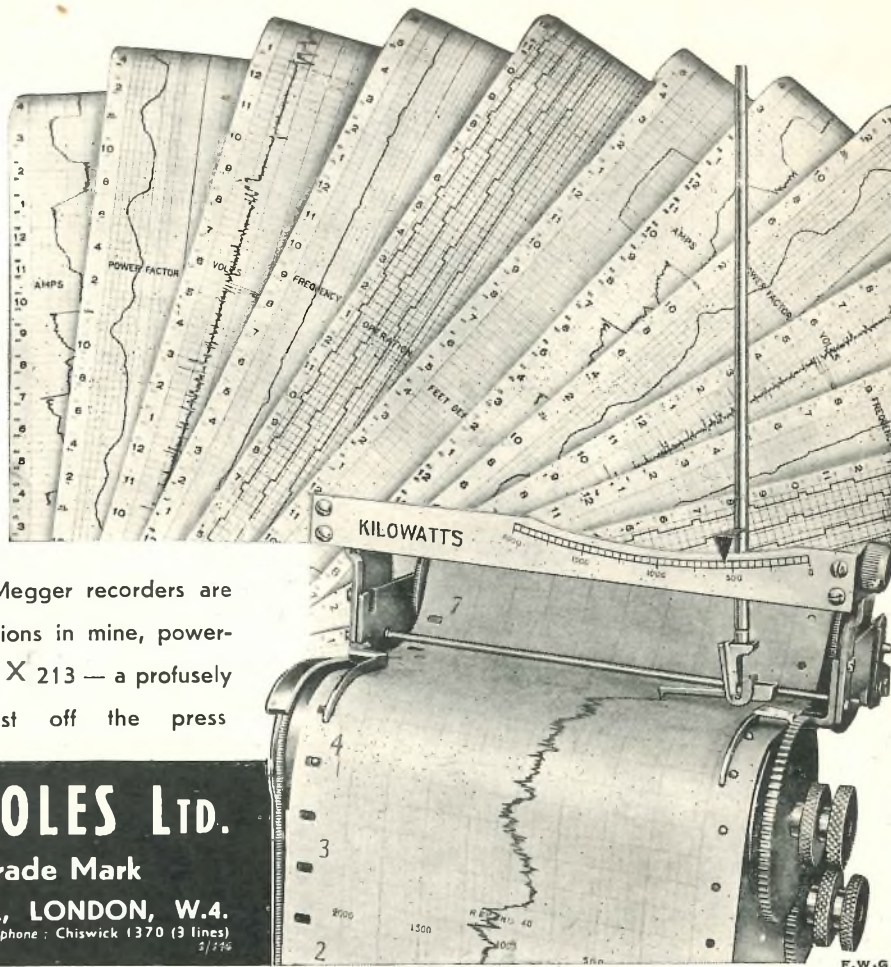

EVERSHED & VIGNOLES LTD.

Registered "MEGGER" Trade Mark

ACTON LANE WORKS, CHISWICK, LONDON, W.4.

Telegrams: Megger Chisk, London

Telephone: Chiswick 1370 (3 lines)

E.W.G.

For quick and economical telegraph transmission The TELEPRINTER

The British Post Office, following their progressive policy, has been steadily replacing Morse Apparatus by Teleprinters during the last few years.

This change-over enables 100 telegrams an hour to be dealt with on each circuit as compared with approximately 30 by the Morse System.

Today there are nearly 3000 Teleprinters constantly at work handling telegrams with great efficiency and economy

Model No. 3a
Tape Teleprinter



Model No. 7 Page Teleprinter



CREED & COMPANY, LTD.,

Telephone—
Croydon 2121

Telegraph House
CROYDON

Telex—
Croydon Telex 1082

SIGNS of the TIMES

The Budget has restored
POLICE OPPORTUNITIES

The Air Force is to be increased
AVIATION MUST DEVELOP
Pay cuts have been restored.

CIVIL SERVICE

Suitable to both sexes. Ages 15½ to 24.
**PERMANENT, PROGRESSIVE,
PENSIONABLE POSITIONS.**

G.P.O. ENG. DEPT.

**CUSTOMS AND EXCISE, INSPECTOR OF
TAXES, ETC. NO EXPERIENCE REQUIRED.
OPEN EXAMS.**

MATRICULATION

There are many ways of commencing a career,
but Matriculation is the jumping-off board for
all the best ones.

We prepare candidates for all

INSTITUTE EXAMS

TECHNICAL, ACCOUNTANCY,
SECRETARIAL, INSURANCE, ETC.

ENGINEERS and DRAUGHTSMEN

All Branches—Employers are
advertising for them.

TELEPHONY, RADIO and MOTOR
ENGINEERING are expanding rapidly.
There are lots of vacancies. Our postal
courses will make you eligible. Advice
on all careers Free.

Also ask for our New
Book (Free of Charge)

THE HUMAN MACHINE

Secrets of Success



CAN YOU
CHANGE MY
EXPRESSION?

IF SO, YOU MAY BE
THE ARTIST THAT
COMMERCE IS
WAITING FOR.

Just try it for yourself.
Trace or draw the out-
line and then put in
the features

There are hundreds of openings in connection with
Humorous Papers, Advertisement Drawing, Posters,
Calendars, Catalogues, Textile Designs, Book
Illustrations, etc.

60 per cent. of Commercial Art Work is done by
"Free Lance Artists" who do their work at home
and sell it to the highest bidders. Many Commer-
cial Artists draw "retaining fees" from various
sources, others prefer to work full-time employment
or partnership arrangement. We teach you not
only how to draw what is wanted but how to make
buyers want what you draw. Many of our students
who originally took up Commercial Art as a hobby
have since turned it into a full-time paying profes-
sion with studio and staff of assistant artists;
there is no limit to the possibilities. Let us send
full particulars for a **FREE TRIAL** and details of
our course for your inspection. You will be under
no obligation whatever.

Jim Duak Art Dept. 24

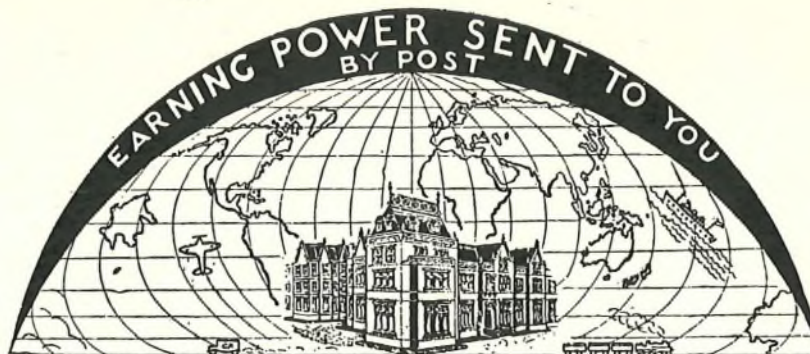

STUDY AT HOME IN YOUR SPARE TIME

OPEN LETTER TO PARENTS

Dear Sir or Madam.—When your children first arrived they brought with them a wonderful lot of sunshine. Later you became proud of the intelligence they displayed, but still later you became anxious as to what would become of them in the future. Perhaps you were anxious when you visualised them as grown men and women. Even with plenty of money it is not always easy to select the right career, and a parent is sometimes inclined to ask advice of some relative and in ninety-nine cases out of a hundred that relative knows nothing at all about the possibilities of employment. Why not let me relieve you of some of your anxieties? In fact, why not let me be their Father? We do not profess to act as an employment agency, but the nature of our business compels us to keep an eye upon the class of men and women that are wanted and who want them. There are some people who manufacture an article and put it on the market to sell. We do not do that, we work in exactly the opposite direction. We find out what employers want and we train our students to fill those jobs. We have to be experts in the matter of employment, progress and prosperity. If you have any anxieties at all as to what your sons and daughters should be, write to me, or better still, let them write to me personally—Fatherly Advice Department—and tell me their likes and dislikes, and I will give sound practical advice as to the possibilities of a vocation and how to succeed in it. Yours sincerely,

J. Bennett

YOU CAN HAVE A COLLEGE TRAINING IN ALMOST ANY CAREER FOR A FEW SHILLINGS MONTHLY

Accountancy Examinations
Advertising and Sales Manage-
ment
A.M.I. Fire E. Exam.
Applied Mechanics
Army Certificates
Auctioneers & Estate Agents
Aviation Engineering
Banking
Boilers
Book-keeping, Accountancy and
Modern Business Methods
B.Sc. (Eng.)
B.Sc. (Estate Management)
Build'ng, Architecture and
Clerk of Works
Cambridge Senior School
Certificate
Civil Engineering
Civil Service
All Commercial Subjects
Commercial Art
Concrete and Structural
Engineering
Draughtsmanship. All branches.
Engineering. All branches,
subjects and examinations
General Education
G.P.O. Engineering Dept.
Heating and Ventilating
Industrial Chemistry

Insurance
Mathematics
Matriculation
Metallurgy
Mining, all subjects
Mining, Electrical Engineering
Motor Engineering
Motor Trade
Municipal & County Engineers
Naval Architecture
Pattern Making
Police, Special Course
Preceptors, College of
Pumps and Pumping Machinery
Radio Service Engineering
Road-Making and Maintenance
Salesmanship
Sanitation
Secretarial Exams.
Shipbuilding
Shorthand (Pitman's)
Structural Engineering
Surveying
Teachers of Handicrafts
Telephony and Telegraphy
Transport Inst. Exams.
Weights and Measures Inspector
Welding
Wireless Telegraphy and
Telephony
Works Managers

If you do not see your own requirements above, write to
us on any subject.

HOW TO STUDY

In your spare time when it suits
YOU. You fix your own time, you
do not GO to your studies—the
postman brings THEM TO YOU.
There is nothing that a class-room
teacher can show on a blackboard
that we cannot show on a white
paper. The lesson on a blackboard
will be cleaned off, but our lessons
are PERMANENT. A class-room
teacher cannot give you a private
word of encouragement, but a Cor-
respondence Tutor can do so when-
ever your work deserves it. On the
other hand he can, where necessary,
point out your mistakes
PRIVATELY.

TO STUDENTS LIVING ABROAD

or on the high seas, a good supply
of lessons is given, so that they
may be done in their order, and
despatched to us for examination
and correction. They are then sent
back with more work, and in this
way a continuous stream of work is
always in transit from the Student
to us and from us to the Student,
therefore distance makes no
difference.

IT IS THE PERSONAL TOUCH
WHICH COUNTS IN POSTAL
TUITION

EVERY DEPARTMENT IS A
COMPLETE COLLEGE.
EVERY STUDENT IS A CLASS
TO HIMSELF.



Dept. 24

THE BENNETT COLLEGE, SHEFFIELD.

THE GENERAL ELECTRIC COMPANY LIMITED

x.

The popularity of the bakelite handset type of telephone is world-wide, the convenience and pleasing appearance having received universal recognition. The further advantage of the Gecophone set—its self-contained nature, dispensing with the need for a separate bell-box—makes an instant appeal both to users and Administrations. This telephone is unsurpassed in efficiency and in the degree of side-tone suppression.

For Automatic, C.B. Manual and Magneto systems. Also as a convertible telephone, initially for use on Magneto systems, readily adapted for C.B. Manual or Automatic service.



G.E.C.

TELEPHONE WORKS
COVENTRY

Telephone : Coventry 4111 Telegrams : "Springjack, Coventry"

London Office : MAGNET HOUSE, KINGSWAY, W.C.2

BRANCHES AND AGENCIES THROUGHOUT THE WORLD

THE POST OFFICE ELECTRICAL ENGINEERS' JOURNAL

Vol. XXVIII

July, 1935

Part 2

Recent Developments in Electrical Lighting

E. G. KENNARD, A.M.I.E.E.

WORLD-WIDE interest having been aroused in the remarkable performance of the electric discharge lamp, frequently referred to as the gas discharge lamp, the writer believes this to be a fitting opportunity to review the history, to present some of the technical details in abridged form, and to examine the possibilities of interior lighting with this form of lamp.

HISTORICAL DEVELOPMENT OF THE ELECTRIC DISCHARGE LAMP.

In the course of its evolution the discharge lamp has passed through at least six stages, as follows:—

- (1) The Geissler Tube.
- (2) The Cooper Hewitt Mercury Vapour Lamp.
- (3) The Moore Carbon Dioxide Tube.
- (4) The Quartz Mercury Arc.
- (5) The A.C. Mercury Arc.
- (6) The modern Electric Discharge Lamp.

The *Geissler tube* was undoubtedly the first attempt to produce an electric discharge lamp. This was of scientific interest only, as the light emitted was too feeble to be of any practical use. Further a very high voltage was necessary to operate the lamp, the Wimshurst machine or the Induction Coil being generally used for this purpose.

The *Cooper Hewitt tube* is believed to be the first practical lamp of the luminous gas type. The light was obtained from a mercury arc formed between two electrodes in an exhausted glass tube about 18" long. The arc was struck by tilting the tube and allowing mercury to flow from one electrode to the other. The lamp was only suitable for direct current circuits. The consumption was approximately 300 watts on a 100 volt circuit, with a lumen output of 3600.

The *Moore tube* was the first practical discharge lamp for A.C. circuits. Carbon dioxide gas was raised to luminescence by a high tension discharge between two ends of a long glass tube fed from a step-up transformer.

In the *Quartz lamp* the tube was made from fused quartz with the object of using mercury vapour at a higher temperature and pressure than the values

employed in the Cooper Hewitt tube in order to increase the efficiency. A much higher candle-power was obtained from a lamp of smaller dimensions, the values for a 200 volt lamp being:—

Power consumption, including ballast resistance	630 watts.
Mean hemispherical candle-power	3000 approx.
Total lumen output	18000 "

This lamp also was only suitable for direct current. A curve is shown in Fig. 1, taken from the Illum-

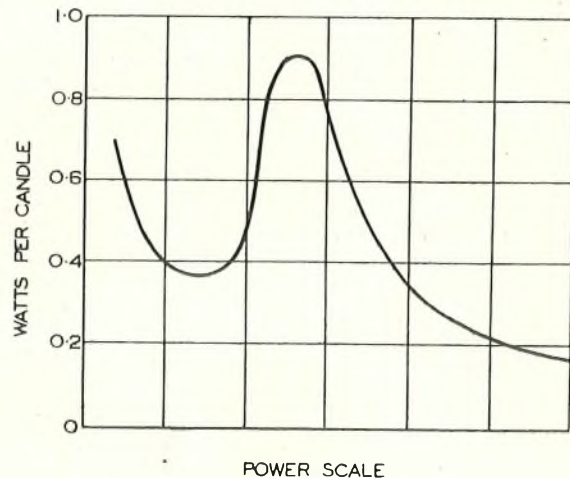

FIG. 1.—VARIATION IN WATTS PER CANDLE OF A QUARTZ MERCURY ARC LAMP.

inating Engineer Magazine, June, 1912, illustrating how the watts per candle of a quartz tube mercury vapour lamp were found to vary with power input and therefore with the temperature. Although the lamp showed considerable promise as a competitor with the arc lamp, the high cost of fused quartz and the difficulty of suitably sealing the electrodes no doubt accounted for its failure to make progress.

The *A.C. Mercury Arc*. It is well known that a mercury arc cannot be maintained under normal con-

ditions on alternating current. Three-Electrode lamps have been constructed in which one electrode is connected to the central point of an auto-transformer, thus obtaining a uni-directional current. Based on experiments made with mercury arc rectifiers, M. Henri Georges constructed a successful A.C. mercury vapour lamp which was described in the proceedings of the Académie des Sciences, February 13th, 1920. The lamp had a tube 40 cms. long with an electrode at each end, and was operated at 3000 volts from a step-up transformer. The tube contained neon gas at a pressure of 1 cm. The discharge through the neon gas at the moment of switching on commenced the vaporisation of the mercury as in the modern forms of discharge lamps. The chief drawback to this lamp seemed to be the large size, as the lamp consumed 1 amp. at 3000 volts, and power factor $0.7 = 2100$ watts.

The *Modern Electric Discharge Lamp*, as placed on the market 12 years later, is very similar to the latter lamp in detail. The high voltage starting difficulty has been overcome by the use of argon in the tube, and the working voltage reduced to normal value by the provision of electron-emitting cathodes.

The successive steps have occurred approximately in decades as shown in the following table:—

	Year
(1) Geissler tubes	1890
(2) Cooper Hewitt Mercury Arc	1900
(3) Moore tube (CO ₂)	1900
(4) Quartz lamp	1910
(5) M. Georges A.C. mercury lamp	1920
(6) Philips hot cathode sodium lamp	1930
(7) Osira (& others) cathode mercury lamp	1932

It would seem that in the development of the present day electric discharge lamp, insufficient credit has been given to the earlier work of M. Henri Georges on the A.C. mercury lamp.

MODERN DISCHARGE LAMPS.

Development of modern lamps has been along two different lines, viz., the cold cathode and the hot cathode lamps. A brief survey of the characteristics of these lamps will no doubt be of interest to those who have been unable to keep pace with the developments which have taken place.

Cold Cathode Lamps.

The first type to come into general use was the small "neon" lamp consuming about 3 watts and giving about $\frac{1}{4}$ c.p. The light from this lamp was obtained from the discharge between two plate electrodes. A considerable proportion of the power taken was absorbed in a ballast resistance contained in the cap of the lamp. Other types of cold cathode lamps are to be found in practically all the tubular sign lamps so widely used for advertising purposes.

The lamps are quite simple in construction, consisting of a well annealed glass tube about $\frac{1}{2}$ " in diameter, absolutely clean, and free from air, with an electrode of iron or nickel at each end. As the name implies, it is unnecessary to heat these electrodes to enable the lamp to function properly. After exhaus-

tion, a small quantity of the requisite gas is introduced into the tube before sealing.

The lamps will operate on A.C. or D.C. circuits, but their use is practically confined to A.C. on account of the high voltages necessary to operate the tubes. On account of the negative resistance co-efficient of all gases a ballast resistance, or an impedance in series with the tube, is necessary, otherwise the current would rapidly increase after the discharge has started, and the lamp would be destroyed. The tubes require about twice the normal working voltage to enable them to strike up. They are therefore fed from a transformer having a voltage regulation on the secondary side, of approximately 50%.

Different colours are obtained by filling the tubes with different gases. Some of these are shown in Table I.

TABLE I.

Colour of light.	Gas used.	Volts per foot run of tube.	Voltage drop at electrodes.
Red	Neon	150	150
Blue	Argon and Neon (with Mercury)	180	180
Yellow-White ..	Helium	160	160
Yellow	Helium in yellow glass tube	160	160
Green	Argon and Neon (with Mercury) in yellow glass tube	160	160

The luminous intensity is low, not exceeding 6 candle-power per foot for the neon gas and being somewhat lower for the others. As an example the circular tubes, often exhibited in shops windows, are about ten feet in circumference, and are rated at 60 watts. Their efficiency is of the order of 10 lumens per watt or less.

As a general rule cold cathode tubes are filled with gases as distinct from metallic vapours. This enables the tubes to give their maximum intensity immediately current is switched on.

Apart from advertising purposes, cold cathode lamps are of little use for general lighting.

Hot Cathode Tubes.

Reference has already been made to the negative resistance coefficient of cold cathode lamps, whereby an increase in current is accompanied by a decrease in voltage across the electrode. The lumen output from a discharge lamp increases with the temperature and watt consumption, hence the luminous intensity of a lamp can be increased by reducing the amount of series impedance and allowing more current to flow. If this is done, however, what is known as "sputtering" is liable to occur. Sputtering is the name given to the coating of the interior of the tube near the electrodes with solidified particles of the gas. If the lamp is over run in this manner, the gas pressure in the tube is reduced and the lamp is rendered useless.

Obviously it is an advantage to employ a heavy current to obtain a lower voltage per foot run of

lamp and to increase the light intensity without increasing the size of the lamp.

Herr Pirani, of the G.E. Co., Berlin, discovered how to restrict the sputtering by employing a heated cathode in the lamp similar to that employed in a wireless valve. By this means the cathode drop is reduced from 160 to 20 volts, and the current may be safely increased from 80 to 100 times the normal. High candle-power is readily obtained with lamps constructed on this principle, burning on normal supply voltages of 200-250.

Two main types of hot cathode discharge lamps have been developed on these principles, viz., the sodium and the mercury types.

Sodium Type. Viewed from merely the efficiency standpoint this is the most promising lamp at present. The colour of the light is nearly monochromatic, practically all the visible rays being in the yellow part of the spectrum. As sodium only exists in vapour form at a temperature above 200 deg. Cent. a small quantity of neon gas is also introduced into the tube to facilitate starting.

Fig. 2 illustrates the 100 watt "Philora" type of sodium lamp. Briefly, it consists of a glass tube

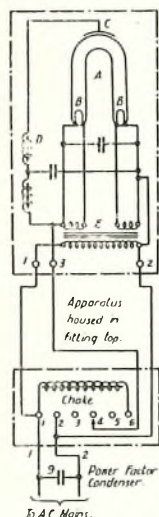

FIG. 2.—CIRCUIT OF THE PHILORA SODIUM LAMP.

18 inches in length, shaped to form a compact lamp about 8" by 4". The tube contains a small quantity of sodium and is fitted with two heater filaments to form the electrodes. A resonant starting device is provided to give about twice the normal voltage for starting purposes. Immediately after switching on, the neon gas commences to glow with a red light, the filaments being heated through a 1½ volt transformer winding. As the temperature increases the sodium starts to evaporate, the conducting gas giving off yellow rays, and for a few minutes red and yellow rays are emitted. After 6 or 7 minutes the sodium is completely evaporated and yellow light only is emitted, the lamp giving about 4000 lumens and consuming a total power of 100 watts.

The lamp is made from a special glass to resist the action of hot sodium vapour, and the light emitting portion of the lamp is enclosed in a vacuum jar (similar to a thermos flask) to reduce the heat losses.

A sodium lamp for horizontal burning is now made in a straight tube 18" long. The operating mechanism is also simplified.

High Pressure Mercury Type. This lamp is slightly less efficient than the sodium type, the colour not being entirely monochromatic, but the lamp is less complicated in detail. As in the case of sodium, mercury does not exist in a gaseous form at normal temperatures, therefore a small quantity of argon, or other suitable gas, is introduced to assist in starting. At a suitably low gas pressure argon becomes a fairly good

conductor, a start can therefore be made without an increase of terminal voltage. At least four different firms are supplying the market with this lamp under the names of Escura, Mercra, Osira and Sieray. Taking the Osira lamp as an example, the sequence of operations is as follows :—On switching on to the 200-250 volt circuit, a current of 4.5 amperes immediately flows through the medium of the argon gas which glows with a faint blue light. The passage of this current heats the electrodes, which consist of tungsten spirals coated with oxides of alkaline earth metals, and also commences to heat the tube. At the moment of starting the voltage across the tube is not more than 20 volts. The mercury then commences to vapourise and the voltage drop across the tube increases. The tube becomes hotter and the light becomes more intense, and less blue in character, until all the mercury is vapourised. This stage is reached after 6 or 7 minutes. The lamp is then giving about 16,000 lumens of blueish white light, and consuming a total of 420 watts, with a voltage drop of 155. The negative resistance coefficient does not obtain until all the mercury is vapourised. A disadvantage of the mercury type (not obtained with the sodium type) is that, should the lamp be extinguished it will take 3-8 minutes to re-light according to the ambient temperature. The high gas pressure in the hot condition requires a higher starting voltage and therefore the lamp must cool to reduce the vapour pressure.

It will be noticed that hot cathode lamps make use of metallic vapours for the light producing source which are inadmissible in the cold cathode type on account of lower operating temperatures.

Some technical data regarding discharge lamps are given in Table II.

TABLE II.

PROPERTIES OF ELECTRIC DISCHARGE LAMPS.

Name.	Osira	Philora	Neon
Particulars.	(Mercury) H.P.	(Sodium).	(tubular sign).
Type	Hot cathode	Hot cathode	Cold cathode
Total watts	420	100	60 per 10 ft.
Colour starting	Blue	Red	Red
.. normal	Blueish white	Yellow	Red
Current starting	5.0 amps.	1.5 amps.	
.. normal	2.8 amps.	.7 amps.	
C.P. when switched on	30	20	
Time to give full light	8.0 mins.	10 mins.	Intermediate
Total S.C.P.	1280	320	} according
Total lumens	16000	4000	} to length
Lumens per watt	38	40	12
Time to re-light	3-8 mins.	at once	at once
Average life of tube... ..	2000 hrs.	2500 hrs.	2000 hrs.
Price of lamp... ..	42/-	48/-	Variable
(without accessories)			

There is a smaller type of high pressure mercury lamp rated at 270 watts with an output of 9000 lumens and an efficiency of 33 lumens per watt. There are also two other sizes of sodium lamps rated at 60 and 180 watts, with outputs of 2300 and 9000 lumens and efficiencies of 38 and 50 lumens per watt respectively.

MODERN FILAMENT LAMPS.

Attention is now drawn to three distinct improvements which have been made recently to the gas filled type of filament lamp.

The "Coiled Coil" Lamp. This lamp has been placed on the market by the different members of the Electric Lamp Manufacturers' Association. One of the main reasons for the relatively lower efficiency for high voltage low wattage lamps, is the increased heat radiation from the long thin filament. This led to the adoption of the spirals in the early days of the gas filled lamp. It has now been found possible to reduce the losses still further by coiling the filament which has already been spirals. A 40 watt lamp so treated has a normal efficiency of 10.5 lumens per watt, which is an increase of 23% over the present type of 40 watt gas filled lamp.

The lamp is guaranteed to give an average life of 1000 hours and is retailed at the same price as the ordinary 40 watt lamp. Sixty and 100 watt lamps are also obtainable at initial efficiencies of 15% and 10% greater than those of the present type.

The Krypton or Xenon Filled Lamp. In the issue of "Comptes Rendue" for June 4th, 1934, a further advance in the efficiency of filament lamps is described by M. Georges Claudes. In the previous development of the gas filled lamp, nitrogen was displaced by argon on account of its higher density. M. Claudes now proposes to displace argon by either krypton or even xenon.

The relative density of krypton is twice that of argon, and xenon is $1\frac{1}{2}$ times that of krypton. The employment of very dense gases in lamp bulbs retards the disintegration of the filament when run at higher temperatures, with a consequent increase in efficiency. A drawback to the use of these gases is their rarity. According to M. Claudes, krypton is present in the atmosphere to the extent of only 1 part in one million, and xenon of 1 part in ten millions. He has, however, established a plant on a commercial basis capable of dealing with 800 cubic metres of air per hour. One of the tests described in his paper was to fill an ordinary lamp with krypton instead of argon. This could then be run at twice the rated voltage for several hours, whereas when filled with argon the lamp would last only for a few minutes. Some experimental 25 watt lamps, filled with krypton gave an increase in efficiency of 33% under normal life conditions. Further news of these lamps is awaited with interest.

Double Filament Lamp. This lamp is constructed with two circuits and two filaments contained in one bulb. When one filament has burnt out a similar filament can be brought into use by turning the cap to bring a third terminal into position. A life of 1000 hours is claimed for each filament.

The cost of the energy burned by an electric lamp at ordinary lighting rates during its normal life of 1000 hours is many times the cost of the lamp itself. Therefore, on the principle of increasing the lamp efficiency by shortening its life, it might be a profitable alternative to run the filament at 10% higher efficiency, thereby reducing the useful life to 500 hours per filament.

This calculation is based on the formula given in B.S.S.161 for general service lamps where

$$\text{equivalent life} = \left(\frac{\text{standard efficiency}}{\text{actual efficiency}} \right)^n$$

where $n = 6$ for vacuum lamps

$n = 7$ for gas filled lamps.

COLOUR CHARACTERISTICS OF ELECTRIC LAMPS.

Electric lighting has always been noteworthy for its usefulness in producing lights of various colours by means of tinted screens.

The electric discharge lamps now enable almost any particular colour to be radiated direct without the use of filters.

This is a direct advantage for such purposes as—

- (1) Red beacon lights for aerodromes.
- (2) Bluish white highly actinic lights for photographic work.
- (3) Yellow light for street lighting.
- (4) Any colour other than white, flood lighting, stage effects.

Table III gives comparative values of the efficiency when producing different coloured light by (a) direct radiation from electric discharge lamps, and (b) gas filled lamps, tungsten filament, with coloured filters.

TABLE III.

100 to 400 watt lamps.	Lumens per watt.	
	Discharge lamp.	Gas filled with filter.
Red	10-15	3
Blue	8-12	5
Blue-white	30-40	10
Yellow	50-60	6
Green	6-8	6
White (approx.)	6-8	15 (no filter)

It is seen that for all colours, except white, the discharge lamp is the most efficient means of producing light. Also, if the attempt is made to produce white light by discharge lamps, viz., helium, etc., then the efficiency is actually lower than that of the gas filled lamp, or carbon arc lamp. This is unfortunate and indeed the stumbling block to greater use of the modern vapour lamps. Red is the only colour that is considerate to the appearance of human beings in artificial light. Even the so-called "daylight lamps" have never attained popularity, mainly on account of their bluish appearance when judged with normal general service lamps. This is largely due to the effect of contrast. When the ordinary gas light first made its appearance, it was of a distinct yellow colour. One will find it described in early periodicals as a brilliant white light.

As successive forms of lighting made their appearance they were each in turn described as brilliant white lights, viz., the batwing flame, gas burner, carbon filament lamp, vacuum carbon lamp, gas filled filament lamp.

The change has been gradual from one type to

another, and it is fairly safe to assume that if all lighting had been effected by "daylight" lamps, the objection to its bluish appearance would have now disappeared.

At this juncture it is profitable to examine the proportions of red rays emitted in the visible radiations of various lamps. Some approximate values are shown in Table IV.

TABLE IV.

Name of lamp.	Lumens per watt.	Percentage of red rays.
Carbon filament	2.5	35%
Vacuum filament	8	30%
Gas filled filament	15	25%
Natural daylight*	7	15%
Sieray lamp	30	4%
Osira lamp	40	1%
Sodium lamp	50	1%

* Gas filled filament type with tinted glass bulb.

These figures are interesting as they show the loss in efficiency that must be tolerated in order to obtain the desirable red rays. The effect of burning a daylight lamp under the following conditions should be given a trial to be appreciated:—

- (1) In a room lit entirely by ordinary metal filament lamps.
- (2) In a room lit entirely by a mercury discharge lamp.

In case (1) it appears a light blue. In case (2) it appears a reddish white. These contrasts indicate that it should be possible to become accustomed to the use of light having a reduced percentage of red rays, where actual colour discrimination is of little importance.

There is also another means of introducing red rays into the luminous flux, from a mercury discharge lamp. There is a brilliant dye named Rhodamine which has the property of transforming light of various wave-lengths into red light. Beneath the rays of the mercury discharge lamp, a surface painted with Rhodamine appears as a normal red tint, whilst other red colours appear brown or dark grey. An Osira lamp, contained in a deep conical shade painted with Rhodamine to a bright red, will give mixed rays approximating to daylight, the lighting from such a source consisting of bluish white rays direct from the lamp augmented by pink rays reflected from the surface of the reflector. Some rough tests made by the writer indicates that a light approximating to daylight can be obtained by this means at a higher efficiency than by filtering the rays from gas filled lamps.

It will be observed that the light from filament type lamps is rich in red rays. A direct connexion exists between temperature, colour and efficiency of all light emitting sources which are dependent on the radiation from incandescent bodies. The efficiency of lamps can therefore be determined simply by matching the colour of the lamp to be tested against a known standard.

The fact may be illustrated by placing a 60 watt carbon and a 60 watt tungsten filament lamp on a photometer bench. Viewed in the screen of a Lummer Brodham Photometer when burning at normal voltage, the colours appear reddish yellow and yellowish white, corresponding to efficiencies of three and ten lumens per watt respectively. Now reduce the current flowing through the tungsten lamp, until the light from it matches that of the carbon filament. A simple measurement will show that the watts are reduced to approximately one half of the former value, and the lumens to one sixth, the result and efficiency for the tungsten lamp now being equal to the carbon lamp, i.e., three lumens per watt.

A similar effect can be obtained by matching the carbon filament to the tungsten.

The relationship between efficiency, temperature and colour will be clear from the figures shown in Table V.

TABLE V.

Efficiency in lumens per watt.	Temperature °C.	Colour.
0.5	1200	Bright red.
3	1850	Reddish yellow.
10	2320	Golden white.
40	3200	Almost white.

An example of this may be noticed after nightfall in almost any main street. Motor car head lamps will appear to be nearly white in colour, when compared with the yellow rays from a passing tramcar, the comparative efficiencies being 16 and 6 lumens per watt respectively.

EFFICIENCY RANGE OF ELECTRIC LAMPS.

Before discussing actual lamp efficiencies it is desirable to fix a value for the lumens per watt resulting from an overall efficiency of 100 per cent.

This will vary according to the colour of the light, as at a certain wave-length the luminous flux is at a maximum. Some useful information on this subject is contained in an article by Messrs. Harris & Jenkins in the *General Electric Journal*, August, 1931.

The ideal values for different colours are given as follows:—

Greenish yellow light ...	670 lumens per watt.
Yellow light	360 " " "
Natural daylight ...	200 " " "

The value of 670 lumens per watt is coincident with a light of greenish yellow, an unearthly tint of little practical use. The next tint to be of practical use is yellow sodium light at a maximum possible efficiency of 360 lumens per watt. It has been stated that Herr Pirani, of the G.E. Co. at Berlin, has actually obtained such a value under artificial conditions. The figure of 360 lumens per watt is therefore the absolute maximum that could be used for the ideal source. Similarly the same authority refers to the possibility of obtaining a value of approximately 100 lumens per watt from a heated body at its point of maximum radiation, this however occurs at the un-

workable temperature of 6400°C. The maximum value that could be attained in practice would be limited to 50 lumens per watt at the melting point of tungsten.

It is interesting to trace how electric lamp efficiency has proceeded towards these ultimate figures.

Looking back through the history of electric lighting it will be noticed that the 60 watt lamp has always been the most widely used unit of low intensity, whether carbon glow lamp, tungsten vacuum, or tungsten filament gas filled type.

Similarly the 400-500 watt lamp has held the same position for lamps of high intensity, viz., open or enclosed arc lamp, mercury vapour lamp, high power gas filled lamp, and finally the electric discharge lamp.

Fig. 3 shows how the 60 watt filament lamp has improved in efficiency since the commencement of

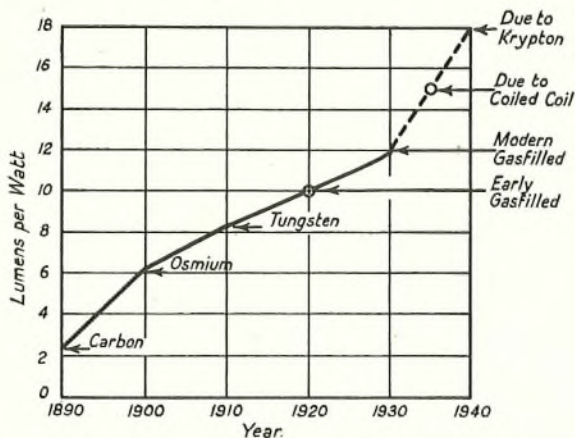

FIG. 3.—IMPROVEMENT IN EFFICIENCY OF FILAMENT ELECTRIC LAMPS, 60 WATT.

practical electric lighting in 1890. Starting at 2.5 and having reached 12 lumens per watt, there is now an indication, from the recent improvements already described, that the efficiency for this size of lamp will shortly reach 20 lumens per watt. Taking the maximum possible value for filament lamps at 50 lumens per watt, this represents an advance from 5% to 40%, a highly creditable achievement to the electric lamp industry.

Fig. 4 shows in a similar manner, how the 400

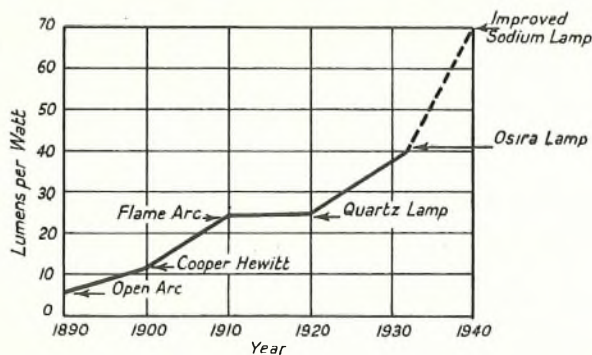

FIG. 4.—IMPROVEMENT IN EFFICIENCY OF 400 WATT ELECTRIC LAMPS.

watt lamp has improved. The figure of 6 lumens per watt for the open arc lamp appears, at first sight, to be too low a figure, as in past days it was customary to refer to 10 ampere open arc lamps as having an intensity of 1000 candle-power. This high value is obtained only in a zone occurring at approximately 45° from the vertical, the luminous intensity in all other directions being remarkably low.

The present figure of 40-50 lumens per watt for electric discharge lamps is likely to be increased to 70 lumens per watt in the near future, as the value can be obtained with a sodium vapour lamp by reducing the losses in the auxiliary apparatus.

Calculating on a maximum efficiency of 360 lumens per watt, this represents an advance from 1.7% to 19%. It will be observed that the modern electric discharge lamp is behind the filament lamp in relative efficiency, the order being 19% to 40% respectively.

It is not generally recognised to what extent the efficiency of a filament lamp depends on the rated current of the lamp. A long thin filament radiates more energy in the form of heat than a short thick one for the same wattage. This will readily be appreciated by turning to Table 2 of B.S.S.161, 1934, for General Service lamps, (or to any lamp makers list), where it will be seen that lamps of the same current rating have approximately the same efficiency, irrespective of rated voltage. From these declared values curves have been prepared in Fig. 5

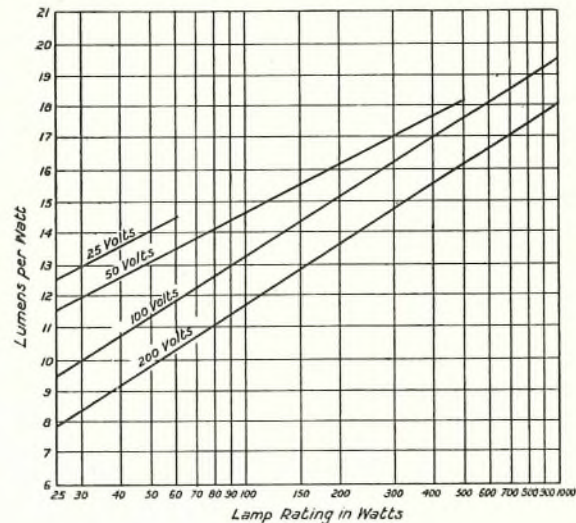

FIG. 5.—COMPARATIVE EFFICIENCIES OF LOW AND HIGH VOLTAGE LAMPS.

showing the lumens per watt for various sizes of lamps at different rated voltages. The marked superiority of lamps made for low terminal voltages is shown in a striking manner. For example a 60 watt 25 volt lamp is shown to give 40% more light than a 200 volt lamp of similar wattage. All these figures are based on lamps manufactured to give a life of 1000 hours. There has been some talk lately of rating lamps for a shorter life in order to obtain a higher working efficiency. In this connexion it is

interesting to note that a special 200 watt lamp is made for photographic purposes giving 40 lumens per watt, with an average life of about two hours. It is also worth noting that a 12 volt 36 watt motor car bulb is equal in efficiency to a high voltage 500 watt general service lamp, both being rated at 15 lumens per watt. Fig. 6 shows how the efficiency of general service lamps varies in terms of the rated current irrespective of the rated watts.

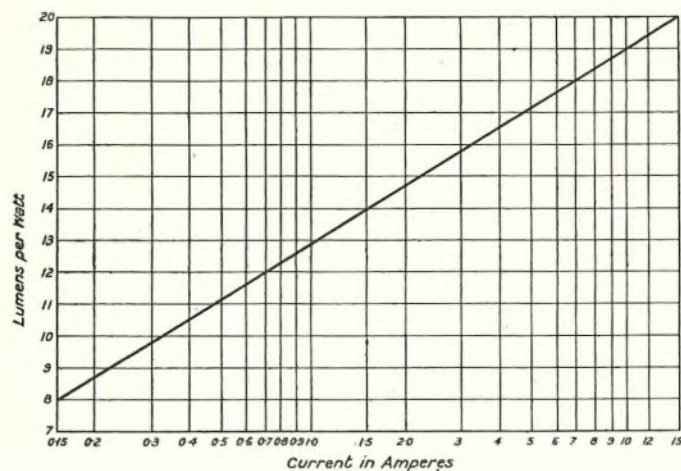

FIG. 6.—EFFICIENCY-CURRENT CHARACTERISTIC OF GENERAL SERVICE LAMPS.

REFLECTION AND ABSORPTION.

The subject of reflection and absorption is at least of equal importance to lamp efficiency in lighting problems. Except for the open type arc lamp no case can be called to mind, in which the total radiation from a light source can be utilised without reflection of some of the rays. With the majority of electric lamps only one fifth of the light is used in the form of direct rays. Successful lighting therefore depends to some extent on the efficient reflection of the indirect rays in the required direction. It is the practice nowadays in lighting calculations to employ the "Utilization Factor," *i.e.*, the ratio of lumens measured in the working plane to the total lamp lumens. This might more aptly be called the "lighting efficiency" as it is a ratio of useful flux to total flux.

The utilization factor varies with :

- (1) The Number of lights.
- (2) The Size of room.
- (3) The Position of light.
- (4) The Polar curve.
- (5) The Reflection factor of walls and ceiling.
- (6) System of lighting.

With so many variables it is only possible to obtain an approximation to the utilization factor, which is influenced very largely by items (2), (3), (5) and (6).

(2) *Size of Room.* With an increase in room dimensions, the relative amount of light absorbed by the walls and ceiling decreases. This point is illustrated by the following example :—

Consider a room of dimensions 10 feet cube, and illuminated by a lamp of 1000 lumens output,

suspended exactly in the centre. Assuming the luminous intensity to be of equal strength in all directions, and the reflection factor of walls at .3, and ceiling at .7 respectively, then, on the basis of six sides of equal area forming a cube, the walls receive approximately 4/6ths of the total lumens.

Now place four such rooms together as shown in plan Fig. 7, removing the inner walls, shown by dotted lines to form one large room.

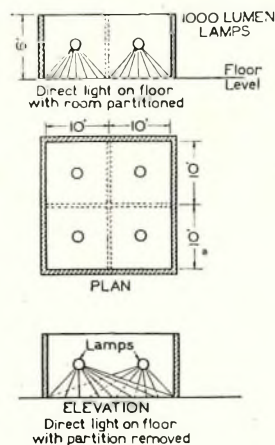

FIG. 7.—EFFECT OF ROOM DIMENSIONS ON THE UTILIZATION FACTOR.

The result will be an increase in the amount of direct light on the floor and a decrease in the number of lumens absorbed as indicated by the shaded area in the elevation. The equivalent illumination received by the walls per 10 feet cube now falls to 2/6ths of the total lumens.

A comparative lumen balance sheet for the small and large room is shown in Table VI.

TABLE VI.

	Small room containing 1000 cubic feet.	The same room forming one fourth part of a room containing 4000 cubic feet.
Total lumens ...	1000	1000
Ceiling area in sq. feet	100	100
Ceiling reflection factor	.7	.7
Illumination received on ceiling ...	16.6%	16.6%
A. Lumens reflected from ceiling ...	$1000 \times .166 \times .7 = 117$	$1000 \times .334 \times .3 = 100$
Reflection factor of walls3	.3
Illumination received on walls ...	66.6%	33.4%
B. Lumens reflected from walls ...	$1000 \times .666 \times .3 = 200$	$1000 \times .166 \times .7 = 117$
C. Lumens received on floor as direct light	$1000 \times .166 = 166$	166
D. Extra lumens due to removal of two walls ...	—	233
Total lumens received on floor A + B + C + D ...	483	616

In this example the utilization factor is increased from 48.3% to 61.6%, by quadrupling the size of the room and leaving other details unchanged. It should be borne in mind, however, that in increasing the area of a room the ceiling height is often also in-

creased. If this practice had been followed in the above example, the increase in the utilization factor would not have been so great.

(3) *Position of Light.* This factor also depends on the amount of direct light, that is unreflected light, received from the lamp. The direct light varies with the height of the lamp and the width of the room. Thus a lamp near the ceiling in a high narrow room may shed only 2½% of direct light on the floor, whilst a lamp relatively near to the floor in a wide room distributes 30% of its rays as direct light. Curves in Fig. 8 have been calculated to illustrate this point, and will also be found useful in many lighting calculations.

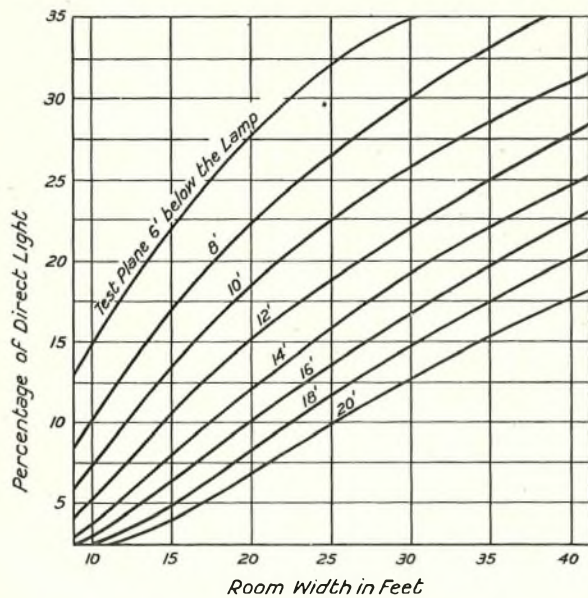

FIG. 8.—EFFECT OF POSITION OF LIGHT.

(4) *Polar Curve.* The polar curve depends on the type of fitting employed. If a fitting is not used then the curve for the bare lamp has to be considered.

(5) *Reflection Factor of Walls and Ceiling.* The reflection factor is the ratio of the light reflected from a surface to the light incident upon it. The reflection factor varies through wide limits—from 15% for walls of a dark brown or red colour, to 70% for a clean white ceiling. It is not easy to obtain a reliable figure by calculation, as windows and blinds, furniture, ceiling, decorations and fittings all enter into the question.

The luminous flux from a lamp suspended in a closed room is distributed as follows:—

- (1) A portion reaches the floor (or test plane) as direct light.
- (2) A portion is absorbed by the walls and ceiling.
- (3) A portion is reflected from the walls and ceiling on to the test plane.

Let the total lumens from the source be A, the lumens received in the test plane as direct light be B, the lumens received on the test plane as reflected light be C. Then the incident light to walls and ceiling will be A - B.

The reflection factor may be conveniently determined experimentally in the following manner:—

- (1) Suspend a lamp of known luminous intensity at a height in the room corresponding to the position the fittings will normally occupy.
- (2) Using a portable photometer, take a sufficient number of readings to obtain a fair average value of the illumination in foot candles in the test plane. Obtain the useful flux in lumens, from the area of test plane in square feet, multiplied by the average foot candles. This value corresponds to item B + item C.
- (3) Place a black non-reflecting screen, below the lamp so arranged that no direct light falls on the test plane, the walls and ceiling being fully illuminated.
- (4) Take a further set of readings with this screen in position and obtain the lumens received on the test plane due to reflected light only (Item C).

Item B will then be found by subtraction and the reflection factor is $\frac{C}{A - B}$

A test to illustrate this method was carried out at the South East London Technical Institute, in a large room measuring 36 ft. by 36 ft. by 25 ft. high. A 1000 watt 230 volt gas filled lamp was used for the experiment. This was suspended at 17.5 feet above the test plane (i.e., 20 feet above the floor level). The total flux from the lamp was A = 16000 lumens. The average illumination from the unscreened lamp was 4.5 foot candle (or degrees, as is the common practice in illumination estimates) and the area of the room 36² = 1296 sq. feet.

$$\text{therefore } B + C = 1296 \times 4.5 = 5860.$$

The average illumination with the opaque screen in position was 2.2 degrees.

$$\text{Therefore } C = 1296 \times 2.2 = 2860$$

$$\text{and } B = 5860 - 2860 = 3000$$

$$\text{Reflection factor} = \frac{2860}{1600 - 3000} = .22$$

The somewhat low factor is mainly due to several large windows, which were covered by dark blinds.

(6) *System of Lighting.* The three systems generally employed are:—

The direct system, in which as much direct light as possible is used without the use of diffusing glass.

The indirect system, in which all the light used is reflected.

The semi-indirect system, in which the direct rays are passed through diffusing glass in order to reduce the brilliance of the light source.

The direct system is preferred where it is desired to provide good illumination at a reasonable cost.

The indirect system is employed where absence of shadow is particularly desirable, and where some degree of intensity is usually sacrificed to obtain this result.

These two systems might be described as "Glare" versus "Gloom." A compromise is made by adopting the semi-indirect system.

CALCULATION OF LIGHTING COSTS.

The changes in lamp prices and also the wide range of prices for electrical energy, are sufficient reasons to make the study of electric lighting costs of considerable interest at the present time. Also the advent of the electric discharge lamp should focus the attention of many lighting engineers on the subject of costs.

Before the general acceptance of the lumen for the luminous rating of electric lamps the "mean horizontal candle power" was the unit in common use. In those days the actual spherical candle power was difficult to obtain owing to the lack of suitable measuring apparatus, such as integrating spheres or cube photometers and it therefore became the practice to employ the mean horizontal candle power as this value was easily obtained.

For those accustomed to visualise their lighting installations in terms of the mean horizontal candle, it is convenient to remember that the "reduction

factor" of a lamp, *i.e.*, $\frac{\text{Spherical candle power}}{\text{mean horizontal candle power}}$ is in the neighbourhood of 0.8, so that the total lumens per lamp equals the mean horizontal candle power $\times .8 \times 4\pi$

$$\text{or total lumens per lamp} = \text{M.H.C.P.} \times 10.$$

Using this formula, lumens and mean horizontal candle power are simple ratios of 10. Also the terms "Watts per candle" and "Lumens per watt" are readily converted by dividing into ten, thus

$$\text{watts per candle} = \frac{10}{\text{lumens per watt}}$$

$$\text{or lumens per watt} = \frac{10}{\text{watts per candle}}$$

At one time it was the general practice to estimate lighting costs in pence per candle hour. Now that the lumen-hour has largely taken its place, the former unit is found to be inconveniently small inasmuch as it involves the use of several noughts after the decimal point. The writer therefore proposes to use a unit of 1000 lumen-hours, to be named the kilo-lumen-hour. This will be found useful in two ways,

- (a) because there are 1000 watt hours in a unit of electricity,
- (b) because modern tungsten filament lamps are guaranteed to give a life of 1000 hours,

therefore,

$$\text{the cost of current per kilo-lumen-hour} = \frac{\text{pence per unit}}{\text{lumens per watt}}$$

$$\text{and the lamp cost per kilo-lumen-hour} = \frac{\text{price of lamp in pence}}{\text{total lumens from lamp}}$$

The kilo-lumen represents the useful light received in a room ten feet square at an intensity of 10 foot candles.

There is a natural tendency to adopt higher values of illumination consequent with improvements in electric lamps, and with the general decrease in the price of current.

In connexion with the Brighter Post Office Move-

ment authority was obtained in 1933 to increase the standard of lighting in Public Offices to eight foot candles. This is still somewhat below the minimum now employed in many public buildings where a value of ten foot candles is customary. It is therefore proposed to show some cost comparisons on the basis of ten foot candles of illumination.

In Fig. 9 some curves have been prepared, according to the method previously described, showing how

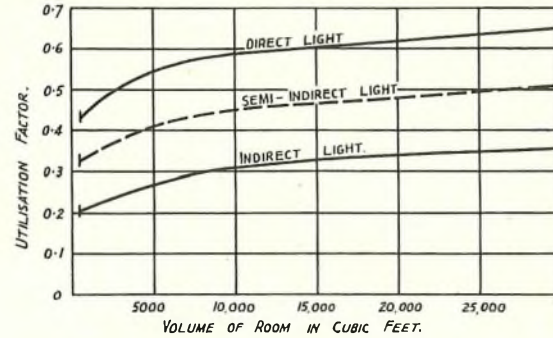

FIG. 9.—VARIATION OF UTILIZATION FACTOR WITH ROOM DIMENSIONS.

the utilization factor varies with room dimensions. The rooms are square in shape with ceiling height in normal proportions. These curves are to some extent approximate, but nevertheless form a useful basis for the determination of cost comparisons.

The following calculations may be taken as an example of the method outlined in this section.

It is required to find the cost per kilo-lumen-hour to illuminate a room 36' square by 20' high to an intensity of 10 foot candles by the indirect system:—

Room area 1,296 square feet.
Room volume 26,000 cubic feet.
Lumens 12,960.

Utilization factor (Fig. 9) .38.

Total lumens required from lamps

$$\frac{1,296 \times 10}{.38} = 34,000.$$

Minimum number of lamps to give uniform distribution = 4.

Lumens per lamp approx. 8,500.

Supply voltage 230.

230 volt 500 watt lamps give 8,250 lumens at 16.5 lumens per watt.

Nearest value of lumens available is therefore 8,250.

Cost of lamp 120d.

„ „ current 3d. per unit.

Current cost

$$(a) \frac{\text{pence per unit}}{\text{lumens per watt}} = \frac{3}{16.5} = .182d.$$

Lamp cost

$$(b) \frac{\text{price of lamp}}{\text{total lumens per lamp}} = \frac{120}{8250} = .0145d.$$

Cost per kilo-lumen-hour from lamps
 $.182 + .014 = .196d.$

Total cost per kilo-lumen-hour received in test plane
 $= \frac{.196}{.38} = .52d.$

Kilo-lumens received in test plane
 $8250 \times 4 \times .38 = 12.6$

Total cost per hour to illuminate room 36' square
 at ten foot candles intensity
 $12.6 \times .52 = 6.5d.$

ECONOMIC CONSIDERATIONS AND CONCLUSION.

In this concluding section it is proposed to show how the new types and methods, described in preceding sections, may be utilised to the best economical advantage. It is necessary to examine the question of electricity charges in order that the choice between a flat rate or a two part tariff may be made. Current used for "lighting only" usually has a poor load factor, and the standing charges are therefore high. The following scales have been adopted by some of the London Supply Authorities:

Flat rate. 3d. to 5d. per unit.

Two part rate.

(a) Standing charge. £10 per kilo-watt of lamps fixed.¹

(b) Running charge. $\frac{1}{2}d.$ per unit.

To make comparisons of the two methods of charging for energy, the approximate number of burning hours per annum must be known.

For a two part tariff the actual cost of current per unit will be:

$$\text{Pence per unit} = \frac{\text{Standing charge per K.W. in pence}}{\text{Number of burning hours}} + \text{running charge in pence.}$$

Using this formula the curve in Fig. 10 has been plotted.

A study of this curve reveals the fact that lighting may be very expensive under this system if the number of hours per year is small. For example, an office having good daylight facilities will not need more than 250 hours lighting per year, corresponding to a cost of 10d. per unit. From this it is evident that when making arrangements for the supply of electricity for lighting purposes only, the terms of supply need careful consideration. Even at 1000 hours per year, which is the generally accepted average value for lighting hours, the actual price is approximately 3d. per unit.

Curves similar to the one shown in Fig. 10 may be constructed to suit any particular two part scheme. An analysis of lighting costs may then be carried out by the same method as previously outlined.

In order to do this effectively, it is convenient to arrange lighting schemes in order of quality, as follows:—

¹ A much lower charge than this is made when electricity is used for purposes additional to lighting, i.e., power and heating.

First quality. For unobtrusive lighting, free from defects, entirely in harmony with architectural details, as required in reception rooms and private apartments.

Second quality. For lighting of good intensity during normal periods of darkness, as required in large offices, exchanges, test rooms, etc.

Third quality. For lighting stores, workshops, garages, etc.

Fourth quality. For lighting yards, loading banks, and basements and sub-basements where illumination is required for long periods throughout the year.

To the interested reader, it will be apparent that with the wide choice of lamps and materials now available, some improvement could be effected in

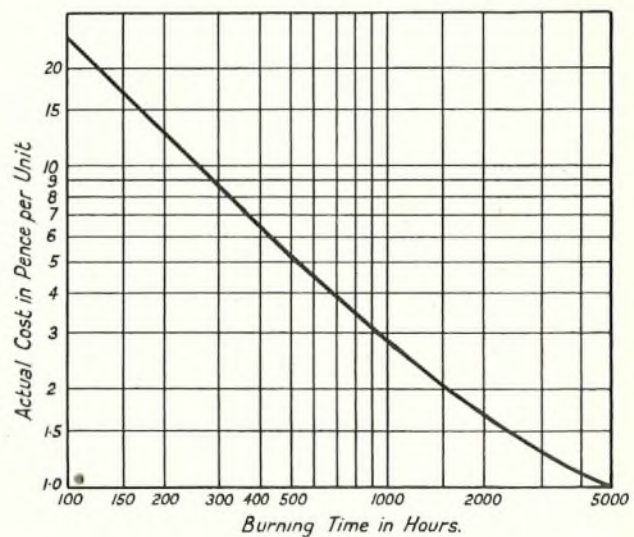

FIG. 10.—VARIATION IN COST PER UNIT UNDER TWO PART TARIFF.

many lighting installations. Advantage might be taken of the following:—

Filament Lamps of Low Luminous Intensity. The 10-20% efficiency increase due to the coiled coil lamp. The reputed double life of the twin filament lamp. The 33% efficiency increase due to krypton gas (when commercial lamps are obtainable).

Filament Lamps of Higher Intensity. The 25% to 50% increase in efficiency due to employment of series burning or heavy current lamps at low voltage. In some cases the improvement may be partly offset by the extra cost of cables.

It is suggested that the original low voltage series system described many years ago by Mr. A. W. Ashton in his I.E.E. paper, May, 1912, might be given a trial now that power condensers of an improved form are available.

High Pressure Mercury Lamp. Although the colour is at present not generally acceptable for indoor lighting, there is plenty of scope for experiment. It has been stated by Mr. Clifford Paterson, in a

lecture before the Illuminating Engineering Society, that, with the correct mixture of neon and mercury vapour, lamps giving exact daylight tints can be obtained experimentally. From experience gained by the writer, of reflectors treated with the rhodamine dye, referred to previously, it is believed that a room could be successfully illuminated by means of unshaded mercury discharge lamps, provided that the walls and ceiling were tinted with rhodamine dye of the correct shade. The Croydon Corporation have also produced a lighting unit of agreeable colour by mixing the light from a 400 watt high pressure mercury lamp with the light from three 200 watt gas filled filament lamps. Their tests show an overall improvement of 60% in efficiency, as compared with the previous installation.

Sodium Vapour Lamp. Further experiments by the writer revealed the fact that it is possible to mix the rays from a sodium discharge lamp with those from the tungsten filament gas filled type. In a room 20' square, normally lit by four 100 watt gas filled filament lamps, the addition of a 100 watt sodium lamp in the centre increased the average illumination from 6 foot candles to 10. The colour of the light was not unpleasant and resembled that of the yellow flame arc lamp.

Under the heading of first quality lighting, not very much can be effected as regards economy. In order to meet the requirements previously set out, special lamps and light absorbing shades are liberally used, and cost becomes a secondary consideration to effect.

Under the heading of second quality lighting, economies may sometimes be effected by careful choice of reflectors, and more efficient lamps. Alternatively the standard of lighting may be improved at little extra cost. The colour of the light given by electric discharge lamps is unsuitable for this class of lighting, but improvements can be made by substituting filament lamps in the higher efficiency range and also by attention to reflection details. If no alteration to existing fittings is desired, the coiled coil lamps offer a ready means of improvement, up to an increase of 20% where low wattage lamps are in use.

Basing an opinion on the results of experiments already referred to, it is suggested that some sort of colour corrected scheme of lighting using discharge lamps might be given a trial for third quality lighting.

As regards the fourth quality lighting, there appears to be no reason why filament lamps should not be displaced entirely by discharge lamps, where long periods of burning are needed.

In conclusion, some cost comparisons are given for the four previously named qualities of lighting. These are based on :—

- (a) Cost of lamps at Makers' list prices.
- (b) Lamp efficiencies from B.S.S.164 and Makers' price lists.
- (c) Utilization factors from Fig. 9.
- (d) Cost of current at 3d. per unit.

Cost of first quality lighting. This generally being of an expensive character, a representative cost may be shown by the use of 200 volt 60 watt general service lamps and employing the indirect system of illumination.

The lumens per watt, from Fig. 5, are 10.2.

$$\text{The current cost (a)} = \frac{3}{10.2} = .295\text{d.}$$

The nominal lumens are 610 and the price of a lamp is 21d.

$$\text{The renewal cost (b)} = \frac{21}{610} = .035\text{d.}$$

The total cost per kilo-lumen-hour from lamps is 0.33d.

Taking the utilization factor (Fig. 9) for a moderate size room at .25, the total cost of effective illumination in the room becomes 1.33 pence per kilo-lumen-hour, that is, the cost of illuminating one hundred square feet of area, to a value of ten foot candles.

Cost of second quality lighting. For offices and business premises, 60-100 watt lamps as direct units, or 150-300 watt semi-indirect fittings are now generally employed. When used in rooms of 5000 cubic feet or less, there is little difference in the total working cost, for the same intensity of illumination between :

- (a) 60 watt lamps direct lighting,
- (b) 200 watt lamps in semi-indirect fittings,

the estimated cost per kilo-lumen-hour in either case being .67 pence. This could be reduced to .56 pence by replacing the normal 60 watt lamps by coiled coil lamps and the 200 volt 200 watt lamps by 50 volt 200 watt lamps.

Cost of third quality lighting. Larger areas to be illuminated are involved under this heading. This enables a trial to be made with electric discharge lamps, as these are not obtainable in units of low intensity.

The Engineer to the Croydon Corporation has already shown that the light from high pressure mercury lamps can be successfully mixed with that from general service lamps. In order to obtain a light approximating to daylight the required lumen ratio is in the vicinity of 65% mercury to 35% filament type. Thus a 400 watt discharge lamp requires the equivalent of 600 watts in filament lamps blended with it, to produce the desired effect.

From the foregoing it will be observed that the use of discharge lamps is restricted to units of high intensity. Some costs have been worked out to show the comparative cost of lighting by large units and these are plotted in Fig. 11. The lowest rating for each type is indicated by a short vertical line at the beginning of the curve. The curves for mixed lighting of sodium and mercury lamps with tungsten filament lamps are based on experimental figures giving the minimum proportion of red rays accept-

able for working in average comfort. From these curves may be deduced the cost of providing third quality lighting by means of general service filament lamps, or by the mixture of discharge and filament types.

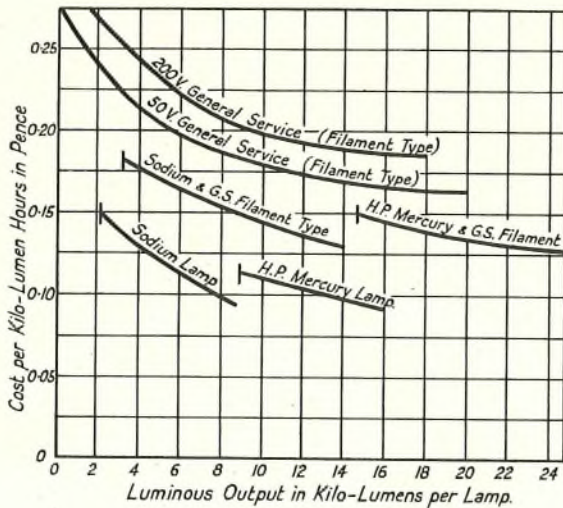

FIG. 11.—COMPARATIVE COSTS OF LIGHTING BY LARGE UNITS.

For the sodium and filament mixture, the lowest available intensity is 4000 lumens. Such a unit would provide an illumination of ten foot candles for an area about 12 feet square, where semi-indirect light is employed, with a utilization factor of .38 (Fig. 9)

Comparisons of three methods follow :—

TABLE VII.

	General Service Lamps.		Mixture of Sodium and General Service lamps.
	200v.	50v.	
Watts taken by lamp ...	300	300	160
Lumens	4400	5100	4000
Lumens per watt ...	14.7	17	25
Cost per K.L.H. (Fig. 11)	.24d.	.215d.	.18d.
Utl. factor (Fig. 9)38	.38	.38
Cost per K.L.H. for the illuminated area63d.	.56d.	.475d.
Relative cost	100	89	75

A saving of 25% in working costs is possible by the use of a suitable mixture of general service and sodium electric discharge lamps.

Cost of fourth quality lighting. For large areas the cost of light from the source per kilo-lumen-hour (from Fig. 11) is .095d. for the larger sizes of sodium or high pressure mercury lamps.

The utilization factor for large interiors employing direct lighting is .6 or more. A minimum lighting cost of .16 pence per kilo-lumen-hour of illuminated area is therefore possible under the above heading. This figure is less than one half of the cost that would be incurred using high power filament lamps.

In conclusion, the writer wishes to express his indebtedness to the Principal of The South East London Technical Institute for facilities to carry out the various tests referred to in this article; also to Mr. Gosse, of Messrs. Philips Lamps, Ltd., and Mr. Villers, of the General Electric Co., Ltd., for technical details, and loan of the Sodium and the Osira lamps respectively. The writer also wishes to thank Mr. R. E. Pooley, of the Testing Branch, London, for the use of some material from his personal file.

Creeping of Underground Cables

In various parts of the country telephone cables laid in ducts have shown a tendency to move slowly but persistently, in the same direction as the majority of the road traffic above them, that is to say, forward on the left of the road.

In several cases cables have moved a foot or so, causing joints to break by being forced against the mouth of the duct. The trouble is certainly due partly to vibration and perhaps also to the slight wave which travels along a duct underneath a heavy vehicle (which may have pneumatic tyres and therefore produce no vibration in the ordinary sense of the word) and causes the cable to execute a feeble imitation of a surf rider, who progresses by sliding down the front of a travelling wave. As might be

expected, the trouble has been reduced by the recent change from solid to pneumatic tyres for heavy vehicles.

The question has been made the subject of a research investigation and measurements are being made with a view to obtaining a relation between measured ground vibration, for a vehicle of known weight and speed, and the rate of creepage. This should at least make it possible to predict whether creepage is likely to be serious on a new cable route. If it is, suitable clamping devices can be fixed when the cable is laid. At the same time the whole problem is being studied with a view to analysing the cause of the trouble.

Cross-talk

S. HANFORD, B.Sc., M.I.E.E.

CROSS-TALK is the result of capacitive or inductive transference of energy from a circuit carrying an alternating current, such for example as a speech current, to an adjacent circuit.

The measure or cross-talk value is defined either as the equivalent attenuation from sending end of disturbing circuit to listening end of disturbed circuit expressed in decibels or nepers, or as the ratio between received voltage on disturbed circuit and sent voltage on disturbing line.

The transmission engineer prefers to use the power ratio expressed in decibels as cross-talk to him is simply a limiting factor to repeater gain, the generally accepted standard being cross-talk attenuation value - 55 db. = maximum permissible repeater gain (i.e., maximum loss on the circuit between repeater stations for zero line conditions). To the tester, however, the simple measurement of the ratio of two voltages is bound to appeal, as it is possible to measure A.C. voltage ratios with accuracy, using apparatus which is not complicated and needs no previous calibration. The ratio is expressed in millionths of the disturbing voltage.

The relationship between the two methods of stating a cross-talk value is shown in the following example :—

100 millionths is a voltage ratio of 10,000, which is equivalent to a power ratio of 10^8 , since power is proportional to the square of the voltage across equal impedances. A circuit having an attenuation of 80 decibels (8 bels) has a power ratio input to output of 10^8 , so 100 millionths is the same cross-talk value as is defined by saying that the cross-talk attenuation is 80 db.

Since the first screened pair cable between the London Trunk Exchange and Broadcasting House was laid and tested, the Department's cable testers have had a standard visual voltage comparison cross-talk set, which could be hooked up when required from standard testing apparatus. The proper operation of this set requires that any pick-up from outside sources or the oscillator should be small and the same, whether measuring on the meter or on the line. The diagram of connexions is shown in Fig. 1.

The points to be watched when wiring up the apparatus are :—

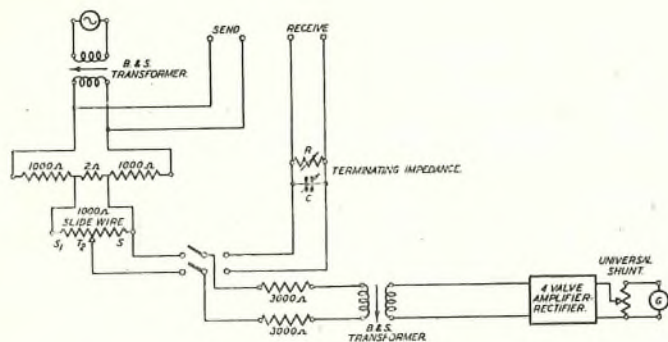

FIG. 1.—CONNEXIONS OF VISUAL CROSS-TALK SET.

- (1) The circuit being "listened on" must be closed with its characteristic impedance.
- (2) The amplifier input impedance must be high, so that when put across either the circuit under test, or the potentiometer, it has no appreciable shunting effect.
- (3) The input transformer to the amplifier must be oriented to reduce to an absolute minimum the pick-up from the oscillator and local external sources. To screen with a $\frac{1}{2}$ " iron box assists, but does not entirely eliminate this pick-up trouble. The oscillator should be located well away from the rest of the apparatus.
- (4) The deflexion on the galvanometer must be the same before any line is connected to the receive terminals, whether the key is thrown to potentiometer set at zero or to "line," and the balance to earth of the B and S transformer windings must be adjusted by a condenser, made of a short length of V.I.R. pair between one end of the winding and the screen earth, so as to achieve this equality.

The operation of the set is extremely simple; tone is put on the disturbing line, the key is thrown to the line being "listened-on," and a deflexion on the galvanometer is obtained which is made reasonably large by increasing the amplifier gain. The amplifier and galvanometer shunt being left untouched, the key is then thrown to the potentiometer, and the slide wire resistance adjusted until the galvanometer spot regains its former position. The ohms reading on the slide wire is then the measure of the cross-talk in millionths of impressed voltage.

With the advent of the Doust heterodyne oscillator, which is completely screened and has the output balanced to earth, and with improvements in amplifier design particularly as regards balancing and screening the input transformer, it was possible, gradually to improve this visual cross-talk set until it would give 5 c.m.'s deflexion on the galvanometer for one millionth of cross-talk and retain reliable operation, and this was the position when the Anglo-French (1933) cable was tested.

The proposal to have a large telephone cable laid in 1934 by contractors, for audio and carrier working between Liverpool and Glasgow by the West Coast route, made it desirable to have available for acceptance test work a cross-talk set which would be self-contained and portable, of wide range yet capable of reading down to 0.1 millionths, and easily controlled and operated. Such a set is illustrated in Fig. 2.

The principle is exactly the same as that of the original hook-up set, but instead of using the potentiometer arrangement of two 1000 ohm ratio arms with an intermediate 2 ohm coil across which the 1000 ohm slide wire is connected, we have in this set an inductanceless resistance box, adjustable between 0.1 and 10 ohms, connected between two resistances of 50,000 ohms when the range of cross-

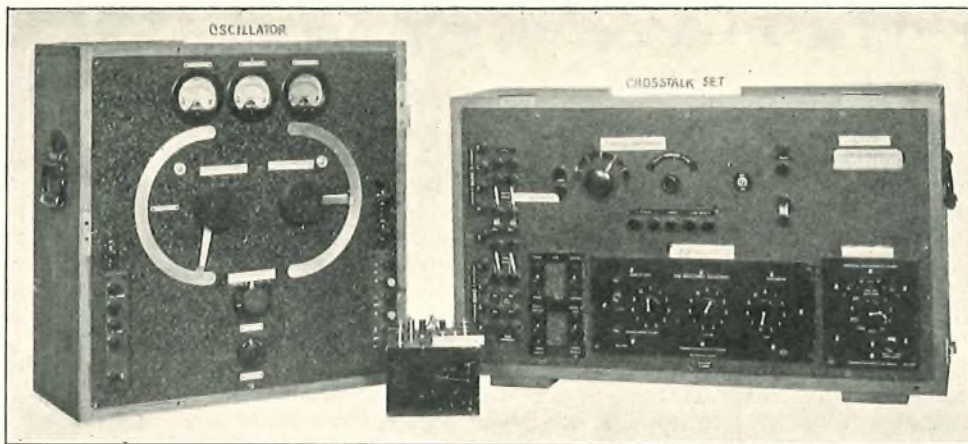

FIG. 2.—PORTABLE CROSS-TALK SET.

talk to be measured is of the order of 1 to 5 millionths. For large values of cross-talk the 50,000 ohms resistances are replaced by 10,000 or again by 5,000 ohms, so increasing the fraction of the total voltage across the potentiometer which the 0.1 ohm in the resistance box represents. The amplifier embodied in the set is an improvement on that used in 1933 and was designed by Mr. J. F. Doust, of the Department's research staff. It has four ranges of amplification controlled by a range switch, and also a variable output control operable on each range, giving a smooth variation of output over the particular range at which the amplifier is set to work. The galvanometer is a Tinsley with a 10 c.m. scale, and is provided with a high-grade shunt with short-circuiting press key. With these three controls it should always be possible to set the spot at some reasonably large value for minute cross-talks, and to cut down deflexion to suit the scale for large values or when measuring attenuation of lines.

Two such sets were made at Dollis Hill workshops during 1934, while the Liverpool-Glasgow cable was being laid by contractors, and all cross-talk tests made on the four repeater sections of the cable have been made with these sets. They have been compared with the sets used by the contractors and no discrepancies have been found. The wiring is, of course, screened pair throughout, and special precautions have to be taken to avoid cross-talk in the keys. The degree of screening achieved can be judged from the fact that the set and oscillator can be used side by side as shown in the illustration.

One of the greatest troubles with sets which depend on the human ear for a decision as to equality of the received cross-talk and of a fraction of the disturbing tone, is that human ears vary; particularly is this so if the disturbing tone is speech or mixed frequency; in fact the official figure of recognised range of speech-listening tests of this nature is 7 db's, *i.e.*, one pair of observers may judge the value at twice the number of millionths which another pair of observers consider it to be. Hence audio measurement of cross-talk is not accurate, and individuals cannot rightly argue with each other about the results which they have obtained. For this reason a speech-

listening test for cross-talk is not a satisfactory thing to specify.

The visual set, even with buzzer input, does give consistent results irrespective of the person operating the set, although, for reasons which appear later, the amplifier has not been fully compensated and high-frequency components of mixed frequency cross-talk are somewhat under amplified.

It will be appreciated that when

measuring with pure tone the visual set is extremely accurate, as the exact amount of amplification does not matter, so long as it is the same with key to line as it is with key to meter.

For a rough estimate of speech cross-talk value an audio measurement with a reed hummer has been the Department's standard for some years, but for accuracy in cases where the value is over or near the specification limit, a visual indication of equality between received cross-talk and a fraction of the disturbing tone is essential. The problem of dealing with the full range of speech frequencies has been occupying attention in the Department for some two years—in fact, as success with the visual measurement method became assured, so it has been the desire to relate the cross-talk values over the frequencies in the speech band, to the mean speech cross-talk obtained by averaging audio tests made by a number of observers. Some success has been achieved in this matter, the basis being the recognition that in speech as transmitted by telephone transmitters, by far the largest power is at about 1100 to 1200 frequency, and that frequencies below about 800 and above 1500 cycles, although essential for quality of diction and recognizability of individual voices, do not exist in the telephone circuits with anything like the intensity of the 800 to 1500 band. Hence the speech cross-talk value is mainly due to frequencies in this band.

Fig. 3 shows a curve of pair to pair cross-talk

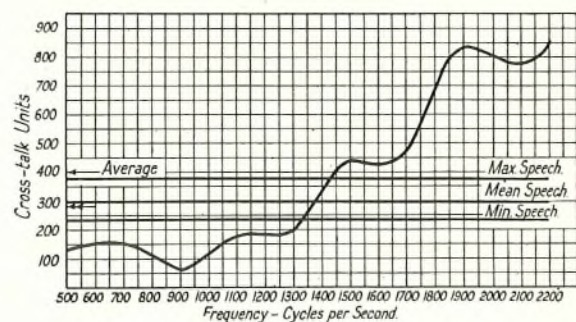

FIG. 3.—PAIR TO PAIR CROSS-TALK—FREQUENCY CHARACTERISTIC.

measured at each 100 cycles over the audio range. The mean speech cross-talk value in this particular case is 300 millionths. If each of the individual values comprising the cross-talk frequency curve is multiplied by a factor which emphasises the importance of those round about 1100 and reduces the importance of those below 800 and above 1500, and these weighted values are averaged, a resultant weighted average which is very nearly equal to the mean speech value can be obtained. It is shown by the double arrow, the single arrow indicating the unweighted average. The shape of the weighting curve used is shown in Fig. 4 and this curve has been found to give mean values from 0 to 2 db's worse than mean speech in some 95% of a number of cases so far investigated. The elimination of difficulties of accurately determining the value of audio cross-talk for cable acceptance test purposes undoubtedly lies along the line indicated above, using a visual set and applying a weighting factor to a cross-talk frequency curve.

The visual voltage ratio measuring set described above is shown in Fig. 2 with the Doust oscillator, which is the Cable Group's standard heterodyne

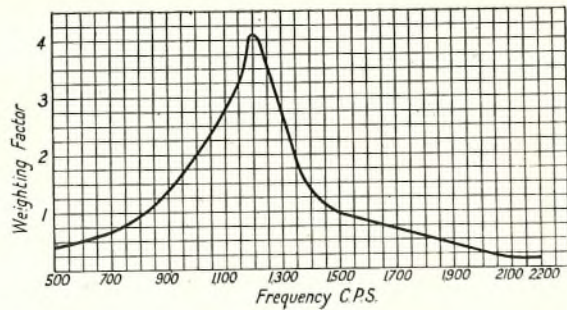

FIG. 4.—WEIGHTING FACTOR CURVE.

oscillator for work outside the laboratories. The cross-talk set can, of course, be used with low value potentiometer resistances for measuring directly the attenuation on a looped circuit, instead of using the Meyer method, and does not suffer from the disadvantage that balances can only be obtained at certain frequencies, as is the case with the latter. The set was designed by the officers of the Department's Cable Group, and made in the Research Section workshops.

Telegraph and Telephone Plant in the United Kingdom

TELEPHONES AND WIRE MILEAGES. THE PROPERTY OF AND MAINTAINED BY THE POST OFFICE IN EACH ENGINEERING DISTRICT AS AT 31st MAR., 1935.

Number of Telephones owned and maintained by the Post Office.	Overhead Wire Mileages.				Engineering District.	Underground Wire Mileages.			
	Telegraph.	Trunk.	Exchange.*	Spare.		Telegraph.	Trunk.	Exchange.*	Spare.
882,834	539	6,648	48,199	5,579	London	37,010	221,410	3,779,837	176,278
109,412	2,120	16,269	48,999	7,906	S. Eastern	5,009	72,584	378,975	57,079
125,454	4,312	37,080	79,156	5,409	S. Western	24,358	64,575	299,574	88,588
86,967	4,234	39,146	73,527	11,713	Eastern	16,325	74,559	179,439	57,202
136,766	5,373	38,660	59,735	20,735	N. Midland	7,393	192,566	344,875	107,721
109,940	3,424	24,795	68,024	12,012	S. Midland	8,801	78,397	330,876	67,671
74,527	2,972	26,868	60,369	8,475	S. Wales	6,186	62,608	168,757	36,207
148,107	4,618	23,847	61,864	13,928	N. Wales	8,223	102,167	461,178	93,352
191,989	984	6,052	28,168	9,903	S. Lancs.	7,751	127,969	674,046	85,635
124,450	5,159	24,573	41,601	7,614	N. Eastern	11,702	102,795	351,224	48,424
81,342	1,253	15,139	29,164	13,738	N. Western	5,385	69,897	256,331	96,990
63,352	1,406	14,056	23,217	7,216	Northern	4,117	54,213	186,635	30,945
31,479	3,045	11,268	12,940	1,169	Ireland N.	389	5,850	74,251	17,606
91,354	4,549	28,121	43,102	8,165	Scotland E.	1,811	61,087	181,766	47,469
113,724	3,986	22,649	35,443	5,644	Scotland W.	9,509	56,352	280,000	40,083
2,371,697	47,974	335,171	713,508	139,206	Totals.	153,969	1,347,029	7,947,764	1,051,250
2,317,399	47,320	347,225	699,315	126,989	Totals as at 31 Dec., 1934	153,479	1,254,936	7,910,285	1,045,834

* Includes low gauge spares (i.e., wires of 20 lb. or less in cables and 40 lb. bronze in overhead routes).

Electric Passenger Lift in the G.P.O. Headquarters' Building

C. W. GOVETT

THE lift recently installed in the G.P.O. Headquarters' building for the use of the Director-General and his staff incorporates several special features, such as automatic door operation, the variable voltage system and collective control, and a general description, therefore, may be of interest.

The capacity of the lift is 15 cwt. and it is balanced for 47½% of its full load; the weight of the empty car with safety gear, etc., is 25 cwt. The internal dimensions of the car are 5' 0" wide by 3' 9" deep by 7' 9" high and it will accommodate comfortably six passengers including an attendant when required. The lift travels at a maximum speed of 360 feet per minute and serves the Ground, First, Second and Third floors, the total travel being 51¾ feet. Spring buffers are provided in the pit at the bottom of the brick well for the car and balance weight, and there is ample clearance both in the pit and at the top of the well for overtravel of the lift. The car and all doors are constructed of steel, and are specially designed and finished in cellulosed enamel to harmonise with the surrounding decorations. The doors, which are provided with vision panels, are hung vertically in two halves from top tracks on ball

bearing hangers, and are guided at the bottom in grooved bronze cills. The leading half door moves at twice the speed of the other half, and when the doors are fully open they are hidden behind a brick nib at the left hand side of the openings; the dimensions of the openings are 3' 6" wide by 7' 6" high. The doors are opened and closed automatically, by means of operating levers and chains which are controlled by a small geared motor fixed at the top of the car. In the event of a failure of the automatic apparatus the doors can be operated by hand provided the car is opposite a landing opening. The doors are perfectly safe and silent in operation and exclude all draught from the well. Photographs of the car and doors are given in Figs. 1 and 2.

The lift motor and winding gear are situated at the top of the well at a level of 7' 6" above the motor room floor and are bolted to a heavy cast iron continuous bed plate which rests on a reinforced concrete capstone. Between the capstone and the three parallel supporting beams there are thick compressed cork pads to prevent the transmission of vibration to the walls of the well.

The maximum equivalent dead load, including the weight of ancillary apparatus which is accommodated

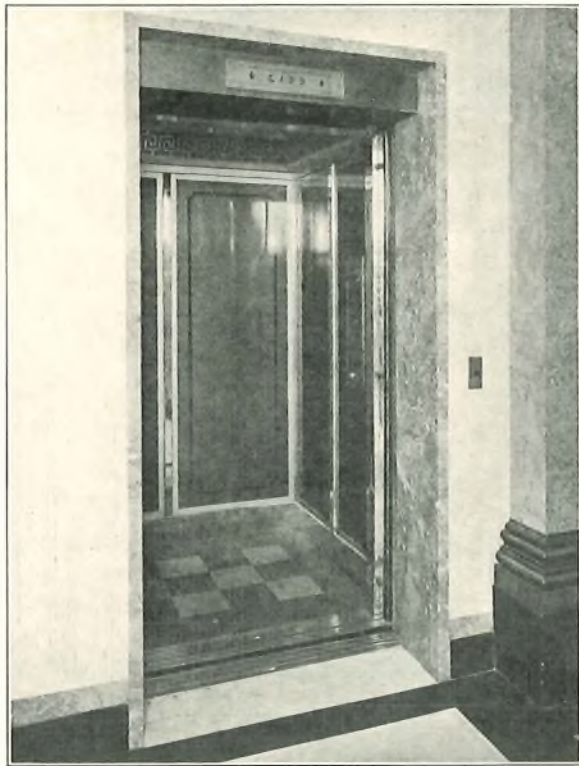

FIG. 1.—VIEW OF THE CAR.

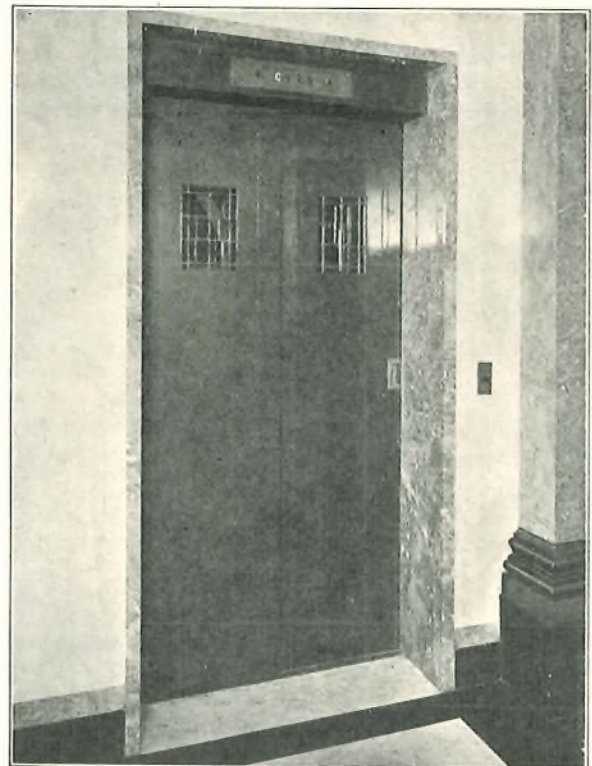

FIG. 2.—THE LIFT DOORS.

immediately below the winding gear and on the floor of the motor room, is approximately 15 tons. In order that this load could be safely carried it was necessary to strengthen with steelwork the supporting walls and the motor room floor. A photograph of the motor and gear is given in Fig. 3.

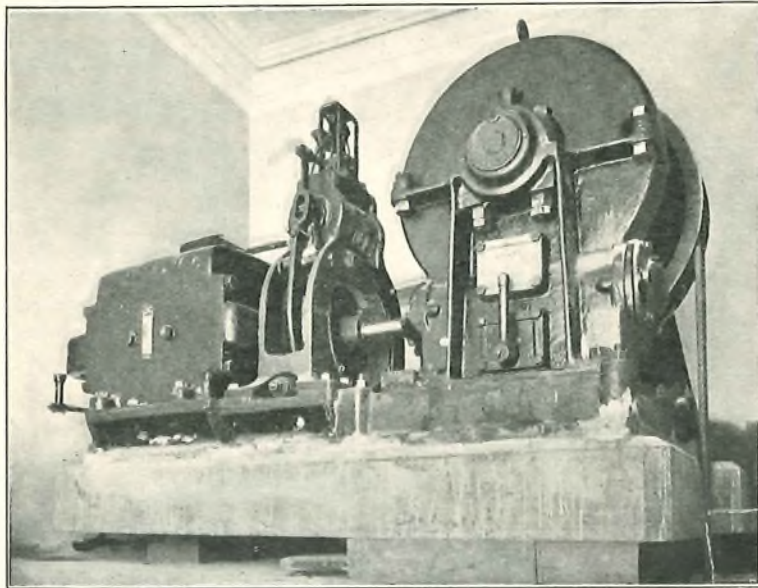

FIG. 3.—MOTOR AND WINDING GEAR.

The worm gear is the single wrap traction geared type, of heavy construction, having a gear ratio of 21 : 1. The worm wheel, which is above the worm, has a phosphor bronze rim and a cast iron centre, and the worm is forged solid with the steel shaft and coupled to the motor in the usual way by means of the brake drum. Double ball thrust bearings backed by self-aligning thrust blocks are provided to take the end thrusts. The maximum loading on the teeth is approximately 570 lbs. per inch width of tooth, and the highest rubbing speed of the worm at the pitch line centre is about 800 feet per minute. Both the worm wheel and the traction sheave, the rim of which is made of semi-steel, are bolted to a spider on a heavy steel shaft to avoid the use of keys; with this arrangement the shaft is relieved of torsional stresses.

Sectional illustrations of the special sheave, which has six grooves, and of the standard vee sheave are given in Figs. 4 and 5.

Six steel wire ropes of 2" circumference giving a factor of safety, initially, of 26 are used. The ropes are of special "Seale," 6/19, ordinary lay construction, and the wires, which are of two different diameters, are formed 1-9-9 over a hemp core. The tensile strength of the centre and inner wires is 100/110 tons per square inch and that of the outer wires 80/90 tons per square inch. It is claimed that this type of rope, when used in conjunction with the peculiarly shaped sheave, has a considerably longer life than is usually the case with traction drive; but as spring anchorages are provided for the ropes on

this lift a longer life on this account also might be expected.

Instead of the usual round steel and H iron guides, machined tee section guides are fixed to the walls of the well, and spring loaded self-aligning guide shoes are provided for the car and the balance weight.

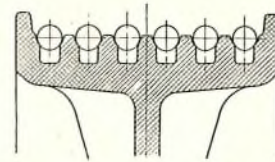

FIG. 4.—SPECIAL SHEAVE.

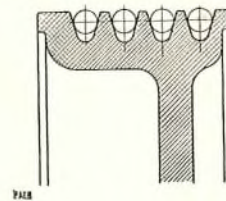

FIG. 5.—STANDARD VEE SHEAVE.

In addition to the usual safety devices, such as electro-mechanical door locks and contacts, limit switches, etc., two centrifugal speed governors are provided, one for the car and the other for the balance weight. The governors act in the following manner :—If the speed of the lift exceeds its normal maximum value by a small percentage, the governor causes the electric supply to be cut off from the lift motor and controller, and the brake is applied. Should, however, the speed for any reason, become excessive a spring loaded grip is made to act on a fly rope, connected to a drum under the car and balance weight respectively; and, as the lift continues to move, the drums rotate and actuate screw clutches which in turn cause the safety jaws to grip the guides; the car and balance weight are thus brought gradually and smoothly to rest. Illustrations of the governor and safety gear are given in Figs. 6 and 7.

The lift motor is 20 B.H.P., D.C., 240 volts, shunt wound with inter-poles and gives a high starting torque with low starting current. The commutator is of ample dimensions and has carbon brushes of large contact area. The bearings are self-aligning and bushed with white metal. The electro-magnetic brake is shunt wound and the shoes, which are lined with Ferodo, are held on by a pair of helical springs.

Although the electric supply to the building is direct current at 220 volts it was considered desirable in this case to adopt the variable voltage system since, as is generally recognised by lift engineers, this system gives the best results for high speed lifts, where comfortable travelling and good floor

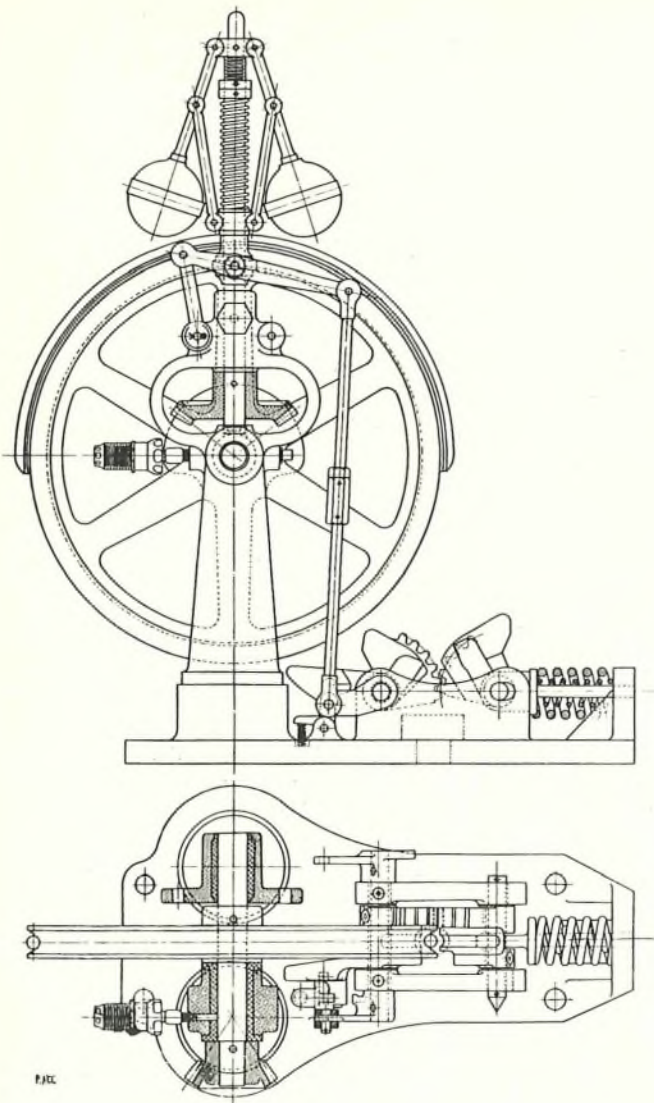
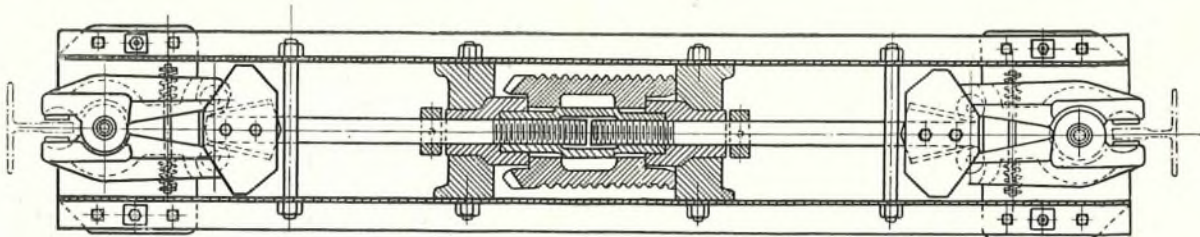

FIG. 6.—CENTRIFUGAL GOVERNOR.



P. AED

FIG. 7.—SAFETY GEAR.

finding are important considerations. With this system a motor-generator is employed; the motor is connected to the supply mains, and the armatures of the generator and lift motor form a permanently closed circuit. Reversal and speed regulation of the lift motor are obtained by simply reversing the generator shunt field and varying its strength which is

done automatically, and the making and breaking of heavy and destructive currents are avoided.

The motor-generator is mounted on a heavy continuous cast-iron bedplate which rests on a reinforced concrete capstone, insulated from the floor of the motor room by means of thick compressed cork pads. The set is designed for high efficiency with low consumption at all loads, particularly at light loads. The generator is of the multi-polar type with inter-poles. A centrifugal speed governor is fitted at one end of the shaft to cut off, automatically, the electric supply to the motor should it develop an excessive speed. A thermal relay, which operates in about 15 seconds, is also provided to protect the motor from overheating. The motor-generator starts up automatically immediately a call is made and it continues to run from 1 to 5 minutes longer than the lift. If calls are made at intervals of less than the adjusted time limit the set continues to run.

Photographs of the motor-generator, the controller and floor selector panel, etc., are given in Figs. 8, 9 and 10.

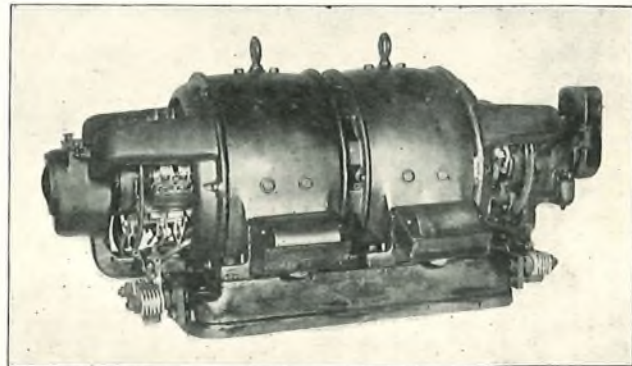

FIG. 8.—MOTOR-GENERATOR SET.

An illuminated position indicator is fitted in the car and under the lintel at each landing opening to show the position of the car in the lift well and the

direction in which it is travelling. Signal lights and a buzzer are also provided in the car.

With the collective control system all calls are registered and dealt with in strict sequence according to the direction of travel of the car. A set of buttons is provided in the car for despatching it to any floor; and "up" and "down" buttons are

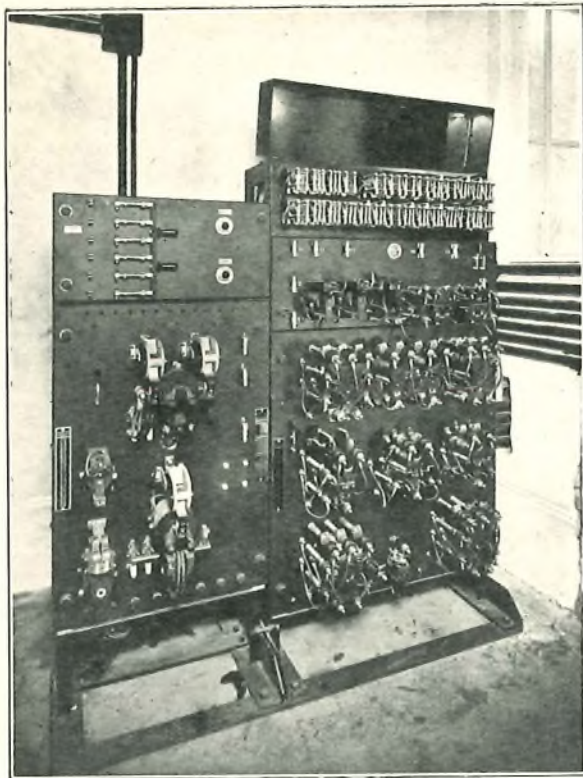

FIG. 9.—CONTROLLER.

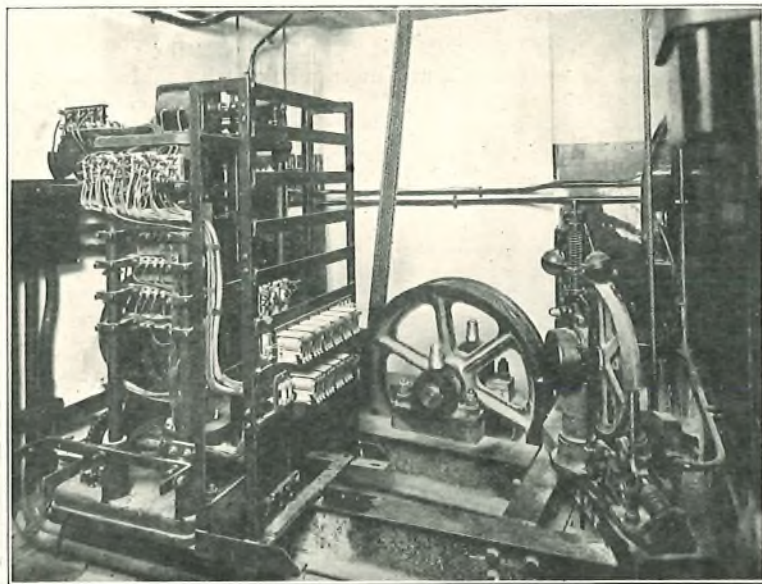

FIG. 10.—FLOOR SELECTOR.

fitted at each intermediate landing and single buttons at the terminal landings, for calling the car to any floor. The operation without an attendant is as follows :—

If the car is at the Ground floor and is despatched to, or called from, say, the Third floor, and immediately afterwards another call is made from, say, the Second floor, the car will first stop at the Second floor and when that call has been dealt with and the doors have been closed, the car, without further operation of a push button, will proceed to and stop at the Third floor. Similarly all calls are dealt with; but the car will not reverse its direction of travel until all calls in one direction have been answered, so that with this system no time is lost in moving the car up and down uneconomically. The interval between the automatic opening and closing of the doors is set at 9 seconds.

When an attendant is operating the car a key switch is turned to " with attendant " position and the operation is as follows :—

If a call is initiated while the lift is in motion or while the car is stationary at a floor, with the landing door closed, a signal light indicates to the attendant that a call has been registered and this light remains on while there are any unanswered calls. Under these conditions the buzzer will not sound. If, however, a call is registered while the car is stationary at a floor, and the landing door is open for more than ten seconds, the buzzer sounds continuously until the landing door is closed. The signal light shows until all calls have been answered.

The sounding of the buzzer is a signal to the attendant to close the doors by pressing a special " up " or " down " button in the car and when this has been done the car automatically proceeds to the floor corresponding to the registered call, thus eliminating the need for a call indicator system in the car. The doors open automatically when the car arrives at a floor and close when a button, either in the car or on the landings, has been pressed; but the doors may be re-opened by pressing a special button in the car before the lift has moved .

A " stop " button is also provided in the car to stop the lift in case of emergency.

The lift was designed and installed by Messrs. Waygood-Otis, Ltd., of London, and incorporates several of the firm's patents.

The Use of a Surveyor's Level to Solve an Engine Problem

E. J. C. DIXON, B.Sc.(Eng.), A.M.I.E.E.

THE problem was how to cure the longitudinal oscillation of a horizontal engine-generator set along its axis? The effect of the oscillation had been to wear out the side face of the engine main bearings which were costly items to replace. The engine contractor had repaired the bearings and readjusted them with the aid of his "clock"—a special dial micrometer gauge which registers changes in the distance between the webs of the crankshaft balance weights (Fig. 2(a)). Shortly afterwards the set developed a precisely similar longitudinal oscillation and a further replacement of bearings soon became essential. The effect on the bearings can readily be imagined when it is stated that the amplitude of the oscillation was $\frac{1}{4}$ inch and the weight of the flywheel about 5 tons. The

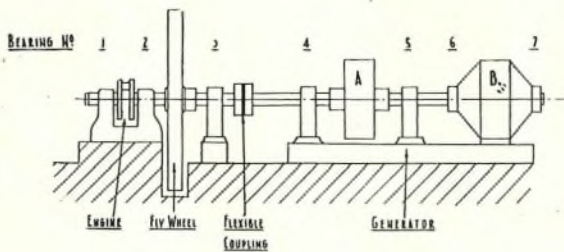

FIG. 1.—LAY-OUT OF ENGINE-GENERATOR SET.

odd behaviour of this engine was the more difficult to account for since an exactly similar engine in the same room gave no trouble of a similar nature and many theories were advanced to explain the oscillation. Amongst these was a suggestion that an asymmetry in the generator windings gave rise to a longitudinal force which varied with the rotation of the generator! The generator had been supplied by a different contractor from the engine contractor, which is not unusual in repeater stations and other places where they use prime movers, and the attention of the engine contractor had been confined to the engine. Before arranging with him for a further bearing replacement, therefore, it was decided to make an investigation of the overall level of the engine-generator set.

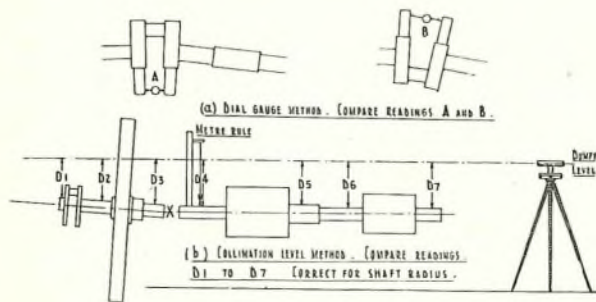

FIG. 2.—METHODS OF CHECKING ALIGNMENT.

A dumpy level was borrowed from the Office of Works and, having been checked for collimation error, was set up in such a position that the depth of the engine and generator shafts below collimation level could be measured by means of a metre rule. To each measurement was added the radius of the shaft in cms. at the point of measurement and the level at each bearing was thus deduced. Fig. 2(b).

The engine was of the horizontal single cylinder type with a large flywheel followed by a flexible coupling of robust webbing which connected the engine shaft to the generator shaft carrying the "A" and "B" armatures. (Fig. 1). There were seven bearings in all, two on the engine bed, one pedestal bearing on a plinth, supporting the flywheel, two pedestal bearings for the "A" generator and two bearings in the "B" generator casting. The shaft varied in diameter from $8\frac{1}{4}$ inches to 3 inches as measured by callipers. The metre rule was fitted with a plumb-bob and was strongly illuminated, while level readings were being taken. It was found possible to read accurately to 0.25 millimetre, *i.e.*, 10 mils approximately. The corresponding accuracy of the engine tester's "clock" was 1 mil change in crank-web spacing which was found to correspond with half a millimetre difference in level between bearings 1 and 3. (Fig. 1).

At the outset it was found that the generator shaft level was 2 millimetres below the engine shaft mean level and that the engine shaft sloped down towards the generator. It was decided to use No. 1 bearing as a reference level and to raise the generator to that level. This was done by inserting shims between the generator bed and bearings. The engine contractor was then called in to repair the engine bearings. The final measurements showed a small drop in engine level relative to the generator (Fig. 3).

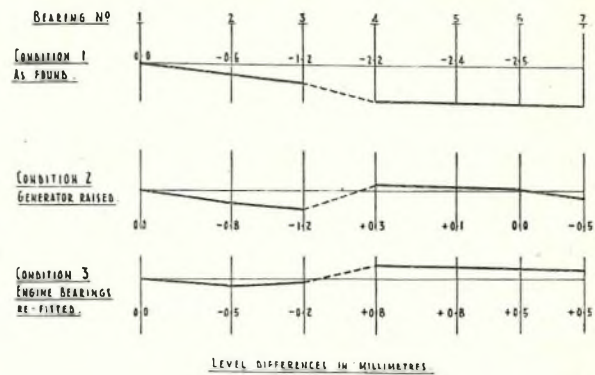

FIG. 3.—BEARING LEVELS.

The longitudinal oscillation was removed, however, and the set has since been promoted from standby to working set, and run for nearly a year without any trouble.

The Unit Automatic Exchange No. 12

C. G. GRANT and
E. M. COOKE

Introduction.

IN the early part of 1929 the Department commenced installing rural automatic exchanges known as Unit Auto. Exchanges No. 5. These exchanges were designed to work in unattended and unheated buildings, and embodied a number of novel features, with the aim of obtaining a low capital cost per line consistent with reliability, low maintenance costs, and a small current consumption. In the design of these exchanges certain of the facilities usually given on the larger auto exchanges were omitted and all calls other than those between subscribers on the same unit auto exchange were made dependent on the service of an operator of a nearby manual switchboard. The nearby exchange became known as the "parent" of the U.A.X. Calls from subscribers on adjacent auto exchanges to subscribers on a unit auto exchange also had to be handled by an operator.

At this period it was not considered economical to introduce automatic working in exchanges of approximately 1000 lines and under, except where such an exchange could form part of a satellite area. Therefore, as the parent of the U.A.X. was usually an exchange of under 1000 lines the handling of calls to and from a U.A.X. by operators was an acceptable practice, since the number of calls where automatic inter-working could be introduced was comparatively small.

As the science of automatic switching developed, it became apparent that automatic working could be introduced on an economical basis in all sizes of equipment, and the programme of general automation is now going forward, with the result that manual boards will become fewer in number and more centralised. The inter-working between exchanges must be effected without the intervention of operators, otherwise calls between two U.A.X.'s a comparatively short distance apart would have to be handled by an operator at a remote manual switchboard, and use made of two lengthy junctions to complete the call. Alternatively, use would have to be made of special equipment which would enable the operator, after obtaining the connexion, to clear down most of the junction route leaving the two U.A.X. subscribers connected over a comparatively short route.

It was eventually decided that the case would best be met by the introduction of a new standard U.A.X. which would provide through-dialling, together with numerous other facilities. This U.A.X. has been termed the Unit Auto Exchange No. 12.

FACILITIES AND GENERAL.

Numbering Scheme.

A 3-digit numbering scheme is used for subscribers' numbers. The initial digit, which is 2, is

absorbed by the selector. This gives a multiple range of 200-299, which is available on the installation of the initial 25 line unit. P.B.X. facilities (2-10 lines) are provided throughout the multiple with the exception that the maximum of 10 lines cannot be provided on levels of the selector serving junctions. The junction route to the parent exchange is obtained by dialling either 0 for the operator, or 9 for the automatic switching equipment, combined use being made of the one group of junctions for both classes of call. When a coin box subscriber dials 0, a separate calling lamp, suitably designated, is lit on the manual board, and this obviates the need for the operator to listen for a special tone which is necessary on the U.A.X. No. 5 equipment.

Provision is made so that when subscribers make a repeat call they secure access to a different selector, and on the route to the parent manual board the selector multiple wiring is so arranged that junctions 1 and 2 are transposed on alternate selector banks. This ensures that the subscriber is not left without service to the parent operator owing to a faulty switch or junction.

On the initial supply of units, levels 6, 7 and 8 will be available as single digit dialling-out codes to adjacent exchanges. The codes 1, 3, 4 and 5 will normally be spare and connected to N.U. tone, but if necessary, arrangements could be made to use levels 3, 4 and 5 for dialling-out codes.

Fig. 1 is a trunking diagram showing the conditions for a U.A.X. No. 12 working to a parent auto exchange, and also having routes to both an adjacent auto and an adjacent manual exchange.

Tandem Working.

It has been visualised that this small type of U.A.X. may work to the parent exchange *via* a larger type of U.A.X., the intermediate exchange thus acting as a tandem exchange. In connexion with this type of working, arrangements are made at the tandem exchange for relaying to the parent exchange, 0 level calls originated by the dependent U.A.X. This enables a subscriber on the dependent U.A.X. to reach the manual board by dialling 0 once only. When a subscriber on the dependent exchange dials 9 he will obtain access to the auto equipment at the tandem exchange and is then virtually in the position of a subscriber on that exchange and will have to dial a further digit 9 to reach the parent auto equipment.

In order that the No. 12 equipment should be suitable for use in existing U.A.X. No. 5 buildings, and also so that it could be kept in a unit form, it has not been provided with the facility described above for relaying 0 level calls, and is, therefore, unsuitable for use as a tandem exchange.

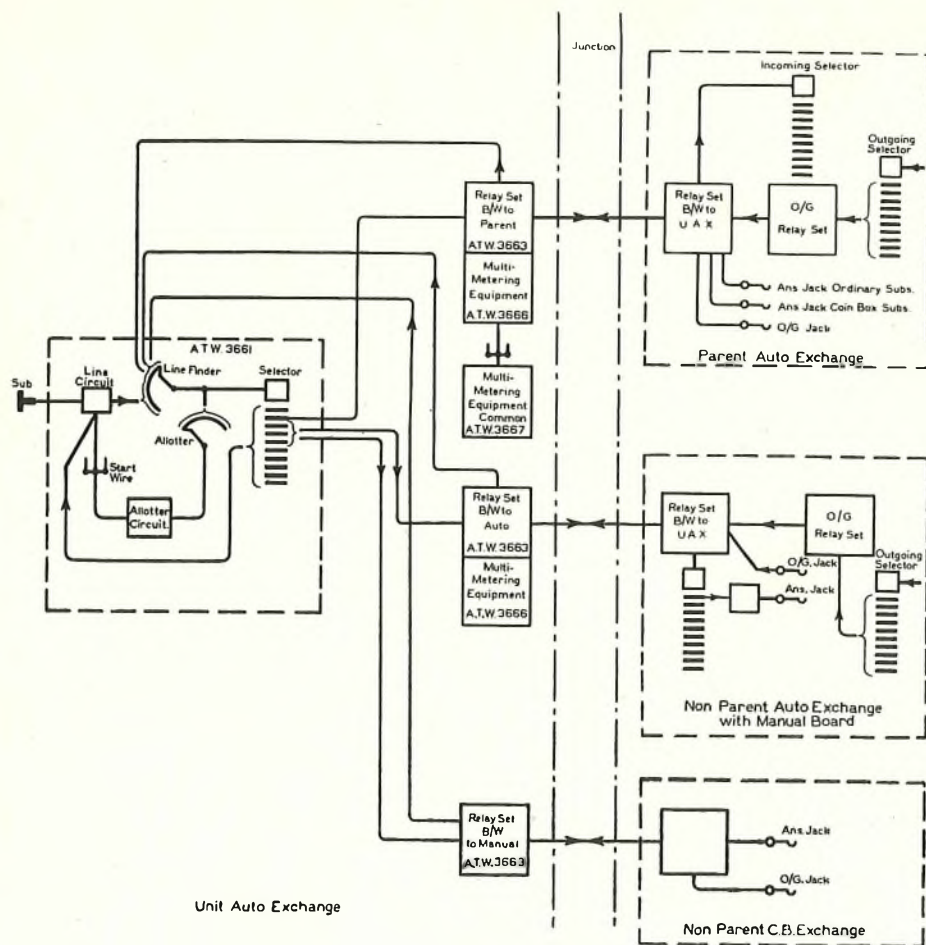

FIG. 1.—TYPICAL TRUNKING DIAGRAM.

Trunk Offering and Assistance.

A trunk call can be offered and completed by the parent exchange operator over any junction in the route from the parent exchange. When the operator dials a free subscriber's number ringing is applied immediately, but should the subscriber's line be engaged, engaged tone and flash are returned to the operator, who, by the momentary operation of her ringing key, can connect to the line and offer the call. The operator subsequently receives a supervisory signal when the subscriber's line is free, and can then complete the trunk connexion by a further operation of her ringing key, which will cause the subscriber to be rung.

The trunk offering circuit has been so arranged that it can be used also for assistance purposes, for example, the monitoring of a call from a subscriber who has complained of difficulty in obtaining a number.

Trunk Calls.

Subscribers will be instructed to dial 0 for trunk calls and the initial demand will be taken by the 0 level operator, who, in the case of a manual or auto group centre exchange, will control the call,

When the parent exchange is a minor exchange, means will be provided for extending the calls to a demand centre in such a way that the subscriber's switchhook will give supervisory signals to the controlling operator. When the parent is a zone centre with both long distance and local suites in the same building, joint access to the junctions will be given from both suites, the call being answered on the local suite and subsequently transferred to the long distance suite.

Manual Hold and Re-ring.

Manual hold is given on 0 calls to the parent manual board, and as the subscriber originates his trunk calls over this route, the re-ring facility has been provided, though this can be utilised only when the parent exchange manual board is of the sleeve control type.

Ordinary subscribers are permitted to dial-out to non-parent exchange manual boards either over a direct junction from the U.A.X. or via other auto exchanges. Manual hold is provided on this type of connexion, an exception being the call to a manual exchange, obtained via a non-director exchange over a junction that already provides for the metering of calls originated by the subscribers on the non-director exchange. Under these conditions calls originated by the U.A.X. subscribers will also be metered, multi-metering being provided where necessary. Metering will not be effected on calls to manual boards from which manual hold is given.

Coin Box Subscribers.

On the U.A.X. No. 5 equipment it is necessary for subscribers to dial 01 in order to reach the parent manual board. To enable coin box subscribers to do this, without the insertion of coins, requires a special circuit at the coin box instrument, embodying a relay which operates and holds, only when 0 is dialled. This relay removes the short circuit from the dial impulsing springs so that 0 can be followed by the digit 1. As the new standard equipment requires only a single 0 to reach the parent manual board, special call office arrangements will no longer be required.

Since coin box subscribers have to insert coins

before they can dial digits other than 0, they will be barred from dialling-out to manual boards other than the parent. To provide this facility would entail the identification of coin box subscribers at the non-parent manual boards, and, further, in pressing button A to speak to the operator their fee would be collected though the called subscriber may not always be available. In addition, the operating procedure would be further complicated when handling calls greater than unit fee. Hence, it has been so arranged that N.U. tone is given when coin box subscribers attempt to dial to non-parent manual boards. Coin box subscribers will also be limited to unit fee automatic connexions, N.U. tone being returned if excess fee connexions are attempted.

Multi Metering.

This facility has been provided so that ordinary subscribers on a U.A.X. can dial to subscribers on auto exchanges that are more than unit fee distance away. Additional apparatus is associated with each junction relay set, which responds to the code or routing digits dialled, and connects the metering wire to the appropriate pulse lead. The design of the apparatus is such that 1, 2, 3 or 4 fee metering can be obtained. The number of routing digits to the different exchanges in an area will depend both on the number of junction routes over which the call passes (this, owing to dialling and signalling limitations, will not be allowed to exceed three) and on whether single or two-digit dialling-out codes are used at any of the intermediate exchanges. It has been necessary therefore to provide a flexible arrangement so that metering discrimination, *i.e.*, the fixing of the appropriate fee, can be effected after the dialling of 1, 2, 3, 4 or even 5 trains of routing digits.

When the number of codes to be dealt with is large, a common equipment is added on the basis of one common equipment per group of junctions. Such a scheme is possible, as the common equipment is not used for all calls, and the time that it is held is short.

Though the multi-metering equipment is primarily used for the determination of the appropriate fee, it is also used for the important function of barring coin box subscribers who attempt excess fee auto calls, or calls to manual boards other than the parent, and for barring ordinary subscribers from making calls to exchanges which, though physically attainable, should not be allowed owing to fee, dialling, or transmission limitations.

The multi-metering equipment is also used to ensure that a subscriber employs the correct routing to an exchange, and does not, either inadvertently or with intent to defraud, set up a call over a circuitous route. Such misrouting, if permitted, would by its unnecessary use of switching and junction plant jeopardise the grade of service.

When a subscriber attempts to dial any of these barred conditions the route is broken down and N.U. tone returned.

A further use for the multi-metering equipment is to provide for manual hold on calls to manual boards obtained *via* the auto equipment of other exchanges. Under these conditions the calls are not metered.

The Parent Exchange.

The answering equipment for 0 level calls will normally be terminated on the "A" positions, and as operators of other exchanges are not permitted to dial through the U.A.X. No. 12 to the parent exchange, it is not necessary to provide for through-signalling on the parent exchange cord circuits. "A" type cord circuits will be used, and fitted where necessary with call timing equipment. Ancillary working will be provided except where the traffic from the U.A.X. is small, two sets of lamps and jacks being required, one set for answering calls from ordinary subscribers and the other for answering calls from coin box subscribers. Calling lamp lock-out will not be provided.

If the parent exchange is automatic and access to the automatic equipment is required, the relay set terminating the junction will connect it to a selector when the subscriber makes a level 9 call.

For calls outgoing to the U.A.X. the operators have direct access to the junctions *via* multiple appearances on the manual board. Access to the junctions can also be given to the parent exchange auto subscribers from selector levels, which will be connected, *via* auto-to-auto relay sets, to the special relay sets terminating the junctions. At present such access will be restricted to U.A.X.'s within unit fee distance until such time as multi-metering is also available at the parent exchange.

Non-Parent Manual Exchange.

The provision made at such an exchange will generally follow that described above for the parent manual board equipment, except that no answering equipment is required for coin box subscribers as they are barred access to all manual boards excepting those at the parent exchange.

Non-Parent Auto Exchange.

As will be seen from the trunking diagram (Fig. 1) the junctions incoming to these exchanges will be terminated on a selector *via* the bothway equipment. This will give the U.A.X. subscriber access to the auto equipment, and where required he will be given access to the manual board from the 0 level of the first selector.

For calls to the U.A.X. the manual board operator will have direct access to junctions *via* multiple appearances on the manual board. Access to the junctions can also be given to the auto subscriber in the manner described for the parent exchange case.

Traffic Incoming to the U.A.X.

The junctions will normally be worked both-way, and the incoming portion of the terminating relay sets will be connected to early choice contacts of the banks of the line finders. The line finders are of the homing type, which ensures that the time of connexion of a junction to a selector circuit is normally within the interdigital pause of a through-dialling subscriber or operator. Further, with so short a finding time, it is not necessary to instruct the operators at exchanges directly connected to the U.A.X. to wait for dial tone. Arrangements have been

made, however, for engaged tone and flash to be given should dialling occur before a selector is connected.

Service Levels.

It will normally be arranged for the subscriber to dial " 0 " for special services, exceptions being the 92 level for the service P.B.X., and the 93 level for Rural Party Lines. Coin Box subscribers will be barred all Service Levels, except Party Lines (93) when in the unit fee area. It will be noted that as the digits 9 and 99 (when *via* a Tandem U.A.X.) are required to reach the parent automatic equipment, these digits will have to prefix the normal service codes.

Tones.

Standard dial, ringing, engaged and N.U. tones are provided, which, though generated by vibrating and inter-acting relays, are barely distinguishable from those generated by a machine.

Alarms.

As the junctions between a U.A.X. No. 12 and its parent or tandem exchange will invariably be worked bothway, it was not considered practicable to provide for the automatic extension of alarms. The arrangements, therefore, are similar to those provided on the U.A.X. No. 5 equipment, in which the parent exchange operator dials the test number at intervals of not less than 4 hours. If no alarm conditions exist, the operator will receive a special tone known as "inverted ringing tone," but she will receive N.U. tone if any of the following faults exist such as blown fuse, charge fail, 2 motion switch stuck off-normal, earth on the engaged tone and hold leads. Absence of any tone will indicate failure in the tone equipment.

Forced Release.

The subscriber's line circuit contains the usual L and K relays, and in addition, has a P relay which acts as a lock-out relay when the subscriber is forcibly released from the selector circuit. The forced release condition is used to prevent congestion occurring on the selector circuits due to P.Gs. on subscriber's lines, and also to clear down connexions on which the called subscriber is held.

Traffic Meters.

A traffic meter will be associated with each allotter circuit, and will be arranged to register when a demand is made for a selector circuit, either by a local subscriber or an incoming call, when all selectors are busy. The meter will, therefore, provide a record of overflow traffic. An overflow meter will also be provided on each group of junctions outgoing from the U.A.X.

CONSTRUCTION AND EQUIPMENT DETAILS.

Provision of Units.

The Unit Automatic Exchange No. 12 has an ultimate capacity of 100 lines (Subscribers and Junctions) and can be built up in unit form as the

exchange area develops. A complete exchange is made up of five totally enclosed units as follows :—

One Auxiliary Unit accommodating the M.D.F., Testing Equipment and Relay Sets providing common services.

Two " Units Auto. No. 12A " (25 Line Units).

Two " Units Auto. No. 12B " (20 Line Units).

Should the requirements of the area be small it is not possible owing to apparatus limitations, to instal a Unit Auto No. 12B to cater for initial demands.

The units, which are 6' 10 $\frac{1}{4}$ " in height, are arranged for fitting in the exchange in the following order :—

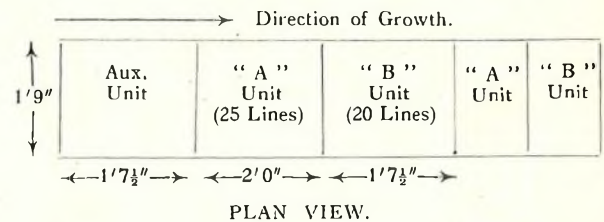

Front and rear views of partially equipped units are shown in Figs. 2 and 3. A brief description of the units follows :—

Auxiliary Unit.

This unit accommodates the Main Distribution Frame, Testing Equipment and Relay Sets contain-

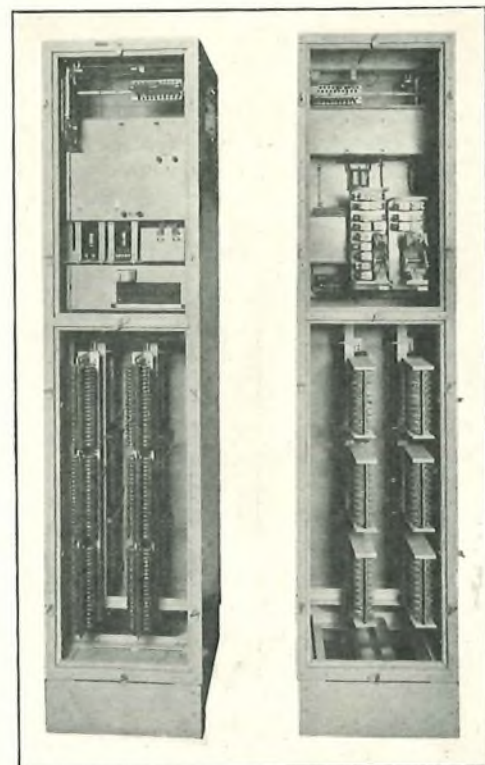

FIG. 2.—AUXILIARY UNIT. FRONT AND REAR VIEWS.

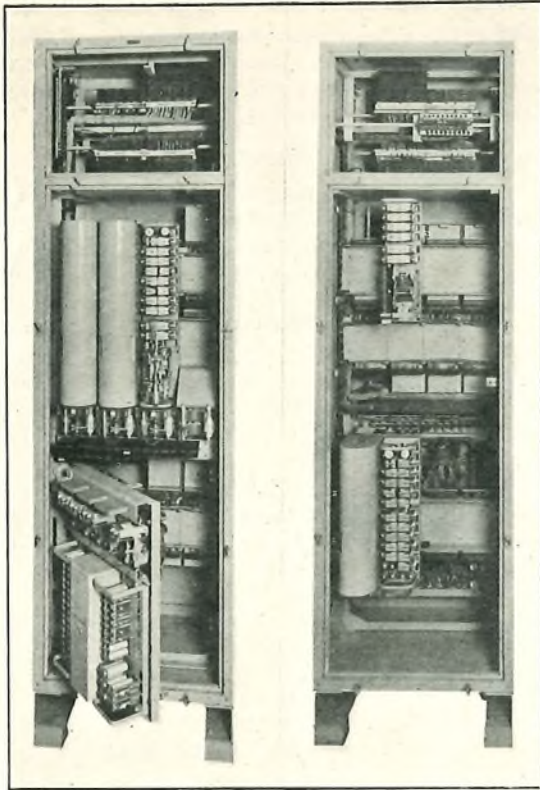

FIG. 3.—UNIT AUTO No. 12A.
FRONT AND REAR VIEWS.

ing the common apparatus, *i.e.*, Ringing, Tone, Time Pulse and Meter Pulse equipment.

The enclosing of the M.D.F. is a novel feature. In previous types of Unit Automatic Exchange the M.D.F. and testing equipment were fitted adjacent, but external, to the cabinet, and were subject to faults and corrosion of metal parts due to the deposition of moisture. In the Unit Auto Exchange No. 12, however, with the enclosing of the M.D.F. this trouble will be eliminated.

An ultimate capacity for six Protectors H.C. & T. and six Fuse Mountings, is provided arranged in two vertical rows of three fitted at the bottom front and bottom rear respectively. Fitted immediately above the protectors is the testing equipment, and above the fuse mountings the relay sets.

In this unit the bottom of the cabinet under the fuse mountings is constructed of removable wood battens which are cut to receive the incoming cables and when these are *in situ* the joints and seams in the battens are sealed with bituminous compound.

The unit has six doors—fitted one at the top and one at the bottom, front and rear, one at the bottom left hand side and one at the right hand side (covering the cable run) viewed from the front. The top doors give access to the testing equipment, relay sets, strips connexion and cable run; the bottom front and rear doors give access to the protectors and fuse mountings respectively, and the bottom left hand side door gives access to the 1st vertical of the protectors and fuse mountings to facilitate cabling and jumpering.

Mounted on the cabinet above the bottom left hand door, but external to the unit, is a bracket supporting a Telephone No. 162F with Bell Set No. 25, which are normally connected to the Exchange Service line and have the number 290, but which may be used as a testing instrument as required.

Units Auto. No. 12—Types A and B.

These units are similar in construction, but differ in width and capacity.

The units accommodate the subscribers' line relays, meters, selectors and associated uniselectors, junction relay sets and multi-metering relay sets.

Each unit is fitted with four doors, one at the top and one at the bottom, front and rear, giving access to the cable run and unit I.D.F. and the automatic apparatus respectively.

A hole is left in both sides of the units near the top so that a clear run is left for the cables throughout the upper compartments when the units are in position.

The strips connexion, cable run and unit I.D.F. are separated from the lower portion of the unit by a sheet steel bulkhead which permits work to be carried out on the strips connexion without the apparatus in the lower portion being exposed.

General Construction.

All units are constructed of mild steel framework and sheet steel cavity cabinets, and the doors are clamped against fabric covered rubber cord thus making the units airtight.

When the units are being lined-up, the door which covered the cable hole in the auxiliary unit is removed and fastened over the cable hole in the right hand side of the last unit, a wooden gasket being fitted round the cable holes between each pair of units to keep them airtight.

The rack framework of each unit is constructed of $1\frac{1}{2}'' \times 1'' \times 3/16''$ mild steel angles to which the interior of the cabinet is securely fastened.

The selectors and relay sets are mounted on pressed steel channel type shelves of standard construction, but of varying lengths to suit the width of the framework on which they are fitted, and with special drillings for cable supports.

In the auxiliary unit, two channel type shelves are fitted in the upper portion at the rear.

In the 25 and 20 line units, three channel type shelves are fitted—one at the front for the selectors and two at the rear, the upper shelf carrying the multi-metering relay sets and the lower one carrying the junction relay sets.

A fuse panel is mounted in each unit near the top of the framework on the left hand vertical viewed from the front.

In the auxiliary unit the M.D.F. verticals consist of two lengths of mild steel angle secured to the framework and suitably drilled to accommodate the jumper rings and horizontal mild steel bars on which the protectors and fuse mountings are fitted.

The line testing equipment, equivalent to Case Test D.9262, is mounted on wooden panels above the protectors, the complete assembly being hinged and

secured to the framework by means of suitable brackets.

In the 25 and 20 line units the mountings for the subscribers' line relays, resistor coils, and line finder uniselectors are accommodated on a hinged framework. The allotter uniselector and associated relays, which are provided in the 25 line unit only, are also mounted on this framework. This arrangement provides access to the wiring side of these circuits which would otherwise be obscured by the junction relay sets.

In the 25 and 20 line units battery jacks are provided on the basis of three per unit. Two of these are fitted on the front of the framework on the right hand vertical viewed from the front—one in each of the upper and lower compartments, and the third jack in the lower compartment, at the rear of the framework, on the right hand vertical viewed from the rear. In the auxiliary unit two battery jacks are provided, one at the front and one at the rear.

Cabling and Wiring.

In previous designs of U.A.X's the cabling between the M.D.F. and the units and the inter-unit cabling was exposed, thus necessitating the use of lead covered cable to prevent low insulation faults. In the Unit Auto. Exchange No. 12, however, this cabling is totally enclosed, with the result that it is possible to use switchboard cable with consequent

economy and increased adaptability. As an additional precaution against low insulation faults all conductors in cables, jumper wires, and wires in forms are enamelled. The general cabling arrangements are shown in Fig. 4.

Apparatus Details—General.

The apparatus components include 10 level (5 on—5 off) 25 contact uniselectors which are used as line finders, and 25 contact uniselectors of various level capacities employed as line finder allotters, meter and time pulse distributors, etc.

The selectors are of the Strowger 2-motion type and function as both group and final selectors.

With the exception of the subscribers' line circuits the standard Post Office "3000" type relay is employed throughout this equipment together with the No. 100 type meter.

The subscribers' line circuits (L, K and P relays) conform to normal standard main exchange practice by utilising the Post Office "600" type relay.

Jacked-in Equipment of the Units.

Five of the circuits involved have been accommodated in the units on a jacked-in basis as follows:

- (1) (a) Tone and Time Pulse Equipment—Relay Set No. 3092.
- (b) Ringing and Meter Pulse Equipment—Relay Set No. 3093.

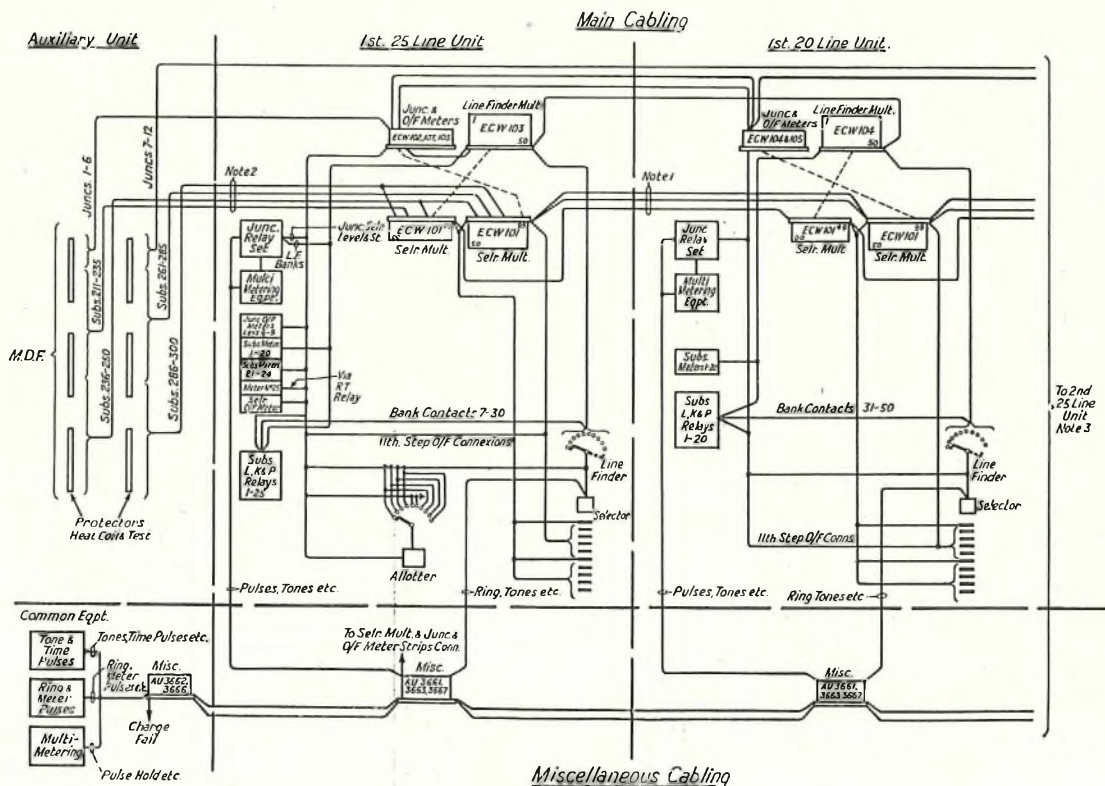

FIG. 4.—CABLING SCHEMATIC.

- NOTES.—1. The complete selector multiple cabling between units to be provided initially.
 2. Fuse mountings, protectors and 25 pair cables from the M.D.F. to the 1st unit to be provided as required.
 3. Cabling between 2nd 25 line unit and 2nd 20 line unit as between 1st pair of units.

- (2) Link Circuit—Selector No. 3149.
- (3) B/W Junction Circuit to Auto and Manual Exchanges—Relay Set No. 3307.
- (4) Multi-metering Equipment—Relay Set No. 3310.
- (5) Multi-metering Common Equipment—Relay Set No. 3311.

All these items follow normal standard jacked-in practice, but in the Multi-metering Relay Set a cross-connexion field is provided to arrange for the metering conditions. This is done by means of strappings on strips connexion which also terminate the bank connexions of the uniselectors involved. These uniselectors and strips connexion are mounted in adjacent positions on the relay sets. The strips connexion are singled-sided and the unselector bank wiring is terminated on the inside notch of the tags, thus leaving the remainder of each tag free for strapped connexions, etc.

On Relay Set No. 3310, to facilitate strapping, the spare code tag is duplicated at regular intervals. This avoids the use of long lengths of wire and consequent congestion. The strappings can be made vertically, in the notches provided at the extremity of the tags, with Wire, Copper, Tinned No. 25, S.W.G. Where code tags have to be passed by a spare code strap, the connexions from the spare code tags adjacent to the code tags are made with insulated wire.

A view of the general lay-out of this relay set is shown in Fig. 5.

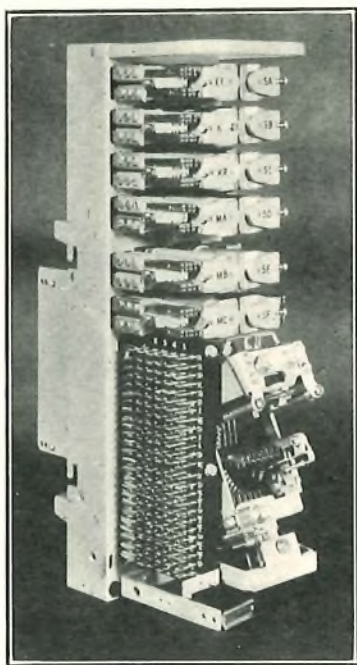

FIG. 5.—MULTI-METERING RELAY SET.

Building and Site.

The building, which is of the Post Office Standard Type A (General) is similar in construction to that of

the Unit Auto. Exchange No. 5, incorporating cavity walls to guard against temperature variation. The internal dimensions of the building are as follows :—
Width—7' 7", length 14' with a clear height of 8' 9".

Three classes of "A" type buildings are available—brick, stone and the "flooded area" type. In the latter type the building is of brick construction with the floor raised to cater for a 2 ft. flood line above ground level.

Fig. 6 shows the building and exchange lay-out.

A typical site measures 60 ft. in length with a frontage of 20 ft., but must at least be of sufficient length for two building units to be placed end to end behind the building line and to provide for soakaways, a call office (Kiosk No. 3), a footpath to the door at the rear and a reasonable clearance for the pole or underground lead-in.

Power Plant.

The power plant equipment is similar to that used in existing types of unit automatic exchanges—three schemes being available.

If the public supply is A.C. an automatically operating single battery power plant will be provided. This scheme is similar in general principles to that described by Messrs. H. C. Jones and H. S. Waters in the *P.O.E.E. Journal*, Vol. 26, Part 2, under the title "Small Automatically Controlled Power Plants."

If the public supply is D.C., or if there is no public

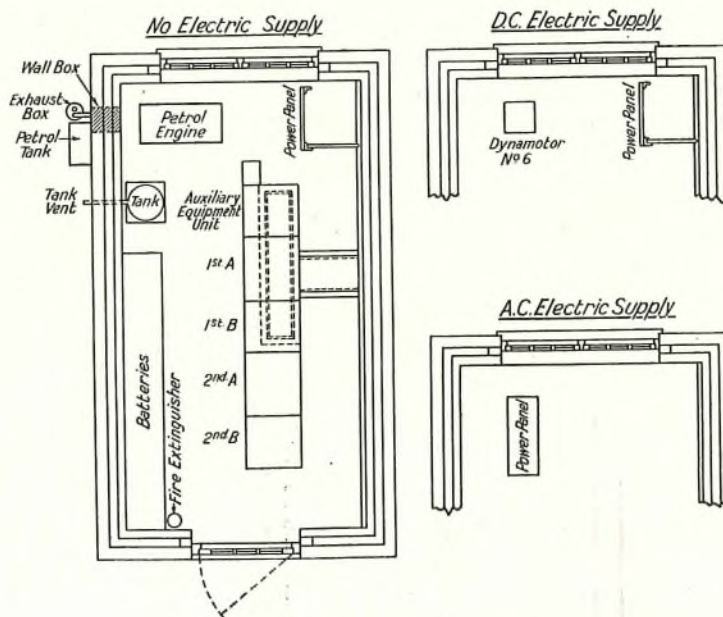

FIG. 6.—BUILDING AND EXCHANGE LAY-OUT.

supply available, a double battery charge/discharge scheme with a dynamotor or petrol engine charging set will be installed.

The lay-out for each of the above schemes is shown in Fig. 6.

CIRCUIT NOTES.

It is not proposed to describe the whole of the circuits in detail, as in general they follow standard lines. The special circuit arrangements used in the U.A.X. No. 5 equipment, in order to secure economy in current consumption, have not been perpetuated. The circuits, however, contain a number of novel features which have been introduced to provide the additional facilities, and it is proposed to deal with these at some length.

Subscriber's Line Circuit.

On reference to Fig. 7 it will be noted that the L and P relays both have their 5.5 ohm windings short circuited. The reason for adopting this method of making the relays slow acting, is that the relays are of the 600 type, and the provision of the normal copper slug on this type of relay would have necessitated the introduction of a new piece part.

The Coin Box Discriminating Signal.

The discriminating signal to indicate that a coin box subscriber is calling, is obtained by the simple expedient of removing the earth from the meter in the line circuit and replacing it by battery. When a coin box subscriber originates a call, this battery causes relay CB in the selector circuit to operate and lock. Should the coin box subscriber attempt to dial-out over a barred route (shown as level 7 in Fig. 8, relay CC will be prevented from releasing by earth *via* level 7 of the vertical marking bank, CB change-over operated, CC make, and C change-over normal. A change-over contact of CC connects N.U. tone to the line. The coin box subscriber is permitted to use the route to the parent manual board, and under these conditions a low resistance battery is passed forward *via* the D wire and contacts JC, MC, and CB operated, which will operate relays CB, WS, and WR in the relay set (Fig. 9).

If the coin box subscriber were permitted access to the parent auto exchange the strap (Note 1, Fig. 8) would be removed so that relay CC would not apply N.U. tone. No signal is passed into the relay set until relay B in the selector releases and connects through the battery from the coin box subscriber's meter. This battery causes only relay CB in the relay set to operate, which has no immediate effect on the junction signalling conditions. Should, however, the coin box subscriber attempt an excess fee call N.U. tone will be applied from the multi-metering equipment shown in Fig. 10, and the junction route cleared down by the release of relay HJ.

Combined use of one group of junctions for 9 and 0 calls.

When an ordinary subscriber makes a call to the parent manual board, a high resistance battery is connected to the D wire which causes only relay WS to operate in the relay set. This arranges the junction signalling conditions, so that a battery calling signal is connected *via* relay DD to the positive line operating relay LA at the parent end,

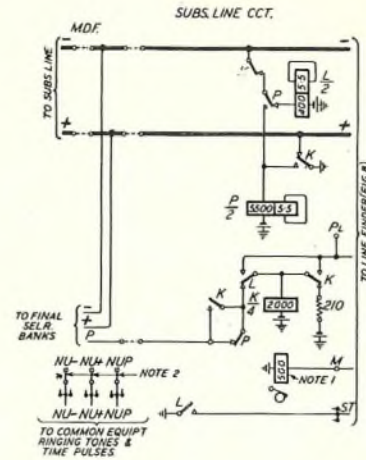

FIG. 7.—SUBSCRIBER'S LINE CIRCUIT.

- NOTE.—1. On C.B. lines meter to be connected to battery.
2. For dead numbers connect —, + and P to NU—, NU+ and NUP respectively.

a typical circuit of which is shown in Fig. 12. The operation of relay LA causes the ordinary subscriber's calling lamp to be lit, and an engaged test to be placed on the outgoing junction multiple. If, however, the call had originated from a coin box subscriber, the additional operation of relays CB and WR in Fig. 9 would have caused an earth to be applied to the negative line, which would have operated relay LB at the parent end (Fig. 13) causing the coin box calling lamp to light. If either an ordinary or coin box subscriber makes a call to the parent auto equipment, loop calling conditions are applied to the junction, which operate both relays LA and LB at the parent exchange. This causes a loop to be placed across the lines to the incoming selector, which on seizure operates relay SW. Change-over contacts of this relay disconnect the calling equipment, and connect the junction to the selector. If the U.A.X. is directly connected to a parent exchange to which auto access is not required, the insertion of a strap in the selector circuit provides a holding circuit for relay CC, and applies N.U. tone to the subscriber's line, when the digit 9 is dialled.

The foregoing signalling conditions combined with the bothway use of the junctions have necessitated, under idle circuit conditions, the simultaneous application of battery and earth to both ends of the junction lines. While under ideal conditions this would cause no trouble, in practice the voltages at either exchange will vary, causing current to flow between the two batteries, and this condition may be further aggravated by the existence of earth potential differences. In the design of these circuits the false operation, or holding, of the signalling relays by such currents has been prevented by the insertion of series metal rectifiers. On referring to the circuit element shown in Fig. 13 it will be seen that these rectifiers are placed virtually back to back, so that current flow in either direction is prevented.

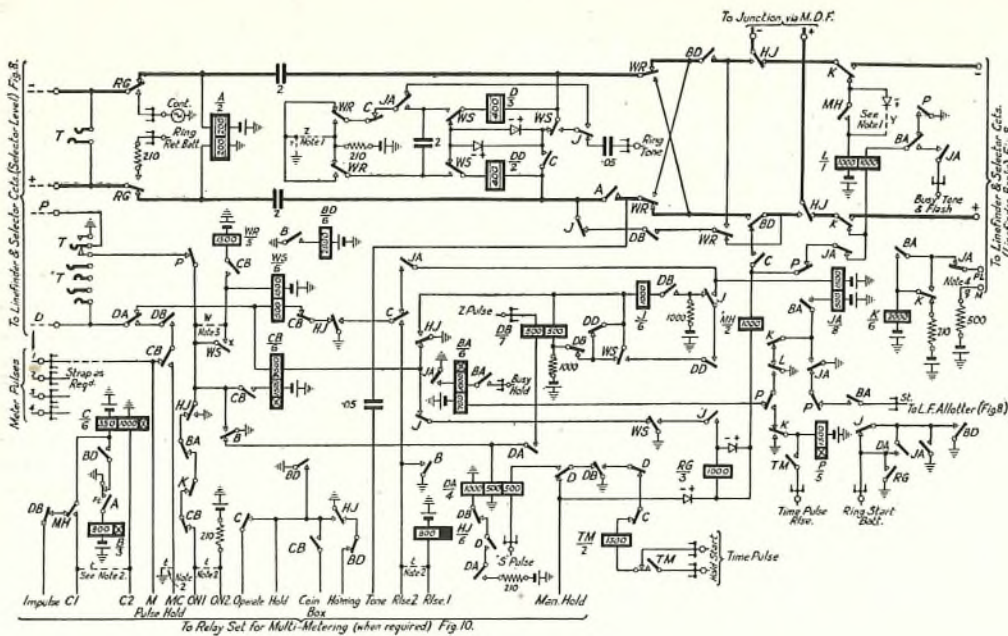

FIG. 9.—BOTHWAY JUNCTION RELAY SET.

NOTES.

1. When parent exchange is manual and not 50v, disconnect straps " y " and insert straps " z. "
2. When multi-metering is required, disconnect straps " t. "
3. Insert strap " w " when working to non-parent manual exchange.
4. Insert strap " q " when working to parent exchange.

Use of Levels for both Junction Outlets and Subscribers' Lines.

When the digit two is dialled for a local call, the selector (Fig. 8) is stepped to the second level, and relay LD is operated via the vertical marking bank. A contact of LD completes the release magnet circuit. The switch releases, and when the off normal springs return to normal relay LC operates. On the receipt

LD, which will restrain the application of ringing, and the connecting through of the negative and positive lines. Should, however, all junctions in that group happen to be busy, the subscriber will receive engaged tone instead of N.U.

If a dialling-out code is dialled, e.g., 7, the selector will be stepped to this level, and will cut-in and test for a disengaged junction. If all outlets are busy,

of the tens and units digits, the selector behaves like a normal final selector having 2-10 P.B.X. facilities. Should a spare subscriber's number (the bank position of which is being used for a junction outlet) be dialled, the selector will switch to the outlet if it is free. On the operation of the switching relay H, an earth is returned over the D wire from the relay set operating relay CC, which will return N.U. tone to the calling subscriber. The operation of relay CC will prevent the re-operation of relay

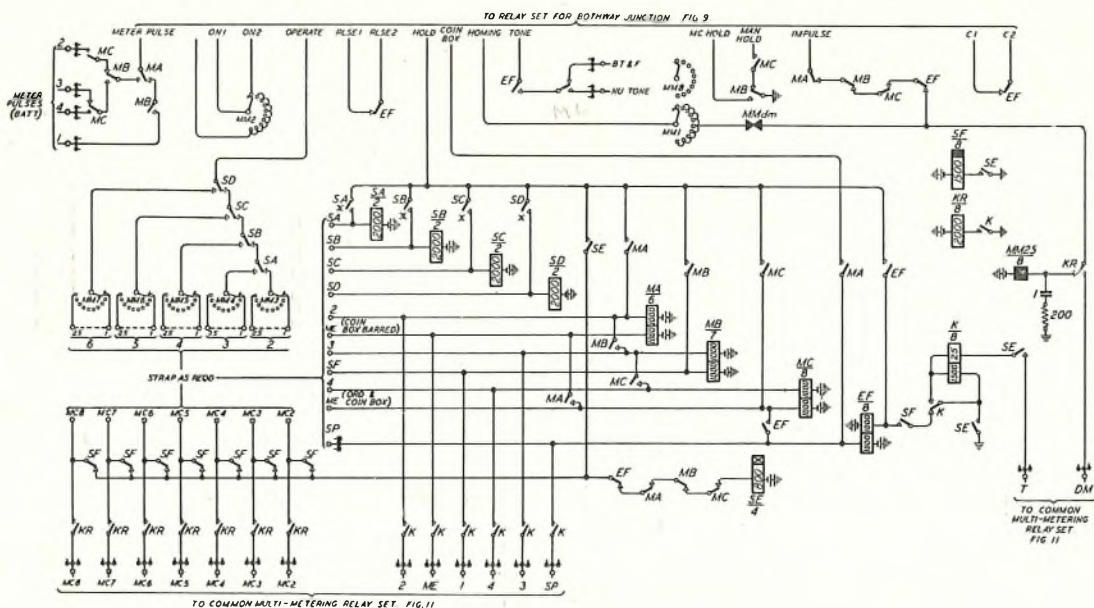

FIG. 10.—CIRCUIT OF MULTI-METERING RELAY SET.

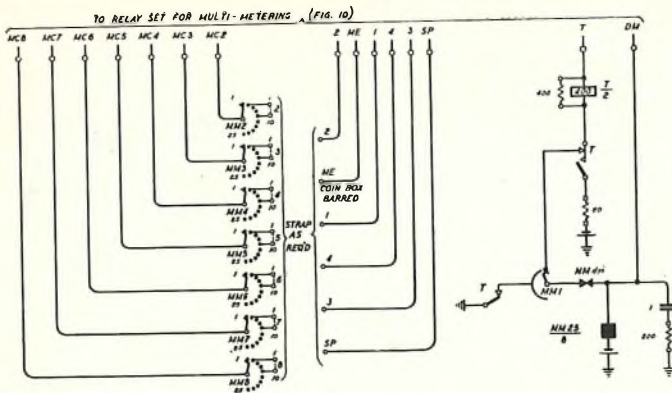

FIG. 11.—COMMON MULTI-METERING SET.

relay BR will be operated when E releases on the last contact of the junction group. A break contact of BR will release relay G, and thus allow the rotary magnet and relay G to interact, driving the selector over the subscribers' lines that follow the junction group until the 11th contact of the level is reached. Engaged tone will be returned to the calling subscriber, and an earth from the S springs over the D wire will operate the overflow meter.

Multi-Metering Equipment.

When a junction relay set (Fig. 9) is used on routes to auto exchanges it will be necessary to equip each junction relay set with multi-metering equipment as shown in Fig. 10. The function of this apparatus is to count the trains of impulses dialled over the junction until a point in the call is reached, at which one of the following conditions can be determined:—

- (1) The appropriate fee lead to be connected to the meter wire.

- (2) The call is either to a spare code or cannot be allowed to a coin box subscriber.
- (3) The call is either to a spare code or cannot be allowed to an ordinary subscriber.
- (4) The call is to a manual board barred to coin box subscribers and manual hold is required for ordinary subscribers.
- (5) The call is to a manual board not barred to coin box subscribers and manual hold is required.

The uniselector driving magnet receives a pulse for every digit dialled over the junction until discrimination takes place, and five levels of this switch are available for strapping to the various relays. The operation for a typical code to an auto exchange 985 is as follows: The switch responding to the digit 9 steps to contact 10. (The normal position of the switch is on contact 1). Earth is then extended over the wiper of MM3 and contact 10 which is strapped to relay SA. This relay operates and locks, causing the earth to be transferred to level MM4. The switch then responds to the digit 8, and the wipers come to rest on contact 18 of MM4, which would be strapped to relay SB. Relay SB operates and switches the earth to MM5. The switch responding to the final code digit 5, comes to rest with its wipers on contact 23. This contact on MM5 is strapped to the appropriate meter fee lead, e.g., 3 fee, and relays MB and MA operate. Contacts of MA and MB connect the meter lead to the 3 fee pulse lead, while break contacts of these relays cut the uniselector stepping circuit.

Such a call would be barred to a coin box subscriber, and the operation of relay CB in the junction relay set, extends an earth over the CB lead into the multi-metering equipment, which on the operation of MA causes relay EF to operate. Relay EF operates relay MC and contacts of these two relays connect N.U. tone to the line. The operation of EF also releases the junction switching relay HJ, which breaks down the junction route.

If a code dialled is excess fee to both ordinary and coin box subscribers, or is a dead code, the bank contacts are strapped to relay EF, which in conjunction with MC applies N.U. tone.

Should the multi-metering equipment associated with the junction relay set be inadequate to deal with the required number of codes, additional apparatus (Fig. 11), common to a group of junctions, is provided. When it is required to take the common equipment into use, earth is extended from one of the bank contacts

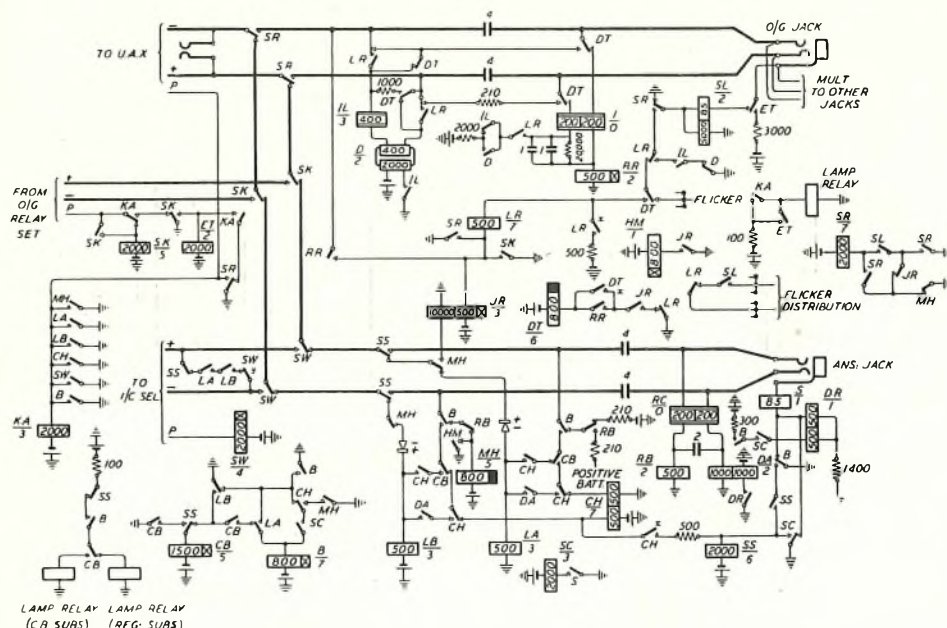

FIG. 12.—PARENT EXCHANGE RELAY SET, SLEEVE CONTROL.

of levels MM3, 4, 5, 6 or 7 to one of the 7 wires connected to the 7 wipers of the common equipment uniselector. Relay SE which is connected to all these wires is therefore operated and contacts of SE connect relay K to the common equipment test

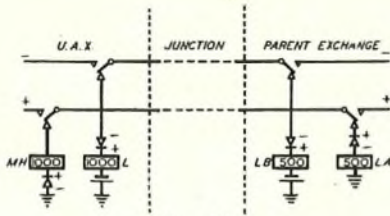

FIG. 13.

wire. If the common equipment is free, K operates together with its relief relay KR, thereby connecting the necessary leads through to the common equipment. The slow relay SF will also operate and disconnect relay SE from the 7 wipers of the common equipment. The next train of impulses will step the uniselector in the common equipment, and at the end of the train the selector bank and contact of this

these conditions when a manual board code is dialled, the bank contact is strapped to relay MA which operates and brings in relay MC. A contact of MC prepares the manual hold circuit by applying an earth to the MH relay in the junction relay set. Should, however, a coin box subscriber attempt such a call relay EF would also be operated, thereby causing the route to be broken down and N.U. tone returned to the calling subscriber.

When it is required to give a coin box subscriber access to a remote manual board, the bank contact is strapped to a special lead to operate relay MC alone, and so apply manual hold.

Ringing Tone and Time Pulse Equipment.

This equipment is shown in Fig. 14. When relay MS is operated, the three relays X, Y and Z operate and release in cyclic order, performing a complete cycle in approximately 200 milliseconds. A contact of relay X is used to step an 8 level uniselector and the banks of this switch are suitably connected to provide ringing and ringing tone periods, engaged tone and flash, and S and Z and meter pulses.

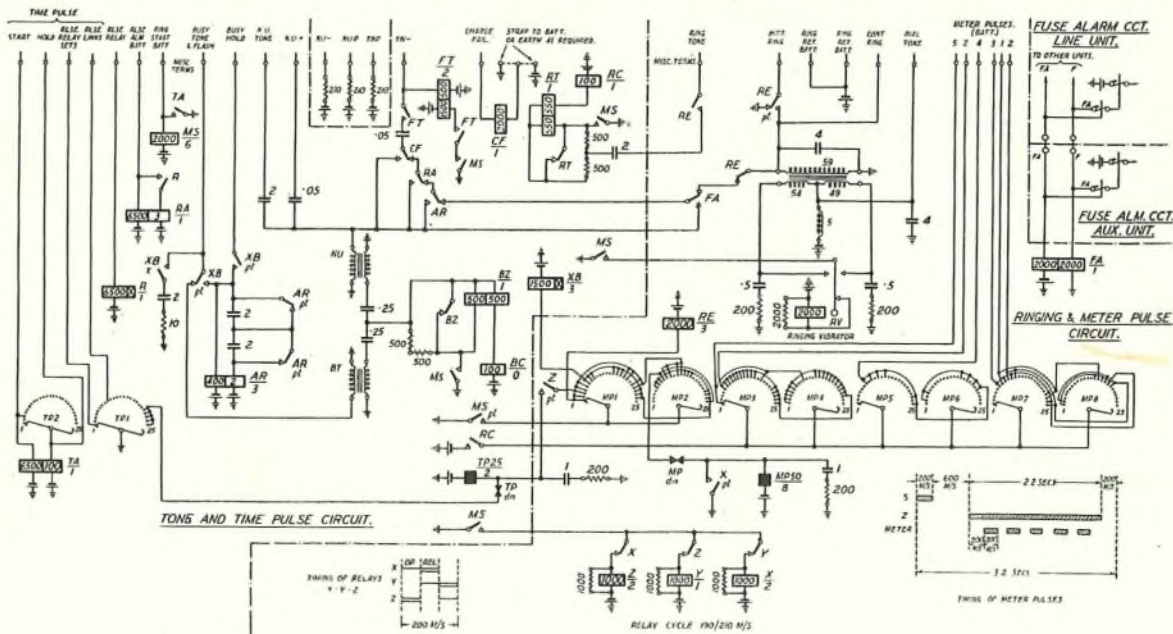

FIG. 14.—COMMON EQUIPMENT, TONES, PULSES, ETC.

equipment are used to extend earth to the required discriminating relay. It should be noted that the common equipment is not arranged for switching from wiper to wiper, as can be done in the individual multi-metering equipment.

If a relay set attempts to switch to a common equipment and finds it busy, relay K will fail to operate, therefore, when the slow operate relay SF operates, it will complete a circuit for relay EF, which will operate and return engaged tone to the calling subscriber.

A further function of the multi-metering equipment is to provide for manual hold on calls to manual boards obtained *via* distant auto equipment. Under

The remainder of the circuit is on similar lines to those used in the U.A.X. No. 5 and contains the test number equipment. The chief differences are that when the start condition is applied, the ringing vibrator is run continuously on the trembler bell principle which enables dial tone to be obtained from a suitable tapping on the transformer; further, the use of twin contact relays in the common equipment has obviated the need for the duplication of contacts as was done in the No. 5 equipment.

In conclusion, the authors desire to thank Messrs. General Electric Company, Ltd., for the photograph of the multi-metering relay set, and Mr. A. J. C. Henk for details of cabling arrangements, etc.

A Method of Locating High Resistance Faults in Loaded Cables

A. ROSEN, Ph.D., A.M.I.E.E.
(Messrs. Siemens Bros. & Co., Ltd.,
Woolwich)

INTRODUCTION.

HIGH resistance faults are generally troublesome to locate as they are usually variable in nature. The value of the fault resistance is liable to change erratically and as a rule is affected by the strength of the current passing through it. Hence in these cases, methods of location which depend upon more than one reading being taken, during which time the fault is assumed to remain constant, do not give accurate results.

The method to be described depends essentially on a change in the fault resistance, and therefore it can be applied in cases where other methods fail. Briefly, it consists of measuring the impedance of the faulty conductor with earth return by means of an alternating current bridge, and noting the values as the fault resistance changes. From the readings obtained and the phase constant of the circuit, the distance of the fault can be calculated.

THEORY.

Let the attenuation and phase constants of the circuit be β and α respectively, and the propagation constant

$$\gamma = \beta + j\alpha$$



FIG. 1.—POSITION OF FAULT IN LINE.

Let the fault be at a distance l from the measuring end, and let the distant end of the line be terminated by its characteristic impedance, Z_0 (Fig. 1).

When the fault has a resistance R_1 , the measured impedance

$$Z_1 = Z_0 \frac{(Z_0 + R_1) \cosh \gamma l + Z_0 \sinh \gamma l}{Z_0 \cosh \gamma l + (Z_0 + R_1) \sinh \gamma l} \dots (1)$$

When the fault changes by an amount ∂R to R_2 , the measured impedance

$$Z_2 = Z_0 \frac{(Z_0 + R_2) \cosh \gamma l + Z_0 \sinh \gamma l}{Z_0 \cosh \gamma l + (Z_0 + R_2) \sinh \gamma l} \dots (2)$$

$$\text{The change of impedance } Z_1 - Z_2 = \partial Z = \frac{\partial R}{\partial Z / \partial R}$$

$$= \frac{\partial R}{\frac{\cosh \gamma l + (1 + R_1/Z_0) \sinh \gamma l}{\cosh \gamma l + (1 + R_2/Z_0) \sinh \gamma l} \dots (3)}$$

$$= \partial R \cdot e^{-2\gamma l} / D \dots (3a)$$

$$\text{where } D = 1 + (R_1 + R_2)/2Z_0 + R_1R_2/4Z_0^2 - \{(R_1 + R_2)/2Z_0 + R_1R_2/2Z_0^2\}e^{-2\gamma l} + (R_1R_2/4Z_0^2)e^{-4\gamma l}$$

Let the angle of D be \emptyset . Now ∂R is of zero angle, and the angle of $e^{-2\gamma l}$ is $-2\alpha l$.

$$\therefore \Theta = -(2\alpha l + \emptyset) \dots (4)$$

Thus \emptyset will be small

- (a) when R_1/Z_0 and R_2/Z_0 are small compared with 1, i.e., for small values of fault resistance;
- (b) when Z_0 is of small angle (i.e., when dealing with loaded lines), and $2\alpha l$ is approximately a multiple of π .

Fig. 2 shows the manner in which \emptyset varies with the ratio R/Z (assuming the fault varies about a mean value R), and with the angle $2\alpha l$; attenuation effects are neglected.

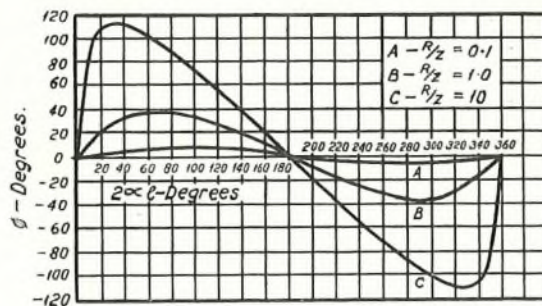

FIG. 2.—VARIATION OF ERROR WITH PHASE CHANGE AND WITH MAGNITUDE OF FAULT.

When \emptyset can be neglected, the distance of the fault is given by

$$l = -\Theta / 2\alpha \dots (5)$$

It will be observed that the angle Θ is always negative and that the location is independent of the actual value of the fault resistance.

The magnitude of the change in the fault resistance is given by

$$\partial R = \partial Z e^{2\beta l} \dots (5a)$$

METHOD OF TEST.

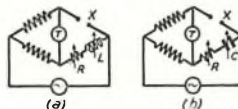

FIG. 3.—IMPEDANCE MEASURING BRIDGES.

- (a) Series inductance bridge.
- (b) Series condenser bridge.

The impedance bridge used should preferably be one of the series type, in which the resistance component A is read directly. In the series inductance bridge, Fig. 3(a), $Z = R + j\omega L$, and in the series condenser bridge, Fig. 3(b), $Z = R - j/\omega C$.

If successive vector values of $Z = A + jB$, obtained as the fault resistance changes, are plotted, the resistive component A along a horizontal axis and the reactive component B vertically (Fig. 4), the locus will be a straight line when Θ is in the neighbourhood of $n\pi$, n being a negative integer, i.e., when the change in the impedance is practically all

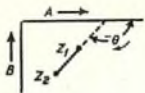

FIG. 4.—LOCUS OF IMPEDANCE VECTOR WHEN FAULT RESISTANCE CHANGES.

resistive. (The locus will be a straight line for all values of Θ when R/Z is sufficiently small). If the angle measured from the A-axis to the locus in a clockwise direction is $-\theta$, then $\Theta = n\pi + \theta$. Since α is very nearly proportional to frequency, by a suitable choice of frequency it is possible to arrange that Θ is approximately equal to $n\pi$. Fig. 2 shows that the error in neglecting θ is greater for even values of n than for the odd values; e.g., with $R/Z = 10$ when $2\alpha l = 179^\circ$, θ is 1° whereas when $2\alpha l$ is 359° , θ is 5° . Hence it is preferable for large faults to select odd values of n .

To determine suitable testing frequencies, two preliminary sets of readings are taken with a small frequency interval between them, such that n will be the same for both. Let these be f_1 and f_2 , and let the corresponding values of θ be θ_1 and θ_2 respectively. Then since $\alpha \approx 2\pi f \sqrt{CL}$, where C , L are the capacity and inductance per unit length respectively.

To determine suitable testing frequencies, two preliminary sets of readings are taken with a small frequency interval between them, such that n will be the same for both. Let these be f_1 and f_2 , and let the corresponding values of θ be θ_1 and θ_2 respectively. Then since $\alpha \approx 2\pi f \sqrt{CL}$, where C , L are the capacity and inductance per unit length respectively.

$$l = - \frac{n\pi + \theta_1}{4\pi f_1 \sqrt{CL}} = - \frac{n\pi + \theta_2}{4\pi f_2 \sqrt{CL}} - \frac{\theta_2 - \theta_1}{4\pi(f_1 - f_2)\sqrt{CL}} \dots\dots\dots(7)$$

This gives a rough value for l which is then used to calculate a frequency at which $\Theta = n\pi$, n being preferably odd, i.e.,

$$f = - n/4\sqrt{CL} l \dots\dots\dots(8)$$

$$= - n\pi(f_1 - f_2)/(\theta_2 - \theta_1) \dots\dots\dots(8a)$$

If a test by another method has been made which gives the approximate position of the fault, the preliminary readings would not be necessary, and equation (8) can be used directly.

A series of readings is then taken at this frequency, and an accurate value for Θ obtained. It is desirable to use two or more frequencies which are multiples of the lowest, in order to obtain check values.

In applying the above equations, it should be remembered that n , Θ and θ are all negative.

DETERMINATION OF THE PHASE CONSTANT.

The phase constant may be conveniently determined by means of an A.C. bridge, using the "open" and "closed" method. If Z_f Z_c are the respective impedances with the distant end of the line open and short-circuited, then

$$\alpha = \frac{1}{2l_1} \left(2m\pi + \tan^{-1} \frac{2h \sin \psi}{1 - h^2} \right) \dots\dots\dots(9)$$

where $h/\psi = \sqrt{(Z_c/Z_f)}$

l_1 = total length of line,

and m is an integer.

When the angles of Z_f and Z_c are the same, $\sin \psi = 0$, and equation (9) simplifies to

$$\alpha = m\pi/l_1 \dots\dots\dots(10)$$

Hence a simple method is to adjust the frequency until the angles of the "open" and "closed" impedances are the same, and then to use equation (10). The angles are the same when $R_f C_f = R_c C_c$ for the condenser bridge, or $R_f/L_f = R_c/L_c$ for the inductance bridge.

The value of m is determined from the approximate relation

$$\alpha \approx 2\pi f \sqrt{CL}$$

C the capacity and L the inductance per unit length refer to the conditions under which the test is made, i.e., a single wire with earth return. The capacity is approximately 1.6 times the mutual capacity of a side circuit for a multiple-twin cable and 1.9 times for a star quad cable. The inductance is approximately one-quarter of the inductance of a pair for a coil-loaded cable (side circuits only loaded) and one half for a continuously loaded cable.

EXPERIMENTAL VERIFICATION.

A trial was carried out on a 4-mile length of continuously loaded 14-pair cable. The pairs were looped up to form a long length and an artificial fault was inserted in one wire at a distance of 4 miles, measurements being made on the pair. Whilst good agreement was obtained with the formulæ for small values of the fault, there was a marked discrepancy for the larger values. This was attributed to the following cause:—

The capacity system of a balanced pair is as shown in Fig. 5. Each of the wires AB has a capacity to earth C_e and there is a capacity C_w between them. Under normal working conditions the potentials of A and B are symmetrical with respect to earth and effective capacity is $C_w + \frac{1}{2}C_e$. When a large resistance is inserted in series with one wire, the symmetry is disturbed. The effective capacity is no longer $C_w + \frac{1}{2}C_e$ and consequently the characteristic impedance no longer has the same value. This was verified by inserting equal resistances in each wire of the pair, so that the balance to earth was not disturbed, and it was found that the discrepancies disappeared.

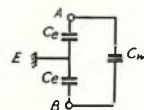

FIG. 5.—CAPACITY SYSTEM OF BALANCED PAIR.

The effective capacity is no longer $C_w + \frac{1}{2}C_e$ and consequently the characteristic impedance no longer has the same value. This was verified by inserting equal resistances in each wire of the pair, so that the balance to earth was not disturbed, and it was found that the discrepancies disappeared.

In practice of course, a fault would occur only in one wire, and hence a test on a balanced pair would lead to error. The difficulty was overcome by starting with an unbalanced circuit, i.e., using one wire of the pair with earth return. In this case, looping up to form a long circuit was no longer possible, owing to the induction between circuits in the same cable using earth return. The effect of a long cable was simulated by a resistance-condenser combination which was adjusted for each frequency to the characteristic impedance of the cable under the new conditions, and the artificial fault was inserted between the end of the line and the network.

The results are shown graphically in Fig. 6, in which the impedance is plotted for the four frequencies 915, 1830, 2745 and 3660 cycles, correspond-

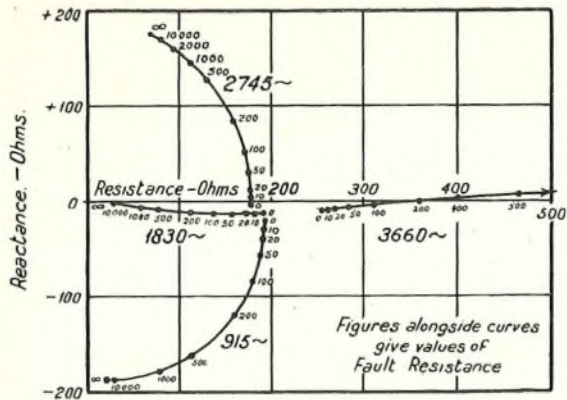

FIG. 6.—EXPERIMENTAL RESULTS USING VARIABLE ARTIFICIAL FAULT RESISTANCE.

ing to $2\alpha l = \frac{1}{2}\pi, \pi, \frac{3\pi}{2}$ and 2π , respectively. The

characteristic impedance is of the order of 200 ohms, and it will be seen that for small values of fault resistance (up to 20 ohms, *i.e.*, $R/Z = 0.1$) the locus is a straight line for all cases, and Θ is equal to $-2\alpha l$. In the neighbourhood of $2\alpha l = \pi$ and 2π , the locus is approximately straight for quite large values of fault resistance; at $2\alpha l = \pi$ it is more nearly horizontal than at $2\alpha l = 2\pi$, confirming that the error is less for odd values of n .

PRACTICAL APPLICATION.

A high resistance fault on a submarine cable had been tested by the Reid method,¹ during which the fault had varied from 12 to 1488 ohms: the results varied from 3.94 to 4.62 miles from one end, with a mean of 4.36 miles.

The A.C. bridge method was applied, the impedance of the faulty wire being measured with the other wires of the quad put to earth. The bridge used is shown in Fig. 7, a 10 : 1 ratio permitting variations of 1/100 ohm to be easily observed.

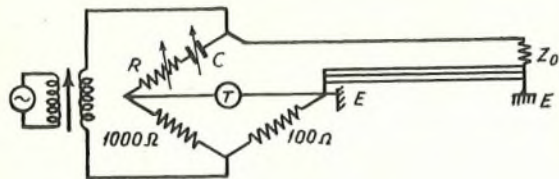

FIG. 7.—SERIES CONDENSER BRIDGE USING 10 : 1 RATIO.

It was then found that the fault had practically disappeared, and during the time of waiting for the fault to reappear, the phase constant was measured. Actually, the faulty wire was used for this measurement, the other wires of the quad being put to earth. (Had the fault been observable, the second wire of the pair would have been used. The balance between the wires of the pair is such as to give the same values for the constants, whichever be used. The results

¹ "Cable Testing," by E. S. Ritter; I.P.O.E.E. Paper No. 104.

of the phase measurements are shown in Fig. 8. Since α is very nearly proportional to frequency, it is more convenient for interpolation to plot α/f against frequency.

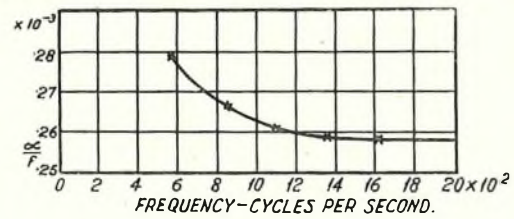

FIG. 8.—VARIATION OF α/f WITH FREQUENCY.

Towards the end of the second day a small variation of the fault was observed and a series of readings was taken at three frequencies. The results are shown in Figs. 9, 10 and 11. The deduced position of the fault is shown in the following table :

TABLE.

f cycles	$\frac{\alpha}{f}$ $\times 10^3$	α radians per naut.	Θ degrees.	Θ radians.	$\frac{\Theta}{2\alpha}$ nauts.
750	0.2695	0.2021	- 102.2	- 1.785	4.41
1500	0.2583	0.3874	- 196.3	- 3.426	4.42
2250	0.2580	0.5805	- 295.4	- 5.156	4.44
				Mean.	4.42

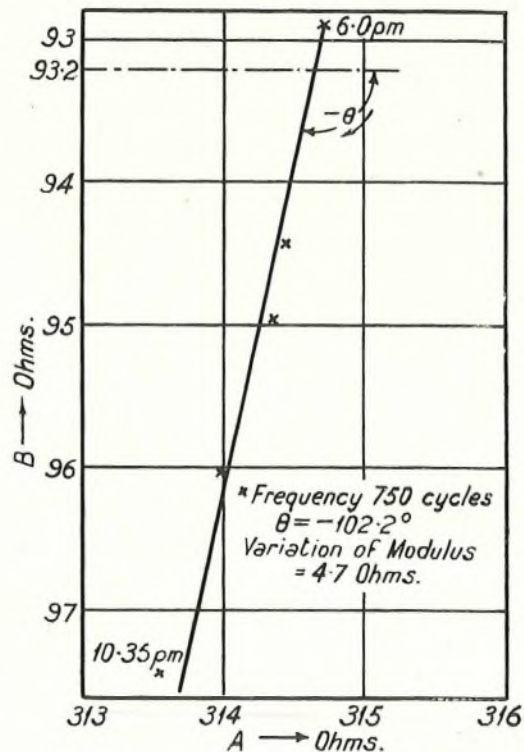

FIG. 9.—TEST ON SUBMARINE CABLE. VARIATION OF IMPEDANCE AT 750 CYCLES.

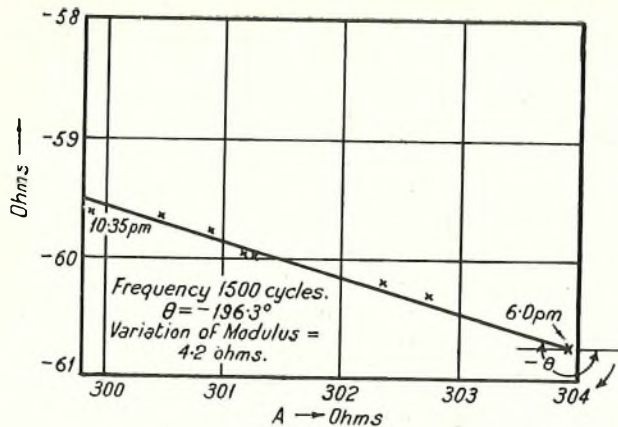

FIG. 10.—TEST ON SUBMARINE CABLE. VARIATION OF IMPEDANCE AT 1500 CYCLES.

The observed change of modulus ranged from 4.7 to 3.75 ohms, corresponding to a change of fault resistance of about 8 ohms. The agreement between the three sets of readings to less than one per cent. is remarkable, considering that the fault variation was only 0.2 per cent. of the loop resistance of the pair.

Up till the time of writing, it has not been found necessary to remove the fault, but the agreement with the D.C. Reid test and other evidence show that the location obtained by the impedance-variation method is accurate to one per cent.

CONCLUSION.

The location of high resistance faults is generally a tedious process. Faults disappear completely for days, and become tantalisingly variable when they reappear. The method described above may require considerable patience in waiting for the necessary changes of resistance; the more variable the fault,

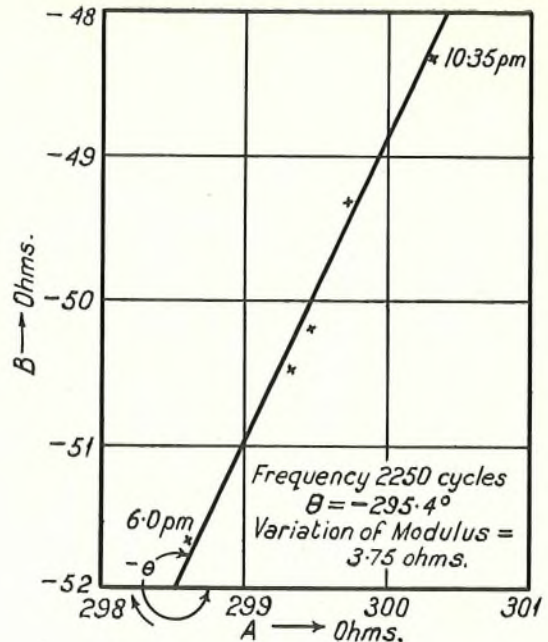

FIG. 11.—TEST ON SUBMARINE CABLE. VARIATION OF IMPEDANCE AT 2250 CYCLES.

the sooner the measurements can be completed. It is capable of a good degree of accuracy even when the fault is quite small, and should prove useful as a complementary method to those already known for the purpose.

The author wishes to express his thanks to the Research Section of the Post Office Engineering Department for co-operation in the practical tests described, and will be glad if readers who try the method will communicate to him the results of their experiences.

Telephone Line Insulators of Various Types

A Research Report dealing with comparative tests on porcelain, glazed and unglazed, American glass, pyrex glass and black composition insulators has just been issued. The tests were carried out both in the laboratory and also on insulators which had been exposed to the weather for two years in various districts. Consideration was given also to tests carried out on recovered composition insulators.

Unglazed porcelain insulators deteriorate on exposure to a greater extent than the glazed type, and the loss of insulation resistance cannot be recovered by cleaning. The tests on recovered composition insulators show that a very large percentage fail the specification tests on the reduced requirements for recovered insulators. The tests show that the original characteristics of glazed porcelain insulators can be restored, after a period of exposure, by cleaning, and the general conclusion is that they are

superior to composition insulators which undergo a permanent deterioration.

The American double shed glass insulators are also inferior to glazed porcelain insulators in respect of lower initial D.C. resistance, and in that they are permanently affected after a period of exposure. A direct comparison with Pyrex glass insulators was not possible since only Pyrex glass insulators of the single shed pattern were available. Pyrex glass insulators were, however, found to have a high A.C. insulation resistance even under adverse atmospheric conditions. It is for this reason that they have been used to a considerable extent in the U.S.A. on open wire lines where carrier working is employed.

The general question of the suitability of glass as an insulator material is being investigated at length by an E.R.A. committee on which the Post Office is represented.

Ultra Short Wave Radio Telephone Circuits to Northern Ireland

A. J. A. GRACIE, B.Sc., A.M.I.E.E.

Introduction.

THE general expansion in telephone traffic following the reduction in trunk tariff rates, brought into force in October, 1934, necessitated the provision, at short notice, of additional circuits to Northern Ireland. This necessity immediately raised the question of utilizing radio circuits for spanning the sea portion of the route as a possibly cheaper alternative to a submarine cable.

A previous article¹ described an experimental radio circuit, operative on wave-lengths round 5 metres, which was installed in 1933 for communication across the Bristol Channel between Lavernock and Hutton and which was extended at each end to Cardiff and to Weston-Super-Mare respectively. This circuit was operated on traffic for data purposes for over a year and, considering the experimental nature of the apparatus, the circuit proved very stable. It was therefore decided to develop a multi-channel equipment on similar lines and a six-circuit radio equipment was designed and constructed in the Radio Laboratories at Dollis Hill. This equipment, when assembled, was set up for test purposes at two points near Bristol and Cardiff and measurements of frequency constancy, transmission stability, cross-talk and such matters vitally affecting the performance of the equipment were carried out. These tests were still in progress and slight modifications to the equipments arising from the results of the tests were in process of being carried out, when the urgent demand for additional circuits to Northern Ireland arose.

A quick survey of the relative economics of radio versus submarine cable as a means of conveying the speech across the North Channel showed that the radio circuits seemed likely to be the cheaper alternative, besides possessing some other incidental advantages. Enquiries from British contractors revealed that suitable radio equipment could not be produced in the time available and it was therefore decided to transfer the Post Office six-circuit equipment from the Bristol Channel to the North Channel.

Sites.

A survey was therefore made and, in carrying out a search for possible sites, the following requirements were borne in mind—(a) the two sites should be within optical range of each other since the behaviour of ultra short waves is liable to become erratic over non-optical distances, (b) they should be reasonably near to a public power supply and to a main telephone route, (c) they should be at least a quarter-mile from a main road to avoid interference from motor car ignition systems, (d) an area approximately 300 yards

by 80 yards should be obtained to allow for possible future expansion, (e) the sites should preferably slope downwards in the direction of transmission, (f) the annual rental should be small. It will be realized that the various requirements were in some respects contradictory, but two sites were eventually selected which fulfilled requirements very well. One of these was situated near Ballygomartin, a village about $2\frac{1}{2}$ miles N.W. of Belfast and having an elevation of 800 feet above sea level, while the other was on Enoch Hill about 1 mile east of Portpatrick, in Wigtownshire and some 250 feet above sea-level. The distance between these two points was about 36 miles, but the elevated situation of the Ballygomartin site allowed an optical path between the two centres. The approximate location of the sites is shown in Fig. 1. The site at Enoch Hill was within one mile of the

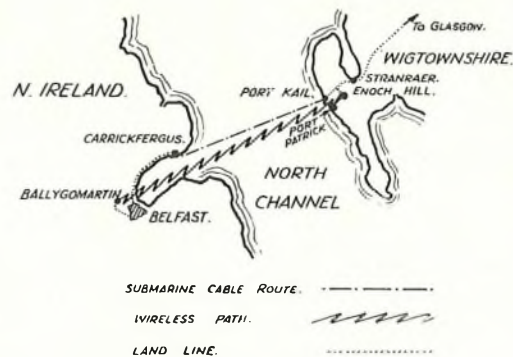

FIG. 1.—LOCATION OF SITES.

Portpatrick radio station which transmits telegraph and telephone messages to ships on wave-lengths ranging from 160-650 metres, and it was feared that harmonics of these longer wave emissions might cause interference to reception on the ultra short wave circuits. As it happened, however, the main transmitter at this station was in process of conversion from spark to valve working and hence it was possible to give consideration, in the design of the output circuit, to the prevention of even feeble radiation on the higher harmonic frequencies. The steps taken proved adequate, no interference eventually being experienced.

Erection.

As soon as the site question had been settled arrangements were put in hand for the leading-in of the necessary power supply and land line extension circuits, for the erection of the aerial system, and for the provision and erection of the huts to house the radio equipments. This work, which was put in

¹ P.O.E.E. Journal, Jan., 1933. "Ultra Short Radio Waves." F. E. Nancarrow.

hand in early October, involved among other things the laying of a new telephone cable, in existing ducts, from the Portpatrick site to Stranraer (approximately 6 miles) and the provision of two miles of H.T. power line on the Irish side, but by mid-December operations were sufficiently far advanced, in spite of bad weather, to allow the radio apparatus to be transferred to its new quarters. The completion of the power supply arrangements, assembly of the apparatus, connexions to land-lines and aerial systems, and charging of batteries occupied a further fortnight, and it was not until Saturday, December 22nd, that it was possible to conduct the first radio tests across the channel. It speaks well for the design of the radio equipments and for the preliminary testing work carried out across the Bristol Channel that, two days later, one circuit was brought into commercial use and early on Xmas day, four additional circuits were handed over for traffic purposes as part of London-Belfast and Glasgow-Belfast trunk circuits, the sixth circuit being retained as a speaker circuit. It should also be mentioned that, since Xmas day, the circuits have been in practically continuous use, apart from a short withdrawal, one at a time to enable some aerial modifications to be carried out.

Equipment.

The general arrangement of huts and aerials is well illustrated in Fig. 2 which shows the receiving hut

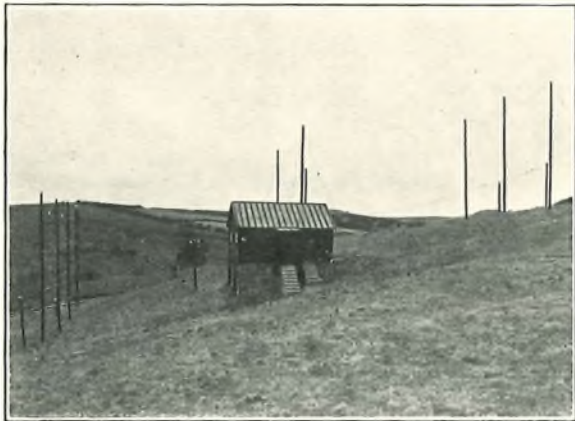

FIG. 2.—ENOCH HILL SITE.

and receiving aerials on the Enoch Hill site. The hut is of wood, some 26 feet by 20 feet, and contains the apparatus room in which are situated the radio (receiving), land line terminating and battery charging equipments, a battery room, and office accommodation. A similar hut, some two hundred yards away, is used to house the transmitting equipment. The aerials, which are designed to concentrate the transmitted and received energy in the desired directions, are suspended from 40 foot telegraph poles and consist of a number of half-wave radiators—mostly of the horizontal type—fed in phase. All the transmitting arrays, six on each site and each tuned to a slightly different frequency, are grouped in close proximity to each other, with the receiving aerials,

also grouped together, situated some two hundred yards away in order to minimize "throw-in" between the go and return paths in each radio "four-wire" circuit. Since the photograph was taken, reflecting curtains and additional radiating curtains have been added to the arrays, each of which gives an energy concentration, compared with a simple half-wave doublet, equivalent to an increase of transmitted or received power of 12 decibels. The radio frequency energy is fed to or from the aerials by parallel open wire transmission lines, rigidly kept at constant spacing by pyrex tube separators, and special quarter-wave lines are used to match the impedance of the array systems to the surge impedance of the lines—thus obviating reflexion losses.

Twelve radio frequencies in all are used, six in each direction, the corresponding wave-lengths all lying between 4 and 6 metres. One set of the transmitting apparatus is shown in Fig. 3, the six transmitters being shown mounted one above the other on

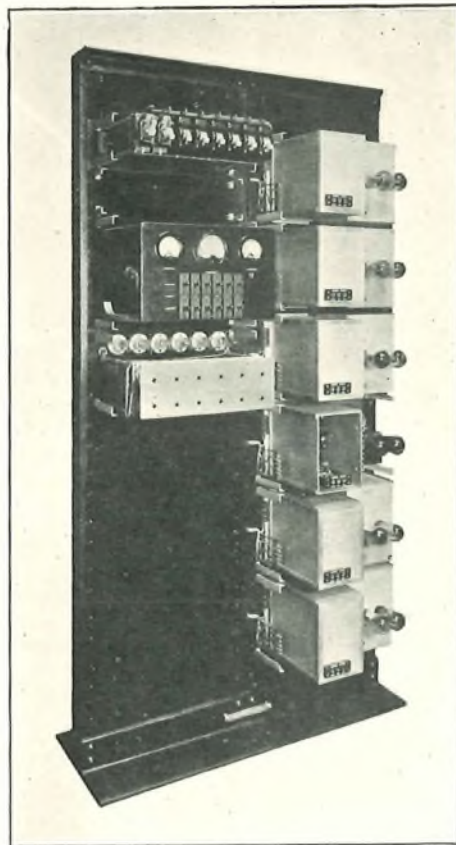

FIG. 3.—TRANSMITTER BAYS, WITH COVER REMOVED.

the right hand side of the photograph. The incoming speech on each channel is amplified and is then passed to a "Class B" modulator equipped with two ten-watt valves of rather special L.S.5X type, the output of which is arranged to modulate the voltage applied to the anodes of the high-frequency oscillator. This oscillator consists of a pair of valves of somewhat similar type to the modulator valves, but

with a higher " *m* " factor, working in push-pull in a self-excited circuit, reaction being applied between the grid of one valve and the anode of the other valve through a small condenser. The anode circuit of the oscillator is tuned by a variable condenser which is specially compensated to correct for variations in the transmitted frequency due to temperature changes and by means of this condenser and by the use of secondary cells for all power supplies, the frequencies of the transmitters are maintained sufficiently constant to give the necessary degree of transmission stability. The high frequency power output from each transmitter is of the order of 5 watts.

A general view of the receiving equipment is shown in Fig. 4. The receivers used are of the super

common oscillator, through a buffer amplifier to obviate cross-modulation, to all the radio frequency oscillator-detector stages. Provision is made for the automatic switching-in of a spare quench-frequency oscillator in the event of a failure of this component. The high frequency stages are shown on the top right hand side of the photograph, with the quench oscillators below; the centre panel is occupied with monitoring and power-supply apparatus and at the bottom of the left hand rack are mounted six line amplifiers for controlling the speech level delivered to the radio transmitters and above, test oscillators and speech level measuring equipment. Tests have shown that the automatic volume control of the receiver output results in a very constant transmission equivalent of the overall circuit and no provision

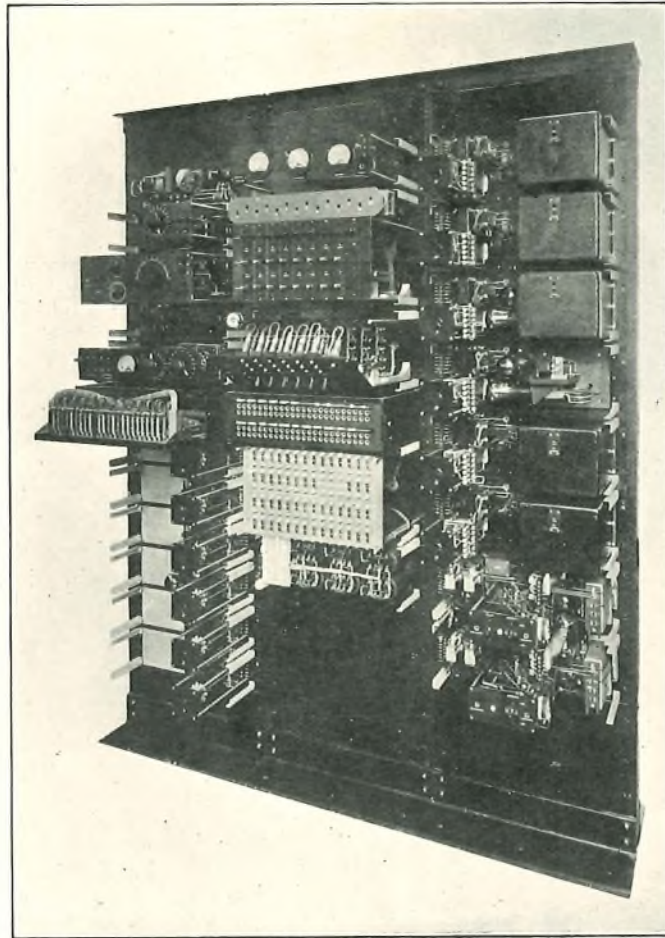

FIG. 4.—RECEIVER BAYS, WITH COVER REMOVED.

regenerative pattern, a type which is extremely efficient at the frequencies employed and which combines the merits of low cost, an enormously high amplification in a minimum number of stages, and automatic control of output volume. As in the case of the transmitters, individual radio-frequency circuits are used for each speech channel, but the supersonic " quench " frequency is applied from a

of voice-operated devices is necessary. Each radio path is operated at a gain of 5 decibels.

As previously stated, all power supplies to the actual radio equipments are provided from secondary cells. These are charged from the power supply mains *via* copper-oxide rectifiers, no machines being used. A special " floating battery " arrangement is employed, the battery voltages being kept at constant levels,

within very fine limits, by means of thyratrons which control the charging currents. A photograph of one of the charging panels is shown in Fig. 5. The four batteries, two 30 volt 72 amp. hour for filaments and

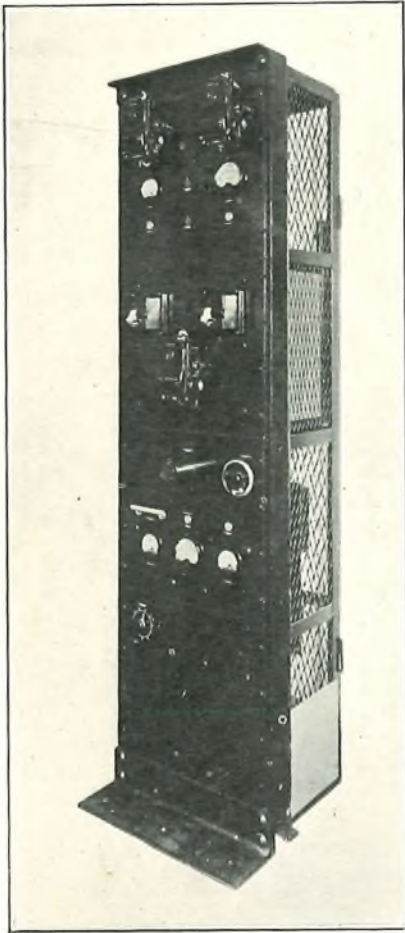

FIG. 5.—TRANSMITTER POWER CUBICLE.

300 volt 16 amp. hour and 150 volt 16 amp. hour for anode supplies, enable the circuits to be maintained in working order for some eight hours in the event of a power supply failure.

The radio equipments are designed for unattended operation, and experience during the first five months of this year has shown that very few troubles are to be anticipated.

Connexion between the radio circuits and the land line circuits is effected through suitable transformers at the radio sites and hybrid coils are provided at the terminal exchanges, normal "four-wire" trunk working thus being adopted. Ringing is effected by

500/20 cycle tone generators. The radio circuits on the Irish side normally terminate in Belfast, while on the Scottish side, three circuits are normally extended to London, one to Liverpool and the remaining two to Glasgow. The signal noise ratio on the radio circuits measured by a volume indicator having a flat response up to 4000 cycles averages 47 decibels, and the level of noise on the overall trunks—which are lined up as 3 db. circuits—compares well with the submarine cable routes and is sufficiently low to enable the circuits to be extended, if desired, to the Post Office overseas radio links.

Advantages.

The radio apparatus described is comparatively inexpensive to produce and annual maintenance costs should be low due to the low power and to the small number of valves used, while the equipments have already demonstrated that they are capable of providing reliable links in the general telephone network. There is thus good reason to believe that the use of ultra short wave circuits threatens to become a serious competitor to the use of submarine cables over short sea-routes, particularly in cases where, due to rocky sea-beds, tidal action and shipping, maintenance costs of cables are liable to be high. Although the chances of failure of individual circuits for short periods is greater in the case of the radio circuits than in the case of the submarine cable, there is much less likelihood of an extended breakdown of a number of circuits simultaneously, as was well exemplified over the 1934 Xmas period when, due to the exceptionally stormy conditions, several cable circuits were rendered inoperative.

An additional advantage offered by the radio links, in the matter of costs, is that additional circuits can be added, one at a time if necessary, to meet actual traffic requirements and thus the desirability of providing spare circuits at the outset, to meet possible future traffic growth, does not arise. Further it would be a comparatively simple process to shut down one or more of the radio circuits if not required—say at night-time—by remote control from the terminal exchanges or adjacent repeater stations, thus economising in power and valve costs.

In conclusion, it will be appreciated that the rapid manner in which the circuits described above were brought into action was only rendered possible by the close co-operation of several Branches of the Engineer-in-Chief's Office, by the untiring efforts of the staff of the Scotland-West and North Ireland districts, and by real hard work on the part of members of the Radio Experimental Group whose dubious, though possibly adequate reward, was to spend Xmas day watching "bob calls" passing successfully to and from our friends in Northern Ireland.

Recent Developments in Telephone Repeater Station Power Plant

F. W. G. DYE

Introduction.

TELEPHONE repeater equipment has formed the subject of many recent articles, each of which has dealt primarily with the repeater itself. The associated power plant has not been described in any detail and this perhaps was natural as, until quite recently, development and new design were confined to the actual amplifying equipment. The original design of power plant has been adequate to meet the conditions imposed by the introduction of any new type of repeater at existing stations and development had necessarily to be deferred until new stations were required, which occurred during the latter part of 1934. New stations, at Whitchurch (Salop), Kidderminster and Oxford, had then to be considered in connexion with the London-Liverpool cable, and the opportunity was taken to design the power plant to embody the following features which experience had proved to be desirable:—

- (a) Continuously floating filament and anode batteries.
- (b) Automatic voltage regulation of floating generators.
- (c) Automatic voltage regulation of filament discharge circuit.
- (d) Automatic starting of standby engine.

BATTERY SUPPLIES.

There are three separate battery supplies required in a modern repeater station, the voltages and uses of which are given in Table I. For simplicity, they will be referred to under the Department's designation of "A," "B" or "C" Battery.

TABLE I.

Departmental designation.	Voltage.	Purpose.
"A" Battery	24	Filament heating and relay circuits.
"B" Battery	130	Anode potential.
"C" Battery	10	Grid priming.

"A" Battery. All relay circuits in the station are connected to this battery *via* a choke in the negative lead. The choke is required to prevent voltage fluctuations across the filament circuits, due to the back EMF set up by the relays on release.

Only 21 of the 24 volts are used for the actual filament circuits, 3.0 volts being dropped in the resistance of the automatic voltage regulator. Four valve filaments are connected in series requiring, in a 4-wire double stage repeater, a total of 12 volts, *i.e.*, two four-volt and two two-volt valves per repeater. The remaining voltage is dropped across

resistance spools and is used for automatic grid priming and adjustment of filament current. In 2-wire and 4-wire single stage repeaters four-volt valves are used throughout, requiring a total of 16 volts. Insufficient voltage remains to provide all the grid priming required and a C battery supply is therefore necessary for both these types of repeater.

"B" Battery. This supply is required for the anode potential to the valves. Prior to 1933, 130 volts were provided on Messrs. Standard Telephone and Cables' installations and 150 volts on Messrs. General Electric Co's installations, but all valves have now been standardised to work with 130 volts on the anode and the B batteries at all new stations have this voltage.

"C" Battery. As already mentioned, this supply is required only at stations in which 2-wire or 4-wire single stage repeaters are installed. Two 10 volt, 16 ampere-hour batteries are provided and used alternately to furnish a current of 10 milliamperes through a potentiometer from which 4 and 8 volt tappings are taken to the grid circuits of the repeaters. A variable resistance is connected in series with the potentiometer to maintain the current of 10 milliamperes and an alarm contact type of milli-ammeter is provided to indicate any variation in current. As the batteries are of small capacity, they are charged from the working A battery and no special equipment is required other than the necessary change-over switches, resistances and indicating instruments.

CONTINUOUSLY FLOATING A AND B BATTERIES.

Experience has proved that the system of continuously floating batteries is an economical one, permitting the use of much smaller machines and batteries compared with the charge and discharge scheme, with a consequent reduction in capital costs and building dimensions. Prior to the new design of plant it was the practice to install duplicate batteries, each having a capacity sufficient for a discharge of 48 hours, and to work them on a charge and discharge basis. The charging generators had outputs sufficient to complete a charge in 9 hours.

The first installation of the new design was provided at Whitchurch and is of an experimental nature. The batteries and generators are provided in duplicate and worked on the continuously floating basis. The A and B batteries consist of 12 and 65 cells respectively, and they are floated at 2 volts per cell to provide 24 volts and 130 volts. This is contrary to usual practice, which is to float at 2.15 volts per cell to maintain the battery in a fully charged condition. If this procedure were adopted it would result in an A battery voltage of 25.8 and a B battery voltage of 139.75 which values are in excess of those required. A power wastage would

therefore occur which, at the maximum values of floating current, would be considerable. An alternative would be to provide 11 cells and 60 cells for the A and B batteries, in which case 24 and 130 volts would be obtained by floating at 2.15 volts per cell, but these voltages would immediately drop to 22 and 120 in the event of a failure of the floating generators.

As the open circuit voltage of a secondary cell when fully charged is 2.1 volts, each battery when first connected to the load is allowed to discharge for a short period until the voltage has reduced to 2.0 volts per cell. The floating generators are then connected and their automatic voltage regulators maintain a voltage of 24 and 130 across the A and B batteries for the remainder of the floating period, which is one week for each set of batteries. At the end of this period, the second set of batteries is put into service in the manner described above and the first set is given a short reconditioning charge from the second A and B generators to make good the capacity lost during their floating period. As the generators are duplicated, it will be seen that, in effect, a reserve machine is available in the event of a failure of the one on floating duty and, in view of this, the battery itself will very seldom be called upon to serve the equipment unaided. Comparatively small batteries can therefore be used and it was decided that their capacity need be sufficient for only one hour's supply.

The output of the generators is that required under floating conditions, but the generators must also be capable of normal charging duties, and as the ampere hour capacity of the batteries is small, they can, if necessary, recharge the batteries in 4-5 hours.

A comparison between the sizes of batteries and generators for the original and new design of plant is shown in Table II. The maximum discharge current for the A and B supplies has been assumed to be 100 amperes and 15 amperes respectively for both designs. The 15 amperes include a small percentage for emergency lighting.

TABLE II.

Design.	A-hr. capacity at 9 hour rate.		Generator outputs.	
	A	B	A	B
Original	4,800	580	600	70
New	400	60	100	15

It will be appreciated that the elimination of audio-frequency ripple from the floating generator is of the utmost importance. Any fluctuation of battery supply to the repeaters will of course be amplified and result in noisy circuits. This possibility becomes more serious where two or more stations on a cable route are employing the floating system as each would add its complement of noise to the circuits.

The elimination of generator ripple therefore forms an important part of the specification for floating type generators. A smoothing circuit is necessary consisting of a choke coil and, when required, electrolytic condensers. The permissible limits of audio-frequency fluctuations from the generators are as follows:—

Noise measured across the generator terminals without smoothing equipment must not exceed that equivalent to 2 milli-volts R.M.S. of 800 c.p.s. noise per D.C. volt generated, at full load current.

The noise of A generators, which for the purpose of the above test have a voltage of 25 volts, must not exceed that equivalent to 50 milli-volts at 800 c.p.s. The corresponding figure for B generators is 262 milli-volts as these machines are tested at a D.C. voltage of 131 volts. These values were specified in order to ensure that generators having reasonably small noise-content would be obtained. Further values, covering the ultimate limits of noise at the bus-bars in the repeater room are:—

“ A ” Generators.

When floating across the station A battery via the smoothing circuit, the noise measured at the bus-bars in the repeater room must not exceed that equivalent to 0.5 milli-volts R.M.S. at 800 c.p.s. at any value of current from $\frac{1}{4}$ to full load.

“ B ” Generators.

The test to be similar to the above except that the noise measured must not exceed that equivalent to 7 milli-volts R.M.S. at 800 c.p.s.

Under these conditions the respective batteries play an important part in the elimination of noise, as they provide a low impedance shunt path for the generator ripple. In view of this the lay-out of the plant must be such that the shortest possible route is obtained for the cables between the batteries and power board, in order that the resistance shall be kept as small as possible. A further precaution is taken by arranging each battery in two halves standing side by side, with the connexion between them at the end remote from the power board. A “ loop ” circuit is thereby formed which results in the battery inductance being reduced to a minimum. The reduction of inductance is more important than the reduction of resistance, since it has been found, in the majority of cases, that the A.C. impedance of a secondary cell battery has an inductive reactance which, at 800 c.p.s., is greater than its effective resistance. In view of this, generators having a low frequency ripple are most likely to fulfil the conditions.

Low frequency ripple is also preferable to high frequency due to the fact that the ear is considerably less sensitive to low frequency notes than to those of the order of 1000 c.p.s. of equal amplitude. This fact can be seen from the curve in Fig. 1 which has been reproduced from a report issued by the Comité Consultatif International. The weighted values indicate the amount of disturbance caused at different frequencies relative to that at 1050 c.p.s. for equal

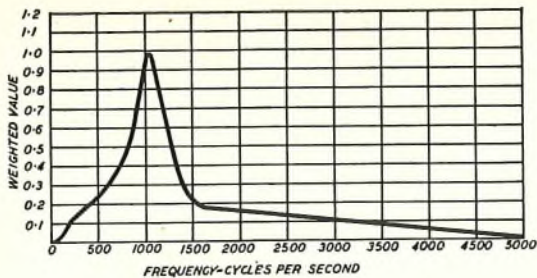

FIG. 1.—RELATIVE DISTURBANCE OF DIFFERENT FREQUENCIES.

values of disturbing voltage, *e.g.*, the disturbance at a frequency of 400 c.p.s. would be only 0.2 of that at 1,050 c.p.s.

As the disturbance effect is a function of frequency as well as of amplitude, an instrument capable of measuring only the latter is not alone sufficient. The measuring set actually used for the generator tests is one designed by the Research Section and consists essentially of a valve-voltmeter having a "weighting" network in the input which gives an overall frequency response similar to the curve shown in Fig. 1. In this way an allowance for frequency is provided and a result obtained which is a measure of the disturbing effect as distinct from actual disturbing voltage.

With the A and B generators at Whitchurch floating with full load current, the noise level at the output of a 2-wire repeater on full gain, measured across a non-reactive resistance of 600 ohms was found to be -76 db. below 1 milli-watt.

AUTOMATIC VOLTAGE REGULATION OF FLOATING GENERATORS.

The most important requirement to ensure the complete success of the continuously floating battery scheme is constant voltage from the floating generator. This will enable the battery to be kept in a satisfactory condition and at the same time provide a steady voltage for the discharge circuit, this latter condition being especially necessary when the load comprises the filament and anode circuits of telephone repeaters. The usual hand-regulation is inadequate as it cannot immediately cope with the output current and speed variations that normally occur under working conditions. Some automatic voltage regulator is being used with excellent results.

The regulator is manufactured by Messrs. Isenthal and is of the vibrating contact pattern depicted in Fig. 2. The contacts K and H are vibrated by the eccentrics G which are belt driven from the generator shaft. The contacts alternately short-circuit and insert the resistance W in the field circuit of the generator and produce an average value of field current which will maintain the correct voltage. The relative position of the short-circuiting contact H, and the resulting value of field current is controlled by the movable core C of the solenoid S which is connected across the generator terminals. In the event of the generator voltage tending to rise, the core C lifts the contact H and causes a longer "break" period which results in a reduction of field current

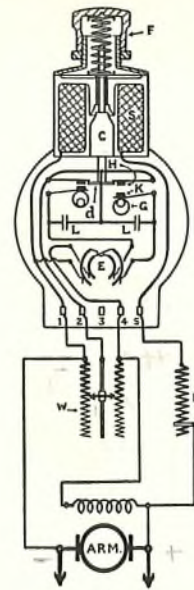

FIG. 2.—VIBRATING CONTACT VOLTAGE REGULATOR.

and corresponding restoration of voltage. The reverse operation occurs should the generator voltage tend to decrease. The spring F is provided for initial adjustment of the solenoid core and the condenser L absorbs contact sparking. The commutator E is operated by a handle passing through the front case of the regulator and provides a means of disconnecting the regulator and also of reversing the polarity of the contacts. This latter operation is carried out daily and reduces the wear on the contacts.

By means of these regulators the A generator voltage is held at 24 ± 0.5 volts and the B generator at 130 ± 2.0 volts, from no load to full load.

AUTOMATIC VOLTAGE REGULATION OF FILAMENT DISCHARGE CIRCUIT.

As previously mentioned, 21 volts are required for filament heating. This is obtained from the A supply, the 24 volts being reduced to 21 by means of a regulating resistance in the positive lead. The regulator is variable and is common to the number of filament circuits that will load it up to its maximum current carrying capacity. In the original design of power plant a hand operated regulator was employed and consisted of a large number of low resistance strips connected in series, the required number being introduced into the circuit by means of a rotary switch. This form of regulator was mounted upon a power board, known as the Voltage Control Board, and in the majority of stations at least two were in use, each having a capacity up to 80 amps. To facilitate distribution to the repeater racks, the voltage control board was situated midway in the gangway between the racks running the whole length of the repeater room.

The function of the regulator was to provide a means of maintaining the filament voltage constant while the A battery voltage was diminishing during its discharge period. The resistances in the regulator were graded and had individual values such

that a voltage of 21 ± 0.5 volts could be maintained at the filament fuse panels at any value of current up to the maximum for which the regulator was designed. A contact voltmeter was provided for each regulator, the contacts of which could be set to operate a visual and audible alarm in the event of the above limits being exceeded.

In the floating battery scheme the need for voltage regulation of the filament circuit is not so apparent, as the A battery supply is maintained at constant voltage by the floating generator. A voltage variation can only occur when for any reason the floating generator is shut down and the battery only is serving the repeaters. While this condition is admittedly rare it must nevertheless be catered for and a regulator is therefore provided with the new design of plant, but here again the automatic type has been adopted instead of the hand controlled. The regulator used is a pilot operated carbon pile pattern, supplied by J. Stone & Co., and is depicted in Fig. 3. As will be seen, the overall dimensions

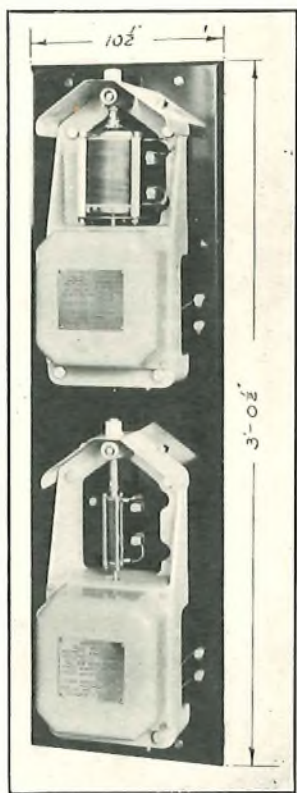

FIG. 3.—CARBON PILE VOLTAGE REGULATOR.

are reasonably small and the regulator, together with a fuse panel of similar size, is mounted at the end of a repeater rack. The voltage control board is no longer required and the wide gangway down to the centre of the repeater room that was necessary for its accommodation has been dispensed with. This has resulted in a considerable saving in floor space, the repeater racks being installed across the whole width of the room with normal gangways at the sides.

The operation of the automatic regulators depends upon the well known property of carbon to change in resistance with varying degrees of compression. The main regulator consists of a stack of carbon rings the mechanical compression of which is controlled by the position of an armature rotating between the poles of an electromagnet. The initial compression is obtained by a spring which has a torque opposing that exerted by the armature when the latter is being influenced by the field of the electromagnet. The electromagnet is connected across the discharge circuit at the point where a constant voltage is required. If, due to a variation in applied volts or a change in load current, the voltage at this point alters, the correct field strength will no longer be obtained, and the armature will rotate, with a resulting change in pile resistance, until once again the desired discharge voltage is obtained across the electromagnet. The armature will now come to rest on account of the state of equilibrium existing between the forces exerted upon it by the electromagnet and the spring.

As seen from the photograph in Fig. 3 and the circuit arrangement in Fig. 4, two regulators are

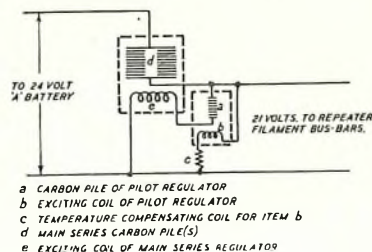

FIG. 4.—CIRCUIT OF CARBON PILE VOLTAGE REGULATOR.

actually employed, the larger, which carries the main current, being actuated by the smaller "pilot." This arrangement is necessary when close limits of regulation are required as the pilot regulator with its light construction is a much more sensitive component than the main regulator. Each pile of the main regulator will carry 25 amps. and the regulator can be constructed with three of these piles connected in parallel, giving a maximum current carrying capacity of 75 amps. The overall regulation guaranteed for the combined pilot and main regulators is 21 ± 0.25 volts. In actual practice closer regulation than this is maintained.

AUTOMATIC STARTING STANDBY ENGINE.

Long trunk circuits have as many as ten repeater stations en route and the whole of the repeated circuits in the cable would fail if the A or B supplies at any one station failed. Adequate emergency arrangements must therefore be provided at each station to guard against this possibility which would most likely be caused by a failure of the power mains serving the floating generators. Large batteries could be used with capacity sufficient to maintain service for the maximum anticipated period of power mains failure, but this would annul the economic advantages already enumerated.

The emergency arrangement adopted is the provision of a stand-by oil engine which will start-up automatically in the event of a mains failure and continue to drive the floating generators during the breakdown period. Continuity of service is thereby assured and the need for a power plant attendant during a mains failure is obviated. In addition, the automatic feature renders it unnecessary to staff the repeater station at night.

A lay-out of the plant—supplied by Messrs. Austinlite, of Birmingham—is shown in Fig. 5.

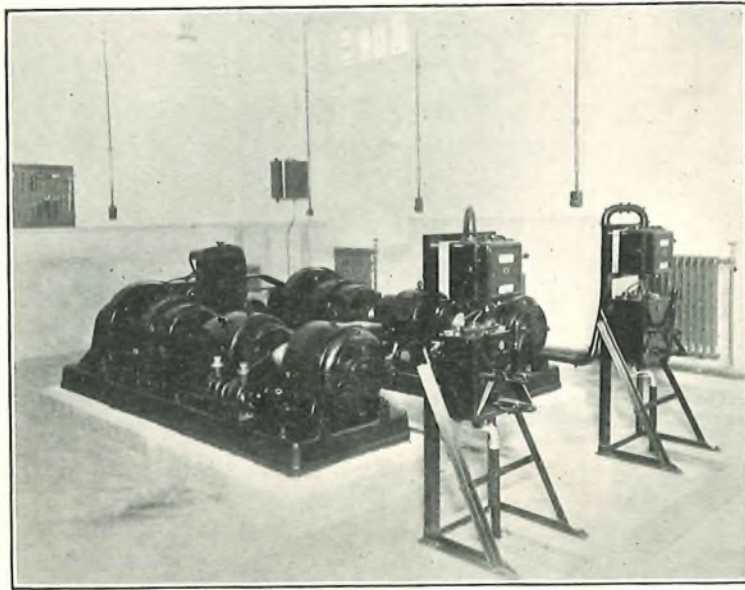

FIG. 5.—VIEW OF MACHINES.

Each set consists of a squirrel cage motor coupled to shunt wound A and B generators, each of which has an Isenthal automatic voltage regulator connected in its field circuit. The nominal speed of the motors is 1500 R.P.M. Mounted on the end of the shaft of each set is a solid steel flywheel and half of a magnetic clutch. The other half of the clutch is carried on a short shaft end on to, and in line with, the generator shaft. This short shaft also carries a pulley which accommodates two vee belts coupling up to the stand-by engine which is mounted centrally between the two sets. The engine is of the twin cylinder, horizontally opposed Diesel type, running on light Diesel oil and is water cooled *via* a radiator whose fan is belt driven from the engine shafting. Mounted on the bed-plate of each set is a centrifugal switch, belt driven from the generator coupling and a high and low speed centrifugal switch, belt driven from the engine and controlling the operation of a decompressor and fuel injection solenoid mechanism, is also provided.

Referring to the diagram in Fig. 6, the operation of the automatic engine-starting equipment, assuming that set No. 1 is running on floating duty and that a failure has occurred to the A.C. mains serving the motor of this set is as follows:—

The set will begin to slow down and when 5% reduction in speed occurs, the contacts VS1 of the

centrifugal switch driven from the generator shaft will “make,” providing 24 volts *via* SW1 to the coil of contactor R1, which operates. This contactor has two pairs of contacts, one pair completing a locking circuit for the contactor and the other pair providing 24 volts *via* switches SW3 and SW4 to

- (a) the coil of contactor R2 *via* the normally operated contacts of R5;
- (b) the clutch starter solenoid CS1;
- (c) the magnetic clutch CL1 associated with Set No. 1.

Contact R2 operates and disconnects the A1 and B1 generators from their batteries in order to prevent the circuit breakers tripping on the reverse current which would flow due to the reduction in speed of the set. The clutch starter CS1 also operates. This component is a solenoid, the plunger of which carries a contact which slides over four studs and during its operating time of approximately four seconds, short circuits in steps the resistance LR1 in series with the magnetic clutch CL1. The clutch starter thus supplies an increasing current to the clutch which is thereby “eased-in” in a manner equivalent to that adopted in a car, and ensures that the drive applied to the engine is a comparatively gradual one. Both halves of the clutch are “solid” when the resistance LR1 is completely cut out and the momentum of the fly wheel is sufficient

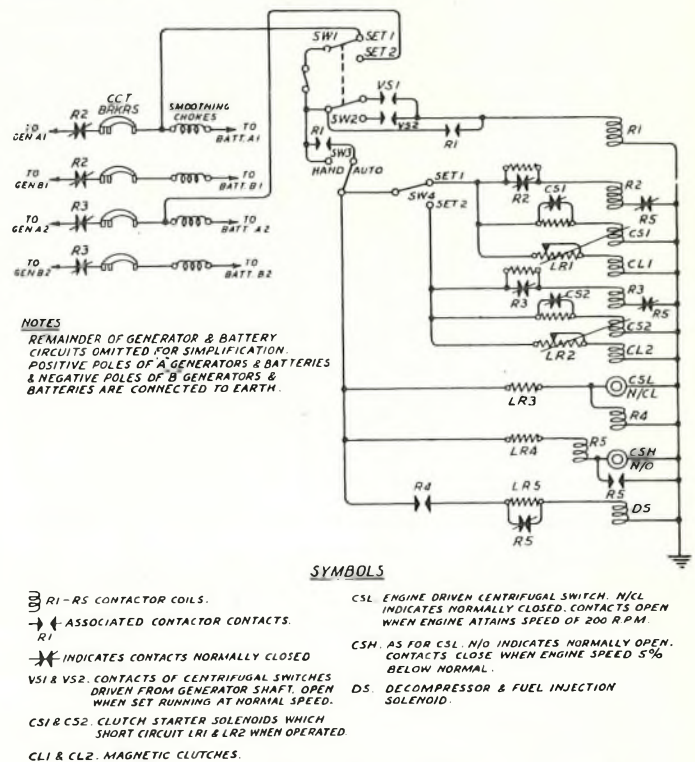

FIG. 6.—CIRCUIT OF AUTOMATIC ENGINE-STARTING EQUIPMENT.

to turn the engine shaft *via* the vee belt drive. The engine is normally decompressed and will remain so until it has attained a speed of 200 R.P.M. when the low speed contacts of the centrifugal switch CSL—which is belt driven from the engine—will open and remove the short circuit from contactor R4. This contactor will now operate and its contacts provide 24 volts to energise the decompressor solenoid DS, the plunger of which is arranged to give the engine full compression and also to turn-on the fuel. The engine will now fire and run up to the speed which is sufficient to close the high speed contacts of the centrifugal switch CSH. These contacts complete the circuit for contactor R5 which operates and

- (a) provides a locking circuit for itself;
- (b) removes a short circuit from an "economy" resistance in series with the decompressor solenoid DS;
- (c) opens the circuit of contactor R2.

Contactors R2, in releasing, restores the A and B floating generator circuits and normal conditions obtain except that the engine instead of the motor is driving the generators. The whole of the operations described, from the instant of mains failure to that of the restoration of contactor R2, occupy no more than 12 seconds, during which time the repeaters are being served by the batteries only. As previously mentioned, the battery voltage is the same as the floating generator voltage so that the repeaters are in no way affected by a mains failure.

Contactors R3, clutch starter CS2 and magnetic clutch CL2 are associated with Set No. 2 and operate if this set is running instead of Set No. 1. The LR resistances in series with the contactors adjust the various currents to the required value.

Referring to Fig. 6, it will be seen that by means of switches SW1, SW2 and SW4 the set which will continue to run from the engine, in the event of a mains failure, can be selected. This facility is necessary when both sets are running, one charging one set of batteries and the other floating the remaining batteries across the repeaters. Under this condition, the switches are put to the position that will ensure the floating set being driven from the engine should the mains fail.

Switch SW3 is normally in the AUTO position, but, by operating to the HAND position, it will be seen that 24 volts are applied to the automatic starting equipment and the sequence of operations previously described—less the energising of contactor R1—will take place resulting in the starting of the engine. By this means, the equipment can be routine tested as required.

The contactors, etc., are mounted on the left-hand panel of the switchboard depicted in Fig. 7.

The batteries and associated change-over switches have been omitted from Fig. 6 for the sake of simplicity. The switching has been arranged to enable either of the A batteries to be floated or charged from either of their respective machines.

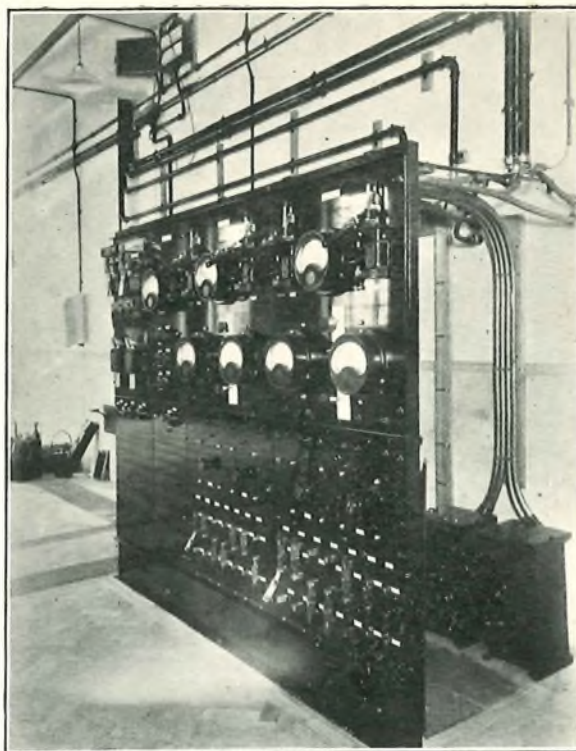

FIG. 7.—VIEW OF POWER SWITCHBOARD.

The two A batteries can also be paralleled if necessary, as can also the two A generators and the combination floated across the repeaters. Similar facilities are provided for the B batteries and generators. A two-position switch is included in the field circuit of each generator, whereby the automatic regulator can be replaced by normal, hand controlled rheostats when the generators are required for battery charging.

CONCLUSION.

The continuously floating method of working made possible by the automatic features embodied in the plant described has resulted in a considerable reduction of capital costs, building dimensions and maintenance charges. A further advantage is obtained in the constancy of overall circuit performance, due to the battery supplies to the repeaters being maintained at a fixed value by the automatic voltage regulators. It will be appreciated that this condition becomes especially desirable on a cable route employing a number of repeaters. With the charge-discharge scheme, occasions must arise when the B batteries at two or more repeater stations are simultaneously approaching the end of their discharge period which will result in a slight reduction of repeater gain and a corresponding degrading of all the circuits concerned. The introduction of the new plant will therefore contribute to an increased efficiency on long distance telephone circuits.

Telephone Transmission—VI.

R. M. CHAMNEY, B.Sc., Assoc.M.Inst.C.E. A.K.C.

THE main principles upon which transmission systems are based should now be understood from the previous articles in this series. It remains to apply them to the line network so as to design the plant in a sound manner.

In this country the lines connecting towns, exchanges and subscribers are classified as follows:

Long trunks (over 25 miles radial distance).

Short trunks (under 25 miles radial distance).

Junctions.

Subscribers' lines.

Junctions connect together exchanges whose distance apart is such that not more than two unit fees are involved (the unit fee being one penny). This definition is being modified to meet future conditions whereby the junction will cover four unit fees.

It will be evident that traffic as a whole can be divided into types in the same manner and indeed the engineering and traffic aspects naturally run together.

A town may have one or more local exchanges and from the normal intercourse of the population, together with the small fee chargeable, the traffic will be large. After the immediate environs of the township are passed the traffic falls into the short trunk group where, with a lesser community of interest and a higher fee, the volume of traffic becomes reduced. Cases, of course, do arise in certain areas where two large townships fall within the short trunk fee range, but these are not very numerous. In large cities the local fee area may be more extensive than in small towns, London having a radial distance of $12\frac{1}{2}$ miles from Oxford Circus for a 2d. fee, whereas in smaller towns this distance becomes $7\frac{1}{2}$ miles.

Beyond the short trunk limit comes the main trunk service. The fees being proportionately increased and the community of interest less, the volume of traffic is smaller in amount than on the short trunk service. The proportion of circuits provided in each group will naturally vary with the traffic demand and therefore in general terms the further the lines are projected the smaller will the number of such lines be.

It is a generally accepted fact in all communication systems that long distance traffic must take precedence over short distance traffic, since the cost of long distance communication both to the vendor and the consumer is greater. Taking railways as an analogy, an expensive and high-speed express, carrying as it does valuable traffic, must take precedence over slow trains. In the same manner a long distance telephone line held up for a local line clearance is most undesirable because its greater revenue-earning capacity is being wasted. It pays, therefore, to foster the long line and spend money upon it with greater freedom. Faults on long lines are expensive luxuries, therefore more expensive terminating, protection and switchroom gear must be used.

For these reasons the backbone system of long

distance trunks has been provided on a firm and sound basis with the most efficient plant that can be obtained consonant with the ability of the circuit to give its proper financial return. As the grade of circuit decreases in importance money can be saved by cheaper construction.

Turning now to the transmission aspect, the main backbone circuits are relatively few compared with junction and subscribers' lines. If then by suitable technical methods the backbone trunks can be made very efficient in transmission, for the same overall efficiency the junctions and subscribers' lines can be made up from lighter gauge conductors. Since the latter are so very much more numerous a very great economy can be realized.

The general lay-out, therefore, for an economical transmission scheme is to provide for the long distance trunks connecting the main cities on a "zero" loss basis as described in Article V, and to throw back towards the subscriber's line as much as possible of the total permissible transmission loss.

The British Transmission System.

The ideal of providing all exchanges with direct lines to all other exchanges to which there may be traffic is impracticable. A system whereby traffic is segregated into definite channels by collecting and distributing networks is therefore necessary.

The country has been divided up into a number of units called *groups* of exchanges, the groups themselves being further grouped into a considerably smaller number of *zones*. Each group of exchanges is made dependent on one exchange usually in the largest central town available. This exchange is known as the *group centre* and acts as a collecting and distributing centre for all traffic circulating to and from all exchanges outside the group. The size and shape of the group will depend on the density of population, community of interest and geographical features of the locality. Some groups in the more populated areas are so small geographically that they embrace an area of only 100 or so square miles; on the other hand some groups cover large tracts and have lines from the group centre to outlying exchanges of 100 miles in length.

The zones have a *zone centre exchange* in a large central city to collect and distribute traffic from and to a number of groups. Every group centre has lines direct to its zone centre and also to every exchange in the group where the cost can be reasonably justified. In principle every zone centre should have direct connexions to every other zone centre, but in practice owing to lack of direct traffic this has not been found economical in certain cases.

Fig. 1 shows the present zone centres and the method of routing the traffic between them. The letter D indicates that direct lines already exist.

Fig. 3 shows the existing group centres.

For long distance traffic the normal routing is as

TO FROM	ABERDEEN	BELFAST	BIRMINGHAM	BRISTOL	CARDIFF	CARLISLE	DUBLIN	EDINBURGH	GLASGOW	LEEDS	LEICESTER	LIVERPOOL	LONDON	MANCHESTER	NEWCASTLE	NOTTINGHAM	PLYMOUTH	SHEFFIELD	SWANSEA	
ABERDEEN		GLASGOW	GLASGOW	LONDON	LONDON	GLASGOW	GLASGOW BELFAST	0	0	GLASGOW	LONDON	GLASGOW	0	GLASGOW	EDINBURGH	LONDON	LEEDS	GLASGOW	LONDON	
BELFAST			LIVERPOOL	LIVERPOOL	LIVERPOOL	GLASGOW	0	GLASGOW	0	GLASGOW	LIVERPOOL	0	0	0	GLASGOW	LONDON	LEEDS	LIVERPOOL	LIVERPOOL	
BIRMINGHAM				0	0	LEEDS	LIVERPOOL	GLASGOW	0	0	0	0	0	0	0	0	0	0	0	0
BRISTOL					0	LEEDS	LONDON	GLASGOW	0	0	BIRMINGHAM	0	0	0	0	0	0	0	BIRMINGHAM	0
CARDIFF						MANCHESTER	LONDON	NEWCASTLE	BIRMINGHAM	0	BIRMINGHAM	0	0	0	0	0	0	0	0	0
CARLISLE							LIVERPOOL	0	0	0	LEEDS	0	MANCHESTER	0	0	LEEDS	LEEDS	LEEDS	LEEDS	LEEDS
DUBLIN								GLASGOW	BELFAST	LIVERPOOL	LIVERPOOL	0	0	LIVERPOOL	LIVERPOOL	LIVERPOOL	LONDON	LIVERPOOL	LONDON	
EDINBURGH								0	GLASGOW	GLASGOW	GLASGOW	GLASGOW	0	GLASGOW	0	NEWCASTLE	LONDON	MANCHESTER	GLASGOW	BELFAST
GLASGOW										0	BIRMINGHAM	0	0	0	0	BIRMINGHAM	BRISTOL	LEEDS	BRISTOL	
LEEDS												0	0	0	0	0	0	BRISTOL	0	BIRMINGHAM
LEICESTER												0	0	0	0	0	0	0	0	0
LIVERPOOL													0	0	0	0	0	BRISTOL	0	0
LONDON														0	0	0	0	0	0	0
MANCHESTER															0	0	0	BRISTOL	0	LIVERPOOL
NEWCASTLE																0	0	LONDON	0	BRISTOL
NOTTINGHAM																	0	BRISTOL	0	CARDIFF
PLYMOUTH																			LONDON	BRISTOL
SHEFFIELD																				
SWANSEA																				BIRMINGHAM

FIG. 1.—ZONE TO ZONE PRIMARY ROUTING.

from the local exchanges to the group centre are provided on what is known as a "No delay" basis, that is to say the number of circuits on a route is increased when the times that all circuits are engaged becomes noticeable.

No delay circuits are worked, with few exceptions, on a junction signalling basis.

The trunk service between zone centres is operated on a Demand basis, where a certain large percentage of the calls are put through on Demand, that is to say, the subscriber is not released but obtains his call without having to hang up. The basis of provision is such that less trunks are used than with the "No delay" service.

follows :—The subscriber at an exchange is switched *via* his group centre to the zone centre and thence *via* the remote zone centre to a second group centre and on to the requisite exchange to which his correspondent is connected. This is shown diagrammatically in Fig. 2.

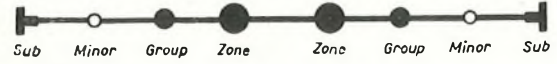

FIG. 2.—NORMAL ROUTING OF LONG DISTANCE TRAFFIC.

In theory all long distance communication should conform to the routing shown; in practice, however, there are variants which alter the problem. It is clearly reasonable to set up trunk circuits in addition to the foregoing where the traffic justifies this action, and in practice many zone centres are provided with direct circuits to group centres in other zones and conversely some group centres have lines to several zone centres. London has direct circuits to group centres such as Middlesborough, Hull, Hanley, Exeter, etc., and Derby as a group centre has lines to London, Manchester, Leeds, Sheffield, Nottingham and Leicester as well as to its proper zone centre, Birmingham. The elimination of unnecessary operating together with the speed of service will justify this course where the community of interest is such that heavy traffic exists.

Provision and Method of Operation.

The provision of trunk and junction circuits must be regulated on some definite plan so as to avoid wastage of plant. The junction and trunk circuits

Toll Areas.

Associated with the larger zone centres situated in big commercial cities are a number of group centres at no great distance from the zone centre and each other. The community of interest between these exchanges is great and the traffic correspondingly heavy. It pays therefore to set up rapid communication facilities covering the area concerned and to work a group to group service direct or *via* the zone centre exchange on a no delay basis. An area thus constituted is termed a Toll area. The London Toll area comprises roughly the counties of Kent, Sussex, Surrey, Essex, Middlesex, Hertford and parts of Bucks, Berkshire and Hampshire.

Transmission Design.

It has been laid down that as a basis in this country the line transmission loss between any two exchanges should not exceed 15 db. except in the obviously difficult sparsely populated areas where a small proportion of subscribers on an exchange cannot otherwise be served except at prohibitive cost.

It has already been stated that all zone to zone links are now planned on a basis of zero loss and therefore the full 15 db. is available for distribution elsewhere in the system. The group is thus the unit area for transmission purposes. Every exchange in a group must thus be able to reach the zone centre with a total loss of 7.5 db.

In many cases zone to group circuits are now provided by means of light gauge cables and amplifiers. Circuits so set up can be operated at "zero" loss if worked on a four-wire basis, but should oscillation occur during operating due to temporary discon-

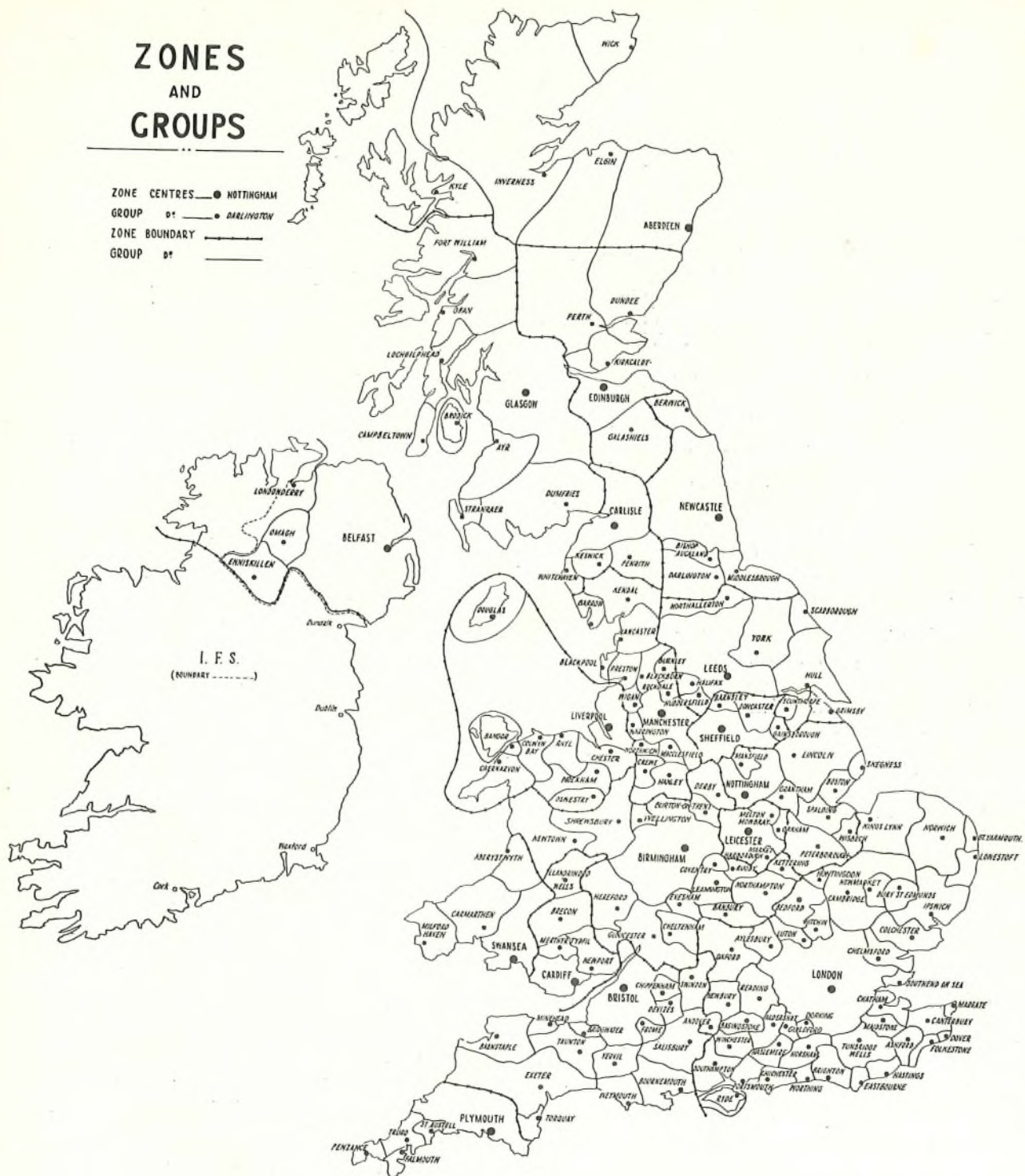

FIG. 2.

nexions at one end the resulting disturbance to subscribers and other circuits in the cable would be severe. Were it possible to use echo suppressors on all these circuits this difficulty would be avoided, but as this is ruled out on grounds of expense the safe limit has been found in practice to be 3 db. This

link may thus be set down as having a maximum permissible loss of 3 db.

The junction or short trunk circuits from the group centre to the dependent exchange can thus have a maximum limit of $4\frac{1}{2}$ db.

These allowances are sufficient for traffic circulat-

ing throughout the entire system and circuits having losses not exceeding these figures are suitable for long distance or inter-zone work and may be called "Z" circuits.

Since the group is the unit area for transmission purposes it follows that the allowances quoted are suitable not only for the long distance traffic, but also for inter-group or "G" traffic within a zone.

Within a multi-office area any two exchanges must be able to communicate without exceeding the standard allowance, but since the junction circuits provided for "Z" and "G" traffic have losses of only 4.5 db., plant based on this figure would be wasteful. Any two junctions which may have to be connected in tandem can be provided on a maximum basis of 6.5 db. for each junction. This gives a margin of 2 db., but allows of an economical gauge of cable. Such junctions are called "G₂" circuits.

Circuits handling direct traffic ("D") only between two exchanges in such an area and not available for tandem switching are allowed a maximum allowance of 12 db.

Fig. 4 and the following table show typical connexions together with the line allowances. It will be noticed that in cases where the local exchange has not direct connexion to its group centre the junction allowance must still be within the 4.5 db. figure. All figures quoted are maxima.

Circuit.	Type.	Allowance db.
Zone centre to zone centre	Z	0
Zone centre to group centre in another zone	Z	3
Zone centre to group centre in the same zone	Z	3
Group centre to group centre	G	3
Group centre to minor exchange	Z & G	4.5
Group centre to dependent exchange via a minor ex- change	Z & G	4.5
Group centre to minor ex- change for switching in multi-office area	G ₂	6.5
Any two exchanges for terminating traffic only ...	D	12

This then is the transmission plan for this country. The new figures have only been adopted recently and although very much transmission upgrading has been done years will pass before all the links are within the limits set down. Old plant with useful life cannot be ruthlessly scrapped nor can it always be modified to work satisfactorily on modern lines, but as opportunity occurs the work is undertaken to bring the lines within standard.

It will no doubt be realized that the huge majority of calls do not incur the whole transmission loss of 15 db. For instance, more than 75% of calls between say London and Liverpool exchanges are to and from subscribers in these cities, thus one and more often both zone to group links are cut out.

Transmission upgrading was started with the inter-zone links so that the maximum benefit would be

realized both in transmission of long distance calls and in economies in local networks. It may be assumed that, taking average transmitters and receivers, 90% of traffic in this country is within the standard thus described.

The transmission plan as outlined above is not in any sense a finality. Unquestionably in the near future a zero loss zone to group link will be possible. Transmission losses can then be expended entirely in what may then be called the local system. It is ever the desire of the transmission engineer to throw

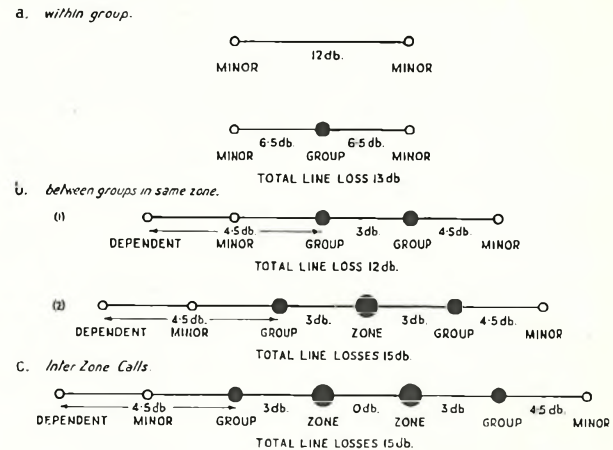

FIG. 4.—TYPICAL CALLS. REVISED TRANSMISSION STANDARDS.

these losses further and further back so that he may realize a great economy in the cheapest possible local line network.

The future inevitably holds enormous changes both in technical advance and methods of construction. Good transmission is not only a necessity, but a valuable and sound business investment. The work already done on the present plan in giving really first class transmission on the trunk system has, together with the demand service of rapid connexion, been the greatest aid in keeping the British telephone service ever expanding during the recent years of depression. These two factors have made the service not only popular but a business necessity, and have had no small influence on the telephone surplus.

Conclusion.

These articles have been compiled with the hope that the subject of Transmission in its widest sense, both theoretical and applied, may become more popular and intelligible to those whose work is both too arduous and removed from the subject to the more academic and mathematical works on the theme. The author hopes that by keeping each article to a short length and by treating the matter in a rather different manner from the usual the interest of readers may have been stimulated.

The author wishes to acknowledge the very helpful assistance of his colleagues in preparing these articles and to Messrs. Stratton and Luxton for extracts from their Institution Paper No. 153.

The House Exchange System

W. LOWNE and
T. G. MORRIS

Introduction.

As a means of communication between a number of internal stations, intercommunication or house telephone systems possess certain important advantages over branch exchange systems. Chief of these are the ease and rapidity of connexion afforded and the ability to obtain connexions without the aid of an operator at a central point. Private intercommunication systems, however, suffer from the serious disadvantage that they are completely divorced from lines to the public exchange.

The advantages to be gained by the linking up of an intercommunication system with public exchange lines have long been realised, but certain difficulties, concerned principally with mechanical design, have

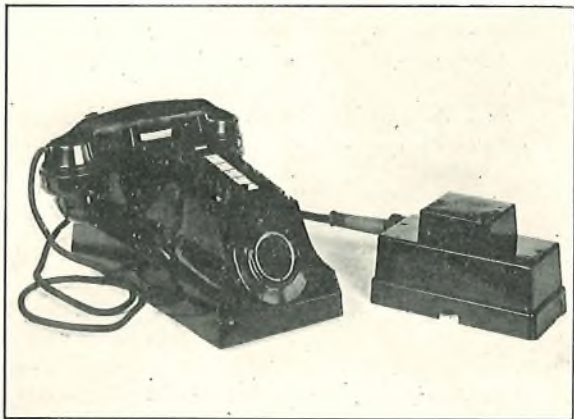

FIG. 1.—TELEPHONE INTERCOM. NO. 1.

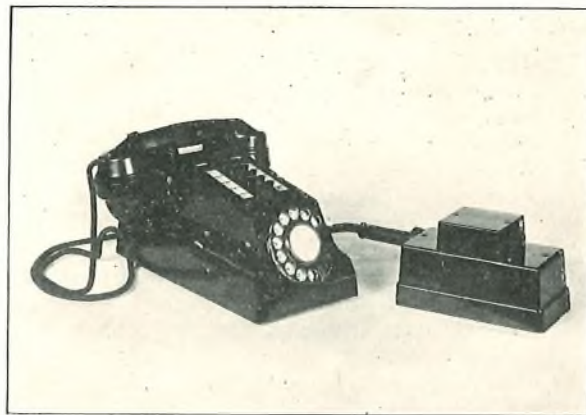

FIG. 2.—TELEPHONE INTERCOM. NO. 2.

hindered the satisfactory solution of the problem. As far back as 1915, circuits for a house telephone system with exchange facilities were developed by Mr. Blight, of the Post Office Engineering Department, and after the war some mechanical design work on the system was carried out at Holloway Factory, but it was found difficult to reduce the apparatus to a convenient size.

In 1931 various alternative designs were brought to the notice of the Department and it was decided to conduct an investigation to determine whether any of these would be suitable for adoption as a standard. As a result of this investigation a system, which fulfils the Department's requirements, has been developed. It is suitable for installations which up to the present have been served by—

- (a) Private intercommunication systems supplemented by direct exchange line installations.
- (b) Private Branch Exchanges.
- (c) Plan Number extensions.

FACILITIES.

In order to appreciate the facilities offered it will be appropriate to distinguish between the various types of station which may be associated with the system.

- (1) An internal extension station is a station equipped with a special telephone set provided with plunger keys, as illustrated in Figs. 1 and 2. The two sizes of apparatus available are shown.
- (2) A main station is an internal station equipped with a unit or units in addition to the special telephone set. The units contain signalling and switching apparatus used in connexion with incoming calls from the exchange or

from the external extension station. A combined unit, as used on systems with one exchange line and an external extension station, is shown in Fig. 3.

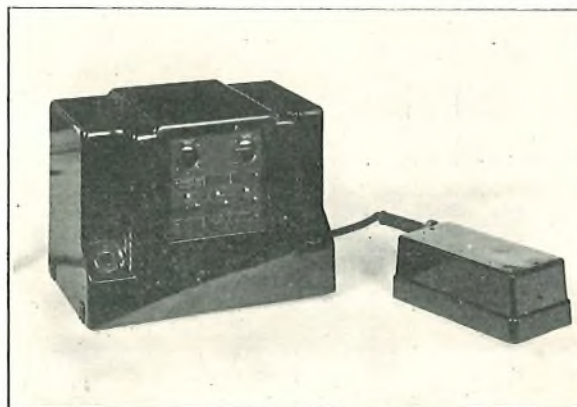

FIG. 3.—UNIT TRANSFER INTERCOM. NO. 1A.

- (3) An external extension station is a two-wire extension equipped with a C.B. or Auto microtelephone and a bell set. One external extension only may be connected to any installation.

The following schedule indicates the main facilities afforded by the system :—

On Local Intercommunication Calls.

- (a) Direct calling between all internal extension stations on the system.
- (b) Non-secrecy.
- (c) Engaged signal only if the called internal extension station is engaged on an exchange call.
- (d) Direct calling of an external extension station from all internal extension stations.
- (e) Calling of all internal extension stations from an external extension station *via* the main station.
- (f) Conference facilities, *i.e.*, facilities for speaking from any station to all or any number of stations on the system simultaneously.

On Exchange Calls.

- (a) Direct connexion from any internal extension station to the public exchange system over any exchange line connected to the installation.
- (b) Direct access to the exchange lines may be barred to chosen stations. These stations may, however, originate exchange calls *via* the main station.
- (c) Connexion (*via* the main station) of an external extension station to the public exchange system over any exchange line connected to the installation.
- (d) Incoming exchange calls may be answered at any predetermined station. This station is known as the main station and is provided with special unit equipment. Arrangements can also be made for equipping any one of the internal extension stations as a 2nd-choice main station. On such installations, the functions of the 1st-choice main station can be transferred to the 2nd-choice main station, when desired, by the operation of a key, or keys, at the 1st-choice main station.
- (e) An incoming or originated exchange call with the exception of directly dialled calls originated by the external extension station, may be transferred from any station, to any other station connected to the installation, without breaking down the exchange connexion. On installations with two exchange lines, an internal extension station may hold one exchange line while transferring a call incoming on the second exchange line. If an exchange call is to be transferred to an internal extension station which is barred direct exchange facilities, or to an external extension station, the transfer must be carried out indirectly, *i.e.*, *via* the main station.

- (f) Any internal extension station may hold an exchange call while making a call with any other station on the system. While the exchange line is being held, the outside subscriber is unable to overhear a conversation between the station to which he is connected and the party called by the same station. In addition, on installations with two exchange lines, any internal extension station not barred direct exchange facilities, may hold one exchange line while making a call on the second exchange line.
- (g) On engaged exchange lines, an audible engaged test is given on pressing the exchange line button. It is unnecessary to remove the microtelephone from its rest while making this test—the test is operative whether the microtelephone is lifted or not.
- (h) Secrecy is given on exchange connexions. Monitoring facilities may, however, be allowed at the main stations or any of the internal extension stations if desired.

Night Service. The external extension station may be allowed night service facilities. Under these conditions, incoming exchange calls will ring the external extension station bell in addition to operating the indicator (and alarm bell) at the main station. The external extension station when connected for night service cannot receive local calls from internal extension stations (except by switching at the 1st-choice main station).

Extension Bells. The exchange or external extension alarm bell circuit may be extended to any point or points on the system, but on certain installations it is not possible to give discrimination and it becomes necessary, in these cases, to test for the calling line by means of the instrument plunger keys. The extension of the exchange line alarm bell circuit will enable incoming exchange calls to be received at these points during the night. The instrument buzzer signals may be similarly extended if desired.

INSTALLATIONS.

Standard types of telephone set and main station unit are used on all installations irrespective of the type of public exchange concerned. The telephone sets for use at internal stations are available in two sizes, the smaller size being equipped for one exchange line and up to 5 local stations and the larger for two exchange lines and up to 10 local stations. One station additional to the numbers quoted may be accommodated by appropriating the home station key on each telephone set for this purpose. On installations of either of the above sizes one external extension station may be connected in lieu of an internal extension station.

Four types of main station unit are available :—

No. 1 contains calling and switching equipment for systems with one exchange line and without an external extension.

No. 1A is a combined unit and contains calling and switching equipment for one exchange line together with signalling and switching equipment for an external extension station. One indicator only is associated with the external extension line and serves as the extension calling indicator and a clearing indicator for exchange calls switched through to the external extension.

No. 2 contains calling and switching equipment for systems with two exchange lines and without an external extension.

No. 3 contains signalling equipment for an external extension and equipment for switching this extension to either of two exchange lines. This unit is fitted in addition to Unit No. 2 at main stations on systems with two exchange lines and an external extension, considerations of space having rendered it impossible to combine the apparatus in one unit as with unit No. 1A.

The telephone sets and units are equipped with plugs and cords and are connected to jacks at the terminal points of the cable feeding the station. The plugs and jacks have been standardised so that it is possible to wire an installation with a capacity for two exchange lines and 10 stations at the outset and to fit the smaller size telephones and units initially. The larger size equipment may then be directly plugged-in to replace the smaller when the capacity of the latter is exhausted.

A lay-out for the maximum condition of two exchange lines, ten internal and one external extension station with a second choice main station is given in Fig. 4.

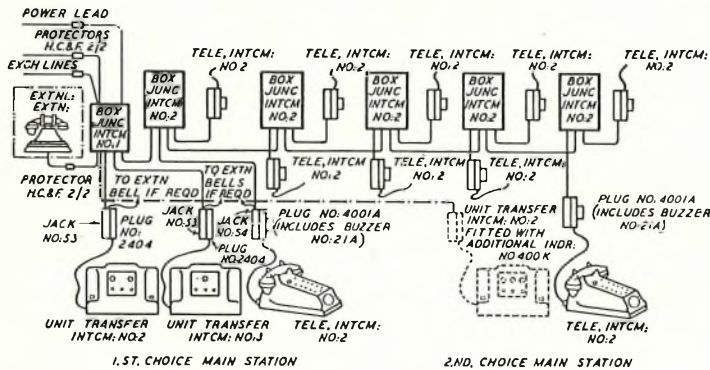

- NOTES.
1. THE DIAGRAM SHOWS THE MAXIMUM NUMBER OF STATIONS THAT MAY BE CONNECTED
 2. THE ADDITIONAL UNIT, TRANSFER, INTCM. NO. 2 (SHOWN DOTTED) WILL BE FITTED ONLY WHEN A 2ND CHOICE MAIN STATION IS REQUIRED.
 3. THE EXCHANGE LINES MAY BE BROUGHT INTO THE MULTIPLE AT ANY POINT ON THE SYSTEM.

FIG. 4.—LAY-OUT FOR TWO EXCHANGE LINES AND TEN INTERNAL AND ONE EXTERNAL EXTENSION STATIONS.

APPARATUS.

Telephone Sets.

The external appearance of these sets can be seen from Figs. 1 and 2. The mechanism is mounted on a metal base and is enclosed in a moulded bakelite case having a cradle for the Telephone No. 164—one

standard case being used for both sizes of apparatus. A dummy dial is fitted at the front of the case and the complete telephone set includes a plug (with buzzer) and the appropriate desk cord, 6 feet in length. When working to an automatic exchange the appropriate Dial Auto No. 10 is fitted in lieu of the dummy dial.

The sloping top of the case accommodates the plunger keys with designation strips adjacent. Double-sided slip-in paper labels with the numbers 1 to 5 printed on one side and 6 to 10 on the reverse, are used with the designation strips. Space has been allowed below the numbers on these labels so that any additional designation which the subscriber desires may be inserted. The numbers corresponding to internal stations with restricted facilities and to external extension stations are specially marked on the labels and the exchange code and number is entered opposite the exchange keys. The exchange keys are coloured red, the local keys black and the conference key green.

On the larger instruments with two exchange lines, there are also two trigger keys coloured red and situated immediately above the exchange keys with which they are associated. These triggers are peculiar to the larger telephone set and their function is discussed later.

The mechanical arrangement of the plunger keys is such that when depressed consecutively (except while the conference key is in the operated position) only one key may remain fully operated at any time. If a local key is in the operated position the depression of a second local key completely restores the first.

The exchange keys have three positions of rest, normal, intermediate, and fully operated. The last is the calling and speaking position and the intermediate is a "hold" position which the key automatically assumes from the fully operated position when a local key or a second exchange key is subsequently depressed. In the fully operated position two sets of springs X and H are operated, the former being released when the key is restored to the hold position. The local keys have two positions of rest, normal and speaking, and a non-locking or ringing position when fully depressed. When pressure is released the keys automatically restore to the speaking position. The conference key when depressed brings into operation a locking bar which allows any number of local keys to be depressed consecutively and to remain in the speaking position when pressure is released.

The action of replacing the microtelephone on its rest automatically restores all keys to normal. The trigger keys have been provided on the larger instrument to enable one exchange key to be released from the hold position to normal while retaining the second key in the hold position, this facility being required when transferring exchange calls.

Fig. 5 shows the larger telephone set with cover removed. The plug and jack used with the set may also be seen in the illustration. The plunger key

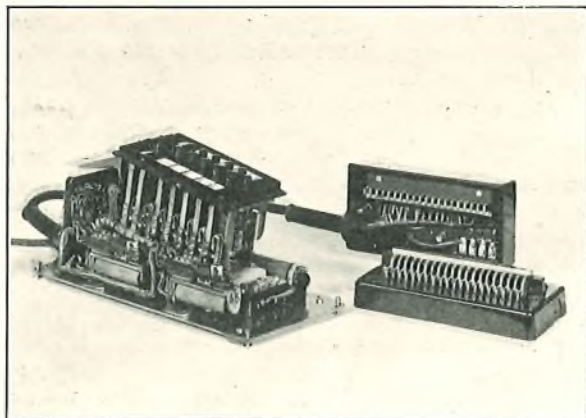

FIG. 5.—TELEPHONE INTERCOM. NO. 2 WITH COVER REMOVED.

mechanism may be removed as a unit leaving *in situ* the spring banks and cabling and each spring bank is also removable as a unit.

Fig. 6 shows the set with the plunger key mechanism removed. The buzzer associated with

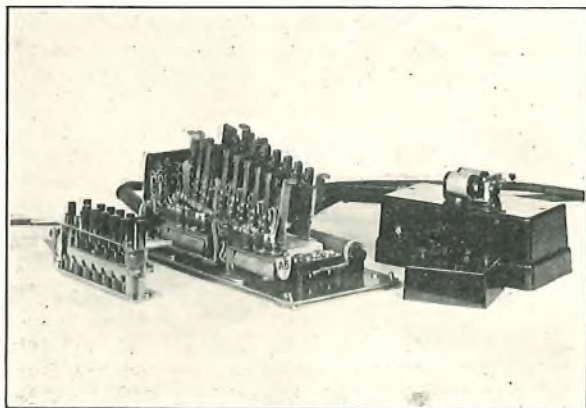

FIG. 6.—TELEPHONE INTERCOM. NO. 2. COVER AND PLUNGER KEY UNIT REMOVED.

the set is mounted on the plug external to the telephone and may be seen in the picture.

The instruments are equipped with a 3-winding anti-sidetone induction coil and the relays which are mounted on detachable brackets are of the Post Office 600 type. In order to minimise the possibility of cross-talk, one twisted pair per exchange line is provided in the desk cords. Strap connexions are provided in each instrument so that the circuit may readily be modified to give monitoring or trunk offering facilities in lieu of secrecy. Terminal points have also been provided in the instrument to facilitate the fitting of a loudspeaker telephone should it be decided to offer this facility at a later date.

Units.

As with the telephone sets, all the units are housed in a standard size moulded bakelite case. Indicators and lever keys are mounted on the faceplates and "Exchange Call" buttons, the function of which is explained later, are accommodated at the sides of the case near the bottom.

An internal view of unit No. 2 is shown in Fig. 7. Eyeball type indicators and standard lever keys are used and the relays are all of the Post Office 3000 type. Metal rectifiers are connected in parallel with the D.C. type indicators to prevent chattering to ringing current.

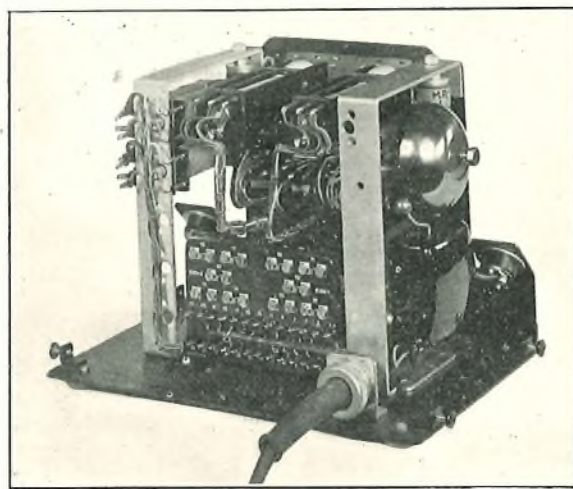

FIG. 7.—UNIT TRANSFER INTERCOM. NO. 2.

The units work on C.B. principles, but may be fitted on installations working to any type of public exchange. When the installation is connected with a local battery exchange it is necessary to fit auxiliary apparatus units at the exchange line terminations. The auxiliary apparatus unit used for C.B.S. exchanges is similar to that already in use with private branch exchanges. The auxiliary apparatus unit used in conjunction with magneto exchanges provides automatic ring-off facilities and resembles the unit already in use with the group service system except that a low resistance line relay is used in order to provide C.B. transmission.

Junction Boxes.

These are constructed in two sizes having 30 and 48 terminals per strip respectively. A view of the smaller size box with cover removed is shown in Fig. 8.

The junction boxes are built up of 4 bakelite terminal strips enclosed in a moulded case of the same material. The terminals are staggered and the front portions are drilled in order to facilitate cross-connexion by means of special link wire of square section. This construction also allows the necessary switchboard wire jumper connexions to be made on the front of the strips. Typical link and jumper wire connexions may be seen in the illustration.

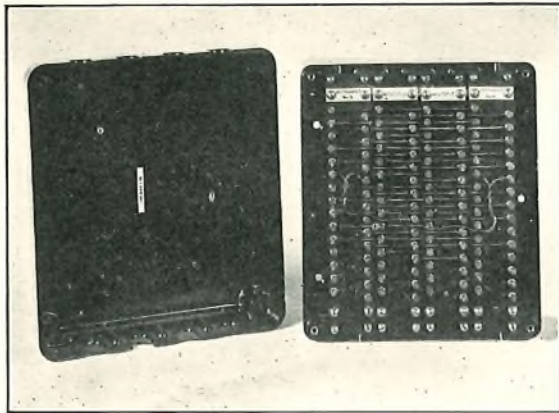

FIG. 8.—BOX JUNCTION INTERCOM. No. 1.

The junction boxes have been designed so that it is normally possible to feed two instruments from each intermediate box and three instruments from a terminal box, but special junction box arrangements are necessary at first choice main stations.

Power.

The system has been designed to operate efficiently on voltages between 18 and 28 and the current required on a system with two exchange lines and 10 extensions under conditions of maximum demand is of the order of 1.3 amps. The power supply will normally be obtained *via* a power lead from the exchange, but where this is not available a 24 volt battery of primary cells will be installed. A trickle-charging set consisting of 11 or 12 secondary cells together with a unit for charging from (a) Power Lead or (b) A.C. mains is in course of development. This will allow a high resistance power lead to be provided to serve subscribers situated at considerable distances from the exchange.

CIRCUIT DESCRIPTION.

Internal Station Calling Internal Station.

The circuit of the telephone set provided at internal stations is shown in Fig. 9.

The caller removes his microtelephone and fully depresses the key adjacent to the number of the wanted station, thereby operating the common spring bank and the local key springs to extend earth to the " B " line of the required station. An audible signal is given at the called station by earth received on the " R " line and connected *via* the exchange key springs (H3), cradle switch springs (HM1) and buzzer to battery. When the caller removes his finger from the local key the latter partially restores to a " speaking " position. The L springs remain

operated in this position, but the common spring bank is released thus connecting the telephone to the " A " and " B " lines. The called station answers by lifting the microtelephone which is automatically connected to the " HL " and " R " lines by the operation of HM1. Both stations provide a battery feed for transmission purposes and at the termination of the call the replacing of the microtelephones restores the instruments to normal, the local key at the calling station being released automatically.

If the wanted station is engaged on a local call, the caller will break into the conversation. If the wanted station is engaged on an exchange call the caller's buzzer will operate (as described later) to give an engaged signal.

Internal Station Calling External Station.

The circuit of the external extension auxiliary

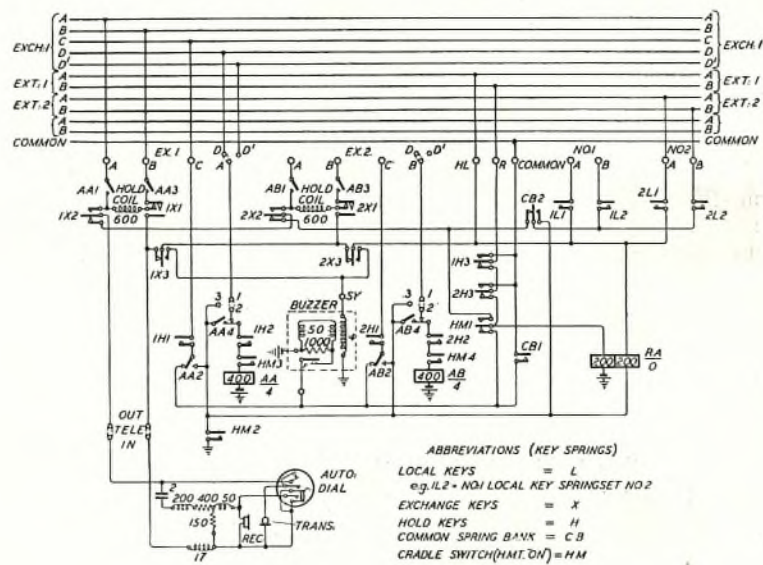

NOTES:-
 1. COMMON SPRINGBANK IS OPERATED WHEN A LOCAL KEY IS FULLY DEPRESSED.
 2. WHEN EXCHANGE LINE SUPERVISION IS REQUIRED REMOVE STRAP 1-2 & CONNECT STRAP 2-3
 3. WHEN A STATION IS TO BE BARRED DIRECT ACCESS TO THE EXCHANGE, REMOVE LINKS DA & DB & CONNECT LINKS D'A & D'B (THESE CONNECTIONS ARE MADE AT THE JUNCTION 5C:1E5)

FIG. 9.—CIRCUIT OF INTERNAL STATION WITH TWO EXCHANGE LINES.

apparatus, which is housed in a unit at the main station, is shown in Fig. 10.

The external extension station is allotted a number on the system in the same way as the internal stations, and the calling procedure at the internal station is as described above for a call between internal stations. Earth received on the " R " line at the external extension auxiliary apparatus operates relay BZ and *via* its own contact (BZ3) causes this relay to release and re-operate in succession. A series of pulses is applied to line *via* contacts BZ1 and 2 and the magneto bell at the external extension station is rung throughout the period that the local key is held depressed.

The external extension station answers by lifting the microtelephone thereby operating relay L in the auxiliary apparatus unit and removing relay BZ

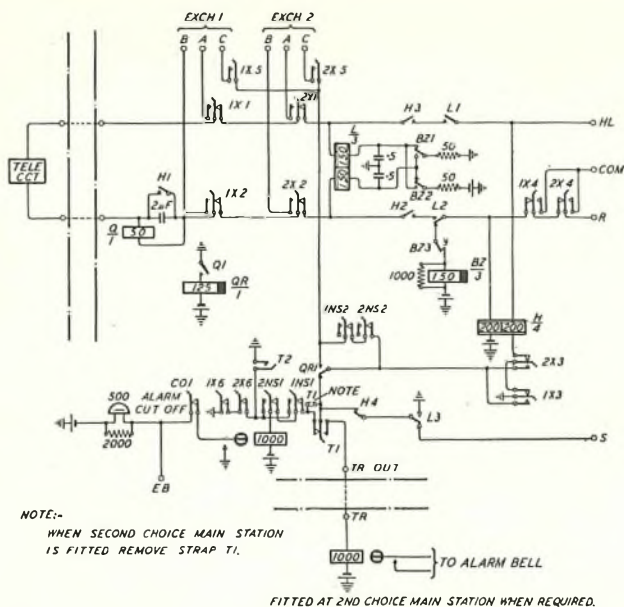

FIG. 10.—Circuit of External Extension Unit, Used on Installations with Two Exchange Lines.

from the " R " line. On the operation of relay H *via* the calling station's telephone loop, the through connexion is completed. Relays L and H together with the retard RA which is in circuit at the internal station serve to provide the necessary transmission feed. The conditions when the external station is engaged on a local or exchange call are similar to those described in connexion with a call between internal stations.

External Station Calling Main Station.

All calls originated by the external station must circulate *via* the main station. On lifting the micro-telephone at the external station, a loop is completed to operate relays L and Q in the auxiliary apparatus unit (Fig. 10). Relay L closes a circuit for the calling indicator and in addition prepares the speaking circuit. Relay Q serves no purpose on a local call. The main station answers by removing the micro-telephone and depressing the plunger key situated adjacent to the external extension number on the telephone set. Relay H then operates *via* the telephone loop and completes the speaking circuit.

Incoming Exchange Calls.

These are received on indicators forming part of the unit equipment at the main station. The circuit for the unit apparatus used at first and second choice main stations on installations with one exchange line is shown in Fig. 11.

The main station answers by lifting the micro-telephone and depressing the appropriate exchange key on the telephone set (Fig. 9). If the call is incoming on the first exchange line, relay AA operates—*via* the D wire to earth at a normal contact of relay G (Fig. 11)—and locks over its own contact. Relay AA in addition extends earth *via* the " C " wire to

operate relay " G " which at G1 removes earth from the " D " wire to prevent intrusion by another station. Contact G2 removes the exchange indicator and condenser from the line. The earth applied to the C wire also serves to complete a circuit for the buzzer of any internal station depressing the key corresponding to this exchange line. Connexion of the telephone to the exchange line is completed *via* closed exchange line key springs and the operated contacts of relay AA. The H3 springs of the exchange key serve to connect the " R " and " Common " wires thus providing an engaged (buzzer) test to any station attempting to make a local call to the station engaged on the exchange line.

Internal Station Calling Exchange.

The exchange lines may be tested by depressing the appropriate exchange key before or after lifting the microtelephone. If the exchange line is engaged the calling station's buzzer will operate as described above. If the exchange line is free relay AA operates and the resulting sequence of operations is exactly similar to that described under incoming exchange calls. If the installation works to an automatic exchange the caller will receive dialling tone and may proceed to set up a connexion.

External Station Calling Internal Station.

The external station first gains the attention of the main station by lifting the microtelephone. The main station then calls the desired internal station in the normal way and requests this station to call the external station, *i.e.*, the call is reverted.

External Station Calling Exchange.

The external station gains the attention of the main station attendant who proceeds to test the exchange lines. When a free line is obtained the attendant operates the appropriate " Extension to Exchange " key on the main station unit (Fig. 10), thus switching the external station telephone direct

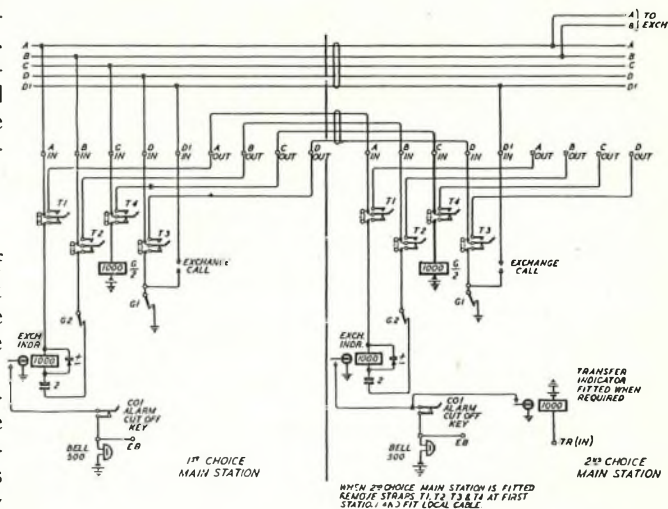

FIG. 11.—Circuit of Main Station on Installation Having One Exchange Line.

to the exchange line. The throwing of this key also serves to operate relay G (Fig. 11) and to connect the " R " and " Common " wires so that engaged test conditions are given to local callers. Relay Q operates from exchange battery and operates relay QR. At the termination of the call, relays Q and QR release and QR1 completes a circuit to operate the clearing indicator at the main station.

External Station Calling Exchange (Night Service).

Under night service conditions the external station is switched permanently to an exchange line by operation of two keys labelled " Extension to Exchange " and " Alarm Off (Night Service) " respectively. These keys appear on the main station unit.

Under these conditions internal stations may make use of the night service exchange line when this is not in use by the external station, but exchange calls made by the internal stations on the night service line are non-secret to the external station.

When the Alarm Off (Night Service) key is operated, NS1 (Fig. 10) disconnects the clearing indicator and NS2 leaves the operation of relay G dependent upon QR1. If the installation is working to an automatic exchange, relay Q responds to the dialled impulses; QR remains operated, however, thus holding relay G to maintain a " guard " on the line.

Transference of Exchange Calls.

(a) *One Exchange Line in use.* If a station speaking on an exchange line desires to transfer the exchange call to another station (with full facilities) on the system, the local key corresponding to the distant local station is depressed (the exchange key being thereby released to a " hold " position) and the distant local station is requested to " pick up " the exchange line in question. To do this the distant station depresses the appropriate exchange key whereupon the distant station's buzzer operates from the engaging condition applied to the " C " wire by the first station. Buzzer tone is passed back to the transferring station who will then release the exchange call from his instrument by replacing the microtelephone, thus restoring the exchange key and releasing the guard relay G.

(b) *Two Exchange lines in use.* If on an installation with two exchange lines the main station is talking on one line when a call comes in on the second line, the main station may depress the second exchange key (thus automatically restoring the first exchange key to a " hold " position) and accept the call. This call may then be transferred to another station on the system by depressing the appropriate local key (thus restoring the second exchange key to the " hold " position) and desiring the distant local station to pick up the second exchange line. On receipt of the usual tone the main station operates the trigger key associated with the second exchange line which serves to release the relative exchange key and thus allows the distant station to take the exchange call. The first exchange key has meanwhile remained in the " hold " position and, by again fully depressing this key, the main station may continue the conversation on this exchange line.

Without the trigger keys, the only means of transferring the call would be by operation of the cradle springs which would result in a clearing signal being given on the first exchange line.

Conference Calls.

When it is desired to make a conference call, the stations which will participate are first called individually. The conference key is then depressed, bringing into operation a locking bar which allows any number of local keys to be depressed consecutively and to remain in the operated position when pressure is released. The keys corresponding to the stations which are remaining in readiness are then re-operated and the conference call may proceed. Each station provides a battery feed for transmission purposes.

Calls to and from Stations with Restricted Facilities.

Any chosen internal station may be barred direct access to the exchange lines, but may be allowed exchange calls at the will of the main station operator. In the telephone sets fitted at these stations the AA and AB relays are connected to the multiple D' wires (Fig. 9) and therefore to the " Exchange Call " buttons situated on the main station units (Fig. 11).

If an exchange call is to be allowed the main station attendant will test for a free exchange line. When this is found, the internal station is instructed to depress the appropriate exchange key on his instrument, causing buzzer tone to be passed to the main station operator who then holds down the appropriate " Exchange Call " button, at the same time replacing the microtelephone. The operation of the " Exchange Call " button completes a circuit for the AA relay of the calling station to earth at the normal contact G1.

If an internal station desires to transfer an exchange call to a station with restricted facilities (including the external extension station) the exchange line must first be transferred to the main station.

Conclusion.

The combination of facilities afforded by this system is peculiarly suitable for installations in private residences and small offices where it is important that operating attendance be reduced to a minimum. As a further step in this direction it is possible to extend the alarm circuit so that any internal extension station may answer an incoming exchange call and thus dispense entirely with the services of an attendant at the main station. This obviates the undesirable practice sometimes resorted to on cordless boards of leaving all extensions in parallel on an exchange line.

It is intended to limit the application of this system to small installations and the apparatus described will be available in July. The development of apparatus for installations with 3 Exchange Lines and up to 15 stations is contemplated, but for larger installations a P.A.B.X. would probably be more suitable.

The major part of the circuit and mechanical design work on this system has been carried out in conjunction with Messrs. Ericsson Telephones, Ltd.

Post Office Telephone and Telegraph Convention

B. O. ANSON, M.I.E.E.

IN the January issue of this Journal it was announced that the first Post Office Telephone and Telegraph Convention would be held at The Hayes, Swanwick, Derbyshire, from May the 24th to May 30th.

The Convention was held, as arranged, and the opening ceremony took place at 6.15 p.m. on Friday, the 24th, when Sir Donald and Lady Banks received the guests and visitors. From the start the Convention was an obvious success and much of the credit must be given to the glorious weather that continued throughout the period. A very large number of the visitors arrived at The Hayes about 5 p.m., having just completed long and pleasant motor drives from

constituency and the response to his speech was made by the Director General, who proposed the Postmaster-General's health amidst much enthusiasm on the part of the visitors. The Convention was also addressed by loud speaker from New York where Mr. T. G. Miller, the Vice-President responsible for the Long Lines Department of the American Telegraph and Telephone Company, spoke on the significance of the occasion. Mr. Phillips, the Director of Telecommunications, replied to Mr. Miller's speech.

It was a great misfortune that, owing to a clashing of dates, the Conference of the Association of Head Postmasters was being held in Edinburgh at



COL. SIR DONALD AND LADY BANKS WITH MEMBERS OF THE ORGANISING COMMITTEE.

various parts of the country. Approximately 300 Post Office officials and their wives sat down to dinner on the first evening and the number continued to the end of the period somewhere between 250 and 300. There were well over 100 ladies present throughout the Convention.

It was unfortunate that the Postmaster-General could not adhere to his original intention of being present, but he addressed the Convention from his

the same time, but it was felt that this should not entirely separate the two bodies and an interchange of greetings, as between the Association and the Convention, took place. We hope, of course, that next year more favourable circumstances will permit of more Head Postmasters attending the Convention.

The opportunity at Dinner on the first evening was taken by Captain B. L. Barnett formally to welcome Sir Donald and Lady Banks to the Con-

vention and the Director General in a very happy and inspiring speech responded.

The arrangements that had been made by the Committee to ensure visitors to the Convention rapidly getting together proved excellent. Each visitor was given and asked to wear a name badge which also showed from which Department or Office the visitor came. Stewards were appointed to ensure that on this first evening visitors should not be left unacquainted to their colleagues, but it has to be placed on record that these stewards had nothing to do as the visitors found excellent means of getting together and making each other's acquaintance.

It was very gratifying to the Committee that Mr. F. R. Gardiner, the Deputy Director General, found it possible to break his journey from Edinburgh to London on Sunday, the 26th, and to stay at the Convention until Monday evening.

The Film Unit of the Post Office had put on an excellent cinema show, which ran throughout the period of the Convention and was in complete working order on the first evening. Also, under the guidance of Captain Cohen, of the Research Station, a very fine set of exhibits and technical demonstrations had been arranged in the Lecture Hall, and the records show that about 95% of the visitors attended these demonstrations. Perhaps the figure may have been higher as the cinema show was frequently full and people standing, and it may be that, as the demonstrations were in the same room as the cinema show, the remaining 5% visited the demonstrations but were not recorded.

An excellent series of visits to the beauty spots of Derbyshire and interesting industrial works had been arranged by the Entertainment Committee and were generally supported by thirty to sixty persons per outing. These visits included excursions to Dove-dale, Bakewell, Monsal Dale, Welbeck Abbey and Chatsworth, with visits to Rolls Royce Works, Glapwell Colliery, Grassmoor Colliery, Sheepbridge Iron Works, D.P. Battery Works, Ericsson's Telephone Works, Boots' Factory, Stanton Iron Works, and the Works (or shall we say Studios) of the Crown Derby Pottery. It was remarkable the number of

people who, in spite of the glorious weather, desired to go down a coal mine.

Later in the week loud speaker addresses were received from Mr. H. P. Brown, Director General of Posts, Telegraphs and Telephones, Melbourne (responded to by Col. Lee, Engineer-in-Chief), and Capt. J. Webb, Director General of Telephones in Egypt (replied to by Mr. M. C. Pink, Deputy Controller, London Telephone Service).

An excellent series of four Lectures had been arranged as follows:—

Saturday, 25th of May. "Publicity," by A. G. Hight.

Monday, 27th of May. "New Telephone and Telegraph Developments," by Captain B. S. Cohen.

Tuesday, 28th of May. "Telephone Finance," by Sir Henry Bunbury, K.C.B.

Wednesday, 29th of May. "Automatization of the Telephone," by H. Dive, M.B.E.

These lectures were in all cases most appropriately prepared for the purpose they were intended to serve and stimulated free discussion, often of a very interesting character. From the first it was understood that, in discussing these lectures, the informality of the occasion should be fully utilized to enable each speaker to express his views freely.

The games section of the activities was naturally a great success as the weather was so favourable and it is interesting and gratifying to record that, in some cases, the prizes were won by guests of the Convention who, of course, were not members of the Post Office staff.

In a cricket match between London and the Provinces which was played on Wednesday, the 29th, London won easily by 89 runs.

From numerous enquiries that have already been made as to the date of the Convention next year, it would appear probable that, if the Convention is not an annual event, it is likely to be one of frequent recurrence, and the Committee wish to express their appreciation to all concerned for the hearty co-operation that was a characteristic feature of the whole of the proceedings.

50 C.P.S. Valve-Maintained Tuning Fork

A 50 c.p.s. valve maintained tuning fork has been developed for checking the speed of teleprinter motors where a frequency of 50 c.p.s. from controlled A.C. mains are not available. The fork is intended to be used in conjunction with a Synchroscope (Panel Telegraph No. 34) or a Telegraph Distortion and Margin Tester, and a special unit has been developed to enable the synchronous motor of the synchroscope to be driven from the fork. In order that any number of synchrosopes or telegraph distortion and margin testers may be operated from one fork, the output is arranged to drive a telegraph relay and the feed for the various units is taken from the tongue of this relay. The power supply for the valves used

with the fork may be obtained from D.C. supply mains of 100-250 volts.

In the design of the fork unit all causes of variation of frequency except temperature (*i.e.*, supply voltage variations, etc.) have been reduced to negligible proportions, and with an ordinary steel fork and the temperature changes likely to be experienced under normal conditions, the fork will not vary from the standard frequency by more than ± 0.1 per cent. This will be quite satisfactory for the purpose in view, but could if desired be reduced by the use of an ellinvar fork and/or temperature control. Trials of the unit under practical conditions are to be undertaken.

Gas Explosions: Precautionary Measures

P. J. RIDD, M.I.E.E.

READERS of the Journal will, it is thought, be interested to learn of recent developments in connexion with precautionary measures to reduce the risk of poisoning or explosion due to the presence of gas in manholes and other jointing chambers. The developments have been based upon the report of a committee on the subject, and are designed chiefly to reduce the extent of the use of a naked flame in manholes.

Lighting of Manholes.

Following the decision to substitute the present Acetylene Gas Handlamps by Electric Handlamps, a specification has been prepared and contracts are about to be awarded for the first supplies of Electric Handlamps. These will be of a light portable type to provide lighting for about 10 hours per charge, but tests are also being made with a heavier type of electric lamp unit suitable for use in manholes where extensive works, necessitating shift duties, are required to be carried out; the heavier portable battery will give not less than 30 hours continuous illumination averaging about 12 candle power. The battery will be placed on the roadway or footway and one or two lamps with long flexible leads suitably protected will be connected to it. Switching will not therefore be necessary in the manholes.

Wiping of Joints.

Considerable progress has been made in standardizing the "Pot and Ladle" method of wiping cable joints. A new metal pot has been introduced (Fig. 1) with the object of reducing the risk of accident from the spilling of metal in the course of lowering a pot into a manhole. The new type of pot has been very favourably received.

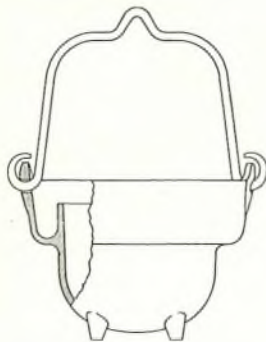

FIG. 1.—NEW METAL POT.

Mechanical Joints for Cables.

Trials have been made of mechanical types of sleeve joints for auxiliary joints. One of the types, which has been introduced and favourably reported upon, is shown in Fig. 2. This joint consists of a rubber ring, which is essentially a double U washer, with a metal housing in two sections which are clamped round the collars of two cylindrical butt

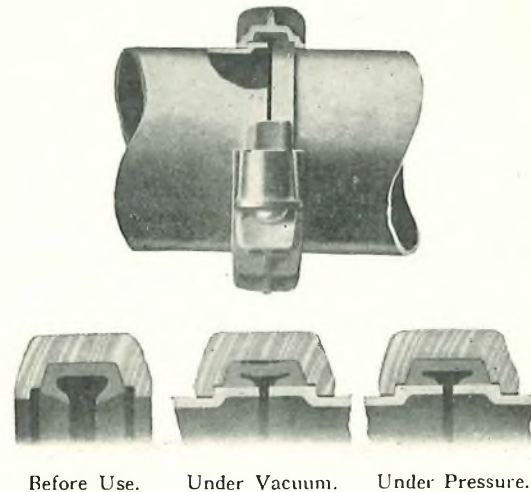

FIG. 2.—MECHANICAL JOINT SHOWING SECTIONS THROUGH HOUSINGS AND RINGS.

jointed tubes. To adapt the joint for the purpose required in cabling work, a copper tube extension, with collar, is provided and permanently wiped to the lead cable and a domed copper cylinder with similar collar is provided to contain the wire joints. The copper parts in contact with the rubber ring are tinned to avoid deleterious action of the copper on the rubber. In assembling the joint the outside of the rubber ring and the inside of the housing are greased with castor oil to provide an easy fit and to prevent the pinching of the rubber by the clamp. A nozzle is fitted permanently to the sleeve cap of the joint to permit of pressure testing the joint or for desiccation purposes. Fig. 3 shows a typical joint using copper tube of an external diameter $2\frac{3}{8}$ ". Other tubes are on trial of diameters 3" and $3\frac{1}{2}$ ".

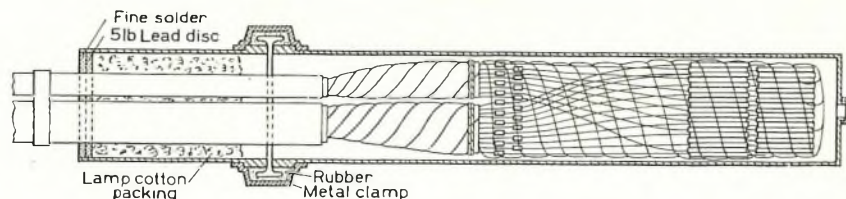

FIG. 3.—AUXILIARY JOINT USING MECHANICAL JOINT.

The experiment has been confined initially to auxiliary joints and, as a result of the favourable report which has been received, it has been decided to extend the experiment. Laboratory experiments are also being made with a similar type of mechanical sleeve joint for use on through cable joints.

Drying of Joints.

The introduction of Silica Gel for the drying of cable joints has given general satisfaction. The

disposition of the cotton gauze pockets in a typical joint is shown in Fig. 4. More than 1 ton of Silica Gel has been used during the last six months for the

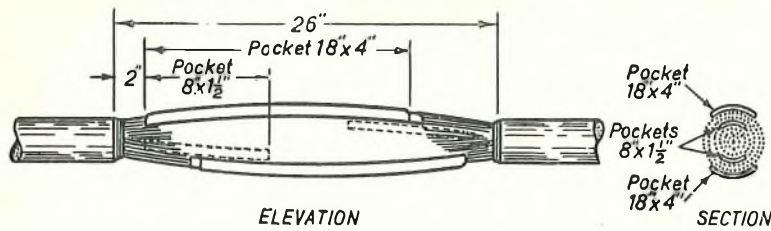

FIG. 4.—TYPICAL JOINT WITH POCKETS FOR SILICA GEL.

drying of joints and a considerable increase in this rate of use may be expected. The use of Silica Gel is at present specified on new construction work in manholes, on the assumption that greater risk is incurred by the use of a flame in manholes than in other types of jointing chambers, but recent events have demonstrated that the necessity for the curtailment of the use of naked flames in surface boxes, and even at buried couplings, is scarcely less urgent. It is desirable therefore to extend the use of Silica Gel and there is no reason why the Gel should not be used in any joints where the work necessitates the replacement of the existing sleeves and where the slightly larger dimensions of the required sleeves are permissible.

Joints on certain working cables have already been dealt with. A graph of a typical case is shown in Fig. 5. It will be seen that a steady increase of practically 1,000 megohms per day was obtained during a period of 12 days with a final reading of 21,500 megohms per mile.

It has been shown that Silica Gel may be used as a substitute for Calcium Chloride in the drying

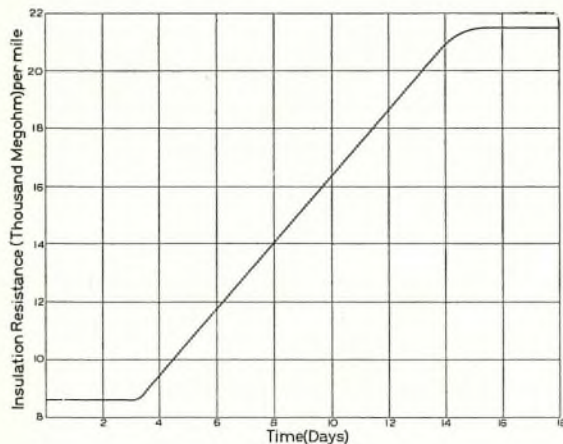

FIG. 5.—IMPROVEMENT IN INSULATION RESISTANCE, USING SILICA GEL.

cylinders of desiccating pumps. A motor desiccator has been adapted for use with Silica Gel and is in experimental use in the London Engineering District.

A novel feature of the adapted pump is the use made of the heat of the exhaust of the petrol motor for the drying of the Silica Gel which has become saturated in use. Two identical drying cylinders are provided and are connected alternately by stop cocks to the cable under desiccation. The Gel in the cylinder not in use for this purpose is at the same time heated as described above and reconditioned for further service.

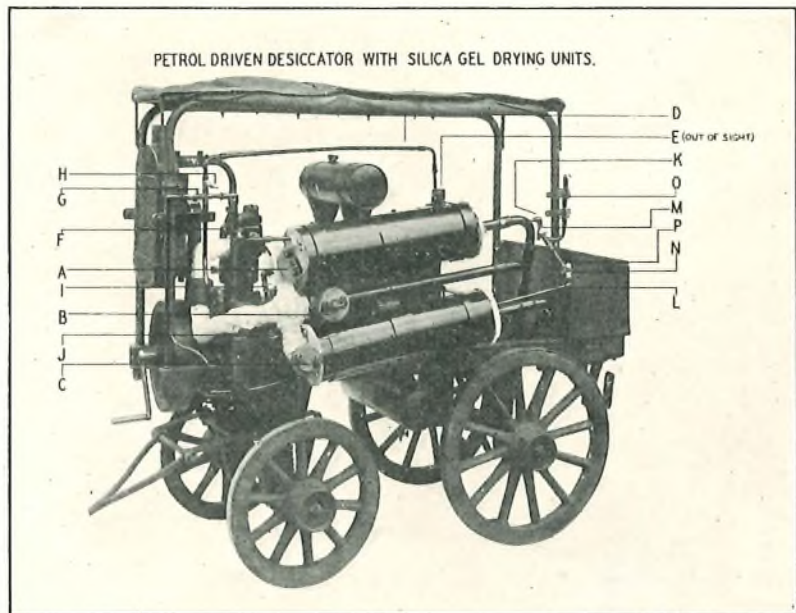

FIG. 6.

The adapted desiccator is shown in Fig. 6.

Palladium Chloride Gas Leak Indicator and Safety Lamp No. 2.

Some 2,800 Palladium Chloride Gas Leak Indicators (Fig. 7) have been issued and all workmen employed on the underground works should now be in possession of the indicator. There is no doubt this indicator meets a long felt need, but it is regrettable to have to record that in the case of four recent explosions there were failures to make the standard tests which would have given warning of the dangerous conditions.

It has been noted that some of the Palladium Chloride solution issued to meet early demands is of a colour which, in the absence of gas, stains the test paper a darker colour than the reference face plate of the indicator. This is receiving attention, but, in the meantime, no practical difficulty should arise in distinguishing the somewhat darker brown stain from the grey-black or black stain indicative of the presence of gas.

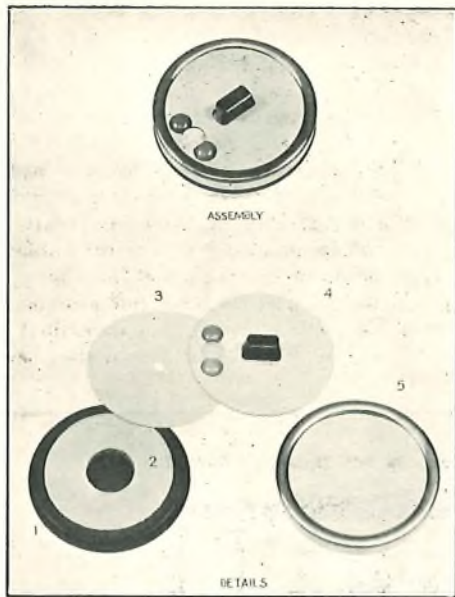

FIG. 7.—PALLADIUM CHLORIDE GAS INDICATOR.

Experience with the first 100 Safety Lamps No. 2 (Fig. 8) has justified an extension of the trial and 200 additional lamps have been placed on order. It may be expected that sufficient Safety Lamps No. 2 will be made available to substitute Safety Lamp No. 1 for use in all Urban areas.

Much interest has been taken by Local Authorities in various parts of the country in the precautionary

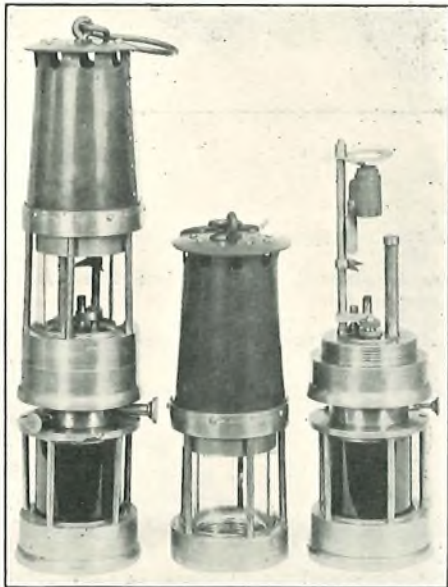

FIG. 8.—SAFETY LAMP No. 2.

measures adopted by the Post Office for the detection of gases. Enquiries have been received from Municipal Engineers and the Engineer-in-Chief has been glad to furnish information and to supply copies of Departmental Instructions. The importance of the subject is stressed in a report issued by the Ministry of Health on "Accidents in Sewers"¹ which report is worthy of the study of all Engineers concerned with underground operations.

The measures adopted by one of the London Boroughs on the lines of those recommended in the Ministry of Health report were discussed recently in a paper read before the Institution of Municipal and County Engineers and published in the Journal of the Institution dated April 9th, 1935.

Discussions have recently been conducted between the Department and representatives of the Institution of Gas Engineers and the National Gas Council of Great Britain and Ireland with the object of establishing a procedure to facilitate the notification of leakages and to make provision for co-operation by the Post Office and Gas Undertakers, where desirable, with a view to expediting the clearance of the leakages. Reference was made to the fact that in the case of some recent explosions it was known that the Gas Undertakers were aware, some time prior to the explosion, of the existence of leakages in the neighbourhood of Post Office plant and it was suggested that the explosions might possibly have been averted had timely advice of the leakages been given to the Post Office. The representatives of the Gas Undertakers have agreed to arrange in future, for advices of any serious leakages which might affect Post Office plant to be given at the earliest possible moment and it is hoped that this will prove effective in reducing explosion risks.

It is probable also that the Post Office will agree to an extension of the arrangements already existing in London by which certain Gas Undertakers are permitted to remove manhole and box covers in emergency for the purpose of ventilation. It will, however, be a condition necessary to such consent that the Gas Undertakers shall indemnify the Post Office against accidents caused by the removal or improper replacement of covers by employees of the Gas Undertakers. The arrangement will not be regarded as giving Gas Undertakers' employees a general right of access and it is not intended that access should include right of entry to Post Office manholes. Further, during normal working hours, application by telephone will be necessary for the attendance of Post Office workmen when it is desired to raise covers and in any other case, notification of any covers lifted will be required.

¹ "Accidents in Sewers," published by His Majesty's Stationery Office (1934). Price 2d.

Liverpool New Parcel Post Office

R. S. PHILLIPS, A.M.I.E.E.

General.

THE site for the new Liverpool Parcel Post Office, which has an area of 44,000 sq. ft., was acquired as far back as 1913, but, due to the Great War and subsequent financial stringency, building operations were not commenced until February, 1933. The Office, which is the second largest of its kind in the Kingdom, was officially opened on October 2nd, 1934, by Sir H. Kingsley Wood, the Postmaster-General.

The basement of the building consists mainly of a garage and space for storing bags of parcels awaiting shipment from Liverpool. The garage, which accommodates seventy postal vans, and its associated workshop occupies 15,400 sq. ft. and is equipped with a travelling crane, power driven petrol pumps, hydraulic pressure washing plant, a sprinkler fire extinguishing system and ventilating plant to remove the exhaust fumes. The latter consists of main and auxiliary apparatus. The main plant is capable of dealing with 18,500 cubic ft. of air per minute and extracts from the main portion of the garage through hollow compartments built round the main pillars in the basement. The fumes then pass through ducts in the garage floor to the atmosphere. The remainder of the garage is ventilated by the auxiliary plant which extracts through two grids fitted in an iron ductwork.

Bags of parcels, which are made up in the Sorting Office on the ground floor and have to await shipment from Liverpool, are dropped through hoppers in the Sorting Office floor and fall down spiral chutes (shown in Fig. 3) to the basement storage space, where they are placed in various groups according to their destination.

The Sorting Office, with an area of 26,400 sq. ft., occupies almost the whole of the ground floor. Parcels, after being delivered to the Office in vans, are dropped through balanced trap doors in the loading platform and fall on to a conveyor band (parcel conveyor) which delivers them to the Sorting Office floor. They are then sorted into bags which are either dropped down the spiral chutes to the basement storage space to await shipment, or down other chutes to a second conveyor band (bag conveyor) which delivers the bags back to the loading platform for despatch by the postal vans. Some idea of the numbers of parcels and bags which this office will deal with will be gained from the fact that approximately 7¼ million parcels and 750,000 bags of parcels were handled in the Liverpool Parcel Post Depot during the year 1934.

Customs officers, who are permanently attached to the Post Office for the purpose of examining parcels from abroad, occupy a portion of the first floor. The remainder of the floor consists of retiring rooms, clerical offices and a large space for storing many thousands of cleaned empty bags.

The dining room, kitchens, and additional offices occupy the second floor.

Three enclosures for the lift winding engines and

control panels are built on the roof of the building.

Brief descriptions of some of the plant of particular interest to members of the Engineering Department are given below.

Electricity Supply.

The electricity supply, which is three-phase, four-wire, fifty cycles at a voltage of 230 between line and neutral, is received from the Liverpool Corporation, a duplicate service being provided. The two main cables, each four core, are terminated on a four pole change-over knife switch mounted on a switchboard in the basement, the operation of the switch enabling either of the supplies to be connected to the building. The switchboard bus bars are fed through a 400 ampere, triple pole, oil immersed circuit breaker. Three double pole, 150 ampere service boxes, one of which is connected to each phase *via* an ammeter, 0-200 amperes, control the lighting circuits whilst 60 ampere service boxes are provided for the lifts, bag cleaning machine and heating plant circulating pumps. In addition to the Corporation's meter each of the three main lighting circuits and the power circuit is provided with a meter.

In a building of this nature the standard of illumination is necessarily high and the total power of the lamps installed is 62 kilo-watts. The total horse power of the motors is 104 and it is estimated that the annual consumption of electricity for the building will exceed 200,000 units.

Lifts.

The building is served by three modern electric lifts, two goods and one passenger, which were built and installed by Messrs. Pickering's, of Stockton. The full load capacity of each lift is 30 cwts. and the maximum speed 200 ft. per min. Dual control is provided in each car and pushes installed on the landings operate a buzzer combined with an indicator fitted in the car.

The winding engines—motor, brake, and gearing—and control panels are installed in specially built enclosures on the roof of the building. The 30 H.P. motors are of the variable speed A.C. commutator type with full load speeds of 960 revs. per min. and 240 revs. per min, corresponding to car speeds of 200 ft. per min. and 50 ft. per min. respectively, the latter of course being the landing speed. Traction drive is employed for two of the lifts and drum drive on the third and in each case reduction from the motor speed to the car speed is effected by over-type worm and worm wheel reduction gearing.

Cam type safety gear is fitted on each car and balance weight. These cams operate and clamp the car and balance weight on their respective guides in the event of any of the suspending ropes breaking or slackening. Limit switches, which automatically stop the car before it reaches the bottom or top of the lift well, are provided. The efficiency of modern gearing is such that lifts are not usually self sustaining and an emergency handle is, therefore, fitted in the car. When operated, this handle disconnects

the lift supply and applies the brake. In addition, the drum drive lift is fitted with a switch which automatically stops its motor if the car or balance weight is brought to rest from any cause.

Conveyors.

(a) *Parcel Conveyor.* This conveyor, which has a length of 60 feet, carries parcels from the loading platform (Fig. 1), outside the main entrance to the office, and delivers them to trolleys in the Sorting

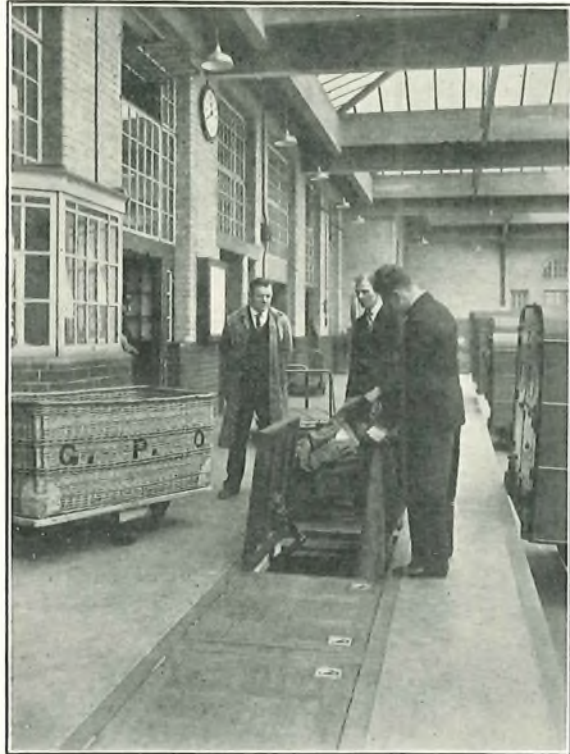

FIG. 1.—PARCELS ENTERING THE CONVEYOR.

Office. On entering the conveyor at the loading platform the parcels are carried some distance horizontally, after which they are lifted almost vertically to the Sorting Office floor by means of a twin band conveyor. One of the bands being corrugated in section is capable of preventing the parcels slipping during the lifting period. Fig. 2 shows the delivery end of the conveyor in the Sorting Office, the photograph being taken before the erection of the protective wood and metal surround. A system of coloured lamps installed at the delivery end and lighted by switches at the loading platform inform the attendant of the type (Collections, Foreign, Locals) of parcels which are being carried and thereby facilitates sorting. Woven cotton is used in the manufacture of the bands which are 36 inches in width and run on hollow cylindrical steel

rollers at a speed of 150 ft. per min. This conveyor is capable of carrying a load of 800 lbs., being driven by a 3 H.P. motor. Plant for extracting dust from the bands is installed on the horizontal section of the conveyor and consists of a brush in contact with the underside of the band, the dust being collected in the box which houses the brush gear.

(b) *Bag Conveyor.* This is somewhat similar in construction to the parcel conveyor except that it has a length of 165 feet, the bands are 42 ins. in width and it is designed to carry a load of 1,200 lbs. The conveyor is erected in the basement under the Sorting Office floor (Fig. 3) and delivers bags of parcels to the loading platform. The bags are dropped through four chutes on the Sorting Office floor to the conveyor band, shock absorbing pads of sorbo rubber being fitted under the bands at those points where the bags leave the chutes. As in the case of the parcel conveyor the bags are raised to the loading platform by means of a corrugated band (Fig. 4) and dust extracting plant is installed. Silence of operation was considered important and both conveyor motors are therefore specially designed for silent running.

Messrs. Sovex, of Southwark, London, built and installed both conveyors.

Bag Cleaning Plant.

The mail bags are periodically cleaned by bag cleaning apparatus of the latest type which is installed in the basement. The machine is of the Eureka¹ (Herbst Patent) type (Fig. 5) and consists of a suction fan which extracts the dust from the bags when they are held on a specially shaped spout. The bag is drawn sharply into the unit "inside out"—still held by the operator—and is then pulled downwards from the machine and the operation repeated to re-turn the bag to its original side. Thus, both sides of the bag are cleaned and, furthermore, the

¹ W. S. Snell. *P.O.E.E. Journal*, Vol. 27, Part 4—"A New Mail Bag Cleaner."

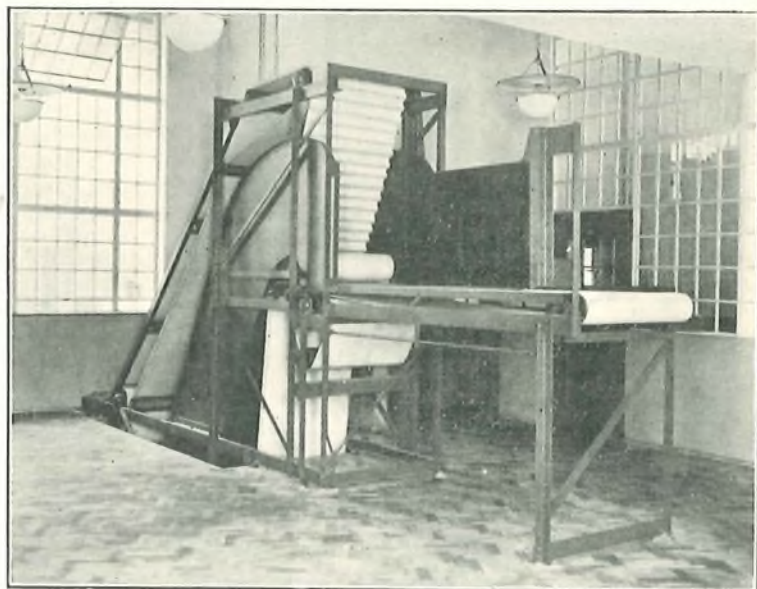

FIG. 2.—DELIVERY END OF PARCEL CONVEYOR.

operation of re-turning the bags is done automatically and not by hand which was the case with the older types of machines. The average output of a machine of this type is approximately 500 bags per hour. A grid and inspection window are fitted in the spout, the former to intercept anything which may have been left in the bags and to prevent the bags being drawn into the machine. This plant was provided by Messrs. S. Howes, of Wembley.

Heating.

The building is heated by a low pressure hot water system supplied from two steel sectional boilers situated in the basement and two centrifugal pattern circulating pumps are installed to improve the rate of circulation. The total heating surface provided is 13,200 sq. ft. Standard type cast iron sectional radiators are fitted on all floors with the exception of the Sorting Office, where it was con-

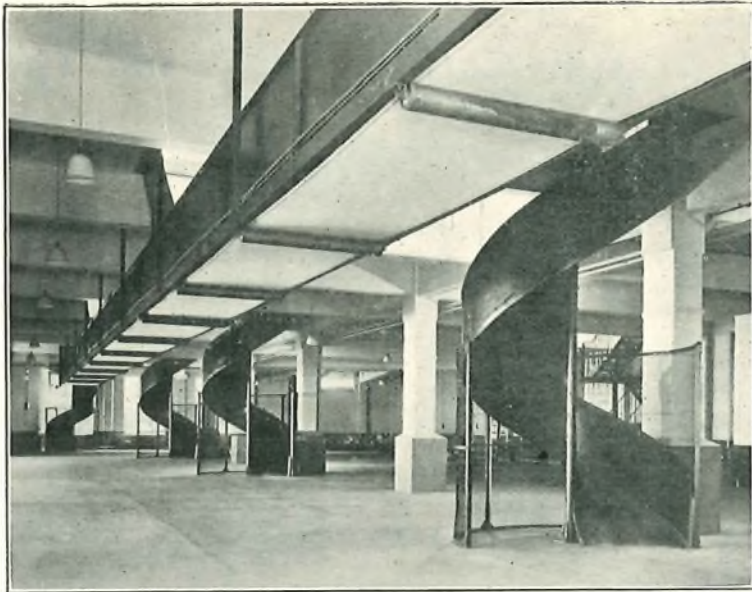

FIG. 3.—UNDERSIDE OF BAG CONVEYOR AND SPIRAL CHUTES.

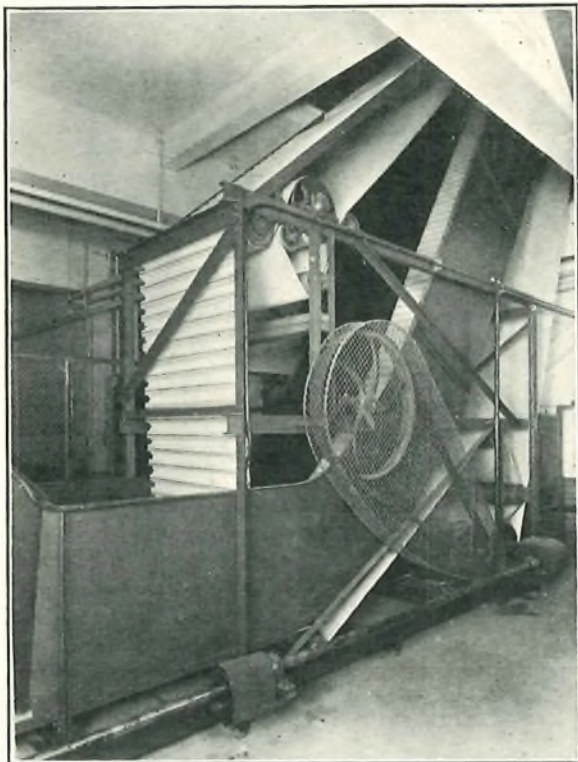

FIG. 4.—RISER BAND OF BAG CONVEYOR.

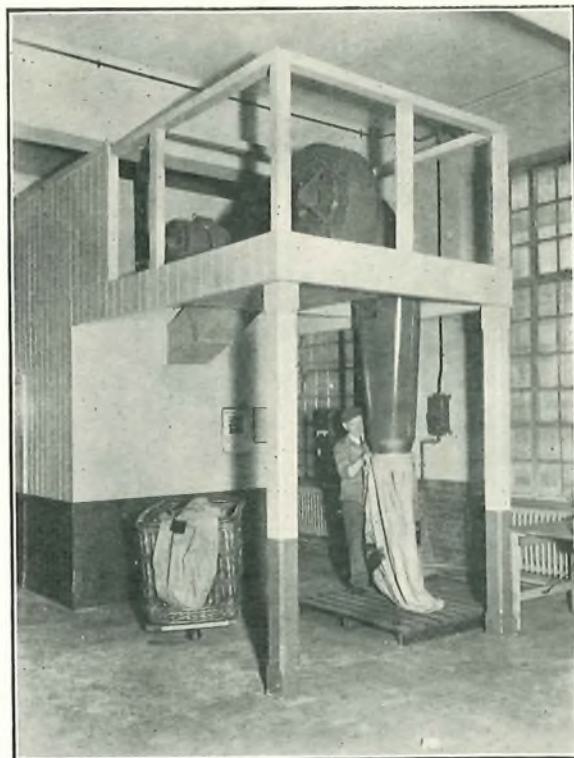

FIG. 5.—BAG CLEANING MACHINE.

sidered this type of radiator would not only restrict the floor space, but would hamper the movements of the sorters wheeling parcel trolley baskets. This office is therefore heated by forty-seven panel type radiators fitted on the ceiling and supplied from the hot water system on the floor above. The approximate size of each of these units is 9' 0" x 3' 0".

Conclusion.

The lifts and conveyors were built and installed in accordance with specifications prepared in the Engineer-in-Chief's Office, Power Branch, and the building together with its equipment is a typical example of a modern Parcel Post Office.

Newcastle—Carlisle Cable and The Roman Wall

INCLUDED in the programme for the extension of the British interurban telephone system is an underground cable between Newcastle and Carlisle. The cable is protected by ducts where it passes through "built up areas" and elsewhere is of the armoured type laid direct in the ground. Four pairs of 40 lbs. screened conductors and 156 pairs of 20 lb. conductors are provided and the cable when completed will form a valuable link between the two backbone underground routes which traverse the country from North to South, the one in the East through Newcastle-upon-Tyne and the other in the West through Carlisle.

That the British Broadcasting Company proposes to open its new broadcasting station for the North of England somewhere in the near vicinity of the cable is now an open secret and the requisite conductors for broadcasting purposes have, therefore, been included. The cable has been supplied and installed by Messrs. Siemens Bros.

A particularly interesting feature associated with the work of installation of the cable is that it is laid for the greater part of its total length of approximately 53 miles along the so-called "Military road" and that this road follows for many miles the course of the great Roman Wall, the greatest monument of Roman history extant in this country.

it was levelled by the constructors of the road, the lower courses being utilised as an excellent ready-made foundation for a portion of the width of the new road and the debris as "penning" for the remainder. Consequently, for many miles the remains of the wall in various stages of preservation lie immediately below the metallated surface of the present road which is by degrees being widened and levelled and generally improved so as to form an additional artery for vehicular traffic across the North of England.

The Roman Wall was built of masonry with a maximum thickness of approximately ten feet and it originally stood some twenty feet above the ground level. Its construction was commenced in the time of the Emperor Hadrian, about 123 A.D., and for this reason it is commonly known as Hadrian's Wall.

The conjectural sketch here reproduced will give some idea of the appearance, section and proportions of the wall and of the fosse or ditch which accompanied it on its North side. There were substantial stone built forts or camps astride or abutting on the South side of the wall at approximately four mile intervals. Milecastles were provided at every Roman mile, *i.e.*, about 1,678 yards, and two turrets between each milecastle and the next. Numerous detached forts also existed in the vicinity and were obviously part of the defensive system which the Romans found

necessary to establish to keep the Caledonians within the bounds considered legitimate for them. In such a huge system of defence works communication would be a most important consideration. The turrets which have been mentioned were advantageously situated and served as signal towers and by these means signals could be conveyed from end to end of the line of the wall with despatch. The turrets were spaced approximately 540 yards apart. The suggestion has been made, but not accorded much credence,

that a system of communication by means of a brass tube was employed between turrets. No evidence has been found to support such a contention.

The Roman Wall with its associated forts, milecastles and turrets is now protected under the Ancient Monuments Act of 1931 and will consequently receive attention by the Ancient Monuments Department of the Office of Works in whose capable hands it will be preserved for the nation.

Some fine specimens of the wall are exposed on private property above ground, but for the most part, as intimated, the remains of the wall lie beneath the

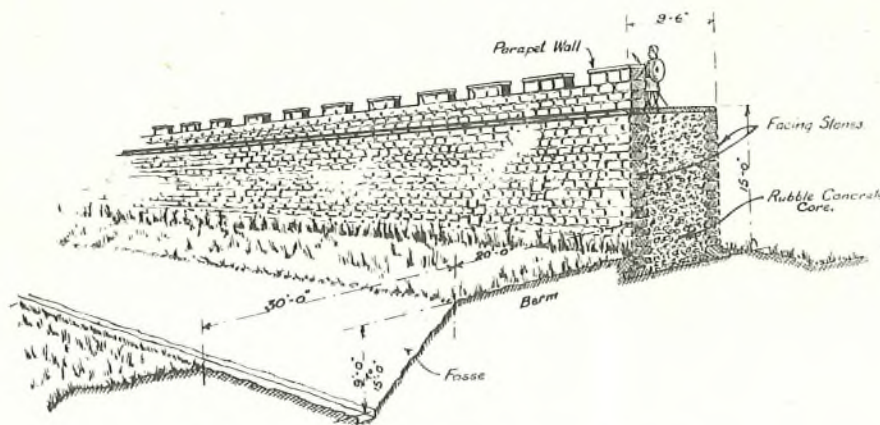

FIG. 1.—CONJECTURAL DRAWING OF THE ROMAN WALL.

The "Military road" is also known as "Wade's road" because its construction as a military provision has generally been attributed to General Wade, the great military engineer and bridge builder. As Wade died in 1748 and the construction of the road did not commence until 1751 such a supposition can hardly be correct.

When the road was originally constructed nearly two hundred years ago, the Roman Wall existed above ground and across country for many miles in a fair state of preservation except that it had been extensively denuded for local building purposes, but

macadamised surface of the military road. It has been disturbed and more or less demolished along its whole length and at no point is it intact.

The excavation for the new cable was for the most part along the greensward which lined the side of the road, a plough being employed for the removal of the surface, the trench then being deepened by means of the spade. In carrying out this work tons of hewn sandstone blocks which had once formed part of the wall, but which had been displaced as previously described, were removed and the buried wall was encountered and exposed at several points. It was found still to be in distinct formation and fair state of preservation which, however, varied from place to place. Extreme care was exercised in order



FIG. 2.—PLOUGHING THE TRACK.

to avoid unnecessary damage and, in view of the considerable distance for which the cable was laid in proximity to the wall, the disturbance was surprisingly small. From time to time discoveries of coins and other valuables have been made in the vicinity of the wall principally near to, or within the camps and forts associated with it, and other objects of great archaeological interest have been unearthed. Needless to say the numerous workmen employed in laying the cable kept a sharp look out for anything of value, but no "treasure trove" was discovered.

One small object of considerable interest was, however, found near to the site of one of the turrets. It was a spherical ball of whinstone which is a local basaltic rock composing the great whin sill which

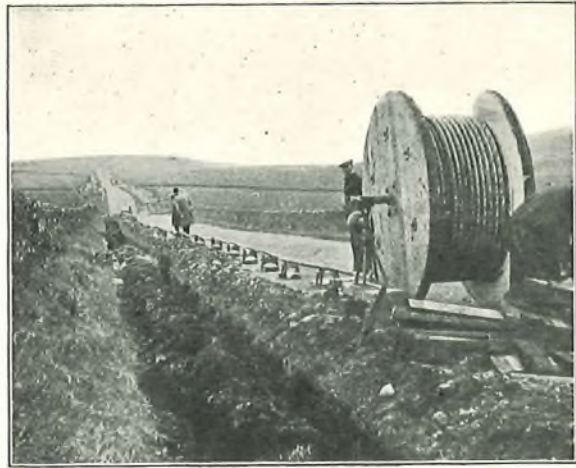

FIG. 3.—LAYING OUT THE CABLE ON ROLLERS.

stretches across the north of England from the Pennines to the North Sea, terminating as the famous Farne Islands of Grace Darling fame. The whinstone occurs in greater profusion in the locality in question than the sandstone of which the wall is almost exclusively constructed, and outcrops as immense and picturesque crags to the north of Haltwhistle. The stone ball is now exhibited in the museum of the Newcastle Society of Antiquaries, Black Gate, Newcastle-on-Tyne.

Mr. Parker Brewis, M.A., F.S.A., Vice-President of the Newcastle Society of Antiquaries and a recognised authority on the Roman Wall, informed the writer that the Roman soldiers were undoubtedly afflicted with an acute form of boredom during their long intervals of idleness when the Caledonians thought fit to leave them unmolested and that they occupied themselves with various games and pursuits. One such pursuit no doubt was the manufacture of stone balls similar to the one found which,



FIG. 4.—LIFTING THE CABLE INTO THE TRENCH.

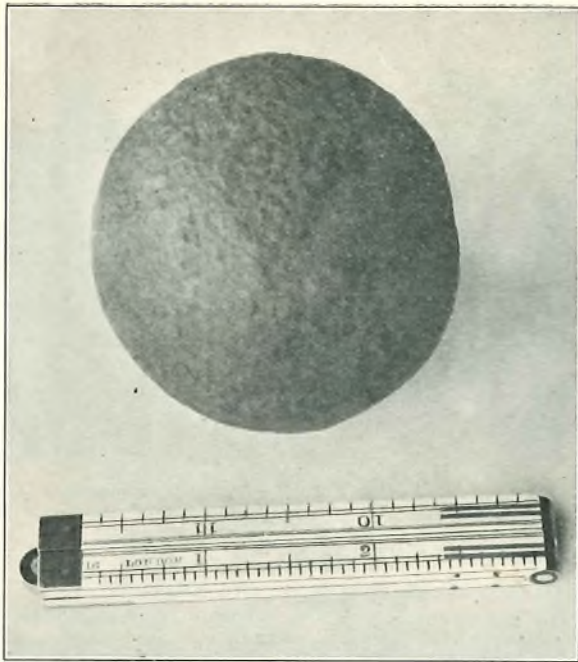

FIG. 5.—BALLISTA BALL FOUND DURING OPERATIONS.

however, were intended, so Mr. Brewis says, for a more serious purpose than amusement. The whinstone ball is two and one eighth inches in diameter and weighs $9\frac{1}{2}$ ozs. Mr. Parker Brewis explained that the stone ball was one of a type generally known amongst archæologists as a Ballista Ball, *i.e.*, a ball used as a missile, and that it was intended for discharge from some form of catapult used in military operations. The Ballista was a machine of this type, invented and employed centuries before the Roman Empire reached its zenith. In fact it seems clear that Archimedes, the celebrated Greek Physicist and Geometrician, who was born about 287 B.C., was the inventor of this instrument as well as many others of a similar type for military purposes. The generally accepted idea is that in ancient times Ballistæ were employed for discharging stones and Catapultæ for throwing darts, but modern thought has suggested, so the writer is assured, that the reverse was the case.

A photograph of the Ballista Ball, found in November at a point near Whittle Dene, kindly taken for this Journal and supplied by Mr. Parker Brewis, appears on this page and photographs of the cable laying operations are also included.

F.G.C.B.

Book Review

"Principles of Electric Power Transmission by Alternating Currents." H. Waddicor. 449 pages, 164 illustrations. Chapman & Hall. 21/- net.

This book is intended primarily for more advanced students pursuing a course in electric power transmission: it contains, however, a large amount of data of a practical nature suitable for the day to day problems of the power transmission engineer. While the approximate methods of treating the subject of both short and long transmission lines are dealt with in sufficient detail for practical use, rigorous methods of solution for long transmission lines containing all the more important mathematical methods of treatment are given. Two full chapters are devoted to Line Construction and Insulation and form an excellent survey of current practice and principles of design. The chapters on Cables have been thoroughly revised since the last edition and present an up-to-date picture of all the most recent developments, especially those in connexion with very high voltage cables of the oil filled and pressure types. The chapter on Economic Principles and Calculations, a subject which is too often neglected altogether in text books, deals with this most important aspect in a way which is no doubt sufficiently detailed for the students for whom it is intended. The frequent variations since the war in prices of labour, plant and

materials have made the handling of this matter particularly difficult in a text book which cannot be revised frequently. From the point of view of the communication engineer, the subject of dangerous rises of current and dangerous voltage rises must be of preponderating importance, and the chapters devoted to the causes and effects of these phenomena are particularly thorough. Protective systems and apparatus are fully dealt with and numerous methods of preventing surges of current or voltage are described. The method of calculating the magnitude of fault currents from the reactances in circuit is of particular interest. No attempt appears to have been made to deal with the subject of Telephone or Radio Interference which is necessarily a matter of considerable importance to transmission engineers and may seriously affect the route chosen for a power line: nor is the subject broached of induced voltage in communication circuits due to fault currents from the power system, though it is satisfactory to note that power engineers have other weighty reasons for endeavouring to avoid heavy fault currents. The book, as a whole, is of very great value and indicates not only a profound knowledge of the subject but also the author's ability to condense the fundamentals in a concise and practical form.

P.B.F.

Notes and Comments

Silver Jubilee

THE Post Office participated in many ways in the Jubilee celebrations and in addition to decorating and flood lighting buildings, the Engineering Department was called upon to perform many interesting tasks outside the scope of its normal duties. Among these was the provision of a circuit and device for firing the bon-fire in Hyde Park from a press button which the King depressed in Buckingham Palace. This was arranged to operate a relay which connected a 12 volt battery across a piece of resistance wire enclosed in a box of highly combustible material. The arrangements were entirely successful and the bon-fire burst into flames immediately.

We offer our congratulations to those of our colleagues to whom Jubilee medals were presented.

Sixpenny Telegrams

The telephone has proved so serious a competitor to the telegraph that, despite the complete reorganization and modernization of the latter service, it has not yet been possible to do more than effect

reductions in the annual loss on telegrams. The Postmaster-General's step in re-introducing sixpenny telegrams will, therefore, be enthusiastically welcomed within the service as a means of encouraging fresh traffic. We feel confident that this bold decision will be as successful as the recent reductions in telephone tariffs and charges in attracting fresh business and trust that it will shortly enable the telegraph service to show a profit.

Dr. Michael I. Pupin

We regret to have to record the death on March 12th of Dr. Michael I. Pupin, the distinguished physicist whose researches have left a permanent mark on the scroll of telephone history.

Dr. Pupin's career was a remarkable one for, starting life as a shepherd boy in Serbia, he became Professor Emeritus of Electro - Mechanics at Columbia University and had a long list of scientific developments and inventions to his credit. To telephone men the outstanding one of these was the invention of the Pupin loading coil which marked a vast step forward in the solution of the problem of long distance communication,

Retirement of Major H. Brown, O.B.E., M.I.E.E.

The retirement of Major Brown from the post of Deputy Engineer-in-Chief on June 30th, shortly after reaching 60 years of age, removes yet another name from the rapidly diminishing list of engineers who were cradled in a Telegraph Instrument Room, where their earlier diet was the Morse alphabet and their stronger food "Slingo and Brooker" and "Preece and Stubbs." Many of them have had the unique experience, while making their varied contributions to the development of the telephone system of to-day, of being called upon to assist in the advent of a new telegraph system in which their beloved Morse has no place; but Major Brown is more fortunate than those who have preceded him for he has stayed to see the return of the "sixpenny telegram," to the 1885 example of which he probably owes his entry to the Birmingham Post Office in 1890.

Six years' service as a telegraphist was followed by four years as a clerk in the South Midland District Superintending Engineer's Office at Birmingham; then came the plunge into the deep waters of practical engineering work—a Sub-Engineership at Coventry; after this, in turn, charge of the Stafford Section; the South Midland District Estimates Section; and (as Engineer, First Class) the Belfast Section. A year of travelling in connexion with the inventory of the National Telephone Company's plant was followed by promotion to an Assistant Staff Engineership in the Survey Section, where a very strenuous time was spent under the guidance of the late Sir William Slingo in preparing evidence for the arbitration proceedings to determine the purchase price.

On the outbreak of war Major Brown took up duty as Assistant Director of Army Signals (Home Defence): in 1915 he was appointed to the command in France of No. 5 Telegraph Construction Company and for his services was awarded the Order of the British Empire.

Major Brown from the beginning of his service had

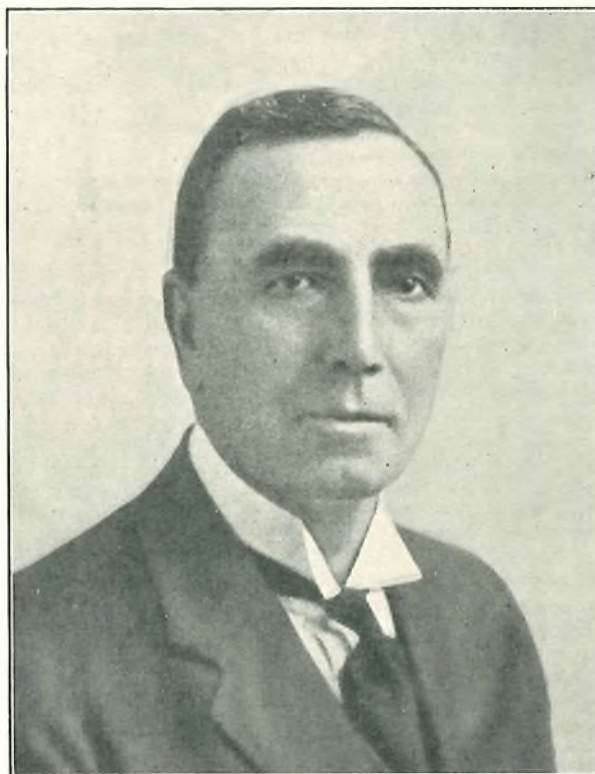

given much thought to the problem of securing increased efficiency in the organization of engineering work and when in 1927 it was decided that a Commission of Enquiry

should visit Sweden, he was selected as one of the members, the others being Mr. E. J. Wilby, also of the Engineering Department, and Mr. H. Buckland, of the Accountant General's Department. Valuable information was obtained in Sweden, and, after an examination of the outdoor construction work in all the engineering districts, Major Brown and Mr. Buckland visited the United States for the purpose of obtaining first-hand knowledge of the organization in the large American telephone centres.

Promotion to the rank of Assistant Engineer-in-Chief came on 1st September, 1929, carrying responsibility for the control of the efficiency organization both at Headquarters and in the Districts; and in April, 1934, he became the first holder of the office of Deputy Engineer-in-Chief.

Since 1929 Major Brown has undertaken a large amount of Committee work and among the more important of his responsibilities of this type have been his membership of the Motor Transport Committee which, under Mr. E. Raven, C.B., recommended the present system of maintenance by the Engineer-in-Chief of both the postal and engineering fleets, and his chairmanship of the Standing Joint Committee which was instituted to deal with the numerous questions arising out of the revision in January, 1930, of the engineering workmen's establishment.

It is always difficult to say with confidence what part of the work of a man of Major Brown's type and calibre will ultimately prove to be of the greatest value, for the full harvest of pioneer work is seldom reaped either visibly or quickly. When, however, one's mind ranges over the

past seven years and sees a picture in which some of the prominent features are a decreased volume of engineering work, a steady increase in effective output per man and a large number of employees whose services could not be retained, there seems little doubt that the discussions and negotiations with representatives of the staff must be awarded pride of place. The directness of approach to the subject under treatment; the willingness to listen to the statement of the men's point of view; the knowledge of the practical conditions or the evident desire to acquire it—in short, the obvious wish to deal honestly with each and every man—created an atmosphere of confidence and goodwill of lasting benefit to the public service, the best interests of which are the vital consideration. Major Brown's sense of humour was an asset of no small value in these discussions, but "the other side of the table" will agree that it never caused him to deviate from the opinion that if an item of work can be well done in one manhour, 61 man-minutes represents inefficiency!

It is a pleasure to know that, in this instance, retirement does not spell immediate cessation of contact with his colleagues—Major Brown's services are retained for a time to assist in the negotiations between the Post Office and the Tramway Authorities which, it is hoped, will establish a mutually satisfactory basis for the avoidance of disputes arising out of the electrolysis of underground cable sheaths in tramway areas. We wish him success in this last official undertaking and, on its conclusion, a long and happy leisure to watch the continued development of the public services to whose progress he has made a contribution of which he may well be proud. J.W.A.

Col. A. S. Angwin, D.S.O., M.C., T.D., M.I.E.E.

Col. A. S. Angwin, D.S.O., M.C., T.D., M.I.E.E., after leaving East London College and training as an engineer with Messrs. Yarrow & Co. joined the Post Office Engineering Department in 1906. Until the outbreak of war he was stationed at Glasgow where he became well versed in all branches of District work and particularly in underground construction.

During the war Col. Angwin served at Gallipoli, in Palestine and on the French front, and was awarded the Distinguished Service Order and Military Cross for his services.

On being demobilised he joined the Radio Section of the Engineer-in-Chief's Office and was actively engaged in the design and construction of the Leaffield and Rugby Wireless Stations. He was promoted to Executive Engineer in 1920, Assistant Staff Engineer in 1925 and in 1928 he became Staff Engineer in charge of the Radio Section.

In 1933 he was promoted to Assistant Engineer-in-Chief and now receives further advancement to the post of Deputy Engineer-in-Chief. Among other things Col. Angwin has identified himself particularly with the question of interference with wireless reception and with the introduction of television. During the last few years he has represented the Department on the Television Committee and recently visited America in this connexion.

Outside the office, Col. Angwin has taken an active part in the affairs of the Institution of Electrical Engineers and he is also an associate member of the Institute of Civil Engineers. He also acts as an examiner of the City and Guilds of London Institute. He is well known in Territorial Army circles, with whom he still maintains a very live interest, being at present the Deputy Chief Signal Officer to the Eastern Command.

Col. Angwin is the popular Chairman of the Engineer-in-Chief's Sports Club and all grades will be unanimous in congratulating him on attaining his new rank.

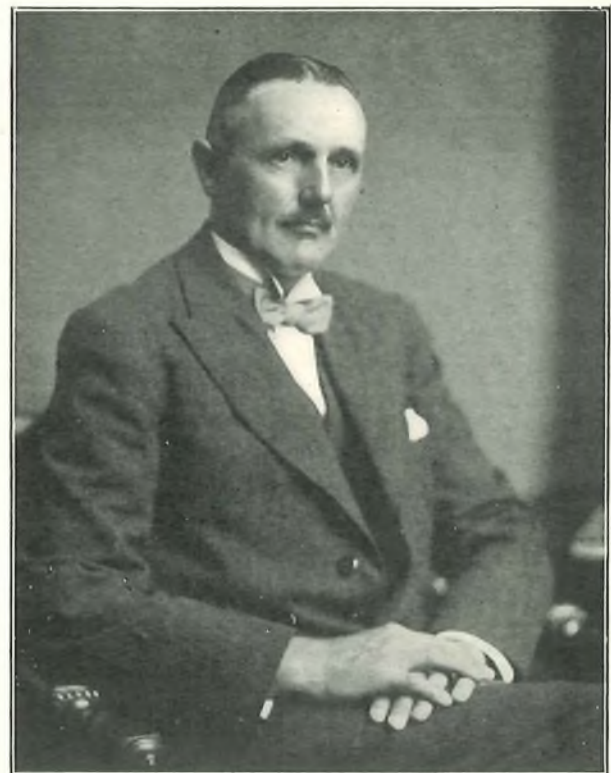

Photo by

Elliott & Fry

J. Innes, B.Sc., M.I.E.E.

Mr. J. Innes is well-known to readers of the Journal, of which he was Managing Editor from 1931 till March of this year. During the same period he was also Secretary of the Institution of Post Office Electrical Engineers, and his keen interest in the Institution and Journal has contributed much to the welfare of both.

He began his career at Headquarters, but after two years in the Lines Section went out to serve in the field, and during the ensuing fourteen years he supervised practically every kind of work for which the Engineering Department is responsible.

When the South African Government required an Engineer to advise them on the introduction of an Automatic Telephone system in the Johannesburg and Cape Peninsula areas, Mr. Innes was selected, and during the year he spent in South Africa he laid down the principles on which the automatic system there has been designed and extended. To-day it is recognized that his judgment on that important matter was sound and farseeing.

On his return from South Africa he served first in the Test Section where he obtained an intimate knowledge of cable design and manufacture. On transfer to the Equipment Section he showed equal versatility in dealing with exchange equipment problems. It may not be generally known that he was closely concerned in the negotiation of the agreements between the Post Office and its contractors for the supply of underground cables and exchange equipment.

Two years ago he visited America where, in addition to a catholic interest in technical developments, he devoted considerable attention to the financial and economic structure employed in American telephone business.

In discharging the duties entrusted to him he has enjoyed throughout the co-operation and confidence of his colleagues and the enthusiasm of his staff. His

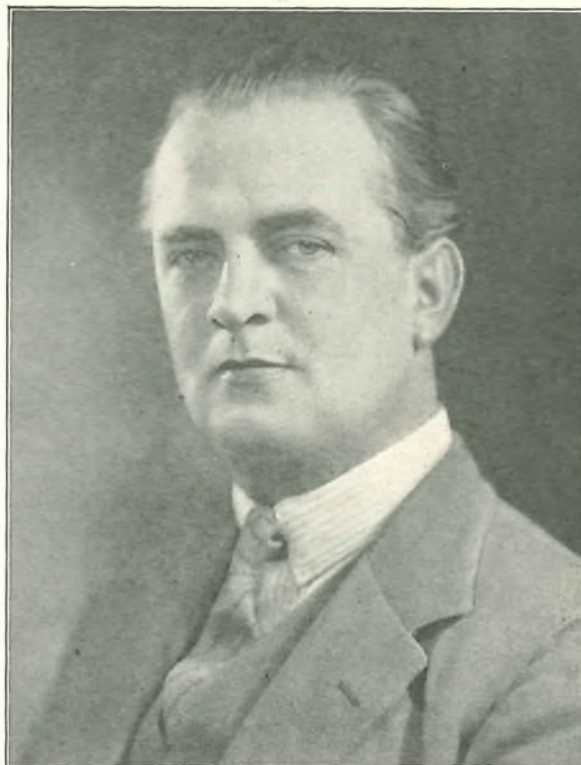

appointment as Assistant Engineer-in-Chief will furnish the opportunity to apply his varied knowledge and experience in a wider field and his many friends and colleagues will wish him well in his new sphere.

C.A.T.

G. F. O'dell, B.Sc., M.I.E.E.

Mr. G. F. O'dell, who takes over the Exchange Equipment and Accommodation Branch, entered the Post Office Engineering Department by open competition in October, 1909. After a period of training in the Engineer-in-Chief's Office, and in the old Central Metropolitan District, he was posted to the Willesden Section in May, 1910. In that Section he was engaged principally on both internal and external construction. In November, 1910, he was transferred to the Central Telegraph Office under the late Mr. James Fraser. At the end of August, 1911, he visited America in company with Mr. F. G. Turner under a scholarship scheme initiated by the Engineer-in-Chief of that date (Major W. A. J. O'Meara). Altogether he spent fifteen months in America, and during that time had experience in all phases of the telephone industry, including manufacture, operation, and maintenance. In addition he acquired his first experience of automatic telephony, which was a comparatively new development at that time. On his return to this country he was posted to the Telephone Section of the Engineer-in-Chief's Office to assist Mr. B. O. Anson who was then engaged on the development of automatic telephony to meet the requirements of this country. He very soon became interested in the trunking aspect of automatic telephony, and for a time was engaged solely on that work. Mr. O'dell's contributions to the theory and standardization of trunking are of international importance and too well-known to need recapitulation here. In March, 1927, he became executive engineer in charge of automatic maintenance, and in March, 1928, he took charge of the trunking group which was formed at that time. On June 1st, 1932, he



became assistant staff engineer in charge of telephone development, and remained on this work until receiving his present position. During this period he has been chairman of the Nomenclature and Symbols Committee and of the joint Committee of manufacturers and the Department charged with the important task of introducing the 3000 type relay into all telephone circuits in place of the various types made by individual manufacturers hitherto. The standardization of the two-motion selector

by the development of the type is to be known as the 2000 type is now proceeding and doubtless Mr. O'dell will be sorry to leave this work before its completion.

Mr. O'dell has written a number of papers, chiefly on trunking, for the Institution of Post Office Electrical Engineers, and has contributed to this Journal on more than one occasion. In December, 1926, he read a paper on trunking before the Institution of Electrical Engineers.
B.O.A.

The Institution of Post Office Electrical Engineers

RETIRED MEMBERS.

The following members, who have retired from the Service, have elected to retain their membership of the Institution :—

- G. F. Greenham, M.B.E., M.I.E.E., 16 Court Lane Gardens, Dulwich, S.E.21.
- J. M. Shackleton, M.I.E.E., "Ballitore," Cranes Lane, Ormskirk, Lancs.
- S. F. Whetton, 128 Stainbeck Lane, Chapel Allerton, Leeds 7.
- A. E. White, A.M.I.E.E., 35 Chandos Road, S., Chorlton-cum-Hardy, Manchester.

W. Wilson, 42 Springwood Avenue, Allerton, Liverpool.

CORRESPONDING MEMBERS.

The following have been elected :—

- C. van der Wateren, c/o Divisional Engineer, G.P.O., Cape Town.
- W. Withiel, Mojare, Virginia Avenue, Cape Town.
- R. W. Murrell, P.O. Box 713, Salisbury, S. Rhodesia.
- G. R. Turtle, Egyptian State T. and T., Medina Queen Nazli St, Cairo.

Local Centre Notes

North Eastern Centre

The final meeting of the 1934-5 Session was held on March 12th, when Mr. R. Lyle, H.C.O. of Leeds, read a paper entitled "The Negotiation of Wayleaves and Activities Incidental Thereto." The widely popular subject attracted a large and enthusiastic gathering.

On May 1st, 50 members participated in a visit to the L.N.E. Railway signalling school at York. The various systems of automatic signalling were demonstrated by means of working models and the members were also privileged to see the whole of the apparatus installed at

this important railway centre in connexion with telegraphic and telephonic communication.

Scotland West Centre

An outing, which proved interesting and instructive to the Members participating, took place on the 13th May, when the Glasgow Corporation Power Station at Dalmar-nosk was visited. The event closed a useful session, the programme of which was comprehensive. A good average attendance was maintained at the meetings.

Junior Section Notes

Aberdeen Centre

Mr. J. McIntosh, Efficiency Engineer, Edinburgh, gave a paper entitled "Police Telephone Signal System" at our last meeting. In view of the projected installation of a system at Aberdeen, the subject was of great practical interest and a valuable discussion followed.

Aldershot Centre

The 1934-5 Session of the above Centre has proved most successful, and instructive, as may be gathered from the following programme. Papers read before the Centre :—

- "Rural Automatic Exchanges," by Mr. A. R. Clatworthy.
- "Random Notes on Transmission," by Mr. F. V. Padgham.
- "Brief Outline of Electric Light and Power Installation and Maintenance," by Mr. H. J. Ebbage.
- "Alternating Currents of Audible Frequency for Testing Purposes," by Mr. E. Brown.

"The Megger," by Mr. C. F. White.

"Transmission Testing," by Mr. J. W. Branson.

A visit was also made to the works of Messrs. Hack-bridge Cable Coy, when about 24 members spent a very enjoyable afternoon, following the processes of cable manufacture from the raw material to the completed cable. The tour extended over a period of three hours. Excellent facilities were provided for the comfort of the party, groups of eight being conducted by three very efficient guides. No trouble was spared, and a skeleton staff was kept on duty to demonstrate the numerous machines.

The party was then entertained to an excellent tea, at the conclusion of which our gratitude for such hospitality was expressed by Mr. S. H. Allen.

On April 16th, the Annual General Meeting was held, and officers were elected for the 1935-6 Session. The Chairman, Mr. S. H. Allen, paid special tribute to the excellent services rendered by Mr. R. Smith, as Secretary of the Centre since its inception, and proof that this was

recognised by all was made known by the hearty applause which these words brought forth. He also mentioned that the Centre was going to miss him very much, but at the same time congratulated him on his promotion to Inspector's rank.

Cambridge Centre

Interest has been maintained during the Session 1934-35 and the attendances have been very good. A very high standard was set by those members who read papers, and it would be invidious to single out any paper for special mention.

The programme for the second half of the Session was as follows:—

Jan. 4. Visit to Cambridge Auto. Exchange.

Feb. 1. "Graphical Statistics"—Mr. A. L. Challis.

Mar. 1. "Radio Interference"—Mr. W. E. T. Andrews.

„ 15. "Internal U.C.C."—Mr. H. G. Smith.

Members were pleased to welcome Capt. Cave-Browne-Cave to the meeting of the 1st February and Mr. W. M. Osborn to the meeting of the 1st March.

At the Annual General Meeting on 5th April Mr. A. J. Stearn was appointed Secretary. Mr. H. Kitteridge, the retiring Secretary, was warmly thanked for his services since the formation of the Branch.

By the time these notes appear the annual outing will have taken place. This year a visit to Messrs. H.M.V. Co's Works at Hayes, Middlesex, has been arranged.

The programme for 1935-36 is in course of preparation, and it is hoped that papers will be forthcoming from members who have not previously contributed.

T.C.L.

Chester Centre

The 1934-5 Session opened on October 8th, 1934, under the Chairmanship of Mr. J. C. Spiers (C.I.). The membership reached a total of 30, an increase of 7 over the previous year.

During the Session 12 papers, covering a wide range of subjects relative to the telephone service, were read, and two nights were devoted to the exhibition of some of the Department's films, viz., "Methods of Renewing Poles," "The Telephone Workers," and "The Manufacture of High Tension Cables."

A visit was made on March 9th to Liverpool Telegraph, Repeater, and Trunk Test rooms which afforded a very pleasant and instructive afternoon.

The average attendance was 22, which, as the area is scattered, the Committee think very good. The Chairman and Committee wish to thank all for the way in which the members pulled together to make the Session such a success.

Dundee Centre

Arrangements were made for Mr. A. T. J. Beard, of the Engineer-in-Chief's Office, to give his paper on the "Provision and Maintenance of Repeated and Amplified Circuits" at our meeting in March. There was a good attendance, and the discussion was proof of the interest the paper evoked.

Edinburgh Centre

At the March meeting Mr. D. Imlach read a paper on "Transmitters and Receivers," which evoked a good discussion.

A large number of our members paid a visit to the Corporation Gas Works at Granton on the 8th April. These works are up-to-date and possess the most modern equipment. Our thanks are due to J. Jamieson, Esq., Gas

Engineer and Manager, for the privilege of the visit, and the admirable arrangements made for conducting the party.

Mr. A. T. J. Beard, of the Engineer-in-Chief's Office, delivered his paper on the "Provision and Maintenance of Repeated and Amplified Circuits" at our last meeting of the Session, on 30th April. The paper was full of interest and, if time had permitted, more of our members would have taken part in the discussion, which was keenly sustained.

Fenny Stratford Centre

A very interesting and instructive Session has just been concluded. Notwithstanding that the Centre is a small one, and that there is not much scope to increase the present membership of 20, no less than 12 papers were read during the 1934-5 Session. The general excellence of the papers read was such that the selection of two, for consideration by the Senior Section Committee in connexion with the Annual Prize Competition, was a matter of some difficulty.

Glasgow Centre

A successful Session was brought to a close on 29th March when Mr. J. Graham read a paper on "Trunk Demand Working"; a lively discussion followed and a thoroughly enjoyable evening was spent. The meetings, of which six have been held during the Session, have proved interesting and informative; the atmosphere is cordial and encouraging. Several visits by members of the parent body have been made, our visitors have joined in the discussions and where possible have filled in gaps with information and views from a different angle.

The committee are busy arranging the programme for 1935-6 and there is no doubt that, as in former years, the subjects will be attractive and up to standard.

Opportunity is taken to thank our contributors for their services and to remind others that the benefits of preparing a lecture cannot be overestimated. Our thanks are due also to the parent body for the use of slides and for their co-operation and to our friend who supplies the lantern.

T.N.A.

London Centre

The past year has seen rapid strides in the growth of the membership in the Metropolis. The latest available figures before going to print show that the present membership is 550, an increase of 100% on last year's total; an encouraging result of a year of hard work!

No less an achievement has been the holding of 56 meetings in the seven sections comprising the Centre. The division of London into seven areas enables members to save time and money in travelling and the Programme Sub-Committee to consider the particular needs of each area separately.

Visits of the best technical interest were paid to the London Air Port at Croydon, our own Research Station at Dollis Hill, the Post Office Tube Railway at Mount Pleasant and the National Physical Laboratory at Teddington. These visits were attended up to the limiting numbers, the first three being duplicated with second visits, so heavy was the demand from members. In this connexion the Committee desires to express its regret that it has not yet been able to arrange a second visit to the N.P.L.

A fitting climax to this interesting year was on the occasion of the Annual General Meeting, held as usual at Denman Street on May 17. The Superintending Engineer was warmly welcomed, and in the course of his ensuing remarks drew a verbal picture of events which had

occurred during his last twenty-five years' association with the Department. The incidents were no less surprising than delightful, and from them we drew the moral—one must be up-to-date, and the best way is to assume membership as soon as possible.

Following this we listened to a very interesting paper given by Mr. Gibbon on the subject of "Recent Developments in External Construction." Our sincere thanks are due to the Supt. Engineer, our President and the other members of the Senior Section who supported the meeting. The Committee also desires to place on record an expression of its warm appreciation of the valuable help given by Messrs. C. W. Brown and E. J. Hill in its past year's work.

Manchester Centre

The past Session has proved equally successful as its forerunners and the reports furnished at the Annual General Meeting held on April 15th showed the Centre to be in a flourishing condition.

The election of officers for the forthcoming Session resulted as follows:—

Chairman—W. Davies.

Vice-Chairman—R. Kibble.

Hon. Secretary—W. H. Fox.

Hon. Treasurer—E. H. Frowde.

Committee—G. Hodson, J. Lawton, R. S. I. Ogden, G. Pratt, R. Sephton, C. Wood.

It has been agreed to reduce the annual subscription to 2/- and it is hoped that the present membership of 90 will be considerably augmented as a result.

Subscriptions are now due and should be remitted to Mr. E. H. Frowde, c/o Toll Test, Telephone House, Salford 3.

A further Essay competition is to be held on the same lines as last Session. Two prizes of £1 1s. 0d. each and Certificates of Merit will be awarded for the best essays contributed by local members on any subject relevant to the work of the Junior Section. Entries must be in the hands of the Local Secretary on or before Saturday, September 14th, 1935.

The Committee will shortly be commencing work compiling the new programme and would welcome suggestions from members regarding suitable papers or places of interest to which visits may be arranged.

W.H.F.

Newcastle-on-Tyne Centre

We have completed a very successful 1934-35 Session, during which papers on the following subjects were read: 1934.

Nov. 9. "Unit Auto No. 4 P.A.B.X.," by Mr. T. B. J. Dent.

Dec. 14. "Construction in Relation to Maintenance," by Mr. W. F. Smith (Sectional Engineer).

1935.

Jan. 11. "Engineering Repair Service," by Mr. R. Richardson.

Feb. 8. "Four Wire Repeater Circuit," by Mr. T. Wood.

Mar. 8. "Wireless Interference and Investigation," by Mr. S. Thompson.

We are indebted to Mr. W. F. Smith, Sectional Engineer, Mr. S. L. Helman, Assistant Engineer, Mr. A. K. Robinson and the past and present Secretaries of the Senior Section for their support, encouragement and valuable assistance, also to Mr. C. W. Brown and his staff at Dollis Hill for the loan of slides, etc., which have given an added interest to the papers read.

The Annual General Meeting was held on April 5th, 1935, when the following officers were appointed:—

Chairman—Mr. J. B. Croney.

Vice-Chairman—Mr. S. Thompson.

Hon. Secretary and Treasurer—Mr. T. B. J. Dent.

Committee—Messrs. Hazlewood, Cook, Richardson and Hill.

Auditors—Messrs. T. G. Taylor and J. P. Smith.

We are now embarking on the 1935-36 Session and an interesting programme, which we hope to issue at an early date, is being compiled.

We offer a welcome to all members of the staff to our meetings, and those desirous of becoming members of the Junior Section may obtain information from the Hon. Secretary, Mr. T. B. J. Dent, P.O. Engineering Department, Telephone House, Carloli Square, Newcastle-on-Tyne.

Peterborough Centre

A meeting was held at the Telephone Exchange, Bridge Street, Peterborough, on Friday, May 17th, 1935, for the purpose of establishing a local centre of the Junior Section.

Mr. J. M. Owen, Sectional Engineer, presided and welcomed the interest in the undertaking. He said that the Junior Section was for the benefit of the men and that he had no doubt that the venture would be a success and that the interest in the centre would not lag in the future.

Mr. C. A. Carpenter, the Local Secretary of the North Midland Centre, then gave a short outline of the constitution and rules, and made a special mention of the library facilities. A number of questions were answered by Mr. C. A. Carpenter and Mr. J. M. Owen.

It was decided to establish a Local Centre at once with an initial membership of 40 and the result of the election of officers was as follows:—

Chairman—Mr. J. Mc.A. Owen, Sectional Engineer.

Vice-Chairman—Mr. R. W. R. Porter.

Secretary—Mr. V. P. List.

Treasurer—Mr. C. Welch.

Committee—Messrs. R. W. H. Clewer, J. W. E.

Ball, J. E. Daniels, J. D. Andrews, E. Hands and R. G. Gaut.

Auditors—Messrs. L. K. Kisby, and E. F. Baxter.

A reference library will be available at the Section Headquarters.

A programme of the forthcoming Winter Session will be compiled as soon as possible and a copy sent to all members.

Southend-on-Sea Centre

The 1934-5 Session proved to be another very successful one. The papers contributed covered a variety of subjects, including "Underground and Overhead Development" (E. W. Miller), "Motor Transport Ignition Systems" (J. H. Kellet and M. E. Fryatt), "Trunk Demand Working" (R. Foulsham), and an abridged version of the Senior Section paper "Some hints on Maintenance and Fault Control" (by the Sectional Engineer, Major H. Yorke Starkey).

Papers have again been submitted for the annual prize competition, in which last year one of our members, Mr. D. J. Porter, obtained a certificate.

The Annual General Meeting has recently been held, and arrangements for next Session's programme are now in hand. Mr. L. C. Frampton has been appointed local Secretary.

District Notes

South Wales District

Pontypridd Automatic Exchange was opened on Saturday, 1st June. This exchange, which was installed by the Automatic Electric Company, replaced a C.B.12 exchange which had been in service for 22 years. The exchange is accommodated in a new Post Office building which was opened on 16th May by the Assistant Postmaster General, Sir Ernest Bennett. The equipment is of the most up-to-date line finder type with an initial multiple capacity of 500 ordinary and coin box lines and calling equipments for 420. As all but 10 of the latter are already allocated, it is necessary to provide further extension immediately. Assistance traffic is provided by the Cardiff manual board which is approximately 12½ miles away. In order to provide additional junctions necessary to carry this traffic and also to carry junction development for Pontypridd and exchanges in the valleys beyond, a new 104pr/40 lb. loaded underground cable has been provided between Cardiff and Pontypridd by Messrs. Siemens Brothers.

Pontypridd stands at the head of the Taff, Rhondda and Cynon Valleys and while working manually acted as junction lending centre for all the exchanges in these valleys. The transfer of the manual board to Cardiff on conversion to automatic working made it necessary, to provide facilities for these exchanges to be able to dial through the Pontypridd equipment in order that their trunk calls may be completed *via* the Cardiff manual board and that they may also have access with each other.

On 30th May Carmarthen exchange was transferred to automatic working. This exchange was formerly of the C.B.S. No. 2 type and the new automatic equipment is of the same type as that provided at Pontypridd. The initial equipment is for 500 lines multiple and 400 calling equipment. The exchange opened with 357 subscribers. The formal opening of the exchange was the subject of a call between the Bishop of St. David's and the Assistant Postmaster General. Sir Ernest Bennett's reply was broadcast from loud speaker equipment fitted in the room in which the ceremony was held.



In common with the rest of the country the South Wales District has been intensely active with Telegraph Publicity. On May 31st the speeches of the Postmaster General and the Prince of Wales in the new hall at the Central Telegraph Office were relayed by land line and broadcast through loud speakers to a select company in the Head Postmasters' rooms at Cardiff and Swansea.

In connexion with the Jubilee Week festivities, the

Prince of Wales was at Cardiff on Saturday, 11th May, and one major feature of the celebrations consisted of a Pageant of South Wales Industries. The Department participated in this by providing a two-ton lorry decorated to symbolise the world wide activities of Post Office communications. A floor pattern switchboard was placed in the centre of the lorry and at this was seated an operator in Welsh costume. At each of the four corners of the lorry was seated an operator dressed to represent the countries of Japan, Italy, Argentine and India. Supported by two telegraph poles across the chassis was an enlarged scale model of a Hand Micro Telephone inscribed with the words "Wales Speaks to the World." A photograph of the arrangement is shown.

Eastern District

CAMBRIDGE AUTOMATIC EXCHANGE.

The Cambridge telephone system was successfully changed over to automatic working at 1.30 p.m. on Saturday, May 4th, when some 3200 subscribers and 209 trunks and junctions were transferred.

The new exchange replaces the ex-N.T.Co's C.B. exchange erected in 1909. The Non-Director system has been adopted, involving the provision of Cambridge main exchange with satellite exchanges at Cherryhinton and Girton, the exchange equipment being manufactured and installed by Messrs. Standard Telephones & Cables Ltd.

The automatic equipment for the main exchange, which caters for 3400 subscribers' lines, is distributed over four floors of the new Cambridge Head Post Office building. Provision has also been made for 600 subscribers' lines at Cherryhinton and 200 subscribers' line at the Girton exchange. Standard Strowger equipment is used except that heavy duty uniselector finders of the Bypass type are employed as line finders.

The exchange power plant consists of two 17 k.w. motor generators, with duplicate batteries of 1050 ampere hour capacity and ringing plant giving the usual standard facilities.

The auto-manual switchboard consists of seven 3-position and two single-position sections, comprising 3 J.E.B., 14 A, 3 Delay, 2 Enquiry and 1 Plugging-up, positions, all of which have been equipped with Free Line Signals and Chargeable Time Indicators.

The scheme has provided through dialling facilities for 27 exchanges in the Cambridge and adjoining areas, exchanges as far apart as Thetford, Norfolk, and Bishop's Stortford, Herts, having through-switching *via* the automatic plant at Cambridge.

Two exchanges of the U.A.X. type were installed at Trumpington and Teversham under the transfer scheme. The Trumpington exchange is of the 50/200 advance supply type, and the equipment has been arranged for through dialling to the main automatic plant. At Teversham two Units Auto. No. 6 have been provided with junctions terminated on the Cambridge manual switchboard.

The main exchange building also houses the transformer network and through and terminal amplifying equipment served from the A.C. mains for the London-Cambridge cable.

The external work in connexion with the transfer involved the provision of over 50 miles of underground cables having a total single wire mileage of over 6000 miles and terminating about 10,000 pairs of wires on the various M.D. Frames.

South Western District

AN ANTI-CREEPING DEVICE FOR USE IN COUPLINGS.

Early in 1935 it became necessary to give attention to a serious case of creeping of the Taunton-Minehead cable in the Bishops Lydeard, Crowcombe and Washford areas over a distance of approximately 5,000 yds. Couplings No. 8 are installed throughout, except at the loading points and it was necessary to pull back the cable to its original position and to fit some type of Anti-Creeping Device.

A description of the device actually used may be of interest. The basis of the design originated in the Faunton Section, but the description to follow includes some slight modifications introduced by the Engineer-in-Chief.

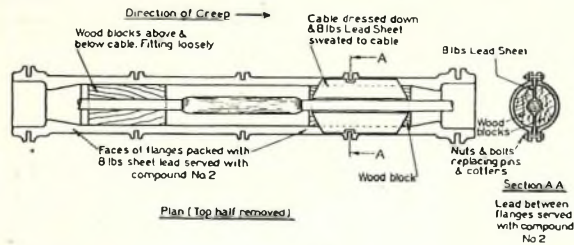

It will be seen from the associated drawing that, after the cable had been dressed down on the "Creep-out" side of the joint, a strip of 8 lb. sheet lead, approximately 10" long, was sweated to the lower half of the cable sheath and another piece, of similar length, was dressed around but not fixed to, the upper half of the sheath. The edges of both lead sheaths were firmly clamped between the flanges of the coupling, using nuts and bolts instead of the usual pins and cotters. In order to obtain efficient sealing of the coupling the remaining portions of the flanges were packed with 8 lb. sheet lead served with compound No. 2. To ensure that the lead sheets will remain rigid, wooden blocks, cut to fit inside the coupling and around the cable, were placed above and below them. Any movement of the blocks due to further creeping-out of the cable will cause these blocks to wedge tightly on to the cable owing to their tendency to enter the tapered portion at the end of the coupling.

Buckling of the cable due to creeping-in at the other end of the coupling was restricted by means of further wooden blocks which fitted the couplings, but did not grip the cable.

At "pull through" points the length of the lead strip on the "Creep-out" side was increased to 15 inches.

ROUGH WORK IN THE SCILLY ISLANDS.

The telegraph cable connecting St. Mary's in the Scilly Isles with the mainland at Porthcurno, Cornwall, broke down in December last. After some preliminary tests, the fault was handed over to the Submarine Department and taken up by H.M.T.S. "Alert." The Commander ultimately decided to lay a new shore end and the landing of this was undertaken on the 19th December and the following days. A landing party was formed of Mr. V. C. Pendry, a gang of 5 men of the Plymouth Section (who were on the island in connexion with another minor inter-island fault) and 5 casual labourers engaged at St. Mary's.

The cable had to be hauled in from below water mark to the cable hut, over rocks and up the face of a cliff for a distance of about 100 yards. On the evening of the 19th December it was temporarily secured in position, and was permanently fixed by Mr. Pendry and the casual

labourers on the following days by clamping and cementing into the cliff face and rocks. The heavy seas running made it impracticable to use ladders and the work on the cliff face had to be done from a bosun's chair. High winds, heavy seas and frequent rainstorms made the conditions extremely difficult and unpleasant for the men engaged, who were wet through for the greater part of each day.



The photograph shows the shore end being paid off from the ship's lifeboat by some of the crew of the "Alert" and being hauled over the rocks at the base of the cliff by the landing party. This was taken during some of the quieter moments and gives no idea of the tough job that in reality it was.

South Midland District

Increased activity, due to the extended main underground programme has been experienced in this district and the following cables have been completed during the last few months:—

1. Ryde-Sandown-Shanklin-Ventnor. This is a 60 pair, 20 lb. cable and was provided under overall guarantees by Messrs. Pirelli. In some sections it was drawn over five other cables in the same duct, but this did not lead to any undue difficulties and a rate of progress of about one mile per week was accomplished.

2. Bournemouth-Southampton No. 2 cable is a 104 pair, 20 lb. cable and is to be used with amplifiers. It was provided by Messrs. Pirelli and loaded by the Department, a good rate of progress being maintained. Its provision will allow a considerable lightening of the existing aerial route which at present is considered by some to disfigure the countryside through the New Forest. An interesting feature was the arrangement made for co-operation between this district and the South Western District in connexion with the group and final tests which resulted in a considerable saving of time. A Testing Officer from each district collaborated throughout the route and it was found possible to maintain a rate of progress of one loading section group test per day.

3. Southampton-Chichester No. 2 cable, mainly 60 pair, 20 lb., was provided in a similar manner to the Ryde-Ventnor cable and in this case opportunities for co-operation with the South Eastern District were obtained.

MECHANICAL EXCAVATOR USED FOR DUCT TRENCHING IN CONNEXION WITH THE LONDON-LIVERPOOL BACKBONE ROUTE.

The photograph shows a mechanical excavator of the bucket-chain type used by a duct-laying Contractor for the trenching in the Shipston-on-Stour to Oxford section of the London-Liverpool main cable route,

The excavator is driven by a 45 H.P. petrol motor and five men were employed for its operation; one being the driver, two preparing and roughly levelling the track (to ensure a vertical trench) and two trimming the trench.

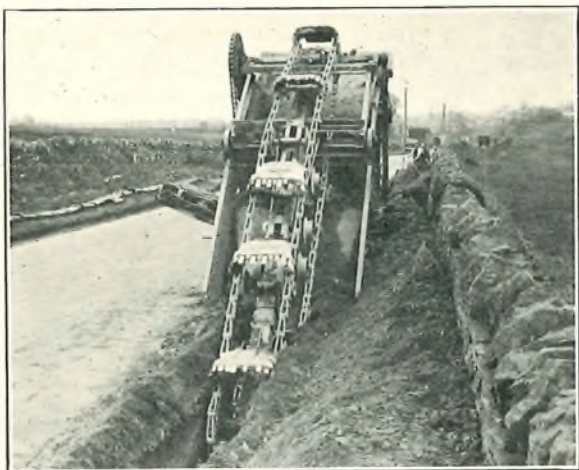

The minimum width necessary for the operation of the excavator is 10 feet and, subject to a certain amount of re-lining up, normal curves can be taken. The space occupied rather limits the use of this excavator to wide grass margin and the actual width of trench excavated is two feet, which was considerably wider than required for the ducts to be laid.

These limitations and the fact that the soil throughout contained a large amount of shale and soft rock, prevented a comparison of cost with manual excavation from being impressive; the best progress made in one day by the machine being 388 yards.

North Wales District

RETIREMENT OF MR. F. FLANAGAN, ASSISTANT ENGINEER, STOKE.

On 19th April Mr. Francis Flanagan, Assistant Engineer, Stoke Section, retired at the age limit, after 39 years with the National Telephone Company and the Post Office.

Mr. Flanagan was born in Chester in 1875 and entered the National Telephone Company at that town in 1896 as a Wayleave Officer, and his skill in conducting difficult negotiations remained with him to the end. Later he became an Engineering Inspector and after the transfer to the Post Office he served as a Senior Inspector, Chief Inspector and Assistant Engineer. In Stoke-on-Trent he has seen the gradual conversion from overhead wiring to underground systems and the transfer to automatic working in 1927.

Mr. Flanagan was for many years a successful amateur actor, and his genial presence, his bonhomie and inevitable cigar will be greatly missed among his colleagues in the Section and North Wales District who

gave Mr. Flanagan a cordial send off with a writing bureau and an all mains wireless set as a tangible sign of their goodwill.

TERMINATION OF CABLES AT WHITCHURCH REPEATER STATION.

There are two cables to be repeated at Whitchurch Repeater Station, the Birmingham-Liverpool, 352 pair/25 lb. plus 4 pair/40 lbs. screened, and the London-Liverpool-Glasgow, 360 pair/25 lb. and 4 pair/40 lb. screened. The

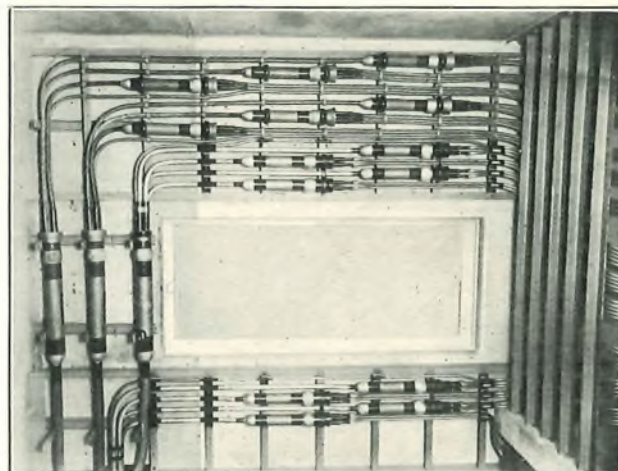

cables are terminated on test tablets each of which accommodates 24 pairs, and the attached photograph gives a good idea of the sub-division of the cables for termination. A cable containing 24 pairs can be connected to each test tablet.

THE WARSOP PETROL DRILL.

This tool is a portable mechanical drill for breaking up road surfaces, and consists of a light two stroke petrol engine carrying a small supply of fuel, and arranged to give about 1800 blows per minute to the drill. The tool is completely self contained and is of reasonable weight for use by one man. Considerable use is being made of the tool in the Birmingham area and it has been found capable of breaking up all types of hard road surfaces. It has been found particularly useful on small works such as road crossings, or opening for access for fault clearance purposes.

WOMBOURNE U.A.X.

A U.A.X. of the Department's No. 7 type was brought into service at Wombourne at 9.30 a.m. on 26/3/35, the first of this type in the North Wales District, 135 subscribers and 21 junctions being changed over. The facilities provided are of some interest, direct communication by means of dialling out codes with subscribers on 8 auto and 2 manual exchanges being provided.

Staff Changes

PROMOTIONS.

Name.	From.	To.	Date.
Angwin, Col. A. S.	Asst. E.-in-C.O.	Deputy E.-in-C.O.	1-7-35
Innes, J.	Staff Engr., E.-in-C.O.	Actg. Asst. E.-in-C.O.	1-7-35
O'dell, G. F.	Asst. Staff Engr., E.-in-C.O.	Actg. Staff Engr., E.-in-C.O.	1-7-35
Vickery, W.	Exec. Engr., E.-in-C.O.	Asst. Staff Engr., E.-in-C.O.	8-5-35
Baldwin, D. Z.	Actg. Exec. Engr., E.-in-C.O.	Exec. Engr., E.-in-C.O.	12-3-35
Mobbs, H. J.	Asst. Engr., E.-in-C.O.	Exec. Engr., E.-in-C.O.	12-3-35
Tamplin, G. R.	Asst. Engr., S. Wales.	Exec. Engr., S. Wales.	8-5-35
Beer, H. G.	Asst. Engr., E.-in-C.O.	Exec. Engr., E.-in-C.O.	14-5-35
Britton, F. T.	Asst. Engr., N. Wales.	Exec. Engr., N. Midland.	1-8-35
Brent, W. H.	Asst. Engr., Eastern.	Exec. Engr., S. Lancs.	14-5-35
Baines, J.	Asst. Engr., N. Eastern.	Exec. Engr., N. Eastern.	2-7-35
Edwards, J. J.	Asst. Engr., E.-in-C.O.	Exec. Engr., E.-in-C.O.	14-5-35
Gibson, W. W. M.	Asst. Engr., E.-in-C.O.	Exec. Engr., E.-in-C.O.	14-5-35
Smith, H. S.	Asst. Engr., E.-in-C.O.	Exec. Engr., E.-in-C.O.	14-5-35
Bentlett, W. J.	Asst. Engr., E.-in-C.O.	Exec. Engr., E.-in-C.O.	14-5-35
Husband, S. J.	Asst. Engr., E.-in-C.O.	Exec. Engr., E.-in-C.O.	14-5-35
Hodge, H. R.	Chief Insp., N. Wales.	Asst. Engr., N. Wales.	1-5-35
Pirie, H. A.	Chief Insp., E.-in-C.O.	Asst. Engr., E.-in-C.O.	1-6-35
Wood, J. A.	Chief Insp., Eastern.	Asst. Engr., Eastern.	1-6-35
Still, W.	Chief Insp., E.-in-C.O.	Asst. Engr., E.-in-C.O.	1-6-35
Elliott, G.	Chief Insp., London.	Asst. Engr., London.	1-6-35
Burrows, W. N.	Repr. Officer, Cl. II., Northern.	Chief Insp., Northern.	1-12-34
Pierson, J. H.	S.W.I., N. Ireland.	Insp., N. Ireland.	10-11-34
Waterhouse, L. R.	S.W.I., N. Eastern.	Insp., N. Eastern.	10-3-35
Skea, J.	S.W.I., Scot. East.	Insp., Scot. East.	1-1-35
Wearn, R. G. O.	S.W.I., N. Midland.	Insp., N. Midland.	23-3-35
Adams, W. R.	S.W.I., E.-in-C.O.	Insp., E.-in-C.O.	19-8-34
Anderson, F.	S.W.I., Rugby Radio.	Insp., E.-in-C.O.	1-1-35
Bell, W. T.	S.W.I., E.-in-C.O.	Insp., E.-in-C.O.	28-10-34
Buckley, G.	S.W.I., E.-in-C.O.	Insp., E.-in-C.O.	24-11-34
Clayton, W.	S.W.I., E.-in-C.O.	Insp., E.-in-C.O.	24-11-34
Coombes, R. G.	S.W.I., E.-in-C.O.	Insp., E.-in-C.O.	14-10-34
Englefield-Bishop, C. G.	S.W.I., E.-in-C.O.	Insp., E.-in-C.O.	19-8-34
Erratt, R. S.	S.W.I., E.-in-C.O.	Insp., E.-in-C.O.	19-8-34
German, A. G.	S.W.I., E.-in-C.O.	Insp., E.-in-C.O.	30-9-34
Gerry, P. R. C.	S.W.I., E.-in-C.O.	Insp., E.-in-C.O.	19-8-34
Hall, A. W.	S.W.I., E.-in-C.O.	Insp., E.-in-C.O.	6-9-34
Kelly, T. S.	S.W.I., E.-in-C.O.	Insp., E.-in-C.O.	17-11-34
Cooper, W.	S.W.I., Scot. West.	Insp., Scot. West.	26-5-35
Lafosse, L. P.	S.W.I., E.-in-C.O.	Insp., E.-in-C.O.	13-10-34
Manley, E. H.	S.W.I., E.-in-C.O.	Insp., E.-in-C.O.	7-11-34
Mitchell, H. B.	S.W.I., E.-in-C.O.	Insp., E.-in-C.O.	24-11-34
Myers, B. L.	S.W.I., E.-in-C.O.	Insp., E.-in-C.O.	5-7-34
Postance, J. C. E.	S.W.I., E.-in-C.O.	Insp., E.-in-C.O.	3-7-34
Potts, C. M.	S.W.I., E.-in-C.O.	Insp., E.-in-C.O.	8-12-34
Sayers, C. F.	S.W.I., E.-in-C.O.	Insp., E.-in-C.O.	17-3-35
Shearing, M. R.	S.W.I., E.-in-C.O.	Insp., E.-in-C.O.	8-4-34
Stanley, J. W.	S.W.I., E.-in-C.O.	Insp., E.-in-C.O.	11-12-34
Sundewall, J. R.	S.W.I., E.-in-C.O.	Insp., E.-in-C.O.	17-11-34
Taylor, E. A.	S.W.I., E.-in-C.O.	Insp., E.-in-C.O.	1-9-34
Taylor, R.	S.W.I., E.-in-C.O.	Insp., E.-in-C.O.	13-10-34
Young, G.	S.W.I., E.-in-C.O.	Insp., E.-in-C.O.	19-8-34
Bailey, A. P.	S.W.I., S. Wales.	Insp., S. Wales.	25-1-35
Hannah, W.	S.W.I., Scot. West.	Insp., Scot. West.	15-11-34
Moore, J. J.	S.W.I., S. Lancs.	Insp., S. Lancs.	14-4-35
Hartley, C. A.	S.W.I., N. Eastern.	Insp., N. Eastern.	28-4-35
Philipson, W.	S.W.I., E.-in-C.O.	Insp., E.-in-C.O.	30-3-35
Hills, J. E.	S.W.I., S. Eastern.	Insp., S. Eastern.	8-4-35
Andrews, W. E. T.	S.W.I., Eastern.	Insp., Eastern.	To be fixed later.
Askew, E. A.	S.W.I., Eastern.	Insp., Eastern.	do.
Chambers, C. R.	S.W.I., Eastern.	Insp., Eastern.	do.
Day, W. S. C.	S.W.I., Eastern.	Insp., Eastern.	do.
Dell, H. H.	S.W.I., Eastern.	Insp., Eastern.	do.
Duffield, H.	S.W.I., Eastern.	Insp., Eastern.	do.
Knights, G. A.	S.W.I., Eastern.	Insp., Eastern.	do.
Manning, J. R.	S.W.I., Eastern.	Insp., Eastern.	do.
May, E. G. A.	S.W.I., Eastern.	Insp., Eastern.	do.
Such, R. C.	S.W.I., Eastern.	Insp., Eastern.	do.
McCarthy, G. W.	S.W.I., Testing Branch.	Insp., Testing Branch.	do.
Green, E. S.	S.W.I., Testing Branch.	Insp., Testing Branch.	do.
Wheatley, S. J.	S.W.I., Testing Branch.	Insp., Testing Branch.	do.
Ingram, E.	S.W.I., N. Ireland.	Insp., N. Ireland.	5-7-34
Forbes, G. A.	S.W.I., Scot. West.	Insp., Scot. West.	4-1-35
Beresford, T. W.	S.W.I., N. Wales.	Insp., N. Wales.	7-11-34
Pickford, F. W.	S.W.I., N. Wales.	Insp., N. Wales.	7-5-35

PROMOTIONS (continued).

Name.	From	To	Date.
Barnes, J. L.	S.W.I., N. Wales.	Insp., N. Wales.	4-5-35
Rowlands, W.	S.W.I., N. Wales.	Insp., N. Wales.	11-4-31
Hardy, J.	Draughtsman, Cl. II., N. Wales.	Insp., N. Wales.	To be fixed later.
Spence, L.	Draughtsman, Cl. II., N.E.	Actg. Draughtsman, Cl. I., N.E.	2-7-34
Soper, W. A.	Draughtsman, Cl. II., L.E.D.	Draughtsman, Cl. I., L.E.D.	1-5-35
Hind, B. C.	Draughtsman, Cl. II., E.-in-C.O.	Draughtsman, Cl. I., E.-in-C.O.	17-6-35

RETIREMENTS.

Name.	Rank.	District.	Date.
Brown, Major H.	Deputy E.-in-C.O.	—	30-6-35
Gibbon, A. O.	Asst. Staff Engr.	E.-in-C.O.	30-4-35
Gadsby, G. J.	Exec. Engr.	E.-in-C.O.	28-2-35
Witherby, J. C.	Exec. Engr.	S. Wales.	9-3-35
Hills, W. H.	Asst. Engr.	E.-in-C.O.	29-4-35
Whetton, S. F.	Asst. Engr.	N. Eastern.	30-4-35
Flanagan, F.	Asst. Engr.	N. Wales.	30-4-35
Attrill, P. F.	Asst. Engr.	N. Eastern.	15-5-35
McLeod, N.	Asst. Engr.	E.-in-C.O.	24-5-35
MacMillan, F. S.	Chief Insp.	London.	12-3-35
Temple, H. A.	Chief Insp.	E.-in-C.O.	30-4-35
Disspain, G. W.	Insp.	London.	31-3-35
White, E. J.	Insp.	London.	31-3-35
Lee, J. W.	Insp.	N. Eastern.	27-4-35
Farrow, A. A.	Insp.	S. Eastern.	12-2-35
Simpson, C. R. E.	Insp.	Northern.	10-5-35
McHardy, R.	Insp.	Northern.	27-5-35
Walker, A. H.	Insp.	Testing Branch.	30-4-35
Baker, G. F.	Insp.	London.	31-5-35
Johnson, R.	Insp.	S. Wales.	30-5-35
Mushens, A. T.	Insp.	Northern.	15-6-35
Mitchell, J. N.	Draughtsman, Cl. II.	S. Lancs.	21-3-35
Stevens, E.	Draughtsman, Cl. I.	L. E.D.	30-4-35

DEATHS.

Name.	Rank.	District.	Date.
Miller, E. H.	Insp.	London.	20-5-35
Clark, S. J.	Insp.	S. Wales.	16-5-35

TRANSFERS.

Name.	Rank.	From	To	Date.
Miller, A.	Asst. Engr.	E.-in-C.O.	London.	10-3-35
Blake, D. E.	Asst. Engr.	London.	E.-in-C.O.	10-3-35
Clarke, C. W.	Asst. Engr.	Eastern.	S. Wales.	1-4-35
Brooke, C. H.	Chief Insp.	London.	E.-in-C.O.	1-4-35
Voss, L. C.	Insp.	E.-in-C.O.	Testing Branch.	24-5-35
Coombes, R. H.	Insp.	N. Wales.	E.-in-C.O.	1-6-35
Williams, C. H. M.	Draughtsman, Cl. II.	London.	E.-in-C.O.	1-6-35

APPOINTMENTS.

Name.	From.	To.	Date.
Wilcock, A.	Prob. Insp., E.-in-C.O.	Insp., E.-in-C.O.	1-6-35
Lawrence, J. A.	Prob. Insp., E.-in-C.O.	Insp., E.-in-C.O.	1-6-35
Cooper, W. H. B.	Prob. Insp., S. Midland.	Insp., S. Midland.	1-6-35
Jeffs, H.	Prob. Insp., N. Western.	Insp., N. Western.	1-6-35
Pooley, E. H.	Prob. Insp., Eastern.	Insp., Eastern.	1-6-35
Todhill, H.	Prob. Insp., S. Lancs.	Insp., S. Lancs.	1-6-35
Roberts, W. G.	Prob. Insp., E.-in-C.O.	Insp., E.-in-C.O.	1-6-35
Masters, E. J.	Prob. Insp., S. Midland.	Insp., S. Midland.	1-6-35
Dixon, J.	Prob. Insp., N. Western.	Insp., N. Western.	1-6-35
Seymour, R. A.	Prob. Insp., London.	Insp., London.	1-6-35
Probert, G. A.	Prob. Insp., N. Wales.	Insp., N. Wales.	1-6-35
Birnie, R. C.	Prob. Insp., Scot. West.	Insp., Scot. West.	1-6-35
Duggan, W. G.	Prob. Insp., London.	Insp., London.	1-6-35
Roberts, W. J.	Prob. Insp., London.	Insp., London.	1-6-35
Surman, W. L.	Prob. Insp., N. Midland.	Insp., N. Midland.	1-6-35
Heenan, J. P.	Prob. Insp., N. Midland.	Insp., N. Midland.	1-6-35
Crook, F.	Prob. Insp., London.	Insp., London.	1-6-35
Newson, F. W.	Prob. Insp., London.	Insp., London.	1-6-35
Rapkin, L. W.	Prob. Insp., London.	Insp., London.	1-6-35

APPOINTMENTS (continued).

Name.	From	To	Date.
Norris, J. W.	Prob. Insp., London.	Insp., London.	1-6-35
Stapley, G. R.	Prob. Insp., S. Lancs.	Insp., S. Lancs.	1-6-35
Branston, A. J.	Prob. Insp., London.	Insp., London.	1-6-35
Britton, A. D.	Prob. Insp., London.	Insp., London.	1-6-35
Wardrop, C. G.	Prob. Insp., London.	Insp., London.	1-6-35
Endecott, A. H.	Prob. Insp., E.-in-C.O.	Insp., E.-in-C.O.	1-6-35
Plumpton, F. E.	Prob. Insp., S. Midland.	Insp., S. Midland.	1-6-35
Winter, F.	Prob. Insp., Eastern.	Insp., Eastern.	1-6-35
Alston, G. J.	Prob. Insp., S. Lancs.	Insp., S. Lancs.	1-6-35
Wilcher, F. B.	Prob. Insp., E.-in-C.O.	Insp., E.-in-C.O.	1-6-35
Tinto, J. M.	Prob. Insp., S. Western.	Insp., S. Western.	1-6-35
Glazier, E. V. D.	Prob. Insp., E.-in-C.O.	Insp., E.-in-C.O.	1-6-35
Collins, J. E.	Prob. Insp., E.-in-C.O.	Insp., E.-in-C.O.	1-6-35
Easterling, C. E.	Prob. Insp., E.-in-C.O.	Insp., E.-in-C.O.	1-6-35
Harding, J. P.	Prob. Insp., London.	Insp., London.	1-6-35
Clarke, W. J. F.	Prob. Insp., E.-in-C.O.	Insp., E.-in-C.O.	1-6-35
Hickox, W. F.	Prob. Insp., S. Eastern.	Insp., S. Eastern.	1-6-35
Wheeler, L. K.	Prob. Insp., N. Wales.	Insp., N. Wales.	1-6-35
Ellen, L. W.	Prob. Insp., London.	Insp., London.	1-6-35
Hopkinson, E.	Prob. Insp., N. Eastern.	Insp., N. Eastern.	1-6-35
Hall, G. K.	Prob. Insp., N. Eastern.	Insp., N. Eastern.	1-6-35
Watt-Carter, D. E.	Prob. Insp., London.	Insp., London.	1-6-35
Burgess, A. G.	S.W.I., E.-in-C.O.	Prob. Insp., E.-in-C.O.	1-6-35
Neate, A. D.	U.S.W., E.-in-C.O.	Prob. Insp., E.-in-C.O.	1-6-35
Trueman, G. F.	S.W.II., S. Lancs.	Prob. Insp., E.-in-C.O.	1-6-35
Burr, D. W.	U.S.W., London.	Prob. Insp., E.-in-C.O.	1-6-35
Wells, L. A.	U.S.W., London.	Prob. Insp., E.-in-C.O.	1-6-35
McMillan, F. N.	S.W.II., E.-in-C.O.	Prob. Insp., E.-in-C.O.	1-6-35
Bird, J.	U.S.W., London.	Prob. Insp., E.-in-C.O.	1-6-35
Yells, H. M.	U.S.W., E.-in-C.O.	Prob. Insp., E.-in-C.O.	1-6-35
Humphreys, L. W.	S.W.II., St. Albans Radio.	Prob. Insp., E.-in-C.O.	1-6-35
Clifford, F. G.	S.W.II., London.	Prob. Insp., E.-in-C.O.	1-6-35
Chilver, L. W. J.	U.S.W., London.	Prob. Insp., E.-in-C.O.	1-6-35
Winkley, W. J. F.	U.S.W., London.	Prob. Insp., E.-in-C.O.	1-6-35
Lamb, A. H.	S.W.II., N. Eastern.	Prob. Insp., E.-in-C.O.	1-6-35
Branston, E. C.	S.W.II., London.	Prob. Insp., E.-in-C.O.	1-6-35
Spratley, E. W. F.	S.W.II., E.-in-C.O.	Prob. Insp., E.-in-C.O.	1-6-35
Kerner, S.	U.S.W., London.	Prob. Insp., E.-in-C.O.	1-6-35
Walters, J. R.	U.S.W., London.	Prob. Insp., E.-in-C.O.	1-6-35
Loughlin, J. J.	U.S.W., London.	Prob. Insp., E.-in-C.O.	1-6-35
Arthur, J. C. C.	S.W.II., London.	Prob. Insp., E.-in-C.O.	1-6-35
Moffatt, J. J.	S.W.II., London.	Prob. Insp., E.-in-C.O.	1-6-35
Sawyers, L. F.	U.S.W., London.	Prob. Insp., E.-in-C.O.	1-6-35
Kent, S. T. E.	U.S.W., London.	Prob. Insp., E.-in-C.O.	1-6-35
Lauderdale, F. S.	S.W.II., N. Eastern.	Prob. Insp., E.-in-C.O.	1-6-35
Russell, A. R.	S.W.II., London.	Prob. Insp., E.-in-C.O.	1-6-35
Halton, T. J. V.	S.W.II., S. Lancs.	Prob. Insp., E.-in-C.O.	1-6-35
Brian, R. H.	S.W.II., N. Midland.	Prob. Insp., E.-in-C.O.	1-6-35
Smith, N. D.	S.W.II., E.-in-C.O.	Prob. Insp., E.-in-C.O.	1-6-35
Dennis, H.	S.W.II., N. Midland.	Prob. Insp., E.-in-C.O.	1-6-35
Mead, A. C.	S.W.II., London.	Prob. Insp., E.-in-C.O.	1-6-35
Stevens, S. T.	S.W.II., Testing Branch.	Prob. Insp., E.-in-C.O.	1-6-35
Batt, T. D.	U.S.W., London.	Prob. Insp., E.-in-C.O.	1-6-35
Alexander, G. E.	S.W.II., London.	Prob. Insp., E.-in-C.O.	1-6-35
Milton, A. G.	S.W.II., London.	Prob. Insp., E.-in-C.O.	1-6-35
Barnsdall, L. G. W.	S.W.II., N. Midland.	Prob. Insp., E.-in-C.O.	1-6-35
Baxter, E. C.	U.S.W., E.-in-C.O.	Prob. Insp., E.-in-C.O.	1-6-35
Daniel, R. G.	U.S.W., E.-in-C.O.	Prob. Insp., E.-in-C.O.	1-6-35
Charles, E. E.	S.W.II., Rugby Radio.	Prob. Insp., E.-in-C.O.	1-6-35
Morgan, J. L. W.	S.W.I., E.-in-C.O.	Prob. Insp., E.-in-C.O.	1-6-35
Wadeson, D. E.	S.W.II., London.	Prob. Insp., E.-in-C.O.	1-6-35
Easton, W.	Unest'd Draughtsman, E.-in-C.O.	Prob. Insp., E.-in-C.O.	1-6-35
Smith, J. R. G.	S.W.II., London.	Prob. Insp., E.-in-C.O.	1-6-35
Phillips, H. A.	U.S.W., S. Western.	Prob. Insp., E.-in-C.O.	1-6-35
McEachan, J.	Draughtsman, Cl. II., Northern.	Prob. Insp., E.-in-C.O.	1-6-35
Groves, F. W.	S.W.I., London.	Prob. Insp., E.-in-C.O.	1-6-35
Kelly, F.	U.S.W., London.	Prob. Insp., E.-in-C.O.	1-6-35
Beardmore, R. J.	U.S.W., S. Western.	Prob. Insp., E.-in-C.O.	1-6-35
Varney, R. E. H.	U.S.W., London.	Prob. Insp., E.-in-C.O.	1-6-35
Eustace, J.	U.S.W., London.	Prob. Insp., E.-in-C.O.	1-6-35
Hayward, R. W.	S.W.II., London.	Prob. Insp., E.-in-C.O.	1-6-35
Barber, B. D.	U.S.W., London.	Prob. Insp., E.-in-C.O.	1-6-35
Smart, J. H. C.	S.W.II., S. Lancs.	Prob. Insp., E.-in-C.O.	1-6-35
Richardson, C. A.	U.S.W., London.	Prob. Insp., E.-in-C.O.	1-6-35
Fuller, W.	U.S.W., London.	Prob. Insp., E.-in-C.O.	1-6-35
Freeman, J. H.	U.S.W., London.	Prob. Insp., E.-in-C.O.	1-6-35
Turner, E.	S.W.II., Testing Branch.	Prob. Insp., E.-in-C.O.	1-6-35
Laver, K. S.	U.S.W., London.	Prob. Insp., E.-in-C.O.	1-6-35

APPOINTMENTS (continued).

Name.	From	To	Date.
Oakford, E. R.	U.S.W., London.	Prob. Insp., E.-in-C.O.	1-6-35
Moore, S. J.	S.W.II., London.	Prob. Insp., E.-in-C.O.	1-6-35
Stone, A. A.	Youth-in-Training, London.	Prob. Insp., E.-in-C.O.	1-6-35
Laver, F. J. M.	Open Competition, Dec., 1934.	Prob. Insp., E.-in-C.O.	1-6-35
Bomford, K. D.	Open Competition, Dec., 1934.	Prob. Insp., E.-in-C.O.	1-6-35
Morris, D. W.	Open Competition, Dec., 1934.	Prob. Insp., E.-in-C.O.	1-6-35
Neill, T. B. M.	Open Competition, Dec., 1934.	Prob. Insp., E.-in-C.O.	1-6-35
Harris, R. J.	Open Competition, Dec., 1934.	Prob. Insp., E.-in-C.O.	1-6-35
Hayman, H. W. S.	Open Competition, Dec., 1934.	Prob. Insp., E.-in-C.O.	1-6-35
Greenman, L. H.	Open Competition, Dec., 1934.	Prob. Insp., E.-in-C.O.	1-6-35
Mew, R. J.	Open Competition, Dec., 1934.	Prob. Insp., E.-in-C.O.	15-6-35
Cheek, P.	Open Competition, Dec., 1934.	Prob. Insp., E.-in-C.O.	4-6-35
Bradford, H. J.	Unest'd Draughtsman, E.-in-C.O.	Draughtsman, Cl. II., E.-in-C.O.	1-4-35
Alexander, H. C. A.	Unest'd Draughtsman, E.-in-C.O.	Draughtsman, Cl. II., E.-in-C.O.	1-4-35
Evans, C. I.	Unest'd Draughtsman, E.-in-C.O.	Draughtsman, Cl. II., E.-in-C.O.	3-4-35
Eamer, E. C.	Unest'd Draughtsman, E.-in-C.O.	Draughtsman, Cl. II., E.-in-C.O.	12-4-35
Baker, N. H.	Unest'd Draughtsman, E.-in-C.O.	Draughtsman, Cl. II., E.-in-C.O.	5-5-35
Manners, H. F.	Unest'd Draughtsman, E.-in-C.O.	Draughtsman, Cl. II., E.-in-C.O.	10-5-35
Flatt, H. H.	Unest'd Draughtsman, E.-in-C.O.	Draughtsman, Cl. II., E.-in-C.O.	2-6-35
Turner, H. B.	Unest'd Draughtsman, E.-in-C.O.	Draughtsman, Cl. II., E.-in-C.O.	3-6-35
Brain, C. C. F.	Unest'd Draughtsman, S. Western.	Draughtsman, Cl. II., S. Western.	1-3-35
Pead, H. H.	Unest'd Draughtsman, L.E.D.	Draughtsman, Cl. II., L.E.D.	11-3-35
Davenport, D. B.	Unest'd Draughtsman, L.E.D.	Draughtsman, Cl. II., L.E.D.	22-3-35
Simpson, G. E.	Unest'd Draughtsman, N. Midland.	Draughtsman, Cl. II., N. Midland.	19-5-35
Dunn, R. H.	Unest'd Draughtsman, S. Midland.	Draughtsman, Cl. II., S. Midland.	28-5-35
Stephens, T. W.	Unest'd Draughtsman, N. Midland.	Draughtsman, Cl. II., N. Midland.	4-6-35

CLERICAL GRADES.

RETIREMENTS.

Name.	Rank.	District.	Date.
Tyson, J.	Staff Officer.	Scot. West.	30-6-35
Thornburn, W. H.	Staff Officer.	S. Midland.	31-8-35
Walker, A. T.	Staff Officer.	N. Midland.	27-11-35
Bailey, W. R.	Higher Clerical Officer.	Scot. West.	22-7-35
Thompson, J. T.	Higher Clerical Officer.	S. Eastern.	9-8-35
Scouller, W. H.	Higher Clerical Officer.	Scot. East.	1-9-35

DEATH.

Name.	Rank.	District.	Date.
Impett, C. W.	Executive Officer.	E.-in-C.O.	3-5-35

PROMOTIONS.

Name.	From.	To.	Date.
Baker, A. J.	Exec. Officer, E.-in-C.O.	Actg. Staff Officer, E.-in-C.O.	22-4-35
Griffis, J. J.	C.O., E.-in-C.O.	Actg. Exec. Officer, E.-in-C.O.	22-4-35
Ford, A. W.	C.O., E.-in-C.O.	Actg. Exec. Officer, E.-in-C.O.	22-4-35
Collett, L. C.	C.O., E.-in-C.O.	Actg. Exec. Officer, E.-in-C.O.	22-4-35
Boyd, R.	Actg. Exec. Officer, E.-in-C.O.	Exec. Officer, E.-in-C.O.	31-5-35
Burton, A. E.	C.O., E.-in-C.O.	Actg. Exec. Officer, E.-in-C.O.	31-5-35
Schofield, W. H.	Actg. H.C.O., S. Midland.	H.C.O., S. Midland.	1-3-35
Simpson, W. W.	C.O., S. Midland.	H.C.O., Testing Bch., Birmingham.	7-4-35
Fewster, T.	Actg. H.C.O., Northern.	H.C.O., Northern.	1-4-35
Keith, H. J.	C.O., Scot. West.	Actg. H.C.O., N. Midland.	1-5-35
Cullen, M.	C.O., Scot. West.	Actg. H.C.O., Scot. West.	1-4-35
Binnington, T. C.	H.C.O., N. Ireland.	Staff Officer, N. Ireland.	22-3-35
Penfold, Major F.	H.C.O., S. Midland.	Staff Officer, S. Midland.	1-9-35
Barratt, D.	H.C.O., S. Lancs.	Staff Officer, S. Lancs.	To be fixed later.
MacLachlan, D.	H.C.O., Scot. East.	Actg. Staff Officer, Scot. East.	do.
Cullen, M.	Actg. H.C.O., Scot. West.	H.C.O., Scot. West.	11-5-35
Keith, H. J.	Actg. H.C.O., N. Midland.	H.C.O., N. Midland.	1-7-35

PROMOTIONS.

Name.	From	To	Date.
Slater, L. H.	C.O., N. Western.	H.C.O., N. Western.	11-5-35
Lawrie, T.	C.O., Scot. East.	Actg. H.C.O., Scot. East.	1-9-35
Roberts, E. J. S.	C.O., S. Midland.	H.C.O., S. Midland.	1-9-35
Dineen, W.	C.O., S. Eastern.	H.C.O., S. Eastern.	To be fixed later.
Nimmo, G.	C.O., Scot. West.	Actg. H.C.O., Scot. West.	23-7-35
Lothian, H. S.	C.O., Scot. East.	Actg. H.C.O., Scot. East.	1-9-35
Johnston, F.	C.O., Northern.	Actg. H.C.O., Northern.	22-4-35
Dunkerley, H. W.	C.O., S. Lancs.	Actg. H.C.O., S. Lancs.	To be fixed later.

TRANSFER.

Name.	Rank.	From	To	Date.
Parker, A. G.... ..	H.C.O.	N. Midland.	S. Wales.	1-5-35

BOARD OF EDITORS

- B. O. ANSON, M.I.E.E., Chairman.
 C. J. MERCER, M.I.E.E., M.I.R.E.
 P. J. RIDD, M.I.E.E.
 A. J. GILL, B.Sc., M.I.E.E., M.I.R.E.
 G. F. O'DELL, B.Sc., M.I.E.E.
 J. INNES, B.Sc., M.I.E.E.
 R. M. CHAMNEY, B.Sc., A.K.C., A.M.I.C.E.
 J. READING, B.Sc. (Eng.), A.M.I.E.E., Managing Editor.
 H. LEIGH, B.Sc. (Eng.), A.M.I.E.E., Assistant Editor.

Copyright

The entire contents of this Journal are covered by general copyright, and special permission is necessary for reprinting long extracts, but Editors are welcome to use not more than one third of any article, provided credit is given at the beginning or end thus: "From the *Post Office Electrical Engineers' Journal*."

The Board of Editors is not responsible for the statements made or the opinions expressed in any of the articles in this Journal, unless such statement is made specifically by the Board.

Communications

All Communications should be addressed to the Managing Editor, *P.O.E.E. Journal*, Engineer-in-Chief's Office, Alder House, Aldersgate Street, London, E.C.1. Telephone: NATIONAL 6321. Remittances should be made payable to "*The P.O.E.E. Journal*" and should be crossed "& Co."

Binding Cases

Binding cases and copies of the Contents for Vols. 3 to 27 are available, and may be obtained from the Local Agents for 1s. 9d. Subscribers can have their copies of Volumes bound, with index included, at a cost of 3s., by sending the complete sets of parts to the Local Agents or to the Publishers. Orders for binding for Vols. 3-19 should indicate whether the original binding case with black lettering, or the later pattern with gold, is required. Cases with gold lettering will be the only type stocked from Vol. 20 onwards.

Back Numbers

The price of the Journal, which is published quarterly, is 1s. (1s. 3d. post free) per copy, or 5s. per annum post free. Back numbers can be supplied, subject to availability of stocks, at 1s. each (1s. 3d. post free). Orders for back numbers may be sent to the Local Agents or to the Publishers.

Advertisements

All communications relating to space reservations should be addressed to the Advertisement Editor, *P.O.E.E. Journal*, Alder House, Aldersgate Street, London, E.C.1. Communications regarding advertisement copy, proofs, etc., should be addressed to the Publishers, Messrs. BIRCH & WHITTINGTON, 10, Station Road, Epsom, Surrey.

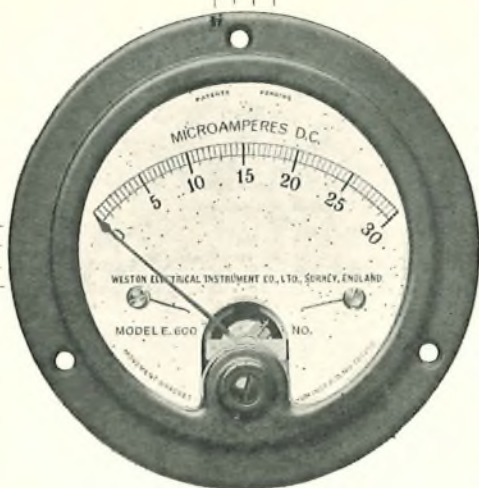

Model E 600

THE reliability and durability of WESTON instruments have been famous the world over for nearly half a century.

As a wide variety of WESTON British-made models is now available, you can now specify British-made WESTON instruments for your requirements, and thus be assured of having the best.

You are invited to write for particulars, mentioning the class of instrument in which you are interested.

WESTON
"Standard the World over"
PIONEERS SINCE 1800

Announcement of the Weston Electrical Instrument Co. Ltd.,
 Kingston By-pass, Surbiton, Surrey. Tel.: Elmbridge 6400-01.
 Telegrams: "Pivoted, Surbiton."

LATEST EXAMINATION SUCCESSSES

Since the B.I.E.T. was founded several years ago, we have specialised in preparing candidates for leading Technical Examinations, and our success may be gauged from the following remarkable results:

THREE 1st PLACES!

*In the 1932 and 1934 Probationary Inspectors' Examinations, and in the 1933 Assistant Superintendent of Traffic Examination, a B.I.E.T. Student obtained **First Place** in each case.*

FIRST TWO PLACES.

In the Asst. Superintendent of Traffic (Limited Competition) Examination, 1934, the candidates placed 1st and 2nd in the list were trained by the B.I.E.T.

*In the Probationary Inspectors' Examination held in December 1934, **71 B.I.E.T. candidates passed the Examination.***

*In the Assistant Superintendent of Traffic Examination held in 1934 **42 B.I.E.T. candidates passed the Examination.***

We teach successfully by correspondence and definitely guarantee—

"NO PASS--NO FEE"

You are advised to send for a copy of our General Prospectus "ENGINEERING OPPORTUNITIES." This Hand-book contains 268 pages of most useful information. It also contains particulars of all leading Engineering Examinations, including

Probationary Inspectors (Open & Limited Competition)
Probationary Assistant Engineers (Limited Competition)
Assistant Superintendent of Traffic (Open and Limited Competition)

City and Guilds, Special G.P.O. Examination, I.E.E., B.Sc., A.M.I.C.E., London Matric., etc., etc.

The Hand-book also outlines "up-to-the-minute" courses of Home-Study in all branches of Engineering.

Special Courses are offered in **Telegraphy, Manual Telephony, Automatic Telephony, Telephone Transmission, Electrical Technology, Wireless and High Frequency Radio Communication, Alternating Currents, etc., etc.**

Our 268 page Hand-book should be on your Book-shelf. It will be gladly sent on request, FREE and without obligation. (Please state subject or Examination of most interest).

British Institute of Engineering Technology

369, Shakespeare House,
 29/31, Oxford Street, London, W.1



1910 SILVER

LONDON TR

25 YEARS DE



AREA OCCUPIED
IN 1910

IN 1910, telephonic communication from London was limited to the main cities and towns in Britain and to Paris, Brussels, Calais, Boulogne and Lille.

The average overseas traffic was then about 1,000,000 mile-minutes per day which was handled at four manual positions.

All trunk calls were set up via record operators on a reverting basis and the average time taken to establish a connection was approximately 15 minutes.

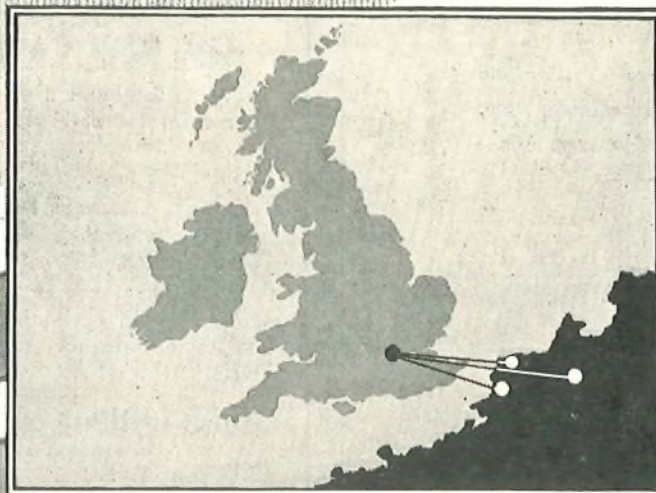

THEN A
"STANDARD"
MAINTAINS ITS H
FOR RELIABILIT

Standard Telephones
CONNAUGHT HOUSE.
Telephone:- F

JUBILEE 1935

TRUNK SERVICE DEVELOPMENT

TO-DAY, London can talk to Canada, South Africa, India, Australia and New Zealand, to nearly all the colonies and dependencies and to the principal foreign countries in the world.

The total average daily traffic overseas is about 12,000,000 mile-minutes and the number of positions handling it has increased to 100.

Improvements in equipment and methods have enabled nearly all inland trunk calls to be connected immediately on demand.

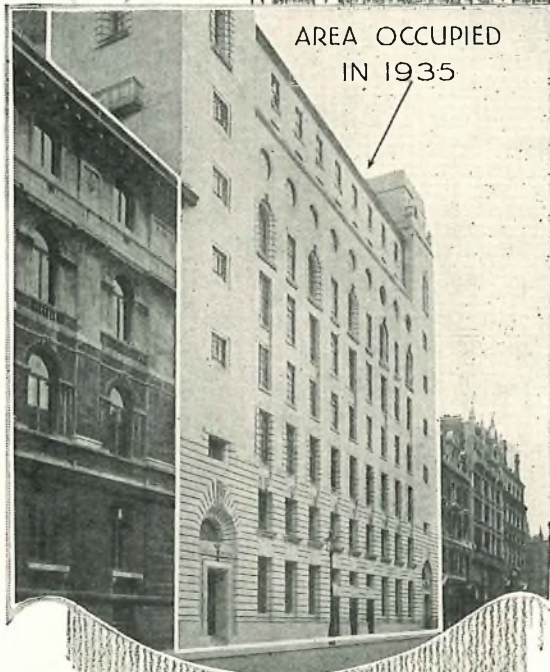

AREA OCCUPIED
IN 1935

**IS NOW
EQUIPMENT
HIGH REPUTATION
IN SERVICE**



and Cables Limited
ALDWYCH, LONDON, W.C.2
BOLBORN 8765.

INDEX TO ADVERTISERS.

	PAGE		PAGE
Automatic Telephone Mfg. Co., Ltd.	vi & vii	Hall Telephone Accessories (1928), Ltd.	xiv
British Institute of Eng. Technology	... xi	Pirelli-General Cable Works, Ltd.	... xviii
Creed & Co., Ltd.	... viii	Standard Telephones & Cables, Ltd.	xii & xiii
Croydon Cable Works, Ltd.	... ii	Siemens Bros. & Co., Ltd.	... iv & v
Ebonestos Insulators, Ltd.	... xiv	Smith, Frederick & Co.	... xvii
Elliott Brothers, Ltd.	... xvii	Telephony Publishing Corp.	... xiv
Ericsson Telephones, Ltd.	... iii	The General Electric Co., Ltd.	... x & xvi
Ernest T. Turner	... xv	The Bennett College, Ltd.	... xi
Evershed & Vignoles, Ltd.	... viii	Weston Elec. Instrument Co., Ltd.	... xi
Ferranti, Ltd.	... xv		

Hall Telephone Accessories (1928) Limited.

Suppliers to the British Post Office and
- Foreign Government Departments. -

Manufacturers of prepayment telephone multi-coin collectors, pre-selecting automatic dials, automatic stamp selling and ticket selling machines, automatic slot machines and fire alarm apparatus.

Registered
Office & Works : 70, DUDDEN HILL LANE,
WILLESDEN,
LONDON, N.W. 10

Tel.: WILLESDEN 51412/3.

Moulders to the Trade

*Established
30 Years*

**MOULDINGS
IN WHITE OR
COLOURS.
BAKELITE —
BEETLE
AND OTHER
SYNTHETICS**

PLASTIC MOULDINGS HAVING
HEAT — ACID — OIL — ALKALI —
WATER RESISTING QUALITIES.

EBONESTOS INSULATORS LTD

Excelsior Works,
Rollins Street,
Canterbury Road,

Telephone
NEW CROSS 1913 (5 lines) LONDON, S.E.15.



OF INTEREST TO ALL TELEPHONE ENGINEERS

Articles on every conceivable subject having to do with telephone engineering, design, construction and maintenance are published in the weekly issues of TELEPHONY. That is why this journal is read by progressive telephone men throughout the world. TELEPHONY has been the leader in its field for over thirty-three years. Subscription price \$5.00. U.S. money, for 52 interesting and instructive issues.

Address: Electrical Trading and Electricity Technical Book Dept., 85,
Long Acre, London, W.C. 2, for a sample copy of TELEPHONY.
TELEPHONY PUBLISHING CORP., 608, S. Dearborn St. Chicago, ILL, U.S.A.

Ferranti

ELECTROSTATIC VOLTMETERS

From 0-150 Volts to
0-3500 Volts for use
on D.C. and A.C.

NO ENERGY CONSUMPTION.
MAGNETIC DAMPING. 2½" 3¼" and 4" DIALS
FLUSH, PROJECTING & PORTABLE TYPES
Over-Voltage Protection Incorporated

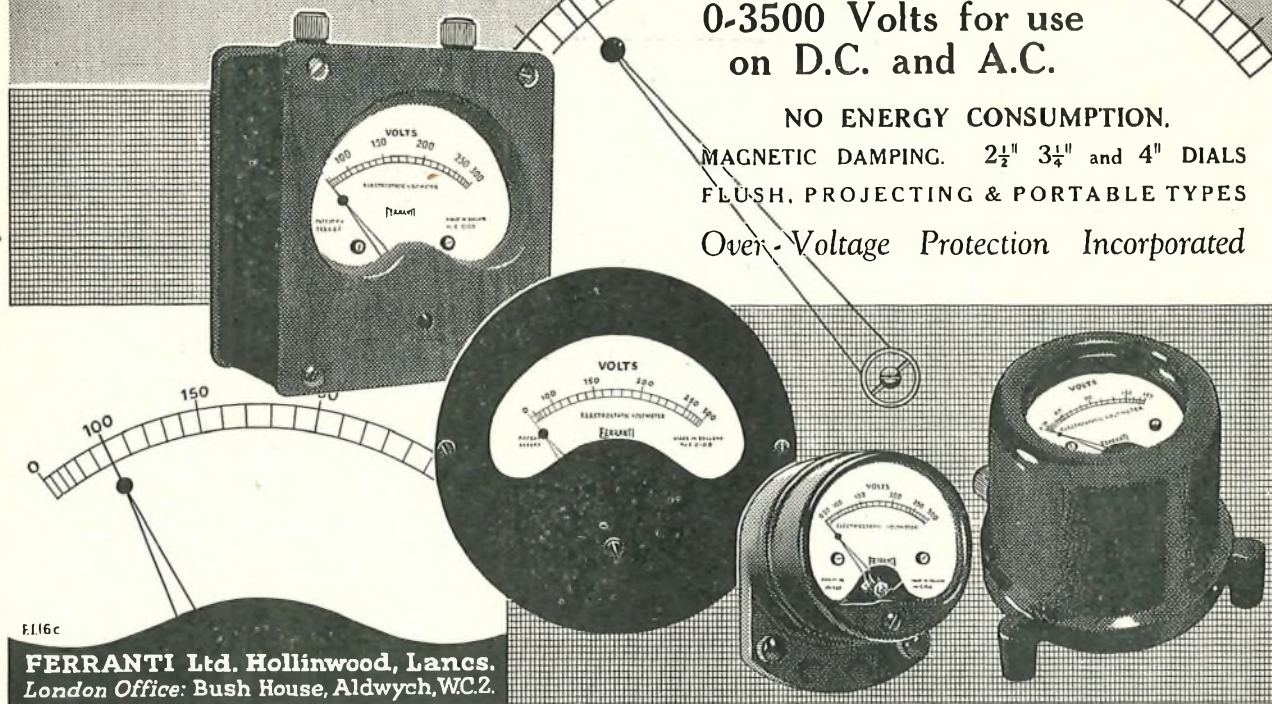

FERRANTI Ltd. Hollinwood, Lancs.
London Office: Bush House, Aldwych, W.C.2.

TURNER DIFFERENTIAL MILLIAMMETERS G.P.O. No. 17 & No. 18

Meet the most
exacting demands
for balancing currents
in multiplex telegraph circuits.
—A quality
product of outstanding
merit—

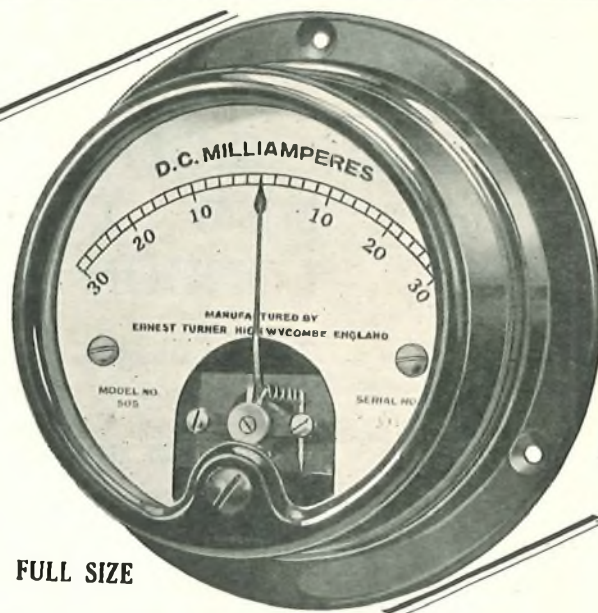

FULL SIZE

Also manufacturers of G.P.O.
Detector No. 4, and a compre-
hensive line of instruments for
precision electrical measure-
ments.

ERNEST TURNER ELECTRICAL INSTRUMENTS, Ltd.

**CHILTERN WORKS,
55-73, TOTTERIDGE AVENUE,
HIGH WYCOMBE,
BUCKS, ENGLAND**

Telephone: High Wycombe 301.
Telegrams: Gorgeous, High Wycombe.

G.E.C.

LOADING COILS



with
GECALLOY CORES
FOR BROADCASTING
CARRIER FREQUENCY
AND TRUNK LINE
CIRCUITS

G.E.C. loading coils
being lowered into
a manhole near
Lancaster, 1934.

**AS USED FOR THE LANCASTER
- CARLISLE SECTION OF THE
NEW TRUNK TELEPHONE LINE
LONDON TO GLASGOW**

G.E.C. Loading Coils can be installed in manholes as shown above or buried direct, or used on aerial lines.

SUPPLIED TO THE GENERAL POST OFFICE, COLONIAL GOVERNMENTS, Etc.

Made at **THE SALFORD ELECTRICAL INSTRUMENT WORKS**
of

THE GENERAL ELECTRIC CO., LTD.,

Head Office: **MAGNET HOUSE, KINGSWAY, LONDON, W.C.2**

Branches throughout Great Britain and in all the principal markets of the World

Differential Moving Coil **MILLIAMMETERS**
For Telegraph Circuits

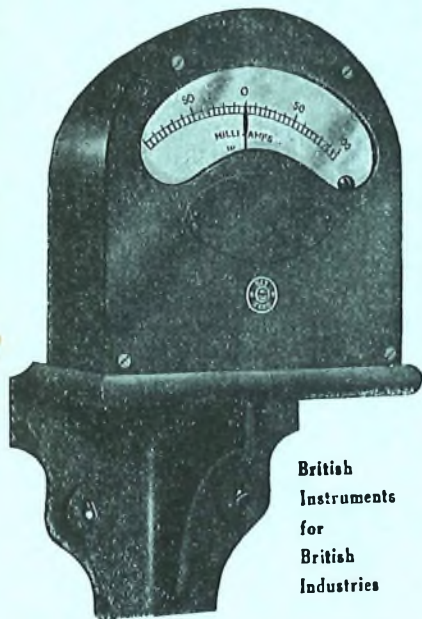

T. 1098 WALL MOUNTING TYPE.

British
Instruments
for
British
Industries



T. 1089. PANEL MOUNTING TYPE.

Frequency and many other Telegraph Systems, also for testing purposes in connexion with Land Line and Radio Communication.

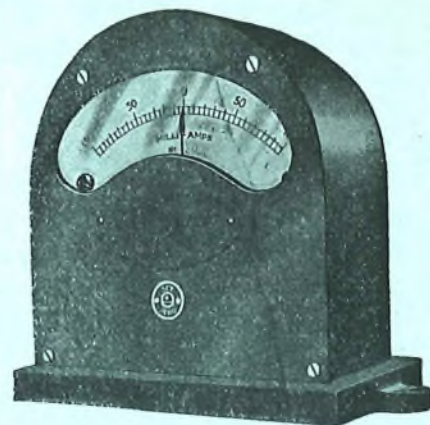

T. 1097. TABLE MOUNTING TYPE.

TABLE, WALL AND PANEL
MOUNTING TYPES

INVALUABLE as line Milliammeters on Differential Duplex, Sub-Audio

Particulars will be sent on request.

ELLIOTT BROTHERS (London) LTD., Century Works, Lewisham, S.E.13

Telephone:
Lee Green 4648

in association with

SIEMENS BROTHERS & COMPANY, LIMITED, Woolwich, London, S.E.18

Telephone:
Woolwich 1161

ANACOS

REGISTERED

BRONZE & CADMIUM COPPER WIRES

SEND US PARTICULARS
OF YOUR JOB, AND OUR
TECHNICAL ENGINEERS
WILL PROVIDE YOU WITH
THE DATA YOU NEED.

as supplied
to H.M. Post Office for
TELEPHONE LINES

SILICIUM-BRONZE, COPPER
COPPER - CADMIUM
TAPES & BINDERS

FREDERICK SMITH & COMPANY

INCORPORATED IN THE LONDON ELECTRIC WIRE
COMPANY AND SMITHS, LIMITED
ANACONDA WORKS SALFORD 3, LANCs.
Telephone: Blackfriars 8701 (8 lines) Telegrams: Anaconda, Manchester."

SOUTHAMPTON- BOURNEMOUTH

THE INSTALLATION OF
28 MILES
OF PIRELLI-GENERAL
104 PR/20 P C.Q TRUNK
CABLE HAS JUST BEEN
COMPLETED

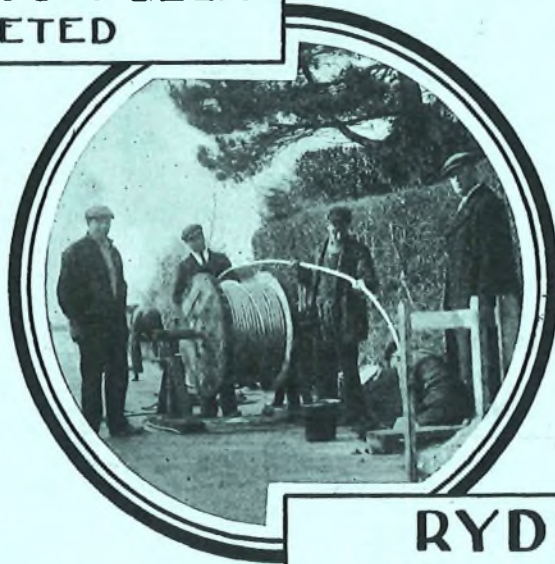

RYDE- VENTNOR

THE INSTALLATION OF
A FURTHER 14 MILES
OF PIRELLI - GENERAL
TELEPHONE CABLE LINKING
UP RYDE - BRADING - SANDOWN
SHANKLIN - VENTNOR IS
NOW IN PROGRESS.

TELEPHONE:
SOUTHAMPTON
2141 (3 LINES)

PIRELLI-GENERAL
CABLE WORKS, Ltd., SOUTHAMPTON

TELEGRAMS:
"PIGEKAYBEL,
SOUTHAMPTON."

Proprietors: PIRELLI, LTD., and THE GENERAL ELECTRIC CO., LTD.