

THE LISTENER'S RESPONSIBILITY—BY SIR JOHN REITH

MODERN WIRELESS

1/1-

Vol. XIV. No. 43

July 1930

THIS MONTH'S
SPECIAL FEATURE

THE L.F. TRANSFORMER REVIEW



ALSO THIS MONTH:

THE "STAR-TURN"
FOUR
AND
THE "STAR-TURN"
CRYSTAL SET

Two powerful designs, each
embodying the new "M.W."
principle of selective
tuning.

RADIO CONSULTANT-IN-CHIEF Capt. P. PECKERSLEY M.C.

PLAIN FACTS ON THE POWER VALVE



The degree of signal energy produced by the amplifier stages of a receiver has tremendously increased with the development of modern radio design. As a result it is essential that an output valve capable of handling big power is used in the last stage. A harsh distorted speaker performance is the result of using an output valve of insufficient power-handling qualities. In the range of Mullard Power and Super Power valves there is a type for your own receiver. Long experience and advantages in the manufacturing process enable us to produce a power valve that is unsurpassed in performance and service.

Ask your dealer for the following type numbers:—

<u>Power</u>	<u>Super Power</u>
2 volt P.M.2.	P.M.252.
4 volt P.M.4.	P.M.254.
6 volt P.M.6.	P.M.256.

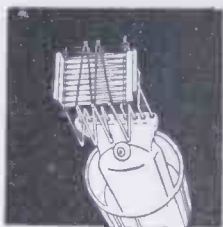

Above: The Mullard P.M. Filament, which since its discovery, over four years ago, has set a precedent in radio valve design.

Mullard
THE · MASTER · VALVE

ADVT. THE MULLARD WIRELESS SERVICE CO., LTD., MULLARD HOUSE, CHARING CROSS ROAD, LONDON, W.C.1.

Arks

CONTENTS

VOL. XIV. No. 43. MODERN WIRELESS. JULY, 1930.

	Page		Page
Editorial	3	On the Short Waves	81
The "Star-Turn" Four	4	The "Star-Turn" Crystal Set	52
Melbourne's Masterpiece	9	Questions Answered	56
Banishing Background	11	The "Varley" Three	57
"Neuting" the S.G.	13	Your L.F. Valves	59
The World's Programmes	15	How Diagrams Help	61
New Components	18	Too Many Volts?	63
Mixing the Melody	21	America's Television Theatre	64
The "Reactive" Two	22	Mixing Speakers	66
Telephone Vision	26	From Cone to Coil	67
The Ferranti A.C. Mains Receiver	27	A Novel Wavemeter	69
Your Electric Motor	28	The K.B. Portable	72
The "M.W." L.F. Transformer Review	29	The Dubilier D.C. Mains Set	74
My Broadcasting Diary	37	In Passing	75
Human Electricity	39	Radio in Hungary	78
At Your Service	41	Set-Making by Machinery	79
Loudspeaker Correction	43	H.F. Switching	83
Output Control	44	Radio Battery Pointers	87
The Eye Radio Portable	45	Canada's Railway Radio	89
Trouble Tracking	47	Radio Notes and News	90
The Listener's Responsibility	48	Energy From the Sun	95
Screens and Screening	50	Recent Record Releases	98
		From Our Readers	100

As some of the arrangements and specialities described in this Journal may be the subject of Letters Patent the amateur and trader would be well advised to obtain permission of the patentee to use the patents before doing so.

Edited by **NORMAN EDWARDS.**

Technical Editor: **G. V. DOWDING, Associate I.E.E.**

Radio Consultant-in-Chief: **Capt. P. P. ECKERSLEY, M.I.E.E.**

Scientific Advisor: **J. H. T. ROBERTS, D.Sc., F.Inst.P.**

FERRANTI Radio Meters are *essential* to the expert and the ordinary listener alike

To adjust a Radio Receiver to give the best results all voltages and currents must be right. The right H.T. on the anodes of the valves, the right grid bias and anode current, and correct L.T.

To ensure these things a Radio Meter is essential.

A Radio Meter enables L.T. and H.T. accumulators to be kept in good condition by indicating when charging is necessary, and prevents the irritation of lost programmes through batteries running down unexpectedly.

For all these purposes and many others a Radio Meter is a necessity, and the best Radio Meter is FERRANTI.

Ask for List W.406.

PRICES FROM

35/-



COSSOR

New Process

A.C. Mains Valves

**6 Types
Now
Available**

TO the long list of Cossor achievements is now added this series of New Process A.C. Mains Valves. You'll find in them a fidelity of reproduction that has never before been achieved. Remember their Inter-locked Construction System gives them unequalled strength. For pure, trouble-free radio use Cossor New Process A.C. Mains Valves—they will never let you down.

Mains Valves

4-volt Indirectly Heated Cathode		Heater Amps.	Anode Volts	Impedance	Amp. Factor	Price
41 M.H.F.	H.F. or Detector	1 amp.	200 max.	14,000	32	15/-
41 M.L.F.	First L.F. Stage	1 amp.	" "	7,900	15	15/-
41 M.R.C.	R.C.C. or Detector	1 amp.	" "	20,000	35	15/-
41 M.P.	Normal Power Use	1 amp.	" "	5,000	13	17/6
41 M.X.P.	Extra Power	1 amp.	" "	2,000	6	25/-
41 M.S.G.	Screened Grid	1 amp.	" "	400,000	1,000	25/-

Rectifying Valves

		Filament Amps.	Anode Volts	Output	Price
612 B.U.	Full Wave Rectifier	.4 amp.	250	50 m.a.	20/-
412 B.U.	Full Wave Rectifier	1.0 amp.	250	70 m.a.	20/-
412 S.U.	Half Wave Rectifier	1.0 amp.	250	70 m.a.	15/-
624 B.U.	Full Wave Rectifier	2.0 amp.	550	60 m.a.	20/-
625 B.U.	Full Wave Rectifier	3.0 amp.	550	120 m.a.	22/6
44 S.U.	Half Wave Rectifier	.4 amp.	200	20 m.a.	15/-

A. C. Cossor Ltd.
Highbury Grove, London, N.5.

Depots at:

- | | | |
|--|--------------------------------------|---|
| BIRMINGHAM:
8 Temple Street. | BRISTOL:
14 Bath Street. | DUBLIN:
Corn Exchange Bdgs., Burgh Quay. |
| GLASGOW:
200 St. Vincent Street. | LEEDS:
4 Park Place. | LIVERPOOL:
42 Paradise Street. |
| MANCHESTER:
21 Bridge Street. | NEWCASTLE:
15 High Bridge. | SHEFFIELD:
Congo Buildings, 30 Trippett Lane. |



Cossor New Process Battery Valves in 2, 4 and 6 volt type are also obtainable from any wireless shop.

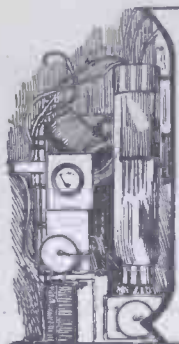

MODERN WIRELESS

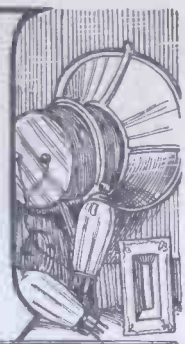

Vol. XIV. No. 43.

July, 1930.

This Month's Sets—The "M.W." Transformer Review—The New B.B.C. Chairman—"To Entertain and Instruct"—How the B.B.C. is Governed—Two More Members of the Board?

This Month's Sets

THE sets in this issue include the "Star-Turn" Four, which is another outstanding design using the famous "M.W." Star-Turn coils. The special points about this receiver are great range and power, first-class selectivity, and very simple control.

The "Reactive" Two has been so named because of the remarkably fine and smooth reaction obtainable in this simple receiver. The set was not designed for those in the swamp areas of local stations, but it has adequate selectivity for all normal purposes, and sensitivity well above the average.

The "Star-Turn" Crystal Set includes the Star-Turn principles, which are applied to the simplest possible form of receiver. The result is a crystal set with knife-edge selectivity, plus the quality of unusual power. You can easily build this set, and you will get good results even if your local station is practically next door.

The "M.W." Transformer Review

THE "M.W." L.F. Transformer Review should prove of considerable value to constructors, for in this special illustrated supplement all the leading makers of transformers are dealt with, and their products illustrated. The theory and use of the transformer is also dealt with in detail and should prove a mine of useful information for the set builder.

The New B.B.C. Chairman

THE appointment of the ex-Speaker, Mr. J. H. Whitley, to preside over the Board of the B.B.C., caused a good deal of surprise, for more than one reason. To begin with, Mr. Whitley is Chairman of the Committee which is inquiring into Labour conditions in India. He will thus hold two important posts. As Chairman of the B.B.C. he will receive £3,000 a year, which, plus his pension of £5,000 a year, makes a very nice sum.

"To Entertain and Instruct"

THE names of Lord Lee, Lord D'Abernon, Mrs. Snowden, Lord Gainford, and others, have all been mentioned in connection with the post, but it was not until the last minute that Mr. Whitley was known to be a likely candidate.

To quote the "Saturday Review": "The appointment of Mr. Whitley as Chairman of the B.B.C. is an odd one. The business of the B.B.C. is to entertain and instruct, the business of a Speaker of the Commons is neither. But we must hope for the best; if he cuts short some of the more tedious broadcast talks he will earn our gratitude and his own salary."

With the above we are in complete agreement.

How the B.B.C. is Governed

THE Board of the B.B.C., as at present constituted, is as follows: Mr. Whitley (Chairman), with salary of £3,000 a year; Lord Gainford (Vice-Chairman), salary £1,000 a year; Sir Gordon Nairne, Dr. Montague Rendall, and Mrs. Philip Snowden, who each receive £700 a year.

The Charter entitles the B.B.C. to a Board of seven members, but whether the two vacancies will be filled is a matter for some speculation.

Rumour had it that Sir John Reith, the Director-General, would be given a seat on the Board, but this has not transpired at the time of going to press.

Two More Members of the Board?

CAPTAIN IAN FRASER, the Chairman of the B.B.C.'s Listeners' Organisations' Advisory Committee, has also been mentioned as a likely candidate. Captain Fraser would certainly be an excellent choice, and his nomination to the Board would be welcomed everywhere.

Whether there is any truth in the rumour that Mr. C. B. Cochran, the well-known producer, is another candidate, we cannot tell, but with Mr. Cochran on the Board listeners would at least be pretty sure of getting a greatly improved programme service, and incidentally some really first-class vaudeville.

Fraser and Cochran are, indeed, two ideal men for the vacancies.

These two men would prove more than valuable—Captain Fraser for his energy, disinterestedness, and devotion to the cause of broadcasting; and Mr. Cochran for his brilliant qualities as a producer, and expert knowledge of entertainment psychology.

We hope they will be appointed.

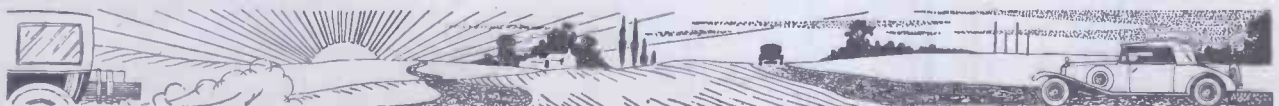

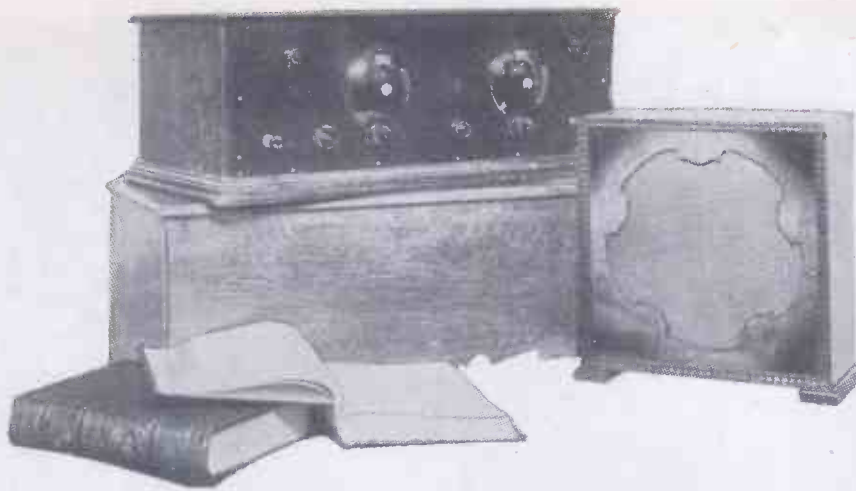

The

Those are just two of the primary requirements which the listener asks from a good loud-speaker set. He wants a lot more than those for his money.

Even a good "local-station" set will give good measure in these respects, if carefully designed, but most "M.W." readers will not be tied down to their local station. Most of us have the radio wander-lust.

We want sets that can sweep the Continent for concerts, and in these days of high-power programmes we feel we are missing something if we can't call on Vienna for a waltz, or rely on Rome for an opera.

Simple Control

In a nutshell, we want plenty of programmes to choose from, Continental as well as British, high quality and adequate power being taken for granted. And we want a lot more than that.

IT was only the month before last that we introduced readers of MODERN WIRELESS to our latest line of sets—the "Star-Turn" series. Yet already they are firm friends! Shoals of letters have reached us praising the phenomenal selectivity, the ease of handling, and the wonderfully realistic quality of reproduction attainable with the "Three" and the "Two" which have appeared; but this month we come to the acknowledged star-turn of all the "Star-Turns"—the "Four."

However you look at it there is something supremely satisfying about a good four-valver, because of the power it has in hand. There is no straining after effect, no uncertainty, no "perhaps-I-can" about operating a really good "Four."

Getting Real Power

When an efficient H.F. stage pulls in a station and hands it on to a sensitive detector, and when the detector hands it on to an L.F. valve that really is amplifying well and truly, the last valve receives a robust input which, after being amplified finally for the loud speaker, is something to rejoice over. You have the power—majestic and unmistakable; and you have the delicacy of detail that goes so satisfyingly with great power.

It will be remembered that back in May we said that the "Star-Turn" Three was only a beginning, and that good things were to follow.

This was no idle promise. In putting you on to the "Star-Turn" Four we are putting you on to "a good thing" in the truest sense of that hard-worked phrase.

Set Requirements

Perhaps this all sounds a little lyrical for a constructional article. But look at the circuit, and judge for

yourself whether we are not fully justified in being shaken out of our usual calm.

Let us purposely get ourselves into a critical frame of mind, and ask what it is that we should expect of a really first-rate set in the admittedly difficult transition period through which broadcasting is now passing. What should we like a set to do?

First of all we want quality. Real, satisfying music, tuneful and tone-full. With drums that are drums, flutes

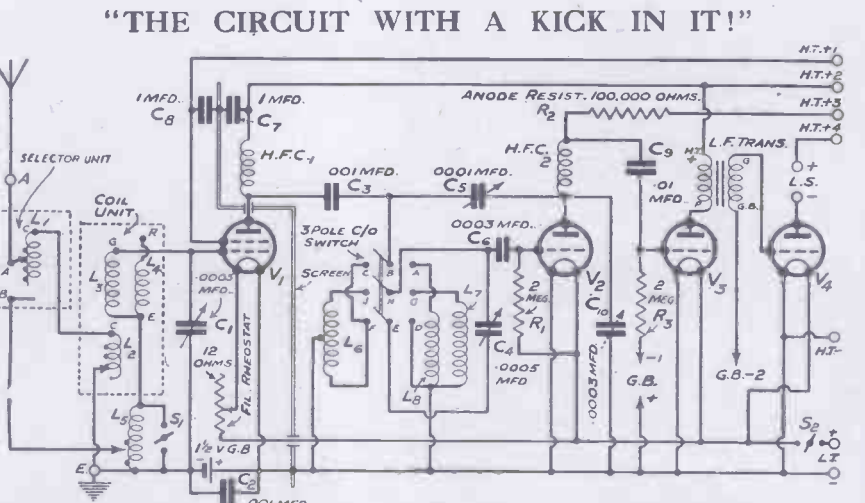

Tremendous power is developed by the circuit arrangement of the "Star-Turn" Four, and the selector unit in the aerial gives that extraordinary selectivity which is so desirable nowadays, but so seldom met with in practice. A striking feature of the set is the ease with which both wave-bands can be explored by the tuning controls.

that are flutes, and all the other instruments in the orchestra not only recognizable, but realistically reproduced.

And we not only want fidelity of tone, but we want full tone. The volume must be there if wanted, even if we hold it in reserve most days of the week, contenting ourselves with the quieter items, until a symphony concert comes along and we feel we want the full-blooded beauty of massed musical effects.

Selectivity we must have, for the Continent is no good at all if you have to wait till the local station closes down to get it free from background. The set must pass from station to station with the finality and completeness of a railway train on a main line!

Ease of tuning is another absolute necessity. The day is past when tuning was a creditable conjuring trick. Hanging on to a dial with each hand, holding the breath, and hoping

"Star-Turn" Four

If you want superb power and a really striking degree of selectivity this is the set for you! A wonderful range of programmes, easily "pulled in" and rendered with magnificent fidelity of tone—that is what you get with this easy-to-make set.

Designed and Described by the "M.W." Research Dept.

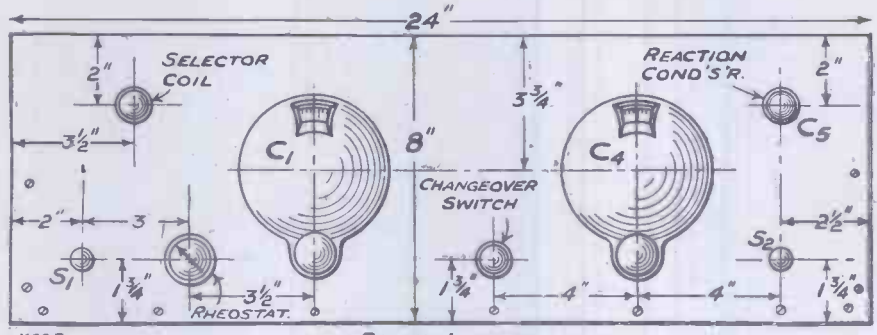

PANEL LAYOUT.

There is a pleasing "handiness" and accessibility about the layout which makes for very easy operation and smooth control on all wave-lengths.

for the best, is definitely out of date. We want our stations "on tap."

Add to all this the facts that we don't want to spend too much money, nor use a lot of trick components that are difficult to wire up, nor be excluded from the long-wave stations unless we change the tuning coils, and you have enumerated most of the desirable features that the discriminating listener would like.

But the really artful old hands will ask for still more than that! "About the volume control," they will say. "Is it smooth?"

"And what about the screening? Is everything boxed in, or is the base-board get-at-able?" And the best way we can answer all these points is

to run over the circuit of the "Star-Turn" Four.

The diagram (on the first page) shows it to be a set with one high-frequency amplifying stage of the screened-grid variety, followed by a detector and two low-frequency amplifiers.

The detector is the standard and universally approved arrangement of leaky-grid, with condenser-controlled reaction, whilst the first low-frequency stage is resistance-capacity coupled, and the second is of the transformer-coupled type. (A very strong com-

ination which many enthusiasts feel sure has never had the full recognition which its merits deserve when it follows an H.F. stage.)

Secret of Selectivity

Where does the phenomenally good selectivity of which the set is capable come from? The main answer to that question is in the rather remarkable aerial circuit which has been chosen.

The aerial terminal, you will see, is connected to a switch-arm on a selector unit, the coil inside which is marked L_4 . For the long waves the

This close-up of the back of the set shows how the main components are placed and wired.

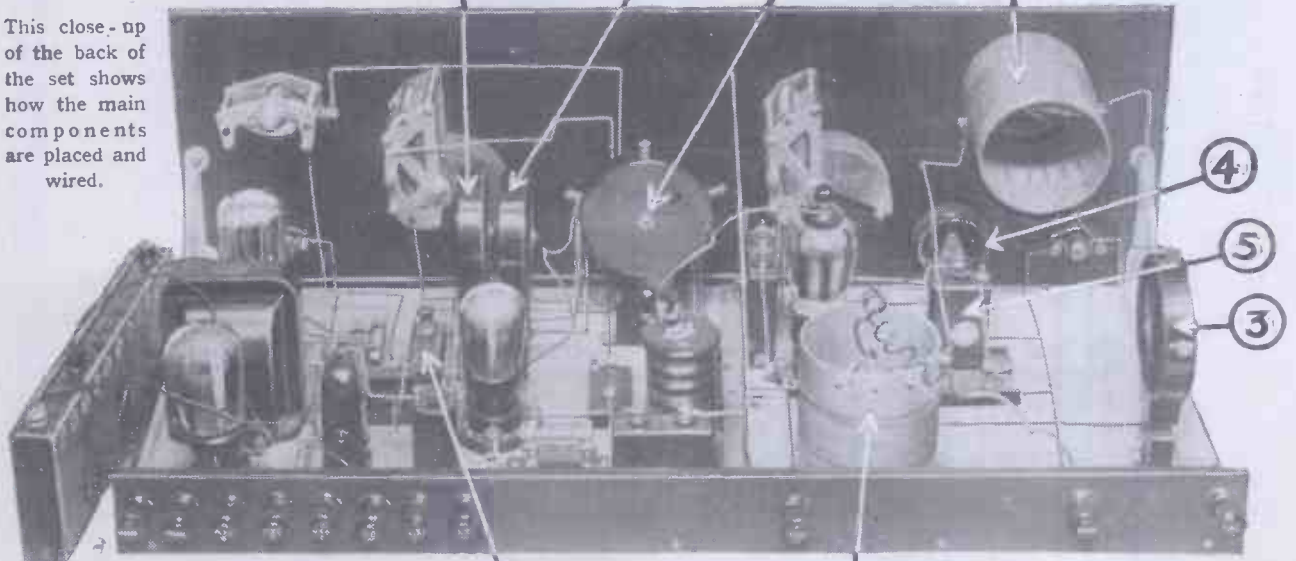

(1) is the special selector coil which is controlled from the front of the set; (2) the coupling coil unit, and (3) the long-wave aerial coil. Volume is controlled by the H.F. valve's rheostat (4).

The grid bias for the S.G. valve is shown at (5), and (6) is the detector's grid coil for the lower waves.

The numbers (7) and (8) denote L_7 and L_8 respectively, the latter being the long-wave reaction coil. The H.F. by-pass condenser across the detector valve is shown at (9).

Easy to Build and Easy to Tune

switch-arm is placed on B, which cuts out L_1 , and brings the aerial lead to the tappings on the long-wave coil L_5 .

For ordinary wave-lengths, where we want the stations to "come in" and to go out within only a few metres of one another, the adjustment of the selector switch serves as a swift and easy aerial tuning adjustment. And joined to L_1 is the coil L_2 , which is the link between the aerial and the grid circuit of the H.F. valve.

Clean-Cut Tuning

This coil L_2 is a very small one. And, moreover, it is connected to earth by means of a plug on a flex lead which enables it to be made

the set going near a powerful local station, and have experienced the clean-shave feeling which it gives.

L_2 passes on the cleaned-up output from the aerial circuit into L_3 , which is tuned in the usual way by the tuning condenser C_1 , and connected to the grid of the S.G. valve. There are several points about this valve which are worthy of mention.

For one thing it is provided with negative grid bias from a $1\frac{1}{2}$ -volt battery, which not only economises its H.T. requirements, but further assists to get star-turn selectivity.

The filament rheostat in series with the positive L.T. lead to this valve

cutting out the long-wave coil in conjunction with the switch-arm in the selector unit already referred to.

On the other side of the screen a 3-pole change-over switch is used to go from one wave-band to the other.

Long-Wave Arrangement

The action of this is interesting, and will readily be understood from the diagram. The contacts marked A, B, and C govern reaction connections, while D, E, F, and G, H, J, attend to the tuning coils.

The long-wave coil L_7 gets its reaction effects from a separate reaction coil L_8 , placed in the adjacent coil holder. (All coil sizes, etc., are mentioned later.)

When the switch is thrown over to the lower wave-band only one coil (L_6) is used, and this serves for both reaction and tuning on the well-known Hartley system. To accomplish this the lower-wave coil L_6 must be of the centre-tapped variety (the centre-tapping making connection to the filament circuit by means of a flex lead coming from the V_1 valve holder).

Not much need be said about the detector and following stages, as these follow conventional lines, but one point is perhaps worthy of emphasis. It is in connection with the variable condensers C_5 and C_{10} , both of which are connected to the plate of the detector V_2 .

C_5 is the condenser which controls reaction, and in order to provide an additional H.F. escape path and so ensure maximum signal strength, C_{10} is used in conjunction with it, and needs adjustment only when the set is first put in action. After this C_{10} is left alone for good.

The Reaction Scheme

You will see that C_{10} by-passes H.F. impulses from filament to plate direct, while the reaction condenser conveys H.F. currents through their respective reaction windings, according to which way the 3-pole switch is working. The idea is to set C_{10} permanently in such a position that adequate reaction results are only just obtainable with C_5 for all dial positions. You can do it in a couple of minutes when the set is working, and after that C_{10} is ignored, and whatever reaction you may require is smoothly supplied by C_5 .

PLENTY OF POWER PROVIDED

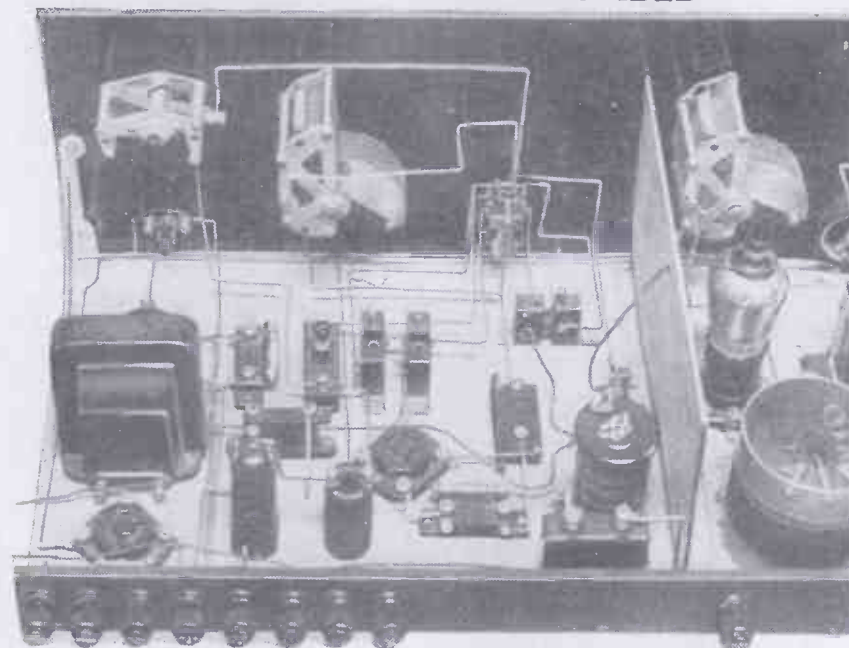

The wiring to the change-over switch is really very simple, as this illustration shows, and you will find all the contacts and connections clearly marked on the wiring diagram. When finished the set gives an easy change-over from low to long waves, with a wonderful choice of alternative programmes.

smaller still. As this small coil affords the only coupling between the already tuned-and-selective aerial and the set itself, we have here the clue to the uncanny keenness of tuning which is possible with this set.

To call it "knife-edge" would be to put it far too bluntly. "New-razor-blade-edge" gives a better idea, but we can't hope to convey in these cutlery terms much idea of the effect which is obtained. You will understand our difficulty in adequately describing it when you have got

gives a smooth and effective control of volume. For a 2-volt valve use 5 or 6 ohms, or for a 6-volter use 20 ohms. The value shown (12 ohms) is O.K. for 4-volters, and can, at a pinch, control either a 2- or a 6-volter, though the above values are better.

The H.F. input is adequately shielded from the stages which follow it by means of one simple screen, which is amazingly effective in use.

On the input side of the screen is the H.F. wave-change switching, which is a very simple affair, the switch S_1

The constructional work necessary to build the set is all of the straightforward variety, and really it hardly seems necessary to say much about it. The list of parts tells you what to buy, and gives a good selection of alternative makes, so that there should be no difficulty here.

Panel-drilling dimensions are given on a separate diagram, and on the wiring diagram a scale is given for the making of a cardboard "ruler." With this distances on the diagram itself can be measured, and with a proper ruler they can be transferred to the actual baseboard, etc. Be sure to get the coil holders, screen, coil unit, choke, etc., in the correct relative positions, for although it looks such a simple set the "Star-Turn" Four has a rare punch that will do a lot of disconcerting things if not properly applied to the right place.

Trying the Set

It will be a pity if you hurry over the constructional work. Not only is it more enjoyable to take time and make a good job of it, but it is better from a reliability point of view to have everything "just so," because the set will prove such a pleasure in use that you will feel like kicking yourself if you have to take it down to do some half-scamped soldering all over again.

For the long waves the aerial-coil socket (L_5) needs a 200 X coil or 150 centre-tapped, and the H.F. socket, L_7 , a 250-turn "plug-in." The long-

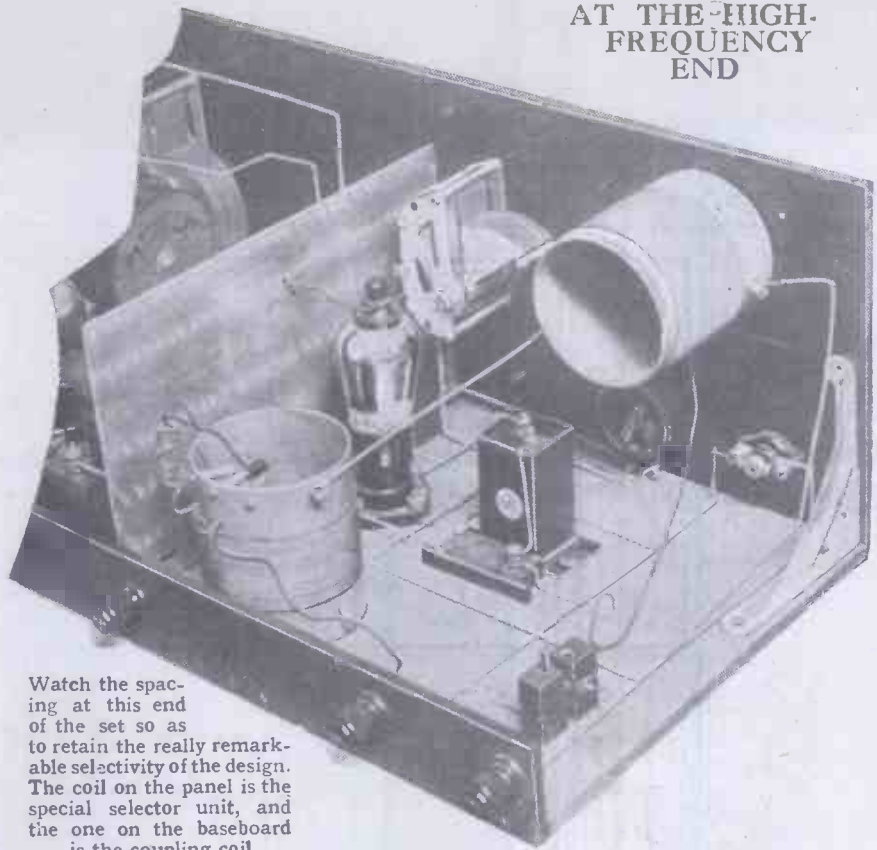

AT THE HIGH-FREQUENCY END

Watch the spacing at this end of the set so as to retain the really remarkable selectivity of the design. The coil on the panel is the special selector unit, and the one on the baseboard is the coupling coil.

wave reaction, L_8 , will need either a 100 or 150 plug-in coil, the H.T. +3 plug and C_{10} being adjusted in the manner we have already detailed.

For the lower wave-band the aerial and grid coils are contained in the coil units, but you will need a

60-turn centre-tapped coil for the L_9 socket.

Two-, four-, or six-volt valves all work excellently in this set, the screened-grid valve being of the upright type shown. For the detector use an "H.F." valve (20,000 ohms or so), the following valve (V_3) being

THE PARTS YOU NEED TO MAKE THE "STAR-TURN" FOUR

- 1 Panel 24 in. x 8 in. (Goltone, or Trollie, Paxolin, Keystone, etc.).
- 1 Cabinet to fit with baseboard 10 in. deep (Pickett, or Keystone, Camco, Lock, etc.).
- 2 .0005-mfd. variable condensers (Lotus, or Lissen, J.B., Igranic, Dubilier, Burton, Ready Radio, Utility, Polar, etc.).
- 2 Slow-motion dials if condensers not of slow-motion type (Lissen, or Ormond, J.B., Formo, Igranic, Lotus, etc.).
- 1 .0001-, .00013-, or .00015-mfd. reaction condenser (Polar, or Dubilier, Lissen, Lotus, Formo, Burton, Magnum, Ready Radio, Ormond, Bulgin, etc.).
- 1 On-off switch (Lissen, or Wearite, Bulgin, Ormond, Lotus, Magnum, Igranic, Jewel, Benjamin, etc.).
- 1 L.T. switch (Junit, or Lissen, Wearite, Bulgin, Ormond, Magnum, Igranic, Jewel, Lotus, Benjamin, etc.).
- 1 3-pole change-over switch for panel mounting (Wearite, etc.).
- 1 Filament rheostat (see text); (Igranic, or Wearite, etc.).
- 1 Special "Star-Turn" tapped selector coil with switch (Wearite, or Ready Radio, Paroussi, Magnum, Keystone, etc.).
- 1 Special "Star-Turn" tuning and coupling coil unit (Wearite, or Paroussi, Ready Radio, Magnum, etc.).
- 4 Sprung valve holders (Benjamin, or Lotus, W.B., Formo, Igranic, Lissen, Wearite, Burton, Precision, Bulgin, etc.).
- 4 Baseboard-mounting coil holders (Wearite, or Lissen, Lotus, Magnum, Igranic, Bulgin, etc.).
- 2 1-mfd. condensers (T.C.C., or Lissen, Dubilier, Hydra, Ferranti, Mullard, etc.).
- 2 .001-mfd. condensers (Lissen and Igranic in set, or T.C.C., Graham-Farish, Dubilier, Mullard, Clarke, Goltone, etc.).
- 1 .0003-mfd. condenser (Lissen, or Igranic, T.C.C., Graham-Farish, Dubilier, Mullard, Clarke, Goltone, etc.).
- 1 .01-mfd. condenser (T.C.C., or Lissen, Igranic, Dubilier, Mullard, Clarke, Goltone, etc.).
- 1 .0003-mfd. max. compression-type condenser (Formo type J, or R.I., Igranic, Lewcos, etc.).
- 2 H.F. chokes (Varley and Keystone in set, or Lewcos, R.I., Lissen, Dubilier, Lotus, Ready Radio, Wearite, Magnum, Igranic, Bulgin, etc.).
- 2 2-meg. grid leaks and holders (Dubilier, or Graham-Farish, Lissen, Igranic, Ediswan, Mullard, etc.).
- 1 100,000-ohm anode resistance and holder (R.I., or Lissen, Ready Radio, Varley, Igranic, Dubilier, Mullard, etc.).
- 1 L.F. transformer (Lissen, or Ferranti, Varley, Igranic, R.I., Lotus, Mullard, Telsen, Lewcos, Cossor, etc.).
- 2 Panel brackets (Magnum, or Keystone, Bulgin, etc.).
- 1 Terminal strip 24 in. x 2 in.
- 11 Terminals (Belling & Lee, or Burton, Ealex, Clix, Igranic, etc.).
- 1 "M.W." screen 10 in. x 6 in. (Magnum, or Ready Radio, Wearite, Paroussi, Keystone, etc.).
- Wire, screws, flex, G.B. plugs, etc.

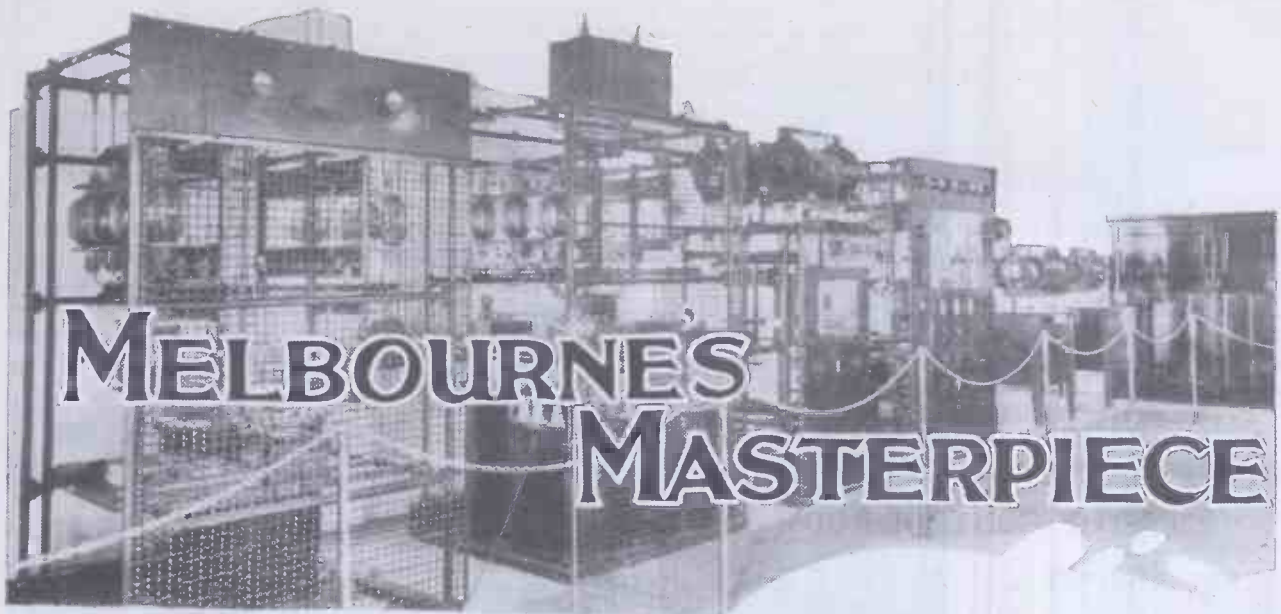

A review of the famous 3LO. By Our Special Correspondent.

IF the fact of ever-increasing technical efficiency is anything to go by, then station 3LO, Melbourne, Australia, now reigns supreme as the "star" station of the Southern Continent.

3LO is, if one may so put it, the 2LO of the Southern Hemisphere. It has a similar complexity and vastness of organisation, and, from an engineering point of view, 3LO's equipment has many points in common with that of our own 2LO.

There have been several transmitters at 3LO, Melbourne. The latest one has a power rating of 5 kilowatts, but actual tests have proved that the transmitter can be made to operate at a power of 17 kilowatts.

The power supply of the station's latest transmitter is drawn from the mains of the State Electricity Com-

mission, this mains supply taking the form of a three-phase 50-cycle current at 415 volts pressure.

This current is transformed by means of a three-phase auto-transformer in order to provide the plate supply of the transmitter.

The filament supply for the transmitter is drawn from a 240-volt three-phase 50-cycle current, which is obtained by means of a tapping between one of the phases and neutral. The current so derived is then led to the filament transformers through adjustable auto-transformers.

So much, therefore, for the main details of 3LO's power supply.

The transmitter proper at 3LO has, even since its new erection, been submitted to several modifications and improvements in design. It is, of course, built up



Outside broadcasts of sporting events are a strong feature of the 3LO programmes, and this is a scene in the control-room just before the beginning of a big race.

3LO is the 2LO of the Southern Hemisphere

strictly upon the now almost universal unit system, each unit of the apparatus being separately controlled.

Speaking broadly, the transmitting equipment may be divided up into five distinct units, to wit, the modulator, rectifier, drive, and oscillator units, and the tuning equipment.

Melbourne's 3LO transmitter has been tuned in a number of ways from time to time. At present, however, a simple wire helix and flat-plate condenser are employed for this purpose, these having been found to answer every possible requirement for routine broadcasting.

Rather an interesting feature of 3LO's transmitter is its control equipment, and it is in this apparatus

IN THE CONTROL-ROOM

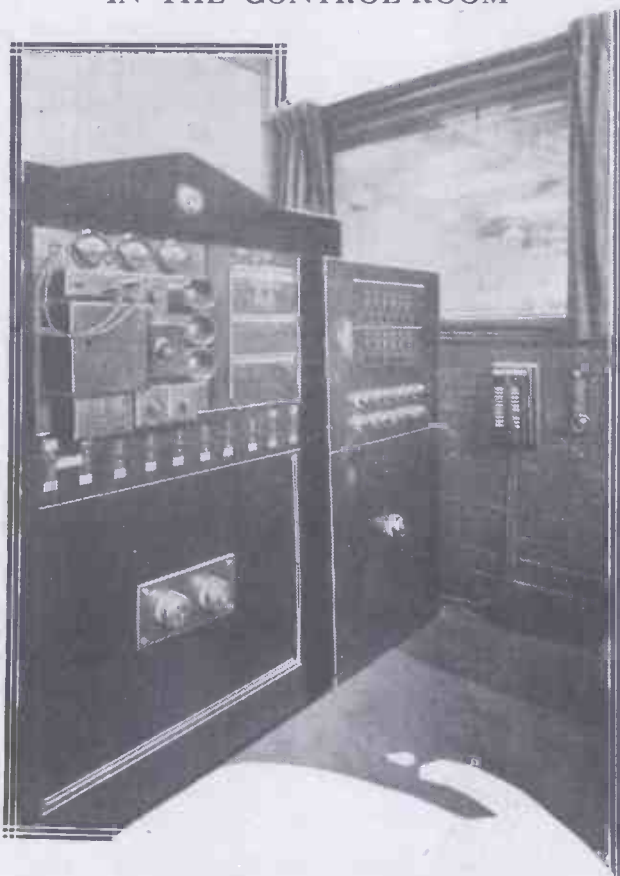

A section of the control-room, showing amplifying gear. Note the window from which the control engineer can see into the studio.

that the more recent modifications have been made.

Nowadays the control equipment of the transmitter is situated in a sound-proof room adjacent to the studio of the station. The control engineer is able to look into the studio through a double plate-glass window, but he is only able to hear the items which are being sent out from the studio by means of a loud speaker connected up to an ordinary receiver.

All the studio controls are located in this apartment, as well as many of the transmitter controls. An amplifying panel is here, too, together with a system of relay boards which connect up the station with almost any other portion of the Australian Continent.

The studio of 3LO retains all its old features. It

is 32 ft. long by 25 ft. wide, the walls being suitably treated in order to ensure the required acoustical properties of the apartment. 3LO's studio was long famous as being the only one in the world at which the public were admitted as an audience during the actual broadcasting transmissions.

Whilst other studios in different parts of the world have now adopted this plan with success, the 3LO studio

SEATS IN THE STUDIO



3LO was the first station to encourage a large audience to listen in the studio while broadcasting was in progress.

at Melbourne is still foremost in the world in respect of its seating capacity.

The studio microphones are of the usual Western Electric "double-button" type, and these, too, are employed for all the very numerous outside broadcasts from theatres, music-halls, churches, and other public buildings.

Indeed, so strongly has station 3LO developed the outside broadcasts that radiating from its control-room are more than fifty pairs of permanent land-lines, representing many hundreds of miles of wire.

3LO is, of course, heard regularly all over Australia and Tasmania, and also in New Zealand, whilst reports of its clear reception from many other parts of the world are not at all uncommon.

THE AERIAL TUNING

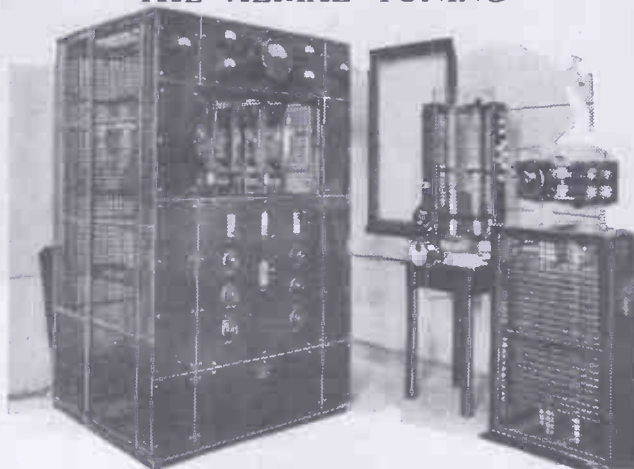

The large coil standing on the table to the right is part of the aerial tuning inductance.

BANISHING BACKGROUND

There is nothing more annoying than to have to listen to your radio through a background of unwanted noises, and in this article you will find some practical suggestions for removing the trouble.

By P. R. BIRD.



A VERY great portrait painter once laid down the dictum that in painting a portrait it was always very *important* to make the background look *unimportant*. In other words, the background should be a background—unobtrusive and unnoticed. Can you honestly say that your radio background is like that?

Far too many sets to-day are given the impossible task of forming a true sound-picture against a background of unwanted noise. That low buzzing like bees, the distant roar of the rapids, or hum of the hive—all these unnecessary noises spoil the sound picture and rob you of your rightful radio enjoyment.

Those Unnecessary Noises

So much has been written and said about the loud-speaker's ability to reproduce certain frequencies that we are in danger of forgetting no-frequency-at-all. True, we do need the scrape of the violins, and the boom of the bass, but we need silence, too. All extraneous noises should be abolished, and each sound picture should stand clear-cut upon a background of silence. Silence is the common denominator that gives all music its relative values.

How is this desirable state of affairs to be achieved in practice when a hum is heard? What steps should be taken when unnecessary noises always accompany the programme?

Plenty of Variety

One of the difficulties in dealing with background is that there are dozens of different kinds of background. Among the commonest are clicks, crashes, humming, buzzing, vibrations, howling, roaring, and whistling. And there are plenty of others!

To tackle the trouble one must first diagnose it, for if you can decide what causes it you can almost certainly cure it. The stock advice given to listeners who are troubled with a background of interference is that they should write to the B.B.C. about it. This is all right so far as it goes, and the B.B.C. will doubtless

of identifying it. The first thing to notice is whether the noise is continuous or intermittent. If it is completely continuous hum, lasting all the time the set is switched on, you can be fairly sure it is caused by electric mains.

Tracing the Trouble

It may be conducted from the mains to your set by the wiring of a mains unit, or you may be picking it up in the aerial or earth lead, or it may come through a long battery- or long loud-speaker lead. A good mains unit is provided with smoothing chokes and condensers that eliminate hum, etc., provided the mains unit is not placed too close to the set itself.

In scores of cases the smoothing has been blamed as being inadequate when the real trouble was the crowding into the cabinet of the unsmoothed supply. For around the chokes in a mains unit are powerful magnetic fields, and these must not be placed too close to the receiver.

In tracing interference there is much to be said for the old and simple plan of disconnecting the aerial and earth wires to see how this affects it. If the trouble ceases when, say, the aerial is disconnected, this gives a certain indication of the origin of the disturbance.

A Battery Check

In such a case the respacing of the aerial lead away from all walls, etc., the shortening of the aerial, or an alteration of its position, should enable you to banish the background. If the aerial, earth, and loud-speaker leads themselves appear to be innocent, you can check whether the interference is coming from a mains unit by borrowing a battery to replace it.

If the set works silently with a battery, but not with the unit,

OLD-FASHIONED, BUT EFFECTIVE!



Very often a simple alteration to the L.F. transformer will reduce or banish a background. All that is necessary to try the stunt is to reverse the connections to the primary (or the secondary), remembering that before any such alteration is made the H.T. negative plug should be removed from the battery.

do all they can to help in such cases, but a glance at the formidable list of types of interference given above shows that the B.B.C.'s task will be a heavy one, unless the listener himself can help.

Fortunately the worse the interference is the easier becomes the task

Some Methods of Preventing Interference

obviously the latter is to blame, either for inadequate smoothing or inadequate spacing from the set and its leads.

The Earth Lead

When a borrowed battery fails to cure such a background, it is a good plan to try the effect of turning off the mains switch controlling lighting. And if this stops the trouble, replace the mains switch, and then remove one by one the fuses that govern various sections of the house wiring, to see which section of the lighting system is responsible for the row.

Sometimes a hum can be traced to the earth connection, and yet when

positions of the coils relative to each other can be adjusted, so that the coupling may be varied as required by different coils.

Apart from loosely coupling the coils, or in conjunction with this, small fixed condensers (of the order of .0001 mfd.) can be tried in the aerial or earth leads, the effect being rather like that of loose coupling. Yet another plan is to do away with the earth connection altogether and to use a counterpoise or "false aerial," which resembles an ordinary aerial in every way except in the fact that it is connected to the earth terminal, and is usually placed only a foot or so above the ground. (It is sometimes

you have an old L.F. choke or an L.F. transformer with one winding O.K., which is quite capable of carrying the milliamps required, place this between the mains unit and the appropriate terminal on the set.

The smoothing effect is further enhanced if a large fixed condenser of 1 or 2 mfd. is joined between the choke and the set on one side, and its other side connected to earth.

Some Final Hints

Finally, do not forget that what may appear to be a background of noise may be caused by one or more faulty components in the set. Poor contacts in a resistance, an imperfect primary or secondary winding, and poor insulation (especially of the aerial lead-in where a D.C. mains unit is being employed) can all give rise to very troublesome "interference."

One important little point to remember in all sets using L.F. transformers and troubled with interference that it is advisable to try reversing the leads to either the primary or secondary terminals of this. Anyone can do it in a few moments (provided he takes care to disconnect H.T. neg. first, for safety's sake), and it is surprising how often this simple alteration will enable you to banish an unwanted background.

WHERE A BACKGROUND IS IMPOSSIBLE



A Berlin radio building in which immense pains have been taken with screening to prevent pick-up and interference

the earth lead is respaced, etc., or even when a new earth altogether is tried, the trouble remains. This most commonly occurs in industrial neighbourhoods where powerful electrical machinery in the vicinity is connected to earth, the "background" caused in this way being very difficult to remove.

A "False" Aerial

One good plan is to connect a large fixed condenser in the earth lead. Another method that is often successful, and should always be tried in such cases, is to couple the aerial inductively to the set. In other words, use a separate aerial coil and, if possible, place this in a two-coil holder of the type in which the

necessary to raise a counterpoise several feet, to give clearance underneath it, but usually better results are obtained where the wire or wires are only about 1 ft. from the ground.)

Do not forget that a counterpoise should be insulated just as carefully as an aerial, and that it should be carefully spaced from walls, etc. If one of the above remedies, or several of them in combination, fail to clear up the fault, it may be due to inadequate smoothing in cases where the H.T. supply comes from the mains. Although the "internals" of a mains unit are best left alone except by the manufacturer, it is quite easy to add extra smoothing *externally*.

Special attention should be paid to the detector's H.T. supply, so if

RADIO JOTTINGS

The success with which hum has been eliminated from directly-heated A.C. valves can be gauged from the fact that even high-magnification valves of the screened-grid H.F. type are made to work very successfully under these conditions.

* * *

Usually detector valves which are directly heated from A.C. mains should be fitted with a special potentiometer across the filament supply, the grid-bias-battery return lead being taken to the slider of this.

* * *

A.C. valves using an indirectly-heated cathode usually have the connection to this brought to the terminal on the top of the valve, but where a five-pin base is used the extra cathode is generally connected to the centre-pin.

"NEUTING" the S.G.

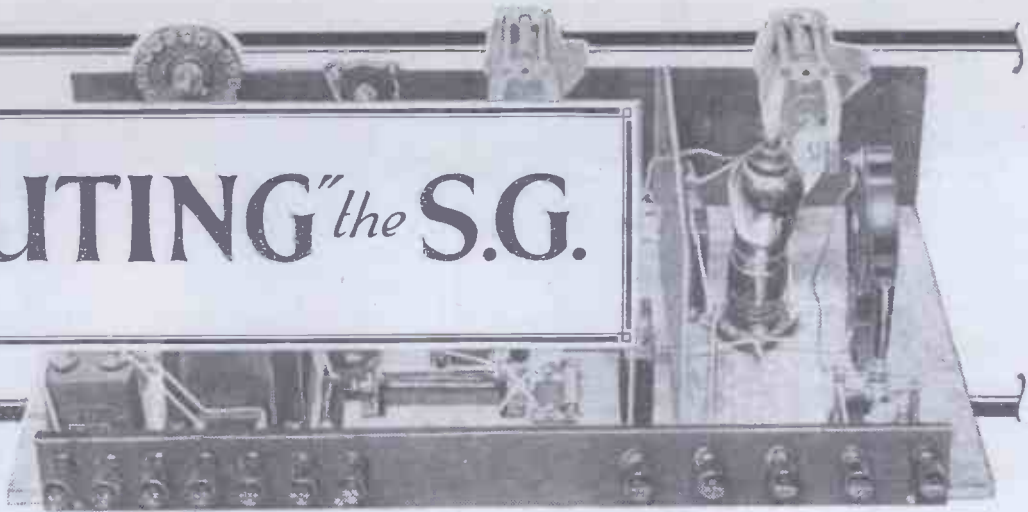

FOR over two years I have been working on and off on the question of neutralising the screen-grid valve.

Although valves of this type have improved somewhat of late, I still find that the use of highly efficient circuits will send the amplifier into oscillation unless the residual capacity is neutralised.

The desirability of neutralising is sometimes even greater now than before, because the A.C. type of S.G. valve has come on the market with its short-path construction and high efficiency, and is very liable to be unstable, especially when used in a self-contained frame-aerial set.

A "Mag." of 400!

In practice I have obtained a magnification of approximately 400 from a Cosmos A.C./S.G. valve (using one stage of H.F. only) when neutralised,

A "SPLIT-SECONDARY"

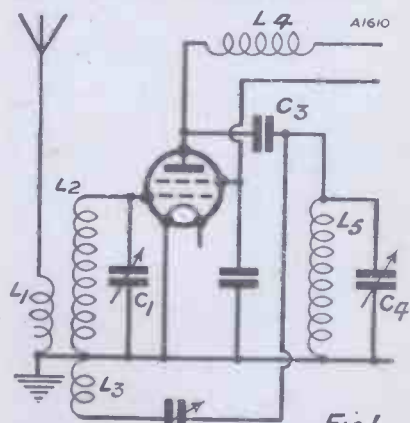

The circuit mostly used by our enterprising contributor.

but nothing like this value, not even a tenth, is readily obtained from it in a straight circuit without instability either at the top or bottom of one or

When the S.G. is neutralised it can be operated at the peak of its efficiency without "feed-back" troubles occurring. Enormous amplification is given and, as our contributor points out, it is not a difficult arrangement to put in practice.

By C. P. ALLINSON,
A.M.I.E.E., F.Inst.P.Inc.

both of the two broadcast wave-length ranges.

In my work on neutralising the S.G. valve I came across certain peculiar effects the origin of which was not at all clear at first. These effects presented difficulties in the application of neutralised circuits to the S.G. valve which anyone might come across when experimenting, and I have therefore collected together details of them for the benefit of those who are working with such circuits.

First of all, I must describe as briefly as possible certain circuits I have been using with S.G. valves. There is the split-secondary circuit which I have used mostly and this is shown in Fig. 1.

Importance of Layout

Here the neutralising winding consists of one or two turns of wire L_3 , coupled to the tuned grid circuit L_2-C_1 at the L.T. or earth end. The ratio of turns is exceedingly critical and the variation of a single turn may upset the balance.

What is, however, equally important is the layout of this portion of the receiver.

The first set I made with a neutralised S.G. valve had only the detector circuit boxed, the H.F. stage being left open. The layout was on the lines sketched in Fig. 2A. It will be noted a vertical 6-pin coil A is used,

and a most important point you should remember is that in practically every coil of this type the grid end of the winding is at the top of the coil.

With this layout, therefore, we have the anode of the S.G. valve B relatively close to the grid end of the grid coil, and thereby extra capacity is introduced between grid and anode. The extent to which this occurs will be appreciated from the fact that I had to use six turns for L_3 to neutralise the valve instead of the one turn which I had calculated would be correct.

One Turn for Neutralising

The fact that my calculations were correct was borne out when I rebuilt the H.F. amplifier, using the new type of screening box that I developed specially for use with S.G. valves, as shown in Fig. 2B. Here you will see

"OPEN" H.F. STAGE

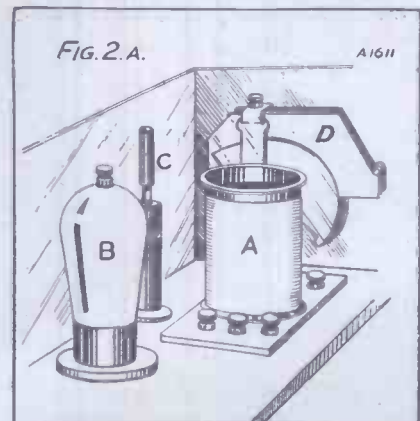

The first set tried had only the detector stage completely screened, the H.F. section being left "open."

that the coil A and the condensers C and D have been screened from the valve itself, so that additional capacity is not introduced, as described in the previous paragraph. On doing this

Amazing Amplification Given by "Neuted" S.G.'s

I found that only one turn was required for neutralisation.

The only snag with regard to this circuit that you are likely to run up against is the question of coupling the aerial. I made up a number of experimental coils and among them was one that would not neutralise properly. I tried different numbers of turns on the neutralising and grid windings, but all without result—it would not behave as it should.

Right Way Round

Finally it occurred to me to check up the aerial winding, and I found that this was wound the reverse way to what I thought it should be. I therefore rewound it in the right direction; whereupon the set promptly neutralised correctly.

Now this is quite an important point and Fig. 3 shows the correct way of winding the three coils when using this type of neutralising with an S.G. valve. The grid and "neuting" windings are wound in the same direction and the ratio between them should in all cases be approximately 70-1.

THE COIL UNIT

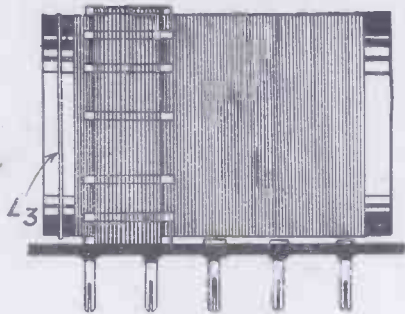

A1613 FIG. 3.

The grid and "neut." windings must be wound in the same direction.

On the broadcast band this means that the grid coil should have 70 turns and the neut. winding 1. If this brings the inductance up too much for the size of variable condenser you are using, you will have to use a slightly smaller former, but be careful you don't sacrifice efficiency.

The aerial winding L_1 , which may either be wound on top of the grid coil L_2 on spacers in the well-known manner, or may be wound on a former

which will slip inside the grid winding, must be wound in the *opposite direction* to the grid coil. The ends of the neutralising coil and the aerial coil which are nearer to the earth end of the grid coil are the ones to be connected to earth.

SPECIAL SCREENING

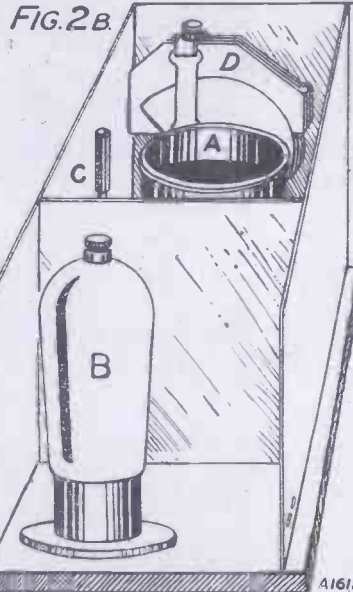

A1612 This type of screening box was developed especially for use with S.G. valves.

The aerial former, if one is used, should be located so that one end coincides with the earthed end of the grid coil. The other end, which will be a short distance up the grid coil, will be connected to the aerial.

Now there is another type of neutralising circuit that can be used, and that is a variation of the split-primary circuit. This is shown in Fig. 4. You will note that I have used shunt feed rather than series feed, and there is a reason for this.

Using Shunt Feed

First of all examine the circuit as drawn. The valve has the usual tuned circuit connected between grid and filament. In the anode is an H.F. choke which supplies the H.T. to the valve, while it diverts H.F. impulses via the coupling condenser C_2 to the tuned circuit L_3-C_3 .

Coupled to L_3 is a small winding L_4 , connected back to the grid of the H.F. valve through a neutralising

condenser C_4 . The size of this winding will depend again on the layout of the receiver, and in this case care must be taken to reduce to a minimum any capacity between the neutralising condenser and the grid end of L_3 .

A Point to Watch

Two methods of construction are suitable. (1). Put the neutralising condenser in the screening box containing the H.F. stage close against the screen so that the lead from L_4 comes straight to it by the shortest possible path.

(2). Put the neutralising condenser through the screen so that one side is in each compartment. For this purpose a condenser such as the Gambrell Neutrovernia is particularly suitable, as it is indeed for all S.G. neutralising, since it allows a very fine adjustment to be obtained.

Another point to be watched with the neutralised S.G. valve, and that is—do you intend to use reaction in the detector circuit? If you do you must use the Fig. 1 circuit, i.e. the

SPLIT-PRIMARY TYPE

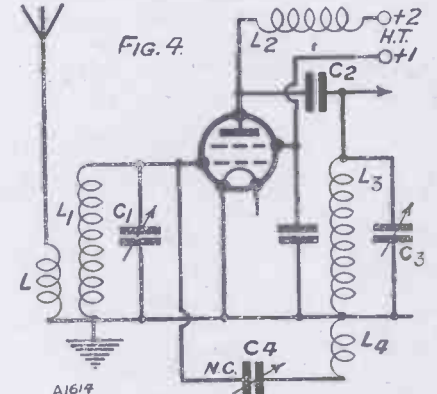

A1614 FIG. 4. Another type of neutralising circuit that can be used.

split-secondary type of circuit as adapted to the S.G. valve. If you attempt to use the split-primary type you will find reaction upset your's neutralisation.

You may ask why should one want to use reaction when so much amplification can be obtained without it, and my answer is to remove the extremely heavy damping imposed by the detector valve on the tuned circuit.



The WORLD'S PROGRAMMES

WHEN, WHERE, AND HOW TO
HEAR THOSE FOREIGNERS
CONDUCTED BY "D.X."

"PLACING" YOUR STATIONS

Ever made a chart of the tuning-dial positions? It's great fun and a great help in finding foreigners. Here's how—
You need some squared "graph" paper, sharp pencil, ruler, an odd half hour, and a rubber. And with that little lot you can work wonders!

First, rule a big square on the squared paper, and mark its bottom divisions to correspond with your tuning-dial figures. That is to say, start in left corner at 0, and carry on, 10, 20, 30, etc., as far as your dial goes (i.e., 100 deg. or 180 deg.).

Next, commencing bottom left-hand corner again, mark upwards, along left side of big square, the wave-lengths your condenser should tune over. Probably 200 to 600.

Each little square up the side represents a certain number of metres, just as each little square along the bottom line stands for a certain number of degrees on the dial. And now we can get down to brass tacks.

Suppose Daventry (5GB) comes in at 160 deg. on your dial. Draw a light line up the chart from the 160 mark.

Next draw a line across the chart to correspond with Daventry's wave-length. (He works on 479 metres.) Where that line crosses the 160 deg. line put a big dot. That's Daventry, that is!

Carry on like that with several other stations—all you can get easily, in fact.

If London National comes in at 21 deg. on the condenser, run a line up from that, and another line across from 261 metres, and where they meet put another nice dot. That's London National nailed down nicely!

THAT INSULATOR—

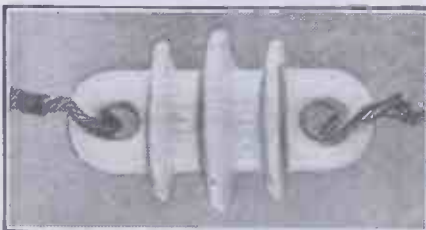

—should have a long leakage path, or surface, between ends. Soot and other deposits should be cleaned off periodically.

When you've got several of the stations you'll see the beauty of the stunt. They begin to make a line of their own across the chart. Yes, they do! They "fall into line," good as gold!

And once they do that, you're on clover. For when you lightly pencil in a line or "curve" to join the station dots together, your chart will always show the wave-length against degrees, and vice versa!

Your tuning straightens itself out into a cert. You now "know where you are" on the dial.

EVER TRIED THIS?



You wind a hank of wire, 15 turns or so, and tie it to your grid coil with cotton. Then join one end of it to earth. Disconnect your aerial lead and join that to the other end. In many cases this sharpens tuning remarkably, so try it if your "local" is troublesome.

"Who is this carrier-wave on 122 degrees?" you say. You take out your chart, and run up from 122 to the "curve" with the dots on it. And then you look at the corresponding wave-length, and you say "381 metres, eh? Why, that's Toulouse's wave-length. Listen, you guys, I've got Toulouse now."

And the guys all crowd round and wonder how you know. And you show 'em the curve. And explain. And they go away saying "Gee! He's hot! Knows where to pick up every station on the dial."

You just grin to yourself. And start on another chart. Long waves this time. Good idea. What?

HOW TO NEUTRALISE

Start with your neutralising condenser (N.C.) and reaction condenser (R.C.) at zero. Place the "aerial" tuning condenser at about 50 deg., and then slowly rotate the H.F. tuning condenser to bring the two circuits "in step."

Usually this causes the set to oscillate. (You can tell when it oscillates by the extra "liveliness," a slight rushing noise, and the loud double clicks that result from touching the condenser's fixed vanes with a wet finger.)

Increase the capacity of N.C. a little (generally by screwing it down), and oscillation ceases. Now increase R.C. a little, and the set will begin to oscillate again. Stop this by increasing N.C. slightly. (Remember to keep the two tuned circuits exactly "in step" by very slight readjustments when necessary.)

Once again increase reaction a little to make the set oscillate, and then stop it again by increasing N.C. slightly. And continue thus until you find you've gone too far, and that any further increase of N.C. causes oscillation to increase instead of decrease.

In this way you will discover what setting of the N.C. permits stability (non-oscillation), even when R.C. has been advanced a long way from zero.

If R.C. is too far advanced nothing you can do with N.C. will stop oscillation. But up to a point N.C. adjustment controls the set and holds it stable in spite of R.C. adjustment. You can find that point on your set as explained above. And when you've found it you can pat yourself on the back, for your H.F. stage is properly neutralised.

CLEAN IT!



Many a good foreigner "goes west" at the earthing switch, the contacts of which often suffer from the weather. A cover over it helps.

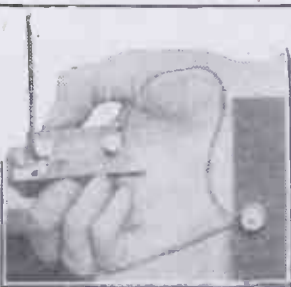

YOURS FOR THE TUNING!

The Principal Stations of Europe
in order of wave-length.

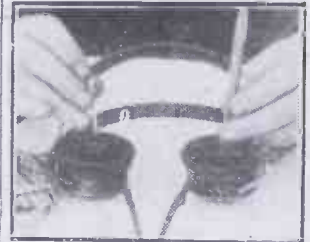

Wave-length in metres	Name of Station	Power in kilowatts
1961	Ankara (Turkey)	7
1935	Kaunas (Lithuania)	7
1875	Huizen (Holland)	6.5
1796	Lahti (Finland)	40
1725	Radio Paris (CFR)	12
1635	Königswusterhausen (Zeesen) (Germany)	26
1554	Daventry National Station (Gt. Britain)	25
1491	Moscow (Old Komin-tern) (Russia)	40
1445.7	Eiffel Tower	12
1411	Warsaw (Poland)	8
1348	Motala (Sweden)	30
1304	Kharkov (Russia)	25
1200	Istanbul (Turkey)	5
	Boden (Sweden)	0.6
1153	Kalundborg (Denmark)	7.5
1116	Novosibirsk (Russia)	4
1103	Moscow, Popoff (Russia)	40
1073	Rostov-Don (Russia)	4
1071	Hilversum (Holland)	6.5
1010	Basle (Switzerland)	0.25
1000	Leningrad (Russia)	20
938	Moscow (Trados Union)	50
870	Tiflis (Russia)	4
840	Nijni Novgorod (Russia)	1.8
800	Kiev (Russia)	20
778	Petrozavodsk (Russia)	2
770	Östersund (Sweden)	0.6
760	Geneva (Switzerland)	0.25
720	Moscow (Experimental)	20
700	Minsk (Russia)	4
690	Lausanno (Switzerland)	0.6
574.7	Ljubljana (Yugoslavia)	2.5
	Freiburg-im-Breisgau (Germany)	0.35
570	Hamar (Norway)	0.7
565.1	Hanover (Germany)	0.35
565	Smolensk (Russia)	2
560	Augsburg (Germany)	0.25
550	Budapest (Hungary)	20
542	Sundsvall (Sweden)	10
533	Munich (Germany)	1.5
525	Riga (Latvia)	13
517	Vienna (Rosenhügel) (Austria)	15
511	Archangel (Russia)	1.2
509	Brussels No. 1 (Belgium)	1
501	Milan (Italy)	7
497	Moscow (Russia)	1.2
493	Osto (Norway)	60
487	Prague (Czechoslovakia)	5
479	Midland Regional Station (Gt. Britain)	25
476	Simferopol (Russia)	1.2
473	Langenberg (Germany)	13
463	Lyons (La Doua) (France)	5
	San Sebastian (Spain)	0.3
450	Zürich (Switzerland)	0.63

Wave-length in metres	Name of Station	Power in kilowatts	Wave-length in metres	Name of Station	Power in kilowatts
	Porsgrund (Norway)	0.7	390	Glasgow (5SC) (Gt. Britain)	1
	Aalesund (Norway)	0.3	394	Bucharest (Rumania)	12
	Salamanca (Spain)	1	390	Frankfurt (Germany)	1.5
	Bolzano (Italy)	0.2		Fredrikstad (Norway)	0.7
453	Danzig	0.25		Lwow (Poland)	1.5
	Klagenfurt (Austria)	0.5	385	Genoa (IGE) (Italy)	1
	Tromsø (Norway)	0.1		Wilno (Poland)	0.5
	Uppsala (Sweden)	0.15	381	Toulouse (Radio) (France)	8
	Tampere (Tammfors) (Finland)	0.8		Manchester (2ZY) (France)	1
450	Moscow (Russia)	1	372	Hamburg (Germany)	1.5
447	Paris (PTT) (Ecole Supérieure)	0.8	370.4	Radio LL (France)	—
445	Notodden (Norway)	0.05	368	Seville (Un.on Radio) (Spain)	1.5
	Rjukan (Norway)	0.18		Bergen (Norway)	1
441	Rome (IRO) (Italy)	50	363.5	Algiers (N. Africa)	13
436	Stockholm (Sweden)	1.5	360	Stuttgart (Germany)	1.5
	Malmberget (Sweden)	0.25	356.3	London Regional Station	30
432.3	Belgrade (Yugoslavia)	2.5		Graz (Austria)	7
427	Kharkov (Russia)	4	351	Leningrad (Russia)	1.2
424	Madrid (Union Radio) (Spain)	2	349	Barcelona (Radio) (Barcelona) (Spain)	8
418	Berlin (Witzleben) (Germany)	1.5	342	Bрно (Czechoslovakia)	2.4
413	Dublin (2RN) (Ireland)	1	338.2	Brussels No. 2 (Belgium)	3
416	Rabat (Morocco)	2.5		Cadiz (Spain)	0.5
408	Katowice (Poland)	10	335	Poznan (Poland)	1.2
403	Berne (Switzerland)	1	332	Naples (Italy)	1.5

Wave-length in metres	Name of Station	Power in kilowatts
328.2	Paris (Poste Parisien) (France)	0.5
325	Breslau (Germany)	2
322	Göteborg (Sweden)	10
319	Dresden (Germany)	0.25
316	Bremen (Germany)	0.35
	Marseilles (France)	0.5
314	Oviedo (Spain)	0.7
313	Cracow (Poland)	0.5
310	Cardiff	1
308	Radio-Vitus (France)	1
303	Bordeaux-Lafayette (France)	1
301	Aberdeen	1
299.8	Hilversum (Holland)	6.5
	Falan (Sweden)	0.5
	Kosice (Czechoslovakia)	2
293	Limoges, PTT (France)	0.5
291.1	Turin (Italy)	7
291	Viiuri (Viiborg) (Finland)	0.4
	Bournemouth	1
	Bradford	0.13
	Dundee	0.13
	Edinburgh	0.35
	Hull	0.13
288.5	Liverpool	0.13
	Newcastle	1
	Plymouth	0.13
	Sheffield	0.13
	Stoke-on-Trent	0.13
	Swansea	0.13
287.5	Lyons (Radio) (France)	0.5
285	Montpellier (France)	0.2
	Berlin Relay (Germany)	0.5
283	Magdeburg (Germany)	0.5
	Stettin (Germany)	0.5
	Innsbruck (Austria)	0.75
281	Copenhagen (Denmark)	0.5
280	Radio Liege (Belgium)	—
279	Bratislava (Czechoslovakia)	12.5
276	Königsberg (Germany)	2.5
272	Rennes (France)	0.5
263	Barcelona (Radio Catalana) (Spain)	10
265.4	Lille (PTT) (France)	0.7
263	Moravska-Ostrava (Czechoslovakia)	10
261.3	London National Station	30
259	Leipzig (Germany)	1.5
257	Hörby (Sweden)	10
255	Toulouse (France)	1.5
253	Gleiwitz (Germany)	5
251	Almeria (Spain)	1
246.2	Schaerbeek (Brussels) (Belgium)	—
242	Belfast	1
239	Nîmes (France)	1
	Nürnberg (Germany)	2
238	Bordeaux-Sud-Ouest (France)	1
237	Örebro (Sweden)	0.2
232.2	Kiel (Germany)	0.35
227	Cologne (Germany)	2
224.4	Cork (6CK) (Ireland)	1
222.9	Radio Luxembourg	4
175	St. Quentin (France)	—

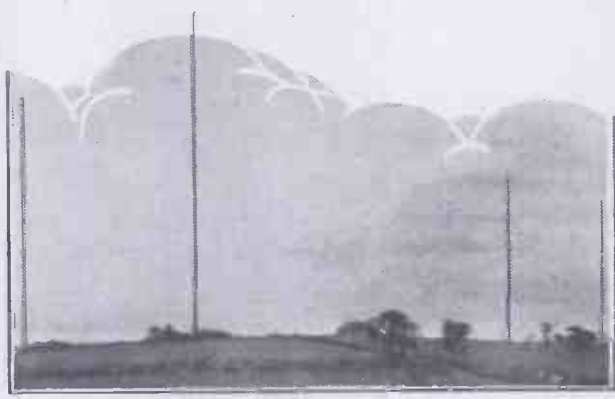

RADIO IN THE GARDEN

That's a queer place for radio trouble, isn't it? Most people think "everything in the garden's perfectly lovely"—But is it?

How about that buried earth plate? You water the roses, and the lawn, and they benefit by it. Repay you ten times over for the trouble, don't they? So, during a dry spell, would the earth-plate!

The earth round it should be moist and cool, but ten to one it's neither. And when foreign stations—weakened by daylight—try to start a flutter in your aerial there is this dry and high-resistance earth connection to contend with.

It doesn't really give the aerial a chance with foreigners, so sometimes it gets its own back on you by "tuning-jumps." Ever had tuning-jumps?

The symptoms are that stations hop about! Instead of being in the right place they move up a few degrees or down a few! The dial seems suddenly bewitched.

But it isn't. It's that poor old earth-plate, dry as a bone, that causes those tuning-jumps.

And the cure is water. Lots of it. Good old H₂O, in buckets.

You pour it on the earth, and it acts like a balm. Peace descends on the tuning dial. Smiles arise on yours.

And when you hear of somebody else troubled by "tuning-jumps" you can put them wise. You can tell them they "ought to take more water with it!"



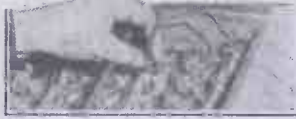

PODEBRADY, the new Czecho-Slovakian short-wave station, is to have twin transmitters, working on 15 and 20 metres.

RABAT, MOROCCO, famous for its 416-metre transmissions, is now testing on short waves as well.

PARIS is still laughing over the world's most lugubrious item. An undertaker there, to celebrate his 50th year in business, broadcast an offer of reduced fees!

BIRR, right in the centre of Ireland, is considered the probable site for the Free State's projected high-power station.

LANGENBERG gives a physical-jerks' course at 6.45 a.m. daily, except Sundays.

WASHINGTON has the world's first "bug-killing" station, working on 3,000 metres. (Radio waves are broadcast over infested orchards from 4 till 7 a.m. daily, but the official view of the experiment is decidedly sceptical.)

TATSFIELD is rumoured as being a possible site for a new Empire short-wave station.

Station Information

NAPLES' aerial is said to be exactly 1,000 miles from Marconi House, Strand, London. The station's interval signal is a single dot, repeated every seven seconds.

VENICE has just installed Italy's first radio beacon, to assist vessels approaching the harbour in foggy weather.

HILVERSUM works on 298



RADIO-ROMA uses crystal-control of wave-length, and keeps the crystal's temperature even by means of a thermostat.

PARIS EXPERIMENTAL, formerly on 29 and 40.9 metres, has been testing on 300 metres.

TRIESTE AND PALERMO are to have powerful broadcasting stations working within 12 months.

TOKYO station broadcasts news of situations vacant to the unemployed

RADIO BUCHAREST and other Roumanian stations only work four hours daily, owing to the expense.

ALGIERS recently broadcast an Arab wedding ceremony.

AACHEN, GERMANY, is now sharing 227 metres with Munster and Cologne.

KATOWICE, POLAND, often makes announcements in the French language.

RADIO CATALANA, the Barcelona station, which owing to faults in its transmitter had to close down some months ago, is now "on the air" again from 7.30 to 9 p.m. daily.

SAN SEBASTIAN was the culprit that was recently heterodyning the Glasgow transmissions.

TELL TALE TICK-TOCKS



No! It isn't the announcer's cheap watch that you hear! Some stations switch on a metronome and let it tick during intervals in the programme. And different stations tick at different speeds, so the number of ticks per second can be used as a station indicator.

Here are some of the **TELL-TALE TICK-TOCKS**:

Belgrade	432 metres	Sixty beats per minute.
Berlin	418 "	Thirty-six beats in 10 seconds.
Breslau	325 "	Sixty beats per minute.
Bucarest	394 "	Opening signal is five minutes of metronome ticking 160 beats per minute.
Königswusterhausen (Zeesen)	1,635 metres	Forty beats in 10 seconds.

Other stations using a metronome (or clock), at times, are:

Berne	403 metres	Graz	352 metres
Hamburg	372 "	Leipzig	259 "
Posen	335 "	and	
Zagreb	308 "	Vienna	517 "

SCHLOSS SOLITUDE is the queer name of the German listening-post for America, the equivalent of our Tattsfield. It is linked with Stuttgart.

metres, but changes its wave-length to 1,071 metres after 5.40 p.m. on weekdays (11.55 a.m. on Saturdays) and all day on Sundays.

FAVOURITE SHORT-WAVERS

This chart shows you "how the stations stand" in wave-length order between about 15 and 80 metres. It will be seen that, unlike long- and medium-wave stations, they are "bunched" in groups.

This is no disadvantage, because tuning is phenomenally sharp on short waves. Just a hair's-breadth of your tuning dial may cut out one station and bring in its neighbour without a trace of interference.

In practice, you don't try to cover all the stations shown here on one coil and condenser. It's better to use different coils for different parts of the wave-band, but this illustrates how the principal stations stand relative to one another.

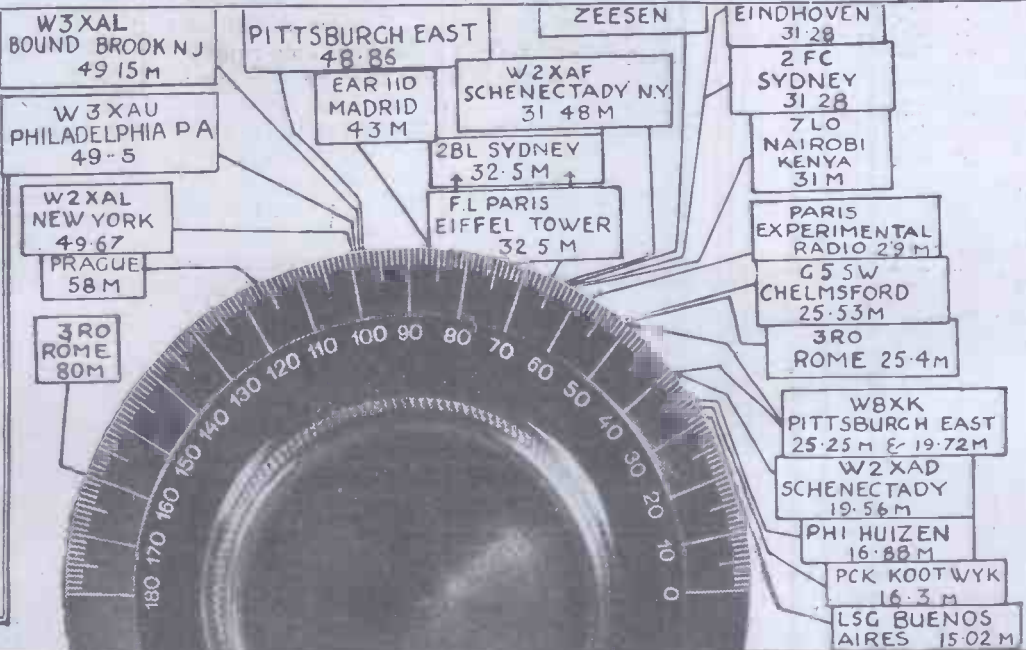

*By the
Technical
Editor.*



A corner of the "M.W." Research and Construction Dept.

Cam-Brell Voluvernina

MESSRS. GAMBRELL RADIO, LTD., recently sent us one of their new and improved Voluvernias. The "Voluvernina" is a potentiometer device, the range covered by the sample sent us being 0—500,000 ohms.

It is a well-designed and constructed component and its action is wonderfully smooth and free from the patchiness that one learns to associate with many such devices. Its retail price is 6s. 9d.

Regenstat Power Resistance

There is a growing demand for a resistance that will satisfactorily give a variation over a wide range and yet carry a fairly heavy current. Such devices are needed as voltage controls in mains units and for various other purposes in modern sets.

One of the soundest that we have come across is the Regenstat, a product of the Regent Radio Supply Company. It is of the compression type with a range of from 250 to

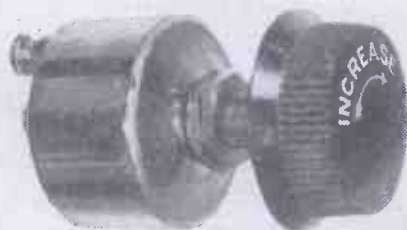

This is the "Regenstat" resistance.

4,000,000 ohms, with a recommended maximum constant dissipation of 10 watts.

It does not contain the usual graphite-mica powder, but has special

resistance elements which are contained in a resilient cartridge. Positive pigtail connections are taken to the terminals. The device is built into a substantial, but compactly-made casing.

The whole structure is robust, although, at the same time, the component is not over-large, and is certainly very nicely finished. The movement is smooth and so is the control of resistance. There is, of course, no packing, and constant settings are obtainable. The price of the Regenstat is 7s. 9d.

Singaldrop Battery Blotter

A useful radio novelty has been evolved by A. E. Bawtree, of Sutton, Surrey. This is the Singaldrop battery blotter. It is like an ordinary blotter in appearance, but it has the power of giving an indication as to the condition of your accumulator.

All you have to do is to touch the surface of the blotter with a matchstick or glass rod that has been dipped in the acid of one of the accumulator cells. The colour that the material then adopts tells you the specific gravity of the acid.

The blotter costs 2d., and can, of course, be used a very large number of times.

A Universal Fuse Holder

Those enterprising Bulgin people keep us adequately supplied with gadgets that are both novel and helpful.

The latest product, at the time of writing, of A. F. Bulgin & Co. is a Universal fuse holder. This Universal fuse holder is a remarkably useful

New

little article. It has three terminals and it can carry two of the Bulgin fuses.

The one fuse comes in the H.T. circuit and the other is in series with the grid bias. Thus the valves are protected against any accidental short-circuit of either H.T. or G.B.; and, in modern sets where upwards of 20 or 30 volts G.B. are to be found, such a double precaution is distinctly a wise step.

The fuse-holder is a neatly made little piece of apparatus; indeed, it comprises one of the best little bakelite mouldings we have come across for some time. The retail price is 1s. 9d., which is decidedly reasonable.

New "Camco" Cabinets

Those well-known radio cabinet manufacturers, the Carrington Manufacturing Co., Ltd., have produced quite a new line in the way of their own specialised products.

This is a radio set cabinet that is not fitted with an ordinary baseboard as a separate unit additionally to that of the cabinet itself.

The base of the cabinet is made to act as the baseboard of the set.



One of the smaller new-type Camco cabinets.

The top of the cabinet is also different from the usual. As you will see from the accompanying photo, there is an attractive cut-away "ledging." Further, the base is raised by a similar artistic arrangement.

As is usual with "Camcos," it is sturdily constructed and nicely finished.

A Novel Aerial

Those amateurs who are unwilling or unable to put up an outside aerial

Components

A critical survey of some of the radio apparatus received for review during the past few weeks.

should be interested in Stiktape, a quite new thing of American origin that is being handled by the Rothermel Corporation, Ltd. Stiktape is a thin, narrow, black adhesive tape with a backing of metal foil.

It is sold in rolls of 50 ft. Each roll measures about 3 in. across by $\frac{1}{4}$ in. thickness. The special rubber adhesive enables the tape to be stuck to any surface. It can, for instance, be run up the side of a window frame and thence around the room behind the picture rail.

For the short distance that it may be visible, the silvery strip does not look at all unsightly. It is, of course, only a few minutes' work to instal the whole thing.

It is not generally considered advisable to run an aerial conductor close along a wall or other such surface, but the Stiktape aerial has a surprisingly good pick-up.

Some Utility Components

The ordinary push-pull type of on-off switch is likely to lose much of its erstwhile popularity in favour of those small snap switches, and we note with interest that Messrs. Wilkins & Wright, Ltd., have now gone into production with a switch of the latter type.

It is extremely small in size and is a one-hole panel-mounting device; and yet it can handle 1 ampere at 250 volts or 3 amperes at 125 volts. The mechanism is completely enclosed in a bakelite moulding; and, altogether, at the price of 2s. 6d., it forms

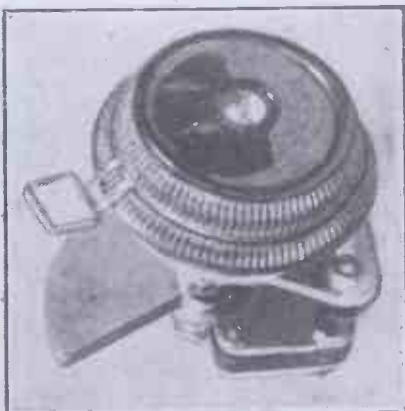

The larger dial provides the slow-motion control of this Utility bakelite variable.

a very attractive proposition. A snap switch of this kind makes a particularly pleasing on-off control; while, of course, it can be used for wave-changing or for anything else for which simple circuit closing is required.

A further new Utility component is a bakelite condenser. This is a compact variable employing sheets of bakelite as a dielectric instead of the more usual air-spacing. By this means, of course, the very small size is obtained.



*
This
"Utility"
switch can
handle up
to 250
volts.
*

Thus the '0005-mfd. maximum-capacity type has only five moving vanes, and these are only a little over an inch across. The movement of this Utility bakelite condenser is smooth and the article is substantially constructed and pleasingly finished.

With a plain dial the '0001-mfd. type costs 2s. 6d. and the '0005-mfd. 4s. The condenser is also available with a vernier dial movement; and a very nice movement it is, too, except that its presence makes the component a four-hole instead of a single-hole panel-mounting component. One of these holes is nearly an inch across!

Six-Sixty Adaptors

The Six-Sixty people have produced a couple of very useful adaptors. The one is for transforming a four-socket valve holder and its connections into a five-socket mains valve holder. The other enables a five-pin mains valve holder to accommodate a battery valve.

We can think of no more useful devices for the experimenter, while amateurs whose mains are being changed from A.C. to D.C. or from D.C. to A.C., or who are just having the power laid on for the first time,

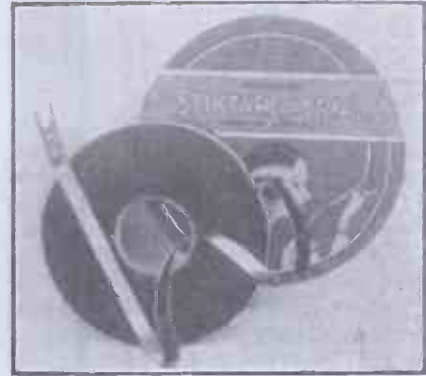

One roll of "Stiktape" aerial.

should find them very helpful indeed.

The price of the A.C. to D.C. adaptor is 1s. 6d., and the other, 2s. They are well made and very nicely finished and are by no means dear at that price.

Lightning Protection

It is at this time of the year when it is advisable for radio enthusiasts to make certain that their aerial arrangements are adequately protected against lightning. One of the best schemes is to employ a lightning arrester.

The arrester has the advantage over a switch in that it does not require any attention at all, or should not if it is substantially constructed.

Recently, Messrs. E. R. Morton, Ltd., of Bartlett's Buildings, Holborn Circus, London, E.C.4, sent us one of their Wirt radio lightning arresters. This article sells at 7s. 6d., complete with a galvanised fixing bracket and brass screws.

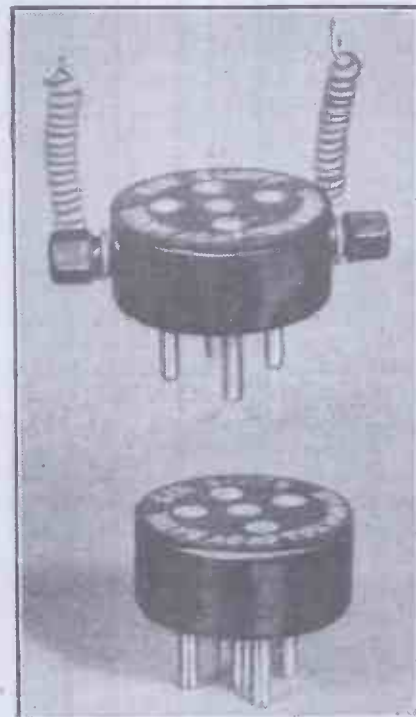

The Six-Sixty valve adaptors.

Radio Reflections Occasioned by a Moving-Coil

You do not have to break the down-lead in order to insert this arrester in circuit; the one continuous length of wire can still be retained. A special connecting screw arrangement enables the wire to be gripped firmly, and good contact is established. A similar connector is provided for the wire which has to go direct to earth.

The Wirt arrester is of the non-adjustable variety and is, indeed, entirely enclosed in a very robust bakelite moulding. The device is of a completely weatherproof nature and should, as far as we can see, last for a practically indefinite period.

No-Mast Aerial

We have just concluded a series of tests with the Goltone No-Mast Aerial



The "Wirt" Lightning Arrester.

sent us for this purpose by Messrs. Ward and Goldstone.

The No-Mast is intended to replace the usual outdoor aerial. It consists of a wooden frame carrying a metallic grid structure and provided with a substantial down-lead.

You fix the device securely to a chimney stack or other high point. It becomes a permanent fixture, presenting no surface to the wind, as it can be fixed flat against the brickwork.

Its price is 24s. with a heavily-insulated down-lead, or 30s. with a down-lead of "Negrolac," that special Goltone conductor.

The No-Mast gave very good results indeed, and its pick-up equalled that of an average outdoor aerial. It is certainly a neat alternative to this, and should find considerable favour among those who do not like the presence of the conventional masts and wires.

New H.F. Chokes

Watmel Wireless, Ltd., have produced a new H.F. choke in two types.

There is the D.X.3 at 6s. and the D.X.2 at 4s.

The general construction of both types is the same. As you will see by the accompanying photo, the design is binocular.

Each of the two sections is wound on a properly sectioned former.

The D.X.3 is intended for H.F. coupling and other purposes for which high efficiency is needed, and the D.X.2 for ordinary detector reaction circuit arrangements.

Both chokes cover the normal broadcasting bands efficiently and being well made, neat and reasonably priced, they should "get over" well.

It should be mentioned that whereas the D.X.3 has its windings protected by a transparent material, the D.X.2 has not. The covering is, however, nothing much more than a refinement.

G.E.C. Moving-Coil Speaker

Towards the beginning of last year there seemed to be a large number of different makes of moving-coil loud speakers on the market. Many of these have now disappeared.

It was apparent that some firms rushed into production with such speakers without fully and scientifically investigating their designs.

Even now there still seems to be an idea abroad that if a loud speaker incorporates a dynamic movement it must be good.

That is, of course, quite wrong. There can be bad moving-coil speakers just as there can be bad speakers of any other type.

But it is an obvious fact that there is a glamour around the moving-coil that tends to invest it with magic qualities—in the mind of the tyro.

A moving-coil speaker can give



This is the D.X.2 Watmel H.F. choke.

extraordinary results in comparison with the usual small cone, but a good set (not necessarily large) is essential, and, of course, it is vital that the speaker be a proper representative of its class.

This the G.E.C. certainly is. It is beautifully made, and it has a combination of robustness and clean lines that would be hard to equal.

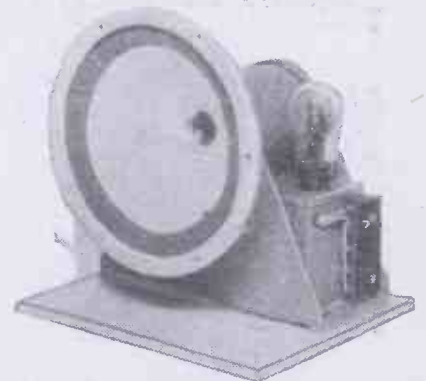

This G.E.C. speaker unit is for A.C. mains, and has a rectifier "built in."

Its most outstanding technical point is its sensitivity. It is more sensitive than most ordinary speakers.

It achieves this sensitivity through unusually fine machining, an extremely small gap between the coil and the field magnets being obtained by this means.

Built-in Rectifier

The particular model illustrated in the above photograph is for working with A.C. mains of 200/260 volts, 50 to 80 periods.

A valve rectifier is built into the unit itself and the Osram U.5 full-wave rectifying valve that is used can be seen.

There are clearly-marked terminals for the necessary connections and an ebonite safety cover of ingenious design is provided.

The D.C. model also has a smoothing device built in, and this results in a wonderfully silent background.

There is an input transformer of a centre-tapped variety so that the speaker can be matched up with either one of two impedances for any particular set output valve.

The G.E.C. moving-coil speaker unit is available mounted upon a properly designed baffle if desired.

Altogether we consider it a first-class proposition, and we advise interested "M.W." readers to make a point of searching out and listening to one.

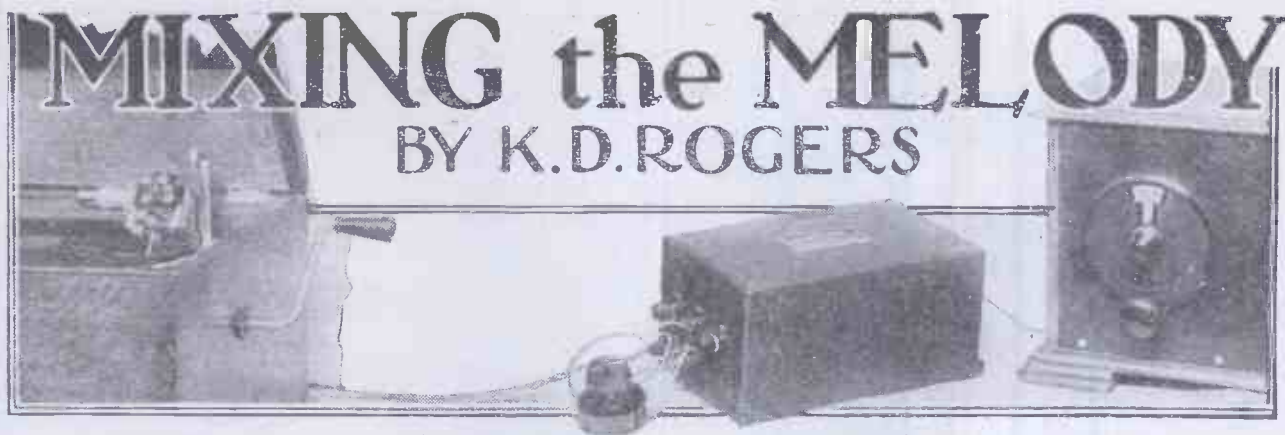

THE title of this article may appear to be a little strange at first sight, but it is the outcome of some tests which have been carried out with tone filters, scratch eliminators and the like, and incidentally two commercial devices which have been placed on the market for changing the response curves of pick-ups.

A New Device

The first of these, the "Novotone," has already been reviewed in MODERN WIRELESS. This device has the effect of increasing the bass reproduction, and at the same time increasing the volume, and incidentally the effect of increasing the brilliance of the reproduction. The second device is the Celestion "Tiltatone," which is an interesting affair and enables one to vary the musical balance while the record is being played.

It consists of a system of inductances and resistances (we are not at liberty to give the exact details, of course), and on the panel of the little instrument is placed a volume and a tone control. The volume control, of course, merely controls the volume, and no noticeable decrease of high frequencies occurs as the strength is reduced.

Varying the Tone

The other knob, which controls the tone, has the effect of varying the balance of the reproduction. It is claimed that it varies the middle and upper middle frequencies so that you can either cut them down and have treble and bass, or allow the middle and upper middle frequencies to come in and have normal tone. Exactly how it does it is not clear, because the effect is rather more that of increasing the bass, and at the same time the volume, or else cutting out the bass and leaving the higher frequencies.

The instrument sells for about

To be able to balance the low, middle, and high frequencies of our pick-up reproduction as desired is an ideal we all should like to attain.

£4 17s. 6d., and is very fascinating to use. There is no doubt that adjustment for individual records by the "Tiltatone" has many advantages.

Used on a certain pick-up, one of my favourite ones, it gave me an opportunity of very effectively damping down a slight peak which seemed to occur at about 3,500 cycles. It will round off the pick-up reproduction in a manner which is very pleasing.

When carried to excess, however, it seems to result in a certain amount of persistence, with this particular pick-up at any rate, but when used

melody besides applying a control device to the pick-up.

Mr. Kendall has already shown MODERN WIRELESS readers how one can include an adjustment in their sets by using a small choke in series with the resistance of a resistance-coupled stage in an amplifier, in order to increase the high-note response, while increasing the bass by means of correctly placed fixed condensers or fixed condensers plus transformer systems.

Further Schemes

I believe one firm at least is at the moment experimenting with an output-filter stage which gives control of the various frequencies at the same time.

Another device which may quite likely appear on the market is an interval type of tone control, but for the pick-up user who wants to adjust his tones when using a pick-up the "Tiltatone" is distinctly useful.

A USEFUL "TONE-MIXER"

Here is the Celestion "Tiltatone," a useful little device which sells for £4 17s. 6d. It enables you to control the musical balance you have in your pick-up reproduction.

The input terminals and tone control are on the left, while the remaining knob controls volume, and the output to the set is taken from the right.



judiciously it can be made to provide very realistic reproduction indeed.

Of course, the "Tiltatone" cannot be expected to make up for the deficiencies of very bad pick-ups, but with a good pick-up it is a very useful little addition.

There are other ways of mixing the

It does not vary the control by any drastic extent, there is no cutting right out of the high frequencies or the bass, but it does give a very valuable final adjustment to the quality obtained from your pick-up, and is one of the best tone controls which we have come across.

The



LAST month we gave constructional details of the "Star-Turn" Two, a two-valver of exceptional selectivity which was ideal for reception of either local or foreign stations, even if the listener were in the swamp area of Brookmans Park.

But it is not everyone who needs such a super-selective set as the "Star-Turn," and so this month we are providing readers of MODERN WIRELESS with a description of a simple, cheap, but effective two-valver which will be ideal for the constructor who lives some distance away from a powerful transmitter.

Razor-sharp selectivity is not required by the great majority of listeners, and so here is a set which, while not being non-selective, nevertheless does not possess that knife-like quality in tuning associated with the "Star-Turn" circuits.

Specially Smooth Reaction

Such sharpness is not needed 20 or so miles away from Brookmans Park, or any other high-power station where the question of tuning out is by no means a formidable one, and any set with a good average degree of selectivity is quite satisfactory.

But it is not much use to have no problems concerning the cutting-out of your local station if your set will not get anything else but that local. So in the design of the "Reactive" Two we had in mind the requirements of the more distant listener—that of loud-speaker reception of his nearest station and of good 'phone, or occasional speaker, reception of Continental programmes.

Therefore we decided to employ a circuit which would satisfy these requirements; one that would be

reasonably selective and sensitive, and, moreover, one that would be easy to operate and cheap to construct.

The result is the "Reactive" Two, so called because the reaction circuit is specially designed for efficiency and smoothness in control.

Quite a surprising amount of uneven reaction can often be traced to the vagaries of the H.F. choke, and it has been found that a resistance of about 25,000 ohms, instead of the choke, will allow smoother control to be obtained. Tendency to threshold howl, ploppiness and lag is prevented by this resistance. Therefore it was incorporated in this receiver.

seen that it is an ordinary leaky-grid-condenser rectifier transformer-coupled to the L.F. valve.

A further point about the tuning circuit and reaction—it will be noticed that a differential reaction condenser is employed, this enabling reaction control to be carried out without having a deleterious effect on the tuning of the set.

Nothing is more annoying when you are trying to tune-in a distant transmission than to find that every time you alter the reaction condenser setting you have to readjust the tuning. By using the differential reaction condenser this trouble is obviated.

Outstanding Performance

Thus the "Reactive" Two has some very strong points in its favour, and as a DX receiver it is certainly outstanding in its performance.

The aerial coupling is such that the best compromise between selectivity and sensitivity has been obtained, while the transformer-coupled L.F. stage makes the most of the signals rectified by the detector valve.

A glance at the list of components

A SIMPLE BUT EFFECTIVE CIRCUIT

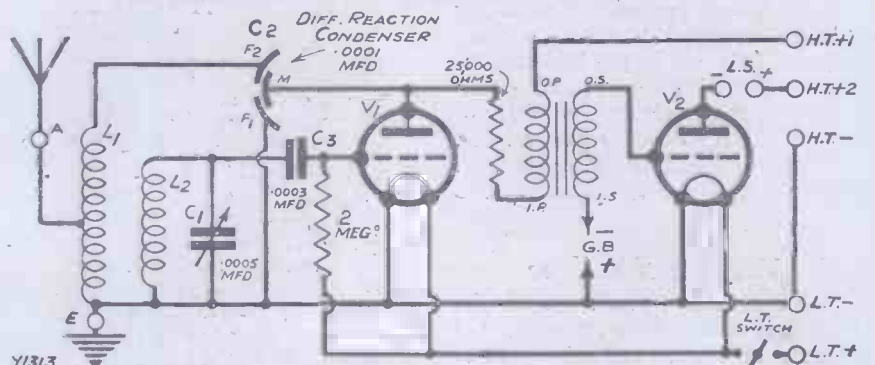

This is the circuit of the "Reactive" Two, from whence it gets its name. Note the special reaction circuit, with the 25,000-ohm resistance which is used instead of an H.F. choke, in order to ensure smooth reaction control.

A form of Reinartz reaction is employed, the coil L_1 being at once the reaction and aerial coil, which is coupled to the tuned grid coil L_2 .

The reaction-aerial coil is, centre-tapped, the whole coil acting as reaction, and the bottom half as aperiodic aerial coil.

For the rest of the set it will be

and the photographs will show that the set is not an expensive one to construct—as a matter of fact, it is surprisingly cheap—and also that there is nothing difficult in the construction of it.

Operation is simplicity itself, the one tuning dial (preferably with vernier control) is all that has to be

"Reactive" Two

This remarkable two-valver has been specially designed to meet the needs of the ordinary listener who is not in the swamp area of a big station, and who wants not only his local, but continental programmes either on 'phones or speaker. A special form of reaction circuit is employed, making the reaction extremely smooth, while the set is both easy and cheap to construct and to operate.

Built and Described by the "M.W." Research and Construction Dept.

used for searching the ether for programmes, while the small knob on the left of the panel is that controlling the reaction condenser (C₂).

There is little in the construction of the set, and if you follow the diagrams and photos carefully you should not encounter any setbacks. Make your layout look exactly like the one in the original set and you will not go far wrong.

Important Points

When building a set you should always take notice of such little points as the relative positions of valve holders, which way their grid and plate

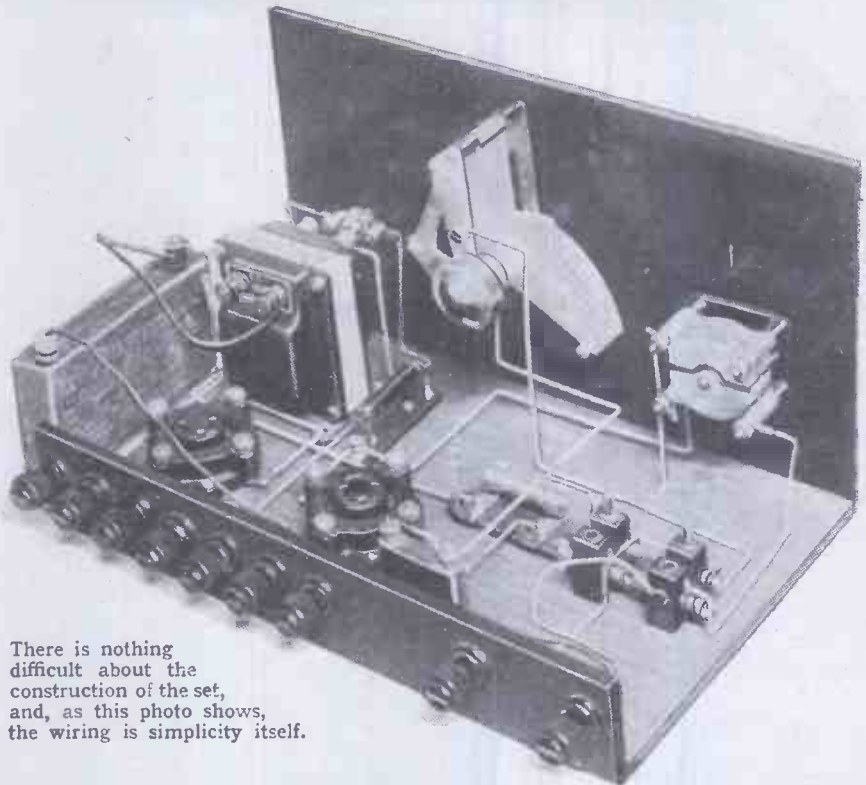

There is nothing difficult about the construction of the set, and, as this photo shows, the wiring is simplicity itself.

sockets face, and of the way round coil holders are fixed.

If two holders have their pins

together in the original set, place your coil holders like that, also make sure that the wires that should go to the pins do go to the pins in your set; and not to the sockets.

Little things like the reversal of coil-holder connections may seem quite unimportant, but a wrong connection will often prevent a set from operating properly.

So in this set, don't rush it because it looks easy. Take care over every detail, and make sure your copy of the original is equal to this latter in every way. There is no need why it should not be.

Try and make the wiring look like the original, too. Many home constructors copy the layout of a set reasonably well, but when it comes to the wiring they fail ignominiously.

Wire the Set Carefully

A little care is all that is needed, and although in this set it may seem rather unnecessary, it is a habit that should be cultivated, for careful wiring is an essential in all receivers, and the power to copy an original wire by wire is extremely valuable when you are building a large, complicated receiver.

The "Reactive" Two, in common

CHEAP TO BUILD AND EASY TO HANDLE

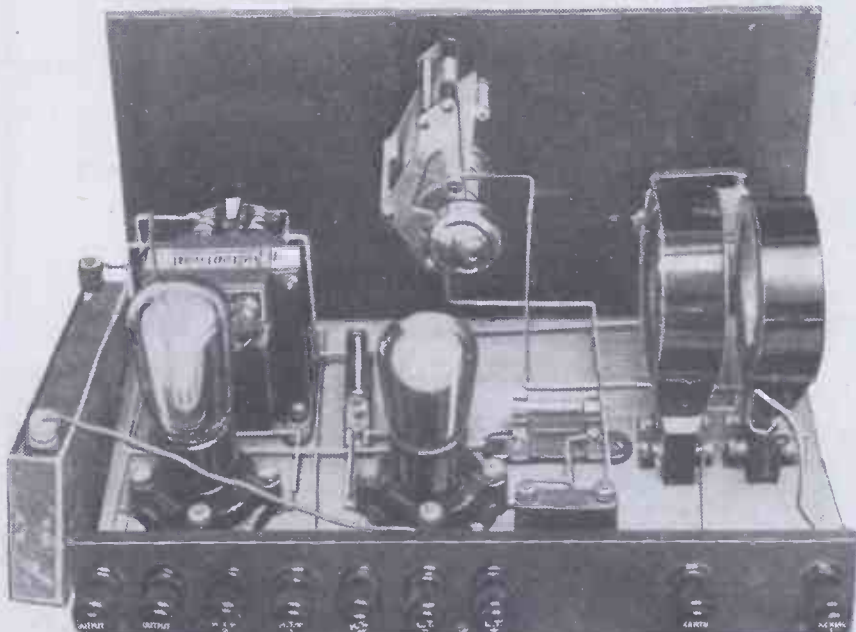

A centre-tapped aerial-reaction coil is employed, this being untuned, and coupled to the secondary coil. Differential reaction control is used, making the set wonderfully easy to handle.

with all our battery-driven sets, is suitable for use with either two-, four-, or six-volt valves. The detector valve should be either of the H.F. variety or else of the special detector type such as the P.M.2DX. The L.F. valve can be a small power valve such as the P.215, when moderate signal strength is required from a nearby station, but for long-distance reception on 'phones the ordinary L.F. valve would be rather a valuable aid to signal strength.

The H.T. Voltages

The H.T. employed should be of the order of 70-90 volts for the detector, the higher voltage being used for the reception of the local station, and adjustments being made with various voltages till best reaction results are obtained. For the L.F. valve anything up to 150 should be O.K., with

grid bias to suit the valve and H.T. used.

The coils required for the "Reactive" Two are: aerial No. 50 or No. 60 centre-tapped, according to the size of your aerial and secondary No. 60 for the shorter broadcast wave-band; and aerial 200, and secondary 250 turns for the long waves.

The set is not designed for use very near a local station, but no doubt if further selectivity were required an "X" coil could be used for the aerial, though such a procedure would of necessity greatly decrease the strength of reception.

It would then, of course, be of not very great use for DX reception, beside the fact that the 50-turn coil would then be a 60-turn coil and so reaction would tend to become rather fierce.

Only in the case of severe jamming

SIMPLICITY IN DESIGN IS A STRONG POINT

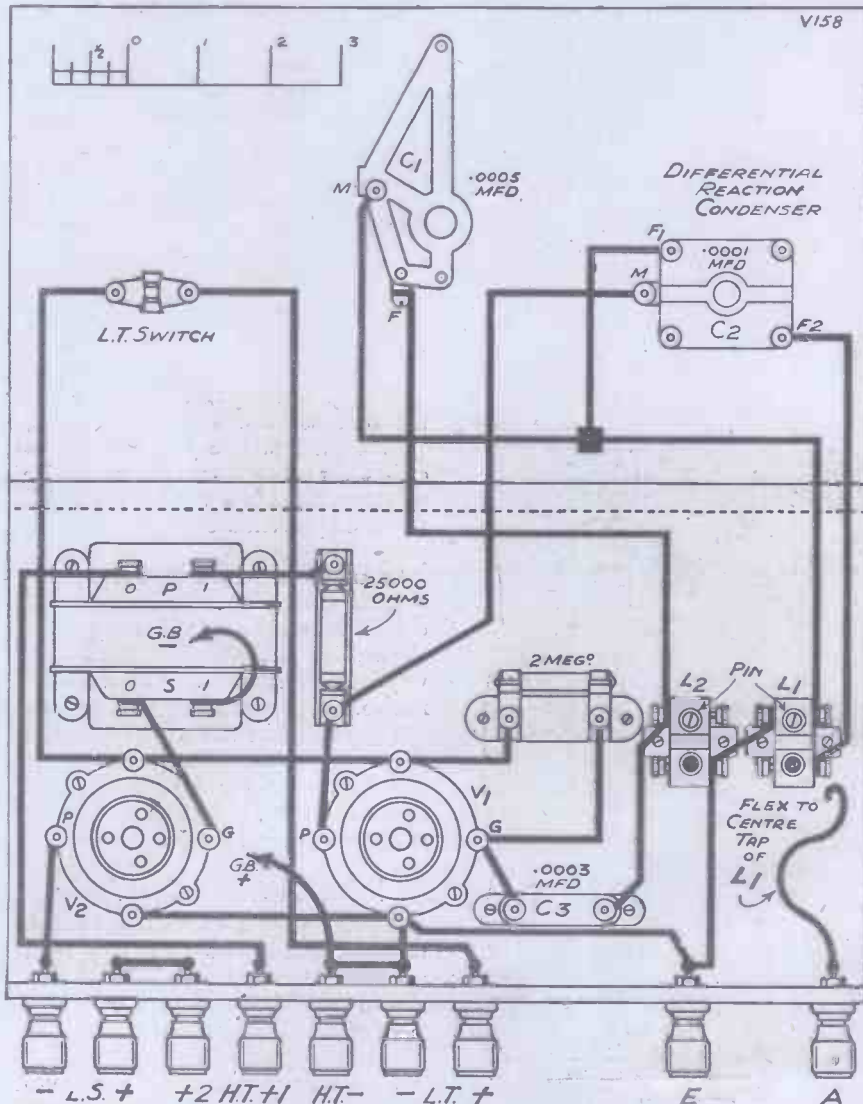

It should not take you very long to wire this receiver. There are no "snags," and if you follow this diagram closely you will be sure of success.

by Brookmans Park transmissions—that is, use of the set at distances nearer the local stations than it was designed for—should an "X" coil be resorted to. Then it would help to separate the twin transmissions, though loss of sensitivity would also result.

- *****
- WHAT YOU REQUIRE**
- * 1 Panel, 12 in. x 7 in. (Trolite, or Goltone, Paxolin, Keystone, etc.).
 - * 1 Cabinet, with baseboard 7 in. deep to fit (Camco, or Pickett, Lock, Osborne, etc.).
 - * 1 .0005-mfd. variable condenser (J.B. or Lissen, Igranic, Lotus, Dubilier, Ready Radio, Ormond, Polar, etc.).
 - * 1 .0001-, .00013-, or .00015-mfd. differential reaction condenser (Lissen or Lotus, Burton, Dubilier, Ready Radio, Polar, Formo, Magnum, Ormond, etc.).
 - * 1 L.T. switch (Benjamin, or Lissen, Igranic, Jewel, Bulgin, Lotus, Ormond, Magnum, Wearite, etc.).
 - * 2 Baseboard-mounting single-coil holders (Magnum, or Lotus, Lissen, Igranic, Wearite, etc.).
 - * 1 .0003-mfd. fixed condenser (T.C.C., or Lissen, Igranic, Graham-Farish, Dubilier, Mullard, Clarke Goltone etc.).
 - * 1 2-meg. grid leak and holder (Lissen or Ferranti, Dubilier, Ediswan Igranic, Mullard, etc.).
 - * 2 Sprung valve holders (Igranic, or Benjamin, W.B., Lotus, Formo Lissen, Precision, Wearite, Bulgin, Magnum, etc.).
 - * 1 25,000-ohm fixed resistance and holder (Ready Radio, or Ferranti, Lissen, Varley, Igranic, R.I., etc.).
 - * 1 Low-frequency transformer (Telsen, or Lissen, Lotus, Igranic, Varley Leweos, R.L., Mullard, Cossor, etc.)
 - * 9 Terminals (Belling & Lee, or Eelex, Igranic, Clix, etc.).
 - * 1 Terminal strip, 12 in. x 2 in.
 - * Flex, G.B. plugs, wire, screws, etc.
- *****

And now, having given the general details of the set and its construction, let us go a little deeper into the matter and see which will be the most simple way in which to proceed when you are carrying out the construction.

The Best Way

The photos show that this is not a difficult task by any means, but there is obviously a best way for everything, and the building of the "Reactive" Two is no exception.

The first thing to do is to prepare the panel, drilling the necessary holes for the two condensers, the on-off switch and the mounting screws, according to the positions shown in the panel diagram.

Sensitive, Smooth and Simple in Operation

If you have not a drill large enough to do the main condenser spindle you can use a smaller drill and reamer it out with a proper reamer (which costs about a shilling),

on the place for any length of time. If you have to do this it is a sign that the iron is not hot enough, or that the places to be soldered are dirty.

they will probably get hot and will melt the ebonite through which they pass. This will loosen the terminals and will (in bad cases) cause the terminal to become dirtier than ever. Also, don't let the iron touch the ebonite or it will need recleaning.

ALL THERE IS ON THE PANEL!

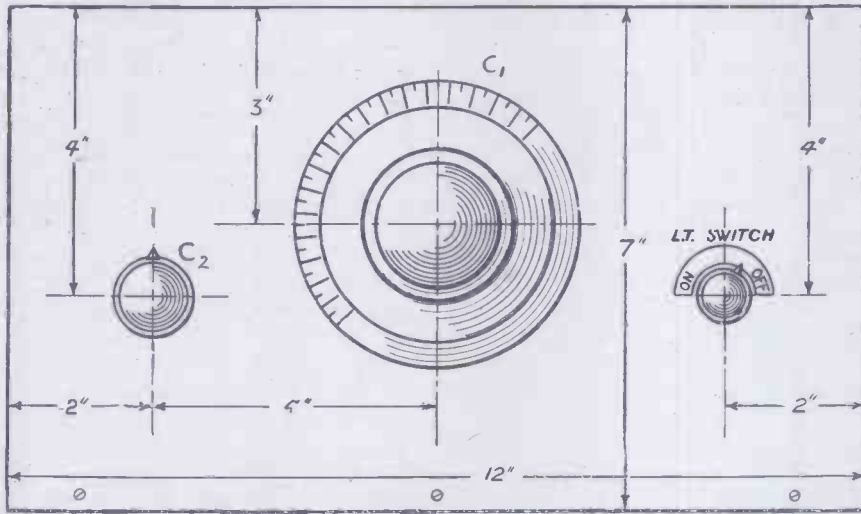

When soldering the resistance holder connections take the resistance out, or you may cause damage to it owing to the heat, and, finally, don't keep the iron on such terminals as the fixed condenser and transformer connections for any longer than you can help, or you may melt the soldered connections *inside* the components.

Don't Forget to Check It

It is usually best to get the filament wiring and earth connections done first; these can be tucked away close to the surface of the baseboard. Then the H.T. leads to transformer and to L.S. terminal can be done, followed by the L.S. to plate of last valve lead, and the transformer-resistance-plate lead of the detector valve.

The reaction condenser, tuning condenser, coils and grid leads can be done next, and any other leads that remain:

When all has been done the wiring should be carefully checked with the wiring diagram.

On the left is the reaction control, and in the centre the tuning condenser knob. The remaining panel control is the on-off filament switch.

or file it with a small round or half-round file.

After the panel the components should be laid out on the baseboard in exactly the same relative positions as shown in the illustrations and wiring diagram, which latter is to scale.

Then mount the panel and the terminal strip, which can be obtained ready prepared, and proceed to wire up.

In the original set ordinary tinned copper wire was used, being well stretched out so as to avoid kinks and to make it perfectly straight, and covered with Systoflex covering. Alternatively, Glazite or Junit wire could be employed.

An Important Point

In making the soldered joints, which help a great deal to provide neatness and efficiency in the wiring, always remember that as little fluxite as possible, consistent with a good joint, should be used, and the iron must be really hot, and the pieces of metal perfectly clean.

Many hopes of good joints are ruined by either (1) a dirty iron; (2) too cool an iron; (3) or dirty wires and terminals. Remember that the solder should flow readily and that you should not have to hold the iron

This trouble is likely to occur mostly at the terminals, and if you hold the iron on the terminal shanks for long

HOW YOUR SET SHOULD LOOK

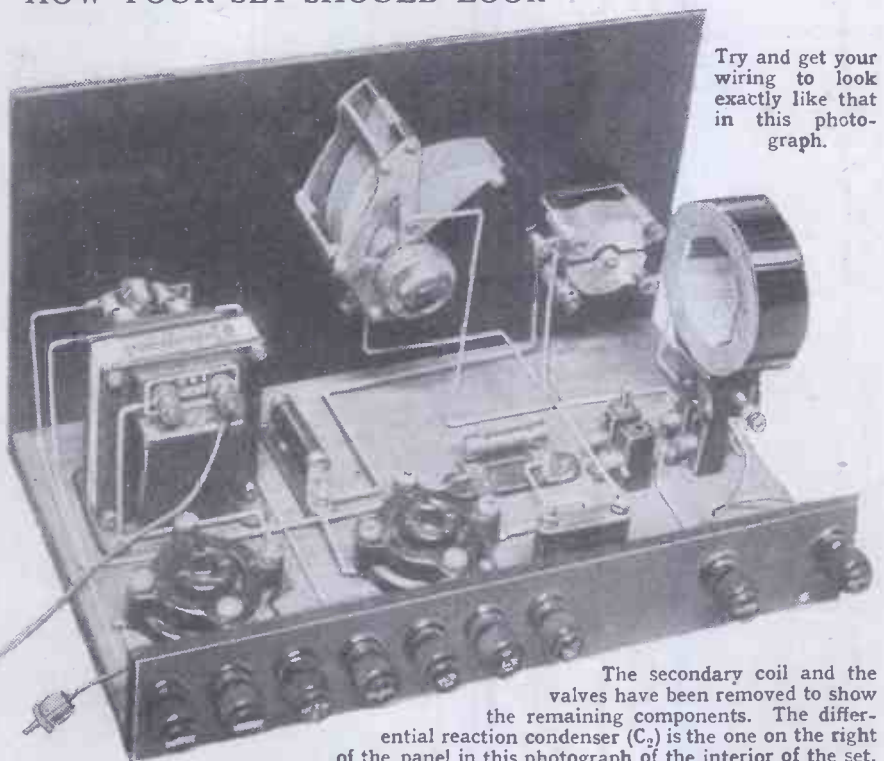

Try and get your wiring to look exactly like that in this photograph.

The secondary coil and the valves have been removed to show the remaining components. The differential reaction condenser (C₂) is the one on the right of the panel in this photograph of the interior of the set.

TELEPHONE VISION

That one day we shall be able to see the persons to whom we talk on the telephone has long been considered a dream of the scientist. But it is now an accomplished fact, and you will find much to hold your interest in this account of how it is done.

By A SPECIAL CORRESPONDENT.

TELEVISION has taken another step in its development with the production of a two-way land-line system which can supplement the usual two-way telephone, permitting the parties to a conversation to see as well as to hear each other.

An experimental service between two remote points has just been demonstrated in America.

A person seats himself in a television telephone booth before a frame in which he will see the face of the person with whom he is talking. His own face is rapidly scanned by a mild beam of blue light which reflects from his face to the photo-electric cells and gives rise to the current which transmits his image to the distant booth.

No Glare

There is no fierce glare to the scanning beam, and one is not annoyed by its presence.

The first thing which strikes the observer when he steps into the booth—which is lighted with a dim, orange light, to which the photo-electric cells are insensitive—is the absence of the usual telephone.

Special telephone transmitters and receivers are concealed in the booths. One talks face to face to the distant person, and a hidden reproducer speaks the words which seem to issue from his mouth.

An ordinary telephone is not used because it would hide part of the speaker's face from his distant observer, but this novel arrangement of concealed transmitter and receiver avoids that difficulty and adds naturalness to the conversation.

Easily Recognised

The other party to the television-telephone conversation appears with sufficient detail for recognition of facial expression, but the effect is rather like looking at an animated cabinet-sized photograph. This is because the image is produced in monochrome. What one sees is like an instantaneous moving picture done in black on a pink background (due to the colour of the neon tube).

The television image is greatly improved over that originally demon-

strated by Bell Telephone Laboratories in 1927, and is about twice as large with corresponding increase in detail. The image, which has the detail of about five thousand discrete points of light, is formed eighteen times a second.

Improved Sensitivity

The photo-electric cells used in picking up the face which is to be transmitted have been much improved in sensitiveness, and give rise to about ten times the current for the same amount of light as did those developed for the earlier demonstration. That increased sensitivity and the use of the blue scanning beam have made possible the reduction of

with his seeing the image of the person to whom he is talking.

The increased area and detail of the image necessitate the use of a wide band of frequencies, and the circuits where the experiments have taken place have been adapted to the transmission of a frequency band of forty kilocycles.

How Calls are Made

The experimental service is operated in such a way that if someone in one street wishes to call a person in a street farther removed he steps into a small ante-room and places his call with the attendant. She in turn ushers him into the television booth, where he seats himself in a swivel chair and swings around to face the apparatus.

What he sees is a blue spot of light and below that through an inclined plate of glass a small frame showing the words, "IKONOPHONE—watch this space for television image." He is told that as soon as the party he is calling is similarly placed in the distant booth this sign will be lifted and in its place he will see the other

OUTSIDE THE TELEPHONE-TELEVISION BOOTH

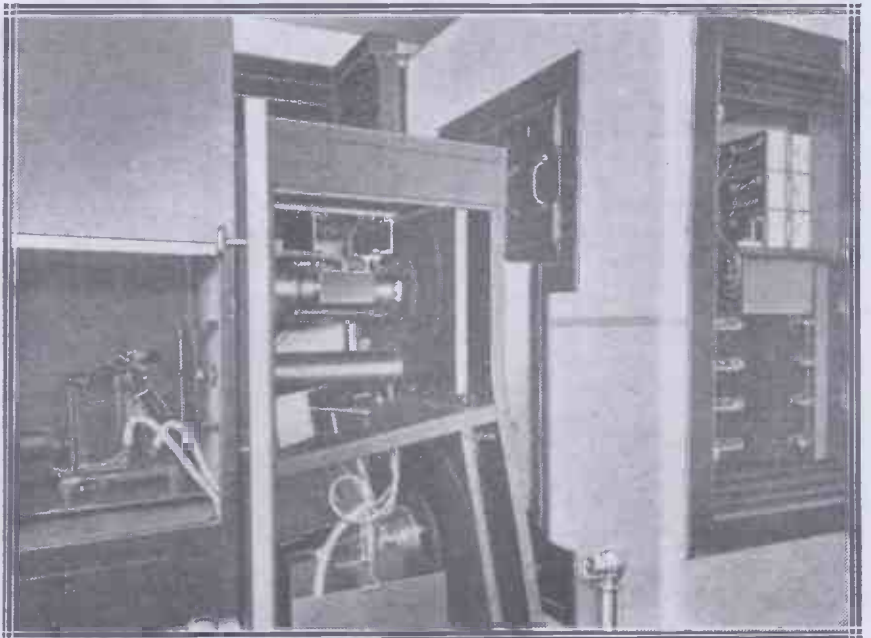

There are three main cabinets for containing the apparatus, and they can be seen here with their covers removed. In the right-hand one the terminals of the photo-electric cells can be seen, the middle one contains the scanning discs, while the arc lamp is situated in the third.

the dazzle and glare which occurred to a certain extent in the earlier forms of apparatus.

The person whose image is being transmitted is, therefore, practically unconscious of the fact that his face is being swept eighteen times a second by a scanning beam of light; and the beam is not bright enough to interfere

party, and that when he does so he may start talking.

Then the sign is drawn aside by the operator, and he finds himself looking at the person he has called. When this unique telephone conversation is completed and he swings his chair around to leave the booth the sign reappears ready for the next conversation.

THE FERRANTI A.C. MAINS RECEIVER

The famous transformer manufacturers have turned their attention to complete receiver design, and this is an example of the excellence of their work.

By the "M.W." Research Dept.



NOVELTY in design and a pleasing severity in appearance are two of the main characteristics of this A.C. receiver, built by one of the oldest established firms of electrical engineers in the country.

The Ferranti A.C. mains receiver has been designed on original lines, and upholds the traditions of Ferranti in a noteworthy manner. This set is the first Ferranti receiver to be put upon the market, and is a three-stager, with a transformer-coupled S.G. valve, using the M.S.4, a leaky-grid detector using the M.H.L.4, and a transformer-coupled L.F. stage employing the P.625.

A Quality Receiver

First and foremost this is a quality receiver, and it is interesting to note that the famous A.F.6 intervalve transformer, the high-ratio model recently introduced by Ferranti, has been employed to couple the detector to the low-frequency valve. Grid bias for the last valve is obtained from a half-wave metal rectifier, but the high tension has a full-wave valve rectifier (U.9) with very simple but effective smoothing.

In construction the set is a masterpiece of engineering, the iron plates used in the construction of the housing and the shielding being held together by rivets and spot welding. A flexible drive is employed between the reaction and volume controls, and the condenser and swinging coils with which they are associated.

Excellent Rejector Unit

Wave-change, of course, is included, and an extra novel feature is the special rejector unit which plugs into the base below the set. This is

supplied to assist those who are close to a powerful local station in cutting him out and getting continental reception free from interference.

The rejector unit consists of three tuned rejectors, which are adjusted to the wave-lengths of 261, 356, and 1,554 metres, to deal with the National and Regional programmes and 5 X X. A three-way switch is provided, which will introduce either the pair of short-wave rejectors, or the long-wave rejector, or short the lot and connect the set direct to the aerial with the rejector unit out of circuit.



The back view of the Ferranti Three. Note the holes for ventilation and cooling of the A.C. valves.

Small variable condensers are provided for adjusting the rejectors so as to alter them for your own particular aerial conditions.

It will be remembered that this set was reviewed in MODERN WIRE-

LESS in the "Tested" columns some time ago, but since then we have had the opportunity of further examining the set, and seeing how it operates under ordinary working conditions.

It has been taken out to a place only about eight or ten miles from Brookmans Park, and there, on a comparatively large aerial, it has given an excellent account of itself. The tuning is remarkably sharp, a useful control of volume being given by a small variable condenser in the aerial lead.

No Trace of Hum

The National and Regional stations were quite easily cut out with the aid of the rejector, and a large number of foreign stations brought in. Many of these were perfectly clear of interference, and provided programmes to which it was a delight to listen.

Contrary to a great number of all-mains receivers, the Ferranti A.C. Three is particularly free from any hum, even when reaction is employed for the getting of distant transmissions.

Another interesting point about this remarkable set is that in the back there is a connector which allows the introduction of a gramophone pick-up. The pick-up is fed into the detector grid circuit, and the necessary negative grid bias is obtained by a voltage drop across a special resistance in the cathode circuit.

Used with a Pick-Up

Used with a rather insensitive pick-up the magnification was hardly great enough for average purposes; but with a pick-up which has a fair degree of sensitivity excellent results

Illuminated Dials Facilitate Station Searching

were obtained, and although a change-over switch is not supplied for radio-cum-pick-up work the set makes an excellent radio-gram receiver.

Illuminated Dials

It is priced at £27 in oak, and £28 in walnut or mahogany, and from the listener's point of view is really an excellent receiver. In appearance, as you will see from the photographs, it is delightfully severe, and not only are the control knobs quite conveniently placed, but the illuminated dials make reading of the condensers an extremely easy job.

Finally, we must draw our readers' attention to one piece of remarkable but praiseworthy candour that is typical of the way Messrs. Ferranti

carry on their business. It is contained in the technical data section of the booklet that describes the A.C. mains receiver, and concerns the output.

After stating that the receiver gives an output of 600 A.C. milliwatts, Ferranti's add: "With a maximum distortion of 3½ per cent. No output is distortionless, due to valve characteristic curvature and slight imperfections, even in the best amplifiers."

As the distortion that is present in the Ferranti set is inaudible, and much less than is taken as the standard permissible for first-class reception, the acknowledgment that distortion is present can but increase the admiration already held for this go-ahead firm.

The Ferranti set is good, and the makers know it; and to show their confidence they guarantee it against defects in workmanship and materials for a period of twelve months from the date of supply.

Special Output Stage

The output stage is a strong feature of the set, and is well worth noting. In order to cater for ordinary high-resistance speakers and also for the low-resistance moving-coil type, the set is provided with an output transformer having two ratios.

There is no doubt that the Ferranti A.C. mains set can be regarded as one of the best of the all-mains receivers on the British market, and as such should certainly find a place in a very great number of British homes.

In the following article I have endeavoured to enumerate the various essential qualities of design which should be embodied in a really satisfactory electric gramophone driving unit.

Firstly, the electric motor itself should be considered. Solid construction is most essential for vibrationless running. A cast casing fitted with brass brushes at the bearings, and Stauffer box lubrication, with a thrust adjustment device at the free end of the shaft, comprises an ideal motive unit.

Multi-pole Armature

A multi-pole armature and commutator are desirable for steady running, with silk-covered windings for trouble-free service. Between the commutator and bearing an oil baffle should be fitted, so that oil from the bearing cannot creep to the commutator and cause sparking, with its attendant troubles.

A small fan attached to the shaft, inside the casing, for air circulation keeps the working temperature down considerably.

Square-section brushes are better than the round-section type, because of the tendency of the round-section brush to revolve in the brush holder, causing uneven brush wear, sparking, and consequential damage to the commutator.

No Slackness

To complete inspection of the motor, the fit of the shaft in its bearings should be tested. It is most

YOUR ELECTRIC MOTOR

By J. T. WISH.

essential that the armature and shaft revolve freely without the slightest "looseness" or rattle at the bearings, otherwise it is impossible to get quiet and steady running.

Secondly, the frame of the unit must be considered. Rigidity is absolutely essential, as any tendency to warp will cause jamming or tightness at some vital point.

Aluminium with its qualities of



The Columbia radio-gramophone, which is a first-class piece of design. It incorporates a useful scratch filter control by which the brilliance of the reproduction can be varied at will, and, of course, includes a perfectly silent electric motor. No trace of hum or background is present in the output.

lightness in weight and rigidity is about the most satisfactory material. The suspension bolts should be so spaced that the weight of the unit is evenly distributed on the motor board.

Thirdly, the speed-regulating device requires consideration. Although a few types of motors are controlled by varying the input—which is not a very satisfactory method where constant speed is required—the majority employ the centrifugal governor.

The weights of the governor should be of ample size and weight, 5/8 in. diameter by 1/8 in. thick being an average size in a good quality machine. The friction wheel should be highly polished, so that the speed-regulator pad does not cause undue friction. It is also essential that the friction wheel be perfectly flat, otherwise jerky running will result.

Obtaining Quiet Running

Fourthly, the main spindle and drive must be considered. For quiet running a fibre worm-wheel is necessary on the main spindle. The top and bottom bearings of the main spindle should be set concentric in the frame so that the mesh of worm and worm-wheel may be adjusted for best running position.

The main spindle should ride on a ball bearing in the bottom bearing.

Lastly, it is most important that all moving parts be well and constantly lubricated. But as the motor is generally in an inaccessible position, oil boxes or reservoirs should be fitted at all bearings.

THE "M.W." L.F. TRANSFORMER REVIEW

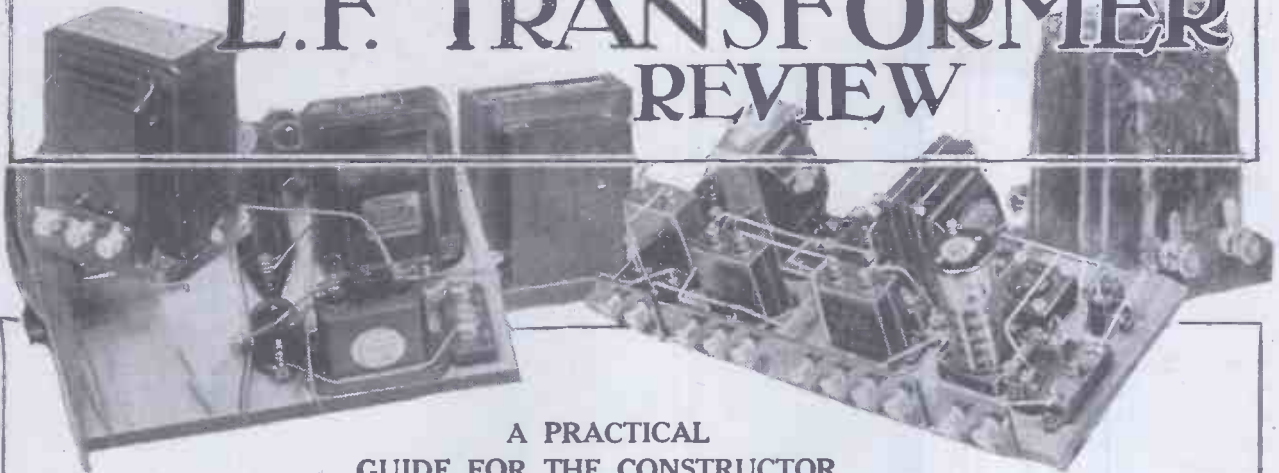

A PRACTICAL GUIDE FOR THE CONSTRUCTOR

PRACTICALLY every modern radio receiver uses at least one L.F. transformer. And this is a component that can do more to make or mar results than almost any other.

The position it usually occupies in a set is a "key" one, for it forms the vital link between two stages. Additionally, its windings occupy important positions in these stages and upon them depends, to a large

extent, the correct functioning of the valves concerned.

In these circumstances it is obvious that the radio set constructor should pay particular attention to his selection of L.F. transformers.

In this special supplement all the leading makes of L.F. transformers for intervalve coupling are illustrated, and a comprehensive survey of their use and operation is given.

THE L.F. transformer is a most interesting component. Although it looks such a simple, lifeless article, the electrical and magnetic activities that take place within its interior are far more complicated than those peculiar to the valve.

In comparison with, for instance, a variable condenser, its operation is exceedingly complex. The average constructor may well find it difficult

to believe this, because it is inevitable that the mechanical should make a more direct appeal to the senses than the electrical. That is, of course, generally speaking.

The variable condenser, with its ball bearings and its slow-motion gearing, would seem to be doing much more in a set than a "static" device such as an L.F. transformer.

However, the job of a variable condenser is relatively straightforward, while that of an L.F. transformer is beset with difficulties. But radio is like that throughout. Appearances are terribly deceptive.

Those Early Transformers

Now what does an L.F. transformer have to do? In the position it usually occupies in a set it has to take the low-frequency impulses from one valve and pass them on to another valve for further amplification. That sounds a rather simple job, doesn't it?

Well, it is a simple job until you endeavour to get that energy passed over without much loss occurring or without it being badly mangled.

The early L.F. transformer was an elementary sort of affair. It com-

prised a simple and often solid core of iron, and the two windings—primary and secondary—were wound in bunches on it in a quite primitive manner. The energy was fed into the primary and collected again from the secondary, and one hoped for the best!



This is the type "A" Brown L.F. transformer. Its ratio is 1-3.5, and although its price is higher than most, its "curve" is extraordinarily fine.



This B.T.H. L.F. transformer has a ratio of 1-4. It is guaranteed to conform to within 5 per cent of its published curves.

"M.W." L.F. Transformer Review—Contd.

The reason why scientific design did not enter into the construction of these pre-war transformers to any marked degree is plain to see. Those transformers did not have to handle frequencies covering the whole musical scale.

The most onerous task they had to perform was to deal with human speech in telephone arrangements.

But as the microphones of the day—and, indeed, all the rest of the apparatus used—were of somewhat primitive characters, and as the band of frequencies necessary to convey recognisable speech is quite narrow, it can be said that those L.F. transformers were adequate for their time.

It seems that it was not until broadcasting came along that serious attention was paid to producing really decent L.F. transformers. Many of those that were fitted in early broadcast receivers were replicas of those that had served their purposes so well in nothing-but-morse-receivers, and the results given by those early broadcast receivers suffered the more!

Very Important Details

And it is exceptionally hard to imagine how bad those early broadcast receptions were, as judged by modern standards!

But to return to the L.F. transformer itself. The modern transformer differs only in detail—although mighty important details—from its predecessors. There are still the iron core and primary and secondary

windings built into a case provided with four terminals.

We will give a brief sketch of the theory of operation of the component just to refresh your memory.

Lines of Force

When a current of electricity flows through a conductor, what is known as a magnetic field is built up around the conductor. This is an area of "lines of force," and the intensity of the

AN EARLY TYPE

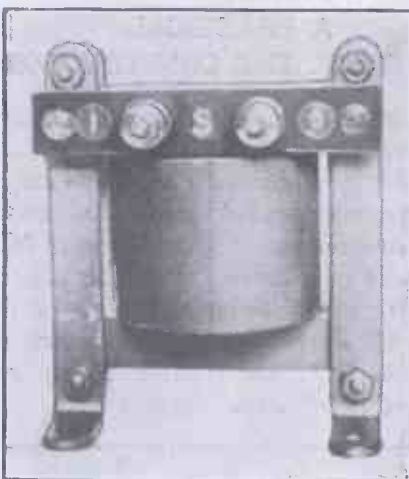

Very few modern L.F. transformers are, like this earlier model, without a casing.

magnetic field is calculated from the number of lines that exist within a certain space.

The more lines there are the stronger the magnetic field. These

TESTING TRANSFORMERS



The continuity of a transformer's windings can be tested with a small battery and a pair of 'phones.

lines take up the form of a series of rings around a straight wire. The strength of the magnetic field is increased when this wire is wound in the form of a spiral, so that the lines of force that are set up interlink the one with the other.

If the magnetic field, as it builds up, cuts through another conductor, it induces in this a current of electricity; thus in an L.F. transformer the lines of force emanating from the primary cut through the turns of wire constituting the secondary winding and induce current in this.

An Induced Current

When we say "cut" we mean that the lines of force—or if you prefer to think of it as such, the magnetic field—rises (or falls) through the wire into which the current has to be induced, like a wave in the sea rising up or subsiding and cutting across the struts of a seaside pier.

The strength of the magnetic field existing around a given winding of wire depends directly upon the value of the current flowing through it. If the current increases the intensity of the magnetic field increases; if the current drops the intensity of the field drops also.

Such "variations in the intensity" of the magnetic field are equivalent to its rising and falling to a certain extent, and, of course, these rises and falls are the causes of the varying current induced in the secondary winding of the L.F. transformer.

It is worth noting, in passing, that the induced current flows in an exactly opposite direction to the current that sets it up, and the voltage of the induced current depends directly upon the ratio of the turns of wire in the two windings.

If there are twice as many turns in the secondary winding as in the

HOW TRANSFORMERS ARE MADE

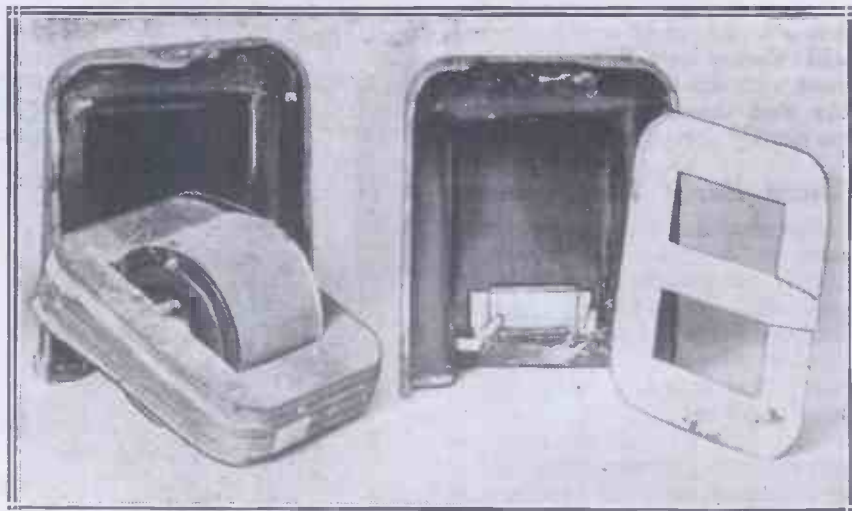

A modern transformer opened up for inspection. Note the two windings, and the one lamination (right) removed from the core. In the one section of the case can be seen the small fixed condenser that is joined across the primary winding terminals.

How Low-Frequency Transformers do their Work

primary the voltage induced in the secondary will be twice that existing in the primary. If the secondary winding were the smaller, having, for example, only half the turns of the primary, the voltage induced in it by a fluctuating current in the primary would be only a half.

You cannot pass direct current through a transformer—at least, from the primary to the secondary—for the simple reason that a current that flows in one direction only and at a fixed rate sets up a magnetic field of unvarying intensity.

Stepping-Up Voltage

On the other hand, either A.C.—that is, current which changes its direction a definite number of times per second—or fluctuating direct current—that is, current which flows in only one direction but with variations in strength—can create electrical energy in the secondary winding, because either will set up a fluctuating magnetic field.

You will remember that the intensity of a magnetic field depends directly upon the value of the current



The "Cossor" L.F. transformer is available in 1-2, 1-3, 1-4, and 1-5 ratios, either shrouded (as above) or unshrouded.

flowing through the conductor around which the lines of force are constituted.

Now, an L.F. transformer that has a larger secondary winding than a primary is known as a step-up transformer, for the simple reason that it "steps-up" voltage. This is the type invariably used for intervalve coupling.

A voltage increase is, of course, a distinct advantage, because a valve is a voltage-operated device; the grid of a valve is not so much interested in current as expressed in terms of amperes as in voltage differences—



The Brownie "Popular" has a high ratio and sells at an attractively low price.

voltage differences existing between its grid and its filament. A variation of grid bias, as it were. It is such that cause the resistance of a valve to vary and thus produce a fluctuating anode current.

So much for the bare bones, as it were, of the L.F. transformer. Now let us see exactly what we want from an L.F. transformer.

The primary winding is generally joined in series with the anode circuit of either the detector or first L.F. valve.

Primary Impedance

We want to get as much energy out of that valve as possible for handing over to the second valve for further amplification. The first consideration, therefore, is to confine as large a proportion of the voltage variations developed to across the primary terminals of the L.F. transformer as is practical.

The valve has a certain impedance, and it can be shown that it is advantageous to have a primary winding in the L.F. transformer of an impedance two or three times greater than that of the valve.

In practice, we find that an L.F. transformer having a primary with an inductance of at least 50 to 75 henries fulfils these conditions. The inductance will depend upon the number of turns of wire and the core upon which they are wound.

You can increase the inductance

of the primary winding by increasing its number of turns, but there is a limit to this imposed by the "step-up" ratio. Obviously, the greater the step-up ratio, other things being equal, the greater will be the effective amplification achieved by the subsequent valve.

Remember, the voltage is stepped-up in a transformer in accordance with its ratio, and that this step-up is determined by the ratio of the numbers of turns of wire constituting the secondary and primary windings.

What Capacity Does

Therefore, if you increase the turns of wire on the primary, to retain the same ratio of step-up you have also to increase the turns of wire on the secondary. You might have a primary winding of, say, 50 henries, comprising 7,000 turns of wire. To achieve a 1 to 3 step-up you have to have 21,000 turns of wire on the secondary. Even this indicates an enormous amount of wire.

You cannot go on increasing the turns even with specially sectionalised windings without increasing the self-capacity considerably. This brings us up against quite a new factor.

You can easily see that a large amount of wire wound in a bunch must have a fair amount of capacity.

Now, you do not want any marked degree of capacity between either the primary or secondary terminals, for such will tend to by-pass the higher frequencies. The result of this is a falling-off in the response of the higher notes.

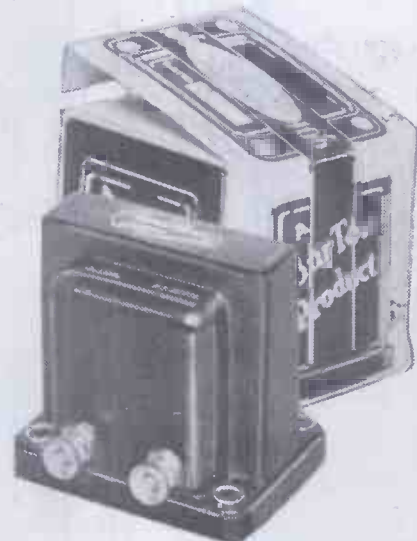

1-5 is the ratio of this Burton L.F. transformer.

"M.W." L.F. Transformer Review—Contd.

There is a further effect that can be due to self-capacity. This is what is known as resonance. The secondary winding, as with the primary, has a certain inductance. There is always a certain amount of self-capacity.

These two factors—i.e. inductance and capacity being present—render the circuit resonant at a certain frequency, and the greater the capacity for a given inductance the lower will be that frequency.

The practical effect of resonance is that the transformer will handle one certain frequency very much better than all the others, and so it gets amplified out of all proportion. There is a "peak," as we say.

The transformer designer always endeavours to push his peak well up to the top of the scale—to round about 6,000 or 7,000.

Losing H.T. Volts

The "peak" is not so pronounced as we might have led you to believe, because of the necessarily high resistance of the secondary winding. As you will no doubt know, resistance tends to introduce damping.

This leads us to another interesting point. It is advantageous for the primary winding to have as low a resistance as possible, although this does not apply to the secondary winding for other reasons than the one we have just mentioned.

The lower the ohmic resistance of

the primary winding the better. There is an inevitable wastage or a drop of H.T. voltage through the primary winding, and this will be proportional with its ohmic resistance.

Where Transformers Score

This is where the L.F. transformer scores over resistance-capacity coup-

Thus for 100 volts, should you be using as much as this, all but ten or so may get to the anode of the valve. On the other hand, the "ohmage" of the anode resistance in an R.C.C. unit must be greater than that of the valve or there will not be an efficient coupling, or passing through of energy.

You see, the impedance of an anode resistance is built up almost entirely of ohmic resistance; there is no appreciable inductance, which is the most exaggerated factor in the case

ANOTHER TRANSFORMER DISSECTED

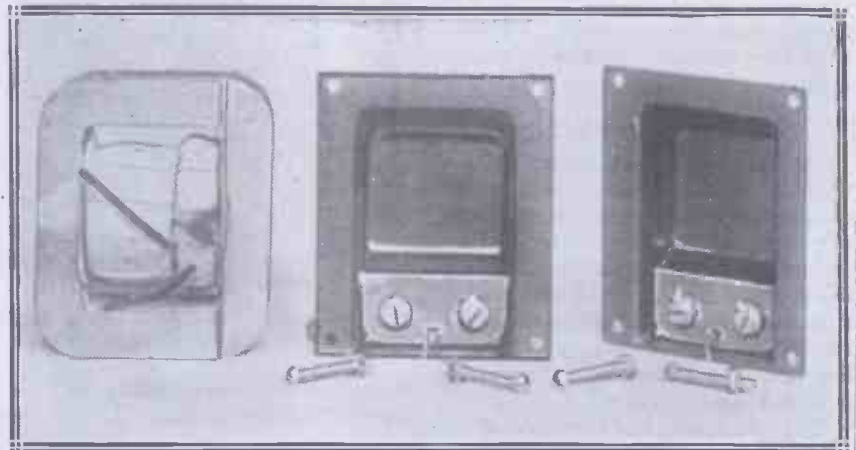

This is a rather differently designed transformer. There is no condenser and the windings are arranged in another manner.

ling. The few thousand ohms of resistance that are to be found in the primary of the ordinary transformer becomes only a small proportion of the total resistance in the anode circuit where the valve may contribute 10,000 or more ohms.

of the primary winding of an L.F. transformer.

The 50 henries at least of inductance that is to be found in the primary winding of almost any modern L.F. transformer can give you as much as 35,000 or 40,000 ohms impedance at a frequency as low as 120.

But the resistance-capacity coupling gains in that its coupling impedance hardly varies with varying frequencies, inasmuch as its impedance is built up almost entirely of ohmic resistance.

Two Great Advantages

The same cannot be said of any make of L.F. transformer so far, although the component has improved out of all knowledge and, for all practical purposes, it can be regarded as being almost equal in this regard to the R.C.C. arrangement.

Thus you will see that the L.F. transformer has two very great advantages over R.C.C. One, it permits you to achieve a definite voltage step-up and thus add to the effective amplification obtained, and, secondly, by virtue of the electrical nature of its primary winding there is a far smaller H.T. drop.

So far, so good, but there are various things that can cause serious losses in an L.F. transformer unless

PULLING THE CORE TO PIECES

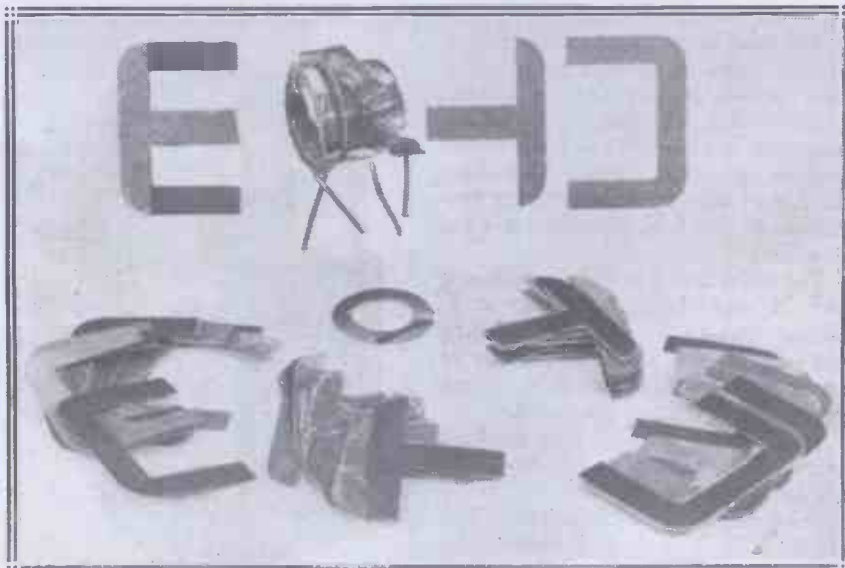

Now you can see how the core is built up in this particular transformer. The separate "laminations" fit together in the order suggested by the top part of this photo. Imagine the pieces closing in on the windings and you will get a clear picture of it.

A Component that Occupies Important Positions

the article is extremely carefully designed.

The purpose of the core, for instance, is to increase the intensity of the magnetic field and to provide an easy path through which the lines of force can be led. Obviously, as the lines of force do flow through the core, currents will be set up in it.

These currents, which are known as eddy currents, dissipate themselves in heat with a consequent waste of energy. In order to minimise eddy currents L.F. transformer cores are built up, not of solid pieces of metal, but of thin layers of metal known as laminations. And each layer is generally insulated from the others by a thin coating of an insulating material such as shellac.



A senior member of a famous family—the Ferranti A.F.5.

The resistance of the core as a whole is, therefore, very considerably increased and eddy currents minimised.

There is another magnetic effect which may have serious consequences unless it is scientifically dealt with. This is what is known as hysteresis.

Core Construction

Hysteresis is a lagging of the magnetic effect behind the current that causes it. Senatore Marconi used this phenomenon with great practical effect in his historic magnetic detector. But hysteresis is not wanted in the modern L.F. transformer. Its presence means a wastage of energy and frequency distortion. Frequency distortion, we should add, is the unequal treatment of different frequencies—the amplifying of some more than others.



This is the Super-Grand "Goltone." Its ratio is 1-5.

The core of an L.F. transformer does not consist of a simple rod of metal either solid or in layers. It has a very definite form or structure and it generally assumes the shape of a rectangle with a bar across the middle, the bobbin holding the two windings taking its place around this central bar.

Arranging Laminations

The purpose of such a core shape is to confine the lines of force to a definite "magnetic circuit." Any air gap in this circuit reduces the efficiency of the core as a whole; therefore, we find these strips or laminations arranged so that they overlap and, instead of being bolted



The "Formo" L.F. transformer with a 1-5 ratio. It has a gilt casing.

together by rivets passing through them, they are kept intact and clamped.

At this juncture you might well ask why use an iron core at all, since lines of force are set up in any case? The answer to this is that iron offers a vastly easier path to lines of force than air. It has what is known as a greater permeability; the lines can more easily permeate.

Explaining Permeability

Permeability is to lines of force more or less what conductance is to electrical current; conductance is the direct opposite to resistance. The higher the resistance of a wire the less its conductance or the less easily it conducts electricity.



The Gecophone "Hiflux" has a brown crystalline finish.

Thus, with a magnetic core, the greater the permeability the more easily the lines of force are carried through it. The very earliest transformers had cores of ordinary soft iron; later on it was found that an alloy of silicon and iron had a still greater permeability.

Reducing the Turns

It must not be forgotten that the greater the permeability of the core on which the transformer is built, the greater will be the inductance of the primary winding for a given number of turns. And any reduction in the number of turns is very much to our advantage, for it means that there is going to be less self-capacity and, in the case of the primary, less of that voltage dropping resistance.

Of recent years, what is considered

"M.W." L.F. Transformer Review—Contd.

by many to be a very great step forward has been taken in the development of core alloys by the introduction of nickel. It has been found that nickel-iron alloys can be designed to give very high permeabilities indeed.

"Talking" Transformers

The practical advantages are to be seen in the many new transformers that use cores of these special alloys and which are remarkably small and efficient. High primary inductances are achieved with small windings on cores of comparatively small bulk; and there are hysteresis decreases and eddy current reductions as incidentals to contribute to the better performances. However, there are people whose opinions cannot be lightly dismissed who say that there are snags in the use of nickel-iron core alloys of certain specific kinds.

A curious phenomenon that one comes up against now and then is an L.F. transformer which directly produces sound waves. When one of these "talking" transformers is in a set you hear broadcasting even with the loud speaker disconnected. The cause of this is loosely clamped core laminations. These loose laminations vibrate at audio frequency in sympathy with the fluctuations of magnetic intensity existing in the component.

Core "Saturation"

An interesting sidelight on the development of the L.F. transformer is afforded by the fact that nowadays breakdowns in transformers are much rarer than they used to be. Such breakdowns were often referred to as burn-outs.

Actually, the breaking down of the



The Lamplugh is of an out-of-the-ordinary design, and has a distinctive shape.

windings was more often due to the mechanical fracture of the wire (often following electrolytic action). Fine though was the wire of which the components were wound, it could generally handle more current than was present in an average anode circuit without even warming up.

And, talking about current, there is a further point that must not be forgotten. That is the magnetic polarisation, or limiting effect as it were, due to a steady current passing through the primary of the component. Above a certain value of current what is known as "core



The Lewcos L.F.T.5 has a centre-tapped secondary, allowing it to be used also in push-pull circuits.

saturation" will occur; above this the impedance of the device will rapidly fall off with a consequent frequency distortion. In earlier transformers a figure of one and a half or two milliamps. of steady current would represent a fair limit, although nowadays upwards of four or five can be accommodated.

Nevertheless, it is often an advantage to remove the direct-current component from the transformer and pass through this only the fluctuations.

This is accomplished by joining in series with the anode of the valve a resistance or L.F. choke capable of carrying all the current that might be met with in practice.

The L.F. impulses are diverted



The little Igranitic type "J" gives results out of proportion with its size.

through a fixed condenser to the primary of the L.F. transformer.

There is one further point in connection with transformer losses that should be mentioned. This concerns losses that are due to a "leakage inductance."

The job of the core in an L.F. transformer is, as you should by now know, to concentrate the magnetic field set up around the primary winding and make it flow through the secondary core without loss. But 100 per cent efficiency is impossible, and there will always be in the very best of L.F. transformers a few lines of force that do not link the primary and secondary together.

These are called "leakage lines," and it is the inductance that is associated with them that is called Leakage Inductance.

We will conclude this rather scrappy survey of a very big subject with a few words about the L.F. transformer in action.

Using Two Ratios

Transformers are made in varying ratios, although there are fewer ratios to-day than there were at one time. We are, of course, referring to transformers designed for intervalve coupling.

As we have shown, there is a limitation fixed for the ratio, for, although it would be an advantage to be able to increase the step-up in many cases, we cannot go much beyond 1 to 4 because of the necessity of compromising between a high-inductance primary winding and a low-capacity secondary winding.

Where two stages of L.F. transformer coupling are concerned it is generally the rule to employ the higher ratio transformer in the second position. The reason for this is that a lower ratio infers, prima facie anyway, a bigger primary with its higher resistance and impedance.

And the impedance of an early valve will be higher than that of a later one, and, remembering that the

Read About Those Transformer Points That Matter

higher the impedance of a valve the higher has to be the impedance of anything connected in its anode circuit to take off the maximum energy, the reasons for the preference of the arrangement we have mentioned are obvious.

And when two transformer couplings are employed there is much to be said for the employment of at least two different types, if not makes. If you use exactly the same type in each case it is a probability that there will be coincident peaks with a consequent tendency towards instability near one definite frequency.

Terminal Markings

Owing to the high amplification possible with two L.F. transformers, precautions against instability have to be taken and the employment of different types is one which we recommend

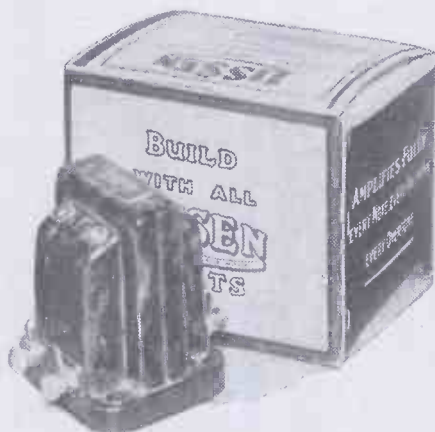

The new Lissen "Hypernik" L.F. transformer (ratio, 1-4).

The markings on the four terminals of an L.F. transformer are generally as follows: "A," for anode; H.T. +; G, for Grid; and G.B., for grid bias.

At one time the standard method of marking was I.P. and O.P., and I.S. and O.S., indicating "In Primary" and "Out Primary," and "In Secondary" and "Out Secondary." Those were definite indications of the beginnings and endings of the windings.

Coping with Instability

That was scientific up to a point. Where the method failed was that it was all very well to know the beginnings and endings of the windings, but this was of little use if there were no clear indications as to the disposition of the windings.

Not that this mattered very much, because it is a simple matter experi-

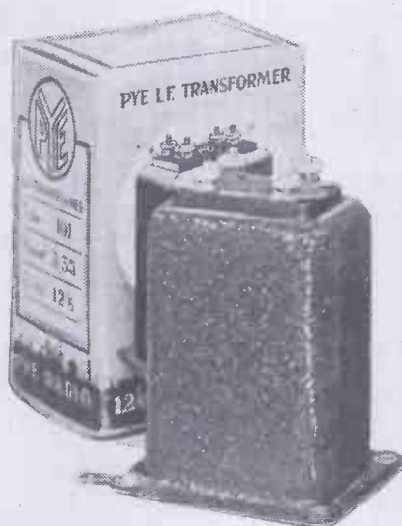

The economist's Pye—the type No. 101, which has a ratio of 1-3'3.

mentally to reverse the terminal connections should such a procedure be necessary. This may be when one is endeavouring to cope with instability.

"Antimobo" Devices

Low-frequency howling or instability is caused by a feed-back from a later valve to an earlier valve, a sort of reaction effect. Such a feed-back can be caused by a mutual coupling present in an H.T. supply.

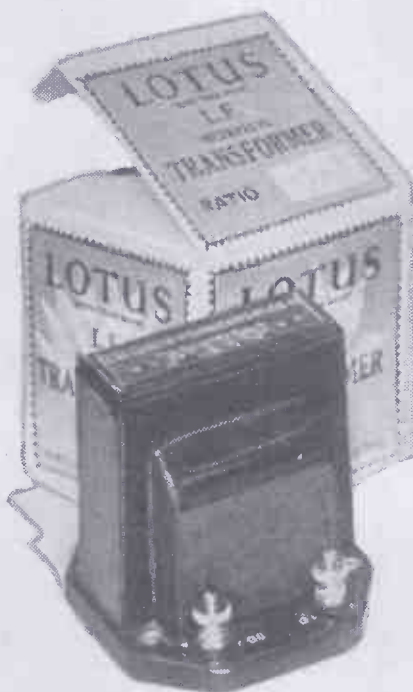

A special connecting point to earthing the core, if desired, is a feature of the Lotus.

"Antimobo" devices, decoupling arrangements, and so on, have as their main purpose the elimination of such a trouble. A choke-condenser output arrangement also materially assists, but quite often a permanent cure can be effected by changing over the secondary connections of the second L.F. transformer and thus effecting a phase change in the energy that is being dealt with.

Primary Condensers

There are several transformers on the market at the present time that have small fixed condensers permanently connected across their primary windings. Such a combination "lowers the tone" of the energy dealt with and also makes a transformer more suitable for the anode circuit of a reaction valve employing one of the older regeneration arrangements. In cases, proper detection may be impossible without it.



The Mullard "Permacore" has a nickel-iron core, a silver-wire primary, and a nickel-wire secondary

At one time metal cases around transformers were almost always used; the reason given for the presence of these was to prevent the magnetic field of the component from coupling with anything else in the set, such as another L.F. transformer, and to screen the component itself from other magnetic fields

Screening Not Necessary

It is interesting to note that modern L.F. transformers, or most of them, have cases of bakelite or other insulating material, but, as you will guess from what we have said already, metal cases are not so much needed for screening nowadays, for there are few lines of force indeed that are not confined to the magnetic circuit

"M.W." L.F. Transformer Review—Contd.

constituted by the core and windings of the transformer. There is indeed very little external field, although, of course, there must always be some.

Now, what do we get through a transformer? There is loss, as we have said. but, generally speaking, the



The Sensitite (Wholesale Wireless Co.) is very cheap, but distinctly effective.

frequencies are dealt with most faithfully. This is rather remarkable in view of the diverse effects, both electrical and magnetic, that take place in and around the core.

Indeed, the electro-magnetic behaviour of iron is weird and wonderful



The "Varley" Ni-Core I is one of the newest and best L.F. transformers.

to the extreme. We have but hinted at the complexities of this fascinating subject.

And when it is remembered that the iron itself must inevitably take up a different attitude, in some degree, to different frequencies, and that eddy currents, heat effects, hysteresis, permeability, polarisation, are factors that can never be completely eliminated, it is indeed wonderful what the modern L.F. transformer will do.

An Interesting Question

To all intents and purposes we can say that it passes the energy on at increased voltage and unimpaired. If you will look at the curve of any decent transformer you will see that it is remarkably straight from, say, 40 or 50 to 4,000 cycles, and that what bumps there are in it are so small as to be inappreciable in their general effect.

In these pages you will find photographs of a score or more modern L.F. transformers, and there is not one whose performance is not very commendable indeed—even in this scientific radio age.

How is it that despite so many inherent difficulties the L.F. transformer has been brought to such a high pitch of perfection? We, personally, think it is partly due to the fact that the L.F. transformer has been the subject of intensive research on the part of a large number of scientists during the last few years.

Scientific Development

And, secondly, that this has been coupled to the fact that the L.F. transformer is directly bound up with the sciences of metallurgy and with cable and line telephony. In these latter activities we find much capital and many big research laboratories.

The L.F. transformer is next door, as it were, to the heart of the science of electro-magnetism. Anybody wanting to develop an L.F. transformer has at his disposal whole libraries of scientific treatises and papers dealing with magnet cores and magnetic coupling, etc.

Therefore, it is hardly surprising that the L.F. transformer is miles ahead in its development of many other things that are met with in radio.

No reader of MODERN WIRELESS need have any hesitation whatever in



One of the smallest but most efficient L.F. transformers—the R.I. Hypermite, the younger brother of the famous "Hypermu."

spending money on the purchase of modern low-frequency transformers, either for building a new set or for replacing old transformers.

Well Worth Buying

They have reached a degree of efficiency that for practical purposes is not so very far away from the quite unobtainable 100 per cent of perfection.



The Telsen Radiogrand has a ratio of 1-3 and a high-impedance primary winding.

No one can, with any certainty, look one day ahead into the future, but we should say that the march of L.F. transformer development has now at least slackened.

Therefore, buy those new transformers you have in mind without hesitation and reap the full benefit given by their remarkable qualities.

There is a very distinct difference between the performance of a 1930 L.F. transformer and one that is a year or two old. You will notice it the moment you change over.

MY BROADCASTING DIARY



Under this heading month by month our Broadcasting Correspondent will record the news of the progress of the British Broadcasting Corporation, and will comment on the policies in force at B.B.C. headquarters.

Noises "On" and "Off"

I MET a friend the other day in the Engineers' Institution which occupies the other part of the building that houses the B.B.C. headquarters in Savoy Hill. I asked him why certain structural alterations were being made along one side of the room in which we met.

He explained that this had become necessary because of the noise of Board meetings in the B.B.C. Board Room hard by. He said that at intervals of about a fortnight, from eleven to one on Wednesday morning and sometimes in the afternoon, the keenness of the deliberations of the controlling authority of the B.B.C. made at least one room of the Institution almost untenable.

I asked him if it were possible to eavesdrop. He said he thought that results were sure to be inconclusive and unsatisfactory. The sounds became too jumbled and mixed to be distinguished; but they gave an impression of recurring conflicts of terrific intensity and some duration.

I suggested placing a recorder so that one of the gramophone companies might issue a disc of the background noises of a B.B.C. Board meeting. But my friend felt that this would be an improper use of the premises of the Institution!

Three Choirs Festival

The Three Choirs Festival at Hereford, in September, is to be broadcast more completely by the B.B.C. this year than ever before. The relays will include one of a service on Sunday, September 7th, and a concert on Wednesday, September 10th.

Sir Thomas Beecham and the B.B.C.

Six months ago in this column I forecast that the next big row be-

tween Sir Thomas Beecham and the B.B.C. would begin in May. I was not quite right, for it began on April 30th!

Sir Thomas let fly with such violence that other opera enthusiasts felt it necessary to dissociate themselves from the accusations. The B.B.C. wisely refrained from comment. The talk of music circles is on what will happen about Sir Thomas Beecham's undertaking to pay half the loss sustained by the B.B.C. in the first season of the orchestra just concluded.

An Unhappy Episode

It is believed that the total loss was not far short of £8,000; in which case Sir Thomas would be called upon for about £4,000. Then there was some general arrangement between Sir Thomas and the B.B.C. represented by Mr. Eckersley to take joint financial responsibility for a new concert hall in London.

It will be very unlikely that all these plans and arrangements can be liquidated without litigation, which will mean a prolonged and bitter public controversy. One wonders how such a debacle will affect the Imperial League of Opera.

It is a pity also that Sir Thomas will be excluded from all B.B.C. engagements in future. So ends an unhappy episode, and there is an uncomfortable feeling that it might have been better handled on both sides.

To link the dynamic force of Sir Thomas Beecham with such a terrific potential musical force as the B.B.C. should not have been impossible.

Mr. Baldwin to Lecture

The B.B.C. will broadcast Mr. Baldwin's Clifford lecture from Coventry on July 14th. The relay will be included in the regional programmes at 8.30 p.m. Mr. Baldwin's subject will be "Democracy," and this is an event which every listener should enter

EXPLORER'S RADIO



The radio apparatus in use at Admiral Byrd's Antarctic base.

Latest News Items for the Listener

in his diary, the circumstances being such as ideally suit the ex-Prime Minister.

Picture House Organs

There has been rivalry between the organ at Lozell's Picture House in Birmingham and the one at the Regent Cinema, Bournemouth. Both have been used for the Tuesday mid-day transmissions, and now Lozell's has gained an advantage, replacing its rival. But the tables may be turned at any moment.

"Diagonalisation"

The practice of diagonalisation of programmes is being steadily extended. This is the expression used to cover the repetition of a programme on another wave-length in the same area on the next day.

Now, however, there is a suggestion of carrying it a stage farther and giving a third repeat performance on the second regional frequency.

My impression is that the third performance is overdoing the idea except for very rare programmes.

A HIGH STANDARD!



This aeroplane is used by the Ferranti people in connection with Radio research.

The Rise of Mr. Ashbridge

Mr. Noel Ashbridge, the new Chief Engineer of the B.B.C., had the particularly difficult and in some ways invidious task of succeeding his old friend and colleague Captain Eckersley. This was nearly a year ago, and it is now possible to measure his success.

This has been very considerable. Mr. Ashbridge was well advised not to imitate his predecessor in those things which were the manifestations of his own peculiar type of genius.

The new head of the B.B.C. engineering department struck out on his own line, and has made for himself a safe and sound reputation already. And it would be a mistake to suppose that Mr. Ashbridge confines himself solely to engineering.

His advice as a member of the B.B.C. Control Board is invariably sound, and frequently original. I believe Mr. Ashbridge will go far in broadcasting, especially as he has the complete confidence, not only of Sir John Reith, but also of the Board of Governors.

B.B.C. and the Trade

A deputation from the wireless trade which recently saw Sir John Reith indulged in some very plain speaking about the intervention of the B.B.C. through its publications in technical matters. It was alleged that certain articles and diagrams in a B.B.C. weekly professed to lay down the only way in which the two programmes at Brookmans Park could be separated.

This, it was argued, was improper for the B.B.C., and, it is stated by one who was present at the interview, Sir John Reith agreed and said he would see to it that the practice stopped.

There were also some complaints about Sunday programmes; but on this subject the Director-General of the B.B.C. held his ground, as on every similar occasion in the past.

A RADIO GUIDE

THERE must have been more absolute rubbish written about radio than about anything else. And the amount of wool that has been pulled over the eyes of book publishers by so-called "radio experts" is staggering to contemplate. What a relief it is to turn over the pages of a brochure such as "The Wireless Listener's Guide Book," a contribution to Macmillan's sixpenny library, due to Mr. Percy W. Harris.

Mr. Harris is the doyen of home-constructor set designers, and in the nine or so years of broadcasting he has gone from strength to strength. But always he has avoided the academic as gracefully as he has steered clear of that insulting "writing down."

In reading a book by Percy W. Harris you cannot help feeling the vital personality of the author; he conveys the impression that he is there and talking to you about a subject in which he himself is most enthusiastically interested.

And as you read on you cannot help catching his enthusiasm. "The Wireless Listener's Guide Book" is—but we cannot do better than reprint the main part of Mr. Harris's own preface:

"This little book does not pretend to be a treatise on wireless telegraphy and telephony—a number of excellent books on this subject are already available. It does, however, aim at being practically helpful to all who own—or wish to own—a wireless set, and is based upon an experience in the design and handling of wireless receivers dating back to long before the broadcasting era.

"The aim throughout has been to give such guidance as will enable the reader to make an intelligent selection among the various sets offered to him; to appraise at their correct value the many claims made; to handle the set as efficiently as possible; and to diagnose any little troubles that may arise from time to time.

"Incidentally much harm has been done in the past by exaggerated claims made for the performance of certain wireless receivers, and it is hoped that the present attempt to give the reader a truer perspective will be acceptable not only to the public, but to all the more responsible manufacturers of wireless receivers."



HUMAN ELECTRICITY

By Dr. J.H.T. Roberts, F.Inst.P.

An account of a series of fascinating experiments carried out in an effort to determine the nature and extent of electricity in the human body.

FROM time to time we hear of somebody claiming to be a "human wireless receiver," able to receive broadcast messages directly from the ether without the aid of a radio receiver. There are many cases on record also of people complaining that the wireless waves are upsetting their mental or their bodily health.

It is usual to regard these as cases of hallucination or, at any rate, of imagination, and to dismiss them at that.

I fail to see how it can be possible for anyone, however sensitive electrically he may be, to interpret wireless telephony directly through the body without the aid of some external device, and, so far as cases of this particular kind are concerned, I am afraid I am as sceptical as most other people.

Peculiar Effects

As regards the other question of radio waves affecting the bodily health, however, this is a possibility which is not so easily disposed of, for we know that radio waves produce high-frequency electric currents in any conductor, and although the human body would be regarded as a comparatively poor electrical conductor, in consequence of which the high-frequency currents set up would presumably be comparatively weak, this is really no criterion as to the effect which such currents might produce.

We know precious little about the electrical conditions of the body, and therefore we are quite unable to say, with any certainty, what effects even minute electric currents, artificially set up, might be expected to produce.

Personally, therefore, I should feel inclined to reserve judgment on the question as to whether some human

beings might not be peculiarly sensitive to the effect of electro-magnetic waves.

In this connection we must remember that long before radio was even thought of various people have claimed to possess the "divining" power, and although, so far as I am aware, this power has never been proved beyond question, there is a considerable body of opinion, even scientific opinion, in favour of it.

The "Divining" Theory

The interesting point in the present connection is that, according to the most acceptable theory of "divining," the power is due to a peculiar susceptibility on the part of the "diviner" to variations in the electrical conditions as between the earth and the air, these variations being brought about by the presence of liquid or mineral deposits in the earth.

TESTING YOUR REFLEX!

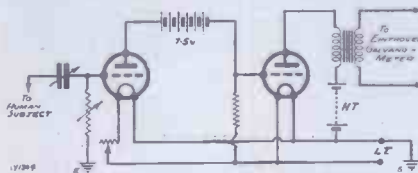

This diagram shows the main features of the apparatus used by Dr. Boyd in his fascinating experiments.

The theory is, in fact, that the diviner is so sensitive to these differences in electrical conditions as he moves over the ground from one place to another that at particular points he will be so stimulated as to suffer muscular movements, the so-called "divining rod" serving merely as an indicator of such movements. The virtue, if it be a virtue, resides not in the "rod," as is sometimes supposed, but in the "diviner."

Furthermore, to come to a much more familiar phenomenon, we have the hand-capacity or body-capacity effects which occur so frequently in the operation of a radio receiver.

It is true that these are sufficiently accounted for by the simple theory that the presence of a body—whether a human body or any other material substance—will affect the capacity conditions in the radio receiver in such a way as to precipitate reaction effects and generally cause disturbances in the receiver.

But that is not to say that one person may not have quite a different body capacity from another, and although no investigations (as far as I know) have been made on this point, it would be interesting to know whether the effect is purely a capacity effect—that is, regarding the human body as being simply an earthed conductor at zero potential throughout—or whether different persons have very different electrical influences upon the receiver.

"Magnetic" Persons

We are all familiar with the term "magnetic personality," and although we use the term metaphorically, I do not think anyone would be entitled to assert that it does not contain some grain of literal physical truth.

At any rate, whatever our attitude may be on these various matters, whether sceptical or open-minded, there is abundant evidence that the human body and, indeed, for all we know, the human brain as well, is susceptible in various subtle ways to electrical influences, and it may be that in the future, when these effects are better understood, so far from regarding them as spurious, we may be able to turn them to good account.

These observations are prompted by a perusal of a very interesting

Potential Variations that Coincided with Heart Pulsations

Paper, entitled "The Electric Field of the Human Body," which has been kindly sent to me by the author, Dr. W. E. Boyd, M.A., M.D., of the Houldsworth Hospital, Glasgow, and which is published in the British Journal of Radiology, March, 1930

In Fig. 1 is the circuit diagram of the arrangement used by the author of the paper for his experiments. The output leads of the L.F. transformer are taken to an Einthoven galvanometer. This galvanometer under working conditions had a sensitivity of about 200 divisions per millivolt.

dental effects due to friction with the clothes, friction of the hands of the operator, and *even friction with the air*, definite records were obtained of the electrical condition of different body regions.

It was shown conclusively that at particular points of the body there was produced a series of regular static potential variations relative to the earth and that these variations corresponded to the rate of the heart-beat.

Static Potentials

It is to be noted that no direct current of any kind could be present

a potential difference relative to earth, and these potentials varied considerably from one part of the body to another. Indeed, the variations were so great that often the Einthoven galvanometer had to be de-sensitised from the condition mentioned above.

As would be expected, it was found that if the skin were wet or water-soaked the results were lessened—that is to say, a surface conduction was set up and the electro-static charges rapidly leaked away.

The detector arrangement, by virtue of its design, is continually sensitive only to alterations in static charge. If a non-variable charge is applied there is only a momentary response, the system soon adjusting itself again.

In this way any static effect that might be due to contact potential-difference between terminal and skin does not affect the results.

It was also found that the production of static electricity must be due either to minutely localised surface activity (as even a needle-point applicator showed differences between adjacent spots) or, as is more likely, to activity internal to the surface of the skin.

Mutual Interaction?

Now we come to a striking paragraph in which the author summarises his conclusions. He says: "In view of these facts it becomes clear that *the human body must be surrounded by a varying field of force of static origin*, the variation being due to the charges originating in the body and also due to the continual readjustments accompanied by the redistribution of the lines of force of this field.

An interaction of such fields must occur when people approach one another, and it is not difficult to visualise in a broad way the complex fields of force present in a large group of people.

"In this research there is some evidence that this field of static origin consists not merely of stationary lines or tubes of force, *but possesses vibratory characteristics of a nature at present unknown, which vary in character with the origin and amount of potential concerned.*"

According to these highly interesting results the human being is not to be regarded as a neutral detached object, but as being electrically associated, perhaps very intimately, with surrounding objects and in particular with other human beings.



MARCONI'S LATEST

Marquis Marconi, and the latest radio transmitter installed on his yacht "Elettra." It was with this transmitter that he sent the messages from Genoa to Sydney on the occasion of the opening of the Sydney Electricity and Radio Exhibition

Now I come to the experiments carried out with this arrangement.

In most of these experiments the human subject was a boy who, owing to electrostatic charges being produced by the friction of ordinary clothes, had to be dressed up in a sleeveless suit made of copper gauze arranged so that different parts of the body could be investigated. It was found best to earth the skin surface of his feet.

Special Electrodes

By using special types of electrode and taking great care to avoid acci-

idents in the part of the circuit applied to the subject, owing to the interposition of the grid condenser. It seems, therefore, that at about each beat of the heart the whole skin of the body suffers a rise and fall in static potential.

The exact cause of this is not yet known, but it may relate to the blood flow in the skin capillaries rather than to the nerve impulse in the heart.

Again, using a somewhat similar arrangement, but with a different type of terminal or applicator, and moving this to different parts, it was found that every portion of the skin showed

AT YOUR SERVICE

BY THE
TRADE
EDITOR



HAVING bought a wireless set, it is often a rather difficult matter to obtain reliable maintenance. True, reliable service stations will always do all they can to assist a customer who is in trouble with his set, but steady maintenance has so far not been attempted to any great extent.

A Valuable Service

Readers will be interested, therefore, to hear that the Radio Association has been reorganised, and from September 1st next is to put into operation a national scheme for the maintenance of listeners' radio sets. In connection with this the Association invites the co-operation of reputable wireless traders throughout England and Wales, and applications for trade details should be addressed to The General Secretary, Radio Association, 22-23, Laurence Pountney Lane, London, E.C.4.

Owing to the organisation work involved in order that smooth working of this scheme is obtained in the coming autumn, broadcast listeners are asked not to apply for membership details until August, when full plans will have been completed, and the Association will be all ready to provide full working instructions.

Mullard Receivers

Owners of the famous Mullard "Master" Three or "Master" Three Star receivers will be interested to know that the April issue of "Radio for the Million" contains a most interesting article showing how, at small cost, these receivers can be provided with a screened-grid valve for the first stage, a detector, and then either a power or pentode in the output stage.

Another article describes the conversion of these sets for use with A.C. mains, the result being efficient all-mains receivers. "Radio for the Million" is well worth the three-

This is a special feature that will provide an invaluable link between the reader and the advertiser. The latest doings of radio firms will be chronicled each month under this heading, though tests on apparatus will still be found in the special "Tested" section elsewhere in this journal. Firms are invited to send in news of interest for inclusion, in these columns.

pence which is charged for it; this, being purely a nominal price, is fixed to prevent the wastage that would occur were it placed on the market free of charge. Any radio dealer will be able to get you a copy.

A Radio Film

The latest thing in the way of the dissemination of radio knowledge is being carried out by Messrs. Ensign, Ltd., with a special radio film. This film, which is of the 16 mm. type, contains many useful hints on the construction, maintenance, and manipulation of the various products associated with radio.

The design of sets, component parts, how they work, why they should be used or should not be used according to the circumstances, are fully explained in an interesting film which will shortly be available to radio societies for showing to their members.

You Should See It

No special precautions as regards fire or licences are necessary, and the films can be shown in any hall or room where meetings usually take place. In addition to the film, a fully qualified operator with all equipment and apparatus will be provided by Messrs. Ensign, Ltd., and the film is being distributed by the Cine-Film Department, at 40, Shaftesbury Avenue, W.1. Secretaries of radio and scientific societies interested in the film, and who have not already made arrangements to have it shown, should communicate with the above address.

Just over a year ago the Pye Radio Company was reorganised and

WHERE YOUR VALVES COME FROM?



A view of the final test and packing department of the Osram valve works. All valves have to pass stringent tests before being sent out to the public.

See Your Set Made on the Screen

completely reconstructed. They went to the public at a time when a great many companies were springing up, including many gramophone companies, and some of them have since very much faded away. Not so with Messrs. Pye, who, we are glad to see, return profits for their first year's working of £63,686. This compares very favourably indeed with the prospectus estimate of not less than £50,000, and we are sure readers will congratulate them on realising their promised estimate to such a full extent.

Moving Fast

Things seem to be moving very fast among the valve firms, and many of them are working at very high speed in order to get new models ready for the Show. What those new models are we are not at liberty to say at the moment, but we understand that some very startling battery valves are about to make their appearance, and there is no doubt that a great deal will be done with the pentode.

The first all-A.C. pentode of the

SOMETHING LIKE A TRANSFORMER!

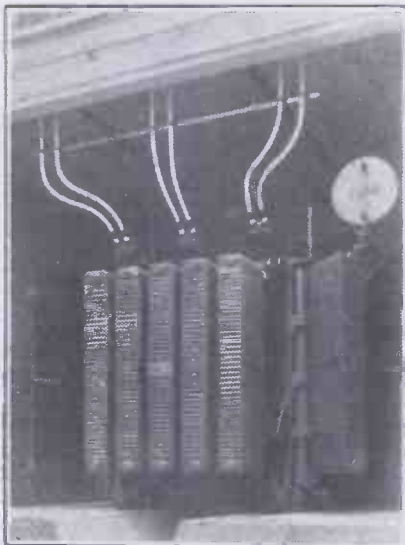

A special Ferranti 12,000-K.V.A. 3-phase 25-period transformer installed at the Birmingham Ham's Hall generating station.

indirectly-heated variety has appeared, and most valves are being altered, reconstructed, and improved in all directions. Messrs. Cossors have come along with a remarkable screened-grid A.C. valve which has a magnification factor of 1,000 and an impedance of only 400,000 ohms.

And talking about valves, I should like to bring to the notice of my

readers the fact that the 2-volt Lissen valves mentioned on page 539 of MODERN WIRELESS last month, and said to be 7s. 6d., are, of course, 10s. 6d. instead of as stated. Also, I should like to point out that the P.X.61 is a 6-volt 1-amp. valve, but that the price has not yet been fixed.

in order to assist the dealer in the overhauling of Kolster-Brandes sets which have been returned as faulty by their purchasers. And, by the way, the K.B. pick-up is £2 10s., instead of as stated in last month's issue, while the Marconiphone is £3 3s. and not £2 5s.

GETTING READY FOR THE "SHOW"



All the radio firms are hard at work getting ready for the "Show." Here we see a section of the Varley assembly shop.

The race for supremacy in receivers is also becoming a decidedly more strenuous affair, and, concerning the race for supremacy, it is amazing what thousands of radio patents are taken out every year. Some never see the light of day in the way of full patents (not passing the provisional stage), others are filed and forgotten, and remarkably few find their way into receivers and manufacturers' programmes.

Your Inventions

As a way of getting your patents noticed and brought before the public eye, the International Exhibition of Inventions is an annual event it is well not to miss. The fifth International Exhibition is to take place in October, from the 1st to the 11th inclusive, at the Central Hall, Westminster, and, as in previous years, will comprise a trade section in which the latest ideas in all classes of goods will be offered for sale to the trade and the public.

A new inventions section will be included in which inventions which have not yet reached the market are to be shown. If any of my readers have something good in the way of inventions they should get into touch with the Secretary of the International Exhibition of Inventions, 39, Victoria Street, Westminster, S.W.

An interesting feature of the new Kolster-Brandes depot in Great Portland Street is a fully-equipped service department which has been opened

The building of the new "Ekco" factory near Leigh-on-Sea is nearly complete. The floor space is roughly 2 acres, and this latest development of the famous mains unit manufacturers is a sign of their remarkable popularity.

We understand that but five years ago the turnover was £500, and now it has risen to the gigantic figure of £500,000—a remarkable increase! In addition to the 2-acre factory, 9 acres are being kept in reserve, so Messrs. E. K. Cole are evidently expecting their growth to continue at the same surprising rate—and why not?

And talking about factories, Messrs. R.I. are comfortably "in" at Purley Way, Croydon, to which all communications should now be addressed.

"Service after purchase" is rightly becoming the slogan of many of the big firms, but few have gone to the lengths of the Marconiphone Co. in providing free training for their dealers and assistants in after-sales service.

The scheme they provide consists of three courses:

(A) A standard short full-time course of one week at the Marconiphone Dagenham works.

(B) A comprehensive three-week full-time course at the works.

(C) Evening classes of 16 lectures and practical demonstrations at Radio House, Tottenham Court Road.

LOUDSPEAKER CORRECTION

We know where the most serious shortcomings of a radio set occur, but it is difficult to decide how to set about their correction. Here is a practical contribution to this perplexing question.

By G. V. DOWDING, Associate I.E.E.

THE ideal in radio reception is rather hard to visualise. A perfect replica of what is happening in the broadcasting studio would not prove suitable for an ordinary medium-sized drawing-room.

On the other hand, it wouldn't sound quite right even if you were able to accommodate the volume. You see, the B.B.C. people do a certain amount of doctoring to the energy created by the studio sound waves. For instance, they frequently add a modicum of echo.

It is all very well to talk about achieving "complete realism," but there is no "complete realism" to achieve. The special design of the studio makes it completely different from any ordinary room.

The walls, the floor, the ceiling and everything inside the studio are constructed so as to have peculiar acoustic properties, properties that you do not meet with in ordinary circumstances.

What Sets Should Do

Actually, what we have to do is not to endeavour to reconstruct in its entirety some standardised original in sound construction, but we have to co-operate with the B.B.C. in the production of what may be termed "synthetic" speech and music.

The receiving side of the bargain is a perfectly straightforward one. The electrical characteristics of the set should be such that equal treatment is given to all audio frequencies over a wide band.

The output of the loud speaker should be the point at which the success of the outfit should be judged.

That is to say, instead of striving for straight-line results at each individual point in the set; it is as legitimate to "doctor" a set as it is for the B.B.C. to doctor the electrical energy they handle.

The result of such a procedure can be said to be exactly the same as localised straight-line treatment when the ideal is reached, but there is this important difference.

Whereas it is not difficult to carry out very marked correction in an L.F. amplifier, and thus markedly straighten the output of the loud speaker, sectionised "straight-lining" is quite impossible in the present state of the art.

Items That Baffle

It is possible to arrange valve-couplings with wonderfully straight characteristics, and even the L.F. transformer has been improved until its performance over a wide band is extraordinarily consistent, but there are items that completely baffle us.

For instance, there is no loud

speaker available, and no new one in sight, that will do anything but provide a response about as level or straight as a mountain peak!

Nevertheless, the modern loud speaker is a very excellent instrument, and does its extremely difficult job very well.

However, you will see that it is quite useless striving for a straight line in the set if the output is to be bent at the ultimate stage.

Therefore, the logical thing to do is to recognise the failure of the output and arrange the set characteristics accordingly. And this is what is being done by many modern set designers.

Compensation

The "M.W." Research Dept., for instance, is producing a series of

STUDYING THE SHORT WAVES

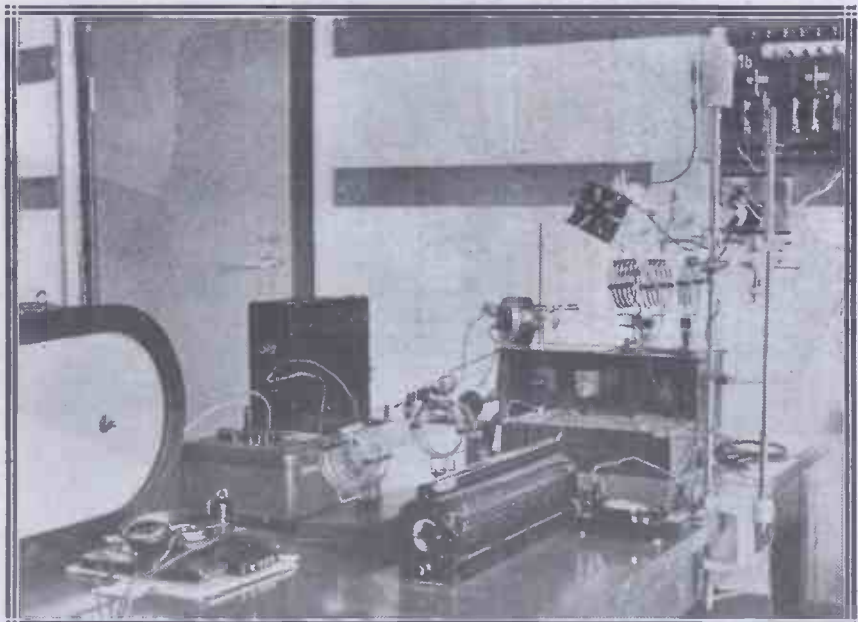

The apparatus at the Berlin Radio Institute that is used for precise measurements of short-wave apparatus.

A Simple Unit for Controlling Tone

receivers that introduce compensating correction.

This has to be done carefully, very carefully, in fact, because loud-speaker characteristics vary a great deal. It is easy enough to bring up the bass and increase the high notes quite a lot, but we have to be careful that such increments do not overlap loud-speaker peaks.

If they did do this the result might be rather unpleasant.

The ideal way is to take a loud speaker of a certain type and design a set for it! But this is not practical in the usual way.

Amplifier Design

However, by the very careful selection of coupling characteristics and so on, the normal or average loud-speaker deficiencies can be countered to some extent.

We know when the average speaker begins to fall off at the upper and lower ends, and it is not difficult to design amplifiers accordingly.

But the point to note is that these will be far from being straight-line amplifiers. If we had straight-line loud speakers we could aim at straight-lining everything else.

Component manufacturers are doing right to produce straight-line components, for we must have a

standard, a basis upon which to work up our ideal response.

If manufacturers started to give their components correcting factors it might make the set-designer's work harder instead of easier.

Components That Matter

After all, no component works alone; a bunch of components operate as a team, the one with another, and their faults are, in a sense, cumulative. Also, they can be arranged to provide practically any characteristic—that is, in conjunction with suitable valves and so on.

Actually, of course, there are but few components that have marked frequency characteristics by themselves, but it is such components (L.F. transformers and L.F. chokes, for instance) that play such important roles in the chain of energy transference in a set.

OUTPUT CONTROL

A novel loud-speaker response balancing device.

IN the above article the subject of amplifier correction is dealt with. Apropos this, readers will find the

R.I. unit illustrated on this page of some considerable interest.

This unit takes its place in the

tone ADJUSTMENT

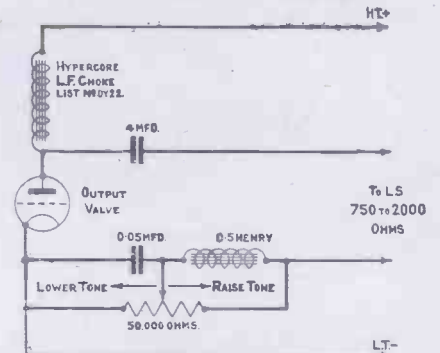

The theoretical circuit of the R.I. loud-speaker tone-control unit.

anode circuit of the last valve, and by means of one control it is possible to adjust the tone of the output within fairly wide limits.

How It Works

There is an L.F. choke and a fixed condenser additionally to the normal choke-condenser items, and these are joined in series with a potentiometer connected across them.

The values of these extra components are arranged to be resonant at mean speech frequencies. Thus a low-impedance path for them is provided.

When the potentiometer introduces a bypass of less resistance across the choke (0.5 henry), the impedance of the choke becomes less effective and the higher notes pass more easily.

When the condenser is partially or wholly short-circuited by a like means the lower notes have less opposition, and the tone is lowered.

Constructional Details

The circuit can be built up into an extra unit, for attaching to any set, on the lines of the accompanying photo, or it can be built into a set.

The R.I. people offer the circuit for free use by amateur constructors, and have a large supply of the special components available.

All the essential details are given in the above diagram, and the photograph shows the way the components, etc., should be arranged in unit form.

The arrangement works exceedingly well, and applies just the corrections needed to the average radio outfit.

ONLY ONE ADJUSTMENT

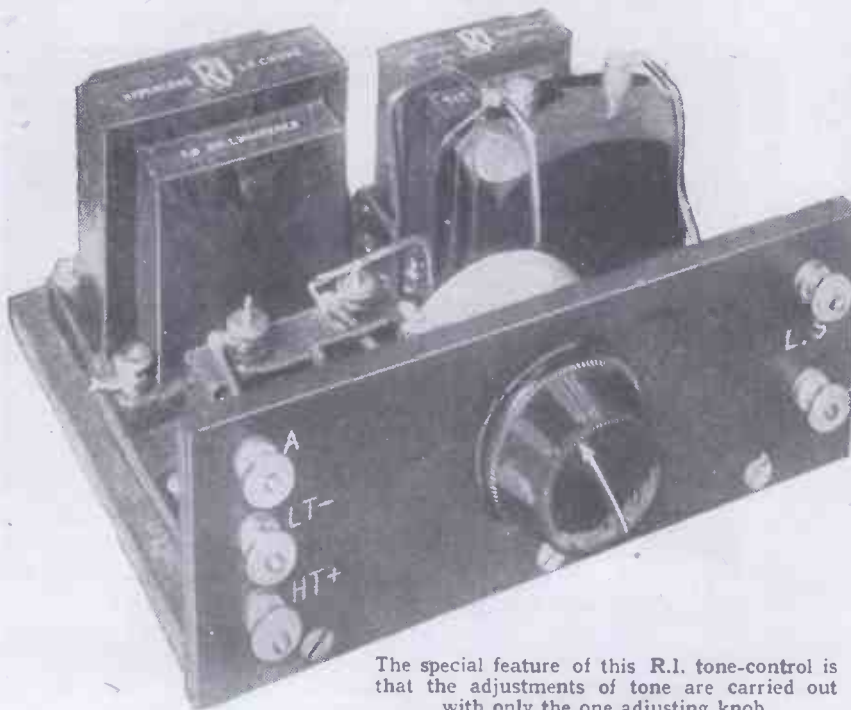

The special feature of this R.I. tone-control is that the adjustments of tone are carried out with only the one adjusting knob.



THE PYE RADIO PORTABLE

An account of the outstanding features of this famous five-valver, which, recently modernised, has been adding to the laurels it gained in the past.

WHEN you test a set for the first time it is not so easy to approach it with an absolutely unbiased mind as one might imagine. For one thing, the appearance of the set is bound to affect you straight away!

The Main Features

Unconsciously you are predisposed in favour of a really good-looking set, and a little critical with one which may be perfect in every detail except its external appearance. And so many people speak well of the Pye Portable Receiver that it is necessary to try and forget these good reports and take the technicalities only if a test of it is to be an unbiased one.

So, first of all, what are the facts about the Pye? It stands 14½ in. high, is 15½ in. broad, and 7½ in. from back to front. A cone loud speaker is incorporated, and the weight is 27 lb. complete with aerial, batteries and everything on board. The price (complete and including royalties) is 19 guineas.

Five valves are employed in this set, the first two for high-frequency amplification, the middle one for detection, and two stages of low-frequency amplification. The detector works on the leaky-grid principle and both the low-frequency amplifiers are transformer-coupled.

Reaction is applied from the detector's plate circuit to the aerial

by means of a differential condenser, and the set covers ordinary and long waves. Either a walnut or mahogany cabinet can be supplied.

A Quality Set

Now, you can be as dispassionate as you like in considering the Pye, but as soon as you switch on you smile, for the quality is excellent. Probably this is one of the most important of the underlying reasons for the great popularity of the Pye portable.

However much one hankers after foreigners the majority of listening is done on the local station. That being so, good quality is probably the most important asset that a set can possess, and everyone who hears it will agree

no doubt that, good as the old Pye set was, this latest one is far better.

The controls, placed at one end of the case, are unusually accessible. There is a drum-dial condenser placed so that tuning is the easiest thing in the world. Below the tuning condenser are two other control knobs, that on the right being a switch of the three-position type, placing the set on long waves, short waves, or "off."

Aerial Arrangements

The left-hand knob is styled "reaction control," and it really *does* control reaction. It is completely effective on the long and on the ordinary wave-lengths, bringing the set up from the no-reaction position to easy oscillation by gradual increase and without a trace of "plop."

Apart from the main controls this little side panel contains an earthing plug, and on the case above is a socket for making an external aerial connection. These enable the set to be used under ordinary conditions, increasing its range and extending the power (on account of the much greater pick-up from an outdoor aerial than can be obtained on a small frame aerial).

On the top of the set is a good strong handle, flat to pack and convenient to carry, and beneath the set is a little turntable, so that when placed on the table the set can be swung round in any required direction without any need to lift it.

WHEN THE
"PYE" WAS
OPENED!



The pleasing accessibility of the batteries, valves, etc., and the consequent easy adjustment is one good point that the purchaser will be sure to appreciate.

that the Pye is a good-quality portable receiver.

The photographs reproduced with this review of the set show it to be of singularly attractive appearance. The model shown incorporates a number of recent improvements, and there is

A Quality Set for All-Round Reception

This is an important point, for, as most people know, when using a frame aerial it should be pointing in different directions at different times according to the station which is being received and the degree of volume which is required from it.

Swinging the set round on the turntable to test this brought into view that side of the cabinet opposite to the one on which the tuning controls are placed. Here another improvement was discovered. Two sockets with an adaptor plug are provided for

of the parts, etc., is equally pleasing. The five valves stand side by side, and they are provided with soft rubber cushions so that if the set is carelessly carried they cannot dance about and damage themselves.

A Pleasing Point

Below the valves and the set itself, on the "ground floor" of the cabinet, as it were, are the three batteries. The low-tension is a 2-volt accumulator of the unspillable type, which will run for about 40 hours without

One particularly pleasing point is that the tuning dial is calibrated in wave-lengths running from 204 to 556 metres on the lower waves and from 1,025 to 1,905 on the long. You set the dial to the wave-length and there you are!

As a first test the tuning dial was placed at 261 metres, the switch turned over to S for short waves, and the National transmission from Brookmans Park came in at tremendous strength without reaction at a distance of 11 miles.

NOT AN INCH OF SPACE WASTED!

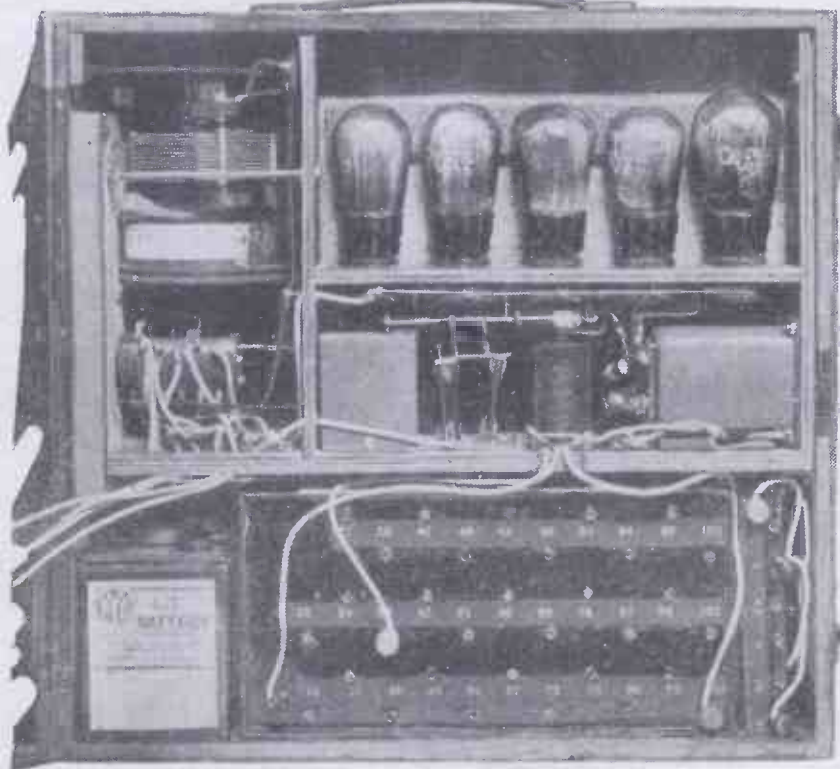

The set's handsome external appearance does not belie the design of the interior, which—as this close-up illustrates—is singularly well-arranged.

using an additional loud speaker if required.

Protecting the Valves

Nothing could be simpler than the scheme adopted, for when the plug is inserted half-way in the socket you hear both the loud speakers at once. When the plug is pushed right in the cone loud speaker in the set is disconnected and only the other one is left working. The advantages of this method for working a loud speaker in another room, etc., are obvious.

Inside the case the arrangement

being recharged, so that if you use the set for two or three hours a day a fortnightly charge will be sufficient.

Placed beside the accumulator, with accessible leads and every plug where you can get at it, is the high-tension battery, and fitting in between this and the other end of the cabinet is the grid bias, equally convenient and accessible.

These are the briefly-stated main features of the receiver. Its strongest point has hardly been mentioned at all—*performance*. In use the set is really-delightful.

Plenty of Foreigners

Equally good was the National programme from 5 X X on the long waves, and the good selectivity here can be judged from the fact that Radio Paris was quite "clear" of 5 X X when the tuning was adjusted to 1,725 metres.

Even in broad daylight half a dozen foreign transmissions could be heard, so that with an outdoor aerial, or after dark, the set gives plenty of alternatives to the local programme.

Try as you will to be critical of it, the Pye "gets you" in the end, for its convenience, its quality, and its handsome appearance combined with sensitivity make it a set of really outstanding merit.

FOR THE CONSTRUCTOR

If you are employing a neutralised H.F. stage, do not forget that this will need re-neutralising if a different valve is employed for it.

In nearly all circuits it is the moving vanes of the variable condensers which are connected towards earth to avoid hand-capacity effects.

With indirectly-heated A.C. valves the undesirable A.C. hum is eliminated by using a separate electron-emitting cathode heated by radiation from a hot "filament" placed very close to it.

All grid return and earth connections, etc., in an indirectly-heated A.C. valve circuit are made, not to the heater electrode itself, but to the electron-emitting cathode placed in close proximity to it.



TROUBLE TRACKING

On this page the Chief of the "M.W." Query Dept. discusses, month by month, some of those common difficulties and troubles which can be so perplexing. This month he explains how "motor-boating" and L.F. howling may be obviated by taking simple precautions.

I AM convinced that the most common trouble with the present-day high-efficiency set is "motor-boating" and L.F. howling.

Dealing as I do with hundreds of queries, I am able to form a good impression as to which fault produces the greatest number of letters.

This epidemic of "motor-boating" and its "colleagues" distortion and howling are due firstly to the enormous increase in the amplification of the modern transformer and valve. Secondly, by the popularity of the mains H.T. unit.

"Motor-Boating"

There is no doubt that with a really well-designed set capable of high magnification the greatest care must be taken to avoid any trouble from the source of H.T. In other words, the H.T. supply must be "separated" from the receiver.

Eliminators are by no means the only cause of "motor-boating." The ordinary dry cell battery and the H.T. accumulator can also produce this annoying phenomenon.

The term "motor-boating" has been rather loosely applied to all troubles on the L.F. side which give rise to instability. This is scarcely true. "Motor-boating" is really a slow pop, pop, popping similar to the exhaust note of a single-cylinder motor-cycle.

How to Cure It

It occurs at regular intervals, and is due to the fact that the modern L.F. stages amplify right down to the lowest musical frequencies around about 50 cycles.

This "popping" noise could be remedied by cutting out some of the bass in the amplifier or, in effect, reducing its efficiency.

The correct method, of course, is to eliminate it at its source by interposing the necessary "filter" devices between the H.T. and the set. If you

cut out the true "motor-boating" the chances are a hundred to one that the L.F. side will be stable and that no howling or oscillation at either audible or super-audible frequencies will take place.

One of the usual schemes is to employ an "anti-motor-boating" device in the detector valve anode circuit. The method is now well known and consists of a resistance and a large condenser.

inhibitive in the case of the very large capacities. Therefore it is necessary to compromise by using a reasonably large condenser and assuming that the constructor will choose a suitable mains unit or purchase a double- or triple-capacity H.T. battery, according to the size of the set.

Output Filters

I should have said that the type of receiver most liable to L.F. troubles is

STOP THAT HOWL!

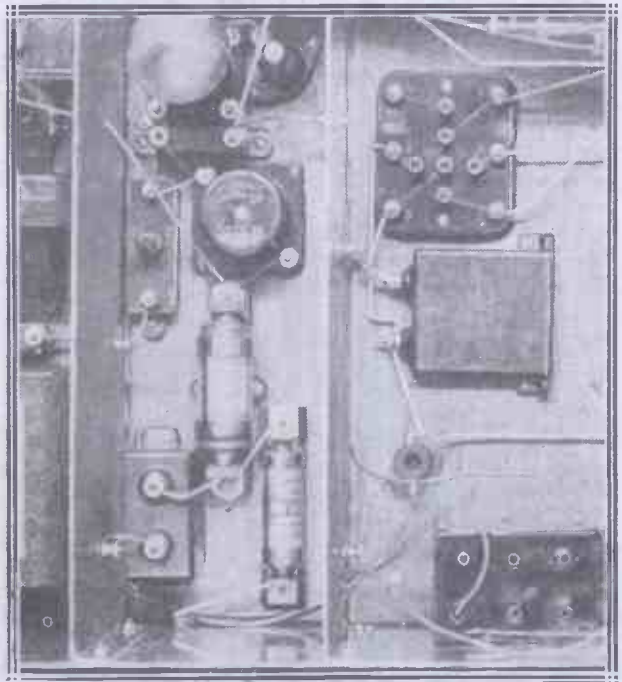

An "anti-motor-boating" device is a great help in reducing any tendency towards L.F. howling and general instability. The unit consists of a resistance and a large by-passing condenser. This scheme used in conjunction with an output filter will, in most cases, ensure freedom from trouble.

The resistance should be of the wire-wound type and may have a value of 30,000-50,000 ohms. The minimum size for the condenser is 2 mfd. It is actually better to use the largest condenser you can obtain. Although 2 mfd. is effective up to a point, 4 mfd. is better, and 8 mfd. would be better still.

Against this there is the question of cost, which is unfortunately pro-

that which employs two transformer-coupled L.F. stages. One of the best schemes to use in conjunction with the "anti-motor-boating" device is an output filter with one side of the loud speaker taken to L.T.—. This is a very useful method of improving the stability of the L.F. stages. The filter should consist of a good 20-henry choke having a low D.C. resistance, and a 2-mfd. condenser.

The Listener's

"THERE IS A BURDEN OF RESPONSIBILITY TO BE CARRIED BY THE LISTENER AS WELL AS BY THOSE AT THE OTHER END OF THE ETHER."

I AM inclined to quote some more Latin. I should be interested to see what the Editor would make of it this time! He certainly enjoyed himself last month, and I should like to supply another opening for the exercise of his nimble wit. I do not, of course, mean to imply that he is dependent on other people for openings, but sometimes they are welcome.

Articles are often rather dull affairs to the authors of them—whatever they may be to other people!

When the requisite number of words has been duly produced and dispatched on (approximately) the bidden day, the author may feel well quit of them. Their subsequent printed appearance may even be a rather distasteful, however essential, part of the system.

How is one to feel when one's wisdom or foolishness is immediately followed

by editorial interpretation and observation? It certainly complicates the process, but I suppose it makes it more interesting, too. One has to walk—or, rather, write—warily.

Making Life Worth Living!

Further, it is probably necessary to read the original article again, and that is what many would avoid if they could. This editorial practice is not invariably satisfactory.

Editors have a way of adding an Olympian footnote which shatters—or seems to shatter—the best-conceived arguments of their correspondents. Theirs is the great prerogative of the last word. It is very unfair, but there we are. And I suppose an editor must have something to make life worth living.

I shall, however, resist the temptation with which I am assailed, and shall write neither in parables nor in Latin. But the reference to the feelings of authors

and journalists has made me think of the feelings of broadcasters under circumstances which are in some respects similar.

I have said that many of the former call it a day when they have done as they were bid, and that quite likely they neither expect nor desire to hear aught of the matter again.

Of course, this must not be taken too literally, as there is with most of them, let us hope, a residual and final transaction the nature of which has no relevance at present.

No "Come-Back"

Others of them look forward to the printed page, and then are anxious to see how it has gone down with readers. They look for signs of its effect. They may be disappointed, but still may flatter themselves that they are moulding public opinion, whatever that may be; and we may leave them in that satisfaction, for whatever it may be worth.

But take the position of the radio broadcasters—artistes and staff. For them there is, of course, no printed page; but there is an analogy of another sort. For them, so different from their brothers and sisters of the boards, there is usually no applause, vociferous or restrained, by which they may judge the effect of their efforts. There is no "come-back" to hearten or inspire. At least, there is certainly nothing immediate.

When the Broadcast Ends

Of course, this is a basic, however unfortunate, feature of radio work. It is inherent in the medium, but we do not always make due allowance for it both at this end and that. It is a peculiar and particular feature which has to be borne in mind by artistes and staff, and it certainly should be borne in mind by listeners. The fact is obvious enough, but its importance is not so obvious.

The greater the amount of imaginative, creative energy which has been directed to the conception of a programme feature, the more assiduous the labour and the care in rehearsing

**BRITAIN'S
EMPIRE
BROAD-
CASTER**



An unusual view of the two tubular masts and the aerial system of 5 S.W., our Empire short-waver at Chelmsford, Essex.

Responsibility

By SIR JOHN REITH

Director-General of the British Broadcasting Corporation.

and producing, the more disturbing and, indeed, distressing is the inevitable silence which ensues. Of course, they get used to it, but there is a danger in getting used to things.

For perhaps an hour or more men and women in studios have been keyed up to a high pitch of temperamental and artistic strain; the last word is spoken, the last note sung or played; the producer gives the final turn to his controls; studios are faded out; the red lights are extinguished. It is all over. There is an unnatural and embarrassed silence, a sudden flatness. The tension is snapped.

The Artiste's Attitude

The producer, at any rate in most cases, has heard it all on his loud speaker and has had that advantage over the players. For them there has only been the unresponsive microphone, which cannot see and seems also as if it could not hear. How has it got across?

How many were listening? Millions? Anyone? There we have it. Was anyone listening at all? One still meets people who appear to find it impossible to conceive that anyone is hearing them, but this cannot, in these days, be a product of the technical mysteries of the process, nor of any lack of confidence in electrical apparatus and connections.

The world soon became adjusted to the printed news page where before all communication had been by word of mouth. The microphone is fast coming into its proper place in the scheme of things, but it cannot fully do so until the peculiar *psychological* circumstances of wireless work have been understood and adopted as perfectly normal and natural. This has not happened yet—not by a long way.

Unsmiling "Mike"

Of course, the microphone must not be thought of as inanimate and unsympathetic and unresponsive. As a piece of mechanism it certainly is, but mechanism must not stand in the way.

All the recent talk in the Press about the duties of the newly-appointed Chairman of the B.B.C. has emphasised the fact that enormous responsibility is invested in the Director-General, Sir John Reith.

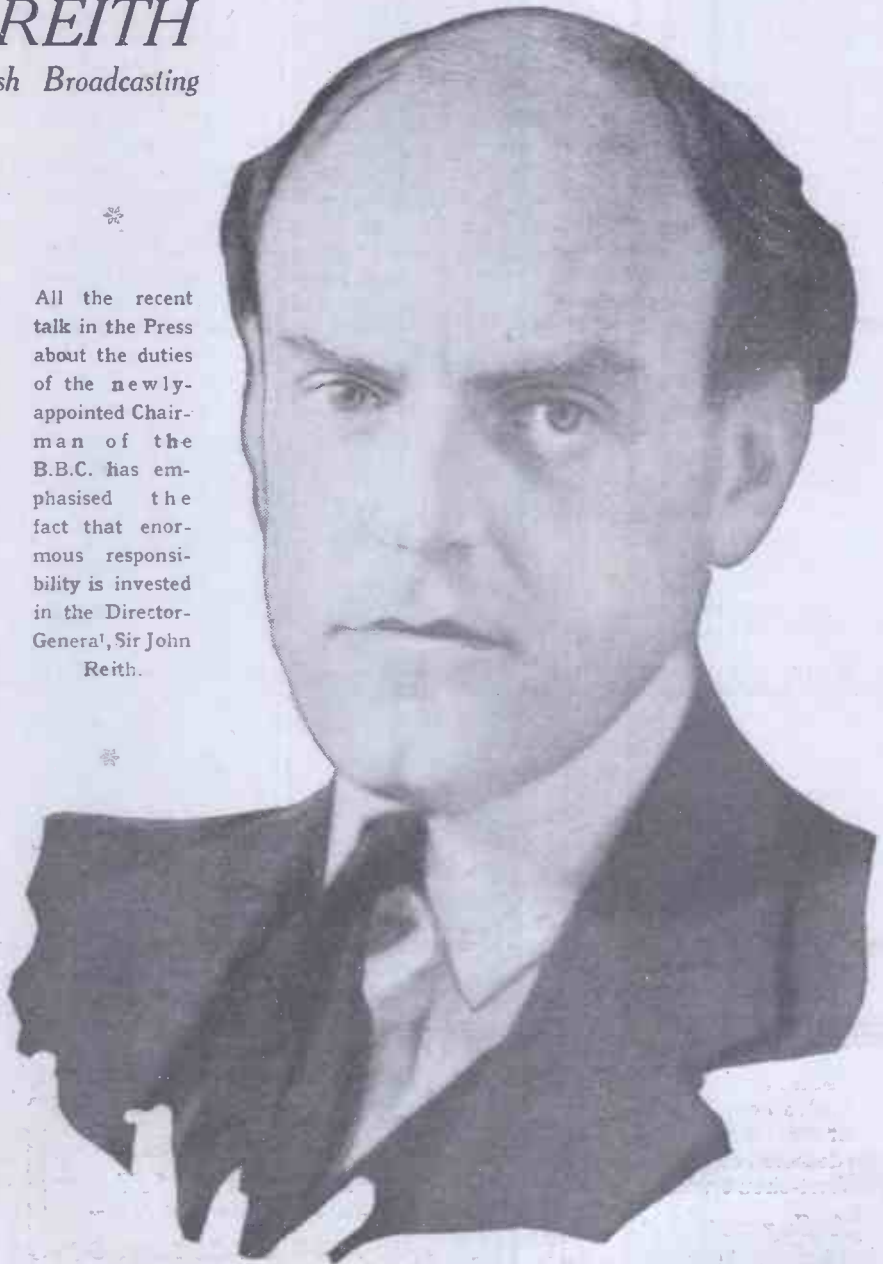

People cannot give their best through the microphone so long as they feel they are speaking or playing or singing to it, nor so long as they are afraid of it or annoyed with it. They must retain a wholesome respect, not for it, but for what it represents.

But how are we to assess the relevance, the popularity, the value of that which is broadcast? How many listeners have thought about the matter from the point of view of

those who have spent many hours of intense effort of one kind or another over the production of a feature which occupies half an hour or an hour in programme-time—perhaps a play, a sketch of some sort, a revue, a feature programme—often, largely original matter?

The hour passes and immediately, from some other studio, the next item proceeds. It is hard for those who

(Continued on page 50.)

SCREENS AND SCREENING

By L. M. WATERHOUSE,
A.M.Inst.C.E., M.I.E.E.

THE advent of the screened-grid valve has brought into prominence the question of the effective screening of stages, especially in those sets where multi-stage amplification is adopted and where adequate and effective screening between stages is essential.

A large number of sets described in the technical Press call for a certain amount of screening, and in some cases this may consist of one or two vertical screens only, separating the high-frequency stages, or it may call for a baseboard covering of copper foil and possibly the screening of the inside of the ebonite panel. In cases where the most entire screening is necessary, it may be necessary to employ metal boxes or compartments throughout.

Danger of "Shorting"

It is frequently necessary to mount components and accessories on copper foil covering the baseboard, and in order to do this effectively great care must be taken to attach the copper foil evenly to the baseboard, so that it presents a smooth and even surface.

The necessity for this arises from the fact that many components were designed before the time when screening was considered so essential as it is to-day, with the consequence that the clearances of the screw heads in certain valve holders, grid leaks, etc., is quite insufficient and the slightest irregularity in the metal base may occasion a direct short-circuit.

Trouble is often occasioned, also, by thin metal soldering tags attached to valve holders when not in use for connections. These may inadvertently be deflected or bent so that they form a short-circuit with the copper foil.

A Suggested Alternative

I have recently examined a number of such components, particularly valve holders, grid leaks, and high-frequency choke bases of reputable make, and find that the effective clearance in some cases ranges between 1/32nd in. and 1/16th in., whereas in a number of grid-leak holders there is no clearance at all.

I would suggest a simple alternative, and that is in the place of a solid 1/2-in. or 3/8-in. wooden base this should be made up of two pieces of 1/4-in. 3-ply wood, with the strip of copper foil between them, so that when the vertical screens are mounted their screws make contact with the foil.

It may be urged against this method of construction that there is a difficulty in screwing the ebonite panel on to the baseboard, but the answer to this is that the correct method for this attachment is by means of aluminium brackets and preferably those of the cast variety.

The wiring of filament circuit wires through the vertical screens is a simple matter, and insulated wire can be drawn through 1/8-in. holes in the screens; but where H.F. wires are passed through screens, it is preferable to use armoured connectors

IN THE CLOUDS!



The radio equipment of an American plane which tried to beat the record for the Los Angeles and New York service.

THE LISTENER'S RESPONSIBILITY

—continued from previous page

have been so intimately concerned to judge of the success of their efforts.

They have a pretty clear idea as to whether or not it has gone as they had wished and planned. But what are they to hear about it afterwards? And what, in fact, do they hear? Very little.

Of course, they might rest content in their own opinions and proceed irrespective of response week after week. Love of their job, interest in their particular task, conviction that they are on the right lines, will carry them a long way.

Makes for Better Programmes

There is plenty of inspiration in factors like this. But inspiration of another kind is needed too. The most outspoken criticism—provided it is kind and intelligent—is infinitely more welcome than the stony silence which is often their lot. It is, in fact, just what is so badly wanted.

All sorts of efforts have been made to organise constructive and intelligent criticism on a systematic basis. On the whole very little has come of it. Perhaps we might be inclined to feel at times that with less effort, less meticulous care of detail, many of the shows would have been just as satisfactory to listeners.

But a high standard and an insatiable appetite for progress and improvement prevent the adoption of such a fatalistic attitude. But there could be more definite data upon which to go; many of the staff would be greatly encouraged in their work and the work itself would certainly benefit.

I seem to have had the Productions Department, as it is termed, particularly in mind. But the same thoughts apply in general to all who are associated with programme building.

We seem to be passing, to some extent at any rate, from the days of vehement criticism, based upon individual opinions and likes and dislikes; and that is all to the good. But it would be unfortunate if this were succeeded by comparative apathy.

Your Responsibility

Not the apathy that indicates dissatisfaction, for it might as readily indicate the reverse. But however that may be, it would be more than regrettable from the point of view of both broadcasters and listeners alike if anything in the nature of a general attitude of toleration, of negative acquiescence, were to be the rule.

There is a burden of responsibility to be carried by listeners as well as by those at the other end, and it is very much in their own interests that they should realise this.



ON THE SHORT WAVES

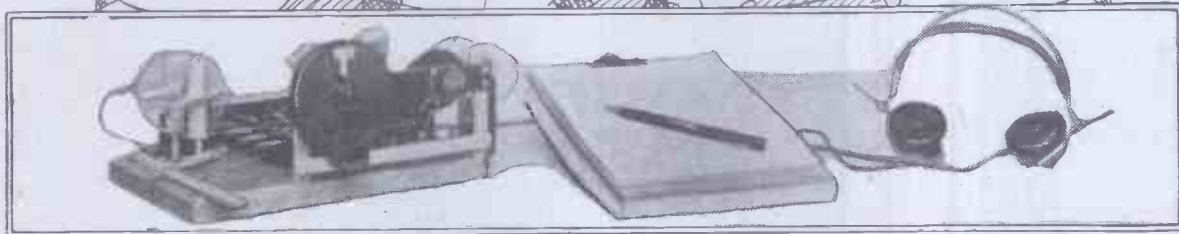

The effects of climate and local conditions on short-wave reception are often very marked, and our short-wave expert relates some interesting experiences in this connection.

By W. L. S.

THIS year certainly affords an interesting example to those who are studying the effect of weather upon radio. Never have I known such a thoroughly bad spring, as far as short-wave long-distance conditions are concerned, and equally never as far as weather goes!

Better Results Last Year

I distinctly remember that all through May last year I was up early in the mornings carrying out tests with stations on the West Coast of America, and, in the way that one does stare at something when listening to weak signals, I remember staring hard at my mast at the bottom of the garden, with the glaring sun on it as early as 6 a.m., and the blue sky behind.

To the best of my knowledge we have had very few mornings like that this year; certainly the West Coast Americans have never come through at all. In this case it appears that the local weather conditions have quite a say in the matter. When the long-promised anti-cyclone arrives from the Azores we shall have an opportunity of watching the change in conditions.

I have to acknowledge an interesting letter

and photographs from "A. E. S.," of the N.W. Frontier Provinces, concerning his short-wave experiences. Several "fans" in the R.A.F. camp have collaborated, and the conditions certainly do not appear to fulfil the requirements of a short-wave fan's Utopia!

Quoting from the letter: "We all live at the top of a very high bungalow and the earths are of necessity very long. Mine, the shortest, is 40 ft. The place is surrounded with high hills rich in iron and the storms here sometimes last as long as ten days, lightning within ten miles all the time. This is in the winter. As soon as this is over all the fans begin to contribute their little bit towards the general din. (Not short-wave fans, electric

fans.) They are fed from the unboosted power-house, which, though the system is D.C., is two miles away. The whole wiring system is the world's worst; in my particular bungalow there are 54 lights and 48 fans. These are fed from two wires from the mains and have one turn to hold them tight. In the heavy winds they slide along the wires and make quite a few noises."

Somewhat Unfavourable!

That is not the start of "A. E. S.'s" tale of woe, however. He continues: "The fans are looked over by natives, whose idea of an overhaul is to rub the com. with No. 2 glass paper." Then, in the summer, there are dust storms, when one can draw a 6-in.

brush discharge from the aerials. It is quite impossible to wear 'phones after the end of May."

In spite of all these difficulties, almost any one of which would make a British short-wave enthusiast sell out, "A. E. S." gets Huizen every night, 5 S W now and then, Sydney whenever he is on, all the Javanese stations, Zeesen, 3 R O (Rome), G 2 G N, KA1XR (Manila), HS1PJ (Bangkok), and shoals of others.

His receiver is a "Chassis" short-waver, using an S.G. stage.

A GOOD EXAMPLE OF COIL WINDING

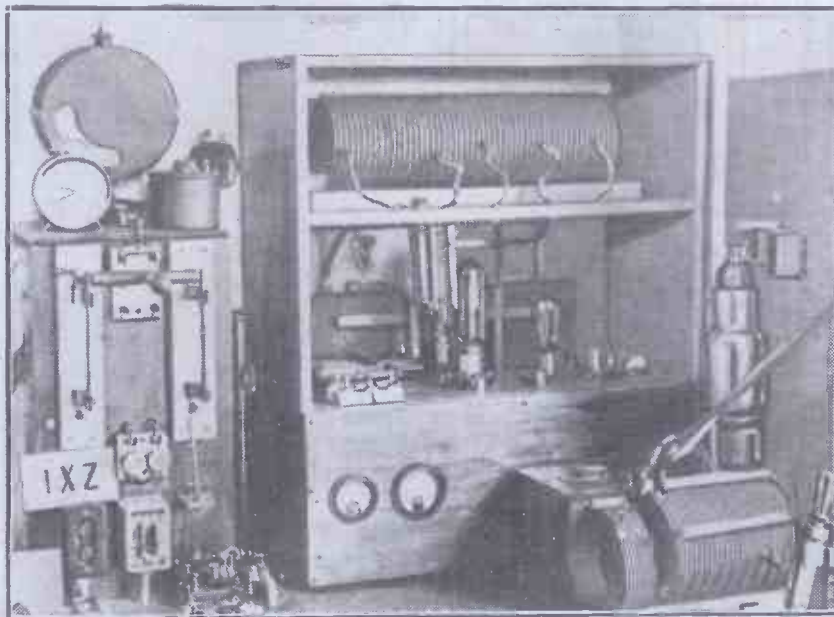

The main aim of amateur transmitters is efficiency, and the owner of the above station does not mean to lose any in his coils!

WITH the advent of the Regional Scheme the problem of selectivity from the point of view of the crystal-set user has become extremely serious.

Take, for example, the London area, which is served by the two Brookmans Park transmitters operating on wave-lengths of 261 and 356 metres respectively. The majority of crystal-set owners residing within, say, 30 miles of these twin-wave transmissions find it quite impossible to receive the regional station without interference from the National transmission and vice versa.

The Regional Situation

This is a tragic state of affairs, because it means that a large number of these crystal sets have become utterly useless.

As the regional scheme extends to other parts of the country the ordinary single-circuit type of crystal receiver will become a hopeless proposition, unless it is modified in some way or other in order to provide a degree of selectivity adequate for the new conditions.

Now these modifications will in most cases cut down the signal strength to a marked extent.

For instance, the usual methods of inserting small condensers in series with the aerial, employing a tapped aerial circuit, etc., while increasing selectivity, in nine cases out of ten also reduce the volume, and leave the listener with a signal hardly loud enough for decent reception.

Drastic Methods

Moreover, in areas within ten to fifteen miles from the regional transmitters much more drastic methods than these are essential if adequate separation of the two programmes is to be ensured.

It is interesting to consider the various types of crystal receivers in

SELECTIVE BUT SIMPLE

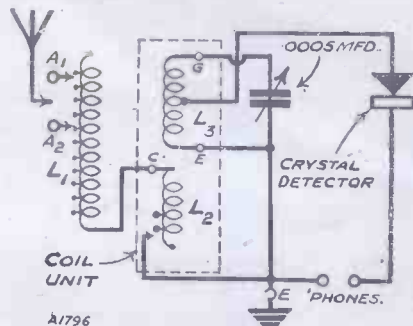

The aerial circuit is fully tuned, and is loosely coupled to the secondary by the winding L2.



The

use before the new twin-wave transmissions commenced.

A few years ago the only station that could be brought in on a crystal was the local, and this up to a distance of perhaps 15 miles if the aerial were a good one. Such a set did not require a selective tuning circuit, and a common scheme was to employ a variometer or a tapped inductance.

Even with a valve set, in which there is reaction to sharpen up the tuning, great pains have to be taken to obtain sufficient selectivity. In the case of the crystal set there is no reaction to help one, and, moreover, the usual

- *****
- WHAT YOU WILL REQUIRE**
- *****
- | | |
|---|---|
| 1 Panel 7 in. x 7 in. (Goltone, Trolite, Paxolin, etc.). | 5 Terminals (Belling & Lee, or Eelex, Clix, Igranic, etc.). |
| 1 Cabinet, with baseboard 10 in. deep (Pickett, or Camco, Keystone, Lock, etc.). | Wire, flex, screws, etc. |
| 1 .0005-mfd. variable condenser (Lissen, or Igranic, Lotus, J.B., Burton, Dubilier, Ready Radio, Utility, Polar, etc.). | COIL MATERIAL. |
| 1 Permanent type crystal detector (R.I., or Jewel R.D.40, etc.). | 1 Coil former, 3 in. diameter x 3 1/2 in. long, and one 3 in. diameter x 4 in. long (Pirtoid, Paxolin, etc.). |
| | 1/2 lb. No. 24 D.C.C. wire. |
| | Plug and 3 sockets, 2 alligator clips, screws, etc. |
- *****

Then came Daventry Junior (5 G B), and crystal listeners within 60 miles or so from this station naturally wanted to receive the alternative programme. To do this necessitated an increase in selectivity.

The problem was not serious, however, in most cases, owing to the big difference in wave-length between 5 G B and the local transmission. Hence an "aperiodic" or tapped aerial circuit would usually do the trick.

Keeping Up Strength

The difficulty of separating the twin-wave regional stations is much greater. In the first place, you have two transmissions operating on wave-lengths which are closer together, and, secondly, the two stations are working on considerable power.

methods of improving the selective properties if they are made drastic enough tend to decrease the available signal strength to too great an extent.

New Possibilities

It is quite evident, therefore, that something better than the usual palliatives is needed if a crystal receiver is to be worth while under the new conditions.

The aerial circuit must be capable of giving adequate selectivity and yet must not reduce signal strength appreciably.

This problem of providing the necessary volume allied with selectivity has long been troubling the "M.W." Research Department, especially since the crystal itself, unfortunately,

“Star-Turn” Crystal Set

Here is a remarkable little receiver which will give you high selectivity with splendid volume. It enables even Londoners to tune in the twin transmissions free from interference, and is the complete solution of the crystal enthusiast's difficulties.

Designed by the
“M.W.” Research Department.

exercises a strong damping effect on the tuned circuit.

In the search for selectivity combined with simplicity and reasonable first cost the energies of the Research Staff were directed into new channels, and a circuit of a very promising nature was developed with successful results. A receiver incorporating the circuit appeared in the

IT EASILY
SEPARATES THE
REGIONALS



May issue of this journal entitled the “Star-Turn” Three.

The basic idea is to use a fully tuned aerial circuit loosely coupled to a tuned secondary circuit, a scheme known to give a high degree of selectivity together with maximum efficiency.

The chief difficulty was to simplify the aerial circuit and the method of obtaining variable coupling without introducing complications in the adjustments.

The Final Scheme

The final scheme was to employ a selector circuit tuned entirely by means of a tapped inductance and to couple this to the secondary circuit by a separate small coupling winding consisting of a few turns. The coupling was made variable by tapping the turns.

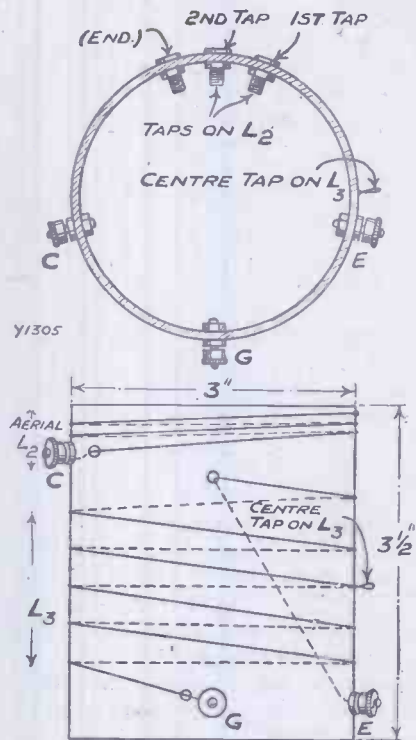

Here are the details of the coupling and secondary coils. Note carefully the directions of the two windings.

This circuit was so satisfactory that it was decided to apply it with suitable modifications to a crystal set. The results were excellent, and in London the two Brookmans Park transmissions could be separated without the slightest trouble. In addition this was achieved without the usual distressing loss of volume.

Suppose we consider briefly the theoretical circuit of the “Star-Turn” Crystal Set.

The coil L_1 forms the tuned aerial circuit, and it is a simple solenoid with tappings. Two flexible leads, one from each aerial terminal, go to points along the coil.

Making the Coils

One end of this coil L_1 is taken to the coupling winding L_2 , which is wound on the same former as L_3 . L_2 has three tappings which go to sockets inside the coil former.

This small coil L_2 is coupled to the centre-tapped secondary winding L_3 , which is tuned by a .0005-mfd. variable condenser. The crystal itself is joined across half the winding, a scheme which produces a higher degree of selectivity, since it reduces the damping effect of the crystal. The method of adjusting the tappings in order to tune-in a station will be given later.

The coils themselves are easy to make, and each consists of a single

Either Programme—No Interference

layer of wire on an insulating tube.

First of all we shall deal with the selector winding L_1 . A former of some insulating material such as Pirtoid or Paxolin, 3 in. in diameter and 4 in. long, is required.

The coil itself consists of 76 turns of No. 24 D.C.C. with 16 tapplings (not counting the two ends of the winding). The procedure is as follows. Make two holes in the tube near the top end and loop the end of the wire through two or three times to secure it firmly.

The Tapplings

Leave this end of the wire bare. Then wind on 8 turns and take a tapping by twisting the wire into a loop and baring it with a sharp knife. Next wind on four more turns and take another tapping. Do this every four turns, so that you have tapplings at the 12th, 16th, 20th, 24th turns, and so on. The 76th turn is taken to the point C on L_2 . The length of the winding is approximately 2½ in. We next come to the coupling winding and the centre-tapped secondary. These two coils are wound on a former 3½ in. long and 3 in. in diameter.

The start of the winding L_2 is about 1 in. from the panel end of the former, and the coil consists of 50 turns of No. 24 gauge D.C.C. wire. A centre-tapping is taken at the 25th turn. The method of taking this tapping is to wind on 25 turns and then to make a loop in the wire by twisting it, afterwards continuing with the coil for another 25 turns. The twisted loop is then bared with the aid of a sharp penknife or razor blade.

Finishing Off

At the 50th turn a hole is made in the former and the end of the wire is passed through and taken to terminal E, as shown in the

diagram. The start of the winding goes to terminal G, and the centre-tapping to one-side of the crystal detector.

Then, allowing a space of ¼ in. between the end of L_3 and the beginning of L_2 , wind on six turns for the coupling winding (L_2). The end marked C is nearest the E end of the winding L_2 . You will be able to follow the direction of the windings easily from the sketch.

There are three tapplings along this small coupling winding, one after two turns, another at the fourth turn, and still another at the sixth turn or finish of the coil. These tapplings are clearly shown on the wiring diagram and are marked "Socket Taps on L_2 ." No. 24 gauge D.C.C. is also used for this winding.

Tuning-In

The easiest method of attaching the coil former to the panel is to obtain a flat strip of wood about ¾ in. in width, and to fashion the two ends so that the strip pushes tightly into the former. A hole can be made in the strip, and a screw passed through both the strip and the panel. A nut on the end of the screw will hold the former tightly in position.

The same procedure can be followed in the case of the selector coil L_1 , a wood screw being used to secure the strip to the baseboard.

Now, how about tuning in? The operation may appear to be complicated, but it is really perfectly straightforward. We will assume that you have the aerial ready, and the earth joined to its terminal, and also a pair of high-resistance phones joined to the telephone terminals.

The Coupling

First of all you must make a preliminary adjustment on the selector coil L_1 for the particular station you wish to receive.

Suppose it is the London Regional transmission. Very well. Join your aerial lead to A_1 and attach the flexible lead from A_2 to a

EASY TO MAKE

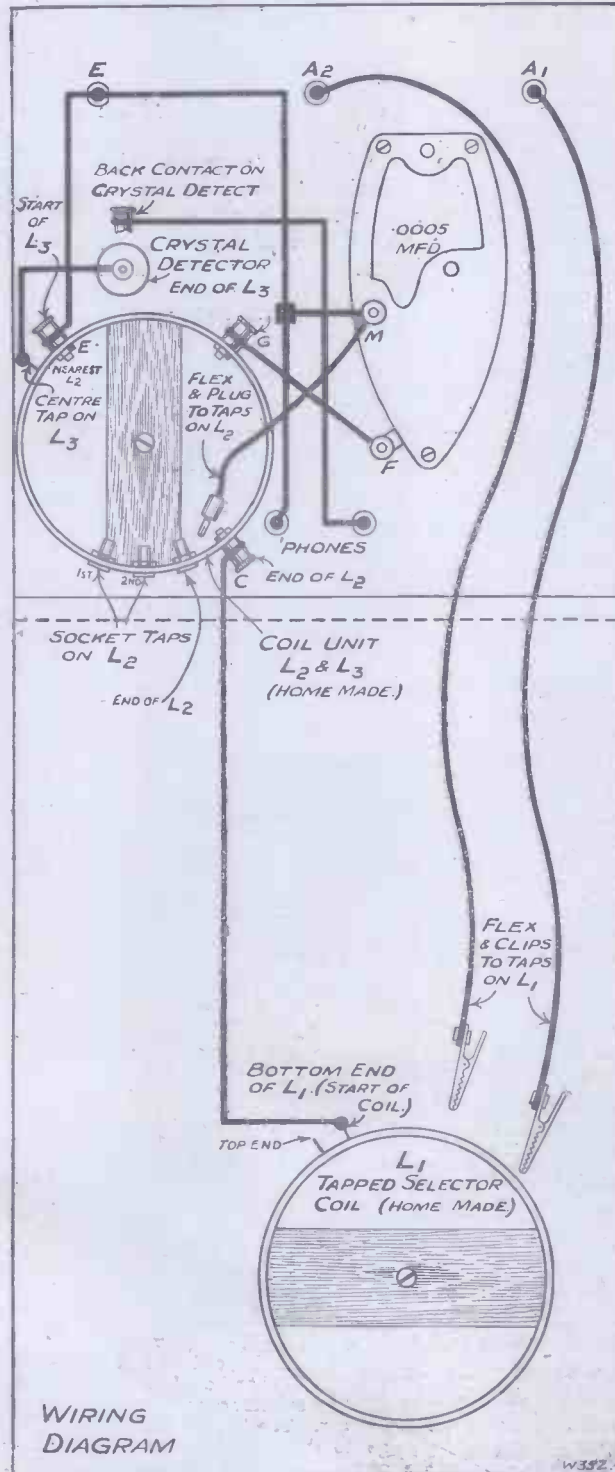

The three sockets for the tapplings on L_2 are arranged inside the end of the former. Selectivity can be adjusted by varying the position of the tapping plug in these sockets.

tapping point along L_1 at about 32 turns.

Place the plug which goes to the tappings on L_2 in the socket at the sixth turn—marked "end of L_2 ." This will give the tightest coupling and the lowest degree of selectivity.

The Second Station

Then adjust the variable condenser until you hear the Regional transmission on 356 metres. Readjust the flexible lead attached to the aerial terminal A_1 until you obtain maximum signal strength, and if you get any interference from the 261-metre transmission loosen the coupling by inserting the L_2 plug in one of the remaining two sockets.

Next you should adjust the set for the 261-metre transmission. Connect the aerial lead to the other aerial terminal A_2 and make a preliminary adjustment by attaching the A_2 flexible lead to a tapping along the coil at about 24 turns.

A Final Touch

Then retune on the condenser until you hear the National transmission and adjust the tapping on L_1 , and, if necessary, the coupling, for maximum volume and freedom from interference.

There is no fixed adjustment, and

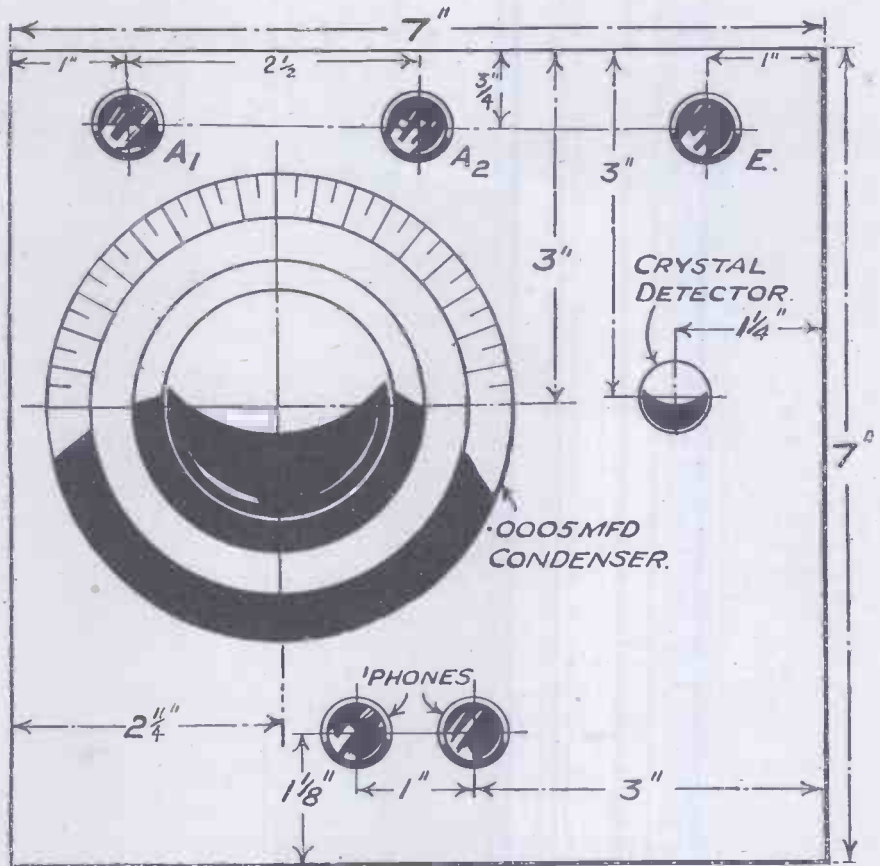

Y1306

PANEL LAYOUT.

In spite of the high selectivity of this receiver, there is only one tuning control, and all the adjustments are quite simple and straightforward.

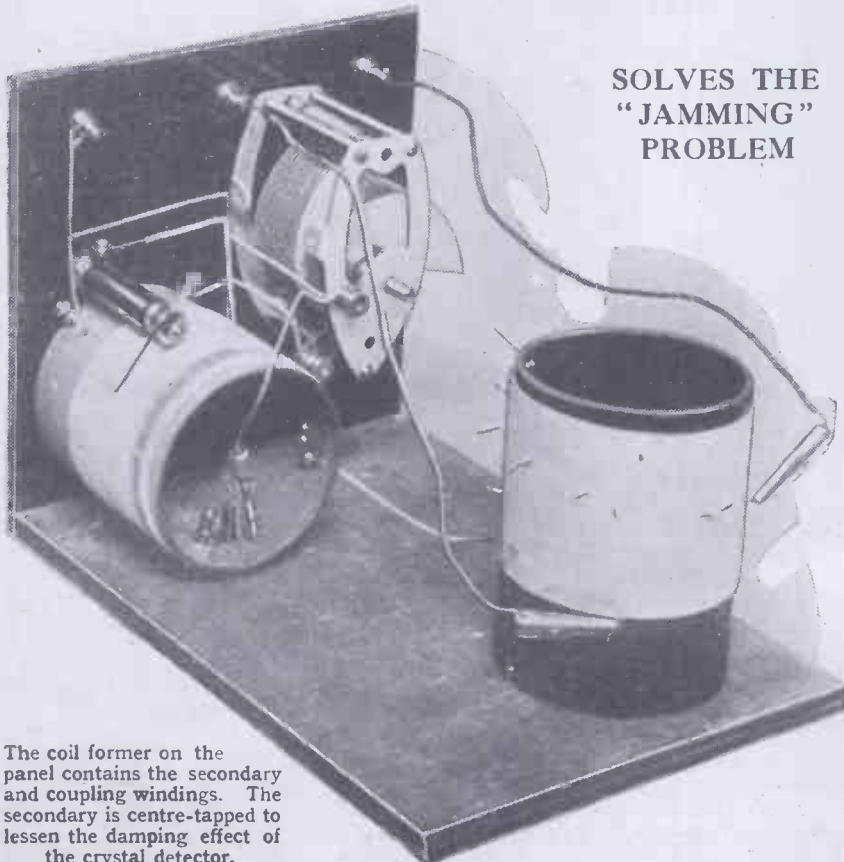

The coil former on the panel contains the secondary and coupling windings. The secondary is centre-tapped to lessen the damping effect of the crystal detector.

SOLVES THE "JAMMING" PROBLEM

every receiver requires individual treatment according to the distance of the set from the broadcasting station. The nearer the receiver is to Brookmans Park the more critical will be the adjustment, but there will be so much available signal strength that the loose coupling necessary to separate the stations will not entail any appreciable loss of volume.

Aerial Connections

You will see that the aerial lead will have to be changed from the aerial terminal A_1 to A_2 , and vice versa, according to which particular station it is desired to receive. The tuning condenser should, of course, be readjusted each time, but since only two adjustments will be necessary for the Brookmans Park transmissions, the two positions for the tuning dial can be marked once the final adjustments have been carried out.

Incidentally, there is no need to wind on as many as 76 turns for the selector winding if you only want to get the two Brookmans Park transmissions. In this case 50 turns should be adequate with most aerials.

QUESTIONS ANSWERED



By the "Modern Wireless" Query Department.

A Long-Range Receiver

H. K. (Wolverhampton) asks us if we have a blueprint of a set which we can recommend as being suitable for long-distance loud-speaker reception of Continental stations. He wants full loud-speaking together with a high degree of selectivity, and he does not mind how many valves are employed, since he is able to obtain his H.T. from the mains.

The set we suggest is the "High-Power" Five—"M.W." blueprint No. 2—which can be obtained, price 7½d. post free, from the Radio Queries Department, Fleetway House, Farringdon Street, E.C.4.

The "High-Power" Five is an up-to-date design, consisting of one neutralised H.F. stage, followed by an S.G. valve, a detector, and 2 L.F. stages, the first being resistance-coupled. The receiver is very selective, since both H.F. stages are tuned, and jack switching is incorporated to enable a gramophone pick-up to be employed if desired. The receiver is particularly suitable for use with a mains unit, since the valves have decoupling devices, and there is an output filter in the last stage.

Testing a Condenser

F. P. S. (Forest Hill).—"Some time ago I fitted an output filter to my set, but I now have a feeling that the 2-mfd. coupling condenser is faulty, because my H.T. battery has run down very rapidly. Is there any way in which I can test this condenser, bearing in mind that I have no special apparatus at my disposal?"

It is very difficult to test a condenser without proper equipment, and therefore we suggest that you send the component back to the makers, who will be able to tell you whether or not it is faulty.

You could apply a rough test, however, if you have a milliammeter. Con-

nect the condenser and milliammeter in series with a battery, and observe whether there is any reading on the meter. If so, the condenser is leaky. This, of course, is a very rough test, and will only show up a bad leak.

Mains Units and Current Output

R. D. (Harpenden).—"I have just constructed a four-valve receiver, and I am troubled with bad distortion and a tendency towards L.F. in-

is the cause of the distortion and other trouble which you are getting with your four-valve receiver. You will have to obtain another unit capable of supplying 30 m.a. or more, and we then have no doubt that you will obtain satisfactory results. At the same time, make sure that you have an anti-motor-boating device in series with the detector valve, and also an output filter.

Ensuring a Good Earth

G. C. (Wallington) uses an earth consisting of a 2 ft. 6 in. length of copper tube driven into the ground outside his window. He asks whether any special precautions should be taken during the summer months to ensure satisfactory contact with the surrounding soil, since he does not wish the efficiency of his set to fall off.

Your best scheme, G. C., is to pour a quantity of water down the tube at regular intervals during the dry weather. If you carry out this procedure once or twice a week your earth should give satisfactory results throughout the summer months. Incidentally, it is necessary for the tube to have a number of holes drilled in it at intervals along its length.

Transformer Connections

M. G. (Oxford) is making the "Star-Turn" Two (June MODERN WIRELESS), and has a 3:1 ratio L.F. transformer marked as follows: I.P., O.P., I.S., and O.S. He asks us how he should connect it up, since the transformer markings given on page 520 of the June issue differ from those on his particular instrument. The connections are as follows:

- O.S. to the grid of V₂.
- I.S. to G.B.—
- O.P. to one side of the H.F. choke.
- I.P. to H.T. + 1.

THE TECHNICAL QUERIES DEPARTMENT

Are you in trouble with your set?

The MODERN WIRELESS Technical Queries Department is now in a position to give an unrivalled service. The aim of the department is to furnish really helpful advice in connection with any radio problem, theoretical or practical.

Full details, including the revised and, in cases, considerably reduced scale of charges, can be obtained direct from the Technical Queries Department, MODERN WIRELESS, Fleetway House, Farringdon Street, London, E.C.4.

A postcard will do: on receipt of this all the necessary literature will be sent to you, free and post free, immediately. This application will place you under no obligation whatever. Every reader of MODERN WIRELESS should have these details by him. An application form is included which will enable you to ask your questions so that we can deal with them expeditiously and with the minimum of delay. Having this form you will know exactly what information we require to have before us in order to solve your problems.

London readers, please note: Inquiries should not be made in person at Fleetway House or Tallis House.

stability. Previously, I had a two-valve receiver which gave highly satisfactory results from my eliminator.

"I am now using the same eliminator with my new four-valver, and a friend has informed me that my particular unit is not capable of supplying sufficient current for the two extra valves. If this were so, would it account for the trouble I am having?"

Yes, it is highly probable that this



A description of the D.C. version of a popular all-from-the-mains receiver.

ONE of the rooms in our technical section is labelled the "Photographic Annexe." This room is equipped with powerful electric flood- and spot-lights, and it is here that our photographer takes the majority of "M.W." photographs.

The room has another and less important use; there are several groups of large shelves and on these are stored ancient apparatus and old "M.W." sets. If you were interested sufficiently to poke about among this gear you would come across one or two sets that had been sent to us by manufacturers at one time or another.

Britain's Best Sets

They may be reviewed—some day; more probably they will be quietly returned. They are sets for which we can arouse no enthusiasm. They are not bad receivers, for, as a matter of fact, we do not think there are any sets on the British market at the present day that are wholly bad, but we do not consider that they are quite worth while bringing to the notice of "M.W." readers.

Space in "M.W." is extremely valuable, and we are sure that readers are much more interested in the best that our modern radio industry can produce than in the worst. The best sets are more representative of up-to-date British radio and we must

never forget that "M.W." has a world-wide circulation.

We do not mind telling the world about, for instance, the "Varley" All-Electric Three receiver. This, we can say right away, is a first-class instrument.

It has the stamp of the thoroughbred in every detail.

Looking at it casually, one finds it hard to believe that it is, in fact, a complete all-electric set. There are only the two or three normal radio set controls visible on the front panel and the thing is built into an unusually attractive walnut cabinet.

But then, of course, the essence of mains working is simplicity in everything, operation, maintenance, etc.; and although some firms have failed to carry this principle to its logical conclusions, such a lapse could not be anticipated from such a concern as Varleys.

This refined, polished Varley set is the culmination of a series of operations threading through a mighty factory. Great workshops humming with complicated winding apparatus, huge assembly rooms, and numerous testing departments controlled by expert engineers, all have contributed their little bits to this "Varley" Three.

There is probably very little in it in the way of component parts, large and small, that did not originate in the Varley works. Obviously, the set as a whole gains much from this.

A Straightforward Statement

Now let us see what the makers themselves say about this set in their catalogue:

"These receivers embody the best types of modern valves, screened grid, H.F., detector, and output. In the case of the alternating current model A.C. valves are employed. The best modern practice compatible with efficiency, stability, sensitivity, and reliability is employed.

Special attention has been paid to adequate screening and the elimination of hum. Full loud-speaker volume of good, clear reproduction is available on most stations, and operation is extremely simple, thumb-control drums being fitted. Facilities are also available for connecting a gramophone pick-up. The alternating current model is supplied for 100-120 volts, or 200-250 volts, 40-100 cycles. It can, however, be obtained for 25-cycle supplies, if specially ordered, at a small additional charge. The D.C. model is made for 200-250 volts. The wave-length range of both models is 200-550 metres, and also 1,000-2,000 metres. No batteries of any description are employed in these receivers. Both models are housed in an attractive burr-walnut cabinet of good quality. List No. AP3. A.C. Model, Price 25 Guineas; List No. AP4. D.C. Model, Price 25 Guineas. Marconi Royalty extra, each 20/-.

NOTE.—When ordering

STRAIGHT TO THE FUSE

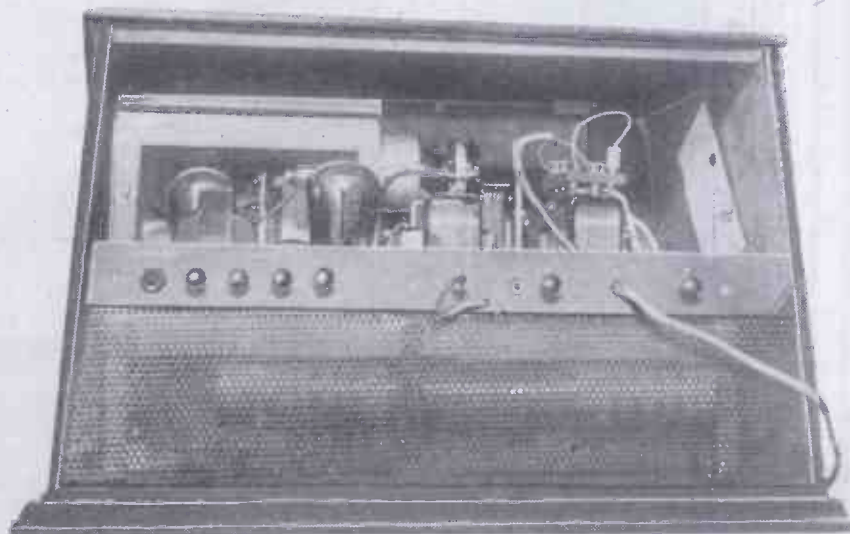

A view of the Varley D.C. set with its back removed. The resistances are built into the bottom part of the cabinet. The mains connecting flex goes through the terminal strip straight up to a two-way fuse.

Completely Stable—Smooth and Easy Reception

state exact voltage and periodicity of the supply on which the set is to be used.
Overall dimensions: 21½ in. × 13½ in. × 13 in. high. *Weight:* 30 lb.

A perfectly straightforward statement of claims. As a matter of fact, they could, quite legitimately, have said much more or even inserted a few colouring adjectives.

Sensitive and Selective

For instance, on test we found its sensitivity and selectivity well above the average. Radio-Paris was tuned in, quite clear of 5 X X, with exceptional clarity. This implies a better performance than might be thought, for our building is badly screened by metal-work and to get Radio-Paris at all on a three-valver is generally considered to be good.

In our opinion one of the best features of the Varley set is its sim-

Our mains are rather rough, and it is indicative of the excellence of smoothing that is embodied in the Varley set that not the slightest trace of hum got through to the loud speaker.

There is adequate power for the operation of a moving-coil speaker, and the quality of reproduction with such is of a high order; but, again, that is only to be expected in view of the quality of the components employed.

And, talking about the components, readers should look closely at the photograph of the interior of the set reproduced with this article.

It is only of late that the commercial receiver has been developed on true electrical engineering lines, and the Varley set is well to the fore in this respect. Its interior is, in its

Purchasers of the Varley set need have no qualms as to its safety. It is obviously just as safe as the most ubiquitous of domestic electrical appliances. In this regard we come up against a rather interesting feature.

There is no power switch on the set itself. You must switch it on and off at the power point—just as you do most electric irons. We are in favour of this, for it means that when the set is not in operation the flex cord connecting the set to the mains must be dead.

Our Tests

Now let us describe in more detail our tests of this Varley receiver. Its installation is perfectly simple. You just plug the mains connecting lead into a power point, join up the aerial and earth, switch on the loud speaker, and away you go.

Brookmans Park needed a very drastic application of the volume control. Rome came in with great power and with excellent quality; and some of the Germans were equally well receivable.

Altogether we found about a dozen stations on the lower wave-band that were worth listening to.

As we have already mentioned, Radio-Paris came in with more than usual strength and there was also no difficulty in picking up Eiffel Tower and Zeesen.

On both wave-bands the set was completely stable and the reaction control smooth and easy.

An Outstanding Proposition

We obtained just as good results with a gramophone pick-up, and this is, of course, proof of the high all-round efficiency of the set.

As "M.W." readers will no doubt know, it is very hard to produce a set that will function equally well for both radio and records. Quite often, if you want good radio results you have to sacrifice pick-up efficiency, and vice versa.

Here, in the "Varley" Three, there is no appreciable loss on either side.

We consider the Varley All-Electric Three an outstanding proposition. It would not be true to say that it is vastly superior to anything else that we have handled, but we can say quite honestly that, taking everything into consideration, price, appearance, etc., it is right in the very front rank of modern commercial set design.

SIMPLE CONTROLS

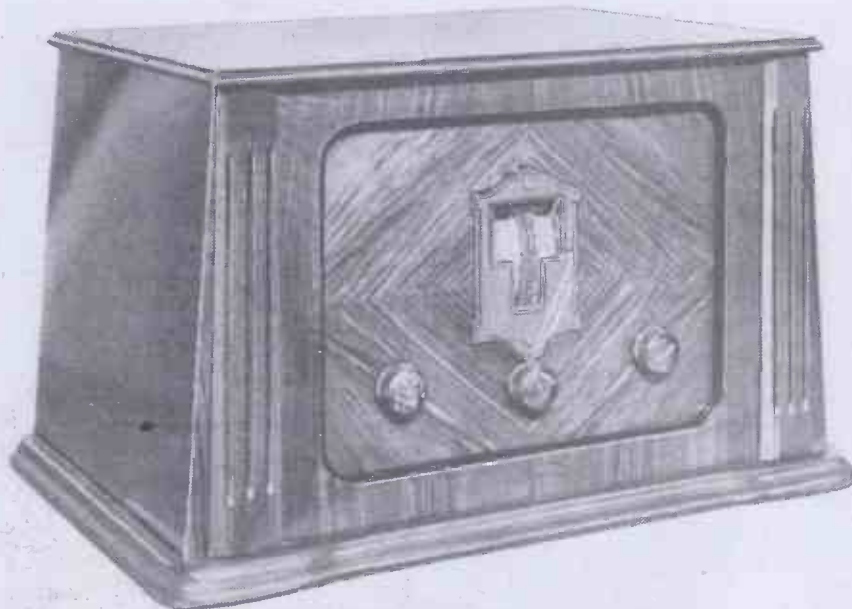

Tuning is carried out with the centrally-placed drum-drives. The other three controls are: (left to right) volume, wave-change, and reaction.

licity of control. There is thumb-control tuning, a reaction adjustment, a volume control and a wave-change switch. The most inexperienced listener would not have to spend much time with this simple group of controls before being able to rope in plenty of stations.

There are two aerial terminals, the one giving you a greater degree of selectivity than the other, but we did not find this one necessary in the centre of London, the Brookmans Park stations being quite easily separated from others.

way, quite as attractive as its pleasing exterior. Everything is mapped out to fine limits; there is adequate separation but no wastage of space.

Skilful Screening

Skilful screening has enabled a quite surprising compactness to be obtained without sacrificing any efficiency.

In the D.C. model the resistances are at the base of the cabinet. There is adequate ventilation and no undue heating occurs.

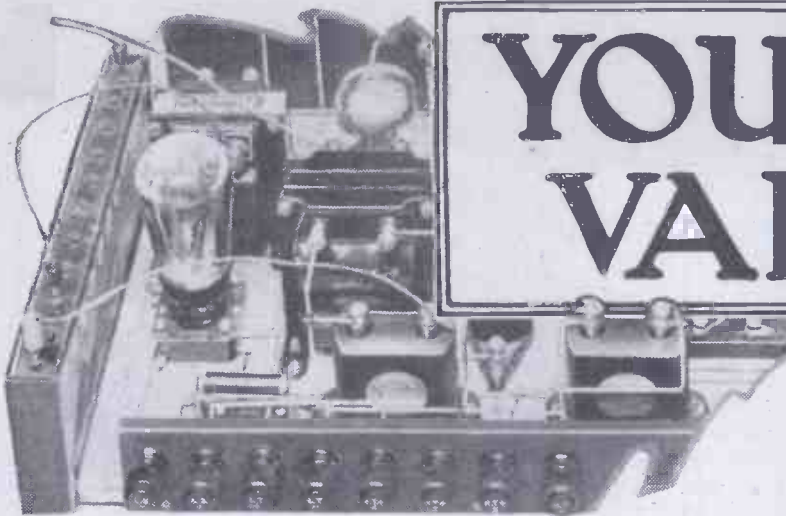

YOUR L.F. VALVES

By G. W. EVANS.

A practical article that should be of assistance to a large number of battery-driven valve-set users.

THE choice of a suitable L.F. battery valve for a particular receiver is not a difficult one provided a little thought be used. The following brief notes, however, will I hope be of assistance to some of my readers, and will be appropriate as the current number of MODERN WIRELESS is a special transformer number.

Many Good Valves

There are large numbers of good L.F. valves on the market, and there should be no difficulty in choosing one to suit any particular purpose you require. For instance, if you want an L.F. valve to precede resistance coupling you have quite a wide choice

before you, and though there is no golden rule as to what type of valve suits any particular purpose, the choice of a satisfactory valve is by no means a difficult business.

To get the last ounce out of any set you may have to do a little experimenting with several types of valves, but for ordinary purposes you can usually go straight to a valve-maker's catalogue and pick out the particular valve you want for any particular purpose.

It is a general rule in the detector stage to use an H.F. valve or one of the special detectors, whether the detector valve is transformer- or resistance-coupled to the next stage.

Assuming it is resistance-coupled to the next stage, and you use an H.F. detector valve, what sort of valve are you going to choose in the next holder? This will depend partly upon the signal strength to be impressed upon its grid, and partly upon the coupling between that stage and the next.

factor of anything from 10 to 15 should do quite well here.

Shunt-Fed H.T.

As a matter of fact, as the stage is transformer-coupled to the next stage, the valve should not be of very low impedance unless the H.T. is shunt-fed. This is because the valve is likely to take so much plate current that it will cause a serious drop in inductance in the primary of the transformer, and possible saturation of the core. As a general rule, however, we can choose a valve of the type mentioned.

Now what about the last valve?

This will have quite a big signal strength to deal with, owing to the

A BIG VALVE!



The P.625A, which has an impedance of 1,600 ohms and an amplification factor of 37.

FOR YOUR OUTPUT STAGE

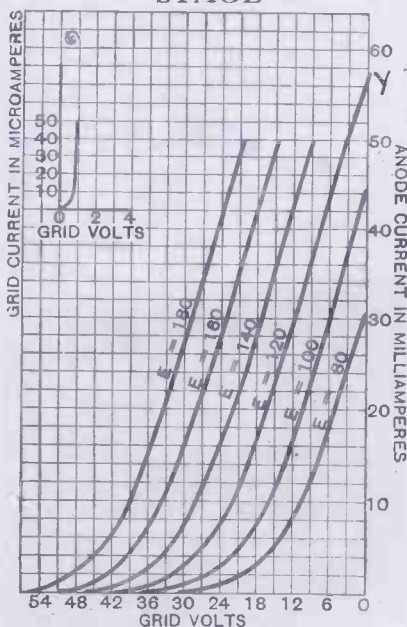

With H.T. max. recently increased to 200 instead of 180 volts, the 625A should be biased to provide an anode current of 25 milliamps.

Avoiding Overloading

Suppose you have a detector and two L.F. set in which the detector is resistance-coupled to the next valve, and this valve is transformer-coupled to the last stage. You are not likely to get a tremendous build-up in signal strength from the detector on to the first L.F. valve, so you can put a valve there which has not a very big grid swing, though it can have a fairly high magnification factor; something of the order of the L.210, or even in some cases one of the special detector valves manufactured by Mullards, such as the P.M.2D.X., will do.

Roughly, a valve having an impedance of somewhere about 10,000 to 14,000 ohms and a magnification

Solving the Detector-Valve Problem

magnification properties of the preceding valve and the amplification derived from the transformer, so for local station work, at any rate, we must have a super-power valve here.

A valve with a big grid swing, taking a grid bias of not less than 15 volts at its maximum H.T.

Naturally, the larger the valve the larger the input will you be able to put on its grid without overloading, but you must not forget that if you have an unnecessarily "large" super-power valve you are likely to lose considerably in amplification.

The Super-Power Valve

The super-power valve does not amplify very much, although it will handle quite a considerable amount of input, and enable you to make full use of the amplification of preceding stages. But for loud-speaker work on the local station, as large a super-power valve as you can afford to run should be employed, bearing in mind the fact that it will take a heavy H.T. consumption.

If you are a long way from the local station you can use a smaller valve in the last stage, one which will give you high amplification in itself, for it will not have to carry a very big grid swing. So a power valve of the order of 4,000 ohms, with a magnification factor of something like 6 or 8, will be very useful in this case.

o use an H.F. valve as the first L.F., something of the order of 20,000 ohms, with a magnification factor of 20, and then use an ordinary small power valve in the last stage.

signal strength with which you wish to deal.

If you have H.F. amplification in front of your detector it is advisable not to use an R.C.C.

THE PENTODE AND THE PORTABLE

The small pentode valve is especially valuable where portable sets are concerned, and this photo shows a picnic party listening to tea-time music on a small portable receiver.



This H.F. valve will give you a much bigger amplification than the ordinary L.F., and for distant-station work this increased amplification will be very valuable indeed.

Now suppose the set has two transformers, the detector being transformer-coupled to the first L.F. and this valve transformer-coupled to the last. In this case I hardly think an H.F. valve in the second holder—

valve for rectification, as so many people are tempted to do, even if it is resistance-coupled, and even if you can get smooth reaction, usually so difficult with an R.C. valve.

You will notice that hitherto I have mentioned nothing about this type of valve; I bring it in here not only because I want to emphasize the importance of having smooth reaction in a set, but also because if you have H.F. in front of your detector valve you must look out for overloading of the detector, and this is liable to occur with local transmissions if you use an R.C. valve.

ALL THOROUGHLY TESTED

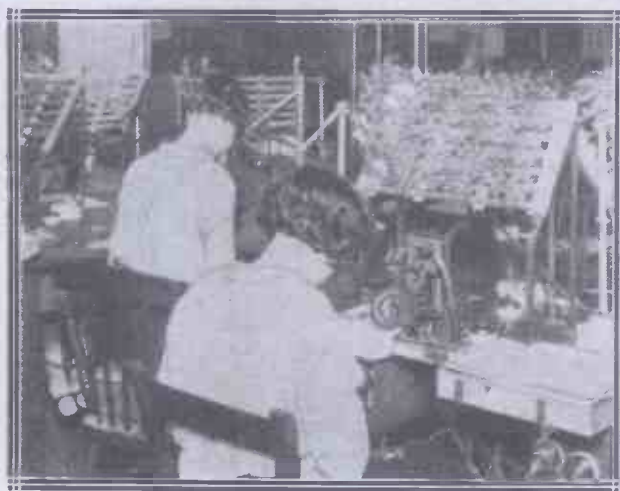

All modern valves are thoroughly tested before being sent out for public "consumption." Here we see a corner of the Osram valve works, showing girls assembling the electrodes of some of the valves.

Also, if you are a considerable way from a broadcasting station, and have difficulty in getting strong signals (and assuming you do not want to use H.F. amplification in front of the set), perhaps it would be advisable

that is, the first L.F. stage—would be advisable under any circumstances. It might lead to instability, and it would be best to use ordinary L.F. types here, with a power or super in the last stage, according to the

A Golden Rule

Therefore, the golden rule for detectors is to use the H.F. or special detector types practically always, no matter what type of set you are using. (In the case of tremendously powerful sets it is sometimes advisable to use a power detector, but that type of set hardly comes under the attention of an article such as this.)

We must not forget the pentode valve, however, for as a last-stager in a small set, or one used for DX reception, the small pentode is a very useful output valve.

Where large volume is required, the power pentode, such as the P.M.24A, or even the new P.M.24B, can be employed; these valves giving adequate output to provide really loud moving-coil-speaker results.

HOW DIAGRAMS HELP

By "M.W.'S" Chief Draughtsman

To endeavour to describe a new piece of wireless apparatus, or the design of even the simplest wireless receiver, by words alone, would be an extremely difficult task. It is generally necessary in the case of technical descriptions, especially those of a constructional character, to embellish the text with explanatory diagrams.

Seen at a Glance

It is, in fact, no exaggeration to state that in many cases apparatus described in MODERN WIRELESS could be constructed solely from the illustrations accompanying the written matter.

This, of course, assumes that the reader has a good general knowledge of the theory and practice of wireless. He can then read the diagrams much as he would read a written description, but in far quicker time. He can visualise actual components by a glimpse at their theoretical (symbolical) counterparts; he can check a theoretical circuit

against a wiring diagram (pictorial) in order to satisfy himself that no errors in wiring have been made; he can, in short, read much that is contained in the text simply by looking at the illustration.

The point is made solely in order to emphasise the importance of diagrams and the assistance that they are capable of rendering. It is not for a moment suggested that the read-

A valuable article, full of hints and tips on the practical interpretation of diagrams, together with some general advice on the construction of sets.

ing matter is unnecessary.

Explanatory text is obviously essential in all cases. No diagram could explain, for instance, the exact claims made for the apparatus, its performance under test, etc.

The wireless receivers described in MODERN WIRELESS are invariably accompanied by at least three dia-

to wire-up their apparatus by following the theoretical circuit after having positioned the components according to the layout shown on the back-of-panel and baseboard-wiring diagram.

The Symbols Used

To the beginner or less fully instructed reader it is highly probable that the theoretical diagram will be useless as a guide. In order to give some little assistance in this respect, a few of the symbols commonly used in theoretical circuits are shown in Fig. 1. In time the tyro will learn to associate these symbols with the actual components.

It is important to remember that in

MODERN WIRELESS diagrams wires in theoretical circuits are shown looped one over another at those points where no electrical contact is made. Where two or more wires are joined together the fact is indicated by a small black circle. Where wires cross on the back-of-panel and baseboard diagrams no

loop-over is shown, and the joining of two wires is indicated by a solid black square at the connecting points.

The battery symbols may, in some instances, confuse the novice. The standard practice in this country is to show a short, thick line for the negative pole and a slightly longer and thinner line for the positive. The polarity is indicated by a plus sign

DO YOU RECOGNISE THESE THEORETICAL SYMBOLS?

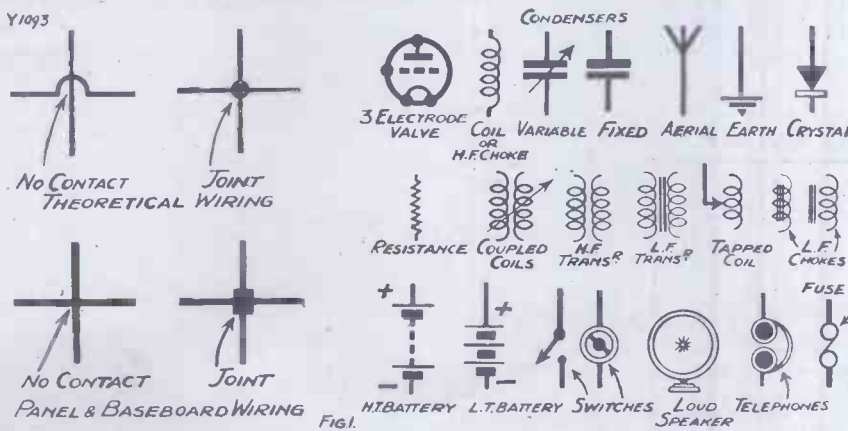

Here are shown various of the signs more commonly used in "M.W." diagrams.

grams: a theoretical circuit, a front-of-panel layout, and a back-of-panel and baseboard-wiring diagram.

Wiring from "Theoretical"

To the initiated the theoretical diagram shows in the simplest form possible the circuits utilised in the receiver and the various components employed. It can be followed easily, and many advanced enthusiasts prefer

How to Use Wiring Diagram Scales

for the positive and a minus sign for the negative, see Fig. 1. Many American technical journals reverse the order of the symbols, using the thick, short line for the positive, and the thinner line for the negative. The plus and minus signs are, however, used in both cases to denote positive and negative respectively.

A careful study of the pictorial wiring diagram in conjunction with the theoretical diagram will soon teach the beginner how to read theoretical circuits.

Drilling the Panel

The front-of-panel diagram is intended to show the constructor of the apparatus the exact points at which the panel should be scribed for drilling. The dimensions are clearly shown on the diagram and, with the aid of a ruler and perhaps a straight-edge and a set-square, the panel marking presents no difficulty.

As an example, take a panel, 12 in. by 7 in., and assume that the layout requires three drilling points, as illustrated. First make certain that your panel is square by using a set-square as shown in Fig. 2A. Place the set-square with the right angle on the corner of the panel with one edge of the set-square in alignment with one edge of the panel. Try each corner of the panel in this manner and work from the corner which shows the smallest error. Any

USING A SET-SQUARE

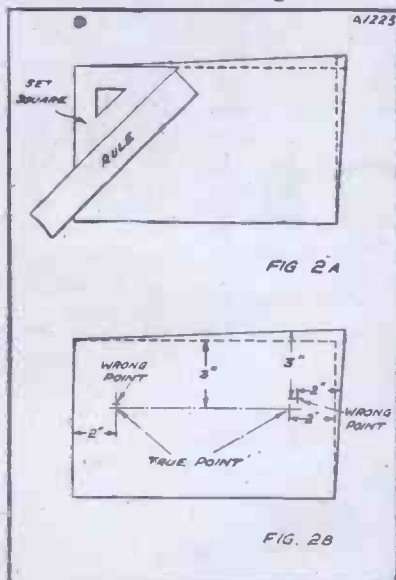

Make sure your panel is truly square before marking it out for drilling.

irregularity in the shape of the panel can be rectified before scribing and drilling, but not afterwards.

If a badly-cut panel is dimensioned off from the edges and drilled before being cut square, the result will be unsatisfactory, because the drilling points will not have been made in the proper places. Fig. 2B shows quite clearly the danger to be avoided.

THE SCALE

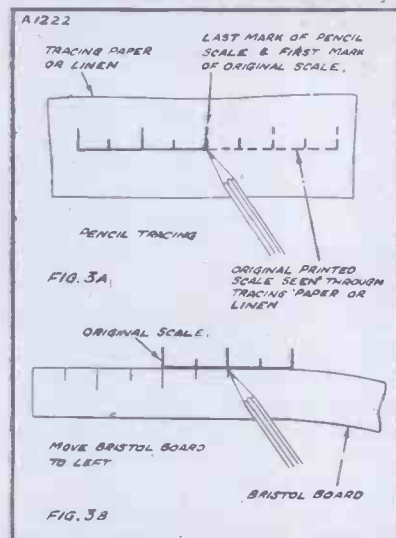

How the scale is transferred to linen or Bristol board.

The back-of-panel and baseboard-wiring diagram is, from the average constructor's point of view, the most important. This drawing is always made to scale, and a scale is shown on the illustration for the benefit of the individual who wishes to construct the apparatus.

Using the Scale

Use can be made of the scale by cutting it from the paper, by making a tracing, or by the method indicated in Fig. 3B. The first method is simple, but has two drawbacks. Firstly, the periodical must be mutilated, and, secondly, the scale will be very short. Either the second or third alternative can be adopted, not only to give an accurate scale, but to provide a scale of any length.

If a tracing is made, see that the tracing paper or linen is fixed firmly over the scale so that no movement is possible. Then carefully draw in your scale in pencil and remove the tracing. Now move your pencil scale along to the left of the original until the final inch mark of your drawing coincides with the first line of the

printed scale. Fix your tracing again and add a further three or four inches as the case may be. You can make a scale of any length by this method, although 12 in. will serve for most purposes.

Having completed the dimensions, gum the tracing on to a piece of stiff cardboard and ink over the pencil drawing. Then cut the board away level with the inch marks, and you have a scale ready for use.

A Quicker Method

The third way is to take a strip of Bristol board or clean white cardboard with a perfectly level edge. Place the board against the printed scale and mark off the scale direct on to the edge of the Bristol board, as shown in Fig. 3B. This procedure is much quicker than making a tracing, but unless the marking is done very carefully indeed it is liable to be less accurate. The Bristol board is moved to the left as before when it is required to add more inches to the scale.

Once the scale is completed, the position of any component or drilling point is easily found on the diagram without the need for any dimensions being given in figures. The panel

MEASURING THE BASEBOARD

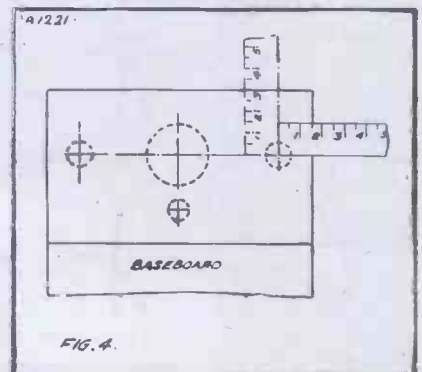

How to apply the scale in order to ascertain baseboard dimensions.

layout in Fig. 4 is not dimensioned, but the use of the scale would immediately supply the wanted distances, namely, $1\frac{1}{2}$ in. in from the side of the panel and 3 in. from the top.

In applying the scale to the drawing, remember that it is a scale, and do not make the mistake of using the scale rule when measuring on the actual panel or baseboard.

TOO MANY VOLTS?

by B. R. HILL

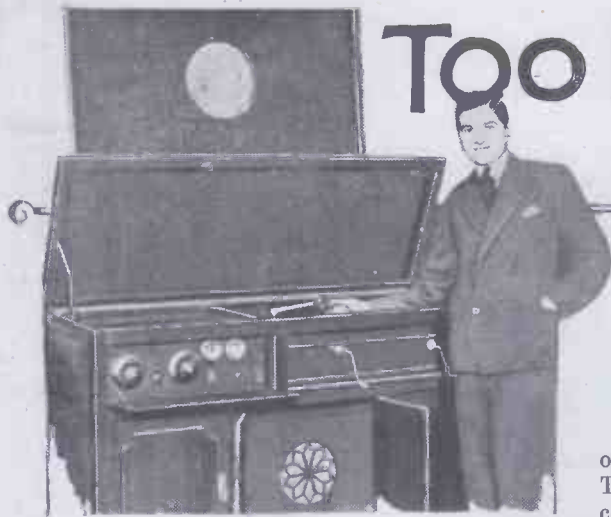

How do you fare when you switch over from "radio" to "gramophone"? Do you find you are troubled by distortion due to overloading? This is quite a frequent state of affairs, as is shown in the following article, which also concerns the very simple remedy.

It not infrequently happens when one tries a pick-up with an ordinary radio receiver that horrible distortion occurs. The set may be O.K. on radio, but as soon as the gramophone is used—ugh!

This is usually due to the fact that most pick-ups give to the first valve a grid voltage far greater than it obtains from a radio input.

The Input Voltage

If we take the ordinary three-valve set, working on radio, we find that the input voltage at its highest is as a rule well under one volt, probably only a very small fraction of a volt, but when it comes to a pick-up we find that it is not unusual to have a peak voltage of one or even nearly two volts. Consequently, although the first valve may take it quite well, the succeeding valves will almost surely be overloaded if no volume control is employed.

Thus we often hear that so-and-so's set is "quite all right on radio," but that a pick-up is an absolute "wash-out," and often the whole idea of using electrical reproduction is condemned simply because the particular listener has bought a fairly sensitive pick-up, and although he gets loud results he also gets distortion—because he is overloading.

Use a Volume Control

Many pick-ups will overload a set in this way, but there are also others which require three stages before they will give adequate volume. When you use a pick-up it is nearly always essential to have some sort of volume control (preferably across the input), but there are cases where a volume control in this position is quite useless if a sensitive instrument is to be used in the first stage

of a three-valve set. That is, if it is to be connected to the detector valve.

In such cases the volume control has to be put down to "minimum," and control is therefore very poor indeed. Where a pick-up is very sensitive it is essential to place it in the first L.F. stage, so that there is only two L.F. valves after it.

Although a very sensitive pick-up means that you do not have to use so many valves, and also gives one the idea that one is at least getting the most for one's money, yet I think that some of the models now on the

CHECKING THE VOLUME

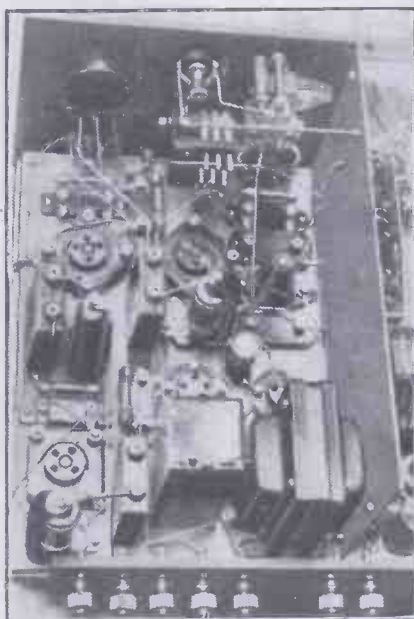

The "gramophone end" of a radio-gram receiver. Note the volume control (top left of photo) which operates on the first L.F. valve.

market are rather overdone with regard to their sensitivity.

There are now available types capable of giving well over $1\frac{1}{2}$ volts input to the valves to which they are connected, while at the other end of

the scale there are also pick-ups which will not provide more than about .07 to .1 of a volt. Which is preferable for the average man?

With a three-valve receiver that is capable of giving good amplification I would choose one of the less sensitive of the pick-ups. Failing a good three-valve set, I would prefer the medium sensitivity make, which will give perhaps three-quarters of a volt at the outside, and this type I have found is quite satisfactory.

A Safety Factor

But whatever type you use, and whatever your set, the pick-up should be capable of providing a fair, though not excessive, strength, and should be used in conjunction with a volume control.

It is as a rule best to have quite a fair margin of safety, and to use a three-valve set with any but the most sensitive of pick-ups, but I must impress upon my readers the necessity in every case of providing a volume control of the potentiometer type and having a resistance of anything from half to two megohms, this being connected across the pick-up.

In this case you can control the volume right at the beginning. Obviously if one controls the volume in the first stage there is no possibility of any of the valves being overloaded.

Avoid Overloading

Also, I would definitely advise readers not to use resistance-capacity coupling valves, as these have very short grid swings, and it is not difficult to overload them, even direct from the pick-up, if one is using a very sensitive instrument.

For the two-valve man, of course, a very sensitive pick-up is useful, as he then gets the most out of his outfit. But whichever type you use, do be careful not to overload.

America's Television

By WILLIAM J. BRITAIN—



NEW YORK.
WITH fifty receivers working—some in homes of the public, some in civic officials' homes, some in public buildings, and one in the street—television is being broadcast here from what is claimed to be the "world's first television theatre."

The apparatus is that of the Jenkins Television Corporation, and the broadcasts are being sponsored by Jersey City Chamber of Commerce. The theatre is to have a week's run.

"Nothing Startlingly New"

I went over to the première and, frankly, saw nothing startlingly new. Around the municipal building in Lincoln Square were ringed about 200 policemen; passes were demanded of everybody at the door, over which there was a large sign: "Entrance to World's First Television Theatre," and in the large studio there were even policemen behind the sound curtains.

But this, I was assured by Jenkins' officials, was not directed against spies—it was just civic pride.

In the small hall used as the studio was a television transmitter—a disc about three feet in diameter, with 48 holes in a spiral, spinning at 900 revolutions a minute, making 15 frames a second.

A motor just underneath revolved the disc. Behind the disc, enclosed in a box like a magic lantern, was an orthodox photo-electric cell with refinements, I was told, by the Jenkins' laboratories.

Six Big Lamps

In front of the disc was the usual optical system trained on three reflectors arranged like a screen, where the victim had to stand. In

a semi-circle around the whole were six great film-studio lamps.

Four receivers were in a room above, in addition to those spread about the city. They were commercial models made in the Jenkins' factory. In the cabinet was a short-wave receiver and the television apparatus—a neon lamp, again with Jenkins' refinements; a metal drum 8 in. wide and 4 in. deep, with four spirals of 16 holes each, spinning horizontally at 3,600 revolutions a minute; and a disc with four slots spinning vertically to act as a shutter so that only one spiral was seen at once.

The neon lamp was inside the drum. Before the slotted disc was the usual

A TELEVISION PIONEER



A recent portrait of C. Francis Jenkins, pioneer of television in America and President of the Jenkins Television Company.

magnifying lens, and this gave an image only 4 in. square.

For the first half-hour there was nothing to be seen but fine bands of pink and black, with occasional glimpses of a chess board in agony. Eventually, however, a man's face began to show. There were flashes for a second or so of images as clear as I have seen anywhere in the world.

Then the image settled down (with occasional nigger minstrel

The first Television Theatre in the world opened at Jersey City recently. This absorbing article tells you just what our Special Commissioner thought of it.

effects) to a moving face not detailed enough to show whites of eyes or flickers of eyelids, but good enough, I thought, to enable me to recognise the man being televised.

I went downstairs looking for a man plumper than the one I saw before the transmitter. When I went upstairs again I found I could recognise in the image the features of the man—but that was after I had seen the man.

Messages came in that one of the 50 receivers outside was receiving the image, and it was being received at the Jenkins' plant.

Chasing Images

The television signals were carried by land-line to the Jenkins' television station in the city, W 2 X C R, and broadcast on a wave-length of 139 metres, occupying a total band of 60 kilocycles.

Signals from the microphones—voices of the speech-makers and entertainers, and the music of the police band—which played between the numbers—were carried by land-line to three sound broadcasting stations. Upstairs loud speakers by the side of the television cabinets gave the sound.

At first the television signals were carried to the receiving cabinets

Theatre

—“M.W.’s” SPECIAL COMMISSIONER

upstairs by land-line, but interference was so great that the signals were picked up “off the air” with better results.

The images sometimes chased each other, suggesting faults in synchronisation, but the 60-cycle synchronous motors were being run from the same current as the motor driving the transmitting disc. If the power sources had been different, necessitating manual control, I am afraid the select visitors would not have seen as much as they did see.

“Images Were Crude”

Among those at the première, smiling—half with real pleasure, half indulgently—was the tall figure of Dr. Lee de Forest. He chatted, telling of the strides science had made in his day.

And, in the glare of the six great lamps, he addressed the “Ladies and gentlemen of the sight and sound broadcast audience.”

It was in Jersey City that he made radio broadcasts twenty years ago, in 1910, he said. He gave first phonograph records, and then broadcast Caruso from the Metropolitan Opera House.

“To-night we have the experimental evidence of the feasibility of radio television or radiovision,” he said. “Not a polished, finished per-

The Jenkins television outfit installed at the New Jersey station that was specially designed for the transmission of pictures by radio

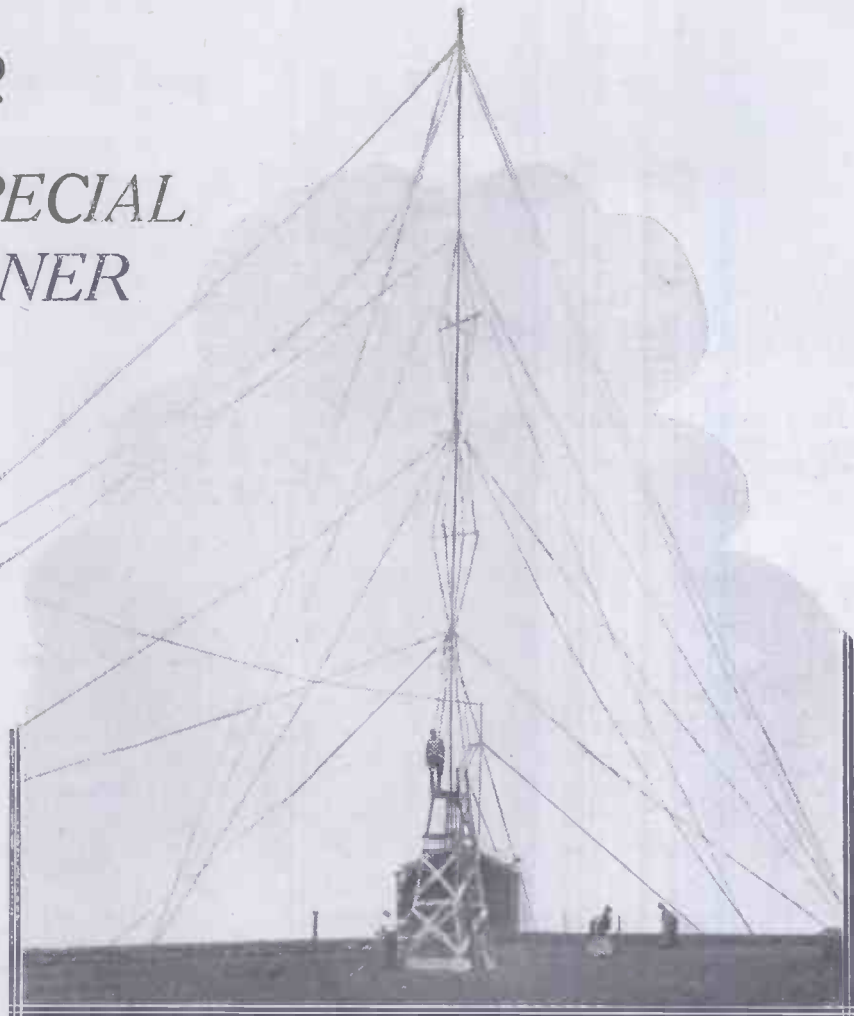
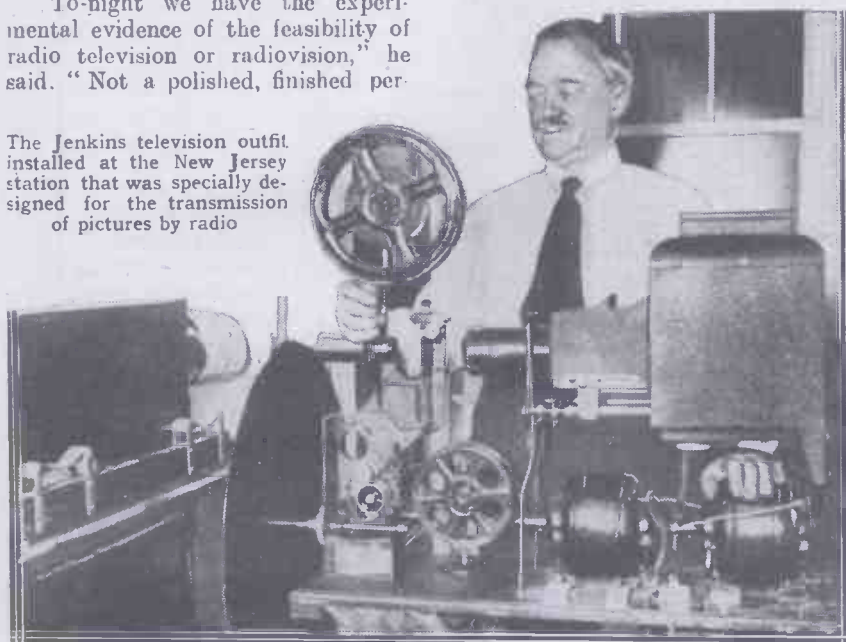

This is the aerial system of W 2 XCR, the New Jersey television station that works on 139 metres.

formance, to be sure, but at least a bold start in sight broadcasting.

“Rather than retain this television art in the laboratory, the Jenkins

engineers have preferred to place their efforts before the public so that the requirements of everyday use might serve as the severest incentive towards truly constructive progress.”

The images were crude, he said, but when he broadcast Caruso, listeners could not tell whether it was a banana vendor or the world’s greatest tenor.

A Feeble Effort

Television at present was a “feeble effort,” but it might duplicate the history of sound broadcasting.

The Chamber of Commerce are surprisingly keen to try to give television a footing. They early “gave a hand” to radio; and when the Jenkins Corporation were looking for a site, they attracted them to Jersey City.

On the first night the programme was exhausted by nine o’clock, and it was decided for the remainder of the week to give a programme of just more than an hour, instead of from seven to ten every evening as announced.



The method described hereunder will often solve the problem of operating two dissimilar loud speakers from one set.

By T. B. SANDERS.

MOST modern commercial moving-coil loud speakers are of the low-resistance type, and a step-down output transformer has to be used in order to "match" the impedances of speaker and last valve.

When a moving-coil loud speaker is installed it is usually the owner's first desire to test its performance against one of the more common moving-iron variety.

After having begged, borrowed, or stolen one of the latter type it is nearly always found to have high-resistance windings, and, therefore, a fair test of the comparative merits of the two speakers cannot be made by connecting the high-resistance speaker to the output terminals of the step-down transformer.

Choke Filter Necessary

On the other hand, it is not a very wise procedure to connect any loud speaker directly in the plate circuit of the output valve of a set designed to operate a moving-coil loud speaker to its best advantage.

The choke output filter is, of course,

the correct method of connecting a high-resistance loud speaker to such a set, but for the mere purposes of making a test it is scarcely worth while purchasing an expensive choke.

Easily Arranged

The condenser, on the other hand, is a more readily available component, and few owners of moving-coil outfits are without a spare 2-mfd. condenser.

All that is required, then, is a choke, and, fortunately, one has not far to

look for this essential component. The primary of the step-down transformer will possess very high inductance if the instrument is at all capable of fulfilling its original purpose.

All that has to be done then in order to connect the high-resistance loud speaker to the set, so as to give it every chance in the impossible task of competing with the moving-coil instrument, is to adopt the scheme suggested in the diagram.

Examination of this diagram will reveal that the primary of the output transformer functions as a choke. The primary terminal which goes to the plate of the valve is connected to one terminal of a 2-mfd. condenser.

RUNNING DISSIMILAR SPEAKERS

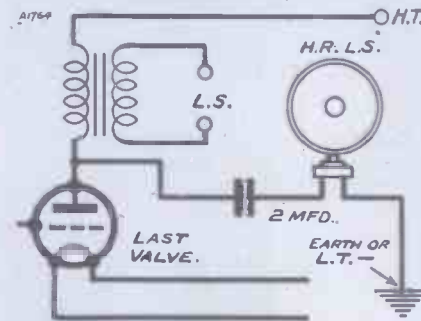

This method of coupling two speakers is often very valuable.

Reliable Comparison

To the other terminal of this condenser is connected one of the high-resistance loud-speaker leads, and the other speaker lead is joined either to the L.T. negative or to earth.

In this way every reasonable precaution will have been taken to enable the moving-iron loud speaker to show to its best advantage against the moving-coil speaker.

THE EDITOR, "MODERN WIRELESS."

Sir,—Just an appreciation of the article, "Revolutionising the S.G." by Mr. K. D. Rogers, in the April issue of "M.W." I had found out some time previously that voltages of 120 on the anode and 70-80 on the S.G. were unnecessary, but I never dreamt of getting down to the suggested pressure by Mr. Rogers. However, I did a little experimenting, and eventually fixed the pressure at 28, on the anode and 44 on the S.G.

"Very Best Results"

This gives the very best of results on two different S.G. valves, both

REVOLUTIONISING THE S.G.
 A Reader's Experiences.

Mullard P.M.12, although one requires more filament current than the other. There is not the least drop in the H.F. amplification, and there is certainly a purer background.

Also there is certainly an improvement in selectivity. For instance, I could not get Zeesen clear of 5 XX previously. I have a .0005 variable condenser in series with the aerial, and by reducing the capacity to

approximately .0001 I can now get Zeesen with only the faintest background of 5 XX, which is quite inaudible when Zeesen is transmitting; only when Zeesen stops can I hear the faint background of 5 XX.

Home-Made Set

My set is an S.G.4 of my own construction, using Mullard valves and Lewcos binocular coils.

Please convey to Mr. Rogers my appreciation of his article. I might say that the voltage mentioned is actual.

Yours faithfully,
 Middlesbrough. H. J. B.



FROM CONE TO COIL

Points to watch when making the change.

By E. A. ANSON.



It is uncanny the way a coil loud speaker shows up the weak spots in a set. Little details that didn't seem to matter with the old speaker have a habit of speaking the truth when the change over is made.

Although it is not necessary to install an H.T. system of which the power station might feel proud, it is certainly advisable to overhaul the H.T. supply and make a few other simple alterations if it is desired to get the best out of the coil speaker. The last valve may now possibly require a higher H.T. voltage than before.

The Problem of H.T.

However, it is not necessary to go above 200 volts. The H.T. drain necessarily goes up; it is doubtful if it will be lower than fifteen milliamperes and may exceed twenty milliamperes. If the old cone were driven by the smaller type of H.T. batteries, it would be unwise and uneconomical to ask them to overstrain themselves.

If it were not a fact that most coil speakers require more input to give results equally loud as the cone there would be no need for altering the H.T. at all. But merely altering the H.T. in itself does no good. All this alteration does is to make it possible to increase the grid bias, so that we can give the coil speaker the extra input it wants.

There must be many cone speakers giving fairly

satisfactory results with a grid bias of only six volts or so. There may be overloading to a small extent, and the high notes may be clipped a little, but the original speaker smooths over these weak spots. If we increase the grid swing and instal a coil speaker

Providing your set is moderately powerful it will no doubt operate a moving-coil loud speaker. But this type of instrument possesses none of the camouflaging colouration peculiar to many ordinary cones, and it reveals faults in a set's output with striking clearness. In this article suggestions for eliminating these are made, and many readers will find these hints useful even if they do not contemplate using a coil-driven speaker.

which most decidedly does not smooth over the weak spots, but renders them in utter faithfulness, the result will be surprisingly unsatisfactory. Whatever the last valve it is doubtful if a grid swing below 10 is sufficient.

With some three-electrode valves a grid bias of 20 would be all too small. Anyway, when you change from cone to coil, if you do not understand valve curves, consult your valve maker. He will tell you whether you ought to insert a different valve, and he will advise you as to your grid bias. The point is, don't just hitch on the coil speaker and imagine all will be perfect, for more than likely it won't be.

Use Reaction Carefully

There is just one little snag connected with the increased input that the coil speaker will want. Be careful how you use reaction. Up to a point it is perfectly permissible to boost up the signals with reaction. But you will soon find that the coil speaker seems to lose its brilliance and becomes dull if reaction is pushed too far—not nearly as far as with the older loud speakers which were very tolerant of this abuse.

The coil speaker is capable of responding to almost the whole musical gamut with a very close degree of faithfulness. If by reaction you cut off the middle and high notes, don't blame the speaker. If you must have things boosted up, add another valve. Some sticklers for purity bias their 3-electrode H.F. valves by a decimal of a volt or so when they change over to a coil.

On strong inputs from a near station this probably does help, anyhow, it does no harm and

GIVE YOUR CIRCUIT A LITTLE THOUGHT

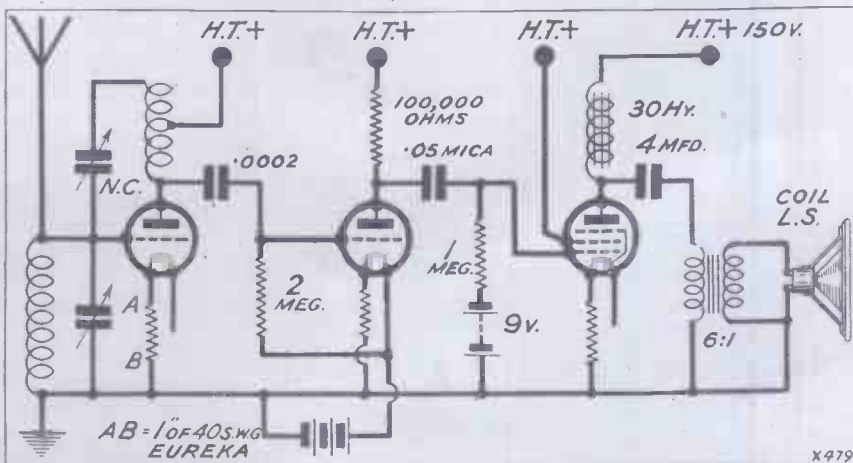

This diagram shows a three-valve circuit incorporating the schemes suggested by the author.

How to Couple Coil Speakers

incidentally reduces the H.T. current to the H.F. valves. The simplest way to do this is to connect about one inch or so of 40 S.W.G. Eureka wire in the L.T. negative leads of the valves concerned.

Method of Detection

Unless you are abnormally sensitive to music it is very doubtful if a change from grid detection to anode bend will make any noticeable differ-

STEP-DOWN OUTPUT

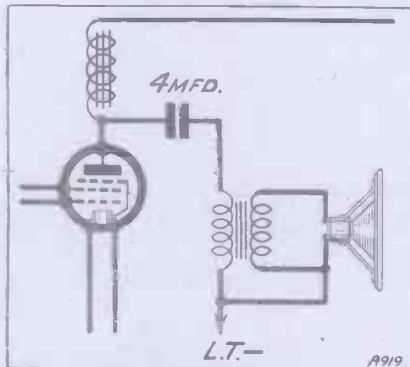

With a low-resistance moving-coil loud speaker a suitable step-down transformer is required, and can be connected up to a pentode valve as shown.

ence. The much-abused grid detection has many things in its favour, and it is probably wise to leave it well alone—just as it stands.

The method of coupling the coil speaker to the anode circuit of the last valve merits a moment's thought. Most cone speakers are coupled

THE FAMOUS R.K. SPEAKER

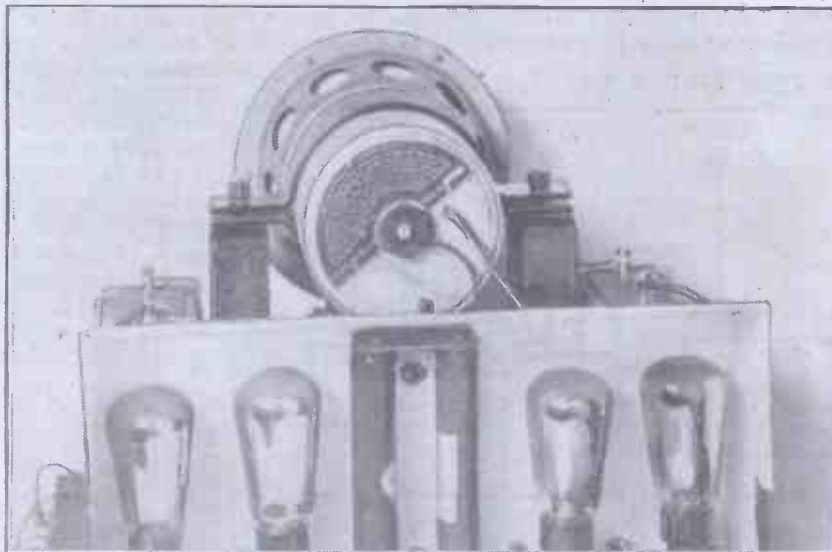

The R.K. (Rice-Kellogg) loud speaker, one of the earliest of its type, carried its own special amplifier, as this back view of the instrument shows.

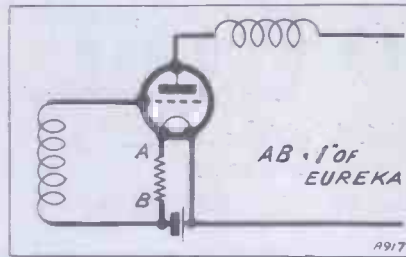

The insertion of a little resistance in the L.T. circuit of an H.F. valve biases it by a fraction of a volt.

straight into the anode circuit. In addition, they are sometimes connected to a fixed condenser of about .0005 mfd., in order to get a more even response. This method is not at all suited to the coil speaker. Mostly because it has a smaller and a more even reactance to the musical frequencies. Coil speakers are made either with low-resistance coils of a hundred ohms or so, or with high-resistance coils of about 1,000 ohms.

Choke Output Coupling

The former require special transformers. The latter are the most common. Good results may be obtained if they are choke connected, as in one of the diagrams. Probably this method is about the best for the average coil speaker. As a matter of fact, the efficiency depends on the valve used, but for any of the three-electrode super-power valves the constants given will be found perfectly satisfactory.

Fortunately for the coil loud speaker

the new pentode valves arrived on the scene in the nick of time. It is only too true that for full output, generally unwanted, a coil speaker must be driven by a miniature power house if three-electrode valves are used. The pentode overcame this.

Better Results

With an amplification of 50 to 100 and a grid bias of 10 volts it will replace a whole battery of L.S.5A.'s and, what is more, the valve before the L.S.5A. as well.

Those changing from cone to coil should consider very seriously the purchase of a suitable pentode. If

FOR HIGH RESISTANCES

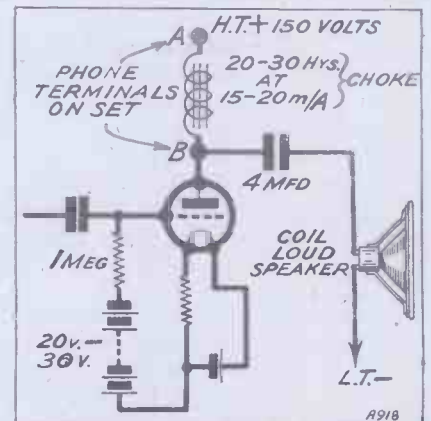

A simple choke-coupling is quite O.K. if the coil speaker has a high-resistance winding.

the present set uses two L.F. valves, it would be unwise for the pentode to replace the last power valve. If you do this the odds are the pentode will be overloaded. Let it replace the previous L.F. valve as well, it can do so, and even then give better results.

Don't forget, however, that if you use a pentode it should be coupled to the speaker by means of a suitable output transformer. If this is not provided the result may be that reproduction will be too high-pitched.

Well Worth While

Provided it is realised that there are a few things to do when changing from cone to coil, and the change over is done with due attention to these details, the results will be well worth while. There will be no sibilant resonances, no uneven amplification of certain notes, and the drum, the cello, the flute and the violin will take on a new clarity.

A NOVEL WAVEMETER

In previous issues our contributor has described the theoretical aspects and practical applications of the screened-grid valve as an oscillator. Here we have full constructional details of a simple but effective S.G. wavemeter.

By J. ENGLISH.

SOME time ago I made up an experimental S.G. oscillator for use in my own laboratory. This little instrument has proved to be so versatile and generally useful that I have developed from it a special unit which will be of considerable interest to keen amateurs and experimenters generally.

The unit incorporates those features which I found to be most desirable after experience with the experimental model, and, if carefully con-

is no coupling between anode and grid circuits, and that the control grid is connected direct to the filament. Tuning the anode coil with a variable condenser alters the wave-length of the oscillations, while any desired wave-length range can be covered by using different coils of suitable inductance values.

Unique Feature

Another unique feature of the S.G. oscillator is that the waves radiated from the tuned circuit can be modulated just like the carrier-wave of a broadcast station simply by connecting a microphone and transformer or a gramophone pick-up across grid and filament. This arrangement, which really works well, constitutes the simplest model transmitter I have ever handled.

As you will see from the illustrations, the unit is quite compact and rather pleasing in appearance. The filament rheostat is mounted on the front of the box and provides an adjustment of the intensity of oscillation, while the rest of the controls are placed on the horizontal panel

forming the top of the box, where they are easily accessible.

You will notice that the front and top panels, which are permanently fixed together, form a framework upon which all the components are mounted. The screen-grid valve is protected by partially sinking it into the box, the valve holder being

THE BASIC CIRCUIT

A/587

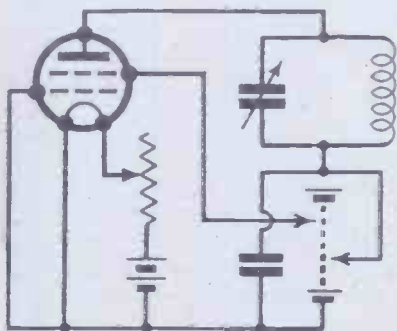

FIG. 1.

With certain values of anode and screen voltages, the screened-grid valve can be made to act as an oscillator in the circuit shown above.

structed and calibrated, it forms a laboratory instrument of considerable value to the serious experimenter.

If you are interested in the why and wherefores of the S.G. oscillator I would refer you to my previous articles on this subject, but for the benefit of new readers I will recapitulate briefly the main points of interest.

Low H.T. Voltages

If you refer to Fig. 1 you will see an S.G. valve connected up in rather a strange way. When certain voltages are applied, usually 12 volts anode and 45 screen grid, the valve possesses the unique property of generating H.F. oscillations in the tuned-anode circuit at the natural wave-length of the latter.

This is in spite of the fact that there

MODIFIED ARRANGEMENT

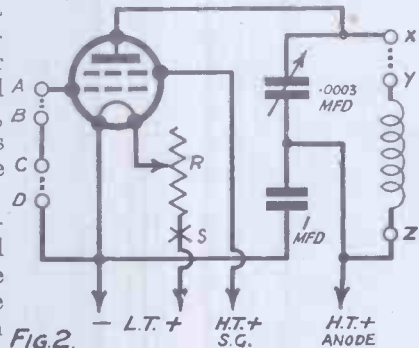

FIG. 2.

This is the final circuit used for the S.G. wavemeter described in these pages.

mounted a little distance underneath the panel and a flexible lead brought out for connection to the anode terminal on the valve.

An outstanding feature of the design is its flexibility as regards wave-length ranges. The medium wave-band is generally required more often than others, so that a coil covering a band of approx. 150 to 550 metres is permanently mounted inside the unit. Referring to Fig. 2 (the theoretical diagram of connections) you will see that this coil is joined to terminals Y and Z and brought into circuit by shorting X and Y.

Standard Loading Coil

For the long-wave range a standard "M.W." loading coil is placed into series with the fixed coil by connecting it to X and Y; while for wave-lengths below the minimum of the fixed coil, suitable short-wave coils can be connected to X and Z, the

READY FOR USE



A very neat wavemeter, as seen above, can be constructed using the circuit shown in Fig. 2.

built-in coil then being shorted out of circuit altogether.

There are four other terminals on the left-hand side of the unit, marked A, B, C, and D. These are normally shorted, but if you want to modulate the H.F. output, A and B are unshorted and the L.F. input connected to these terminals.

The other pair of terminals, C and D, are provided so that you can quickly connect up a grid battery to furnish the small negative bias up to

oak-faced three ply for the panel. There is no object in using an ebonite panel, as all that matters is the insulation of the three terminals X, Y and Z, which are here mounted on a strip of ebonite over $\frac{1}{2}$ -in. clearance holes in the wooden panel.

The woodwork is finished off by staining and polishing, a quickly and easily applied stain being Brunswick black enamel thinned down with plenty of turpentine to give the required shade.

section of wood inside one end of the former flush with the edge, and then a strip of wood is screwed to this section and to one of the valve-holder supports. From the photograph of the interior of the unit the coil may appear to be dangerously close to some of the components, but actually there is an all-round clear-

INTERNAL CONNECTIONS

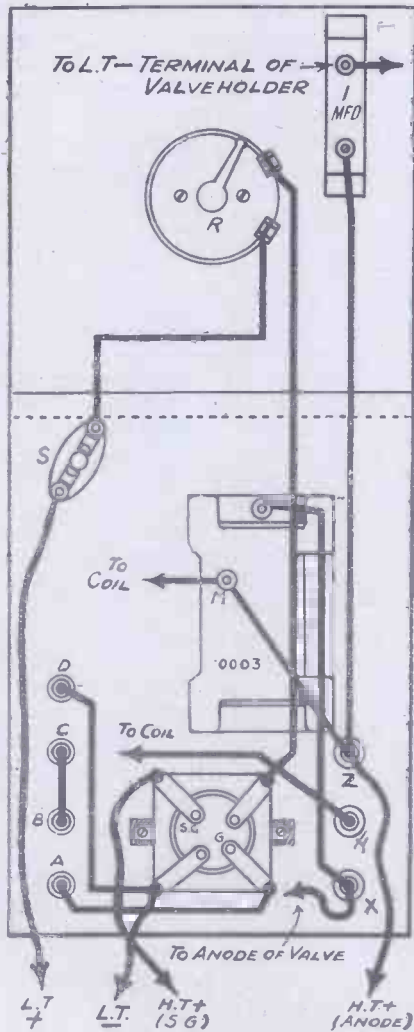

As you see here the wiring is a very simple business.

1½ volts required for undistorted modulation.

The easiest method of construction is to make up a wooden box measuring 8 by 6 in. outside and 5 in. deep inside, with top and front panels temporarily fixed in position. All four sides and edges can then be planed up and sand-papered clean in one operation.

For the sides and bottom use $\frac{3}{8}$ -in. thick wood and $\frac{1}{4}$ -in. mahogany- or

An Important Point

If you prefer to obtain the box and panels ready stained and polished, no doubt one of the cabinet-makers advertising in this magazine will supply them to order for a reasonable charge.

It is important when mounting the variable condenser and dial to make quite sure that both are firmly secured to the panel and to one another, so that no change in relative position can later upset the calibration of the unit.

The slow-motion dial must also be well fitted so that it works quite smoothly over the full condenser scale. The process of calibration and subsequent use of the unit is much facilitated if you use a dial which can be easily read to parts of a degree, such as the type illustrated, which enables quite accurate readings to be obtained.

Avoiding Hand-Capacity

Notice that the operating knob of the dial is so placed that one's hand does not come sufficiently near to the field of the coil or the condenser to affect tuning.

The supports for the valve holder are 2-in. lengths of wood $\frac{3}{8}$ in. by $\frac{3}{8}$ in. section; alternatively, $\frac{1}{2}$ -in. rod can be used. If you are unable to beg, borrow or steal the necessary drill for the clearance hole for the S.G. valve, you will have to adopt the rather tedious alternative of drilling a ring of small holes running into one another. The serrated edge of the hole so formed can then be finished off with file and sandpaper.

The "Medium" Coil

For the built-in coil a 3-in. diameter paxolin former, 2½ in. long, is required, upon which are closely wound 65 turns of No. 26 D.C.C., securing the ends rigidly in place by threading the wire through two small holes. A low-loss coil, rigidly constructed and mounted, is essential for efficiency and permanency of calibration.

The coil is mounted by glueing a

THE PANEL MEASUREMENTS

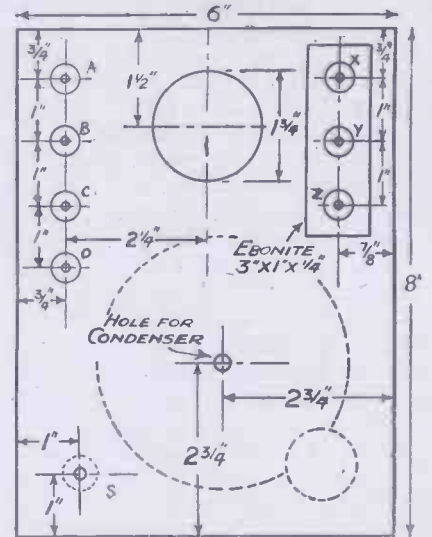

Y1205

How the panel layout is arranged.

ance of at least $\frac{1}{4}$ in., which is quite sufficient.

For a small instrument like this you will probably agree that there are already quite enough terminals without having another row for the battery connections. Accordingly,

CALIBRATION CHART

A1589

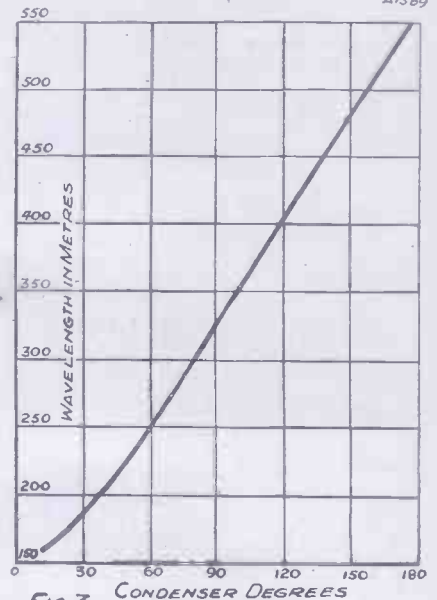

FIG. 3. CONDENSER DEGREES

A beautifully straight calibration "curve" was obtained with the original wavemeter.

Covers all Ranges of Wave-lengths

leads of sufficient length are soldered direct to the various terminal points behind the panel.

When the panel assembly is finally screwed in place these four leads are bunched together and taken through a $\frac{1}{2}$ -in. hole drilled near the bottom of the back of the case. You will find this system of battery leads very convenient when you are in a hurry to connect up the oscillator unit.

Suitable Voltages

You should have no difficulty in getting the unit to work properly on the first trial, provided no mistakes have been made in wiring up. The screen-grid valve is a fierce oscillator given the proper anode and screen-grid voltages, which for most 2-volt valves are round about 12 and 30 respectively, some types requiring a rather higher screen potential.

For running on low voltages I find that one of the most satisfactory valves is the Cossor S.G.220, which oscillates merrily with only 12 volts anode and 18 volts screen grid. Incidentally, it is rather a curious fact that all the 2-volt screen-grid valves which I have tested require approximately the same minimum anode potential—i.e. round about 12 volts. The minimum screen voltage, on the other hand, is different for various types.

You may find it necessary to experiment with screen voltages up to 60 volts in order to get full oscillation, but this potential can generally be reduced by giving the grid a positive bias by reversing the filament battery connections. This lowers the minimum screen-voltage necessary to make the valve oscillate without being in any way detrimental to the valve or the operation of the unit, except when it is used as a modulated oscillator, in which case a negative bias up to $1\frac{1}{2}$ volts is advisable.

The Calibration Chart

For the process of calibration, which is really a very simple matter, you must be able to tune in on the receiver a few stations of known wave-length. Reduce the aerial coupling if necessary until tuning is reasonably sharp and keep well off oscillation.

Suppose the receiver is tuned first of all as accurately as possible to 2 L O. The oscillator is then switched on and the condenser slowly rotated until the heterodyne whistle comes

right on top of 2 L O's transmission, which will then sound distorted. The heterodyne whistle disappears when the oscillator is dead on tune and reappears if very slightly detuned.

Note carefully the condenser reading of the unit, which is now tuned to radiate a wave of 356.3 metres, the wave-length of 2 L O. You can then repeat the operation for other stations, such as 5 G B and the National transmitter, which will give you condenser readings corresponding to 479.0 and 261.3 metres.

A few more readings will be required for intermediate wave-lengths, which can be obtained by tuning in those Continental stations of which you know the wave-lengths.

You have now sufficient readings to prepare the calibration curve of the unit, which is done by plotting on

unit. The usefulness of this curve is that wave-lengths can be converted into condenser degrees and vice versa. For easy reference you might paste the medium-band curve on the box.

S.L.W. Condenser

You may have noticed that the variable condenser chosen for this unit is a straight-line-wave-length component. Theoretically the calibration curve obtained with this type of condenser should be a straight line, but stray capacities cause a slight upward bending over the lower condenser readings.

Another type of condenser suitable for this unit is the straight-line frequency pattern which produces a straight calibration "curve" when condenser degrees are plotted against frequencies.

THE WAVEMETER'S "WORKS"

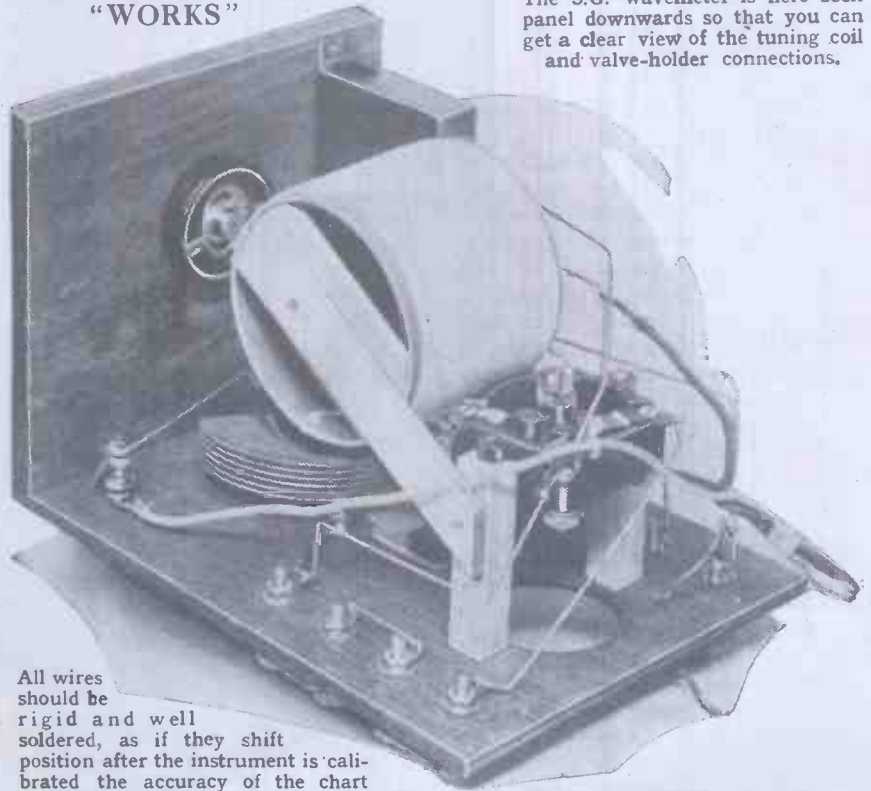

The S.G. wavemeter is here seen panel downwards so that you can get a clear view of the tuning coil and valve-holder connections.

All wires should be rigid and well soldered, as if they shift position after the instrument is calibrated the accuracy of the chart may be impaired.

graph paper condenser degrees against wave-lengths. The calibration curve of the unit illustrated here is given in Fig. 3, which will tell you all you want to know about plotting your own curve.

This should approximate closely to that of Fig. 3, which you can therefore use as a preliminary guide to the condenser settings of your own

FOR YOUR NOTEBOOK

If an ivory tab on your set has become loose, it can be reattached by ordinary rubber solution, as used for cycle tyres.

* * *

A liberal application of French chalk dusted across the teeth of a file will prevent them from getting clogged when used to trim a panel, etc.



The K.B. PORTABLE

Convenient and compact, the portable set offers exceptional possibilities to the listener, and, as is shown in this article, has many outstanding advantages.

THOSE who have never owned a portable can have little idea of the delight that this type of receiver can be. Wherever one may be, at home or in the country, by the seaside or on the moors, one can have music or other form of entertainment brought to one's very side.

Lazy Luxury

At home it is always a bit of a nuisance having to get up and retune a receiver (possibly in another room) when one wants to change the station one is listening to, or one wishes to switch it off. With a portable set you simply lean back in your arm-chair with the receiver at your elbow and switch on or off, change wave-lengths and programmes, as you desire, by just raising your hand.

Nothing could be simpler or more effortless, and though we should be the last to say that the ordinary receiver is doomed—it has advantages the portable does not at present possess—we are bound to admit that there are great possibilities in the portable set. As a matter of fact, we have just been having a lazy week-end with the K.B. Portable Four, and an excellent companion we have found it.

Taking it home on the Friday night, we decided to have no truck with our standard receiver, and to devote ourselves entirely during our periods of radio reception to the portable.

Minute Instructions

A glance at the little leaflet given by Messrs. Kolster-Brandes with their receiver soon showed that nothing had been omitted in the way of instructions to the purchaser of their set. Full details of battery connections, valves, how to tune, logging stations, etc., so that it would be impossible for even the most "ham-handed" of listeners to go wrong.

In addition to the frame aerial the set can also be used with an outdoor aerial, in which case, of course, the effective range of the set is greatly increased, and many stations which cannot be picked up with a frame aerial will be received satisfactorily.

But as a start we decided to use the set with the frame, and except for a short time we did not connect it to the outside aerial at all, having found that we could get all we required on the set as it was without any external aid.

The set was used at a place not far from Brookmans Park, and we found that we could comfortably

tune between the two transmissions, and also bring in 5GB at good strength, giving us three alternative stations from the British selection of wave-lengths on the short waves. On the long waves, of course, 5XX came in very well.

Also on the short waves we had no difficulty in tuning-in Langenberg in the evening (though he was not audible during daylight), and also Rome and one or two of the more powerful Germans.

The Long Waves

On the longer waves Hilversum was just audible in the evening; 5XX, as expected, was distinctly loud; Radio Paris was good, and Zeesøn was also

HOW THE SPACE IS FILLED

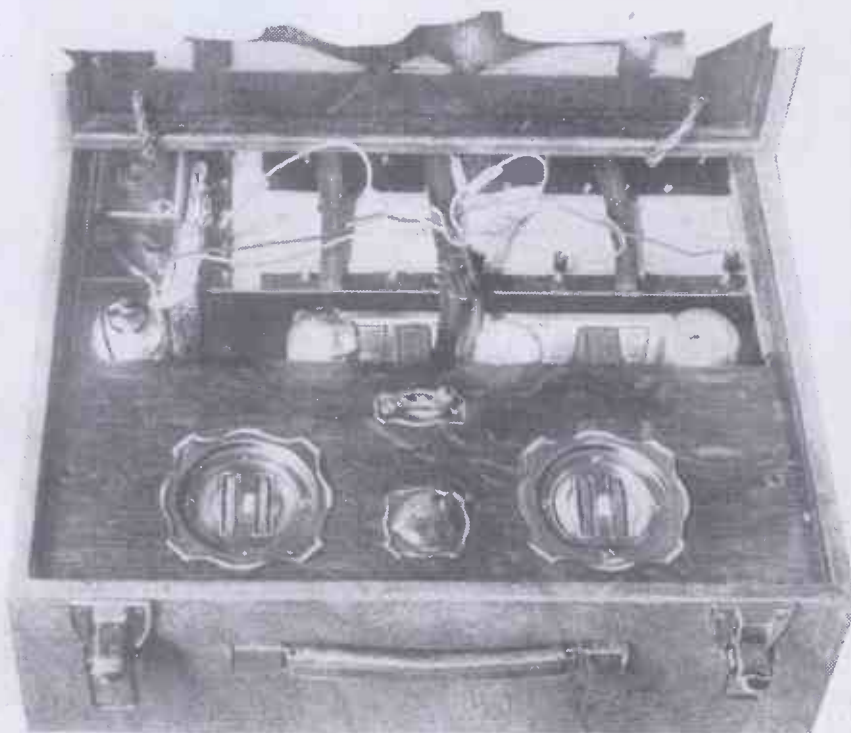

Everything in a portable has to be carefully stowed away, and this photo of the K.B. with the "lid" off shows how the various accessories are arranged.

MUSIC BROUGHT UP SHARP!



Voices in sharp relief; song clear and true; music full of life; that is what the LISSEN Secret Process does for your radio.

Because the current that flows from the large cells of this battery is produced by a new chemical combination and process which makes it pure, silent and sustained. There is never a sign of ripple in the current, never a trace of hum. It flows smoothly from beginning to end of the longest programme, and throughout months and months of use.

You want pure power for your radio: any good wireless dealer will supply you with the Lissen Battery that will give it to you.

PRICES:

60 volt (reads 66) ..	7/11
100 volt (reads 108) ..	12/11
120 volt ..	15/11
36 volt ..	4/6
60 volt. For Portable Receivers ..	7/11
99 volt. For Portable Receivers ..	12/6
60 volt Super Power ..	13/6
100 volt Super Power ..	22/-
4½ volt Grid Bias ..	10d.
9 volt Grid Bias ..	1/6
16 volt Grid Bias ..	2/9
4½ volt Pocket Battery 5d. each (4/6 a dozen)	
Single Cell Torch Battery 4d.	

MADE IN ENGLAND

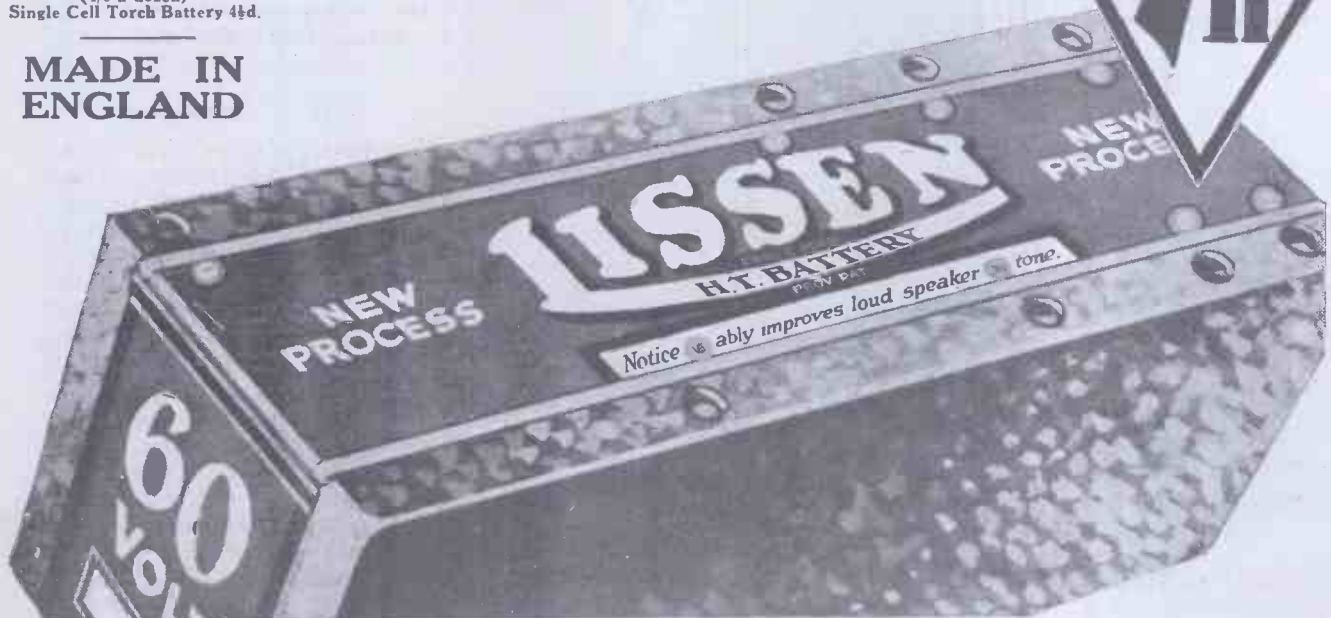

LISSEN LIMITED, WORPLE ROAD, ISLEWORTH, Middlesex. Factories also at Richmond (Surrey) and Edmonton. (Managing Director: T. N. COLE.)

quite worth listening to. Using an outdoor aerial, of course, was like adding at least one H.F. stage, and these stations and several others came in at very good strength.

Easy to Tune

The set was extremely easy to tune, and after a most interesting evening it was stowed away ready for the open-air on the morrow. Saturday, therefore, saw us packing the set away in a car with the usual encumbrances in the way of hampers, and clearing off down to the South Coast for a day in the open.

As luck would have it the weather was not too bad, and, accompanied by our portable, we spent quite an enjoyable day. Reception varied, of course, with the location we were in, and on the South Coast itself naturally 5GB was not particularly loud. 5XX came in very well even though

it was daylight, and the National and the London Regional were at moderate strength.



There is no "extras" need for any everything is contained in the set itself. with a portable ;

There were places, sheltered spots, in which fading was rather troublesome, but the short tour we made with the set showed that it was indeed a business proposition, and that whether at home or in the country one could be sure of radio entertainment. The following day we devoted mainly to listening at home, whenever we wanted any entertainment from the ether, and not once did the "K.B." fail us.

The Circuit Employed

The circuit consists of a screened-grid H.F. followed by a detector of the R.C. type, then an ordinary L.F. valve, and an output valve of the moderate-size power variety.

A useful ivorine tablet for entering up the dial readings and wave-lengths of the stations you wish to make a record of is provided, and is situated above the batteries of the set.

THE DUBILIER D.C. MAINS SET

THIS receiver is designed mainly for use on D.C. It incorporates a screened-grid high-frequency stage, a detector, and a low-frequency amplifying valve.

A special feature about the set is

the care that has been taken in the design to ensure adequate insulation of all parts with which the user of the set is liable to come into contact.

Well Insulated

Not only has the metal panel adequate insulation, but the wave-change switch has also been insulated, so that the possibility of contact with live metal is avoided. The set is absolutely safe to use, and however

unused you may be to operating anything from the mains you need have no fear that anything untoward will happen when you operate the Dubilier D.C. Three.

Provision has also been made in the design of the set so that it can be converted to be suitable for A.C. circuits if required. This is a very useful point, because all the mains in the country are being changed from D.C. to A.C., and eventually there will be one standard "household" voltage of A.C. throughout Great Britain.

A UNIQUE D.C. MAINS RECEIVER



The Dubilier D.C. set has a very handsome appearance. The voltage regulator is not shown in this photograph.

Between the set and the mains is a rather unusual-looking unit, a resistance unit, which contains an electric bulb and a resistance to step-down the voltage of the mains, so that the set can be operated at a correct voltage.

Wide Wave-Range

The wave-change switch allows one to tune from 230-600 metres and from 750 to 2,000 metres as required. Selectivity is good, and this can be increased by careful manipulation of the volume-control knob, which also controls reaction. Results obtained were good, quite a few stations being heard at our laboratory in the heart of London.

Out in the country, however, where conditions are much better, several other stations on the low wave-length were heard quite clearly; and on the long waves, Hilversum, Konigs-wusterhausen, and Eiffel Tower were among those added to the previous bag of 5XX and Radio-Paris.



WELL, bung ho, chaps! Here we all are then, fairly launched into the holiday season and all's well. Are landladies wearing black-beaded dresses as usual—and charging a tanner (6d.) a week for “Use of cruet”? I'll bet they are!

The Scot used sea-salt—like Papa Ghandi—and said that he never took pepper, and that the landlady was all the vinegar he had any use for. “But what about the mustard?” asked Mrs. Perkins. “Eh, wummun!” quoth Sandy. “I ken it's verra hot stuff, and I hae nae need for any after watching yon bathing costumes.”

“In Walked the Boss”

But there! I must not try you with obscure jokes. You are giving your heads a rest for a week or two, and I'll just have to let you down lightly; none of my usual erudite stuff! How's the water?

OBSCURE JOKES



The Scotsman and the landlady.

A day or so ago I was sitting in my corner—where they throw all the old blue-prints and dud panels—hard at it as usual. I was looking at seed catalogues in the hope of getting inspiration—those Latin names sound like “impots” and Mussolini speeches and chemists' prescriptions

—when, lo and behold, who should walk in but the Boss?

That meant something horrid. A stinker, in fact, for when he has to play a particularly nasty card he imagines that he softens the blow by refraining from pressing the button which operates that obscene-voiced buzzer.

“Jones,” he said, “I'm thinking of starting a new feature, and as I can't increase the pay-roll you had better take it on.”

“Any mortal thing except interviewing B.B.C. sopranos,” I replied, at the same time covering the seed-feller's catalogue with “Treatise on the Square Root of Minus One.”

He sat on the corner of my desk, confidential, free and easy. Man to man, as it were.

“The new feature is half a page of criticism of the B.B.C. broadcasts. Snappy, penetrating, brilliant. Scorching, shrivelling—yet constructive. No truckling, no flattery! No vulgar abuse, no idle dismissal of talent! You understand? Turn in the first lot by this day week, and don't wander:

Somewhat Seedy

“Do you like seeds? I see that you do! So do I! Off duty! What do you think of *Sedum purpureum* and *Saxifragum Miss Doodleberry*? Give 'em shade, and plenty of limestone chips, and no manure. Nice room you've got here. Good-morning.”

Thus spake He. Very nice, too, and a fine day for it, I thought, and rang my bell for strong tea.

That night, as the film caption says, I produced the following criticism. I modelled it on the lines followed so consistently by Melborne Mossford, the critic who claims to have invented radio criticism,

“I say! What did you think of jolly little Miss Murcher's song cycle? Pity she called it a ‘thong thycle,’ though. We should like to hear her again, and I expect we shall, don't you? We have heard George Vrilyl play his penny whistle too often.

“The band was good. Talks on Glue have ceased to appeal, as I told the commissionaire at Savoy Hill last month. The commentary on the darts final at the Angel was marred by the comments of a lady near the Saloon Bar entrance. I don't think women should intervene in manly sports.

The Editor “Regrets”

“Dance music up to snuff. Thanks to those who wrote to congratulate me on my criticism of last week's announcer's apology. I quite agree. Rene Ratz was frightfully good. So was Andantia Ankuffs in her ‘Cucumber's Lament’ on the jews-harp. Artie Kite sang the ‘Lost Chord’ feelingly. We don't hear him or it often, do we?”

Conventional dope, I thought, with the hall-mark of a Fleet Street alley all over it. The Editor sent it back;

THOSE TALKS



Talks on Glue have ceased to appeal.

inscribed: “This paper will hold a threepenny piece and a pennorth of chips. Go and get 'em!” Later in the day he had me on the carpet, on the worn patch just aft of the mat, where many a man has drunk deep of the “well of English” most defiled. He told me not to act the goat!

“But it's absolutely the spit of Melborne Mossford's twaddle,” I stammered. “I thought that you admired his pen work.”

“So I do, laddie, so I do! It's the standing joke at the Press Club. But I want real criticism for my periodical.”

The Experienced One

Whereupon I penetrated a certain office and withdrew therefrom an aged and wicked journalist, to whom I fed strong drink for a long period. At the right moment I filled up his glass and sought his counsel.

“Boy,” he said, “I've seen

Another Recruit for the local Halma Club

thousands of critics—absolutely *thah-sands*—and the fat ones with large families and little places at Tooting were not critics at all; they were just —er—blinkin’ tomcats. How nicely they purred! The others were either notorious or starving. Give it to ’em with butter on both sides. This is great stuff, even as the ad. saith. Now help me up and take me back. I’ve two columns to do by ten to-night —hic.”

HE BUZZED!



“Call yourself a journalist?”

I felt that it was hardly fair on the thinking minority as I wrote my second dose thus:

“Truly we are indebted to the B.B.C. and the Slocumbe Co-operative Company’s band for a most delightful treat. The rendering of ‘The Men of Harlech’ reached the summit of artistic talent. My readers will have treasured the memory of the dominant brass *motif*, of course. More, Sir John, please!

Returned Again!

“Can we ever forget dear Margery Miggs in her inimitable burlesque of Mrs. Malaprop? And John Crumbleby’s recital of nursery rhymes must have appealed with unforgettable force to those listeners who have little *olive branches* in the house. The Berkeley Boys are as fresh as ever, whilst the Quarterly Quartette upheld their reputation of first-class warblers.

“The talk on Sewerage threw a new light on a little-known subject, and the chamber music last Wednesday was a revelation of what can be done with a few strings and a Bechstein. Altogether a delightful week, despite the lack of the usual thrill of hearing that one of the engineers has left in order to go into ‘talkies’!”

My manuscript was returned to me with the following words written thereon in blue pencil: “Pour this cheap treacle down your collar and pull

yourself together.” So I tried once more. This time, I decided, I would be myself, and give the blighters the straight tip. It was in this vein:

“The Straight Tip”

“Frankly, there’s far too much female footlery in the programmes for my taste. Only one woman in forty million has a 100 per cent sense of humour, and only five in the whole world can be really funny—consciously and deliberately comical, I mean. Hence you need not expect me to applaud Miss Washy Wann’s imitations of Yorkshire kids at play. It was a forced and lugubrious display. I could sooner laugh at a Dutch cheese.

“Then that man who sang ‘The Trumpeter’! He ought to be indicted as a public nuisance. As for the so-called play, ‘The Crimson Banana’—I never heard such twaddle offered to an adult audience. Who the ass that accepts these clots of balderdash is I do not know. But I reckon that he is the nephew of one of the B.B.C.’s Governors. Otherwise I cannot account for the plays.

“Gwen Bunstroker’s voice is a public scandal. It needs dry-cleaning and a good bran mash. And the young fathead who reads the news ought to have been cancelled out at the age of three. If things in the ether don’t improve—here’s another recruit for the local Halma Club.”

I guessed that this would pull the old boy up in his tracks, and it did. He buzzed for me, and before I could rise from my stool he was in the room.

“Perishing pica! Do you think I want *all* the B.B.C. departments sending delegates demanding apologies? Me—with a double number in hand, and my golf handicap what it is. Call yourself a journalist, eh? More like a sacked policeman with a grievance, *you* are!

Quite Unprintable

“Do you think I could print that poison—I wish I could, Jonesy—you little Lloyd Limehouser, you! Can’t you turn out something arresting—vital—intriguing—er—snappy, without being scurrilous?”

Thus spake he! And thus I wrote in response: “If Kate Kandleberg’s pa didn’t bribe the B.B.C.’s programme man I’m a Dutchman too. As for the Talks recently, I spy the sinister hand of the Left Wing of

the Labour Party. Russian influence is visible in every line, disguised as Scotch folklore.

“Oswald Offerman—German spy, I expect!—ought to be run out of the country instead of being allowed to pollute British ether with his nonsensical, nay, putrid, or, rather, festering, discourses on Milk and Its Uses in the Nursery. If the Government thinks that Clarence Pimberig is a fitting person to broadcast talks on Ribbon and its Romance let them ask Miriam Cohen of Gypsy Hill what he told her on a certain pier at a place not 100 miles from Margate on a certain July evening not a hundred years ago! The serpent!

The Final Failure

“The weather forecast is faked by a Board School boy in the employ of a gang of dope smugglers. But that is another story. I say no more. The clerk in charge of bassoon control at Savoy Hill is said to be clairvoyant and a bigamist. Is that fair to the public? No wonder we are treated to displays like that given by the Cecil Syncopaters!

ESCAPED?



The Doolum Sisters.

“The Doolum Sisters—we let ’em down light because the ‘Downtown and Realtor’s Gazette’ don’t strike feminines—must have escaped from somewhere. They are not cured yet and had better go in again before the ward is filled up.”

“There,” I said, planking the MS. down under the Old Man’s nose, “that’s my last word.”

He read it, took a pinch of snuff, and, with his voice well under control, remarked:

“Jonesy, I see quite plainly that as I can’t afford to increase the staff there will be no critical feature in this outfit. Go and clean the ink-pots!”

My versatility is not appreciated.



PROVES VARLEY QUALITY

Varley have built their name on quality. Quality of materials and manufacture; quality of appearance; above all, quality of performance. Varley's ever-growing factory proves the popularity of Varley All-Electric Sets and Radio-Gramophones. Read what one of many enthusiastic users says of Varley quality:

"The results obtained from this instrument are really remarkable . . . I have no hesitation in recommending it."

You can be proud of Varley quality. Your dealer will demonstrate.

- Varley All-Electric 2-Valve Receivers. List Nos. AP1 (A.C.) and AP2 (D.C.) **16 Gns.**
(Marconi Royalty extra, each 15/-)
- Varley All-Electric 3-Valve Receivers. List Nos. AP3 (A.C.) and AP4 (D.C.) **25 Gns.**
(Marconi Royalty extra, each 20/-)
- Varley Upright Radio-Gramophone, A.C. or D.C. model **39 Gns.**
(Marconi Royalty extra, each 28/-)
- Varley All-Electric Console Radio-Gramophone, A.C. or D.C. model **65 Gns.**
(Marconi Royalty extra, each 40/-)



Advertisement of Oliver Pell Control Ltd., Kingsway House, 103 Kingsway, London, W.C.2. Telephone: Holborn 5303.

FORMO
BY HIRSH, PUGH & CO. LTD.

for all
CONDENSERS

15'6
3'- VERNIER DIAL
3'- .0005 DUAL GANG
3'- CAPS. .0005 .00035 .00025 .00015
3'- DIFFERENTIAL
3'- GOLDEN SQUARE PICCADILLY CIRCUS LONDON
2'9
2'9 CAP. 00015
2'9 CAPS. 0002 0001
MIDGET REACTION
GERRARD 1863.



RADIO IN HUNGARY

HUNGARY in its post-war condition numbers but eight million inhabitants, of which nearly one million live in Budapest, the capital. Budapest is situated more or less in the centre of the country, and thus a broadcasting station in the capital, with sufficient power, can cover practically the whole country.

Unique Studio Features

Budapest has a system of wired broadcasting which is the oldest in the world. The broadcasting company and the wired-wireless company have now amalgamated.

The large studio contains unique features. It is the only European studio which is "first and last" a broadcasting studio, and has not been made to resemble a semi-demi-super-size drawing-room.

The wall at one end is of special artificial marble for obtaining echo-effects, it can be covered or uncovered at will by means of curtains. Right round the studio there are long strips of curtain that can be pulled up or down, can be moved to and fro, or can be turned round their own axis.

The producer is thus enabled to use only part of the studio, to divide it up into smaller squares, to completely damp sound, or to make any sound seem to come from the interior of a large cathedral.

The third unique feature of the Budapest studio, and this is perhaps the most startling, is the fact that the Hungarians have banned the

.....
Unlike most other European countries, Hungary has not a whole chain of broadcasters, but relies on one very efficient centrally placed transmitter, which is here described in detail.

 By A. A. GUILLILAND.

conductor of orchestras, operas, etc., from the studio.

He is enclosed in a glass cage, which permits him to be seen very clearly, although he can only hear what he is conducting via transmitter, receiver, and L.S.

He conducts his orchestra and soloists according to what the listeners

THE BLENDING ROOM AT BUDAPEST

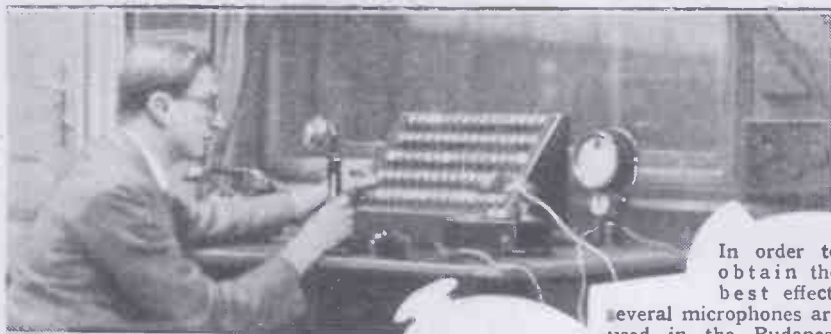

In order to obtain the best effect, several microphones are used in the Budapest studio, and their outputs can be combined as desired.

hear, and not according to what he would hear in the studio.

Conducting for Loud Speakers

That this is the ideal method of conducting broadcast music has been shown quite definitely during the past one and a half years at Budapest, where the most famous Hungarian conductors have conducted in the glass box, and have said that, after all, broadcast music is loud speaker

music and not concert-hall music.

The Hungarian broadcasting company looks after everything that goes on in front of the microphone, but the Post Office engineers are responsible for whatever happens after this. For this reason the control department is divided off from the rest of the building by a swing-door.

The Control Room

The control room contains switching arrangements which permit different microphones and amplifiers to be used prior to the A amplifiers that pass the modulating current out to the transmitter at Lakihegy. The output of the different microphones can be blended at will, and the interval signal brought into circuit if so desired.

The Budapest transmitter was formerly a short distance from the town on the Isle of Csepel. This transmitter is still in existence, and is used should a break down occur at the main transmitting station.

Lakihegy, where the new station is situated, is about ten miles from the town. The transmitter is of the same type and power as the German Langenberg station, but it is proposed considerably to increase its power.

The transmitter is on perfectly level ground, and I was told that the exceptionally good "ground-water" conditions was one of the reasons for the excellent range of the station. It has been regularly received on a crystal-set in Cairo.

Listeners in Hungary pay about 2s. per month for their licences, and the post office keeps the greater part of this.



SET-MAKING *by* MACHINERY

A fascinating article which gives you a clear picture of the internal workings of modern radio set factories.

By H. A. HARTLEY.

THE first consideration in the building of a set is the appearance of the finished article. As a professional radio engineer, I have no particular axe to grind on the subject of home-built sets. But I have seen many hundreds of these in my time and I can say that the vast majority have an appearance which is not suitable for a commercial receiver.

This is no reflection on the abilities of the designs department of this or any other paper, nor on the man who assembles the set, for in each case limitations are imposed by the necessity of using ready-made component parts, and of assembling these parts in a manner which anyone may follow without recourse to machines or elaborate tools.

The manufacturer, on the other hand, especially if he contemplates a large production of one particular model, may create each individual part specially for the design under consideration, and have recourse to processes which are utterly beyond the resources of even the most enthusiastic amateur.

Those Long-Wave Stations

The more technically-minded of my readers may be surprised that I have considered appearance first, but I am convinced that an attractive exterior is the most important quality of a good set. Clothes may, or may not, make the man, but they undoubtedly make the radio set.

The next point is ease of control, and this includes the facility, or otherwise, of changing from medium to long waves. A switch or other equally simple device should perform this operation, and it should be one switch, and not two or three.

The changing of coils cannot be tolerated, firstly because it is a

nuisance, and secondly because a modern broadcast receiver must not have any separate parts which might be lost or damaged.

I know that quite a number of manufacturers would like to see the long-wave stations abolished, for satisfactory wave-range changing is sometimes very difficult to attain, but there are two really important reasons why the long-wave stations should continue to exist.

In the more remote parts of the country 5 X X is the only B.B.C. station which can be received with any degree of reliability, and a change in its wave-length to something under 500 metres would be fatal to listeners

be flooded with cheap American receivers.

Returning to ease of control, there should be no more than two tuning controls, a reaction control, a volume control, and a switch to put the set into or out of operation, in addition to the wave-length switch. This is the maximum permissible, and the fewer controls there are the better.

Assembling Multi-Valvers

Thirdly, the set must be assembled easily by unskilled labour, and permit of easy testing. This is of great importance to the manufacturer.

I am acquainted with one prominent receiver on the market which,

A SCENE IN A LARGE RADIO FACTORY



Hundreds of girls are daily occupied in the assembling of components, the checking of grid-leak resistance values, testing transformers, etc., in this radio factory. (*Pye Radio*).

at present dependent on that station.

The other reason involves the life or death of the radio industry in this country. If there were no long-wave stations in Europe the market would

on the face of it, would be a very tough nut for even a skilful amateur to assemble, yet which, by good design, was assembled satisfactorily by girls whose sole previous experience had

been the filling of jam pots and the packing of safety razor blades. For reasons similar to those given in the consideration of appearance, the amateur-built set is quite unsuitable as a commercial design, owing to the time required to put it together.

Kit sets have been advertised which can be assembled in 90 minutes, whereas an inexpensive commercial receiver may be completely built in as little as ten minutes. Furthermore, the set must work properly as soon as it is finished.

Other Considerations

An apparent paradox arises here, in so far as a designer will often complicate a set to make it simpler; simpler, at any rate, from the point of view of assembly.

Other considerations arise which are not so important. Quality of reproduction is, strange as it may appear, of minor importance.

THE LAST STAGE OF MANUFACTURE

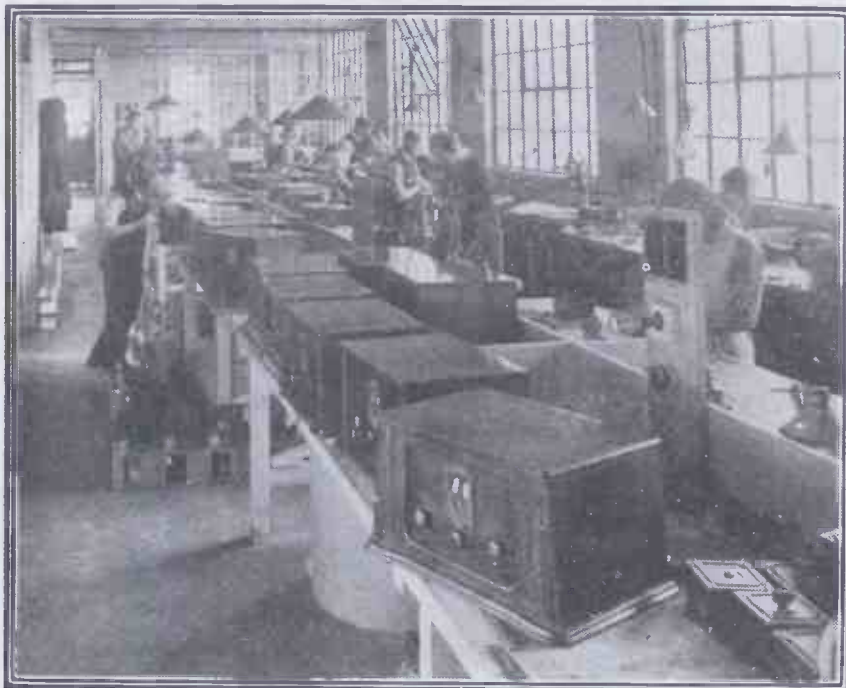

Here we see completed receivers going through their efficiency tests. All reputable firms test their sets very thoroughly before offering them to the public. (Varley.)

The good commercial receiver should possess qualities which the man who "rolls his own" does not worry about. For example, the volume control, which should come before the detector to avoid detector valve overload, should not affect the tuning of the circuit to which it is applied as different degrees of control are used. And the reaction control should be consistent, by which I mean that the same amount of rotation of the reaction knob should be required on any wave-length.

This property, which by no means all sets possess, means that the reaction control can be advanced to the required degree, and the tuning circuits can be adjusted to any particular station, without requiring further adjustment of the reaction.

The average listener cannot get the best out of his set; and delicacy of control of reaction, which makes all the difference to the performance of a set on a distant station, is more than ever emphasised with a poorly designed reaction circuit.

Having outlined the major points of difference between the manufactured and home-constructed sets, I can illustrate one or two of these points by reference to the receivers now on the market; considerations of space do not permit me even to outline the design and development of a complete receiver.

The majority of manufacturers have realised the importance of mak-

them with a more or less artistic escutcheon plate; and in this connection it is curious to note how slavishly the English manufacturer has followed American practice, a noticeable feature of British design during the last five years.

Again, the abolition of multi-stud switches and the provision of suitable insulating materials in the components themselves renders the classic ebonite panel unnecessary. And it is becoming customary for the woodwork of the cabinet itself to act as a panel, if it can be called a panel; for the set is complete in itself, and requires something in front merely for ornamentation.

Ease of Control

Ease of control in a commercial receiver is got in many ways. If it be a three-valve set, two tuning controls are almost essential, as it is well-nigh impossible to gang two tuned circuits and retain efficiency, or, at any rate, enough efficiency to get more than two or three stations at really good loud-speaker strength.

Close matching of inductances and condensers is quite useless, as the capacity of the aerial will upset the tuning of the circuit to which it is coupled.

Stray capacity can be added to the circuit coupling the H.F. valve to the detector, but this calls for a new adjustment for any particular aerial. This would not be tolerated, for sets must leave the factory ready for use. There is the further drawback that capacity added to this circuit, which is sharply tuned by virtue of the use of reaction, will restrict the tuning range.

If more than one H.F. stage be used, then ganging becomes easy, for with an outside aerial two efficient and perfectly screened H.F. stages provide far more amplification than can usefully be employed.

Reaction is not required with two efficient H.F. stages, the difficulty being to avoid unwanted reaction effects through insufficient screening.

Wave-Range Problems

Thus by using two screened-grid valves the reaction control and one tuning control can be dispensed with, and this is becoming the usual practice in better-grade sets.

Wave-range switching has always been a difficult problem, although the screened-grid valve has made matters easier in this respect also. H.F. transformers were invariably used with triodes, and this meant switching both primary and secondary.

ing the exteriors of their sets attractive, and the hideous knob-infested panels of a few years ago are now defunct.

I think I can say that the advent of the screened-grid valve has caused a revolution on the outside as well as in the inside of radio sets, for the increased H.F. amplification available with these valves has resulted in a reduction in the number of controls.

This enables the manufacturer to group his few controls, and surround

TESTS OF TIME

Big Ben stands for...

...reliability and accuracy all the world over. It is a standard by which time itself is judged.

T.C.C. too, is a standard—a standard by which other condensers are judged—a standard of accuracy, reliability and dependability. The letters T.C.C. are an assurance of good service—recommended by experimenters, scientists and amateurs alike—the famous “condenser in the green case.” So, remember this, when next you ask for a condenser.

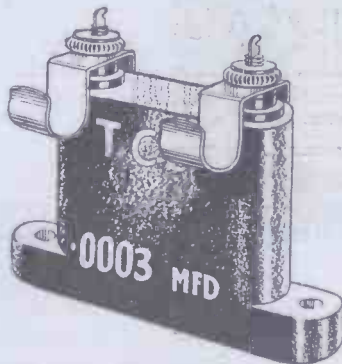

Illustrated above is a .0003 mfd. T.C.C. Upright Type Mica Condenser. Price 1/6 each. Other capacities in this type are made from .0001 mfd. to .25 mfd. Prices 1/6 to 18/-.

BIG BEN

ADVERT. OF THE TELEGRAPH CONDENSER Co. Ltd. N. ACTON, W.3
4979.

Your Portable needs no Batteries now and your accumulator is always

on full charge

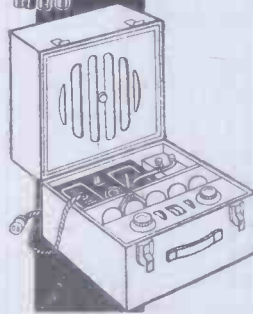
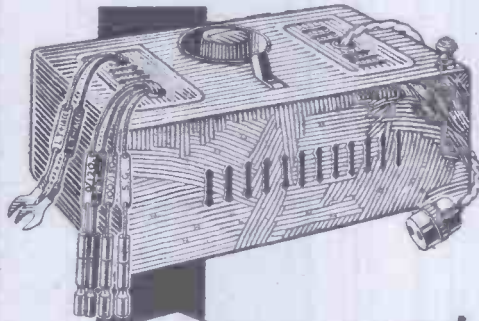

.. and you save 50% of your running costs.

Plug-in — that's all!

Fit the very latest development in All-British All-Electric Radio—THE “EKCO” ALL-POWER UNIT, specially designed to fit snugly in all Portables but also designed for use with any type of set from one to five valves consuming up to 20 m/a.

All you have to do is slip this amazingly efficient Unit into the space previously occupied by your battery—connect your battery and accumulator leads to the “EKCO” Unit terminals—plug the “EKCO” Adaptor into the nearest electric light or power socket, and then, switch-on—that's all. Fitted in less than three minutes.

MODEL C.P.1. for A.C. Mains combines Trickle Charger and H.T. Unit, eliminating batteries and keeping the accumulator fully charged. Tappings: S.G.; 0-120, 120/150 (100 volts only, if required) . . . £6. 0. 0.

MODEL 1V.20 for A.C. mains, eliminating H.T. Batteries only. Tappings: S.G.; 0-120; 120/150 (100 volts only if required) £4. 12. 6.

MODEL 1V.20 for D.C. Mains, eliminating H.T. Battery only. Tappings: S.G.; 0-120; 120/150 volts £2. 10. 0.

Westinghouse Metal Rectifier—flexible output leads and variable tapping in A.C. Models.

Obtainable on Easy Payments. Write for NEW illustrated literature! E. K. Cole Ltd., Dept. M.W. “Ekco” Works, Leigh-on-Sea.



ELECTRIC POWER UNITS FOR ALL PORTABLES — and all other Radio Sets

A Set With No Wires

The tuned-anode coupling, which returned to favour with the arrival of the screened-grid valve, calls for only one coil to be switched, but as it is gradually being realised that transformer coupling is likely to give better results with screened-grid valves also, the problem will remain as difficult as ever.

The usual practice in switching is to connect the short- and long-wave coils in series, when shorting the long-wave section gives the normal wave-range.

Care has to be taken that the long-wave coil is as far out of the field of the short-wave coil as possible, otherwise the efficiency of the circuit on short waves will be seriously impaired. Neat switching of the various circuits is usually accomplished by ganging the various switches and transferring the motion of a suitable knob on the front of the set to this ganged assembly.

Constancy of Reaction

Much mechanical ingenuity has been displayed in one or two examples now on the market. I cannot leave the subject of switching without paying tribute to a four-valve receiver which has short-, medium- and long-wave ranges, and which, as a short-wave set, handles like a normal broadcast receiver.

I have mentioned constancy of reaction as a desirable feature, and this is most easily secured by using the Hartley circuit. This calls for a centre-tapped inductance, and has been adopted, in an ingenious form, by one manufacturer.

Two slab coils, each centre-tapped, are mounted face to face. For reception between 200 and 550 metres the

coils are connected in parallel, including the taps, and for long waves the coils are in series, the original taps ignored, and the connecting link between the two coils constitutes the new centre-tap.

This calls for rather elaborate switching, but the arrangement has the great advantage of compactness, and the coils are practically astatic, that is, the external field of the combined coils is very small, which allows the unit to be mounted fairly closely to screens or other parts of the set.

The adoption of a metal chassis as the foundation of a receiver eliminates a large amount of wiring.

Components are designed, as far as possible, in such a manner that they can be riveted or screwed together, and I recollect examining one German receiver in which there were no wires at all.

Every component was either riveted or eyeleted to some other part, and certain of the eyelets connecting components actually formed the sockets of the valve holders.

Elaborate Testing

Component parts are rigorously tested before the sets are assembled, and as it is almost impossible for the people who do the wiring to go wrong, for it is not usual for one person to do more than two or three operations to any one set, the final test is really little more than a formality.

Where production warrants the provision of an elaborate final test-room, the receivers are never tested on broadcasting at all, but measurements are taken showing the total gain and overall performance, which are much more definite than purely aural tests on the reception of signals.



BRITAIN'S LATEST RADIO STATION

A general view of the new Baldock Post Office station which is being built to carry on 'phone communication with the Antipodes.

When a 4-volt or 6-volt detector valve is to be run as economically as possible, from a 4- or 6-volt battery respectively, a low resistance rheostat can with advantage be incorporated in the filament lead, suitable values for 1 amp. valves being four ohms for the 4-volt valve, and six ohms for the 6-volt type.

The S.G.'s Plate

Normally the "plate" pin of an S.G. valve is connected internally to the screen, which is arranged to nullify the inter-electrode capacity of the valve that was so detrimental to proper H.F. amplification in ordinary three electrode valves.

RADIO REMINDERS

If you use directly heated A.C. valves of the 8 type, remember that the filament voltage should be maintained very accurately, as small variations, even of a fraction of a volt, mean a very large percentage variation in the filament current.

* * *

Owing to the very high magnification provided by screened grid valves and especially those of the A.C. type, it is essential that the circuit should

provide for adequate screening between the input and output circuits of this class of valve.

* * *

When buying a new valve the maker's literature accompanying it should be kept and studied carefully, as it usually embodies some very useful and important hints about the correct method of using the valve.

Grid Bias

The correct grid bias for a valve depends on its circuit, and it may vary widely. For instance, it may be any figure between three volts negative and 1½ volts positive, according to the way the valve is used.

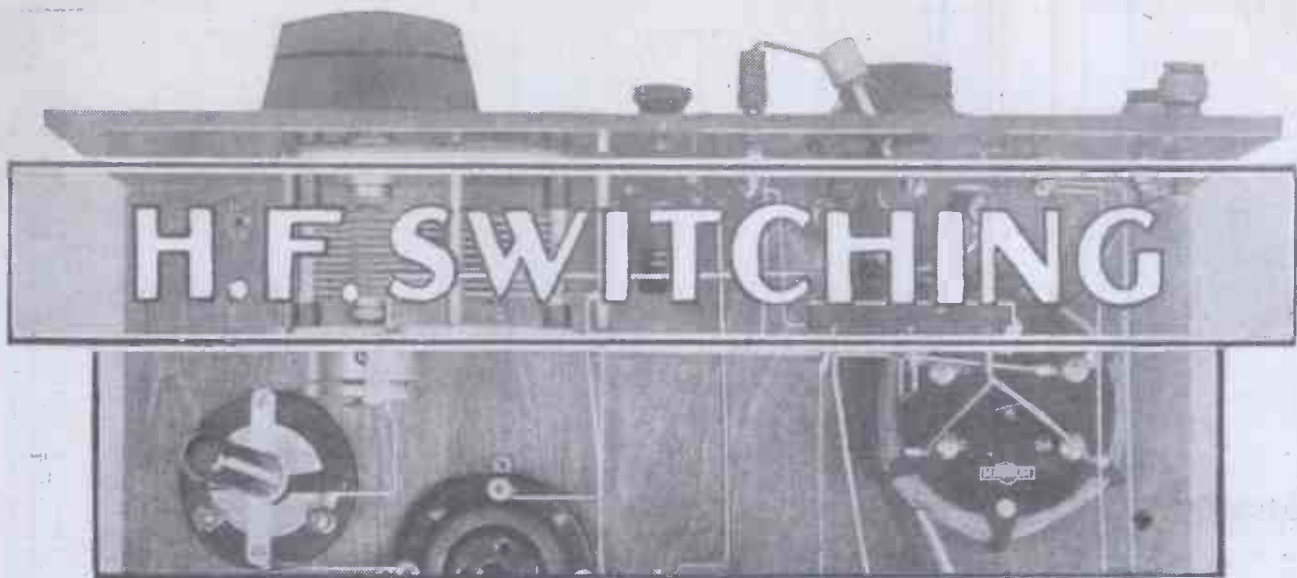

A practical article telling how an H.F. stage can be cut out for local-station listening.

By J. BOSWELL.

THE problem of cutting out the H.F. valve in a receiver is one of the most difficult with which we are faced. The idea of having a switch whereby we can have perhaps one or two H.F. stages or the detector only is very attractive, but in practice it is well-nigh impossible. The modern high-frequency stage is usually designed to give a very high degree of amplification, and because of this the smallest amount of feed-back or interaction makes the circuit become unstable, and therefore uncontrollable.

Take the case of the ordinary split-primary H.F. stage. Here we have a critically adjusted valve which is rendered stable by neutralisation.

Switching Not Practicable

This neutralising is carried out by means of a very small condenser, and in most cases there is only one point where the H.F. valve is stable over the whole wave-band. The split-primary transformer is carefully separated from the aerial circuit with either a screening box or a vertical shield.

Now many listeners would like to be able to have a switch on the panel so that by a simple movement they could cut out the H.F. valve and use the detector circuit only. This sounds very easy in theory, and it would actually be quite simple to draw out a circuit scheme so that one could switch straight over to the detector circuit for the reception of a powerful transmission. The average listener forgets that in order to do this it would be necessary to have wires from both the split-primary transformer

and the aerial coil to the switch on the panel, and therefore all the advantages gained by the use of careful shielding and spacing would be nullified.

Cutting Down Magnification

As a matter of fact, various schemes have been tried and in practice have been found to be quite unsuccessful, instability usually resulting. For this reason one never sees an up-to-date, critically-tuned set which incorporates switching on the H.F. side. To do this it is necessary to cut down the

magnification of the H.F. stage, thus reducing the efficiency of the whole set.

In the old days, when the H.F. valve was more or less a passenger and therefore completely stable, it was to a certain extent possible to switch over from the aerial-grid circuit to the detector-grid circuit.

Another scheme was to turn out the filament of the H.F. valve, the various stray capacities and the inter-electrode capacity of the valve itself being sufficient to bypass the H.F. currents and give fairly good results.

It can be seen that such a scheme

USING AN EXTRA TERMINAL

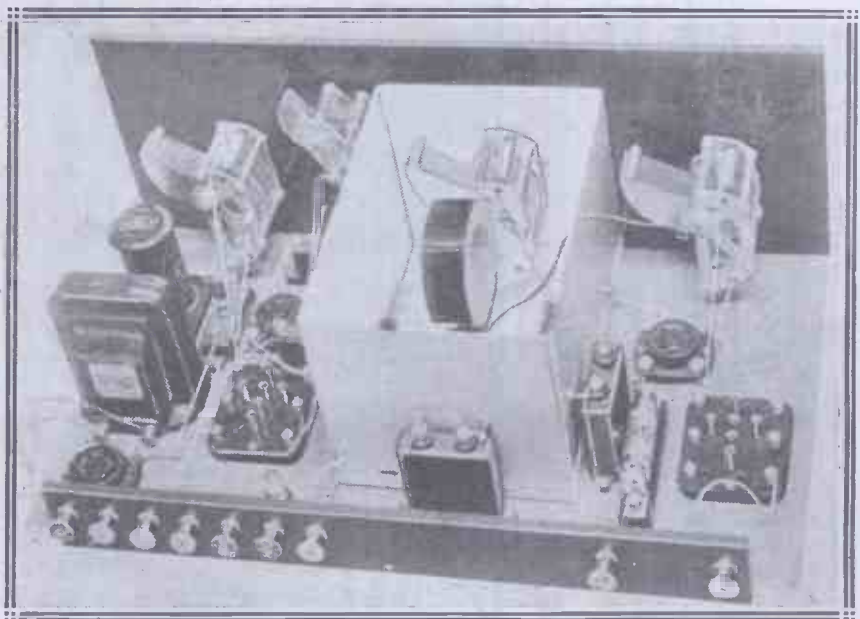

This is the "Olympia" Three—a design which readily lends itself to modification owing to the convenient position of the second six-pin coil base.

Simple "Switching" Without Using a Switch

is not possible with a neutralised or screened-grid valve, and, even if it were, modern circuit design is such that the method would be very inefficient.

A Good Example

There are, however, one or two schemes which readers might try for themselves if they are keen on cutting out the H.F. stage or stages for the reception of the local station. Let us take the case of certain sets that have already appeared in MODERN WIRELESS. We have, for instance, the "Olympia."

This set consisted of a screened-grid H.F. valve followed by a reaction detector and one L.F. stage. Those who care to turn to the description of this receiver will see that the second six-pin base, into which is inserted the split-primary H.F. transformer, is not in a screening box and, moreover, is fairly near the terminal strip at the back of the baseboard.

The Method to Use

The scheme which I suggest is as follows. Take a lead from terminal No. 1 on the six-pin base to one side

joined to the new terminal on the strip the circuit will be through the small condenser to the grid side of the coil L_3 , and with this arrangement it should be possible to get quite good results on the local station.

able and there is no reason why a fairly high degree of sensitivity should not be achieved.

Then, to take another case, we have the "Brookmans" Three. Here again a screen-grid H.F. stage

A SCHEME WORTH TRYING

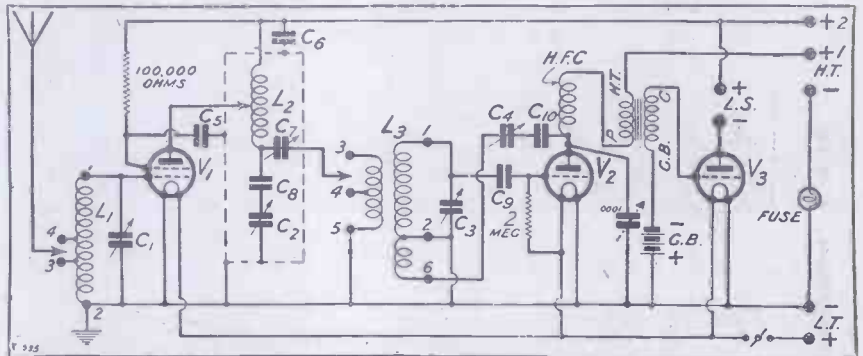

The theoretical arrangement of the "Olympia" Three. The aerial can be removed from L_1 , and taken through a fixed condenser to No. 1 or No. 3 on L.

The alternative method is to make use of the primary winding between terminals 3 and 5. This may be more effective in practice. When it is desired to cut out the H.F. stage the flexible lead which is intended to be used on either terminal 3 or 4 should

of a highly selective type was used, and it will be noticed that the aerial circuit and the detector circuit both make use of standard "X" coils and are therefore of similar type. The best scheme in this case would be to take the aerial lead direct to the bottom end of the coil L_3 , that is, to a point on the lead which joins the pin of the L_3 coil holder to the small neutralising condenser C_8 .

With the suggested schemes the H.F. valve could be used for distant reception only, but in both instances we are faced with the fact that the H.F. valve filament is still alight and the valve is still consuming energy although it is serving no useful purpose.

Switching Out the Filament

To overcome this the positive filament lead to the first valve could be broken and a panel-mounting on-off switch inserted, thus making it possible to switch out the valve filament when necessary.

It is not a difficult matter to deal with the ordinary straightforward neutralised split-primary circuit, since in this case the H.F. valve can be removed from its holder and the aerial lead plugged into the anode socket of the valve holder, thus making connection with terminal 5 on the six-pin base.

Remember, however, that when you attempt to apply this scheme you must insert a fixed condenser in series with the aerial lead as a safeguard against possible short-circuits.

RECEIVE THE LOCAL ON TWO VALVES

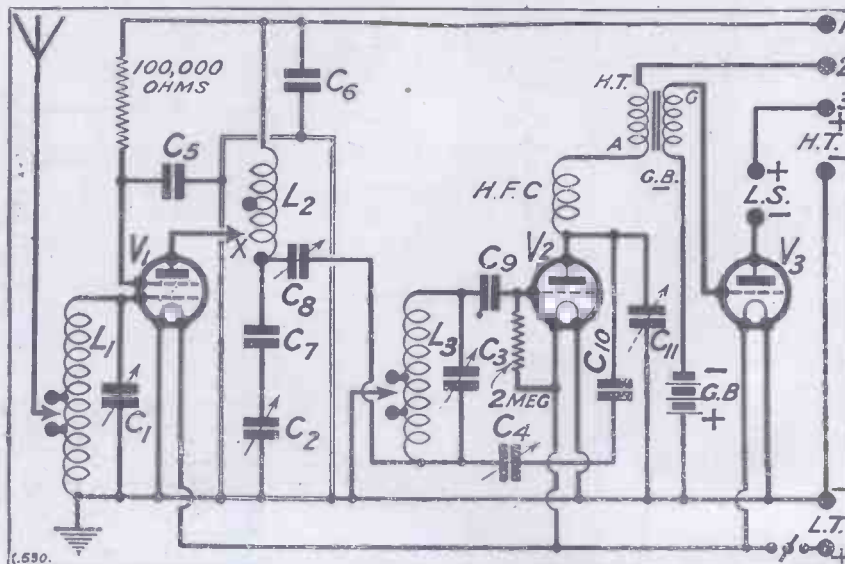

The circuit diagram of the "Brookmans" Three, another receiver that can easily be altered for local listening on the lines indicated.

of a .0001-mfd. fixed condenser. Join the other side of the fixed condenser to a terminal on the terminal strip and let this be aerial terminal 2.

If the aerial lead is removed from the existing aerial terminal and

be removed, and instead the aerial lead should be taken to either of these points.

It is not necessary to interfere with the existing earth connection. With these schemes reaction is still obtain-

Comparison proves Value

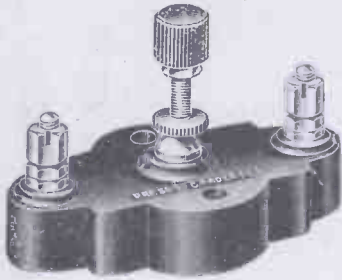

**IGRANIC PRE-SET
CONDENSER**
Price from 2/-

Before you buy another Radio Component, just compare an Igranic component with a competitive article. This comparison will show that the Igranic Radio device has been designed and manufactured to give unfailing dependability. The **QUALITY** is unapproachable, **PERFORMANCE** is unbeatable, and the **FINISH** appeals to every eye.

IGRANIC COMPONENTS ARE KNOWN FOR **QUALITY AND PRECISION, AND ARE GUARANTEED COMPONENTS.**

Have you a copy of the Igranic Radio Catalogue? If not, may we send you one? Write to Dept. J.1052.

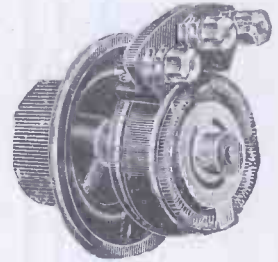

**IGRANIC MEGOSTAT
VOLUME CONTROL**
Price 6/-

149, Queen Victoria Street, LONDON

The New Green Flyer Induction Motor

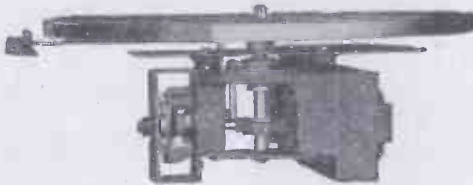

Here at last is a thoroughly dependable induction-type electric gramophone motor that will give you faithful service. There are no brushes or commutators to cause sparking and spoil reproduction. The Green Flyer is used as standard equipment by leading manufacturers and is undoubtedly the motor of the future.

For 110-volt A.C.,	with 10" table	£3 15 0
" 220/240 "	" 10" "	£3 15 0
" 110 "	" 12" "	£3 18 6
" 220/240 "	" 12" "	£3 18 6

Nickel-plated fittings and complete with speed regulator. Write for Bulletin.

The Rothermel Corporation Ltd.
24, Maddox Street, London, W.1.

Phone: MAYFAIR 0578/9.

Continental Sales Office: 27, Quai du Commerce, Brussels, Belgium

Enormous Range

SCREENODION

15/6 The best Screen-Grid in the world.

Bivolt . . .15 amps.
Forvolt .075 amps.

SUPERBLY SELECTIVE.

SUPER HF
5/6

Bivolt . . .15 amps.
Forvolt .075 amps.

Super DETECTOR

6/6 A super-sensitive detector for anode-bend or leaky-grid rectification

Bivolt . . .15 amps.
Forvolt . . .075 amps.

HYPER-POWER.

Bivolt .3 amps.
Forvolt .15 amps.

9/6

Write for Free Folder to
IMPEX ELECTRICAL, LTD.,
Dept. H, 538, High Road,
Leytonstone, London, E.11.

UNIVERSAL RESISTRON 5/6
SUPER POWER 7/6
and the **Super Power PENTODION** 18/6

DARIO VALVES

DARIO L.F. TRANSFORMER.

A little marvel. Guaranteed for two years. Completely shrouded. Perfectly designed and perfectly made.

5-1 or 3-1.

5/6

Best way to all Stations

RADIO BATTERY POINTERS

If you want to run your set economically take care of your batteries... Here are some practical hints that will be of value to all set owners.

By C. E. FIELD, B.Sc.



ONCE a wireless set is made or purchased, if you do not happen to be of an experimental turn of mind little is done in the way of alterations or renewals.

The batteries, however (assuming that the set is a valve receiver employing batteries), do require renewing, sometimes inconveniently often, and there arises the chance either of making a mistake or of spending your money wisely and improving your reception.

For example, if your set is a four-valver it might comprise an H.F. (S.G.) valve, consuming 0.25 amp.; a detector, 0.1 amp.; an L.F. or small power valve, 0.15 amp.; and a super-power valve, 0.4 amp. Adding all these currents together gives a total consumption of 0.9 amp.

Now, the capacity of an accumulator (i.e. the amount of electricity contained in it) is expressed as a certain number of ampere hours, and dividing this figure by 10 gives the maximum current that it is generally advisable to take from the battery.

Thus a 50 ampere-hour battery should not be expected to provide a current of more than 5 amperes, which it will do for a period of approximately 10 hours.

This, however, is a maximum figure, and it would be much better from all points of view to divide the accumulator capacity by 20, giving in the case of the 50 ampere-hour battery a current of 2½ amps., which could be taken for a period of 20 hours, or perhaps a little longer.

Let us return now to the four-valve set with a consumption of 0.9 amp.

A Suitable Accumulator

If we err on the safe side, and call the current 1 ampere, multiplying this figure by 20 gives 20 ampere-hours as the capacity for a suitable accumulator.

Turning now to the high-tension battery, we encounter one of the most important links in the chain of good wireless reception, and here again the correct size of the battery is of the utmost importance.

Except in cases where only head-phone strength is required, a 60-volt battery, costing perhaps 7s. 6d. is *not good enough*, and a battery of 100 or 120 volts should always be employed.

In Fig. 1 you will see illustrated a series of curves which show how the grid swing (which is another way of saying signal strength) that can be handled by a valve increases as the H.T. voltage is increased: curves being given for typical L.F., small power and super-power types of valves.

Capacity of Batteries

A high-tension dry battery is not rated, like an accumulator, according to its capacity in ampere-hours, but the makers usually state the maximum current that should be taken from it.

If you do not know the current taken by your set, the chart given in Fig. 2 will give you a guide as to the

EFFECT OF H.T.

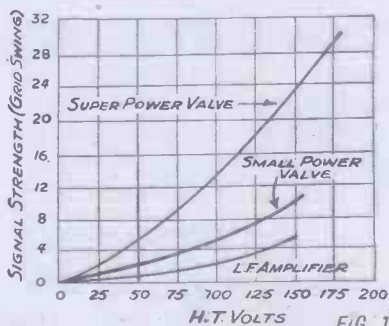

A17/3 Showing how signal-handling capacity increases with increase of H.T.

The results which you obtain from a valve set can be absolutely made or marred by carelessness with regard to batteries.

Take first the case of your low-tension battery.

Here the secrets of success and absence of worry lie in having two accumulators of ample capacity, and keeping them in good condition by regular recharging.

Total Filament Current

When determining what size of battery should be employed, the first step is to find out how much current your receiver takes. This, of course, you do by adding together the currents taken by all your valves.

WHAT YOUR SET TAKES

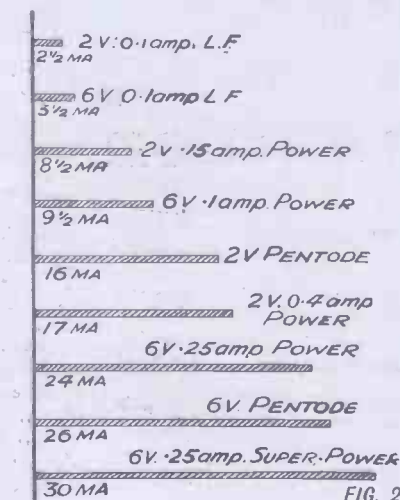
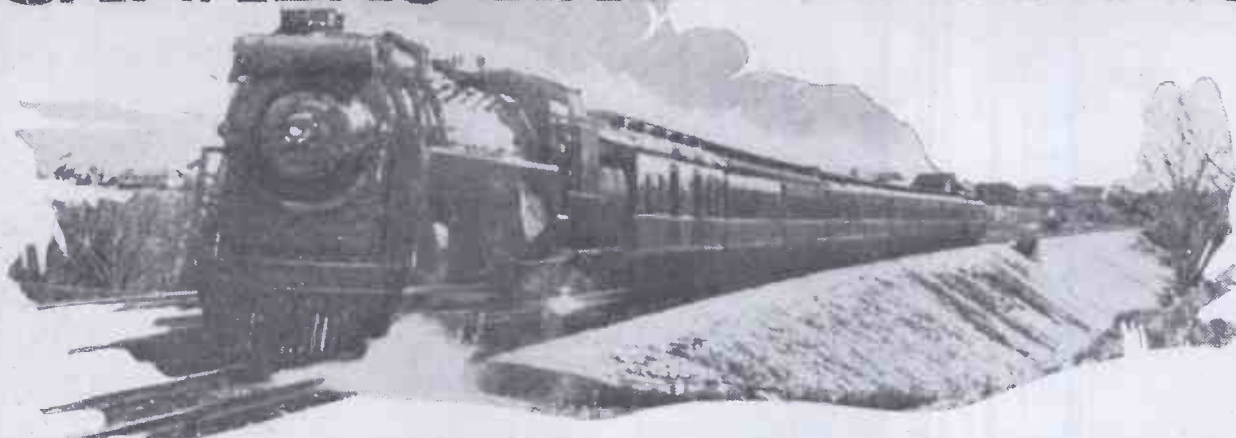

FIG. 2

A useful H.T. current-consumption chart.

requirements of your L.F. and power valves, other valves (detector, ordinary H.F.) taking usually about 1 milliamperes or less. An S.G. valve will take about 3 milliamps when properly biased.

CANADA'S RAILWAY RADIO



A JOURNEY across the Dominion of Canada from Halifax in the East to Vancouver on the Pacific coast occupies four and a half days and nights of continuous travel. That, at any rate, is the time taken for the entire journey by the quickest of the Canadian National Railway's expresses; a journey, one might add, of 3,778 miles.

But even shorter train journeys on the vast Canadian National Railway's system are, compared with the journeys made in England, very long indeed. It is only a matter of a few hours' run from King's Cross to Edinburgh, but many of the express runs which have to be made on the C.N.R. system take a day or more to complete.

It is not surprising, therefore, that the Canadian National Railway's authorities have for some considerable time taken up the question of radio broadcast reception in express trains very seriously indeed. So thoroughly, however, has the matter been dealt with that the C.N.R. may well claim to have now firmly established a railroad radio service second to none in the world in point of efficiency and convenience of operation.

Every C.N.R. railroad car of any

From a Correspondent

Every C.N.R. train of any importance is now equipped with an up-to-date receiving outfit for the benefit of passengers.

importance is now equipped with an up-to-date receiving set, and in order that reception shall be as efficient as possible at all points of the journey the C.N.R. have established, or have entered into broadcasting arrangements with, some sixteen transmitting stations situated in towns from the Atlantic to the Pacific coasts.

Each member of this chain of broadcasting stations has the call-sign "C N R," and many of them have

been picked up from time to time by English amateurs.

The Receiving Outfit

Many types of receiving aerial have been experimented with by the C.N.R. radio experts, but for general use it has been found that a closed loop of about 200 ft. of stranded aerial wire, carefully insulated from the top of the railroad car, provides the most efficient collector of radio energy. The lead-in is taken off this aerial loop at any convenient point, and it enters the car through a rubber-lined U-shaped, piece of copper tubing.

The receiver is usually situated in the "library" car of the train, although from this point the set is often wired up to other portions of the train.

The receiver itself—which, of course, throughout the journey is always in charge of a fully trained radio attendant—is of a compact and "built-in" type, and, naturally enough, it is of a design specially elaborated for the rather severe conditions under which it must necessarily operate.

Housed in an ornamental cabinet, the receiver embodies five H.F., detector, and two L.F. stages. The valves

WHILING AWAY A LONG JOURNEY



A radio-gram outfit in operation on a Canadian National Railway express

Very Popular with Long-Distance Travellers

are of the A.C. indirectly-heated type, the necessary current being derived from a rotary converter mounted in a compartment under the car and driven from the direct-current lighting supply of the train.

This converter delivers up a supply of 100 watts of A.C. power at 60 cycles, 110 volts.

Moving-Coil Speakers

Not only does the converter supply A.C. current to operate the valves, but it also energises the moving-coil loud speakers with which the set is provided.

There are some regions of Canada through which the C.N.R. expresses pass in which it is difficult to obtain any satisfactory reception at all. The regions of the Canadian Rockies, for instance, render the railroad reception of radio very unreliable.

To combat this difficulty, therefore, the C.N.R. expresses are equipped with radio-gram sets, which are so wired up with the main broadcast receiver that the change-over from radio to gramophone record programmes can be made by the attendant at a second or two's notice.

Fifty 'Phones

The C.N.R. library, observation, and club cars are permanently wired up for headphones; some fifty of these instruments and points for their plugging-in being included in the equipment of each radio train. At the end of the journey each headset is collected, cleaned and disinfected before being put back in the car for further use.

The output from the receiving

set or radio-gramophone is fed through a special control panel, which not only provides for a reduction or increase of signal volume if required, but also enables the loud speakers of any section of the 'phone circuits to be switched on or off as desired.

The 'phone circuit of the railroad car, it ought to be mentioned, is arranged in a series-parallel grouping made up in the form of a bridge. In the event of any possible short-circuit at any one of the 'phone

points the trouble can be localised immediately and remedied without interfering with the reception obtained at the other points of the distribution circuit.

A Popular Service

The earthing arrangements of these C.N.R. radio sets have caused some difficulty, but the present practice is to earth the set on to the steam and water pipes of the car and to weld these latter at suitable points on to the steel frame of the car.

The radio cars of the Canadian National Railways have proved very popular with long-distance travellers. The radio service is, of course, entirely free to passengers, and, generally speaking, radio or radio-gram entertainment is available, at least by headphone, to any passenger at any period of the day or night.

THE INVISIBLE TRAIL



Admiral Byrd, the explorer, makes great use of radio in his expeditions. Here you see one of his portable direction-finders being used in the Antarctic.

YOUR MAINS UNIT

It should not be assumed that variations in the voltage output of a rectifying valve can be made by dimming the filament, as often the manufacturers specifically state that this should under no circumstances be done.

A high resistance in series with the output, or tappings of the transformer secondary, are usually the methods recommended by the makers for variations in the output voltage of a rectifying valve, which should not be run at a reduced filament voltage for this purpose.

Directly-heated A.C. mains valves use a very thick filament which is supplied through a suitable step-down transformer with current from the lighting mains.

The current-voltage requirements for directly-heated A.C. valves are such that the filaments do not respond quickly to changes in temperature, and therefore unsmoothed alternating currents can be used to heat them.

Different Principle

The indirectly-heated A.C. mains valves work on a principle entirely different from A.C. mains valves that are directly heated.

VALVE HINTS

When a two-volt valve is to be run from a two-volt battery at slightly below its recommended rating, a suitable rheostat value to use is two ohms.

Many R.C., H.F., and detector valves will work satisfactorily and economically at a filament voltage somewhat below the figures given by the makers.

When using a pentode valve re-

member that the greatest care should be taken not to open the plate circuit whilst the filament and H.T. voltages are "on."

If your grid-bias plugs are joined up to more than 1½ volts or so they should not be altered when the filament is on.

G.B. Adjustment

With very large power valves the negative grid-bias values given by the makers are usually only intended as a guide, the final figure being decided by the bias necessary to give the requisite anode current as measured by a milliammeter.

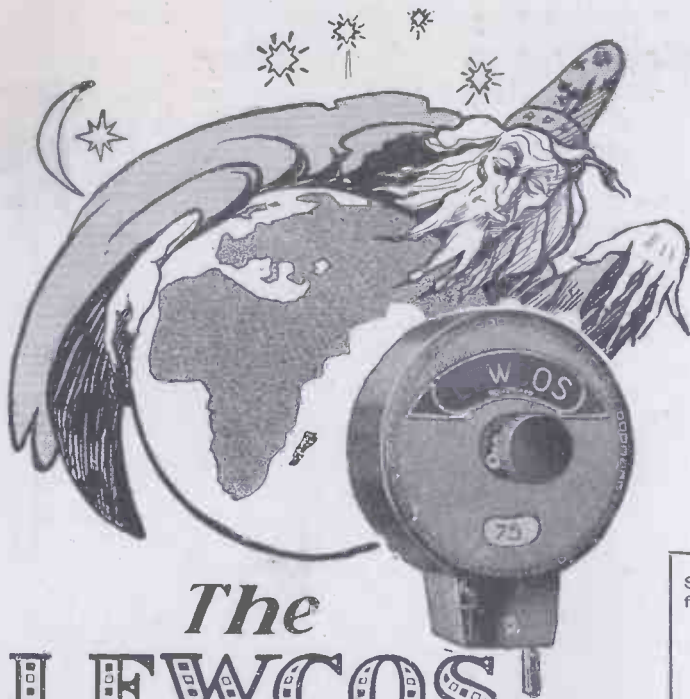

The LEWCOS Centre Tapped COIL

A WIZARD IN EFFECT!

Lewcos Centre Tapped Coils, as illustrated below, are specially constructed to deal with the problem of selectivity; they are Litz-wound and have an extraordinarily low H.F. resistance. The effect of fitting Lewcos Centre Tapped Coils to your set is verily magical!

A fully descriptive leaflet, Ref. R.34, will be sent on request.

The Lewcos Centre Tapped Coil is suitable for the "STAR-TURN" FOUR

Stocks held at the following Branches:

- BELFAST
- BIRMINGHAM
- CARDIFF
- DUBLIN
- GLASGOW
- LEEDS
- LIVERPOOL
- LONDON
- MANCHESTER
- NEWCASTLE
- NOTTINGHAM

THE LONDON ELECTRIC WIRE COMPANY AND SMITHS LIMITED, Church Road, Leyton, London, E.10.



Don't 'accumulate' batteries

A receiver no longer requires attendant batteries for its power. A mains unit is more reliable, more efficient. Build one to-day with



POWER TRANSFORMERS

F. C. HEAYBERD & CO., 10, Finsbury Street, E.C.2. Telephone: Clerkenwell 7216

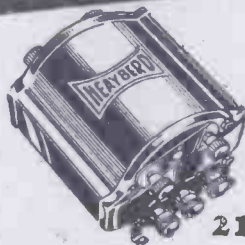

21/-

TYPE W.14.

For all A.C. Mains, 100/250 volts, 50 cycles. Special models for 25 cycles 25% extra.

W.B.

for VALVE HOLDERS of every type



Leading valve manufacturers test with them; popular set makers build with them.

- Universal Type (for vertical or horizontal mounting) .. 1/3
- 5-pin Type for A.C. Valves (as illustrated) .. 1/3
- Anti-phonetic Type .. 1/3
- Rigid Type, with terminals 1/-; without terminals .. 9d.

1/3

WHITELEY, BONEHAM & CO., LTD., Nottingham Road, Mansfield, Notts. Phone: Mansfield 762. Grams: "Whiteley Mansfield." London Office: 21, Bartlett's Buildings, E.C.4.

POWER FOR YOUR SET

- There will be a special supplement in the August issue of "Modern Wireless" devoted to this vital subject.
- The efficient working and economical and trouble-free operation of a set depend more upon the power supply than any other factor.
- Special illustrated articles dealing with H.T. batteries and mains units, L.T. supplies, G.B. and Chargers appear in this special issue of "Modern Wireless," and no radio enthusiast should miss reading them.

Price 1/-, as Usual. Order Your Copy Now.



for PORTABLE and TRANSPORTABLE CABINETS

Model illustrated is the "Favourite."

48/- 52/6
Oak Mahogany

Carrington Manufacturing Co. Ltd., 24, Hatton Garden, London, E.C.1.

Holborn 8202.

Factory: Camco Works, S. Croydon.

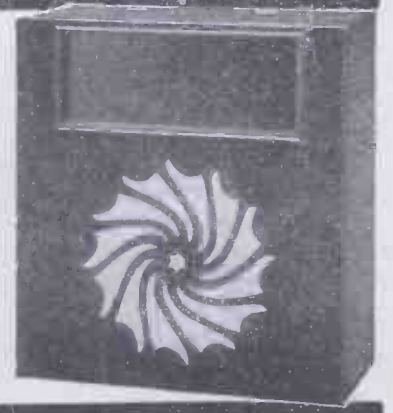

RADIO NOTES and NEWS of the MONTH



That Surplus!

There has been a lot of talk lately in the papers about a State theatre maintained by a grant of £100,000 a year by the Government. This £100,000, by the way, it is suggested should come from the surplus licence revenue now held by the Postmaster-General. Altogether, this sum totals at the moment about £300,000.

The next thing they will ask the B.B.C. to do is to subscribe to the Charing Cross bridge!

We feel that a good many people will join with us in suggesting that this £300,000 should be given back to the B.B.C. for the improvement of broadcasting, which is what it was originally intended for.

The Radio Van

As a result of the visit of the Post Office "Radio Detective" Van to the Tyneside area nearly 2,000 radio pirates have capitulated. This van certainly seems to be working wonders in those areas where listeners have been a little tardy in taking out licences.

A Doubtful Distinction

Nevertheless, Newcastle still has the doubtful distinction of having the smallest average number of licensed listeners per thousand in the country. The figure, to be exact, is forty-five per thousand.

Radio Medicine

The latest news from America indicates that wireless may be used as a curative agent. A description has

reached this country of a new device (according to the "Evening Star") which produces an artificial fever in the human body. The apparatus is similar to a radio transmitter, but includes a tube which produces an oscillating current. This current is concentrated between two condenser plates, and the human body to be heated is placed between them.

Rough on Germs

It is stated that the value of the apparatus lies in the fact that certain germs cannot withstand the fever temperature of the body, and this new method is said to be more efficacious in certain diseases than the injection of serums, etc.

An Important Point

A very important legal decision was passed in Paris a few days ago concerning the rival claims of French and American firms to exploit and sell a certain type of coil.

Concerning this coil, an American firm tried to obtain patents in the United States in January, 1919, and in France in December, 1919. The French Company applied for the patent for the same coil in France in March, 1919.

(Continued on page 92.)



A New Magnum Product! WIRE-WOUND POTENTIOMETERS

In following values: 5,000, 10,000, 25,000 and 50,000 ohms. Will carry 10 m.a. Supplied also as plain resistances in the same values and price.

PRICE 7/6 EACH

CONSTRUCTIONAL KITS. We specialise in the "Star-Turn" Four, "Reactive" Two, "Star-Turn" Crystal Set, and all apparatus described in "Modern Wireless." Full particulars, including an interesting list of leading Short-Wave Stations, Free on request.

BURNE-JONES & CO., LTD.,

"MAGNUM" HOUSE, 296, BOROUGH HIGH STREET, LONDON, S.E.1.
Telephone: HOP 6257 & 6258.

MAGNUM SHORT-WAVE CONVERTOR

Readily converts your present set into a highly efficient Short-Wave Receiver.

PRICE
£3:15:0

"Wireless World" (June 4th) test report and full particulars on request.

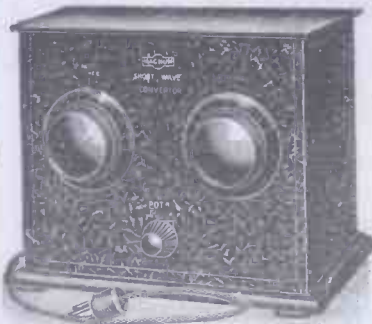

The BENJAMIN Turntable with folding legs is unique

A NEW ball-bearing turntable combining several new features, folding legs, which can be opened out for outdoor use, considerably reducing capacity of set to earth, and folded up for indoor use. Fitted with rubber buffers—preventing damage to the polished receiver or article on which the receiver is placed. The smooth running ball bearings make "direction finding" easy.

Price 7/6 complete.

Write for illustrated leaflets on all Benjamin radio products.

Buy

BENJAMIN

and buy the Best!

THE BENJAMIN ELECTRIC LTD.
BRANTWOOD WORKS, TOTTENHAM, N.17

Successful reproduction

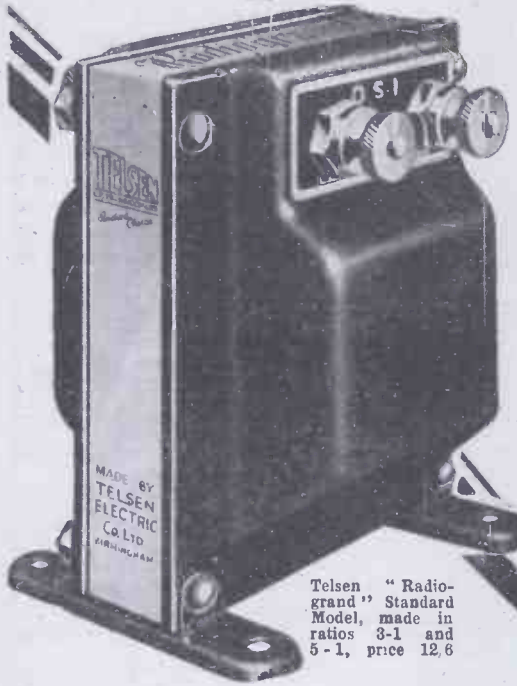

Telsens "Radio-grand" Standard Model, made in ratios 3-1 and 5-1, price 12/6

Telsens Transformers are instruments of magnificent quality, giving ample power and an amazingly faithful reproduction of the original performance.

Remember, no component is apt to make or mar the quality of your reception more than the transformer. Therefore, wherever an "L.F." Transformer is specified you can with confidence fit a Telsens. Successful reproduction is then assured.

Advt. Telsens Electric Co., Limited, Birmingham.

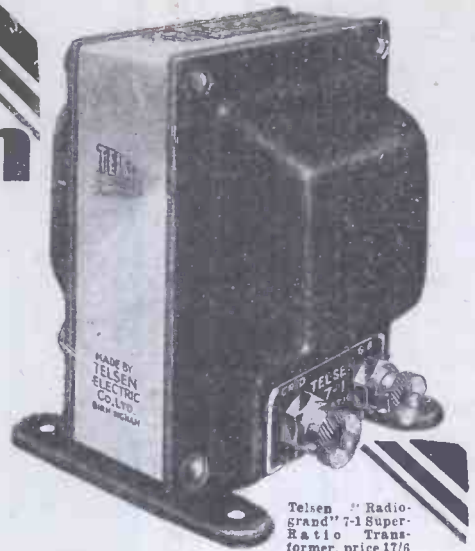

Telsens "Radio-grand" 7-1 Super-Ratio Transformer, price 17/6

TELSEN

TRANSFORMERS

A most unusual murder mystery—

"GREEN EYE"

by

Hulbert Footner

Here's a most unusual and amazing murder mystery—a long complete story of crime, intrigue and love—a story by the author of many famous and thrilling novels—a story to grip you from beginning to end. There are many other grand features in the JULY issue of

CASSELL'S

For JULY

Now on Sale - 1/-

MAGAZINE

RADIO NOTES AND NEWS OF THE MONTH
—continued from page 90

The question was whether the American firm had the right under the Washington Convention to assume that the priority of its American patent held good in France, or whether it should be considered that this was anticipated in France by the March patent.

The decision was given in favour of the French patentees, and it is reckoned that this will affect sales of £160,000 a year for this particular type of coil.

His Little Task!

According to the "Evening Standard," the S.O.S. official at the B.B.C. sits in a room all day at Savoy Hill with a telephone book, Lloyds' Register, a medical directory, and a list of police-stations in front of him.

This seems a cheerful sort of task, but he is the man who has to decide what is, and what is not, to be regarded as a legitimate S.O.S. message.

A Curious SOS

This official must have some very funny requests put to him from time to time. Lost dogs, umbrellas and other odds and ends are often put before him as suitable subject matter for S.O.S. calls.

One of the most curious cases was a man who installed a set and, twenty-four hours later, heard his name called in an S.O.S. message to visit a stricken relative.

B.B.C.'s Orchestra

The B.B.C. has decided on the formation of a large new permanent orchestra of 112 or 114 players, which is to be the best in England. In due course concerts are to be given every Wednesday next season at the Queen's Hall. Dr. Adrian Boult, the B.B.C.'s new Musical Director, stated recently that the new orchestra is intended to be of a national character, and will be, in fact, the permanent enlarged form of the experimental orchestra of 98 players which was formed about a year ago.

The Promenade Season

To some extent this new orchestra will "overlap" Sir Henry Wood's Queen's Hall Orchestra, as some of

the players will belong to both, but it is pointed out that it will be distinct from the London Symphony Orchestra.

This new orchestra will be heard in the Promenade Season at the Queen's Hall for the first time on Saturday, August 9th, and it is the aim of the B.B.C. that it should be the best in England, and certainly equal to any other orchestra in Europe.

For the Blind

We understand that the B.B.C. has sent a cheque for £100 to the British Wireless for the Blind Fund, following the controversy of the broadcasting of the Cup Final.

Still Selling Fast

The Postmaster-General recently stated in the House of Commons that 3,117,000 wireless receiving licences were in force on April 30th last.

Difficult Relay

Miss Amy Johnson's broadcast was rather a triumph for the B.B.C., for although she only spoke for about three minutes, the relay was a difficult one, and in all a distance of 12,000 miles was covered by her voice.

(Continued on page 94.)



It would be FATAL to lose CONTROL

Write for free Booklet, "Volume Controls, Voltage Controls, their uses."

Barbed wire—trenches—du-rout—s—a field set and a thin strand of wire.

The difference between control and lack of control may spell life or death to an entire brigade.

It's a far cry from No Man's Land to the comforts of your home

But even in your radio set . . . control plays a vital part . . . and it has been the privilege of CENTRALAB to furnish the volume controls of millions of radio receivers.

Is your radio—CENTRALAB equipped?



Centralab

The Rothermel Corporation, Limited, 24, MADDOX STREET, LONDON, W.1.

'Phone: MAYFAIR 0578/9

Continental Sales Office: 27, Quai du Commerce, Brussels, Belgium.

WEARITE COMPONENTS

Modern Coils for Modern Circuits.

- Tapped Coil with Selector Switch 12/6
- Coupling Coil Unit 5/-
- Or per pair 17/6
- H.F. Choke, 10-2,000 metres 6/6
- Potentiometers 2/6
- Volume Controls 4/-
- H.F. By-pass Unit 5/-
- Standard 6" x 6" x 6 1/2" Screening Box (in heavy-gauge aluminium), Grey finish, 6/6
- Polished finish 7/6

Mains Transformer for "Orgola" H.T. Supply Unit 30/-

Paxolin Panels and Formers. L.F. Choke, 20-henry 21/-

Write for free illustrated lists.

WRIGHT & WEAIRE, LTD., 74D, HIGH ROAD, TOTTENHAM, N.17.

'Phone: TOTTENHAM 3947/8.

TWO NEW BOOKS for the HOME CONSTRUCTOR

Sets for Every Purpose and Every Pocket

6^{d.}



"BESTWAY" BOOK No. 367

Contains complete constructional details of the following inexpensive and easy-to-build receivers. All have passed the most exacting tests before being published.

A ONE-VALVER

Of novel construction, using a home-made cabinet and plug-in coils. Covers ordinary and long waves

A TWO-VALVE ALL-WAVE-LENGTH SET (Det. and L.F.)

Capable of loud-speaker results under good conditions on both short and long waves. Uses standard parts and plug-in coils. Easy to operate

THREE-VALVE RADIOGRAM RECEIVER

Circuit is Det. and 2 L.F. Very selective and gives high quality reproduction either of radio or of gramophone records.

FOUR-VALVE "POUND-PER-STAGE" SET

Costing about £4. Uses home-made coils. Circuit employed being H.F., Det., and 2 L.F. Highly selective.

"BESTWAY" BOOK No. 368

These Super sets are for MODERN CONDITIONS and will enable constructors to take full advantage of the dual programmes under the Regional Scheme.

A SUPER-SELECTIVE ONE-VALVE SET

For ordinary and long waves. Easy wave-change and very simple operation. Includes the famous "Brookmans Rejector" to cut out interference.

A TWO-VALVER (Det. and L.F.)

For all waves including short. Special wave-change switch enables wave-range to be altered without changing coils.

An UP-TO-DATE THREE-VALVER

Using S.G., Det. and Pentode. Highly selective; employs plug-in coils and has volume control and switch for the reproduction of radio or gramophone records.

An "ALL-FROM-THE-MAINS" FOUR

A powerful set for A.C. mains, which comprises H.F., Det., and 2 L.F. stages with the special new A.C. Valves. Covers long and ordinary waves and is very easy to operate.



6^{d.} each from all Newsagents and Booksellers everywhere, or 7^{d.} post free (Home or Abroad), from "Best Way," 291a, Oxford Street, London, W.1.

"STAR-TURN" FOUR

PRICE LIST OF ALL THE CORRECT PARTS

	£	s.	d.
1 Drilled ebonite panel 24 x 8		9	0
1 Hand-polished oak cabinet, with 10-in. baseboard	2	10	0
2 Ready Radio .0005 variable condensers		9	0
2 Igranite Indigraph slow-motion dials	12	0	0
1 Polar Volcon condenser, .0001		5	6
2 Ready Radio on-off switches		1	8
1 Wearite 3-pole change-over switch		4	0
1 Wearite rheostat		1	6
1 Ready Radio special tapped selector coil with switch		17	6
1 Ready Radio special tuning and coupling coil unit			
4 Benjamin valve holders		6	0
4 Ready Radio single-coil holders		3	4
2 Dubilier 1-mfd. condensers		5	0
2 Lissen .001-mfd. fixed condensers		2	0
1 Lissen .0003-mfd. fixed condenser		1	0
1 Lissen .01-mfd. fixed condenser		2	0
1 Formodenser, type "J"		2	0
1 Varley H.F. choke		9	6
1 Keystone H.F. choke		5	0
2 Dubilier 2-meg. grid leak and holders		7	0
1 Ready Radio 100,000-ohm wire-wound anode resistance, with holder		8	6
1 Lissen Super L.F. transformer		19	0
1 Pair Ready Radio panel brackets		10	0
1 Ready Radio "M.W." standard screen		2	0
1 Terminal strip, 24 x 2		3	0
11 Belling-Loe terminals		5	6
1 Set Ready Radio non-soldering insulated connecting links		4	0
1 Lewcos 250X coil		6	6
1 Lewcos 250 plain coil		4	6
1 Lewcos 100 coil		4	6
1 Lewcos 60 C.T. coil		3	6
4 Mullard valves as specified		2	16
Screws, flex, grid bias plugs, etc.		1	5
TOTAL (including valves), etc.	£13	12	3

Any of the above components can be supplied separately if required.

KIT A less valves and cabinet **£8 : 6 : 3**
or 12 equal monthly payments of 15/3

KIT B with valves less cabinet **£11 : 2 : 3**
or 12 equal monthly payments of 20/6.

KIT C with valves and cabinet **£13 : 12 : 3**
or 12 equal monthly payments of 25/-

READY RADIO

"STAR TURN" SELECTOR COIL

WITH SWITCH, READY FOR MOUNTING.

As specified for the "Star Turn" Three, the "Star Turn" Two and the "Star Turn" Four **12/6**

READY RADIO IMMEDIATE DESPATCH SERVICE.

TO INLAND CUSTOMERS. Your goods are despatched post free or carriage paid, cash with order. If desired you can avail yourself of the C.O.D. system on orders over 5/-.

TO OVERSEAS CUSTOMERS. All your goods are very carefully packed for export and insured, all charges forward.

Write, Wire or 'Phone

1930 Illustrated Catalogue, Post Free, 1/-.

Ready Radio

159, BOROUGH HIGH STREET,
LONDON BRIDGE, LONDON, S.E.1
Telephone HOP 5555 (Private Exchange).

RADIO NOTES AND NEWS OF THE MONTH

—continued from page 92

Only for an instant did the reception fade, and from reports received it seems that not one listener really lost the sense of her remarks.

Brighton's Orchestra

Brighton is very offended because the B.B.C. has refused to broadcast its Municipal Orchestra. A deputation was sent to Sir John Reith, the Director-General, and he assured them that the matter would be looked into. But the residents of Brighton are by no means satisfied, and they demand that Dr. Boulton shall come down to Brighton and hear the orchestra himself.

The Cause of Complaint

The Director of the Brighton Municipal Orchestra and many of his musicians say that they feel offended

Mr. Lewis for London

The B.B.C. has transferred Mr. Joseph Lewis, the Musical Director of the Birmingham Studio Orchestra, to London.

This change has caused a good deal of regret in the Birmingham area, for Mr. Lewis has always been regarded as the inspiration of the Birmingham Studio Orchestra.

Mr. Lewis will take up his new duties in September.

Programmes from Belgium

According to the "Daily Express," remarkable developments in international broadcasting are foreshadowed by the fact that in about eight weeks' time two high-power stations, which will be heard easily in all parts of the British Isles, will be opened near Louvain, in Belgium, and will broadcast British programmes.

For British Listeners

One of these stations belongs to Radio-Belgique Corporation, and the

TESTED AND GUARANTEED!

All "M.W." Sets are thoroughly tested before being passed for description.

ALSO, DON'T FORGET THE

"MODERN WIRELESS" BLUEPRINTS

- "M.W." Blueprint No. 2. "A High-Power" Five.
- " " No. 3. The "Switch-Over" One-Valver.
- " " No. 4. The "Titan" Two.
- " " No. 5. The "Full-Tone" Two-Stage Amplifier.
- " " No. 6. A "Simple-Change" Three.
- " " No. 7. An "Every-Purpose" Three.
- " " No. 8. The "Simple-Screen" Four.

Obtainable from the Technical Queries Dept., MODERN WIRELESS, the Fleetway House, Farringdon Street, London, E.C.4.

Price 6d. per Blueprint.

A stamped addressed envelope should be sent with your application.

by Savoy Hill because an engineer was sent to hear them play instead of a competent critic. Sir Henry Wood, Sir Thomas Beecham, and other famous conductors who have conducted the orchestra in the past have expressed satisfaction with it.

Picture Radio

The "Evening World" announced recently its intention to transmit by wireless complete newspaper pages, at the rate of a quarter of a page at a time, for the benefit of the National Radio Convention meeting in Atlantic City. This is the first time that a complete newspaper page has been dealt with in this manner.

other to the Flemish Catholic party. Both stations will be heard in the Southern Counties better than 5 G B, and they will broadcast regular programmes for British listeners. English orchestras, singers and concert parties will broadcast, and it is hoped to engage the services of some of the famous announcers of the past, including Rex Palmer, Arthur Burrows, Cecil Lewis and Eric Dunstan.

A Spare-Time Job!

This Continental enterprise is said to be the work of British enthusiasts, who founded the organisation in their spare time and at their own expense.

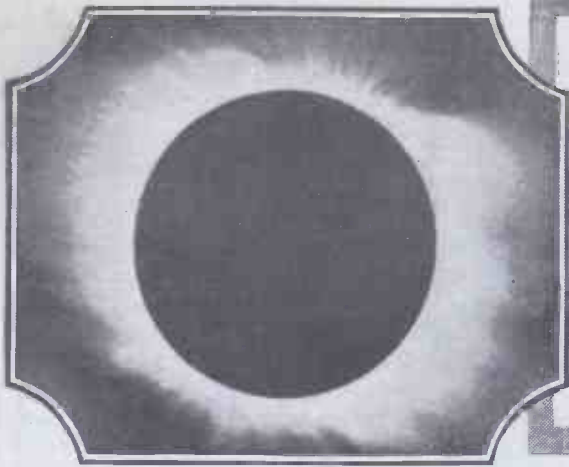

ENERGY FROM THE SUN

It can be calculated that there are (in round numbers) approximately 9,000 horse-power of energy per day being radiated from each square foot of the sun's surface.

Now, the sun has a mean diameter of 865,000 miles, so that the number of square feet of its surface must, when worked out, attain a colossal figure.

Thousands of Horse-Power

Of course, the earth itself only receives a very small proportion of the total amount of energy radiated by the sun. But even when we take into account the northern latitude and climate of England, and also allow for the fact that much of the sun's energy is absorbed by the atmosphere before it reaches the ground, it can be estimated that the average amount of solar energy falling upon one acre of land in England during the daytime is more than 1,000 horse-power.

As matters stand at the present time, most of this energy is simply absorbed by the ground. If, however, it were only possible to devise some method by means of which the radiant energy from the sun could be made to do useful work, the material benefits derived would be very great.

Glimpse of the Future

Indeed, under these conditions the entire face of industry would be changed. Smoke and grime would be things of the past, cheap and abundant supplies of lighting, heating, and motive energy would be available to everyone, whilst large factories and industrial concerns would run their machinery on the energy supply derived from energy-collectors situated upon their roofs.

Such prognostications are by no means fantastical. Indeed, some attempts at collecting energy direct

By J. F. CORRIGAN, M.Sc., A.I.C., who says that the radio and electrical genius who solves the problems of harnessing this power will prove a benefactor to the whole of mankind.

from the sun have been made in past times. Some years ago, for instance, the sun's heat was collected and focussed by a system of mirrors and glasses on to water boilers, and so made to raise steam.

However, all this happened in Egypt, and it would obviously be impossible for it to be carried out in this country. Moreover, any attempt at tapping the radiant energy of the sun by means of a system of heat engines is useless on account of the very small proportion of solar energy converted.

What is required, therefore, in order to take advantage of the prodigious amounts of solar energy which are continuously poured down upon the earth's surface is some simple

COLOSSAL POWER

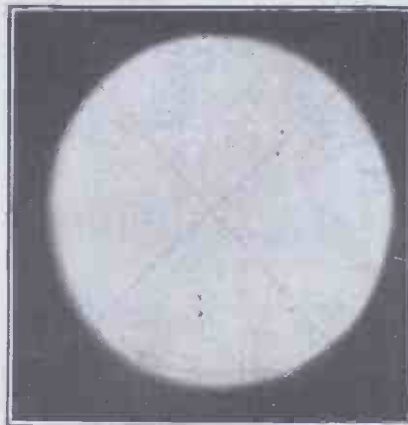

A photograph of the sun taken at the Royal Observatory at Greenwich, showing sun-spots—surface eruptions caused by gigantic energy storms.

and direct means of converting that energy into useful power, just as a crystal set is able to convert the radiant energy of the broadcasting station collected by the aerial into the energy utilised in vibrating the diaphragms of the 'phones.

Akin to Radio

After all, the difference between the two cases is one of degree more than of kind. Wireless receiving sets deal with radiant electro-magnetic energy travelling through space in wave-lengths of a few hundred metres. The electro-magnetic energy coming to us from the sun, however, is in the form of wave-lengths of a fraction of a millimetre in length.

We all know how easily possible it is to deal with the artificially created medium wave-lengths of the broadcasting station. Why, therefore, are we unable to tap the abundantly produced ultra-short sun waves?

The problem may not be so difficult of solution as we think. Certainly, its solution does not run counter to any physical law. We know more about the problems of electro-magnetic radiation than we do about those of atomic energy. Consequently, one assumes that the problem of tapping the radio energy of the sun for the benefit of mankind is less difficult than the much-talked-of problem of atomic energy.

Not Impossible

It is almost certain that if the problem of collecting and utilising the sun's radiant energy is ever satisfactorily solved, such a result will come about by the application of radio methods. After all, the problem is almost wholly a radio one in itself. It is not a theoretically impossible one, and ultimately some genius may come along and solve it by the simplest of means.

The Valve Holder with a Reputation

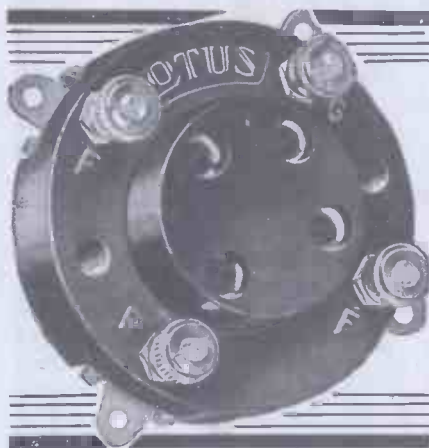

Lotus Valve Holders are acknowledged to be the best in their class. Follow the example of the most famous manufacturers and fit Lotus Valve Holders to the set you are building.

The Lotus Miniature type Valve Holder (illustrated here) is anti-microphonic and measures only 1 1/8" in diameter. Made from the finest bakelite, there is no surplus metal between the valve legs, and the leg sockets are in one piece with the phosphor bronze springs. Price, with or without terminals, 1/3.

Ask your dealer for details of the Lotus 5-pin Valve Holder for A.C. Valves—price 1/3; or send for full particulars of the complete range of Lotus Valve Holders.



GARNETT, WHITELEY & Co., Ltd.,
Lotus Works, Mill Lane,
Liverpool.

Causton.

HERE and THERE

A Fascinating Game—The Robot Regime—Service Areas—B.B.C. Finance—General Ferrie Retires.

WHAT would you do if you were head of the B.B.C.? It's an old question, but it has fascinating possibilities. No doubt many readers of "M.W." have, at one time or another, imagined themselves in full charge of British broadcasting. Lots of people thought on such lines during the war. Tea-table critics especially. They usually began like this: "If I were in Haig's place—" Well, no doubt they got a lot of fun out of it. A harmless pastime, though sometimes a little boring for other people.

Plain Words

Still, the game has possibilities, and sometimes, when interesting and clever people indulge in it, constructive ideas are born, light is thrown on dark places, defects are pointed out, and some sound commonsense displayed.

In a recent issue of the "Daily Record and Mail" Miss Ellen Wilkinson, M.P., explained what she would do if head of the B.B.C. She would brighten the news bulletins, make talks more personal, cut out the Robot regime and—particularly—do something about Sunday programmes. In her own words:

"Then these 'Reith Sundays,' with their church music and their cantatas. How many did that man Bach write? On the day when we have most time to listen there is a Bible reading and a children's service and a church service, and, as though that wasn't enough, the whole show closes down during church hours.

"The people who don't go to church are penalised, and so are those who do, for they come back from church and have another service over again. What is given only claims to satisfy a small minority anyhow, the Protestant church-going public."

Now that's pretty definite! We have often wondered how many cantatas Bach wrote. Something like thirty, we believe. Bach has proved a great blessing to the B.B.C. Sunday programme policy!

Unfriendly Robots

Miss Wilkinson likes the talks, but she would emphasise the personality side of the business. Few will disagree with the following:

"I remember hearing Captain Eckersley give a wireless talk about the Heavside layer and similar technical matters, and so much personality came through that I felt a friend had been talking. Why should not the news items, the announcing, the odds and ends of the linking of the programme be as individual as, say, a *révue* by Mr. Cochran?"

"Folk can't make friends with Robots!" No, they can't. And that is the root of the trouble at Savoy Hill.

Admirable and first-rate in dozens of ways, the Robot atmosphere still persists. Spontaneity, individuality, presentation—all these essential qualities cannot have proper play if Robotism is made a *fetish*.

Never mind, things will change—in time. But we hope Miss Wilkinson won't be discouraged.

Where Licensees Live

The B.B.C. recently pointed out the fact that the total number of licence holders included in the service area of the dual-programme transmitter at Brookmans Park is approximately 1,000,000. This total represents approximately one-third of the total number of licences which are held in the entire British Isles. Consequently the first dual-programme Regional station was built for the service of London and the Home Counties.

In the north region the service area, with its centre near Huddersfield, will include nearly 700,000 licence-holders, approximately one-quarter of the total number of licence-holders in the British Isles. Thus more than one-half of the total number of licence-holders can be served with alternative programmes by two high-power medium wave-length stations built near London and Huddersfield. It is for this reason that the London and North Regional transmitters were built before the Scottish or South-West Regional transmitters.

With the completion of the North Regional station the three dual-programme transmitting centres (London, Midland, and North Regional) supply approximately three-quarters of the total number of licence-holders with alternative programmes.

YOUR BATTERIES O.K.?

So much depends on having suitable batteries or units, properly installed and maintained, that next month's issue of "M.W." will be a special number dealing with

RADIO POWER

'MODERN WIRELESS' 1/- AUGUST
Order Your Copy Now

Since the death of the old B.B.C. and the start of the new the gross proceeds from licences has been £3,969,000, and of this the Post Office has taken £496,000 and the Treasury £856,000. These "rake offs" may be justifiable when the broadcasting system is established, and money is required only for programmes and ordinary maintenance, but at present the B.B.C. is in the middle of an ambitious and decidedly costly expansion, and the Regional Scheme, which was long kept waiting for the approval of the P.M.G., is now waiting for the money to pay for it.

The fact is, the B.B.C. wants more money, and the question is, will it exercise its right to raise a loan? This policy has little in its favour: to keep within the limits of current revenue is good finance. But if the money question becomes really acute, then surely the Post Office and the Treasury should part with some of the "pickings."

And, incidentally, what is being done with the money held by the
(Continued on page 97.)



BULGIN S.W. CHOKES EVERYTIME
They have a reputation, unsurpassed, for efficiency on all wave-lengths from 8 to 80 metres. Try one in your next set.

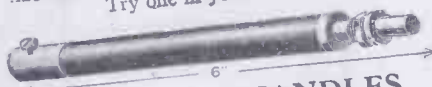

EXTENSION HANDLES
Here is a cure for hand-capacity effect. They are 6" long, dead true, and will fit any $\frac{1}{8}$ " or $\frac{1}{4}$ " condenser spindle. **2/3 EACH**

FUSEHOLDERS
No matter which set—it is incomplete without this BULGIN safety device. They are worth more than their weight in gold." **9d. EACH**

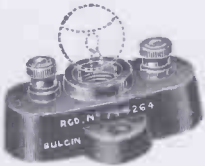

Send for our 56-page Catalogue. 2d. Postage

Obtainable from all the best dealers.

A. F. BULGIN & Co. Ltd. 19-11, GURSITOR ST., CHANCERY LANE, E.C.4

BETTER RADIO at LESS COST

See page 36 for illustration of the Famous "Sensitite" Transformer - List Price, 6/9
Power Transformers for Eliminators.
Largest stocks in England. Write for lists.
Wiring diagrams free.

THE WHOLESALE WIRELESS CO.
103, Farringdon Road, London, E.C.1.
Telephone: Clerkenwell 5312.

THE PICTURE PAPER WITH THE MOST NEWS

-SUNDAY GRAPHIC-

IN "RADIO FOR THE MILLION"

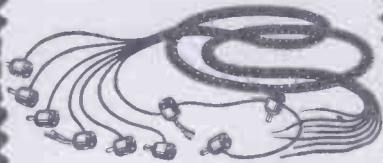

Belling-Lee 9-way Battery Cord with Belling-Lee Wander Plugs and Spade Terminals.

5/9

Also specified: Belling-Lee Terminals. Price 6d.

BELLING-LEE
FOR EVERY RADIO CONNECTION

Advt. of Belling & Lee, Ltd., Queensway Works, Ponders End, Middlesex.

HERE AND THERE

—continued from page 96.

Treasury and the Post Office—the money collected from the millions of 10s. contributions made by licencees?

This very unsatisfactory state of affairs has been going on long enough, and if the B.B.C. does raise a loan, we can imagine no little public outburst of amazement and indignation when the real facts about licences are given wider publicity. That is half the trouble.

Few people know anything about the "pickings" which the Treasury and the Post Office have had from licence revenue. And the fact should be realised more widely that, were it not for these "pickings," the licence fee could probably be reduced from 10s. to 7s. 6d.

That Army Wireless

One of France's greatest radio experts has just retired. He is General Ferrie, head of the French Army Radio Service, and the man who had a great deal to do with the design for the Eiffel Tower station.

According to the "Birmingham Post," a special law has been passed permitting him to continue as Chief of the French Army Radio Service and President of the Radio Department of the League of Nations. Says the "Post":

"Although General Ferrie's name is, perhaps, not familiar to the average listener to broadcasting, the great number of radio experimenters and G.P.O. telegraphists who in 1914 formed the nucleus of the military wireless service in France will recall his valuable work in developing the valve as an amplifier of wireless signals. In the early days of the war the crystal and other types of detectors of wireless signals worked at a disadvantage owing to the necessity of their being connected to high aerials which were constantly shot down by the enemy. General Ferrie and his staff brought the thermionic valve (which was invented by Professor Fleming) to such a state of efficiency that high aerials became unnecessary. They produced the hard vacuum valve which was marked by cheapness of construction and adaptability. Its use by the Allies became general, and the design was later copied by the enemy."

FOR YOUR NOTE-BOOK

Really high magnification in a valve is an advantage only where the input it is desired to handle is a small one (this class of valve is very easily overloaded).

A crystal detector can often be improved by attention to the tightness of the terminal contacts

If one of the joints in a crystal detector is suspected of being imperfect (for instance the joints between the outer terminal and the cat's-whisker), a distinct improvement will often be noticed if a flexible lead is soldered between these two points.

A Remarkable Drum Dial

This J.B. Precision Instrument is the most up-to-date on the market to-day. It makes tuning easier and more accurate, and its action is so smooth that it is a real pleasure to handle.

PRICE **10/6**



All parts of the Dial are insulated from the Condenser, so that the drum becomes an anti-capacity shield and may be earthed.

The scale is Ivorine, reading 0-100, and is reversible so that reading may be altered to 100-0

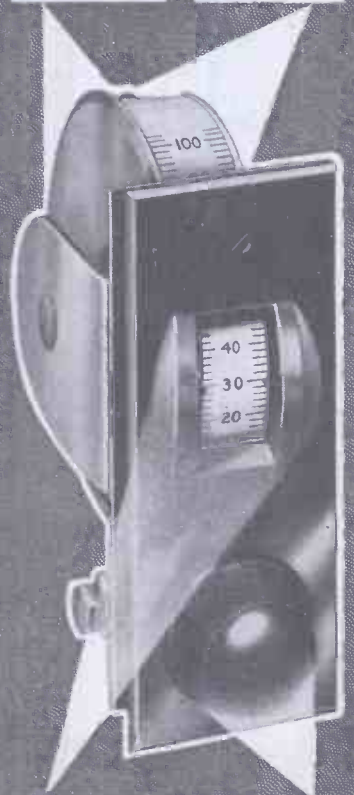

The scale is flush with the panel, making it exceptionally easy to read. The powerful friction drive prevents backlash and slip.

The Control Knob is placed immediately below the scale—the most convenient place for it.

Advertisement of Jackson Brothers, 72, St. Thomas' St., London, S.E.1. Telephone: Hob 1837

Fit the Lotus L.F. Transformer

and note the improvement in your set.

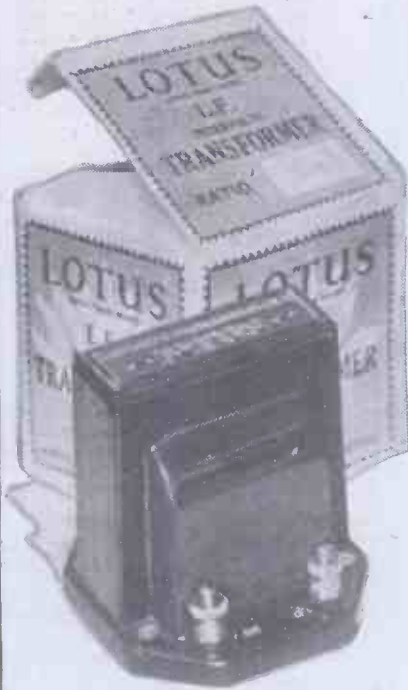

Whether you are building a new set or merely overhauling your old one, the installation of a Lotus L.F. Inter-valve Transformer will double its efficiency.

Housed in a black bakelite moulded case, the Lotus Transformer is both compact and efficient. It embodies all the accuracy and careful finish which are expected from Lotus components.

Available in ratios of 3-1 and 5-1

Price **12/6**

Full particulars on request

LOTUS

L.F. TRANSFORMER

GARNETT WHITELEY & CO., Ltd.
LOTUS WORKS, MILL LANE, LIVERPOOL

Causton

RECENT RECORD RELEASES

A brief survey of some of the latest gramophone records. Those mentioned should be of special interest to the radio-gramophone user.

Broadcast "Tens"

THE outstanding disc in these famous 1s. 3d. records this month is undoubtedly *Amy*, the new special number composed in honour of Miss Amy Johnson. It is played by Nat Lewis and his Dance Band on 570, and is sure to be extremely popular.

Other dance tunes released include *Molly*, and *Alone in the Rain* (565), *Mona* and *I'm on a Diet of Love*, from "Happy Days" (566), by the same band, and "*The Stein Song*" (567) and *Cryin' for the Carolines* (568), by The Riverside Dance Band. All good numbers, "The Stein Song" being especially attractive for its lively rhythm.

The band of H.M. Welsh Guards provides us with a descriptive piece, *A Voyage in a Troopship* (564), an unusual item that will have a strong though necessarily somewhat limited appeal.

Singin' in the Bathtub, by Billy Marlow (561), and *You Die if You Worry* (560), by Bobbie Comber, are amusing comedy numbers; while the inimitable Sandy Powell provides *The Singing Lesson* (a humorous sketch), on 559.

Broadcast "Twelves"

Broadcast "Twelve" Super Dance records are always worth hearing, and the following are among the more interesting this month: *Should I?* and *The One I Love* (2564); *If I Can't Have You*, and *Good-Bye to All That* (2565); All by The Manhattan Melody Makers.

Then we have Al Benny's Broadway Boys playing *Moanin' for You*, introducing "Alone in the Rain" fox-trot (from "The Grand Parade"), and *Lazy Louisiana Moon* (2567); *Ro-Ro-Rollin' Along* and *Vagabond King Waltz*, Selection (2568). All with vocal refrains.

The ordinary "Twelves" contain a very good couple of discs of *Excerpts from "La Bohème"*, Puccini's famous opera.

Mabel Constanduros and Michael Hogan are to be heard in a new Buggins' sketch, *The Bugginses' Picnic*, a typical farce in which

grandma and the rest of the famous family are characterised at their best—or worst.

H.M.V.

It is difficult to pick out records from the H.M.V. lists and to say "these are the best," so we have just selected a few from those sent us for review.

Premier place must be given to the Berlin State Opera Orchestra's rendering of Mendelssohn's *A Midsummer Night's Dream*, on C1883-1884. These two records provide an example of modern recording of large orchestras, the wail of the violins being particularly impressive.

Next we come to John McCormack singing *Now Sleeps the Crimson Petal* (Quilter) and *A Fairy Story by the Fire* (Merikanto), on D1111, beautifully rendered and perfectly recorded, though we would have liked the piano accompaniment in the former piece to have been a little less prominent.

Napoli and *Carnival of Venice* (B3425) form a couple of interesting items in which a cornet solo takes the honours. The instrument is accompanied by a band, of course.

Stuart Robertson, bass-baritone, evidently enjoys himself in *Ma Belle* and *My Sword and I*, from "The Three Musketeers," and his evident enjoyment in singing greatly assists in his "getting over" really well (B3442).

Parlophone

Of the Parlophone releases we are very fond of the "Summer Day's Suite" by Eric Coates. The *In a Country Lane* and *Joyous Youth* are recorded on E11002 by the Royal Opera House Orchestra of Stockholm.

One glance at the "Radio Times" is sufficient to show the popularity of the works of Eric Coates. He certainly belongs to the foremost rank of light orchestral composers in England to-day.

Schwanda, the Bagpipe Player (Selection), By Jaromir Weinberger, played by the Berlin State Opera House Orchestra, is a most

(Continued on page 99.)



D.C. or A.C.
'Portable'
Combined Units
 (H.T. with L.T. Charger)

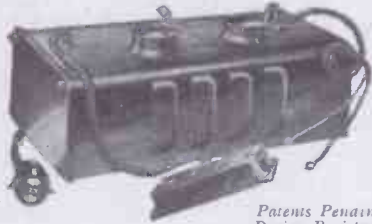

Patents Pending.
 Design Registered.

If supplied with 'Xtra-Point'
 Lampholder and Plug, 4/6 extra.

They fit inside any portable, and are equally suitable for all popular 2-, 3-, and 4-valve Receivers.

Write for full particulars.

REGENT RADIO SUPPLY Co., 21, Bartlett's Buildings, Holborn Circus, London, E.C.4.

Telephone: Central 8745 (3 lines).

RECENT RECORD
 RELEASES
 —continued from page 98

enlivening piece of music. It is best described in the rather unusual pen picture of the Parlophone catalogue.

"The story of 'Schwanda' is based on an old fairy tale, and is classic nonsense from beginning to end. The scene in Hell—where the inhabitants are allowed to regulate the heating—would ease and comfort the mind of any dying criminal.

"The music, too, would indicate a long association between the composer and 'Beachcomber's' friend, Miss Violet Cork; the 'joyage' and 'gladdery' of it all are supreme! The second scene polka, which opens the second side of this record, is a gloriously fatuous tune, particularly so when it collects its wolloping trombone accompaniment in the repeat"

Finally, Gwen Henry, Melville Gideon, Raie da Costa, Annette Hanshaw, and Ronald Frankau are among the Parlophone artistes, and their records are all worth careful attention.

Zonophone Records

The Blue Danube and Wine, Women and Song, by The London Orchestra. "The Blue Danube" Waltz has become very popular during the past few months, and this rendering by the London Orchestra is one of the best we have yet heard.

The McCravy Brothers are well recorded on 5576, when they give us *Trundle Bed and Hide Away*.

Jimmie Rodgers with guitar "appears" again, while a novelty is provided by a couple of harp solos played by John Cockerill.

The Arcadians Dance Orchestra, that tuneful organisation which pleasingly includes the organ in its ensemble, are to be heard in *Sunshine of Marseilles, Molly* (5581); *The Love Parade* (Selection), and *What Can I Do?* (5582).

"Sunshine of Marseilles" has a good tune, and is coupled with "Molly," from the film "The Grand Parade," another well-known number. The other specimen we have received contains a selection of the best numbers from the film everyone is "raving" over—"The Love Parade." An added attraction to this selection is the vocal refrain.

On the other side is an attractive, up-to-the-minute melody.

ELIMINATE
 BREAKDOWNS



For vivid clarity of reproduction, and complete elimination of all your amplification troubles—be sure to get a Brownie POPULAR Transformer when building your new set. It costs only 9/6 from your dealer.

WITH
 THE

BROWNIE
 "POPULAR"
TRANSFORMER

Browne Wireless Co. (G.B.) Ltd., Nelson Street Works, London, N.W.1

Piano—CRAFTSMANSHIP
 Improves your SET!
 or
RADIO-GRAM.

Note "Patent"
 Baffle Chamber.

The outcome of seven years' experiments followed by exceptional demand—leading Experts—Famous Engineers—5,000 users.
 Direct from Craftsman's bench to your home. You may have ON APPROVAL FREE TEST, and return at our expense if you wish to part with it. Prices run from £5-5-0 (or £10 to £15-15-0 for Exclusive models). Cash or Easy Payments. Photographs and full particulars FREE.
PICKETT'S, Radio Furniture Makers (M.W.).
 Albion Road, Bexleyheath, Kent.

SCREENS **PAREX** **COILS, etc.**

"STAR-TURN" FOUR
 Special Tuning and
 Selector Coils
 21/- per set.

"M.W." STANDARD SCREEN, 10" x 6", 2/-
 "PAREX" REACTION CONDENSER - 4/-
 H.F. CHOKE, 3/6 L.T. SWITCH, 1/-

E. PAROUSSI,
 10, Featherstone Buildings, High Holborn,
 London, W.C.1
 Phone: Chancery 7010

Make
The DAILY SKETCH
 YOUR Picture Paper

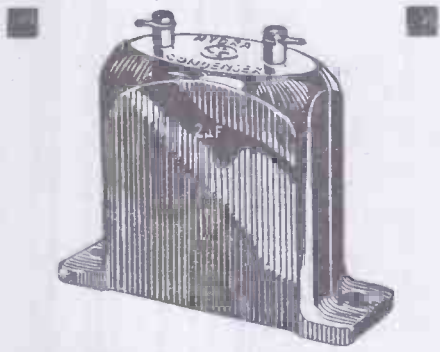

A condenser cannot live to fail twice! A Hydra cannot fail to live throughout the lifetime of your set—and longer! Hydra condensers never fail—they do not leave our factory until we are satisfied of that!

HYDRA
LOUIS HOLZMAN

37, Newman Street, W.1.
 Telephone: Museum 2641.

FROM OUR READERS
Distant Listening—Safeguarding the Set.

“Distant Listening”

Sir,—I am also a listener of some considerable experience, and am exceedingly glad to find someone has challenged Captain Eckersley's article.

If Captain Eckersley were, as Mr. S. G. Brandon suggests, to sit down and listen to some of the Continental transmissions, he would very quickly alter his opinion. In many cases he would find real music, not a jumble of noises created by a chamber orchestra, and I can also assure him that, apart from atmospheric disturbances, the quality of these Continental stations is as good any day as the “twins” at Brookmans Park—in fact, very often better.

I use a four-valve receiver—two screened grids, detector and power Pentone valves—all-electric, and as yet have not had anything to grumble about my distant reception. Captain Eckersley ought to realise that we are not the only people at radio; as Mr. Brandon says, the Dutchmen and the Germans are now leading the way. My views are also very definite on the subject, and every listener with a receiver capable of bringing in “real music” from far and wide will, I feel sure, agree with me.

In conclusion, I hope through MODERN WIRELESS Captain Eckersley is going to give us his very able help.

Thanking you,

Yours truly,

VERNON A. M. POWELL.

Dulwich Village.

[EDITORIAL NOTE.—At the risk of attempting to teach our correspondent something he may already know, it should be pointed out that there is more in this question than meets the

eye at first. To get good quality from certain distant stations and poor quality from the local is by no means uncommon with a powerful set unless it is provided with some effective form of pre-detector volume control. This is particularly the case with receivers in which there is the least trace of instability; it may not be apparent on distant stations, but the powerful carrier of the local will show it up immediately.

It is not to be assumed, of course, that experiences of this sort have much weight as arguments to prove that the B.B.C. quality of trans-

NEXT MONTH

The next issue of “M.W.” will be a special number dealing with

RADIO POWER

Don't miss this special issue which tells you all about L.T. Batteries, H.T. Batteries, all classes of Mains Units, etc.

Order your Copy Now!

MODERN WIRELESS

August One Shilling

mission is inferior to that of the foreign stations. We can assure our correspondent that when received with proper equipment the B.B.C. quality is so good that any further improvement could only be detected by a highly-trained ear.

Is there not a risk here of confusing quality of transmission, which is purely a matter of faithful reproduction, with the quality of the programmes? Our correspondent's feeling reference to chamber music seems to betray a very natural tendency to blame the *manner* of the transmission for something which is really a question of the *matter*.

It should not be forgotten, too, that the condition in which a receiver is normally operated for long-distance work generally produces a rounded and “mellow” tone, which, though false, appeals to many ears.

“Safeguarding the Set”

Sir,—I note in the June issue of “M.W.” a letter from Mr. H. J. Wyatt suggesting that a satisfactory method of protecting valve filaments is the use of a resistance of 1,000 ohms in the common H.T. negative lead. By taking abnormally low figures he succeeds in showing that there is thereby no serious loss of what he calls the “current available to the set.”

A consideration of more practical figures for the current consumption of the set would probably put rather a different complexion upon the matter, but that is not my reason for intruding upon your columns. I wish to point out a more serious aspect of Mr. Wyatt's suggestion: If the trustful reader takes the idea literally he is almost certain to be rewarded with an L.F. howl if his set contains two L.F. stages.

The point is that Mr. Wyatt is deliberately inciting the reader to set up a violent case of “battery coupling,” and we all know what that does to a modern high-magnification receiver. To make matters worse, he even suggests that the resistance should be in the form of a choke!

Yours, etc.,

G. ELTRINGHAM.

Lewcos Wave-change Coil-holder

We find that “Super” coils are not suitable for the Lewcos six-pin wave-change base described in “M.W.” last month.

Lewcos binocular coils should be used with that device.

INDEX TO ADVERTISERS

	PAGE
Belling & Lee, Ltd.	97
Benjamin Electric, Ltd.	90
Brownie Wireless Co. (G.B.), Ltd.	99
Bulgin, A. F., & Co., Ltd.	97
Burne-Jones & Co., Ltd. (Magnum)	90
“Bestway” Wireless Books	93
Carrington Manfg. Co., Ltd.	89
Cole, E. K., Ltd.	81
Cossor, A. C., Ltd.	2
Cassell's Magazine	91
Ferranti, Ltd.	1
Formo Company	77

	PAGE
Garnett, Whiteley & Co., Ltd.	96, 98
Hayberd, F. C., & Co.	89
Holzman, Louis	99
Hughes, F. A., & Co., Ltd.	Cover iii
Igranic Electric Co., Ltd.	85
Impex Electrical, Ltd.	85
Jackson Bros.	97
Lissen, Ltd.	73
London Elec. Wire Co. & Smiths, Ltd.	89
Mullard Wireless Service Co., Ltd.	Cover ii
Paroussi, E.	99
Pickett's Cabinet Works	99

	PAGE
Radio Instruments, Ltd.	Cover iv
Ready Radio	94
Regent Radio Supply Co.	99
Rothermel Corp., Ltd. (Centralab)	92
“ ” ” (Induction Motor)	85
Telegraph Condenser Co., Ltd.	81
Telsen Electric Co., Ltd.	91
Varley Products	77
Whiteley, Boneham & Co., Ltd.	89
Wholesale Wireless Company	97
Wright & Weaire, Ltd.	92

All communications concerning advertising in “Modern Wireless” must be made to John H. Lile, Ltd., 4, Ludgate Circus, London, E.C.4. Telephone: City 7261.

BLUE SPOT TRIUMPHS

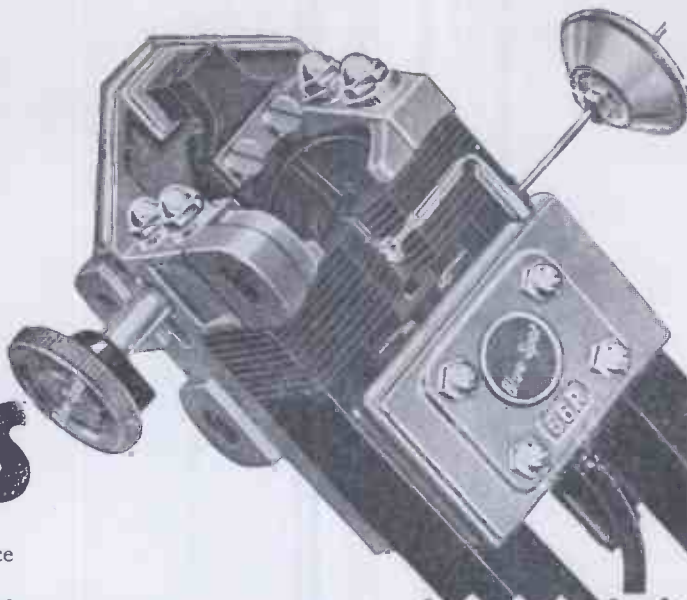

**66R
35/-**

Only Blue Spot could produce a unit that is an advance on the famous 66K.

Here is one. The new 66P Unit! It is the logical development of the famous 66K Unit and in its manufacture proved technical principles and extensive practical experience are incorporated, resulting in a unit which approaches perfection. Owing to the special improved details in design, covered by various patents and obtainable only in Blue Spot products, this unit will give remarkable results.

An entirely new method of moving the anchor between the four poles has been adopted, and the precision of adjustment is so keen that it is now possible practically to place the anchor the exact distance from the poles as is theoretically necessary to obtain the best effects as yielded by a magnetic unit under the best conditions. The noticeable result of this increased sensitivity is the larger range of frequencies obtainable. In addition to the powerful reproduction of the bass register with its full beauty, the higher frequencies which largely determine the character of speech and music are also reproduced faithfully.

Blue Spot Power Unit Type 66P	27/6
Blue Spot Major Chassis Type 37P	15/-
Blue Spot Special Chassis Type 31P	10/6
Blue Spot Minor Chassis Type 28P	9/-
Permissible D.C. Current	30 m/a
D.C. Resistance	1,000 ohms

Here is the other. The Blue Spot Power Unit Type 66R. It will handle enormous outputs without distortion or rattle, and in this respect the advantage of the patented adjustment obtainable only in Blue Spot products is appreciated more than ever. The powerful electric energies acting upon the anchor, energies that converted into audio frequencies can cause at the bass notes even a sensible vibration of the furniture and the floor, would wear out by friction any link or weak construction of the part supporting the anchor. The patented adjustment of the Blue Spot Unit will never wear out, but will work with just the same exact precision as on its first day.

This is one of the advantages that guarantee for you the wonderful brilliance and volume of this Blue Spot Unit. The 66R Unit stands a triumphant tribute to the painstaking care and ingenuity of the Blue Spot designers.

Blue Spot Power Unit Type 66R	35/-
Blue Spot Major Chassis Type 37R	15/-
Blue Spot Special Chassis Type 31R	10/6
Permissible D.C. Current	50 m/a
D.C. Resistance	500 ohms

F. A. HUGHES & CO., LIMITED,
204-6 Great Portland Street, London, W.1.

'Phone: Museum 8630 (4 lines).

Distributors for Northern England, Scotland and North Wales: H. C. RAWSON (Sheffield and London), Ltd., 100, London Road, Sheffield ('Phone: Sheffield 26006), and 22, St. Mary's Parsonage, Manchester ('Phone: Manchester City 3329).

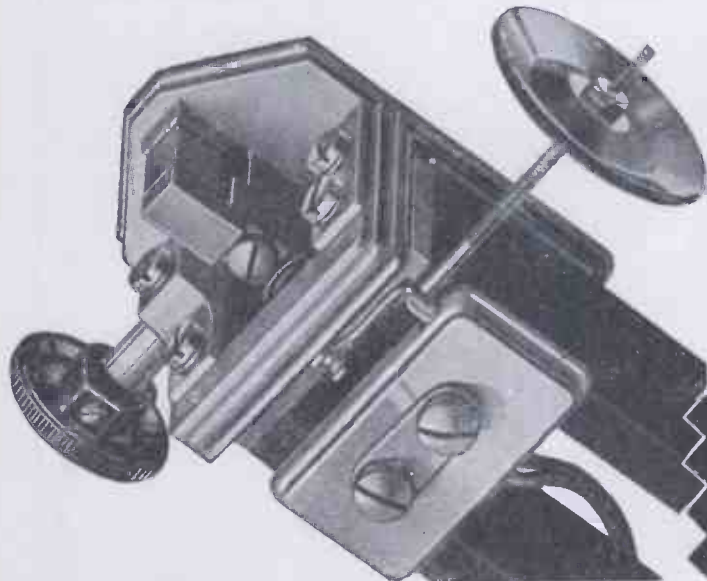

**66P
27/6**



The HYPIER-RIGHT THIRIE



HYPERMITE

A transformer with core of new nickel alloy of enormous permeability yet sold at a price within the reach of all. Its amazingly high inductance (over 50 henries), with a retention of high and low frequencies, ensures perfect performance, eminently better than that of many bulky, higher-priced models.
Weight, 7 ozs.
Size, 2½ × 1½ × 2½ ins.

12/6

HYPERMU

The world's best transformer for modern circuits—a statement which has been tested and proved by experts and amateurs all over the world. The latest N.P.L. Curves prove amazing superiority of performance under ordinary working conditions.
Weight, 14 ozs.
Size, 3 × 1½ × 3 ins.

21/-

First "Hypermu," then "Hypermite," and now "Hypercore," an amazing trio of components that together enable set builders to get the absolute best out of modern valves and modern circuits in the smallest space with *minimum* weight—components that set a new standard of efficiency in modern radio reception.

Write for the leaflets which give full details of this wonderful trio.



HYPERCORE

The first commercial L.F. Choke with a core of new nickel iron. Less than half the size and weight of chokes built with silicon iron cores, yet has an inductance of 30 henries. Enormously improves quality of reception and sets new standard for L.F. Choke efficiency in smoothing equipment and filter output circuits.
Weight, 18 ozs.
Size 2 × 2½ × 2½ ins.

17/6

EXTRACTS FROM THE WIRELESS PRESS

The Hypercore gave perfect satisfaction, and was just as good from the smoothing point of view as a large standard choke of 20 H. weighing **THREE TIMES** as much. As an output choke the Hypercore can be used in any normal receiver with complete satisfaction. . . . the R.I. Hypercore points the way to the extensive use of this type of component in mains units and for similar purposes.

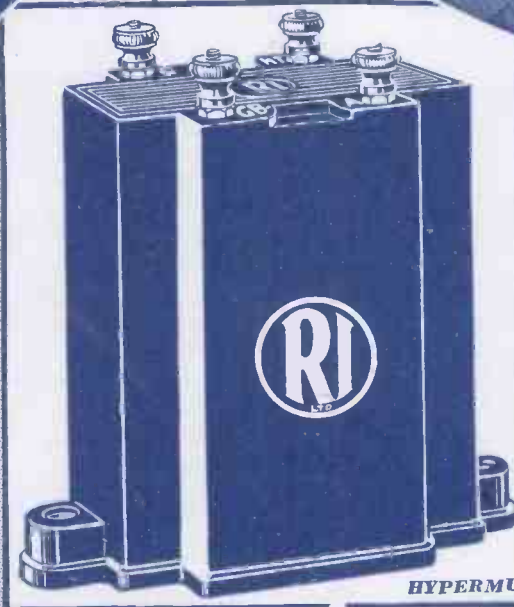

Here is shown the new R.I. Factory and Offices.



The site is situated on the Parley Way, Croydon

R.I. LTD., "MADRIGAL" WORKS, PURLEY WAY, CROYDON