

A COMPREHENSIVE VALVE GUIDE FOR READERS

MODERN 1/- WIRELESS

VOL. XIII. N°42

JUNE 1930

FULL DETAILS OF THE "SIMPLE-CHANGE" THREE

An inexpensive, easy-to-build wave-change set for distant programmes.

THE "STAR-TURN" TWO

A set that attains a higher selectivity and greater power than any two-valver previously designed on such simple lines.

THE "DIFFERENTIAL" ONE

Just the receiver you want for long-distance telephone reception.

OTHER SPECIAL FEATURES:

*Sir Oliver Lodge, F.R.S.,
on
"AT WORK—AND PLAY"*

*Sir John Reith on
"THIS 'TALKS' BUSINESS"*

*"The World's Programmes"
When, Where, and How to
Hear Those Foreigners.*



SPECIAL VALVE
SUPPLEMENT
SEE PAGE 535

RADIO CONSULTANT-IN-CHIEF CAPT. P.P. ECKERSLEY M.I.E.E.

A NEW PICK-UP BLUE SPOT 88



Designed for the true critic and lover of gramophone music this wonderful pick-up will discover new beauty in your gramophone records. Coloration and depths of tone which you have not previously heard will be revealed. All that is incised on the record will be reproduced without over-emphasis and without attenuation. Ask any good wireless dealer for a demonstration and you will be both delighted and amazed with the realism of the reproduction. **Price £3.3.0** complete with volume control.

THE CHASSIS FOR THE 66K UNIT

Everyone knows the 66K Unit; soon everyone will know the Chassis that was specially designed for it.

In five minutes you can build yourself a speaker which for quality and sensitivity is unexcelled. Screw the unit to the chassis—the cone is already in position—connect up to your set and you will hear Blue Spot at its best.

66K Unit costs 25/- and is sold under guarantee.

The Chassis is sold in two sizes: The Minor, with 9½" Cone (as illustrated), costs 12/6; The Major, with 13" Cone, costs 15/-.

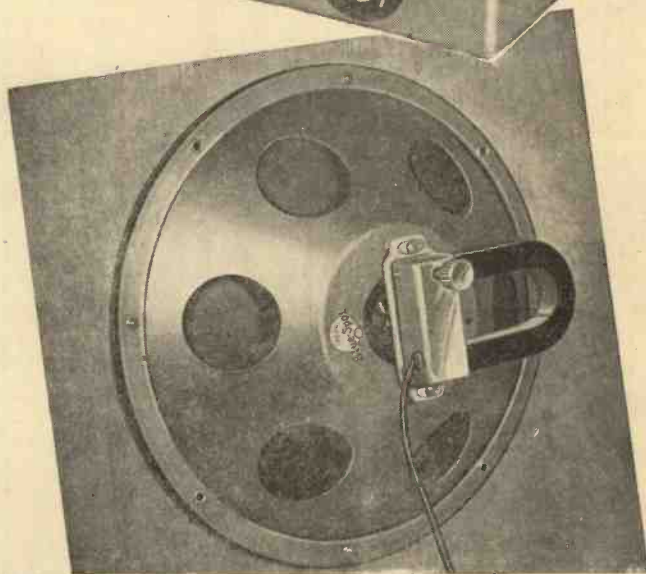

F. A. HUGHES & CO., LIMITED, 204-6 Great Portland St., London, W.1

Phone: Museum 8630 (4 lines)

Distributors for Northern England, Scotland and North Wales: **H. C. RAWSON (Sheffield and London), LTD.**, 100 London Road, Sheffield. Phone: Sheffield 26006. 22 St. Mary's Parsonage, Manchester. Phone: Manchester City 3329

CONTENTS

VOL. XIII. No. 42. MODERN WIRELESS.

JUNE, 1930.

	Page		Page
Editorial	515	Musical Motors	568
The "Star-Turn" Two	516	On The Short Waves	569
The World's Programmes	521	Spotting "Peaks"	571
Trouble Tracking	524	Wireless And Air Travel	572
Resistance-Capacity Push-Pull	525	Radio Power Problems	575
This "Talks" Business	528	Random Jottings	576
"Oslo"	532	Ambling Ammeters	577
At Your Service	533	Your First Loud Speaker	579
Valves For All	533	Volts For The "Twin-Frame" Four	580
At Work—And Play	544	Germany's Single-Wave Stations	583
At Home With The R.I. Madrigal	547	Making An Accumulator Tray	584
Hints On Making Portables	549	Test Your Coils	586
Tested This Month	550	Using Your Detectors	587
Questions Answered	552	Speaking Personally	590
My Broadcasting Diary	553	Valve Varieties	594
The Igranio A.C.2	555	What Is That L.F.?	595
Pruning Your Radio	557	The 0-1 Metre Band	598
The "M.W. Differential" One	559	In Passing	599
Interesting New Pick-ups	561	Radio Notes and News	602
The Inefficient Loud Speaker	563	Recent Record Releases	607
The "Simple-Change" Three	564	Compromises In Radio	609

As some of the arrangements and specialities described in this Journal may be the subject of Letters Patent the amateur and trader would be well advised to obtain permission of the patentee to use the patents before doing so

Edited by NORMAN EDWARDS.

Technical Editor: G. V. DOWDING, Assoc.I.E.E.

Radio Consultant-in-Chief: Capt. P. P. ECKERSLEY, M.I.E.E.

Scientific Advisor: J. H. T. ROBERTS, D.Sc., F.Inst.P.



MAZDA A.C. VALVES will increase range and volume—and give vastly improved quality.

Over two years of constant research have made Mazda A.C. Valves the standard by which all indirectly heated valves are judged.

THESE FIGURES PROVE IT . . .

	PRICES		A.C./ S.G. Screen Grid.	A.C./ H.L. Det.	A.C./ P. Power.	A.C./ P.1. Super Power.
AC/SG	25/-	Filament Volts	4.0	4.0	4.0	4.0
AC/HL	15/-	Filament Amps.	1.0	1.0	1.0	1.0
AC/P	17/6	Anode Volts ...	150	200	200	200
AC/P1	17/6	Screen Volts ...	60	—	—	—
		Mutual				
		Conductance	2.0	2.6	3.75	2.5
		Amplification				
		Factor	1,200	35	10	5
		Impedance ...	—	13,500	2,650	2,000

The Amazing

MAZDA

ALL MAINS VALVES

THE EDISON SWAN ELECTRIC CO., LTD.,
Radio Division.

1a, Newman Street, Oxford Street, W.1.
Branches in all the Principal Towns.

EDISWAN



**I'm the most Powerful—
most Silent—
Challenge me if you will**

H.T. BATTERIES.

For 2-valve Sets (6 m.a.):
 "WINNER" Series, 60 volts, 7/-
 "POPULAR" Series, 60 volts 9/6

For 3- or 4-valve Sets (10-16 m.a.):
 "POPULAR" POWER Series, 60 volts - - - - 13/6

For Sets with Pentode Valves:
HIGH-POWER SIXTY,
 60 volts - - - - 15/6

I'm

EVER READY

REGD. TRADE MARK

BRITAIN'S BEST BATTERIES

Send for List of Standard Sizes suitable for every set,

THE EVER READY CO. (GT. BRIT.) LTD., 23, HERCULES PLACE, HOLLOWAY, N.7.

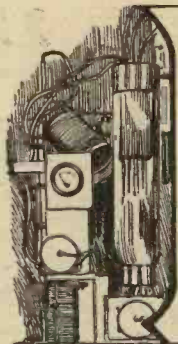

MODERN WIRELESS



Vol. XIII. No. 42.

June, 1930.

Another "Star-Turn" Set—An Economical Three-Valver—Our Special Valve Supplement—
Sir John Reith's Article—Sir Oliver Lodge.

Another "Star-Turn" Set

THE special sets in this issue include the "Star-Turn" Two, which, as its name implies, is a two-valve version of the very popular three-valve design we described in last month's issue of MODERN WIRELESS.

This two-valver has a very high degree of selectivity, achieved with only one tuning condenser. Constructors will notice no "ganging" is employed. On test we found this set to possess very good power. The circuit includes the "Star-Turn" coil unit, constructional details of which were also given in last month's issue. Incidentally, we would point out that most radio stores are now stocking these "Star-Turn" coil units.

An Economical Three-Valver

THE "Simple-Change" Three is a wave-change receiver using ordinary plug-in coils, and we can recommend it as an inexpensive, easy-to-build receiver which is completely modern in every respect. It is the economist's long-range loud-speaker outfit, and as such will make a very wide appeal.

The "M.W." "Differential" One is quite a straightforward one-valver incorporating differential reaction and grid adjustment. Consequently there is a smoothness in operation which is unusual, and a virility in the results obtained which you will find surprising. Many alternative programmes with telephone reception will be found to be available when using this receiver.

"Volts for the 'Twin-Frame' Four." This is a fine little H.T. mains unit designed in particular for use with that popular MODERN WIRELESS set, the "Twin-Frame" Four. But it can also be used with any portable set. You simply take the H.T. battery out of the portable and slip in the unit, and thus save battery current when the set is used in the home.

Our Special Valve Supplement

WE should like to draw the attention of our readers to the special valve supplement in this issue, which covers in a condensed, comprehensive form practically every known valve of repute.

There is also our new feature, "At Your Service," conducted by our Trade Editor, which aims at keeping

the reader and the manufacturer as close in touch as possible. Although the idea of a liaison article each month between reader and advertiser is not new, we venture to think that the form in which this feature has been presented offers a striking difference in method of treatment. This feature not only offers you a definite service, but is written in a way which eliminates any suggestion of dullness, just as our new feature, "The World's Programmes," strikes a new and, we think, a happy note, providing DX listeners with a variety of useful and entertaining information concerning reception of distant stations.

Sir John Reith's Article

WE should also like specially to refer readers to Sir John Reith's article, "This Talks Business." As our readers know, there has been lately a considerable amount of controversy about the talks, and Sir John himself recently made one of his rare appearances before the microphone in order to explain the latest Talks Syllabus issued by the B.B.C.

Sir John's article contains references to an article on Talks which was contributed to the "Listener" by the Editor of this journal, and many readers who happen to have read that article will appreciate the humour of the conclusion to Sir John's article, the Latin tag of which is dealt with by the Editor in an article following on Sir John's.

* Sir Oliver Lodge

SIR OLIVER LODGE also contributes to this issue a rather unusual article. Although this is definitely a radio magazine, we feel sure our readers will be interested in some personal revelations of one of the greatest scientific pioneers of the age concerning his methods for "keeping fit." And this article is all the more topical in view of the fact that on June 12th Sir Oliver Lodge attains his seventy-ninth birthday.

We feel that all our readers will wish to join with us in wishing him many happy returns, and many, many more birthdays to come. We can only hope that if, by chance, we are lucky enough to attain such an age, we shall be able to carry out with such success the hints which Sir Oliver gives for keeping fit.



The "Star-Turn"

For STARTLING SELECTIVITY

Uncanny "keenness" in tuning, with enhanced power—this is the combination that set designers have sought in vain, till now. The "M.W." "Star-Turn" circuit has cut right through the difficulties and cleared the way for the technical triumph represented by this revolutionary "Two."

Far more selective, stronger in action, simpler to make, and in every way better than its forerunners, this set is sure to score a staggering success, by the sheer pulling-power of its performance.

It was designed FOR YOU
By the "M.W." RESEARCH DEPARTMENT.



THE readers of MODERN WIRELESS can certainly be congratulated on their quickness in spotting a good thing when it comes their way; although we were told that it was a sheer waste of such a fine new design as the "Star-Turn" Three to release it at so unfavourable a time of year, there are abundant signs that it has justified our confidence and caught on strongly.

A New Standard

Well it might, of course, for it is a really good thing, but all the same it says much for our readers' discernment that they should have appreciated its virtues so quickly and built it in remarkable numbers at a time

of year usually regarded as rather stagnant. We are writing very early in the month, of course, but it is already pretty clear that those readers who were sufficiently experienced to see that the circuit was a definite step forward are reaping their reward and getting a standard of performance hitherto considered impossible with an easily handled "detector and L.F." receiver.

All this is very gratifying to us, of course, for it confirms us in our belief that we could trust our readers not to miss an outstanding development like the "Star-Turn" circuit even if we presented it at a slack period from the home-constructor's point of view. It encourages us, too, to go ahead and show how our readers can exploit the new scheme to the full and apply it in all sorts of ways.

A Noteworthy Advance

As a matter of fact, we believe that it is so valuable and meritorious a method of achieving the selectivity needed nowadays that we consider it should be explored most thoroughly, and we have already made our plans for quite a series of these sets. Some will be simpler than the original "Star-Turn" Three, some more elaborate, but all will possess the same special merit of most exceptional selectivity combined with practically the same ease of handling as an ordinary simple set and an even greater sensitivity.

Anyone who has struggled with the problem of increasing the selectivity

of the simpler types of sets will realise what a noteworthy achievement this is. That problem is truly a difficult one, for it is no solution at all to adopt the obvious way out offered by additional ordinary tuned circuits: two circuits instead of one may give the selectivity you want, but sensitivity is very apt to go down

COIL COUPLING

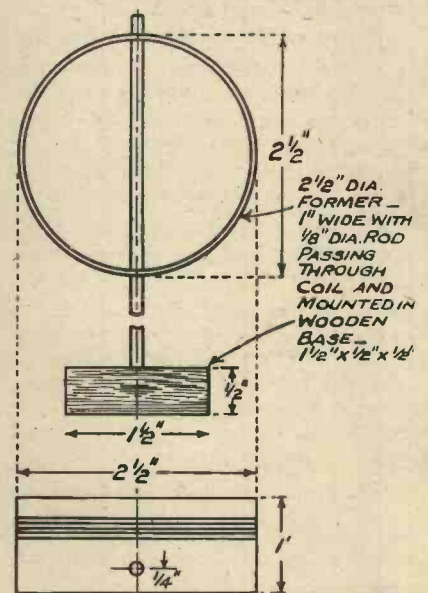



it takes only 'a brace of shakes' to make the coupling coil L₁, but it's wonderful what knife-edge selectivity you get with it.

(remember we are thinking of "detector and L.F." sets), and what about the poor wight who will have to operate the receiver when it has been designed and built?

He is likely to entertain bitter feelings towards the designer, for it

ABOUT THOSE PARTS—



 <p>2 Baseboard mounting coil holders (Lotus or Igranie, Lissen, Magnum, Keystone etc.)</p>	 <p>1 Slow-motion dial, if condenser not of slow-motion type (Lissen, or J.B., Ormond, Lotus, Igranie, Formo, etc.).</p>
--	---

Instead of a mere list of parts required we are showing throughout the article these little pictures, which you can link up with the diagrams. Look over them carefully and the set begins to "come to life" in your mind, doesn't it?

Two

will almost certainly be a very difficult set to handle. It is true that by spending lots of time and thought on a two-circuit "det. and L.F." receiver it is possible to produce a design which loses no sensitivity, and is no more difficult to handle

YOU WILL NEED—

	
<p>1 .0003-mfd. fixed condenser (T.C.C., or Lissen, Atlas, Mullard, Dubilier, Goltone, Igranic, etc.).</p>	<p>1 L.F. transformer (R.I., or Lissen, Ferranti, Telsen, Varley, Lotus, Lewcos, Mullard, Cossor, etc.).</p>

You can pick these parts out in the theoretical diagram above, where they are marked C₄ and L.F.T. respectively.

than any other set with two dials, but to do so many special devices must be introduced.

Even then the delightful simplicity of the one-dial set is lost, and operation becomes a matter definitely calling for a little skill—a decided drawback from the "domestic" point of view. The simplicity of operation of the normal "detector and L.F." receiver is probably one of the main reasons for the very wide popularity of the type, and it is the great merit of the "Star-Turn" arrangement that it preserves this simplicity almost to the full.

How It Works

Although it incorporates two tuned circuits, the scheme only calls for one variable condenser, and so there is still only one dial to be operated. The other circuit (the aerial) is tuned by means of a tapped "selector" coil, and the adjustment here is not at all critical, so that the stronger stations can be picked up with the selector switch set anywhere near the right stud.

In effect, therefore, you still have almost single-dial tuning, since you only move the selector switch at intervals, and just seek for the exact stud for the best strength after you have found your station. It may seem rather paradoxical that the adjustment of the tuned aerial circuit should be so flat when it gives such

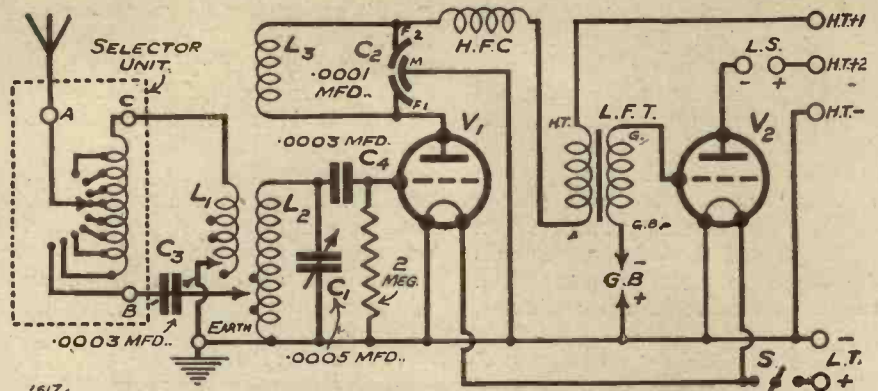

ONE-DIAL TUNING with super-sharpness and selectivity had been regarded as "impossible" until the "Star-Turn" circuit showed the way. Yet fundamentally the set is a "straight" one, and to make the circuit clear we have shown the symbols in the sketches illustrating the parts you need to build the set.

excellent selectivity, yet it is a fact. The flatness, of course, is actually more apparent than real, and is chiefly the result of the special method of tuning adopted.

You can see now how easy a "Star-Turn" set must be to operate, and you will begin to understand how it gets its extraordinary selectivity. The essence of the idea is to have two tuned circuits, of which one is the usual secondary made up of a coil and variable condenser, and the other is the aerial circuit tuned by means of a tapped inductance.

A suitable degree of magnetic coupling is provided between the two

circuits with the aid of a small winding coupled to the secondary and placed in series in the aerial. To enable varying conditions to be met, this coupling winding is provided with a few taps, and that is all.

A Simplified Design

The original "Star-Turn" Three was a moderately elaborate receiver, with wave-change switching and other special features. For our example this month we have produced a design intended to demonstrate almost the simplest way of applying the scheme to a set of a severely plain

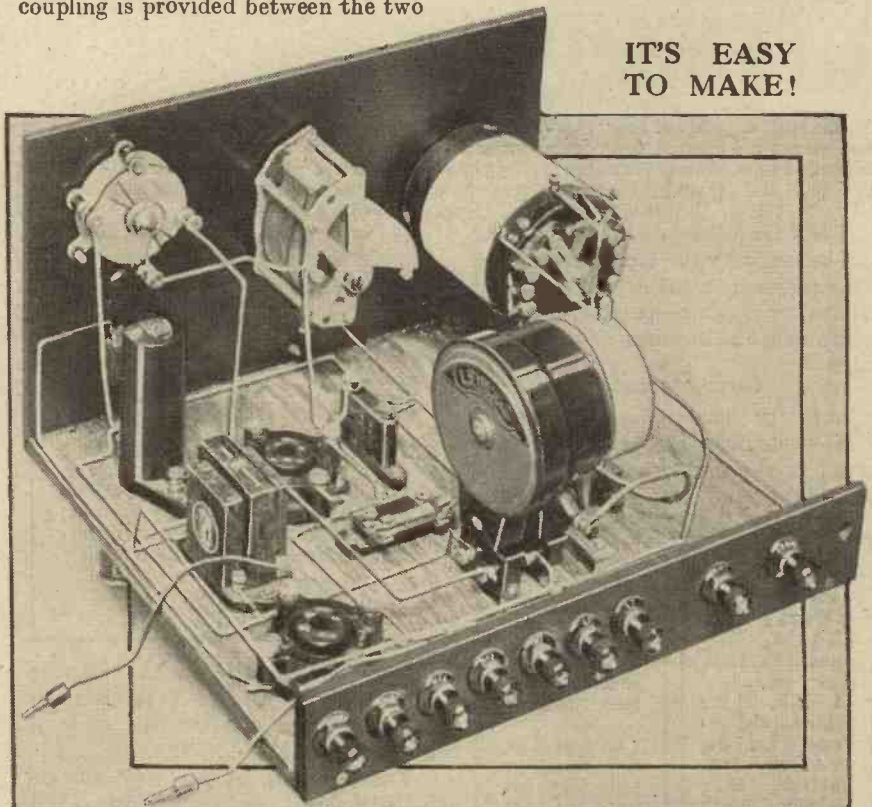

Transformer coupling is used, you see, and even the confirmed adherents of resistance-capacity will have to admit that not only is the power phenomenal, but the purity and fidelity of performance is a revelation of what really modern wireless technique can do for us.

and straightforward type, yet preserving the essential virtues we have enumerated, including that of perceptibly better sensitivity than the ordinary schemes in which the aerial circuit is untuned.

This time, instead of a specially wound unit, we have used plug-in coils for the secondary and reaction windings, and the only special coils are the little aerial coupler, which anyone can make in a few minutes,

coil fits against the side of the secondary. It consists of a little piece of insulating tubing (Pirtoid, Paxolin, or other good material), $2\frac{1}{2}$ in. diameter and about 1 in. in length, and it carries five turns of No. 24 D.C.C. wire (double silk will do just as well, and No. 22 gauge is also suitable), with tappings made at the 3rd and 4th turns.

Any handy method of mounting will do for this coil, so long as it comes

PACKED WITH POWER !

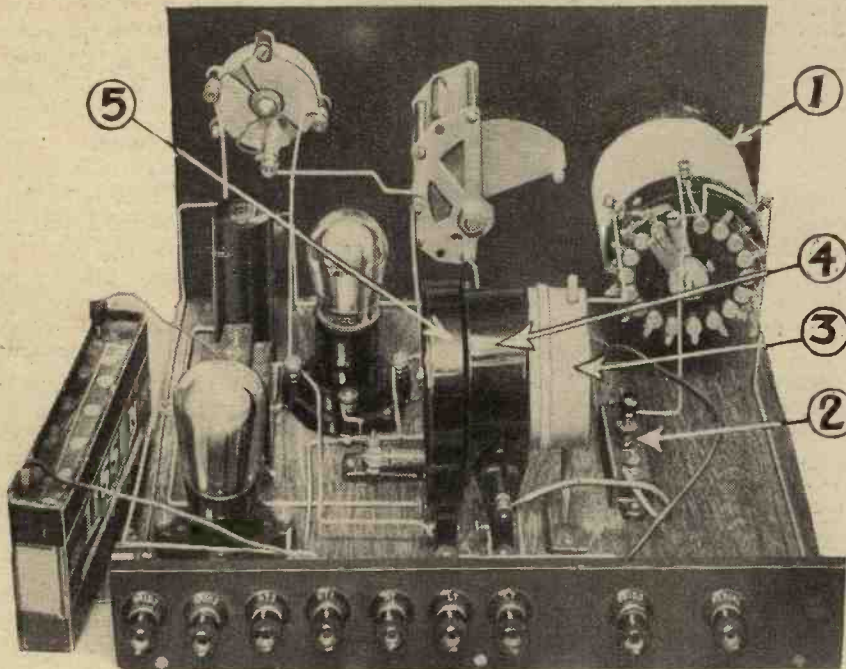

All the special points of the "Star-Turn" Two can be identified in this illustration, which also shows the compactness of layout achieved. (1) The selector unit, and (2) the compression condenser for adjusting long-wave selectivity; (3) is the special coupling coil (L_1), and (4) and (5) represent respectively the grid and reaction plug-in coils.

and the tapped selector. This latter can be made by the more experienced constructor from the details given last month, or it can be purchased ready-made from various firms.

Coil Details

Now for some practical details. The secondary and reaction coils stand in the usual sockets upon the baseboard, and the aerial coupling

close up against the side of the secondary in the way you see in the photos. The original coil was mounted on a

SOME POINTS FOR PURCHASERS

1 "Star-Turn" selector coil (Wearite, Ready Radio, Magnum, Paroussi, etc.).
1 H.F. choke (Lissen, or Lewcos, Lotus, Varley, Dubilier, R.I., Igranic, Ready Radio, Keystone, Wearite, Magnum, etc.).

1 Panel, 12 in. x 7 in. (Paxolin, or Trolite, Goltone, Keystone, etc.).
1 Cabinet to fit, with baseboard 10 in. deep (Pickett, or Keystone, Camco, Lock, etc.).

1 .0003-mfd. (max.) compression type condenser (Formo, or R.I., Lewcos, etc.).

1 2-meg. grid leak and holder (Dubilier, or Ediswan, Igranic, Lissen, etc.).

9 Terminals (Igranic, or Eelex, Belling & Lee, etc.).
1 Terminal strip 12x2 ins.

1 Piece of insulating tube, $2\frac{1}{2}$ in. dia. 1 in. long. Wire, screws, flex, G.B. plugs, etc.

1 .0001-, .00013-, or .00015-mfd. differential reaction condenser (Dubilier, or Ormond, Lissen, Ready Radio, Polar, Lotus, Formo, Wearite, Magnum, etc.).

1 .0005-mfd. variable condenser (Lotus, or Lissen, Ready Radio, J.B., Igranic, Burton, Dubilier Polar, Colvern, etc.).

These and the six sketches below indicate more of the few components required for the "Star-Turn" Two.

projecting so that the clip can be attached thereto when it is desired to include the whole winding in circuit. The direction of the winding does not matter, by the way.

The wave-changing arrangements just call for a word of explanation. To go over to long waves you must change the two plug-ins for larger sizes and set the selector switch right round to the end stud (knob turned fully to the right). This switches the aerial right through to the "B" terminal of the selector coil unit, and cuts out the aerial coupling coil. Therefore, you must use a coil of the "X" type for the secondary on long waves and attach the flex lead from C_3 to one of the "X" tapping points.

For Rough Searching

For the ordinary wave-band the secondary can be of the plain type, but it is interesting to note that an "X" coil can be used here also. If you then connect the flex lead from C_3 to one of the tapping terminals on the "X" coil, you can, if desired, cut out the tuned aerial circuit and have an ordinary single-tuned circuit for rough searching

bit of wooden rod in the manner illustrated in a sketch on another page, and you will find this quite a convenient method.

The tappings, by the way, can be loops twisted up in the wire and scraped bare for engagement with the tapping clip, and the finishing end of the winding should also be left

purposes. To do this, set the selector switch to the end stud as though for long waves, but do not change the coils.

You can then tune-in your station on the condenser dial alone, afterwards turning the selector switch back on to the active studs, so bringing in the special tuned aerial circuit.

Having located the best stud, you will note the great increase in selectivity provided by the "Star-Turn" aerial tuning and coupling method, and a distinct increase in volume on the weaker stations.

coil (this naturally adjusts selectivity), and secondary tuning by the main variable condenser.

Note the compression-type adjustable condenser on the baseboard. This controls the selectivity on long

if a greater degree of selectivity is needed.

There, now you have the gist of the matter before you, and you are ready to go ahead and discover for yourself what remarkable things can be done with a "Star-Turn" receiver. We don't think there is much doubt about the nature of the surprise you will get!

Now for a few miscellaneous operating details for which we find we still have space. First of all, you will have noticed that we specify either an "X" coil or a centre-tapped one for the secondary coil L_2 on long waves, and it should be explained that the choice here depends on the degree of selectivity required.

SIMPLE DRILLING, SIMPLE CONTROLS

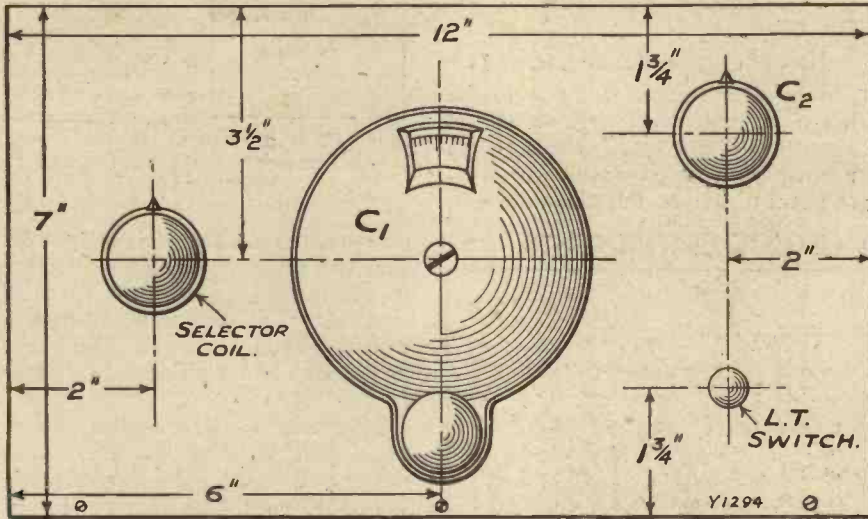

PANEL LAYOUT.

The selector switch controls the aerial, all the real tuning being carried out on C_1 . Above the L.T. switch is C_2 , which governs reaction.

Constructionally, we have only one hint for you, because the set is such a simple and straightforward job that to elaborate further would merely be to waste your time and ours. Our one and only hint is to the effect that you should on no account alter the layout of the coils; "Star-Turn" sets are sensitive to stray couplings, and their proper working is dependent upon these stray effects being kept well down.

waves, or whenever the "X" or centre-tapped coil is being used without the special aerial tuning scheme being employed. Normally this condenser should be set to maximum, and then reduced only

Peculiar Coupling Effects

The "X" type naturally gives weaker aerial coupling and so provides better selectivity, hence it is likely to be the one required whenever the "Star-Turn" Two is being called upon to deal with difficult conditions. When the aerial is a small one, however, it may be possible to use the centre-tapped type with advantage, for the tighter coupling will improve the strength of the long-wave stations so long as it does not bring in too much interference.

On medium and large aerials it is likely to do so, and the interference

WIRE IT IN ONE EVENING!

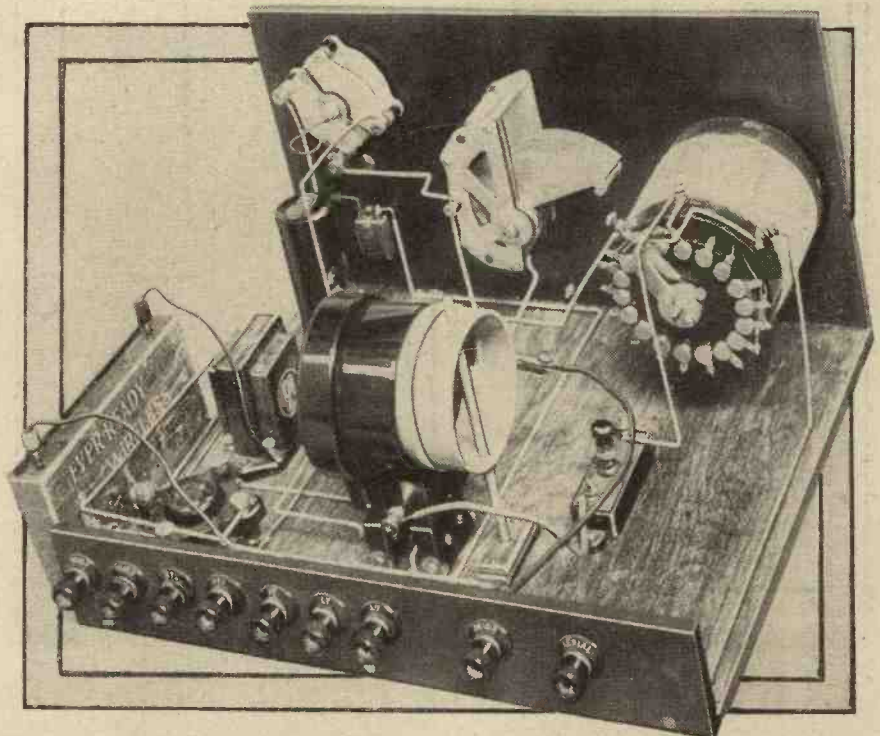

Such is the simplicity of the baseboard and panel wiring that even a novice can "do the necessary" in one evening. And although no room is wasted, there is no crowding or complexity at any point.

Valves and Voltages

Working data you require just in outline, as follows: The detector should be the usual H.F. type, of 20,000 to 30,000 ohms impedance, while for the L.F. stage a small power type is advised. There are separate H.T. terminals for the two valves, and to H.T. + 1 you should apply the usual 60 volts or so, adjusted to give the smoothest reaction, about 100 or 120 volts being required on H.T. + 2.

Here are the coil sizes: the secondary (L_2) will be a No. 60 for the ordinary wave-band (plain or "X"); and a No. 250 ("X" or centre-tapped) for long waves. The reaction coil should be a No. 50 or 75, and 100 or 150 for medium and long waves respectively.

The various adjustments are very simple. Aerial tuning is controlled by the selector switch, coupling by the tapings on the little coupler

will probably show up in a rather peculiar form. The long-wave stations will still tune fairly sharply, but interference will be experienced from the low-wave local station! There is, as a rule, no "tuning" to be observed about this interference, and it is spread right round the dial, just getting a little stronger towards the lower end.

The effect is a rather mysterious one, and is by no means so rare as one might imagine. It appears to occur whenever a rather large aerial coupling winding is in use on the long waves, and is not stopped by

reducing the capacity of the series aerial condenser, hence it does not seem to be entirely a matter of coupling. It is probably something to do with the natural wave-length of the coil or portion of a coil being used for aerial coupling, but considerable further investigation is needed.

Another Peculiar Effect

Just a little interference from the low-wave local at the bottom of the long-wave dial is, of course, quite normal with single-circuit receivers at short distances, but this does not,

FINAL PURCHASES

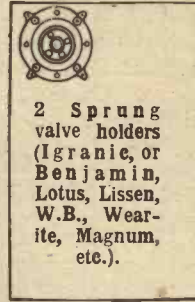

2 Sprung valve holders (Igranie, or Benjamin, Lotus, Lissen, W.B., Wearite, Magnum, etc.).

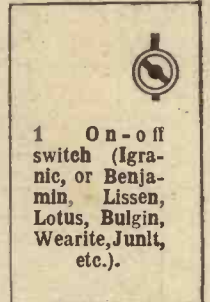

1 On-off switch (Igranie, or Benjamin, Lissen, Lotus, Bulgin, Wearite, Junik, etc.).

In all there are fourteen of these little sketches showing the parts required to make the set.

YOU CAN WIRE AND CHECK FROM THIS

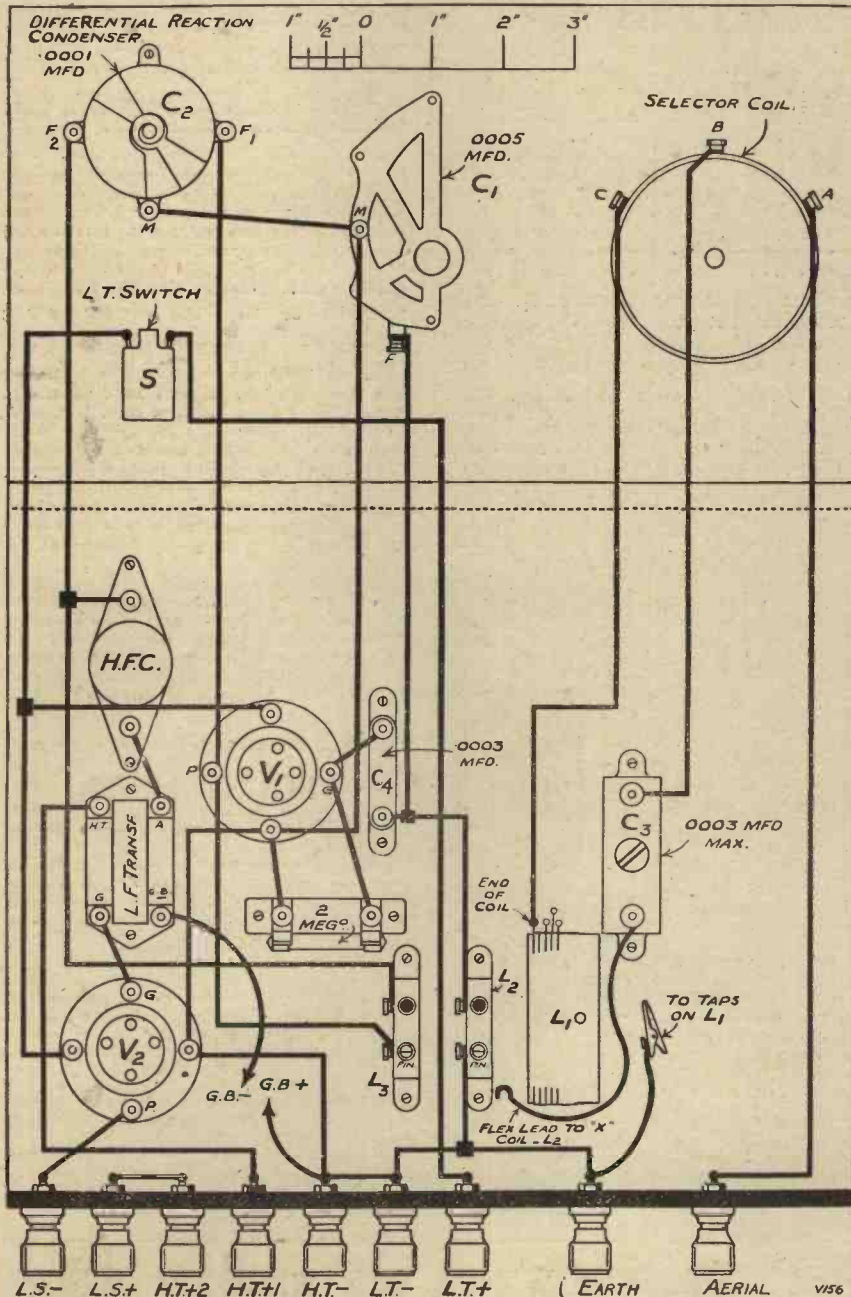

Very careful attention has been paid to spacing, and this can be duplicated accurately if you use the scale "ruler" given at the top of this diagram. Measure with this to find the exact distance between one component and another.

as a rule, cause any serious trouble. This effect, too, is sometimes puzzling to the novice, who doesn't see why if he can tune out the local on low waves, it should come in again when he has tuned to a much longer wave-length.

The main reason, of course, is that when you set the long-wave dial nearly to minimum you have a much less selective circuit than even the equivalent single-circuit arrangement on low waves. Not merely is the H.F. resistance much higher because your coil is so much bigger, but there is very little capacity across the circuit.

Tuning the Locals

Here is a hint we should like to pass on about the treatment of the two Brookmans Park transmissions: At the shorter distances it is not necessary to tune the aerial circuit to get adequate strength from them. You can just put the selector switch at the minimum position (fully to the left), and tune entirely on the variable condenser, getting enough selectivity by virtue of the very weak aerial coupling then available.

NEXT MONTH
IN MODERN WIRELESS
 you will find full details of another fine "Star-Turn" design in the form of a wonderful 4-valve receiver.
DON'T MISS YOUR COPY!

One final tip: If your aerial is a large and high-capacity one you may get better results by keeping a fixed condenser of .001 mfd. or .0005 mfd. permanently in series in the aerial lead.

Before we leave you, let us just remind you that when you start searching for the foreigners you will find it a great help to refer to the "Foreign Programmes" section of "M.W." for the latest information about times, wave-lengths, and so on.

The WORLD'S PROGRAMMES

WHEN, WHERE, AND HOW TO HEAR THOSE FOREIGNERS CONDUCTED BY "D.X."



HAVE YOU EVER TRIED— USING TWO AERIALS?

Sounds a bit funny at first, doesn't it? But you ought to try it!

Keep your present aerial up out-of-doors, and back it up by an indoor aerial made of thin insulated wire. (Old coil-wire will do.)

Then use the indoor aerial for the local programmes. You'll find it's more selective, freer from noises, and less liable to interference.

You can keep the outdoor aerial earthed except when you're "out for foreigners." (It should always be earthed when not in use, anyway.)

And you'll be surprised to find how good an indoor aerial can be. Especially if you insulate it well, as you ought.

Anyway, try it. You lose nothing, and gain experience.

TIPS FOR TUNING

Holding the Dials.

When searching for foreign stations, don't stand up and bend in back-breaking positions in order to read the dial figures. Get a chair. Sit down. Take it easy.

Get accustomed to using one hand for one dial, and the other hand for the other. It's a two-handed job to coax weak foreigners down your aerial. Use

both hands for it. (You'll wish you had three hands before you've finished with some stations!)

Notice how reaction and tuning are inter-dependent. When tuning "goes up," you have to increase reaction a bit. When the tuning comes down you need less reaction.

Hold the outer edge of the dial—not just the centre. You get a bigger leverage that way, and so can make finer adjustments. [A little point, perhaps, but it makes a big difference.]

Go slow. Use a pencil and paper. Remember "Rome wasn't tuned-in in a day," but YOU can get him at night, because that's the best time for reception.

Finally, keep cool—and keep a log!

PILLORIED PROGRAMMES

When a certain wave-length is allotted to a broadcasting station that station should stick to it. But among the stations recently in disgrace for wave-length-wobbling were:

Station	Found trespassing on	Extent of wave-length wobble
Belgrade (Yugo-Slavia)	428.5 metres	1.5 metres
Rabat (Morocco)	416 "	4 "
Hamar (Norway)	566.1 "	3.9 "

Even if you can't hear what is said, nor understand the language, you need never despair of identifying a foreign station. For many of them have musical call-signs, which are intended to let long-distance listeners know the source of the sounds.

Hammer Strokes on an Anvil is the pleasing and distinctive sign of Katowice, Poland. The sounds indicate the industrial nature of the neighbourhood.

Sleigh Bells, softly striking, are the sign that you are listening to Cracow.

The Cuckoo's Call has been chosen by two widely separated stations, and is probably the most easily recognised of all musical calls. The stations in question are Leningrad (Russia), 1,000 metres, and Ljubljana (Yugo-Slavia), 575 metres.

A Huntsman's Horn is the novel and attractive sign of Wilno, Poland.

A Melodious Gong, struck seven times per minute, denotes that you are listening to the Turkish station at Stamboul (sometimes spelt Istanbul). This station is particularly difficult to identify otherwise, as it shares a wave-length (1,200 metres) with the Swedish station at Boden.

Turin's Nightingale

The Nightingale's Song has been chosen as a musical interlude sign by Turin, Italy. It is played on a gramophone with electrical pick-up, and is a very effective station-marker at most seasons of the year. But this very pleasing call has the disadvantage that it may be confused by British and other stations which relay the actual nightingale's song as a "stunt" broadcast.

Loud-Ticking Clocks, or metronomes, are employed by many Continental stations, and usually the number of ticks per minute will enable the station to be identified. (More about these tell-tale tick-tocks next month.)

WHEN TO LISTEN

Time is important in radio, because the sun affects reception. Ordinary wireless waves are received twice as well after dark. That's one reason why enthusiasts sit up late!

Another reason is that you get far better reception when the local station closes down. For generally the local oscillator shuts up at the same time! (Bad dreams to him!)

But the funny thing is that some of the short-wave stations get over better in daylight. And the real long-wave stations are pretty good in daylight, too—they don't fade with the sun half as badly as medium waves.





Wave-length in metres.	Name of Station.
453	Aachen (Germany)
453	Aalesund (Norway)
301	Aberdeen (2BD)
311	Agen (France)
364.5	Algiers (Algeria)
251	Almeria (Spain)
1961	Ankara (Turkey)
511	Archangel (Russia)
560	Augsburg (Germany)
268	Barcelona Radio Catalana
349	Barcelona (Spain)
1010	Basle (Switzerland)
242	Belfast (2BE)
430	Belgrade (Yugoslavia)
364	Bergen (Norway)
283	Berlin Relay
418	Berlin (Witzleben)
403	Berne (Switzerland)
228.4	Biarritz (Côte d'Argent)
218	Bjorneborg (Finland)
1200	Boden (Sweden)
453	Bolzano (Italy)
231	Borås (Sweden)
304	Bordeaux (Lafayette)
238	Bordeaux-Sud-Ouest
288.5	Bournemouth (6BM)
288.5	Bradford (2LS)
279	Bratislava (Czechoslovakia)
319	Bremen (Germany)
325	Breslau (Germany)
342	Brno (Czechoslovakia)
509	Brussels (No. 1)
338.2	Brussels (No. 2)
394	Bucharest (Roumania)
550	Budapest (Hungary)
335	Cadiz (Spain)
310	Cardiff (5WA)
246	Cartagena (Spain)
246	Cassel (Germany)
235.5	Charleroi (Belgium)
227	Cologne (Germany)
281	Copenhagen (Denmark)
224.4	Cork (6CK)
313	Cracow (Poland)
453	Danzig (Germany)
1554	Davenport, National
479	Davenport, Midland Regional
319	Dresden (Germany)
413	Dublin (2RN)
288.5	Dundee (2DE)
288.5	Edinburgh (2EH)
246	Eskestuna (Sweden)
298.8	Falun (Sweden)
214	Fécamp Radio
218	Flensburg (Germany)
390	Frankfurt-on-Main (Germany)
385	Fredriksstad (Norway)
570	Freiburg-im-Breisgau (Germany)
204	Gävle (Sweden)
760	Geneva (Radio-Genève)
385	Genoa (Italy)
399	Glasgow (5SC)
253	Gleiwitz (Germany)
322	Goteborg (Sweden)
352	Graz (Austria)
329	Grenoble (France) PTT
216	Halmstad (Sweden)
231	Hälsingborg (Sweden)
570	Hamar (Norway)
372	Hamburg (Germany)
566.1	Hanover (Germany)
221	Helsinki (Finland)
298.8	Hilversum (Holland)
1071	Hilversum (Holland)
257	Horby (Sweden)
270	Hudiksvall (Sweden)
1875	Huizen (Holland)
288.5	Hull (6KH)
283	Innsbruck (Austria)
1200	Istanbul (Turkey)

Europe's Broadcasters

Wave-length in metres.	Name of Station.	Wave-length in metres.	Name of Station.
202	Jonköping (Sweden)	263	Moravska-Ostrava (Czechoslovakia)
270	Kaiserslautern (Bavaria)	1481	Moscow (Old Komintern)
246	Kalmar (Sweden)	938	Moscow (Trades Union)
1153	Kalundborg (Denmark)	1103	Moscow (Popoff)
196	Karlskrona (Sweden)	497	Moscow
218	Karlstad (Sweden)	720	Moscow (Experimental)
408	Katowice (Poland)	450	Moscow (RA2)
1935	Kaunas (Lithuania)	1348	Motala (Sweden)
427	Kkarkov	533	Munich (Germany)
1304	Kharkov (Russia)	234	Münster (Germany)
246	Kiel (Germany)	332	Naples (Italy)
800	Kiev (Russia)	288.5	Newcastle (5NO)
246	Kiruna (Sweden)	248	Nice (Juan-le-Pins)
453	Klagenfurt (Austria)		(France)
276	Konigsberg (Germany)	840	Nijni Novgorod (Russia)
1635	Konigsbustherhausen (Germany)	239	Nimes (France)
293	Kosice (Czechoslovakia)	270	Norrköping (Sweden)
203	Kristinehamn (Sweden)	445	Notodden (Norway)
1796	Lahti (Finland)	1116	Novosibirsk (Russia), RA33
473	Langenberg (Germany)	239	Nürnberg (Germany)
680	Lausanne (Switzerland)	237	Orebro (Relays Stockholm)
200	Leeds (2LS)	218	Örnsköldsvik (Sweden)
259	Leipzig (Germany)	493	Oslo (Norway)
1000	Leningrad (Russia)	770	Östersund (Sweden)
351	Leningrad (Russia)	314	Oviedo (Spain)
280	Liège (Belgium)	447	Paris (Ecole Supérieure), PTT
265.4	Lille (PTT)	1445.7	Paris (Eiffel Tower), FL
293	Limoges (France)	329	Paris (Poste Parisien)
246	Linz (Austria)	370.4	Paris (Radio LL)
288.5	Liverpool (6LV)	1725	Paris (Radio-Paris), CFR
574.7	Ljubljana (Yugoslavia)	308	Paris (Radio-Vitus)
356.3	London (Regional)	778	Petrozavodsk (Russia)
261.3	London (National)	246	Pietarsaari (Jakobstad) (Finland)
234	Lodz (Poland)	288.5	Plymouth (5PY)
223	Luxembourg	453	Porsgrund (Norway)
385	Lwow (Poland)	335	Poznen (Poland)
466	Lyons, La Doua (France), PTT	487	Prague (Czechoslovakia)
286	Lyons (Radio Lyon)	412	Rabat (Morocco)
424	Madrid (Union Radio), EAJ7	219	Radio-Beziers (France)
283	Magdeburg (Germany)	272	Rennes (France)
436	Malmberget (Sweden)	525	Riga (Latvia)
231	Malmö (Sweden)	445	Rjukan (Norway)
377	Manchester (2ZY)	441	Rome (1RO)
316	Marseilles (PTT)	1073	Rostov/Don (Russia)
501	Milan (Italy)	246	Säffe (Sweden)
700	Minsk (Russia)	453	Salamanca (Spain)
286	Montpellier (France)	459	San Sebastian (Spain)

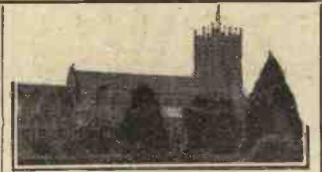

Wave-length in metres.	Name of Station.
250.9	Schaerbeek (Brussels)
368	Seville (Spain)
288.4	Shffield (6FL)
476	Simferopol (Russia)
565	Smolensk (Russia)
175	St. Quentin (France)
283	Stettin (Germany)
436	Stockholm (Sweden)
288.4	Stoke (6ST)
360	Stuttgart (Germany)
542	Sundsvall (Sweden)
288.4	Swansea (5SX)
296	Tallin (Reval) (Estonia)
453	Tampere (Tammerfors) (Finland)
870	Tiflis (Russia)
255	Toulouse (France), PTT
381	Toulouse (Radio du Midi)
270	Tromhättan (Sweden)
453	Trois (Norway)
291.1	Turin (Italy)
246	Turku ABO (Finland)
283	Uddevalla (Sweden)
231	Umeå (Sweden)
453	Uppsala (Sweden)
283	Varberg (Sweden)
517	Vienna (Rosenhügel)
291	Vilpuri (Viborg) (Finland)
1411	Warsaw, No. 1 (Poland)
214.2	Warsaw, No. 2 (Poland)
385	Wilno (Poland)
308	Zagreb (Yugoslavia)
459	Zürich (Switzerland)

SOME SHORT-WAVERS

99	Motala (Sweden)
80	Rome (Italy)
54-02	New York City
49-67	New York (W2XAL)
49-4	Vienna
49-34	Chicago (Ill.)
49-34	Newark (N.J.)
49-15	Bound Brook (N.J.)
49-02	Richmond Hill (U.S.A.)
48-86	Pittsburgh East (W8XK)
48-8	Manila (Philippine Is.)
43	Madrid (EAR)
42	Perth (Australia)
41	Radio Vitus.
34-68	Long Island (N.Y.)
34-68	Oakland (California)
32-5	Sydney (2BL)
32-5	Paris (Eiffel Tower)
32	Berne (Switzerland)
31-8	Poznan (Poland)
31-6	Lyngby (Denmark)
31-48	Schenectady, N.Y. (W2XAF)
31-38	Zeesen (Germany)
31-28	Eindhoven (Holland)
31-28	Philadelphia (Pa.)
31-28	Sydney, 2FC
31-25	Bergen, LGN
31	Nairobi (Kenya)
	Relays G5SW
29	Paris Experimental
26-1	Manila K1XR
25-6	Winnipeg (Canada)
25-53	Chelmsford (G5SW)
25-4	Rome (Italy), 3RO
25-25	Pittsburgh East (W8XK)
19-72	Pittsburgh East (W8XK)
19-56	Schenectady (W2XAD)
16-88	Huizen (Holland)
16-8	Bandoeng (Java)
16-3	Kootwyk (Holland)
15-94	Bandoeng (PLE)



WAVE-TRAP WRINKLES

When once a good wave-trap is set it remains set for good—yet scores and scores of listeners never set their traps properly.

The first time a wave-trap is put into commission you should study the directions which accompany it, and *carefully* try to carry them out. Half the "unsatisfactory" wave-traps that one hears about have never had a chance because they have never been adjusted properly to begin with.

The commonest fault in wave-trap working is too-hasty adjustment.

HOW TO ADJUST IT

As the trap needs adjustment only once, this operation should be carried out *slowly*, patiently, and painstakingly.

Many wave-traps employ compression-type variable condensers, with screw-down adjustments. It is

very easy to tune too fast with these, especially if the control-knob is slotted (for a screwdriver).

It is usually easier to find the exact cut-out setting when the programme is not too loud, so you should "dim" the first valve, or shorten the aerial, temporarily, or otherwise weaken reception until the trap has been adjusted.

EXIT "THE LOCAL"

And once it's adjusted properly it need never be altered. It will always put the lid on the local, with speed and certainty. (You can arrange a switch to control it if you like.)

But, remember, a wave-trap is just a time-waster and money-gobbler unless you adjust it properly to begin with. And that's not the wave-trap's fault. Nor mine. That's *your* fault.





Station Information

TRIESTE. Work has commenced on the site for the new station.

HUIZEN is being "gingered up," the improvements including new valves and higher masts.

RADIO ALGIERS is broadcasting English talks at 9.45 p.m. on Mondays, Wednesdays, and Fridays.

MUNICH will in future relay church bells at 11 a.m. on Sundays, instead of the town-hall clock chimes

TORONTO'S orchestral music is being relayed on Wednesday and Sunday evenings by the following American stations: W J Z, W B Z A, W B Z, W H A M, K D K A, and W J R.

STROMBEEK (BELGIUM) has recently been broadcasting tests from a new aerodrome station, on about 900 metres.

PARIS short-wave experimental transmissions are being sent on increased power (1.2 kw.) from 7.30 p.m. to 9 p.m., on a wave-length of 29 metres, instead of 31.6.

PRAGUE AND BRNO are planning to continue their broadcasting till midnight from now till September.

EIFFEL TOWER is to be used every half-hour by the French police for short-wave broadcasts (on various wave-lengths).

The receiving stations for this radio-network will be established all over France.

MOSCOW is so badly received here, owing to heterodyning, etc., that extensive alterations are planned, and Russia may even co-operate with the rest of Europe in the working of the "Prague Plan."

NAIROBI, 7 L O, the Kenya Colony short-wave station, has recently been received so strongly in Melbourne that listeners have mistaken it for the local station.

SCHENECTADY, N.Y. (W2XAF), has recently been conducting short-wave tests with a new Melbourne station.



powerful broadcasting station soon, if proposals now before the Government are accepted.

WILNO (Poland) at present well received in this country, is to increase its power to 16 kw.

TOKIO has just finished an international receiving station for picking up European broadcasting. Plans for a Japan-to-Europe transmitter are now being discussed.

NAPLES has recently been trying out a new interval signal, which takes the form of a sixteen-note musical scale.

KONIGSWUSTERHAUSEN (near Berlin) is now being well received in America (via the short-wave relay) where he is popularly known as "The German Jaw-Breaker"!

NAUEN (Germany) was recently used as a link between Batavia (Java) and Buenos Aires (Argentine) for telephonic radio tests.

MONTREAL has been successfully trying telephone tests with the Montreal-Chicago express train.

BOSTON, MASS. (W E E I) has inaugurated a series of combined television and short-wave radio tests.

STATIONS YOU HAVE HEARD— MADRID

The capital of Spain, Madrid stands proudly on a central plateau. Has stood—high and aloof—for centuries.

Long held by the fanatical Moors, it was wrested from them finally in 1084. And Wellington captured it from the French as recently as 1812.

In turn enriched by Spanish adventurers and impoverished by wars, it is a city with a strange past.

Population: 650,000.

Madrid's broadcasting station opens with "Siegfried's Bugle-Call" Theme, from the opera of that name, and closes with the Spanish National Anthem.

WAVE :
424
METRES.



POWER :
2
KW.

MUNSTER, the new Swiss-Regional station (not to be confused with Munster, Germany), is to work on 459 metres, with a power of 60 kw.

SYDNEY, 2 B L, the famous Australian station, now has its studio in the same building as Sydney 2 F C, the latter being run by Amalgamated Wireless, and 2 B L by the Government.

BUDAPEST (550 metres) is famous for its University clock-chimes, broadcast at noon daily, on a power of 20 kw.

VIENNA has special programmes arranged for the first two weeks of June, which is the Vienna Festival Fortnight.

CANBERRA, the Australian Federal Capital, is to have a

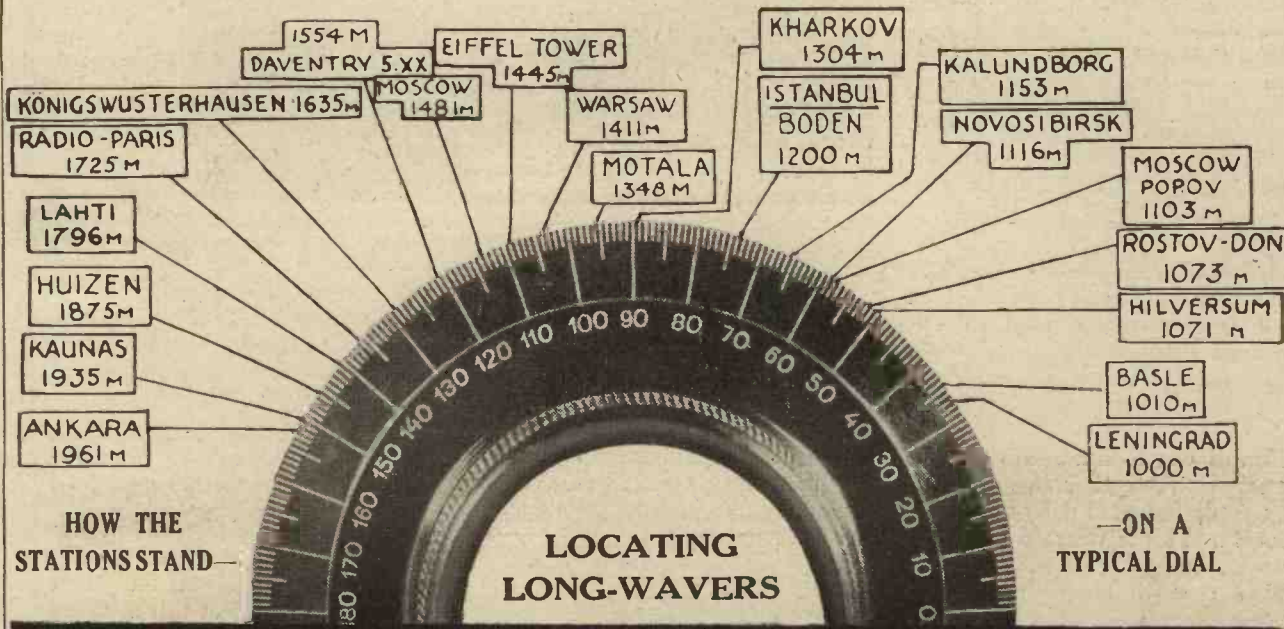

TROUBLE TRACKING



On this page the Chief of the "M.W." Query Dept. discusses, month by month, some of those common difficulties and troubles which can be so perplexing. This month he explains how very helpful it is to be able to check the various voltages, and also the anode currents taken by the valves.

THE old saying that prevention is better than cure holds good in radio as in most other things.

Have you ever realised how very valuable a couple of meters can be?

It is true that good instruments are not cheap, but after all they last a lifetime and will be found invaluable by all those who desire to keep their receivers in the "pink."

Voltage Drop

A moving-coil voltmeter is almost an essential if one wishes to keep a watchful eye on the condition of the H.T. batteries. In any set of the loud-speaker type it is necessary to supply the valves with their correct voltages.

The usual "hit and miss" scheme is satisfactory up to a point, but it is much better to know exactly what values are being applied to the different H.T. terminals.

A voltmeter enables you to check the voltages under load, that is, after the receiver has been working for some time.

It is a well-known fact that an H.T. battery of the dry-cell type tends to drop in voltage when it has been in use for a while.

This drop takes place after a few weeks if the battery has been supplying current consistently over that period, and increases as the cells become exhausted.

Choose the Right Type

When the set is first switched on the battery gives its rated voltage, and then perhaps after a couple of hours distortion commences or instability and loss of volume take place.

How is one to know whether the battery is at fault unless there is some ready means of determining the voltage? This is where a voltmeter is so helpful.

Take care to choose a suitable instrument. There are moving-iron

and cheap, low-resistance types on the market which not only give inaccurate readings but also consume far too much current.

L.F. Troubles

The correct type is one with a high-resistance winding taking not more than, say, fifteen milliamps at full-scale deflection.

You can obtain a suitable instrument for about 30s., and it is advisable to choose a scale giving a reading of 150 volts, because you will then be in a position to check your maximum H.T. voltage.

If, for example, the battery reading was originally 120 volts, and then afterwards on test is found to have dropped to 90 volts, it is practically certain that the cells are in a condition to produce instability.

Sometimes some of the cells may become faulty. If so the voltmeter will enable you to determine which ones are below standard and these can be cut out of circuit.

Measuring Anode Currents

The second exceedingly useful instrument is a milliammeter. For an ordinary set which utilises a super-

CHECK YOUR H. T. VOLTAGES REGULARLY

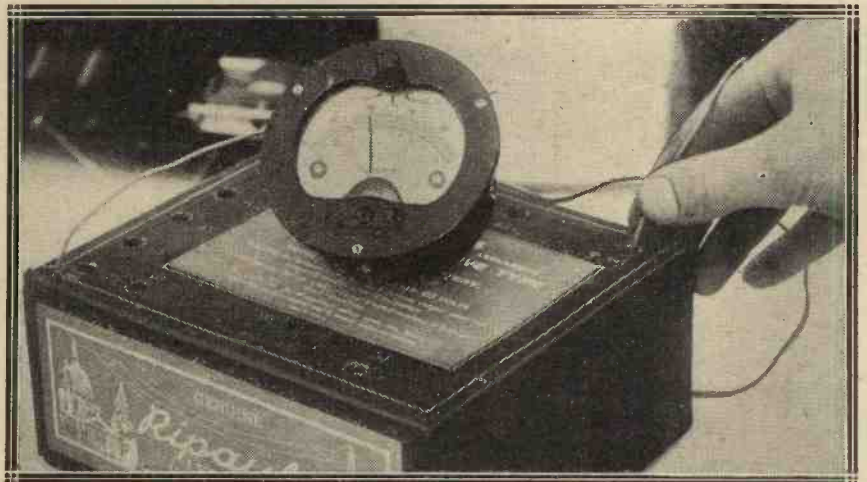

Many puzzling faults are caused by a partly run down H.T. battery. A good high resistance voltmeter will tell you the condition of your battery at once, and so enable you to avoid trouble.

Armed with a good voltmeter there is little excuse for troubles such as L.F. howling or poor signal strength due to a partially run-down H.T. supply. In nine cases out of every ten, distortion and whistling on the low-frequency side of a receiver are caused by the internal resistance of the H.T. battery.

This will be shown on the voltmeter by a drop in voltage across the H.T.+ and H.T.— terminals.

power valve a maximum scale reading of 25 milliamps is adequate.

With the help of a milliammeter you can check the anode currents taken by the various valves and tell immediately if any of them have lost their emission.

When the valves begin to get old the anode current will tend to decrease, and at the same time the signal strength will fall off. A milliammeter enables you to detect this at once.

Resistance-Capacity Push-Pull

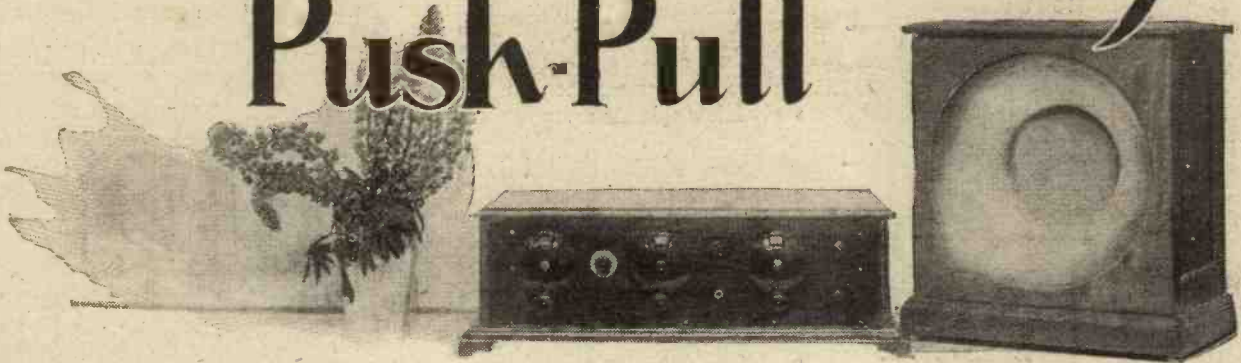

I HAVE for some time been working on the question of getting push-pull resistance-coupling straight from the detector valve without the intermediary of an input transformer.

Usually, if you want to employ R.C. in push-pull you have to use an input transformer first. If we do not, how can we get the phase reversal necessary to give push-pull with a resistance?

PUSH-PULL DETECTORS

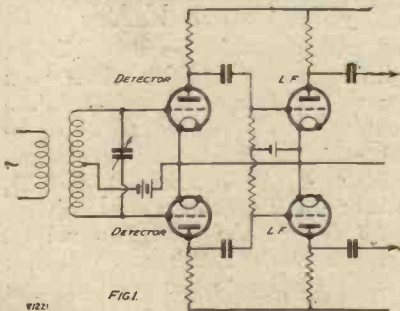

Although at first sight this appears an easy way of obtaining R.C. push-pull, actually only the H.F. component is working in push-pull.

At first I thought that the solution was a simple one, viz., push-pull a couple of detectors, as shown in Fig. 1, with R.C. coupling to the first L.F. valve, and the job was done. But when I came to test it out I found that it was not working in push-pull, but that the effect was as if the valves were in parallel.

Merely in Parallel

When I came to look into the circuit more closely I found what was happening. The detector valves are in push-pull merely as regards the H.F. component of the carrier.

The problem of obtaining push-pull amplification without the use of transformers has long claimed the attention of radio engineers. Some of the difficulties that have to be overcome before a solution is reached are described here.
By P. C. BAKER.

When engaged in rectifying (anode-bend for choice, since this is potential-operated rectification and not current-operated like cumulative grid), the two audio-frequency components in the output circuits of the two detectors are not out of phase except as regards half-cycles at radio-frequency. This frequency it is obvious is negligible at audio-frequencies and, therefore, the two lots of speech frequencies can be regarded as being exactly in phase.

An Easy Matter

The push-pull arrangement shown in this figure either pushes or pulls, but does not do both.

Of course, with a gramophone pick-up the problem is an easy one. You simply connect the pick-up across a couple of equal resistances placed in series, as indicated in Fig. 2, and you can then use as many stages of resistance-coupling as you like.

If you want to use a volume control on the input, then a potentiometer can be used by the addition of a couple of condensers and leaks, as shown in Fig. 3, at C_1 , C_2 , and R_2 , and R_3 .

Here we still have our push-pull circuit while retaining the conventional potentiometer volume control at R_1 .

However, to return to the question of the radio set which we want to push-pull with R.C. coupling.

What is Required

If we could arrange that either the common point of the resistances RR or the potentiometer R_1 in Figs. 2 and 3 respectively was the output resistances of a detector valve, the solution to the problem would be found. (In the case of Fig. 2, condensers and leaks would, of course, have to be incorporated in the usual manner.)

There is a way in which we can do it, but only one unfortunately, and that is by having a separate L.T. and

FOR PICK-UPS.

When using a gramophone pick-up it is an easy matter to arrange the input of a push-pull R.C. amplifier by means of two resistances.

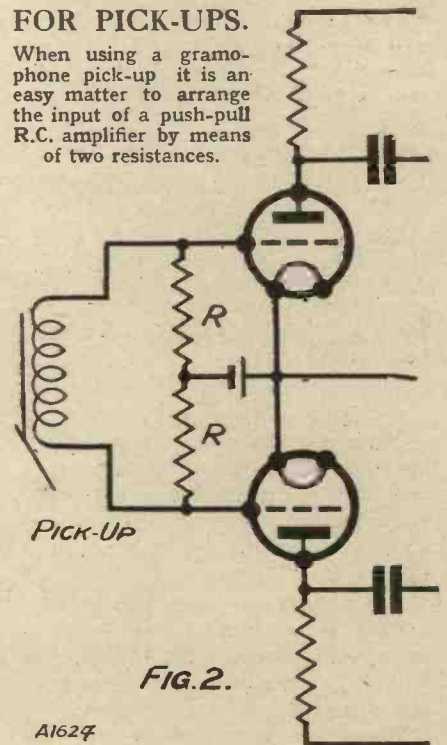

H.T. battery for the detector stage. The way this scheme would be used in actual practice is shown in Fig. 4. $L_1 C_1$ is the detector-tuned circuit, anode-bend or leaky-grid rectification being used, whichever you prefer (anode-bend is shown).

Volume Control

Here is a simple way to arrange a volume control with a pick-up when following it by R.C. push-pull.

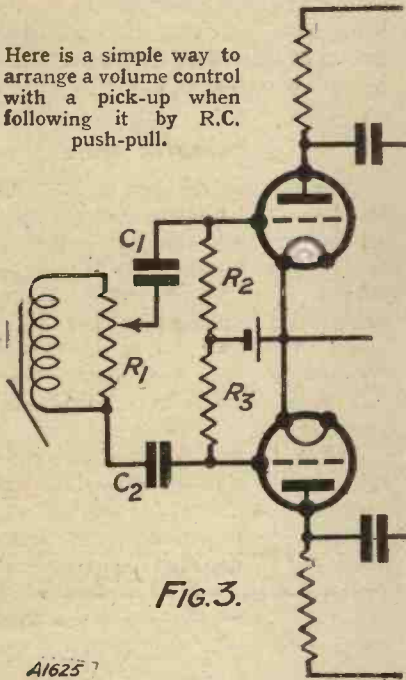

FIG. 3.

A1625 7

In the anode circuit of the valve are connected two resistances, R_1 and R_2 , in series, or else a single centre-tapped resistance. So that the resistance shall be at a low H.T. potential, I have connected the H.T. battery on the anode side of the resistances.

The two grid condensers, C_1 and C_2 , for the push-pull arrangement are connected to the outer ends of the two resistances, while the grid return is taken from the centre point between the two grid leaks and the centre-tap on the resistance.

Just as a precaution a large fixed condenser C_3 is connected at this point.

Eliminating Hum

On the face of it it may seem ridiculous to expect anybody to have a special set of batteries for the detector stage, but let us look at the question in an unbiased manner.

Many sets are worked with H.T. eliminators. If there is any hum, in nine cases out of ten it originates in the detector stage. By using a separate battery here the hum will be cut out.

If anode-bend detection is used the detector plate current will seldom exceed about 1 milliamp, or 2 at the very outside, so that the smallest

capacity battery will do for the job, as the small amount of current taken will hardly run it down at all.

Since a separate L.T. battery will be needed, it will be preferable from the point of view of expense and bulk to have a 2-volt battery and a 2-volt detector valve. All the better. The lower the filament voltage the sharper is our rectifying curve, and less curvature on that part of the characteristic used for rectification the more truly faithful is the reproduction given by the set.

If the set is one that is worked entirely from A.C. mains there are two ways of incorporating this circuit. One is to use separate batteries as described; and in this case I think very marked results in the reduction of hum will be experienced, for the detector is extremely sensitive in all A.C. sets to the generation of hum.

Another Method

The second is to have a separate H.T. eliminator for the detector H.T.; and as an indirectly-heated cathode valve will probably be used, the separation of its cathode from the others will be all that is necessary to effect the desired alteration.

As a guide to those who wish to try out this system I give two circuits in Figs. 5 and 6 respectively. The first is an entirely battery-operated set, while the second works altogether from A.C. mains. Both are four-valve sets incorporating one S.G. H.F. stage, detector, and two L.F. stages.

To turn to Fig. 5 first, the tuning coils and condensers will have the usual values for the two wave-bands.

Apart from the provision of the separate L.T. and H.T. batteries for the detector, the only point to notice is the fixed condenser C_4 between the bottom of the tuned circuit $L_3 C_3$ and the L.T. negative busbar, which is,

of course, the return path for grid and anode circuits of the H.F. valve. This must be put in to complete the H.F. anode circuit.

Anode-bend rectification is used in the ordinary way, and the two coupling resistances R_1 and R_2 will have a value of 150,000 to 200,000 ohms each when the detector is a high-mu R.C.

A PRACTICAL SCHEME

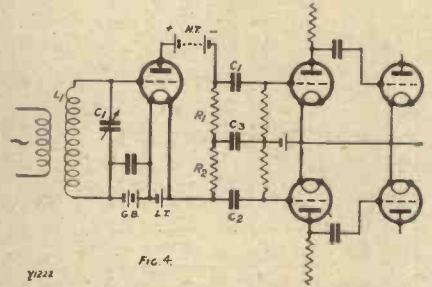

FIG. 4.

By using separate batteries for the detector valve, it can be followed by resistance-capacity push-pull in much the same way as can a gramophone pick-up.

valve, or 50,000 to 60,000 ohms each with an H.F. valve, i.e. a valve such as the D.E.5B, P.M.5X, or similar valves in the various voltages.

As a 2-volt valve will probably be used, then one of the D.E.H. valves, or else a P.M.1A, will be correct for use with the higher resistances, and the H.L. class or the P.M.1 H.F. will be right for use with the lower values of resistance.

Use Power Valves

I, myself, would use a D.E.H.210, with values of 200,000 ohms each for the resistances R_1 and R_2 . The coupling condensers C_6 and C_9 will be .01 each, preferably mica dielectric, while the H.F. stoppers R_5 and R_6 will be .25 megohm each.

As regards the next two valves, these should be R.C. power valves of a type similar to the L.S.5B, with suitable resistances in the plate circuits.

BATTERY-DRIVEN R.C. PUSH-PULL CIRCUIT

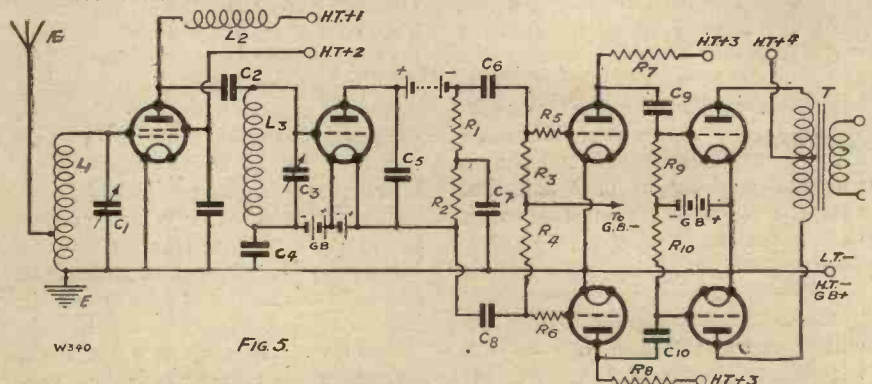

FIG. 5.

This arrangement comprises an S.G. H.F. amplifier, a detector valve with separate H.T. and L.T. batteries, and two stages of push-pull L.F. amplification.

An All-Mains R.C. Push-Pull Set

If you have plenty of H.T. available these valves should certainly be used. At the same time, these are expensive valves, and if you are satisfied to get rather less magnification you can

are not rated at the same voltage as the last valves. The latter will need to have the very highest allowable voltage to handle the volume delivered to them.

The points to note are that the heater of the detector valve is supplied by a separate filament winding, and the H.T. for it by a separate eliminator, the bias for rectification being obtained by a resistance in the cathode return shown at R_2 (shunted by the condenser C_6).

NO BATTERIES WHATEVER ARE REQUIRED

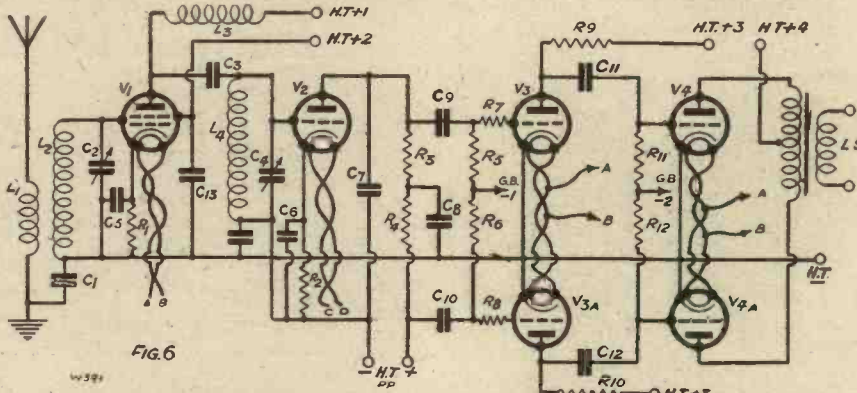

This set is very similar to the circuit shown in Fig. 5, but instead of being run from batteries a mains unit is employed. Separate H.T. and L.T. supplies are still necessary for the detector.

use a couple of P.625's, or equivalent valves, with 30,000- or 40,000-ohm resistances for R_7 and R_8 .

With these lower values of coupling resistances you will need larger coupling condensers C_9 and C_{10} , and these should be .1 mfd. each, while the grid leaks R_9 and R_{10} should not be more than 250,000 ohms, especially if large output valves are used, such as the L.S.6A, or similar valves.

The output coupling may either be a transformer, as shown, or else a centre-tapped choke can be employed. Personally, I prefer the transformer, because a ratio suited to your loud speaker is more easily obtained.

As regards operating voltages, the screen grid should be given 150 volts H.T. if you can manage it, for the increase in amplification obtained by the increase to this value from 100 or even 120 volts is very marked. The detector should have not less than 100 volts, and more if it can be managed.

Cheap Battery Will Do

The very cheapest little battery will do here, for the H.T. current consumption is negligible. The grid-bias battery for the detector will not need to be more than 1½ to 3 volts, depending on the H.T. In most cases 1½ volts will be found to be ample.

The two L.F. stages should both have ample H.T., and, in view of the voltage drop across R_7 and R_8 , H.T. + 3 could have the same value as H.T. + 4, even if the first L.F. valves

Now we come to the A.C. version of this circuit. This is shown in Fig. 7, which gives the receiver circuit as distinct from the eliminator circuit.

H.T., L.T. AND G.B. FROM THE MAINS UNIT

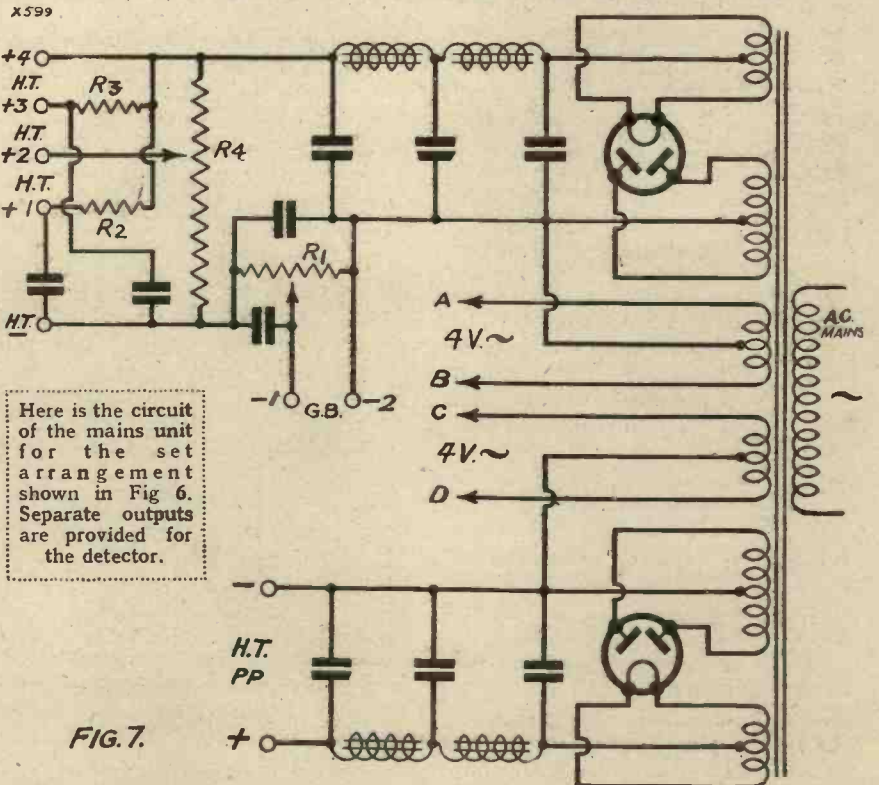

Here is the circuit of the mains unit for the set arrangement shown in Fig. 6. Separate outputs are provided for the detector.

FIG. 7.

This circuit is more or less the same as the Fig. 5 circuit, only A.C. valves are used and automatic bias obtained on the H.F. and detector valves.

Automatic Bias

This method of getting the bias should be satisfactory here, since a separate filament winding is employed. In any case, a single 1½-volt cell, connected as in Fig. 5, won't take up much space if you prefer to use it.

All the other valves have their filaments fed from a common winding AB, and the H.T. by another eliminator.

In Fig. 7 you will see the eliminator circuit. This is all quite straightforward. H.T. PP for the detector does not need to deliver any appreciable current, so that the appropriate H.T. winding on the transformer can be the thinnest of wire and a small valve used.

Although I have shown a full-wave rectifier, a single-wave would probably do, and would be cheaper.

This "Talks"



Dr. Eckener, of the Graf Zeppelin, broadcasting a topical talk on the future of airships from London.

By
**SIR JOHN
REITH**

less as one does with most other things. When listeners have learnt to make appointments in this way it will be much to their advantage and to the advantage of those who frame the programmes. One can understand, however, why so many failed to participate in this event.

Epoch-Making Event

Unfortunately it happened in that period of the day which, for a considerable proportion of the population, witnesses the confused conglomeration of the end of breakfast, the mutual admonitions and farewells, the preparation for the road, and the achievement of the proper train to town.

Over this crowded and difficult period was super-imposed that epoch-making and astonishing experience. For thus it certainly can be described. We heard the two Prime Ministers introduced to each other

I HAVE just been broadcasting. A talk. A talk about talks. Not a particularly inspiring subject on the face of it. A controversial one, of course, and interesting, and important. Moreover, it is one to which the Editor of this journal periodically directs his attention, and on which he has, every now and again, a good deal to say. Some of it he has recently been saying in what he would presumably describe as his esteemed contemporary, "The Listener." At least, I trust he would so describe it, whatever sentiments he actually entertains towards it.

Is There a Problem?

So this "talks" business is somewhat on my mind at the moment. But not only because I had to give a talk about it—an unusual and distracting procedure. I am normally pretty closely in touch with what is happening or proposed, but naturally had to go into things more closely recently to enable me to talk about it at all. Then I am finding the subsequent correspondence interesting, and even illuminating.

I have, in fact, been studying the whole talks problem and getting a good deal of information about it. The Editor will observe that I refer to the talks "problem" without even adding what a good many people would expect me to add—if there be one.

There is another matter which is much to the fore in my mind at

present as I write. The date is April 30th, and this morning, in common, one imagines, with many hundreds of thousands of people, I listened to the interchange of greetings between the Prime Ministers of Great Britain and Australia.

Throughout the day I encountered several who were in high dudgeon with themselves for having forgotten to remember this event. It was just another example of the necessity for making appointments with the wire-



Miss Gloria Swanson, the great film star, who recently won fresh laurels in the talkie called "The Trespasser." She is seen here before the microphone in an American broadcasting studio.

Business

Here is an opportune pronouncement by the Director-General of the B.B.C. upon a subject that has recently created an enormous amount of interest and discussion. In this not-to-be-missed article, Sir John—trenchant as ever—deals with the various future aspects of "This 'Talks' Business," as well as with its immediate programme value.

and, as it were, shake hands over eleven thousand miles of space.

We heard their preliminary greetings and interchanges, and shared the astonishment and excitement of the meeting. Then I went forth to the day's duty, and, I understand, a valve on 261 went off duty simultaneously. (In justice to the engineers, it was replaced in about a minute's time.)

But I had heard enough to be mightily impressed and even awed. I think that those sentiments are proper and desirable. We must not permit ourselves too quickly to get accustomed to this annihilation of distance; to this bringing the ends of the world together. What statesmen say to each other has often been fraught with great moment to the peoples of their respective countries. Now they can say it in the hearing of all.

The Next Generation

One is sorry for those who can fail to see more than a passing, "stunt" in a transmission of this sort. One is almost sorry for the infants who are growing up with it. By the time they are old enough to understand what is happening, they will regard it as a commonplace. They will see nothing particularly wonderful about it, though, of course, other things, equally wonderful, will doubtless come along instead. We must not miss the wonder of it.

We should pause periodically and survey the scientific scene. We should compare notes with the past. I can do this quite easily, because twelve years ago I would have given a month's salary to have been able to speak on the telephone from Philadelphia to London or Glasgow. Now I have conversed with friends in America, Canada, the Argentine, and even, last October, Australia; and this with the same facility as if



Britain's Prime Minister, Mr. J. Ramsay Macdonald, talking across the world by radio to the Prime Minister of Australia.

they had been in London. Yet I am inclined to feel there is nothing extraordinary about it. It is quite natural to-day. Yesterday it was incredible and fantastic.

To hark back to the talks. I have

DIRECTOR-GENERAL OF THE B.B.C.



Sir John Reith.

been reading the Editor's opinion upon them. Well, many no doubt will agree with him. But if he were to write with equal emphasis, but in

the opposite sense, many would agree with him, too. So with music, general and particular; so with plays; with vaudeville; so, in fact, with almost any feature of the broadcast programmes.

It may be that an anathema against talks, the talks programme and talks policy, would find more sympathisers than would an equally impassioned defence of them. Even so, we should draw no definite conclusions. For those who approve and defend are considerable in number, and even more considerable probably are those who express no opinion at all.

The Last Skittle

Ninepins is, I understand, an amusing game. I am not familiar with it, but I have participated in another country in a diversion termed Skittles. I remember a diagram on the wall which, for the benefit of the English, proclaimed that in one species of play "the centre skittle not to be hitten." It sometimes seems to me that people set up ninepins in order to knock them down again.

I do not suggest that the Editor was doing this, and even if he were, I will admit that one skittle, and possibly the centre one, has not been knocked down, either by him or by the B.B.C. It has been shaken, however, and it will be knocked down soon. Presentation.

We are well aware that some talks and some series of talks have been failures in greater or less degree; not because the material was dull, and still less because the subject was devoid of a fairly general interest, but because the presentation was defective.

Sir John's Latin

He is quite right in saying we are a long way from Utopia, but I believe we are moving nearer that unattainable and probably non-existent goal. To be aware of a prejudice is the first step towards removing it. To admit it is the second. But we have done far more than that, as many speakers, by experience—which perhaps to them was painful and even irritating—will confirm.

I once read an article by the Editor in which he quoted a sonorous piece of Latin. I do not know whether he has ever done so in this journal, but he cannot blame me for doing it

now. He can translate it for the benefit of any who may not understand it. If he does, I hope he will explain its significance. *Per tot discrimina rerum tendimus in Latium.*

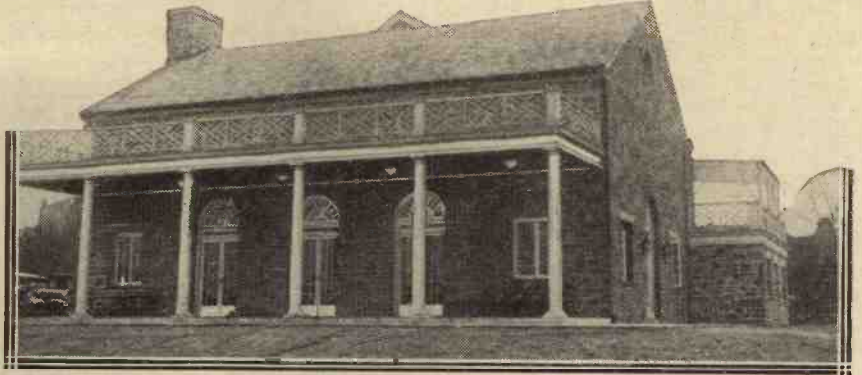

Claimed to be the first television theatre in the world, this New Jersey building is run by America's first announcer, Mr. McMahill.

**SUBTLE
SIR JOHN!
By THE EDITOR.**

YES. Subtle is the right word. Undoubtedly!

But before readers of MODERN WIRELESS join in the joke I must briefly explain that a few weeks ago I wrote an article in "The Listener" criticising the B.B.C.'s educational talks.

Among other things, I said that the B.B.C.'s idea of presentation of talks was bad. For example, "Professor X. on Bio-Chemistry" is not a very alluring title, but by presenting the subject with a more attractive title probably many more people would listen to such a talk without being frightened by its rather highbrow presentation. And so on and so on,

with several other criticisms, some of them apparently striking Sir John as being a little pedantic and, perhaps, finicky.

Still, there's no harm in paying attention to detail, and I stressed the point in my article that the B.B.C. should pay much more attention to the detail of presenting talks and in choosing better methods of broadcasting.

Sir John obviously read this article, because, two nights later, he broadcast a talk himself—"A Talk on 'Talks,'" in fact—and although he did not refer to my article I was not insensible to one or two little digs he got in at me during the course of his talk!

A few days later I wrote to him and told him that I was expecting another article from him for this issue of MODERN WIRELESS, and I was not very surprised when I received the article which you have just read above.

Now I think you have got a rough idea of this little friendly controversy between Sir John and myself, and you will begin to appreciate the significance which might lie in Sir John's invitation that I should translate his Latin tag: *Per tot discrimina rerum tendimus in Latium.*

Well, to use a very old phrase—I believe it originated in Scotland—when Sir John finished his article with this little bit of Latin he was, to use a colloquialism, "cocking a snook" at me.

**RADIO
PERSONALITY**



Virgil's "Tag"

Literally, the tag means: "By so many distinctions of the things, we extend in Latium." Freely translated, this means: "By taking so many different points of view (of affairs) we have gained ground in Latium." Not, you will say, very subtle.

But just a minute. This Latin tag, if I remember rightly, was written by Virgil of the time when Rome was overcoming the opposition of the Latin cities and merging them into Mother Rome. No doubt many of my readers will remember their school books, when they read of the row between the Romans and the Sabines. Well, the people of Latium—Latium was a sort of State which the Romans had to subdue—were being more or less rounded up by the Romans, and the tag expressed the view of the Romans, who said that because the Latins took too many

A great broadcaster with a strong radio personality—Mr. Stanley Baldwin, M.P.

different possibilities into account, they divided their councils, weakened themselves, and consequently were beaten by the Romans.

From this we get another version—that the Romans themselves said: "Because we took every likely contingency into account, and therefore made provision against every possibility, we gained ground in Latium."

A Modern Meaning

Now, this can be taken two ways. Sir John might mean, apropos of the talks, that there have been so many points of view expressed that "we have gained ground in Latium"; or, in other words, Sir John and those responsible for the talks at Savoy Hill have benefited by the ventilation of these arguments and, consequently, they have gained ground in an attempt to reach the Utopian ideal of perfect talks.

But the significance of Sir John's Latin can be interpreted another way, because from this little bit of ancient history which I have described, and the Latin tag in connection with it, a modern interpretation of the tag is sometimes given in this sense: that prominence, or success, in affairs, argument or controversy has been obtained by splitting hairs; or, if you like, by being over-meticulous.

What Sir John might mean is that I've made rather a fuss about the talks, and in my article in "The Listener" produced one or two arguments which Sir John admits I have won, and which Mr. Gerald Barry (who replied to my article) conceded to me, but *only because I have been splitting hairs!* Perhaps that's why Sir John expressed the hope in his article that I would translate his Latin and explain its significance!

Take Your Choice

I have done my best, but, as my readers will see, the significance of the tag can be taken in two ways: (1) That so many points of view have been given about the talks that the B.B.C. has benefited by the criticisms it has received and have consequently gained ground in its attempt to attain perfection; or (2) that the points I have made in my critical article in "The Listener" have only been gained by splitting hairs and by being over-meticulous.

I am rather inclined to think that my second interpretation of Sir John's

Latin is the one he had in mind when he quoted the tag, and that's why I think he is "cocking a snoop" at me. And very cleverly, too!

HINTS ON SHORT-WAVERS
By G6QB.

A USEFUL piece of gear for those that suffer from hand-capacity effects on their short-wavers, in spite of all precautions, consists of a "dummy panel," which may conveniently be made of three-ply, carrying the two main tuning dials, which are connected to the condensers on the main panel of the set by extension rods.

Suitable rods are made by the

hand-capacity troubles on and below 10 metres.

There is no need even to mount this dummy panel on to a baseboard with brackets—mine simply stands loosely on the table and carries two bushes, through which pass the metal ends of the extension rods, the two slow-motion dials being screwed on to the wooden panel.

Another little experiment worth trying out sometimes is simply to raise your receiver three inches or so off the table by propping it up on valve-boxes.

An Interesting Phenomenon

It seems to be a fact that whenever a set develops a "threshold howl" signals become stronger. All the known methods of killing the howl also reduce signal strength slightly,

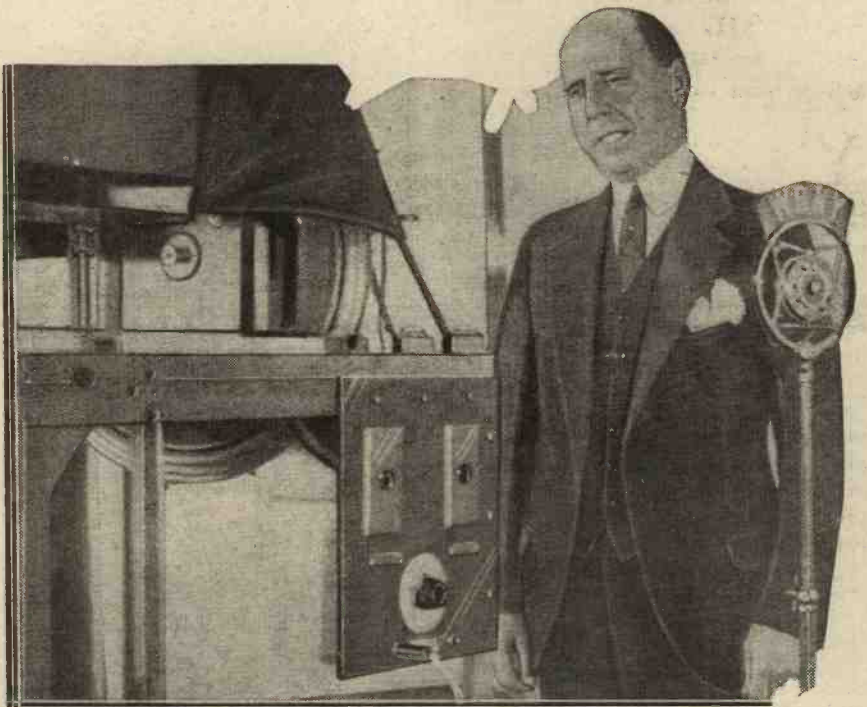

This is Mayor Frank Hague, of Jersey City, broadcasting an inaugural address and "television" from the Television Theatre, which is illustrated on the preceding page.

manufacturers of Cyldon condensers, and sell at 3s. 6d., and another type is made by Messrs. A. F. Bulgin & Co., to mention only two firms. They are very cheap and very useful, but do not appear to have found favour among short-wavers for some reason.

I confess that I have rigged up a panel of this kind myself, chiefly on account of the fact that with my particular earth lead I found it quite impossible to get rid completely of

although hardly to a degree worth worrying about.

I believe, also, that when a set goes to the other extreme and goes into oscillation with a "plop," one also notices that signals, just at the point where it is impossible to hold them, are stronger than usual. I have been trying for some time to find a cure for threshold howl that does not reduce strength, but have had no success so far.





A
PICTORIAL
VISIT TO
ONE OF
EUROPE'S MOST
POWERFUL
BROADCASTERS

This giant Norwegian station operates on a wave-length of 493 metres with the colossal power of 60 kw. You can hear it working just above the Midland Regional station, from which it is separated by only 14 metres (Prague lies between them on a wave length of 487 metres).

Two giant masts are used to support the "T" type aerial, which is so placed that the lead to it runs straight up from the power house situated between the two masts. The latter are of the "straight" type, pivoted at the bottom and held in place by numerous stays.

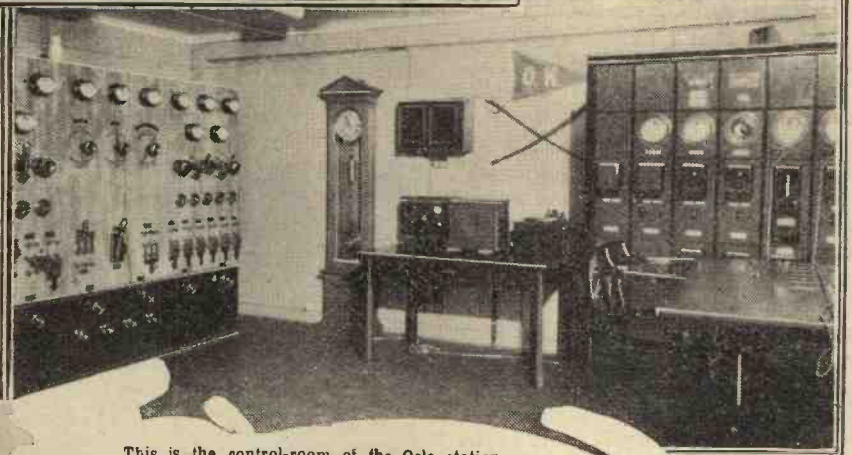

This is the control-room of the Oslo station. The master clock governing the time throughout the station buildings can be seen.

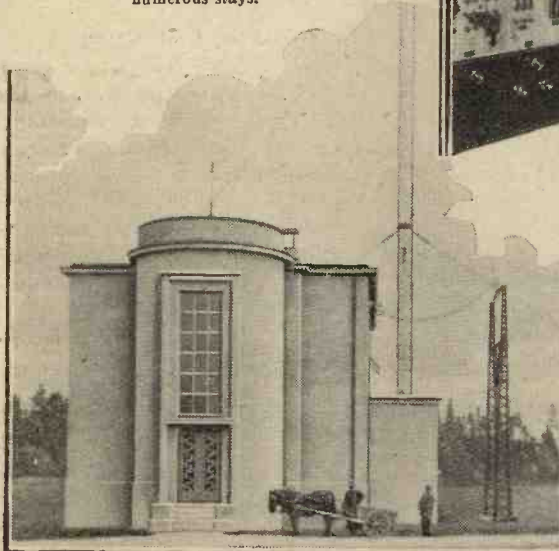

Here is the transmitter house, which is built on original architectural lines.

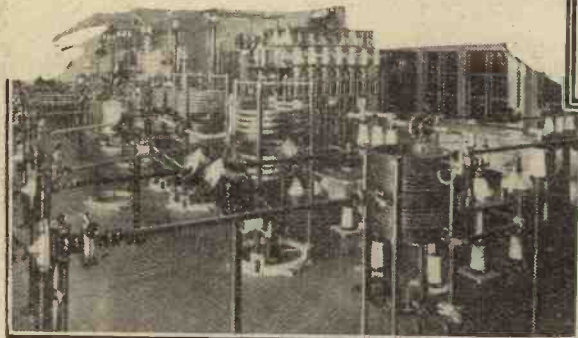
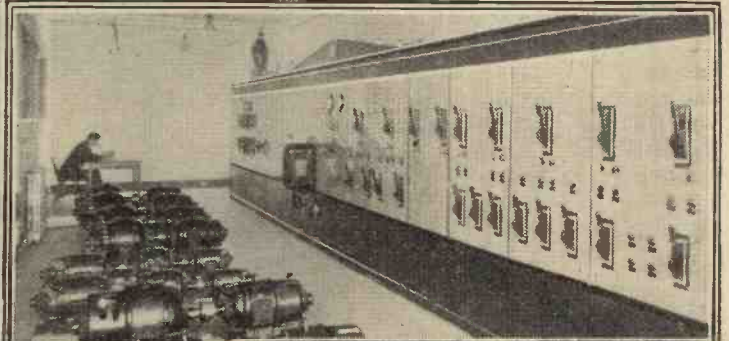

Above is the rectifier section of the transmitter, while (top) right is a general view of the machine-room. On the left of this photograph you can see a row of coupled electric motors and dynamos, which have outputs of different voltages for supplying to various circuits in the transmitter. To the right (below) you see the high-frequency parts of the 60-kw. transmitting outfit.

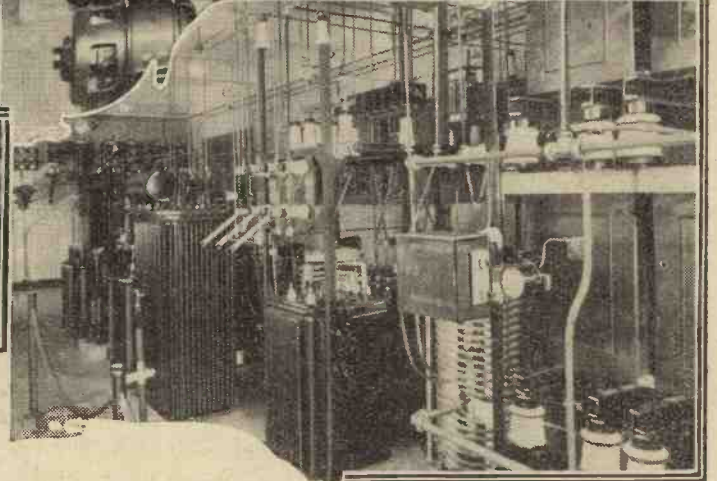

AT YOUR SERVICE

BY THE
TRADE
EDITOR



IN this section every month we are endeavouring to give news of interest about the wireless trade, recording the various happenings that will affect the reader of MODERN WIRELESS and the home constructor.

This month one of the events that will have most effect on the radio trade is the fact that Messrs. R.I., who have been in Hyde Street, Oxford Street, ever since broadcasting began, are moving to a new factory and offices which they have just had built.

R.I. on the Move

This factory, which is distinctly modern, as you will see by the illustration, is now nearing completion, and Mr. Joseph, the Managing Director of Radio Instruments, Ltd., hopes to move towards the end of June.

Messrs. R.I. have always been noted for quality components, and this move should mean a great deal to the home constructor, for there is no doubt that Mr. Joseph, always an energetic man, will have great scope for his energies in the design of apparatus when he has settled down in his new factory near Croydon.

Summer, we are led to suppose, is a comparatively dead period from the manufacturer's point of view; for fine weather, and the call of the open air, prove too strong for the set constructor, and that new receiver he intends building is put aside until the autumn. "The black months," as Messrs. Philips call April, May, June and July, are to see a special campaign to remedy the slackness in trade which usually occurs at this time of the year.

A Special "Push"

Messrs. Philips have decided on an extra-special "push," and are confident of breaking all records for this time of the year. The campaign is to cover Great Britain in its entirety,

Here is a new feature that will provide an invaluable link between the reader and the advertiser. The latest doings of radio firms will be chronicled each month under this heading, though tests on apparatus will still be found in the special "Tested" section elsewhere in this journal. Firms are invited to send in news of interest for inclusion in these columns.

and large spaces have been booked in the most widely distributed daily and weekly newspapers, to advertise the new four-, three-, and two-valvers, and the new Philips' portable.

These will be mentioned in every advertisement in the press, on posters, and in magazines during the next three or four months. As these are first-class goods, there should be no doubt about the success of the "big push."

tion in the direction of radio batteries, of which a large variety are already available.

Attention is drawn in their leaflets to their types R.C.1 and R.G.1, and these batteries incorporate a very interesting device which eliminates any possibility of the battery running down unnoticed during an interesting programme.

Simple But Sure

This device consists of white, green and red floats incorporated in the cells, their positions in the electrolyte showing the state of the batteries. Messrs. Smith & Sons will be pleased to send full details to any readers who will write to them for copies of their folder. The address is S. Smith & Sons, Cricklewood Works, London, N.W.2.

Messrs. A. C. Cossor announce the

RADIO INSTRUMENTS' NEW HOME

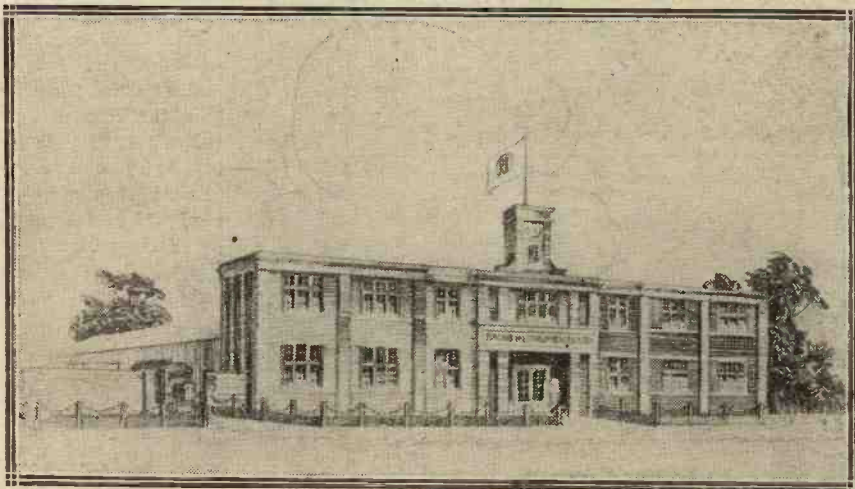

This is a sketch of the new R.I. building, nearing completion at Croydon. Messrs. R.I. "move in" towards the end of this month.

Those of our readers who are motor enthusiasts will be especially interested to know that Messrs. S. Smith & Sons, noted for their speedometers and car clocks, are now turning their atten-

fact that they are now in production of their new process four-volt valves after a slight delay in the manufacturing programme.

"Are you a mains enthusiast?"

Getting Ready for "The Show"

If so, you will be glad to hear that Messrs. Ferranti have just placed on the market a new mains transformer to meet the demand of a transformer for use with the full-wave rectifying valve U.9.

With this valve, and the new transformer, one is provided with a smoothed output of 250 volts. The price of this transformer is 32s., and it is finished in the usual Ferranti totally-enclosed style. It is tested to 2,000 volts.

An Interesting Collection

An interesting collection of leaflets is available from Messrs. Burne-Jones & Co., Ltd., dealing with pickups, volume controls and dissolvers, and with their short-wave converter and "Universal Three" receiver. This latter receiver works on the ultra-short waves of 15 metres upwards, and covers the range from that band up to 2,000 metres.

* * * *

Messrs. Graham Amplion, Ltd., were never "backward in coming forward," but we were surprised to find that they have already issued their main sales programme for the 1930-31 season. Several new lines are included, of which three

It seems somewhat too early to think of next year's Radio Show, but manufacturers are already busily booking space, while an innovation is to be a trade day before the actual opening of the show to the public.

An aerial view of the giant "Exide" works just outside Manchester. The Chloride Electrical Storage Battery Co. have long been well to the fore among accumulator manufacturers.

HOW THE WIRELESS WAVE SEES IT



This trade day will probably mean that Olympia will open on the afternoon of Friday, September 19th, instead of waiting till early on the Saturday for the usual opening.

Lissen Leaflet

The Lissen people have published a leaflet in which details are given regarding the improvement of the selectivity of the Lissen S.G.3 receiver. Another Lissen publication deals with the Lissenola Two-valve Transportable Regional Receiver. This is an all-electric A.C. set, which is, in

tion of existing wiring, and it incorporates a switch which enables one to go from radio to records and vice versa without removing the adaptor. The device forms the subject of Igranic leaflet No. 6650.

Useful Battery Book

The Standard Battery Company has revised the Standard Battery booklet, and copies are now available, post free, on request. The booklet contains full details of the Standard batteries and accessories and hints on their use.

Lotus All-Mains Unit

Messrs. Garnett, Whiteley & Co., Ltd., have produced an all-mains unit especially for the Osram Music Magnet receiver. The unit is supplied complete, ready for installation, the only addition necessary being three Osram A.C. valves. The price is £7 : 7 : 0.

A Regentone Unit

A recent leaflet issued by The Regent Radio Supply Co., describes the new Regentone combined H.T. mains unit with L.T. charger for all portables and all popular two-, three- or four-valve receivers.

Electradix Radios

The new catalogue of Electradix Radios comprises some 72 pages packed with descriptions of electrical and radio gear. Some is new stuff and some is fine ex-Army and ex-Naval apparatus going at ridiculous prices.

Sovereign Compression Condenser

The Sovereign "type J" compression condenser has been reduced to 1s. 9d. This component is a speciality of J. R. Wireless Co., Ltd. The J. R. Wireless people are also producing a dual-range coil for either baseboard (8s. 6d.) or panel (9s.) mounting.

PRODUCING PYE PRODUCTS

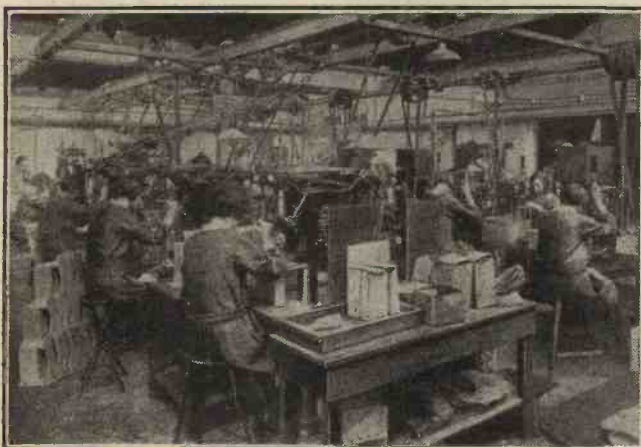

Cambridge is noted for many things, and not the least of these is the fact that Pye's have their works there. Here is a view of the main drilling shop.

types of speakers, a portable set and a cabinet radio set are the most outstanding.

Amongst the speakers there is a new power type balanced-armature unit. The portable set will be on the market by the time these notes are in print. It is a four-valver with a total anode consumption of only 10 milliamps. It is to sell at somewhere about £24 15s., complete with batteries.

effect, a portable that you plug into the nearest light point. For complete portability a battery-operated model is available.

Igranic Switch Adaptor

This is a device that will interest the radio-gram enthusiast. It provides a simple method of connecting a pick-up to the set without altera-



THE following pages contain a comprehensive résumé of the products of the most outstanding valve firms in this country. Not only is this special supplement of value to the set constructor who is faced with the task of choosing valves for his new set, but is also of interest to the general listener who wants

to keep abreast with radio progress, and to learn of the recent developments in the world of valves. The supplement is in alphabetical order, so that reference to the various firms' products is particularly easy.

IF we were asked exactly how many receiving valves there were on the market in this country we could no more tell you than prophesy the weather you are going to get for your summer holidays; but this we do know, that of the gigantic total that must run into many hundreds, Messrs. A. C. Cossor have over fifty.

Long Experience

We are including, of course, rectifying valves, mains types, special power valves, pentodes, etc., but *not* including transmitting valves.



One of the new Cossor power series the 630X.P. (25/-).

This large number, which is a goodly proportion of the total number on the market, is no more than one might expect, for Messrs. Cossor, Ltd., have specialised in the manufacture of high-vacuum products, such as wireless valves, X-ray tubes and Neon lamps, etc., for more than twenty years.

**Valves Made
by
A. C. COSSOR, LTD.**

Their latest valves employ a new type of tungsten-cored filament, which is enormously strong and has high emissive properties. The valves may be divided up into groups, and we will take these groups in order.

First of all we have the H.F. valve, with which, of course, is incorporated the screened-grid valve. Messrs. Cossor's have one ordinary and one screened-grid H.F. valve in each of their groups—that is, in each of the 2-, 4- and 6-volt battery lists—and one H.F. and another screened-grid in the mains valves.

Popular Two-Volters

The most popular are undoubtedly the 210H.F. (10s. 6d.) and the 220S.G. (22s. 6d.). The former is designed for use as a high-frequency amplifier of the ordinary three-electrode type, while the latter is the screened-grid valve. Both are for operation with a 2-volt accumulator, but have their counter-

parts in the 4- and 6-volt types in the 410H.F. and 410S.G. and the 610H.F. and 610S.G. at similar prices.

Messrs. Cossor's are to be congratulated on simplifying their valve lists to the extent that all three of the ordinary H.F. valves have the same impedances (20,000 ohms) and the same magnification factor of 20. The screened-grid valves also have been standardised, having impedances of 200,000 ohms and magnification factors of 200.

Detectors

Then we come to the detector valves, in which class we find there are no special detectors, but that for most purposes the ordinary H.F. valve is most suitable. Occasionally, if you want a low-impedance detector, one of the L.F. valves, such as the 210 L.F.,



A two-volt screened-grid valve—the 220 S.G. (22/6).

"M.W." Special Valve Supplement—Cont.

with its 12,000 ohms and mag. of 10, the 410 with 8,500 ohms, and the 610 with 7,500 (the latter two having the magnification factor of 15), can be used, but this is only in special circumstances, where the detector valve is liable to have to deal with a large



The 680P.
A new power valve capable of providing a very large output where great volume is required.
Price 25s.

input. As a rule these L.F. valves are better employed in their proper capacity—that is, for L.F. amplification. They cost 10s. 6d. each.

Valves for R.C.C.

In exceptional circumstances, where high magnification is required and special smoothness of reaction is not necessary, or where no reaction is employed, the R.C. valve can usefully be employed. (10s. 6d.).

A "15-WATTER"

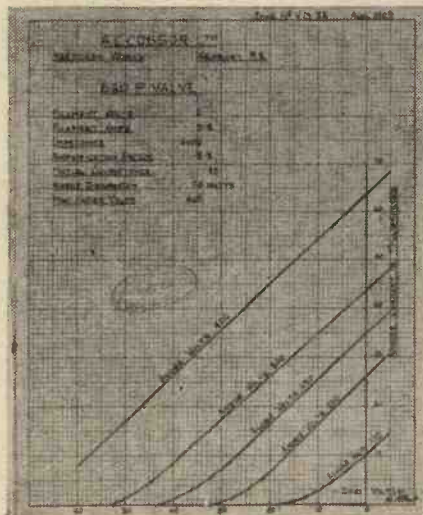

These are the characteristics of the valve seen above. Note the big grid swing when 400 volts anode potential are used.

The Cossor R.C. valves are of quite moderate impedance—about 50,000 ohms, with magnifications round about 36 to 40. There is, of course, one of each in the 2-, 4- and 6-volt series.

Reverting to the L.F. valves once more. These are medium-impedance valves which are used as first-stage L.F.'s, or occasionally as detectors.

They are not suitable as output valves, the impedance being far too high, and, of course, the grid swing being correspondingly small.

The Small "Powers"

Now for the power-valve series, valves of about 5,000 ohms or thereabouts, and here Messrs. Cossor's have some very useful examples.

In the 2-volt class they have the 220P. and the 215P., the former

USEFUL CHARACTERISTICS

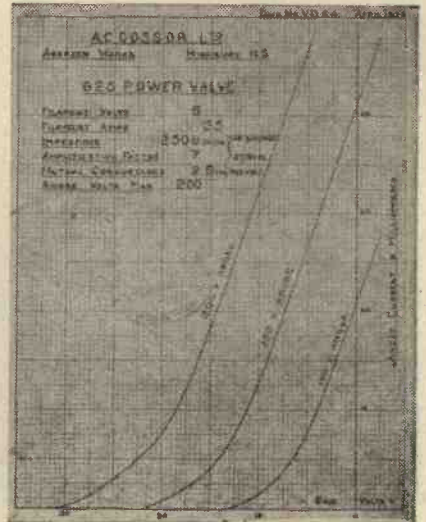

The curves of the 625 Power—a six-volt power valve of very high merit.

unless the amplification has previously been obtained in the set.

ALADDIN UP TO DATE!



Here we see the modern Aladdin's cave—at Highbury.

They include the 625P., the 620T., 660T., 680P., 680XP., and the 680H.F. and the 41XP. The first has an amplification factor of 7 with an impedance of 2,500, and is an exceedingly useful valve, taking only quarter of an amp. at 6 volts. The anode consumption is something like 25 m.a. at 200 volts. (15s.)

having an impedance of 4,000 ohms and a magnification factor of 8, and the latter a magnification of 9, with an impedance of 4,000 ohms. (12s. 6d. each.)

They are very similar valves, both designed for the last stage of a set which has not a great number of low-frequency stages. The grid swing is something of the order of 9 volts either side of the biased point, and they take 150 volts max. on the anode.

Super-Power Types

The 4-volt and the 6-volt series have each one power valve, while in the next group we have several very useful super-power valves. These, of course, are used where really big volume is required, though it must not be considered that a super-power valve will give you greater volume

Low Impedance

The 620T. has an impedance of 1,400 ohms and an amplification factor of 3-2, and takes 400 volts maximum anode pressure, with a

The 625P.

Here is the Cossor power valve, which has an impedance of 2,500 ohms, and whose characteristics you see above.

Price 15s.



An Amazing A.C. Screened-Grid Valve

milliamp. consumption of 50 (30s.). Another low-impedance valve is available, where tremendous volume is required, in the 660T., which takes 4 amps. at 6 volts and has an amplification factor of 2.25. The emission is something like 120 milliamps. at 500 volts. The impedance is 800-1,000 ohms (105s.) It is frequently used in small transmitters for modulating purposes.

The 680P. has an impedance of 6,000 ohms and amplification factor of 5.5. It takes .8 amp. at 6 volts, while the 680X.P. also has the same filament wattage with an amplification factor of 3 and impedance 2,750. It passes 25 milliamps at 400 volts (25s.)

a good choice of these is turned out from the Cossor works.

Those who have extra large volume will find the last class, indicated in the Cossor catalogue under the title of "P.," the best to use. These valves are specially "large" and are used in talking film work for large amplifiers, and also for small transmitters.

Valves made by
**EDISON-SWAN
ELECTRIC Co., Ltd.**
(Mazda Valves)

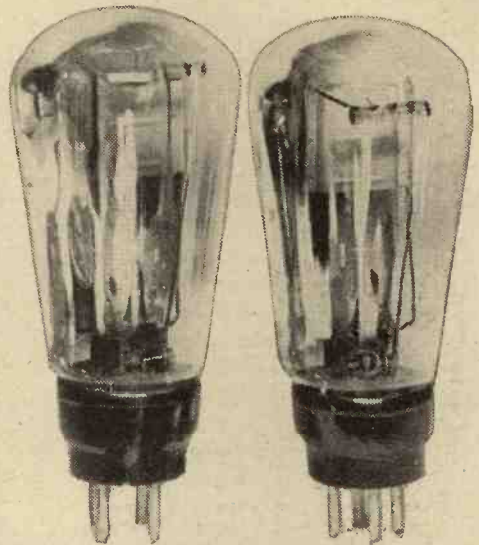

On the left is the Mazda P.625B; on the right the P.650 by the same firm.

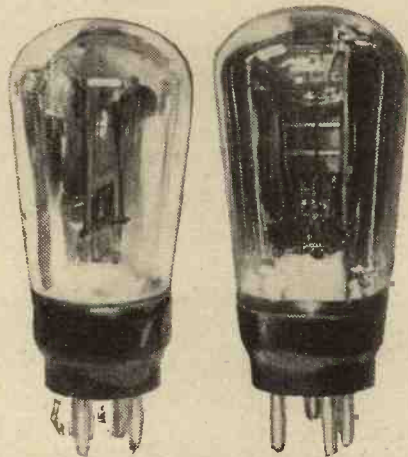

The Mazda two-volt power valve and the L.607 L.F.

We must not forget the pentode valves, which are becoming increasingly popular as last-stagers in small sets, though care has to be taken here that overloading shall not occur. Cossor's have two pentode valves, a 230 and a 415 (no pentode valve yet being available in the 6-volt range) (15s.)

Special Mains Types

In addition to these battery valves there are some special mains valves (either directly-heated or indirectly-heated) for working on A.C., and constructors who have A.C. mains should consider very carefully whether or not they will operate their sets from the electric-light supply. Very efficient valves are available for this purpose, and the running costs are ridiculously small. They cost from 15s. to 25s.

For mains eliminators the SU and the BU (half-wave and full-wave) rectifiers are available. and quite

The Ediswan people have got a rather peculiar range of Mazda valves, peculiar inasmuch as very little seems to be done in the 4-volt types, though there are plenty of good 2- and 6-volt valves. These Mazda valves, however, are remarkably efficient, and unless you are a 4-volt valve user very little trouble should be experienced in picking out a valve which will suit your requirements to perfection. Here are the outstanding Mazda valves, with their characteristics and their prices.

Full Range of Two-volters

In the 2-volt variety we have the H.210, 59,000 ohms with amplification factor of 47, at 10s. 6d.; the H.L.210, 21,000 ohms and 26, an excellent detector or H.F. valve at the same price; the L.210, with 10,000 ohms and mag. of 15.5, an L.F. amplifier, also at 10s. 6d.; the P.220, a power valve, with 3,700 ohms impedance and magnification factor at 12.5, at 12s. 6d.; and P.240, super-power, with 1,900 and a mag. of 7, at 15s.

In addition we have the S.G.215, which has an anode impedance of 270,000 ohms and an amplification of 300, (at 22s. 6d.), and is one of the finest screened-grid battery valves extant.

The 230 pentode, of which no official figures are given, except that the mutual conductance is 1.8, is priced at 25s.

Thus you see a fairly full 2-volt series is available. Of the 4-volters, however, only two valves—with the exception of the indirectly-heated A.C. valves—are available. They are the P.425, a super-power valve having an impedance of 1,950 and an amplification factor of 3.5 (at 15s.), and the

425 pentode, having a mutual conductance of 2, price 25s.

When we come to the 6-volt valves, however, we find quite a fair range, for we have an H.607, with 90,000 ohms and mag. of 40, for resistance-capacity coupling (at 10s. 6d.); an H.L.607, for H.F. work, with 20,000 and 20, at 10s. 6d., and then we get right away to the P.625B., with impedance of 2,500 and a mag. of 7, at 15s.; the P.625A., with 1,600 and a mag. of 4, also at 15s.

The "Super Supers"

In addition to these super-powers there are what might be known as super-super-power valves, the 650 P., with an impedance of 1,300 and a magnification factor of 3.5 (20s.), and

The forerunner of an amazing series of S.G. valves—The Mazda screened-grid 215 valve. Its A.C. "Cousin" has astonishing characteristics, having an impedance of about 600,000 ohms, and the colossal magnification factor of 1,200.



"M.W." Special Valve Supplement—Cont.

still bigger valve taking 7.5 volts. It is the P.P.3/425, with an impedance of 2,900 and a mag. of 2.85, at 30s.

This valve has an H.T. maximum of 425 volts, and is capable of giving a colossal output.

In addition the Mazda people have scored tremendous successes with their A.C. valves, among which the S.G. has been the object of a tremendous amount of enthusiasm.

It has the fine figures of 600,000 ohms impedance with an amplification factor of 1,200.

so that no matter what your set you may be sure of finding what you want. We have the H.210, the 410, and the 610, a resistance-capacity coupling valve; the H.L.210, 410



Here we have the new Osram P.2—a two-volt steep-slope power valve whose curves are reproduced below. Price 15/-.

Valves by
THE GENERAL ELECTRIC CO., Ltd.
(Osram Valves)

We cannot do better in introducing the Osram valves than to refer to the Osram book, which states that: "The range of Osram valves embraces the needs of every listener, whether concerned with battery-operated receiving sets, or with sets of an all-electric type," and when one looks through the list of valves that are obtainable one realises that such indeed is the case.

Among the Osram valves there is a full range of two-, four- and six-volters,

and 610, the L.210, 410 and 610, as H.F. and detector and L.F. purposes respectively (10s. 6d.).

Following these we come to the power valves at 12s. 6d., in which we find the P.215, the P.410 and the P.610. These have impedances of 5,000, 5,000 and 3,600 ohms respectively, with magnification factors round about 7 and 8.

Next in price (at 15s.) come the P.240, a 2,500-ohm valve with an amplification factor of 4; the P.425, of 2,300 ohms and a factor of 4.5; the P.2, a new 2-volt valve with A.C. resistance of 2,300 and amplification factor of 6.5; the P.626 (2,400 ohms and 6); and the P.625A., of 1,600 ohms with a mag. of 3.7.

Remarkably Good Valves

These are all remarkably good super-power valves suitable for output work when you are dealing with quite heavy amplification.

Next we come to the £1 5s. 0d. super-power valves, the P.X.4, which is a remarkable 4-volter taking a grid bias of about 40 volts negative with an anode voltage of 200, and having an impedance of 1,450 with an amplification factor of 3.8.

There is no counterpart of this valve in the 2-volt class, but amongst the 6-volters, with the L.S.5A. and the L.S.5, at the same price, the former having an impedance of 2,750 ohms and a mag. of 2.5 and the latter an impedance of 6,000 ohms and an amplification factor of 5.

These are really heavy-duty valves having a maximum anode potential of 400 volts, the L.S.5A., taking a grid bias of 112 volts and passing an anode current of 33.5 milliamps.

We must not forget the L.S.6A., which is a super-power valve costing £1 10s. 0d., and having a magnifica-

A HEAVY-DUTY "SUPER"

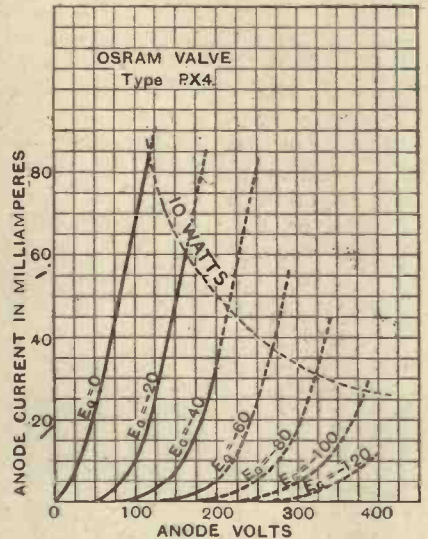

For "big" loud-speaker work the P.X.4 is specially suitable.

tion factor of 3 with an impedance of 1,300 ohms. A remarkably fine output valve with a remarkably steep slope, it takes an average negative grid bias of 93 volts with 400 volts on the anode, and an anode current of 63 milliamps.

Among the screened-grid valves we have the S.215, the S.410, and the S.610, of the vertical type, having

THE LATEST OSRAM PRODUCT

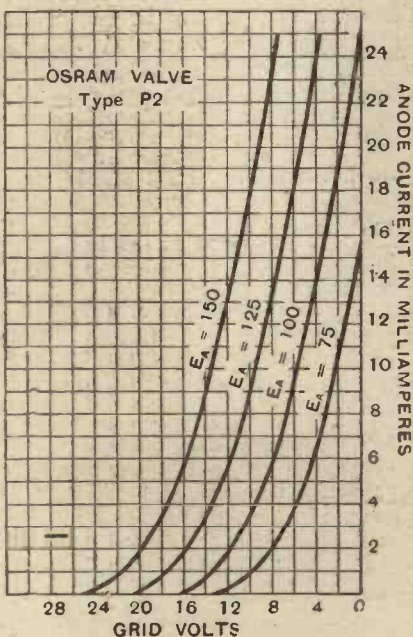

The curves of the new P.2 two-volt super-power valve.



The battery and A.C. models of the Osram S.G. valve.

Popularising the Pentode Output Valve

impedances of 200,000 ohms and amplification factors varying between 170 and 210; and then the horizontal type, the old S.625 is still retained for use in sets built for this valve, which, of course, has an impedance of 175,000 ohms and a mag. of 110 (£1 2s. 6d.).



The famous Osram P.625 power valve.

Several pentodes are available. We have the P.T.240, a 2-volter with an impedance of 55,000 ohms and amplification factor of 90; the P.T.425, with 50,000 ohms and a mag. of 100; and the P.T.625, with 43,000 ohms and 80 magnification factor.

In addition to these there is a complete series of A.C. valves available.

a 2-volt with similar characteristics: 55,000 ohms impedance and a magnification factor of 100. The Bivolts (for 2-volt accumulator) take .3 amp. at 1.85, and the Forvolts about .5 amp. at 3.5 volts. The price of these is 18s. 6d.

Then for 5s. 6d. we get a choice of H.F. "Universal" and resistance valves for either 2- or 4-volt types. The Universal Bivolt has an impedance of 10,000 ohms and an amplification factor of 9, making an excellent L.F. valve; whilst the Resistron Bivolt has 60,000 ohms and 30 as figures, and is suitable for R.C. coupling.

In addition, there is the Super H.F. Bivolt (21,000 ohms and 25), which is a really efficient H.F. amplifier. Backing these up are the Super-Power and the Hyper-Power 2-volt valves, the former having 4,500 ohms impedance and a mag. of 9, and the latter 2,700 ohms and 5 for impedance and magnification factor. The former is 7s. 6d. and the latter is 9s. 6d.

The 4-volt Universal Resistron,

and 25; Super-Power has an impedance of 5,000 and mag. of 9; while the Hyper-Power has an impedance of 2,500 and a mag. factor of 5.

Valves made by
LISSEN, Ltd.

This month Messrs. Lissen are supplementing their complete 2-volt valve lists with a series of 4-volt valves of similar type. In the former range we have the R.C. and H.F. valve (the H.210), which takes .1 amp. at 2 volts and has an anode impedance of 58,000 ohms with an amplification factor of 35.

Following this are the general-purpose H.L.210, amplification factor 18 and impedance 21,000; and the L.210 L.F. amplifier or detector with 10,000 ohms and a mag. of 10. These valves are 7s. 6d. each.

Then we have a power valve speci-

Valves made by
**IMPEX
ELECTRIC Ltd.**
(Dario Valves)

Messrs. Impex Electrical, Ltd., have roughly a score of valves from which to choose, the battery valves being confined to 2- and 4-volters, while the mains valves have the peculiar filament voltage of .6 and a filament amperage of 1 and 1.5, depending upon the type of valve.

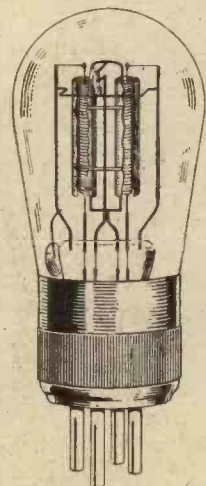

One of the famous Dario Bivolt valves.

Screened-grid and pentode valves figure in the list, the "Bivolt Screenodion" having an impedance of about 250,000 and a magnification factor of 250, and the "Screenodion Forvolt" having similar figures, both costing 15s. 6d. In the pentodes there is a 4-volt and

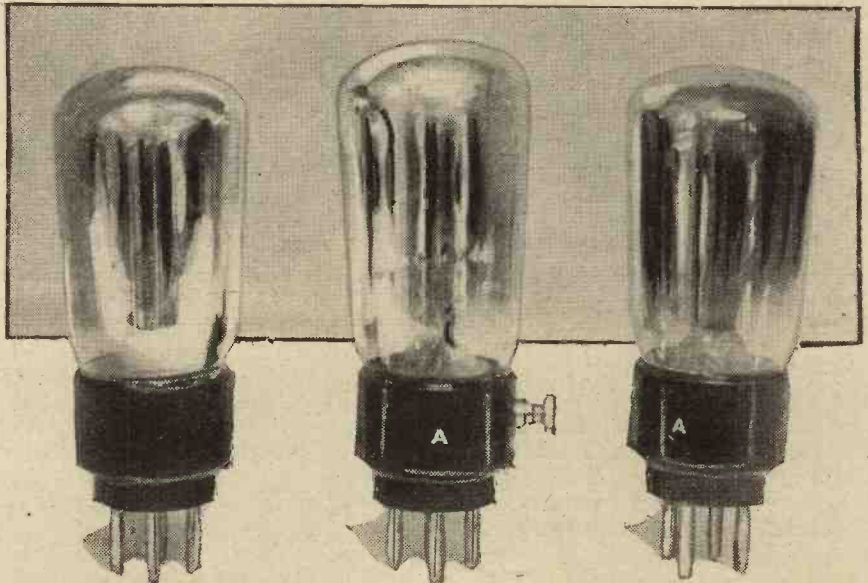

Three representative Lissen valves—The H.L.210, L.210, and (centre) the Pentode "minor" (7 milliamp. type), the P.T.225.

Super.H.F., Super-Power and Hyper-Power valves have exactly the same characteristics as the 2-volters, though their filament current consumption is lower and they cost the same price respectively.

The mains valves vary in price from 7s. 6d. to 12s. 6d.

The general-purpose valve has an impedance of 10,000 and a mag. of 10; the Super H.F. and R.C. 20,000

ally designed for use in the last L.F. stage (the P.220), which has an impedance of 4,700 and an amplification factor of 7, at 12s. 6d.; a screened-grid valve at 22s. 6d., with 200,000 ohms and 180 mag.; and a super-power (the P.X.240), with 2,000 and a mag. of 4, at 15s.

These complete the list of the 2-volt valves with the exception of the pentodes.

"M.W." Special Valve Supplement—Cont.

There is a special pentode (the P.T.225) specially designed for the output of a two- or three-valve set, and for portable receivers operated by H.T. batteries. Unlike the ordinary pentode, the H.T. current demand is well within the capability of a standard H.T. battery. It takes an H.T. voltage of 150 maximum, and has an impedance of 24,000 ohms, the magnification factor being 90.

With correct bias the anode current is of the order of 7 milliamps.

Those wanting a larger pentode output valve should choose the super-power pentode, the P.T.240, which has an impedance of only 22,500 ohms and an amplification factor of 45. This valve costs 25s., while the former one is only 17s. 6d. The P.T.240 has a very much higher milliamp.consumption and larger grid swing.

Of the 4-volt Lissen valves the following list gives concise details, the prices being similar to those corresponding types in the 2-volt range.

An example of the Loewe multiple valves—the three stage L.F. model. (See below.)

We have the S.G.410 (180 mag. and 200,000 impedance); H.410 (40 and 60,000); H.L.D.410 (25 and 21,000); L.410 (15 and 8,500); P.410 (9 and 4,500); P.425 (4.5 and 2,250). Then the P.T.425 (pentode) has a mag. of 70 with 35,000 ohms impedance; and the P.X.61 a mag. of 6 and impedance of 2,000 ohms.

Valves by LOEWE, Ltd.

Readers will need no introduction to the Loewe range of valves, whose amazing mutiple valves, which are rapidly becoming popular, are now in use by many constructors.

The most remarkable of these valves is the three-in-one valve, which costs

£2 3s. 6d., but includes a complete three-stage amplifier inside the vacuum of the valve.

The double valve has two H.F. stages for long-range reception, is available at £1 12s. 6d., and the valves can be repaired, if not mechanically damaged, at an inclusive charge of 17s. 6d. For portable set construction the Loewe valve is exceedingly valuable and makes the building of a three-stage receiver an exceedingly simple business.

Valves by LOWDEN, Ltd.

Some very inexpensive valves are obtainable in the Lowden improved process series. These valves have special spiral-wound anodes and double-strength thorium-coated filaments, which, it is said, are made to withstand rough usage.

They are British made, and here are the prices: Screened grid, 17s. 6d.; 2-, 4-, and 6-volt general-purpose L.F. and H.F. valves at 6s. 6d.; power valves, 8s. 6d.; super-power valves, 10s. 6d.; and a very useful range in the various series is available.

Valves by MARCONIPHONE, Ltd.

All types of valves can be obtained from the Marconiphone Company, from small 2-volters to 1,000-kw. transmitters, but it is with the receiving valves with which we will

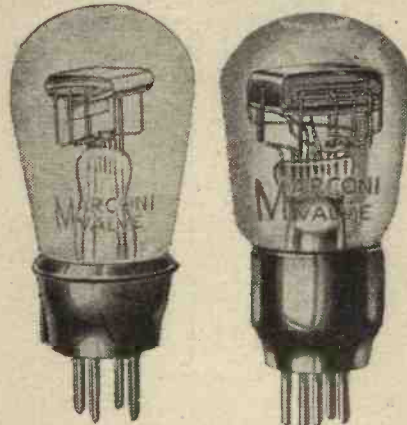

The H.L.210 and the P.T.240 (curves above), popular two-volt H.F. and Pentode valves.

concern ourselves in this supplement. Let us take them in order. First of all we have the H.210 (price 10s. 6d.), which is a highly efficient dull-emitter with a high amplification factor, specially designed for resistance-coupled amplifiers or as a grid-leak detector or anode-bend rectifier preceding resistance coupling. It has an impedance of 50,000 ohms and an amplification factor of 20.

A Larger "Brother"

The H.L.210 is its larger brother, or perhaps we should say cousin, at the same price, and is designed mainly for H.F. and detector work, having an impedance of 23,000 ohms and a magnification factor of 20.

A ROBUST PENTODE

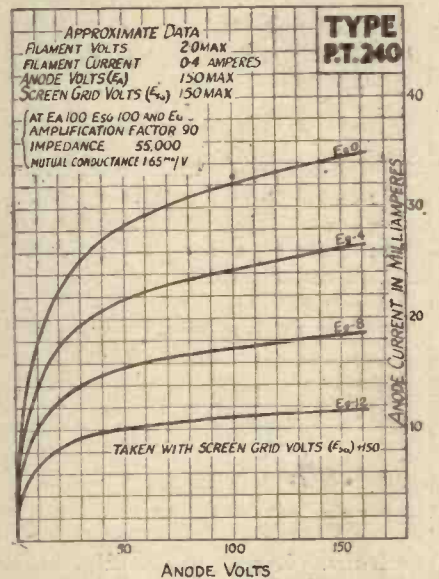

The curves of the two-volt Pentode, which is illustrated below.

The 2-volt L.F. valve is specified L.210, and has an impedance of 12,000 ohms and an amplification factor of 11, the prices of all these valves, until we come to the power valves, is 10s. 6d.

Very Fine L.F. Valve

But we will deal with the power valves separately. Let us now come on to the 4-volters. Here we have the H., the H.L., and the L. again, having impedances respectively of 60,000, 30,000, and 8,500. The former has an amplification factor of 40, the H.L. of 25, and the latter of 15.

In the six-volters the H.610 has an amplification factor of 40 and an impedance of 60,000; the H.L., 30,000 ohms with a mag. of 30; while the L.610, a remarkably fine L.F. valve, by the way, has an impedance of 7,500 and an amplification factor of

"M.W." Special Valve Supplement—Cont.

15. All these valves are 10s. 6d. Those who want screened-grid valves can find one in each classification. There is the S.215, the S.410, and the S.610. All have impedances of 200,000 ohms and magnification factors of 170, 180 and 210 respectively. Their price is 22s. 6d., and they can be relied upon to give remarkably good amplification.

There is also another six-volt screened-grid valve of the horizontal type, the S.625, which has been retained for those receivers already designed to take this type of valve, which it will be remembered appeared before the upright type. It is priced the same, and has an impedance of 175,000 ohms and a mag. of 110.

"Last-Stagers"

Of power valves at 12s. 6d. we have a goodly supply. There is the P.215, a remarkable little two-volter with an amplification factor of 7, and an impedance of 5,000 ohms.

The P.410 is the four-volt counterpart. It has not quite so much grid swing, having a 5,000-ohms impedance with an amplification factor of 7.5. The 610 has a steeper slope



Two well-known S.G.'s—the Marconi and the Mullard two-volters.

still, and with an amplification factor of 8 has an impedance of 3,500.

We must also mention the new P.2, a 2-volt valve for power work, which was put on the market on the

first of last month. This is an exceptionally fine valve, having an impedance of the low figure of 2,500 ohms and an amplification factor of 6.5; giving a mutual conductance of 2.8 (12s. 6d.).

In addition, we have a large series of pentodes and super-powers from which to choose. There is the P.T.240, with an impedance of 55,000 ohms and mag. of 90; the P.T.425 (50,000 and 100), and the

A FAMOUS "PENTONE"

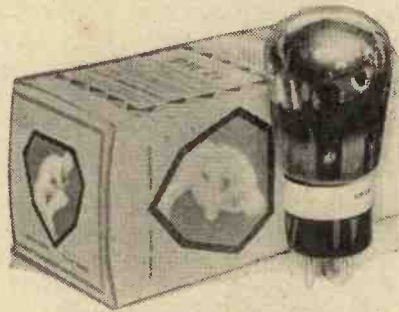

The P.M.26, a six-volt "Pentone" valve.

P.T.625 are also noteworthy pentodes, especially this latter, which has an impedance of 43,000 ohms and an amplification factor of 80.

Now for the super-powers. Here we have the P.240, a remarkable valve. Its impedance is 2,500 and the amplification factor is 4.

Similar in size and price is the P.425 amongst the 4-volt series, and similar in price, but not in size, is the P.625 and P.625A. six-volters.

"A Size Larger"

And now we come to a size larger, the P.X.4. It has an impedance of 1,450 ohms and amplification factor of 3.8, and is specially suitable for very large loud-speaker work.

Finally, we must mention the super type—the L.S.5 class. These consist of the L.S.5, L.S.5A. and L.S.6A., priced in the former two cases at £1 5s., and the latter £1 10s. They are power amplifiers taking about 400 volts H.T., with an anode consumption in the case of the L.S.6A. up to 63 milliamps. and in the case of the L.S.5A. up to 33.5 milliamps.

Both directly-heated and indirectly-heated mains valves are available, the former at 15s. for the ordinary type, 25s. for the screened grid, and 17s. 6d. for the power.

Valves made by
**MULLARD RADIO
VALVE CO.**

The Mullard Radio Valve Company is, of course, specially noted for its "Pentones" and special detector valves. Mullard's were the leaders in the introduction of the pentode valve, and no other firm has specialised so strongly in the design of valves for rectification purposes in the ordinary set.

Special Detectors

The special detector valves (10s. 6d.) therefore are well worth noting.

We have such valves as the P.M. 2D.X., the P.M.4D.X., the P.M.5X. and the P.M.6D. The P.M.5X. has not very long been on the market, and its characteristics are particularly noteworthy because it forms a fellow to the P.M.6D., which is of the rather lower impedance and lower magnification type of detector.

The outstanding "pentone" valve of the Mullard series, of course, is the P.M.24A., which is a power pentode valve of very useful dimensions,

The P.M.24A. takes 4 volts and .275 amp. It has an impedance of

THE FIRST "PENTONE" VALVE

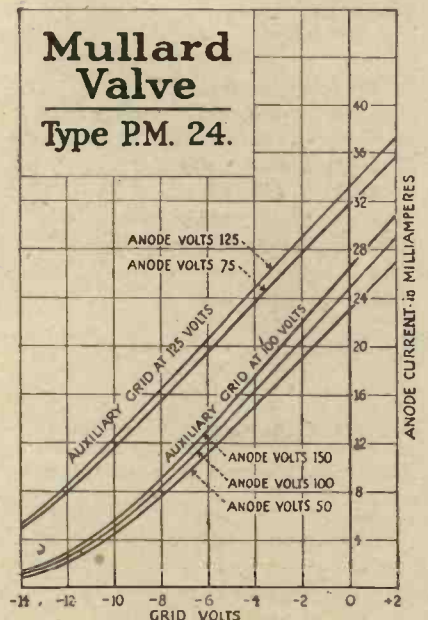

The curves of the well-known P.M.24, the four-volt "Pentone."

"M.W." Special Valve Supplement—Cont.

53,000 ohms and an amplification factor of 83 (30s.).

Other "pentones" are the P.M.22, P.M.24 (the P.M.24A's smaller brother, but an excellent valve), and the P.M.26. All these are extremely efficient and thoroughly reliable (25s.).

But although we have devoted so much space to the special detectors and pentones, it must not be forgotten that Mullard's have a full range of H.F., L.F., power, super-power and mains valves suitable for practically all purposes

Mains Valves

In addition to the complete range of H.F., Det., R.C. coupling, S.G., power and super-power valves, including the new P.M.256A. Mullard's have an extensive range of indirectly-heated cathode valves.

These include the S.4V., a valve with an amplification factor of 1,000 and an impedance of 1.33 megohms, at £1 5s. Od., the 354 V. with an impedance of 14,000 and a mag. of 35, at 15s., which is an excellent H.F.

and detector; the 164V., with an impedance of 6,650 and a mag. of 16, at 17s. 6d.

Then there is a small power valve; and the 154V., another power valve, with 7,500 ohms impedance and an amplification factor of 15. This costs 17s. 6d.



The Philips rectifier for trickle charger work.

Finally, we have super-power valves, one with 2,800 ohms impedance and an amplification factor of 10, the 104V., costing 17s. 6d. Then we must not forget the D.F.A.9 (20s.), D.F.A.6, D.F.A.7, and D.F.A.8 (25s.). These valves can be used quite well with raw A.C. on the filament, if desired, though the filament voltage is 6 volts, as against the 4 of the indirectly-heated cathode type.

Among the rectifying valves must

be mentioned the D.U.10, at 15s., a half-wave rectifier; and the D.U.2, a full-wave rectifier, costing £1 0s. Od.

Valves by PHILIPS RADIO, Ltd.

This famous firm does not go in for the ordinary receiving valves, but are more concerned with the placing on the market of high vacuum and gas-filled rectifiers. These are available for every purpose, having outputs varying from 13 milliamps. to 40 amps., and are sold at prices varying from 15s. to £9 10s.



A very useful valve—the Pentode four-volter.

This latter valve, of course, is for extra heavy work, but the smaller rectifiers are useful in providing half or full-wave rectification for A.C. mains eliminators. We have the 373, giving 30 milliamps. for half-wave rectification; it requires a filament voltage of 4 and a filament current of 1 amp. This valve costs 15s. Then there is the 506, which gives 75 milliamps. and costs 20s., while we have the 1562, giving 110 milliamps. at 7.5 filament volts and 1.25 filament amp. This costs 30s. and is a full-wave rectifier suitable for use for very heavy amplifier work. In fact, no matter what amplifier you want to run, or whether you want a trickle or full charger, you can find a valve to suit you in the Philips list.

Valves made by P.R. PRODUCTS

A large number of P.R. Super Golden series valves are available for the home constructor, the majority of the valves costing 4s. 6d., with the exception of the power, which costs 7s. 6d., the super-power (12s. 6d.), and the screened grid (15s.).

They are all called the "G.P.R." the classification being obtained from the numerical order.

Quite a useful range of characteristics is shown by the P.R. valves. In the 2-volters we have one with an impedance of 24,000 ohms, one with 12,000 ohms, and the third with 40,000 ohms for H.F. and detector, L.F. or R.C. work respectively, with a 6,000-ohm power valve and a 3,000-ohm super-power. The S.G.25. has a mag. of 150 and impedance of 220,000 ohms.

Four-Volters

In the 4-volters we have the G.P.R.9 (22,000 ohms), for H.F.; the G.P.R.10 (10,000 ohms), for L.F.; the G.P.R.11 (44,000 ohms), for R.C.; the G.P.R.40 (6,000 ohms), for power valve; the 140 (3,500 ohms) being the super-power.

The 6-volt series has no super-power valve at the moment and consists of G.P.R.17 (20,000), for H.F.; G.P.R.18 (11,000), for L.F.; and G.P.R.19 (75,000), for R.C.; with G.P.R.60 (6,000) as a power valve.

Valves by SIX-SIXTY, Ltd.

Any type of receiving valve which you may possibly require can be found in the Six-Sixty catalogue. Starting off with the 2-volters, as usual, we have S.S.210H.F., suitable for H.F. amplification and detection, having an anode impedance of 25,000 ohms and an amplification factor of 19 (10s. 6d.).

The S.S.210L.F. is quite a useful valve, having an impedance of 12,500 and an amplification factor of 10.6; while the S.S.210 R.C. is a high-impedance valve of 65,500 ohms with a mag. of 39.

There is a useful special detector (the 225D.), 7,000 and 13.5 (10s. 6d.), a super-power (the 230P.), and an ordinary power (the 220P.), at 15s. and 12s. 6d. respectively, all well worth noting. The 215S.G. at 22s. 6d. has an anode impedance of 230,000 ohms and an amplification factor of 190; while we must not forget the



An efficient four-volt S.G. valve made by the Six-Sixty people.

Specially Coated Barium Valves.

S.S.230P.P., a 64,000 ohms pentode, which has an amplification factor of 80 and costs 25s.

A very similar range appears in the 4-volt types, with the exception of an L.F. valve corresponding to the S.S.210L.F. The 410D., a special detector valve, has an impedance somewhat lower than the 2-volt detector, being 7,250, with an amplification factor of 14.5. It costs 10s. 6d.

Two Four-Volt Pentodes

Two pentodes are available in this series, the S.S.415P.P. at 25s., which has an impedance of 27,000 ohms and a magnification factor of 60; and a super-power pentode, the S.S.4P.P., which has an amplification factor of 80 and an impedance of 53,000 (30/-).

In the 6-volt range we have an H.F. and an R.C., a special detector (the 610D.), with an impedance of 9,250 and an amplification factor as high as 18 (all 10s. 6d.). Then we have a power valve, a super-power, and a special pentode, this latter having an impedance of 28,500 and an amplification factor of 54. It costs 25s., while the super-power valve costs 15s. and the ordinary power costs 12s. 6d.

Finally, we have a series of mains valves of the indirectly-heated type, with 4-volt heaters taking a current of 1 amp.



The Six-Sixty two-volt Pentode.

TRIOTRON VALVES

Some interesting A.C. valves are available in the Triotron range. These are the type S.C.N.4. The screened-grid at 18s. 6d.; the S.N.4, a detector-high-frequency valve at 10s. 6d.; and the A.N.4, for general purpose, at 10s.; the W.N.4, a resistance valve, at 10s.; and the Y.N.4, a low-frequency power valve, at 10s. 6d.

In addition to these there are two full-wave and one half-wave rectifiers, giving maximum D.C. outputs of 60

and 30 milliamps. for the full wave, and 30 milliamps. for the half wave.

These cost 12s. 6d., 10s. 6d., and 9s. 6d. respectively, and are known as the G.A.24, the G.N.24, and the G.N.14.

Of the battery type we have the 2-volters—the T.D.2, the S.D.2, the H.D.2, the W.D.2, at 10s.; the Z.D.2 at 7s. 6d., and the U.D.2 at 8s., and the 2-volt screened-grid valve, the S.G.2 at 17s. 6d. These valves are, of course, the H.F., detector, L.F. and power valves and the super power type, and are available again with an additional "Super" in the 4-volt list at similar prices.



One of the most popular of the Triotron products.

Valves made by TUNSGRAM, Ltd.

The Tungram Valve Company have nearly 30 valves from which we may choose.

The method of denoting their valves is somewhat different from usual, the resistance valve being called "R.," the high-frequency valve is called "H.," the ordinary low-frequency valve is called "L.G.," denoting a low-frequency and universal or general valve; "P.," of course, is power, super-power "S.P.," and the screened-grid valve is not catered for at all.

Double-Grid Valves

There is, however, a D.G. valve in the 2- and 4-volt series, having an impedance of 5,000 and an amplification factor of 5. It is a four-electrode valve, suitable for use in portable sets and receivers where low anode voltages are required.

Now let us take the valves in order of their prices, which we find are remarkably low. We have R.C. and H.F. valves priced at 5s. 6d., the power valve at 7s. 3d., the super-power valve at 8s., the indirectly-heated A.C. valve at 9s. 6d., and

the 4-volt A.C. power valve at 8s.

The first valve is the R.208 and has an impedance of 50,000 ohms and an amplification factor of 35. The H.210 is an H.F. valve having an amplification factor of 25 and an impedance of 25,000 ohms, while the L.G.210 is useful for high, low, or detector work, and has an impedance of 10,000 ohms with a magnification of 10.

Coming to the power, we find the P.215 has an impedance of 3,300 and an amplification factor of 5. The super-power (S.P.230) has an impedance of 2,500 and a magnification of 5.

From the 4-volters we have eight to choose, besides the double-grid; a resistance valve, 406R., of 18,000 and 25, the G.405, G.407, and G.409; 20,000 ohms, 5,500, and 7,000 ohms respectively; the latter being a useful valve having a magnification factor of 16.5.

Following this we have the P.410, 3,500 and 5; the P.413, the super-power P.414 and P.415, three 6 volt L.F. valves and a useful series of A.C. valves.



A typical Barium valve.

HOW THEY ARE MADE



Sealing the valve bulbs in the Edison-Swan Mazda valve factory.

SIR OLIVER LODGE, F.R.S., on—

At Work—



"For many years golf was my chief form of exercise."

THE Editor has asked me to write on how I keep fit; by which, I suppose, he means how, in spite of my long continued sedentary occupation, my muscles and joints are not altogether stiffened up and useless.

It certainly has not been always easy to find time for exercise; but when in London I always used to walk in preference to taking a vehicle; for the time saved by riding was small, so that the benefit of walking was secured with comparatively little loss of time.

I have always worked hard, but have not played hard. At no period of my life have I been conspicuously successful in strenuous games. Some of my holidays were spent in tramping excursions with a knapsack, when I used to do occasionally thirty miles a day; but that was rather too much and I preferred twenty.

In my teens I had a good deal of horse-exercise; for I was in my father's merchant business, and that entailed riding about the district and outlying places, so that I got very much accustomed to saddle-horses.

Concentrating on Work

Afterwards, when a senior student in London, I took no exercise at all, except walking, but concentrated on work, pretty well night and day: never dissipating my energies in social functions, and to a large extent living the life of a recluse, or at any rate of a student keenly anxious to make up for lost time.

Being somewhat older than the rest of the students, I became a teacher

as well, and thus earned a small livelihood; but every hour, indeed every minute, of the day had to be economised.

Later on, when Professor at Liverpool, where for a time I taught both mathematics and physics, I often lectured five hours a day, and was too tired to do more than walk the couple of miles each way to and from the college.

Golfing Holidays

Later on, when Forsyth took over the mathematics, and I had an assistant, I managed once a week to get over to Hoylake for golf, a game which, during one summer holidays, Professor Tait had been good enough to teach me at St. Andrews.

For many years golf was my chief form of exercise, and I occasionally won a club prize. I was a member of Hoylake, of Felixstowe, and especially of Gullane, near Edinburgh: and it was at Gullane chiefly that I spent the Long Vacation, taking with me a number of books and papers, and doing work in all the intervals; sometimes taking an extra room for the purpose, that I might not be interrupted.

Now that I am grown old and live in the South, good golf is not so

"Indoor rowing" exercise is made possible by weights and pulleys.

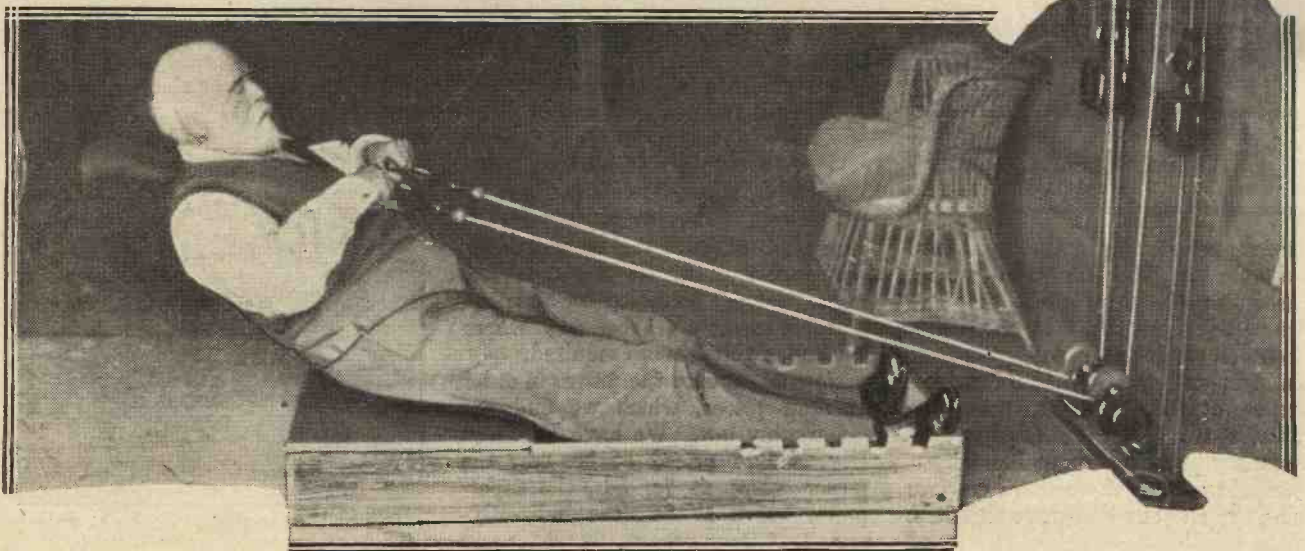

and Play

This month Sir Oliver Lodge—doyen of British scientists—celebrates the 79th anniversary of his birthday.

¶ *Honoured the world over for his brilliant and original researches into physics, Sir Oliver lays special claim to the affection and admiration of all radio enthusiasts, for he was the inventor of tuning.*

¶ *The world wide interest attaching to his birthday prompted me to ask Sir Oliver for a personal account of his spare-time activities, and this he gives below in a characteristically readable manner. THE EDITOR.*

accessible, and, moreover, it takes too much time; for, as one gets on nearer the end of life, time becomes a still more invaluable commodity; and it is difficult to respond to the many calls that are made upon one, in fact quite impossible.

I have never gone in for fishing or shooting, or any country sports; my exercise was often cutting down and sawing up trees, until lately, when I went with my family for a trip to Norway on the S.S. "Carinthia."

Life on board ship is not wholesome unless one takes some exercise. Walking round the decks is monotonous; there were, however, games; but I

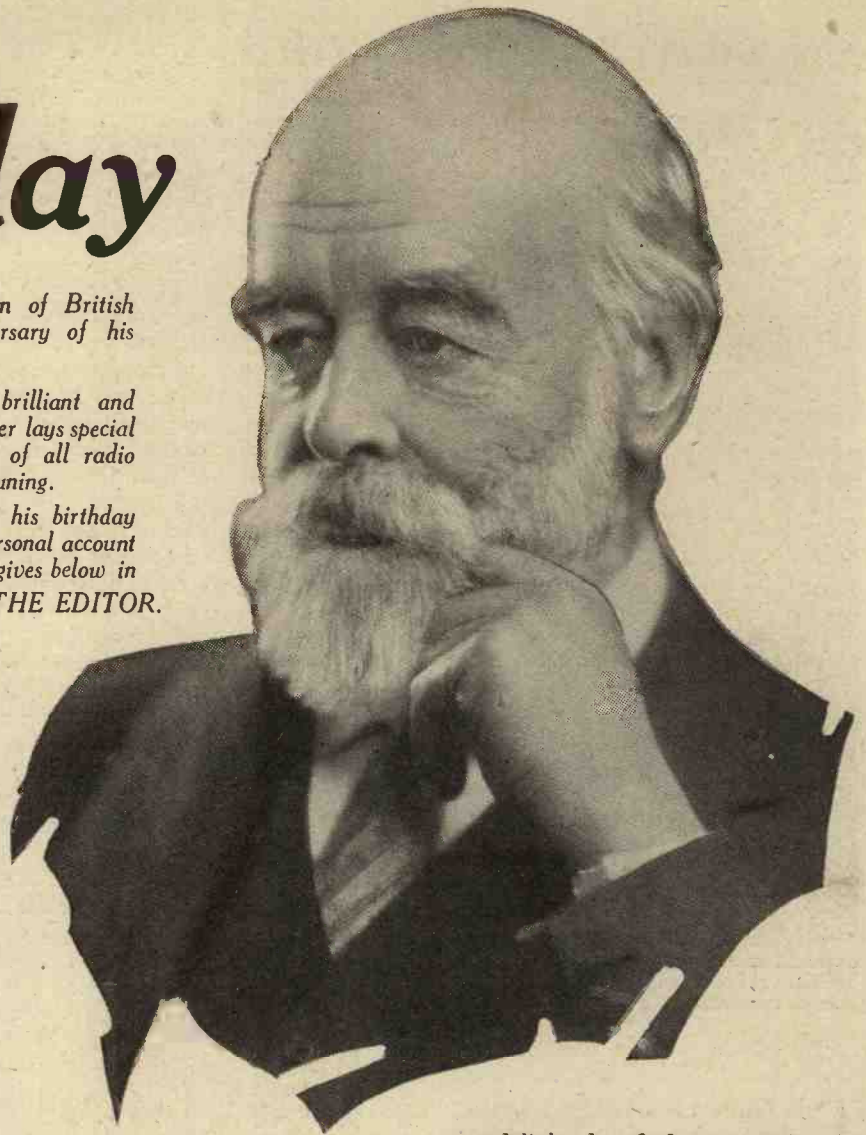

"Work has always come rather more easily to me than play," says Sir Oliver.

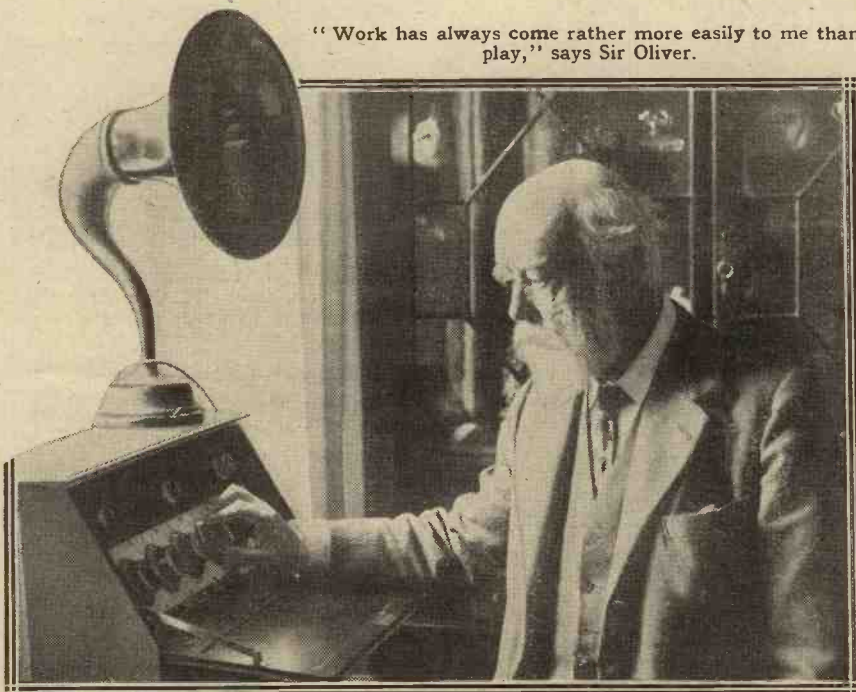

was delighted to find a gymnasium in the bowels of the ship, well fitted up with apparatus, and under the supervision of a petty officer instructor called Mr. Crane.

An Electric Horse

To him I went for advice and encouragement; and I am told by my family that when I was missing I was usually to be found in the gymnasium. It was fitted up not only with the usual athletic appliances, but with electric apparatus, which did some of the work for one; especially an electric-horse, on which one could ride for a quarter of an hour together; thus getting the effect of bodily exercise without over-exertion and without undue expenditure of time.

For even there I did some mathematical reading, in the intervals of sightseeing and excursions. Work, in fact, has always come rather more easily to me than play. But, finding the benefit of the vicarious bodily exercise attained in the ship's



Finding the benefits of gentle exercise in a ship's gymnasium, Sir Oliver Lodge decided to fit up similar apparatus in a barn at his home.

gymnasium, I set up some of the apparatus in a barn at home.

And the photographs which the Editor has secured illustrate a few of these which are useful in the winter months, and are independent of the weather. Mr. Crane's advice was not to overdo the exercise; his slogan, as he said, was "Little and Often." "Little" is easy enough; "often" is not so easy.

Purposeful Exercise

But, still, if something is done every day, and if one gets a daily game of Badminton in a covered court, the time expended is comparatively small, and the exercise good.

I truly take exercise for the sake of the work, so as to get as much done as possible before it is time to move on. How soon that may be I cannot tell, but it cannot be long; and I have much in contemplation before I go.

People seem to think that when a man has retired he has leisure for all manner of demands on his time. I am not, however, a man of leisure, and never expect to be. Naturally I

want to retain as much health and vigour as is possible, in order to do the work properly during the time that remains.

Appreciation

By strictly economising time throughout my life and not dissipating energy, I have managed to prepare or train myself so that work can be done with ease and quickness; and as long as that condition lasts I am well content.

Laboratory work is no longer satisfactorily possible except by deputy; one's eyes are not as good as they were. But writing and calculation are still feasible. The interest in the times in which we live is very great; the progress of science during the present century is

astonishing; and if one cannot take one's full share in it, I can at least appreciate the extraordinary genius of others, and am fortunately able,

for the most part, by previous study, to assimilate their work in the main, and sometimes to make it available for a wider public.

Broadcasting is a great institution, and I find that people are willing to listen, when they are not always willing to read books. Still, I am grateful to those of the public who do read; for it would be of little use writing books if no one read them.

I am aware that I have some gift in writing and making things clear. Physical science has grown so complicated that clear ideas on it are not always feasible, its recent developments have grown very abstract and difficult. It is in a transition period, out of which we may hope in due time to emerge.

An Ambitious Scheme

When physics has reached a completer and more comprehensive stage, I am in hopes that Life and Mind, or rather the physical vehicle for those primary apprehensions, can be brought into the scheme of physics, which at present has excluded them; and so I hope that my psychical researches may help to begin the treatment of mental and spiritual entities from a scientific point of view.

It is an ambitious scheme, no one can hope to do more than make a beginning, but I feel sure that some day it will be done, and that if I fail others will carry on the work. It must suffice if, by keeping fit to the end of my life, I am able to blaze a trail.

IN HIS WILTSHIRE HOME



This view shows Sir Oliver in characteristic attitude in the study of Normanton House, Lake, near Salisbury.

AT HOME WITH THE "RI" MADRIGAL



The "Madrigal" without its stand and speaker.

Being an account of a pleasant evening spent with the latest product of one of Great Britain's leading radio manufacturers.

MODERN WIRELESS readers will remember that in January we published a brief description and report of the R.I. "Madrigal" receiver, the set with the Golden

THE VARIOUS CONTROLS

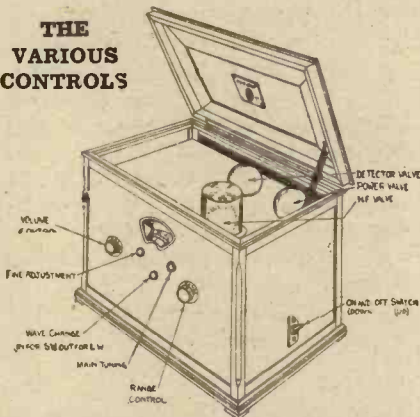

This sketch gives an idea of how the controls are arranged.

Voice. Since then we have been fortunate enough to hear the set under ordinary home conditions, rather than in the atmosphere of the laboratory in which it is more often our lot to listen to broadcast reception.

Unless you take the "Madrigal" home and use it in the ordinary dining- or drawing-room you cannot appreciate the set to its fullest extent. Placed on an easily movable stand incorporating a loud speaker, the whole outfit makes a transportable set of no mean order.

Always Ready, Anywhere

It can be plugged into the electric-light socket of any room, and, what is more, no aerial or earth troubles have to be solved. You simply wheel the set into whatever room you want to listen, plugging in to the electric-light socket, and there you are.

We tried it in at least four rooms in the house and in each it worked equally well. It was about 8 o'clock in the evening when we settled down to enjoy ourselves with the "Madrigal," and, after looking at the wavelength settings provided in the little handbook, we wondered which station we would try for first.

We were using no aerial, although provision for an aerial is made by alteration of one connection at the back of the set, and so we thought we would give the set rather a severe test, and decided to "get" Rome.



Mr. J. Joseph, Managing Director of Radio Instruments, Ltd.

Consequently we pushed in the wave-change switch knob and slowly turned the dial towards 80 degrees. Round about 20 degrees we suddenly come across a very strong station which quickly faded out again. "That surely cannot be the National transmission?" said somebody. "It

would be much louder and much broader in tuning if it were."

But it was, for although we were only about eight miles away the wonderful selectivity of the "Madrigal" obviated any tendency to spread on the part of Brookmans Park.

Achieved the "Impossible"

Off we went again, hearing little bits here and there from various stations, as we swept past on through the London Regional station towards Rome.

On approaching the 80 mark we began to slow down till eventually we heard a faint station obviously coming from a foreign land. We increased the volume control and brought the station up, and then a little gentle manipulation of the reaction brought him in at quite good loud-speaker strength. We had accomplished what would seem to be

BEHIND THE SCENES

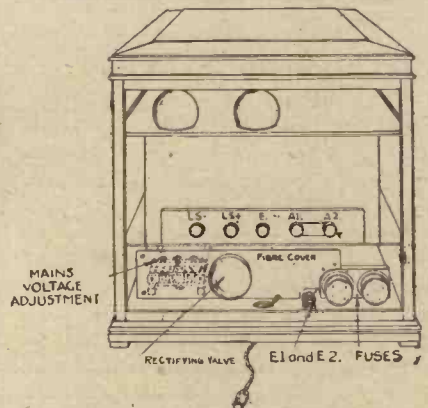

The mains connections are safely tucked away inside the back of the set.

almost the impossible on a three-valve set, we had brought in Rome

Neat in Appearance—Efficient in Operation

without aerial or earth, and brought him in on the loud speaker at a strength sufficiently loud to give interesting listening.

A few more stations were tried, and then somebody suggested the higher wave-lengths, so up we went to the higher waves, and began to listen as before. Radio-Paris came in remarkably well, Hilversum was not quite so good, but there was no doubt about his presence, while 5 X X, of course, was remarkably strong and clear. Motala did not seem too anxious to oblige, while the other stations on the higher wave-length range were not too ready to come forward.

Stations "Rolled In"

"Now let's try an aerial and earth," was the suggestion. So we hooked up a 20- or 30-ft. length of wire through the window and across the garden, rigged up a water-pipe earth, and returned to the set to listen once more. By this time the British news bulletin was being broadcast, and there was a hitch in the proceedings whilst we listened to the usual discussion about deep depressions, and that sort of thing; but we can assure readers there was no deep depression in the room in which we were listening to the "Madrigal."

Once more we manipulated the tuning knob, and the wave-change switch, and immediately the stations began to fall in at nearly every degree of the condenser. Oslo, 5 G B, Langenberg, Rome, a couple of unidentified Germans, Toulouse, the London Regional, and then a whole

host of Spanish and French stations, followed by the National programme way down on the wave-length scale.

READY FOR ACTION!

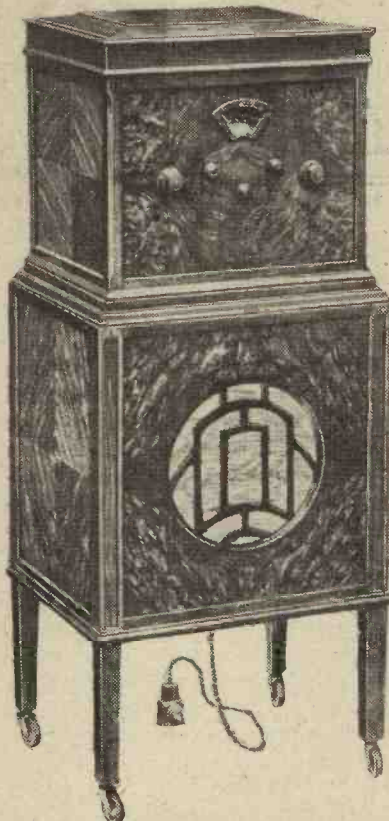

This shows the set mounted on the stand, which incorporates a moving-coil speaker. The set by itself costs £30, the stand and speaker being extra.

Such was the bag on the short waves. As we were out for an

evening's enjoyment as well as to test the set, no one worried very much about identifying the lesser-known stations. There were too many of them to identify properly, and in any case we had fully proved the worth of this remarkable receiver.

There is no doubt that an aerial does make a tremendous amount of difference, but for the person who does not desire to put up an aerial the scheme introduced by Messrs. R.I., Ltd., of using the mains as their aerial is remarkably efficient, and thoroughly satisfactory in operation.

A great deal of the success of the "Madrigal" is no doubt due to the AC-SG valve, which is potentiometer-controlled with regard to the screening voltage. This valve is remarkably efficient and gives wonderful amplification.

Remarkably Efficient

Then it is backed up by two other fine valves, the ACL and the ACP. Half-wave rectification is employed for both set and speaker, the latter being an excellent model of moving-coil type, while automatic bias is obtained by means of resistances in the cathode circuits.

Throughout, in design as well as finish and performance, the R.I. "Madrigal" is a remarkably efficient set, and we must congratulate Mr. Josephs on a first-class job. We were very disappointed when the clock struck twelve, and we had to silence that "Golden Voice" and close down for the night.

WHAT HAPPENS INSIDE THE R.I. "MADRIGAL"

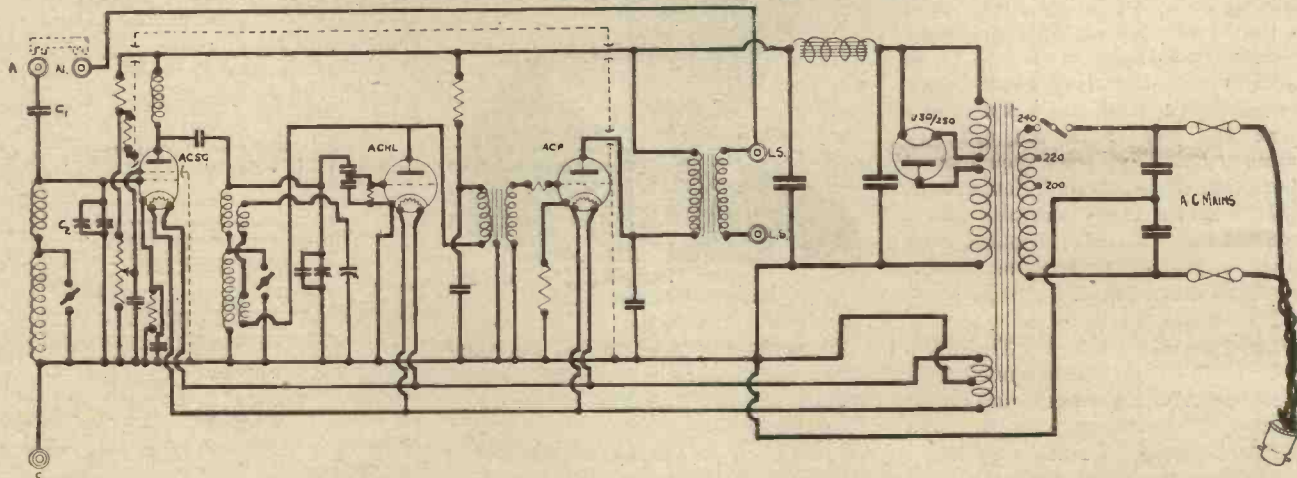

This is the circuit of the "Madrigal." Half-wave rectification is used, but no hum is present in the output. Note the provision made to use the loud-speaker leads as aerial if desired. This is a novel feature that works exceedingly well, as you will judge if you read the above account. The screened-grid valve has its screen potentiometer-controlled, thus forming a useful volume control.



Up the river, down by the sea, or on the dizzy heights of Wales or Scotland; no matter where you may be a portable set will keep you in touch with home happenings, and will make an excellent companion. And, moreover, there is no reason why it should be expensive, as is shown below.

By L. FRENCH.

IF you are starting the construction of a portable or, at least, thinking of commencing one, and you have had no previous experience of this type of receiver, you will need to know the snags to avoid and how to proceed for the best results.

The Easiest Way

Of course, the easiest way is to follow out carefully a good and reliable published design. On the other hand, quite a number of constructors like to work out their own design, even if it is only a modification of a published one.

If you are going to do this, you will find the practical hints given here of assistance in getting the most useful layout, and in overcoming little difficulties which may crop up as the work of construction proceeds.

Although these notes apply chiefly to inexpensive one- and two-valve portables intended for 'phone reception, much of the information will be useful if you are making up a loud-speaker portable.

First of all a few words about design, which is the first step. You can save yourself much time and trouble if you have a clear idea of how you are going to proceed.

So commence by working out on paper the arrangement of the receiver, dividing up the available space between batteries and accessories on the one hand and the actual works of the set on the other.

Distributing the Weight

I find a "fifty-fifty" division about right for small portables, using a 10-in. long fibre case for one-valvers and a 15-in. one for a two-valve outfit.

Whatever the type of portable you are building it is important to get an even distribution of weight by suitably placing the batteries, which constitute the bulk of the total weight. Nothing is more irksome than a portable which is heavier at one end than the other, and so drags on the handle.

A good scheme of construction for small portables is to place the tuning arrangements on the left-hand side of the case, with the rest of the "works" towards the middle front. This leaves room at the rear (the bottom of

A NEAT SUITCASE SET

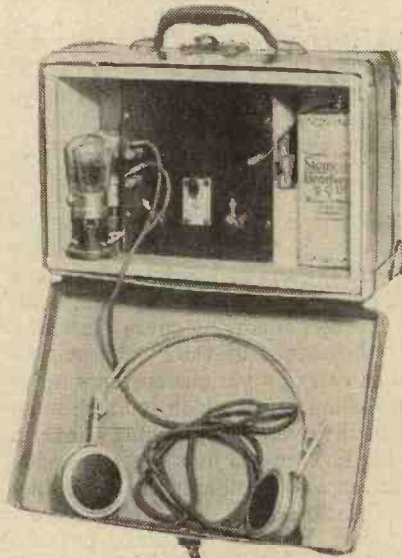

Here we see the interior of a neat and light portable two-valver for use with 'phones.

the case when carried by the handle) and the right-hand side for batteries and accessories.

Two things you will naturally aim at are mounting components compactly and keeping the batteries from

getting mixed up with the valves when the case is in transit.

The best way of doing this is to make up a four-sided framework of thin wood, the depth of the case, with suitable partitions to divide off space for batteries, etc.

The Tuning Controls

The sides of these partitions form little baseboards of a greater area than you could provide by using a flat baseboard with normal vertical mounting, besides making fuller use of the available space.

If you use $\frac{1}{4}$ -in. thick white wood or satin walnut, the actual woodwork will be quite light and strong.

An important part of the construction is the mounting of your tuning controls (usually two variable condensers), which should be readily accessible and easy to manipulate without cramping the fingers. Especially is this true of a small portable with a built-in frame aerial, when you should arrange the condenser knobs so that they can be operated from outside when the case is closed.

Winding the Frame

If you mount the condensers on the left-hand side of the framework, two holes can be cut in the side of the case through which the control knobs will project. You will then find that knobs as generally used for reaction condensers project just far enough for comfortable manipulation.

Wire down to No. 30 gauge can be used for medium-wave frames and, No. 36 D.C.C. for the long-wave section.

For wiring up components I strongly advise you to use No. 20 gauge stiff covered wire.

By the
Technical
Editor

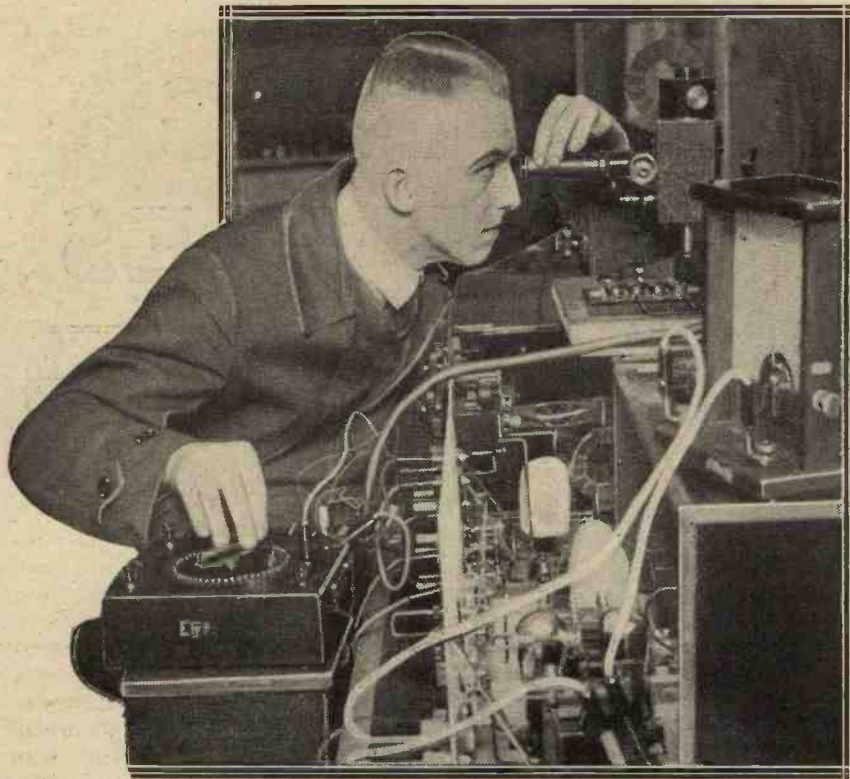

regarding the "Hypercore." It is a notable addition to a famous range of radio productions, and is yet another step, and a big one, in the development of that straight-line response that is the ideal at which all set-builders, amateur and professional, are constantly aiming.

We have carefully tested the "Hypercore" and find it excellent in operation. Particularly as an output filter choke or as an H.T. shunt choke is its effectiveness most marked.

Polar Differential
Condensers

There is now a new and improved type of Polar differential condenser. The special feature of this is that the



This is the R.I. "Hypercore."

Remarkable New L.F. Choke

THE application of nickel-iron alloys to the construction of L.F. transformer cores has been attended with great success.

At first doubts were expressed as to the electrical reliability of such high permeability cores, but these doubts have been swept away by the high degrees of reliability (and efficiency) reached by such components as the R.I. "Hypermu" and "Hypermite" transformers.

The "Hypercore" is less than half the weight and size of the standard R.I. silicon-iron choke, its total weight being a mere 18 ounces.

Owing to the use of the special metal, it has been possible to reduce the size of windings a great deal and achieve high inductance and very low self-capacity.

This is a very great gain, for self-capacity is the real bugbear of L.F. choke design, and is at the root of the inefficiency in high-note response in many otherwise first-class outfits.

Carries 50 m.a.

So you see that the reduction of the component's physical dimensions is really an incidental advantage, though a remarkably important one.

The accompanying curve illustrates the behaviour of the "Hypercore" when carrying various currents up to 50 milliamperes, which is much more than the average smoothing choke in a big H.T. mains unit has to handle.

Even at 50 milliamperes the inductance is 20 henries. The "Hypercore" is built into a first-class bakelite moulding and bears that polished, high-class finish that the R.I. people manage to impart to all their productions.

And the "Hypercore" costs only 17s. 6d., and is thus attractive in price as well as in its electrical virtues.

"M.W." readers should make a point of securing the R.I. literature

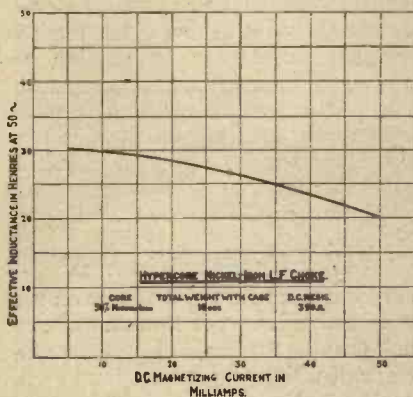

This curve illustrates the wonderful qualities of the new R.I. Choke.

Going a very big step forward in the radio use of nickel-iron, Messrs. Radio Instruments have now produced the "Hypercore," an L.F. smoothing and filter output choke which embodies a core of this new alloy.

spindle is insulated so that the component can be mounted either on ordinary or metal panels without fear of complications occurring.

It is undoubtedly an excellent little component, compact and robust in construction. The metal work is carried out in good quality brass and the small terminals fit snugly. The movement is perfect, there being just the right amount of freedom to permit of easy adjustment and the correct proportion of resistance to enable microscopic settings to be obtained.

The Polar differential condenser is available in four capacities: .0001 mfd. each side at 6s. 6d.; .00015 mfd. at 7s.; .00025 mfd. at 7s. 6d.; and .0003 mfd. at 8s. 6d.

TESTED

This Month

A REVIEW OF A FEW OF THE NEW COMPONENTS EXAMINED CRITICALLY IN THE "M.W." TECHNICAL DEPARTMENTS.

In all probability the differential condenser will completely displace the ordinary type of reaction condenser in the course of the next

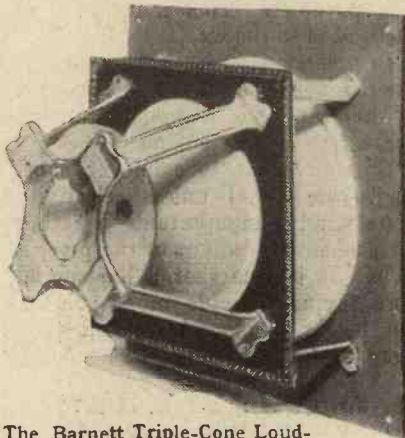

The Barnett Triple-Cone Loud-Speaker arrangement.

year or so. The differential method enables you to adjust the reaction without interfering to any serious extent with the tuning, while its use undoubtedly makes for greater sensitivity.

Omega Super Switch

From the Earl Engineering and Electrical Co., of Coventry, we have received a sample of the Omega Super Switch. This is a simple but effective device. The switch contact is made by screwing a pointed rod down on to a metal plate. The equivalent to locking the set is achieved simply by removing the Omega switch control. The price of the Omega switch is 2s.

Triple-Cone Speaker

Apropos our recent remarks concerning dual-cone loud-speaker assemblies, it is interesting to note that there is at least one assembly on the market that embodies *three* cones.

This is manufactured by M. Barnett, of North Street, Barking. The three

cones are of different sizes, as will be seen, and all are mounted on a common spindle driven by the single unit.

The Barnett assembly gives pleasing results and should prove of interest to "M.W." readers.

New Amplion Loud Speaker

One of the radio events of 1929 was the introduction of the guinea Amplion loud speaker. This is known as the Guinea cone, and it still holds a leading place in the radio market as exceptionally good value for money.

The Amplion innovation for 1930 is the new Junior Cabinet Cone speaker that has just been placed on the market under the name of the Amplion Two-Guinea Cone, type AB8. The price of this is, as its name suggests, 42s.

Only by scientific mass-production could such value be offered to the radio public. It is a fine-looking instrument, and its appearance is not at all suggestive of its low price. Of course, its performance does not equal that of a moving-coil instrument; but still, bearing in mind the price, we must say that we think the new speaker very good.

We should certainly advise those "M.W." readers who are interested in loud-speaker reproduction to endeavour to listen to one of these new Amplions. When one remembers the response of those loud speakers for which one had to pay as much as five guineas for a few years back, one gets an inkling of the progress that has been made.

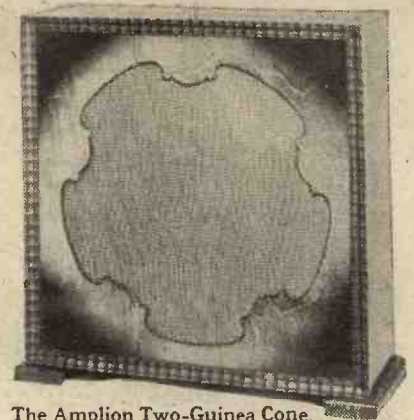

The Amplion Two-Guinea Cone.

"Lewcos" Wave-Change

The "Lewcos" people have concentrated on the dual wave-band problem and have produced solutions to it of typically sound characters.

The one "Lewcos" scheme forms the subject of this report. It is a coil holder for baseboard mounting with switching controlled by a rod passing through the panel. The holder accommodates long and short wave-length six-pin coils.

A Complete Change-Over

The device consists essentially of two portions, the upper portion carrying the sockets for the two six-pin coils, and the bottom portion six terminals for the ordinary circuit connections. When the top section is moved over by the operation of the control knob, either one or other of the two coils is brought into circuit with the six terminals. The coil holder is well made—that goes without saying, since it bears the Lewcos trade-mark—and it does its job with complete satisfaction. It requires

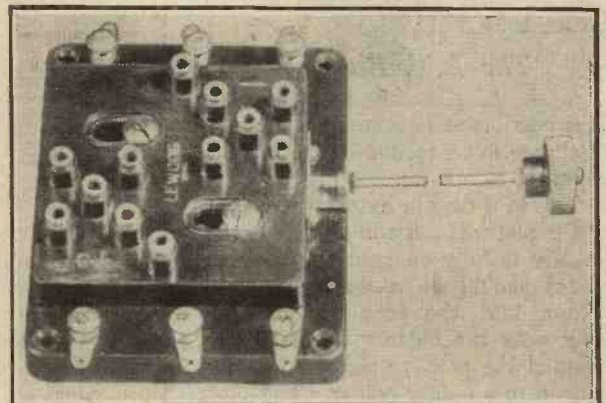

Pulling and pushing the control rod of this Lewcos device effects the wave-change.

two coils of the Lewcos Super or Binocular type which are arranged for six-pin mounting.

The price of this very useful component is 10/-

QUESTIONS ANSWERED

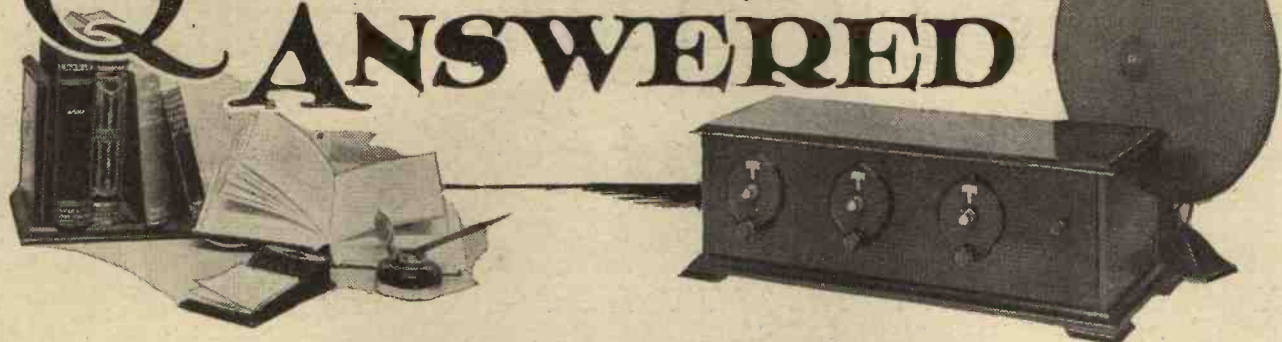

By the "Modern Wireless" Query Department.

Moving Coils & Sensitivity

M. B. (Eltham).—"I am desirous of getting the best possible reproduction, and I should like to instal a moving-coil loud speaker. Unfortunately, my set is only a simple one, consisting of a detector and two L.F. stages (R.C. and transformer). I have been told that a much larger set is necessary, and also that I should need 6-volt valves, my existing 2-volters not being capable of handling sufficient volume."

Your present set, M. B., should work a moving-coil loud speaker quite well, provided you only want moderate volume.

For domestic purposes, a valve of the P240 type in the last socket will handle sufficient volume. An H.T. voltage of not less than 120, and a grid voltage of 18 or more, according to the H.T. voltage, will fill an ordinary room with undistorted music. This holds good for the average three-valve set within about 30 miles of a Regional transmitter, and assuming an outdoor aerial to be used.

The L.T. Battery

A. J. A. (Clacton) asks whether it is possible to determine the amount of charge in an accumulator from the colour of the plates.

Yes, to a certain extent the colour of the plates is a useful guide. If the battery is fully charged the positive plates should be a deep chocolate colour, and the negatives a slate grey. As the battery becomes discharged the positive plates gradually change to a lighter colour. The best scheme, however, is to employ a hydrometer and to take the specific gravity of the acid. This is the only reliable test, and the gravity when fully charged should be in accordance with the value marked on the accumulator case.

Heterodyne Whistles

P. L. (Gravesend).—"I notice that when I tune in distant stations on my three-valve set I often hear a high musical note which interferes with my reception. Is this due to any fault in the receiver?"

No, it is most probable that the musical note to which you refer is a heterodyne whistle caused by two distant stations "beating" with each

doubled the length of my aerial would I get louder signals?"

In the first place, R. T., you are limited by the G.P.O. to a maximum length of 100 ft. for broadcast reception purposes. This is inclusive of the lead-in to the set.

In practice, 100 ft. is too much if the receiver is being used within, say, 50 miles of the Regional stations, because selectivity suffers.

It is advisable to employ a short single-wire aerial unless selectivity is relatively unimportant—a rather unusual state of affairs at the present time. It is true that a long aerial does frequently give more volume, but height is more important than mere length.

Improving Insulation

A. L. M. (Rochester) asks us whether he could improve his reception by placing extra aerial insulators in series with the existing ones.

If the aerial has one really good insulator at each end of the horizontal span there is little to be gained by adding others. It is true that the chances of leakage would be less if a second insulator were placed in series at each end, but in the ordinary course of events one insulator is adequate for broadcast reception purposes.

Adding an Amplifier

D. S. T. (Cambridge) asks whether he can add the "Regional" Amplifier (May MODERN WIRELESS) to his set, which is a four-valver, consisting of an H.F., det., and two transformer-coupled L.F. stages.

We do not advise the addition of another L.F. stage to a set of this type, because three transformer-coupled stages would produce instability, and the receiver would in all probability become unmanageable.

THE TECHNICAL QUERIES DEPARTMENT

Are you in trouble with your set?

The MODERN WIRELESS Technical Queries Department is now in a position to give an unrivalled service. The aim of the department is to furnish really helpful advice in connection with any radio problem, theoretical or practical.

Full details, including the revised and, in cases, considerably reduced scale of charges, can be obtained direct from the Technical Queries Department, MODERN WIRELESS, Fleetway House, Farringdon Street, London, E.C.4.

A postcard will do: on receipt of this all the necessary literature will be sent to you, free and post free, immediately. This application will place you under no obligation whatever. Every reader of MODERN WIRELESS should have these details by him. An application form is included which will enable you to ask your questions so that we can deal with them expeditiously and with the minimum of delay. Having this form you will know exactly what information we require to have before us in order to solve your problems.

London readers, please note: Inquiries should not be made in person at Fleetway House or Tallis House.

other. With a set of the type you are using you cannot cut this out, and we are afraid there is no remedy while there are so many stations transmitting on certain portions of the broadcast wave-band. We assume that your set is perfectly stable, and is not being worked in an oscillating condition.

Aerial Length

R. T. (Sutton).—"Does the length of the aerial make very much difference to reception? For instance, if I

MY BROADCASTING DIARY



Under this heading month by month our Broadcasting Correspondent will record the news of the progress of the British Broadcasting Corporation, and will comment on the policies in force at B.B.C. headquarters.

"The Immortal Hour"

THERE is much pleasurable anticipation of Sir Barry Jackson's revival performances of "The Immortal Hour" at Malvern in August. Arrangements are being made to use the Birmingham orchestra and choir in return for S.B. broadcasting facilities.

London Choral Union

It is reported that there is some chagrin and a good deal of resentment in London Choral Union circles because the B.B.C. turned down the offer of a relay from a special concert at Kingsway Hall on April 8th. Supporters of the Choral Union are considering what reprisal measures can be taken against the B.B.C. It is also contended that the Choral Union's standard is far better than the B.B.C. standard. More will be heard of this.

Sir James Barrie for Scotland

There is to be a broadcast of Sir James Barrie from a function at Kirriemuir on June 7th, but for Scotland only. No reason has been given for the London boycott.

Thrillers by Bransby Williams

I am told that the B.B.C. is arranging with Mr. Bransby Williams for a special series of readings of thrillers, including stories from "The Incredible Adventures of Rowland Hern."

Canterbury Festival

The B.B.C. is not co-operating to the same extent this year as last. The festival takes place from June 7th to 14th. There will be a relay of the Thanksgiving Service early in the afternoon of June 7th, when the Archbishop of Canterbury will preach, supported by a choir of 150.

St. Olaf Celebrations

I hear that Major Atkinson, the Foreign Director of the B.B.C., has prevailed upon his colleagues to co-operate with the Norwegian broadcasters in the special pro-

grammes arranged in connection with the 1,000th anniversary of St. Olaf. These will take place in August or September.

Trouble with Brighton

Having decided to include the Brighton Municipal Orchestra as a regular programme item, the B.B.C. has now changed its mind. No definite reason is given, but it is believed that second thoughts brought the conclusion that the Brighton orchestra was not good enough.

Deputations from Brighton have been unavailing, and there is now a good chance of a big war between the South Coast resort and the B.B.C. Brighton angrily denies the inferiority of its orchestra to that of other places, such

AERO RADIO

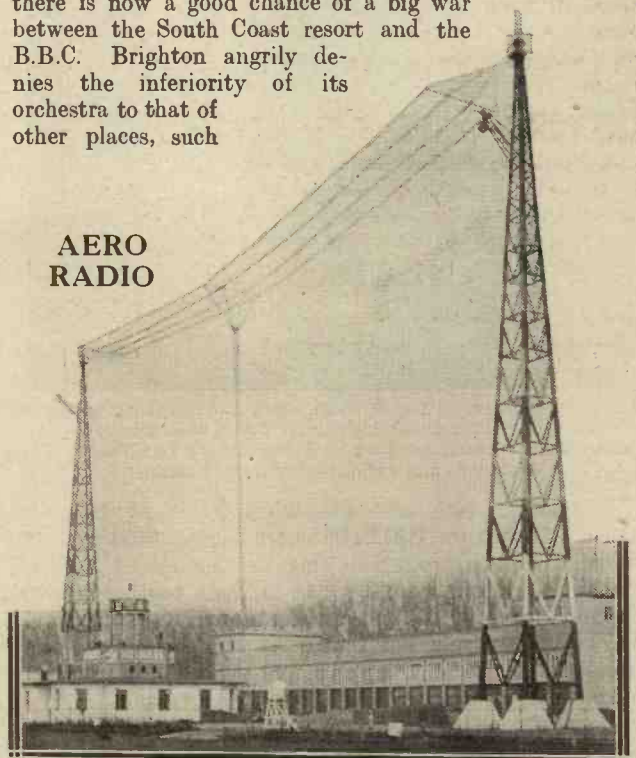

This radio station at the Tempelhof Aerodrome (near Berlin) is used for communicating with airships in flight.

Latest News Items for the Listener

as Bournemouth, for instance. There is high feeling in the town and on the Council.

Mrs. Roger Eckersley to Talk

Mrs. Roger Eckersley, wife of the Director of B.B.C. programmes, is to give a special series of six o'clock talks from London on the subject of "The Care of Dogs." Just as her husband has made a hobby of chicken-farming, so Mrs. Eckersley has become a nationally recognised authority on dogs, which she breeds with distinction and success.

WIRELESS WONDER-HOUSE



The chief engineer of the German State Broadcasting Corporation carrying out tests at his private house at Zehlendorf. All the German broadcasters can be connected by landline to this residence and various relay links arranged.

It is not generally known that Mrs. Eckersley exercises much influence on B.B.C. programme construction. It is believed at Savoy Hill that the mantle of "king-maker" formerly worn by her brilliant brother-in-law, Captain Eckersley, has been assumed by Mrs. Eckersley. Anyway, it's a safe bet that what Mrs. Eckersley feels strongly about usually happens, and the aid of her shrewd judgment is constantly sought by the Governors.

Mr. Vernon Bartlett

There seems some doubt about whether Mr. Vernon Bartlett will go on with the International affairs' talks

which have been so popular in the past three or four years. Mr. Bartlett feels overworked, and the continuous strain of the microphone has worn down his resistance. In the B.B.C., too, there is a feeling that perhaps a cheaper arrangement might be made with Mr. Harold Nicholson, himself possessing a knowledge of foreign affairs as great as that of Mr. Bartlett.

Aesthetics and Morals

Some discussion is going on now as to whether or not the B.B.C. gives disproportionate recognition to the attitude and philosophy of the "bright young people." The younger school of thought seems to be pretty strongly entrenched in the Programme Branch, where there is growing disregard of anything that might be classified as old-fashioned.

It follows that as most of the bright young people are to the "left" in politics as well as in art, Tory views get short shrift. Revolutionary views are not actively propounded; perhaps not even consciously tolerated; but there is an under-current favourable to them. This is clear in the debates and talks on political and economic subjects.

Similarly in the dramatic department there are several very advanced exponents of new art, including forms of necromancy. Personally I believe this is all to the good. If risks must be taken, far better to the virile left than to the stodgy right. But, of course, such tendencies require the most careful watching.

This is probably why the Governors put their feet down on the proposed big series on "Russia To-Day," which the Programme Branch had worked out with such care.

Spiritualism and the B.B.C.

Despite the violent rebuff to Sir Arthur Conan Doyle by the B.B.C., a new effort is being made to get spiritualism on to the ether. The latest move concerns spiritual healing through organised prayer.

It is alleged that a committee of distinguished physicians and surgeons "on the other side" has been active for some time past, and has decided on a plan of campaign for a general toning up of the health of humanity through stimulating prayer by wireless. It will be interesting to see how the B.B.C. handles the new move.

Last time the Religious Advisory Committee took the blame: have they wide enough shoulders to reject spiritual healing through prayer as well?

France Studies the B.B.C.

I hear there has been a representative committee of Frenchmen studying the B.B.C. organisation and work recently. The inquiry was brought about through the activity of a Paris newspaper, which sent over a representative last March, and whose report was so flattering to the B.B.C. that many Frenchmen have realised for the first time how backward their country is in radio organisation. The object of the new inquiry is to create a B.B.C. for France.

Incomplete Alternatives

There is a good deal of grumbling about the increase in the number of programme items which the B.B.C. do not provide any alternative for. The first was the debate about war books late in March. Since that time there have been at least half a dozen programmes given simultaneously on all available British wave-lengths.



"THE set you will be proud to own." That is the slogan which the manufacturers associate with the A.C.2 All-Electric receiver. In view of the big claims made for it, and of the great reputation of its makers, the Igranitic Electric Co., Ltd., it was with special interest that the A.C.2 was unpacked and examined.

Simplicity Itself!

Divested of its trappings, the set revealed itself to be one of the table type, enclosed in a particularly handsome cabinet. It has a sloping front that makes for easy adjustment and operation, the top is hinged to form a lid, and all the terminals are arranged at the back out of sight.

"All the terminals" is, perhaps, a little grandiloquent, for there are only five of them. Two of these take the loud-speaker leads, one is for the earth lead, and the remaining two are aerial terminals, either of which can be used according to the degree of selectivity which your aerial gives.

Coming from the back, also, there is a flexible lead with a plug

A brief account of a very interesting try-out of this famous All-Electric Receiver.

on the end which goes to the electric-lamp socket. And that is all! No low-tension accumulator to charge and run down, no high-tension batteries to be purchased, nothing but just the aerial and earth, the plug to the power and the lead to your loud speaker. Such are the striking advantages of an all-electric supply!

If compactness and simplicity in the valve-supply systems have been

worked out with signal success, what can be said of the panel controls? Well, the accompanying illustrations tell the whole story.

All the tuning takes place on one dial in the middle of the panel. To the left of this there is a simple-push-pull switch, "Out" for lower waves, and "In" for the long. Symmetrically placed to the right of the tuning dial is the reaction control, and below the panel is a central switch of the on-off type, which puts the set in or out of action.

An Exacting Test

It must be confessed the external appearance is strikingly favourable. The cabinet (obtainable in either oak or mahogany) is a solidly-made and

handsome piece of furniture of pleasing lines and excellent finish. It is not only that the workmanship is good, but in general the set has an air of stability and a hint of latent power.

To connect the loud speaker, join up aerial and earth, and place the plug in an electric-light socket is but the work of a minute, and these leads can then be left permanently in position. The on-off switch on the set thus gives a control as complete as that of an electric light.

A PEEP INTO THE INTERIOR

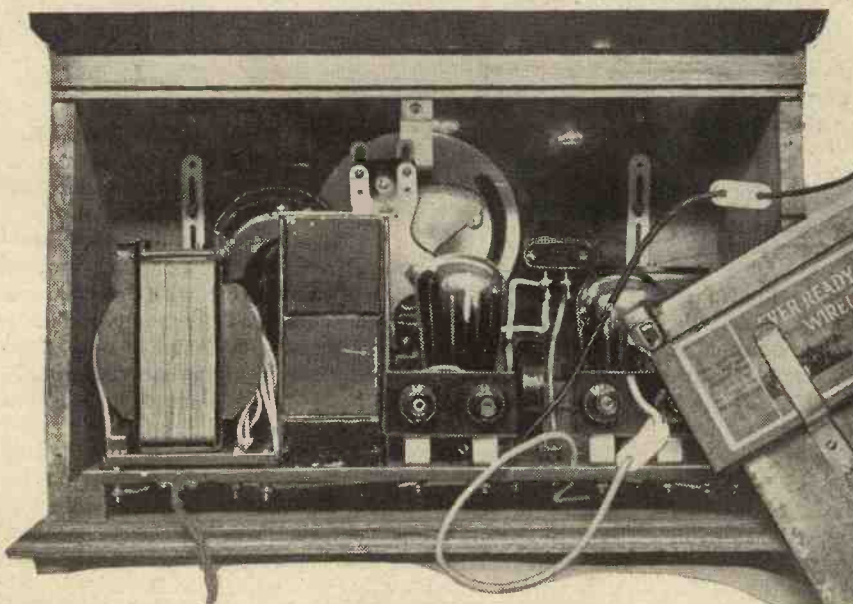

Although the back of the set is not supposed to "take off," it was removed for the purpose of this illustration to show the remarkable degree of compactness attained. The only "renewal" necessary is the G.B. Battery, which can be moved from its clip inside the cabinet in a second.

"The Set you will be Proud to Own"

The set was tried in the heart of London, on a very poor aerial, in full daylight. And straight away the Regional programme roared in at splendid strength. In fact, when fully tuned in the power was overpowering; reaction, of course, being left at zero. Towards the bottom of the tuning scale the National programme was tuned in, and as this programme is always badly received on the particular aerial used, the reaction control had to be very slightly advanced to obtain equal power.

Plenty of Programmes

Satisfactory strength having been obtained easily at the bottom of the dial, the tuning dial was turned back again past the point where the "Regional" roared in, towards the top of the scale. Here the Midland

incapable of performing on the particular aerial employed.

So that on a good aerial, especially after dark, this "local station set" would let you listen half across Europe. And a two-valve set which will do that is a set worth looking into!

"Looking into" the All-Electric A.C.2 receiver reveals that the secret of its success is the valves! For the circuit is a standard one, being detector with capacity-controlled reaction, followed by a low-frequency amplifying stage of the usual transformer-coupled type. But the valves are anything but ordinary.

The splendid volume obtainable is due to the use of a pentode output valve, the plate of which receives 150 volts from the mains, while the step-down transformer supplies its filament with the necessary four volts. The

mains transformer are embodied in the set, it will be evident that space is carefully conserved, and the utmost attention has been given to the layout of the parts. Not a cubic inch is wasted anywhere, and in order to show the careful arrangement of panel and baseboard a photograph was taken of the whole "works."

Not An Inch Wasted!

From this it will be seen that the careful workmanship which characterises the outside of the case is equally in evidence inside the instrument, the job being thoroughly workmanlike in every detail. One point of passing interest is the grid-bias battery.

This battery could have been dispensed with and a suitable grid bias obtained from the mains (in the same way as L.T. and H.T. have been provided), but in view of the very infrequent renewals necessary for grid-bias batteries and the ease with which they can be replaced, it seems hardly worth while to complicate even an all-electric set to provide grid bias when an inexpensive battery will serve the same purpose.

Its very low cost and the fact that it lasts for at least six months are facts which place the grid-bias battery in a class apart from L.T. and H.T., and we do not doubt that most purchasers will agree that such infrequent replacements are better than the alternative of a more complicated set.

Low Cost of Upkeep

In short, then, the Igranite A.C.2 All-Electric Receiver is a high-quality set that was specially designed for local station work, but is easily capable of picking up foreigners under good conditions. The price, including royalties and complete with valves, is only £13. The running costs are practically nothing, and in most households no difference whatever would be noticed in the electricity bills as the result of its "upkeep."

It is both easy to instal and easy to control, and quality programmes are available on long or low waves without bothersome coil changing. These main points, in conjunction with a pleasing appearance and remarkable compactness, are ample justification for the claim of the makers that the A.C.2 is "the set you will be proud to own."

IT IS VERY EASY TO CONTROL



The A.C.2. was really designed as a "local" set, but the reaction control enables you to bring in foreigners as well.

Regional, more familiarly known as 5 G B, was found in high fettle. So this made three easily obtainable alternatives on a dud aerial in daylight!

One finger on the wave-change switch flicks the set away from the lower wave-band over to the long waves, and here 5 X X was found repeating the National transmission at full strength. Moreover, with the aerial lead adjusted to the high-selectivity-aerial-terminal the Radio-Paris programme was next clearly reproduced, which incidentally is a feat that many a three-valve set is

high amplification factor of this valve gives phenomenal power compared with the output valves of two or three years ago.

No Hum At All!

The detector valve is one of the new indirectly-heated-cathode type, the filament of which is not fed direct from the mains, but gets its heat across the small space that separates it from an adjacent heating electrode. And though that small space does conduct the heat across, it shuts the door on the hum!

As both the rectifying valve and the

PRUNING YOUR RADIO

By P. R. BIRD.

GOOD gardeners who pruned their roses a few months ago will now or a little later be reaping the benefits of this policy. But did you know that it often pays to prune your radio?

In wireless, as in horticulture, mere quantity is not everything; and in time the knowing listener will prove for himself that a ruthless trimming and tidying now and then will often make a vital difference.

Length of Leads

This is especially true in matters of selectivity. Too often the idea prevails that the longer the aerial the better. Although 100 ft. length is the limit fixed by the P.M.G., there is very rarely any need for more than 70 ft. In many cases 50 ft. is more than sufficient, and in the home counties, where Brookmans Park is the local station, the length may be reduced considerably below this.

Indoor-lead pruning is always an advantage. If you can move your set closer to the point of lead-in instead of having it at the far end of the room, or if by taking up the floor-boards you can let the earth lead take a short cut to the water pipe, you should do so.

Many a foreign programme which arrives on the aerial never gets into the set properly because of the long and tortuous path of the lead-in wire. And, of course, to prevent one station spreading over the dial too far there is nothing like shortening your aerial.

For Sharper Tuning

Incidentally, the advice to do this is the stock remedy of the B.B.C. for listeners who cannot cut out a powerful station. If you are unable for any reason to cut off a length of the

Some practical suggestions for improving strength and selectivity.

aerial, and you suspect it would be an advantage to do so, you can obtain the same effect electrically by connecting a small fixed condenser in series with it. But it must be a *small* condenser.

THOSE LONG LEADS

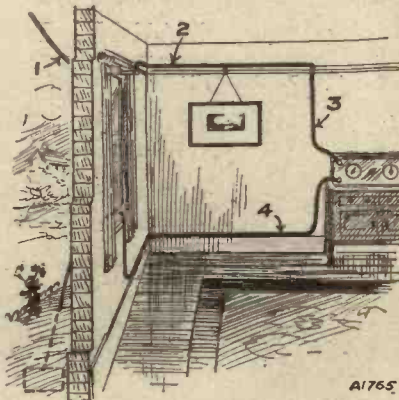

Shortening the aerial (1) often improves results. To run an aerial wire near a metal rod (2) is a sure source of loss, while (3) and (4) illustrate too-long leads, which could be obviated by placing the set nearer the window.

The little semi-variable ones with a maximum of about .0002 mfd. are useful for this purpose, as also are the neutralising condensers, for the smaller the condenser the greater is the effect. (But you may find that an N.C. weakens reception too much for use on the long waves.)

Another method of electrical pruning is to use a smaller aerial coil (in

cases where a separate coil is used for this in conjunction with a grid coil). If it is a plug-in coil, use one size smaller; or if it is a home-made coil, take off a few of the turns. By "pruning" the inductance in this way you may reduce strength slightly but you will improve selectivity, so that it is often a very great advantage.

"The Better 'Ole"

One of the greatest aids to flat tuning and non-selectivity is a too-long earth lead. And if you use a buried earth, a poor connection here or bad contact with the soil owing to the choice of a dry situation may not only cause flat tuning but may make your dial readings erratic until the cause of the trouble is removed.

Do not forget that earth wires can often be run underneath floors very easily. Half an hour's "fishing" with a stiff wire through a ventilating brick from outside the house may enable your earth lead to take a short cut under the floors and through the wall to that mecca of the wireless man and of the infantry—"a better 'ole."

An Earth-Lead Hint

It is an advantage, if possible, to arrange a buried earth in soil that is watered by an overflow pipe or that is well exposed to rain. But in your enthusiasm for pruning the earth you must not place it too close to the wall of the house, as this is invariably dry. Or should be!

Remember, too, that while you are about it, it is a good plan to bring the earth wire up from the buried plate through a gas pipe or something similar, into which water may be poured in hot weather to ensure that contact with the soil shall be good.

The "M.W."

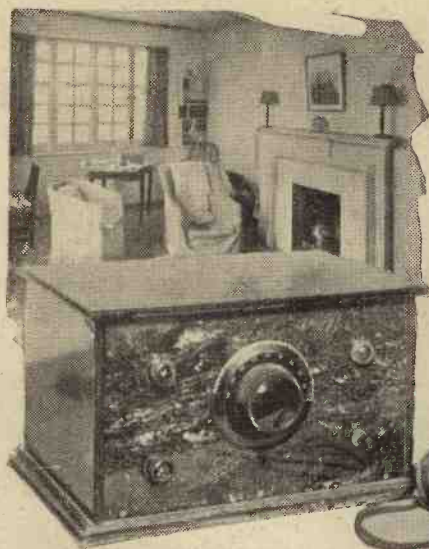

Plenty of programmes assured.

Regional quite free of either, and even find a little clear dial space for a few foreigners as well.

All very gratifying to the designer (the results quoted were decidedly better than we ourselves should have expected!), but wait until you hear what Reader No. 2 had to say. He described the set in no uncertain

terms as an absolute failure, and it was obvious that he had a strong suspicion that it was a bad design and incapable of working properly under any conditions. (He didn't say so, but he did remark that a local "expert" who had failed to cure his trouble had told him that this design "never did work.")

A Really Bad Case

This reader lived on the south side of London, and although he was sixteen miles from Brookmans Park

he could not separate the two transmissions properly, the Midland station was hopelessly smothered, and he could get no foreigners at all. His set appeared to be a perfectly satisfactory copy of the design, and he was using coils of a good make; the only clue appeared to be in his aerial, which was obviously inefficient but extremely large.

Simple But Impracticable

How we wished we could introduce him to Reader No. 1 and leave them to cancel out! Even more, how we wished we could breathe a few winged words in the ear of that "expert"! This allegation that the design is "no good" appears to be the stock excuse of a certain type of "set doctor" when baffled, and we have met with it many times.

However, to return to our problem. It was pretty obvious that our dissatisfied friend was suffering from the effects of his very large aerial, exaggerated by the tremendous power of the new transmissions. It was equally obvious that it would be

THE tremendous intensification of the jamming problem which the opening of the Brookmans Park station has brought about in the London area has brought to light many interesting facts about selectivity, some of them rather surprising.

For example, before this severe testing which all our sets have been undergoing, few people could have anticipated the really extraordinary differences in selectivity which are now being reported as between sets made from the same design and operated on different aerials. Of course, such differences were known to exist, and were indeed regarded as quite normal, but the extent of the variations now observed is far greater than we have been accustomed to in the past.

What High Power Does

No doubt these effects are natural enough when we remember the very high power of the new twin transmitter, but, all the same, actual examples of the kind of thing which is occurring come as something of a surprise. Here is an example of a striking but by no means isolated nature; in the course of one week we once received reports from two readers who had built a certain popular "detector and two L.F." with extraordinarily different results.

Reader No. 1 lived in North London, some eight miles from the new station, and he sent us a glowing testimonial to the set, which he thought a really fine piece of work. He found that by placing a semi-variable condenser of the compression type in series in his aerial lead, and setting this to a suitable capacity, he could separate the two transmissions with comparative ease, could get the Midland

MAKING THE MOST OF IT

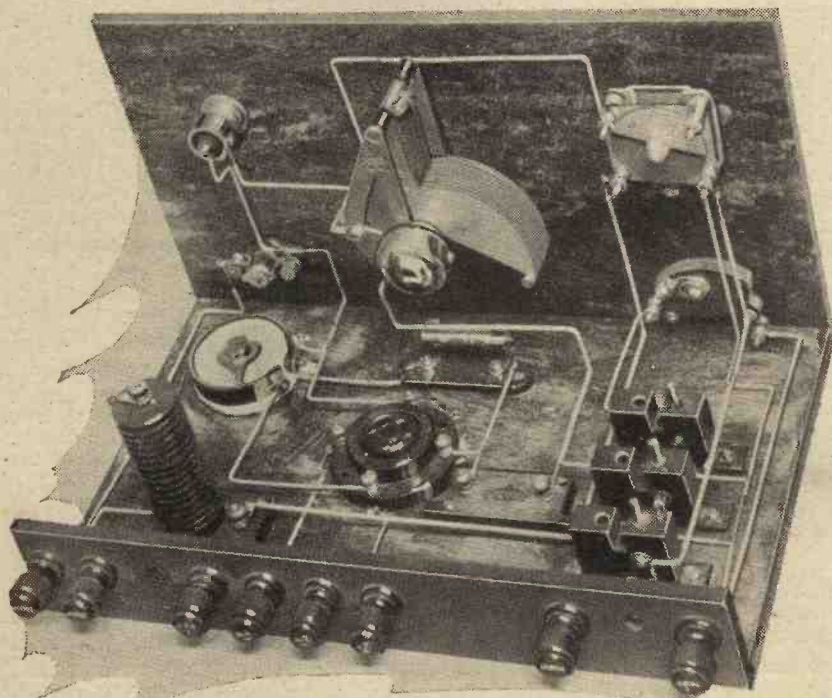

You couldn't do more with one valve than by using this set. It gives an exceptionally efficient performance and has none of the drawbacks that are so often associated with one-valvers "pushed to the limit."

"Differential" One

A SENSITIVE RECEIVER FOR LONG-DISTANCE TELEPHONE RECEPTION.

DESIGNED AND DESCRIBED BY
THE "M.W." RESEARCH AND CONSTRUCTION DEPARTMENT.

useless to recommend him merely to reduce its size, because it was so inefficient that he would then have had no strength of signal left.

Instead, we suggested to him a series of special methods of weakening the coupling of the aerial to the receiver, and urged him to experiment with

- *****
- COMPONENTS RECOMMENDED**
- * 1 Panel 12 in. x 7 in. (Trolite, or Goltone, Paxolin, Keystone, etc.).
 - * 1 Cabinet to fit, with baseboard 7 in. deep (Cameo, or Osborn, Lock, Pickett, Gilbert, etc.).
 - * 1 .0005-mfd. variable condenser (J.B., or Lissen, Lotus, Dubilier, Polar Ready Radio, Burton, etc.).
 - * 1 Vernier dial, if condenser not of slow-motion type (J.B., or Lissen, Igranic, Formo, Brownie, etc.).
 - * 1 .0001-, .00013-, .00015-, .0002-mfd. differential reaction condenser (Lotus, or Lissen, Formo, Ready Radio, Magnum, Polar, Wearite, Paroussi, Keystone, etc.).
 - * 1 .0005-mfd. Brookmans condenser (Ready Radio).
 - * 1 Panel light (Bulgin).
 - * 1 On-off switch (Lissen, or Igranic, Lotus, Benjamin, Bulgin, Wearite, Junit, Magnum, etc.).
 - * 3 Coil holders (Wearite, or Lotus, Igranic, Magnum, Lissen, Keystone, etc.).
 - * 1 Valve holder (W.B., or Igranic, Benjamin, Lotus, Lissen, Junit, Wearite, Magnum, etc.).
 - * 1 .0003-mfd fixed condenser (Lissen, or T.C.C., Dubilier, Mullard, Igranic, Goltone, Atlas, etc.).
 - * 1 2-meg. leak and holder (Lissen, or Igranic, Dubilier, Mullard, Ediswan, etc.).
 - * 1 400- or 200-ohm potentiometer (Igranic, or Lissen, Ready Radio, Wearite, etc.).
 - * 1 H.F. choke (Lewcos, or Varley, Lissen, Lotus, R.I., Igranic, Keystone, Ready Radio, Magnum, Bulgin, Wearite, Dubilier, Climax, etc.).
 - * 1 Terminal strip, 12 in. x 2 in.
 - * 8 Terminals (Belling & Lee, or Igranic, Ealex, Burton, etc.).
- *****

them. We never heard any more of him, and can only hope that he has found the solution of his problem.

Now, there is a moral in all this, and that is that the adjustment of aerial coupling, especially in sets which depend for their selectivity upon a single tuned circuit, has become of

VERY SMOOTH REACTION

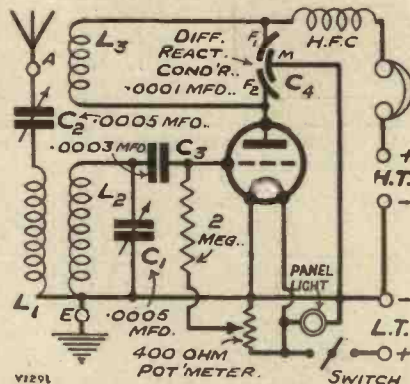

The special reaction arrangement and the grid return adjustment make this little set wonderfully virile and silkily smooth in operation.

vital importance now that we have so overwhelmingly powerful a local signal to contend with.

Now that our selectivity standards have had perforce to be raised con-

siderably there will inevitably be cases wherein the conventional methods will be inadequate, and a wider range of control of aerial coupling must be provided.

More Complete Control

There are various ways of getting the desired wider range of control, one of the simplest and best being the use of some form of adjustable capacity in series in the aerial lead.

What we want, in these cases of special difficulty, is a continuously adjustable control, because we only wish to weaken the aerial coupling just enough to give us the desired selectivity.

A very excellent method of getting the desired control is to make our series aerial condenser actually variable, an expedient scarcely permissible in the past because of the cost of the extra component and the space occupied. Recently, however,

EXCEPTIONALLY EASY TO MAKE

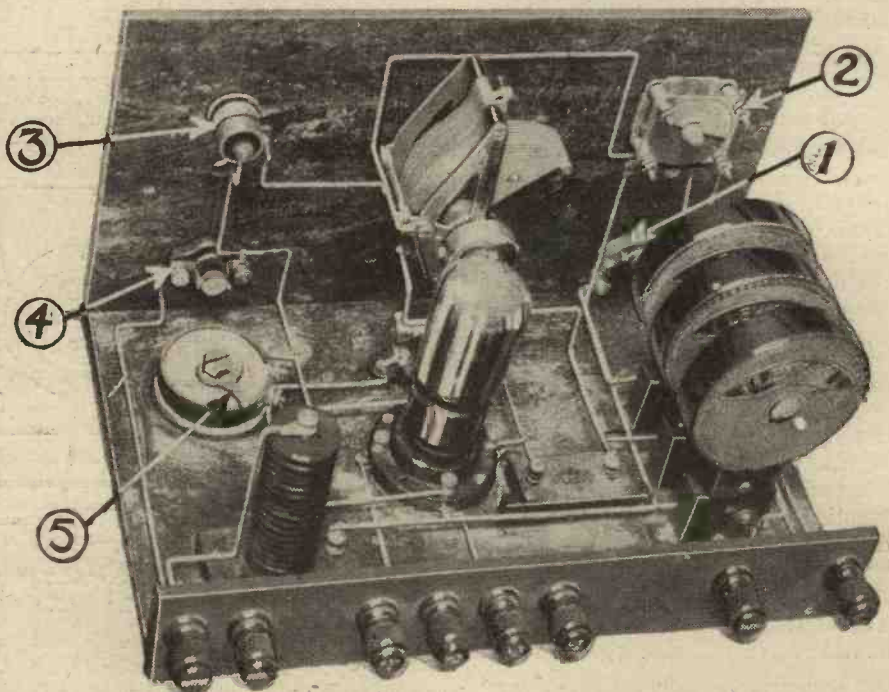

Standard components are used throughout. (1) Aerial coupling condenser. (2) Reaction condenser. (3) Panel light. (4) On-off switch. (5) Potentiometer.

A SYMMETRICAL PANEL

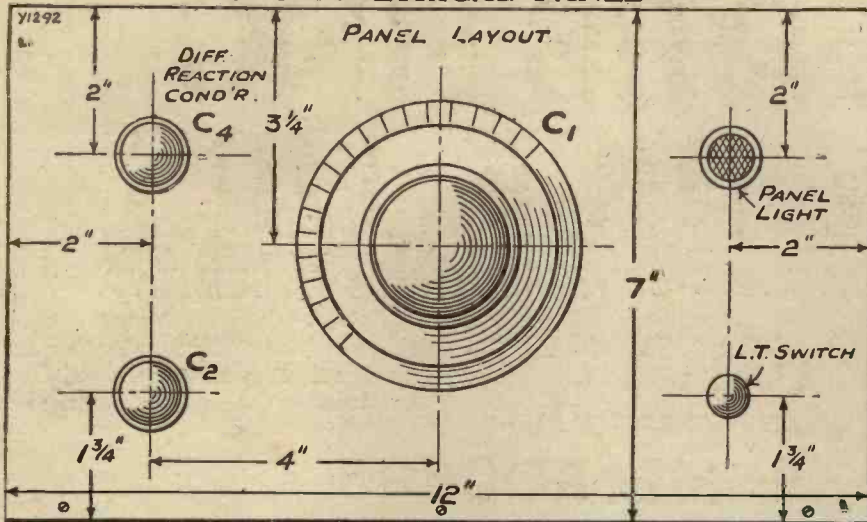

A panel light, which gives you a visual indication that the set is switched on, neatly contributes to the symmetry of the front view.

very compact and inexpensive variable condensers have appeared which serve the purpose admirably, and so the method is likely to find considerable use in the future.

The method can be applied to almost any type of set, of course, and the design we are describing this month is intended very much as an example showing how it can be applied to other receivers. As it stands, this little set is an ideal head-phone outfit of excellent selectivity for general use.

Sensitivity and Simplicity

The sensitivity of the receiver is very good indeed, and it gave an excellent account of itself on test among the foreign stations.

It is exceedingly simple in every way, especially when its outstanding performance is taken into account, and so we do not feel it necessary to describe it in any detail.

The general features of the set will be gathered readily enough from the circuit diagram. Note the condenser C₂ of .0005-mfd. maximum capacity in the aerial lead which gives the control of selectivity, the differential reaction circuit, and the potentiometer

Very Easy to Build

Constructionally the little set is too simple and straightforward a job to call for any special instructions. We would just explain, however, the function of the red "tell-tale" lamp on the panel. This has, of course, no part in the actual working of the set, and is merely a device to act as a warning that the set is switched on and so prevent the user from going to bed and leaving it on.

Now for some working data. The valve should be the usual H.F. or

special detector type of one of the leading makes (Mazda, Marconi and Osram, Mullard, Dario, etc.), and the H.T. should be about 60 volts. The secondary coil L₂ should be a No. 60 for the lower wave-band and a No. 250 for long waves. The reaction coil, L₃, should be a No. 50 or 75, or No. 100 for the upper waves, while for the primary the sizes will be Nos. 35 or 50 and 100 or 150 respectively (the larger sizes are for small aeri-als).

Ready for Work

Preliminary adjustments are very simple. First set the potentiometer so that the slider is as near as possible to the positive end without making reaction become ploppy, and then turn to the series aerial condenser C₂. Start with this at maximum, and then gradually reduce it until you get just enough selectivity.

NICELY ARRANGED WIRING

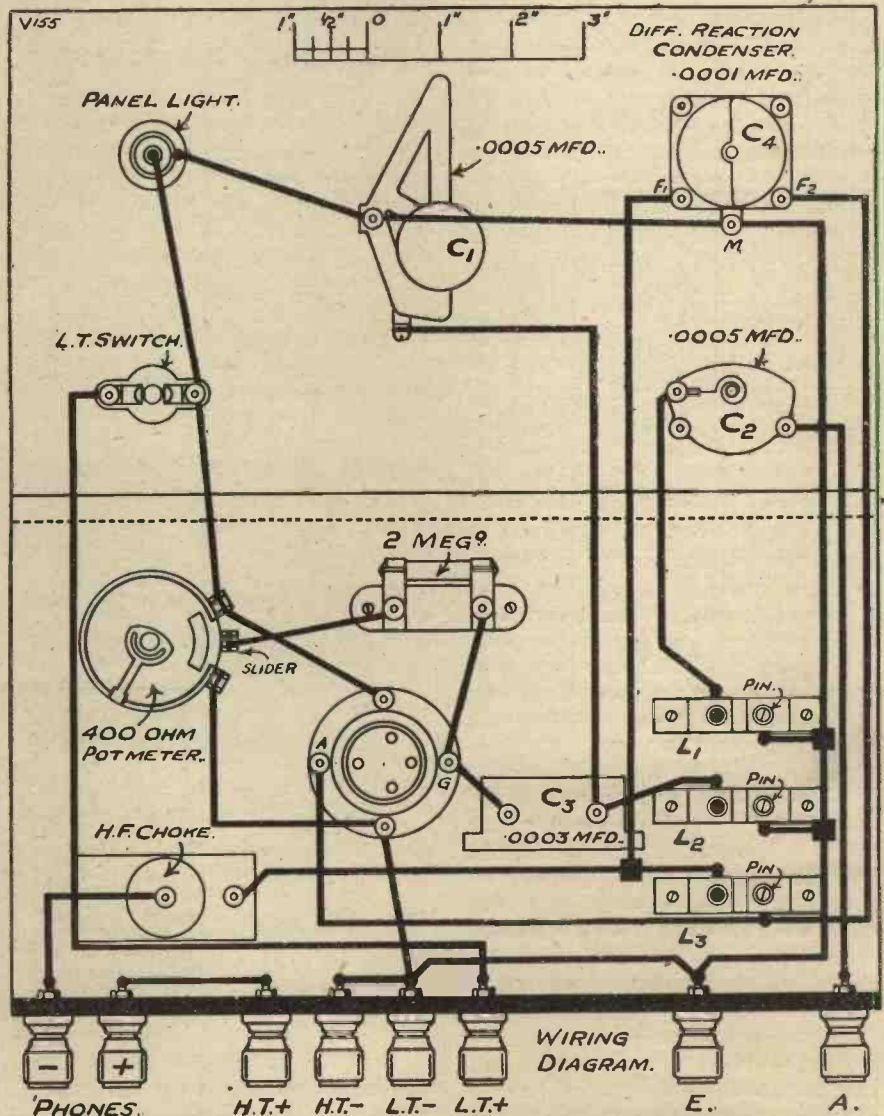

The constructor will find it easy to make the wiring pleasing in appearance, as the component layout is such that awkwardly-run leads are not necessitated. Incidentally, the set owes much of its power to the scientific layout of the parts.

INTERESTING NEW PICK-UPS



BY K.D. ROGERS

DURING the last few weeks we have had a large number of gramophone pick-ups to test, and the following details may be of interest to our readers. Let us take the Blue Spot model first. Although the appearance of this instrument would give one the impression that it is rather hard on the record, in practice this is not the case, as it

*Details and test reports
of some of the latest
"electric sound-boxes."*

of the high notes means, of course, that you get a certain amount of scratch with the pick-up, but if you are to get brilliancy in your reproduction it is difficult to see how scratch can be avoided.

We are of the opinion that a little scratch does not matter, provided you get the brilliance in effect which comes with the true reproduction of the higher notes.

THE BURNDIPT CURVE

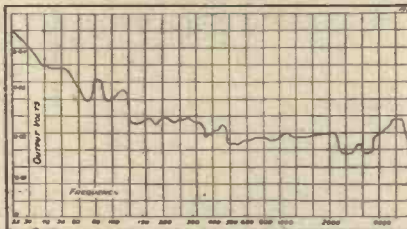

This is the output curve of the new Burndept pick-up.

is well balanced and yet it has sufficient weight to keep the needle well down on the low notes.

In its reproduction the Blue Spot is quite pleasing, and has a characteristic rising towards the bass end, reproducing well down below 150 cycles or so. It brings out the bass notes extremely strongly.

An Ingenious Scheme

Unfortunately, however, there is rather a serious falling off in the treble at about 2,000, which is inclined to make the reproduction from this pick-up a trifle too "mellow." The sensitivity is extremely good, and the system of tone-arm mounting is rather better than in the majority of designs we have seen.

As is common with many pick-ups, you turn the head of the pick-up round when you want to change the needle, but in this case the action of turning actuates a cam which

keeps the whole arm up in the air, so that it cannot by any chance fall on the record, and it does not need an arm-rest at all. The designers of this arm are to be congratulated on an ingenious piece of mechanism. Price £3 3s., with volume control incorporated in tone-arm base.

Next we come to the Burndept, which, as you know, is of the needle-armature type, and is totally different in design from the "electrical sound-box" put out by that firm some years ago. As you will see from the curve reproduced here, the Burndept pick-up is remarkably free from peaks, and has an excellent response curve.

It goes well down below 50 cycles,

One of the Best

The Burndept pick-up is not particularly sensitive, and you need a three-valve amplifier. It is, however, certainly one of the best we have ever come across. The price, complete with tone-arm, is £2 10s.

The Burndept needle system is extremely lightly damped, and therefore is very flexible. It is capable of following the most intricate variations in the record groove, and therefore of going well down the frequency scale; far lower, in fact, than anything

THE LATEST BLUE SPOT MODEL

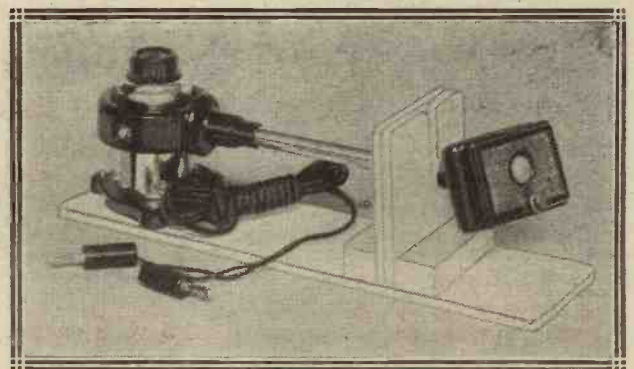

*
How the Blue Spot pick-up is packed for sale.

A simple cam-operated lever keeps the pick-up well above the record while the needle is being changed.
*

the lower end of the curve rising to about 30 cycles, while the cut-off at the high-frequency end comes well above 5,000. This good reproduction

that is normally recorded. We have nothing but praise for this remarkable little instrument.

We were also pleased to test one

Can Pick-Ups Be Too Sensitive?

of the Electramonic pick-ups, which are rather peculiar in design. No needle clamp is provided, and the needle is held in position by the attraction of the magnet and by the weight of the pick-up pressing it

position on response curves, and then a rapid fall as the high frequencies are reached. In the tone-arm pivot a volume control is incorporated. The instrument costs 47s.

The results given by the Harlie

ment is immediately obtained, and the tone-arm is provided with a counter-balance.

Three terminals are fitted on the tone pivot arm—two for connection to the grid and filament of the input valve and the third for earthing the metal parts on the tone-arm. The pick-up is a little heavier than is usual, but after running it several times over the same record no indication of wear could be perceived.

HOW THE HARLIE APPEARS

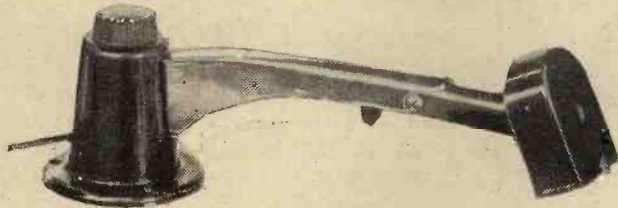

The Harlie has a hinged pick-up, making it easy for the needle to be changed. Weight is also adjustable.

on the record. No offset arm is provided, but the tracking error is reduced by the use of an especially long tone-arm.

As you will see from the photograph, this pick-up is very unconventional in appearance and is really somewhat unwieldy. The needle fits into a V type of groove. On test we did not care too much for the Electramonic. The needle did not appear to be behaving as it should, for results were far from satisfactory. As regards the reproduction curve, this appears to have a rather serious peak round about 3,000, the response falling off after this very rapidly. It also falls off again round about 600 or 700, rising again towards the bass. Price £3 3s.

The Harlie Pick-up

Another instrument sent in for test is the Harlie, in which the design of the pole pieces is particularly unconventional. In the response of this

were not as "clean" as we should have liked, an impression of "carry-over" being present. The pick-up is quite sensitive.

The Marconiphone Model

Finally, we come to the Marconiphone pick-up. This has an extremely interesting response curve. The

UNUSUAL IN APPEARANCE, ISN'T IT?

The Electramonic pick-up is a most unusual instrument, and has some very novel pieces of design incorporated in its structure.



pick-up follows the groove well right down below 50 cycles and has a rising characteristic in the bass which is very valuable.

A peak occurs round about 3,000 to 4,000, and the instrument is extremely sensitive, giving well up to

sensitive to be "safe" in the hands of the ordinary listener, for great care has to be taken that overloading of the set does not occur.

Another New-comer

Another pick-up that has just reached us is the Kolster-Brandes. Unconventional in appearance, the pick-up is rectangular in shape, like a large metal slab, and swivelled so that the needle can be changed.

The design is not unlike that of the Columbia model (in appearance, anyway), and the results are very pleasing.

The response is not peaky, and though it does not appear to go down too cleanly into the bass it nevertheless is certainly among the first five, in our opinion.

Sensitivity is of quite a high order, and the response curve goes up well to about 3,000, where it begins to drop fairly rapidly. The price is £2 15s. 0d. and at that figure we consider it not at all expensive. Its appearance is very pleasing in its severity, and it imparts to the home-made radiogram receiver quite a becoming professional touch.

ONE OF THE MOST SENSITIVE TYPES

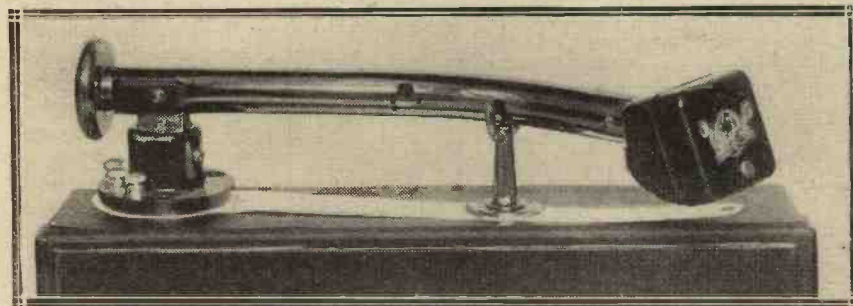

Here is the Marconiphone standing on its mounting template. The pick-up is one of the most sensitive we have come across.

pick-up, as with so many recent designs, there is a distinct rise towards the bass, the pick-up increasing in sensitivity down to about 150 or slightly lower.

At the higher end there is a peak somewhere about 3,000, a favourite

1.5 volts on the middle register and much higher voltages at the bass end of the scale.

The pick-up, which is sold complete with tone-arm for £2 5s., is extremely easy to fit, a template being supplied by the makers, so that correct align-

The INEFFICIENT LOUDSPEAKER



ONE of these days someone is going to discover another way of transforming electrical impulses into sound waves. And that someone will make a fortune if his method is only just a little bit better than any scheme at present known.

The loud speaker is at present quite the black-sheep of the radio family. You can build a set that can hand out a very "straightish" response, but there's no loud speaker that won't mangle the result pretty badly.

Energy Wasted

That is, of course, comparatively speaking. The modern loud speaker is miles in advance of the best that were current only a few years ago.

But it can't do much more than give you one or two per cent of the energy in the way of sound waves—and waste the rest. Also, it can't help showing a fall-off left and right as it were.

Practically all our present loud speakers are electro-magnetic or electro-dynamic. In the first, something is vibrated by a magnet that fluctuates in strength in accordance with the pulsating electric currents. The "something" may be a diaphragm or a reed or armature mechanically coupled to a diaphragm provided for shaking the air.

The Moving Coil

The electro-dynamic (or moving-coil) drive is reminiscent of the electric motor. You have a coil of wire suspended in a very strong magnetic field provided by a big permanent magnet or a big electro-magnet

The low-frequency impulses are passed through the coil, and this then tries to alter its position in relation to the magnetic field.

The coil is attached to the apex of a cone diaphragm, and this develops the air waves as it is pushed backwards and forwards by the coil.

Among the lesser used loud-speaker principles is the condenser variety. This in effect comprises two thin sheets of metal separated by a very small gap of air.

The one sheet is anchored, and the other left free to vibrate like a diaphragm. And this it does when the impulses of electricity are applied across the two sheets. You see the thing is a condenser, and, as in all condensers that are charged, strains are set up across the insulating, intervening air or other dielectric.

The plates try to get to each other, and the stronger the electric charge across them the more nearly they succeed.

As in the case of the condenser loud speaker the charges vary in

ON THE "ELETTRA"

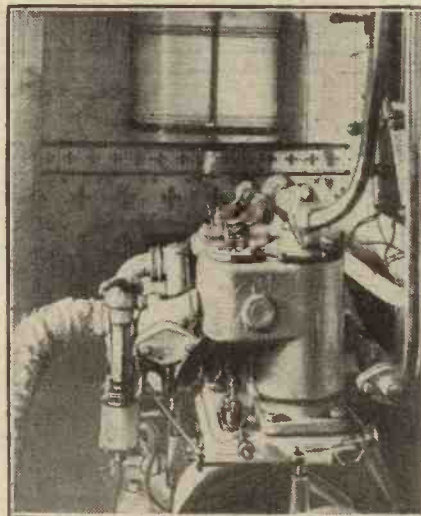

The power plant that supplies the energy for the fine radio installation on Marquis Marconi's famous yacht.

Some interesting notes about an interesting accessory.

By D. GLOVER.

intensity, so the plate that is free to do so vibrates at a varying frequency and with varying effect on the air around it.

Yet another scheme consists of keeping an ordinary sort of diaphragm pulled back and under strain by a thin metal wire.

Through this wire passes the current, and causes it to vary in temperature at audio-frequency. This in turn makes it vary in length, and so the diaphragm moves in sympathy with the current fluctuations.

This is Interesting

Needless to say, these very simple schemes do not give as good results as the electro-magnetic and electro-dynamic—or they would be in universal use.

A very interesting thing is that practically all these schemes are completely reversible. That is to say, if you vibrate the diaphragm of a loud speaker built in accordance with any one of at least three of those principles I have outlined you will set up electric currents.

Thus the instrument could be used as a microphone by directing sound waves on to its diaphragm and collecting the resultant "juice" from its terminals.

Loud-Speaker Microphones

The exception is the "hot wire" type. To get your current from this you would need to heat the wire at varying temperatures, but the current given you would represent but a microscopic percentage of the energy expended in setting it up.

Indeed, any ordinary loud speaker makes a pretty insensitive microphone. This gives you an idea of the losses that are occasioned by the conversion of electrical impulses into sound waves.

Perhaps some day a scheme as simple as the condenser type, but much more efficient, will be evolved by that lucky someone. I hope the day will arrive soon, but somehow I fancy it is fixed in the very far, very misty future.

The

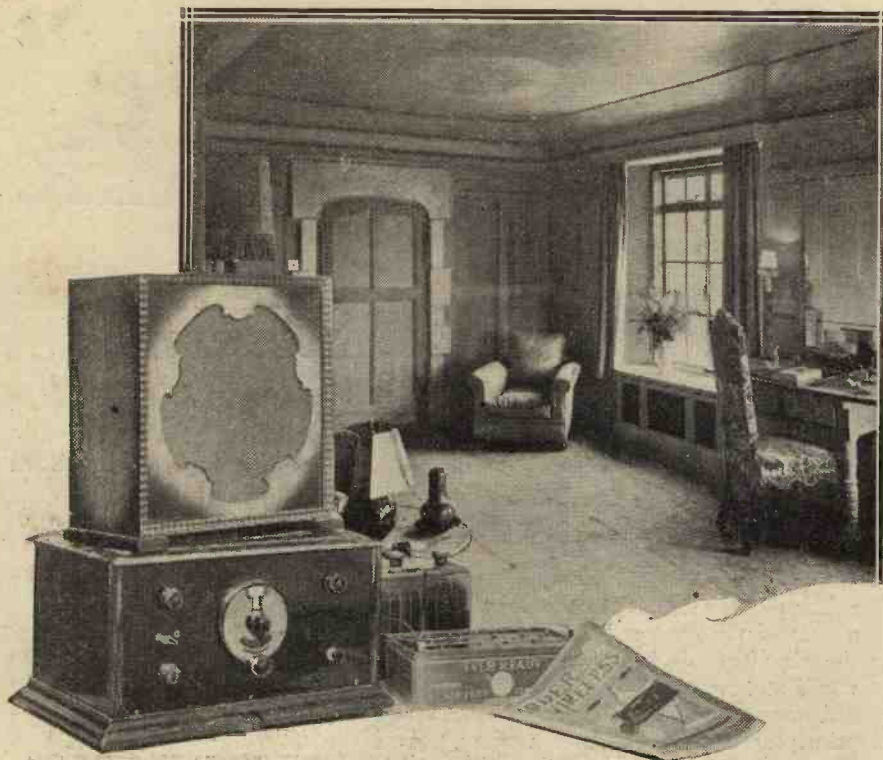

THIS receiver is not more selective than the usual run of good "detector and L.F." sets have been for the last two years! A rather peculiar opening remark, intended to catch the attention of those readers for whom the receiver has been specially designed.

Let us explain. There is an unavoidable tendency for set designers to become so obsessed with the idea of catering for the "Regional" conditions which have arrived in London and are impending elsewhere that they are apt to produce an unbroken succession of super-selective outfits. It is true that such designs must be provided for the use of those of our readers who live in these areas, but we must not forget that there are still great numbers of listeners who need no more than normal selectivity.

Resisting Temptation!

To them this present spate of highly selective designs of all kinds must be getting irritating, for not merely is such high selectivity unnecessary, but it is apt to be something of a nuisance to them. It must make the set more elaborate, almost certainly a little more expensive to build, and not quite so easy to work, although our "Star-Turn" series pretty thoroughly overcomes this latter objection.

It is the ambition of the "M.W." Research Department to cater as adequately as we can for every section of our readers, so we are endeavouring to curb our enthusiasm for super-

selective sets, and provide the necessary proportion of designs for those who live in the outer areas some distance from any powerful station. Here only normal selectivity is wanted—so these designs will depend for their appeal entirely upon other features.

This month, for example, we are presenting a design for a three-valver which has quite an attractive list of special merits, but possesses only just the normal degree of selectivity of the better type of single-circuit receiver. This is sufficient to give an excellent performance wherever there is no powerful source of local interference,

but, of course, it is not intended for use within a radius of perhaps 15 or 16 miles from Brookmans Park, or about 7 miles from an ordinary main station unless a rejector is used.

The special features of the set are these: Extremely simple and efficient wave-change switching, low cost of construction, entirely standard parts throughout, and particularly good sensitivity. The actual construction of the receiver also is considerably easier and simpler than usual, a point you will appreciate when you examine the photographs.

A look over the circuit diagram is suggested at this stage to see how these various features are obtained. First, note that S is the wave-change switch, and then observe that when this is placed so as to bring the coil L_3 into circuit you have an exceedingly simple form of the Hartley arrangement.

The Neglected Hartley

This circuit is one which has been much neglected of late, although it possesses some very decided advantages, notably that of requiring only a single coil in place of the usual two or three. This single inductance is of the centre-tapped plug-in variety, and the grid and filament of the detector are connected across one half, the other half being employed for reaction and aerial coupling. The simplification

EXCEPTIONALLY EASY PANEL CONTROL

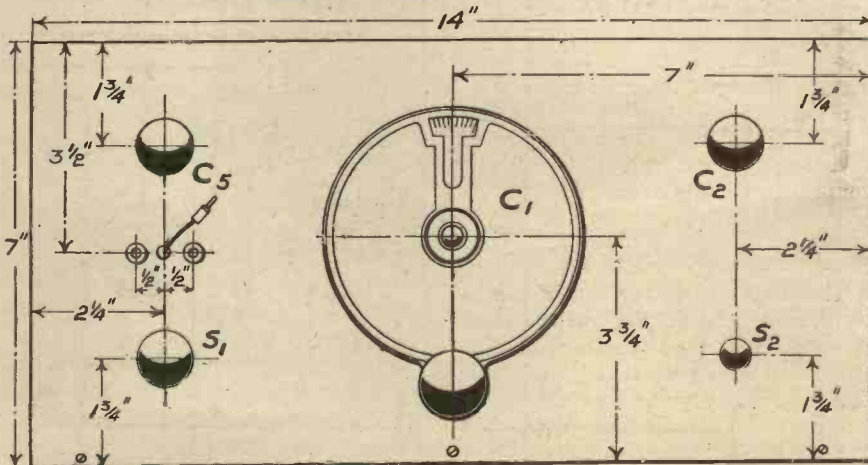

PANEL LAYOUT.

Y1293 5

The wave-changing and aerial-coupling variations are both carried out from the panel front. There is no groping about inside for crocodile clips or condenser knobs.

"Simple-Change"

Three

BROADCASTING AT ITS BEST

The popularity of the three-valver has never been in question, and there will be no doubt of the popularity of this particular variation of a well-tried circuit. Effective wave-changing is carried out by the most simple means possible, while the quality of reproduction leaves nothing to be desired.

The set is designed and described by The "M.W." Research Department.

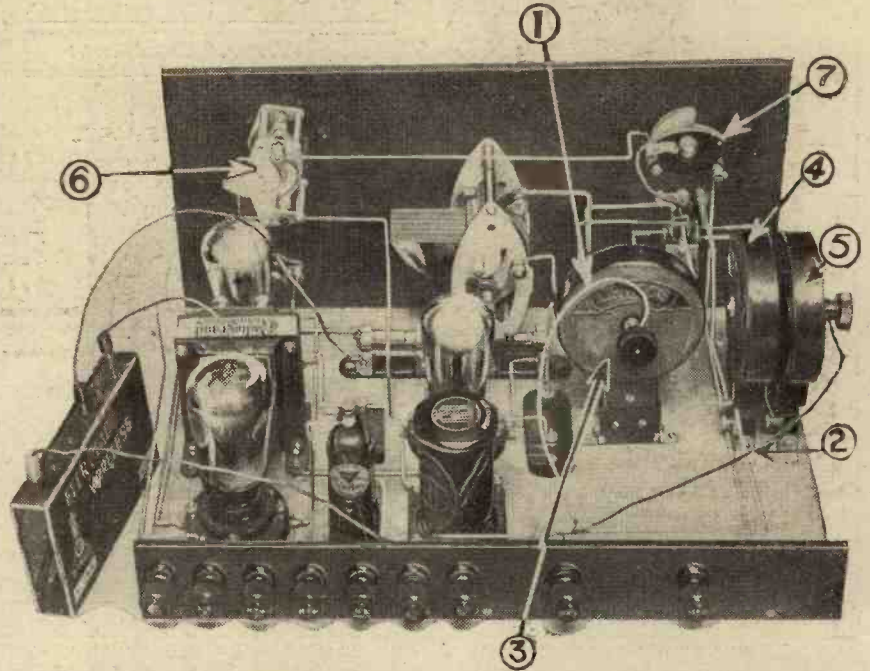

A key to the main features. (1) and (2) are the centre-tap leads to the coils; (3) is the low-wave coil; (4) the long-wave primary; (5) the long-wave secondary; (6) the reaction condenser, and (7) is the series aerial condenser.

and cheapening which results from the use of only one coil are obvious points.

The neglect of the Hartley circuit appears to be due to three difficulties which have been encountered in applying it to modern conditions, but we have found all these quite easily removable. First, there is the obvious fact that to use half the coil for aerial coupling makes it rather tight, and hence gives low selectivity, but a simple remedy for this is to be found in the use of a suitable condenser in series in the aerial lead.

Again, the Hartley is rather prone to give considerable hand-capacity effects on the tuning condenser, but this defect is readily removed by using a good modern type of slow-motion dial. With such a dial the operator's fingers do not come at all near the

condenser spindle, and so the effect is no longer troublesome.

Finally there is the matter of long waves, and here we meet what at first appears to be a really serious drawback; the Hartley does not as a rule work at all well on long waves, the main difficulty being that it is very prone to suffer from intense interference from a strong station working on the lower wave-band. This turns

out to be another difficulty which disappears as soon as it is investigated.

The solution we found is quite a simple one and is the natural outcome of the use of wave-change switching. The point is that while one is about it there is no difficulty in making the wave-change switch alter the circuit into a normal primary and secondary arrangement in going over to long waves, and that is what we have done. You still have the advantage of an ultra-simple low-wave circuit, and only require one extra coil on the long-wave side.

A SIMPLE BUT EFFECTIVE CIRCUIT

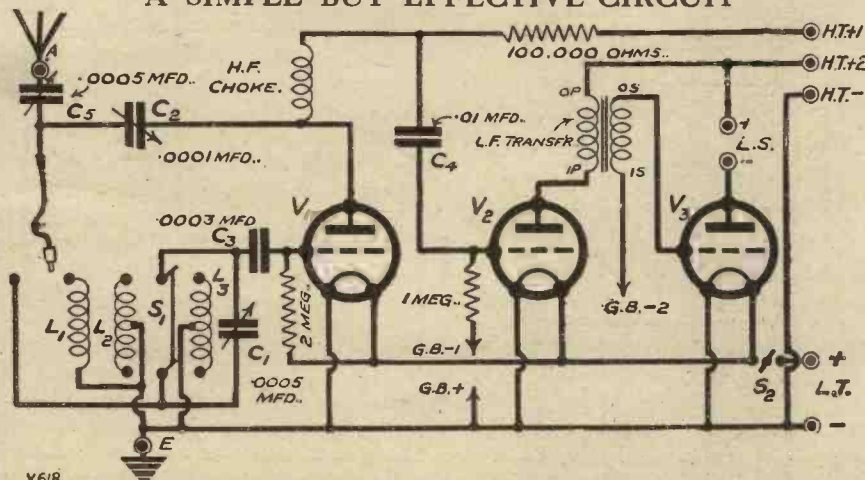

Simply Adjustable Aerial Coupling

The series condenser in the aerial lead we have found very necessary in order to obtain the standard of selectivity necessary nowadays even away from the powerful interference produced by a "Regional" station. The capacity of this condenser requires adjustment to meet individual conditions, and so the usual fixed one is not very satisfactory. Instead, we have provided a variable one of the compact and low-priced solid-dielectric type.

This is marked C₅ in the diagrams, and it should be adjusted to give just the necessary degree of selectivity

The circuit employed is extremely efficient and surprisingly simple. Plug-in coils are used, and real "quality reception" is obtained.

without sacrifice of signal strength. The idea is to keep it set to as large a capacity as you can, so start with it at maximum and then gradually reduce it until you get just enough selectivity for your particular needs.

This is an adjustment you must make for yourself, because the most suitable capacity varies with the aerial.

The remainder of the set you will see is very simple. There is the usual leaky-grid type detector, followed by

two L.F. stages, with one R.C. and one transformer coupling. Just a glance over the circuit will tell you all you want to know about these details, so now we can proceed to give the necessary working data.

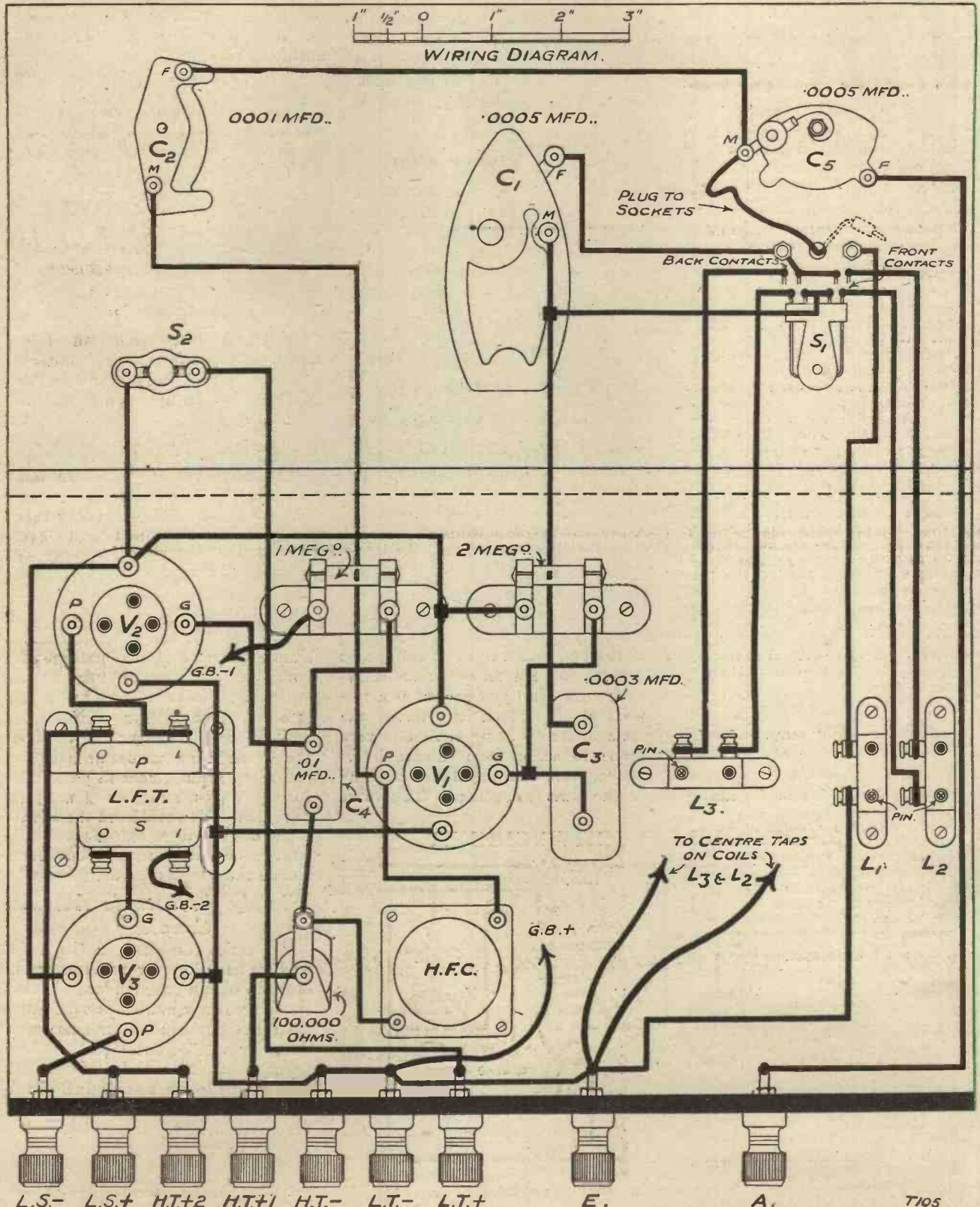

Besides being easy to handle this receiver is particularly simple to construct. The wiring is simply arranged, and you will have no trouble in following this scale diagram.

An Ideal General-Purpose Receiver

The valves should be two of the H.F. type (impedance 20,000 to 30,000 ohms) for the H.F. and first L.F. positions, and a power or super-power for the third valve. (A valve of L.F. type can be used in the first L.F. stage if desired.)

LIST OF COMPONENTS

- * 1 Panel, 14 in. x 7 in. (Goltone; or Resiston, Keystone, Paxolin, Tro-lite, etc.).
- * 1 Cabinet to fit, with baseboard 9 in. or 10 in. deep (Camco, or Lock, Pickett, Keystone, etc.).
- * 1 .0005-mfd. variable condenser (Lissen, or Dubilier, Burton, Igranic, Ready Radio, Lotus, J.B., Ormond, Colvern, Polar, etc.).
- * 1 Vernier dial, if condenser not of slow-motion type (Igranic, or Formo, Ormond, J.B., Lissen, Lotus, Brownie, etc.).
- * 1 .0005-mfd. Brookmans condenser (Ready Radio).
- * 1 .0001-mfd. reaction condenser (Polar, or Lissen, Dubilier, J.B., Lotus, Ormond, Burton, Formo, etc.).
- * 1 On-off switch (Lissen, or Lotus, Jewel, Benjamin, Igranic, etc.).
- * 1 Double-pole change-over switch (Wearite, or Utility, Dubilier, etc.).
- * 3 Coil holders (Lotus, or Keystone, Magnum, Lissen, Igranic, etc.).
- * 3 Valve holders (Lotus, or Igranic, Benjamin, Lissen, W.B., Junit, etc.).
- * 1 .0003-mfd. fixed condenser (Dubilier, or Goltone, Lissen, T.C.C., Mullard, Igranic, etc.).
- * 1 .01-mfd. fixed condenser (T.C.C., or Dubilier, Lissen, Igranic, Mullard, etc.).
- * 1 2-meg. leak and holder (Lissen, or Igranic, Dubilier, Mullard, Ediswan, etc.).
- * 1 1-meg. grid leak and holder (Lissen, etc.).
- * 1 100,000-ohm anode resistance and holder (Varley, or Lissen, Igranic, R.I., Dubilier, Mullard, etc.).
- * 1 H.F. choke (R.I., or Lissen, Lewcos, Varley, Dubilier, Ready Radio, Lotus, Magnum, Wearite, etc.).
- * 1 L.F. transformer (Telsen, or Ferranti, R.I., Lissen, Lotus, Varley, Igranic, Lewcos, Mullard, etc.).
- * 1 Terminal strip, 14 in. x 2 in.
- * 9 Terminals (Belling & Lee, or Eelex, Igranic, Burton, etc.).
- * Wire, screws, flex, G.B. plugs, two sockets, etc.

The detector has a separate H.T. terminal (H.T.+1), and here you should try about 60 volts, adjusting a little to secure smooth reaction if necessary. The L.F. valves require just the usual 100 or 120 volts.

Coil sizes are very simple: L₃, No. 60 (centre-tapped); L₂, No. 250 (ditto); L₁, No. 100 or 150 (plain).

Just one point about the wave-change switching. You have here really a choice of two different

methods of aerial coupling on long waves, by means of the plug and two sockets immediately above switch S₁.

To work on the lower wave-band you place this plug in the right-hand socket and turn the switch to the left. To go over to long waves, just turn the knob of S₁ to the right. You then have a Hartley circuit as before.

An Interference Hint

If you then find that reaction is none too good, or you are getting interference from some powerful low-wave station, move the plug into the left-hand socket. This brings the separate long-wave primary and reaction coil L₁ into use.

ABOUT YOUR H.T.

When a super-power valve is used the ordinary standard-capacity dry H.T. battery is definitely unsuitable, and a double- or triple-capacity battery should be employed.

There is no danger when working from the mains provided your wiring

has been done by an experienced electrician and that you realise the importance of treating it carefully, keeping the unit switched off when not in use, and placed where it cannot be interfered with by any unauthorised person.

Under no circumstances should you attempt to make any adjustment inside a set or in an H.T. unit while the "mains" switch is on.

All the wiring inside or to and from an H.T. unit should be well insulated from other wiring and components.

Noisy H.T.

Crackling noises from an H.T. supply may be due to a dirty contact, defective plug holder, or similar imperfect electrical circuit in the house wiring.

The modern valve will last a long time provided it is not "over-run" by being provided with either too much L.T., too little grid bias, or by having the H.T. applied at too great a voltage.

PLENTY OF POWER: EXCELLENT QUALITY

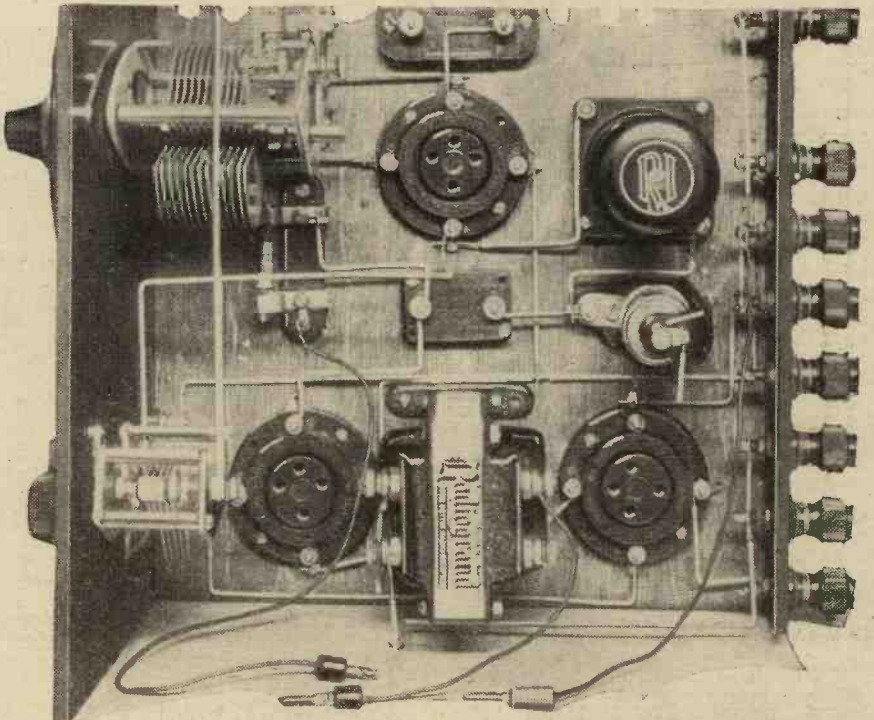

An unusual view of the L.F. end of the "Simple-Change" Three, showing the detector anode circuit and the two L.F. stages.

"MUSICAL" MOTORS

by G. WENTWORTH

The choice of an electric gramophone drive should be made with care, otherwise the "music" of its own operation may seriously detract from your enjoyment of the record.

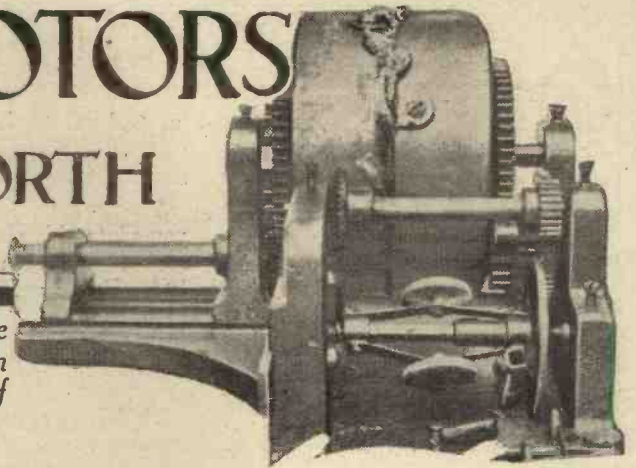

"NASTY mains hum, isn't it?" remarked a friend of mine the other day, as he listened to a record on my pet radio-gram receiver.

"It's not a mains hum," I explained; "merely the electric motor. I'm trying out a new one."

Such was indeed the case, and, as a matter of fact, the "hum" was more of a roar plus crackle (at about $\frac{1}{2}$ to $\frac{1}{3}$ signal strength) than the clean but persistent noise which is the prerogative of the unsmoothed mains.

"What a Time!"

What a time I had with that motor. Priced at—well, over £5, it had been pressed on to me by someone who had merely remarked, "See what you can do with it, old man," and left it at that.

I could do nothing with it. No amount of earthing seemed to do any good, and eventually, after trying all I could think of, I gave it up, for after reducing the "induced" hum between motor and set by shielding, I was left with a vibration transferred noise, due to the vibration of the turntable causing the pick-up to reproduce it.

This vibration was caused by the method of supplying the drive from the motor to the turntable—by a badly-constructed pulley system.

Smooth Running Essential

The belt drive is not essentially at fault in all electric motors, many of which use this method of power transmission quite successfully, but it is essential that no vibration be present in the system, otherwise it will make itself heard, via the pick-up, through the loud speaker.

The motor should run dead smooth if vibration trouble is to be obviated, and personally I rather favour the gear-driven motor for D.C. mains, and the induction motor for A.C. mains, this again being gear-driven.

The trouble most often encountered with "universal" motors is that of sparking between the commutator and the brushes. If one is on D.C. mains one has perforce to use a motor with a commutator, but on A.C. mains things are different and one can have the alternative choice of an induction motor.

This has no such drawback, and the torque is beautifully even. Such a motor as the Igranic or the Apollo is ideally suited for radio-gram receivers.

It is essential when using an electric motor, of whatever type, whether universal or induction, to take all ordinary precautions against induction from the mains into the set. Long pick-up leads are to be deprecated, and the loud-speaker leads should not run close to the electric motor.

it is likely that the vibration will be transferred to the pick-up and thence to the L.F. amplifier.

Mount It Carefully

Careful mounting, then, is the first necessity in the fitting of an electric turntable drive. The second is careful earthing, and, if necessary, shielding.

When choosing a motor examine the bearings and see that there is no undue slackness, and see the motor running, if possible mounted on a platform, noting how true the turntable is, how much, if any vibration there is, and how the motor is affected by a heavy passage of music on placing one's finger on the inner edge of the table.

It should not slow down if one

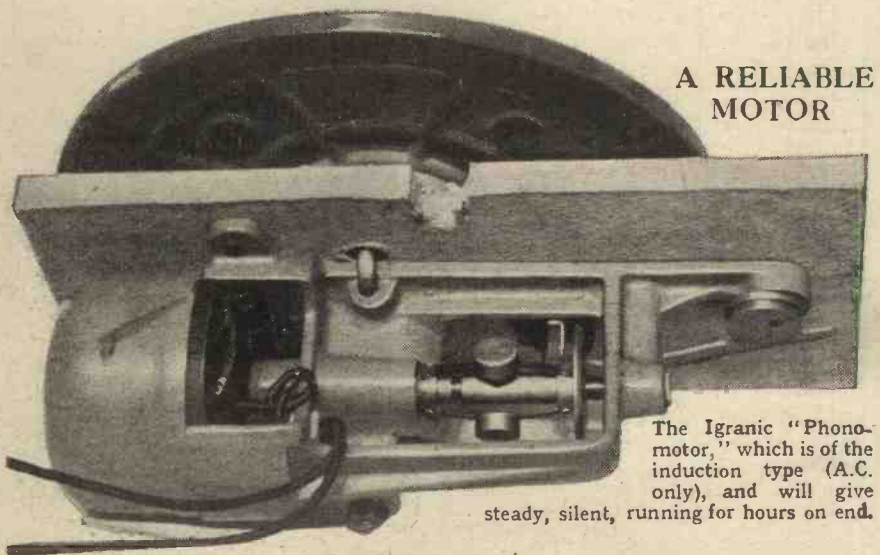

A RELIABLE MOTOR

The Igranic "Phonomotor," which is of the induction type (A.C. only), and will give steady, silent, running for hours on end.

It is often said that electric motors are not a success, but that is hardly true unless it is qualified by the remarks: "unless properly fitted and adequately shielded."

It is essential that one fit the motor firmly, on a platform that will not vibrate, for if the platform vibrates

presses one's finger on the spindle top.

The cheaper the motor the closer should you examine it, unless you know by its note that you are not going to be sold a "pup."

Musical motors may be interesting scientifically, but they are most annoying in practice.

ON THE SHORT WAVES

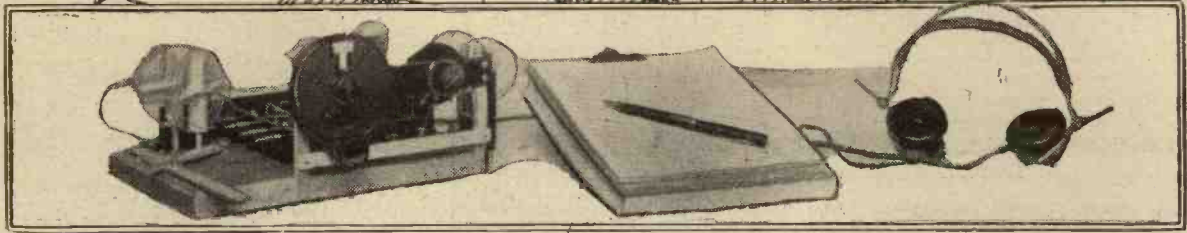

There is a fascinating field for experimenting down on the short waves, and you don't need specialised knowledge or special apparatus for it. Our short-wave expert smoothes away the difficulties and shows you how easy it is.

By W. L. S.

IN last month's article I dealt, I think, fairly fully with the subject of reaction control on short-wave receivers, and my own experiences of the best methods of obtaining a satisfactory combination of components for this purpose.

In this article I propose to mention a few of the pitfalls that await the unwary, and methods for getting out of them when occasion arises.

I can hear veteran readers muttering "threshold howl—he's off again!" but I am convinced that I have said quite enough about threshold howl recently, and I am confining myself to a few words, after which the subject shall be taboo.

What "T.H." Is

Incredible as it may seem, some people still do not know what threshold howl is, and imagine it to be the howl that is reached when the reaction control of an already oscillating receiver is still farther advanced. It is nothing of the kind—threshold howl, obviously enough, occurs at the very threshold of oscillation, after which the receiver oscillates quietly.

"T.H.," as we will call it, has been shown to be largely dependent upon the total inductance in the anode circuit. This explains why it often occurs with a good transformer, and the insertion of a cheap one will cure it. Moral: Use re-

sistance coupling if you are badly troubled, and don't use a high-frequency choke in the anode circuit of the detector if you can get it to work well without one.

Also keep the reaction coil as small as possible, even if it means using a much larger reaction condenser to produce oscillation.

Now to more pleasant subjects! If your receiver behaves in a gentlemanly fashion, but doesn't produce strong signals, look to the detector grid leak and make sure it is connected to the positive end of the filament.

I have been sorely worried for a day or so by a hopelessly insensitive set, signals fading out as the set goes out of oscillation instead of coming up in strength, and the whole trouble has been due to the fact that the detector grid return went to negative L.T.

Hand-capacity effects are rather difficult to talk about, as they divide up into so many different classes. One set of effects may be classified as those due to bad layout—"live" components have been placed sufficiently near the front panel to cause frequency variations through their capacity to earth via the operator's body. Remedy—re-wire the set and move them farther back. It is, of course, assumed that the moving plates of the condensers have been placed at earth potential.

A More Difficult Brand

Another brand of hand-capacity effects occurs when it is impossible to place the hands near *anything* on the set—even the "earthy" portions of the receiver or the earth terminal itself.

In these cases the earth lead is generally found to be rather long, and matters may be cured very often by inserting in series with it a variable condenser of .0003 or .0005 and finding the best value of the latter. A setting will nearly always be found at which the undesirable effects disappear.

It is the latter class that is the most troublesome, as it occurs even when the whole set is in a metal box.

I have had a case myself in which it was impossible to cure the trouble by tuning the earth lead as suggested,

LOWER AND LOWER AND LOWER

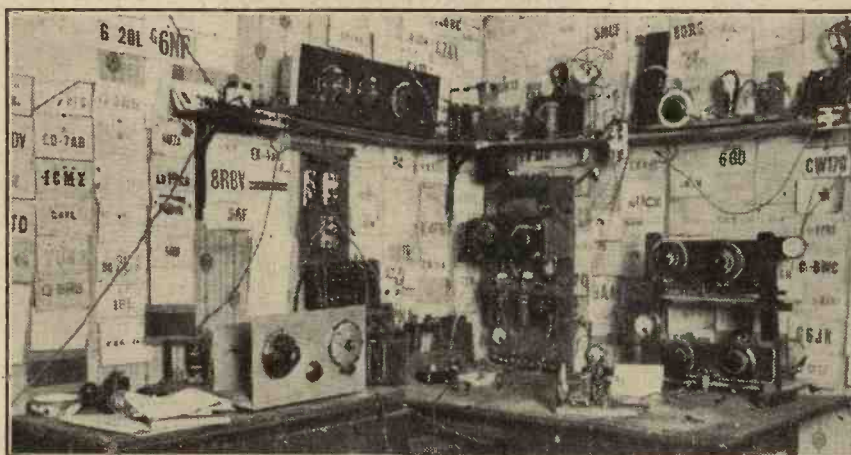

The apparatus used by Mr. Crowe, a London short-wave enthusiast, for his experiments on wave-lengths as low as 3 metres. Note the big collection of cards received from other amateurs all over the world.

through an oversight. (No, an oversight is not a new brand of component!)

Effect of Moon on Short-Wave Reception

and a change of aerial made a marked difference.

It is interesting to note, however, that the ultimate cure was the addition of a screened-grid valve, the properties of which, as an "aerial de-coupler," are now well known. I can thoroughly recommend this to readers, as it has tied the whole receiver down in a wonderful way—it has ironed out "humps" in the reaction control, increased signal strength without noticeably bringing up the background, and made the set a far easier proposition to handle.

Increased Amplification

Incidentally, I have tried tuning the screened-grid stage instead of working it aperiodically, and a great increase of amplification, as might be expected, results. Further, if it is carefully screened, the additional tuned circuit does not increase the difficulty in

tuning, as there is no appreciable "drag" on it.

The detector grid circuit does all the tuning, and the aerial circuit acts virtually as a volume control. As a matter of fact, swinging round the .0001 condenser across this circuit alters the pitch of a signal just enough to act as an extremely useful vernier control. I would not be without this stage for anything.

I hope, incidentally, by the time next month's notes appear to have two tuned S.G. stages going, and no note-mags!

I remember writing a long article on methods of aerial coupling to the short-waver, but in my opinion now there is only one method worth while—to use a screened-grid amplifier.

I noticed a particularly impressive example of the effect of the phase of the moon upon reception conditions this month—referring to the new moon just after April 26th. Prior to that date conditions had been poor, and the only stations audible after 10 p.m.

were a mere handful of South Americans, all of them rather on the weak side.

The first evening after the new moon became visible there was not one of these to be heard, but in their place two or three hundred U.S.A. stations, all on top of one another, and very few distinguishable from the general "mush." A night after that things had straightened out and the "Yanks" were coming in in full force, just as they should have been doing through the whole of April. I believe that conditions *par excellence* generally coincide with a new moon and a barometer with a "rising characteristic."

Excellent Australians

It seems strange that in the Antipodes there is evidence of so much more interest in short-wave work than at home here, and yet that most of the pioneering has been done in the British Isles.

This is not to be read disparagingly of Australia and New Zealand, for their short-wave broadcast is undoubtedly ahead of ours, and their amateurs are all extraordinarily keen and active. The fact simply is that we seem to hit the new things first.

Take 10-metre work, for example. Even "QST" has to admit that we led the A.R.R.L. on this particular score. On 5-metre work we look like doing the same.

Incidentally, on the new Transoceanic transmitting licences issued last April the amateurs are given permission to use the 80-metre waveband once more. This is good news in every way, although they are restricted to week-end work.

Fortunate Amateurs

It is not so much the value of the band that counts as the feeling that the amateur status is improving—otherwise why should the G.P.O. go back on their former decision to close this band to amateur work?

The amateurs really are rather fortunate, one thinks on listening round amid the crush of commercial stations all the way down from 150 metres to zero! To have bands on 160, 80, 40, 20, 10 and 5 metres, all with some part, at least, in harmonic relation to the others, so that one crystal can be used for the whole lot, is quite a good position. There is much to be thankful for.

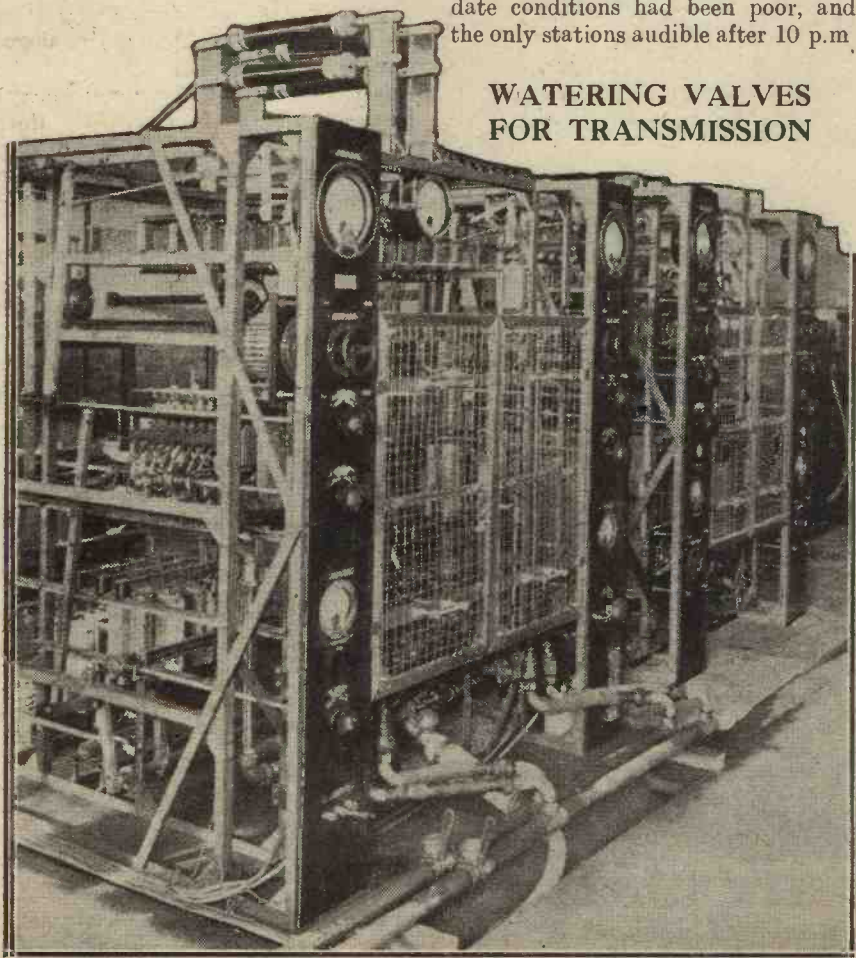

Here is a view of some of the short-wave transmitting gear at Chelmsford. The main valves are water-cooled, and the supply pipes and water joints for this purpose can be seen on the floor in the foreground.

SPOTTING "PEAKS"

by Frederick Lewis



THIS is not an article on mountaineering, merely a brief chat to give the pick-up user some idea of how he may judge his instrument by the reproduction which he gets from his gramophone records.

A "peak" is, of course, the name given to that nasty hump that one sees in the reproduction curve of either a pick-up, a valve amplifier, or a loud speaker.

One must assume for the purpose of this article that one has a loud speaker that does not give annoying peaks on radio, and that the job one has now to do is to choose a pick-up which will give reproduction more or less on the lines of the radio reproduction.

Avoid Exaggerated Humps

In other words, the pick-up response curve must not have exaggerated peaks. In the laboratory one can check these peaks by a valve voltmeter, but for an aural test what are known as the "gliding howling tone" records, made by the Parlophone people, are particularly valuable. In these one gradually slides down the musical scale from about 6,000 to about 100 cycles, and one can very often "spot" a peak just by listening to the reproduction. If this hump comes fairly high up in the scale one may be able to reduce it considerably by a condenser bypass.

Peaks in the bass are not so annoying if they are not too prominent; as a rule they help to bring out the bass of the record, which, as you know, is more or less deficient in the lower tones. If you find, when listening to these howling tones, that your pick-up is particularly peaky, it would be well to change it for another, and in this respect I would

A short article showing what you should look out for when choosing a gramophone pick-up.

advise no one to buy any pick-up until he has *heard* it, or seen its curve, and noticed whether it has got any of these nasty humps.

Humps round about 2,000 or 3,000 are especially to be looked for, and any instrument having a bad bump round about there should be rejected unless you are confident you can deal

A "SUPER" SET



The Igranac Neutrosomic De Luxe Radio-Gramophone, which is a high-quality outfit capable of first-class reproduction. Note the frame aerial on the side.

with it, and get the reproduction from the final outfit exactly to your liking.

A pick-up with a rising characteristic at the bass end is usually all to the good, providing it does not fall

off badly immediately after 2,000. It should go well up to 3,500 if you are to get really good brilliance out of it.

Useful Test Records

If you have not got a series of test records, you may find one or two quite useful records amongst the collection you have, or in the catalogue of the makers.

For high notes one of Boyd Senter's clarinet solos is very useful. Such records as the "Wabash Blues" or the "Eniale Blues," by Boyd Senter, are extremely good for checking peaks round about 2,000 cycles.

They also show up any tendency of the pick-up to "split" high notes, and if you do not get these notes out cleanly and free from woolliness and from frayed edges, when the clarinet may sound more like a wooden one, then you may reckon that the pick-up is not quite up to scratch.

As regards the bass end, it is most essential that the pick-up should be able to follow down to about 80 cycles without jumping about in the groove, and to test this I must recommend you a record which I believe I have mentioned before, the "Juba Dance," by the Light Symphony Orchestra, recorded on H.M.V.

Finding Weak Spots

Most of the modern pick-ups will tackle both of these records exceedingly well, but, as I have said before, they will find out the weak spots in your apparatus, whereas playing ordinary jazz records or organ selections will only give you a mild idea that something is wrong without allowing you any opportunity of putting your finger exactly on the place.

Wireless

By LT.-COMMANDER
**THE HON. J. M.
 KENWORTHY,**
 R.N., M.P.

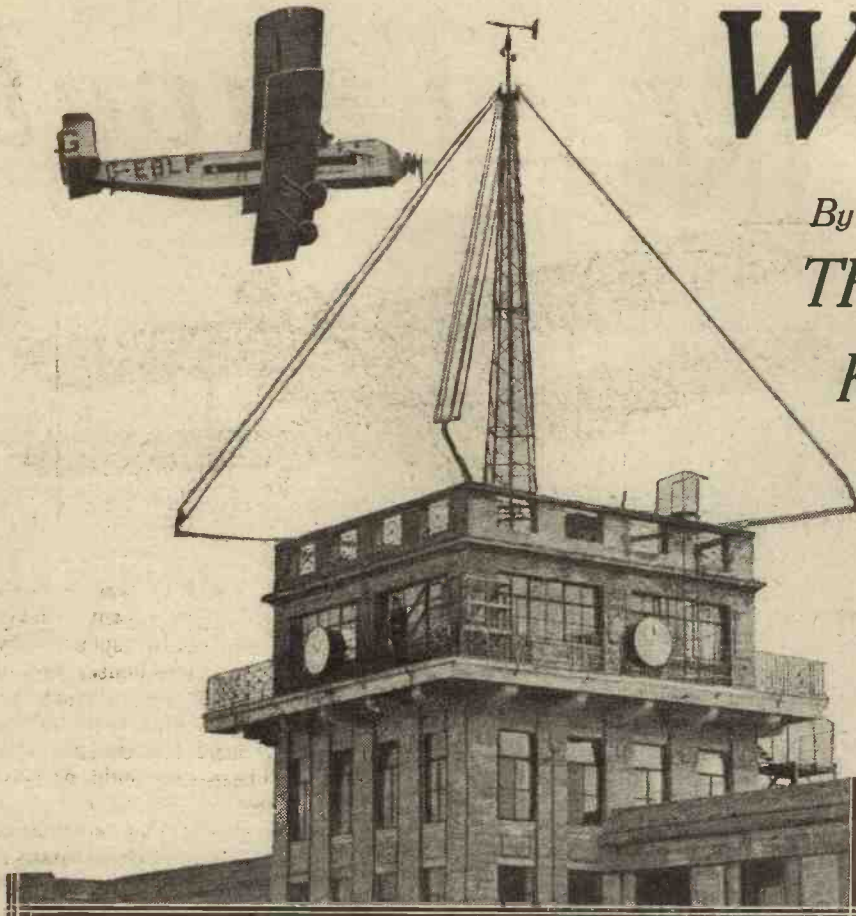

The wireless control tower at the Croydon aerodrome.

30 ft. ahead. The dust-clouds rise to an immense height, even as high as 7,000 ft.

The big three-engined passenger and mail-carrying aeroplanes have a good "ceiling," or power of rising high into the air; but, even so, 7,000 ft. puts a great strain upon them, especially when the aeroplane is fully loaded.

Treacherous Storms

But there is a far greater difficulty, and that is in finding the aerodromes and landing when a dust-storm is blowing. It may be quite fine sixty miles away, which is less than an hour's flying distance, but local winds make landing dangerous, and but for wireless the aeroplane could fly into danger without warning.

I HAVE recently completed 6,000 miles of travel by aeroplane and flying-boat. This was over one of the most important air routes in the world, namely, that from Egypt to India by way of Palestine, the Arabian desert, Mesopotamia, and Persia; then back again over the same route from India to Egypt and across the Mediterranean by flying-boat from Alexandria to Greece.

What impressed me perhaps most of all in this wonderful argosy was the great part that wireless plays in modern aviation. Indeed, without an efficient wireless service it is difficult to see how this vitally important Imperial route could be maintained.

Desert Dangers

The country flown over is for the most part wild, sparsely inhabited; and although weather conditions are generally good except during the Indian monsoon—that is, for about two months in the year—sudden storms arise at intervals during most of the year, and are particularly dangerous in the desert. For the wind blows up minute particles of dust, bringing the visibility down to lower

than that in a thick fog over the English Channel.

In a real desert dust-storm not only is the wind very strong, but it is sometimes impossible to see more than

THE INDIAN AIR MAILS ARRIVE

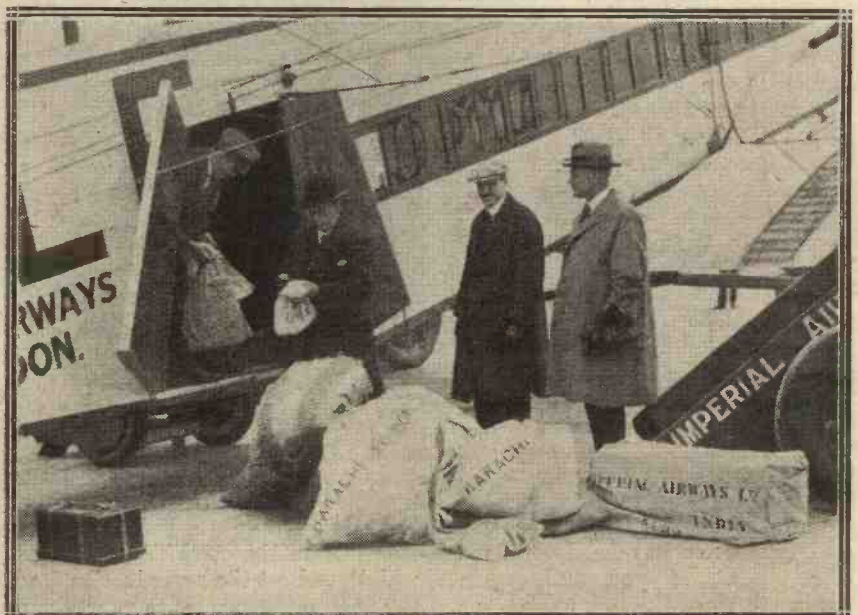

Removing the mails from the "Argosy" liner on its arrival from India at the Croydon Air Port. Imperial Airways use radio a great deal and all their air liners are fitted with wireless sets.

and Air Travel

Our distinguished contributor, who is Vice-President of the Air League of the British Empire, includes, in this fascinating article, details of several personal experiences that prove the vital importance of radio as a practical adjunct to aviation.

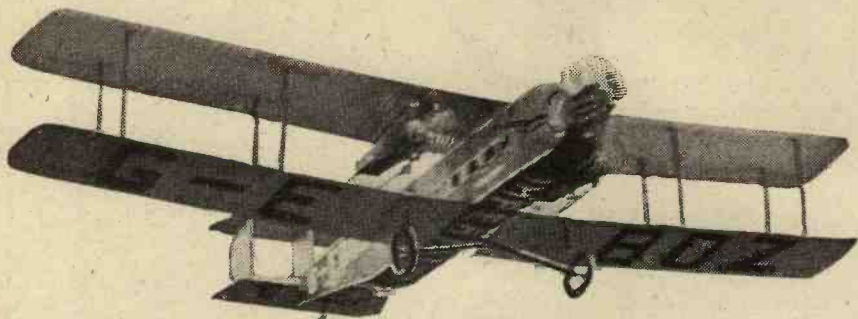

Off to India and the Far East.

As the usual journeys between the desert aerodromes are some three hours' duration, without wireless it would be possible for a machine to leave an aerodrome, say, at Basra, at the head of the Persian Gulf, in perfect weather conditions and, without being warned, fly into a dust-storm and find it impossible to land at Baghdad.

The importance of wireless, therefore, can be readily understood. If a sudden storm arises the aeroplanes in flight can be warned and directed either to go to a safer landing-place or, if the worst comes to the worst, go back and land at their point of departure.

The Radio Warning

I had three experiences of dust-storms during my journeys. The first was in flying from Cairo to Gaza, in Southern Palestine. After crossing the Suez Canal we had to fly over the dread Sinai desert.

The weather was perfect when we left Egypt, but the wind increased between the Suez Canal and Gaza, and soon blew up clouds of fine sand. We were able to ascertain, by calling the wireless station at Gaza, that the landing-ground there was clear and weather conditions fairly good.

Without wireless we dared not have risked this, and would have had to turn back. As it was, by going out to sea we were able to fly round the edge of the storm, the limits of which were fairly visible from the air. There was a stiff wind over the sea, but no dust. Any wind, short of a gale, if unaccompanied by dust, does not worry the modern flying-machine.

Dodging Dust

The second episode was on the farther stages of the same journey, when we were warned by wireless that the Basra aerodrome was experiencing a dust-storm and landing conditions would be bad. We therefore made Baghdad very comfortably, and stayed there the night instead of trying to make Basra.

The third experience was on the way back, when we were held up a whole day at Basra by a terrific storm in which no aeroplane could

live and the visibility was reduced to almost zero. This meant a delay of twenty-four hours, spent very comfortably in a rest-house, but in the knowledge that the moment the weather conditions improved—for the desert storms arise and subside with equal suddenness—we could proceed on our journey.

The passenger-carrying aeroplanes can receive and send wireless messages over considerable distances, and all the landing-places have their own wireless stations. It is, therefore, possible to choose one's weather; and the safety of flying in that part of Asia has been increased at least a hundred per cent by wireless telegraphy.

A Forced Landing

If an unexpected landing is to be made at an aerodrome after dark, owing to head-winds or other causes, the aerodrome-station can be warned by radio in time for the lights to be put up and lit on the landing-ground to facilitate the descent to earth.

There is another danger in air navigation over Asia Minor, and that is of forced landings in the desert through engine troubles or other mishaps. The route from Palestine to Baghdad lies across a huge expanse

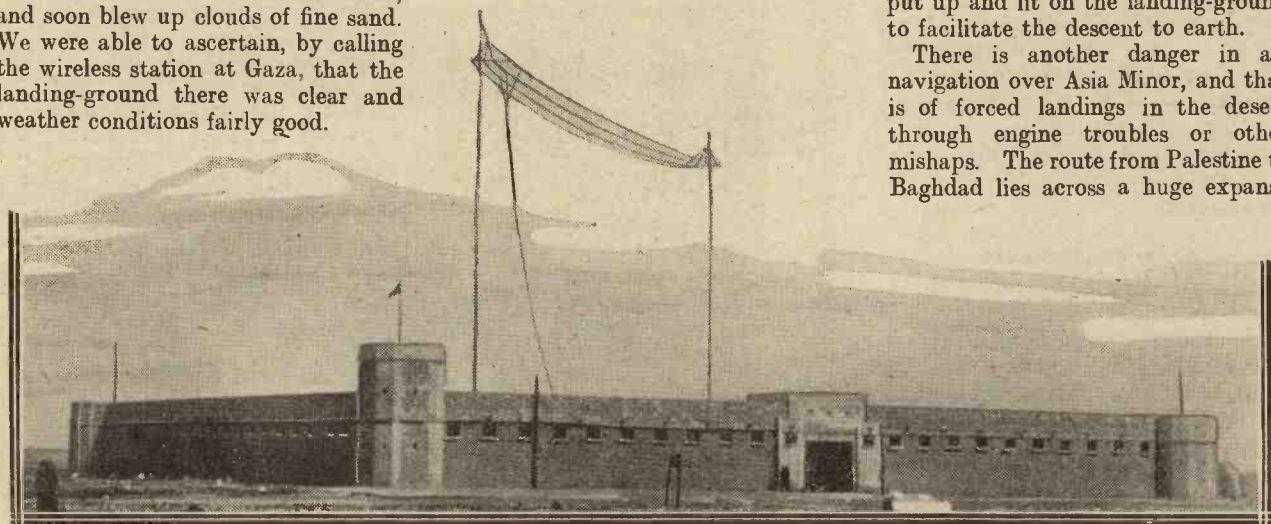

This is the port at Rutbar Wells near where there is a good landing-ground for 'planes, and in which there are adequate petrol and food supplies and a modern radio installation.

The Value of Radio on Desert Routes

of almost uninhabited, flat, sandy wastes.

The intermediate stopping-place is at Rutbar Wells, where there is excellent water and a modern, strongly-fortified post held by a detachment of the Iraq Army. Here is a good landing-ground, petrol supplies, sleeping accommodation and food.

But the nearest permanent habitation is 165 miles away. Rutbar Fort, in fact, is in the very centre of No-Man's-Land. Supposing a machine were forced to land and was not fitted with wireless. It is doubtful if any of the crew or passengers would get out of it alive.

CROYDON CALLING

The air-port for London is situated at Croydon, Surrey, and at this point a powerful wireless station keeps in radio touch with the air-liners.

The wave-length used by Croydon is 900 metres, and listeners whose sets will tune to this can often hear the conversations from the clouds.

If repairs could not be effected, and she was unable to resume her flight, they would have to make their journey over a trackless, almost waterless desert, without camels, and would be extremely fortunate if they managed to reach a settlement.

But there is still another danger, and that is from the native inhabitants themselves. For these are the Bedouin, who have never been brought under the control of any civilised government. They live on their herds of camels, inhabiting low, black tents, are very poor, but are well-armed with modern rifles and look upon travellers as a legitimate source of revenue.

Law of the Desert

The Law of the Desert is the law of the strong right arm. I heard the true story of a small party of missionaries proceeding by motor-car over part of the desert. A tribe of Bedouin swept down, robbed them of everything they had, even stripping them of their clothes and boots, and leaving them to make their way naked and on foot as best they could to the nearest Post.

But if an aeroplane, fitted with wireless, has to land in the desert it can report the fact at once to the nearest aerodrome and a relief 'plane is sent immediately to rescue the

passengers and mails. This has happened more than once.

Indeed, so perfect is the organisa-

WAR AND PEACE!



Ships of war and 'planes of peace! The Marseilles-Algiers mail 'plane passing over H.M.S. Nelson and Rodney during manoeuvres.

tion that the very moment a 'plane leaves one aerodrome to make another across these wild countries, it reports its position every half-hour, and its track is plotted on charts both at its point of departure and its point of arrival.

If there is silence, if the signals do not come through as expected, if the aeroplane is called up by wireless and does not respond, a relief 'plane is sent up immediately to fly along the track and to find out what has happened.

R.A.F. Avengers

This the inhabitants of the desert have learnt to know quite well, and they think twice of molesting aeroplane travellers who may have come down in their territory. For if there is trouble, it will not be an unarmed passenger-carrying aeroplane that will come, but the swooping wings of the Royal Air Force machines, well-armed with bombs and machine-guns and ready to deal out reprisals swiftly and surely.

In Europe the chief danger in flying is not from dust-storms but from fog. Very important experiments with wireless are being carried out now which, if successful—and the results so far are promising—will enable an aeroplane caught in a fog to be directed with absolute certainty to her landing-ground.

It is no exaggeration to say that every improvement in the technique of wireless is of value to aviation and will tend to make flying safer.

"WHAT IS MY POSITION, PLEASE?"

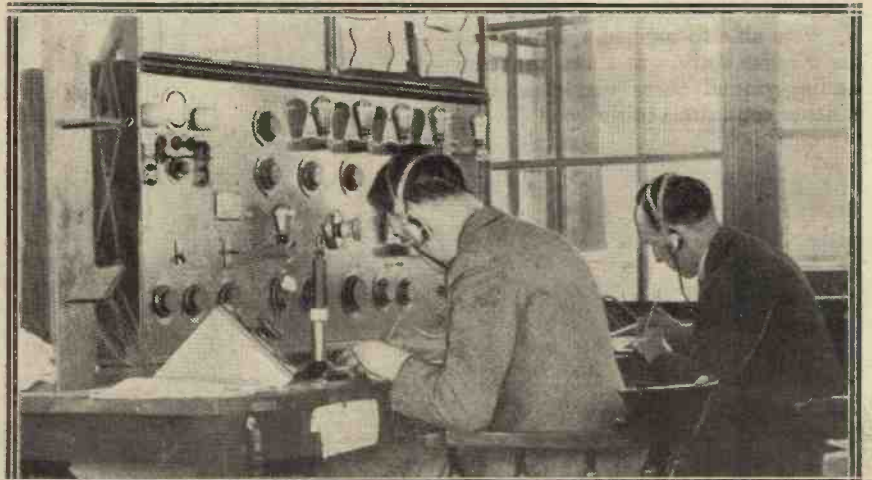

Operators in the Croydon Control Tower receiving messages from 'planes in flight. From this tower the pilots can be informed by radio should they want to know their positions or bearings during foggy weather.

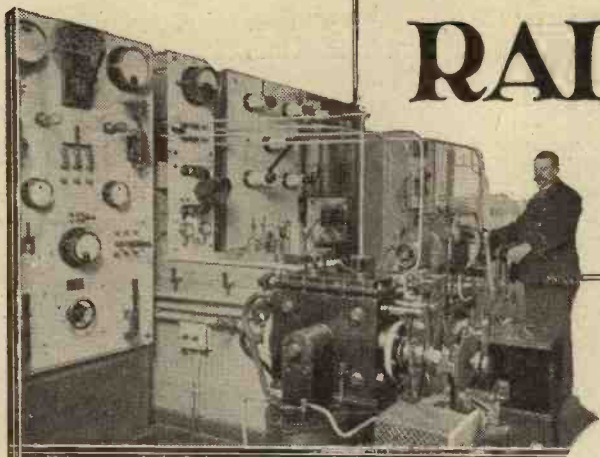

RADIO POWER PROBLEMS

Most people haven't much idea of the power expended in the aerial of a broadcasting station, but this very readable article throws interesting light on the subject.

By T. B. SANDERS.

IT means very little to most people to be told that the power of the old 2 L O at Oxford Street was 3 kw. When, however, it is realised that 3 kw. is *three thousand* watts, people are rather apt to gather from this large figure that a large amount of power is indicated by it.

How Many H.P. ?

The present popularity of motoring has created a much more general appreciation of the significance of horse-power, and almost everyone can tell you nowadays to nice limits the performance of a 20 h.p. car as compared with one of only 10 h.p.

The 3 kw. of power which the old 2 L O transmitter expended can quite easily be expressed in terms of the more familiar horse-power, and thus enable the great majority of people to form a more accurate conception of what is meant by 3 kw.

One horse-power is equal to 746 watts. The smallest-powered car which is commonly obtainable is a certain deservedly famous "Seven," and the power of this, expressed electrically, is easily found to be 5,222 watts; or, in other words, not quite $5\frac{1}{2}$ kw. !

2 L O's Motor-Bike !

The Oxford Street transmitter, of which the B.B.C. was once so proud, with its 3-kw. rating, is actually less than this, being, roughly, 4 h.p. Hardly enough to please an enthusiastic motor-cyclist !

Even the mighty Brookmans Park, which is among the world's most powerful transmitters, only energises each of its twin aerials with a maximum of 30 kw. There is nothing very staggering in this to the motorist, who can name you half a dozen cars with a rating of 40 h.p. which this 30 kw. approximately represents.

The Postmaster-General will allow the enthusiastic amateur (if he applies often enough) to own and operate a private transmitting set, providing the *input* power does not exceed 10 watts. This is very roughly about one-hundredth of a horse-power, and would scarcely be capable of operating a sewing-machine efficiently !

There are inevitable losses of power between the input and output of any mechanical or electrical appliance, and a wireless transmitter is no exception to this rule. One is, therefore, staggered to think how diminutive is the power which energises the amateur transmitter's aerial.

obviously powerful machinery which forms part of the equipment of the Brookmans Park transmitter.

The idea of the smallness of the power of broadcast transmitters which this article has attempted to convey may be hard to reconcile with the contrary impression which these pictures give.

Power in the Aerial

It must be remembered, however, that it is *radiated* power with which this article has so far dealt. The total power expenditure of a broadcast transmitter is an entirely different matter, because the modern transmitter requires such an enormous amount of auxiliary equipment to enable it to achieve its comparatively puny disturbance of the ether.

The power expended on these

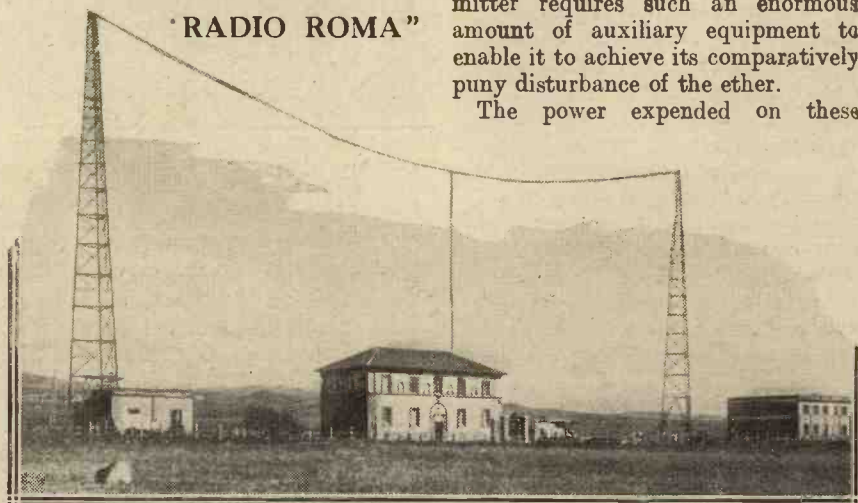

By common consent one of the finest stations on the continent, "Radio Roma" is housed in the buildings shown. It works on a wave-length of 441 metres.

Notwithstanding this, communication with Australia is among the minor achievements of amateur transmitters, most of whom are convinced that their signals could be read on Mars if some obliging listener would only take his set to that planet to listen to them.

A good many readers of this article have probably recently seen photographs of the imposing array of

auxiliaries, however, does not contribute directly to the power radiated from the aerial. They really represent terrific waste of power which our still imperfect knowledge of wireless mechanics renders unavoidable at present.

When a station's power is rated at so many kilowatts, this wasted power is not taken into account.

RANDOM JOTTINGS

Those alternative programmes—We take off our hats to the Talks Department—Dr. Adrian Boult deals with "Better Broadcasting"—The B.B.C. Charter—The Test matches.

LISTENERS are waking up to the realisation of the fact that the Regional Scheme has by no means solved the problem of alternative programmes. Take a look at the programmes for the National, Midland, and London stations for the last few weeks. You will find that the Midland and London Regional programmes get less and less varied. They are different from the National programmes; but between each other the difference is slight.

No Alternative At All

It is, perhaps, hardly fair to pick out one particular evening to quote as an example, but take the programmes for Sunday, May 11th. At 9.5 the National broadcast an Elgar Concert. So did the Midland and London Regional stations.

Why? Admittedly an Elgar programme is important and that, in this case, the famous British composer was conducting, but that is no reason why all three stations should give the same broadcast. And on a Sunday, too. The difference between an average night's Midland Regional programme and the programmes from either the National or London Regional broadcasts are almost farcical.

Captain Eckersley's great idea—the Regional Plan—is certainly being put to queer uses by the B.B.C.

Those Talk Titles

We take off our hats (more in sorrow than in admiration) to the "Talks" department for the fascinating way in which they arranged a talk a little while ago. The title was "Biochemistry." That's all! This method of presenting a talk on such a subject is simply ridiculous when the nature of the B.B.C.'s audience is taken into consideration.

So long as specialised subjects are presented to listeners under such unimaginative titles the B.B.C. must not grumble if it is frankly told it is making a thorough mess of its "educational" talks series; and that it merely succeeds in choking off thousands of listeners who might otherwise be persuaded to listen to the talks instead of vaudeville or light music.

Dr. Adrian Boult, the new musical director of the B.B.C., wrote an interesting article for the "Daily Mail" the other day, in which he dealt with Broadcasting and Better Music.

"This is a problem which must be faced broadly and boldly, but it is not an easy problem to put into words," said Dr. Boult. "A fairly good way of stating it might be to aim at giving our listeners the best music of every kind performed in the best possible way."

"We have a wonderful example of one side of music-making in the Promenade Concerts. Here for more than thirty years Sir Henry Wood has steadily pursued the policy of seizing every opportunity of improving the programmes, and now his audience simply will not be bothered with the operatic fantasias and other tit-bits that they used to applaud to the echo."

True enough, but Dr. Boult must remember that, compared with the B.B.C.'s audience, the "Prom."

RADIO RESEARCH

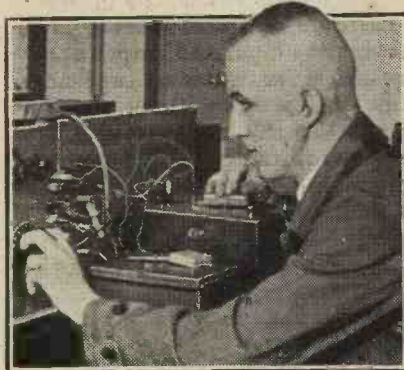

One of the members of the new Institute of Radio Research that has been opened in Berlin.

audience is very small, and limited, in the main, to a regular and more or less specialised clientele. The example is only good in so far as it shows how a musical policy can be successful; but can the same formula be applied to a B.B.C. audience?

Perhaps Dr. Boult's idea of a policy for the B.B.C. is best expressed in these words:

"Music is a truly British thing. There is plenty of it to suit our robust, rough-and-ready temperament. It is a real civilising force. Has anyone gone to the bad through the influence of music? But there is much to be told of the inspiration that music has given to young and old, rich and poor, healthy and, most of all, to those who are lying confined in hospitals and sick rooms."

If he bears that well in mind when considering what musical programmes to arrange for the B.B.C., so that they make as wide appeal as possible to the millions of listeners in this country, he won't go far wrong.

And Sir Thomas Beecham will have to find a fresh reason when next he

tilts at the music policy of the B.B.C.

The Wireless Correspondent of the "Birmingham Gazette" has recently been looking into the mystery of the B.B.C.'s charter. He does not seem to have been greatly edified with the mystery—for mystery it certainly is. But some of his observations are rather interesting. For example, he says:

"Many people are of the opinion that the B.B.C. is a Government department. This opinion may possibly have been gained from the attitude of some of the officials at Savoy Hill.

"The B.B.C. is a self-governing Corporation operating under a Royal Charter and a licence, and its activities are limited only by that charter and licence.

"Exactly what are the terms of the charter and licence it is very difficult to discover. It has been stated that none know (but the supreme heads at Savoy Hill).

True—But Misleading

He goes on to point out that Clause 22 of the charter is reproduced in the B.B.C.'s Year Book, but in such small type that it is scarcely possible to read it. At any rate it gives nothing away from the listener's point of view.

"The Bank of England is constituted by charter and the Royal Academy and many other societies have charters, but they are not Government departments," says the B.B.C. "Nor are we."

We have noted this paragraph ourselves, and admired its ambiguity. It is true, and yet misleading, for no other organisation holding a Royal Charter is more closely in touch with the Government, or more under its sway, than the B.B.C.

It depends on a Government Department—the Post Office—for its cash supplies. Without Post Office help it could certainly not collect its revenue. But the Royal Academy doesn't need Post Office help. Lucky Academy! The P.O. wants its pound of flesh for any help it gives.

"One might go further and say that the B.B.C. is undoubtedly a revenue-producing department for the Government," adds the writer in the "Gazette." "Has not the sum of over £850,000 been handed over to the Treasury since the B.B.C. came into being?"

"The collection of licences by the Post Office, all done in Post Office fashion, with O.H.M.S. envelopes and buff forms, has proved so remunerative at the present scale of deduction that the Government is making hay while the B.B.C. is apparently starving for funds."

Cricket Broadcasts

Few will disagree with the B.B.C.'s contention that lengthy broadcast descriptions of cricket matches are unsuitable. Cricket is one of the few games which does not lend itself to detailed commentaries.

The arrangements made for broadcasting the Test Matches are simple, but should prove quite effective.

An eye-witness account will be given at the conclusion of each day's play—generally between 6.30 and 6.40 p.m.—and the accounts will be broadcast, not by newspaper experts, but by well-known cricketers. A good idea.

AMBLING AMMETERS

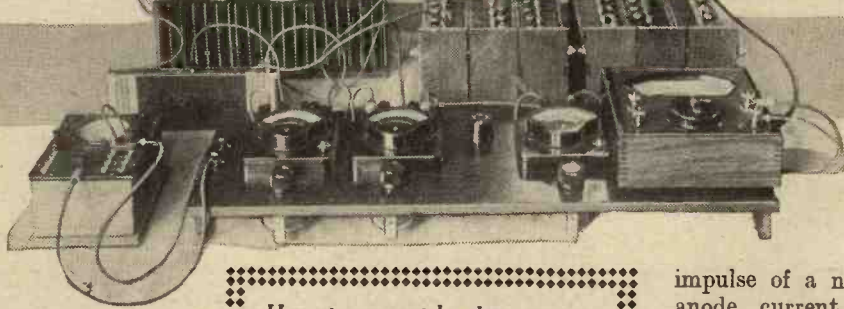

DISTORTION and flickering milliammeter needles seem to occasion some confusion, although it is all very simple and straightforward.

Superficially examined it might seem odd that the needle of a current-recording device should remain steady whilst pulsations of low-frequency are passing through the instrument, but that is very easily explained.

THE "SENTRY"

FIG. 1

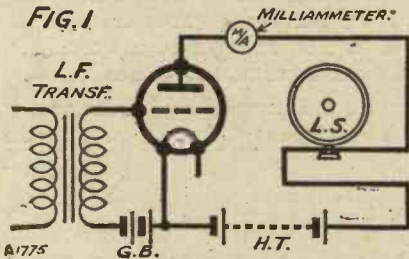

A milliammeter in the anode circuit of an L.F. valve can tell you a great deal about what is happening.

The whole matter hinges on the operation of the valve, so it will be necessary to examine this in some little detail. Let us confine ourselves to the last valve in an average sort of set and suppose this to be a medium-sized power valve.

The Grid Bias

I have drawn a conventional circuit including a milliammeter and an L.F. transformer (Fig. 1). Of course, there is grid bias.

Low-frequency impulses are passed through the L.F. transformer and conveyed to the grid, and you can get a clear idea of what happens by referring to Fig. 2.

There is presumed to be 15 volts bias applied by the G.B. battery, and, normally, there is therefore about 17 milliamperes of current passing through the loud speaker and milliammeter.

If the valve is not to be overloaded, the grid voltage fluctuations must not exceed about 15 volts above and below the bias point—i.e. 15 volts.

Here is an article that we are sure all "M.W." readers will read with great interest. Also, it will help them to understand one of the knottiest points encountered in the operation of a valve set.

By G. V. DOWDING,
Associate L.E.E.

The fluctuations shown in this diagram are obviously well within these limits. You will see that every fluctuation that represents a decrease of voltage in comparison with the 15 volts G.B. is followed by an increase of exactly the same order.

That Straight Section

That means that as we are working on the straight part of the curve, the increases of anode current are exactly equal to the decreases, and this is as it should be for distortionless results.

Let me amplify this point a little. When there are no impulses being fed on to the grid, a steady anode current of about 17 milliamperes flows.

When the grid potential is raised to just over 20 volts by a signal

DISTORTIONLESS RESULTS

FIG. 2A

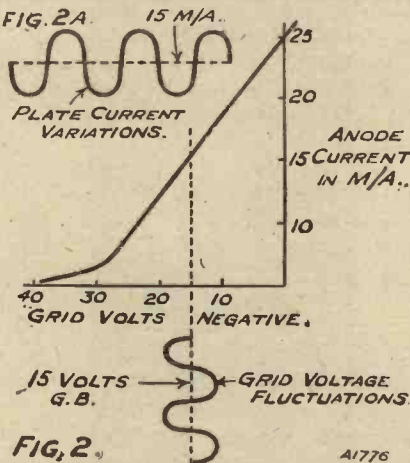

FIG. 2

When the equal grid voltage fluctuations cause equal anode current variations as above, all is well, and the milliammeter needle remains stationary as explained in the article.

impulse of a negative character the anode current falls to about 10 milliamperes (a fall of 7). The negative signal impulse is immediately followed by one that is as much positive as its predecessor was negative, and so the anode current must rise 7 milliamperes.

Very Rapid Variations

The point to remember is that while the signal impulses as a whole

NEEDLE KICKS

NEW AVERAGE CURRENT.

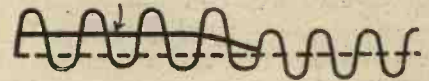

FIG. 3A.

It is when a new average anode current is created that the milliammeter needle moves.

may grow larger and smaller, the variations in their intensity are exactly repeated in both their negative and positive "half waves."

And if the valve is working properly and you have biased it correctly (and it is not being overloaded), the anode current rises and falls accordingly—i.e. each rise is immediately followed by a fall of equal proportions.

The milliammeter needle cannot follow these rises and falls, for they are occurring thousands of times per second; the exact speed depends upon the frequency of the note or notes being dealt with.

Average Current Recorded

You can think of the needle as trying to follow, say, a 5-milliamperere current increase, but before the needle's inertia was overcome and it started to move, that 5-milliamperere current increase would be all over, and there would be a 5-milliamperere current decrease to counterbalance things. The needle just remains stationary and records the average current flow (Fig. 2A).

It doesn't matter what current fluctuations there are (2, 3, 4, 6, 7 or 8 milliamperes), or if they are

How to Read those Needle Kicks

alternately very small and very big, or all mixed up, so long as the increases equal the decreases the millimeter needle stands still.

Overloading or wrong biasing will throw things out and cause the needle to move. Once the grid voltage is swung so that it no longer is confined to the area covered by the straight part of the curve, the equal grid voltage variations are not followed by equal anode current variations.

Wide Variations

Supposing we increased the grid bias to 25 volts (Fig. 3) and had to deal with signal impulses as great or even greater than before.

You will see that the impulses that tend to add to the grid bias of 25 volts negative drop the anode current less than the corresponding positive impulses increase it. The average of the anode current must therefore rise (Fig. 3A), although it would again fall if the grid impulses

fell to such an extent that they did not overlap the bend in the curve.

In practice there are, of course, wide variations in the intensities of the grid voltage fluctuations. Those that are large enough to swing over the

TOO MUCH G.B.

FIG. 3.

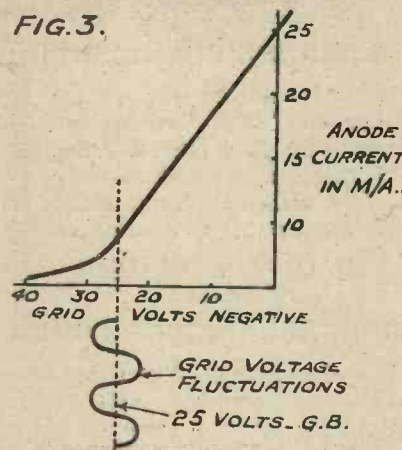

The grid voltage fluctuations are now tending to lap over the bottom bend, with the result illustrated in Fig. 3A.

bottom or top bends in the curve cause the anode current average to shift, and this is shown on a milliammeter by the needle moving.

A decided upwards movement or kick of the needle indicates that the grid impulses are overlapping the bottom bend and that there may be too much grid bias.

When the needle tends to kick downwards the grid bias may be too small.

Minor Movements Unimportant

It is seldom possible to get a milliammeter needle to remain absolutely stationary for long periods.

If you can keep the needle kicks to within 10 per cent of the reading over the loudest and heaviest passages you will be doing very well.

The immovable needle is an ideal at which one can aim, but there are energy "transients" that are apt to cause a "shivering" of the needle, but which have no bad general effect.

EVERY now and then a newspaper correspondent will blame radio for current bad weather. I cannot help thinking that the newspapers that publish such letters should know better than allow such "false alarms" to get into print.

If radio has any effect at all on the weather it is so slight that you could never notice it. Does lightning

RAIN AND RADIO

By N. JERVIS

effect the weather? Well, lightning may, perhaps, be regarded as a part of the weather!

Nevertheless, it is just as well to

bear in mind that lightning causes just the same sort of etheric disturbances as do radio waves, albeit lightning is much more powerful.

There are one thousand million kilowatts of etheric energy in the world at any given moment due to lightning. There are always at least 2,000 thunderstorms in progress.

There are probably more than 2,000 wireless transmitters at work at the same time during some part of the day, but their total power will not equal much more than .01 per cent of the power represented by Nature's radio.

SIGHT AND SOUND



Receiving an experimental television transmission on one of the Baird combined sight and sound receivers. The received image appears at the back of the right-hand aperture and the left-hand one contains the loud speaker.

What About Light

In these circumstances you will see that wireless adds but little to the disturbance of the ether.

Here is another point. Why should it be presumed that ether waves of the order of those met with in radio should affect the weather any more than, say, light waves?

Don't jump at the sun to counter this, because heat waves as well as light waves come from the sun and heat is a very different proposition.

But I have a sneaking regard for these wild and woolly ideas such as how a Farmer Grew Big Beans by Planting Them Under His Crystal Set, because they have such romantic, H. G. Wellsian tints!

Your First Loudspeaker

By ROBERT BLACK.



Whether or not you have just purchased your first loud speaker you should be interested in these practical hints on how to get the best possible results.

WHAT enthusiastic listener who is worthy of the name will forget his first loud speaker? The pride with which it was taken home, the eagerness with which it was connected up, and the "absolute fidelity" of its reproduction!

Experience Tells!

At first everything is flawless. It is only as time progresses that one gets more critical, and discovers that with all our pride we were not getting perfection. In fact, with loud speakers, as with everything else, experience tells, and here are some loud-speaker facts that have been found from experience.

First, as to the position of the loud speaker. If it is placed on top of the set cabinet, or immediately behind it, the loud speaker may cause the valves to "ring." You may find, too (especially in a long and narrow room), that your loud speaker sounds better in one corner than in another, so its permanent position should not be chosen haphazardly, but should be the result of some thought.

Those Long Leads

Long, trailing leads of flex should not be used to join the loud speaker to the set. The scheme is all right for short distances in the same room, provided the flex is placed safely underneath the carpet where there is no risk of a foot catching in it and pulling the loud speaker down. But if you have the set in one room and the loud speaker in another, it is far better to go to the trouble of taking a floor-board up and putting in insulated wiring than to attempt to trail long, flexible leads about.

There is no need whatever for the loud-speaker leads to spoil the appearance of a room or to disfigure the

walls with wires, as small wall plugs can be obtained which can be fixed to the skirting-board in an instant.

A good plan is to run one wire from the set to all the loud-speaker's points in the house under the floor-boards; whilst the return wire from all points can be an "overhead," behind the picture rail. In such cases No. 22 D.C.C. wire is good, as it is practically invisible even where it leaves the picture rail for the "open," and it can be wedged down into the cracks of floor-boards, where it is quite invisible.

FIT A FILTER

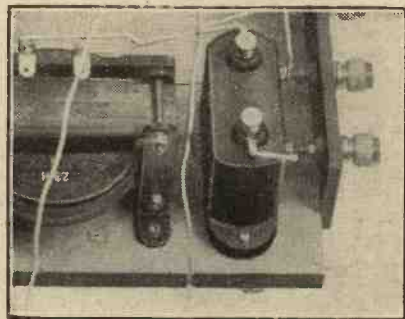

By means of an L.F. choke and one or more large condensers the L.F. impulses can be "filtered out" and fed to the loud speaker separately.

This sinking of thin wire between the cracks of floor-boards is a point worth remembering, for it is very easily done and enables carpets to be removed, etc., without disturbing it in the slightest. It is especially valuable where lino is used, for it will be found that even if a thin wire is placed across the boards under the lino there will be a tendency for a line to appear on the latter owing to uneven wear at this part. Sinking the thin wire into the cracks of the floor-boards prevents this.

When using a power or super-power valve it is usually recommended that a filter output circuit should be used for the loud speaker consisting of a large L.F. choke and one or more large condensers.

Remember the Adjustment

The advantages of this are that H.T. is not then allowed to wander about the house, the H.T. battery is safeguarded from shorts and liability to leakage, and, finally, the loud speaker itself works better when on a filter circuit than when carrying the last valve's plate current.

Most loud speakers are provided with an adjusting screw, and often this gets sadly neglected. Generally, the adjustment is arranged to vary the distance between the permanent magnet of the speaker and the armature. If the two touch, there is an unpleasant rattling and distortion.

If, on the other hand, they are too far apart, you are losing sensitivity, so the best adjustment is slowly to increase sensitivity until a rattle or click shows that you have gone a little too far, and then to turn back the adjusting screw just sufficiently to allow the necessary clearance.

Two Important Points

Loud speakers should be kept dust-free and heat-free. "Dust-free," because the parts are really quite delicate, so that a cover over the loud speaker is only fair treatment when dusting and sweeping is in progress.

All loud speakers, and particularly those of the cone type, should be kept "heat-free," for excessive heat may affect the fabric of which they are made and in so doing may easily alter the reproduction and quality. Never stand a loud speaker in a strong sun in the window at this time of the year, nor too close to the fire in the winter.

Volts for

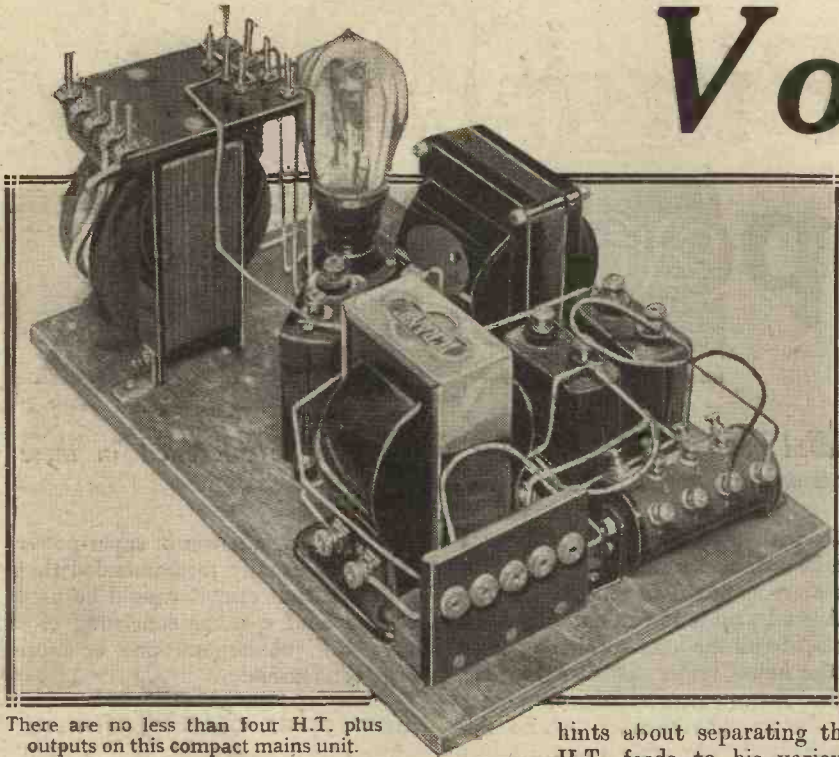

There are no less than four H.T. plus outputs on this compact mains unit.

THIS H.T. unit was originally intended for just one particular set, but when we came to make it there seemed no reason why it should not be produced in the form of an appliance to suit almost any set of the general type we had in mind.

The original idea was an A.C. mains H.T. unit to supply the "Twin-Frame" Four, described in "M.W." a few issues back, and the final decision was to try to turn out one to suit practically any home-constructed portable or all-enclosed receiver, so that the dry H.T. battery can be dispensed with when the set is in use at home.

Compact but Stable

A considerable amount of experimental work has been needed to obtain a satisfactory design, for it is much more difficult to produce a unit capable of working well with the majority of frame-aerial sets than one for normal receivers.

The trouble is that most portable and transportable sets are very sensitive, and having no earth connection has a much lower margin of stability than ordinary instruments. Hence they are much more easily provoked into misbehaviour by coupling effects in the H.T. source.

We have consequently found it necessary to be much more thorough than usual in the matter of de-coupling arrangements, and we shall have to give the constructor some

hints about separating the H.T. feeds to his various valves to prevent motor-boating.

Nevertheless, the unit in its final form is about as "safe" from the stability point of view as it is possible to make it, and we have had very satisfactory results with a number of different frame-aerial circuits.

One of the greatest difficulties we encountered was in obtaining the necessary very complete de-coupling between the various output taps without making the unit large and elaborate.

It was essential that it should be simple, because compactness was obviously a very necessary characteristic of an appliance for use in the limited space usually available in all-enclosed receivers.

Adjustable Layout

Mention of available space reminds us that the constructor should be advised that the layout shown in the photos and wiring diagram is not to be regarded as the only possible one. As a matter of fact, there is nothing critical about a design like this, and you can lay it out pretty much to suit yourself, so long as you are careful to follow out the connections correctly.

It is therefore suggested that you should determine for yourself a suitable size and shape of baseboard to fit the space you have available, and then plan a layout to suit.

Since the unit is intended to be placed inside the receiver cabinet, we have adopted a simple open-baseboard method of assembly which you will find makes it particularly easy to construct.

Just one point in this connection: if the space in which you will place the unit is very close to the "works" of your receiver it may be desirable

ONE EVENING'S INTERESTING WORK

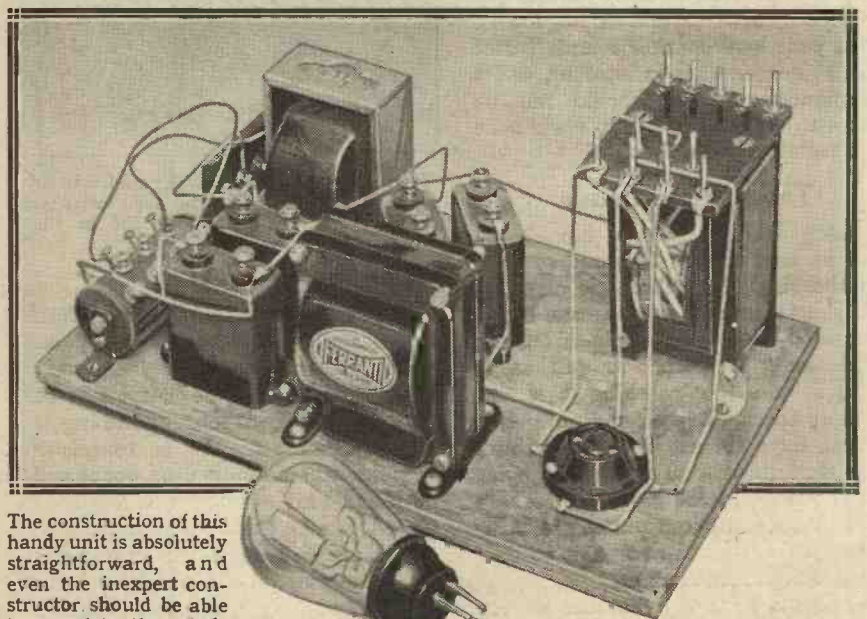

The construction of this handy unit is absolutely straightforward, and even the inexpert constructor should be able to complete the whole job and get the device tested in one very

comfortable and enjoyable evening's work. As you can see, the wiring is exceptionally simple.

the "Twin-Frame" 4

A RELIABLE A.C. H.T. MAINS UNIT FOR USE WITH PORTABLES
DESIGNED AND DESCRIBED BY THE "M.W." RESEARCH DEPT.

to get a tinsmith to make you a tin cover for the unit itself.

Try without it first, however, and if you get a hum then fit the cover and connect it to the filament circuit with a piece of flex. You are not likely to need this screen, but we just mention it to cover all possible cases.

Although especially designed for that popular "M.W." trans- portable set the "Twin-Frame" Four, this exceptionally efficient unit can be employed with any one of many ordinary sets of either portable or "household" varieties.

Now let us run over the circuit diagram and see how the unit is arranged as we go. First, you will note that a full-wave rectifying valve is used, and this is actually of the Marconi or Osram U5 type.

Circuit Design

Feeding this valve there is a power transformer (remember the unit is for alternating current mains), and this must be of a type with the necessary 5- to 6-volt winding for the rectifier filament and a high-tension winding (centre-tapped) rated to give about 150-0-150 volts.

The primary winding must, of course, be rated to suit your own mains, so remember to quote the voltage and frequency when ordering.

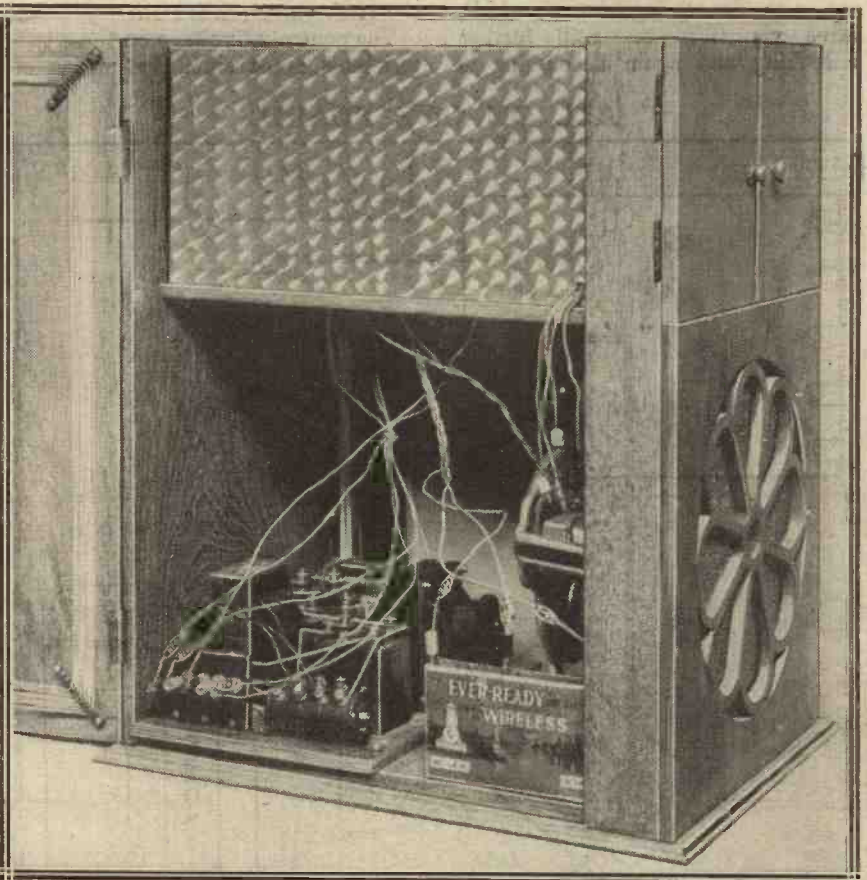

When you want to run the set from the mains you merely take out the H.T. battery and slip in the H.T. unit in its place.

Any transformer coupling with these requirements may be used.

The one in the original unit was one produced by Messrs. Igranik for their "Igranikit" receiver, but also available as a separate component.

WHY IT IS SO SIMPLE

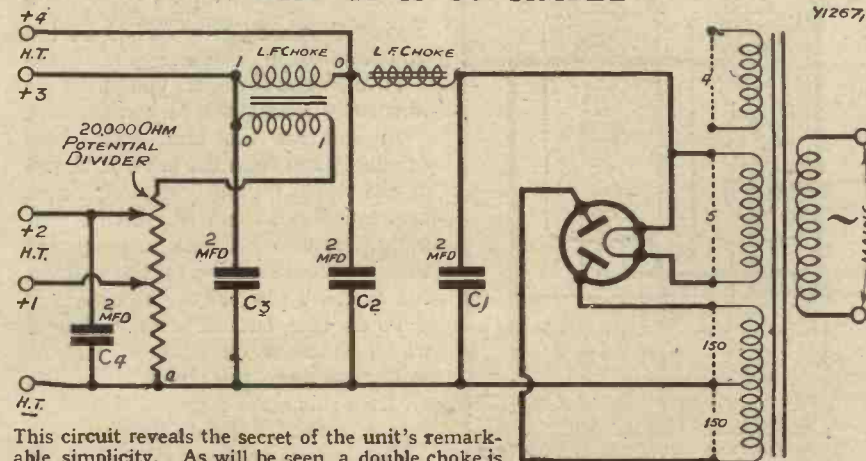

This circuit reveals the secret of the unit's remarkable simplicity. As will be seen, a double choke is used and the smoothing is so arranged that the maximum of smoothing is given by a minimum of components. There is a filament voltage output from the transformer, should this ever be needed.

Just one hint about this transformer: it is not provided with terminals, but with projecting screw shanks to which wires are to be soldered in the present case, and you will have to identify these by their positions, with the aid of the wiring diagram, since they are not marked.

By the way, there is also a 4-volt winding on this transformer, but this is not used in the present unit.

Following immediately upon the rectifier is the main filter, made up of C₁ and C₂ and the single-winding L.F. choke, and from here the H.T. +4 tapping is taken off. This tap is intended for the L.F. valve or valves, which only require a moderate amount of smoothing, and are well

A Smooth, Silent H.T. Supply for Your Set

decoupled from the others in the set by taking their supply from this point.

Farther along you will see a double-wound choke, and one winding of this, with C₃, provides extra smoothing, also decoupling, for the H.F. valve via H.T.+3. Still further smoothing and again decoupling is

given by the second winding in conjunction with condenser C₄. From the potentiometer two adjustable voltage taps (H.T.+1 and H.T.+2) are taken, these being for the detector (H.T.+2) and the screening grid of the H.F. valve (H.T.+1).

The control of voltage on these two terminals is obtained by means of

flex leads to the potential divider. You will generally find satisfactory working will result with the H.T.+1 lead on the No. 7 or 8 terminal of the divider and that from H.T.+2 on No. 5 or 6.

Connecting to Your Set.

By the way, you may wonder why there is no bypass condenser for H.T.+1. We didn't forget it, but left it out deliberately, because this bypass is practically always present in the receiver.

In a number of cases, it will be necessary to arrange for separate H.T. feeds to each valve, and this may call for a little alteration of wiring. This is practically always

ALL ON ONE BOARD

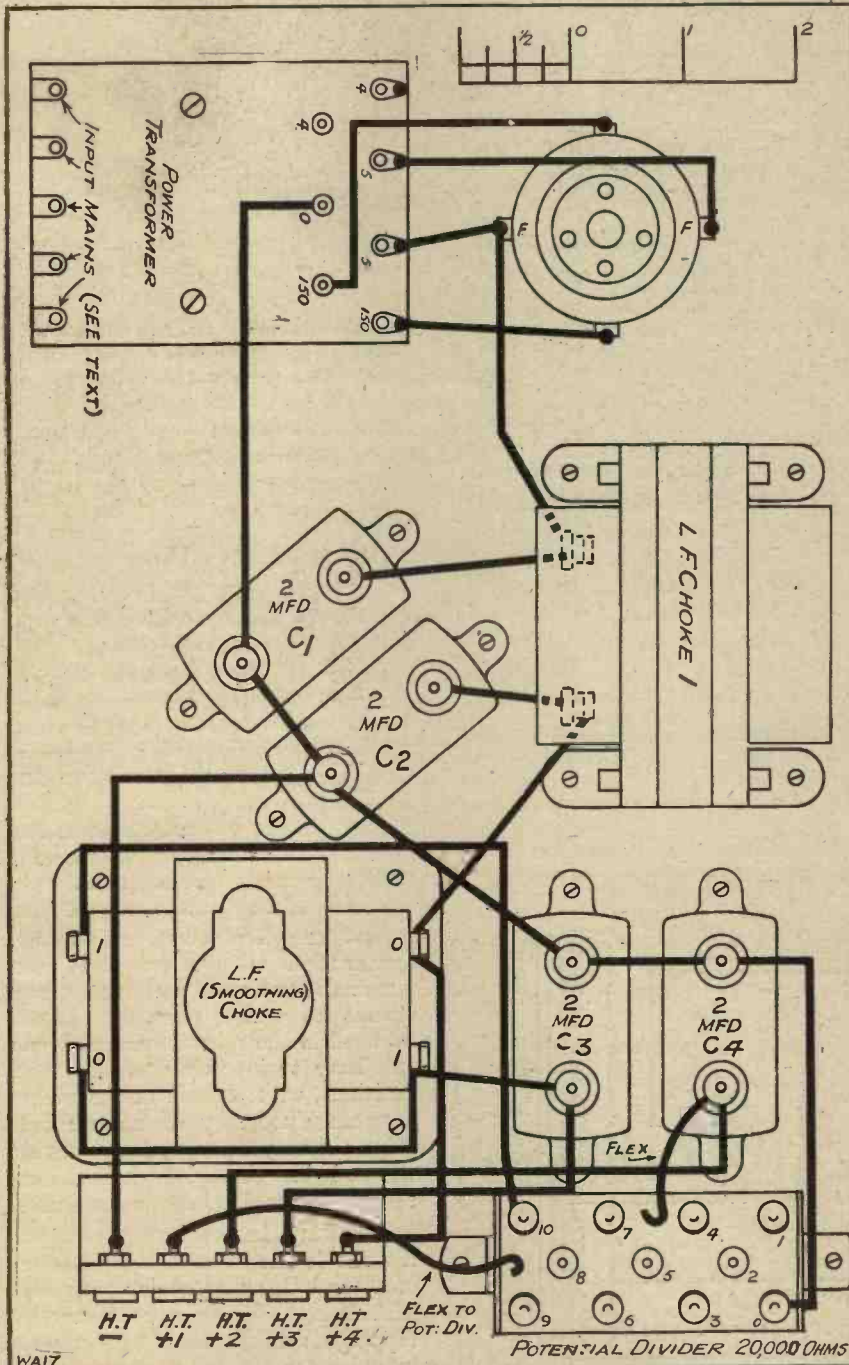

The assembly of the parts and the wiring-up are greatly facilitated by the fact that there is no front panel, all the components being fixed to the baseboard.

- *****
- THE PARTS YOU NEED**
- * 1 Baseboard, about 7½ x 12 in. (see text).
 - * 1 Power transformer, as specified in text ("Igranikit" or equivalent). (Specify mains voltage and frequency when ordering. In case of universal type be careful to connect to correct input terminals for your voltage according to makers' instructions.)
 - * 1 Valve holder (Igranik, or Lotus, Lissen, W.B., Benjamin, Wearite, Magnum, etc.).
 - * 1 Smoothing choke, about 20 henries (Ferranti B1, or R.I., Wearite, Varley, etc.).
 - * 1 Double-wound smoothing choke (Igranik, or Varley, etc.).
 - * 4 2-mfd. condensers (preferably 200-volt working rating or over. Voltages are not high in this unit and ordinary receiving types can be used at a pinch if of good makes). (Dubilier, or Lissen, T.C.C., Ferranti, Hydra, Mullard, Loewe, etc.).
 - * 1 20,000-ohm potential divider (Bulgin, or Wearite, Climax, etc.).
 - * 5 Sockets, piece of ebonite about 2 x 3 in., wire, screws, etc.
- *****

a very simple matter, and if we tell you how to do it in the case of the "Twin-Frame" Four you will see how to set about it in any other case.

In this set the H.F. valve was originally run from the same H.T. tap as the two L.F., and you should now arrange to run the H.F. valve separately, the two L.F. stages being fed together from H.T.+4 on the unit via the H.T.+3 plug of the receiver.

To do this, cut the wire in the set which connects one side of H.F.C.₁ to C₅ and take your new H.T. lead off from this same terminal of H.F.C.₁. This goes to H.T.+3 on the unit.

The screening grid of the valve already has a separate lead, and this goes to H.T.+1 on the unit.

GERMANY'S SINGLE WAVE STATIONS

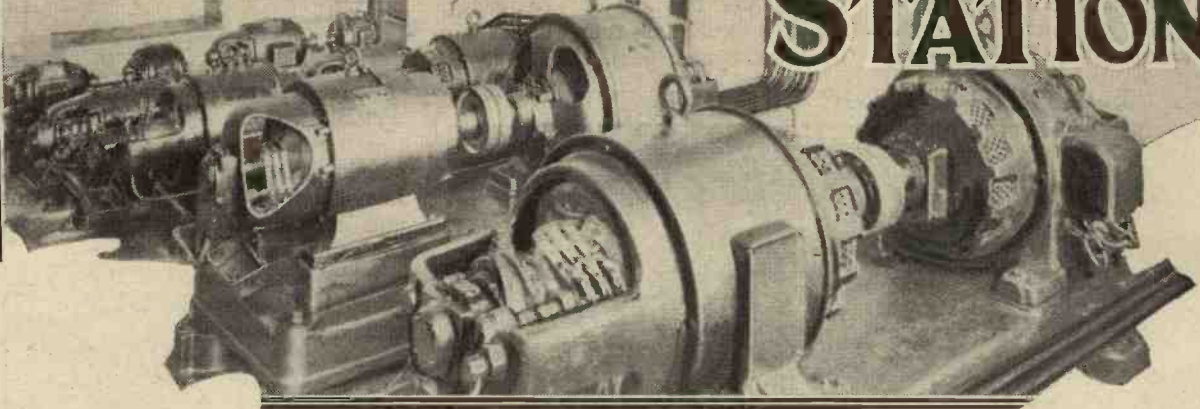

THE steady increase in the number of broadcasting stations in Europe and the consequent shortage of suitable wave-lengths were the two main reasons for the development of a number of schemes either to cut down the number of stations without losing effective range, or to operate a number of stations of only local range on one single wave-length.

International single wave-length working is hardly possible owing to the differences of technique, of system and organisation in the countries concerned, and we all know that the international common waves are only a very poor makeshift.

Britain and Germany

On the other hand, single wave-length working of stations in one country, controlled by one organisation, has been successfully introduced into Great Britain and into Germany. The German system, although probably more costly, is more stable than our system.

Our relays operate on one wave-length. Each relay station provides its own power, and the transmitter is kept "in tune" by means of tuning forks. Now a tuning-fork frequency is subject to every change

.....
A remarkable system of operating groups of relay stations has been tried out with complete success in Germany. By means of a special method of central control a high degree of stability is achieved. Although it is probably a more costly business than the B.B.C.'s plan its practical results do seem to warrant the extra cost.
By Our Special Correspondent.

of temperature, no matter how slight. Also, the personnel of the station must be well trained and continually on the alert.

In Germany it was decided to operate a group of relay stations on a different basis. One central station radiates a frequency of low-power by means of cables to the different relay stations.

At the relay these impulses are

amplified by several stages, so that the power is considerably increased, and by this all the stations linked to the central station can transmit on exactly the same wave-length. The fundamental frequency in the case of the German relays Berlin-East, Stettin and Magdeburg is approximately six hundred times lower than the frequency radiated by the transmitter.

How It Is Done

That means that the fundamental wave on arriving at the relay station has to be multiplied 600 times. This is done in three separate stages according to the Lorenz system. (Lorenz apply the same system to their ordinary transmitters for broadcast stations, one of which is in operation at Munich.)

ONE OF THE GERMAN RELAYS

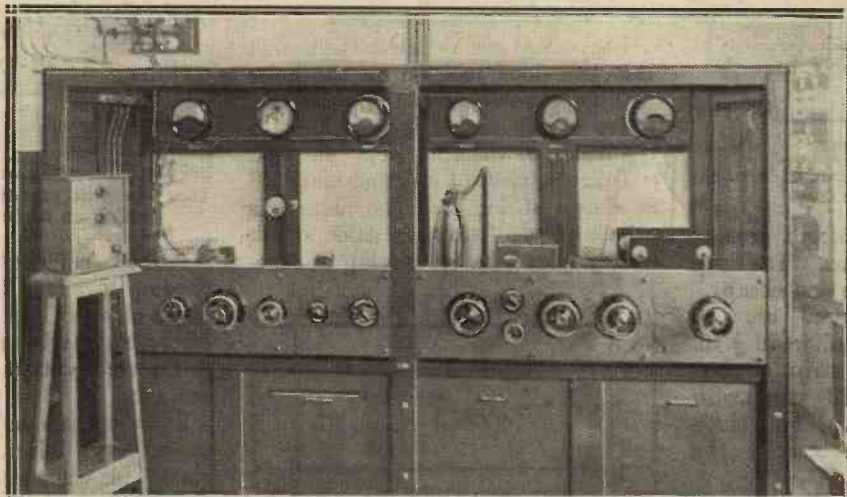

The 0.25-kw. transmitter at one of the German relay stations. It includes a special quartz crystal wave-meter that can be seen on the extreme left. The outfit is wonderfully compact and is particularly easy to maintain.

When the wave has been brought down to the required length, or, rather, when the frequency has been brought up to the necessary value, the power, which is then about 100 watts, is brought up to the required strength by means of two 1.5-kw. transmitting valves.

To operate successfully relays by means of this system three cables are necessary: one for the fundamental wave, one

"A Second Group is Shortly to Follow"

for the modulation, and one for communication between the main and relay stations.

To save one cable the fundamental frequency can be conveyed on the cable also used for the telephone

communication. This is simply done by cutting off all frequencies above 1,000 cycles for speech and thus letting the fundamental frequency, which is somewhere round about two thousand cycles, pass.

It was found that speech was quite understandable, even though all frequencies above 1,000 cycles were cut-off.

The Next Move

Three stations—Berlin, Magdeburg, and Stettin—have been operated by this means for over a year now. A second group is shortly to follow. Langenberg's relays, Munster, Cologne and Aachen will shortly operate on the same wave-length.

I am not informed if this second group will operate according to the system just described, or if a modified system of independent transmitters will be employed controlled by quartz wave-meters, also a system developed by Lorenz.

* * *

When an accumulator is fully charged its positive plates have a healthy chocolate-brown colour, while the negative plates are blue-grey.

* * *

When working on an ebonite panel be careful to keep the bench clean and clear, otherwise screws and wires may scratch the new panel and spoil its appearance.

BUILDING UP THE FREQUENCY

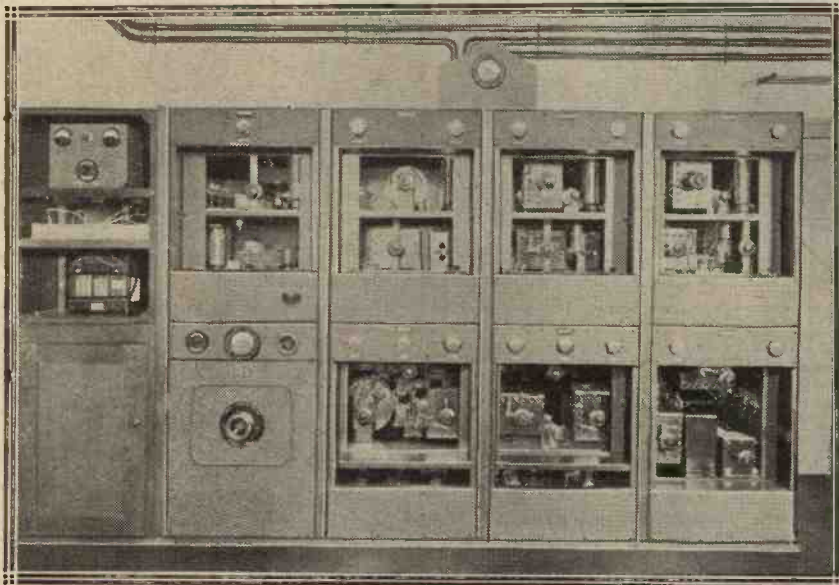

This is a frequency multiplier and amplifier panel such as is used to prepare the energy relayed by landline to a relay station for radiation at a power of 25 kw.

WE all know how difficult it is to prevent accumulator acid from getting to surfaces where damage may be done. Many of us have experienced discomfiture when faced by a member of the family justly annoyed because of an unsightly blemish on some polished surface.

BENDING THE CORNERS



FIG. 1. FIG. 2. A1654
Showing how the lead is doubled in at the corners of the tray.

Any accessory which will prevent such trouble is welcome. The tray described here is simple and cheap.

The materials required are: A sheet of lead, some hard wood $\frac{1}{2}$ in. thick, 4 rubber pads, 2 strips of glass $\frac{1}{2}$ in. wide. Sizes will vary with individual requirements; but these can be simply determined if the description is followed.

First construct the wooden tray as shown at Fig. 4. Inside dimensions should be $\frac{1}{2}$ in. greater each way

MAKING AN ACCUMULATOR TRAY

than the outside dimensions of the accumulator to be accommodated. The depth may suitably be 2 in.

Easily Constructed

Use wood screws, sink them well into the wood and fill up the holes with melted wax, so as to prevent the access of any acid. If possible paint the inside of the tray with hot wax.

Take the piece of lead and mark off as shown at Fig. 3. The margin is calculated as follows: Inside depth of tray, plus $\frac{1}{2}$ in. for overlap of edge,

MARKING THE LEAD

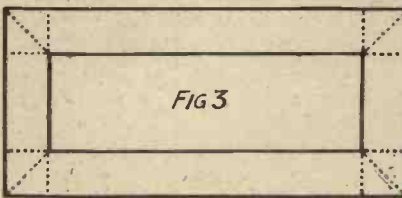

FIG. 3
The margins for the sides must be carefully calculated if a neat job is to result.

plus $\frac{1}{2}$ in. for overlap for the side.

The working of the corners is shown at Figs. 1 and 2.

Place the lead in the tray and work the projecting lead-sheet over the edge and sides. Use a piece of hard wood about 2 in. square to beat the metal out.

If the folds at the corners are carefully worked with a rounded piece

READY FOR USE



FIG. 4
The tray will prevent accumulator acid getting on to floors or carpets.

of wood sufficient expansion will develop to allow for the corners. A block of wood is placed in the corner of the tray and the whole job placed in the vice, so that the base lead will not rise.

Screw the rubber feet to the bottom of the tray. Place the two strips of glass $\frac{1}{2}$ in. wide in the bottom of the tray for the accumulator to rest on. If the wood is stained the finished tray will look quite neat. H. P. W.

**PEOPLE WHO WANT PURE POWER
TURN TO THE**

LISSEN



There is long life in the big cells of the Lissen Battery—there is pure current and power perfectly preserved. Crisp speech, clear song, and music sharply defined is inevitably your reward when you put the Lissen Battery into your set.

Steadily, silently, sustainedly, the pure D.C. current of this battery flows. There is never a sign of ripple in it, never a trace of hum.

Right through the longest programme—through month after month of use, the fine quality and abundant power of this current is maintained. It is economical current and safe current—safe for the children and all at home.

You need pure power for pure reproduction—the secret process of the Lissen Battery gives it to you, and in no other battery do you get it.

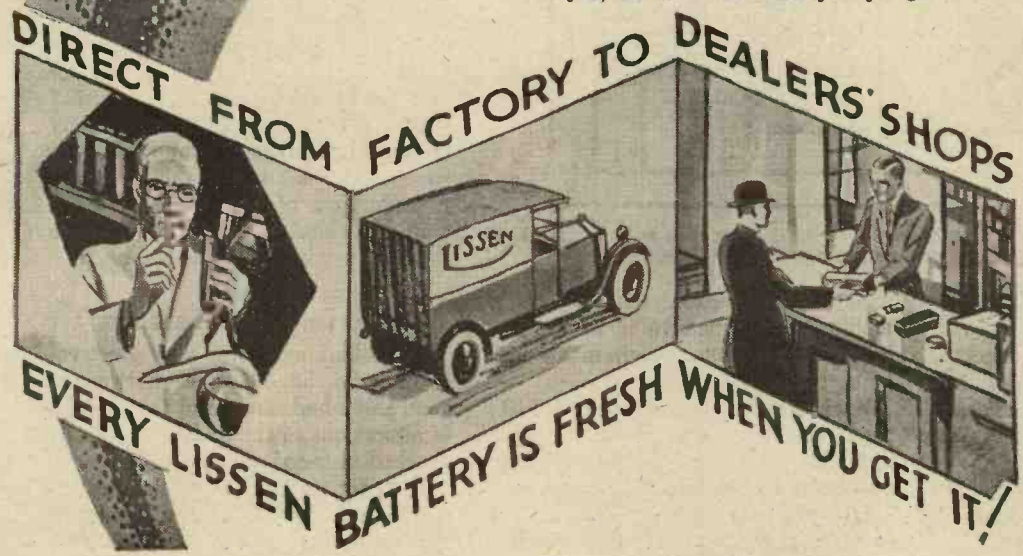

Next time ask firmly for a Lissen New Process Battery and take no other. It is obtainable in all popular sizes at 10,000 radio dealers.

PRICES

60 volts (reads 66)	7/11
100 volts (reads 108)	12/11
120 volts	15/11
36 volts	4/6
60 volts (Super Power)	13/6
100 volts (Super Power)	22/-
9-volt Grid Bias	1/6
16-volt Grid Bias	2/9
4½-volt Pocket Battery 5d. each (4/6 per doz.)	
Single Cell Torch Battery	4½d.

**MADE IN
ENGLAND**

TEST YOUR COILS

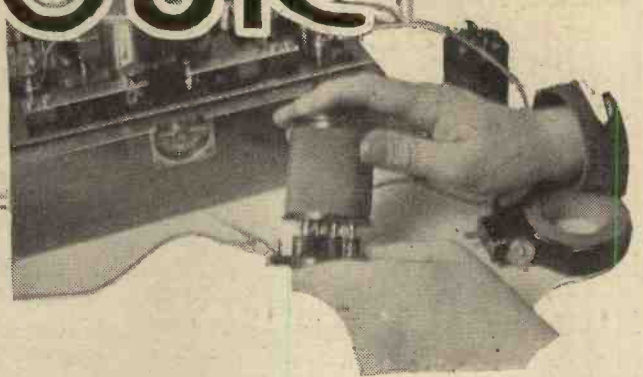

It is not difficult to obtain useful comparisons of the efficiency (or otherwise) of your H.F. tuning circuits, aerial, coils, etc. How this is done is explained below.

By B. L. HUNTLEY.

THE measurement of high-frequency currents in general and of signal strength in particular is quite rightly regarded by most amateur experimenters as being a matter of extreme difficulty.

Accurate measurement of radio-frequency currents demands the use of very elaborate instruments, and no little skill in the interpretation of their readings.

All You Want

For this reason the amateur has paid little attention to investigating the performance of the H.F. side of his receiver, being in most cases content to make his H.F. circuits a close copy of a published design.

It is not generally known that there is available to almost any amateur a ready means of checking these statements. Accurate measurement of H.F. amplification and coil efficiency is out of the question for most constructors, but it is a moderately simple business to make comparative measurements.

The only piece of apparatus which is required is a fairly sensitive milliammeter. This should preferably have a maximum scale reading of about 5 milliamps.

For the purpose of checking signal strength (and thereby assessing the comparative efficiency of the aerial coil and/or H.F. stages) the anode-bend method of rectification must be

grid leak from L.T. positive and joining it instead to a negative tapping on the grid battery. For the valve mentioned, $10\frac{1}{2}$ volts negative grid bias should be used, and about 125 volts H.T.

A Direct Indication

The milliammeter, if connected in the anode-circuit of the detector, will under these circumstances give a very low reading indeed *when no signal is being received*. With the L.210 valve it will be about .25 milliamp.

When, however, a signal is tuned in there will be a very appreciable increase in the milliammeter reading. And this is a direct indication of the magnitude of the signal voltages applied to the grid of the valve.

For instance, in the case of an ordinary det. and L.F. set the milliammeter reading with no signal being received may be .25 milliamp, which on tuning in the "local" rises, let us say, to 2.5 milliamps with a certain coil in the aerial circuit.

On substituting this coil by another and again tuning to the "local" station a reading of 3 milliamps may be obtained, which would indicate the better qualities of the new coil. A reduction of the milliammeter's reading would, of course, indicate that the original coil was the better.

MEASURING SIGNAL STRENGTH

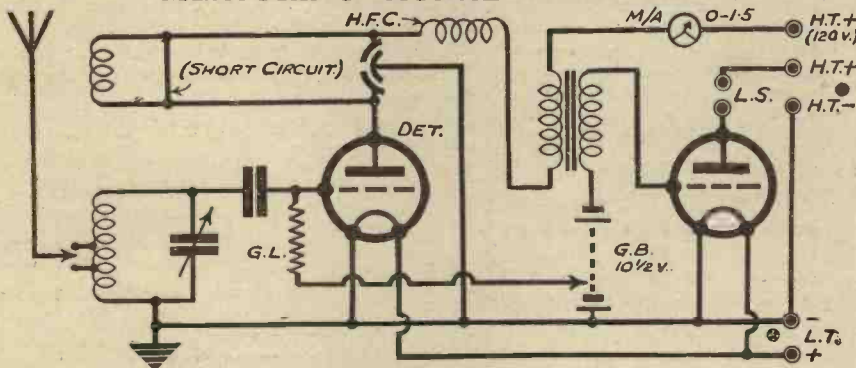

By using an anode-bend detector and no reaction, a very definite idea of the efficiency of your tuning coil can be obtained with the aid of a milliammeter.

In so doing, however, he often goes astray in the matter of his choice of coils. If in the interests of economy, or for other reasons, coils of low efficiency are used, the performances of the H.F. circuits in which they are used fall off very alarmingly.

Even in sets which do not include H.F. amplification, the "goodness" of the aerial coil can exercise an enormous effect on the results given by the receiver.

used. It is better, too, to use a medium-impedance valve as the detector while the measurements are being taken.

Such a valve would be the L.210; there is usually one of similar type available which can be pressed into service as a detector.

In sets where the leaky-grid method of rectification is used, it is usually possible to convert this temporarily to anode-bend by disconnecting the

Aerials and Earths

The milliammeter will very effectively indicate the difference between a good and a bad earth, and the efficacy of alterations to the aerial can also be checked in the same way.

In order to make sure that no unintentional variations are made in the constants of the H.F. circuits. It is better to short circuit the reaction coil altogether.

Using Your Detectors

The detector valve is the heart of the set, and as such it is imperative that it be efficiently employed. Here is some useful information on the subject.

By B. R. HILL.

It has long been supposed that if you want to get pure reproduction from a valve set it is essential that anode-bend rectification be employed, and with this

distant stations, it is preferable to have leaky-grid rectification, unless precautions are taken to ensure that the anode-bend detector will not distort, and that such adjustments to the valve potentials are made that smooth efficient reaction is obtained; not an easy task!

Anode bend, as you probably know, is not exactly noted as a provider of efficient reaction, and if you wish to get long-distance results it is essential that good reaction be obtained.

But it is not of the reaction side of the business that I want to talk in

rectification, but as long as the distortion due to imperfect rectification is not audible we need not worry.

Careful Adjustment Required

But if the anode-bend detector is not adjusted properly, extra distortion will occur, and this will be audible, and it is the purpose of this article to show how this extra distortion occurs, and at the same time to throw some light on a statement which has often been made and which is only a "half-truth."

This is due mainly to looseness of expression when discussing the anode-bend adjustment point. You have probably heard it said that if you are to receive a strong signal on an anode-bend detector it is necessary to bias farther to the left (that is, more negative) than is normally the case, in order to "bring the signal on to the bend." Sometimes it is put another

OBTAINING RECTIFICATION

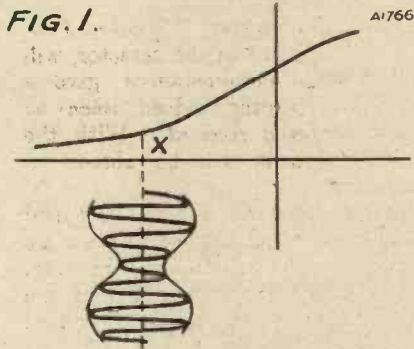

The average valve curve has a very indefinite "bend." Above we show a weak carrier strongly modulated "swing across" the bend point X.

idea in mind it is probable that quite a number of my readers have wondered why MODERN WIRELESS sets do not incorporate anode-bend rectification more than they do.

They will have noticed that the majority use leaky-grid rectification, though occasionally special provision is made so that either leaky grid or anode bend can be employed.

Anode-Bend Distortion

The whole point with regard to this anode-bend v. leaky-grid rectification business is that although theoretically it is possible to get truer rectification using the anode bend, yet in average use it is just as likely that anode-bend rectification will give distortion as will the leaky-grid method.

In any case, for receivers which have to serve the dual purpose of reproducing the local and also getting

this article, but of the anode-bend adjustments necessary for giving really good results.

In the curve of a suitable anode-bend detector valve you will find a point (at several volts negative) on the grid volts-anode current curve where the curve begins to flatten out after coming down the straight portion. In the "ideal" anode-bend valve this turning point would be absolutely sharp. In actual practice one does not get it sharp even in the static curve, while when the valve is working the "sharpness" is reduced even more, and we get a gradual curve.

As a matter of fact, it is doubtful whether we get anything like efficient

TWO-VOLT DETECTORS	
* Cossor	210H.F. *
* Dario	HF "Bivolt" *
* Lissen	210H.F. *
* Marconi	H.L. 210 *
* Mazda	H.L. 210 *
* Mullard	P.M. 1H.F., P.M. 2D.X. *
* Osram	H.L. 210 *
* Six-Sixty	210H.F., 225D. *
* Tungstram	H210 *

VERY BAD DISTORTION

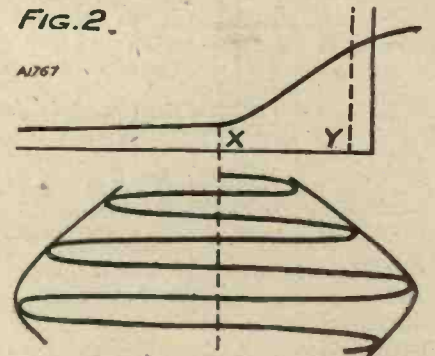

The bend point is just to the right of the dotted line at X. A strong carrier with strong modulation is "going over" into the grid current area to the right of Y.

way, and it is said that "a strong carrier-wave has the effect of moving the bias over to the right" so that you

Careful Bias is Essential for Good Reception

have to add more bias in order to bring the signal on to the bend.

Now these statements are not strictly correct, though they have a basis of fact in them, as you will see if you read this article. In the first case, let us take Fig. 1. Here we see a theoretical curve of an anode-

FOUR-VOLT DETECTORS

Cossor 410H.F. *

Dario H.F. "Forvolt" *

Lissen 410H.F. *

Marconi H.L.410, L.410 *

Mullard P.M.3, P.M.4DX. *

Osram H.L.410, L.410 *

Six-Sixty 4075H.F. *

Tungsram R406 *

bend detector having the usual type of bend. In the other diagrams the bend has been made pronounced for the sake of clearness, though it must be remembered that in actual practice it is not anything like as sharp.

We have a weak carrier, and quite ordinary modulation, this being about, say, 30 per cent of the carrier. We bias the valve so that the bend comes at the correct position according to its curve, and then we find that our carrier-wave swings over on either

DEALING WITH STRONG SIGNALS

FIG. 3.

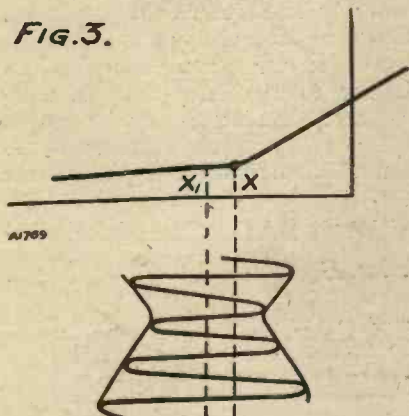

The anode-bend point is at X, but the valve has been slightly overbiased, keeping the strong signal from causing overloading.

side of that point. That is obvious, and we get the one half of the modulation on one side of that bend and the other half on the other, the modulation on the right-hand side of the bend creates variations in the anode current, and the half of the modulation on the lower side of the bend does not have much effect on the plate current and so we get rectification. That's all very nice, isn't it?

Now let us turn to Fig. 2. Here we have the same valve tuned to a very strong signal. What happens? We get a very strong carrier and we get the same percentage of modulation, about 30 per cent, but it reaches to a point where it overloads the valve badly. So we get the signal swinging over on to the positive side of the curve, causing grid current. Obviously, then, distortion is bound to occur, and we have to look out for a way of using the valve so that we can still tune in to this station, but not get the carrier-wave and modulation swinging over to the grid-current line.

What Can Be Done?

What can we do? Let us take a glance at Fig. 3. Here we see that the grid-bias point has been moved from X to X1, so that the carrier-wave now swings about X1, but the whole of the modulation on one side is above the point X. This is important, for X is still the bend point.

Now, the impulses do not swing into the grid-current area, and, moreover, the "upper half" does not swing below X, so that the whole of this half of the modulation is to the right of the anode-bend point. We are now getting proper rectification of the strong carrier with strong modulation on it.

If the modulation were very much stronger we should find that it might swing into the grid-current area, or swing below X, in which case distortion would occur. In this event we could not take the bias point farther to the left, and we should have to take other means of obtaining proper rectification, as you will see.

Every Valve Has a Limit

Now let us have a look at Fig. 4. We see the effect of a strong carrier with fairly strong modulation upon a valve which has been "over-biased" in order to keep the modulation from straying into the grid-current portion of the curve, which it would do owing to the strength of the carrier, if the valve operated across the line marked X, the proper anode-bend point.

But we see that in this case, by further biasing, in order to deal with the stronger signal, we are really causing distortion.

This distortion is taking place because, although one-half (the lower) of the modulation is having little or no effect upon the plate current (as

it should), the other half is swinging over the anode-bend point and is being rectified. Therefore, you get hopeless distortion.

Now comes the natural question: "What can we do if we find that we have a very strong signal to be dealt with by quite a small detector valve

TOO MUCH BIAS

A1752

FIG. 4.

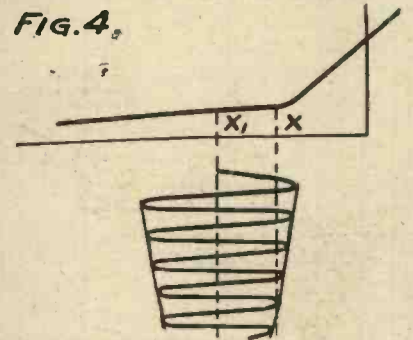

What happens if you over-bias an anode-bend rectifier. Partial rectification of the "upper" or positive impulses is occurring.

working on the anode-bend principle?" The answer is, of course, nothing!

If we over-bias the valve we may stop the signal running into the grid-current area; but if the modulation is at all strong, we shall almost certainly make it run to the left of the anode-bend point, causing rectification of part of the modulation which should not be rectified.

SIX-VOLT DETECTORS

Cossor 610H.F. *

Marconi {H.L.610, L.610, *
D.E.5B., L.S.5B. *

Mazda H.L.607 *

Mullard {P.M.5X., P.M.5D., *
P.M.6D. *

Osram {H.L.610, L.610, *
D.E.5B., L.S.5B. *

Six-Sixty 6075H.F. *

Tungsram G.607 *

The only way in such a case is either to increase the anode potential of the valve, thereby making the straight portion of the valve longer, or else to use a larger valve with a longer straight portion to its curve. Only if the modulation is very weak and the carrier very strong can you successfully "move the bias point" well over to the left.

Look at these Wonderful Characteristics!

The New

MARCONI

Filament Volts	2.0
Filament Current	0.2 amp.
Anode Volts	150 max.
Amplification Factor*	6.5
Impedance*	2,300 ohms.
Normal Slope*	2.8 m.a. volt.

*At Anode Volts 100 Grid Volt 0.

Price
15/-



FIRST AND FOREMOST
IN RADIO

No other Valve can shew such figures! Verb sap!

THE MARCONIPHONE COMPANY, LIMITED, 210, Tottenham Court Road, London, W.C. 1.

Speaking

Being suggestions for improving the B.B.C. programmes, from Sir Arthur Yapp, K.B.E., Mr. Tom Burke, Mr. Andrew Soutar, Mr. Eric M. Gamage, and Miss Gracie Fields.



This is Mr. Tom Burke, the famous tenor, who on this page not only "speaks personally," but explosively, about the B.B.C.!

To me one of the most irritating items of the present programmes is the rapturous applause of the other members of an entertainment party when one of their number has just concluded an item.

I shall not be misunderstood, I hope, if I say that the general impression left on one after listening for some time to an ordinary programme from 2 L O or 5 G B is that it needs expert direction.

Certainly much might be done in the way of eliminating mediocre music, singing and entertaining. If someone could be found who would do for the B.B.C. what Lena Ashwell did for the Y.M.C.A. concerts for the troops in France during the war, it would be an immense help.

"Scrap the B.B.C.!"

By **TOM BURKE.** (The famous British Tenor and Opera Star.)

With the B.B.C. as constituted at present, any suggestion for the improvement of programmes is futile in the extreme. The output of any machine is limited by the capabilities of the machine itself, and no improvement in output can be expected except by some drastic reconstruction of the mechanism of production.

"More Genuine Humour"

By Sir **ARTHUR K. YAPP, K.B.E.** (War-time Food Controller, and until recently Chief of the Y.M.C.A. An Authority on Youth.)

SPEAKING personally, I think the programme carried through by the B.B.C. is excellent, especially when all the difficulties of the situation are taken into consideration.

At the same time there are some changes which I am convinced might be made with advantage to all concerned. The News Bulletins might be made more comprehensive, and the programme might easily be made more attractive. It should not be too highbrow, neither should there be any attempt to play down to the great unseen audience.

My ideal programme would be educational, but easily understood, and it would be well-balanced. Some position would be found for practical matters like "physical jerks." In Canada I have been very much impressed by the fact that many people living in out-of-the-way districts take physical exercises first thing every morning under the direction of wireless.

I do wish it might be possible to introduce more genuine humour; a good deal that passes under that category is very feeble. Even the Children's Hour could be improved; the Uncle and Auntie business is sometimes overdone!



A recent portrait of Sir Arthur Yapp, K.B.E.

Personally

Published views of celebrities often seem to lack the vigour and vim that they would have if spoken personally. But below is a symposium of the "straight-from-the-shoulder" class.

So it is at Savoy Hill. With whatever ideas those in control may have started out, it is quite certain now that they have arrived at the stage when they firmly believe themselves to be charged with a divine mission to thrust their own convictions upon us, and nothing that you or I can say is in the least likely to dissuade them.

What then is the use of making suggestions? Lest we should have any doubts upon the subject, Sir John Reith himself has kindly made the position quite clear.

Speaking recently at a conference of the Institute of Public Administration, he intimated, in effect, that any idea that a public undertaking should set out to give the public what it desires is a fallacy that has been exploded.

It is true that this has been widely denounced as a most bureaucratic statement, but I don't suppose that even that is likely to alter Sir John's opinion.

That is the attitude of the B.B.C. to its public. Its attitude to its artistes is, if possible, even more definite. To them it says, again in effect, "You are lucky if we consider engaging you. Quite a number of millions of people will hear you; your name will be in the papers, and, really, you ought to be only too glad to accept the microscopic fee we are offering. In any case, if you don't,

Andrew Soutar, the novelist, is particularly interested in the possibilities of television.

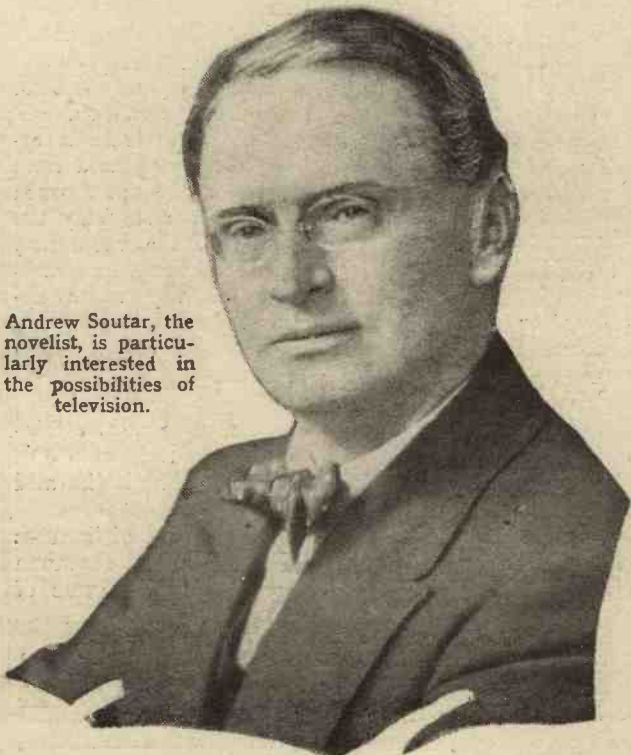

A world-favourite—Miss Gracie Fields

we have a monopoly in this country, and you can't go anywhere else."

Very nice, of course, but you can't have a first-class programme without first-class artistes, and many of the best in the land who, after having spent a great deal on their training, have fought their way step by step up the ladder are not prepared to accept these terms.

Why should they? Theatres and gramophone companies recognise their worth, and it is a fact that hard-won material that may last an artiste several weeks in the ordinary way is entirely staled by one evening's broadcast.

One belief, however, the B.B.C. shares with certain other interests. It is convinced that no good ever came out of England. Let an artiste but possess an unpronounceable name, and come from some foreign capital, and the B.B.C., which grudges seven or eight guineas to the home product, will unhesitatingly agree to any demand.

No, I have no suggestions for the improvement of B.B.C. programmes, but several for the improvement of the B.B.C. itself!

"Meanwhile, Sir John —"

By ANDREW SOUTAR. (The Well-known Novelist and Short-Story Writer.)

I should like to "speak personally" about the changes I expect to see if I live another five years.

Sir John Reith, head of the Savoy Hill ménage, will have had his duties increased tenfold. He will be responsible for television, and I shall press a button in my study

Those Lofty and Educational Programmes

and talk to and see those whom I love, though they should be six thousand miles away.

Meanwhile, Sir John, please cut out from your programme those dreary people who talk about nothing that matters of an evening when I want to listen to good music or singing—the people who give lectures on How to Grow Carrots, and so forth. Broadcasting is only in its infancy, but we must make that infancy interesting.

I would "cut" all talks to five minutes. Remember that the story of the creation of the world, in the first chapter of Genesis, is contained in a few hundred words; why, then, should we put up with five thousand words from some throaty old gentleman who wishes to tell us how the bee stings, and with what?

But it is television, Sir John, that fascinates me more than anything else. If you think it is fantastic, let me tell you of a contract that I had from America this week in which a film company purchased a story and stipulated for the acquiring of the film, talkie and television rights.

"Separate the High-brows"

By **ERIC M. GAMAGE**.
(Managing Director of the Famous Firm, A. W. Gamage, Ltd.)

It is a big subject to deal with in a few words, but speaking generally, and personally, I find most of the B.B.C. programmes are dreadful.

Some of the topical broadcasts are exceedingly well done and well worth listening to. There was also a time when one could get a certain measure of enjoyment from the dance music. This, however, is now seriously injured by the new Regional system.

If it is really necessary to have separate programmes, however, I would certainly like to make a suggestion. Let us have all the highbrow stuff listed in just one of them. We should then be able to listen to the other, which would consist almost entirely of items of a bright and cheerful nature.

It might be as well also to have the wave-lengths of the respective programmes so distinct that the possessor of an average small wireless set would have no difficulty in picking up which ever he preferred.

"Why Not a Real Showman?"

By **GRACIE FIELDS**.
(One of Britain's Favourite Comediennes.)

Obviously it would be hardly fair for me to attempt any real criticism of B.B.C. programmes, when my opportunities for listening-in are so few. Normally the only chance I get is on Sunday evening, and Sunday evening transmissions, I believe, are not popularly considered the best of them. But personal opinion is another matter altogether, and even my limited listening has entitled me to that.

Principally, then, I feel that the B.B.C. is not really in touch with its public. I am afraid that its general attitude and inclination is far too lofty and educational, and that although from time to time somewhat spasmodic attempts are made to placate the lowbrows, listeners are often left afterwards with the impression that those in charge of programmes have afterwards turned with a sigh of relief to something which they consider more worth while.

The B.B.C. receives, I know, a very great number of letters, and these, I believe, are conscientiously read, considered, and sometimes acted upon.

Even in that, however, there is a danger, for every professional producer knows full well that correspondence is rarely a safe test of general public opinion.

Many a well-known artiste has disappeared from the top of the bill through following too slavishly the behests of the vocal few, and disregarding the always great majority which ap-

proves, or disapproves, in silence.

Correspondence is helpful, of course, but only a person of wide experience can hope to assess the real value to be placed upon it.

The B.B.C. officials are probably men of great attainments, but few, if any, of them have had experience of the chastening effects of a box office. That is the acid test of entertainment value!

I should imagine only about one per cent of listeners is highbrow, and I would like to see a real showman given a real free hand to provide a full measure of entertainment for the long-suffering ninety and nine.

A LONDON SUPER SET



The set shown here is installed in Baker Street, London, and supplies two hundred families with loud-speaker programmes.



TESTS OF TIME

Built in
1843..

... by Mr. E. H. Bailey—Nelson's Column has stood the test of time for 87 years! The Telegraph Condenser Co. built the now famous "Condenser in the green case" over a quarter of a century ago. This famous condenser and Nelson's Column have one thing in common—they stand the test of time. Each T.C.C. condenser is individually tested before it leaves the factory. You can be sure—when you ask for a condenser of a certain capacity, if it's T.C.C. you get it!—they are accurate to a point almost of infallibility. Don't put up with inefficient condensers in your Set, there's no excuse now because the T.C.C. condenser costs no more. And remember, they are guaranteed.



The condenser illustrated is 800 volt D.C. test. 400 D.C. working 8/6

NELSON'S COLUMN

ADVERT. OF THE TELEGRAPH CONDENSER Co. Ltd. N. ACTON, W. 3

4688

MULLARD SPECIFY VARLEY

in the new "RADIO for THE MILLION"



Specified in most popular circuits, Varley are again in "Radio for the Million!" These are the Varley components required for the Orgola High Power H.T. supply unit:

STANDARD L.F. CHOKE
Price

£1:0:0

DUAL L.F. CHOKE
Price

£1:1:0

POWER POTENTIOMETERS.

50,000 ohms	10,000 ohms
Price	Price
10/6	10/-

Make sure you get these Mullard-recommended components for your Orgola H.T. supply unit.

Send for the sections of the Varley Catalogue in which you are interested.

SECTION A. 2- and 3-valve All-Electric Receivers, Radio-Gramophones, Gramophone Pick-up and Auto-arm.

SECTION B. & C. H.F. Choke, Regional Coils, Bi-duplex Resistances, Rheostats, Potentiometer, R.C. Couplers and Anti-Mobos.

SECTION D. Nicore Transformers, Output, Push-pull Input and Output Transformers, Push-pull, L.F. and Constant Inductance Chokes.

SECTION E. Power Transformers, Standard, Dual and L.T., L.F. Chokes, Constant Inductance Chokes and Power Potentiometers



Advertisement of Oliver Pell Control Ltd., Kingsway House, 103, Kingsway, London, W.C.2. Telephone: Holborn 5303.

VALVE VARIETIES



THE ordinary amateur who has but little real knowledge of the theory of radio may quite well wonder if the technique of radio reception is not, after all, a rather hit-or-miss, trial-and-error sort of business.

So-and-so tells him he gets far better results when he does this and that, while someone else mentions casually that he does the reverse and gets better results.

Acquiring a "Team"

The amateur himself tries both, and then, apparently, achieves superior results with quite a different scheme altogether.

Take the concrete case of valves. A small gathering of amateurs may find that it contains as many different ideas regarding good detector-valve types and makes as it does members.

All this must be most upsetting to the amateur whose financial resources are distinctly limited. He cannot afford to purchase a couple of dozen of valves of different kinds and try various combinations of them in his three- or four-valve set.

Therefore, a quite usual procedure is that he gets a "team" after much thought which satisfies him to some extent, but leaves him with the feeling that he could get much more out of his set if only he were able to experiment with valves.

Causes and Effects

Of course, a similar condition is often met in other things besides radio, but in radio it is much intensified by the fact that here, as in nothing else, causes and effects are often apparently miles apart, and it takes an expert completely to associate them.

But I want to assure my reader that, even if some aspects of electrical science are apt to form bones of contention between the most eminent of scientists, the radio receiver is a comparatively simple piece of engineering.

Once a designer has completed his work on a new set, and has carried out

Is radio reception a hit-or-miss affair? Are good results with a given set a matter of trial and error? Must set constructors experiment before they can expect their new receivers to operate properly? Some assuring answers to these questions are given
By A MEMBER OF THE "M.W." RESEARCH DEPT.

all his tests, he is able to predict fairly closely what a million replicas of the design will do in given conditions.

When he says that such-and-such a valve with such-and-such H.T. and G.B. will give the best results in a certain stage, you can be sure that it is so.

But you will note that I have said "in given conditions."

ADJUST THAT BIAS

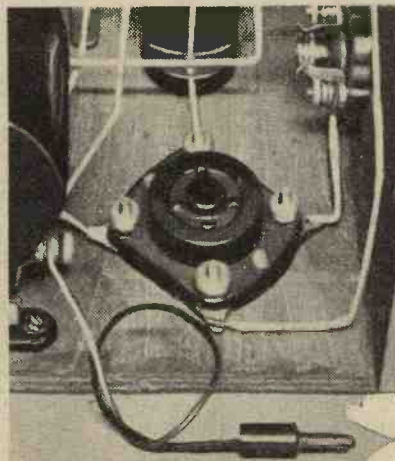

The grid-bias adjustment has a most important bearing on a valve's operating characteristics. Indeed, the whole working of a set can be upset merely by an incorrect grid-biasing.

No radio scientist can foretell what stations a certain receiver will receive when it is hooked on to an aerial and earth system of unknown characteristics, situated in a locality that he has not explored with field-strength testing equipment.

Nevertheless, these things do not affect the "make-up" of the set

itself. A motor-car designer can turn out a machine to do a speed of such-and-such on the track.

It is not his fault if the track is up-hill and covered with bumps.

And so with the radio receiver. A certain "margin of safety" is advisable. Amateurs should aim at an outfit that will give them all they want with a bit to spare against the wear and tear of usage. The batteries can't all be right up to scratch all the time.

I think the reason why amateurs get such varying results is because they work so far away from the correct conditions of working.

Checking Voltages

To return to valves as a good example of what I mean, I wonder how many give their valves exactly the H.T.'s and G.B.'s specified, checking these by means of accurate meters?

Even if one does this one is no nearer the ideal unless one is certain that all the circuit constants are exactly as they should be. Anode impedances, grid capacities and leaks, and so on, all play their important parts in the functioning of a valve.

If all these are not correct for the valve specified in a certain stage, it is not improbable that a totally different valve will appear to give better results. But this doesn't prove that this is a better valve for the job than the "official" type. This last would no doubt give infinitely superior results if operated properly.

Minor Discrepancies

However, despite everything I have said, I must admit that there always does remain a small percentage of chance in the best of arranged outfits.

Personally, I would always like to see this covered by the "margin of safety," for this "margin" should be ample to cope with anything like that. But no doubt there are many who get the most fun out of radio by stretching it to the limit. And if you do that, minor discrepancies in valves, etc., assume some real importance.

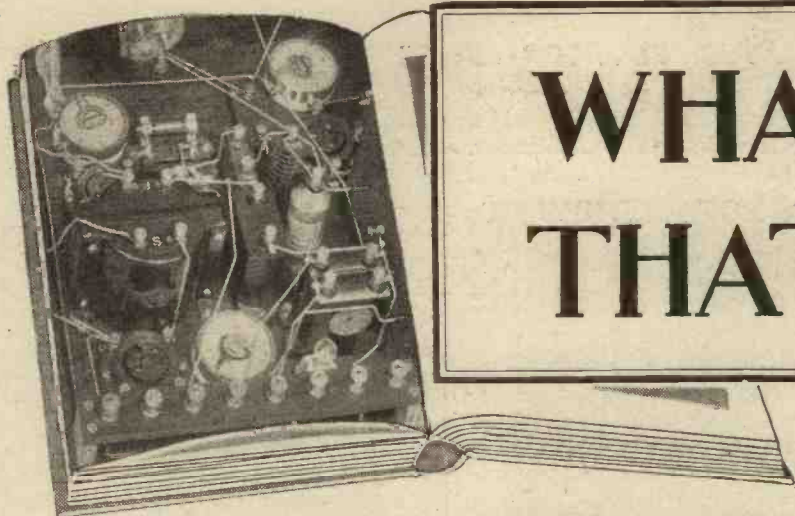

WHAT IS THAT L.F.?

THE letters A.C. are usually regarded in electrical engineering circles as the initials of alternating current. An alternating current is understood to be current that flows first in one direction and then in the other.

But readers who were perfectly well aware of all that must at one time or another get a little confused over the anode current characteristics of an L.F. valve.

One Direction Only

So often is an "A.C. component" of the anode current referred to that it might be thought that there is a true alternating current flowing backwards and forwards in the plate circuits of L.F. valves.

This is not so. There is only one direction of flow for the anode current, and that is, according to the electron theory, from the negative terminal of the H.T. battery through the valve and loud speaker—or anode resistance or transformer primary—back to the positive terminal of the H.T. battery.

If one has any doubts about this the first question to ask oneself is: "Where does the current in a valve's anode circuit come from?"

Obviously it comes from the H.T. battery, and a battery can supply only D.C., that is, direct current, current that flows only in the one direction.

A Fluctuating Resistance

The value of this current depends upon the resistance of the circuit through which it flows and the voltage of the battery that supplies it.

This voltage is a fixed quantity, but the resistance is not. Remember the valve is in the circuit, and the effective resistance of the valve fluctuates in accordance with the voltage variations on its grid.

You may have seen that phrase "the A.C. component" in reference to the anode circuit of a valve. But is there such a thing? This article deals with that question and, perhaps, what is even more important, it explains in simple language what such a term really implies.

By H. A. R. BAXTER.

When the grid is very negative in respect to the filament there is a comparatively small flow of anode current, and when the grid potential becomes less negative or, perhaps, positive, the anode current increases.

Thus you can plainly see that the anode current is not a current that changes its direction of flow, but one that is of a unidirectional nature fluctuating in strength. It rises and falls in accordance with the speech and music frequencies.

An Average Current

There is an average figure of current above and below which there are equal rises and falls, and it is this average current that a milliammeter indicates.

And the current is shown in curve form fluctuating from this average, and, on paper, it looks rather like A.C.

But whereas the line through the sine curves of A.C. represents zero current—that is, points where there

BROADCASTING BEHIND GLASS

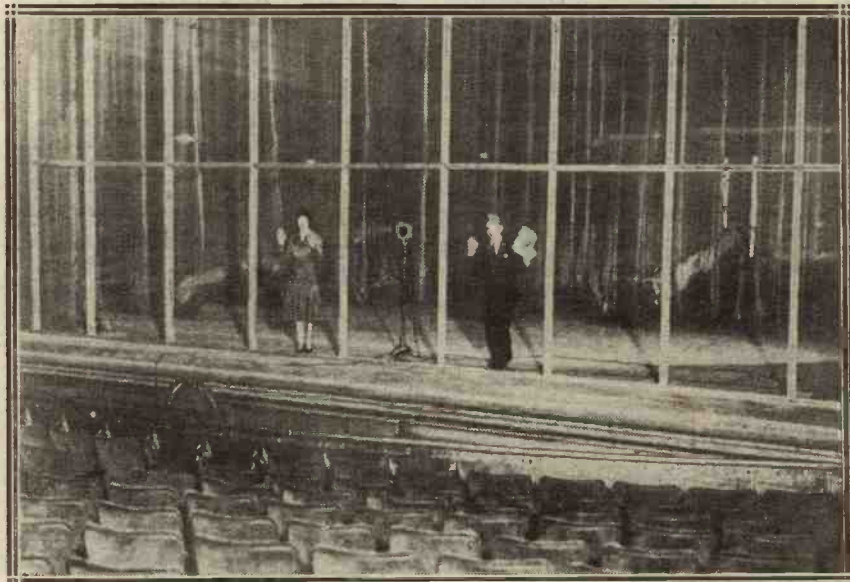

A system that is becoming popular in American broadcasting. The studio is divided into two sections by a sound-proof glass screen through which a large audience can watch the artistes at work.

Between these two limits the energy passed on to the valve for amplification varies the valve's resistance at a low or audio frequency in the case of an L.F. valve.

is no current flow at all—the line through the anode current characteristic indicates an average current.

Above and below the line in A.C. the current first rises to a maximum

How an L.F. Transformer Does its Work

and falls to zero in one direction, and repeats this in the other direction.

But here is a very important point. Fluctuating D.C. can pass energy through a transformer as well as A.C., and if you stop to think you can see why this is so.

How Transformers Work

Transference of energy from the primary winding to the secondary winding of an L.F. transformer is accomplished in this way. On the passage of current through the primary winding lines of force are radiated, and these cut the secondary winding and induce current in it. When the current is stopped the lines of force collapse, and further current is induced in the secondary winding.

If the lines of force are varied in intensity, and this can be done by varying the strength of current flowing through the primary winding, the intensity of the energy developed in the secondary winding varies.

And this is what happens in the case of an L.F. transformer. The anode current passing through the primary is fluctuating, and so throws

out a magnetic field of lines of force that are varying in their intensity.

Thus is a current of a fluctuating

A NOTABLE EVENT



When the Maharajah of Patiala broadcast from London some time ago it was his first appearance before the microphone.

character produced in the secondary winding of the transformer. But this current is of an A.C. character, for, as the magnetic field rises, the current in the secondary is driven in the one direction, and it goes in the other direction when the magnetic field falls.

A.C. is a term that is very much misapplied in connection with the working of a valve set. As we have seen, A.C. (alternating current) impulses are not essential for the input of an L.F. transformer, and it must be added that the same applies to choke-condenser couplings and output circuits and to series fixed condensers.

Why There is Confusion

High-and-low frequency variations of unidirectional current—current that flows only in one direction—can be passed through fixed condensers. Such variations obey A.C. laws—concerning impedance, phase, etc.—to a very great extent, and it is no doubt because of this that so much confusion has been caused.

PERSONALLY, I think that wave-change switching is rather a nuisance. Unfortunately we have a number of long-wave stations in Europe worth listening to.

So we must grin and bear it.

We can, however, reduce our switching schemes to the very simplest form and so avoid unnecessary complications.

Here is an easy aerial switching scheme that I have used very successfully. It enables a good degree of selectivity to be obtained on the short waves and gives good signal strength on the long, while, provided that one stage of H.F. amplification is used, no difficulty will be found on this band in separating Radio Paris from 5 X X.

One Continuous Winding

The arrangement is shown in Fig. 1. The aerial and grid coils consist of one continuous winding, preferably, if reasonable efficiency is to be obtained on the short-wave band, of two windings only.

The portion of the coil marked L_1 is the short-wave grid coil, the usual 50 turns or so on a 3-in. former, or 65 turns on 2-in. former, 24 or 22 D.S.C. being used. The other portion of the coil, L_2 , is the long-wave coil, and since it will be in series with L_1

A SIMPLE WAVE-CHANGE CIRCUIT

By C. P. A.

on the long-waves, 180 to 200 turns only will be required—the actual number will depend on the gauge of wire used and the method of winding adopted.

EASY AERIAL SWITCHING

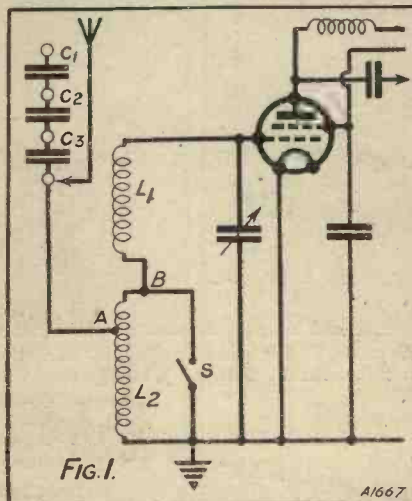

This aerial wave-change circuit also possesses an adequate degree of selectivity.

This winding is tapped at a point A from the upper end, and the number of turns lying between A and the beginning of the winding B will depend on the degree of selectivity you require on the short broadcast band. If little, the tap may be at 20 to 25 turns down; if a great deal, then 8 or 9 turns only should be included. This winding (i.e. L_2) may consist of 36 D.S.C., and will give quite good results on the long wave, and, of course, it takes up very little room.

Only One Switch

The wave-change switching you will see consists merely in shorting out the long-wave winding. When this is done by means of the switch S the aerial is coupled to the short-wave coil by means of the 20-odd turns tapped off the long-wave coil between A and B, while when working on the long waves the aerial is tapped into the grid circuit about a quarter way down from the top to a third the way down, depending on the position of the tapping point A.

If it is desired to have the choice of more than one aerial coupling, then different values of coupling can be obtained by the use of one or more condensers in series in the aerial lead, as shown at C_1 , C_2 , and C_3 .

IGRANIC COMPONENTS

KNOWN FOR QUALITY and PRECISION

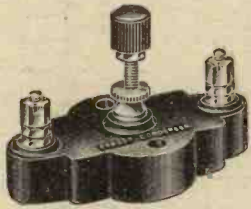

IGRANIC
PRE-SET CONDENSERS
Price from 2/-

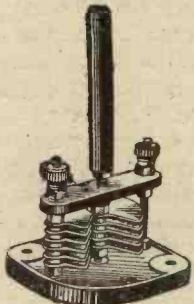

IGRANIC
Baseboard Type MICRO CONDENSER
Price 4/-

IGRANIC RADIO DEVICES

are not manufactured by a mushroom firm down some back alley, but are manufactured by a firm having 30 years' experience in the manufacture of electric devices, with a Works occupying approximately six acres of ground, equipped with the latest and up-to-date plant. Behind every Radio Component stands a reputation that has to be maintained.

Write to Dept. J.1040 for literature showing the whole range of Igranic Components.

Use IGRANIC COMPONENTS and be more than satisfied.



Works BEDFORD

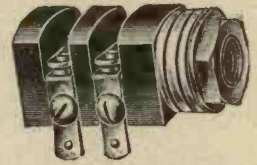

IGRANIC
MIDGET JACKS. Ideal for Portables.
Price from 1/4

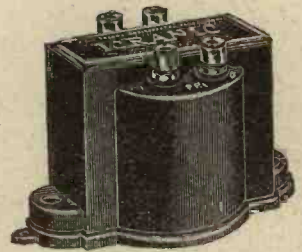

IGRANIC
"J" Type L.F. TRANSFORMERS
Price 17/6

DON'T MISS

Next month's "Modern Wireless" for it will contain

A SPECIAL L.F. TRANSFORMER REVIEW

in which all the leading makes of L.F. transformers will be illustrated. Also there will be an especially long article telling you practically everything there is that is worth knowing about these fascinating components, how they work, how they "grow up," and how they are made.

ORDER YOUR COPY NOW

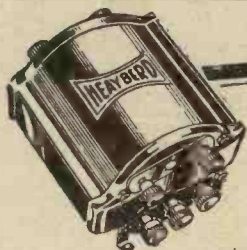

Type W.14
Price 21/-

Specially built
for Mains Units

HEAYBERD
POWER
TRANSFORMERS

The Power Transformer in Mains apparatus controls the current as it flows through the circuit. For this important work you should use the best. Use Heayberd Power Transformers! And get the steady, uniform output so vital to the efficiency of your receiver.

For literature write:
P. C. HEAYBERD & CO.,
10, Finsbury Street, E.C.2.
Telephone: Clerkenwell 7216.

The BENJAMIN Turntable with folding legs is unique

A NEW ball-bearing turntable combining several new features: folding legs, which can be opened out for outdoor use, considerably reducing capacity of set to earth, and folded up for indoor use. Fitted with rubber buffers—preventing damage to the polished receiver or article on which the receiver is placed. The smooth running ball bearings make "direction finding" easy.

Price 7/6 complete.

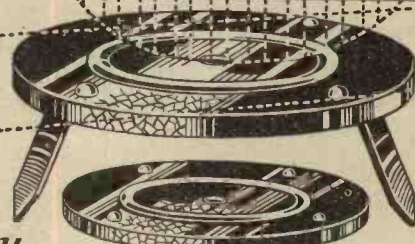

Write for illustrated leaflets on all Benjamin radio products.

Buy

BENJAMIN
and buy the Best!

THE BENJAMIN ELECTRIC LTD.
BRANTWOOD WORKS, TOTTENHAM, N.17

THE 0.1 METRE BAND



A German investigator has been experimenting with radio waves of less than one metre in length. And he has been able to get good results. Some of the curious effects noted during an extensive series of tests are described specially for "M.W." readers.

By Dr. GRADENWITZ.

WAVES as low as 8 metres are conducted by the Heaviside layer, and can be received at places thousands of miles away, but all long-distance reception abruptly ceases below 8 metres, and it is found that the wireless waves no longer come back from space, but spread in a similar way to those of light.

A German experimenter, Werner Ludenio, partly in co-operation with the "Telefunken" Wireless Company, has set himself the task of investigating extremely short waves of less than a metre in length, and experimenting in their transmission to distances of 10 kilometres and more.

Special Apparatus

A transmitter of very high radiating power, and a highly sensitive receiver, had to be provided. As regards, first, the transmitter, the choice lay between valve and spark oscillators, but inasmuch as the amount of energy radiated from the former, in the case of such short waves, is extremely small, Mr. Ludenio expected better results from the use of spark oscillators.

In fact, he ultimately secured oscillations about 10,000 times as energetic, thanks to the use of electrodes of aluminium (or other metal of low atomic weight), and of 0.1 mm. spark gaps.

A simple Hertz mirror was found to give very satisfactory results, so that the whole transmitter could be of very small dimensions and quite portable. In fact, it is thought that by further developing its design the

size of this portable transmitter can be reduced still farther.

The receiver at first used by Ludenio had a crystal detector, the combination galena-silver proving most suitable. However, he eventually devised a valve arrangement which proved sufficiently selective. A high tension of 100 volts or more was applied to the grid, and the telephone receivers placed in the anode circuit in series with a potentiometer arrangement, which enabled the anode to be supplied with an accurately adjusted negative potential.

No Fading

While the way in which this arrangement works is not yet fully understood, it seems to be mainly based upon the high speed reached by the electrons as they are passing through the grid, on account of the

straight line between the transmitter and receiver, are perfect absorbents.

No atmospheric disturbances due to thunderstorms or fading has been noted, but the beams were found to be absorbed in bright sunlight to some extent, particularly above water or snow. Dense fog, rain, and snowstorms are traversed by the beams without any reduction in intensity.

Aids to Navigation

Inasmuch as atmospheric influences have no effect upon these waves, they are admirably suited for navigation purposes, both in mid-air and on the ocean. They would enable a plane or ship safely to steer its course through even the densest fog.

Both marine and aerial navigation will thus be able to fight the worst foe of safety, eliminating the most frequent cause of accidents.

THE COMPLETE OUTFIT USED

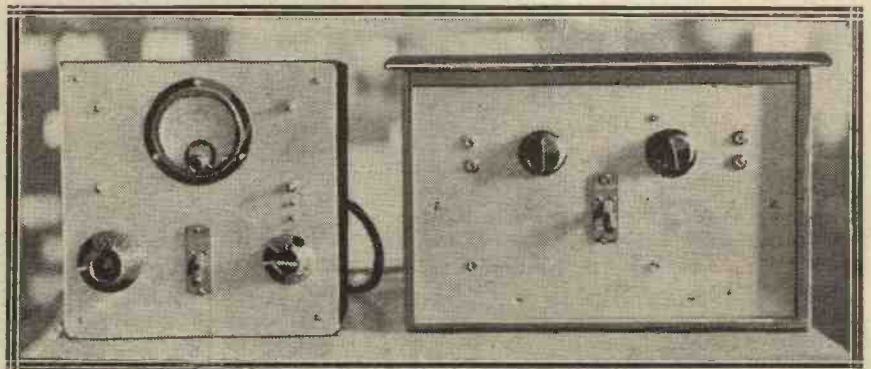

The transmitter and receiver used for the ultra-short wave-length experiments described by Dr. Gradenwitz.

high positive potential of the latter. Reflectors of dimensions depending upon the wave-length were used both at the transmitting and receiving ends.

Radiation through space alone seems to be responsible for the spreading of these very short waves. Trees, houses, and hills, located on a

Whereas waves down to 10 cms. readily pass through fog and rain, there is, in the case of still smaller waves (including the long-wave infra-red or heat rays), a marked absorption by water vapour, so that such waves must be considered far less suited to signalling by wireless telegraphy and telephony.



ONLY the Editor's remark that this is a radio magazine and not a gardeners' and mud-puddlers' gazette restrains me from devoting my space entirely to considerations of leafy June.

Pity the paid scribbler! He is, except in his moments of inspiration, a regular fellow with a guaranteed Real Meat heart and a love for the simple joys of life; a quiet pipe beside a patch of flowers where the bees are busy; a glass or so of nut-brown in some cool old inn where the yeomen bleat and burr in quaint dialect; and so forth. And in such wise.

A Famous Broadcast

Aching in almost every joint and muscle, a sun-burned neck feeling as though it were embraced by a red-hot collar—that is the aftermath of a day spent in flicking hopefully with a hoe in "some land the law calls



"I pictured the sun-burned heroes all clad in solar topees and 'shorts.'"

mine," and now, when I would soothe myself with a little dial-twisting, I must e'en drive the unwilling pen and pass my twitching fingers through my sparse locks, seeking words of power.

Listen! Did you hear my Boat Race broadcast? If not, you missed a scream, or what the Principal of Yale University called a "wow."

It was the biggest thing ever put over on short waves, and made three continents happier and brighter places while it lasted, which was a long time for a broadcast which could normally be done in half an hour, and would have been if J. Posk had not lost his spectacles.

The germ of the idea was a letter from a man in Kenya, who said that 5 SW was a doubtful proposition, and, anyway, he didn't think much of the B.B.C.'s running commentaries, and he wanted 'em done in a snappy, yet human, yet sympathetic, though expert style.

You don't, as a rule, get all that on one slice, but I thought that there was something in what he said, and suddenly I was seized with the notion that an amateur short-wave broadcast of the proceedings of the race wouldn't do any harm to any monopolies, prerogatives or vested interests, and might possibly cheer up some jolly old pioneer at some frightful outpost of Empire, and all that.

Preparing for the Event

I pictured the sun-burned heroes all clad in solar topees and "shorts," sitting on boxes, with the natives a little way off munching bully beef or mealies or eland steaks, while the loud speaker shot out the old-home stuff about the classic struggle between the Bridge and the Brewery.

With a little duck-shoving here and there I managed to get an official benediction upon the proposition, and then looked round for a companion.

I hit upon J. Posk, for good, and ill. He is absolutely the elephant's air-cushion in technical radio matters, but as a navigator—well, he wouldn't even get a job as a potato-peeler in the Swiss Navy.

He is blind without his spectacles,

and idiotic-looking with them. He is so short-sighted that if you were to shove a dust-bin lid in his face he would think you were offering to give him a florin.

We wangled together a beautiful little transmitter, guaranteed to give the 15-20-metre band a headache, and we clamped it all nicely into a framework of battens so that it could be screwed on to a row-boat.

The aerial was a marvel, being specially designed by Slawkins, the "fan" who has a word with the whalers in the Antarctic every morning before breakfast.

Well-formed Plans

We decided that I should be stationed in a rowing-boat with the apparatus, and that J. Posk should tow me by means of a motor-boat, so as to avoid engine noises as much as possible. As Posk is an expert on internal-combustion engines he leapt at the suggestion.

"All we have got to do," I said, "is to get into the tubs at Westminster stairs, toddle along to where the blighters start, and then follow them. We will be there a little before time



"A waterman, lounging over the railing after the manner of his kind."

so as to enable me to describe the scene, and afterwards I can chatter lightly about Boat Race night as we slip back.

"Then we will have a spot of nutriment and buzz off home to collect the congratulatory cables. I expect that we shall have our photographs in the Sunday papers, and that you will be made a Freeman of the Lightermen's Guild, Posky."

Everything Shipshape

"I hope it won't be windy," said Posk, "because my specs are a nuisance sometimes." I had often noticed that the wretched things were prone to slip down to the tip of his nose and thought he was trying to imitate Thackeray, who, judging from the usual pictures of him, wore his giglamps on the end of his bowsprit, so to speak. But had I known then what I know now, I would have lashed them to him.

"Letting Fly Over the Ether"

Well, at Westminster stairs I found all shipshape, aloof and aloft. Posk was already on the job, crouched over his engine like a dog with a bone. Ever and anon, I observed, he had to cling to his spectacles.

A waterman, lounging over the railing after the manner of his kind, affirmed that the tow-rope would part before we reached America. He was good enough to add that we had forgotten the lobster-pots.

All Aboard!

"Hello, Posky!" I shouted, as I ran down the steps. "How's her head? Slight list to starboard, I see—due to your feet! Is she tuned up? Is all my gear on my frigate?" "She's a peach," cooed Posk.

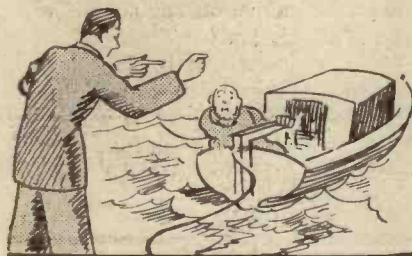

"Specs gone!" he roared.

"She's almost tugging at the painter."

"Don't be so ghastly nautical! Where did you get that bit? Out of 'Robinson Crusoe'? Hi, mind your specs! They nearly went that time!"

I got into my little craft and squatted down to give the transmitter a trial run. She was named "The Banshee." Posk's motor-boat was "Louisa." Just that! What an armada!

Posk Loses his Specs

Posk had a special mixture which, like the liar he is, he alleged to have been revealed to him by Captain Segrave's window-cleaner's cousin. He said that for quick starting Spratt's motor spirit was mere treacle compared with it. He said that it would make a Tank jump clean out of its caterpillars.

I wish that Capt. Segrave cleaned his windows himself, that's all, for "Louisa" took one tremendous bound into the air and then swished off like a startled fawn. "The Banshee" followed, its skipper on the back of his ear on the deck and his legs semaphoring to the universe at large.

It was at this moment that Posk chose to lose his spectacles. The wind

in mid-stream whipped off those absurd things and plumped them into Pa Thames without the slightest fuss. Posk grabbed, missed, and screamed, turning astern a face depicting mingled rage and misery.

"Specs gone!" he roared.

"Unbend the spares," I roared back, "and for the lorsake keep hold of that tiller."

"Never had any," he replied.

"Can you see the river?"

"Pretty well! At least—I think so!"

Then the vials of my sarcasm overflowed and poured forth pure electrolyte of full and proper specific gravity. I grabbed the "mike" and began a burlesque commentary.

A Real "Live" Commentary

"Hello, everybody! Jones, 3 P Q N 4 K T calling. All ready to follow the race? Good! We are dropping rapidly down the river—I should say, up the river, towed by a beetle named Posk, who is in a motor-boat called 'Louisa.' The wind has taken his ridiculous spectacles, so I might as well have chosen a blind man, except that the blind are generally very intelligent. Posk is now bending over the motor, looking like a wombat.

"Our course down this ancient and historic river is not a straight line, but a sine curve with the mumps! We have just dived under the bows of a tug. That, is the tug captain apologising. Naughty, naughty!"

"Boys! I've put to sea with a half-blind, congenital idjit called Posk, who came out to-day in odd shoes, one of 'em tan, t'other black; he is in a tub named 'Louisa' and doesn't know the difference between starboard and starfish! I ask you! He is now steering in circles! I think his father ran a roundabout on Hampstead Heath!"

At this point I deemed it wise to switch on and give my listeners a brief introductory talk. To my horror I found that the set had been "on" since our departure and that I had been letting fly over the ether.

As a matter of fact, so I afterwards heard, halfway through the speech recorded above, amateurs in the U.S.A. were telling amateurs in Europe, Africa, and even New Zealand, to tune into 3 P Q N 4 K T.

Stunned with the thought of my *faux pas*, I gazed outboard in painful reverie. Suddenly my attention was drawn to a ship. Mighty big for Mort-

lake and environs. I gazed around still more. Then, quite forgetting that the "mike" was still all alive-oh, I yelled to Posk:

"Ahoy, there! You flat-nosed son of a petrol-pump! Where d'you reckon you're going? I thought we were going to the Boat Race!"

"Well; so we are, aren't we?"

Hopelessly Adrift

"Immortal goat! I suppose you think that Southend Pier is somebody's fishing-rod, you bat-eyed trilobite! You've been heading for the English Channel. If you can't see, surely you can smell!"

"It's fried-fish night at Westcliff to-night, and the hake is being brought up from the cellars! Turn her round. Round once! I didn't ask you to chase me. Take the tow-rope off your propeller, you—"

But the propeller had gone to join his spectacles! We were adrift at the mercy of the hake! And the "mike" was still alive-oh—forgotten in the agony.

Posk had not the slightest notion of what had occurred and did not know that we were careering round and round like shrimps at play, hurled thither and thence by the current and the wash of other craft, until the note of his motor made him ask me if I noticed anything wrong!

Then I stood up and solemnly told him what he was, where he came from, and where he would eventually go. When I am deeply moved my eloquence reaches heights only touched by Lloyd-George once—at Limehouse. It's the preaching blood in me, the gift of the Revd. Morgan ap Jones



... Just dived under the bows of a tug ...

of Pontyphyl (author of "Sin and the Halma Board," etc.).

Thereafter we got a tow from a passing tug and swished our way to the Race. It cost me a fiver, but we reached the vicinity of the winning post in time for me to give a thrilling description of the finish.



Even response throughout the musical range

Successful reproduction through the Loud-speaker demands transformers that give an equal rendering to the bass and upper treble, in other words even response throughout the entire musical scale.

In the Telsens range of Transformers, you will find this perfect balance of tone, which is essential to true reproduction, and at their price they offer the finest value for money transformers ever made. They are regularly incorporated in the circuits described in this Journal.

Advt. Telsens Electric Co., Ltd., Birmingham.

Telsens "Radio-grand" Standard Model made in ratios 3-1 and 5-1 price 12/6

TELSEN TRANSFORMERS



Telsens "Radio-grand" Super Ratio Transformer 7-1 price 17/6

Don't forget the Telsens "Ace" Transformer specially made for Portable Sets and where space is limited. Ratio 3-1 and 5-1 price 8/6.

Entirely British

WEARITE COMPONENTS

205

Modern Coils for Modern Circuits.

Tapped Coil with Selector Switch and Tuning and Coupling Coil Unit are the latest success. Price, per pair, approved design 17/6

H.F. Choke, 10-2,000 metres 6/6

Potentiometers 2/6

Volume Controls 4/-

H.F. By-pass Unit 5/-

Standard 6" x 6" x 6 1/2" Screening Box (in heavy-gauge aluminium), Grey finish, 6/6, Polished finish 7/6

Mains Transformer for "Orgola" H.T. Supply Unit 30/-

Faxolin Panels and Formers.

L.F. Choke, 20-henry 21/-

Write for free illustrated lists.

WRIGHT & WEARE, LTD.,
740, HIGH ROAD, TOTTENHAM, N.17.

'Phone: TOTTENHAM 3847/8.

Every requirement in VALVE HOLDERS is catered for in the W.B. range

Universal Type (for vertical or horizontal mounting), 1/3.
5-pin Type, for A.C. Valves, 1/3. Anti-phonio Type, 1/3.
Rigid Type, with terminals, 1/-; without terminals, 5d.
WHITELEY BONEHAM & CO. LTD., Nottingham Rd., Mansfield, Notts. 'Phone: Mansfield 762. 'Grams: "White-bon, Mansfield." London Office: 21, Bartlett's Buildings, Holborn Circus, E.C.4. 'Phone: Central 8745 (3 lines).



"FAVOURITE"

Suitable for batteries or eliminators. Complete with inner frame and for 12" cone.

48/- 52/6

Oak Mahogany

Carrington Manufacturing Co. Ltd.,
24, Hatton Garden, London, E.C.1.
Holborn 8202.

Factory: Camco Works, S. Croydon.

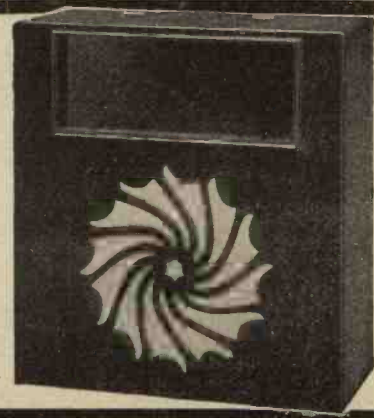

RADIO NOTES and NEWS of the MONTH

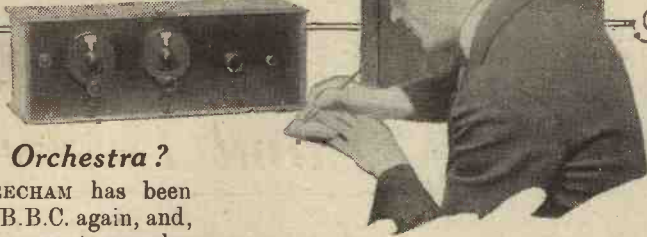

Garden Opera Company, fundamentally disagrees with Sir Thomas, and admits that broadcasting has done a considerable amount, in his opinion, to stimulate interest in Opera in this country. Metaphorically speaking, he takes his hat off to the pioneers of propaganda work done by the B.B.C.

No National Orchestra?

SIR THOMAS BEECHAM has been attacking the B.B.C. again, and, judging by his recent remarks, there is but little chance of the National Orchestra materialising. As our readers know, Sir Thomas Beecham a few months ago was very friendly with the B.B.C., and there seemed every hope of this famous conductor working in collaboration with Savoy Hill. But conditions seem to have changed lately.

Sir Thomas Beecham and Symphony Concerts

The other day, when he returned from Cologne, he had not a single word of praise for the Wireless Symphony Concerts organised by the B.B.C. Sir Thomas considers them a failure. But their failure, he said, resulted from mismanagement, and

his advice to the B.B.C. is to leave the work of promoting concerts to those with a knowledge of proved talent.

"Squandering Money"

Even then, however, Sir Thomas holds out very little hope for broadcast music, which, together with the gramophone, he describes as the merest parasite on the body musical. The B.B.C., he says, simply squanders money in a muddling, blundering way without a policy.

Broadcasting Helps Opera

However, Colonel Blois, the Managing Director of the Royal Covent

A Magnificent Present

Many of our readers probably saw the other day in the papers the story of a man who recently became engaged to a Gloucester girl and wished to give her something as an engagement gift. Her choice must have been almost unique. It was that every blind person in the county in which she lived who was without a wireless set should be given one. This magnificent gift will probably cost £10,000. Incidentally the gift includes the maintenance of the sets installed.

Wireless for the Blind

By the way, the Prince of Wales is President, and Mr. Reginald McKenna Honorary Treasurer of the Wireless for the Blind Fund, and to date about £15,000 has been received in cash, in addition to the above

(Continued on page 604.)



Lewcos Triple-Tapped "X" Coils, 60X and 75X. Price - 4/9 each. 200X, 250X, 300X. Price - 6/6 each. Patent 271,384.



Lewcos H.F. Choke. Waveband Range, 20 to 2000 m. Price 7/9 each

Specified For The— "DIFFERENTIAL" ONE "STAR-TURN" TWO "SIMPLE CHANGE" THREE

Lewcos Centre-Tapped Coils have now firmly established themselves as a necessity with discriminating users of Radio Sets.

Lewcos Centre-Tapped and "X" Coils are now available with three taps in place of the standard centre tap. In addition both coils can be supplied with Continental two-pin fitting.

"The Lewcos H.F. Choke is the most efficient Choke we have tested, there being no sign of instability even when using 150 volts H.T. on the anode of the S.G. valve. The construction is massive and well-finished, and its design places it in the front rank of high-class components." The above is a report of Industrial Progress, Ltd. and gives ample proof of the excellency of the LEWCOS H.F. Choke



Lewcos Centre-Tapped Coil Nos. 25-75, price 3/6 each. Nos. 100-300, price 4/6 each. Patent 271,384

LEWCOS REGD. Radio Products



THE LONDON ELECTRIC WIRE COMPANY AND SMITHS LIMITED.
CHURCH ROAD, LEYTON, LONDON, E.10.
Trade Counter : 7, Playhouse Yard, Golden Lane, E.C.1.

TWO NEW BOOKS for the HOME CONSTRUCTOR

Sets for Every Purpose and Every Pocket

6d.



"BESTWAY" BOOK No. 367

Contains complete constructional details of the following inexpensive and easy-to-build receivers. All have passed the most exacting tests before being published.

A ONE-VALVER

Of novel construction, using a home-made cabinet and plug-in coils. Covers ordinary and long waves.

A TWO-VALVE ALL-WAVE-LENGTH SET (Det. and L.F.)

Capable of loud-speaker results under good conditions on both short and long waves. Uses standard parts and plug-in coils. Easy to operate.

THREE-VALVE RADIOGRAM RECEIVER

Circuit is Det. and 2 L.F. Very selective and gives high quality reproduction either of radio or of gramophone records.

FOUR-VALVE "POUND-PER-STAGE" SET

Costing about £4. Uses home-made coils. Circuit employed being H.F., Det., and 2 L.F. Highly selective.

These Super sets are for MODERN CONDITIONS, and will enable constructors to take full advantage of the dual programmes under the Regional Scheme.

A SUPER-SELECTIVE ONE-VALVE SET

For ordinary and long waves. Easy wave-change and very simple operation. Includes the famous "Brookmans Rejector" to cut out interference.

A TWO-VALVER (Det. and L.F.)

For all waves including short. Special wave-change switch enables wave-range to be altered without changing coils.

An UP-TO-DATE THREE-VALVER

Using S.G., Det. and Pentode. Highly selective; employs plug-in coils and has volume control and switch for the reproduction of radio or gramophone records.

An "ALL-FROM-THE-MAINS" FOUR

A powerful set for A.C. mains, which comprises H.F., Det., and 2 L.F. stages with the special new A.C. Valves. Covers long and ordinary waves and is very easy to operate.



6d. each from all Newsagent Bookellers everywhere, or 7d. post free (Home or Abroad), from "Best Way," 291a, Oxford Street, London, W.1.

RADIO NOTES AND NEWS OF THE MONTH
—continued from page 602

offer. The Radio Manufacturers' Association also offers to supply £10,000 worth of sets and parts, and the Fund—the address of which is 226, Gt. Portland Street, London, W.1—requires a further £25,000 to meet all its requirements.

The Pope to Broadcast

It is expected that on June 29th, on the occasion of the Feast of St. Peter and St. Paul, Pope Pius 11th will be able to send out broadcast readings from the new Vatican broadcasting station—which is being constructed under the personal supervision of Marchese Marconi—to the Sovereigns and Heads of States which have diplomatic relations with the Holy See. It is afterwards expected that the Pope will be able to broadcast personally in benediction to Catholic Missionaries who go on pilgrimages.

Whether the B.B.C. will rebroadcast the Pope's speech has not yet been decided: but no doubt, if the

B.B.C. does not take this outside broadcast, thousands of readers will be able to hear the station direct.

A Town of Radio Pirates?

Newcastle has been visited by the G.P.O. Radio Pirate Van, for it was discovered that only 45 receiving licences are held in the Newcastle district for every 1,000 of the population. This is said to be a smaller proportion than in most other British centres, and suspicion naturally arises in the minds of the G.P.O. authorities that many Newcastle listeners are enjoying the wireless programmes free of charge.

All Because of a Van

Figures are not yet to hand to show what effect the radio van has had on Newcastle listeners, but its recent visit to Manchester resulted in 4,000 fresh licences being taken out in one month.

Cutting Expenses of Midland Regional

The B.B.C. is going to make a grant to the Birmingham City Orchestra to replace the Birmingham Wireless Orchestra of the Midland

Regional station. The old popular Wireless Orchestra cost the B.B.C. about £12,000 a year, but the new arrangement is for the B.B.C. to pay the City Orchestra only £2,000 for the 1930-31 concert season, during which it will give twelve symphony concerts. In the following season the B.B.C. will subscribe only £1,500, plus a £500 guarantee, and the year after the guarantee will be withdrawn.

Musical authorities in Birmingham do not think the two grants will be sufficient to cover the cost of an augmented orchestra, and an appeal is to be made to the public to give the orchestra a guarantee against loss.

What Listeners Think About It

Incidentally, the Midland Wireless Listeners' Petition against the new arrangement has reached a very large size, and the strong protest in Birmingham against the B.B.C.'s new arrangement has by no means fizzled out.

Orders to Quit

The Minister for Posts and Telegraphs, who is in charge of broadcasting arrangements in France, has decided, we understand, to have all

(Continued on page 606.)

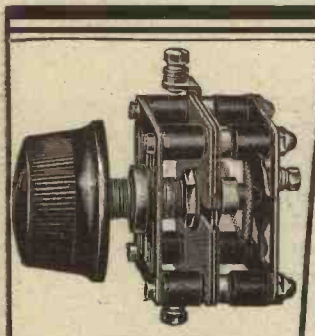

MAGNUM DIFFERENTIAL CONDENSER

Entirely new design incorporating insulated spindle and several other novel features. Capacities: .0001, .0002 and .0003, each half.

Price, each **6/-**

MAGNUM SHORT-WAVE CONVERTOR

This wonderful Unit readily converts your present set into a highly efficient short-wave receiver. No extra valves or batteries are required.

Price **£3:15:0**

CONSTRUCTIONAL KITS

We specialise in the following sets described in this issue, which can be supplied as constructional kits, ready wired and tested, or separate parts as required: "Simple-Change" Three, "Star-Turn" Two, "M.W." "Differential" One, and all apparatus described in "Modern Wireless."

Full particulars, including a list of leading Short-Wave Stations, and "Volume Controls & Dissolvers and How to Use Them," free on application.



BURNE-JONES & CO., LTD.,

"Magnum" House, 196, BOROUGH HIGH ST. LONDON, S.E.1. Telephone: HOP 6257 & 6258.

Watch for the New

Electrad Loftin - White Direct Coupled Amplifier

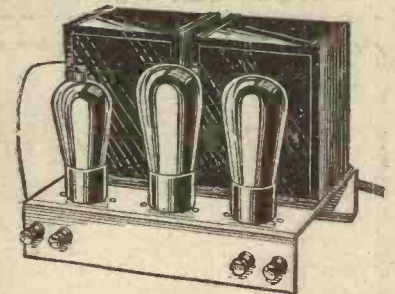

The new Electrad Loftin-White direct coupled (plate to grid) A.C. amplifier will shortly be available. This new revolutionary system of amplification entirely dispenses with the use of transformers and resistances.

The Electrad Loftin-White amplifier employs one A.C. Screen Grid valve in the first stage followed by one power valve and one rectifier, the whole operated direct from A.C. mains. Utilizing only two valves, for amplification tremendous volume is available with a frequency response, registering a practically flat curve from 30 to 7,000 cycles.

The new Loftin-White system will undoubtedly bring about a complete revision of accepted amplifier principles.

For 110 volt 50 cycle A.C., complete with valves, ready to operate **£12 5 0**

For 220 volt 50 cycle A.C., complete with valves, ready to operate **£12 5 0**

Write for further details.

The Rothermel Corporation Ltd., 24/26, Maddox St., London, W.1.

Telephone: MAYFAIR 0578/9

Enormous Range

SCREENODION 15⁶ The best Screen-Grid in the world.

Bivolt . . .15 amps.
Forvolt .075 amps.
SUPERBLY SELECTIVE.

SUPER HE 5⁶

Bivolt . . .15 amps.
Forvolt .075 amps.

Super DETECTOR 6⁶ A super-sensitive detector for anode-bend or leaky-grid rectification.

Bivolt . . .15 amps.
Forvolt . . .075 amps.

HYPER-POWER. 9/6
Bivolt .3 amps.
Forvolt .15 amps.

Write for Free Folder to:
IMPEX ELECTRICAL LTD.,
Dept. H, 53B, High Road,
Leytonstone, London, E.11.

UNIVERSAL RESISTRON 5⁶
SUPER POWER 7⁶
and the Super Power
PENTODION 18⁶

DARIO L.F. TRANSFORMER.
A little marvel. Guaranteed for two years. Completely shrouded. Perfectly designed and perfectly made.

5-1 or 3-1. **5-**

DARIO VALVES

Best way to all Stations

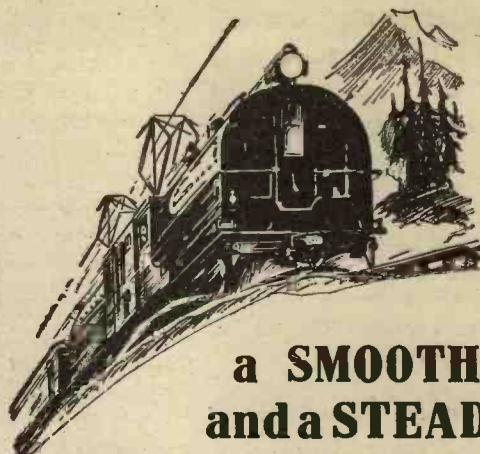

**a SMOOTH Start
and a STEADY Pull**

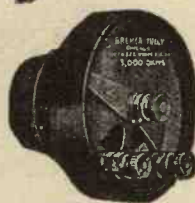

The giant electric locomotive starts with velvet smoothness and pulls the heaviest loads with steady, unflinching power. It's all a matter of proper control. The increased sensitivity of your radio demands the S-m-o-o-t-h control that only Centralab can give. Noiseless, free of inherent sputtering—self-inflicted static. For smooth, quiet, velvety radio reception your radio must be CENTRALAB equipped. Write for free booklet, "Volume Controls, Voltage Controls, their uses."

Centralab

THE ROTHERMEL CORPORATION LTD.,
24, Maddox Street, London, W.1.
Phone: MAYFAIR 0578/9.

*This Summer—Bring Your
Home into the Garden*

"Extending your House into the Open Air" is the title of an interesting article by Inez Crawford in the June issue of "TOWN AND COUNTRY HOMES." This is full of suggestions for the economical furnishing and decoration of sun rooms, loggias and verandahs. Other articles deal with the furnishing and decorating of small gardens.

Colour in the Home is still a subject of absorbing interest to all home lovers, and Grace Lovat Fraser continues her practical suggestions with six colour schemes for a small country house.

Many pages are full of practical suggestions for the planning, building and inexpensive furnishing of small homes, labour-saving equipment, etc.

Elizabeth Craig makes suggestions for Tennis Parties and also writes on the important question of preserving food in hot weather.

"TOWN AND COUNTRY HOMES" is the most beautifully produced of all home magazines and is packed with new and practical ideas.

TOWN and COUNTRY HOMES

Buy the JUNE Issue To-day

“Well! Who Was Right?”

REMEMBER that argument you had with John the other night? Neither of you would give in, and so it went on for hours and hours. But who really was right after it all? You don't know, do you?

Don't argue—buy THIS AND THAT. It will tell you all you want to know about everyday subjects.

It is a paper for men and women of all ages and all classes. Bright, lively and topical—it is the paper for the million. Buy it regularly!

THIS and THAT

Every Thursday - - 2d.

RADIO NOTES AND NEWS OF THE MONTH

—continued from page 604

the broadcasting stations in Paris moved away from the metropolis as soon as possible. In this way it is hoped that mutual interference of stations will be reduced.

The Radio Paris station, which is the strongest of all, is to be moved to a site near Rambouillet, and in its new position its power will be increased to 60 kw.

Moving the Paris Broadcasters

The Petit Parisien station will be removed to a site about twenty miles south-east of Paris, and will have a power of 20 kw.

The Radio L.L. station is also to be moved, while the Eiffel Tower will remain to be used for scientific, official and military purposes.

Combine of “Royalty Charges”

As we go to press we understand that negotiations for an important triangular agreement in connection with the conditions under which royalties are charged on wireless sets sold to the public are in an advanced state of development between the Marconi Company, the Gramophone Company, and Standard Telephones and Cables, Ltd.

If an agreement is definitely reached conditions will be that manufacturers will be able to make sets incorporating any of the patents owned by the three companies mentioned above, and there will be a definite fixed fee of 5s. per valve holder.

Helping the Radio Industry

There is no doubt that this arrangement, if it comes into force, will have a beneficial effect on the radio trade, and upon the purchaser of wireless sets.

For example, to-day the royalty is 25s. for the use of the super-heterodyne patent, and the introduction of an inclusive fee of 5s. per valve would mean that manufacturers would be able to make a substantial reduction in the price of sets, mains units, etc., sold to the public.

TECHNICAL TIPS

One of the ill-effects of a long earth lead is the tendency to flat tuning.

TESTED AND GUARANTEED!

All “M.W.” Sets are thoroughly tested before being passed for description.

ALSO, DON'T FORGET THE

“MODERN WIRELESS” BLUEPRINTS

- “M.W.” Blueprint No. 2. A “High-Power” Five.
- “ ” No. 3. The “Switch-Over” One Valver.
- “ ” No. 4. The “Titan” Two.
- “ ” No. 5. The “Full-Tone” Two-Stage Amplifier.
- “ ” No. 6. A “Simple-Change” Three.
- “ ” No. 7. An “Every-Purpose” Three.
- “ ” No. 8. The “Simple-Screen” Four.

Obtainable from the Technical Queries Dept., MODERN WIRELESS, the Fleetway House, Farringdon Street, London, E.C.4.

Price 6d. per Blueprint.

A stamped addressed envelope should be sent with your application.

Although filament resistances are not usually necessary with modern valves, it is usually an advantage to use such a resistance for the detector in a short-wave set.

* * *

The difficulty of employing suitable H.F. chokes on both long waves and short waves can often be surmounted by mounting the choke on a coil mount or providing it with plug connectors, so that when the wavelength is changed the choke also can be replaced.

* * *

If the wiring can be kept very short it is sometimes an advantage in short-wave work to use a small variable condenser for a grid-condenser instead of one of the fixed type, .0001 mfd. being a suitable maximum capacity.

RECENT RECORD RELEASES

A brief survey of some of the latest gramophone records. Those mentioned should be of special interest to the radio-gramophone user.

Broadcast Records

Among the Broadcast "Ten" records some rather unusual items have been provided, and the Vocalion Gramophone Company seem to be making quite a feature of comedy numbers. So this month we get **Open Up Dem Pearly Gates For Me and She Was Poor but She was Honest** a duet (on 549). Rather a monotonous record, we think.

Also we have **Five Hundred Thousand Million of them There and She Can't Make Up Her Mind** (on 545). This is a distinctly more lively record than the other.

Harry Wilson gives us a couple of yodelling items, **My Own Dutch Home** and **You're Tired** (on 550), while the Stoll Picture Theatre Organ, played by Herbert Griffiths, gives us **Bird Songs at Eventide** and **A Palace of Dreams** (on 556).

Of the dance numbers, **Melancholy** and **We'll Build a Little World of Our Own** from "Happy Days," are good items (on 456). These are by Nat Lewis and his Band, while **Ragtime Medley** parts 1 and 2 provide a rather novel but peculiar record, inasmuch as it is an accordion solo by Emile Charlier with a dance band accompaniment (on 552).

Most Tuneful

The most tuneful Broadcast record we would say was **Molly**, on the Broadcast "Twelve" Super Dance Record, played by Al Benny's Broadway Boys; on the reverse side is **Sweet Nothings of Love** (No. 2560). **Hallelujah** resurrects memories of "Hit the Deck," and is accompanied by **Keeping Myself For You** from the same musical comedy; also by Al Benny (on 2562). The same band provides us with **What Have I Done**, a waltz, and **Melancholy** (on 2561).

An interesting organ number is given on the ordinary Broadcast "Twelve" by the Stoll Picture Theatre Organ, the choice being **Ballet Egyptien** (on 5159). This is very well recorded indeed, and comes through remarkably well, though perhaps a little lack of smoothness in the centre of the record

is rather a pity. Vocal Gems of **Patience** take up two Broadcast "Twelve" records, and are recorded in the usual Broadcast manner.

H.M.V.

This month sees Caruso's last record release, and this is further proof of Caruso's amazing versatility.

Many other new records in the Covent Garden Opera style are available, but nothing comes up to Caruso's wonderful clarion-like reproduction.

Siegfried, Wagner's famous opera in German, is available in Album No. 94 consisting of five records containing the most exhilarating music of the opera. The passages selected are the most popular, and the singers among the very finest in the world.

"Gracie" Again!

Gracie Fields has made yet another hit on which she records **Body and Soul** and **You Can't Kill Flies by Scratching Them**. This latter is one of Gracie's best yet. Her repertoire of animal noises is simply amazing and she makes good use of it here (No. B3383).

A number of cinema organ records are available, including **Molly** from "The Grand Parade" and **Alone in the Rain**, by Sandy MacPherson and the cinema organ of the New Empire Theatre (on B3379), and **Sighing for the Carolines** and **I'll Close My Eyes to the Rest of the World**, by Jessie Crawford (on 3382).

Parlophone

The Parlophone recordings are noted for their crispness and their faithfulness, and especially are we always glad to hear their dance records, owing to the fact that they do give some really good American bands which employ some novel orchestrations.

Chief among these in our opinion is Joe Venuti's "Blue Four," and this month he is playing **Charm of the Jungle** and **That Wonderful Something**, from the film

(Continued on page 608.)

"STAR TURN" TWO

PRICE LIST OF ALL THE CORRECT PARTS

	£	s.	d.
1 Drilled ebonite panel, 12 ins. x 7 ins.		4	0
1 Hand-polished oak cabinet with 10-in. baseboard	1	0	0
1 Terminal strip, 12 ins. x 2 ins.		1	2
1 Ready Radio "Star Turn" selector coil and coupling coil	16	0	
1 Ready Radio H.F. choke	4	0	
1 Formodenser (-0003 max.)	2	0	
1 T.C.C. -0003 mid. fixed condenser	1	6	
1 Buffler 2-meg. grid leak	2	6	
1 Ready Radio grid-leak holder		9	
1 Ready Radio -0005 variable condenser	4	6	
1 Ready Radio differential condenser	5	0	
1 R.I. Hypernite L.F. transformer	1	1	0
2 Lotus sprung valve holders	2	6	
1 Ready Radio switch		10	
1 Igranite slow-motion dial		6	0
2 Ready Radio coil sockets		1	8
9 Engraved Belling Lee terminals		2	3
Flex, screws, plugs, etc.		1	7
Links		2	6
2 Valves as specified	1	3	0
Set of Lewcos coils: 1 No. 60 C.T., 1 No. 250 C.T., 1 No. 50., 1 No. 100.		16	0

TOTAL (including valves, etc.) £6 18 9
Any of the above components can be supplied separately if required.

KIT A less valves and cabinet £4 : 15 : 9
or 12 equal monthly payments of 8/9

KIT B with valves less cabinet £5 : 18 : 9
or 12 equal monthly payments of 10/9.

KIT C with valves and cabinet £6 : 18 : 9
or 12 equal monthly payments of 12/9.

READY RADIO "STAR TURN" SELECTOR COIL

WITH SWITCH, READY FOR MOUNTING.
As specified for The "Star Turn" Three and The "Star Turn" Two **12/6**

"SIMPLE-CHANGE" THREE

KIT A less valves and cabinet £4 : 8 : 3
or 12 equal monthly payments of 8/3.

KIT B with valves less cabinet £6 : 1 : 9
or 12 equal monthly payments of 11/3.

KIT C with valves and cabinet £7 : 5 : 3
or 12 equal monthly payments of 13/3.

READY RADIO IMMEDIATE DESPATCH SERVICE.

TO INLAND CUSTOMERS. Your goods are despatched post free or carriage paid, cash with order. If desired you can avail yourself of the C.O.D. system on orders over 5/-.
TO OVERSEAS CUSTOMERS. All your goods are very carefully packed for export and insured, all charges forward.

Write, Wire or 'Phone.

1930 Illustrated Catalogue. Pos' Free, 1/-.

Ready Radio

159, BOROUGH HIGH STREET, LONDON BRIDGE, LONDON, S.E.1
Telephone: HOP 5555 (Private Exchange).

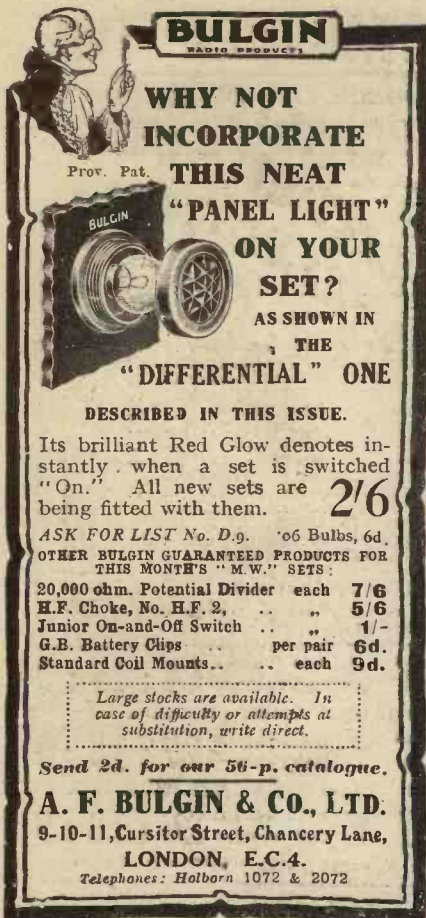

BULGIN
RADIO PRODUCTS

WHY NOT INCORPORATE THIS NEAT "PANEL LIGHT" ON YOUR SET?
AS SHOWN IN THE "DIFFERENTIAL" ONE DESCRIBED IN THIS ISSUE.

Its brilliant Red Glow denotes instantly when a set is switched "On." All new sets are being fitted with them. **2/6**

ASK FOR LIST No. D.g. '06 Bulbs, 6d.
OTHER BULGIN GUARANTEED PRODUCTS FOR THIS MONTH'S "M.W." SETS:

20,000 ohm. Potential Divider	each	7/6
H.F. Choke, No. H.F. 2,	..	5/6
Junior On-and-Off Switch	..	1/-
G.B. Battery Clips	per pair	6d.
Standard Coil Mounts	each	9d.

Large stocks are available. In case of difficulty or attempts at substitution, write direct.

Send 2d. for our 56-p. catalogue.

A. F. BULGIN & CO., LTD.
9-10-11, Cursitor Street, Chancery Lane,
LONDON, E.C.4.
Telephones: Holborn 1072 & 2072

Hand CRAFTSMANSHIP!



BUILT LIKE A PIANO

2 patents - Sound Chamber - equals 3-ft. pipe.

To house YOUR SET - or RADIO-GRAM.

The outcome of seven years' experiments followed by exceptional demand - leading Experts - Famous Engineers - 3,000 users.

The fine beauty of Tone and Style brings a thrill that no words can convey. You may have ON APPROVAL FREE TEST, and return at our expense if you wish to part with it.

Prices run from £5-5-0 (or £10 to £15-15-0 for Exclusive models). Cash or Easy Payments.

Photographs and full particulars FREE.

PICKETT'S, Radio Furniture Makers (M.W.), Albon Road, Bexleyheath, Kent.

RECENT RECORD RELEASES
—continued from page 607

"Untamed" (on R608), and also *Man From The South*, by Lewis Armstrong and his orchestra, is coupled with *After You've Gone*, by Joe Venute's "Blue Four" (on R607). Another fine record is *St. Louis Blues*, rather an old theme, by Trombauer's Orchestra (on R617).

A Remarkable Record

A record that every lover of modern music should get is *Pacific 231*, by the Grand Symphony Orchestra, especially conducted by the composer Honegger. This is recorded on 20108, a twelve-inch double record, which costs 6s. 6d., and is altogether an exceptional record. Being a lover of railway engines, the composer set himself the task of expressing in terms of music a vivid representation of a giant American engine.

The piece opens with the quiet breathing of the engine at rest, the train departing and gradually increasing in speed, until it finally reaches the lyrical state of a fast train, 300 tons of weight thundering over the silence of the night at a mile a minute. It is a remarkable piece of descriptive music.

Zonophone Records

The following are interesting records of the recent Zonophone releases. *Hits From the Past*, by the London Orchestra (on 5566), a record full of memories for everyone. Foster Richardson sings *Drinking* and *Will o' the Wisp* (on 5563) forming a couple of very enjoyable songs.

The International Melody Quartette gives us another couple of items (on 5536), *Whistling Rufus* and *Down South*; the latter will probably be a great favourite. It is not a new number, for it has been issued before, but we have it electrically re-recorded in a new form.

The Punch and Judy Show and *Sweetheart's Holiday* by the famous Rhythmic Eight are very well recorded on 5559.

The Arcadian Dance Orchestra gives us *Sweet Nothings of Love* and *Ka-ki-ak*, from a well-known film. These are recorded on 5561. In accordance with their usual policy of a limited list of selected numbers the Zonophone Company have only issued four dance records this month, but they are all good ones.

FOR YOUR NOTE-BOOK

When choosing a new valve for your receiver, remember it is not the make that should be like the previous valve, but the *type*.

The free gassing of an accumulator on charge is quite a good indication as to whether this is satisfactory, and if one cell gases less than its fellows, it probably needs an individual charge.

Telephones should always be treated carefully as they easily suffer from mechanical shocks.

When telephones are not left connected permanently to the set, but are put away, make sure they are placed in a dry, airy position, as dampness is detrimental to them.

Never drop telephones on to the floor or throw them on to a chair, as apart from the permanent magnets in them being weakened by sudden shocks the diaphragms are easily bent.

A large tuning coil is quite satisfactory as an H.F. choke if its self-capacity is low.

Do not allow a flexible battery cord to rub against the side of an accumulator, or stray acid may affect the insulation and ruin the connection.

When readjusting a semi-permanent crystal detector, remember that the contact consists of two separate crystals, and these should not be ground together, but should be separated, and turned only when the two faces are not in contact.

If your cone loud speaker rattles on certain notes, make sure that the small nut which locks the diaphragm in position has not become loose.

At one time all wireless sets had only two H.T. leads, one negative and one positive, but the differing requirements of different valves have now made it common for two, three or even four or five positive leads from the same battery to be employed, so that the exact potential required is applied to each plate.

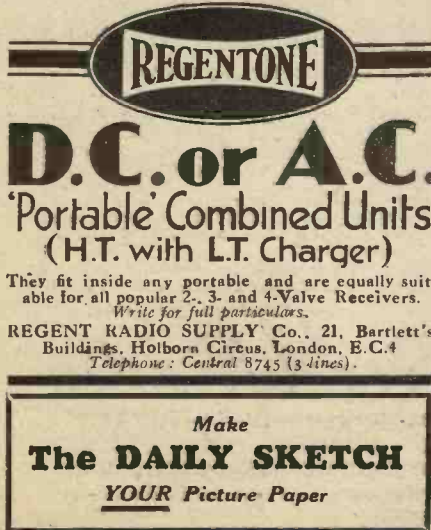

REGENTONE

D.C. or A.C.
"Portable" Combined Units
(H.T. with L.T. Charger)

They fit inside any portable and are equally suitable for all popular 2-, 3- and 4-Valve Receivers.
Write for full particulars.

REGENT RADIO SUPPLY Co., 21, Bartlett's Buildings, Holborn Circus, London, E.C.4
Telephone: Central 8745 (3 lines).

Make
The DAILY SKETCH
YOUR Picture Paper

RADIO VALVES SIX-SIXTY ALWAYS BEST

All types for all Sets



The Six-Sixty Radio Co., Ltd., Six-Sixty House, 171x8, Rathbone Place, Oxford Street, London, W.1. Telephone: Museum 6x167 (Plc. Bch. Exch.)

DUTCH MANUFACTURER of high-class Wireless Cabinets wants **SOLE AGENT**, well known in the trade, to sell his products in large quantities at competitive prices. Please apply with references, to—**No. F.99, Adv. Bur. Gebrs. Gevers, Wynhaven 42, Rotterdam, Holland.**

PAREX

COILS & COMPONENTS

"STAR-TURN" TWO

SET OF 2 COILS, as specified, 21/-
EBONITE PANEL, 14"x7", drilled .. 7/6
DIFFERENTIAL CONDENSER .. 5/-
H.F. CHOKE 3/6 ON-OFF SWITCH 1/-

"SIMPLE CHANGE" THREE

EBONITE PANEL, 14"x7", drilled .. 7/6
REACTION CONDENSER .. 4/-
H.F. CHOKE 3/6 ON-OFF SWITCH 1/-

"DIFFERENTIAL" ONE

DIFF. CONDENSER, as specified .. 5/-
H.F. CHOKE 3/6 ON-OFF SWITCH 1/-
EBONITE PANEL, 12"x7", drilled .. 6/6

E. PAROUSSI,

10, FEATHERSTONE BUILDINGS,
HIGH HOLBORN, LONDON, W.C.1
Phone: Chancery 7010

THE PICTURE PAPER WITH THE
MOST NEWS

SUNDAY GRAPHIC

ELEX

T.14 PLUGS & SOCKETS

Standard Socket 1d. each. Plugs 3d. each (6 colours) Name
plates, 40 kinds. 1d. ea. Write for list B78.
J. J. EASTON & SONS,
118, Bunhill Row, London, E.C.1



COMPROMISES IN RADIO

By J. F. CORRIGAN, M.Sc., A.I.C.

IF you call to mind your crystal set experiences—you will doubtless recollect how it was possible to pick out certain crystals—and even to select particular spots in the one crystal—which were extraordinarily sensitive, but which, generally speaking, could not be used owing to the fact that the crystal contact so formed became too unstable.

The Happy Medium

By dint of careful trial you found the most sensitive spot on the crystal, but you could seldom keep it. You had, therefore, to sacrifice a certain amount of sensitivity in the crystal for a greater degree of stability of the contact.

Similarly, crystal dealers, in making up their products, were always under the necessity of marketing crystals in which a happy medium between high sensitivity and instability, and slightly lessened sensitivity coupled with reasonable contact stability, had been secured.

In other words, a compromise had to be made in each of the above instances. If you gained on the swings, you generally lost something on the roundabouts, and so you had, as we have seen, to be content with the happy medium.

Now, this swings and roundabouts business is active in many other departments of radio besides the particular instance mentioned above.

Take, for instance, radio amplification, either high-frequency or low-frequency, but particularly in the present instance the former. In theory, we all know how it is possible to procure an enormous degree of H.F. amplification of signals. In practice, however, we know what this "enormous" degree of amplification boils down to—something reasonable rather than magical!

Too Much Amplification

Under certain conditions which may be set up by carefully doing away with losses and damping in the circuit, it is possible to send up the H.F. amplification of the valves to an enviable extent. But at what cost? At the cost, one regrets to say, of having hopeless instability in the circuit in use. Under such conditions the valves would break out into

(Continued on page 610)

**PRECISION
CONDENSERS
FOR SELECTIVITY**

J.B. JUNIOR LOG CONDENSER.

Present-day requirements have been studied so closely by J.B. that in their wide range of Precision Condensers you will find just the model you need. Even though you may be within a mile or two of Brookmans Park—J.B. Precision Condensers will do more to separate difficult stations than any other condenser on the market. Your circuit may be last year's design—J.B. Precision Condensers will bring it up to date.

Make it a rule—J.B. for every Set.

J.B. JUNIOR LOG CONDENSER.

·0005	7/-	·0003	6/9
·00025	6/6	·00015	6/6



PRECISION INSTRUMENTS

Advertisement of Jackson Bros., 72, St. Thomas' Street, London, S.E.1. Telephone: Hop 1837.

FORMO-DENSORS

PRE-SET
COM-
PRESSION
TYPE



F. Max. .0001 2/-

F. Min. .00005 2/-

J. Max. .0003 2/-

J. Min. .00025 2/-

G. Max. .001 2/-

G. Min. .0002 2/-

H. Max. .002 3/-

H. Min. .001 3/-

Type J used
in the
"Gramo Radio
D.C. Three."

LOG-
MID-
LINE

Caps.
.0005
.00035
.00025
.00015

4/6

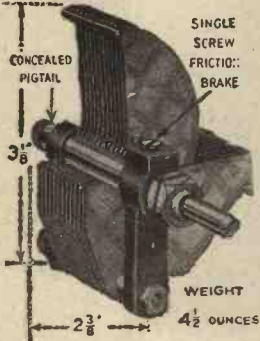

MIDGET REACTION

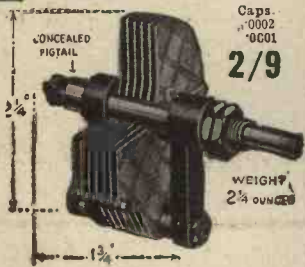

VERNIER DIAL

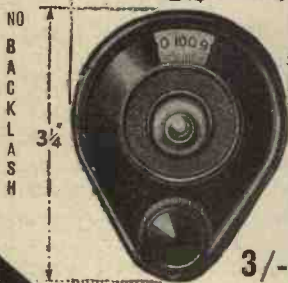

FORMO-DENSOR
EXCLUSIVE FEATURES
CONCEALED INTERNAL
FLEXIBLE CONNECTION
SELF-OILING SHAFTS
LOWEST ELECTROSTATIC LOSS
LOWEST DIELECTRIC LOSS
NEAREST APPROACH TO
AIR SUSPENSION
SILKY ACTION

POINTED
EXCELLENCE



GOLDEN SQUARE,
PICCADILLY CIRCUS,
LONDON, W.1.

Gerrard 1863

COMPROMISES IN RADIO

—continued from page 609

oscillation with the greatest ease, and certainly long before the circuit had been tuned to obtain the theoretically possible degree of amplification.

Take an ordinary elevated aerial. The larger it is the greater the signal strength derived from it—within certain limits, of course. For selectivity, however, a large aerial is not always suitable. Indeed, a small aerial nearly always gives better results in this respect than a big one.

With L.F. Transformers

And so, once again, if an aerial has to be designed for general receiving purposes—that is, for reasonable selectivity combined with the ability to produce good signal strength with any average receiver—the inevitable compromise must be made in its construction.

Then, of course, we have the matter of L.F. transformer design and construction in which the same principle of compromise arises.

A perfect transformer (which, of course, does not exist) would possess a primary winding impedance greater than that of the valve.* Furthermore, in order to effect a maximum amount of amplification, it would also be provided with a big step-up ratio between its primary and secondary windings.

Such constructional features, however, are impossible in transformers as they stand at present. In the first place, if the impedance of the transformer primary is increased by adding more turns to the windings, the self-capacity of the latter may be increased; and this, of course, is detrimental to the efficiency of the transformer. Hence, in order to keep up the impedance of the primary as much wire as possible must be wound on it; but it must be wound in such a manner that the self-capacity of the winding never exceeds a certain maximum.

Theory and Practice

Regarding the step-up ratio of a transformer, this is determined by the ratio between the number of turns of wire on the primary winding and those on the secondary. Keeping the primary turns constant, if we increase the usual number of turns of wire in the secondary windings of the transformer in order to increase

the step-up effect we automatically increase the self-capacity of the winding.

There are, of course, special methods of transformer winding which enable an increased number of turns to be applied to the windings without very greatly raising their self-capacity, but ultimately, in the experimental design of transformers, there comes a point at which the benefit of such increased windings is more than counterbalanced by their raised self-capacity.

Hence another compromise in radio design has to be put in force, and for this reason it is interesting to note that—by means of present-day methods at any rate—it is quite impossible to obtain in practice the degree of amplification which ought theoretically to be possible with any given transformer.

THE GUARANTEED SET

THERE ONCE WAS an Inexperienced Amateur who, Knowing Little of the Construction of Receiving Apparatus, Decided to Purchase the Component Parts of a Guaranteed Set, and Erect the Entire Instrument According to the Instructions of the Designer.

He assumed that the Theoretical Circuit would be O.K., but was Struck by What he Considered an Unpleasant lack of Symmetry in the Arrangement of the Control Dials, and Wondered Whether this Could Not be Remedied. He Found that in Correcting this Fault, some Little Modification of the Baseboard Layout was Necessary.

Further Deviations

He then Discovered that the Lengths for the Connecting Wires No Longer Applied, But by Patient Research he Got The Connections Right. He Also Noticed that Many of the Leads Seemed to be Longer.

In Due Course the Set was Finished. The Panel was Perfectly Symmetrical, and Apart From the Above Modifications, the Instructions had been Followed Faithfully. But Great Was the Inexperienced Amateur's Astonishment to Experience Violent Oscillation and a Total Lack of Signals.

And Did he Lay the Blame Where it was Due? He Did Not. He arose in Righteous Indignation, and Wrote to the Designer, Denouncing Both him and the Guaranteed Set as Little Less than Frauds!

MORAL: Let well alone.

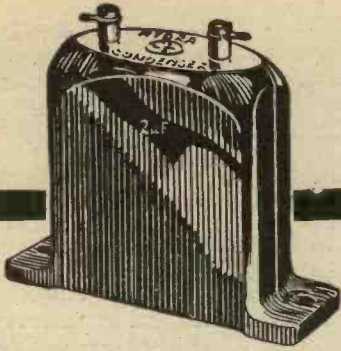

It is 30 years ago since we first said of Hydra condensers — "They never fail." To-day we say so with even more conviction.

HYDRA

LOUIS HOLZMAN

37, Newman Street, W.1
Telephone: Museum 2641.

HIGH-GRADE FIGURED OAK RADIO - GRAMOPHONE CABINET

Height 3' 6". Depth 1' 6".
For Panels up to 21" x 8".
Baseboards up to 11".

£7:7:0 Carriage Paid.
Prices of other sizes in proportion.

All cabinets can be adapted for use with all mains sets.

Manufacturer of all types of wireless cabinets and furniture of every description. Illustrated lists free.

GILBERT, Cabinet Maker, SWINDON.

Estimates Free. Est. 1860.



The simplest, neatest aid to selectivity

Connect the Belling-Lee "Spadenser" to your aerial lead. In every case it will greatly increase the selectivity, and in most cases it will entirely eliminate the unwanted station.

This new idea combines a series condenser with a Belling-Lee clip-on Spade Terminal. On occasions when the extra selectivity is not required the "Spadenser" is reversed. Write for Belling-Lee Handbook, "Radio Connections."



Patent Applied For.

only 2/6

BELLING-LEE
FOR EVERY RADIO CONNECTION

Advertisement of Belling & Lee, Ltd.,
Queensway Works, Ponders End, Middlesex.

SAFEGUARDING THE SET

Sir,—I would like to draw the attention of radio enthusiasts to a little-known method of safeguarding the filaments of valves from damage by accidental contact with the H.T. supply.

Fuses appeal to the uninitiated; they are apparently well designed to fulfil their proper function, but unless proper limitations are recognised I beg to submit that the safety enjoyed by the use of fuses is more apparent than real. To be really effective, a safety device must be capable of considerable elasticity in its working conditions. For instance, a fuse should blow whether the set is using any number of valves, and of any make, or of any current consumption. I hold that a fuse is incapable of working satisfactorily within such a wide range of conditions.

A Suggestion

The safety device I have in mind is simple, cheap, and easy to instal. It consists of a resistance of about 1,000 ohms in series with the H.T. negative feed, preferably wound inductively upon an iron core.

Such resistance can be picked up in electrical junk shops quite easily, being the essential part of telephone exchange indicators.

For those who wished to be convinced of the efficacy of such a simple device let us take the case of the ordinary three-valve set. The current taken by three such valves is $1+1+1=3$ amp.

Resistance of the circuit at 2 volts = $\frac{2}{.35}=5.7$ ohm.

Should a voltage of 120 v. be connected to this resistance, the current $\frac{120}{5.7}=21$ amp. approx., and the valves would be destroyed.

Effect of Resistance

If, however, a resistance of 1,000 ohms be permanently connected in series with the H.T. feed, this figure becomes $\frac{120}{1,000+5.7}$. Ignoring the 5.7,

$\frac{120}{1,000}=12$ amp., which will not harm the least number of valves.

To remove any doubt as to whether the 1,000-ohm resistance is any handicap to the efficient supply of H.T. to the valves:

(Continued on page 612.)

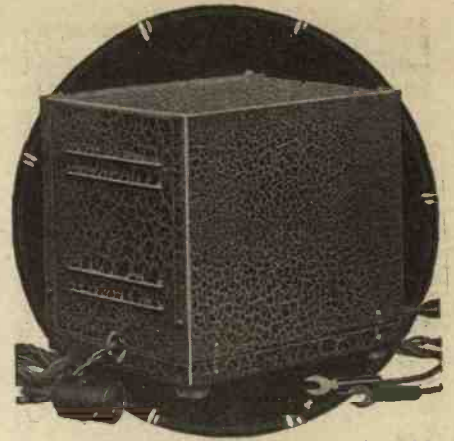

Have You Seen The NEW LOTUS

Power Rectifier Unit

for A.C. Mains?

For those who wish to convert their D.C. H.T. Eliminators to A.C., and for the energising of moving coil speakers, the Lotus Power Rectifier Unit is particularly useful. It consists of a Transformer, Rectifying Valve, Condenser and Smoothing Choke, and can be supplied with windings up to 300/300 R.M.S. volts. The Transformer is available with L.T. windings for A.C. Valves, or directly heated Super Power Valves. Totally enclosed in a metal box, and complete with Valve and Royalty paid, the price is £5 - 0 - 0 cash, or 9/3 down and 11 equal monthly payments. Ask your dealer for full details of this new Lotus line.

LOTUS

POWER RECTIFIER

Garnett, Whiteley & Co. Ltd.,
Lotus Works, Mill Lane, Liverpool.

SAFEGUARDING THE SET

—continued from page 611.

Taking the same set of three valves, probable consumption at full load=6 milliamps.

Therefore, resistance to H.T. voltage= $\frac{120}{.006}=20,000$ ohms. It will be

obvious that the addition of an extra 1,000 ohms will have but little effect upon the current available to the set in the shape of H.T. supply.

Furthermore, the presence of an inductively-wound coil in the H.T. feed is an advantage as a choke, as is well known.

Trusting the above will be of some service to fellow wireless fans, and wishing your paper every success,

I remain,

Yours sincerely,

H. J. WYATT,

A.M.Inst.B.E.,

A.M.Tech. I. (Gt. Brit.).

Warlingham, Surrey.

[It is quite a practical scheme, but not without drawbacks and by no means novel. Some four years ago the Dubilier people marketed a resistance device for limiting anode current. Dr. Roberts, our Scientific Advisor, patented this idea in the early days of radio.—Ed.]

DISTANT LISTENING

Sir,—As a listener of some considerable experience I cannot allow Captain Eckersley's article on "Distant Listening" to go unchallenged. Does he seriously mean that only the B.B.C. output is the best and all the others not worth listening to? I drop on to the B.B.C.

sometimes for music, *sometimes* I get harmony, but always for a musical feast via the ether I tune into a continental station. From Hilversum I get far greater pleasure, more pure and undistorted music, than from London. Sometimes I use Kalundborg, to mention only two of them. Has Captain Eckersley ever listened to the last-mentioned station when it has relayed 5 G B and the old 2 L O, and then, say, Berlin, then quickly switched his own set on to 2 L O direct; personally, I found no difference in the transmission whatever.

Hotted-Up Receivers

I think the mistake is made in using moderate-strength sets hotted right up and all out, and then blame results when the set picks up all mush and fringes of other carrier-waves. The continental stations are satisfactory, but not when heard via Captain Eckersley's or any other designer's 3- or 4-valve sets. Why should our recognised expert in wireless engineering blind himself and us to the fact that the Dutchman has passed us and the Germans, to say the least, are level with us as far as our radio transmission is concerned.

Give us circuits that will pick up these distant transmissions clearly. I use, personally, four stages tuned radio-frequency, with two filters in front of these, and get no interference, unless, of course, there are electrical disturbances in the air.

In closing I should like to add that I have built several of your powerful sets ("World-Wide" Five, "Invincible" Five, "Forte" Four, and "B.P." Five), none of these have been strong enough to get *music* from a distance.

Looking for Help

We are still waiting for Captain Eckersley to help us via good old

MODERN WIRELESS. I do hope sincerely that he is not going to degenerate into a grandmother.

What his article portrays we most of us knew years ago.

Thanking you,

Yours truly,

S. G. BRANDON.

Highgate Hill, N.19.

[Our correspondent seems to have very definite views on the subject! The further opinions and experiences of other readers, particularly regarding the performances of "M.W." sets, should prove of interest.—Ed.]

THE NEW GERMAN GIANTS

THE new Oslo broadcasting station operating with 60 kw. in the aerial, can be considered as of more or less the same type as the new German giant stations now under construction.

The same firm that built Oslo will also construct a number of the German high-power stations. And if Oslo is a big noise, remember that Germany is not so far away as Norway, and that the new German stations will be still bigger noises.

Work on the station at Dürrmenz-Mühlacker, midway between Stuttgart and Karlsruhe, is progressing rapidly. The aerial masts will be 100 metres in height and will be of wood. The second high-power station now under construction is situated close to the little town of Heilsberg, in Eastern Prussia.

News has come to hand that the other high-power stations will not be erected till 1931. It is hoped that the Mühlacker station will be ready by October of this year.

NOTE—A full page of photos of the Oslo station appears in this issue.

INDEX TO ADVERTISERS

	PAGE
Belling & Lee, Ltd.	611
Benjamin Electric, Ltd.	597
Bulgin, A. F. & Co., Ltd.	608
Burne-Jones & Co., Ltd. (Magnum).	604
"Bestway" Wireless Books	603
Carrington Manfg. Co., Ltd.	601
Dutch Manufacturer, etc.	609
Edison Swan Electric Co., Ltd.	513
Eastick, J. J. & Sons Ltd.	609
Ever Ready Batteries	514
Formo Company	610

	PAGE
Garnett, Whiteley & Co., Ltd.	611
Gilbert, J. C.	611
Heyberd, F. C. & Co.	597
Holzman, Louis	611
Hughes, F. A. & Co. Ltd.	Cover II
Igranic Electric Co., Ltd.	597
Impex Electrical, Ltd.	605
Jackson Bros.	609
Lissen, Ltd.	585
London Elec. Wire Co. & Smiths, Ltd.	602
Marconiphone Co., Ltd.	589
Mullard Wireless Service Co., Ltd.	Cover III
Pickett's Cabinet Works	608
Paroussi, E.	609

	PAGE
Radio Instruments, Ltd.	Cover IV
Ready Radio	607
Regent Radio Supply Co.	608
Rothermel Corp'n., Ltd. (Centralab)	605
Do. do. do. (Electrad)	604
Six-Sixty Radio Co., Ltd.	609
Telegraph Condenser Co., Ltd.	593
Telsen Electric Co., Ltd.	601
"This and That"	606
"Town and Country Homes"	605
Varley Products	593
Whiteley, Boneham & Co., Ltd.	601
Wright & Weaire, Ltd.	601

All communications concerning advertising in "Modern Wireless" must be made to John H. Lile, Ltd., 4, Ludgate Circus, London, E.C.4. Telephone: City 7261.

PLAIN FACTS ABOUT THE SCREENED GRID



The screened grid valve is used in the stage before the detector. Its purpose is to amplify the signals transmitted from the radio station before they become rectified by the detector. The magnifying power of the P.M. Screened Grid valve is so great that signal strength weakened by great distance from transmitters is counteracted. The design of the Mullard Screened Grid Valve is such that internal capacity is almost negligible—a fact that ensures stable and efficient high frequency amplification.

Ask your dealer for the following type numbers—

2 volt
P.M. 12

4 volt
P.M. 14

6 volt
P.M. 16



Above, an illustration showing the filament inside a Mullard Screened Grid valve. The thin thread-like filament represents the result of continuous and concentrated experiment in the Mullard Laboratories.

Mullard

THE · MASTER · VALVE

ADVT. THE MULLARD WIRELESS SERVICE CO., LTD., MULLARD HOUSE, CHARING CROSS ROAD, LONDON, W.C.2.

Alfred



The New Home of the Famous MADRIGAL ALL-ELECTRIC TRANSPORTABLE SET

The success of the "Madrigal" and other R.I. products created a demand that could only be met by larger and more up-to-date factories which we will occupy in June. The new Works are built on a site of over two acres on the Great By-Pass Road, between Thornton Heath and Purley, on the London-Brighton route.

Greater facilities for production of the "Madrigal" now enable us to comply with the demand of those who prefer to purchase out of income.

GENEROUS TERMS of EXTENDED PAYMENTS ARE AVAILABLE, PLACING THE "MADRIGAL" WITHIN REACH OF ALL

"Madrigal" is the first real diversion from ordinary radio reproduction.

If you are a music lover, and wireless reception, as you know it, jars you with its imperfections, hear the "Madrigal"; you will be amazed at its complete mastery of all notes and sound.

If you are a reader of wireless journals, you will know that the "Madrigal" has received *more favourable comments than any other transportable electric set. This is justified by the wonderful circuit performance and the amazing quality of tone from its moving-coil speaker.*

NO AERIAL OR EARTH IS NECESSARY for local reception, and it is *transportable anywhere* in the home where an electric light or power socket is available—it is ideal for summer use in the garden.

Ask for full particulars and a copy of the "Madrigal" booklet reproduced in full natural colours. Also let us arrange a demonstration in your home, through your local dealer.

The "Madrigal" All-Mains Receiver only, in walnut or mahogany, handsomely figured and polished.

Price, including all valves and royalties. **£30:0:0**

for A.C. or D.C. mains or deposit £4, and 12 monthly payments of £2:10:0

"Madrigal" All-Mains Receiver and Coil-driven loud speaker, complete, in walnut or mahogany. **£45:15:0**

For D.C. Mains or deposit £6:5:0 and 12 monthly payments of £3:15:0

"Madrigal" All-Mains Receiver and coil-driven loud speaker, complete, in walnut or mahogany. **£48:18:0**

For A.C. Mains or deposit £7:4:0 and 12 monthly payments of £4:1:6

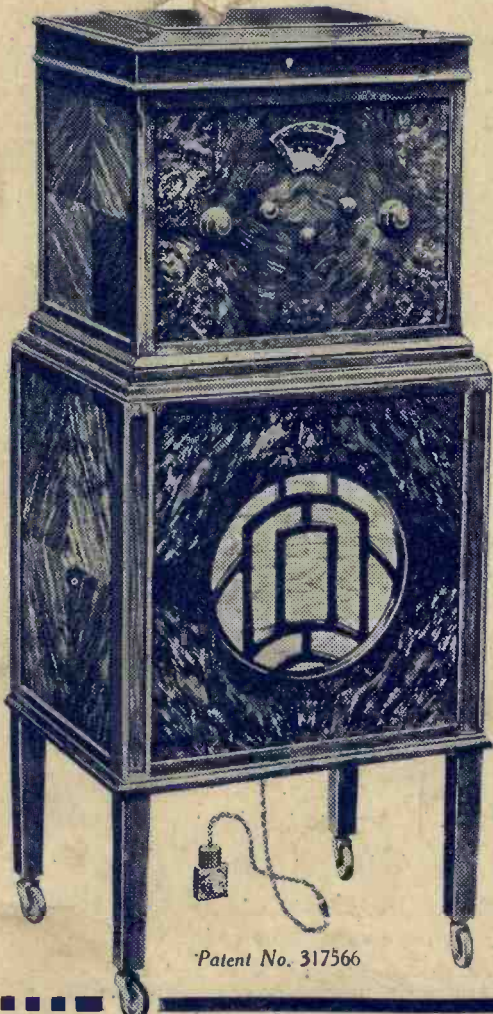

Patent No. 317566



R I LTD, 12 HYDE STREET LONDON W.C.1