

ANOTHER ARTICLE BY SIR OLIVER LODGE

# MODERN WIRELESS

1/4  
MONTHLY

Vol. XII. No. 32.

*The Leading  
Radio Magazine.*

AUGUST, 1929.

IN THIS ISSUE

THE "forte"



5



# IT'S RESEARCH THAT BREAKS RECORDS

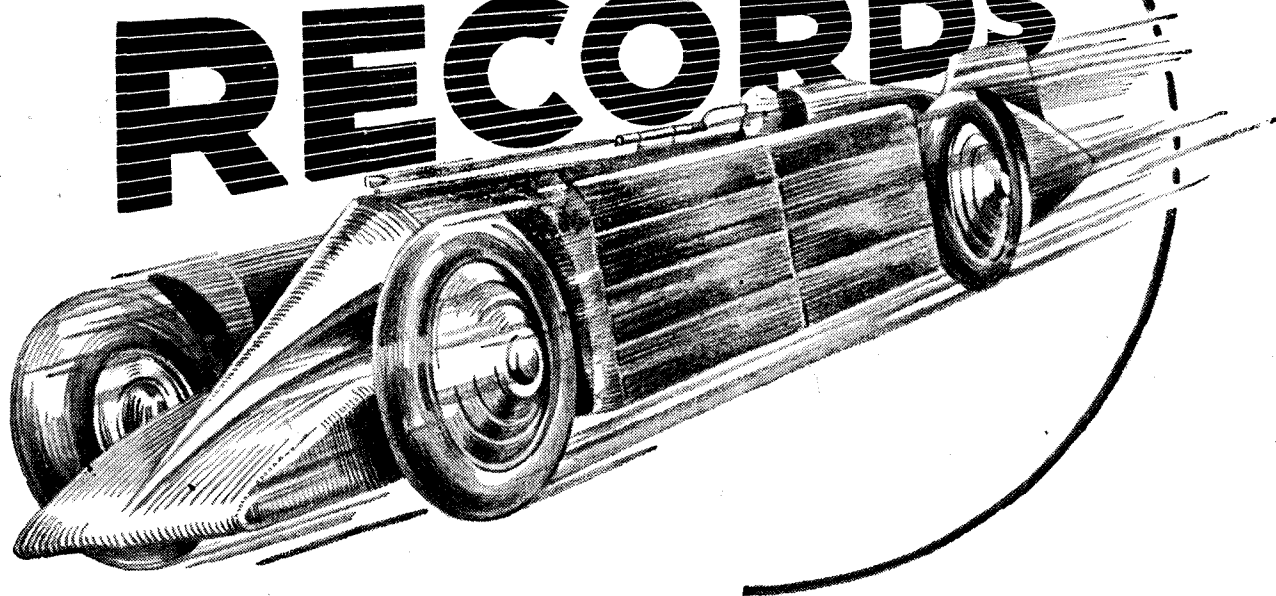

Every Mullard valve throughout the whole wide range is tested to be the best in its class. We would not risk losing one friend to satisfy an experiment.

Our research laboratories are always at work calculating—experimenting—perfecting. We realise that valve design is fluid and performance progressive, and we intend to be first in any future developments as we have always been first in the past.

It is this backing of test and experiment that enables us to say 'Try Mullard valves in *your* set—they improve any radio receiver!'

**Mullard**  
**THE · MASTER · VALVE**



**Advert:—The Mullard Wireless Service Co., Ltd., Mullard House, Charing Cross Road, London, W.C.2.**

Arks

# CONTENTS

VOL. XII. No. 32. MODERN WIRELESS. AUGUST, 1929.

Editorial .....	Page 103	The "Kendall" Three .....	Page 144
Other People's Aerials .....	104	Eliminator Distortion .....	149
On the Short Waves .....	108	A Modern Crystal Set .....	152
The Mystery of Radio Waves .....	109	My Broadcasting Diary .....	155
Improving the Reinartz .....	111	Positive and Negative .....	157
The "Forte" Five .....	114	Radio Set Refinements .....	158
What Readers Think .....	120	Questions Answered .....	162
Making Your Own Cabinets .....	121	In Our Test Room .....	163
The "Magnetic" Two .....	124	Radio at the Yard .....	165
Radio in America .....	128	Radio Abroad .....	166
The Problem of the Electron .....	133	Panel Peculiarities .....	167
Those A.C. Mains Valves .....	135	The Bridge Wavetrap .....	170
Lazy Waves .....	137	That L.T. Switch .....	172
Where the Small Orchestra Scores .....	138	Radio Notes and News .....	186
The Eccentric 'Earth' .....	141	In Passing .....	188
Building that Set .....	143	Some Accumulator Problems .....	194

SPECIAL SUPPLEMENT, "RADIO AND THE GRAMOPHONE," PAGES 175-184.

As some of the arrangements and specialities described in this Journal may be the subject of Letters Patent the amateur and trader would be well advised to obtain permission of the patentee to use the patents before doing so

Edited by NORMAN EDWARDS.

Technical Editor: G. V. DOWDING, Grad.I.E.E.

Scientific Adviser: J. H. T. ROBERTS, D.Sc., F.Inst.P.

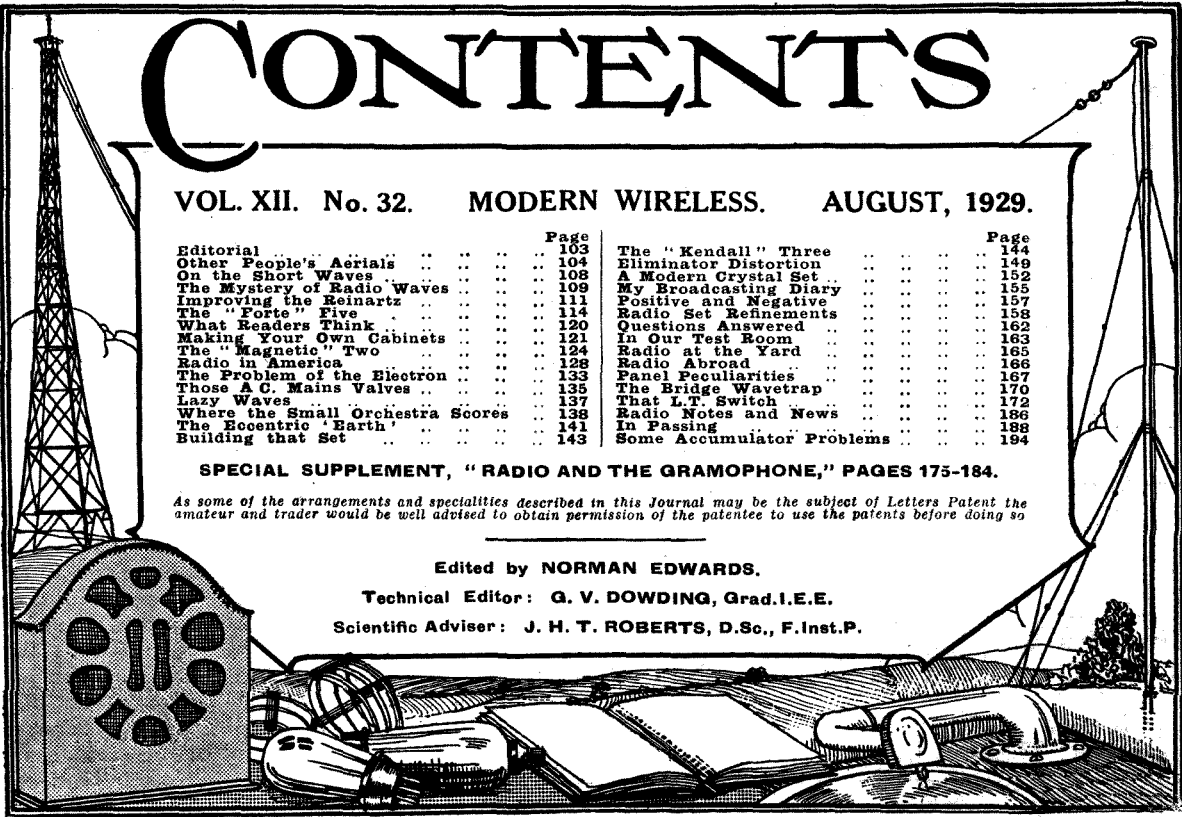

## The Sure Path to Perfect Reception

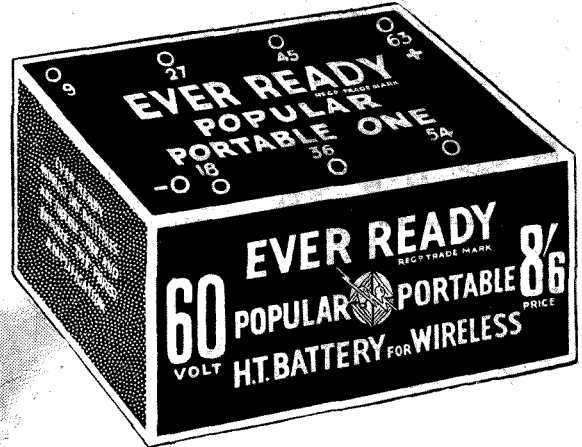

### SPECIAL UNITS FOR PORTABLE SETS

- PORTABLE 1. 63 volts 8 6 Size 6" x 5" x 3"
- PORTABLE 2. 99 volts 13 6 Size 9" x 5" x 3"
- PORTABLE 3. 108 volts 15 - Size 10" x 5" x 3"

# EVER READY<sup>Regd</sup> BRITAIN'S BEST BATTERIES

# SAFE!



**1.** The double length Cossor filament famed for its colossal emission. Note the seonite bridge holding it rigidly in position.

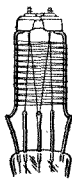

**2.** Around the two stout grid supports is wound the first grid, electrically welded at twenty-five points.

**Cossor makes greatest advance in valve design since the introduction of the Dull Emitter . . .**

# RIGID!

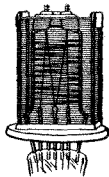

**3.** Note the enormous strength and rigidity of the screen. Built on four stout supports, capped by a metal bridge-piece anchored to seonite insulator

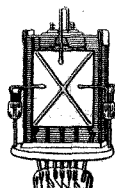

**4.** Finally, observe the construction of the anode. Actually two rectangular nickel plates are used and for greater rigidity each is diagonally ribbed.

The wonderful new Inter-locked Construction employed in the Cossor Screened Grid Valve eliminates all the inherent weaknesses in valve design. Under this system (illustrated here) each element is firmly braced top and bottom. Every joint is scientifically welded. This girder-like construction ensures absolute rigidity. It positively prevents the slightest individual movement of the elements. Even the hardest blow cannot disturb their perfect alignment.

As a result the Cossor Screened Grid Valve retains life-long uniformity of its characteristics. Its Inter-locked Construction (exclusive to Cossor) makes it the strongest and most robust Screened Grid Valve ever produced. Use Cossor in your Screened Grid Receiver — there is no substitute for the Cossor patented system of Inter-locked Construction.

# INTER-LOCKED!

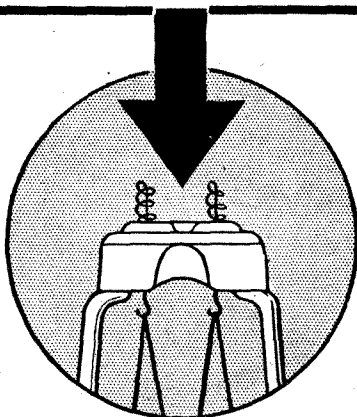

**Only Cossor Screened Grid Valves have inter-locked Electrodes**

# Cossor Screened Grid

**BRITAIN'S STRONGEST AND MOST DEPENDABLE SCREENED GRID VALVE**

Made in 3 types for use with 2, 4 and 6-volt Accumulator

Max Anode Volts 150, Impedance 200,000, Amplification Factor 200, Grid Bias 1.5 volts at max. anode Volts. Price (either type) **22/6**

A. C. Cossor Ltd., Highbury Grove, London, N.5.

9518





# MODERN WIRELESS



Vol. XII. No 32.

August, 1929

*This Month's "M.W." Sets—The Surprise Items—Sixteen Million Listeners.*

### *Five First-Class Receivers*

THE four receivers which we describe in this month's issue are all products of the MODERN WIRELESS Research and Construction Department. For example, there is the "Forte" Five, which may be regarded as the star set in this issue. This receiver incorporates two L.F. and two H.F. stages, and can be built entirely from standard and easily obtainable parts.

The circuit employs a combination of S.G. and neutrodyne H.F. stages, and by this method it was found on test that the receiver achieved great sensitivity, together with very satisfactory selectivity and stability. The Research Department, after putting the receiver through a series of exhaustive tests, report that in their opinion it is one of the best receivers which have been designed in the department.

The "Kendall" Three is an H.F., Det. and L.F. set, embodying a new reaction arrangement developed by the Chief of the MODERN WIRELESS Research Department, Mr. G. P. Kendall, B.Sc. It is a wave-change receiver, and with its volume control and increased sensitivity it may safely be said to represent a distinct advance in H.F., Det., and L.F. design.

The "Magnetic" Two is a powerful twin-valver for loud-speaker work. Readers will find it cheap and easy to build, and quite simple to operate.

We also include in this issue a Modern Crystal Set. We find from our correspondence that quite a number of our readers, close to a broadcasting station, still favour the pure reception obtainable with a crystal and telephones. The particular set we describe is one which includes a new method of giving the selectivity modern conditions together with the optimum sensitivity obtainable with a crystal detector.

In our special Radio and Gramophone supplement this month readers will also find constructional details of a fine electric radio-gram outfit. It comprises an all-from-the-mains three-valve radio set, and a moving-coil loud-speaker, and gramophone turntable, built into a neat and compact cabinet. Lovers of radio-gramophone technique will appreciate the compactness and general efficiency of this design.

### *The Surprise Items*

IT is interesting to note that a few days ago the B.B.C. celebrated the anniversary of its first Surprise feature. The Surprise Item was first introduced in the B.B.C. programmes as a weekly feature.

To be precise, the feature was started on July 13th—but, despite the superstitious number, it must be admitted that the feature has proved one of the most popular ever initiated by the B.B.C.

Undoubtedly the Surprise Item has proved a valuable outlet for novel ideas in B.B.C. entertainment; for example, readers will remember that it was the means of Seamark's introduction to the radio public in August, 1928, when he presented a sketch about Zeebrugge; while in the same month microphones were installed inside and outside the main signal-box at King's Cross station.

Another Surprise Feature which caused a lot of interest was the red-hot criticism of a play which had been performed the same night, and in September last year Jack Hobbs, Sutcliffe, Hammond, Duckworth and Leyland broadcast an au revoir to listeners before the England Cricket Team's departure for Australia.

Other items of the Surprise Feature consisted of the broadcasting of theatre queue entertainers, a surprise visit to the studios at Elstree, a tour of theatres, terminating with the curtain, cloak-room and traffic noises of the London Hippodrome.

In short, the Surprise Feature has been a very happy inspiration for the B.B.C., and we heartily congratulate them on the success they have achieved in this direction.

### *Sixteen Million Listeners*

ONE of the peculiar things about the study of broadcasting politics is that, although grumbles continue—and, in fact, increase—and although critics who should know better still advocate the adoption of an American policy of broadcasting (despite the fact that Canada has now decided to model its National Broadcasting system on the B.B.C.), the growth of wireless enthusiasm in this country is undoubtedly steady and progressive.

This may easily be gathered from the fact that the number of receiving licences in force at the end of May was 2,760,872, an increase of 20,000 over the figure of 2,740,872 at the end of April. 14,830 licences have been issued since the beginning of the year.



# Oth

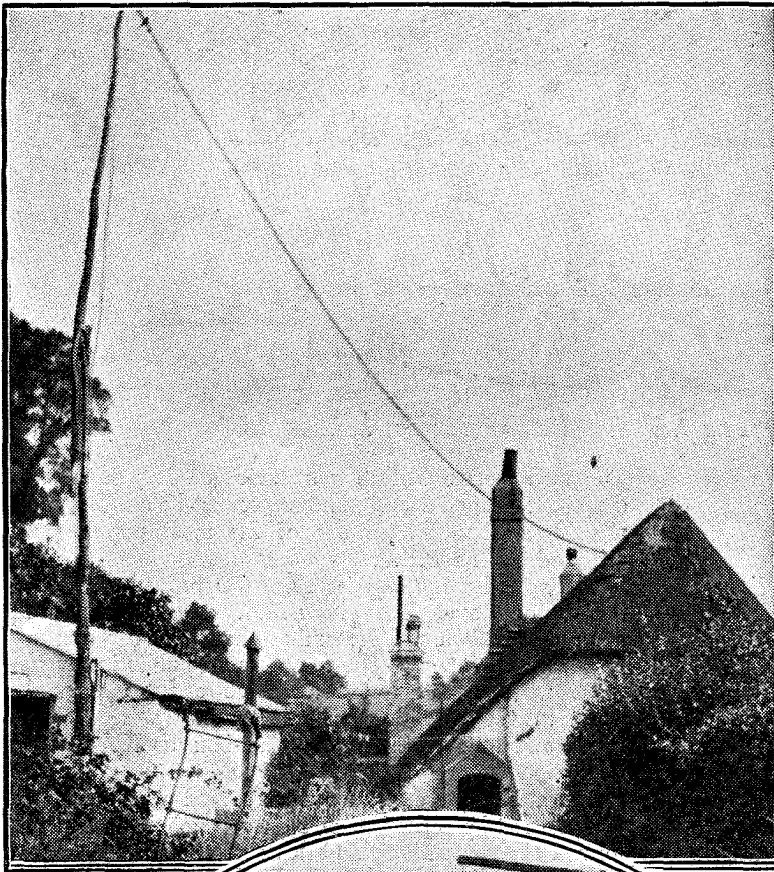

**H**AS it ever occurred to you that while much has been written about the town-dweller's aerial—how to avoid all the many difficulties which beset him in his crowded conditions, and so forth—the country dweller, who from his very location is particularly indebted to wireless, is largely ignored? The conditions in country districts are often quite different from those which obtain in town, and the country-dweller's problems are certainly worthy of separate attention.

## No "Local" Station

First of all there is, for him, rarely such a thing as the oft-quoted "local" station. In some towns an indoor aerial, or even no aerial at all, may be sufficient to pick up quite strong signals with an average set, for the simple reason that the station broadcasting is only a mile or two away. I have even known a case, within a mile of a broadcast station,

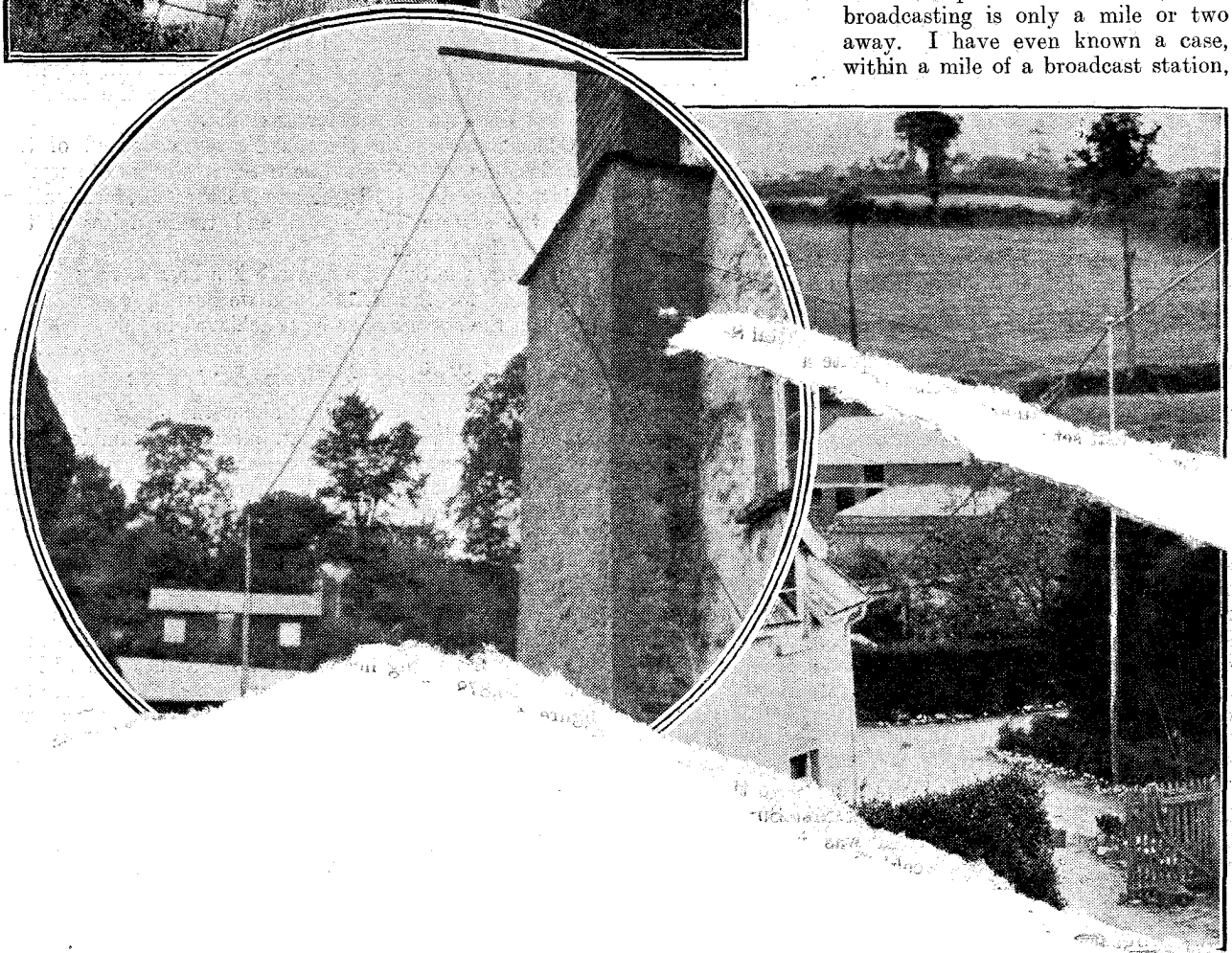

# People's Aerials

*It is always of interest to know how the "other man" fares, especially as regards his broadcast programmes. Radio reception in the country is picturesquely discussed in this special article.*

By PERCY W. HARRIS, M.I.R.E.

where it was found unnecessary to have even a wireless receiving set, for a pair of headphones connected to the ironwork in the building gave very clear reproduction of speech and music! Such occurrences are, however, rare and in the nature of freaks.

There are very large areas in this country where the nearest station is situated at least 100 miles away, and thus, unless multi-valve and perhaps expensive receivers are installed, more than ordinary care must be taken to see that the aerial system is efficient in order to obtain the maximum strength from the passing waves.



(Above) No longer "out of the world." London flat or country cottage — both have the news simultaneously.

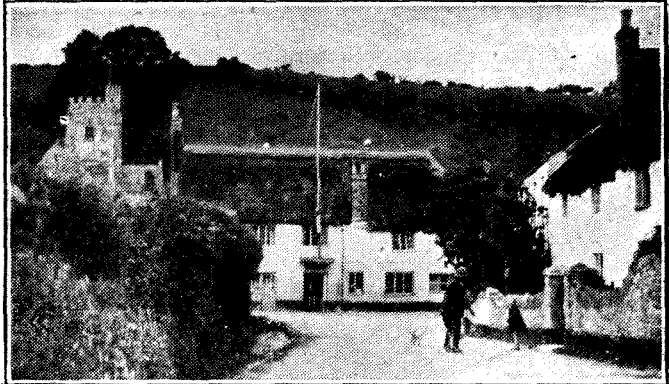

(Right) The village inn, for which a West End hotel may provide the orchestra.

(Below) A sign of progress in the wilds of Devon.

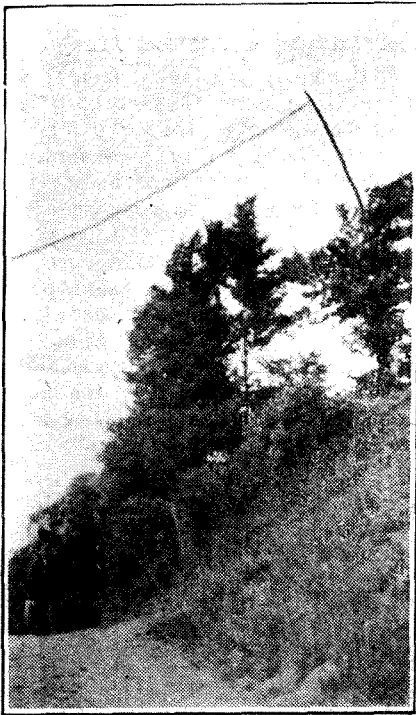

The hillside listener on the left places one mast in his grounds and the other higher up the hill, as shown in the photo above.

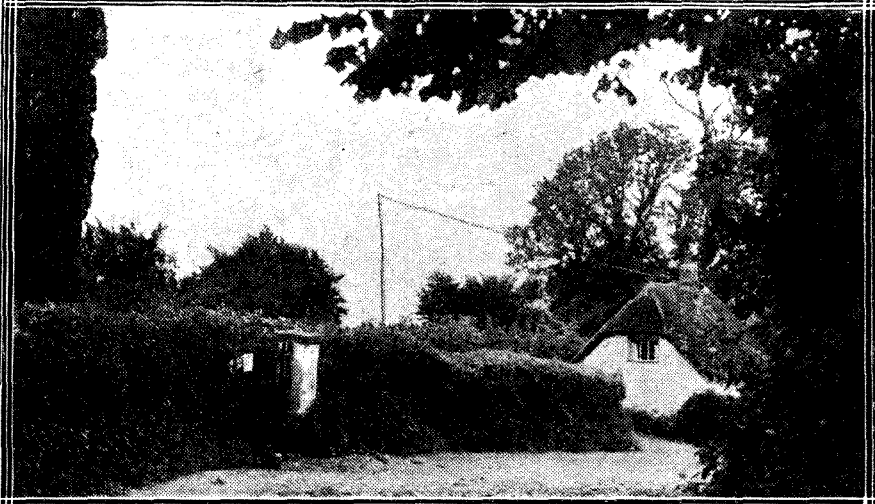



This is particularly the case with the crystal-set user, who in many country areas must depend upon 5 X X or 5 G B. It must be remembered that the crystal receiver has no amplifying power whatsoever, so that it is more than ever important with a crystal set to have a first-class aerial. In this connection I have seen in country districts many needlessly elaborate aerials, quite complicated and costly to erect, and actually from my own experience no more efficient than a single wire. If you use a crystal receiver, aim as far as possible for height and, as much as you can in your particular circumstances, keep the aerial well clear of all buildings. To get the height, do not be afraid to utilise any structure which will support the wire, but avoid running the aerial itself into the foliage of trees.

**Avoid Foliage**

If there is a high tree nearby, attach a rope to its highest portion and make the length of this rope such that its end, when pulled towards the house or wherever the receiver is installed, is well clear of any foliage.

An insulator (or, better still, a chain of three or four) should now be attached to the end of this rope and the outer end of the aerial wire joined to the insulator. Utilise as far as possible the full 100 ft. allowable, and make the earth connection as



This listener has taken his earth lead right through the pavement.

near the ground on the other side, where a heavy weight, such as a large stone, can be attached to it. The weight of this stone will normally keep the aerial quite taut, and as the tree sways in the wind the rope will run backwards and forwards over the pulley, adjusting itself as needed.

**Reducing Interference**

I have seen many country aerials badly screened by trees or adjacent buildings. If you can, try the aerial temporarily in different directions from the lead-in insulator. A few comparative tests in this way will reveal that one position is probably much better than the others, perhaps giving twice the strength of signals. I am also a great believer, when valve sets are used, in a long, low aerial, preferably erected so that its free end is in the direction exactly opposite to the broadcasting station from which you most often receive.

If an aerial can be supported on a few poles, each say 10 or 15 ft. high, using the full 100 ft. and carrying it into, perhaps, an adjoining field, it not only gives remarkably good reception, but is less liable to atmospheric disturbances. Also, being structurally much stronger, it is less likely to be damaged in high winds. Such an aerial is particularly good when a house is built on a hill.

**Increasing Effective Height**

If the house is situated in a spot where the ground rises abruptly a short distance off (at the foot of a hill, for example), then the support for the free end of the aerial can be a pole as far up the hillside as is convenient, but always remember that what you are aiming to do is to get the free end of the aerial as high as possible above the point where the instruments are situated. You may thus get an aerial with very considerable effective height, although the actual mast on the hillside stands but a few feet above the

efficient as you can. A few notes on earth connections will be given later in this article.

The trouble when using trees, particularly high trees, as an aerial support is that they tend to sway in the wind and cause the aerial at one moment to be very loose and the next too taut. If the form and disposition of the tree allows, it is not a bad plan to connect a pulley block at the top of the tree so as to run the rope over the pulley and down

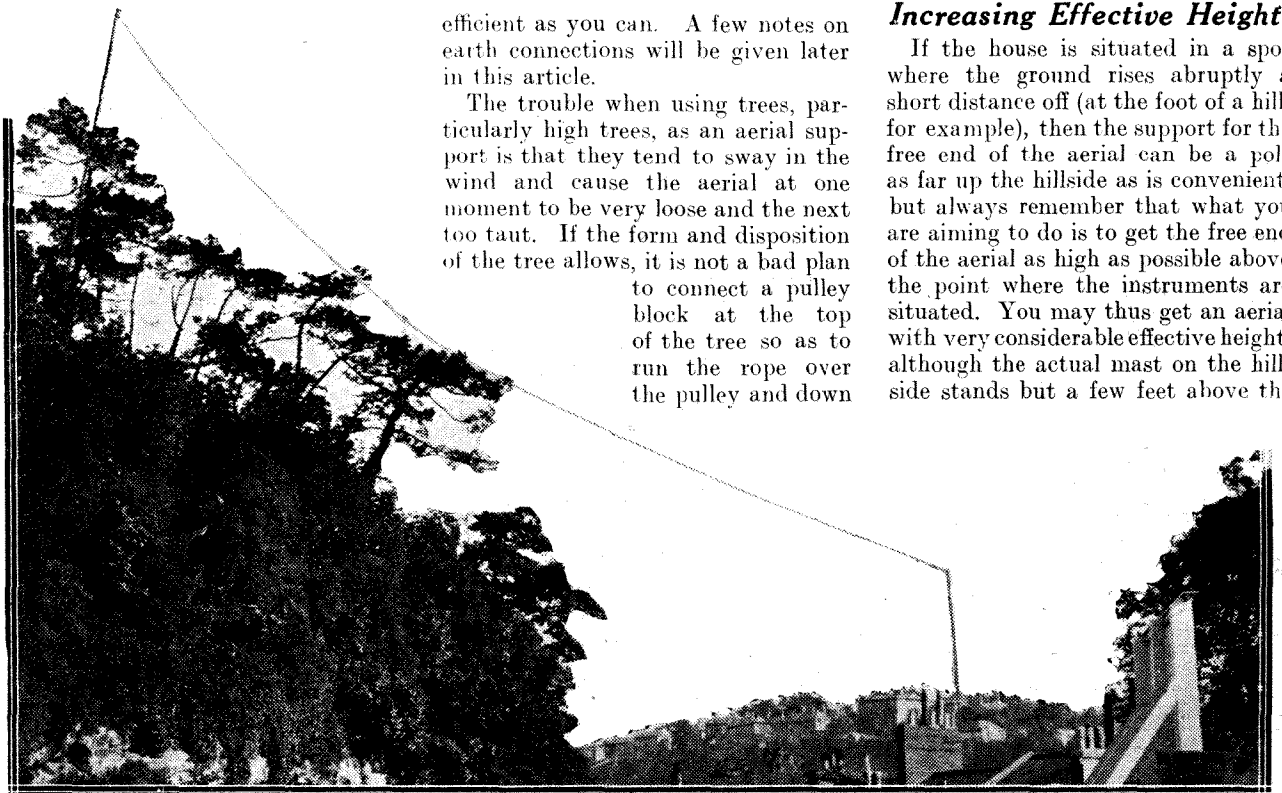

Something like an aerial. Both length and height are catered for in this Torquay enthusiast's structure.

soil. Such an arrangement is very good when the hillside faces the broadcasting station most often received, but much depends upon the nature of the soil, particularly in mining districts where there may be metallic ores not far below the surface.

### The Earth Connection

The earth connection, which often presents such difficulties to the town dweller, is easily made efficient in country areas. Sometimes there is a disused well available, in which case a copper-plate connection to a wire and dropped into it will give you the finest earth connection you could possibly wish for.

A nearby duckpond, brook, or river gives an excellent earth connection and is much preferable to a buried plate in comparatively dry soil. In some cases, however, the situation of the living-room in which the wireless set is used is such that an earth connection of the kind mentioned is impossible or inconvenient, and in one case brought to my notice and illustrated in this article the earth connection is apparently taken out of the front window to some buried metal beneath the pavement. One hesitates to think what would happen in a busy town if one attempted such an arrangement.

There are very many advantages in an earth connection consisting of a metal plate thrown into a neighbouring pond or stream, for not only does it make excellent electrical contact with a large area of the soil through the water, but it can be hauled up

\*\*\*

In the country you can often overcome difficulties arising from shortage of space by placing the mast in an adjacent field. Beware of passing the aerial over corrugated iron roofs or any structures made of sheet metal. If all the building is of metal, as often occurs with a modern farm structure, the effect of bringing the aerial near it is just the same as if you were to bring the aerial within a corresponding distance of the earth.

\*\*\*

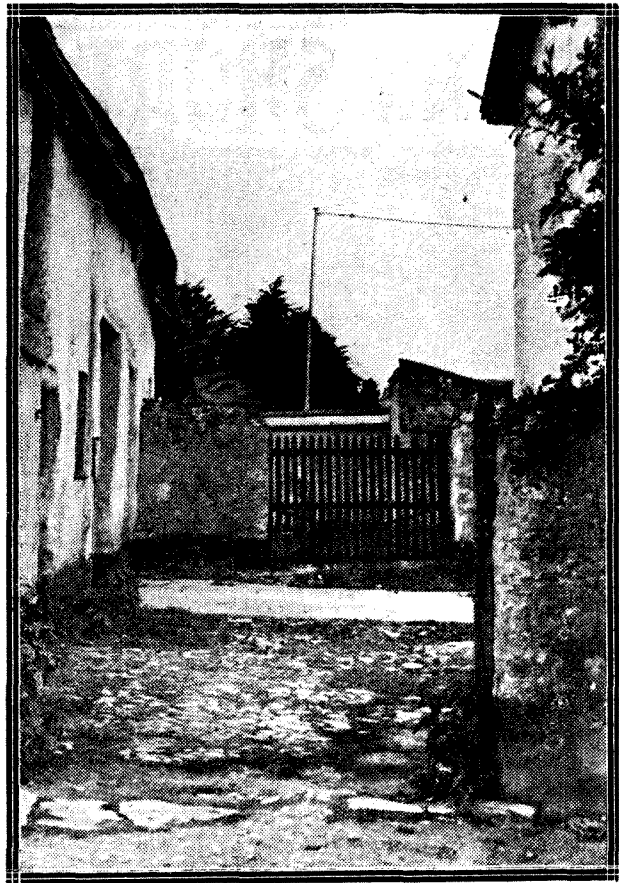

from time to time and examined, whereas the buried earth-plate or box may be corroded away completely without one knowing.

Several cases of this have come to my notice recently, many being due to the corrosion taking place at the point where the wire is soldered to the plate. A certain amount of

acid flux is often left around the joint, and this, in conjunction with the chemical effects of the soil, causes the connections to be completely severed, although the plate may still be in fairly good condition.

### Badly Designed Down-Leads

The chief criticism I would make after having examined a number of country aerials is that, while the aerial itself is generally quite efficient, making good use of the available facilities, much is often lost by the aerial being brought down either in contact with, or very much too close to, the house itself or to a guttering or drain-pipe. It is always best, if conditions permit, to fasten a piece of wood to the eaves so that it will project two or three feet away from the wall. The aerial can then be taken to this, so that in its downward path it is kept well away from the walls.

Such an arrangement is perhaps not so neat as an arrangement of insulated wire tacked to the wall, but in this regard it should be pointed out that the insulation, while preventing a dead short, does very little to prevent leakage of high-frequency currents, which pass into the adjacent conductors through the dielectric formed by the insulation.



In some locations shielding by trees may reduce the strength of reception.

# ON THE SHORT WAVES

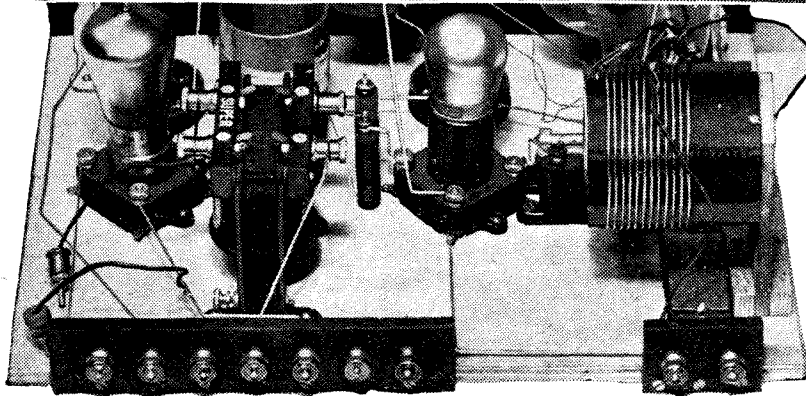

## Notes of Interest on Short-Wave Receivers and Reception. By W.L.S.

By pure chance I recently rigged up an H.F. amplifier for short-wave work, using one of the old double-ended type of screened-grid valves, and it seemed to me that it was giving extraordinarily good results compared with my standard amplifier, with which I had been quite pleased.

I have suspected for some time that individual S.G. valves vary considerably in their performance as amplifiers on the ultra-short waves, and probably there is no more than this to account for the fact that this particular specimen of the double-ended type proved exceptionally good.

### Wave-Change Wave-Meter

It is strange, incidentally, how valves can vary, particularly in this branch of radio, although on paper their characteristics may be absolutely identical; and, in fact, no ordinary test or measurements will reveal any differences whatever.

My most useful possession in the radio line just at present is one of very recent construction, and takes the form of a wave-change wave-meter, for use on either broadcast or ultra-short waves by the turn of a switch.

An "ultraudion" circuit is used (this facilitating the wave-change considerably), and, but for the fact that the whole thing with its valve and batteries is housed in a copper box, it resembles an ordinary ultraudion receiver. On the short waves the range is approximately 15-45 metres, and on the broadcast band the whole useful range is covered.

By plugging in a pair of 'phones it may also be used as a "monitor" for the transmitter, either on the working wave-length or on harmonics in the broadcast band.

There is a very interesting account in a recent issue of "QST" of some experiments recently carried out in the treatment of small animals by means of ultra-high-frequency radiations. The most interesting part of the article is that describing the various circuits used for obtaining waves of the order of 6 metres, 1.7 metres, and practically every intermediate wave-length. These high frequencies have, of course, been undergoing investigation by the medi-

cal profession for some considerable time, but nothing really definite has yet been found out concerning them.

I should be interested to know whether any of my readers have ever really mastered an "all-A.C." short-wave receiver (meaning, of course, A.C. on filaments as well). I have had several moderately successful attempts myself, but I have not as yet been really pleased with any of them, the chief fault being the way in which the A.C. hum came in when one ran into a "dead spot" over which the set would not oscillate.

An "all-A.C." short-waver would be a really useful set to have about the house, but the problem of obtaining a really perfect background is none too easy to solve.

### Special Detector Best

Incidentally, some snags arise when one uses a pentode in conjunction with an eliminator. I am doing so myself at present with no trouble whatever; but a friend of mine has had to provide a special terminal for the pentode priming-grid, with separate smoothing from all the rest of the supply, and even now he has rather a "mushy" background.

I am still strongly in favour of a special short-waver consisting of a detector only, and a really efficient detector at that, carefully screened and laid out, and the output arranged in such a manner that it can easily be strung up to any amplifier available. It is a good idea to use parallel-feed to the detector through an L.F. choke, so that an amplifier with practically any type of L.F. transformer may be used.

## "POLSKIE RADIO"

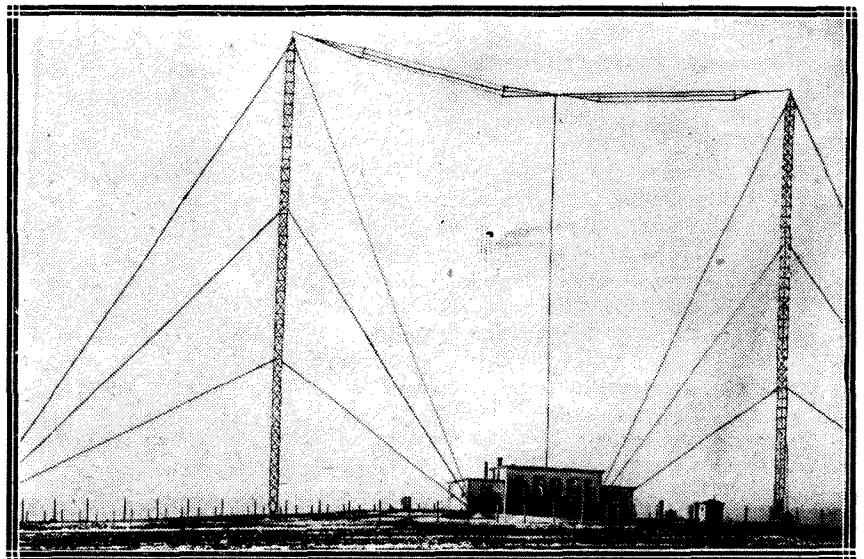

The aerial system of the Kattowice station, in Poland, which is often heard in this country. It broadcasts on 408 metres with a power of 10 kw.



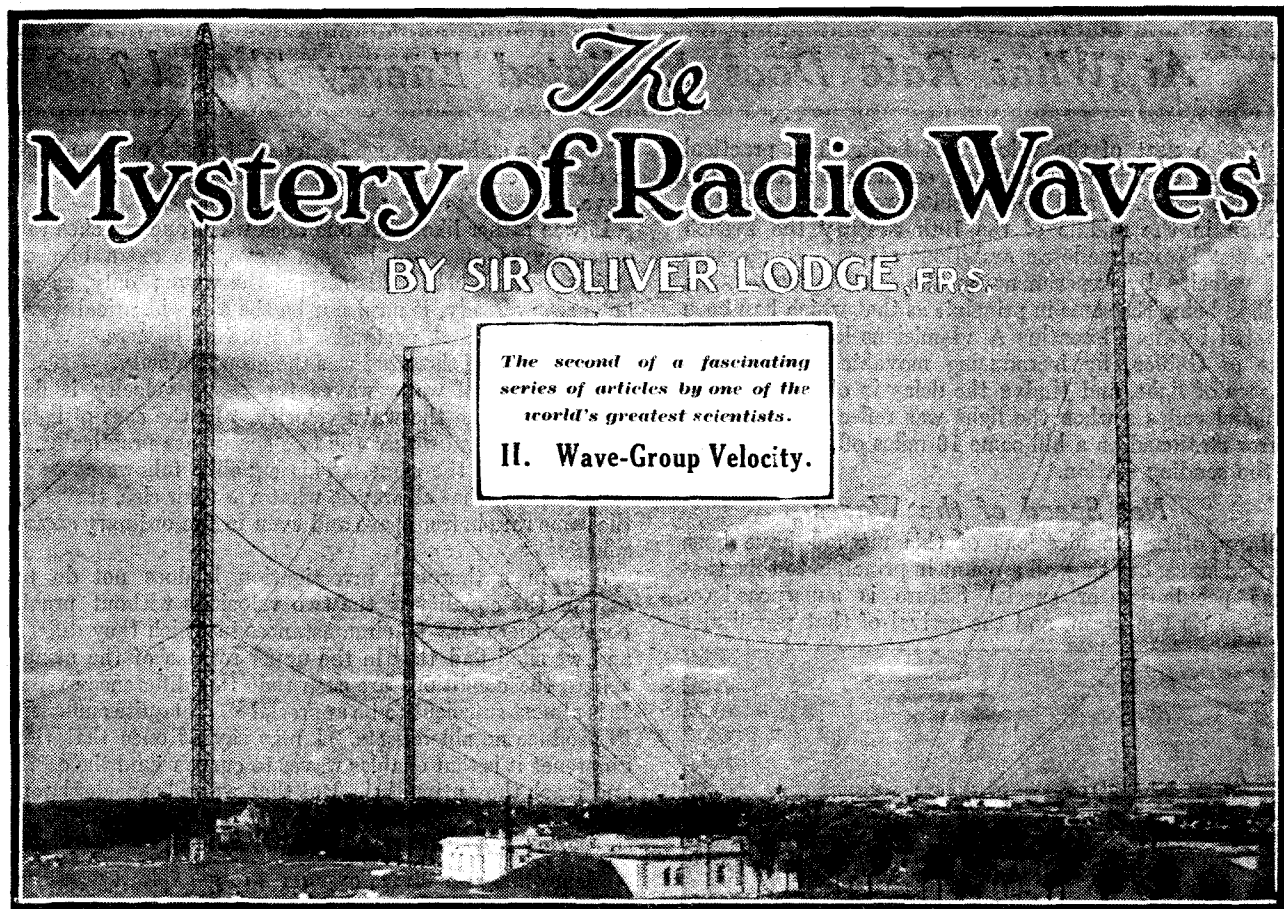

ANYONE at the seaside who has watched with care water waves approaching the beach may have noticed that if he fixes his eye on a specially big wave at a little distance, it does not always retain its bigness as it approaches but tends to get flattened out, while some other wave, originally smaller, swells up into a bigger one. In other words, a wave does not always retain its individual features.

We can hardly label a wave so as to identify it. If we did put a label on a wave—even a mental label—the label would be left behind. It might come in, but it would come in slower.

### *Comparatively Simple Laws*

So if we fix our attention on any specific group of waves, or upon a wave with some individual peculiarity, and watch for the travelling of that peculiarity, we must not expect it to adhere to any one wave and to travel with it. The marked or group peculiarity will travel at a different rate from the waves themselves. This is not so in every kind of wave, but it is so in water waves, and it is so in ripples, in fact, it is so whenever the wave velocity depends in any way on the wave-length, that is, whenever waves of all wave-lengths do not travel at the same rate.

In all such cases therefore we have two velocities to consider, a wave velocity and a group velocity, and these are connected by certain laws. If it were true that these laws never apply to wireless waves or ether waves of any kind, the subject would not be appropriate to this journal, but as a matter of fact those laws do apply under certain circumstances, and so a better understanding of them is desirable.

Fortunately we are not called upon to attend to this complication often, because the laws of light waves and

sound waves are comparatively simple, simpler in fact than any other kind of waves. In sound waves there is no difficulty at all, individual waves and group waves travel at the same rate in air; but that is not always true of ether waves.

It is, however, practically true in ordinary cases, otherwise we should find it difficult to determine the velocity of light. For let us think what we do when we make such a determination.

The first determination was made astronomically, about the year 1700, by the eclipses of Jupiter's satellites. On timing the interval between successive eclipses of the satellites by Jupiter's shadow, Römer found that the time interval stretched when the earth in its orbit happened to be moving away from Jupiter, and on the other hand was contracted when, on the other side of its orbit, the earth was approaching the region of the eclipse.

Measurement of the apparent acceleration and retardation of the satellites gave Römer the necessary data for the determination on the hypothesis that it was only an appearance due to the motion of the earth and the velocity of light. The result, however, was not accepted by astronomers, because it was a new idea that light took any time at all to travel, and the velocity came out excessively great.

### *Further Experiments*

The next determination was made half a century later, when Bradley, the astronomer at Oxford, in trying to measure the distance of stars, observed that each star described a small circle or ellipse about its mean position once a year in every case; thus proving that the apparent motion was not real, but was an appearance caused by the earth's travel round the sun at a speed

# At What Rate Does Radiated Energy Travel ?

1/10,000th part of the velocity of light. The practical agreement of this with Römer's estimate overcame the scientific scruples, and both results were now accepted.

Then in the middle of the 19th century the French physicist Fizeau made an ambitious attempt to measure this velocity by experiment on the earth's surface, his method being the same in principle as that which had been adopted by the Florentine Academicians long ago in the time of Galileo, by introducing movable shutters into a beam of light, and timing the delay in observing these artificial eclipses when the light was reflected back by a mirror stationed on a hill some 16 miles off, and returned to the sending station.

### Not Speed of the Waves

Many other modifications of this method have been devised since, but they all amount in principle to this, that some peculiarity or special feature is superposed or inflicted on the beam, and the arrival of that peculiarity

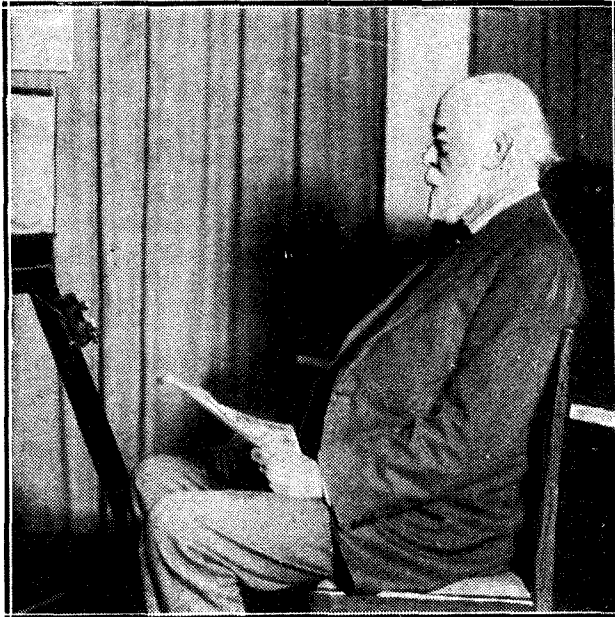

Sir Oliver Lodge, F.R.S., before the microphone at Savoy Hill during one of his series of interesting talks on popular scientific subjects.

after its journey is timed, of course, by some ingenious mechanical device, so that the speed really determined is not the speed of the waves themselves, but the speed with which this peculiarity travels; the peculiarity, both in Fizeau's case and in Römer's case, being a variation of

intensity, a sudden change from dark to light or from light to dark, a change, that is to say, in the amplitude of the wave.

It was rather like what one does when one watches the oncoming of an extra big sea wave, the extra bigness acting as the label for identifying the wave; only, as we have seen already, it need not be the same identical wave which retains that particular feature of bigness. What Fizeau observed therefore was the group velocity.

In the case of water waves the group velocity is decidedly less than the wave velocity. In the case of light waves we now know that the two speeds are practically, if not accurately, the same. This equality follows at once from the fact that all waves, whatever their size, travel at the same rate in free space and even in the ordinary atmosphere.

Still in a thorough investigation it does not do to assume the equality of the two velocities without proof, because there may be circumstances in which they differ: and we shall find that in the upper regions of the atmosphere the conditions are such that this difference exists. It is almost sufficient to be appreciable, and quite sufficient to produce notable effects. I may say at once that this difference it is that enables waves to curve round the earth and reach the Antipodes! But that we will consider later.

### Light a form of Energy

Meanwhile we may express group velocity rather differently. Light or radiation generally is a form of energy, travelling energy; and that energy is what we receive and detect at a receiving station. The question is at what rate does radiation-energy travel.

Recent investigations seem to have made it certain that the energy travels with the group rather than with the wave, and that just as Fizeau observed the group velocity so should we if we attempted to measure the interval of time between the emission of a signal and its reception at the Antipodes, or, indeed, at any nearer station. Hence we might call the group velocity the energy velocity.

Now the theory of Relativity makes it pretty clear, at any rate it definitely assumes—the hypothesis being fairly confirmed by the consistency of its results—that energy cannot possibly travel faster than light. It may travel at the same rate, or it may travel slower, it cannot travel quicker.

Only when the speed of waves depends in any degree on the wave-length does the difference arise. If all waves travel accurately at the same speed, so that there is no dispersion, then radiation energy travels at one constant speed, which we call the velocity of light.

\*\*\*\*\*

**NEXT MONTH'S "MODERN WIRELESS"**

will contain, in addition to its usual features,

**A Further Special Article by Sir OLIVER LODGE, F.R.S.**

and full constructional details of

**FOUR MORE FINE RECEIVERS**

Make sure of your copy and avoid disappointment by placing your order now.

\*\*\*\*\*

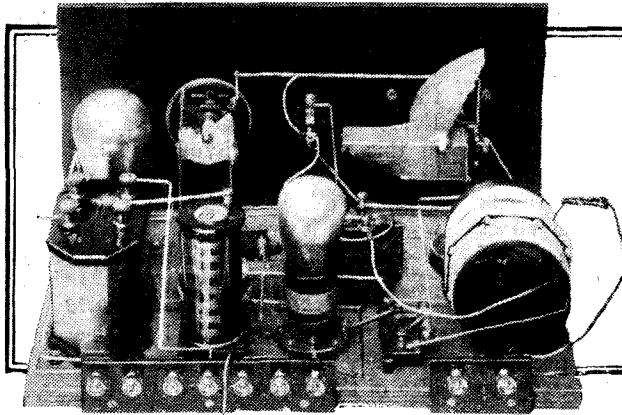

# IMPROVING THE REINARTZ

THAT old controversy about the rival merits of swinging coil and Reinartz reaction seems nowadays to have settled itself to the satisfaction of everyone, except the die-hards of either party, pretty much as follows: The swinging coil method is definitely more difficult to handle, since it calls for considerable delicacy in adjustment and also upsets the tuning perceptibly. Consequently, it must be confessed that it requires considerably more practice to handle such a set than one of the Reinartz variety.

Granted moderately expert handling, however, there can be little doubt that decidedly greater sensitivity to weak signals is obtainable with it; Reinartz reaction, on the other hand, is much easier to handle in almost every case, since with its aid it is a very simple matter to obtain particularly smooth and gradual control, and it has much less effect in upsetting the tuning. Against these advantages we must balance the notable disadvantage that it does not seem in the majority of cases to give quite such good signals on distant stations.

### Why Is It?

Much depends upon the handling of any given circuit, and we can probably sum up the matter by saying that in expert hands, or, at least, in reasonably practised ones, the swinging coil circuit is more sensitive, but it is quite likely that the average non-technical user of a wireless set will get at least as much with the aid of the Reinartz arrangement simply because it is easier to make the correct adjustments. Now, it is natural that one should inquire just why it is that the Reinartz arrangement should appear to give this lower sensitivity, and the inquiry is one which must have passed through the minds of most experimenters of any experience.

*Many are the advantages of capacity-controlled reaction, but its sensitivity usually falls a little below the older swinging coil method. A successful attempt has been made by the "M.W." Research Dept. to determine the cause of the trouble and devise measures for removing it. This valuable work is described below*

**By G. P. KENDALL, B.Sc.**

Many people who have thought over the problem have had a suspicion that the difference was due to something which might be described as H.F. choking in the plate circuit of a Reinartz detector, and it is interest-

ing to compare the two arrangements in the light of this possibility. We shall see at once that in the case of the swinging coil reaction circuit there is a comparatively free path for H.F. impulses from the plate of the valve back to the filament circuit, by way of the reaction coil, and the usual fixed condenser across the telephones (assuming that it is a single-valve circuit). This is, naturally, a comparatively low impedance circuit at radio frequency.

### Lack of By-Passing

In a Reinartz reaction circuit, on the other hand, the H.F. impulses have a choice of two paths, of which

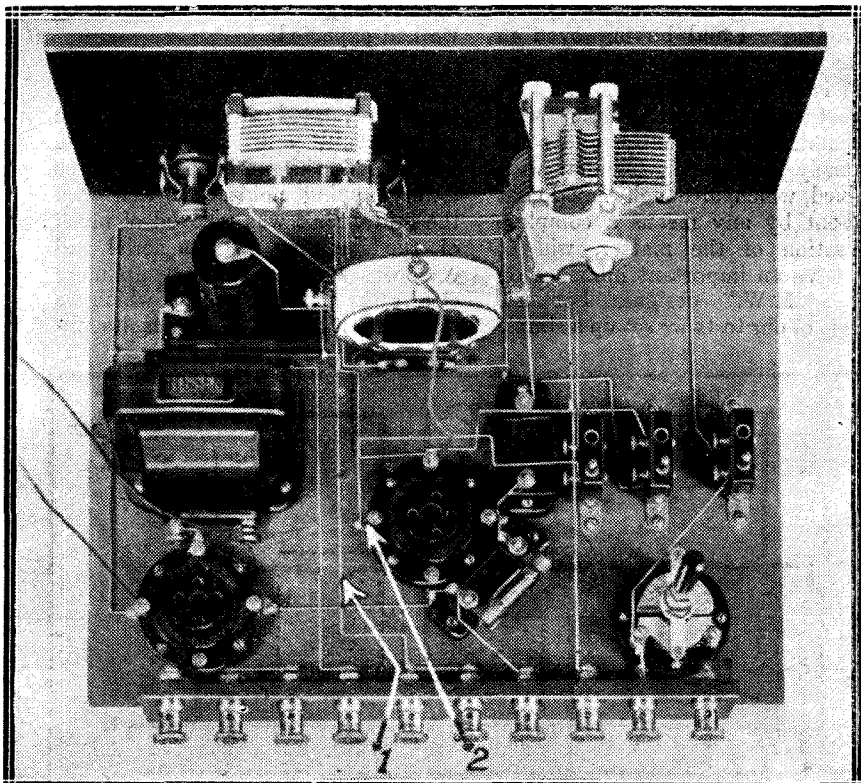

Existing sets with capacity-controlled reaction can be modified very easily to incorporate the new sensitivity-increasing device. All that is needed is a compression-type adjustable condenser connected between points 1 and 2 (L.T. — and detector anode).



one is from the anode through the H.F. choke, and so via the telephones or the intervalve coupling device (or any bypass condensers provided) to filament. Naturally, the H.F. choke pretty well settles the matter here, since it makes it a very high impedance path. The other path is through the reaction condenser and reaction winding to filament, and it must be remembered that we shall often be

measuring circuit, consisting of a detector valve auto-coupled to an aerial and earth, with an H.F. choke in the anode circuit and a milliammeter to indicate by its change of reading on tuning-in the local station at what strength that signal was being obtained. In addition, arrangements were made to determine the effect of inserting a bypass condenser of various sizes from plate to filament, with a view to determining just what gain in signal strength there might be with this bypass in position, and what capacity was necessary to obtain the best effect.

tained now were decidedly striking, since the figure without the bypass was only 4 on our scale, whereas with the addition of the bypass it was 16.5. Evidently, then, there was something in this matter of bypassing, and it became obvious that where other damping effects in the tuned circuit were low, it would probably prove of very considerable importance.

**Practical Modifications**

The figures obtained, by the way, are likely to give rather an exaggerated idea of the importance of the bypass, since it must be remembered that in a practical circuit there would always be a certain amount of bypassing to filament, and we next made tests to see whether the small capacity normally present in this position was sufficient to have a beneficial effect. Readings were accordingly taken with a range of quite small capacities graduated in small steps up to a maximum of .0001 mfd., and interesting figures were obtained.

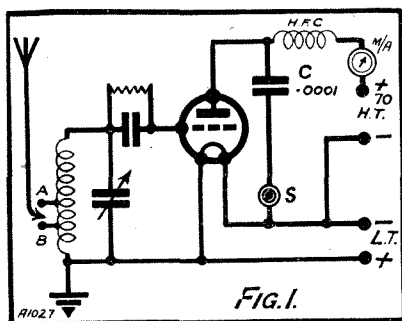

FIG. 1.

working with quite a small setting of the reaction condenser capacity, which again means a high impedance path.

**Methods of Measurement**

Space will not permit us to go into the matter in much detail from this point of view, but it has been obvious to the "M.W." Research Department for some time that the point was one calling for attention, for if the Reinartz could be improved in this respect it would naturally become a still more valuable circuit.

Accordingly, some simple tests were undertaken recently, and some extremely interesting results were obtained, which, although they do not represent by any means a complete exploration of the matter, will at least have an important influence on future "M.W." designs. For the purpose of our tests we set up a simple

**Linked up with Damping**

The circuit used is illustrated in Fig. 1, and you will see that it is of a very simple nature. The tuning coil has two alternative tappings for the aerial, giving two different degrees of coupling, and the first step was to determine the effect of adding a .0001-mfd. fixed condenser (C) as a bypass with the aerial tapping connected to the point A (the larger tapping point).

Results at first were somewhat disappointing, since the figure of signal strength obtained without the bypass was 14 (a purely arbitrary scale used for comparative purposes) and with the bypass the figure was 18. This seemed to indicate quite a small change, very much less than we had expected.

Thinking the matter over, it was remembered that the effect was probably related to damping in the grid circuit, and accordingly we transferred the aerial lead to the lower tapping point. In this way the grid circuit was relieved of much of the damping of the aerial and thus was set free to show up more clearly the particular effect which we were investigating. The results ob-

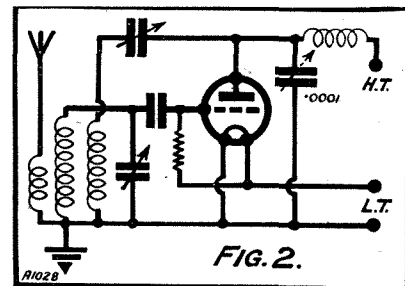

FIG. 2.

We need not trouble the reader with the whole of them here, but up to a value of about .00005 mfd. there was a steady and rapid rise in signal strength, and a more gradual rise from this point up to .0001 mfd., in the particular circuit under investigation. From these tests it is evident that in normal circuits very considerable benefit would be obtained by providing a considerably greater amount of bypassing from plate to filament than is given by the usual Reinartz reaction circuit, with its comparatively small condenser setting.

**Deductions Confirmed**

Further tests were made in which the bypass circuit contained various forms of actual reaction arrangements, these being arranged at some little distance from the tuned circuit, so that true reaction effects should not take place, but, rather, pure bypassing ones, and the results obtained with these more practical arrangements fully confirmed the preliminary deductions made after the first simple tests.

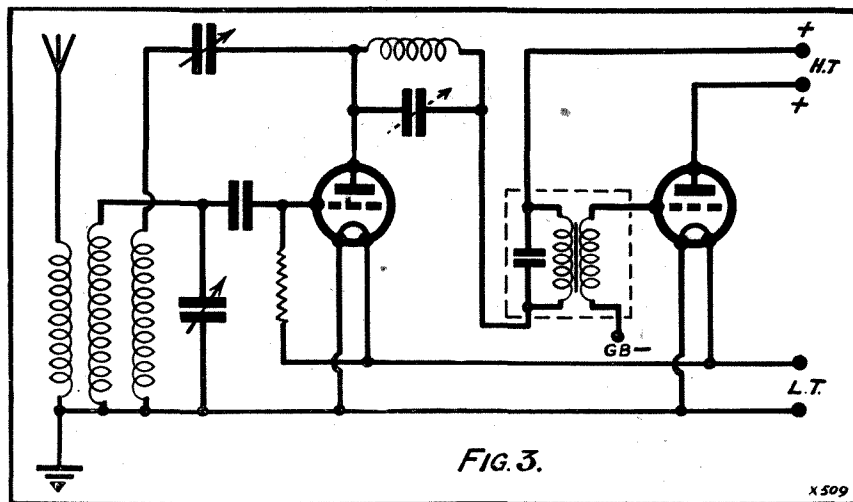

FIG. 3.

x 509

## Sensitivity Without Losing Simplicity

An important aspect of the question concerns the comparatively strong stations on which very little reaction is used, such as the local and 5 G B and 5 X X, since here to obtain good quality one generally sets the reaction condenser right back to zero, in which condition it is evident that a considerable sacrifice of signal strength is being made as a result of the almost complete absence of bypassing from plate to filament. The minimum of the average reaction condenser is definitely too small to serve this purpose at all effectively.

### Future Policy

Having determined the benefits likely to be obtained from the use of extra bypassing from plate to filament in a Reinartz circuit, we made some more tests in actual receiving circuits, and find these benefits quite definitely present, with a marked improvement in sensitivity. We still do not feel that the Reinartz, even in this improved form, is *quite* up to the level of a swinging-coil set in really expert hands, but it is definitely a considerable step in the right direction. We are accordingly planning to provide extra bypassing in such of our future designs as seem suitable, and the reader will no doubt be interested to see some preliminary suggestions as to how this may be done.

Taking first the simplest case of a single-valve receiver, or one in which the detector is followed by a stage of resistance-capacity coupling, it will be seen that all we have to do is to provide a suitable small bypassing capacity from plate to filament, as indicated in Fig. 2. The effect of this will naturally be to require a larger setting of the reaction condenser to obtain actual effects, this again assisting in producing bypassing effects.

### Practical Adjustments

In practice, we have found that by using one of the compression type semi-adjustable condensers, having a maximum capacity of .0001 mfd., it is quite easy to find a suitable setting, the procedure being simply to find the point on the tuning range where the circuit requires the maximum reaction capacity, and then to introduce the bypassing capacity until it is only just possible to obtain sufficient reaction here with the

reaction condenser full in. The improvement in sensitivity at other portions of the scale where the reaction condenser would otherwise be working at quite a small setting is then quite perceptible.

The matter is not quite so simple where the detector is followed by a stage of transformer coupling, since the use of a bypassing condenser here is, in effect, to shunt capacity across the primary of the transformer, and this may be regarded as objectionable from the point of view of the designer of the transformer.

This is particularly the case with those types of transformers in which a condenser is provided across the primary winding actually inside the transformer, since the addition of extra capacity is rather an unfair thing to do, in view of the fact that the manufacturers have carefully chosen the right capacity for their production.

In such cases an alternative connection for the bypassing condenser would be simply across in parallel with the H.F. choke, as is suggested in Fig. 3. Here it has the desired effect in providing bypassing from plate to filament (through the condenser across the transformer primary), and yet it does

interested in the distinctly improved results which he will obtain with their aid.

### Throttle-Controlled Circuits

A rather difficult case, by the way, is likely to be found in the case of the so-called throttle-control circuit. Extra bypassing provides a distinct improvement here, just as in the case of the Reinartz, but it is no longer possible to connect the extra condenser across the choke, as in Fig. 3, to avoid shunting the primary of the low-frequency transformer.

Evidently some other expedient must be developed for this circuit, and various methods are now being investigated. One arrangement which seems promising in preliminary tests is to shunt the bypass condenser

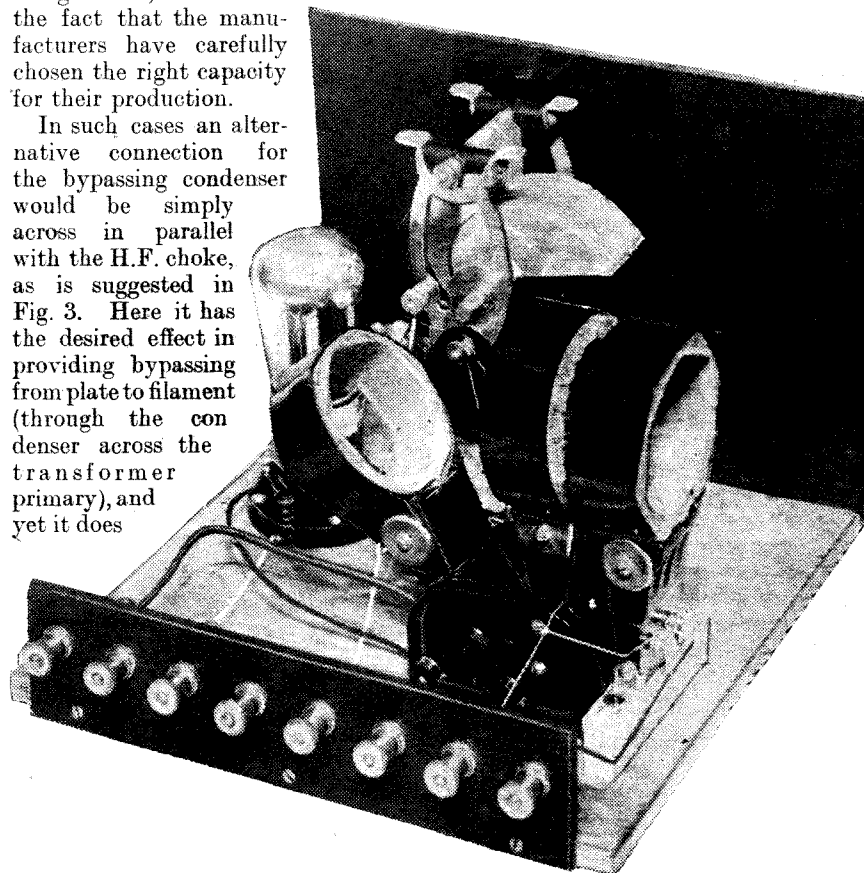

The swinging-coil reaction circuit probably owes its admittedly higher sensitivity to the fact that there is a fairly free path of escape for H.F. impulses from plate to filament of the detector valve.

not have the previous objectionable effect just noted.

Other methods of introducing bypassing will be developed for use in different set designs in the future, and we think the reader will be

right across both reaction coil and H.F. choke—i.e. from the anode of the detector valve to the junction point between the H.F. choke and the L.F. transformer primary. This should have the desired effect.

# The "Forte"

By the "M.W." Research Department.

"ANOTHER mongrel" did you say? Perhaps a natural remark on discovering that this design includes one screened-grid H.F. stage and one ordinary neutralised one, but please suspend judgment until you have heard arguments which we think will convince you that "hybrid" would be a better description. We hope you will agree after hearing our case that by crossing two strains in this particular fashion we have produced something which has a goodly measure of the merits of both parents and is to a considerable degree free from the vices of either.

## The Problem

If you consider what it was that we set out to produce and the alternative ways of achieving our object you will begin to see the point. What we wanted to do, then, was to turn out a good, sound design of the rather "super" class; that is to say, a fairly large set which could be depended upon to bring in pretty well anything that was going, and the first point to be settled was whether one or two high-frequency stages should be used. Well, one ordinary neutralised stage is obviously not enough, and one turns for a moment to the idea of a single screened-grid stage.

Now, to obtain sufficient magnification from a single screened-grid H.F. stage for a set of the calibre we had in mind is not by any means easy and means using very special and somewhat expensive coils. Even then it is by no means certain that

\*\*\*\*\*

### COMPONENTS REQUIRED

- 1 Panel, 24 in. x 7 in. x  $\frac{1}{4}$  or  $\frac{3}{16}$  in. (Resiston, "Kay-Ray," Becol, Ripault, Trelleborg, etc.).
- 1 Cabinet, baseboard 10 in. deep, and pair of panel brackets (Ready Radio, Raymond, Cameo, Artercraft, Pickett, Lock, Bond, Gilbert, Caxton, etc.).
- 3 .0005-mfd. variable condensers, and vernier dials if condensers not of slow-motion type (Lissen, Utility, Lotus, J.B., Cyldon, Raymond, Igranic, Dubilier, Ormond, Burton, Pye, Gecophone, Colvern, Formo, etc.).
- 1 .0001- or .00015-mfd. reaction condenser (Burton, Lissen, J.B., Utility, Dubilier, Cyldon, Peto-Scott, Raymond, Bowyer-Lowe, Ormond, etc.).
- 1 Panel-mounting rheostat (10 ohms for 2-volt valves, or 20 to 30 ohms for 6-volters). (Precision, Lissen, Igranic, etc.).
- 1 Jack (Lotus No. 2 or equivalent).
- 1 1-meg. or 2-meg. volume control (Igranic, Magnum, Gecophone, R.I., Gambrell, etc.).
- 3 10 in. x 6 in. standard screens (Ready Radio, Paroussi, Peto-Scott, etc.).
- 5 Sprung valve holders (Formo, Lotus, Igranic, Pye, W.B., B.T.H., Benjamin, Marconiphone, Magnum, Wearite, Precision, Bowyer-Lowe, etc.).
- 1 Baseboard neutralising condenser (Magnum, Peto-Scott, J.B., Bowyer-Lowe, etc.).
- 1 Single-coil holder (Lotus, Ready Radio, Wearite, Igranic, Magnum, Peto-Scott, Raymond, etc.).
- 2 6-pin coil holders (Magnum, Leweos, Raymond, Bowyer-Lowe, etc.).
- 3 1-mfd. and two 2-mfd. condensers (T.C.C., Lissen, Dubilier, Hydra, Mullard, Ferranti, etc.).
- 2 100,000-ohm and two 25,000-ohm resistances, with holders (Cosmos, Varley, Dubilier, Mullard, Lissen, Precision, Igranic, etc.).
- 2 H.F. chokes (Bowyer-Lowe and Precision in set. Any good make, e.g. Varley, Igranic, Dubilier, Leweos, Lissen, R.I., Climax, Wearite, Magnum, Bowyer-Lowe, Raymond, etc.).
- 1 Compression type adjustable condenser, maximum about .0003 mfd. (Formo, Igranic, etc.).
- Fixed condensers of .0002, .0003, .001 and .01 or .015 mfd. (one of each). (Dubilier, Lissen, Igranic, T.C.C., Mullard, Goltone, Clarke, Magnum, etc.).
- 1 2-meg. grid leak and holder (Lissen, Dubilier, Igranic, Mullard, Cosmos, Ediswan, Loewe, etc.).
- 1 On-off switch (Benjamin, Lotus, Lissen, Igranic, Wearite, Ready Radio, Magnum, Bulgin, etc.).
- 1 Low-ratio L.F. transformer (Ferranti, Cossor, Brown, R.I., Igranic, Phillips, Lissen, Mullard, Marconiphone, etc.).
- 1 L.F. choke for output filter, about 20 henries (Wearite, R.I., Ferranti, Pye, etc.).
- 1 Terminal strip, 22 in. x 2 in. x  $\frac{1}{4}$  in.
- 11 Engraved or indicating terminals (Burton, Igranic, Eelex, Belling and Lee, etc.).
- Wire, screws, flex, plugs, etc.

\*\*\*\*\*

a set of this type gives sufficient selectivity for ideal working under modern conditions, particularly those which may be expected to obtain in

the London area when the regional scheme starts.

The fact that very special coils would require to be used to enable a



A super-sensitive set especially designed to give full loud-speaker strength on a large number of stations, and at the same time to provide really good selectivity.

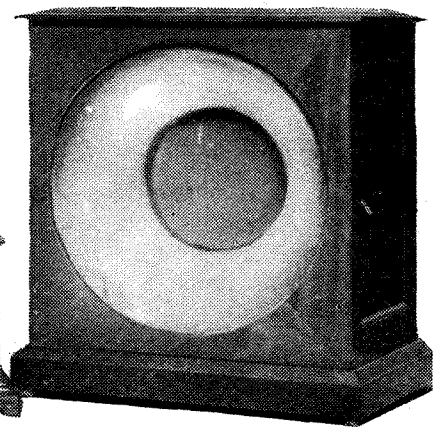
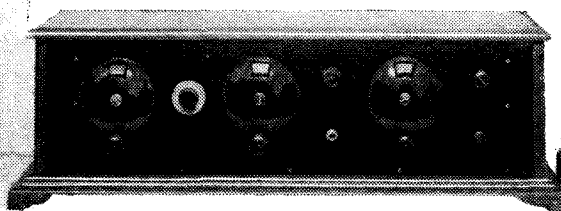



# Five

single screened-grid stage to give the standard of results at which we were aiming, was alone a finally deciding factor, since, as the reader is probably aware, it is the object of the "M.W." Research Department to avoid the introduction of new coils or other components whenever possible. We always endeavour to achieve our results within the limits of existing materials whenever we can, for the obvious reason that to do otherwise is to involve the constructor in considerable expense and is often to

An open and carefully worked-out layout makes the wiring very simple.

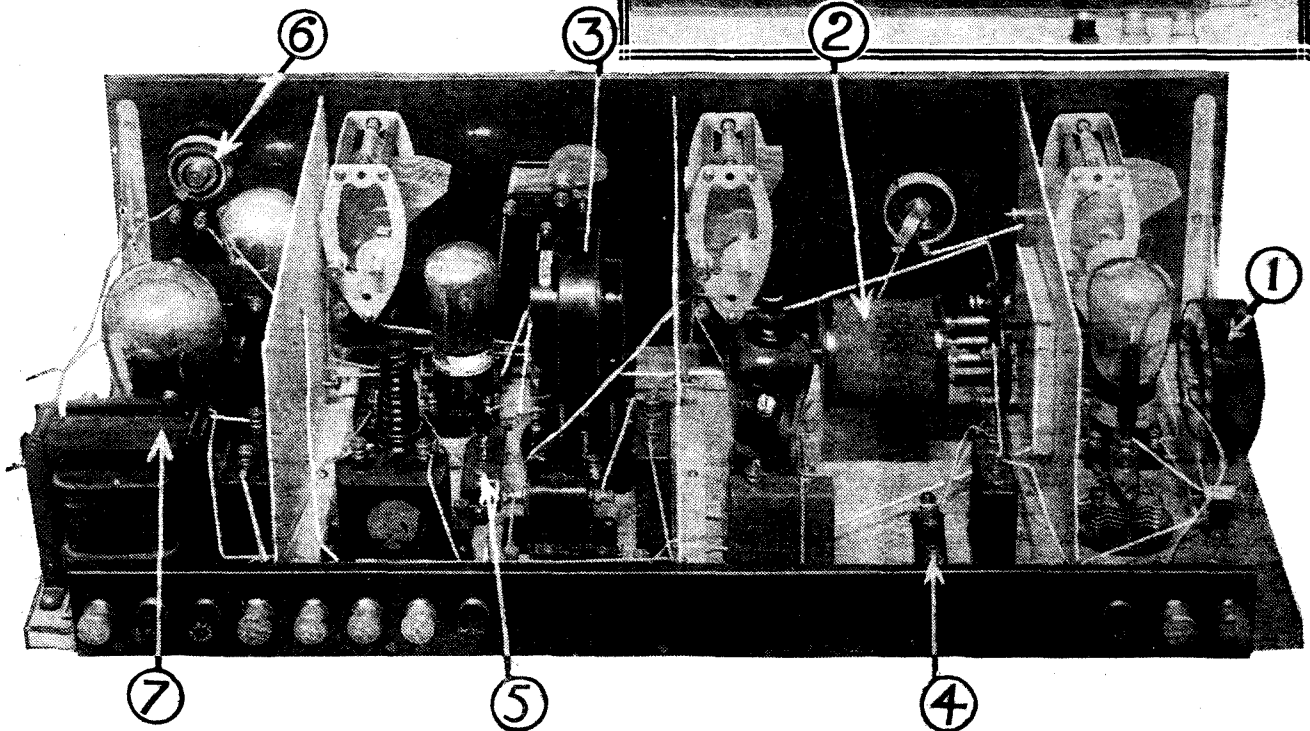
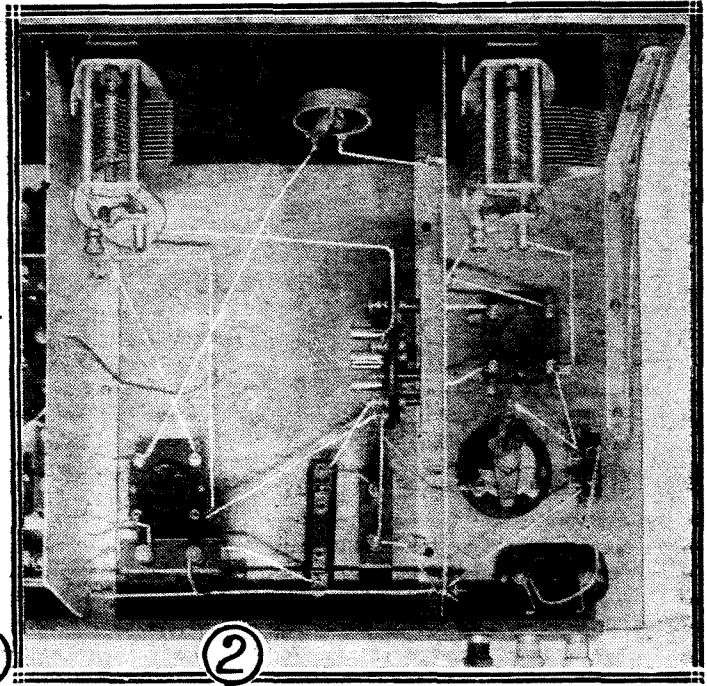

(1) Aerial and first grid circuit coil. (2) Split-primary H.F. transformer. (3) H.F. transformer with interchangeable primary. (4) De-coupling resistance for first valve. (5) Detector anode-filament by-pass. (6) Volume control. (7) Output filter choke.

land him with components which will be of no further use in future sets. Since, then, we cannot obtain the results necessary in this particular design with a single screened-grid stage, it becomes obvious that two stages of high-frequency of some kind must be used.

### A Choice of Methods

Now, two good neutralised stages will give something like the amount of magnification needed, but these have certain drawbacks with which the reader is already familiar. In

their customary form they are apt to be a little critical as to valves, layout, spacing of wiring, and so on, and, moreover, the neutralising operation for two stages requires a certain amount of skill to carry out successfully. Two screened-grid stages, on the other hand, give perhaps more magnification than is needed if the stages are worked at anything like maximum efficiency, and, moreover, with the very high amount of magnification they give a super-excellent standard of selectivity is required, and this is by no means easy to obtain.

In such receivers it is customary to cut down the magnification of each stage somewhat, commonly by the use of H.F. transformer coupling with a reduced number of turns on the primaries, and this, of course, gives the desired degree of selectivity if certain precautions are taken. However, this means special coils once again.

Now consider the advantages obtained by using one ordinary neutralised H.F. stage and one screened-grid stage. In the first place the circuit will be extremely

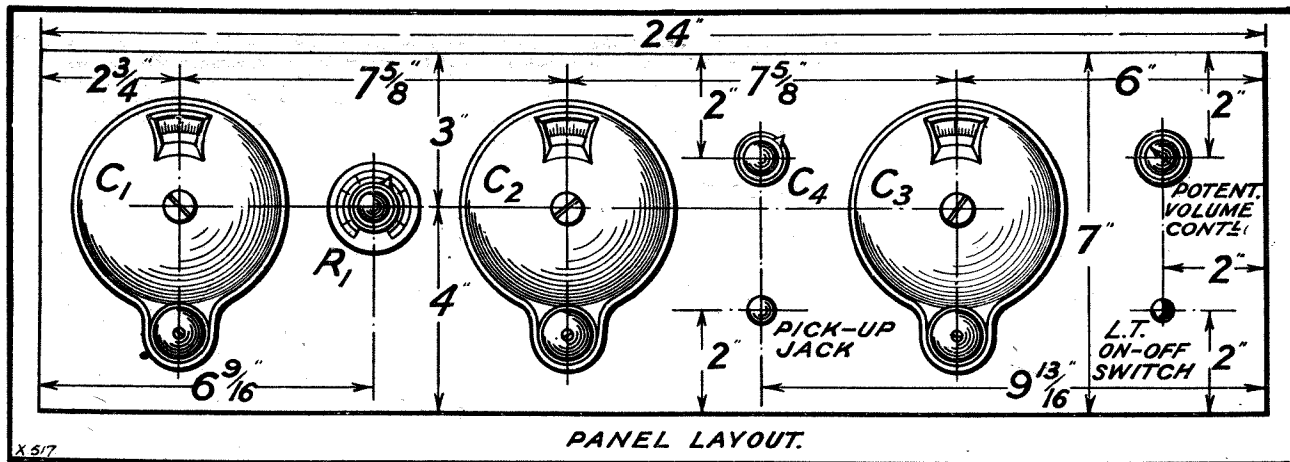

easy to neutralise because there is only one stage requiring it, and the simplest of methods will enable one to obtain an accurate setting for the neutralising condenser quite quickly. Then, the magnification is not excessive and there is no need to cut it down; moreover, the receiver is extremely stable. Again, the use of a neutralised stage of the ordinary split-primary type means that we shall be obtaining a high degree of selectivity right at the beginning of the set, that is to say, where it is most needed.

**Standard Parts Throughout**

If we place our screened-grid valve following this, it will add the necessary amplification without running us into difficulties with broad tuning. These facts alone obviously entitle this combination to quite serious consideration for any receiver of the rather super class, but in addition there is the very weighty one that it is quite an easy matter to arrange it in an efficient manner with perfectly standard coils and components throughout and with only a moderate amount of simple screening of the partition variety.

Now you will understand why it was that we decided upon this combination of a split-primary neutralised

H.F. stage followed by a screened-grid stage for the "Forte" Five. Certainly the results in the case of this receiver have proved well up to, and indeed considerably beyond, our expectations, and it certainly deserves a place very high indeed in the class in which we have endeavoured to place it. Lists of stations received are more or less meaningless these days, and we do not believe that they convey a really true idea of the capabilities of any set, depending as they do so much upon local conditions, aerial system, time of year, the skill of the operator and his possession or otherwise of a good wave-meter, and hence it is not our custom to give them for receivers built for MODERN WIRELESS in the ordinary course of events.

We will content ourselves with saying in this case that after long and exhaustive tests we are convinced that this receiver complies very fully indeed with our first requirements of an outfit which can be depended upon to bring in anything that is going (so long as it is above the general level of noise) and to give a good account of itself under even the most adverse conditions. Moreover, it is very selective, its preliminary adjustments are very easy to make, and although

it has three dials it is by no means difficult to operate.

This last follows from the fact that its sensitivity is decidedly high, and consequently there is a slight crackling of atmospherics and so on which produces a general sound of liveliness whenever the three circuits are in tune. This is quite sufficient to enable you to keep them roughly in step whilst searching.

**A Good Point**

Best of all, it requires only parts of the most standard nature, many of which the experimenter will already have on hand, and all of which he can depend upon to be useful in future sets when (if ever!) he grows tired of this one.

So much for generalities. Now let us take a look over the circuit and layout of the receiver and examine its main features. First of all we have the neutralised H.F. stage, and here you will see a very simple scheme of auto-coupled aerial and tuned secondary for the grid circuit of the valve.

This is actually made up with a standard "X" coil, with two alternative aerial terminals, one of which brings in a fixed condenser of .0002 mfd. for extra selectivity when needed. (Only likely to be necessary in extremely adverse circumstances.)

**The Neutralised Stage**

The coupling between the neutralised H.F. stage and the screen-grid valve which follows is arranged by means of a standard six-pin H.F. transformer of the split-primary type. In the H.T. lead to the split-primary transformer—that is to say, in the H.T. lead for the first valve—you will see the first of the many special features of the set, namely, a 25,000-ohm resistance in series and a 1-mfd. fixed condenser shunted down to the earthed circuit, the two forming an

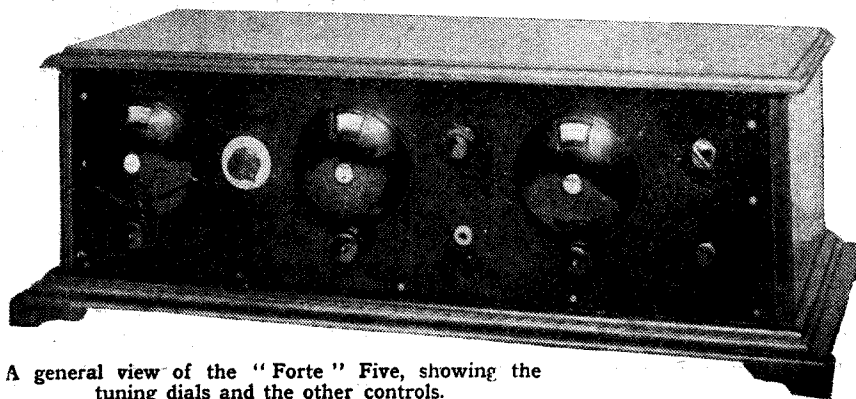

A general view of the "Forte" Five, showing the tuning dials and the other controls.

anti-battery-coupling filter and also serving to drop the H.T. voltage to a suitable figure for the first valve. This device enables the first valve, and also the screened-grid valve, to be worked from a common H.T. positive tapping with the usual standard voltage of 120, or preferably 130. The neutralised valve thus receives a suitable slightly lower voltage, and is relieved of the risk of battery coupling with the screened-grid stage.

**Finely Adjustable Coupling**

Passing on to the screened-grid stage, you will note that this again is transformer-coupled to the detector, a special but already existing type of H.F. transformer being used here. This is the Lewcos "Super" type, which has interchangeable primaries which fit upon a simple pin and socket arrangement on the side of the coil.

By adjusting the size of this primary quite a range of different degrees of selectivity and amplification can be obtained, which will be found to be a very valuable feature when adjusting a super-powerful set of this type to any particular set of conditions. A further anti-battery coupling device will be found here, consisting of a high-frequency choke (marked H.F.C.) and another 1-mfd. bypass condenser down to earth.

This device is quite effective in preventing battery coupling, and at the same time does not drop the H.T. voltage on the valve appreciably. As a further simplification of the receiver, the screening electrode of the valve is connected to H.T. positive via another fixed resistance, of 100,000 ohms this time, also bypassed down to the earth circuit with another

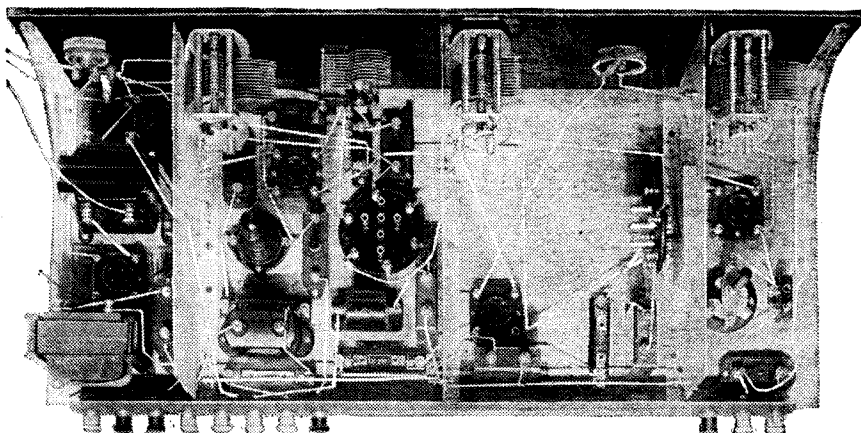

Careful screening enables high efficiency and stability to be obtained.

1-mfd. condenser,  $C_8$ . This enables the screening electrode to be worked from the same H.T. positive tap, thus simplifying the battery connections, and also helps to cut down battery-coupling effects. The value of this resistance, by the way, is not at all critical, since modern S.G. valves are no longer so critical as to screening electrode voltage.

**Special Detector By-Passing**

Reaction from the detector is arranged upon the secondary of this special H.F. transformer, being of the usual capacity-controlled kind. The detector is of the grid leak and condenser type, and is fitted with the special sensitivity-improving device introduced last month in connection with standard Reinartz circuits. This is simply an adjustable bypassing condenser connected straight down from the anode to the filament of the detector, providing a free escape for H.F. impulses.

It is actually a compression type variable condenser with a maximum capacity of .0003 mfd. mounted on the baseboard, and it is set to a suitable value when the receiver is first put on test. The idea is to start with this condenser set to minimum and gradually increase it until you find you can only just obtain reaction effects at all parts of the tuning range by means of the reaction condenser on the panel. The bypassing condenser can then be left alone during all future operations and will serve the purpose of increasing the sensitivity of the detector without further adjustment.

**De-Coupling the Detector**

Another anti-battery-coupling filter is included in the detector stage, consisting of the resistance  $R_4$ , of 25,000 ohms or thereabouts (any value from 20,000 to 50,000 will serve quite well), and a bypass condenser  $C_{10}$  of 2 mfd. These various

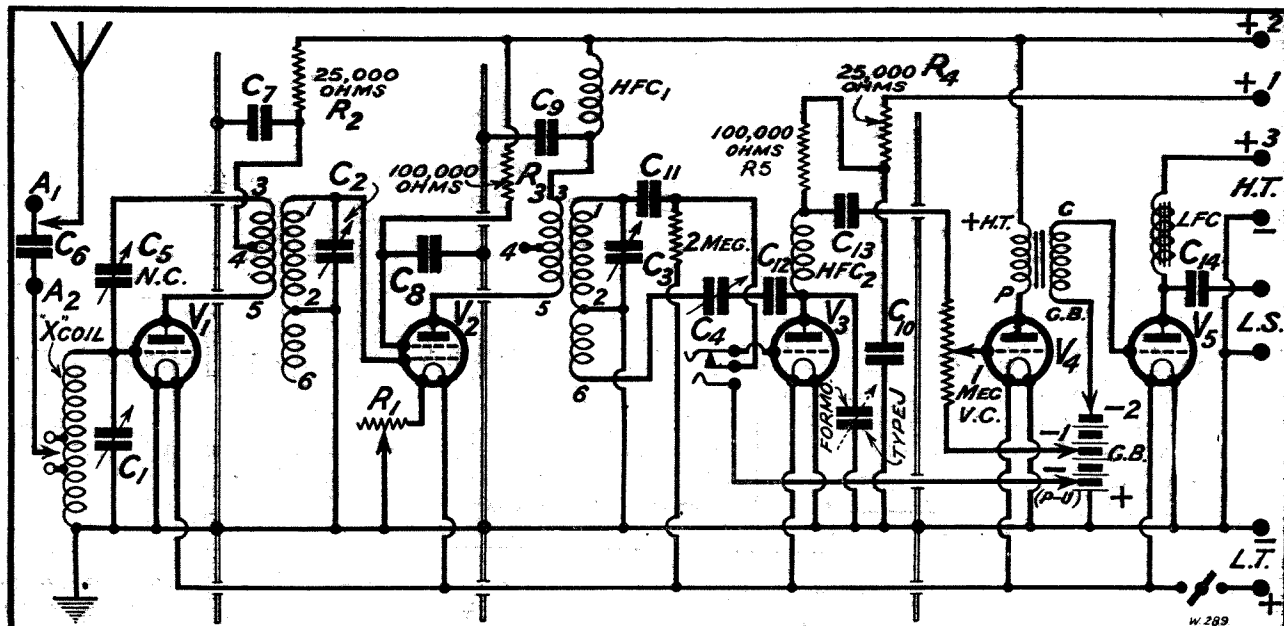



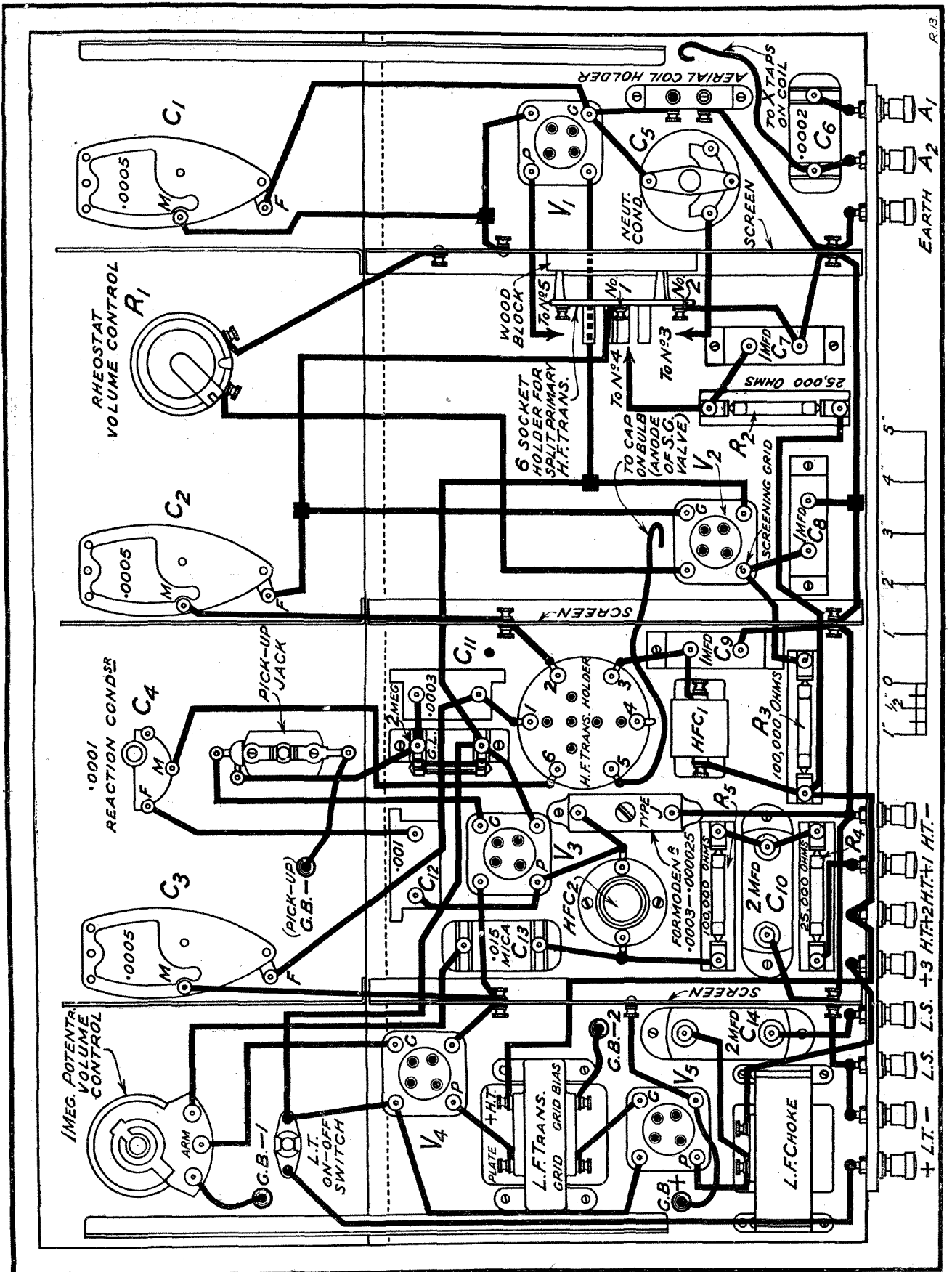

anti-coupling devices make the receiver a particularly stable one, and it can be confidently expected to give no trouble even when used with quite elderly batteries or upon a mains unit in which the "separation" of the output taps is by no means thorough. This particular factor of safety is still further increased by the fact that a properly connected output filter circuit is provided for the loud speaker, so that battery coupling effects from the power stage are very much reduced.

### Improved Reaction

The L.F. side is of a rather standard nature with one exception. This is in the value of the anode resistance in the R.C. stage coupling the detector to the first L.F. valve. Instead of the more or less conventional value of

of jack in which a plug can be inserted for connection to a gramophone pick-up, a flex lead from one of the points on this jack going to a suitable point in the grid-bias battery for applying a small negative bias to the detector valve when used as a low-frequency amplifier for gramophone reproduction. The grid leak of the R.C. stage which follows the

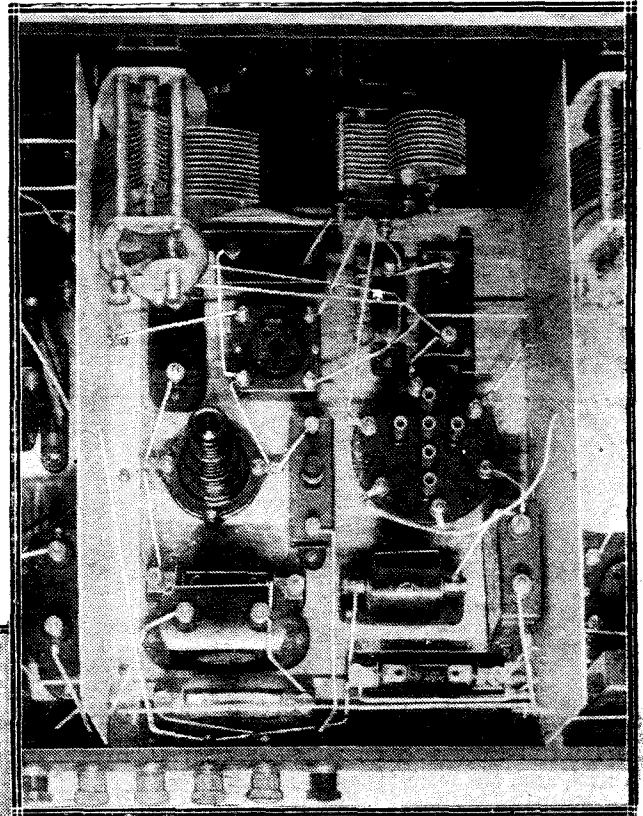

The detector section of the receiver.

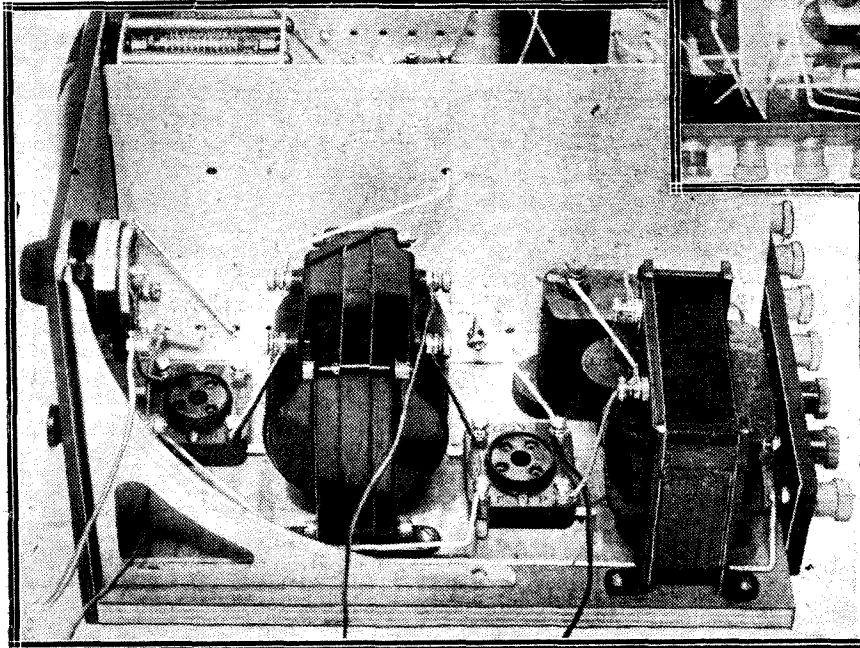

The L.F. end, showing the last two valve holders and the output choke-condenser system.

250,000 ohms, we have used here only 100,000 ohms, which may be considered rather low at first sight. As a matter of fact, we have found that this value gives decidedly more satisfactory results with modern types of H.F. valves when used as detectors, since these are no longer of such high impedance as they used to be.

For such valves a 100,000-ohm anode resistance provides an ample anode load, and this lower value enables considerably smoother reaction to be obtained, with much less tendency to overlap in the adjustment.

Arranged in the grid circuit of the detector valve there is a simple type

detector is provided by the usual high-resistance potentiometer-type volume control, a resistance of 1 megohm being suitable here, although 2 megohms can be used if desired. The first low-frequency valve is coupled to the second by means of a low-frequency transformer, and, as we have noted, there is a properly connected output filter circuit for the loud speaker.

The jack for the pick-up, by the way, does not turn out the filaments of the first two valves when the gramophone attachment is being used, for the simple reason that to use so complicated a jack adds greatly to the amount of wiring and also introduces

considerable possibility of trouble with dirty contacts and so on.

As a matter of fact, the additional L.T. consumption of the first two valves is very low, if they are of the .1- or .15-amp. types. If you like, of course, you can turn out one of them by means of the rheostat  $R_1$ , which is the control for the filament of the screened-grid valve. This is really inserted for use as a supplementary volume control, but having an off position it can be used to turn out this particular valve. The only wasted filament current remaining is that of the neutralised H.F. valve, which will almost always be of the .1-amp. class.

### Volume Control Methods

A few words of explanation about the volume-control rheostat  $R_1$  may perhaps be useful here. The point is this: The full magnification of this set is seldom needed, and it is found most convenient to run it slightly below its full power by cutting down the filament of the screened-grid valve a little. We then obtain a quieter background and have a little reserve of power to cope with fading when it occurs.

A fine control of volume can also be obtained here, this latter point

(Continued on page 199.)

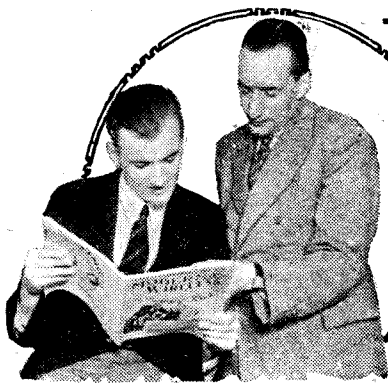

# WHAT READERS THINK

The "Traveller's" Two—Open-Air Radio.

## The "Traveller's" Two

SIR,—I feel I must write and thank you for your excellent little portable, the "Traveller's" Two, by J. English.

Having fixed up for a holiday on the Norfolk Broads this month, I decided to build the above set.

As you know, Barnsley lies some 20 miles from Leeds and Sheffield, also about 50 miles from Manchester. These I tuned in, including 5 GB, on the frame aerial alone without turning the set for direction.

I then fixed the set on my outside aerial, and, of course, tuned in all the above at wonderful strength for two valves.

I also heard a number of Continental stations, but did not stop to identify them.

I then found to my surprise that I had not coupled up my earth wire. On doing this it made very little difference to signal strength, but Continental stations poured in. On the long waves 5 XX came in well and also two others.

On reading your interesting article on using a set out-of-doors in the same number, I feel that I have got an all-purpose set that will be splendid for experimental use.

## "Pound's Worth of Pleasure"

I am now looking forward to my holiday with greater enjoyment, and I hope to be able to write you a full report of reception in that district from a boat, using various aerials and water earths, etc.

The valves I am using are Osrams. Condensers, Burton '0003, Formo '0003. These took some fitting into the limited space. An home-made choke and home-made loading coil for long waves, Telsen "Ace" transformer, and home-made oak cabinet.

I have constructed many sets from your valuable paper, and for house use I run your "P.W." "Tom Tit Three," which blows your head off, if desired, at good quality.

Trusting to have further "port-

able" articles from your very efficient staff in the near future. Every success to your wonderful shillingsworth. I hope to get many pounds' worth of pleasure out of the "Traveller's" Two this summer.

Yours faithfully,

K. L. GRAHAM.

Barnsley.

## Open-Air Radio

SIR,—I have just been reading with great interest the article in a recent issue of MODERN WIRELESS by Mr. Percy Harris on "Open-Air Radio," and noting that he mentions the Dorking district, and asked for readers' experiences, I have ventured to give a few of my results in the hope that they may be of interest.

In every case I have made use of a small receiver so as to keep down the weight as far as possible; in fact, most of my experiments were conducted with a two-valver with frame aerial, batteries and headphones all

included, and weighing less than 7 lb., being very similar to the "All-In" Two described in "M.W." last spring.

Ranmore Common, which, by the way, is over 20 miles from 2 L O, seems to be a good spot for reception, and even with a tiny crystal set I used to get good results from 2 L O and 5 X X with a 30-ft. aerial slung over a tree and a 12-in. earth pin. With a similar aerial and earth and a one-valve Filadyne (ex "P.W."), signals were loud enough for several pairs of 'phones. Any sort of aerial seemed to work the Filadyne with success, and I have often used a wire mattress when nothing better has been available.

The "Hog's Back," between Guildford and Farnham, although high and exposed, does not seem to be a good place for reception, and I have been unable to obtain any better results there than in the midst of Guildford at the foot of the hill.

The two-valve frame-aerial set has also provided some interesting results. I have had strong signals from Bournemouth while riding in a motor coach some 10 miles from that station, and I have also tuned-in 5 G B on the frame when within a few hundred yards of Bournemouth's aerial.

Again thanking you, and trusting that some of the above details may be of interest to you.

I am,

Yours very truly,

Dorking.

D. G. HOPE.

## THE LATEST "PORTABLE"

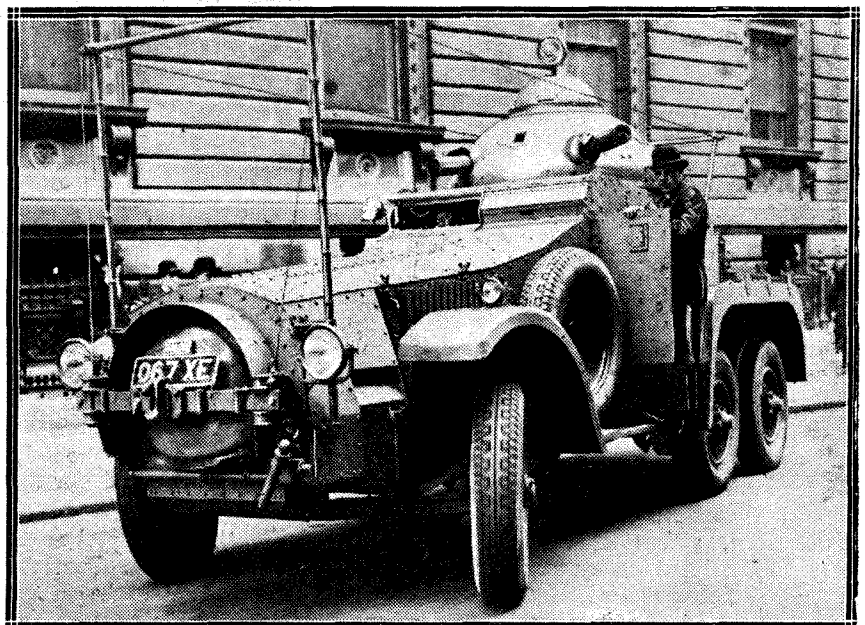

The newest armoured car, specially designed for the rough roads of India, contains a complete transmitting and receiving system which can be used while the car is going at full speed.



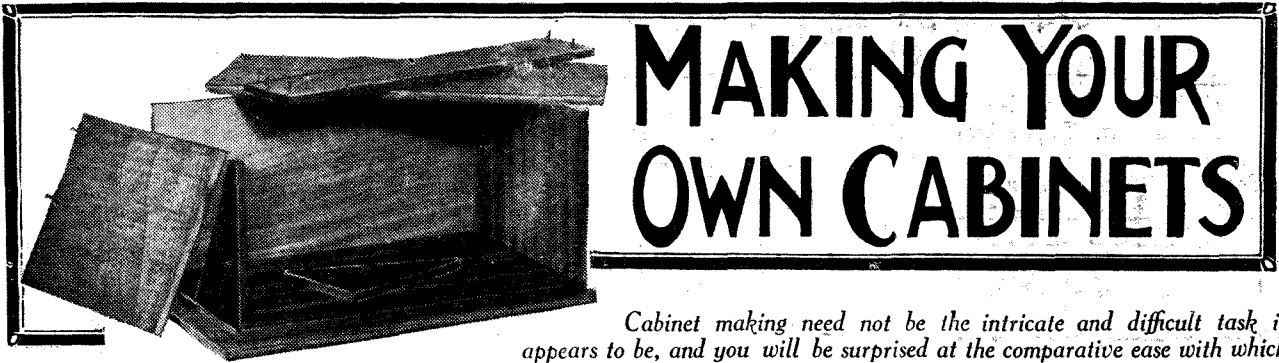

# MAKING YOUR OWN CABINETS

*Cabinet making need not be the intricate and difficult task it appears to be, and you will be surprised at the comparative ease with which quite an elaborate cabinet can be made if you follow the directions given in this article.*

*By H. BRAMFORD.*

**E**VERY really enthusiastic constructor likes making his own cabinet, but many are deterred from so doing owing to the fact that there are little difficulties to be encountered which they do not feel confident of handling.

is taken in the work it can be elaborated to an extent which places the constructor in the possession of something which would be too costly for many to buy ready made. Therefore, woodwork is worth while, especially as we can make not only cabinets, but portable-set cases, or carriers, loud-speaker cabinets, battery cabinets, and all sorts of things.

First a word about wood. We are all acquainted with mahogany, which is easy to work and handsome in appearance. In colour it is rich red, and it takes polish well.

The next wood most commonly used is oak. Here we have light oak and

## "Done with Ease"

The object of these notes is to show the reader how everything can be done with ease, and a professional finish obtained throughout by a beginner without the necessity for any particular degree of skill.

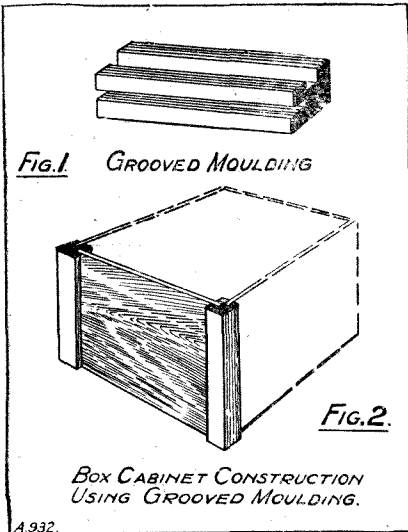

It must be remembered, however, that not only can a cabinet be made for quite a low cost, but if pride

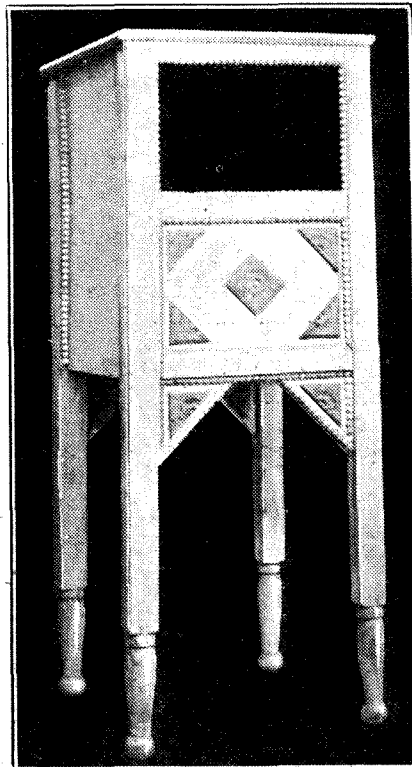
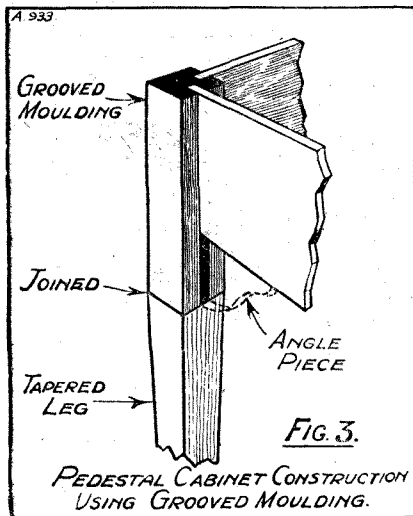

A handsome cabinet made by the author. The construction is not such a difficult task as it appears.

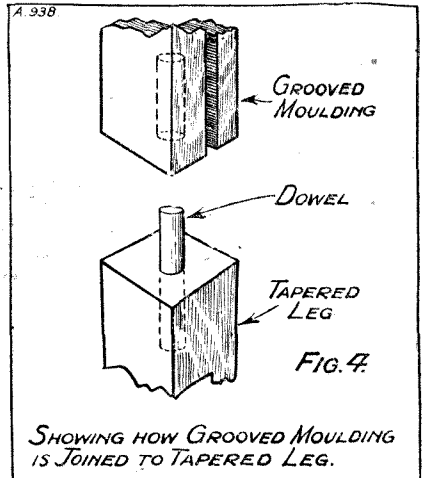

figured oak. Oak is hard, and very durable, and very easy to polish. Its grain is more marked than mahogany. Figured oak is selected for its special beauty of grain, and very excellent appearance.

To the average amateur constructor this presents a limit of choice, but there are nevertheless numbers

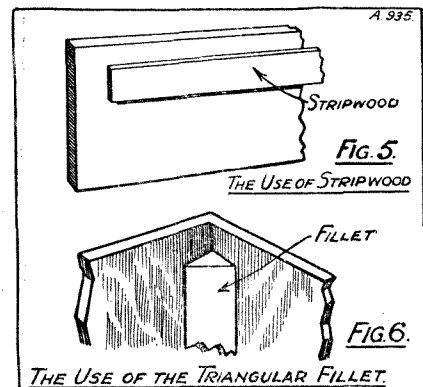

of other varieties of interest, and these are as follow :

**Sycamore.**—This wood is noted for its fine silky figuring, and is a beautiful white in colour. It is valuable for use in contrast to other woods of dark grain. It is not difficult to work.

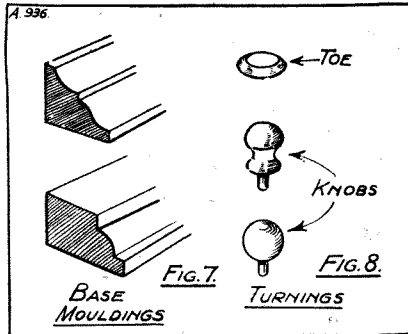

**White Chestnut.**—This is quite white, has practically no figuring, but is useful for delicate work, as it is very strong and durable.

**Satin Walnut** is somewhat better known, and is soft brown in colour. It is richly grained, and easy to work, and takes polish splendidly. It is rather soft.

**Padouk.**—African padouk is the most beautiful coloured wood obtainable. It is a rich bright red, and is suitable where a special colour scheme is desired. It is no more costly than other woods.

**Grooved Moulding**

**Spanish Chestnut.**—This wood is similar in colour and texture to oak, but is softer and easier to work. It is a good substitute, and adapts itself to a brilliant finish.

**Satinwood.**—This is a beautiful rich orange-yellow wood, suitable for the finest class of work.

**Elm.**—A rich wood, easily worked.

**Ilimo.**—A light African wood.

**Beech.**—A light reddish-brown wood, hard in texture.

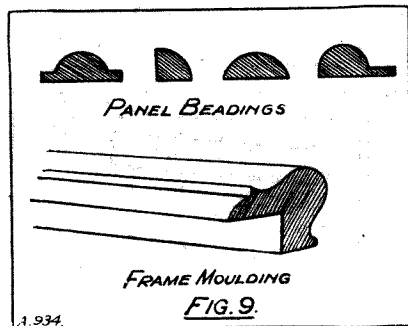

**Mangrove.**—A rich purple-coloured hard wood.

With such a selection there is considerable scope for the blending of colour schemes, the woods being finished in natural polish.

Perhaps one of the greatest aids to cabinet construction is grooved moulding. The type of material I am referring to is illustrated in the diagram, Fig. 1. It will be noticed that this moulding has two sides ready grooved in the manner shown. The moulding is obtainable in this shape already prepared in three sizes—No. 36 with  $\frac{3}{16}$ -in. grooves, No. 37 with  $\frac{1}{4}$ -in. grooves, and No. 38 with  $\frac{5}{8}$ -in. grooves.

**Easy to Use**

This moulding is obtainable from Hobbies, Ltd., at the low cost of 2d. to 3d. per foot. Supposing our requirements take the form of a simple box cabinet, it will be seen from Fig. 2 how easy this is to put together using this moulding, which practically eliminates all constructional work and joinery. No pinning or screwing is necessary, glueing being quite sufficient, the work being clamped tightly while the glue sets.

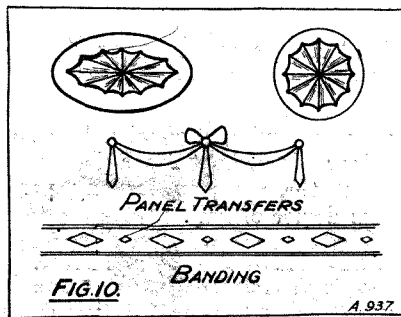

If an angle clamp is used the work should be clamped and set square at one and the same time. With the perfectly cut grooves already made for you, the squaring-up process is naturally much easier.

It is just as easy to construct a pedestal cabinet on the same lines, using the grooved moulding as before, as illustrated in Fig. 2, for the boxed portion, the tapered leg part being carefully dowelled to the corner pieces as indicated (Fig. 3). This is quite simple to do, as dowelling is, perhaps, the most easy woodworking joint to make. If moulding is used having  $\frac{3}{8}$ -in. grooves,  $\frac{3}{8}$ -in.-thick wood must be used for the boxed part of the construction.

**"Dowel" Rods**

The use of dowel rods is quite a straightforward matter. Supposing we are contemplating dowelling a taper leg to a section of moulding. The ends of each piece should first be finished quite square. Then the true centre of each is marked with a pencil, and a small starting punch-hole made. If we are dowelling into

each piece to be joined to a depth of  $1\frac{1}{2}$  in., we shall need to cut off a piece of dowel rod just under 3 in. long.

The diameter of the rod should be proportionate to the sectional area of the leg, so that if a  $\frac{3}{8}$ -in. dowel is

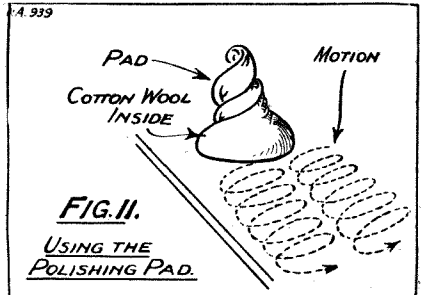

used, the leg should be at least 1 in. square, or nearly three times the diameter of the dowel.

Now a  $\frac{3}{8}$ -in. drill is used and set to drill to a depth of  $1\frac{1}{2}$  in. The leg is drilled first, and the moulding next. The dowel piece is glued and inserted into the leg, and then the moulding is gently tapped on, and the work clamped to set. Any projections should be sandpapered down afterwards. The best dowels to use for strong work are pine. The method described, which applies to all dowel-joint work, is shown in Fig. 4.

**Strip Wood and Fillets**

Strip wood is particularly handy for a number of purposes, such as for providing support behind panels, and arranging as runners for baseboards, motor boards, etc. This material is obtainable in all sizes, or assorted, quite cheaply from most woodworking dealers. It is not worth while to cut special strips of wood when these can be obtained so cheaply. An example of the use of strip wood is shown in Fig. 5. When using strip

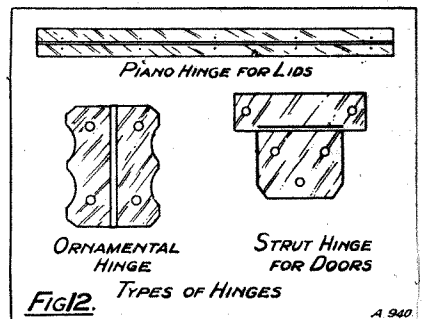

wood it is only necessary to glue it, and if it is not convenient to clamp it, the work may be lightly pinned. Fine pin nails should be used as anything heavier will only split the wood.

## Professional Finish Easily Obtained

Another item of considerable value is the triangular fillet. Its use is obvious as the ideal thing for strengthening all corner joints, as shown in Fig. 6. These fillets present a difficulty if they are to be made, but they can be obtained ready planed on the sides, and only have to be cut to the required lengths. By purchasing them in this way one may be sure that they are perfectly square, and they will, therefore, also assist in generally squaring up the work in which they figure as well as adding to the strength of the construction. Any size section may be obtained.

### The Finishing Touches

For the finishing touches, mouldings, beadings, and turnings may with advantage be brought into use. The mouldings and beadings may simply be glued to the framework, and if not pinned a clamp should always be used for setting. Some examples of very appropriate moulding and beading are shown in Figs. 7 and 9. These may be used for the bases of cabinets, as suggested, and turnings of the type shown in Fig. 8 are useful for feet and handle knobs, etc.

We now come to yet another very interesting phase of woodwork in connection with radio cabinets, and that is the use of transfers. These are obtainable in a number of useful and pleasing designs, some of the standard ones which are most simple and effective being shown in Fig. 10. For ornamenting panels, or adding the finishing touch in appropriate places, they are invaluable.

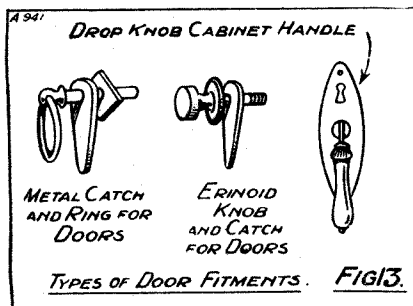

Transfer bandings are also useful for borderings, and give the appearance of finished inlay work.

As most of our woodwork is assembled with the aid of glue, thus eliminating nails or screws or difficult jointing, a knowledge of how to use glue to the best advantage is im-

portant. The old-fashioned gluepot is now out of favour, as it is too messy and troublesome.

There is a large choice of liquid glues on the market, all of which are quite serviceable and reliable. Amongst the best known are Seccotine, Croid, and Hobbies' liquid glue, sold in tins or containers ready for use. The chief thing to remember when using glue is to use a little only, and to let it thoroughly set before trying it.

Before attempting to polish any work, the wood must be papered perfectly smooth, and even then it is not ready for finishing. A wood filler must be used, especially where the grain is deep cut, as in oak. Several makes of this substance, which take the form of a paste, are obtainable.

The filler is applied to a rag, and rubbed into the wood in a backward and forward motion across the grain.

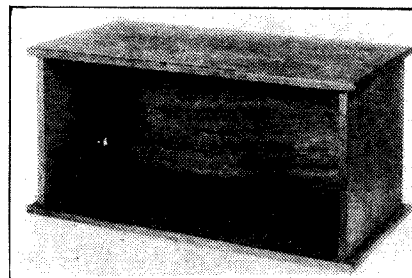

A completed cabinet of simple style.

This is done after the wood has been finally papered, it is then allowed to set and finished again with sandpaper. Wood filling not only fills the grain, but brings it out, thus enhancing the beauty of the work. With closely grained woods, however, this process may be eliminated.

I have already made reference to natural finish, but many readers may not be clear as to what was meant by this. To obtain a natural finish, the wood is not stained, but left in its natural colours, and the effect is often very pleasing. If the wood is light it is treated with oil, and linseed oil is employed for darkening oak, beech, or mahogany.

### Wax Polishing

Wood treated in this manner is best left simply oiled, or finally wax polished, but not highly polished. Wax polishing gives a very refined effect. One preparation may be made by mixing refined beeswax in

turpentine. Wax polish is applied in the same manner as any polishing would be undertaken, and the more "elbow grease" applied the better result, and the work can always be renovated by further polishing.

Another method of finishing that

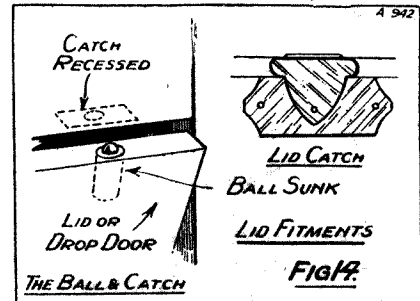

saves time and labour is the use of colour polish, which polishes and colours, or stains, in one operation, and is easy to use. The result, however, is not as good as staining first and polishing afterwards.

White or dark polish may be used for polishing, and the preparation is sold ready for immediate use. A cotton or silk pad is prepared which is wrapped around some cotton wool, and a few drops of polish (not more) are sprinkled on the wool. The pad is then held in the right hand and compressed, while it is moved quickly and lightly over the wood in a circular motion as shown in Fig. 11.

Providing one does not use too much polish, and the movement is quick and light, no difficulty will be experienced in obtaining with ease a polish equal to the professional french-polished finish.

### The Small Fittings

The small fittings obtainable for the woodworker are many, and these little items add much to the finish of the work. First there are hinges as shown in Fig. 12. The piano hinge for lids, the ornamental hinge, and the strut hinge for doors are most useful types. Also for doors are the metal catch and ring, or the erinoid catch and knob, and the drop-knob cabinet handle (Fig. 13).

Another interesting gadget is the ball and catch, for securing doors, etc., in position as shown in Fig. 14, and, finally, lid catches for box cabinets as shown in this diagram. With these accessories the work of cabinet making should be simple, and the choice of design, etc., easy to follow out and to undertake.



# The "Mag"

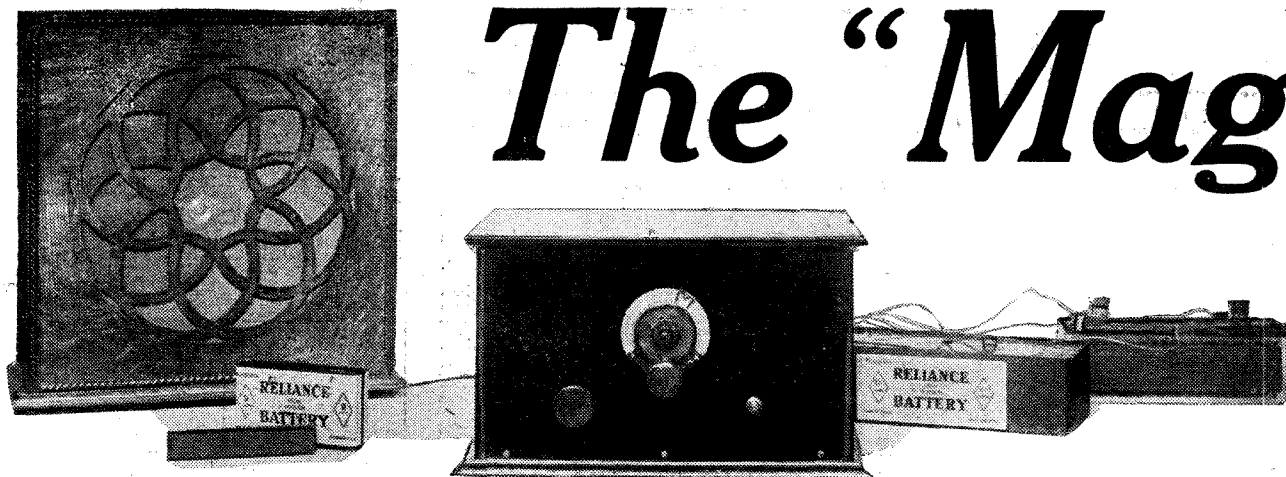

**I**N the last issue of MODERN WIRELESS we described a simple single-valve set employing the magnetic reaction, that is to say, reaction obtained by means of a movable coil arranged so that it can be moved nearer to or farther away from a tuned grid coil. We pointed out in that article that it is frequently possible for the listener to obtain greater volume and more satisfactory results with this method than with the more popular Reinartz scheme.

### Magnetic Reaction

As is well known, the Reinartz scheme has distinct advantages in multi-valve sets, particularly where reaction is obtained by means of a small condenser feeding through into a coil coupled to the detector tuned circuit. The Reinartz scheme is compact and gives remarkably smooth control of reaction; moreover it is very useful on the short waves, where very smooth reaction control is often the greatest aid to success.

Given a suitable two-coil holder, however, the magnetic reaction scheme has much to recommend it. That it does give louder signals is an accepted fact, and as has been pre-

viously stated the reason is connected with the by-passing of the H.F. currents back to the filament of the valve. With magnetic reaction a large by-pass condenser can be used without detriment, whereas with the Reinartz method on the smaller settings of the reaction condenser the capacity is very often too small to give adequate by-passing. Hence we have to pay for our smooth control by a slight loss in volume.

Now the reader will ask why should it not be possible to obtain this smooth control with the magnetic method. Well, the chief reason is that the average two-coil holder does not permit of such a delicacy in adjustment. There are, however, certain two-coil holders on the market that have a vernier or geared adjustment with which it is possible to obtain a very fine control. Now, if in addition a suitable-sized coil is employed, together with carefully adjusted H.T., there is no reason why the magnetic scheme should not give perfectly smooth control.

The "Magnetic" Two is a very simple and straightforward design,

and consists in the main of a grid-leak detector, followed by a single stage of low-frequency amplification with transformer coupling. The set is cheap, the initial outlay being small.

### Selectivity

One of the disadvantages of the swinging-coil scheme has always been the amount of space which had to be allowed for the reaction coil to swing through an arc of roughly 70°. In a set such as a detector and one L.F., space is not the primary consideration, and in addition layout is not particularly critical. Hence there is nothing to prevent the swinging-coil method from being used with satisfaction. Then, again, the large number of stations operating on the medium wave-band makes it necessary for the set to have a reasonable degree of selectivity. One might at first think that it would not be possible to obtain adequate selectivity with an ordinary two-coil holder, since one of the coils must obviously be for reaction.

In the set in question this little problem was overcome quite easily by

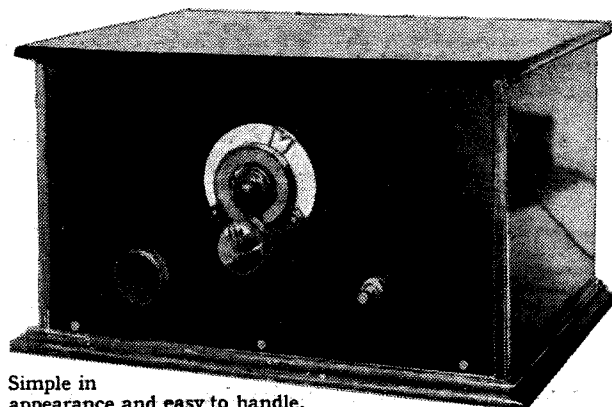

Simple in appearance and easy to handle.

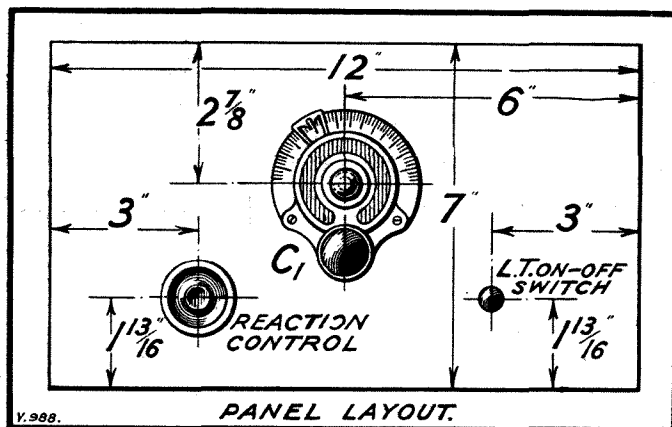

There are only three components to mount on the panel—not a difficult task.

# netic" Two

\*\*\*\*\*  
 \* A remarkably powerful loud-speaker set \*  
 \* which is cheap and easy to build and \*  
 \* extremely simple to operate. \*  
 \* Designed and described by the \*  
 \* "M.W." Research Dept. \*  
 \*\*\*\*\*

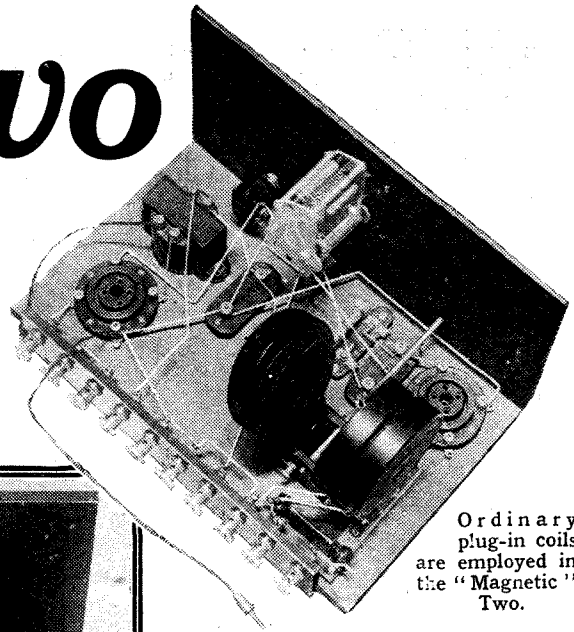

Ordinary plug-in coils are employed in the "Magnetic Two."

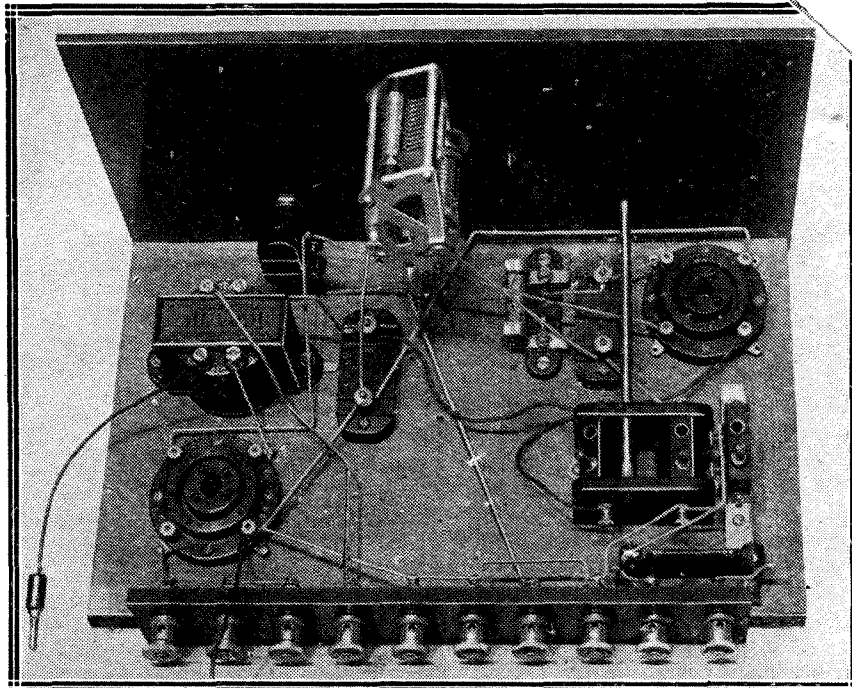

This is the sort of set you can build during the course of one evening and have it working in time to hear the final items of the broadcast programmes.

Now suppose we say a few words about the layout and construction of the set generally. The first point you will no doubt observe is that the panel layout is very simple and there are only three components mounted on it, these being the tuning condenser dial, the L.T. on-off switch, and the knob for the reaction control. Mark out the panel on the back in accordance with the dimensions given in the diagram, and drill the three holes for these components. When you drill a hole for the spindle of the reaction coil make it somewhat on the large side in order to ensure adequate clearance all round the spindle, so that it does not foul the hole and become difficult to rotate.

### Constructional Details

A 3/8th-in. drill will probably serve for all three holes. Screw the panel firmly to the baseboard by means of three wood screws along the bottom edge, and then mount the tuning condenser and L.T. on-off switch. Leave the reaction spindle until later. Now mount the baseboard components as shown in the wiring diagram, and place the two-coil holder carefully in position, passing the spindle through the panel and then screwing on the knob. You will see from the photographs that the aerial coil holder is mounted on a small piece of wood in order to bring the horizontal axis of the aerial coil and secondary coil into line. If this is not done the coupling between the two coils will be weakened. Now for the wiring-up.

It is best to use some form of insulation-covered wire, since then

mounting a separate coil holder right opposite the fixed coil socket of the two-coil holder, so enabling one to use an aerial coil of the aperiodic type magnetically coupled to a tuned secondary coil. Thus by varying the size of the aperiodic coil one is able to obtain different degrees of selectivity. There is also a small fixed condenser having a value of .0002 mfd. placed in series with the aerial, and this can be used when necessary by connecting the aerial lead to the alternative aerial terminal. The selectivity obtained is thus adequate for all practical purposes.

### Probable Range

A two-valve set of this type is a very excellent little all-rounder. Up to distances of about ten miles, or perhaps even twelve miles in some cases, quite good results can be

obtained on the loud speaker if the local station is one of the main transmitters. Daventry 5 X X and 5 G B can also be brought in on the loud speaker at good strength up to distances of, say, 80 miles. Several Continental stations should be audible on the speaker, while a large number will come in at really good telephone strength.

A set of this type requires very little skill in operating. Hence it is possible for the novice to obtain good results with little or no practice. Of course, it is not possible to obtain these results with a small indoor aerial. The assumption is that an aerial of the outdoor type, having a total length, including the lead-in, of 80 to 100 ft., is available. If an indoor aerial must be used, it is still possible to obtain quite good results, but the range will, of course, be very much restricted. Tuning will also be more critical.

if two leads happen to touch no damage will be done. Systoflex covering is very convenient, and was used in the original design. This covering is simply slipped over the bare wire after it has been cut to length. It is best to make well-soldered joints wherever possible, although, of course, in very many

cases the terminals can be used with advantage. You will note that there are two flexible leads from the moving-coil holder, one of these goes to the plate of the detector valve, whilst the other goes to I.P. on the transformer and to one side of the .0003-mfd. fixed condenser.

There are two other flexible leads,

one is joined to I.S. on the transformer and is for grid bias negative, whilst the other goes to the L.T.— terminal on the valve holder and is for grid bias positive.

When you have completed the wiring you will naturally want to try the set out. In the aerial, or primary, coil socket place a No. 25

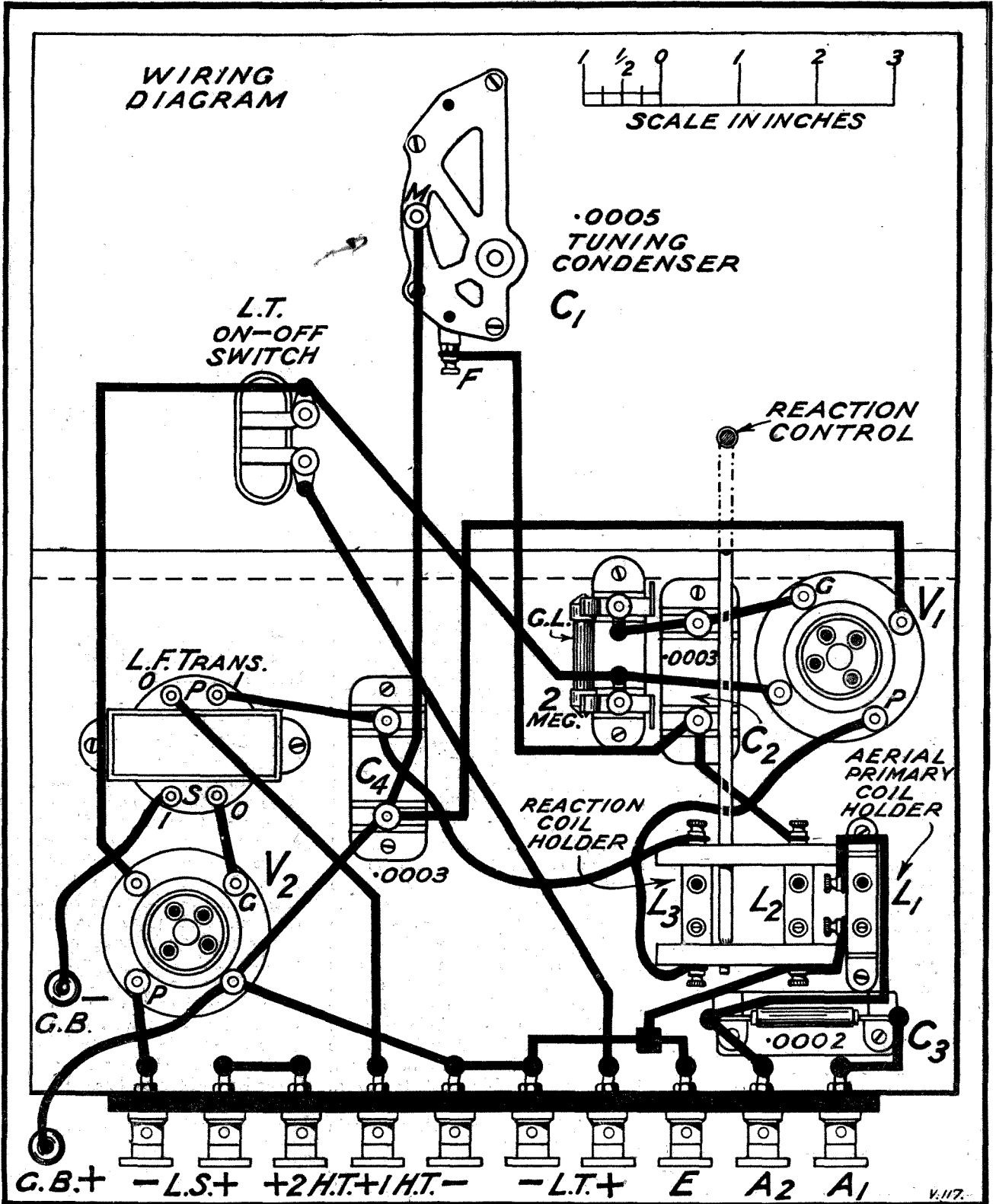

## Excellent Results from Distant Stations

or 35 coil, and in the secondary socket, that is, the fixed socket of the two-coil holder, insert a No. 60. In the moving-coil socket place a No. 50. In the valve holder on the right of

the baseboard, looking at the back of panel, place a valve of the "H.F." type, and in the other valve holder an L.F. or small power valve. Connect up your H.T. or L.T. batteries,

quired will be about 60 volts for the detector valve, and about 100 or 120 for the L.F. valve. When you hear signals from your nearest station bring the reaction coil nearer to the secondary coil, and note whether the signal strength increases. If it does not, reverse the two flexible leads which go to the terminals of the reaction coil holder and try again.

### Adjusting Reaction

You will note that as you bring the moving coil nearer to the fixed coil signals will increase until they become distorted, and then finally the set will burst into oscillation with a "plop" or a squeal. When the set squeals or, in fact, oscillates at all, you will be causing interference with neighbouring receivers, and the idea is always to operate the set so that it is just below the point where signals begin to distort. This is the most sensitive position. If the reaction is very fierce and the set oscillates directly you move the coil, try a size smaller coil in the reaction socket, and also reduce the value of H.T. on the detector valve. Continue to do this until you obtain very smooth control with no suggestion of "ploppiness."

*(Continued on page 196.)*

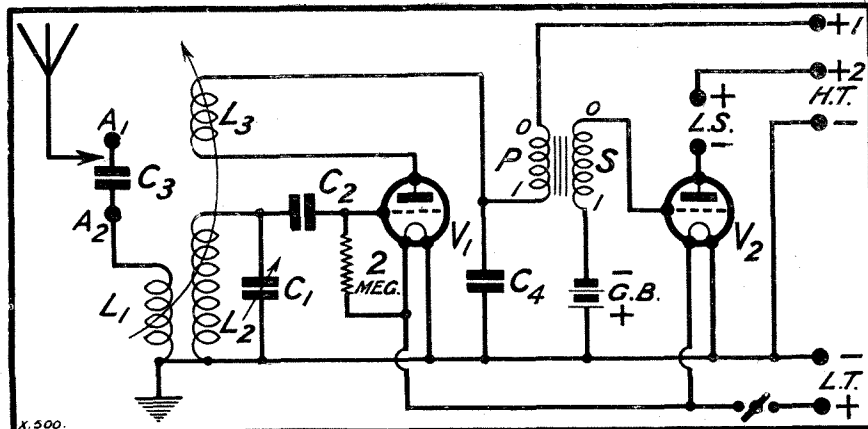

Not an intricate circuit! But it is capable of providing wonderful results.

#### COMPONENTS REQUIRED.

- 1 Insulating panel, size 12 in. × 7 in. ×  $\frac{3}{16}$  or  $\frac{1}{4}$  in. (Becol, Raymond, Trelleborg, Ripault, Resiston, etc.).
- 1 Cabinet to suit, with baseboard 7 in. deep (Arterraft, Raymond, Cameo, Bond, Pickett, Lock, Gilbert, etc.).
- 1 .0005 variable condenser (Lotus, Lissen, J.B., Utility, Igranic, Dubilier, Formo, Raymond, Burton, Geophone, Ormond, Colvern, Bowyer-Lowe, Pye, etc.).
- 1 Slow-motion dial, if condenser not of slow-motion type (Lotus, Formo, Igranic, Lissen, Utility, J.B., Brownie, Rothermel, etc.).
- 1 Baseboard-mounting two-coil holder (Raymond, Lotus, etc.).
- 1 Baseboard-mounting coil socket (Lotus, Wearite, etc.).
- 2 Valve holders, sprung type (W.B., Benjamin, Igranic, Pye, B.T.H., Formo, Wearite, Lotus, Marconiphone, Bowyer-Lowe, Magnum, Ashley, etc.).
- 1 .0003 fixed condenser (Dubilier, Mullard, Clarke, T.C.C., Goltone, Igranic, Magnum, Lissen, etc.).
- 1 .0002 fixed condenser (Igranic, etc.).
- 1 .0003 fixed condenser (Dubilier, etc.).
- 1 On-off switch (Igranic, Lissen, Benjamin, Bulgin, Lotus, Wearite, Magnum, Peto-Scott, Ready Radio, Burton, Raymond, etc.).
- 1 Low-ratio L.F. transformer (Igranic, Cossor, Phillips, Lissen, Mullard, Ferranti, R.I., Brown, Marconiphone, etc.).
- 1 2-meg. grid leak and holder (Lissen, Pye, Ediswan, Dubilier, Igranic, Mullard, Cosmos, etc.).
- 1 Terminal strip, 10 in. × 2 in. ×  $\frac{1}{4}$  or  $\frac{3}{16}$  in.
- 10 Terminals (Eelex, Burton, Igranic, Belling & Lee, etc.).
- Quantity tinned copper wire, Systoflex, etc.

also the aerial and earth, joining the aerial lead to commence with on A<sub>2</sub>. Join a pair of telephones or a loud speaker to the two L.S. terminals.

Then with the reaction coil well away from the secondary coil rotate the tuning condenser and listen for your local station. The H.T. re-

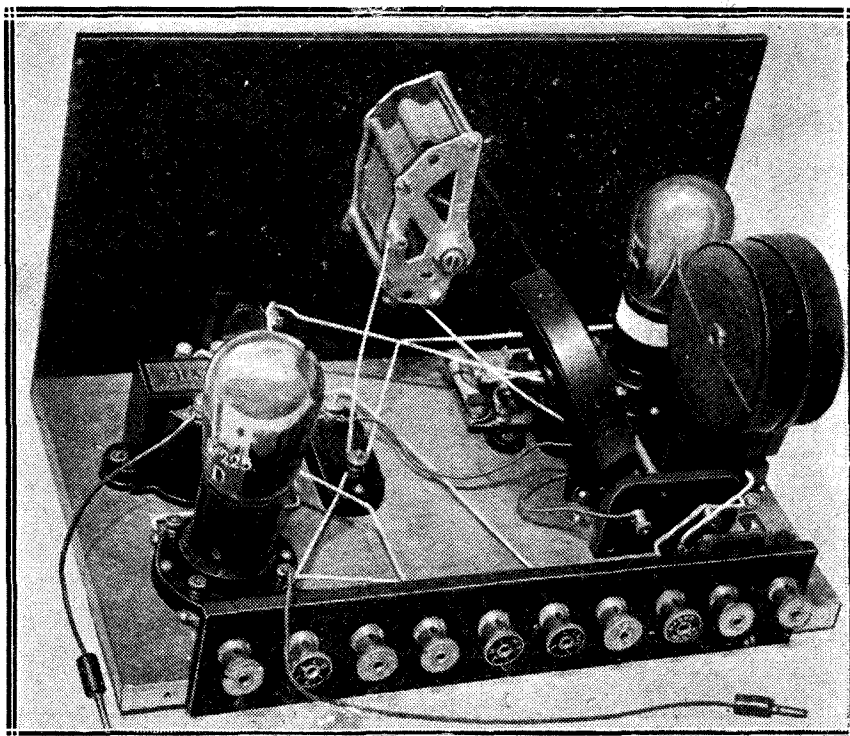

Simple to operate, easy to build, but capable of providing surprising "punch" and from an excellent number of stations.



By  
**MARCUS G. SCROGGIE, B.Sc.**

# Radio

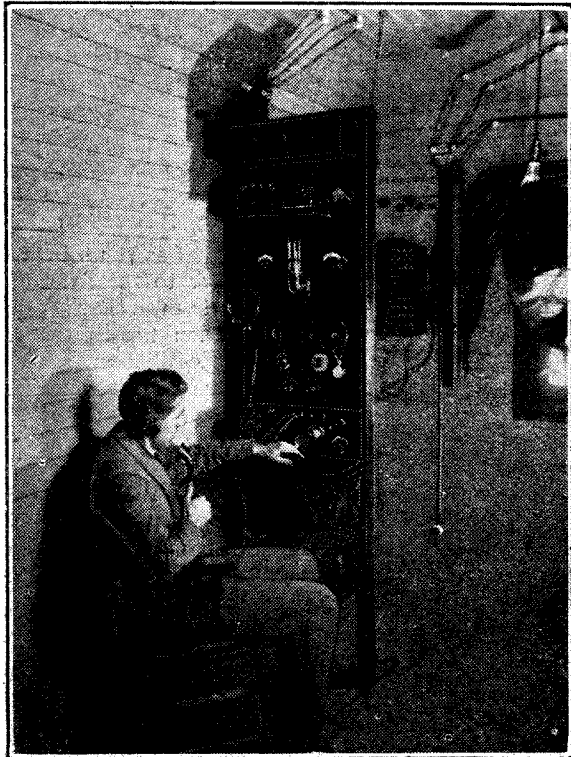

The radio equipment used in connection with the establishment of communication between Toronto and a moving train.



(Left) Mr. Aylesworth, President of the National Broadcasting Company of America. This photo was taken during his recent visit to this country to study the B.B.C.'s methods. (Right) Mr. O. B. Hanson, manager of the N.B.C. plant operations and engineering, throws in the switch which coupled sixty stations of the N.B.C. chain with a relayed programme from England.

**T**HERE are a great many large manufacturers of broadcast receiving apparatus in the United States, and the fact that a single one of these turns out in a day more sets than any except the largest British factories produce in a year is clear evidence that in this respect it is a highly developed country, and to one interested in the production of wireless sets a place worth seeing.

### Quite Different

A recent visit there has confirmed this view, and as American practice is entirely different from our own, and does not receive very much attention in British papers, the following is an attempt to describe some of the outstanding features of

American design and radio conditions generally.

Radio receivers themselves are given such a lot of attention that it is easy to forget that they are not ends in themselves, but are intended to make the broadcast programmes available. Before comparing American receiver design with ours it will make it easier to account for the differences if a little space is devoted to the broadcasting system itself.

### Commercial Competition

Most European countries have adopted a system more or less resembling our own, in which the listener pays directly for the programmes by his licence fee. The programmes are then organised by some independent body, sometimes the State, and can be considered as a whole. The American has a horror of anything approaching a Government monopoly and worships commercial competition.

Subject to fairly broad regulations, almost anybody can broadcast in the United States, and there are hundreds of stations, entirely lacking in uniformity of technique, power or purpose. Some are small affairs putting out only a few watts, others are much

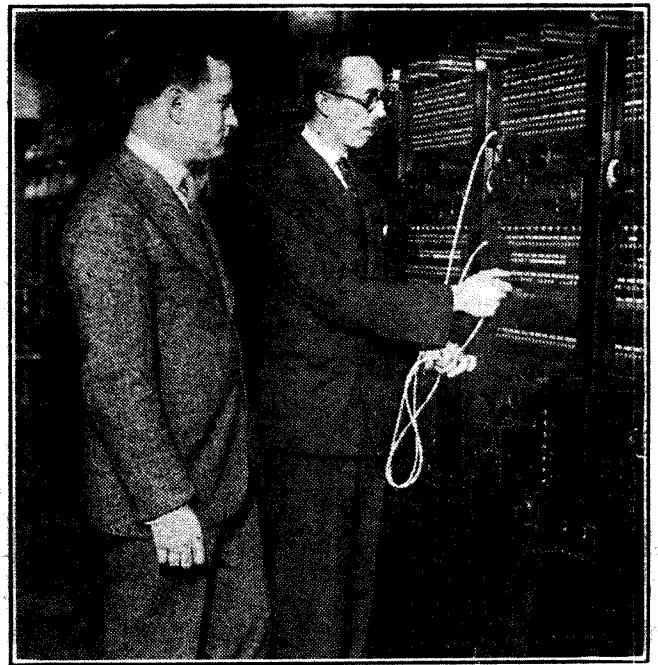

# in America

*Some interesting impressions gathered during a recent visit to the United States by the Chief Engineer of a leading British wireless concern.*

larger even than the high-power Daventry station.

Most large cities possess several. Some are municipal, some commercial, some philanthropic, some religious. As one might expect of America, the commercial ones predominate. As with many other enterprises, a too complete liberty led to something approaching chaos, and a few years ago a nearer approach to our unified system was set up by the formation of the National Broadcasting Company, which now operates through two networks of stations stretching from Atlantic to Pacific.

### **Alternative Programmes**

Generally one has the choice of two programmes, of N.B.C. standard, by listening to the nearest station on each network. There is also the Columbia Broadcasting Company, which works in a similar manner through a chain of high-power stations, linked up by land-lines.

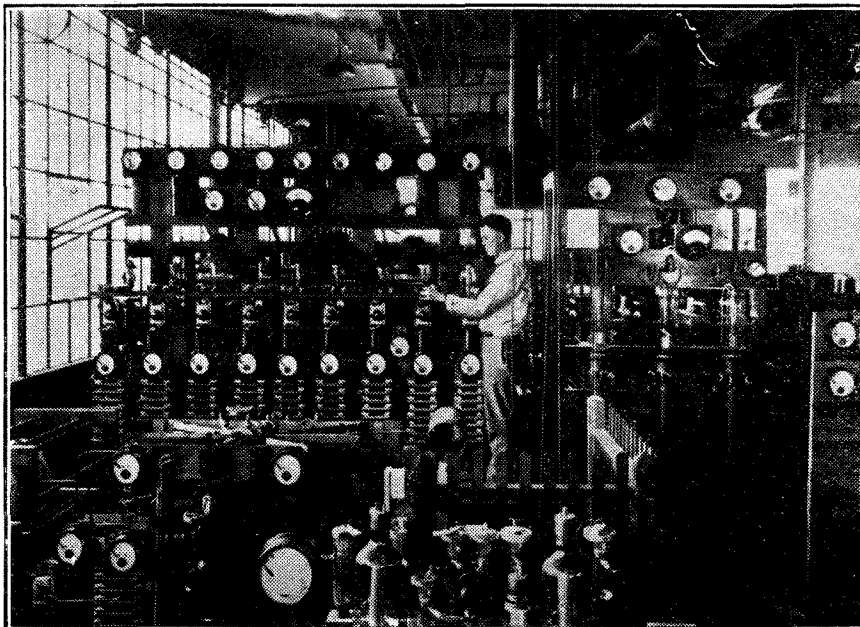

The 100-kw. transmitting outfit at the famous W G Y station.

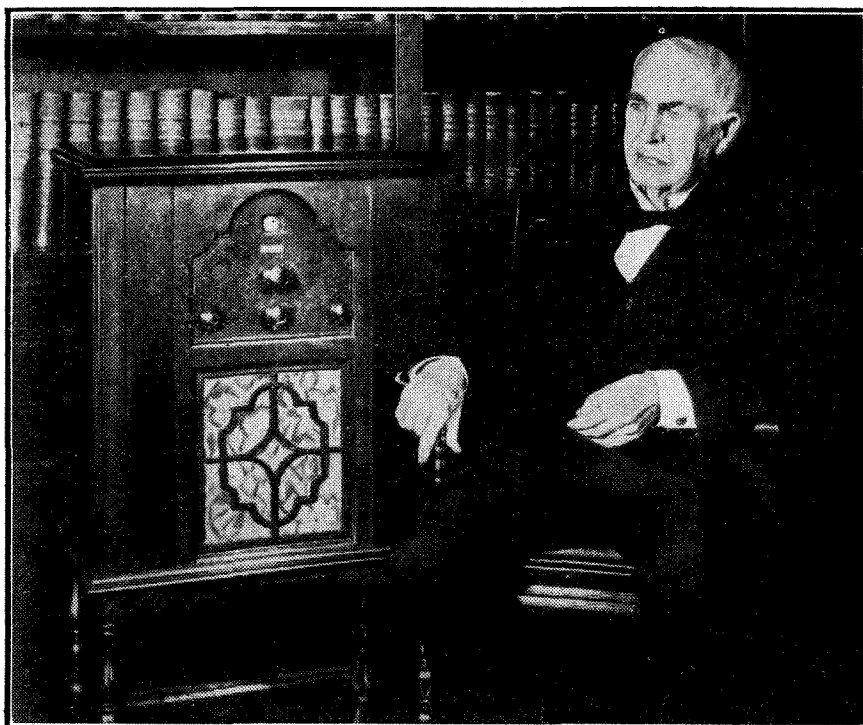

Mr. Edison with his new set. It is a combined radio receiver and electric gramophone, and it is said that on the wireless side static is completely eliminated by a novel and ingenious invention.

There is no licence fee or tax of any kind on receiving sets, so at first sight it might appear that listeners do not contribute to the programmes they hear. Many of them probably imagine that they do not. But as broadcasting in America is run on a commercial basis, and as commerce is not a form of philanthropy expecting no reward for its labours, it is clear that somebody pays.

### **The Listener Pays**

The broadcasting company is paid by concerns whose goods it advertises by means of the programmes. As a result of hearing the programmes the listener is fired with a desire to purchase these goods, and a proportion of the money he pays for them finances the programmes. As no firm would advertise merely to increase his sales to the point of paying for the advertising, it is clear that the listener actually pays more for his programmes than they cost; the advertisers pocketing the difference.

Admittedly the enhanced sales lead to reduced prices, and it is a nice little problem which listeners must decide for themselves whether the

things they buy cost more because they are advertised, or less.

Apart from this question of who pays for the programmes, the advertising system shows itself in the nature of the programmes themselves. The world is gradually getting used to the admixture with its entertainment of an increasing proportion of advertisement.

### The B.B.C. "Ads."

In varying degrees of subtlety the commercial element appears everywhere. Even our dignified B.B.C. cannot be persuaded to refrain from

mean that advertising is so obvious as in this country where it is not allowed. There are concerns who put on programmes and rely on the excellence of the entertainment to incline the listener favourably towards them.

There are also the other sort who are determined not to let even the most butterfly listener be in any doubt as to what they want to sell. There is the sandwich system, in which numbers by the Gaspar Orchestra alternate with the readings of letters from various movie stars and pugilists ascribing their success entirely to the smoking of Gaspar Cigarettes.

fyng without being obliged to hear most of it.

It consists of a cleverly worked out short play or sketch which appears quite genuine until near the end, when the climax is unexpectedly supplied by an application of the advertising medium. The great detective, for instance, unerringly unmasks the criminal by observing on him a smudge of Peach Skin Face Powder ("there is a druggist in every block who supplies it for 75 cents") which the murdered heroine, being a woman of discrimination, used.

### The Technical Side

While in ways like these American broadcasting has progressed beyond ours, the control room and studio technique on the other hand appear to be less highly developed than that of the B.B.C. The whole affair seems slightly more amateurish in execution compared to the atmosphere of organised perfection at Savoy Hill.

The elaborate "studio-mixing" effects which are used here in broadcasting plays are not employed at the N.B.C., so I was told, nor is there the control of echo and the fading and blending of sounds to the extent we have. The actual transmitting stations, of which quite a number of the very powerful ones were inspected, are very finely equipped.

Control of frequency is by quartz crystal, a method which has not been adopted so extensively in Europe. The little quartz plate, much about the size of a postage stamp, is caused to vibrate at radio frequency, and its feeble oscillations are amplified until they control a row of great water-cooled valves.

It was interesting to see stations which had been heard across the water: W G Y and W E A F on the normal broadcast waves, and 2 X A F, 2 X A G, and 2 X O on the short waves. There are no long-wave stations.

### Extensive Shielding

New York and skyscrapers have a place in the same compartment in most minds. Tall buildings are characteristic of American cities everywhere, and they consist essentially of a steel framework, with the walls merely applied to keep out the weather and to keep in the heat which is essential to the incubation of American citizens.

These frameworks form excellent electrical screens, and the field strength of the wireless waves is reduced enormously inside. Consequently outdoor

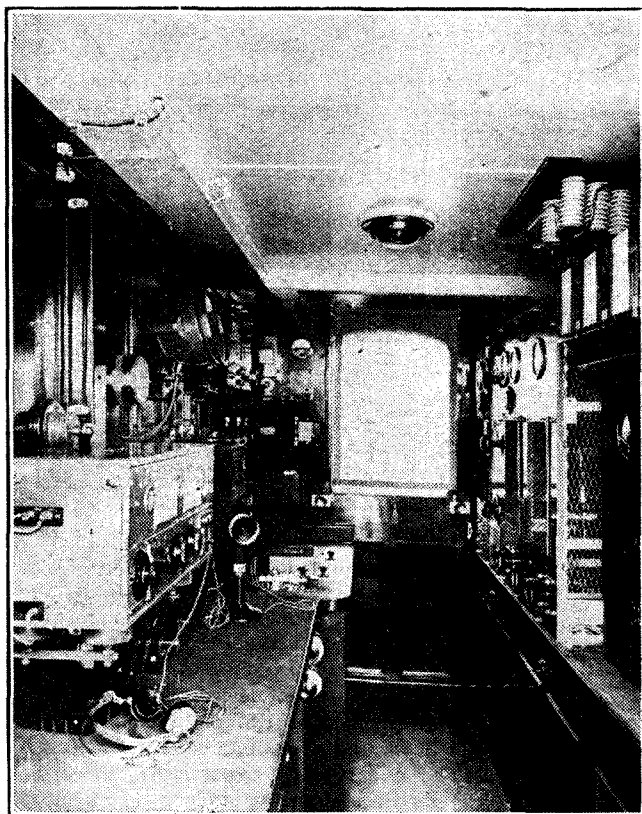

This is the wireless room of "Crusader," a motor yacht, built for an American oil millionaire by a Southampton firm. It is said to be the biggest private yacht built in this country since the war. It is fitted with a quick-firing gun.

calling our attention to the fact that the "Radio Times" may be obtained, price twopence, from any newsagent, or that the gramophone record just played was Screechophone No. so-and-so.

We are quite accustomed to pointed references to the new book which has just been, or is just going to be, published by the learned gentleman responsible for the talk which we are about to switch off, and the announcer is at pains to let us know that the number to be played by the B.B.C. Dance Orchestra is from the show whose title he repeats *ad nauseam*.

### Novel American Methods

The fact that broadcasting in America does not always

This method is so obvious that a switch-over to another station can be effected at an early stage of the proceedings. Then there is the more ingenious type of programme in which the items are chosen to bear some relation to the product which it is desired to put across. For example, the announcement of the number "Mighty Like a Rose" will be followed up with the information that Rose Leaf Soap, which, as all our listeners know, creates a complexion superior to that of any rose, may be obtained at all drug stores for a dime.

This type of propaganda may also be easily detected, and if necessary eliminated. But there is a class of entertainment which my brief stay did not put me in the way of identi-

## Pentodes Entirely Unknown in the U.S.A.!

aerials are more essential than in this country. It has already been explained that for every station we have, the American has more than a score, so that the mild call for selectivity which is raised here amounts to a shout over there.

In fact, an American set is about 90 per cent selectivity. While British receivers have fewer and fewer valves, so that three is now the recognised standard rather than four, American sets start at six and go up. That is partly because in order to gain the all-important selectivity it is necessary to have a large number of tuned circuits and consequently a large number of valves.

### Inefficient Stages

It is possible to obtain great selectivity without this, but only at the expense of range and also of high notes due to side-band cut-off. The difference in mentality which leads many British motorists to favour small highly-efficient sports cars, requiring considerable skill to drive, whereas American cars are almost exclusively of the large-capacity moderate-efficiency type, accounts to some extent for the differences in radio design.

British sets have few valves worked at high efficiency, and less emphasis is placed on simplicity of control than on maximum performance obtained by pressing them to the limit. American sets use many valves of low efficiency, enabling reaction to be dispensed with and tuning circuits to be ganged. A large number of relatively flatly tuned circuits can be ganged more easily than a few sharp highly efficient ones, and provide the right characteristics for selectivity and good quality, too.

### Typical Circuit Design

The heavy tax which cuts down the capacity of British engines finds its counterpart in the Marconi royalty, which restricts the number of valves and stimulates the demand for higher valve efficiency. There are many standard American valves with a slope of much less than 1 milliamp per volt, while we sniff at less than about 2.

There are two main methods adopted in high-selectivity receivers—the super-heterodyne and the “straight” amplifier, with or without neutralisation. The super-heterodyne is a speciality

of one American firm, so apart from this the standard type of apparatus consists of three H.F. valves, detector, one L.F. and two power valves connected in push-pull.

There is only one tuning control, with three or four condensers on one spindle; four if the aerial circuit is tuned and three if it is aperiodic. I mean really aperiodic, not the system with a few turns between aerial and earth which is sometimes erroneously described as aperiodic.

between the filament centre-taps and anode returns, and the three different filament voltages. Stability is obtained by comparatively low efficiency and a high step-up ratio of the H.F. couplings. Some manufacturers go for greater amplification by neutralising the H.F. stages.

### Two Years Behind

American practice is about two years behind as regards screened valves, and it will be next season

## BRITAIN'S RADIO LEAD

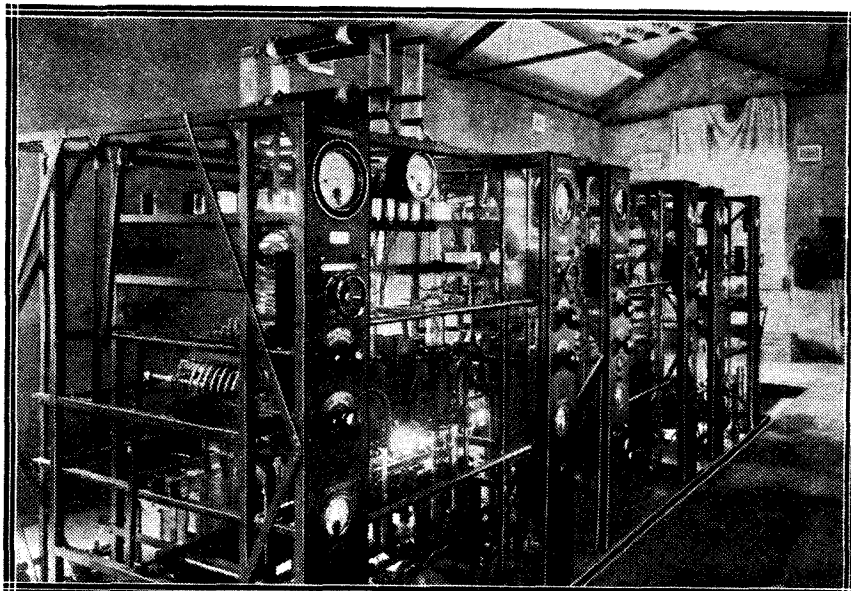

The main transmitting panel of the Ballan Beam station, Australia. Our great Imperial network of economical Beam stations gives Britain the lead over all other countries in world-wide communications.

The scale takes the form of a drum usually calibrated in metres and kilocycles and illuminated from behind. There is no reaction control, and no need for a wave-change switch as there is only one wave-band. The vast majority of sets are arranged for working directly off the mains, as most listeners have an electric supply.

Americans tolerate a good deal more hum than we would, and generally only one valve has a separately heated cathode. The circuit diagram illustrates a typical American design. This particular example has not a push-pull output, so has only six valves, excluding the full-wave rectifier. The three tuning condensers are gang-connected, while the aperiodic aerial circuit serves also as a volume control.

Points to notice are the grid resistors to equalise amplification over the tuning scale, the resistors connected

before they are taken seriously—looked at from the sales view-point, at any rate. The necessity for them has not been so urgent, for reasons which will by now be clear.

One screened valve does not give enough selectivity for America, and three of them cannot be handled very comfortably. Pentodes are entirely unknown. The usual American enthusiasm for novelty stops short of valves, in which they are surprisingly conservative; they stick to a few standard designs, mainly with a much higher filament consumption than we think necessary.

### No Two-Volters

Two-volt valves are not obtainable. The standard voltage for battery valves is 5, for indirectly-heated valves 2.5, and for directly-heated mains valves 1.5, corresponding to



our 6, 4, or 2, 4 and 0.8 respectively.

It is estimated that portables form about 70 per cent of the output of British sets. My estimate for America is 0.001 per cent. Knowing this, I took with me a Burndept Screened Portable. The first chance to try it was on the train going to Southampton.

### Receiving 5XX

Reception from Daventry was strong enough to make it unnecessary to pull the communication cord in order to listen. On the ship, or rather in the ship, the screening was so perfect that the ship's transmitter itself was barely audible. Needless to say, no other station was even audible; and as the weather was such as to throw the 52,000-ton vessel about and smash parts of it, the less electrically screened portions were not accessible to passengers.

In New York most of the observations with the set were made in the very centre of a huge building which has no parallel in this country, and the situation was therefore a rather severe test for a frame-aerial receiver.

Certainly one could not pick up stations many hundreds of miles distant, as at home, but some fifteen alternative programmes were obtainable at more strength than the best people like to use in a hotel. No American set with four or even six valves could equal this performance on a small frame.

American radio is as firmly bound by the dictates of fashion as is feminine attire. The type of reproduction at present in vogue is one which over-emphasises the low notes and removes the high notes more or less completely.

This is obtained by a moving-coil speaker fitted with a filter to cut out

sets, or whether the low prices are due to the absence of the home constructor, by enabling manufacturers to turn out larger quantities.

However that may be, the fact remains that, although the cost of living is higher there, an American set is priced far lower than is possible here. For example, a six-valve all-mains set, less valves, costs about £16 retail.

### Accurate Measurements

One is impressed with the production methods in American radio factories, and particularly with the extent to which laboratory measurements have been applied to factory work. Instead of expressing the performance of a receiver in vague arbitrary terms such as "good loud-speaker strength," "knife-edge selectivity," "perfect tone," etc., all the characteristics are actually measured and stated in scientific units. In this we have much to learn.

So when you begin to hear that a certain receiver gives an output of 2,500 milliwatts with a field strength of 15 microvolts per metre, or that an amplifier has a gain of 560 decibels, do not call it a lot of nonsense, but take the trouble to get used to it, because it is bound to come.

Electricians used to refer to the strength of an electrical source as equal to so many Grove cells, and doubtless thought of volts and watts as a lot of humbug devised by bearded professors to confuse them. Do not let us be slow to substitute measurements for guesswork.

### USEFUL TECHNICALITIES

Varying the value of the grid leak will occasionally help to give really smooth control of reaction.

When an L.F. transformer is suspected as being faulty, connecting a pair of telephones in series with its primary will enable you to check the winding of the instrument.

The most satisfactory method of testing the condition of the H.T. battery is by means of a high-resistance voltmeter.

All measuring instruments, voltmeters, ammeters, etc., should invariably be used carefully, as they generally embody parts which can easily be ruined by wrong connections.

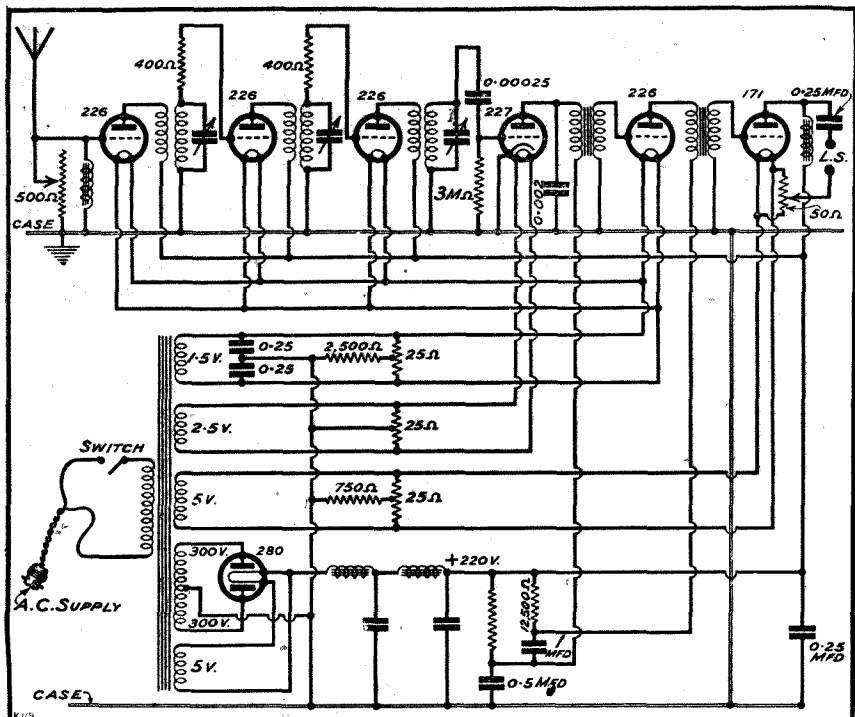

An example of typical American set circuit design. Selectivity is obtained by a multiplicity of H.F. tuned circuits, the condensers being ganged and drum-controlled. All the valves operate from A.C., and the detector is the only one which has an indirectly-heated cathode—the others have raw A.C. on the filaments. Note the elaborate A.C. transformer which supplies L.T., H.T. and grid bias.

On the way back, however, a quieter mood prevailed, and the set was opened out each night to hear the American broadcast receding and the European stations coming in. In this connection it should be recorded that, contrary to general belief, the night range of Daventry 5XX was about three times the daylight range.

It is usually supposed that the wave-length is sufficiently great to avoid this variation to a larger extent.

the high notes. In this respect we are rather in advance, for the craze for low notes has been succeeded here by a demand for brilliance, which had become rather impoverished, particularly when excessive reaction was used.

### Few Home Constructors

The home constructor is not so much in evidence in the U.S.A. It is difficult to say whether this is due to the very low prices of factory-built

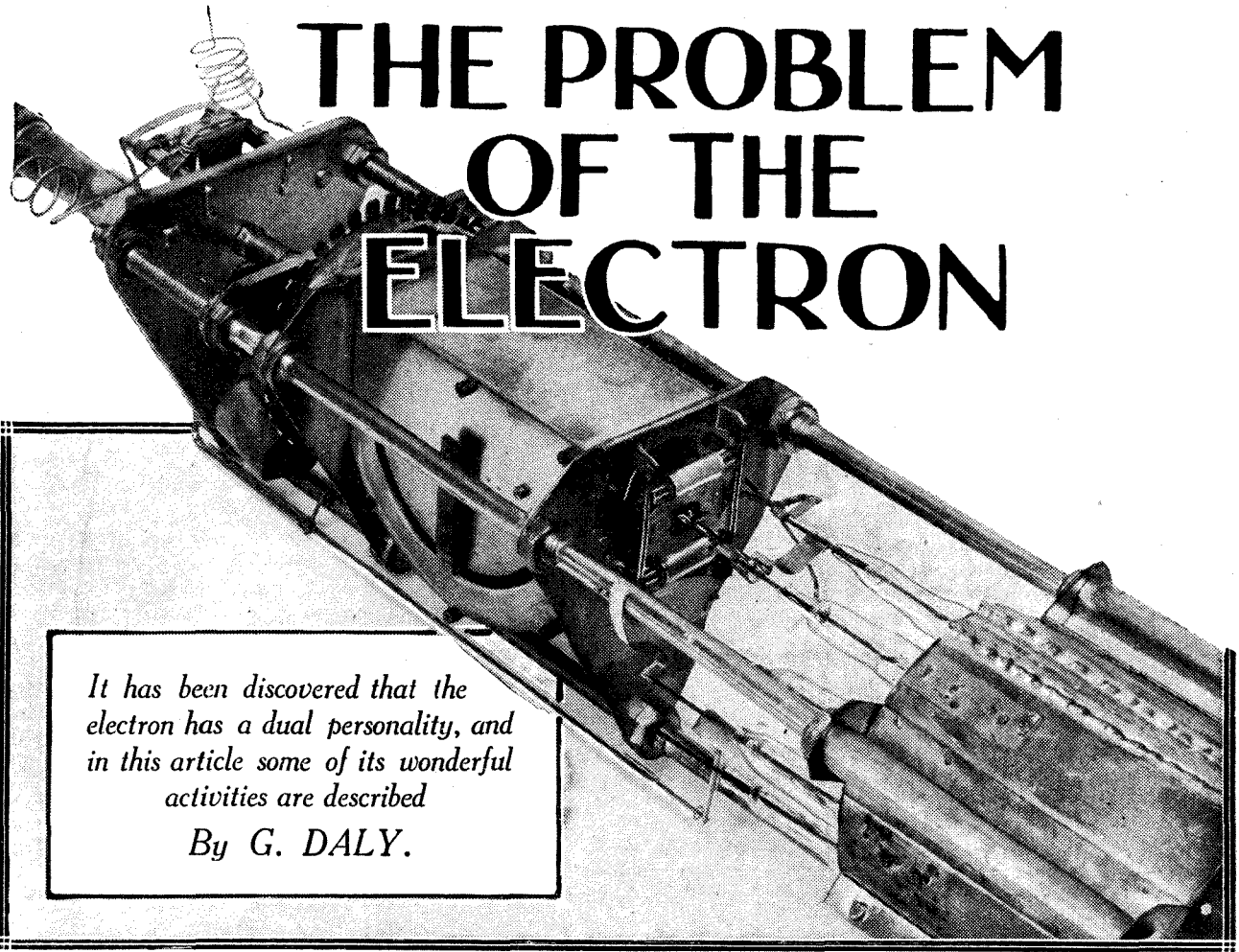

# THE PROBLEM OF THE ELECTRON

*It has been discovered that the electron has a dual personality, and in this article some of its wonderful activities are described*

*By G. DALY.*

**I**n olden times the Ancients thought that if they sailed their ships far enough to the westward they would come to the end of the world; and there was much speculation about what the end of the world would be like, whether you merely toppled over the edge of a kind of waterfall or came instead to a new sphere full of strange men and beasts.

Very much the same idea holds to-day in connection with the world of atoms and electrons. What lies beyond the electron? If we penetrate beyond the electron shall we topple into space, or, like Columbus, shall we find a new world? What is the foundation stone of the Universe?

Slowly but surely physicists are penetrating into the mysteries of the electron and the realm which lies beyond. Already startling discoveries have been made and new theories advanced by such scientists as Professor Eddington of Cambridge, Sir J. J. Thompson, Professor G. P. Thompson and others.

### **Remarkable New Phenomena**

Professor Eddington has shown that many of our ideas of the atom and electron handed down by pre-war science are very wide of the mark indeed. He has upset the mathematics of the electron and advanced a new formula for calculating the charge of electricity in the electron.

He suggested that our idea of electrons being merely minute charges or corpuscles of electricity—an idea almost universally held until recently—was probably inaccurate. Instead, he hinted, electrons might be closely associated with ether waves. In fact, matter—which we have always

regarded as being of a corpuscular nature, like the corpuscular idea of the atom—might be instead closely connected with ether waves, at its foundation.

And so it has been found, for this theory has since been confirmed and remarkable phenomena which is of the utmost importance to electricity has come to light.

### **Entirely New Radiation Revealed**

Sir J. J. Thompson was largely responsible for the present-day electrical theory of matter and much of our knowledge of the electron. So that it seems quite in the order of things that his son, Professor G. P. Thompson, who occupies the chair held by Clerk Maxwell at Aberdeen, should have confirmed the wave theory of the electron.

Professor G. P. Thompson has penetrated into the region which has been referred to as beyond the electron. He has sailed his ship a little farther to the westward of the Ancients into the unknown and found this new phenomenon—that the electron is accompanied by a train of waves.

These electronic waves appear to be an entirely new type of radiation—quite strange to mankind and full of latent possibilities. They have a frequency of about a million times that of visible light and seem to control the path of the electron. They do not follow the electron like the tail follows a comet, but precede it. Needless to say, these waves have considerably upset all previous ideas of the structure of the electron.

Up to a short time ago the electron was looked upon as a single independent charge of electricity moving around its central nucleus in the comparatively roomy atom. It

## Origin of Matter Still a Mystery

was regarded as a single particle or corpuscle of electricity, and it was upon this corpuscular theory that the complicated mathematics of the electron had been based; these mathematics now require a certain amount of revision.

With the discovery of the electronic wave train this corpuscular theory has become untenable, and the corpuscular theory of the electron has given way to a wave theory, or, to be more exact, the electron is partly corpuscular and partly ether wave.

### What is a Current?

This is not the first time in history that a corpuscular theory has given way to a wave theory. It will be remembered that Sir Isaac Newton postulated the theory that light consisted of small corpuscles or particles shot off by the illuminant.

Later, owing to the fact that certain light phenomena, such as interference, could not be explained by a corpuscular theory, but was quite explicable by a wave theory—the latter finally replaced the corpuscular theory of light.

Yet the corpuscular nature of the electron has not entirely been dismissed—far from it, for the electron is still a corpuscle, and in the electron we have come across something which is both a corpuscle and an ether wave—a discovery unique in the history of science.

This is a much more puzzling affair than would appear at first sight. For example, a current of electricity is a movement of electrons along a wire, but if electrons are accompanied by ether waves, what happens then? Ether waves have a constant speed of 186,000 miles per second, and if electrons are partly made up of ether waves, it follows that all electric currents will flow along a wire at the same speed—i.e. 186,000 miles per second.

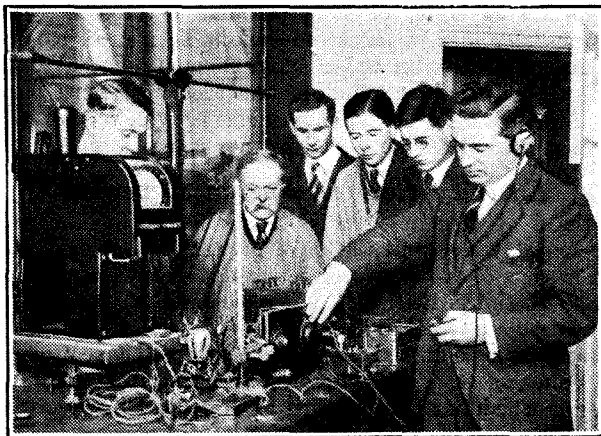

Prof. E. V. Appleton (with 'phones on), who has made many researches into electronic activity and wave motion. Recently he located a "second Heaviside Layer."

But we know by actual measurement that electric currents do not flow along a wire at this great speed—the speed of an electric current depends upon the type of circuit, the constants of the circuit, the resistance and so on. The current which lights our lamps or drives the dynamo does not flow at a speed of 186,000 miles per second.

Here then are two facts that seem irreconcilable. One, that an electric current consists of ether waves which travel at the constant speed of 186,000 miles per second; and two, that by practical measurement the current does

not travel at this speed, but in some cases at only a few thousand miles per second.

The answer is, of course, that the electron has a dual personality, the wave part of the electron which travels at the speed of 186,000 miles per second, and, secondly, the corpuscular portion of the electron which is really the energy, and which travels much more slowly than the wave portion.

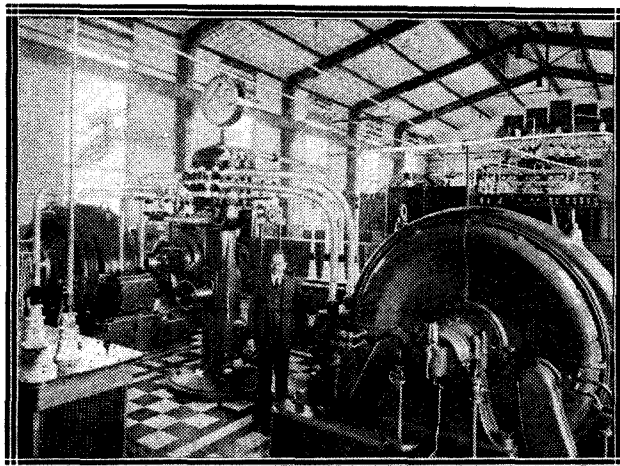

Part of the transmitting machinery at the Monte Grande station, Argentine.

The waves of the electron leap on ahead of the energy, but the waves are nevertheless wholly responsible for this energy and decide its path. As a matter of fact, it has been found that the actual current which lights a lamp does not flow along the wire, but comes into the wire sideways from the electronic ether waves surrounding the wire; the wire is merely a guide.

Any electric current is really a kind of wired wireless reversed, for in wired wireless the wire guides the wireless waves, whereas with an ordinary electric current the ether waves surrounding the wire control the energy in the wire. So it will be seen that our idea of an electric current being merely a flow of electron corpuscles along a wire has to be considerably modified, if not altered altogether.

### Foundations of the Universe

This duality theory of the electron also affects light and wireless theories of wave propagation, but in the case of light the phenomenon of duality has never been observed because the energy and the wave of the electron both travel at the same speed—i.e. 186,000 m.p.s.

In the case of the lower frequency wireless waves, however, the energy probably lags behind the wave a little, and when the matter comes to be more fully investigated we may learn that this is what is causing some of the vagaries of our wireless transmissions about the surface of the earth.

With this discovery of the duality of the electron we have by no means arrived at the beginning of things—the origin of matter is still a mystery. The discovery does, however, bring us nearer the foundations of the Universe, nearer to the mysterious something from which all matter—including our own world, the stars, and the great cosmic cloud which fills the gaps between the stars—was born ages ago, long before the dawn of time.

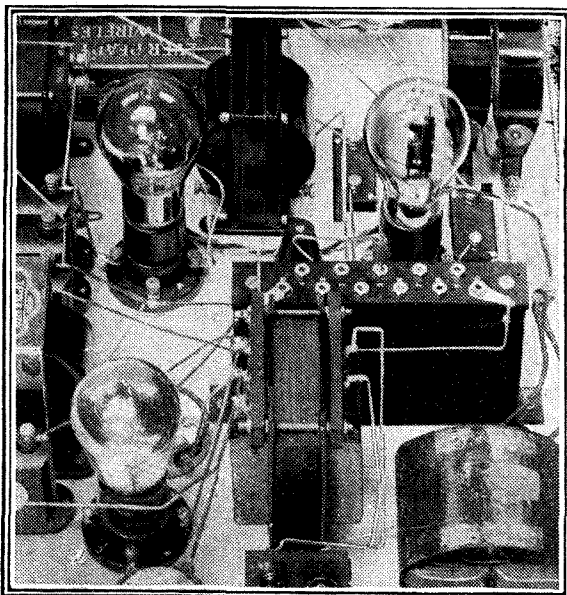

# Those A.C. Mains Valves

*With up-to-date apparatus it is of great advantage to employ the electric lighting mains to provide all the energy for your wireless receiver. Mains-operated valves are extremely efficient and are economical in the extreme. Some of the valves available for mains-operated receivers are discussed in this interesting article.*

*By KEITH D. ROGERS.*

**D**URING the last two years the design of valves suitable for operation from the A.C. electric-light supply has advanced extremely rapidly, and we now have a large assortment of valves from which we may draw when we want to build an "A.C." receiver. The chief trouble, of course, with A.C. is that we are liable to get a hum in our loud speaker unless we are careful in the building of the set.

again we get a definite fall in temperature, then an increase in temperature and then a fall again, so that the electron stream would be very unsteady all the time.

We must have constant electron emission from the filament if we are to have proper reception and amplification. Accordingly, we have to turn our attention to one or other of the two types of special A.C. valves which are on the market. Although perhaps not the best known type, we will mention first the Point 8 type of valve. This is a valve with a very short filament taking 8 amp. at only 8 volt, with the exception of the detector, which takes 1.6 amp., so that we get little voltage drop across the filament and little change in temperature as the A.C. fluctuates in value. These are made by the Marconi and Osram Companies in the usual types: screened grid, H.F., detector, L.F., power, and so on.

electron emission is obtained at a comparatively low temperature.

Now in order to heat this cathode a heating element which carries the A.C. current is placed inside it, quite close to it, but not in connection with it, and through this element is passed raw A.C. of a value of about 1 amp. at 4 volts. This heating element gives off quite a considerable heat, which by radiation heats up the cathode, which in turn emits the electrons.



This Cosmos A.C. screened-grid valve is probably the most powerful H.F. valve yet placed on the market in any country. It has an impedance of about 800,000 ohms and a magnification factor of 1,200. It takes 1 amp. at 4 volts and gives tremendous magnification.

It is impossible to use the majority of "ordinary" valves for operation with raw A.C. on the filament owing to the fact that the length of filament will cause such heat variation due to the current variations that the valve would be noisy in operation. In other words, we would get a hum. The long filaments cause considerable voltage drop, and every time the A.C. current drops to zero and then begins to rise

## No Super-Power Valve

Unfortunately, however, we have as yet no super-power valve in this series, the lowest impedance being the P-8 valve, which has an amplification factor of 6 and an impedance of 6,000 ohms. These valves are useful for small sets, but where very great volume is required it is necessary to use something which will give a rather more "beefy" output, such as the L.S.5A. with its different filament voltage or turn our attention to the indirectly-heated cathode variety.

These are valves which, instead of having the ordinary filament as we know it, have a special type of coated tube as cathode, the coating on which is carefully prepared so that a large

One of the older Metro-Vick Cosmos A.C. valves is this Shortpath Red Spot power valve. Used in conjunction with a screened-grid and a detector (Green Spot) A.C. valve this makes an extremely efficient and powerful "all-from-the-mains" three-valver.

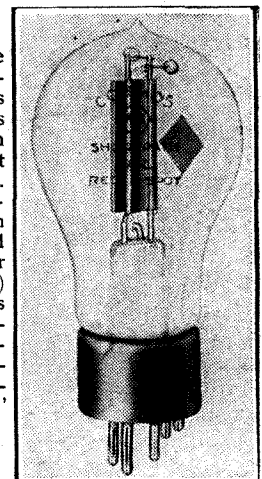

These valves take a little time to heat up, and, of course, some little time to cool down, thus the slight fluctuations due to the dying down at reversal of the A.C. current in the heater element has no effect upon the temperature of the cathode itself, and therefore no effect upon the electron emission of that cathode.

The trouble of hum, therefore, is got over in a very ingenious manner, and by careful design it has been possible to make valves of the



## Economical and Efficient

indirectly-heated cathode type extremely efficient; in fact, the mutual conductance of these valves can be very much higher than that possible with a valve of ordinary filament, and especially in the super-power class is the high magnification factor with low impedance valuable.

For instance, in the Cosmos range the power valve has an impedance of about 2,500 ohms, while the amplifica-

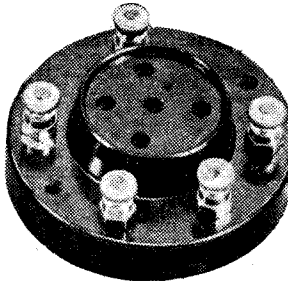

\* One of the new 5-pin valveholders for A.C. valves and for the new Pentones. \*

tion factor is 10, giving a mutual conductance of 4, which is a very high efficiency figure indeed.

We have a tremendous amount of choice in these A.C. valves, and constructors who live where A.C. is available should think very carefully indeed before they decide whether their next set shall be of the battery variety or whether it shall be an all-from-the-mains receiver. Taking the H.T. from the A.C. mains is, of course, a very valuable procedure, but it is still more useful to run the whole set, including the filaments of the valves, from the mains.

### Give Large Output

For "big" loud-speaker reproduction some of these big A.C. valves are invaluable, while the new Cosmos screened-grid A.C. valve is capable of giving a colossal magnification. In fact, the magnification from this is so great that exceptionally careful screening has to be adopted, and the coils in the screened-grid circuit have to be extremely carefully designed.

As a matter of fact, it is not possible to make full use of the magnification obtainable from this valve, but it can be made to give results comparable to one and a half or even two screened-grid valves of the battery-heated variety.

The first examples of the indirectly-heated cathode valves in this country were the K.L. series made by Marconi and Osram, and these were rapidly followed by the K.H. valves. Since then, Messrs. Metro-Vick have brought out a large series of Cosmos

valves which are extremely efficient, and lately the Cossor Valve Company have introduced a complete range of indirectly-heated cathode valves.

The one drawback in the A.C. indirectly-heated valve is the fact that it was to have a special valve holder, but holders are now being made standard, and the valves are being made in the five-pin variety instead of the three- or four-pin and special cathode connections. So if you change your set from ordinary valves to indirectly-heated cathode valves, or vice versa, you will be able to use the same valve holders.

### An Important Point

There is, however, one point which must not be forgotten when wiring up the actual heater element leads in the set which have to carry the L.T. current from the transformer, and that is that these leads should be made of either twisted flex or be lead-covered with the cover earthed, in order to stop A.C. hum being introduced into the adjacent wires of the receiver and thus causing an annoying background.

It is sometimes possible, in the case of certain super-power valves of the ordinary type, to run them quite successfully with raw A.C. on the filaments if care is taken that the correct voltage is applied. Such valves as the L.S.5A., which has a comparatively fat filament, can be used in this manner, and there have been cases in which the P.625a and

the P.625 have been used with raw A.C. on the filaments with good results.

It must not be forgotten that a special L.T. transformer of the step-down variety is required.

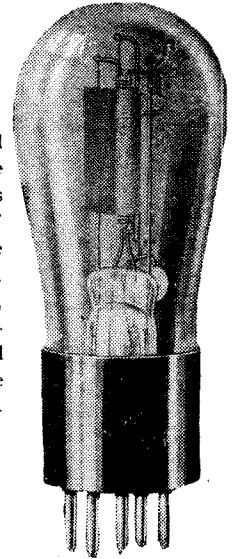

\* This is a typical example of the new Cossor mains valves—the "M" series. These are available in S.G., H.F., R.C., L.F., power, and super-power types, and are made with the new 5-pin bases. \*

In the case of the special '8 valve, the transformer has to be of such a ratio that it will deliver 2 amps. or so at '8 volt. On the other hand, in the case of the indirectly-heated cathode type we want several amps. at 4 volts, so as to supply the 1-amp. heating elements at 4 volts.

Personally I would not hesitate a moment in recommending constructors who have a certain amount of experience in the construction of valve sets, and especially in loud-speaker sets, to go in for A.C. mains receivers, and if they do so to go in for the indirectly-heated filament type, which will give them, in my opinion, more satisfaction than will the '8 variety.

### Changing Over to Mains

These latter, however, are quite useful for the man who wants to convert his ordinary set to raw A.C. without rewiring the same, and he can do this by just changing the filament leads into twisted flex leads, and buying a transformer suitable for stepping down the mains voltage to that required by the valve.

But he must not expect exceptional results. The characteristics of these valves are very much the same as those of the ordinary valves, and the amplification factors are not as great as those of valves of the indirectly-heated cathode types.

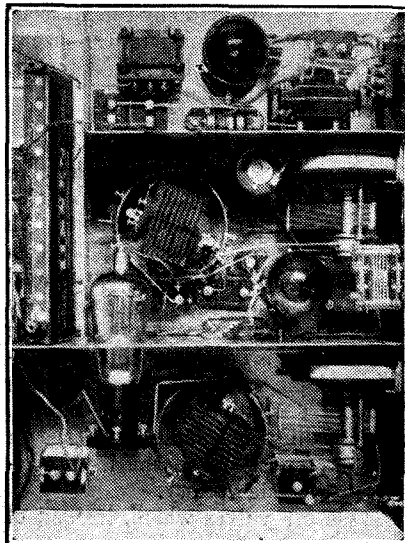

Part of an "all-from-the-mains" three-valver using the Cosmos S.G. mains valve, a Green Spot detector and a Red Spot power valve.

# LAZY WAVES

*Beam Radio has advanced so rapidly that we are apt to forget that a special wireless technique and new theories had to be developed before the present degree of excellence could be attained. The way "beam waves" behave is interestingly described in this article*

*From a Correspondent.*

**T**HERE is always something interesting in the "Marconi Review," and, in a recent issue, Mr. T. L. Eckersley, the brother of Captain Eckersley, has an extremely interesting article on Beam Wireless Waves. Mr. Eckersley proves pretty well conclusively that short waves, similar to those used by the beam system, are quite lackadaisical compared, for instance, with the waves used by the B.B.C.

Furthermore, beam wireless waves do, to a certain extent, wander off the path and, besides lingering on their journey, behave in other ways which provide interesting scientific problems.

## **Peculiar Direction Effects**

In some recent experiments Mr. Eckersley conducted he set up a special direction finder at Chelmsford. The idea was to check the bearings of the various transmissions from Marconi beam stations. As a result, these short-wave transmissions were found to behave in more than one peculiar way. For example, transmissions from the Grimsby beam station, which devotes most of its time to sending to Australia on a wave-length of 26 metres, is in a direction slightly west by north from the Marconi research station at Chelmsford. Curiously enough, however, the direction finder showed it to be bearing west-north-west during the morning and east-south-east in the afternoon!

## **Waves "Waste Time"**

More or less similar discrepancies were discovered to exist when this particular experiment was applied to other Marconi beam stations at Bodmin and Dorchester, and it was further found out that these beam waves took a longer time to reach their distance than theoretical calculations indicated. In fact, it appeared that .08 of a second was wasted by these waves en route. In other words, they dawdled on the way to an extent which, although in our

artificial system of time may be regarded as negligible, had, nevertheless, important significance.

## **Interesting Explanation**

Mr. Eckersley offers a very interesting explanation in the "Marconi Review," and, as one might expect, his explanation brings in the problem of the Heaviside layer, which, as my readers know, exists above the earth's upper atmosphere.

According to the article, it has been discovered that the apparent position of the transmitting beam station, as indicated by the direction-finding apparatus, is the position where the transmitting waves strike the Heaviside layer and are scattered; while the waves reaching the receiving station actually come from a point on the Heaviside layer sometimes thousands of miles away from the original source.

Now, this sort of thing is what complicates the theory of short-wave transmission and reception, and Mr. Eckersley is to be congratulated on being the first investigator to point out this scattering effect. It is generally thought to be the cause of various echo phenomena, an example of which was recently pointed out in MODERN WIRELESS in connection with the Oslo station.

There was a general idea once that when a beam wave strikes the Heaviside layer it is reflected chiefly in one specific direction, though, of course, in a very minor degree in all directions, for the most perfect beam apparatus in the world has not yet

enabled engineers to direct a wireless beam of energy without some slight diffusion of this energy.

As a result, waves arrive at the receiver from more than one direction; and as some of the short waves regard distance as almost non-existent, some of them probably travel round the world in opposite directions, with the result that the same signal reaches its destination by various routes and, consequently, at different times.

## **Very Confusing**

For example, if a dot in the Morse code is transmitted to one of the beam stations, the scattering effect results in the signal arriving by various routes.

This can prove very annoying in the case of a Morse dot, because the difference in time would result in the dot being lengthened as a signal, and perhaps to inexperienced ears sounding something like a dash. More particularly this becomes extremely aggravating in high-speed reception work, as blurring results and, consequently, confusion in signal reception.

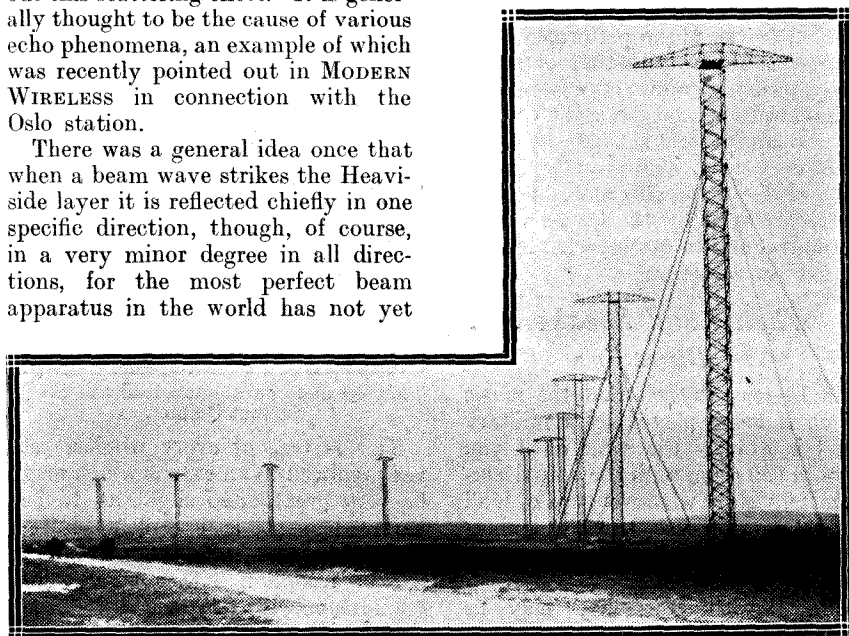

One of the British beam stations—situated near Bodmin, Cornwall

# Where the Small



Mr. Percy Pitt conducting the Wireless Orchestra at Savoy Hill.

**T**HERE are, undoubtedly, many thousands of radio listeners who have a decided preference for wireless music which is performed by small orchestral combinations such as the quintet.

For some reason, which may or may not be clear to them, they find that such a musical combination gives them a peculiar sort of pleasure which is sometimes absent when they are listening to a full orchestra. They will claim, many of them, that the reproduction of the music performed by a quintet is superior to that of many other forms of radio music—and in this they are indubitably right.

Here and there exists a wireless enthusiast who will proudly invite you in to listen to a Promenade Concert played by the Queen's Hall Orchestra, and to marvel with him at the perfect reception.

### *When Loud Speakers "Blare"*

Or he may suggest that the music which is being played by a military band is exactly the same as if you were in the room with the actual performers. Now, whatever type of loud speaker he may use, however elaborate his set, in your heart of hearts you feel that it is not so.

The illusion of reality may be almost perfect when some few of the instruments are playing together or

when there is a solo. But in the big ensemble passages it does not require a super-sensitive ear or even an advanced critical faculty to notice that here and there it—blares.

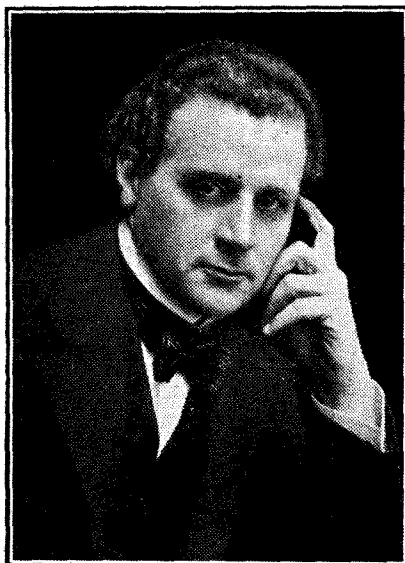

Mr. Gershom Parkington, leader of the famous Quintet.

This is true of every wireless set yet produced to an extent which may be very great or so slight as to be barely perceptible except at infrequent intervals. So far, absolutely perfect reception, either wireless or gramophonic, is a dream that has been almost, but not quite, realised. Whether perfect reception will some

day come is another matter. For the moment it escapes us.

But when a quintet or other small orchestral combination is broadcasting the imperfections are at a minimum. It gets across better than almost any other form of musical radio entertainment.

There is a chance for each individual instrument to play its full part; not exactly to be heard independently, but to be clearly discernible, with a personality and a quality of its own which is quite apparent. This is, of course, because the volume is not too strong for the sensitive microphone, which blurs when it is overloaded, as many a listener must have noticed when large orchestras are playing.

### *Why Quintets are Popular*

This defect is absent to a marked degree in the case of a quintet, where the reception, given a good set and good speaker, is as nearly perfect as it is possible to attain with mechanical means. Generally speaking, the music comes across to the listener with a quite remarkable degree of fidelity, and is to a large extent the secret of the quintet's popularity.

But this is not the only reason. The fare provided is responsible also. A small orchestral combination restricts itself as a rule to short pieces, and this, I think, is one of the fundamentals of radio success. This is due to the

# Orchestra Scores

By GERSHOM PARKINGTON

*" . . . When a quintet or other small orchestral combination is broadcasting the imperfections (in reception) are at a minimum. It gets across better than almost any other form of musical radio entertainment . . . "*

nature of the medium in which the radio artistic works.

Listeners to a wireless programme suffer from more external distractions than is the case with almost any other form of entertainment. They are subjected to more strain, and all the time their attention is being drawn elsewhere by what other people in the room may be doing.

At any moment they may be tempted to join in the conversation, make up a hand at bridge, or water the garden! This does not take into account the enthusiasts for chamber music, symphonies and so forth, who are willing to give their undivided attention, but who are at the same time in a decided minority.

The consequence is that the average listener, and with some justification, demands music or something else that can be listened to for a few moments, dropped for a time, and resumed intelligently and without loss.

## My Programmes

This cannot be done with long orchestral pieces; such as symphonies lasting over half an hour. Once stop listening and the thread is lost. But it can be done with a quintet's short, interesting, musical items.

It is liked both by lowbrows and highbrows. In choosing my own programmes, I try to make them the perfect meeting-ground for both these types who so often argue in the press.

The realm of music is large enough to find material which will appeal to each, and if sometimes it is difficult to know just where the borderline is, so much the better.

Many readers must have noticed that my own Quintet is frequently to be heard in association with radio drama. This, the provision of incidental music, is work which is particularly suitable for the small orchestral combination. In this connection I often wonder how many listeners realise the work and trouble involved in choosing just the right music for the right play?

So much has to be considered. You must suggest the atmosphere and the mood of the play: it is not a simple

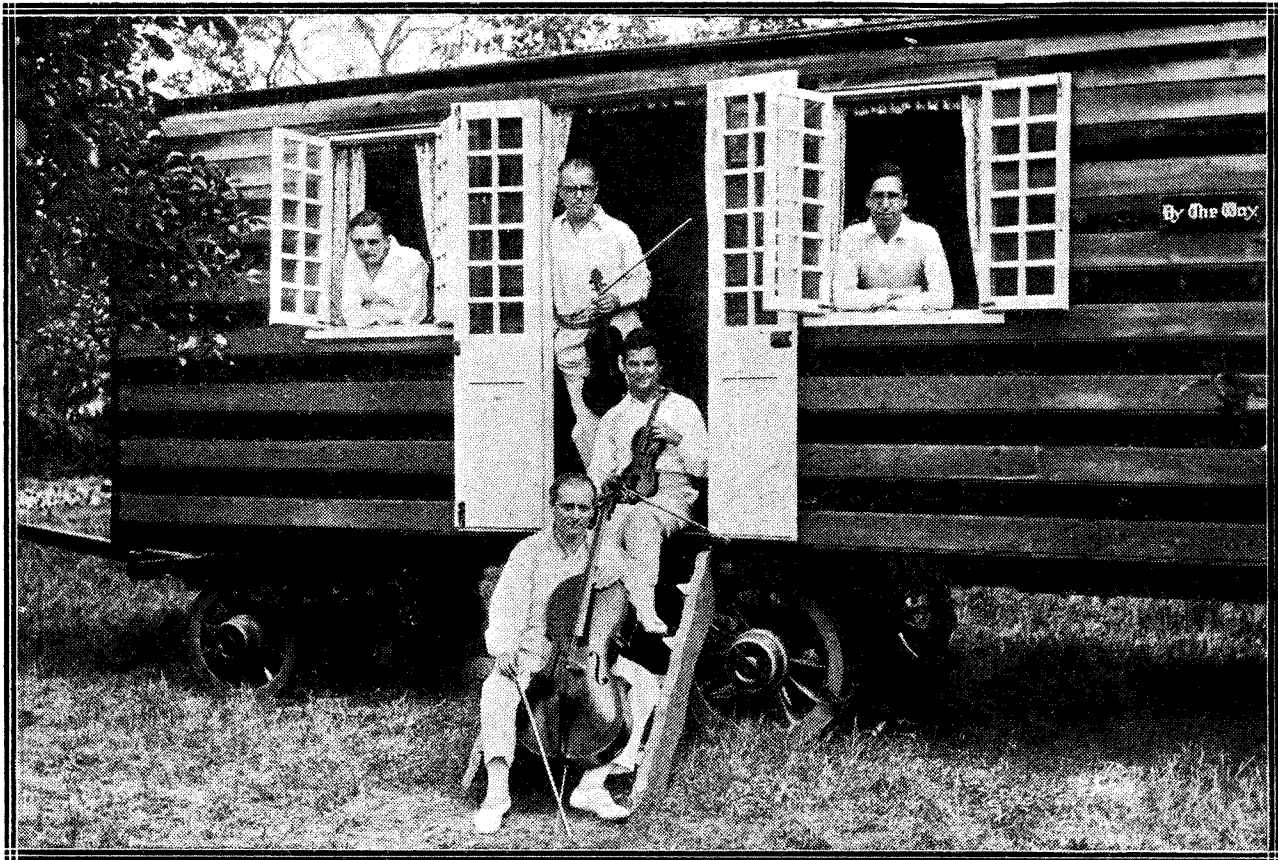

In lighter mood. The Gershom Parkington Quintet, so often heard from the B.B.C. stations, in an unusual setting while on holiday in the West Country.



case of literal musical interpretation. Besides expressing the atmosphere of the play, the music chosen must also serve to link up the acts, and must not contain anything that is foreign to what has gone before or what is yet to come.

**Worth-While Music**

Incidental music to a radio play actually means more than incidental music to a stage play, which sometimes receives scant attention from the

in keeping with the beginning of the next.

All this has to be considered when choosing incidental music for the radio play, and this music is important for yet another reason. It can do much to suggest the atmosphere of a play, where—as is always the case with wireless—setting, period, costume and character have to be left to the imagination of the listener to fill in as best he may.

Again I ask: I wonder if those who

Music, as many listeners have recently pointed out, frequently recalls something to the mind of him who is listening to it, particularly if it is familiar, and if what is chosen is too familiar it may call up an association which is quite foreign to the spirit of the play broadcast, on which the music should be a neutral, if sympathetic, commentary.

If the music, through its familiarity, calls up an incongruous association in the mind of the listener, its value is considerably lessened. To have the desired effect it must be neutral—unknown.



The Wireless Orchestra, conducted by John Ansell.

audience, who instead of listening read their programmes or discuss what the people in the stalls are wearing. It is very different with the radio play. Here the amount of attention paid by the unseen audience is much greater, because the distractions are less!

For this reason it must be worth listening to, of some worth musically, and if it is the musical interlude between the acts, the first part must be in keeping with the end of the act which preceded it, and the last part

have listened to the Quintet playing between the acts of a radio play have ever considered its work as anything more than a casual musical interlude?

**A Further Point**

And here is a further important point which arises out of what has gone before. The field of music from which a choice may be made is wide enough. But whatever is chosen must not only be suitable for the purpose in mind, it must also be not too familiar to the great body of listeners.

\*\*\*\*\*  
**ODDS AND ENDS**  
 \*\*\*\*\*

If you are using a screened-grid set and have a variable high-resistance on hand, try connecting this in the H.T. lead to the screening grid as very often a fine variation of H.T. voltage to this point gives extremely satisfactory results.

\* \* \*

Owing to its fairly high anode consumption, a pentode cannot be used successfully with small batteries. but should be run from the mains or from batteries of the large-capacity type.

\* \* \*

If a small disc, such as a cigarette-tin lid, is threaded on to the aerial just before it reaches the lead-in tube, the rain running down the lead-in wire will be diverted at this point and, therefore, the insulation across the lead-in tube will be improved.



One of the large orchestras employed at the famous short-wave station, K D K A, in East Pittsburg.



By P. R. BIRD.

*A few facts about the very important part played in reception by the earth connection.*

THE month of August is the time of the year when a great many listeners will receive their annual reminder that all is not well with their eccentric friend—the earth. From the autumn, right through the winter, during the spring, and in early summer, the earth connection appears to most listeners to be the one part of their wireless that never needs to be bothered about. But towards the end of summer many listeners are troubled with erratic reception to remind them that the earth plays an important part in a successful wireless receiving installation.

### *Crazy Tuning Effects*

What sometimes happens at this time of the year is that tuning-dial readings are apt to move suddenly, and without apparent cause. Generally, the change is only one of ten degrees or so, and the listener finds that for a night or two the local station's programme, instead of coming in at, say, 70 on the dial, is strongest when the reading is about 80. If this is all that happens he generally concludes that the station has altered its wave-length a little; or else he does not trouble to account for it in any way, merely turning the dial round to the new position and listening in, without bothering about the reason for the change.

In other sets the aerial tuning alterations are often quite extensive. In some cases the change of reading is not a mere ten degrees or so, but may be 30 or 40 degrees. And, what is more, these two widely different readings may alternate during one programme, so that the listener has to be continually jumping up and altering the dials in order to counteract this crazy tuning effect.

### *Double Dial Readings*

Very often one station can be picked up at times in one place and sometimes in another place on the dial, this effect being accompanied by weak signals; in other cases (fortunately not very common) a programme will be found to be coming in at two different places "on the dial."

In the great majority of cases, when erratic effects of this kind arise, it will be found that they are due to an imperfect earth connection. Sometimes the wire itself is at fault, or one of the joints, but most of the cases which arise during dry summer weather are caused by the fact that the soil around the buried earth has become too dry.

### *The Water Cure*

Nowadays, fortunately, it is becoming usual to employ a weak coupling between the aerial circuit and the first tuned circuit, so that earth eccentricities are less noticeable

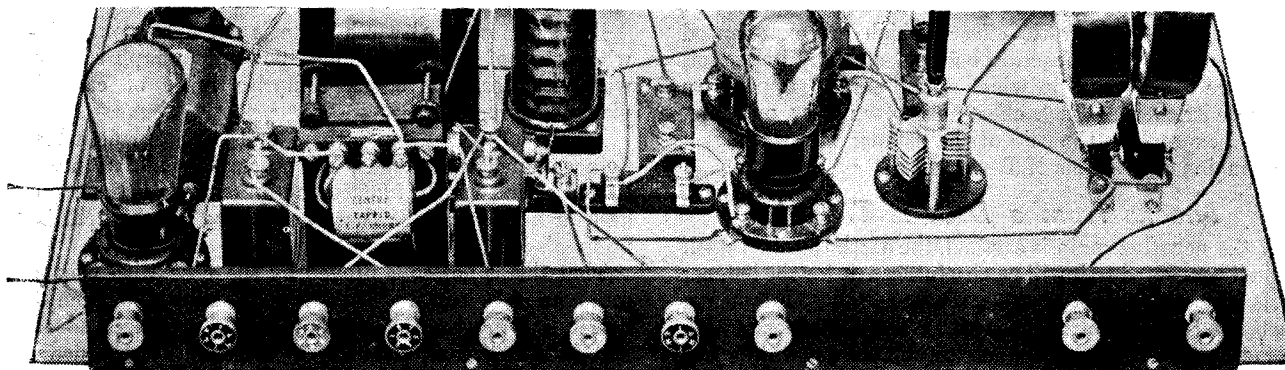

Whether or no the H.T. + terminals will feel "alive" when an H.T. D.C. unit is used will depend upon which main is earthed.

than formerly. But if an old-fashioned set is still in use, or if for some other reason the crazy tuning effects are observed, the listener will generally find that a few buckets of water over the earth will effect a complete cure.

Mother Earth herself is supposed to have no electrical charge, either positive or negative. Electrically, of course, it is a conductor. It is widely used in telegraph and telephone work as such; and earth connections at each end of the circuit act as an earth return wire, through which the currents appear to travel just as effectively as along the carefully insulated metallic conductors carried by the telegraph poles.

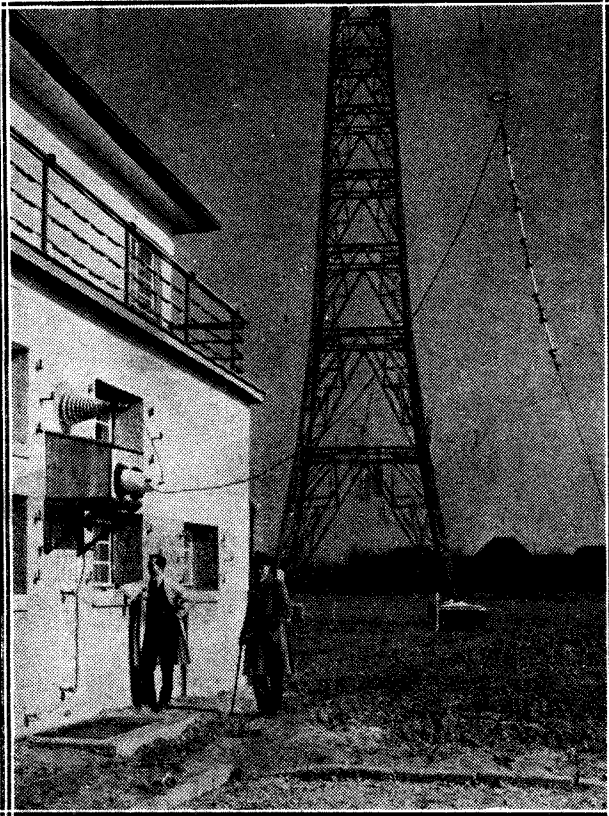

At all transmitting stations great care is taken to ensure an efficient earth. This view was taken at Konigsberg.

More than one bright boy has found to his cost that if the earth wire of a telegraph station is broken it may interrupt communication over several hundreds or even thousands of miles, and all because the essential lead to earth is broken. (Such a Post Office earth, by the way, is an object lesson to listeners, consisting, as it does, of a large sheet of metal solidly connected to a thick wire and deeply buried in moist soil.)

Apart from the erratic effects which are experienced owing to an earth connection being electrically imperfect, there are other ways in which the "earth" appears to act eccentrically. Such effects are often very puzzling. A good example is the case of the listener who employs a D.C. mains unit for his H.T. supply.

### Shocks from a D.C. H.T. Unit

If the negative main is earthed, the earth terminal itself and all connected to it will be absolutely safe for the listener to handle, for he, too, is at earth potential. Filaments, accumulator connections, the earth and aerial leads and, in fact, all the ordinary connections on the set will be free from the possibility of shock; and the only place where a shock would be felt would be in touching the H.T. positive

wiring, or anything connected to the plates of the valves.

This is just what the non-technical listener would expect to find, but it only happens in cases where the D.C. negative main is earthed. Sometimes for reasons of its own the electrical supply company earths the positive main to certain houses in the street, and where this is done the conditions from the point of view of the owner of a mains unit are completely reversed.

Now it is the H.T. positive wiring which is safe to handle, and he may with impunity touch the plates of the valve or the H.T. positive terminal on the mains unit without experiencing any shock. But all the H.T. negative wiring is now "alive."

The aerial and earth wires, the earth terminal, the filaments, the L.T. battery leads, are all liable to tingle when touched, because now they are relatively as far negative to the listener as formerly the H.T. positive wiring was positive to him. Obviously apparatus of this kind should be used carefully, installed by an experienced electrician, and purchased from a reputable firm which understands the possibilities of these potential differences, and lays down designs on "safety first" principles.

### Colossal Earth Plates

The advantages and, indeed, the importance of earthing an outdoor aerial when it is not in use have often been referred to, but it is not always realised that before an aerial is earthed it should be disconnected from the receiver. It is true that in some cases no harm is occasioned if this is not done, but in all cases where the mains are being used for H.T. supply it is advisable, as otherwise there is a distinct possibility of trouble occurring as the result of earthing the mains through the earthing switch. If this is done the least that will happen is that the main fuse will go west, possibly to the accompaniment of some unexpected fireworks.

No article on the eccentricities of the earth connection would be complete without a reference to the huge earthing systems provided at big wireless stations. Some of the B.B.C. earths—that at Daventry, for instance—are huge affairs, consisting of complicated networks of stout wire, leading to large earth plates, usually buried in a system of rings or semi-circles, and covering acres in extent. There is, in fact, as much diversity in earths as in aerials, and there is a certain humour in the way that the listener will depend upon a small earth plate for his earth connection, whilst the wireless operator on a transatlantic liner is only just satisfied when using the whole submerged hull of the vessel for his earth plate. (The earth wire is bolted to the framework of the ship and so makes contact with the surrounding water, port and starboard, from stem to stern.)

### The Other Extremes

Even this colossal earth plate is small by comparison with some of the world's high-power telegraph stations, where the earth systems comprise miles of carefully planned wiring.

At the other extreme, there is the aeroplane which, flying amongst the clouds, has no earth at all. And the buried aerial, which, functioning quite well, disposes once and for all of the idea that the surface of the earth is a no-man's-land for radio currents.

That this is not so is proved by the ease with which a radio message can be sent from a submarine when the vessel is lying on the bottom of the ocean. And this feat indicates that, although it is generally regarded as something of a nuisance, there may yet be a great many surprises for radio men in the earth.



Examining a variable condenser before inclusion in a set.

It is impossible in a short article of this nature to go fully into such an important and large subject as the construction of a modern radio receiver, but I hope to give a few hints to the set builder which may prevent him from falling into some of those little pitfalls from which it can be so difficult to get out.

The first thing to do when building a set, of course, is to collect together the various components required, such as buying fresh components where you are out of stock of particular items, or using up old ones where permissible. Incidentally, it is in this latter point that quite a number of constructors "drop a brick."

### "Anything" Will Not Do

It is not always advisable to use a particular component that you may have on hand simply because you think it "will do" in place of the one recommended by the designer of the set you intend to construct. In such cases as that of coils, or of transformers, or L.F. chokes, these should be carefully considered before any substituting components are employed.

Do not forget that a modern L.F. transformer is a vastly different thing from the transformer which was on the market two years ago, and if you have some of the old stock knocking about do not think that because they are labelled "L.F. Transformers," and have what you think is the correct ratio of turns, that they will do in a modern set.

# BUILDING THAT SET

*Some hints of practical value to the set constructor.*

*By G. WENTWORTH.*

They will give results, but you are almost certain to lose in quality if not in amplification.

Although modern manufacturing methods are greatly improved compared with those of a couple of years ago, one still gets an occasional "dud" in the form of a valve holder which will not make proper contact, or a grid leak or anode resistance which is a little bit off colour, or a switch which makes contact only every now and then.

It is best, therefore, carefully to examine all components such as those mentioned, and if any doubt arises to check them with a pair of 'phones and a flashlamp battery, or with a battery and a lamp, according to the type of component you are testing.

Variable condensers also have a happy knack of going a little bit astray, causing noisy tuning and all sorts of little troubles, and volume controls also are prone to little faults of bad contacts on occasions.

It must not be taken from this that these faults are very liable to occur. They may only occur in 1 per cent, or perhaps one in every thousand components, depending, of course, upon the make and the age of the component; but that one per thou-

sand *may* happen to come along to you, and if you are to guard against such an aggravating occurrence, it is best to examine every component before you put it into a set, especially if it has just come out of another set.

Especially is this the case in anything which has to take a sliding or pressure contact, such as a valve holder, coil holder, or switch.

### Careful Design Pays

Then having made sure your components are "above board," if you are planning a set on your own without any blue print or lay out diagram, do not attempt to save time by rushing the thing together.

Careful thought in the arrangement and position, and also the orientation of valve holders, transformers, and the like, will make all the difference when wiring the set up and in results when the set is placed on an aerial.

In the case of a set which is described and designed by another person, and for which you have a wiring diagram, it is most important to follow the designer's instructions as closely as possible, for in no other way can you expect to duplicate the results obtained in the original receiver.

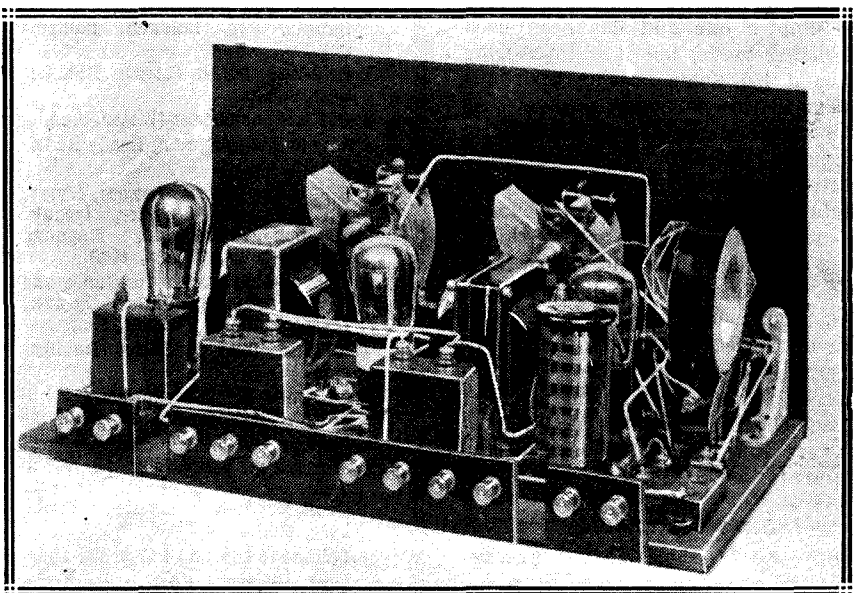

Though apparently jumbled together the components in this set are in reality carefully placed to avoid long grid and plate leads, and unwanted coupling effects.



# The

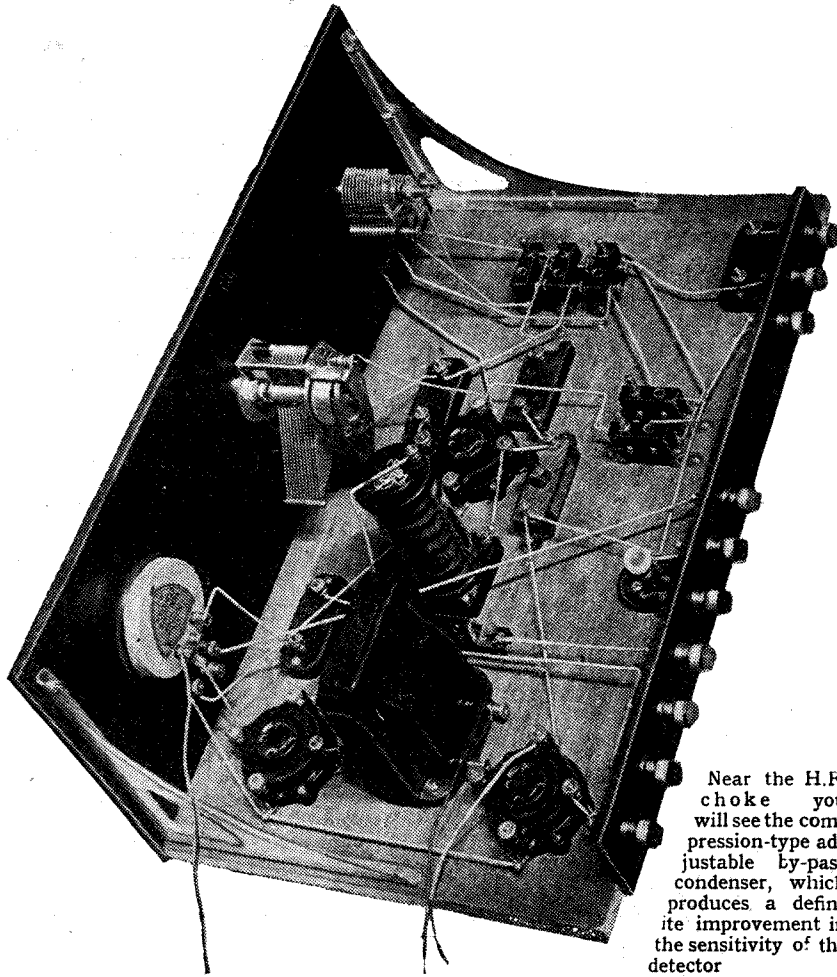

Near the H.F. choke you will see the compression-type adjustable by-pass condenser, which produces a definite improvement in the sensitivity of the detector

control purposes. To start with, the maximum capacity of such a condenser is comparatively small—but what about the values used when the set is working? These are smaller still since the maximum capacity is very rarely needed; in fact, one might almost say, never needed. Oscillation occurs before the moving vanes are completely meshed with the fixed vanes.

### High Impedance

Probably, on the lower end of the condenser dial, only a very small proportion of the reaction condenser is required to produce the necessary signal build-up, and but a trifle more to produce oscillation. This being so, it is easy to see that the only path for the H.F. currents from the anode of the detector valve—via the reaction control and back through the reaction coil to the filament—may be one of a comparatively high impedance. It should be remembered that there is an H.F. choke in series with the anode of the detector valve, hence there is no alternative path.

LAST month we published a single-valve receiver called the "Hercules," in which magnetic reaction, obtained by means of a swinging coil, was used. There is, of course, nothing very remarkable about this since the scheme is a very well-known one and has been used for many years, but it is interesting since it has some bearing upon the design of this particular receiver. As was stated in the article referred to, magnetic reaction is generally admitted to give, when properly handled, slightly greater volume than Reinartz reaction. Now the reason for this is no doubt due to the fact that a large fixed condenser is in all these sets either connected from the H.T. + side of the reaction coil to L.T.—, or alternatively from the coil to H.T.—, which is virtually L.T.—. Hence the H.F. currents have a path of very low impedance back to the filament.

### Small Capacity

Suppose we consider the average Reinartz reaction receiver in which a small condenser of, say, .0001 mfd. or .00015 mfd. is used for reaction

\*\*\*\*\*

### COMPONENTS REQUIRED

- 1 .0002 fixed condenser (Dubilier, T.C.C., Lissen, Igranic, Mullard, Clarke, Goltone, Magnum, etc.).
- 1 .0003 fixed condenser (Dubilier, etc.).
- 1 2-meg. grid leak (Dubilier, Lissen, Igranic, Pye, Ediswan, Mullard, Cosmos).
- 1 Grid-leak holder (Lissen, Dubilier, Cosmos, etc.).
- 1 .001 fixed condenser (Lissen, etc.).
- 1 Fuse holder (Magnum, Ready Radio, Bulgin, etc.).
- 1 H.F. choke (Varley, Leweos, Lissen, R.I., Cosmos, Dubilier, Igranic, Raymond, Precision, Magnum, Bowyer-Lowe, Climax, etc.).
- 1 100,000-ohm anode resistance and holder (Cosmos, Varley, Igranic, Lissen, Mullard, Dubilier, etc.).
- 1 .01-mfd. fixed condenser (Dubilier, etc.).
- 1 Low-ratio L.F. transformer (Lissen, Cossor, Ferranti, Mullard, Marconi-phone, Philips, Brown, Igranic, etc.).
- 1 Insulating panel, size 18 in. × 7 in. ×  $\frac{3}{16}$  or  $\frac{1}{4}$  in. (Ripault, Becol, Resiston, "Kay-Ray," Trelleborg, etc.).
- 1 Cabinet to suit and baseboard 10 in. deep (Artercraft, Pickett, Raymond, Cameo, Lock, Bond, Gilbert, etc.).
- 1 .0005 variable condenser, slow-motion type, or with vernier dial (Dubilier, Igranic, Raymond, Lotus, Utility, Formo, Lissen, Cyldon, Ormond, J.B., Pye, Gecophone, Burton, etc.).
- 1 .0002 reaction condenser (J.B., Burton, Ormond, Cyldon, Utility, Lissen, Raymond, Dubilier, etc.).
- 1 Switch, standard wave-change type (Bulgin, Wearite, Pioneer, etc.).
- 1 L.T. "on-off" switch (Benjamin, Lotus, Lissen, Bulgin, Igranic, Wearite, Magnum, etc.).
- 1 Volume-control potentiometer, 1 to 2 meg. (Magnum, Gambrell, R.I., Igranic, Gecophone, etc.).
- 5 Baseboard-mounting coil holders (Lotus, Wearite, Ready Radio, Raymond, etc.).
- 3 Valve holders, sprung type (Igranic, Benjamin, Lotus, Ashley, W.B., Pye, Magnum, Bowyer-Lowe, Marconi-phone, B.T.H., Precision, Formo, etc.).
- 1 Formodensor, type J (maximum capacity .0003 mfd.).
- 2 Angle brackets (Raymond, Bulgin, Ready Radio, Magnum, Cameo, etc.).
- 1 Terminal strip, 16 in. × 2 in. ×  $\frac{3}{16}$  or  $\frac{1}{4}$  in.
- 10 Terminals (Belling & Lee, Igranic, Burton, Ealex, etc.).
- Quantity tinned copper wire, Systoflex, wander plugs, etc.

\*\*\*\*\*

# "Kendall" Three

Some very interesting work on the problem of improving the sensitivity of the Reinartz circuit has recently been done in the "M.W." Research Dept., under the direction of Mr. G. P. Kendall, B.Sc., and the firstfruits of the results obtained are embodied in this powerful receiver. With its wave-change switching, volume control and increased sensitivity, it represents a distinct advance in "Det. and L.F." designs.  
 Designed and described by THE "M.W." RESEARCH DEPT.

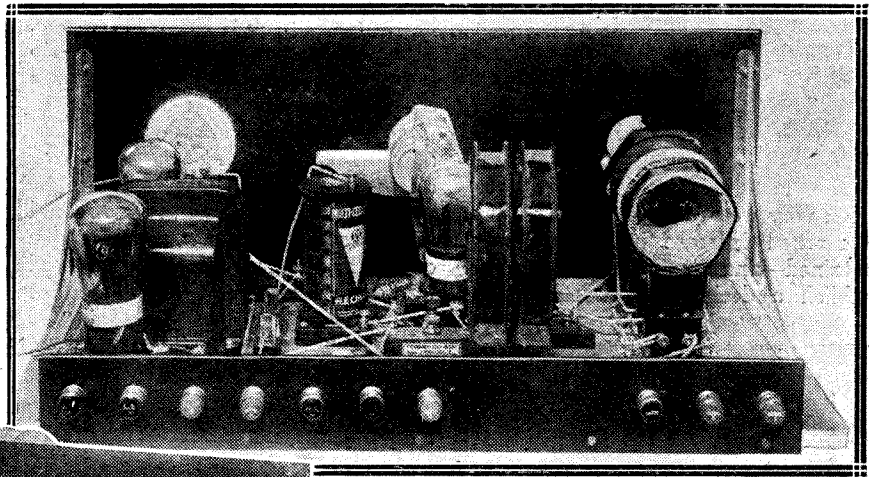

With valves and coils inserted (above) the set presents a very well-balanced and workmanlike appearance. The two groups of coils need careful arrangement. The panel layout (left) is quite symmetrical, and the finished set is an unusually attractive one.

to be considered was: How could a condenser be placed between the anode and L.T.— for by-passing purposes without permitting so much of the H.F. energy to take the alternative path that no reaction would be obtained? And, at first thought, it would seem that two variable condensers are necessary. The first to by-pass the H.F. currents, or, rather, a proportion of them, to the filament,

One can test this theory for oneself by taking a simple anode rectifier, that is, a bottom-bend rectifier, and trying it without reaction, and with no by-pass condenser, on the local station. Upon the strength being carefully noted, a .0003-mfd. fixed condenser should be connected between the anode and the negative side of the filament, and it will be observed that there is an immediate increase in volume. If signals are cut down so as to be just audible, and the fixed condenser is replaced by a condenser of the neutralising type, it will be quickly seen that the variation in capacity has a bearing upon the signal strength.

### Increased Volume

The same thing applies to the condenser when it is used for reaction purposes, and after experiment, with swinging-coil reaction receivers the "M.W." Research and Construction Department endeavoured to evolve a receiver with condenser reaction control having adequate by-passing

for the H.F. currents. It was considered that by so doing an increase in signal strength would be obtained over the ordinary straightforward Reinartz arrangement. The question

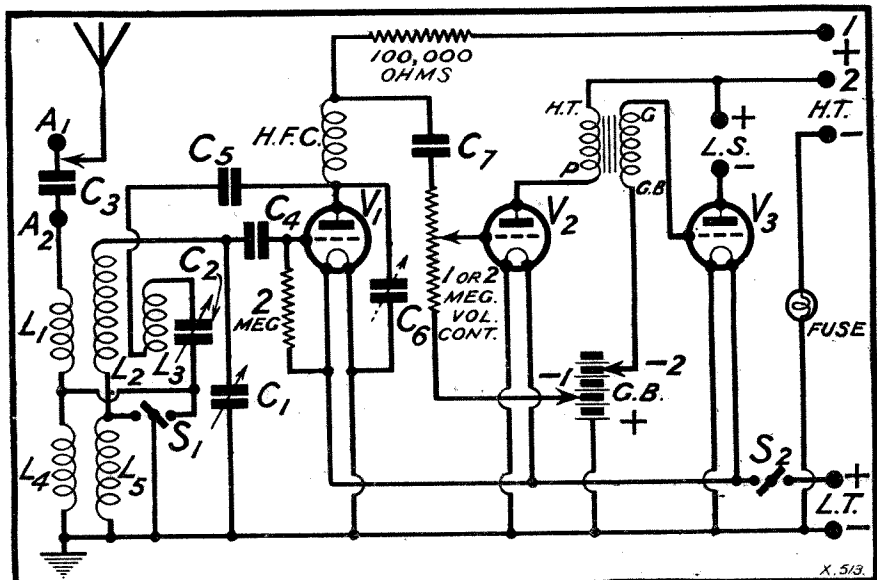

and the other to be used for reaction purposes. This, however, is a needlessly expensive and complicated scheme, since the end can be achieved with the aid of a semi-variable condenser of the Formodensor type.

Accordingly, a Formodensor was connected between the anode of the detector valve and the negative filament or earth, and a reaction condenser following the usual circuit arrangement between the Reinartz reaction coil and earth. The reaction condenser was made larger than the value normally used.

The arrangement was found to work very well—so well, in fact, that a marked increase in volume was obtained—and it was decided to publish a design incorporating this

scheme, the receiver described being the first of this type.

### The Circuit

The circuit of this three-valver is perhaps one of the most popular, since it enables one to obtain good long-distance reception together with full loud-speaker strength from the local station, 5 G B, 5 X X, etc. When the regional scheme comes into force it will be found that full loud speaking can be obtained from at least three British stations. On test, at 15 miles from 2 L O, the selectivity on the long waves was found to be such that Radio-Paris and 5 X X could be separated with the greatest possible ease. The circuit is a detector followed by two low-frequency stages, the first

being resistance-coupled and the second transformer-coupled. Plug-in coils are used throughout, and this is an advantage, particularly when the constructor already has a stock which he does not wish to scrap. It is a mistake to think that plug-in coils are obsolete. In practice they are very efficient provided a properly designed circuit is employed. The reason they have fallen in popularity is probably because of the various new circuits which have been evolved and of the necessity for wave-changing devices of compact type. In this circuit, however, provision has been made for wave-changing with the aid of the usual type of wave-change switch, and it is possible instantaneously to change over to

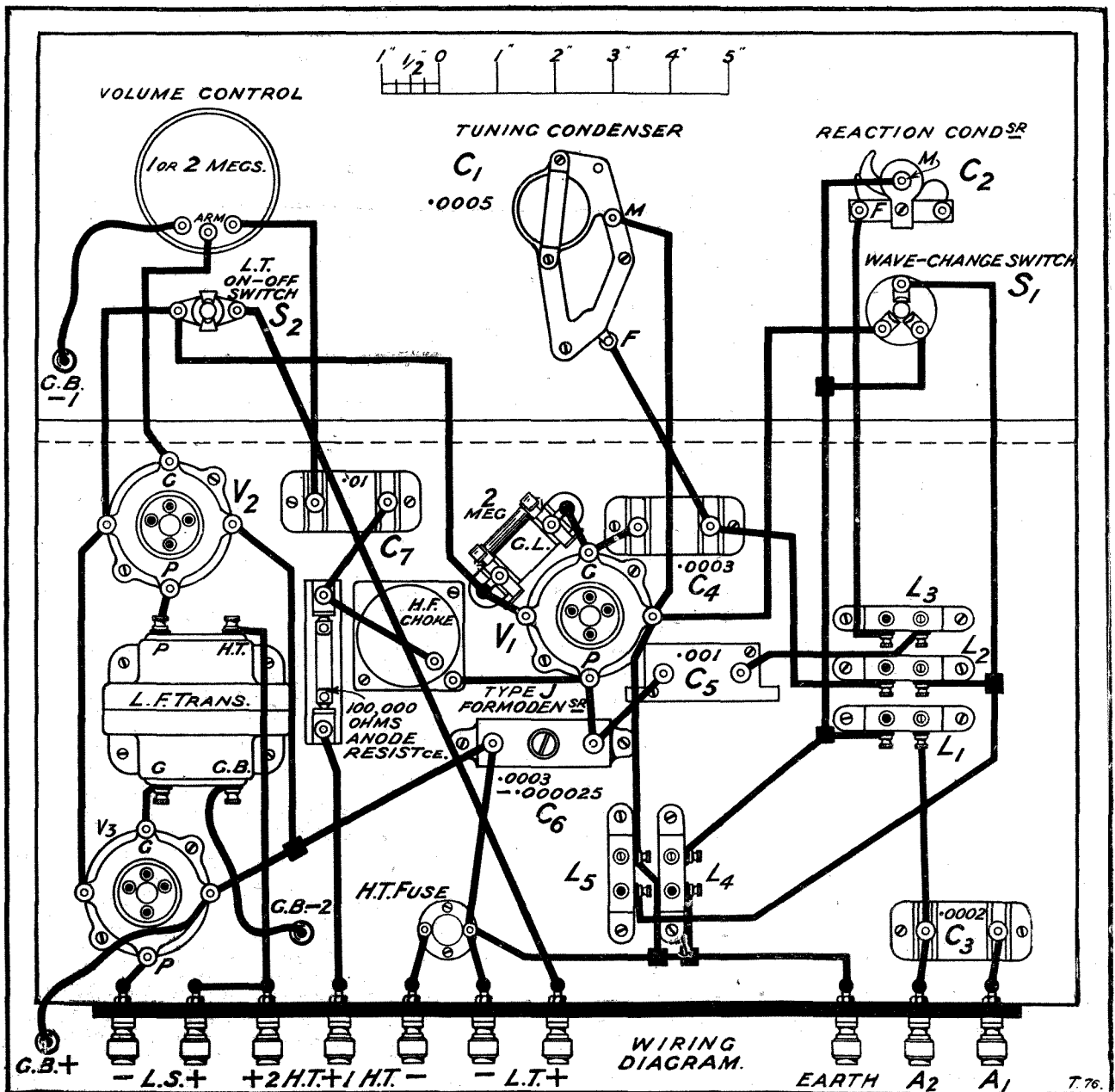

## Adding Punch to the Reinartz

5 X X from the medium wave-band.

In order that volume may be cut down to a whisper or increased to a maximum, a high-resistance potentiometer is connected in the grid circuit of the first L.F. valve. Thus the loud-speaker volume may be controlled to a nicety. Selectivity is

If you look at the photographs of the set you will see that there are five plug-in coils. Three of them are placed together on the left of the baseboard looking at the front of panel. These are the aerial, secondary and reaction coils for the medium broadcast wave-band of 200 to 550 metres. To the right of these are

waves the spring contacts are all shorted. On the long waves with the switch pushed in the springs are all insulated from each other, since they then make contact with the insulated portion of the switch plunger. These details are given since many readers have written in to the "M.W." Query Department complaining that the wave-change portion of their particular set will not function. Upon investigation it has been found that the switch used is of an incorrect type.

### The L.F. Stages

It may be helpful to say a few words about the values employed on the low-frequency side. You will note that the anode resistance has a value of 100,000 ohms, a somewhat lower value than is normally employed. The reason for this is as follows. The extra amplification gained by the use of a high value of anode resistance and a valve of the medium impedance "H.F." type in the detector socket is comparatively small as compared with the value chosen for this set. In fact, the step-up in amplification is scarcely noticeable with such a valve. Now from the point of view of smooth reaction control it is necessary to use a valve of medium impedance, hence there is no point in using an anode resistance of higher value. On the other hand, the low value assists in reducing reaction overlap and on the whole gives a much better control. The L.F.

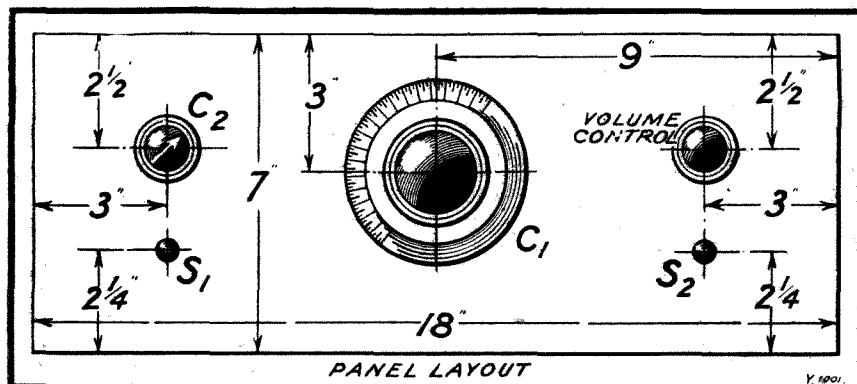

becoming a very important factor in the design of sets, especially in view of the possibility of "spreading" when the Regional scheme comes into force, and in consequence readers within the range of these new stations are faced with a greater difficulty in avoiding interference. In this particular set there are two aerial terminals. One of them permits the use of a small fixed condenser of .0002 mfd. in series with the aerial coil, and the other terminal enables this small condenser to be cut out of circuit.

### Selectivity

With this condenser in circuit the selectivity is greatly increased, and should any trouble from interference occur, the aerial lead should be shifted so as to include this condenser in the aerial circuit. Then there is another factor which controls selectivity, and that is the size of the aerial coil. For the medium broadcast wave-length you can use a No. 25, 35, or 40 aerial coil. Now the 40 may give the loudest signals, but it certainly will not give the best selectivity. Where selectivity is required the No. 25 should always be used, although no doubt the volume will suffer slightly. In an extreme case it may pay to wind a coil of 15 or 10 turns in order to gain more selectivity. This would, of course, only be necessary if the interference was very bad.

two other coils approximately at right-angles to those for the medium band. These are for long waves. The coil nearest the reaction condenser is the primary coil, and next to it is the secondary coil. Suitable coil sizes will be given later in the article.

### The Wave-Change Switch

The wave-change switch is of a type in which the spring contacts or tongues make connection with the centre spindle when the plunger is pulled out for reception on the medium wave-band. Thus on the medium

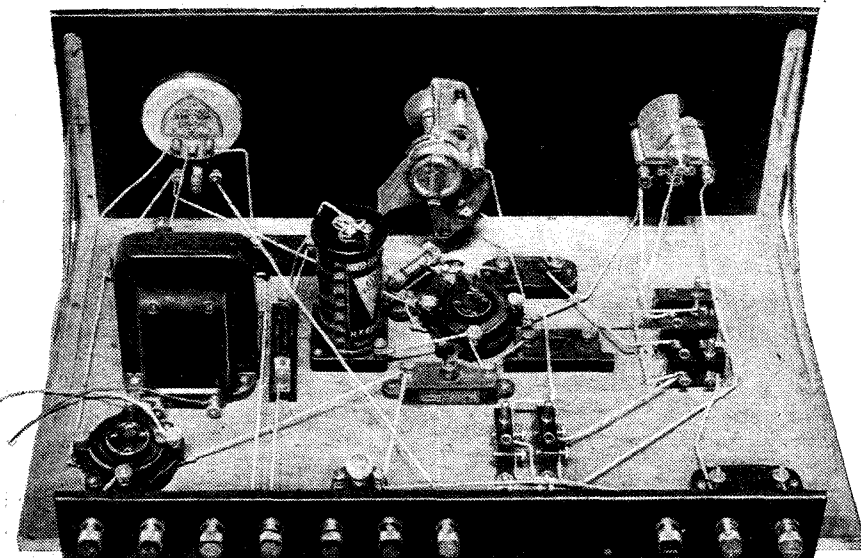

The rather deep baseboard, made necessary by the need for spacing between the coil groups, renders the set a very open and easy one to wire.



transformer chosen should have a ratio of between 2.5 and 3.5 to 1. If a high-ratio instrument is chosen, quality will suffer and the result will be a loss of bass notes. In general, a good average ratio is about 3 to 1.

### The Fuse

The volume control incidentally *must* be of the high-resistance type, that is to say, it should have a value of 1 to 2 megohms.

Then there is the question of the H.F. choke. This must be of good quality and possess a very large number of turns. Otherwise it will be impossible to obtain reaction on the long wave-lengths, and in addition the reaction control may possibly be un-

previously screwed the panel to the baseboard and placed the two angle brackets in position.

When you have made all secure, you will be ready to commence the baseboard layout. This is perfectly straightforward, provided the photographs and wiring diagrams are carefully followed. It is as well to position the coil holders with the coils inserted. In this way the correct distances between them can be accurately ascertained. When the coil holders are in position and the coils are inserted, the space between each coil should be something of the order of  $\frac{3}{32}$  or  $\frac{1}{16}$  of an inch. It should certainly be very small because the coils should almost be touching.

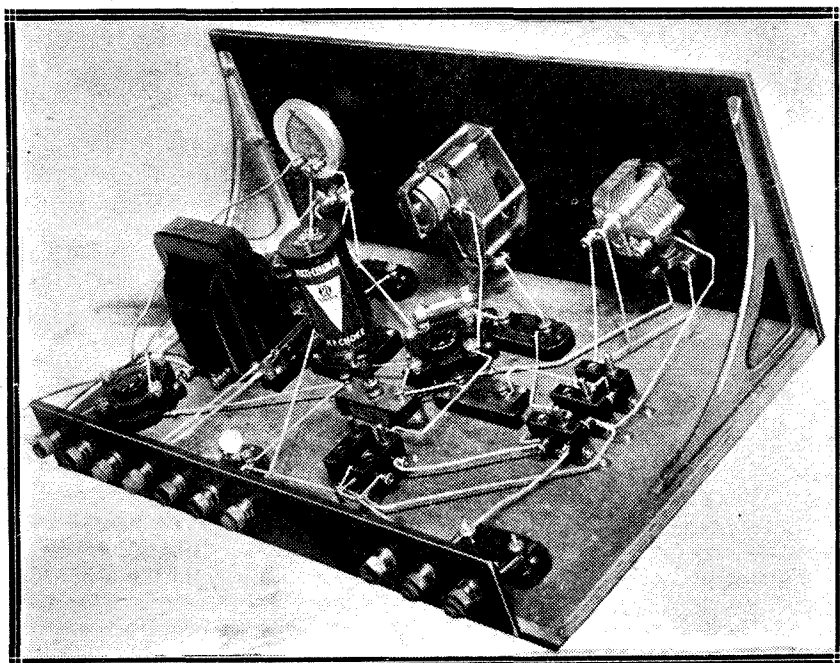

Two alternative aerial terminals are provided, so that a higher degree of selectivity can be obtained when required by bringing a series condenser into circuit.

satisfactory on the medium wave-lengths. You will be quite safe if you purchase one of the makes mentioned in the list of components.

Commence the construction by marking off the panel in accordance with the dimensions given on the panel drilling diagram.

### Marking Out

Mark out the drilling centres with the aid of a centre-punch and a hammer, and then drill the holes for the various components. Do not forget to mark out the holes for the two angle brackets which support the panel and baseboard. There are also five holes along the bottom edge of the panel which secure it to the baseboard. Having drilled the necessary holes, mount the components, having

When you have completed the wiring, you will be ready to try-out the receiver on actual signals.

### Preliminary Tests

In the three coil sockets for the medium wave-band you will need the following coils. In the aerial socket a No. 25 or 35, according to the degree of selectivity required. You should try both sizes. In the centre coil holder for the secondary coil insert a No. 60. In the reaction coil socket use a No. 40 or 50. It is as well to experiment with various coil sizes here.

In the two long-wave coil holders place a No. 200 coil in the right-hand socket and a No. 100 in the left-hand socket. In the detector valve holder place a valve of the "H.F." type,

that is to say, one with an impedance of 12,000 to 20,000 ohms and an amplification factor of 15 to 20. A similar valve will work very satisfactorily in the first L.F. stage, and in the last valve socket you will need a small power valve or, if signals are very loud indeed, a super-power valve.

Apply about 120 volts H.T. to the last valve, adjusting the grid bias in accordance to the maker's instructions.

### The Grid Bias

If you use a small power valve, a 9-volt grid-bias battery tapped at every  $1\frac{1}{2}$  volts will be quite adequate, but if you prefer to use a super-valve, then you will need an 18-volt grid battery.

Place the wave-change switch in the position for receiving stations on the medium wave-band, and switch on the valve filaments, endeavouring to tune-in the local station with the reaction condenser at its minimum setting. When you hear signals from your local station, increase the value of the reaction condenser, and note the position of the vanes at which oscillation commences. You will probably find that you only need a small value to produce oscillation. If so, screw down the adjusting knob on the Formodensor and note the effect. You will now find that in order to produce oscillation you will have to use more of the reaction condenser, that is to say, the vanes will have to be more fully in mesh.

### Final Adjustments

The object is to find such an adjustment on the Formodensor that you can just produce oscillation with the reaction condenser when you are at the top of your tuning range. Suppose, for instance, that the highest wave-length you wish to receive on the medium wave-band is about 500 metres. Well, then, endeavour to locate a station near this wave-length, and screw down the Formodensor until you can just produce oscillation when the reaction condenser vanes are completely in mesh with the fixed vanes.

Now switch over to the long waves, and note whether you can obtain sufficient reaction on 5XX and Radio-Paris with your particular setting on the Formodensor. You will probably find that reaction on the long waves is quite O.K., because in our tests with the original set we found that with the medium-wave setting reaction control was perfectly satisfactory on the long waves.

# ELIMINATOR DISTORTION

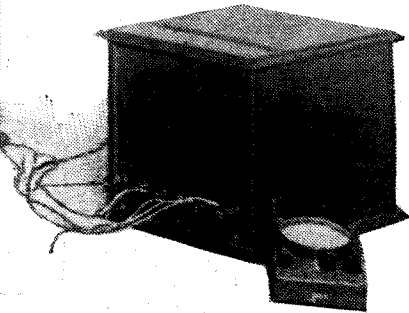
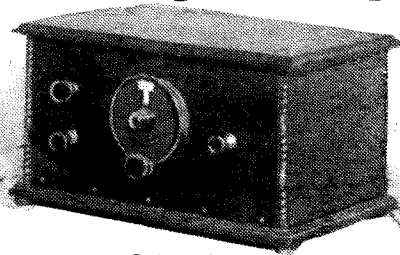

*"Nine eliminators out of ten are not suited for the job they have been bought for," says Mr. C. P. ALLINSON, A.M.I.E.E., F.Inst.P.Inc., in this interesting and illuminating article on mains H.T. units.*

**M**ORE and more are the mains being used for supplying both high- and low-tension current to the wireless receiver. The eliminator, in fact, has come to stay, and once one has experienced the care-free operation of a set off the mains one never wishes to go back to batteries if it can possibly be helped.

The use of the mains for the supply of high-tension is now comparatively common, but there is a point with regard to the choice or design of an eliminator that has not, to the best of my knowledge, received any attention worth mentioning.

Nine eliminators out of ten are not suited to the job they have been bought for! A sweeping statement, I know, but it is a fact that must be faced.

### Source of the Trouble

That this point is an important one has been borne out practically by three actual cases, within the last few weeks, with which I have come in contact personally. How many others there must be it is impossible to tell.

The importance of this point, further, is growing daily, owing to the increasing use of large valves in the last stage or stages of the receiver. It is getting quite usual for a set to employ a couple of P.625A's, or similar valves, in parallel or push-pull, in the last stage, under conditions that require that a total H.T. current of 30-40 milliamps or more shall be taken.

Now if you had such a set, and you probably have, and you wanted to buy an eliminator, you would prob-

ably think that a unit of this description which would supply 30 to 40 milliamps would be satisfactory. But in nine cases out of ten it would not enable you to get the results you expected from your set.

To show why this is so it will simplify matters if we have a look at the characteristic curve of a valve such as the P.625A. This is reproduced in Fig. 1. Let us suppose that we are using it with 120 volts on the plate, then the correct grid bias to bring us on to the centre of the straight-line portion of the curve is -11 volts.

At this figure a steady current of 32 milliamps is flowing, and this would be approximately doubled if two valves were being used in parallel or push-pull; not quite doubled on account of the increased voltage drop occurring in any resistance common to the two plate circuits, which will

result when a greater current is being drawn from the supply.

### Many More Milliamps

This, however, is the static condition, the grid potential being a steady one. Suppose, however, that we apply an alternating potential to the grid, having a value just equal to double the bias voltage, i.e. the steady bias voltage is 11 volts, so that the applied alternating potentials will have a voltage of 22 volts, peak voltage. You will see then that at the instant when the peak applied voltage is in opposition to the bias voltage the effective grid volts will be zero, so that instead of the plate current being 32 milliamps it will rise to 58 milliamps.

If therefore you were to use the set habitually so that the maximum grid voltage permissible was always being applied to the grid or grids of the

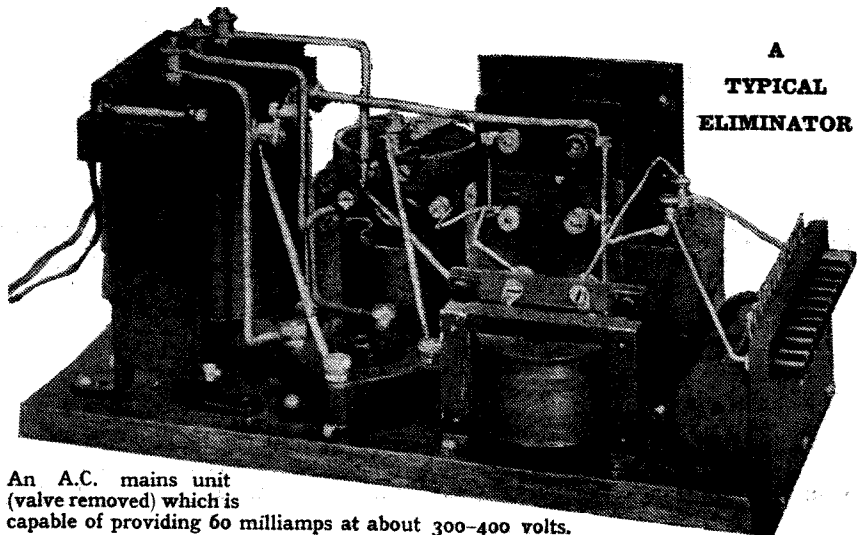

A  
TYPICAL  
ELIMINATOR

An A.C. mains unit (valve removed) which is capable of providing 60 milliamps at about 300-400 volts.

output stage, you would need an eliminator that was capable of producing nearly *twice* the amount of current taken by the output stage under static conditions.

There is, however, another angle to the question which slightly modifies the above conclusion, and that is the presence not only of the output winding, i.e. loud speaker, output transformer or choke, but also the smoothing choke in the eliminator.

The fact that all these components possess a D.C. resistance quite apart from their inductance will modify the valve characteristic. Let us assume that this resistance totals 500 ohms, then the characteristic curve for the valve with a steady resistance of 500 ohms in the plate circuit is somewhat as in Fig. 2 at B, the curve A being the static one. It will be seen that the curve B is not so steep as A, in effect the mutual conductance has been reduced.

**What Really Happens**

It is clear, of course, what actually happens, the increased current taken by the valve at lower negative potentials on the grid results in a greater voltage drop across the resistance; this therefore reduces the plate vol-

value of the resistance infinite it would be a horizontal straight line. Of course, every time we increase the value of the resistance we reduce the effective plate voltage and the plate current is therefore less. At the same time, owing to the flattening of the curve, a larger value of grid bias can be used than is normally indicated by the plate voltage, a fact that is well known to experimenters.

Now, when working the set under actual practical conditions with a

series in the plate circuit. At high frequencies, however, the impedance of the coil will be very high, so that it will be considerably in excess of the D.C. resistance, and will, indeed, be the predominating factor. In this case the dynamic curve will be quite different from the static one.

If, therefore, you are using a receiver with a moving-coil loud speaker, which is one of the few loud speakers capable of reproducing the bass notes with any degree of fidelity, your source of H.T. supply must be capable of giving the current required by the valve at the maximum grid input swing at the lowest frequency it has to deal with. This value will, in practice, for the reasons shown above, be somewhat less than that which would be given by the ordinary static curve. Assuming the value of the output inductance to be 1 henry (about the average value for a moving-coil loud speaker) at 50 cycles, then its impedance will be approximately 320 ohms at 50 cycles. This will give a slightly flatter curve than that shown in Fig. 2 at B, and the maximum plate current demand at maximum input swing will therefore be approximately 42 milliamps.

**Some Practical Examples**

And this is the value that your eliminator should be capable of delivering, and not the 32 milliamps indicated by static conditions.

What happens if it cannot do so? Let me tell you something about the three cases referred to previously.

Case No. 1. Home-made receiver;

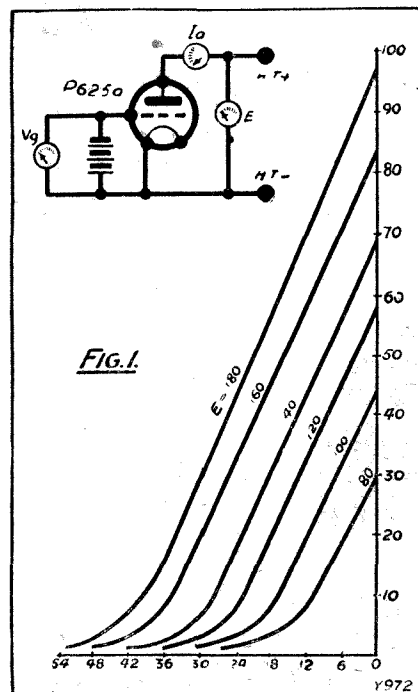

FIG. 1.

tage on the anode itself and thus reduces the anode current.

If we increase this resistance to 1,000 ohms we get the curve shown in Fig. 2 at C. And so with increasing values of resistance the curve gets flatter and flatter, till if we make the

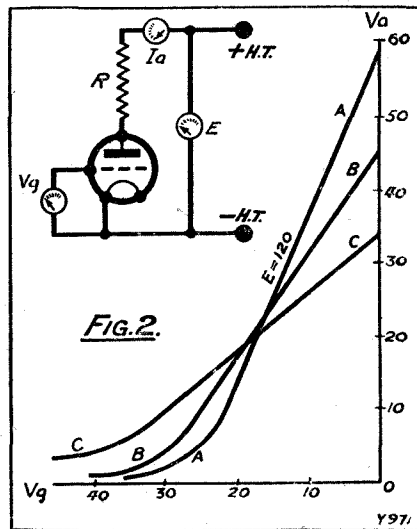

FIG. 2.

loud speaker or equivalent inductive load in the plate circuit of the output stage, the inductance of this component will vary with the frequency, although not very greatly. Its impedance, however, varies very greatly with the frequency, according to the well-known expression:

$$Z = \sqrt{w^2 L^2 + R^2}, \text{ where}$$

$w = 2\pi f$ ,  $L$  = inductance in henries, and  $R$  = d.c. resistance of the winding.

Now, when considering the working or dynamic characteristic of the valve and its output circuit, we must consider the impedance of the output load, and not its D.C. resistance. If now we plot a characteristic curve for the valve at different frequencies with a given inductance in the output circuit, we shall get a number of different characteristics the envelope of which is an ellipse.

**How the Curves Vary**

From the expression given above you will see that at the very low frequencies the impedance will be very little greater than the D.C. resistance of the inductance, so that the dynamic curve will almost exactly correspond with the static curve when a small resistance is included in

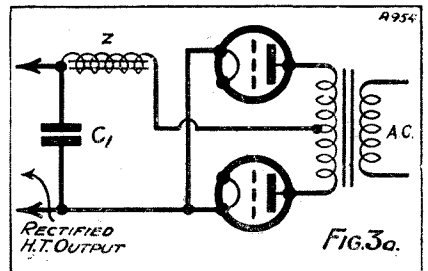

FIG. 3a.

H.F., anode-bend det., R.C. L.F., followed by transformer coupling to 3 L.S.5A valves in parallel, each taking 40 milliamps. Eliminator, specially designed to give 400 volts at 120 milliamps. Actual voltage at 120 milliamps is 435 volts.

Regulation given by large capacity condensers connected across on both sides of the smoothing choke amounting to a total of 10 mfd., 5 each side. Loud speaker, home-made moving coil. Symptoms, output stage would not handle full rated grid swing without chattering of M.C. speaker, and

## Many Eliminators are Under-Powered

continual upward kicking of milliammeter needle on loud bass notes, which could not be cured by adjustment of grid bias, and was obviously not due to straight overloading.

What was happening was that rectification was occurring owing to overloading of the eliminator. Owing to insufficient regulation and the fact that the eliminator was designed to give 120 milliamps, and no more, at 400 volts, a serious voltage drop resulted as soon as a big voltage swing was applied to the grid which required instantaneous values of H.T. current greatly in excess of that required under static conditions, especially at the lower frequencies, where the output impedance was lowest.

### The Second Case

Case No. 2. H.F., anode-bend detector, followed by one R.C. stage and two P.625A's in push-pull. Eliminator, commercial, rated to give 30 milliamps at 150 volts. Loud speaker, moving coil. Symptoms same as Case 1. Slightest increase in volume over a level well below rated input resulted in dither in the loud speaker, and in incurable upward kicking of the milliammeter needle. Regulation an unknown quantity, as

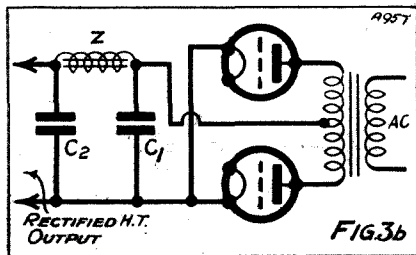

the eliminator was sealed and no technical data available.

### A Third Instance

Case No. 3. Two H.F., grid detector, one stage R.C., L.F., and one transformer coupled to two D.E.5a's in parallel. Eliminator, small commercial one rated to give 30 milliamps at about 120 volts. Set taking this amount under static conditions. Tuning in a strong signal resulted in hopeless overloading of the eliminator, resulting in the output being modulated with a bad 50-cycle ripple, while the eliminator itself began to hum and buzz loudly. This, of course, is an extreme case.

You will have noticed that I have referred to the "regulation" of the various eliminators. This is one of the properties exhibited by the smoothing circuit. If this is of the type shown in Fig. 3 at (a), very poor regulation will be obtained on small loads, i.e. any increase in current consumption will result in a serious drop in plate voltage, but when

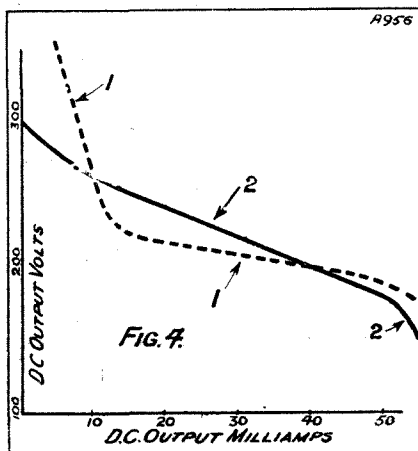

approaching the full output it is much better than with a circuit such as Fig. 3b. Greatly improved regulation is obtained, and the larger the capacity, however, on small loads for the (b) circuit of the condensers  $C_1$  and  $C_2$ , the greater the

improvement. At the same time, increasing the capacity of  $C_1$  results in a drop in the output-voltage of the eliminator.

### Eliminator Design

Typical regulation curves are shown in Fig. 4, which shows the variation of eliminator voltage with the current consumption, and shows how important it is that if a big set is being used off an eliminator that sufficient regulation be provided, or else alternatively that the eliminator be capable of supplying an excess current of about  $1\frac{2}{3}$  of that taken under static conditions. Curve No 1 is the regulation curve for Fig. 3a, and curve No. 2 for Fig. 3b.

There is also another aspect of this regulation question. To return to our Fig. 2 curves, when the maximum negative swing is applied to the grid (the plate circuit having a "load" in series with it) the plate current drops so that the voltage drop across the resistance (or impedance) in the anode circuit is less. This results in a rise in the effective anode voltage, thus tending to pass a bigger current, and so counteract the effect of the signal.

With a badly-regulated eliminator, further, a drop in the current consumption will result in a very appreciable rise in voltage; just as an increase in consumption will result in a big drop in voltage. Thus the actual output voltage of the eliminator will be varying according to the signal.

For the voltage to remain as constant as possible, therefore, the output condenser  $C_1$  in the eliminator (see Fig. 3a) should be as large as possible, probably 16 mfd. will do in practice, and the usual 2 or 4 mfd. is far too small.

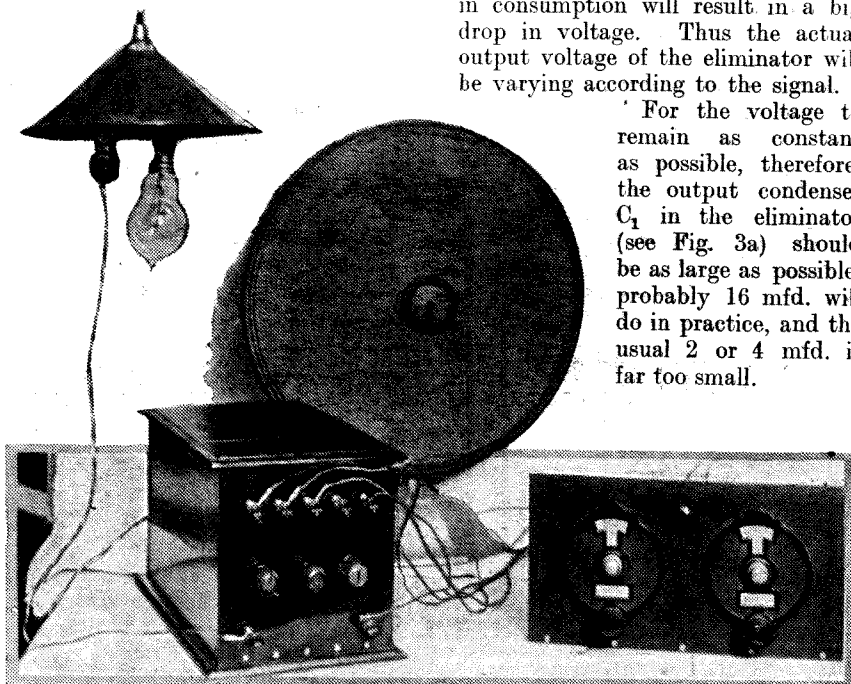

A familiar form of D.C. H.T. unit for use with a loud-speaker receiver. Very careful smoothing is required with some D.C. units.



# A Modern



tap to earth, place a variable condenser across the whole coil, and couple the aerial through half the winding. The detector and 'phone circuit was then connected across the other half of the coil, but it was found that the coupling effects thereby obtained were not by any means the most favourable.

The difficulty was that for the ordinary broadcast range a No. 60 coil was desirable, and half of this proved to give rather too much coupling for the aver-

age size of aerial, while to connect the crystal circuit across as much as half the coil did not give the maximum selectivity or signal strength.

It was evidently a case for a specially wound coil, and since the circuit seemed distinctly promising in its original form, we went ahead and wound up the necessary specially tapped inductance. After a few trials some suitable tapings were located, the original scheme of a centre-tap connected to earth being retained. By tapping the aerial in at various points along one half of the coil, it was found quite easy to obtain suitable auto-coupling effects, while by making a few taps on the other half of the coil a suitable crystal tapping could soon be found.

### A Flexible Design

Some rather interesting features were noted in the course of these experiments, from which it was deduced that one fixed arrangement would not be likely to suit all kinds of aerals, so provision was made for the crystal and 'phone circuit to be tapped across a portion of either half of the coil.

In some cases, for example, we found it best to tap the crystal across a portion of the same half of the coil as that into which the aerial was tapped, while in others it may be found best to connect it across a portion of the opposite half.

The best arrangement to use will naturally depend upon such factors as

This is a thoroughly up-to-date little receiver and one embodying a new circuit capable of giving you all the power and selectivity modern conditions necessitate. Designed and described by the "M.W." RESEARCH DEPT.

aerial size and resistance, the crystal resistance, and so on, and accordingly we have made provision for various combinations to be obtainable in the final design. You will readily see how this was done if you examine the circuit diagram in detail, noting the series of tapings marked upon the coil. The tapping leads are marked T<sub>1</sub> and T<sub>2</sub>, the former being the aerial lead and the latter the crystal.

### Detector Damping Adjustment

One side of the crystal and 'phone circuit is connected to earth, and consequently you will see that by placing the tapping at a suitable position this circuit can be tapped across portions of either half of the coil. If desired, of course, the crystal tap can be placed across as much as one half of the coil, but this is usually too much, and better strength and selectivity is obtained by using a smaller portion.

You will observe that numbers are indicated at each of the tapping points, and these are the turn numbers up to that particular point counting downwards from the top of the coil. This was done for easy reference and to avoid mistakes in winding the

THE crystal set may be a humble sort of receiver, but nevertheless it is an exceedingly useful one for all sorts of purposes where there is a good, strong local transmission available, and we recently set to work to see whether we could produce something a little more suited to modern requirements than the usual schemes. After a little experimenting we came upon the decidedly interesting arrangement shown in the circuit diagram illustrated on these pages, which possesses several rather valuable features.

### A Promising Circuit

The idea began with someone trying out a circuit using a centre-tapped plug-in coil, the original scheme being to connect the centre-

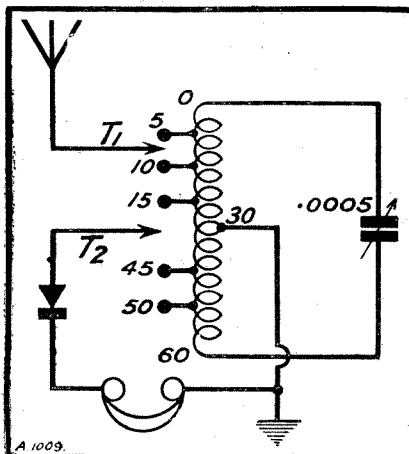

The circuit is such that an excellent compromise between greatest sensitivity and highest selectivity is easily attainable.

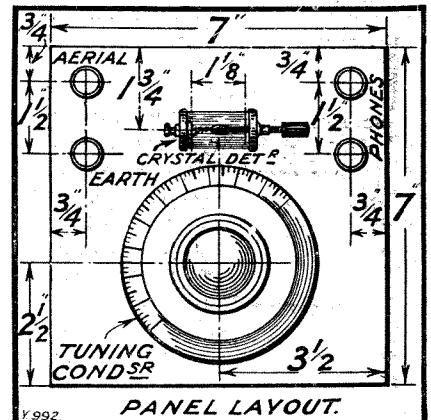

The crystal detector is accessibly placed on the panel just above the one tuning control.

# Crystal Set

coil, and you should note that to obtain the number of turns in use between any given tapping and the centre point, which, of course, is earthed, you must do a little piece of arithmetic.

For example, if you place the aerial tapping clip,  $T_1$ , on the tapping point marked 10, you will observe that this includes 20 turns in the aerial circuit between tapping clip and earth, since it is the 30th turn which is earthed. Similarly if you place the crystal tapping clip  $T_2$  on the 45-turn tapping point you will see that you are placing the crystal circuit across only 15 turns of the coil. You will see how this works

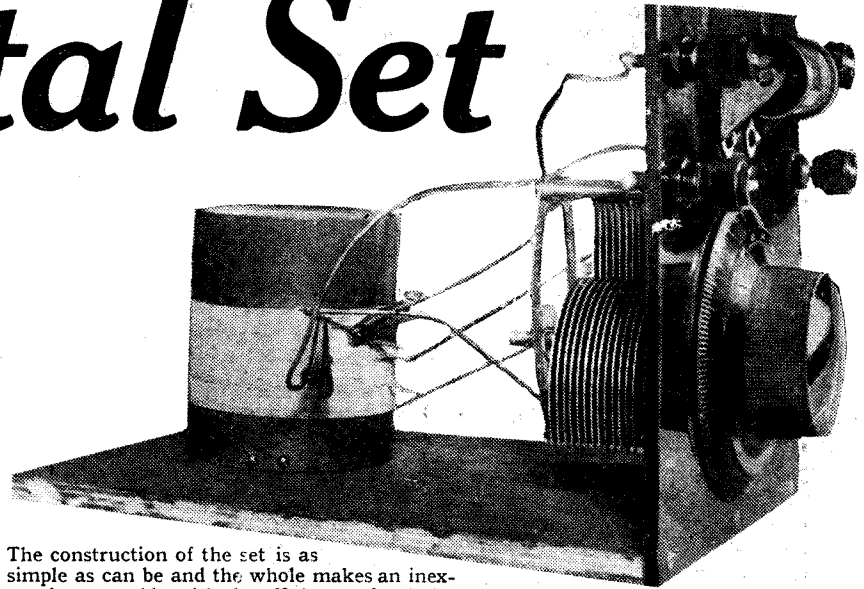

The construction of the set is as simple as can be and the whole makes an inexpensive assembly with the efficiency of a de luxe outfit.

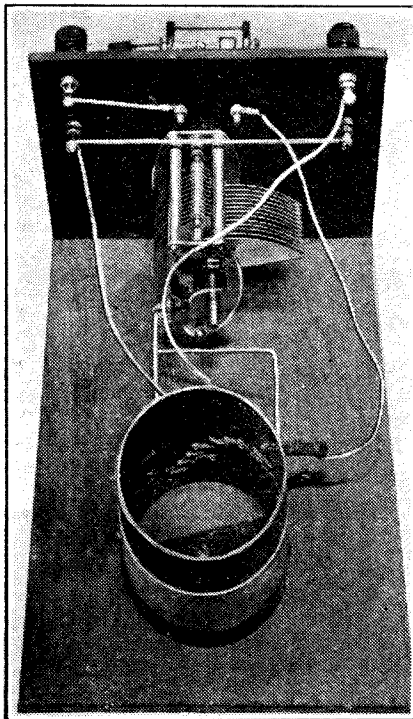

The coil is the "key" item in the design of this remarkable little crystal set. It is a coil that you can easily make.

out in practice when we come to the adjustments of the set for maximum results at a later point.

The set in its final form with the special coil wound to suit it gave particularly pleasing results on test, the strength being well up to standard, and the selectivity considerably above the normal level. The flexibility of the arrangement to suit different conditions is particularly good, and the selectivity is high enough to give

listeners in the London area a good chance of getting satisfactory results from 5 G B.

This statement, by the way, requires some qualification, since those who live very close to the local station must realise that something rather phenomenal in crystal sets is needed to cut out the local in favour of 5 G B, and a wave-trap is really called for. Similarly there are considerable areas in London where 5 G B is not received any too well, and at a strength which is not really satisfactory on any crystal receiver.

### Very Easy to Make

This circuit, too, should be particularly valuable when the two regional stations start in the London area, since its selectivity is definitely good for any crystal arrangement, and should give listeners who are not too far out on the northern side a good chance of separating the two stations properly. The set is a very easy one to build, in spite of the fact that it includes a home-wound coil, and the beginner need not be afraid to tackle it for that reason. The coil is a particularly easy one to make, even if you have never wound one before, since it is merely 60 turns of wire wound in a single close layer on a piece of tube.

The construction of the coil is the main point in building the set, and we will start with this part of the work. You want, first of all, a piece of good insulating tube 3 in. in diameter and  $3\frac{1}{2}$  in. long. (Suitable materials are Pirtoid, Paxolin, Radion, etc.). The first thing to do is to make some provision for attaching this tube to the baseboard of the

set, and a very easy way of doing this is the one employed in the original receiver. What we did was to cut a little wooden strut which fitted crosswise in the lower end of the tube, being just a nice fit therein.

### Coil Mounting

This little cross-piece is held in place in the end of the tube by drilling some small holes in the latter, and passing some round-headed brass screws through the tube and into the ends of the strut. Having fitted the cross-piece, bore a hole in its centre, and then you can fix the tube down to

- \*\*\*\*\*
- ★ **COMPONENT LIST.** ★
- ★ 1 Panel 6 in. × 7 in. ×  $\frac{3}{8}$  in. or  $\frac{1}{2}$  in. ★
  - ★ (Ripault, Trelleborg, Becol, Resiston, ★
  - ★ Kay-Ray, etc.). ★
  - ★ 1 Cabinet to fit, with baseboard 9 in. ★
  - ★ deep (Cameo, Gilbert, Lock, Pickett, ★
  - ★ Raymond, Artercraft, Bond, etc.). ★
  - ★ 1 '0005-mfd. variable condenser (Lis- ★
  - ★ sen, Igranic, J.B., Lotus, Formo, ★
  - ★ Cydon, Gecophone, Raymond, Bur- ★
  - ★ ton, Utility, Dubilier, Pye, etc.). ★
  - ★ 1 Panel-mounting crystal detector, ★
  - ★ cat-whisker type or semi-permanent ★
  - ★ as preferred (G.E.C., R.I., Brownie, ★
  - ★ etc.). ★
  - ★ 4 Terminals. ★
  - ★ 2 Tapping clips. ★
  - ★ Materials for coil (see text). ★
  - ★ Wire, screws, etc. ★
- \*\*\*\*\*

the baseboard of the set by passing a good-sized brass round-head screw through the hole.

Having arranged for the attachment of the tube, we can start the winding. This should be started fairly close to the upper edge, say about half an inch therefrom, and the first step is to secure the end of the

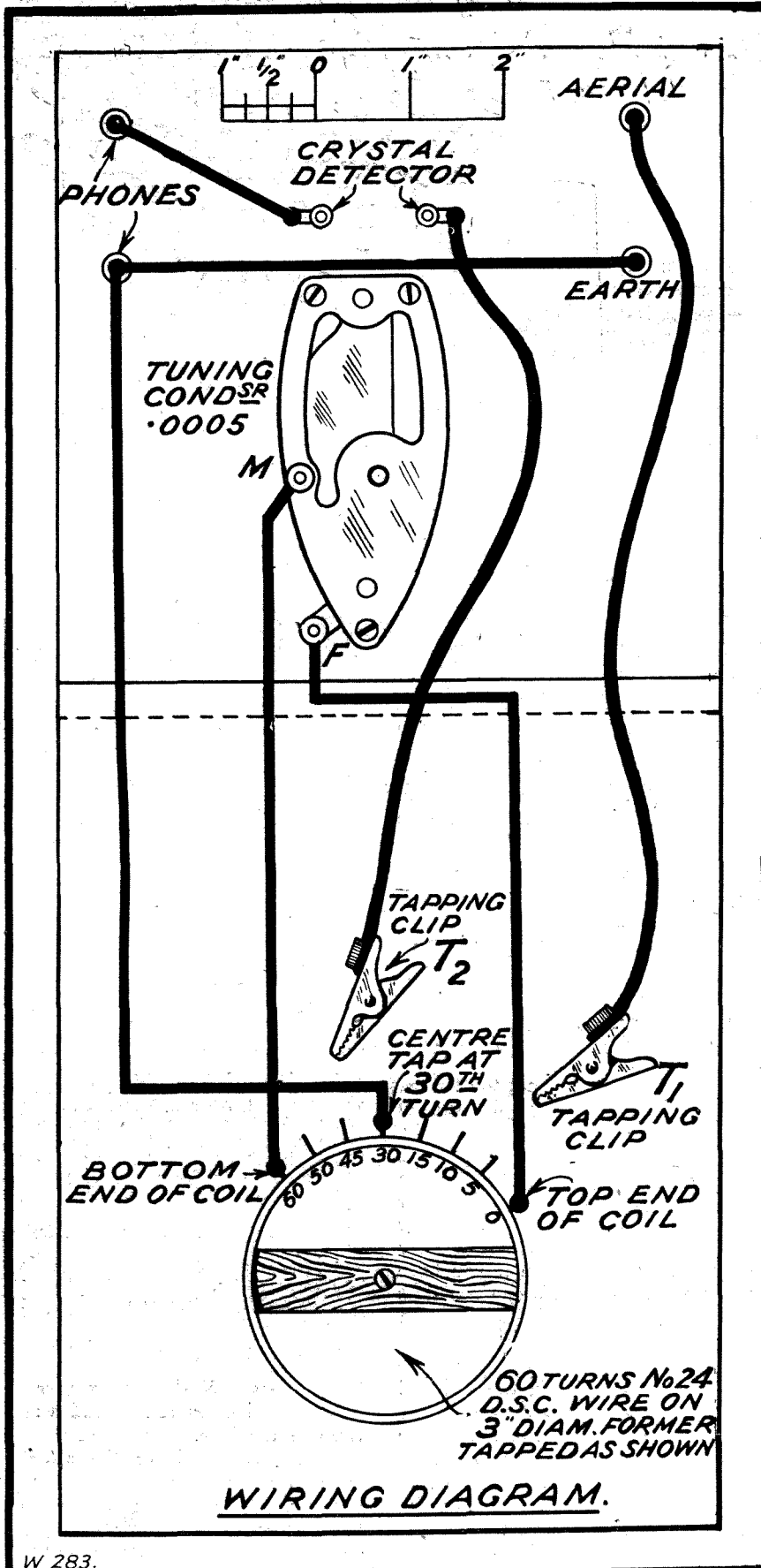

W 283.

wire so that it shall not slip when you start winding. An easy way of doing this is to drill two quite small holes in the tube about half an inch apart, each being the same distance from the edge.

**Securing the End**

Pass the wire into the tube from outside through one of these, and then bring the end back out through the other, leaving the end projecting about half an inch, and you will find this will hold the wire firmly when you pull it tight. Now proceed to wind, putting on the wire in a single close layer, pushing the turns up tight with the thumbnail as you proceed, until you have put on 60 turns. As you go you should make tapping points at 5, 10, 15, 30, 45, and 50 turns, and an easy way of doing this is to twist up a small loop in the wire as you arrive at each point. When the coil is finished you just scrape the wire bare at each loop, thus securing a point at which

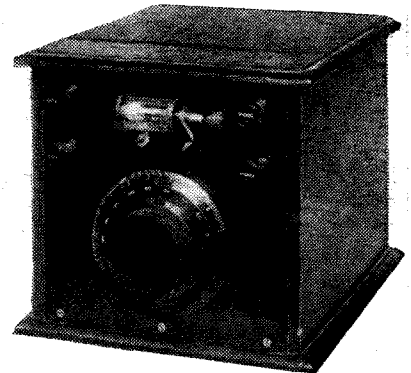

And here you see the completed receiver all ready for use.

one of the tapping clips can be attached. On arriving at the finish secure the end in just the same way as you did at the start of the winding.

**Finishing Off**

Quite an easy job, as you will see, and that is really the greater part of the constructional work involved in this very simple little set. It remains to screw the coil in place on the baseboard, and then to fix the panel to the baseboard by means of the usual three or four screws along the lower edge, first drilling holes in the panel in the positions indicated on the diagram for the terminals, crystal detector, and tuning condenser. Mount up these parts, and then you are ready for wiring.

It may be helpful, since we are suggesting this set as a suitable one for the beginner, to give the actual

(Continued on page 198.)

# MY BROADCASTING DIARY

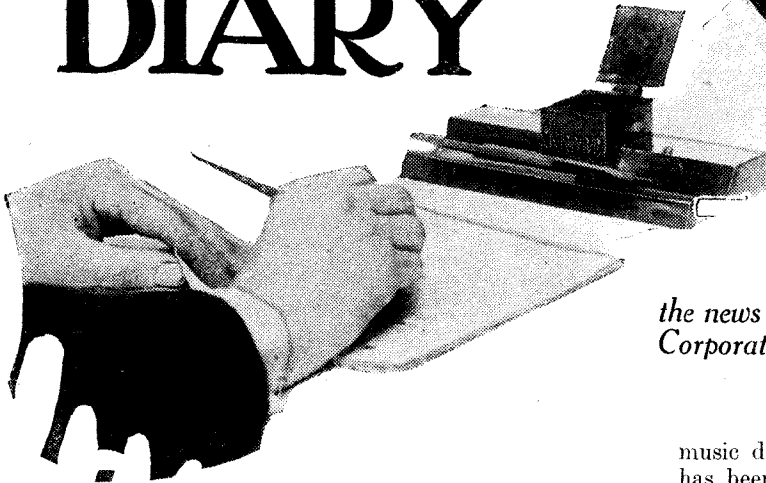

*Under this heading month by month our Broadcasting Correspondent will record the news of the progress of the British Broadcasting Corporation, and will comment on the policies in force at B.B.C. headquarters.*

## *Sir John Reith's Future*

A PERSONAL friend of Sir John Reith was telling me the other day that, paradoxically enough, if it had not been for the troubles in Savoy Hill early in the summer Sir John would probably have accepted one or other of the big offers which were being pressed on him at the time.

It is believed that the Director-General of the B.B.C. had almost made up his mind to seek new worlds to conquer, and was just about to hand over the B.B.C. to the care of Vice-Admiral C. D. Carpendale, C.B., the Controller. Then came the Election Night scene, with consequent troubles and accusations, all of which convinced Sir John that he had better "stick it" a while longer, awaiting calmer seas to hand over the tiller even at considerable personal loss and irritation.

It is fairly definite, however, that Sir John cannot be persuaded to continue at Savoy Hill beyond another year at the most. Although his mind is made up about his successor, it is believed that the Governors are not quite of the same view in this matter.

For one thing, Sir John Reith's name was in the Royal Charter. He is in every way the originator of the broadcasting organisation in this country. His dominating personality, his forceful methods, and his terrific energy, combined with great prestige, made him centre in himself the whole B.B.C. in a way which no successor is likely to emulate.

The Governors, indeed, would hardly be human if they desired to see a continuation of this state of affairs. Therefore I am sure that the Governors will play a much more active and resolute part as soon as the present Director-General resigns.

As to the succession, they will probably favour a new man from outside; but if they do make the appointment from the present staff, then it is certain to be a great surprise to most people.

## *Mystery of the Music Director*

The B.B.C. has not broadcast any dramatic effort more "intriguing" or mysterious than the episode of the succession of Dr. Adrian Boult to Mr. Percy Pitt as

music director at Savoy Hill. The appointment itself has been announced in Birmingham by the municipal authorities there, who are now seeking someone to replace Dr. Boult as their musical director.

Moreover, when Dr. Boult was in the United States recently he discussed his plans for the B.B.C. quite freely. Therefore the appointment is regarded as a *fait accompli* by at least two of the four parties concerned. Savoy Hill declines to say anything; but as they will not deny, they obviously confirm by implication.

Meanwhile, Mr. Pitt also lies low. But I have been told by a friend of his that there may be some very interesting developments. It would seem that the B.B.C. has informed Mr. Pitt that as he reaches the age of sixty next January he automatically retires.

Now this is the first time that Mr. Pitt had heard of an age-limit at the B.B.C. In other words, it was not part of his agreement with the B.B.C. If the present music director challenges the action of the B.B.C. there will be a first-class sensation, and there is little doubt

## AN IMPORTANT RADIO STATION

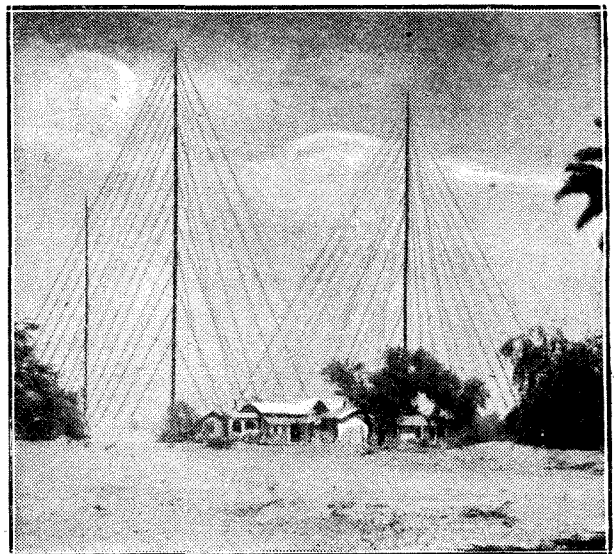

The radio station at the aerodrome at Karachi, India. It is one of the important England-India air-mail posts.



## All the Latest News for Listeners

that public sympathy will be mostly on the side of Mr. Pitt.

### *The B.B.C. and Publicity*

The B.B.C. has never suffered from lack of publicity, although the unnecessary reticence practised recently has not been helpful. It is still the fact, however, that the affairs of the broadcasting service remain as much a matter of keen public interest now as they were seven years ago.

And this is just as it should be. The B.B.C. is of intimate concern to twenty millions of people; the newspaper press is quick to respond to the feelings of its readers, and this is why so much is written of the B.B.C. and its doings, both important and trivial. Taking the publicity of the B.B.C. on the whole, it is remarkably fair and favourable, although frequently misinformed.

The reason for this defect is that the B.B.C. spokesmen are very much more reserved than they used to be, when mistakes of the kind to which I refer were much rarer. It is now rumoured that there is a movement in high quarters at Savoy Hill to reduce the publicity activities to the proportions of the corresponding work at the War Office or Post Office. This would be a blunder of the first magnitude, and might well lead directly to the end of the B.B.C. in 1935.

Publicity and all that it involves are an essential means of defence for an institution such as the B.B.C. To weaken or eliminate the means of publicity is to invite defeat and court contempt. The right course now would be to develop, not restrict, publicity.

For instance, why are the Governors kept in dumb seclusion? In their own interests the B.B.C. should

### THE FIRST RADIO MUSEUM

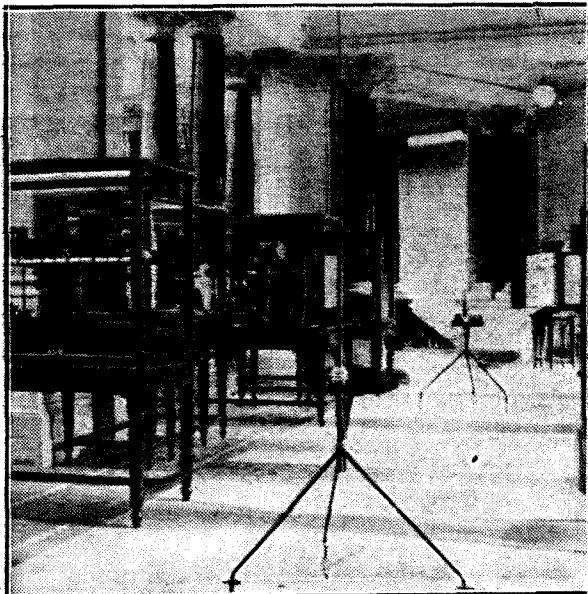

The first radio museum in Europe was recently opened in Berlin. This photograph shows a corner of one of the large halls, with a vertical aerial for short-wave work in the foreground.

use the Governors, particularly Mrs. Philip Snowden, as public exponents and interpreters and, on appropriate occasions, defenders of policy.

### *The Sitwell Affair*

The B.B.C. had announced that on May 31st there was to be a topical talk on the Epstein statue of "Night," by Mr. Francis Hackett, the eminent Irish author of "Henry VIII." Then suddenly, on the day before the broadcast was to take place, Savoy Hill said that Mr. Hackett's engagement was cancelled and that he would be replaced by Mr. Osbert Sitwell.

No explanation was given for the change. Mr. Sitwell's broadcast was typically challenging and iconoclastic. He condemned public taste and all accepted views on art and everything. His remarks were admirably calculated to create a wave of angry denunciation up and down the country. But the significant and interesting thing about the affair is that there was no such reaction. What comment I have heard was entirely favourable to the B.B.C. for putting on Mr. Sitwell.

This shows a remarkable advance in opinion over the position a few years ago, when such an obvious "twit" as Father Ronald Knox's "revolution" bulletin upset the whole of the press and the country. The fact is, that listeners would rather be angered intelligently than just bored. I hope the B.B.C. will take this lesson to heart and recognise that its public need no longer be mollycoddled.

### *The 1929 Proms.*

This year's Promenade Series—again under B.B.C. auspices—which begin on Saturday evening, August 10th, are running for eight weeks, during which Sir Henry Wood will conduct forty-nine concerts. When the arrangements for this season were put in train last year, it was believed that it would be Sir Henry's valedictory to his Promenade public, after thirty-five years of uninterrupted seasons.

Accordingly the B.B.C. was wise in giving Sir Henry practically complete freedom in making his arrangements. The result is the prospect of far and away the best season of the kind ever attempted. And it is good news, too, that the great conductor's health has so vastly improved since last year that he will not hear of any farewell or valedictory in 1929.

Friday is Beethoven evening: all the Symphonies (including the Ninth, with the Chorale Finale) are being given; Monday is devoted to Wagner; certain Wednesdays are the monopoly of Brahms; Bach, Mozart, Handel, Schubert, Haydn, Tchaikovsky, and a few others, divide Tuesday and Wednesday; Thursday is British Composers' evening, when are being heard, amongst other works, Elgar's Symphony No. 1 in A Flat, and Violin Concerto, as well as Vaughan Williams' London Symphony. There are a number of important first performances, including Concerto for Viola and Orchestra, by William Walton, with Bernard Shore as soloist; Music for Orchestra, by Constant Lambert; and Three Orchestral Pieces, by Arnold Bax.

Honegger provides a sequel to his Pacific 231 in a new symphonic movement called "Rugby." Leading artists include Miriam Licette, Walter Widdop, Norman Allin, Rachel Morton, Muriel Brunskill, Horace Stevens, Lamond, Harriet Cohen, Jelly d'Aranyi, and Frank Mullings. There is broadcasting from either 2 L O or 5 G B on practically every evening.

# POSITIVE AND NEGATIVE

*A chat about current flow in which a very perplexing point is dealt with.*

*By H. A. R. BAXTER.*

ONE of the most perplexing things that the radio enthusiast is likely to encounter is the problem of current flow. I know the subject has been referred to before in "M.W.," but little enough has been said about it in the aggregate.

The most striking aspect of the thing is to be seen in the plate circuit of a valve. Here you have the high-tension battery with its positive terminal connected to the plate of the valve (a transformer winding or loud speaker might be interposed, but this will not affect the point at issue), while the negative terminal is joined to the filament of the valve.

## **An Electron Stream**

When the valve is in operation current will be flowing from the H.T. battery around the complete circuit that is constituted. Electrical text-books tell us that current flows from the positive terminal of a battery through the external circuit, and so back to the negative terminal.

Therefore, the "juice" traverses the valve from the plate to the filament. On the other hand, a stream of electrons is being emitted from the filament of the valve and passing to the plate. We are asked to think of the current flow as being in the opposite direction, and as a flow of electrical current is presumed to be a flow of electrons, something seems to be wrong.

## **Only Two Ways!**

Actually it is quite wrong, in the light of modern knowledge, to say that electricity flows from the positive terminal of a battery. But, you see, it is only within recent years that the theory of electricity has been properly laid down. The practical application of electricity was almost fully mastered before the electron was discovered. Electricity was believed to be a flow of energy that passed through wires, and so on, like water passes through pipes; but the real nature of it was quite a mystery.

Nevertheless, enough was known of the effects caused for all sorts of

rules and regulations, such as Ohm's Law, to be evolved. And it became necessary arbitrarily to lay down rules regarding the direction of flow of current. With no electron theory to build upon it was quite impossible to say definitely in which direction current flowed.

There were only two ways through a wire, or through a piece of apparatus, that the current could go, and it was even chances that the correct one would have been hit upon. Unfortunately, that one-to-one bet did not come off, and, as we now know, the wrong way was chosen.

As with all new things, the electron theory was not immediately accepted by the electrical world as a whole; and it is not surprising in this instance, for its acceptance meant the universal

idea of current direction, while, jumping away from universally accepted theory, you find on every hand engineers and text-books working on the old assumption that current flows the other way.

But you can quite safely assume that while electricity is in fact a movement of electrons, the flow of current is always in the reverse direction. You can, for instance, consider that while there is a flow of electrons from the filament to the plate of a valve, a sort of reverse effect causes a flow of electricity in the other direction.

## **Causing Confusion**

Indeed, I think this is the only way to reconcile otherwise quite contrary ideas. It is quite impossible to think always in electrons (although it is quite correct so to do) without meeting confusion in the practical affairs of electricity.

Those old scientists who balloted wrongly on that even chance have provided us with an "old man of the sea" which is going to be very hard to shake off. No doubt the day will come when the last "positive to negative" "die-hard" will expire, but it is still far off.

Radio has done more than anything else to start bringing enlightenment, for with wireless valves you come hard up against the electron theory.

## **The Electron Theory**

You cannot explain the action of a valve at all without bringing in the electron, while it was moderately easy to deal with batteries and dynamos without referring to electricity as anything else but a sort of intangible fluid. Radio can be credited with bringing about much of the text-book revision which has been so marked of late years.

The electron theory has been proved time and time again, and I do not think that it can now ever be upset. But it is curious to reflect that for many years engineers were basing their calculations upon a completely wrong assumption, and that they are still doing this in some measure.

## **A VETERAN VALVE**

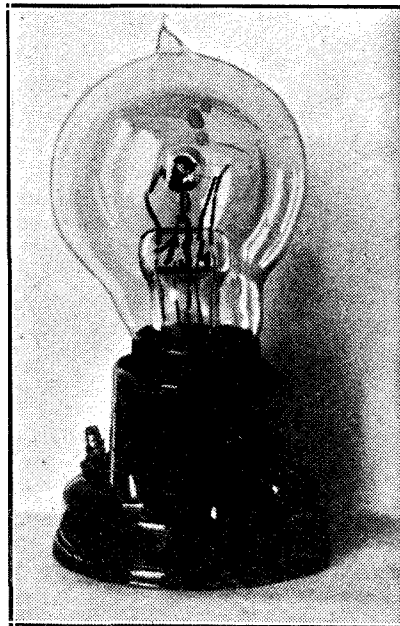

One of the earlier French valves which is exhibited in a museum for the history of wireless which has been opened in New York.

reversal of positive and negative ideas throughout the whole of electrical engineering practice.

So to this day we have the curious position that we have to think of electronic flow to gain the true

# Radio Set



**E**XACTLY what does constitute a refinement in connection with a radio receiver? This is a very hard question to answer, and it is probable that no hard-and-fast line can be drawn between "refinements" and "necessities." It must very largely be a matter of opinion.

This is my dictionary's definition of the word: "Act of refining or state of being refined; purification; separation from what is impure and, etc.; cultivation; elegance; polish; purity; and excessive nicety."

## Loosely Applied

This does not help us much. Yet the word is peculiarly applicable to at least one thing in a set that is often referred to as "a refinement." That is the choke-capacity output arrangement, which can certainly be credited with separating something and perhaps with a purifying action.

Undoubtedly the word is very loosely applied and you can see how widely interpretations vary by reading the descriptions of set designs. In the one instance a designer will wave aside "anti-mobos" or what-not as being "mere refinements"; while, in other instances, the same things will be spoken of as "absolute necessities."

## Circuit Formations

Of course, it would not be fair to make close comparisons, because a great deal depends upon the company

✱ Above you see an "anti-pong" valve-holder. It is a necessity in many cases in order to prevent microphonic noises. To the left is a wave-trap being fitted into a set.

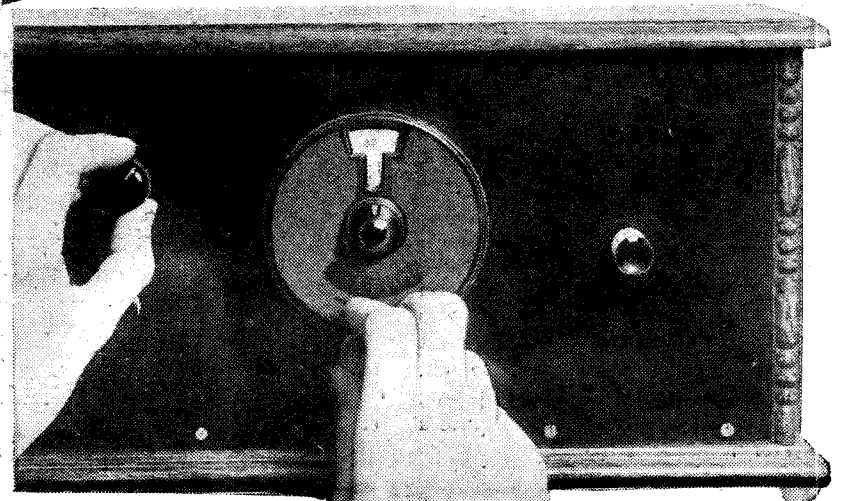
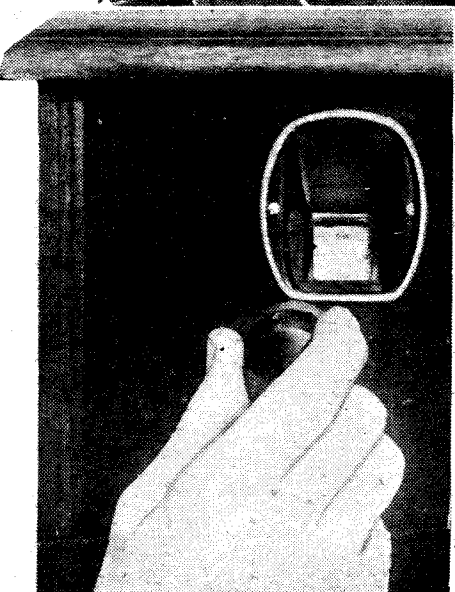

Two varieties of tuning control are illustrated above. Both are excellent slow-motion movements.

# Refinements

*By G. V. DOWDING, Grad.I.E.E.*

the objects in question keep. A choke-capacity output would be a refinement in the case of a crystal set, but either that or a transformer output would be quite essential for a set used with very badly arranged loud-speaker extension leads. The illustration is not quite as good as I would like it to be, but you can no doubt see what I mean.

\*\*\*\*\*  
 \* Is a loud-speaker "filter \*  
 \* circuit" a necessity? This \*  
 \* and many other equally \*  
 \* important questions are \*  
 \* answered in the accompany- \*  
 \* ing interesting article. \*  
 \*\*\*\*\*

As I see it, a refinement is a slight modification or addition to an existing structure. Your existing structure in the case of a radio set is the bare circuit formation such as three valves, one being an H.F. amplifier coupled in a standard manner and another being an L.F. magnifier transformer-coupled. The third valve would be the detector.

On the right is a set incorporating a special output transformer. This is particularly necessary in many a set where a Pentode is used. Above, a "slow motion" dial fitted to the tuning variable of a set.

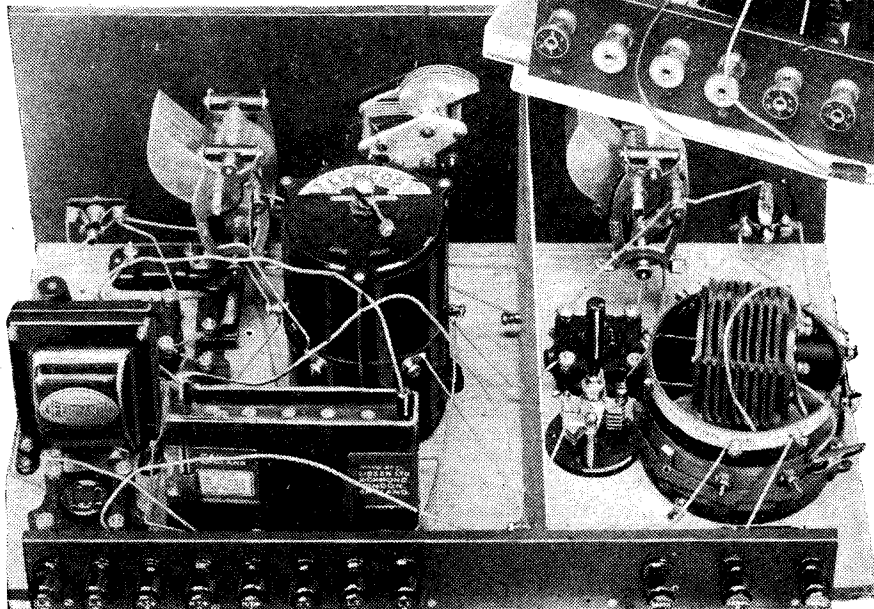
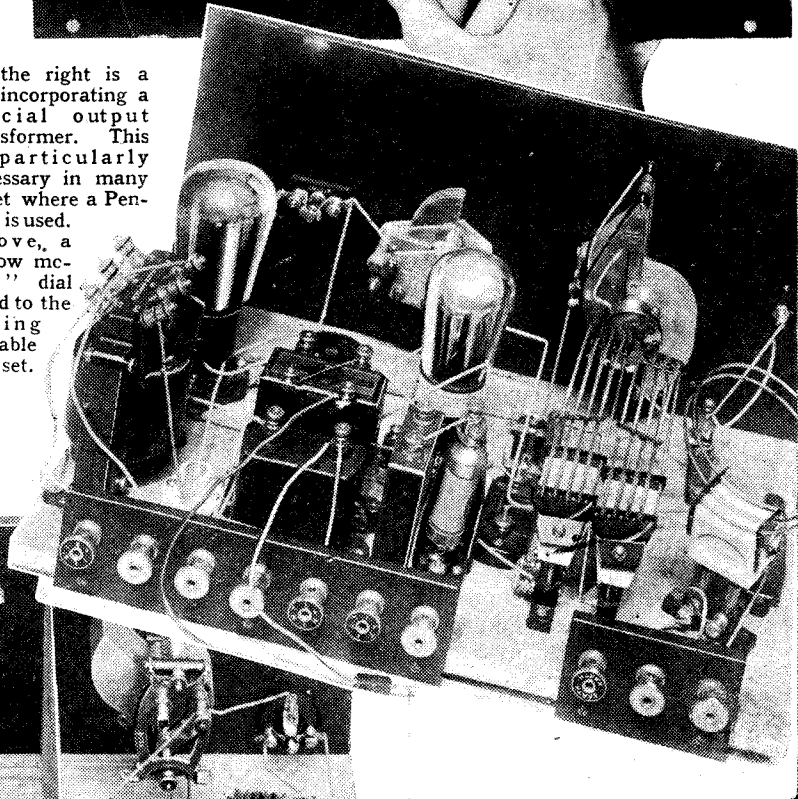
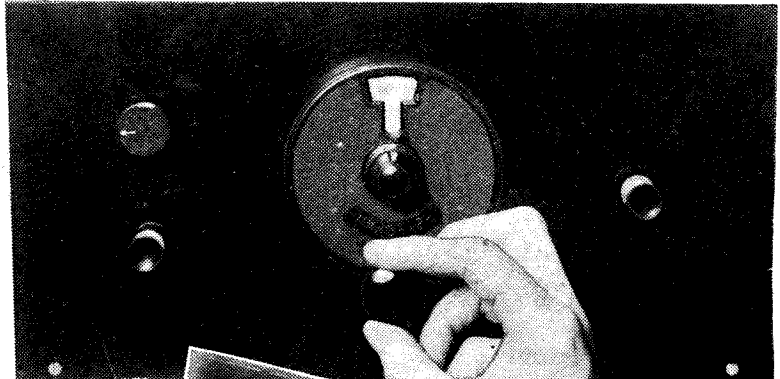

But the bare circuit formation should embody everything necessary to make the most of the particular valve grouping. Nothing that added to the selectivity, sensitivity or quality of the resultant receiver without sacrificing any of the other desirable qualities should be regarded as a refinement.

If a set is minus anything that would improve its efficiency, then it should be reckoned deficient.

The "Titan" coil unit is one of the most successful devices of its kind ever evolved. It enables wave-changing to be effected in a very simple manner.

Instead of talking about adding so-and-so as "a refinement" the designer should say "in order to bring this set up to the highest possible degree of efficiency—"

But you must not regard every receiver that does not include all the circuit "super-structure" of those big and expensive multi-valvers as being "deficient." As I have already said, such comparisons are misleading.

You do not want an anti-mobo device in the plate circuit of a one-valve set simply because there is no work for it to do. Even in the plate circuit of one of the valves in a seven-valve set it might be totally unnecessary. Therefore, just because one circuit hasn't something which figures in another circuit, don't consider the first is lacking "a refinement."

### Tuning Controls

The more I employ that word in this article the more clearly I visualise how mistreated it has been in the past. "This receiver embodies all the usual refinements"; I believe that I have been guilty of this or similar phrases quite a number of times. Anyway, it is high time that the question was thoroughly thrashed out.

And I am going to endeavour to do it right now.

You may have come to the conclusion that I am of the opinion that there is nothing in the art of radio receiver design that can be styled a refinement. If you have, you are wrong. I believe the word is a good one, properly applied.

I have laid down that nothing that adds to the selectivity, sensitivity or quality (freedom from distortion) of a set should be airily referred to as a refinement. This term should only be applied to items that improve the appearance of a set or make it easier to handle. I should certainly say that a "posh" cabinet with doors falls within the category, and I don't think many will quarrel with me; but in regard to ease of control, I feel I am on less secure ground.

Nevertheless, I am going to stick to my guns. Slow-motion dials, gang-controlled condensers, thumb controls, and so on, do not make sets more sensitive. That is a fallacy. You can do just as much without them providing you acquire the necessary manipulative skill.

### That "On-Off" Switch

Note how well that fits in with the dictionary definition: "elegance; polish; cultivation; excessive nicety."

There are certain things figuring in

some circuits which cannot so summarily be dealt with as the broader issues I have called upon for illustrative purposes, but you must allow me a few exaggerated cases to drive my points home. However, a word or two about those other things must be said.

First, there is the H.T. fuse. That, I think, is an obvious necessity, just as is insurance against fire of one's house. But there are harder objects than that to deal with. What about the filament switch? At first one is liable to dismiss this as a refinement and a good example at that. One can almost as easily disconnect one of the accumulator leads as operate a panel switch.

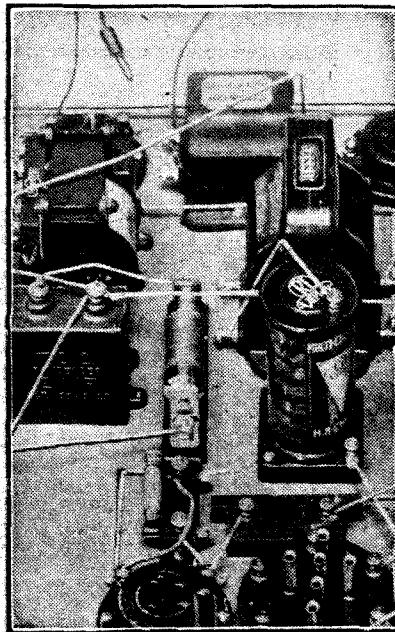

The L.F. end of a powerful set in which you will notice a choke-capacity by-pass for the loud speaker prominently figures.

But an efficient radio receiving outfit must not have loose or disconnected leads hanging about at any time, even when the set is not working. A loose filament lead could easily brush against an H.T. battery terminal with disastrous consequences. No, I think I can safely say that the filament switch is honourably acquitted.

### Wave-Change Schemes

Wave-changing by panel switches is undoubtedly a refinement. And it is a refinement which you frequently have to make sacrifices to gain. At the best the wiring of the set must be somewhat more complicated than without it.

Where it does good work a wave-trap obviously falls within the category of a necessity, and the same

applies to any extra coil or condenser that adds to the selective qualities of a set. This is providing that the set is sufficiently sensitive to make selectivity a useful factor.

The most selective crystal set in the world would be of no more use, or, I should say, could do no more useful work, than the simplest kind in places where only one station is within "crystal range."

I want readers thoroughly to grasp this business of refinements as it is distinctly important. The loose application of the term has undoubtedly lead to a number of things that really are essential for the best results being more or less disparagingly regarded as luxuries.

### Special Output Arrangements

Take the choke-capacity output of which I have already made several mentions. Ask your friends whether they use shunt circuits for their loud speakers. These usually take the form of an L.F. choke connected in the plate circuit of the last valve, as would be the loud speaker in the ordinary way, the loud speaker being joined across this choke by means of series fixed condensers of large capacity. Another way is to use an output transformer.

You will find that the common idea is that a special output arrangement is advised or incorporated in a set merely to stop the steady H.T. current flowing through the loud speaker and causing magnetisation. This is certainly one of the advantages of the system and a very important one, but it is by no means the only one.

If a choke of proper construction is used a considerable saving in respect of voltage drop is effected and there is "more for the plate." Additionally, the choke will be able to handle the large steady current which must be flowing somewhere from the H.T. battery without saturation troubles occurring. The behaviour of the small amount of iron in the average loud speaker when a dozen or two milliamps are abroad is very peculiar, and in these conditions the wave form of the superimposed L.F. impulses assumes ragged proportions.

### Good Choke Needed

You will be no better off if the choke you use is one of those small affairs having a resistance of two or three thousand ohms and a core that wilts at the passing of one milliamper. Further, it is more likely that the general characteristics of a well-designed choke will suit the anode



## You Cannot Replace Those Suppressed Frequencies!

circuit of the last valve much more than the unit of an ordinary loud speaker.

There is no doubt at all that the reason why such schemes as this had come to be regarded as luxurious refinements is because when they were tried by hundreds of amateurs during the earlier days of radio no audible improvement resulted. And such was hardly to be expected.

One improvement where so many were needed could hardly be expected to prove miraculous in its effects. With valves overloading in every stage, sidebands being nipped off here and there and wave and frequency distortion occurring all over the place, not to mention the loud speaker which cut off every note below about two hundred and fifty cycles and framed the rest up like a miniature Mount Everest, what was the use of placing just one improved circuit right at the end—in the very output of the set?

You can't mend mangled notes, and nothing on earth will replace those suppressed frequencies.

### Dotted in Diagrams

But there have been such vast strides forward during the past few years that it is time that the important bearing that some of those so-called refinements have on quality of reproduction was generally realised. It is only too true that the loud speaker is still lagging somewhat behind. I think it is safe to say that the average loud speaker is not good enough for the average valve set. Nevertheless, we have certainly reached the point where the little things count very much.

You will no doubt have noticed that I haven't said anything about those odd resistances and condensers that once upon a time were wont to appear in dotted lines in diagrams with fair profusion. The accompanying text would incite you to try this and that extra component which was not absolutely essential but "was a refinement."

### An Exact Science

You don't often meet them these days, for set designing is now much more of an exact science. At times one comes across alternative values of components and things which you can leave out or put in a set, but these you will discover are necessary to cope with individual conditions.

There are, again, instances where perhaps a by-pass condenser is shown, and of this it is said "this may not in all cases be needed." But you will appreciate the fact that in some circumstances such an item is very much wanted. Maybe the varying circumstances lie between the use of a mains unit and a battery for the H.T. supply.

### Mains Units

In the case of a mains unit there are necessarily certain elements which tend to introduce undesirable coupling effects between valve stages unless certain precautions are taken.

Some sets include components whose only purpose it is to make such "motor-boating" impossible. These may verily warrant the term "refinement" should an accumulator H.T. with its almost negligible internal resistance be used.

An inexpert constructor has rigidly to adhere to a specification, but an inexperienced set-builder can often make slight alterations and omissions in order to twist the design around perfectly to suit his own individual requirements. He is able to hold the balance between "refinements" and "necessities" to his own liking!

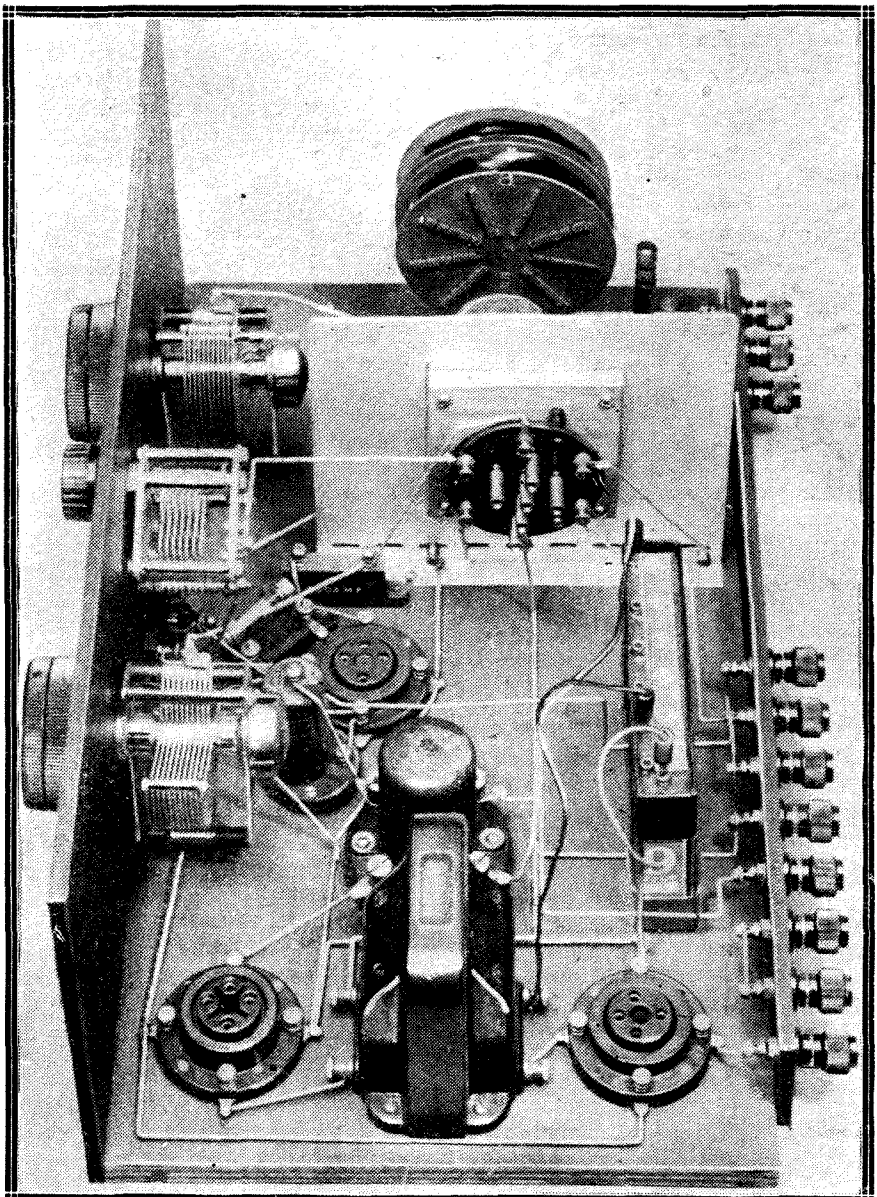

An interesting problem for you is presented by this photo of a four-valve set. Can you discover anything in it that very clearly illustrates one of the main points brought forward by the author?



### The "Summertime" Five

C. R. S. wishes to know the values of the various condensers, etc., shown in the "Summertime" Five, which appeared in the last issue of MODERN WIRELESS.

These values are as follow:  $C_1$  is a compression type, semi-variable condenser, capacity .0001-0005;  $C_2$ ,  $C_4$ , and  $C_7$  are .0003-mfd. variable condensers;  $C_3$  and  $C_6$ , .01 mfd.;  $C_{10}$  and  $C_{12}$ , 1 mfd.;  $C_{15}$  and  $C_{16}$ , .004;  $C_9$ , .0003 mfd.;  $C_5$  and  $C_8$ , .0003 mfd.;  $C_{14}$  and  $C_{17}$ , 2 mfd.;  $C_{11}$ ,  $C_{13}$ , and  $C_{18}$ , 1 mfd. or larger;  $L_5$  and  $L_7$  are two H.F. chokes for the H.F. anode circuits;  $L_8$  is the detector H.F. choke;  $R_7$  is a heavy-duty 50,000-ohm potentiometer;  $R_6$  is a Clarostat volume control;  $R_5$  is a 30-ohm panel-mounting resistance;  $R_8$  is a baseboard-mounting filament resistance;  $R_9$  is 2 megohms.

### Ampere-Hours

M. R. K. (Southampton) asks us how he can work out the time his L.T. battery will last per charge, so that he can determine whether his charging station is keeping it in good condition.

L.T. batteries are rated at so many ampere-hours *actual*. The word *actual* is used to distinguish the method of rating from the old term *ignition* capacity, which is rapidly falling into disuse.

In any case, the actual capacity is one half the ignition rating.

Suppose the actual ampere-hour capacity of the battery is 30, and four valves are employed, making the total filament consumption .5 amp. Then, dividing .5 into 30 gives for its answer 60, which is the number of hours the battery will last per charge. This, of course, is based on the assumption that the cell or cells are in first-class condition. One ampere-hour is equal to one ampere flowing for

one hour, two amperes for 30 minutes,  $\frac{1}{2}$  ampere for two hours, and so on.

### L.F. Instability

D. S. (Clapham) has wired up his three-valve set for a pentode valve, and finds that there is a marked tendency for distortion and howling to occur. He is only using one stage of L.F. and is puzzled by this trouble because he was under the impression that L.F. instability was rather uncommon in cases of only one low-frequency stage.

## THE TECHNICAL QUERIES DEPARTMENT

Are you in trouble with your set?

The MODERN WIRELESS Technical Queries Department is now in a position to give an unrivalled service. The aim of the department is to furnish really helpful advice in connection with any radio problem, theoretical or practical. Full details, including the revised and, in cases, considerably reduced scale of charges, can be obtained direct from the Technical Queries Department, MODERN WIRELESS, Fleetway House, Farringdon Street, London, E.C.4.

A postcard will do: on receipt of this all the necessary literature will be sent to you, free and post free, immediately. This application will place you under no obligation whatever. Every reader of MODERN WIRELESS should have these details by him. An application form is included which will enable you to ask your questions so that we can deal with them expeditiously and with the minimum of delay. Having this form you will know exactly what information we require to have before us in order to solve your problems.

London readers, please note: Inquiries should not be made in person at Fleetway House or Tallis House.

The reason, D. S., is because of the high magnification of the pentode. In some instances trouble does occur on the L.F. side, especially if things aren't just right, and any external coupling exists in the H.T. supply.

Your best remedy is to insert an "anti-mobo" device in series with the detector valve. The procedure is as follows: Disconnect the H.T. lead which goes to the primary of the L.F. transformer, and instead take

the end of the wire to one side of a 50,000-ohm wire-wound anode resistance.

Join the other side of the anode resistance to the transformer primary.

In addition, connect this point to one terminal of a 4-mfd. condenser. Join the remaining terminal of the condenser to L.T. negative.

It is, however, of little use inserting this "anti-motor-boating" device in circuit if the H.T. supply is not designed to supply the fairly heavy anode current which a pentode requires for successful results. Small dry-cell H.T. batteries are not suitable for this work. Only double- or triple-capacity batteries should be employed.

### Neutralising an H.F. Valve

P. L. A. (Wolverhampton).—"I have a three-valve set which incorporates one split-primary H.F. stage. Can you tell me how to neutralise it correctly?"

Set the reaction control at minimum and likewise the neutralising condenser. Now, on setting the tuning condensers so that the two tuned circuits are in step with each other it will probably be found that the set is oscillating. To test for oscillation, touch one or other of the sets of plates of the tuning condensers (this may be either the fixed or moving, according to the particular set). You will probably find that the set will only oscillate under the above conditions when the two circuits are in tune with each other, and this can be used as an indication. It is convenient to perform the operation at some point near the middle of the tuning range. Now, increase the capacity of the neutralising condenser.

Test at intervals for oscillation as this is done and you will presently find that the set has ceased to oscillate and will not recommence even when the tuning dials are slightly readjusted. Now increase the reaction a little until the set once more oscillates and again increase the neutralising condenser setting until oscillation ceases.

Slightly readjust the tuning condensers again to make sure that the set is completely stable once more.

The object is to find such an adjustment of the neutralising condenser as will permit the greatest setting of the reaction condenser to be used without producing oscillation. It will then be observed that when the two tuned circuits are in step and the set is brought to the verge of oscillation a slight movement in either direction of the neutrodyne condenser will cause the receiver to break into oscillation.



*New Mains Units—"Pep" H.T. Batteries—Five-Socket Valve Holders—New "Junit" Lines—Microficient Condensers.*

### **"Book of the Pye"**

**A**N 8-page brochure in colour has been issued by the makers of the famous Pye portable, and should be in the hands of all open-air radio enthusiasts.

### **A First-Grade Instrument**

Ferranti, Ltd., recently sent us descriptive matter relating to their new multi-range test set. With this you can measure over eight ranges of volts and amps. Additionally, power and resistance measurements can be carried out. External shunts can be connected further to broaden the outfit's applications.

### **New Mains Units**

Modern mains units are just as safe to use as any domestic electrical apparatus. In fact, they can now be classed as such, but, of course, a certain amount of care must be taken in their application. Not that the user has to adopt much in the way of anything but ordinary commonsense precautions when he uses "Ekco" mains units. For instance, when he purchases the A.C. model L.T.1, which is designed to replace the L.T. accumulator, he need not fear that any cross connections will cause trouble with his existing H.T. unit.

The A.C. model L.T.1 has a socket on its side and into this is plugged the H.T. unit. The connection for both units is made with the mains by the plug on the L.T. unit, and he would not have to make any alteration to the wiring of his set or any alteration to his installation whatever.

This model L.T.1 can feed valves of 2-, 4-, or 6-volt ratings, taking anything from '3 up to a maximum of 1 amp. Thus it could cope with

the L.T. needs of practically any receiving set.

By the way, a switch is provided which controls both the H.T. and L.T. supply. That is, when an H.T. unit is used as well.

The unit is quite a simple affair. On the front panel are a voltage

Manufacturers and Traders are invited to submit for test purposes radio sets, components and accessories to the "Modern Wireless" Test Room at Tallis House, Tallis Street, London, E.C.4. Under the personal supervision of the Technical Editor all tests and examinations are carried out with the strictest impartiality. Readers can accept the Test Room reports published monthly under the above heading as reliable guides as to the merits and demerits of the various modern productions of the radio industry.

control and a voltmeter showing exactly the volts across the valves. Then there is the filament switch and terminals. The whole thing is encased in a strong metal box of a safety, fireproof character.

The current consumption is a mere 15 watts, which is much less than that of one ordinary electric-light bulb. A Westinghouse metal rectifier figures in

this unit, as well as in the new "Ekco" A.C. model C.2A.

This C.2A. unit is designed to replace all batteries and provides H.T., L.T., and G.B. There are three H.T. tapings of 60, and 120 to 150 volts, and a high voltage tapping for an S.G. valve.

It will operate 2-, 4-, or 6-volt valves, taking any current between .2 and .5 ampere. There are five G.B. tapings up to 13 volts. Despite its versatility the unit is quite a simple, compact affair, and, as with all Ekco units, its construction is on sound and safe lines. The price of the C.2A. is £10 17s. 6d., and the A.C. model L.T.1 costs £8 15s. 0d. On test we found both these units to be perfectly satisfactory. There was no hum and the outputs were found to be up to specifications.

### **"Pep" H.T. Batteries**

R. Cadisch & Sons, of Red Lion Square, London, W.C.1, have sent us samples of their "Pep" H.T. batteries. It is claimed that these batteries, which are manufactured in France, are filled with a special composition designed to give them long life and high recuperative powers.

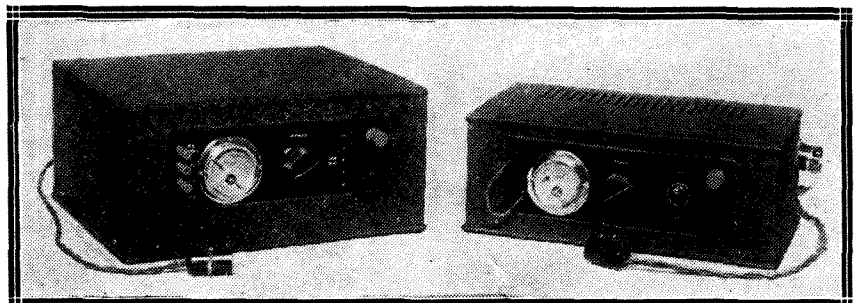

These are the "Ekco" units described on this page, the one on the left being the "all-power" outfit, the other an L.T. "battery eliminator."





## RADIO AT "THE YARD"

*The art of catching crooks is one in which sure and speedy communication is essential. How radio scores in this rôle is related below.*

*By a Special Correspondent.*

HAVE any of our readers picked up messages from the Scotland Yard transmitting station, and have they ever heard messages exchanged between the Flying Squad vans and Police Headquarters? We doubt it, for it was revealed the other day in the "Daily News," in an article on the Yard's wireless, that the present wave-length at Scotland Yard is kept secret, and that, for transmission purposes, a police code of a specially secret character is always used, in conformation with international arrangements with other police forces.

It was as far back as 1921 that Scotland Yard first started making experiments in wireless transmission. In our contemporary, "Popular Wireless," it will be remembered we published one of the first photographs of the original motor tenders operated by Scotland Yard, and which were fitted with radio sets.

### Telephony Unsatisfactory

Telephony was used in those days, but although it was found to be O.K. over short distances, it was distinctly unfavourable in results when cars were travelling at high speeds and when the distance between the receiving and sending stations was at all great.

Consequently, telephony was abandoned in favour of the Morse code, and greater range and greater reliability was attained.

In 1923 further experiments were conducted, with the result that two new 500-watt sets were installed. The old aerials used to consist of five strands of wire on supports which could fold up and down on top of the car when it had to pass under low bridges. This earned for Scotland Yard vans the nickname of "The Flying Bedsteads."

One of the earliest experiments of the use of wireless for police purposes was in connection with the control of Derby Day traffic in 1921. Developments since then have been rapid, and in 1924, with the growth of the Flying Squad, further experiments were conducted on 723 metres for transmission, while the Flying Squad vans replied on 265.

Exactly what are the wave-lengths used to-day is a close secret, but perhaps some of our readers may, by a lucky chance, have picked up Scotland Yard's transmissions and have recognised them as such.

The modern Flying Squad vans, which are fitted with wireless, are difficult to distinguish from ordinary tradesmen's delivery vans, for the sets are tucked away inside, and there is no outward indication of an aerial. These vans are patrolling London at all hours of the day and night, and are in constant touch with headquarters. A code message from Scotland Yard can mobilise these vans by a few seconds' notice, and readers will

probably realise how, if there is a case of a big hold-up and the thieves, say, have got away in a car, Scotland Yard can radiate a message which will at once inform the Flying Squad of what has happened.

### Camouflaged Cars

The vans cannot communicate with each other directly, but the system is so well perfected these days that communication via the Yard, from one van to another, is a simple matter.

Besides these Flying Squad vans, Scotland Yard now possesses a number of private cars which are also fitted up with concealed wireless transmitters and receivers. We probably pass them often in the streets in London, but they are so well camouflaged that the ordinary man-in-the-street would never recognise them.

Scotland Yard's main wireless station is in constant communication with America, Canada and Australia, and on many occasions finger prints have been transmitted half-way across the world in order to assist some police authority.

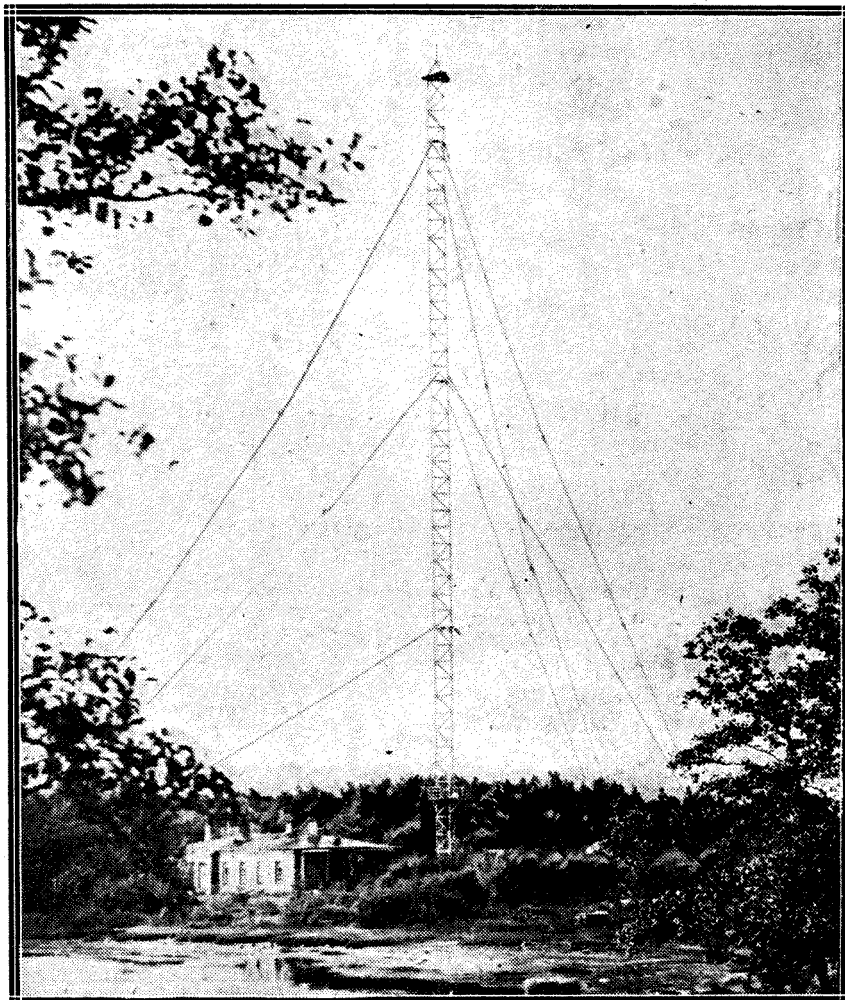

One of the most pleasantly situated of Europe's stations is Helsingfors, Finland, depicted above. It works on a wave-length of 1,875 metres.





# RADIO ABROAD

*Notes and News of Wireless in Other Lands.  
By Our Special Correspondents.*

## Television in Australia

EXPERIMENTS are at present in progress in Victoria in connection with the Baird television system. It is understood that a "B" class broadcasting station is to be used for the time being, and experts from the Baird organisation in London are carrying out the experiments. In due course it is hoped that a company will be formed to exploit television, and to manufacture and sell television receivers.

## Progress in France

Radio matters are going ahead strongly in France, and agreements have been entered into between some of the leading radio manufacturers. According to one arrangement which has been made, the Compagnie Générale de T.S.F., and its associated companies in France and in the French colonies and protectorates, will have the rights to all inventions, processes, and patents belonging to the Matériel Téléphonique, and a reciprocal arrangement applies with regard to the patents, etc., of the former company.

A long-standing difference between the important cable companies (Compagnie Française des Câbles Téléphoniques and La Compagnie Radio France, Cables P Q) has been removed by what is described as a "co-ordination of technical means."

## Programme Tenders

A rather strange suggestion has been issued by the Government of Victoria (Australia) to the effect that the programmes for the whole of Australia should be provided by a

separate organisation from the broadcasting organisations. Theoretically, the British Broadcasting Corporation is intended to be taken as a model, but inasmuch as outside parties have been asked to tender for the provision of programmes, Victoria listeners are afraid that trouble may arise between the broadcasting board and the party to whom the programme contract may be given.

## N.B.C. (U.S.A.)

The recent visit of Mr. M. H. Aylesworth, President of the National Broadcasting Company, U.S.A., has created great enthusiasm amongst U.S. listeners over the possibility of

increased interchange of radio programmes between Europe and America.

"I found universal friendliness between radio interests," said Mr. Aylesworth, "which augurs well for world-wide understanding through common inclination. Particularly the English-speaking world is destined to be much more firmly cemented in the immediate future through the instrumentality of radio broadcasting."

## Advertising by Radio

Mr. Aylesworth found British Broadcasting Corporation authorities highly interested in the American method of financing broadcasts through sale of part of its time to commercial clients.

"There are several variations of the methods used in Europe to finance radio," said Mr. Aylesworth, "but I find that all are giving consideration to the American method."

Mr. Aylesworth was impressed with the strides which England is making with rural education by radio. He states that the B.B.C. Director-General shares his enthusiasm for interchange of radio programmes, and adds, "We both look forward to broadcasts in which statesmen and scholars of all English-speaking countries will be heard by all other English-speaking nations. There is a real community of interest which will be strengthened through hearing each other's voices over the air."

*(Continued on page 200.)*

## ANNOUNCING THE AIR LINERS

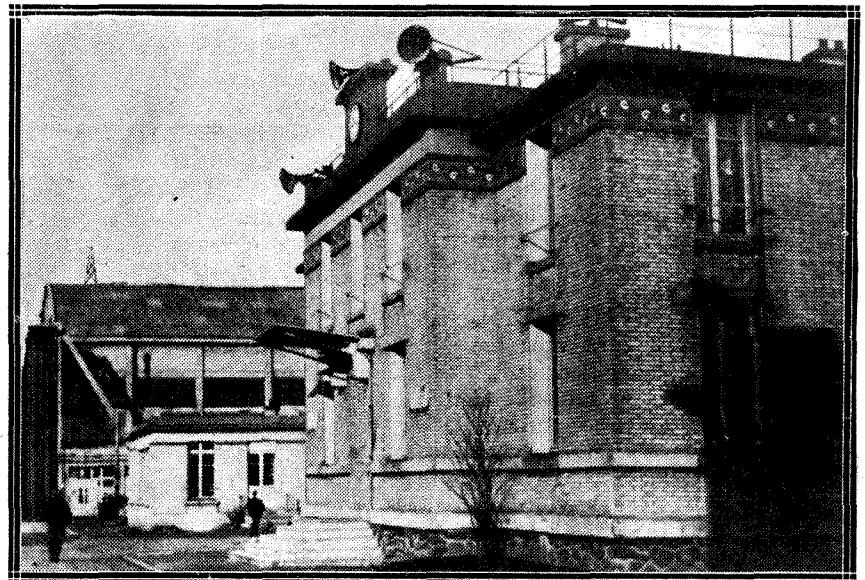

This photo shows the loud speakers on the roof of the headquarters of the principal French air station at Le Bourget. From these speakers are announced the arrivals and departures of air liners.

# PANEL PECULIARITIES

By J. F. CORRIGAN, M.Sc., A.I.C.

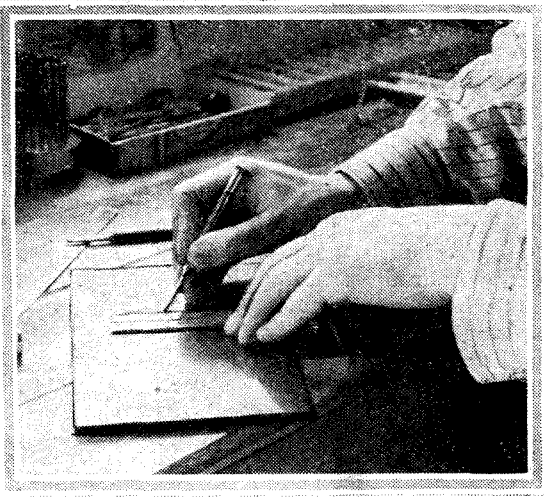

**E**BONITE, as everyone knows, consists essentially of rubber which has been intimately mixed with powdered sulphur at a fairly high temperature and maintained at that temperature for some hours. The whole process is known as "vulcanisation"; the well-known product, ebonite, comprising the last practicable stage to which the vulcanisation of rubber can be taken.

### The Drilling Test

Ebonite, therefore, is a good insulator because it combines the high insulative qualities of rubber and sulphur. It is very durable and it possesses good mechanical strength. Ebonite is non-hygroscopic, that is to say, it does not absorb moisture from the atmosphere, and it can be worked easily.

Notice, for instance, the clean manner in which a good grade of ebonite can be drilled. The drillings come out in little spirals, as illustrated at

Fig. 1, but although these ebonite "tails" may be extremely thin, they hold together well like a ribbon.

This characteristic of ebonite drillings forms a good test of the material.

.....  
 Owing to the demand which has been created for sheet ebonite of the highest quality during the past few years, the radio amateur bent on purchasing a quantity of this material for radio use is nowadays far less likely to find himself in the possession of "dud" material than he would have been, say, two or three years ago. But even now, care in selection should be taken, and this article on the quality of those compounds sold for radio panels will be both of interest and value to all constructors.  
 .....

for when poor-grade ebonite, or one of its low-grade substitutes, is drilled, the drillings break up into a more or less powdery mass at the entrance of

the drill into the material, as depicted in the illustration, Fig. 2. Material which behaves like this on drilling should be regarded with grave suspicion.

### Poor Panels Warp

Exposed to weathering influences, ebonite does not warp to any extent as some of its substitutes do, but it has the unfortunate property of turning slightly green and of decreasing in insulative power after it has been exposed to strong sunlight for any great length of time. It is for this reason that large radio panels should never be allowed to remain permanently fixed near a very bright and sunny window.

Good ebonite, on being sawn, gives off a peculiar sulphurous odour, but there is no smell in the case of low-grade material. Here, then, is another little practical test which should be carefully observed by the set builder.

### WHAT SIMPLE TESTS SHOW

When the Ebonite is GOOD!

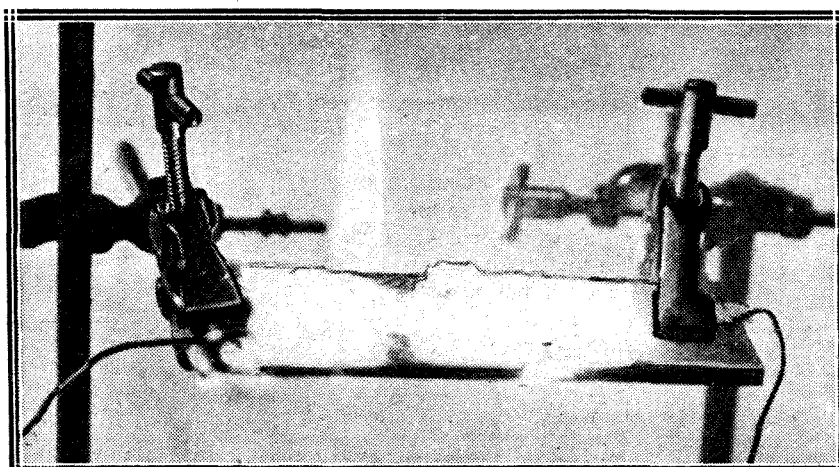
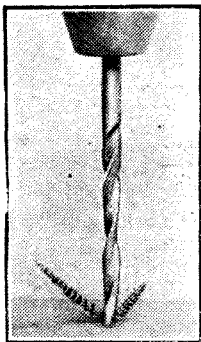

When the Ebonite is BAD!

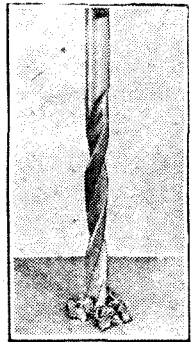

On the left (Fig. 1) we see good quality ebonite being drilled—compare the way it "comes up" with the breaking up under the drill shown in the right-hand photograph (Fig. 2), where a poor substitute is being used. The centre picture shows a luminous discharge due to the application of high potential across a strip of ebonite of low insulative power.

## Be Your Own Panel Doctor!

Of course, for ordinary purposes, many of the ebonite substitutes are as efficient in practice as the real material itself, and they have the advantage of being procurable in different colours, and also in very prettily grained surfaces. Many of these substances are made by fusing up formalin with carbolic acid, together with a little soda, the result of many hours' fusion being a dark brown resinous mass which forms the basis of a large number of artificial insulating compositions.

### Repairing Panels

Synthetic insulating compositions of this nature, although they do not possess quite the insulative power of high-grade ebonite, are stable to light and they do not deteriorate. Moreover, they are generally lighter than ebonite. Hence their frequent employment in the manufacture of portable sets.

It is interesting to note that while ebonite is totally insoluble in nearly every common liquid, many of the synthetic compositions are fairly soluble in liquids such as acetone, amyl acetate, and the other solvents of the new cellulose paint industry.

This is a useful tip for the radio experimenter, for by the use of a small quantity of acetone, cracked panels may be repaired neatly, holes filled up, and other similar tasks undertaken.

Radio panels made of compressed fibre which has been thoroughly impregnated with an insulative medium,

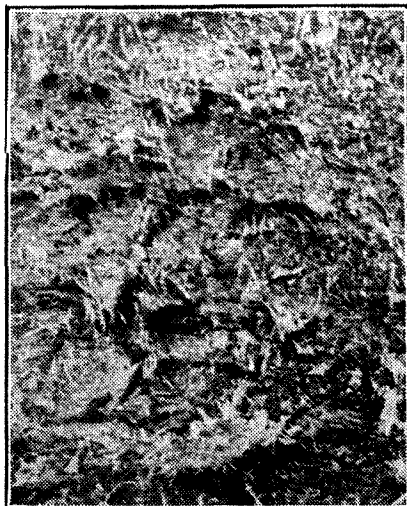

Fig. 5. This photograph of a compound fibre panel was taken under the same conditions as that in Fig. 4.

although not possessing insulating powers as high as those of ebonite or its synthetic resin substitutes, are nevertheless very useful for many purposes. Panels of this nature, an example of which will be seen at Fig. 3, are more or less unbreakable.

### Absorb Moisture Easily

They are extremely light in weight, and they are fairly easily worked. Their disadvantages, however, are that they tend to absorb atmospheric moisture, and to warp under any extremes of temperature and of humidity or dryness. Still, however, for any ordinary use, good quality compressed fibre material is a very good proposition.

The photo-micrographs, Figs. 4 and 5, are of interest in that they contrast the surfaces of ordinary ebonite and one of its compressed fibre substitutes. Fig. 4 depicts the surface of an ebonite panel as disclosed under the high powers of a microscope. Its

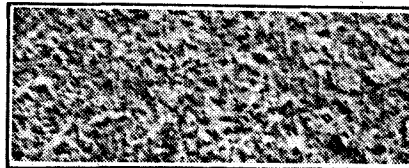

Fig. 4. A high-power photo-micrograph of the surface of an ebonite panel. Actual size of surface is about  $\frac{1}{4}$  of the width shown here.

spongy nature will be noted. It is for this reason that an ebonite panel should be kept scrupulously clean, or else atmospheric impurities, dust and dirt will settle into the surface pores of the material and thus form a slightly conducting surface to the material.

### A Final Test

In the high-power microscope view, Fig. 5, we have a portion of the surface of a compressed fibre panel (in actual area about that of a pin's head). The torn-up bits of fibre and chaff which comprise the bulk of the material will be noted, and from an examination of this photo-micrograph it will be realised that such a material can readily absorb moisture from the air and thus become altered in shape as well as in insulating properties.

Anyone possessing a small induction coil can readily subject a sample of a panel material to a rigid test. Merely connect two ends of a strip

of the panel material to the secondary electrodes of the spark coil, as



Fig. 3. This torn piece of an unbreakable panel made of compressed fibre clearly shows the construction of the material.

depicted in another photograph. If rigid connecting wire be used, the insulated supports for the strip of panel material seen in the photograph will be rendered unnecessary.

Now take the whole apparatus into a darkened room, and pass current into the coil. With good panel material, no surface electrical discharge should take place on the strip. In the photograph, however, the strip of ebonite employed for the test had been exposed out of doors to sun and rain for upwards of two years, with the result that its insulating qualities had been very much lowered, so much so that a luminous surface discharge passed more or less frequently across the surface of the strip, as depicted in the photograph. Any panel material, of course, which gives rise to this result when subject to the test with a 1- or 2-in. spark coil is useless for radio purposes.

\*\*\*\*\*  
\* **LOW-FREQUENCY** \*  
\* **"NOTES"** \*  
\*\*\*\*\*

In order to ensure maximum results with a modern L.F. transformer the makers' instructions concerning the valve impedances should be followed very closely.

One of the disadvantages of using coupling resistances of high value, such as 1 megohm or so, is that small external circuit capacities then begin to exercise a bypassing effect upon the higher musical frequencies, and so destroy the brilliancy of the music.

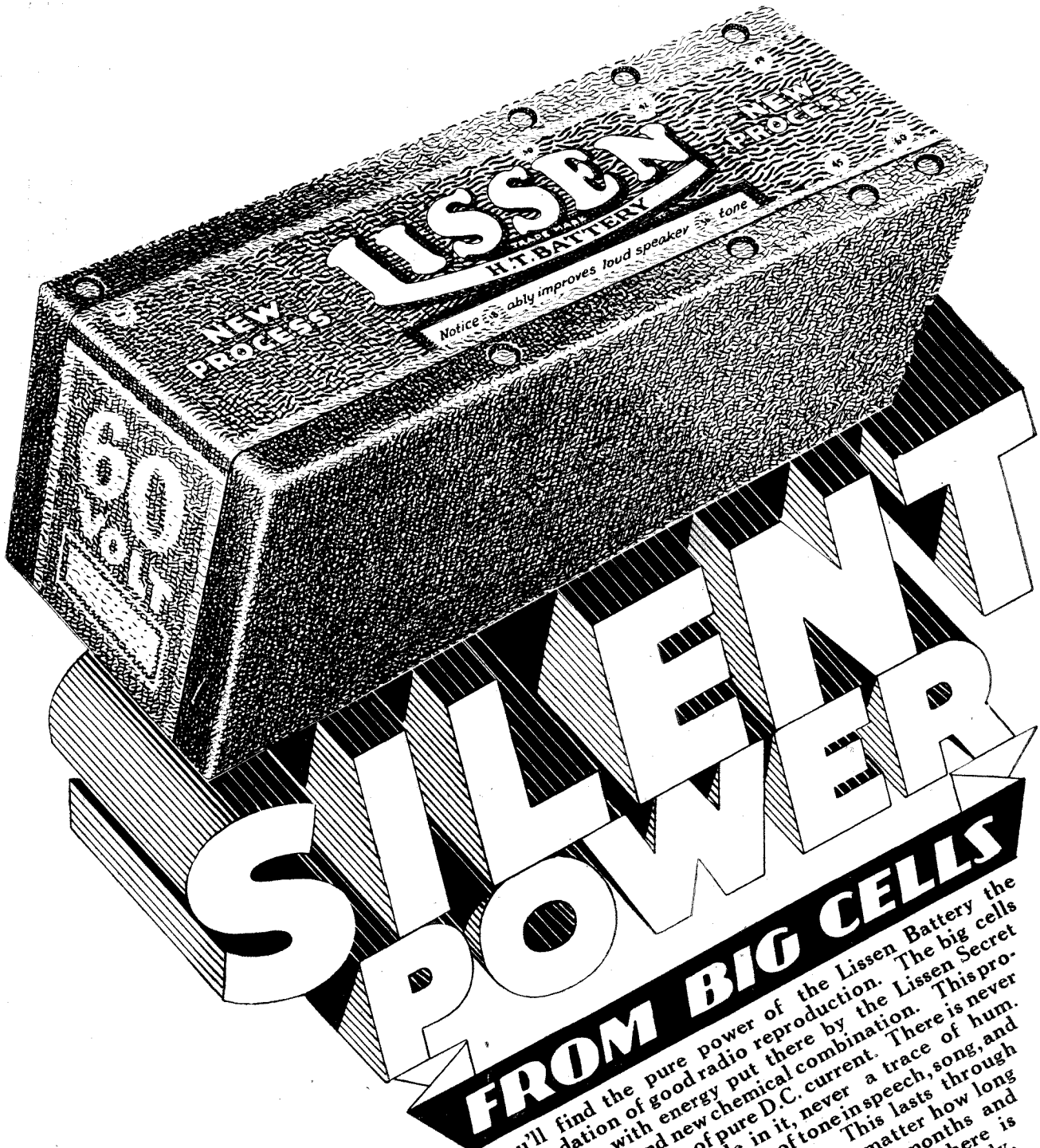

**PRICES:**

60 volt (reads 66) .. .. .	7/11
100 volt (reads 108) .. .. .	12/11
120 volt (standard cells) .. .. .	15/10
36 volt .. .. .	4/6
60 volt Super Power .. .. .	13/6
9 volt Grid Bias .. .. .	1/6
4½ volt Pocket Battery .. .. .	each 5d.
	4/6 doz.
Single Cell Torch Battery .. .. .	4½d.

MADE IN ENGLAND.

**LISSEN, LIMITED,**  
 20-24, Friars Lane, Richmond, Surrey.  
 (Managing Director: THOS. N. COLE.)

**FROM BIG CELLS**

You'll find the pure power of the Lissen Battery the foundation of good radio reproduction. The big cells are live with energy put there by the Lissen Secret Process and new chemical combination. This produces a flow of pure D.C. current. There is never a sign of ripple in it, never a trace of hum. Notice the clarity of tone in speech, song, and instrumental music. This lasts how long every programme, no matter how long it is, and throughout months and months of use. Always there is ample power flowing smoothly, sustainedly.

You will get fine current for radio if you ask for "LISSEN NEW PROCESS BATTERY" and take nothing else.



*From a Correspondent.*

**L**IVING as I do within a mile of 2LO, the question of interference from this station is rather a serious one. Even with an auto-coupled trap of average efficiency I often find difficulty in cutting out interference, especially when using a powerful set which has been designed for purity reception on long-distance transmissions, where sufficient broadness of tuning has to be allowed to prevent the slightest trace of distortion owing to excessive selectivity.

**Unequal Trapping**

Although the auto-coupled trap will give me greater freedom from "jamming" by 2LO than other types of trap, I still, then, on occasion, find that the immunity given is not sufficiently great for some particular purpose.

There is one other drawback from which this trap suffers, and that is the fact that it affects the signal strength of transmissions immediately below it, by reducing their

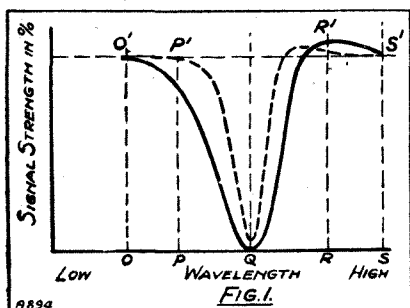

The full-line curve shows the effect of a 20-turn aerial tapping, and the dotted-line curve that of tapping only 10 turns. Note the "hump" to the right.

signal strength, and those immediately above, by increasing it. The latter is, of course, an advantage, but the former is undesirable.

In order to make this point clear, for it is an important point to consider when using this type of trap, to cut out interference from a station just above it, I have drawn a little graph, or diagram, in Fig. 1, which

**Q**In this practical and helpful article the author tells of his experience with a specially efficient type of auto-coupled wave-trap, giving knife-edge selectivity.

**Q**Tested within one mile of 2LO, this trap was found capable of cutting out all interference, even on the adjacent wavelengths.

will serve to explain what I mean. The curve has been drawn so as to show the variation of signal strength, caused by the setting of the trap, on signals of different wave-lengths. The height of the curve gives the signal strength, and the wave-length of the signal is plotted horizontally.

**What Happens**

The trap has been adjusted to cut out a signal with a wave-length corresponding to that given by the point Q. At this point, therefore, the signal strength is zero. Now it will be seen that this curve is not symmetrical about this point. It rises more slowly on the lower wave-lengths than on the high. The dotted horizontal line represents

100 per cent signal strength. Above Q, at a point marked R, the signal strength obtained is greater than that which would be given if no trap at all were used. And it is only at a considerably higher wave-length S that the curve returns to the normal.

But below Q, at a distance QP, which is equal to QR, you will see that the signal strength is below normal value, and that it does not rise to normal till the point O has been reached.

**Not Completely Cut Out**

The extent to which this result is obtained depends very greatly on how far down the coil the aerial is tapped.

The full-line curve in Fig. 1 shows what happens, let us say, when the aerial is tapped on at 20 turns from the bottom of the trap coil L. Suppose now that we tap it on at 10 turns only, what will result?

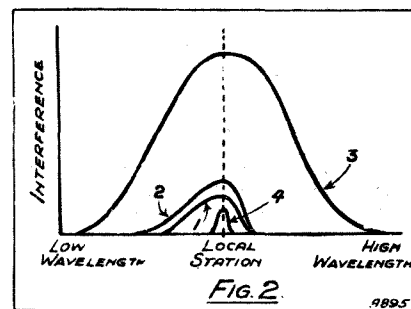

The curve marked 3 shows the wide interference obtained without a wave-trap. The curve marked 1 shows conditions when the aerial is tapped at 20 turns on the trap, and the other curves illustrate the effects of other experiments, as explained in this article.



# Knife-Edge Selectivity Obtained

The effect is shown by the dotted-line curve, and shows you how the curve gets steeper and sharper, while the curious effect referred to above has been considerably reduced. But—and this is a big *but*—it no longer traps out the interference entirely. The signal strength at the point Q is no longer zero. It is about 5 per cent.

\*\*\*\*\*  
 \* "When working with a wave- \*  
 \* trap we have to compromise \*  
 \* according to the actual results \*  
 \* we want." \*  
 \*\*\*\*\*

The actual practical results given by the two settings of the trap are explained in a simple little diagram in Fig. 2.

## An Extreme Case

Now looking at Fig. 2 you will see that the first curve (marked 1), drawn for the conditions when the aerial is tapped on at 20 turns, shows the amount of interference experienced from the local station on either side. As I am dealing with an extreme case where the local station forces its way through when the set is tuned exactly to it, I have assumed a certain value for the signal strength that comes through.

When, however, the tap is shifted down the coil to 10 turns from the bottom, you will see that the interference has spread either side of the

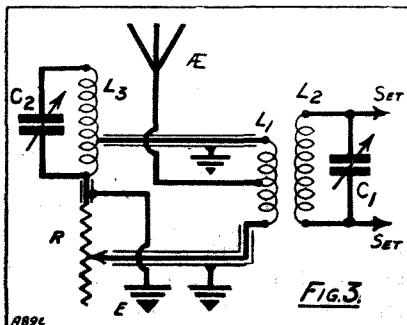

In cases of extreme interference lead-covered wires with the covering earthed can be used. There must be no coupling between the trap coil and the set, and, if necessary, the wires indicated by double lines in this sketch can be lead shielded.

first curve, and is greater at the actual wave-length of the station you want to cut out. (Curve 3 shows the interference obtained without a trap at all.)

You will see then that when actually working with a trap we have to compromise rather according to the actual results we want to get.

## A Better Arrangement

Now one day I had to try and get rid of interference from 2 L O at a wave-length much closer than my trap would usually allow me to do, and I had not got a coil of a low enough H.F. resistance to enable me to do it—indeed, such a coil would be extremely difficult to make if it were to have a high enough inductance—so I had to sit down and try and think out a scheme.

While working on this idea I remembered some experiments I had done with another keen wireless experimenter some time previously, and I carried on on similar lines.

The results I got left little to be desired. Not only was I able to cut out jamming from 2 L O almost entirely on its own wave-length, but I also found that the trapping effect was now symmetrical, while the interference curve for this station was now approximately as at 4 in Fig. 2.

The circuit I finally decided on is shown in Fig. 3. The aerial coil  $L_1$ , which is coupled to the grid coil  $L_2$  of the first valve in the set, has a centre-tap. To this tap you connect the aerial. One end of the winding is connected to the tap on the trap coil  $L_3$ , and the other end to one side of a variable resistance having a range of about 0 to 40,000 ohms. The other side of this resistance is connected to the bottom of the trap coil  $L_3$  (which is tuned by the usual variable condenser  $C_2$ ) and the point where these two join is connected to earth.

## Bridge Effect

The result is that we have a "bridge." Two arms are symmetrical, being composed of the two halves of the primary winding. The other two consist, one of the trap and the other of the variable resistance.

Now suppose we tune in the interfering station at fairish strength and adjust  $C_2$  till the trap has cut it out as much as possible, you will find that by adjusting  $R$  you will find a point at which the trapping effect is greatly enhanced. By making slight readjustments of  $C_2$  and  $R$  you will quickly find the best setting for each.

For those who want to try out this scheme the following figures will prove of use: Trap coil  $L_3$  should have an inductance of 270 to 300 microhenries, and should preferably be wound with real Litzendraht on a paxolin former; 75 to 80 turns on a 3-in. former will be about right. The trap condenser  $C_2$  should have a

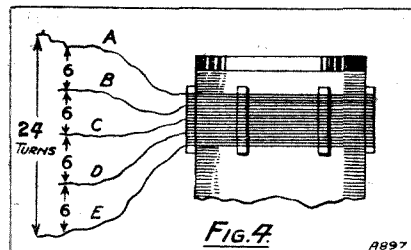

The primary is wound over one end of the grid coil, being separated from it by small ebonite spacers.

maximum value not exceeding .0003 mfd., and a slow-motion dial will be needed to adjust it.  $R$ , as previously stated, will be 0-40,000 ohms.  $L_1$  should be a 20- or 25-turn coil with a centre-tap, or for greater selectivity it should be a 15- or 16-turn inductance.

## The Centre Tap

When using coils which consist of both primary and secondary windings on one former, the simplest way of getting the centre-tap is shown in Fig. 4. Here we have a case where the primary is wound over one end of the grid coil, being separated from it by small ebonite spacers. Suppose the normal primary winding consists of 12 turns, with a tap at 6 for the lower waves or for extra selectivity, then a total of 24 turns will be re-

\*\*\*\*\*  
 \* "We have a balanced bridge, \*  
 \* so that no signal current passes \*  
 \* through the primary winding \*  
 \*  $L_1$ , and no signal therefore gets \*  
 \* into the grid circuit of the \*  
 \* receiver." \*  
 \*\*\*\*\*

quired with three taps. These are shown at B, C, and D.

C is the centre point and is connected to the aerial. A and B, and D and E are brought to two pairs of sockets, so that by means of flex leads provided with plugs the desired tapping can be obtained without disturbing the symmetry of the arrangement and thus upsetting the bridge.

# THAT L.T. SWITCH

*There are certain items in radio outfits which, owing to their familiarity, are apt to receive rather cavalier treatment. In this article the vital importance of a "minor component" is emphasised.*

*By D. GLOVER.*

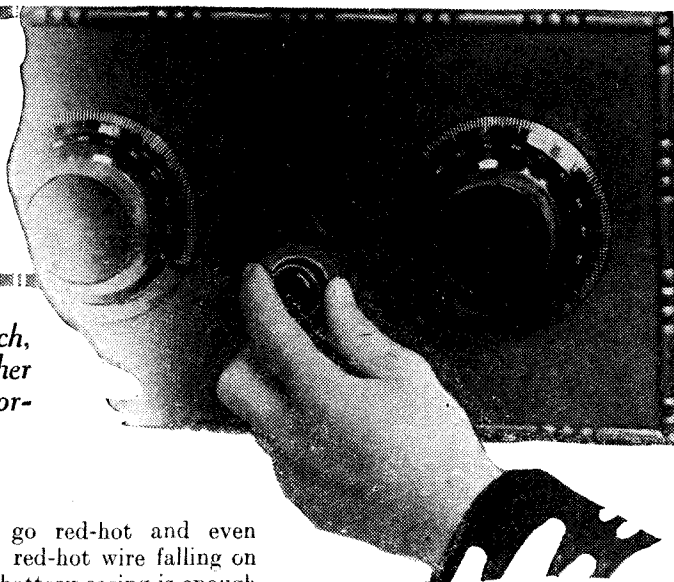

UNLESS the L.T. switch is situated on the accumulator itself it is not really an "on-off" switch. The leads to the set and some of the leads inside the set are "alive" all the time unless the L.T. circuit is broken at the battery.

This is not quite as it should be, because L.T. is much more dangerous than H.T. in most radio installations. At the worst you get a mild shock and a fairly feeble spark from an H.T. battery of the common "dry" type, but an L.T. accumulator is capable of doing a lot more.

### **Dangerous Short-Circuits**

You can get forty or fifty amperes of current from quite a small accumulator cell, and this is enough to make

copper wires go red-hot and even melt. And a red-hot wire falling on to a celluloid battery casing is enough to cause a conflagration.

L.T. short-circuits are decidedly more dangerous than most H.T. demonstrations, unless, of course, an H.T. accumulator is used. In these conditions hefty current and hefty voltage are both available, and the resultant electrical energy is capable of "sending things up in smoke" in fine style.

I wonder if it is generally realised that one can extract two or three kilowatts from some H.T. accumulators; enough power to run a full-size broadcasting station? Of course, the small cells would not deliver such colossal energy for very long, but

quite long enough to do considerable damage.

But my subject is filament switches and I hope that I have made my first point, i.e. that the accumulator is not isolated immediately the switch is pushed over to its "off" position.

I always use an L.T. fuse and consider that this is every bit as important as the one which figures in the H.T. circuit. The fuse is of the flash-lamp variety, although I use a bulb capable of passing the half ampere that my valves consume. The bulb is rated at .5 ampere, 2 volts. It is not a common rating, but a low-voltage high-current type is essential, for it must have a low resistance as otherwise it would limit the current too much.

### **A Handy Reminder**

A small length of  $\frac{1}{2}$ -ampere fuse wire would be better still from the point of view of resistance, but the light-bulb serves two purposes. I have it fixed in a small holder on one of the accumulator terminals. When the set is switched on this bulb lights up and so forms a good "tell-tale."

It is underneath the set, but as the light is quite a bright one you cannot help seeing it. In this way one is reminded that the set is in operation. Last thing at night, when one is sleepy and broadcasting has ceased, it is not difficult to forget to open that little switch.

Practically all filament switches are of the push-pull type these days, and so are wave-change switches, gramophone pick-up switches, and so on. On my set there are four push-pull switches and the L.T. switch is exactly like the wave-change switch which is just above it.

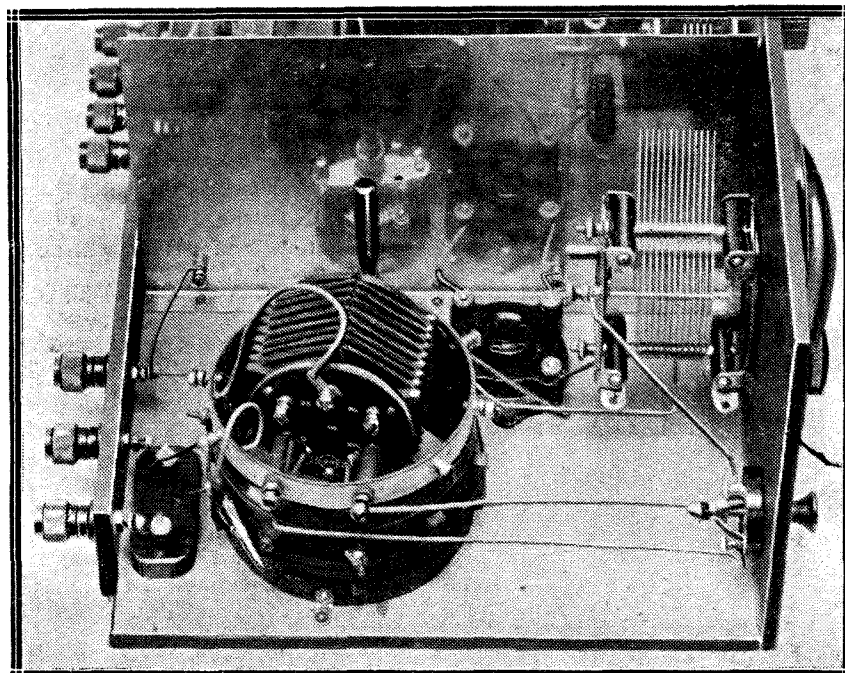

The little switch you can see mounted on the panel of this "M.W." set is used for wave-changing. An exactly similar switch can be employed for the L.T. "on-off" and thus lead to the confusion the author indicates. In this particular set, however, the switches are very widely separated.

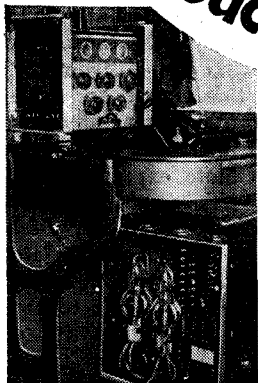
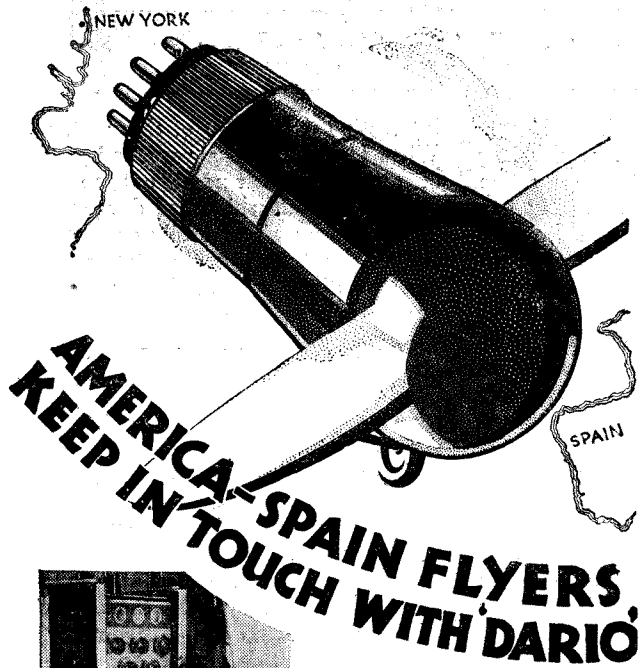

(On left) The wireless receiving and transmitting set on the airplane "Yellow Bird" shewing the "Dario" Valves.

THE Yellow Bird's, and its heroic occupants', flight from New York to Santander, Spain, is already well known. All the time on this journey wireless communication was maintained with Dario Valves. Why not use Dario Valves yourself—they've proved themselves in a matter of life and death—they will improve your set beyond all expectations—Dario prices are little short of marvellous. They are due to one of the biggest and most modern valve outputs in the World. Ask your dealer or write direct for full particulars.

<b>5/6</b>	<b>TWO VOLTS</b>
General Purpose ..	5/6
R.C.C. ..	5/6
Super Power ..	7/6
Super H.F. & R.C.C.	7/6
Pentodion ..	21/-

<b>7/6</b>	<b>FOUR VOLTS</b>
General Purpose ..	5/6
R.C.C. ..	5/6
Super Power ..	7/6
Super H.F. & R.C.C.	7/6
Pentodion ..	21/-

# DARIO VALVES

WRITE FOR DARIO FOLDER!

IMPEX ELECTRICAL, LTD.,  
DEPT. H. 538, HIGH ROAD, LEYTONSTONE, LONDON, E.11



## IGRANIC TAPPED "C.C." OUTPUT UNIT

As a technical man you appreciate the advantages of an output filter circuit. It protects your loud speaker windings, gives better quality, and often is the remedy for L.F. howls and "motor-boating."

The Igranitic Tapped "C.C." Output Unit contains a choke and condenser of the correct proportions, and is provided with tappings so that a step-up or step-down auto transformer effect can be obtained ... .. Price 21/6



IGRANIC "G" TYPE L.F. CHOKE.

For intervalve coupling and output circuits.

27/-

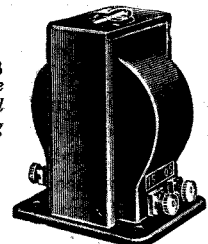

IGRANIC "G" TYPE TRANSFORMER.

For superlative quality.

30/-

Send to Dept. J903 for fully descriptive leaflet. You will find it interesting and helpful.



WORKS: BEDFORD

## Troubles That Are Due to L.T. Switches

My fuse light has saved the situation several times. Quite often I have gone over to the set, pushed in for 5 X X, and wondered why the light of the fuse on the L.T. supply has continued to shine.

### A Switch Suggestion

And as for asking anyone else to turn off the set, that is asking for an all-night use of the apparatus. It would certainly be a good thing if a special kind of switch were set aside for L.T. purposes. My suggestion is that some L.T. switches should be supplied with knobs of adjustable sizes for sets having cabinet doors.

You would adjust the knob size until it was of just the right dimensions for the door of the set to push it in when closing it. This is presupposing that the action of the switch calls for a pushing-in when switching off the L.T.

### Self-Cleaning Contacts

It is an unfortunate fact that all switches do not work alike, although I believe that standardisation is gradually being achieved. Not so

long ago one had to think hard every time one had to use a new switch, for it was even chances that its action would be different from the last one employed. The one would have to be pushed in for the closing operation, while in this position the other would be in its "off" condition.

Some switches are of the "self-cleaning" variety. This means to say that the surfaces of their contacts rub together every time the switches are operated. Other switches incorporate pressure contacts, and here the action is merely the pressing together of two pieces of metal without any rubbing. This is satisfactory providing the contacts are firmly pressed together and the metal of which they are fashioned is not too easily oxidisable.

### "Home-Made" Statics!

Personally I strongly prefer the self-cleaning switch, although, as I have indicated, the other kind can be efficient.

A faulty L.T. switch can produce as much crackling as a dud H.T. battery. Quite recently I had an

interesting experience of this nature. What I took to be a very bad spell of atmospherics turned out to be the L.T. switch which had developed "intermittency." I easily cured the trouble by taking the switch apart and bending one of the contact springs inwards.

### The "Tumbler" Type

I am rather in favour of the tumbler type of switch for L.T. purposes. A miniature of the sort that you have on the wall for controlling the electric lights. The action is a familiar one and the make-and-break is excellent. The contacts are large and completely self-cleaning, and there is a definite switch action every time the device is manipulated.

Switches of this nature are available in small sizes, but generally they are difficult to mount on an ebonite panel and are more expensive than the other designs. Could a cheap one-hole-mounting tumbler switch for L.T. control be placed on the market it should prove popular. I would advise all my friends to buy one!

## KEEPING YOUR AERIAL TAUT

**A**FTER a time your outdoor aerial is bound to slacken, and the down lead hangs close to the wall. And where the aerial and down lead is one length of wire, as it mostly is, it is better if the bare aerial is kept as far away from the wall as possible.

A simple device for achieving this purpose is illustrated in the diagram. All that is needed is, first, an angle bracket of iron of the type shown. Anything of this pattern will do, and can be easily obtainable from any ironmonger. This is attached to the wall near the point where the down lead connects to the A to E switch.

### Easily Adjusted

To the bracket is pivoted, by means of a wing nut and bolt, a stout wood strip, which is slotted as indicated. At the end of the strip is attached a reel insulator. If the device is arranged as shown, with the down lead resting in the groove of the insulator, it is a

simple matter to adjust the wood arm to a position where the aerial will be drawn taut, and the bar is firmly held by tightening up the wing nut.

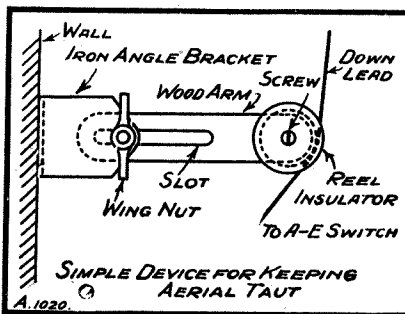

If the aerial again at any time slackens, it is only necessary to extend the position of the wood arm, and tighten up once more.

H. B.

## NOTE - BOOK NOTIONS

The minimum capacity of a good variable condenser is about one-tenth (or less) of its maximum capacity.

\* \* \*

When a pick-up is being used with a gramophone a certain amount of sound and "chatter" will still be heard direct from the instrument unless it has a shut-down lid.

\* \* \*

When mounting condensers, etc., in rather inaccessible places, remember it is often an advantage to put the leads in place and screw them down before fixing the component in position.

\* \* \*

If you use one of the three terminal fixed condensers, be certain that you wire it up the right way, as although it may work when connected wrongly, results will be very inferior to those obtainable under the correct conditions.

## POPULAR WIRELESS

IS THE LEADING RADIO WEEKLY.

Price 3d. Every Thursday.

# Radio and the Gramophone

**In this section of MODERN WIRELESS each month will be discussed both technical and other data of interest to the set owner who is also interested in gramophones.**

**Besides articles of a practical nature, a brief survey and critique of the latest gramophone records is included, making the section of vital interest to all music-lovers.**

Conducted by **KEITH D. ROGERS.**

## CONTENTS

	Page		Page
<b>Replies to Readers</b> . . . . .	2	<b>The "M.W." Electric Gramophone</b> . . . . .	4
A selection of answers to queries from readers of the "Radio and the Gramophone" section of "Modern Wireless."		A description of the construction of an up-to-date and efficient radio-gram receiver. The set and amplifier consists of an all-from-the-mains wave-change receiver and a moving-coil speaker is employed.	
<b>Round the Turntable</b> . . . . .	3	<b>Recent Record Releases</b> . . . . .	8
A page of odds and ends of interest and value to all radio and gramophone enthusiasts.		Our regular review of some of the records published during the month, written from the point of view of their suitability, or otherwise, for electrical reproduction.	
<b>A New Electric Motor</b> . . . . .	3		
Details and test report upon the recently introduced Phonomotor, a new induction type of gramophone drive unit.			

## Radio-Gram Receivers

**T**HE Radio-Gram receiver is rapidly becoming popular, and there are now large numbers of complete outfits on the market. The most unfortunate features about the majority of these, however, are the prices asked—sometimes for jobs that are not all they should be as regards the quality of reproduction.

### Quality Could Be Improved

Some of the 45- to 60-guinea outfits (and sometimes even those of higher price) are not by any means indicative of what really can be done with well-designed amplifiers and really good loud speakers. There is no doubt that with better design (in an electrical sense) very much better reproduction could be obtained, and *at the same price.*

Incidentally, we wonder why so many radio-gram designs which are of pretentious size and colossal price make no provision for records. It is, of course, not easy to provide adequate record space, and in the case of the upright pedestal types this can hardly be expected, but some of the console models might do more in this respect.

The problem of record storage must always be a difficult one to solve, for if you are an enthusiastic gramophone "fan" your stock of records increases at an astonishing rate, until it becomes extremely difficult to keep them safely and tidily. Mere

stacking is hardly adequate, and it usually results in the reduction of stock by some means or other, or else the purchase of a separate piece of furniture in the form of a separate record cabinet.

This latter is undoubtedly one of the best solutions to the problem, though the inclusion of a 50- or 60-record compartment in the radio-gram set itself (not difficult in a console model) is a very convenient refinement.

And while talking about radio-gram outfits, we should like to draw readers' attention to the Electric Gramophone described in these pages. It is a really first-class quality instrument and, while not cheap to build, it is good value for money. Costing about £30, it consists of a complete radio-gram receiver with all-mains set and moving-coil loud speaker.

### The New "Frequency Records"

We are pleased to note that the Parlophone Company are following H.M.V.'s lead and bringing out calibrated frequency records. The Parlophone records are done in a different way from the H.M.V., and are not confined to "pure" notes. With both sets of records it should be easy to make very valuable measurements as to the response curves of pick-ups and speakers. We shall have more to say about these new records shortly.



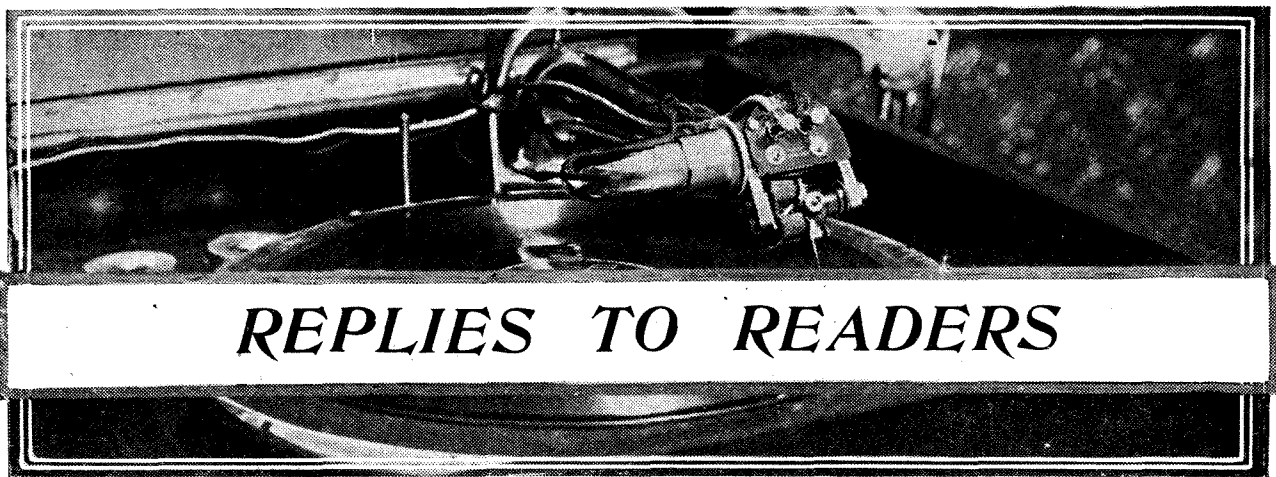

## REPLIES TO READERS

### Sensitive Pick-Ups

H. P. M., of Leeds, enquires which is the most sensitive pick-up on the British market, as he has a two-valve set, a detector and a pentode, and wishes to use it as a radio-gram receiver.

This is a very difficult question indeed to answer, because there are so many pick-ups on the British market which are practically equal in sensitivity, though they may give different response characteristics. Among the most sensitive all-round pick-ups are the Igranic, the B.T.H., Blue Spot, Loewe, Amplion, Burndeft, Magnum, G.E.C., etc., but because a pick-up is sensitive it does not say it will give better results than a pick-up which is less sensitive, though, on the other hand, the sensitivity of a pick-up need not necessarily militate against the good reproduction and response curve. Of the less sensitive variety, the Varley and the Woodroffe deserve mention.

We would advise you to hear one or two of the pick-ups which you may fancy before you decide upon which one you will buy, or, better still, if it is possible get your local dealer to lend you one or two pick-ups to try on your own set.

It is difficult to prescribe any particular pick-up for any particular set unless you know the full characteristics of the set and the loud speaker with which the pick-up is to be used.

### Using a Pentode

A reader from Leicester complains that when he tries to use a pentode valve with a radio-gram receiver he gets instability and a tendency to motor-boat, although motor-boating does not manifest itself in the usual decided manner.

Probably the trouble with our reader from Leicester is that he is getting such high magnification that instability is indeed occurring, and he will probably find that a good choke output circuit, and also a choke-condenser anti-motor-boating device in series with the priming grid of the pentode, will do a great deal of good.

This latter device should consist of a good low-frequency choke and a 4-mfd. condenser connected between the pentode side of the choke and earth, or filament, the choke, of course, being in series with the H.T. positive terminal and the terminal on the pentode valve.

.....  
 ♦ A selection of readers' queries ♦  
 ♦ upon subjects relating to electrical ♦  
 ♦ gramophone reproduction. Let- ♦  
 ♦ ters containing gramophone ♦  
 ♦ queries should be addressed in ♦  
 ♦ the same way as those concerning ♦  
 ♦ other branches of radio. Such ♦  
 ♦ queries come under the general ♦  
 ♦ query rules as laid out elsewhere ♦  
 ♦ in this issue and should be ad- ♦  
 ♦ dressed to the Query Dept., ♦  
 ♦ "Modern Wireless," Fleetway ♦  
 ♦ House, Farringdon Street, London, ♦  
 ♦ E.C.4. ♦  
 ♦.....

Possibly a .0005-mfd. fixed condenser between the pentode plate and the filament may be of assistance when radio is used, as a certain amount of high frequency may be getting through.

### A Question of Volume

D. T. M., of St. Albans, enquires whether a detector followed by a resistance stage, and then by a transformer-coupled stage using the new R.I. Hypermu transformer, will give him sufficient volume from a pick-up with a moving-coil speaker for a very large room.

He also inquires whether the shunt method of feeding the transformer should be applied or whether it would be better to use the transformer in the ordinary way.

With regard to the magnification, provided you use a high-tension voltage of about 200 or upwards you should get quite sufficient amplification and volume for a very large room, especially if you use a sensitive pick-up.

As regards the transformer coupling, you will certainly get more amplification by using it in the ordinary manner, but you will lose somewhat in the reproduction of the bass, and we would advise you to use it in the shunt method as advised by the makers. In this way you will get a very good reproduction of your bass and the volume should be quite sufficient for the purpose you mention.

### Pick-Up Adaptors

B. M., Salisbury, inquires whether the ordinary plug-in adaptor type of pick-up connections are quite suitable for an ordinary radio receiver which he wants to use with a pick-up for gramophone reproduction.

Yes, this type of adaptor is perfectly O.K. It is best to connect the adaptor to the pick-up so that the pick-up has a volume control between it and the adaptor.

The pick-up in this case goes across the volume control, which should be of the 500,000-ohm potentiometer type, and should have one end taken to a grid-bias negative tapping to the grid-bias battery, usually about 1½ volts negative.

The slider of the volume control now goes to the grid connection of the adaptor, and that is the only connection to the adaptor which is necessary.

**DUMETOHMS**



EACH **2/6**

\*25, 5, 1, 1/5, 2, 3, 4, 5, and 10 Megohms. Other higher values specially to order.

**HOLDERS**  
(Horizontal or Vertical)  
EACH — **1/-**



**RESISTORS**

Any Standard Value  
EACH **1/-**



**Holder**  
(Horizontal or Vertical)  
EACH **1/-**

**DUWIROHMS**



10,000 to 100,000 ohms	5/-	250,000 ohms	.. 9/9
150,000 and 200,000 ,,	8/-	300,000 ohms	.. 11/6
Holder	1/6		

**DUBILIER**  
RESISTANCES

If unobtainable from your dealer, write direct to us, giving his name and address.

Dubilier Condenser Co. (1925), Ltd., Ducon Works, Victoria Road, N. Acton, London, W.3. 238/R

# TELSEN

## TRANSFORMERS

Ratios 5-1 or 3-1

To ensure real Quality reproduction you cannot do better than install **TELSENS**

Entirely British.  
All models with detachable feet.  
Ratios 5-1 or 3-1.  
Standardised by all leading Set Manufacturers.

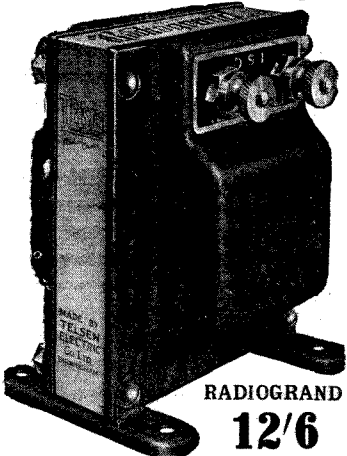

**RADIOGRAND**  
**12/6**

TELSEN ELECTRIC Co., Ltd. Head Offices: Miller St., Birmingham

# Give your set Lotus Logarithmic Condensers

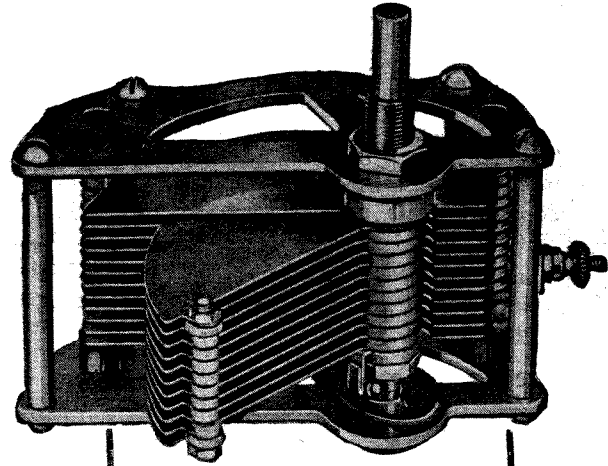

You notice a new sharpness, a new certainty in tuning, when you fit Lotus logarithmic condensers.

The ball bearings and the chemically cleaned special brass vanes and end plates ensure a smooth, firm movement and perfect conductivity, and the ample spacing prevents any chance of short-circuiting of the vanes.

You can rely upon these Lotus condensers. They are strongly and accurately constructed and are definitely to the capacity stated.

**Prices:**

·0005 condenser	.. . . .	5/9
·00035 condenser	.. . . .	5/7
·0003 condenser	.. . . .	5/6
·00025 condenser	.. . . .	5/3
·00015 condenser	.. . . .	5/-

From all radio dealers.

## LOTUS

### VARIABLE CONDENSERS

You can get these condensers fitted to the Lotus Dual and Single Drum Dials—ask your dealer.

**Garnett, Whiteley & Co., Ltd., Liverpool**

Makers of the famous Lotus components—the standard of quality wherever wireless is used.

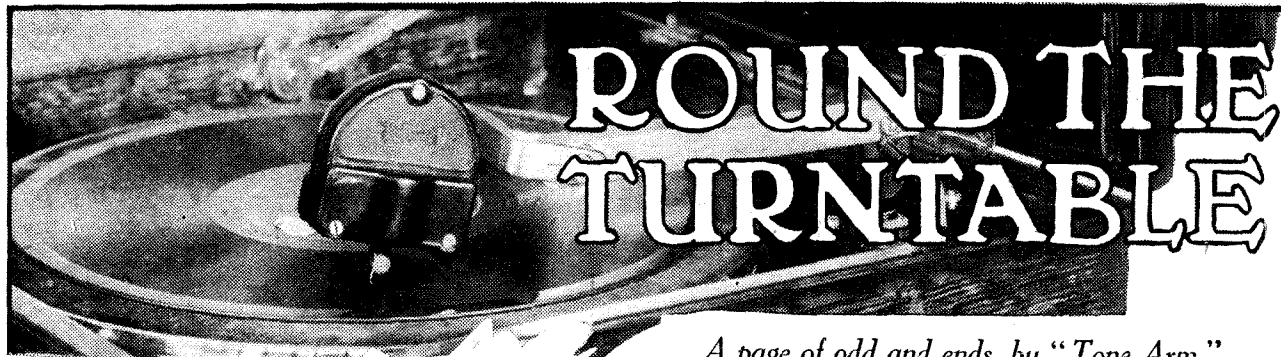

A page of odd and ends, by "Tone Arm."

**Some Surprising Statistics**

THE popularity of gramophone records has become such in recent years that one well-known gramophone concern puts on the market well over a million records a month, while the year's output of sound tracks, if placed end on, would total four million miles!

\* \* \*

Incidentally, if one year's output of these records were played one after the other it would take about 200 years to play them.

\* \* \*

In the pressing of a record the pressure used approximates to something like 60 tons, while many hundreds of records can be made in a day on one press. In the busy months of the year the presses at the Columbia works run day and night without stopping.

**Further Figures**

It is also interesting to note that the greatest number of sound vibrations per inch length of track in the average modern record is about 500 complete cycles, while the smallest is about one cycle per two inches of track, giving, of course, a very deep note!

\* \* \*

The speed at which the sound track passes the reproducing needle averages about 37 inches per second (just over two miles per hour), and the average length of sound track of a 10-in. record is about 550 ft. per side, and of a 12-in. record 840 ft. per side.

**How Many Do You Use ?**

I wonder how many needles each of us use in the course of a year? Perhaps it is almost impossible to calculate how many we use personally, but Columbia's have reckoned that their average output for a year of Columbia needles, if placed end to end, would extend well over 5,000 miles, and over 100 tons of steel are used in their manufacture.

Where a pick-up is of the fairly sensitive variety, an ordinary L.F. valve and a pentode valve are quite adequate for good reproduction of any gramophone record. Such a valve as the D.E.L.610, followed by the P.M.26 or the 4-volt equivalents, give enough signal strength for even a moving-coil loud speaker to operate at comfortable "room" strength.

potentiometer across the valve for this purpose.

\* \* \*

One-and-a-half volts up or down past the centre point on the curve's straight portion may be quite sufficient to cause overloading or other distortion due either to running into grid current or partial rectification on loud signals.

**THE NEW IGRANIC MOTOR**

LAST month we published a photograph of the new Igranac Phonomotor for A.C. mains. Since the publication of this photograph we have been able to test this motor out very thoroughly, and can confidently recommend it to readers who want a good electric gramophone motor to work off the A.C. mains.

Unfortunately, the drive of the motor makes it such that it cannot be worked off D.C. mains, for it operates on the induction principle. This does away with the use of a commutator, and, at the same time, with the possibility of noisy reproduction from your pick-up due to the sparking of the brushes and commutator contacts.

The Igranac Phonomotor is certainly one of the best electric motors that we have come across, and has quite sufficient power with the turntable provided to rotate a 12-in. record having very heavy passages indeed without the slightest suspicion of slowing down.

**Even Running**

Some electric motors we have come across have been inclined to slow down on the heavier passages on the record, which, of course, completely ruins the rendering of the music, but the Phonomotor has no such tendency, and in spite of the fact that we are always rather chary in advising the use of an electric motor with a radio-gram outfit, we can unreservedly recommend the use of the Igranac Phonomotor for those who have A.C. mains.

**This Month's  
Pick-Up Programme**

**ORCHESTRAL.**

Ballet Suite (Gluck) H.M.V. D1529  
Berlin State Opera Orchestra.

Prelude Act 3, La Tosca (Puccini) Col. 5394  
Milan Symphony Orchestra.

Dance of the Hours, Parlo. E10859  
La Gioconda (Fonchielli)  
Berlin State Opera Orchestra.

**BAND.**

Down South H.M.V. B2984  
Coldstream Guards Band.

**INSTRUMENTAL.**

Walse Brillante in E Flat H.M.V. DB1273  
(Chopin)  
Paderewski.

**OPERATIC.**

Casta diva, Norma (Bellini) H.M.V. DB1250  
Rosa Ponselle and Metropolitan Opera  
Chorus.

**VOCAL.**

The Mighty Deep Col. 5398  
Norman Allin.

Flow Not so Fast, Ye H.M.V. B2822  
Fountains  
John Goss.

**LIGHT ORCHESTRAL.**

Melodious Memories (Finck) Col. 9722/3  
London Regal Cinema Orchestra.

Chanson Triste (Tchaikowsky) Parlo. E10861  
Dajos Bela Orchestra.

"Hold Everything" Selection H.M.V. C1683  
New Mayfair Orchestra.

**DANCE.**

Here Comes My Ball and H.M.V. B5653  
Chain  
Coon-Sanders Orchestra.

The Wedding of the Painted Parlo. R367  
Doll  
Sam Lanin's Famous Players.  
A. G. McD.

Great care must, of course, be taken in biasing pentode valves, as some of them are extremely sensitive to the effects of grid bias. For instance, it is not uncommon to come across pentode valves which almost need potentiometer grid-bias adjustment if they are to be accurately biased, and it is quite a good plan to use a

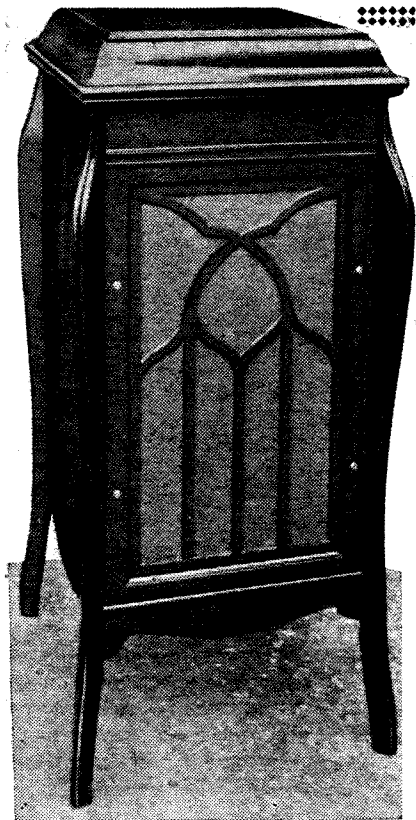

The completed instrument.

THE gramophone, as a whole, consists of three units contained in one cabinet, namely, the motor and turntable, a three-valve A.C. receiver for either radio or pick-up reception, and then the A.C. battery eliminator for H.T., L.T. (and G.B. to last L.F. valve), complete with moving-coil loud speaker on the same unit.

The units are arranged in the order given, that is, motor and turntable at top of cabinet, A.C. three-valve set immediately underneath, and controlled from the back of the cabinet, and the A.C. battery eliminators on the floor of the cabinet, the loud speaker being mounted on a plywood platform, to bring the diaphragm in line with the front wood "baffle" hole.

### Cost of Construction

Before passing on to the various aspects of the outfit, the writer would add that to construct the outfit with the makes of components named in the list of components will entail an expenditure of about £30, as it must not be forgotten that only the very best will suffice if the results are to be much better than the finest mechanical instruments.

By substituting a balanced-armature loud speaker for the moving-coil type, and by employing a cheaper

# THE "M.W." Electric Gramophone

By G. V. COLLE.

*A brief description of the construction of an up-to-date and efficient radio-gram receiver. The concluding part of this article describing the mains unit and speaker will appear next month.*

model spring motor, together with various other substitutions, the cost may be reduced to £20 or less, with the knowledge that quality of reproduction will be as good as the loud speaker incorporated.

Although the expenditure is rather large, it must not be forgotten that one is getting a complete radio-gramophone outfit, including all necessary accessories, which to purchase commercially would cost at least £45—probably £60—taking into account the excellence of the various components.

### Standard Cabinet

The cabinet which houses all the reproducing apparatus consists of the "shell" of a standard pedestal gramophone, specially arranged to the writer's specification by Messrs. G. Winston, Union Place, Curtain Road, E.C.2. Instead of the back

opening, the front wood baffle is removable by extracting four wood screws, when the loud speaker and A.C. mains apparatus, including the potential divider and various plugs from the set, are available for inspection and adjustment.

### A.C. Valves Employed

The set itself is readily accessible by removing the spring motor with its board, though the actual tuning and operating controls project from the back of the cabinet.

Since the walls of the cabinet are built of  $\frac{1}{2}$ -in. mahogany, it will be readily understood that the completed instrument is fit for any place in a well-furnished room.

From the theoretical diagram we find the set consists of three A.C. valves of the indirectly-heated cathode type, having the heaters fed from an A.C. L.T. transformer (on

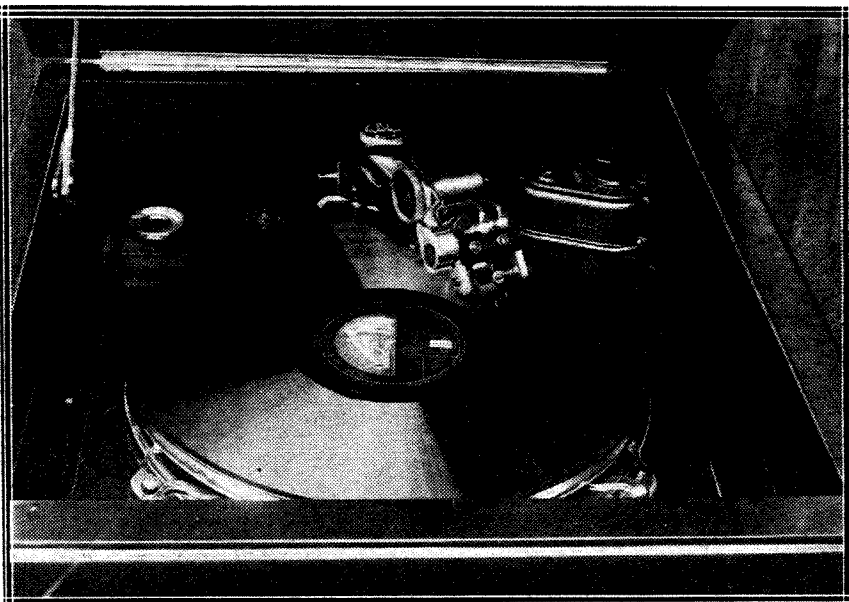

Showing how the pick-up and carrier are arranged, together with the volume control, on the motor platform of the gramophone.

the battery eliminator unit), capable of delivering a full 4 volts A.C. at 3 amperes.

In order to simplify the problem of high- and low-wave coil changing, a "Titan" coil unit was included in the receiver for radio reception, and this is brought into action by a low-capacity single-pole change-over switch, which switches over to gramophone pick-up in its other position.

**The Wave-Change Switch**

Wave-changing is accomplished by a small three-point push-pull switch, marked S<sub>1</sub> on the circuit diagram. Reaction effects are obtained on the old but little-known differential control scheme, applied on a Reinartz principle. Differential reaction control does not affect tuning to any noticeable degree, and therefore, whatever the setting of this control, it should not be found necessary to readjust the tuning condenser C<sub>1</sub> once a station has been tuned in.

Normally, the detector valve (first L.F. when over to "pick-up") operates on the grid rectification principle, accomplished by applying 1½ to 3 volts positive to the grid from the same G.B. battery as employed for biasing the L.F. valves negatively. The detector valve may be made to operate as an anode-bend rectifier by the simple expedient of removing the G.B. + (det.) plug from the G.B. battery and re-inserting it 1½ to 4½ volts to the negative side of the G.B. + (L.F.) plug on the same battery.

In connection with this latter point, the 400-ohm potentiometer situated

consists of two further L.F. valves (first and second when receiver is acting as radio set, and second and third respectively when over to pick-up) resistance coupled.

electric motor could be used, if it is well earthed and really silent. The Igranic Phonomotor is a good, reliable motor. The Garrard motor is totally enclosed, and includes its own oil

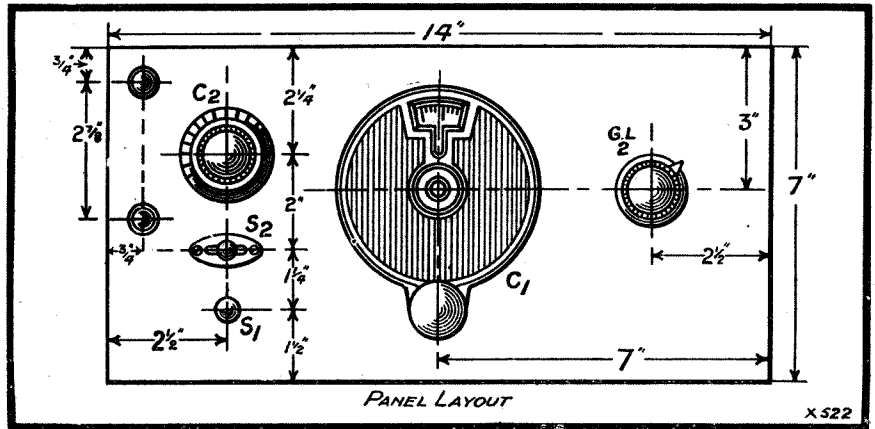

A .5-meg. grid-leak volume control, arranged in the form of a potentiometer, controls the output on "radio." Incidentally, the pick-up is controlled by a further volume

pump, the oil circulating to all the bearings by virtue of an internal feed system—altogether an excellent and silent running piece of mechanism. Lower-priced models are available from the same and other makers, however, to suit the choice of the constructor and the length of his purse.

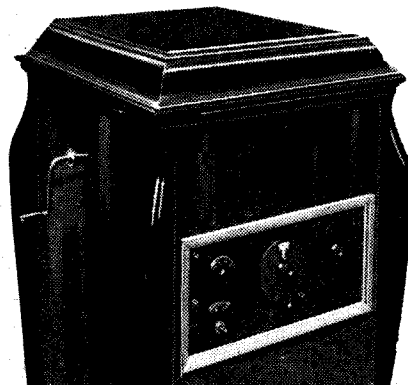

How the panel fits into the back of the cabinet.

**Mounting the Motor**

When mounting the motor on its wood board, see that the hole for the centre spindle is made at the intersection of two diagonals drawn from corner to corner, so that the 12-in. turntable operates within the area allowed for it. Speed control and stop-start trigger automatically remain in relationship to each other on the Garrard super model, but will have to be regulated and fitted by hand with other models.

We now arrive at the point where theoretical considerations can be studied, before turning to the constructional details of the receiver and battery eliminators.

To counteract any H.F. feed-back effects which might occur by having the loud speaker so close to the receiver, it was thought advisable to include an H.F. filter circuit in the anode circuit of V<sub>3</sub>, and this is shown in the diagram.

Finally, in respect to the receiver, the writer would recommend the inclusion of an L.F. choke-filter output (as well as the step-down transformer for low-resistance moving coils) in all cases where the moving-coil loud speaker is other than a Marconiphone.

Since it is imperative to employ a super-power valve of the Cosmos AC/P2 class in the V<sub>3</sub> position on

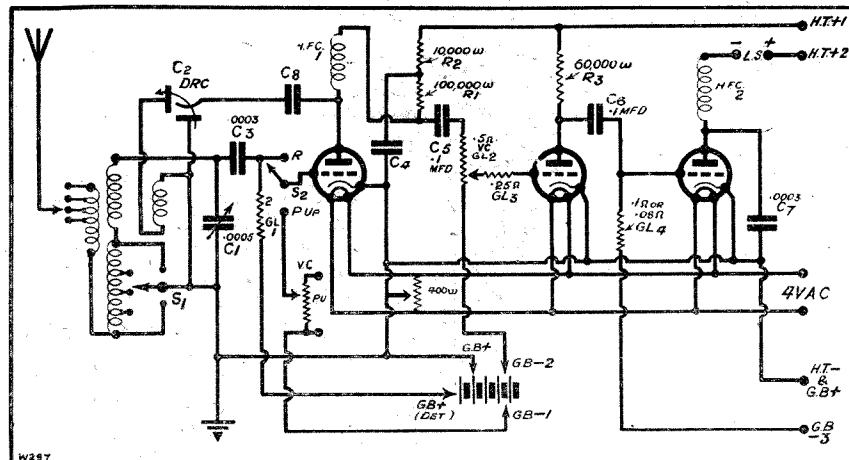

Theoretical circuit of the "M.W." Electric Gramophone.

on the baseboard of the receiver will enable the operator to find a silent working "zone" in the case of an erratic A.C. supply. The remainder of the circuit is quite orthodox, and

control for adjusting the input to V<sub>1</sub> should the pick-up be especially sensitive.

A Garrard super-spring motor was employed originally, although a good



# AS BRITISH AS BRITANNIA



VERY soon your Wireless Dealer will have stocks of the sensational new BROWN "Vee" Unit. It is the biggest Radio development of recent years. For only £2 (the Unit costs 25/- and the Chassis 15/-) anyone can assemble, in two minutes, a loud speaker that gives fine mellow tone and better volume than you have ever heard before. It recreates the living artiste.

Unit - - Price 25/-  
Chassis - Price 15/-

The Wonderful  
**NEW**  
**Brown**  
"VEE" UNIT

Advt. S. G. Brown, Ltd., Western Avenue,  
N. Acton, London W.3.

CA 9524

# The first of the New Varley Components

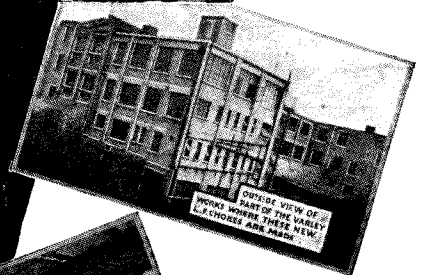

The Coil Winding Shop. Over 300 girls are employed in this shop alone where every wire-wound job is under the supervision of the most skilled and experienced specialists in this country.

The introduction of an L.F. Choke whose inductance remains constant at all loads will be a boon. Hitherto the inductance of a choke has been measured at no load, thus giving no indication of the drop in value that will result when current flows. This drop has mutilated and limited many a set's performance. Our new L.F. Choke, whose inductance is constant at all loads from 0/100 m.a., will be available to the Public soon.

Price 21/-



Advertisement of Oliver Pell Control Ltd., Kingsway House,  
103 Kingsway, London, W.C.2. Telephone: Holborn 5303

# Your Own Alternative Programme

the receiver, the A.C. H.T. battery eliminator must be capable of delivering at least 300 volts H.T. (if not more) at the requisite current. After careful deliberation it was decided that two half-wave rectifying valves of the B.T.H. R.H.1 type and an A.C. full-wave H.T. transformer would "fill the bill," the latter to give 375 volts output at approximately 130 milliamperes.

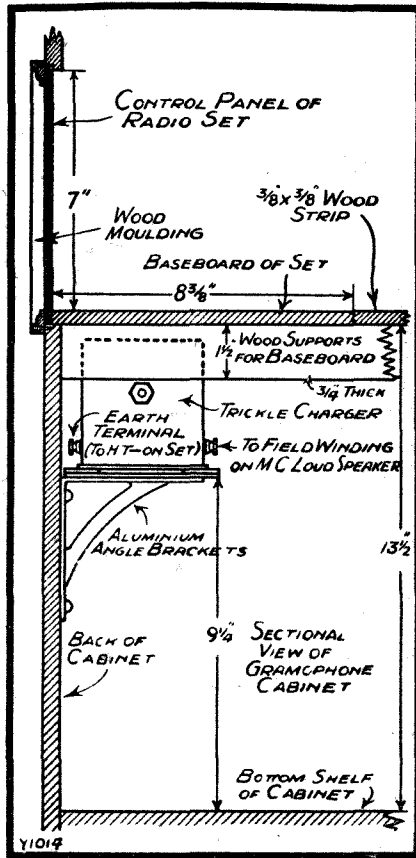

The dimensions of the set and speaker supports.

An A.C. transformer was therefore procured, and was wired to give 7.5 volts A.C. L.T. for the filaments of the R.H.1 valves, the 5.5-volt secondary being ignored. The transformer actually gives slightly more than 375 volts, which is all to the good, in view of the fact that the AC/P2 valve will take up to 400 volts H.T.

### Fine G.B. Variation

To prevent overrunning the AC/P2, and remembering the grid bias is in the region of 45 volts at 300 volts H.T., it was decided to utilise some of this voltage for grid bias, the 15,000-ohm potential divider being tapped for the purpose.

## COMPONENTS REQUIRED

- 1 Ebonite or Paxolin panel, 14 in. × 7 in. × 1/4 or 3/8 in. thick (Wearite).
- 1 .0005-mfd. variable condenser (Lotus).
- 1 Slow-motion dial to fit above condenser (Igranic).
- 1 Special differential reaction condenser (Pye).
- 1 3-point wave-change switch (Bulgin).
- 1 Single-pole change-over switch of low self-capacity; miniature type Utility shown.
- 1 .5-meg. potentiometer volume control (Gambrell). (.25-meg. valve will also prove serviceable.)
- 1 Titan coil unit (Wearite, Ready Radio, Paroussi, Ward & Goldstone, etc.).
- 3 Special A.C. valve holders, for baseboard mounting (Met.-Vick).
- 1 400-ohm baseboard-mounting potentiometer (Igranic).
- 2 .1-mfd. mica condensers, tested 1,000 volts D.C. at least (T.C.C.).
- 2 .0003-mfd. fixed condensers, one preferably being of high voltage test (C7), but if not procurable, two .001 to .0006 mfd. can be connected in series (T.C.C., Dubilier).
- 1 .001-mfd. fixed condenser (T.C.C.).
- 1 H.F. choke, of usual type (Wearite).
- 1 Heavy-duty H.F. choke (Wearite).
- 1 100,000-ohm anode resistance (Mullard).
- 1 60,000-ohm anode resistance (Mullard).
- 1 10,000-ohm power resistance (Ferranti).
- 2 Vertical grid leak holders (Dubilier).
- 1 .25-meg. grid leak (Lissen, Dubilier).
- 1 .2-meg. grid leak (Lissen, Dubilier).
- 1 .1- or .08-meg. grid leak (Lissen, Mullard, Met-Vick, etc.)
- 1 4-mfd. condenser, tested 750 volts D.C. (Hydra).
- 4 Miniature two-socket bases, complete with plugs to fit (any good electrical stores). These plugs must be made of turned ebonite or best quality Bakelite, otherwise insulated terminals will be preferable.
- 1 Plywood baseboard, 15 1/4 in. × 8 3/8 in. × 3/8 in. thick.
- 3 or 4 yds. good quality twisted flex (for A.C. filament connections).
- Quantity of No. 19 or 20 S.W.G. tinned copper wire and 2 m/m Systoflex. Glazite as an alternative.
- 5 or 6 yds. single rubber-covered flex for G.B. leads, etc.
- 2 Sockets complete with nuts for aerial and earth connections.
- 2 Plugs for the above sockets (Clix).
- 2 Red and 2 black wander plugs (Clix).
- 1 15- or 16 1/2-volt G.B. battery, tapped every 1 1/2 volts for first 12 volts (Siemens, Hellesen, Ever-Ready, etc.).

Fine G.B. voltage regulation is made possible by the use of a 1,500-ohm T.15 Truvolt, and the method of using and wiring this will be discussed next month. Under the conditions

outlined the H.T. remains fairly constant, because the whole of the T.15 Truvolt resistance element is always in parallel with a portion of the potential divider, and also,

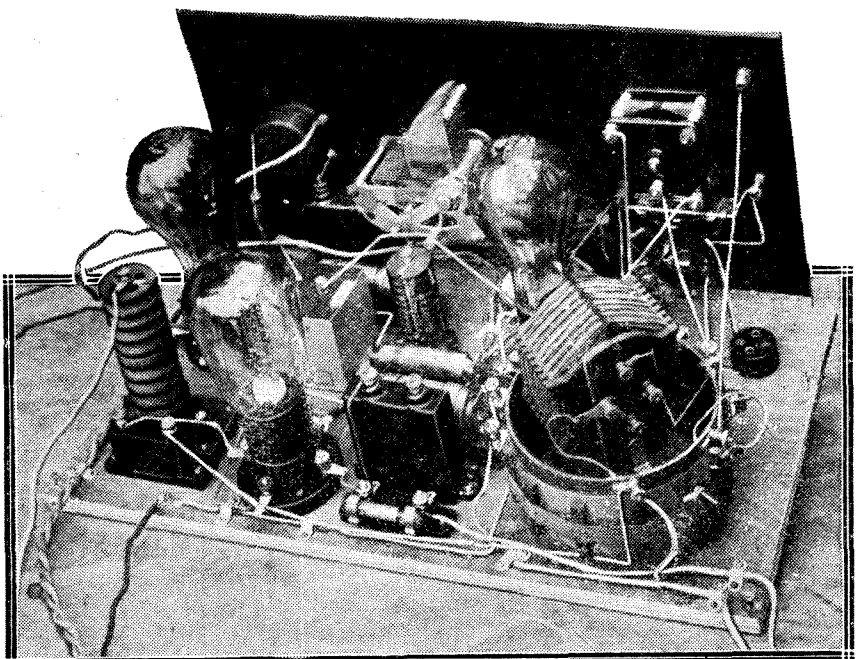

The radio and amplifier side of the electric gramophone, which consists of a detector and two L.F. stages, all A.C. mains operated.

whatever the G.B. voltage, the remaining voltage set up across the divider can be used for H.T.

Great care can be taken to see that the potential divider (15,000 ohms) will carry the required current, which will be 25 milliamperes (current passing through the resistance by virtue of its connections across the H.T. output from the rectifying source), plus the current taken by the anodes of the valves  $V_1$  and  $V_2$ .

### Avoid Overheating

Regarding the anode current of  $V_3$ , this should not overload the potential divider, because normally an H.T. + connection is taken from the extreme

positive end and the G.B. portion is paralleled with 1,500 ohms, which will act as an overload release for that portion of the divider not in the H.T. circuit. The anode current of  $V_1$  and  $V_2$  is not great, and when added to the 25 milliamperes should not cause the divider to become overheated.

### The Pick-up Sockets

Readers will observe that a small, round two-socket base is provided on the receiver baseboard, the sockets going to the pick-up switch and G.B.-1 respectively. The plugs engaging with these sockets are attached to the pick-up via its volume control, both of which are situated

on the motor board at the top of the cabinet.

In practically every case it will be immaterial how the plugs are inserted for the pick-up, this remark also applying to the plugs to the L.T. A.C. transformer, but to no others.

Referring to  $V_2$ , it may be found that in the event of an AC/R valve being used, the volume control on the panel, marked G.L., can be reduced in value from .5 meg. to .25 meg. by the simple expedient of placing a fixed grid leak of .5 meg. in parallel with it, i.e. across its ends.

*(The eliminator will be described next month, together with further details of the instrument.)*

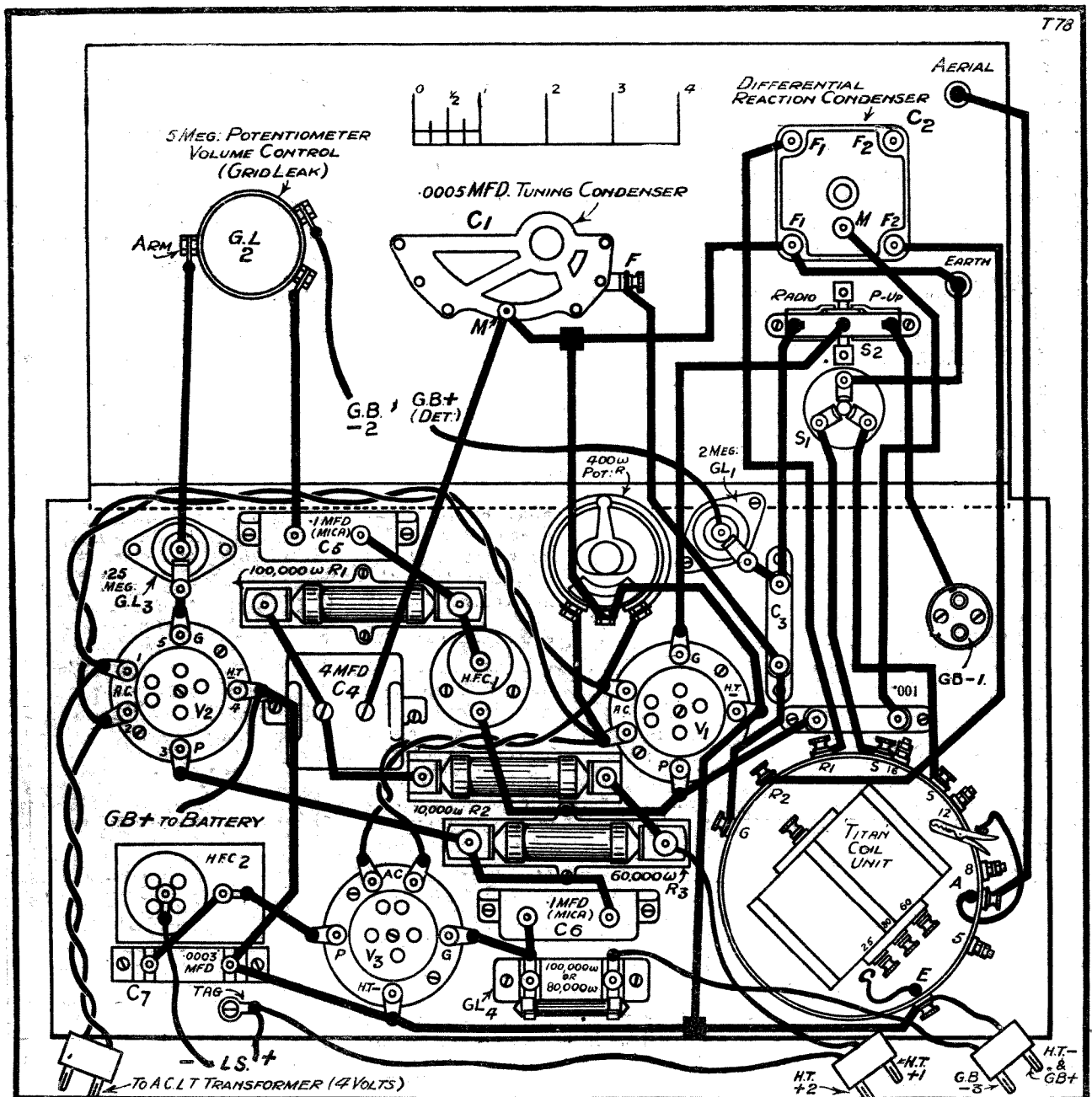

# RECENT RECORD RELEASES



Our monthly review of Gramophone records.

## Broadcast "Twelves"

It is very difficult indeed this month to pick out records from the Broadcast "Twelves" for special merit as regards pick-up reproduction, but one that must be given first consideration is the **Prologue from I Pagliacci**, sung by Gerrard Maine with orchestral accompaniment, on 5083. This is a very good bit of work indeed, and with a good pick-up and amplifier enables excellent reproduction to be obtained.

Lighter vocal selections from the **Yeomen of the Guard** also form the subject of two excellent records, while among the still lighter numbers **Mother's Boy** and **Broadway** vocal selections, with Bidgood's Symphonic Dance Band, on 5086, are well worth mentioning. Those of you who have been to the talkies so titled will welcome these selections as reminders of the films.

## Broadcast "Tens"

There is a whole host of Broadcast "Ten" records placed upon the market this month, and here again it is very difficult to choose one or a group as being more meritorious than the others. Those we have picked out this month for pick-up reproduction are of the lighter variety, and include the following numbers: **There'll Be You and I** and **I'll Always Be Mother's Boy**, sung by Ramon Newton with orchestral accompaniment, on 414, both tunes, of course, being from the talkie film "Mother's Boy."

Then we must mention **Do Something**, from the talkie "Syncopation," and **That's You Baby**, from the "Movietone Follies 1929," on 416. The talkie film theme songs are figuring very greatly in gramophone records

nowadays, and we certainly get some very good numbers by that means.

Then we have **When the Lilac Blooms Again**, a slow fox-trot by Bidgood's Broadcasters on 408, and **My Ideal**, by the same band, on the reverse side.

## H. M. V.

Some excellent records figure amongst this month's releases in the H.M.V. catalogue, one by Arthur Meale (B.3060), and the other by Jesse Crawford (on the Wurlitzer organ), playing **You're the Cream in My Coffee** and **High Hat**, two very different numbers which are most excellently executed. **You're the Cream in My Coffee** also figures in another light H.M.V. record, a piano duet by Jacques Fray and Mario Braggiotti.

The Jesse Crawford record is No. B.3056, and the piano duet is B.3057, the reverse side of which is **Don't Hold Everything**, also from the well-known musical comedy "Hold Everything."

The New Light Symphony Orchestra playing the **Juba Dance** and **From the Canebrake**, on B.3043, produces some very peculiar notes down in the bass register which taxes the pick-up to the utmost. We have not yet found a pick-up that will adequately deal with these particular notes, the result merely resembling a rattly sort of grumble. As a test for pick-up chatter, and to ascertain whether it will bring out these low notes, this record is quite unique, although it seems a little too heavily modulated in certain portions.

## Zonophone

A very varied mixture comes from the Zonophone factory, including a couple of operatic numbers. The first is on G.O.87, **Speak To Me**

of **My Mother** and **Now I Will Dance But to Please Thee**, sung by Gladys Cole, Bessie Jones, and Barrington Hooper, while G.O.88 gives us **Slave, Sweet Girl, Believe Me** from "Rigoletto," and **Hate and Rage** from "Il Trovatore," sung by Bessie Jones, Esther Coleman, Barrington Hooper and Foster Richardson.

Another record, **American Spirit** and **Army Marine** marches, played by the United States Army Band, are well worth mentioning on 5331; while the Zonophone Salon Orchestra, a new musical combination, once more gives us a couple of excellent items (on 5337) in **Come Sing To Me** and **For You Alone**.

These are old songs, of course, but quite a new note in orchestral arrangement has been struck in the composition of these records for an orchestra.

Of the dance items this month one of the best is undoubtedly **I Fall Down and Go Eoom** (fox-trot), on 5348, by the Rhythmic Eight, followed closely in merit by **Carolina Moon** on 5347, played by the Arcadian Dance Orchestra.

We have just received a batch of Parlophone records, unfortunately too late for review in this issue, and these we shall discuss next month.

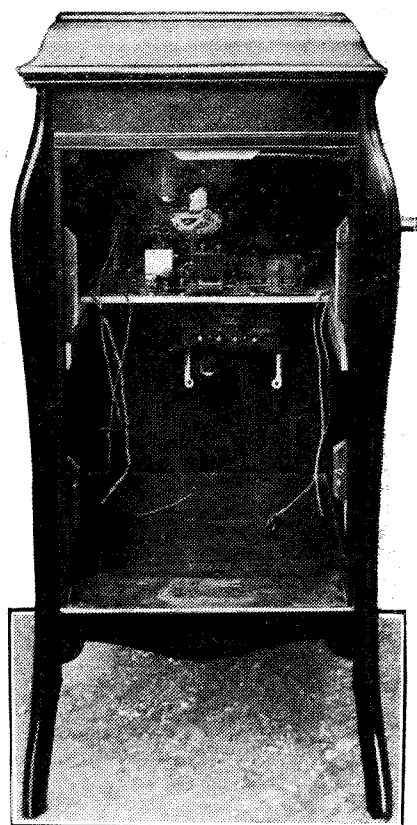

The interior of the "M.W." Electric Gramophone (described in this issue), with loud speaker and mains unit removed.



## Meet "The Twins"

THESE very audacious young women are the talk of the town. Their titillating revelations in the pages of THE LOOKER-ON have set everyone guessing at their identity.

## The LOOKER-ON

is a smart paper for smart people. It has a broad outlook and a sense of humour. In fact, you must read it to keep in touch with your times.

# The Looker-On

Look for the COLOURED Cover Every Friday

3<sup>d</sup>.

Special  
announcement  
by

# LEWCOS

REGD.

In view of the alteration in the wavelengths of British Stations it will be found very necessary to have an efficient Wavetrap for separating the stations.

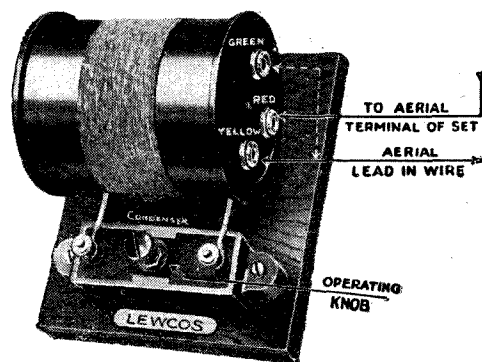

### The Lewcos Wavetrap

Be sure of efficiency over all wavebands—use Lewcos Wavetraps, which are available in the following ranges:—

Ref. No.	Wavelength Range in Metres	Price
WT4	235—400	Each 13/6
WT5	350—550	
WT15	1,000—1,500	
WT20	1,500—2,000	

Leaflet R39 giving full instructions sent on application

LEWCOS  
RADIO  
COMPONENTS  
are available at  
7, Playhouse Yd.,  
Golden Lane,  
London, E.C.1.

Reduction in price of  
**GLAZITE**  
Old price:  
10d. per 10-ft. coil.  
New price:  
8d.  
per 10-ft. coil.

THE LONDON ELECTRIC WIRE COMPANY  
AND SMITHS LIMITED  
Church Road, Leyton, London, E.10.

Trade Counter and Cable Sales: 7 Playhouse Yard, Golden Lane, E.C.1



## RADIO NOTES AND NEWS OF THE MONTH

A feature in which our Contributor brings to your notice some of the more interesting and important Radio-news items.

Conducted by "G.B."

### This Season's Proms.

THE B.B.C.'s Promenade Concerts open at the Queen's Hall on Saturday, August 10th, and listeners will have a fine opportunity this season of hearing not only some excellent music but some first-class soloists: Sir Henry Wood, of course, will conduct, and arrangements have been made to allow for rehearsals to be very thorough.

### A Galaxy of Talent

It is pointed out that in the whole thirty-five years' history of the Promenade Concerts there has never been so large and representative a list of artistes as that now booked for this season. Among others, it may be mentioned that the list includes Miriam Licette, Norman Allin, Frank Mullings, Walter Widdop, Myra Hess,

Irene Scharrer, Lamond, Solomon, Muriel Brunskill, Margaret Balfour, Hedde Nash, Albert Sammons, Jelly d'Aranyi, Isolde Menges.

Incidentally, Thursday evenings will be devoted chiefly to British composers, and new works which have not yet been heard in this country.

### B.B.C.'s Chief Engineer

Mr. Noel Ashbridge, who takes over Captain Eckersley's job, probably by the end of September, received his engineering training at King's College, London, and his practical training with the British Thomson-Houston Co. and the Lancashire Dynamo Company.

During the war Mr. Ashbridge served as an officer in the Royal Engineers, and at the close of the war he entered the Marconi Company, where he was for some years head of

the experimental station at Writtle There, older listeners will remember, he co-operated with Captain Eckersley.

### A Worthy Successor

Mr. Ashbridge then joined the B.B.C. and has been its Assistant Chief Engineer since 1925. On the technical side, therefore, it is pretty obvious that Mr. Ashbridge is a worthy successor of Captain Eckersley, although listeners will not perhaps hear him so often before the microphone as Captain Eckersley.

### Mr. Adrian Boulton

Another new appointment, which was exclusively forecast in our contemporary, "Popular Wireless," is that of Mr. Adrian Boulton, who will succeed Mr. Percy Pitt as Musical Director of the B.B.C. at the end of the year. Mr. Adrian Boulton became Musical Director of the City Orchestra of Birmingham in 1924, where he has done excellent work for the cause of music in the Midlands.

He is the son of Mr. Cedric Boulton of Liverpool, and was born at Chester in 1889. He was educated at Westminster School, Christchurch College, Oxford, and the Leipzig

(Continued on page 190)

# You can now electrify or partly electrify your present Set!

No alterations to set, valves or wiring—just plug the "EKCO" Adaptor into the nearest electric light or power socket and switch on—that's all! These units are as easy to install as a table lamp and enable you to have always plenty of power for the modern valves with their big consumption. They are cheap in first cost and soon pay for themselves. Ask your dealer or write to us for full particulars.

"Ekco" Products are obtainable on Easy Payments.

# "EKCO"

## Pioneers of All-Electric Radio

E. K. COLE, LTD. (Dept. M.W.), "EKCO" WORKS, LEIGH-ON-SEA.

THESE ALL-POWER UNITS ELIMINATE ALL BATTERIES, ACCUMULATORS AND GRID BIAS

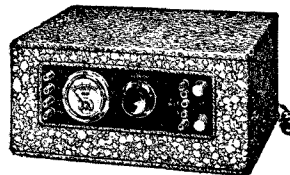

A.C. MODEL C.2.A.

Costs 6/- per 1,000 hours to run. H.T., 3 tappings; S.G., 60, 120/150. L.T., 2-6 v. G.B., 5 tappings up to 13. Price £10 17s. 6d. complete.

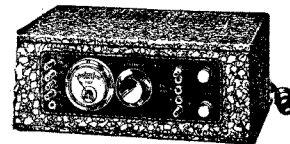

D.C. MODEL C.2.A.

Costs 38/- per 1,000 hours to run. H.T., 3 tappings; S.G., 60, 120/150. L.T., 2-6 v. G.B. tappings up to 12.

Price £5 17s. 6d. complete.

THIS UNIT ELIMINATES THE L.T. ACCUMULATOR A.C., L.T. UNIT, MODEL L.T.1.

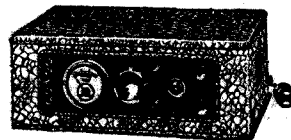

Costs 7/6 per 1,000 hours to run. Provides L.T. for 2-, 4-, and 6-volt valves, from 3 amp. minimum to 1 amp. maximum. Also for use in connection with an A.C., H.T. unit. Price £8 15s. 0d. complete.

\*The above running costs are calculated with electricity at 6d. per unit.

THESE H.T. UNITS ELIMINATE THE H.T. BATTERY

No more dry batteries to crackle as they run down, or to fail in the middle of the programme. An "EKCO" H.T. unit gives you plenty of power always.

D.C. Models, from 17/6 complete.

A.C. Models, from 52/6 complete.

H.T. UNIT, MODEL 1.F.10.

For D.C. mains (as illustrated), 17/6 complete.

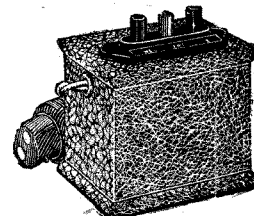

# THE MOST FAMOUS OF ALL LOUD-SPEAKERS CELESTION

*Now obtainable at big price reductions*

MODEL	OLD PRICE	NEW PRICE
C 10 ...	£ 5 10 0 ...	£ 3 15 0
C 12 ...	£ 7 5 0 ...	£ 5 12 6
C 14 ...	£ 13 10 0 ...	£ 11 0 0
C 24 ...	£ 24 0 0 ...	£ 20 0 0

These substantial reductions are made possible only by reason of the greatly improved production facilities, made available in the new and extensive Celestion factory.

*Obtainable from any high-class Radio Dealer*

Write for free Booklet to:  
CELESTION, LTD., Dept. H, KINGSTON-ON-THAMES

**THE VERY SOUL OF MUSIC**

## INVALUABLE TO EVERY AMATEUR & CONSTRUCTOR

### "POPULAR WIRELESS" BLUE PRINTS

of Tested Circuits

The following is a list of the "P.W." 6d. Blue Prints for Constructors in stock, showing the different circuits available.

**P.W. BLUE PRINT Number.**

1. DETECTOR VALVE WITH REACTION.
2. OUT OF PRINT.
3. 1-VALVE L.F. AMPLIFIER.
4. CRYSTAL DETECTOR WITH L.F. AMPLIFIER.
5. H.F. (Tuned Anode) AND CRYSTAL WITH REACTION.
6. H.F. & CRYSTAL (Transformer Coupled, without Reaction).
7. 1-VALVE REFLEX AND CRYSTAL DETECTOR (Tuned Anode).
8. 1-VALVE REFLEX AND CRYSTAL DETECTOR (Employing H.F. Transformer, without Reaction).
9. H.F. AND DETECTOR (Tuned Anode Coupling with Reaction on Anode).
10. H.F. & DETECTOR (Transformer Coupled, with Reaction).
11. OUT OF PRINT.
12. OUT OF PRINT.
13. 2-VALVE REFLEX (Employing Valve Detector).
14. OUT OF PRINT.
15. OUT OF PRINT.
16. H.F. (Tuned Anode), CRYSTAL DETECTOR AND L.F. (With Switch for Last Valve).
17. CRYSTAL DETECTOR WITH TWO L.F. AMPLIFIERS (With Switching).
18. 1-VALVE REFLEX AND CRYSTAL DETECTOR, with 1-VALVE L.F. AMPLIFIER, Controlled by Switch.
19. OUT OF PRINT.
20. OUT OF PRINT.
21. THE 2-VALVE LODGE "N."
22. "THE GUARANTEED REFLEX."
23. THE 1-VALVE "CHITOS."
24. THE "SPANSACE THREE." Three-Valve Receiver employing 1 Neutralised H.F. Valve, Detector with Non-radiating Reaction Control and 1 L.F. Valve.

**P.W. BLUE PRINT Number.**

25. OUT OF PRINT.
26. A "STRAIGHT" 4-VALVER (H.F., Det. and 2 L.F. with Switching).
27. OUT OF PRINT.
28. A "MODERN WIRELESS" 5-VALVER (H.F., Det. and 3 L.F.).
29. AN H.T. UNIT FOR DIRECT CURRENT MAINS.
30. A REINARTZ ONE-VALVER.
31. OUT OF PRINT.
32. THE "CUBE SCREEN" THREE (H.F., Det. and L.F.).
33. A "KNIFE EDGE" CRYSTAL SET.
34. AN H.F. AND DETECTOR TWO-VALVER.
35. THE "UNIVERSAL THREE" (Det. and 2 L.F. stages resistance-coupled).
36. THE "SPANSACE FOUR" (H.F., Det. and 2 L.F.).
37. THE "LONG SHORT" CRYSTAL SET.
38. A TWO-VALVE L.F. AMPLIFIER.
39. THE "SYDNEY" TWO.
40. THE "SUPER SCREEN" THREE.
41. THIS YEAR'S "CHITOS" ONE-VALVER.
42. THE "Q AND A" THREE. A simple set (Det. and 2 L.F.).
43. THE "INEXPENSIVE FOUR."
44. THE "ECONOMY FIVE." For long-range loud-speaker work.
45. A SIMPLE A.C. H.T. UNIT.
46. THE "REGIONAL" THREE.
47. THE "WAVE-CHANGE" ONE.
48. THE "REGIONAL" CRYSTAL SET.
49. OUT OF PRINT.
50. THE "ANY MAINS" TWO.
51. OUT OF PRINT.
52. THE "BANDMASTER."

**ALL "POPULAR WIRELESS" BLUE PRINTS 6d. EACH**

All orders for these Blue Prints should be sent direct to the "Popular Wireless" Queries Department, Fleetway House, Farringdon Street, London, E.C.4, enclosing a stamped addressed envelope and a postal order for 6d. for each Blue Print ordered.



For the first time in the history of this "feature" I am going to write seriously about love. You know what I mean. What they call "lurve" on the stage and what my baker calls "loaf," though he intends no joke. He will say to his wife, "Kiff me der haff-pawnd vate, my loaf." I think he is a Cherman

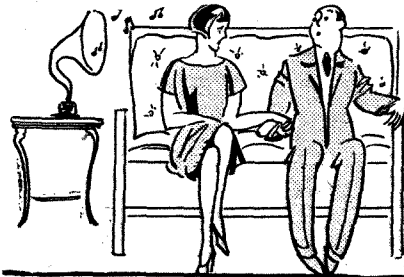

.... "hold her little finger" ....

spy. He certainly is a liar, for he tells me that he was once vort seexty soz-zand pawnds and lost them at cards. Vell, it is not everybody that loafs cards so much as all that. Hein?

Love—so far—has not had a square deal from radio. I know a man who made a note somewhere to propose to his young woman at nine-fifteen the next night. During the next day he kept coming all over queer, just as though something was on his mind.

**Matrimony and Grid Bias**

He looked all over his blotter. No note! He looked at all the old envelopes in his pocket; examined his shirt-cuffs and the walls; he even looked in his diary and the family Bible. Blessed if he could remember what he wanted to find! So he gave it up and went home to fish for Nairobi. At eleven-fifteen he opened his log in order to jot down the readings of a queer station which required closer investigation on another

occasion. The last entry ran: "Modulation rotten and frequency all over shop. Better put it to Min to-morrow after testing with G 3 F F or say 9.0 B.S.T." As it happened, Min got tired of waiting, went out and met a gas-fitter who gassed and gassed and finally fitted her with a ring.

It is notorious that radio has come between husband and wife much more seriously than divorce. In fact, being married to a genuine "fan" is like being linked with a gentleman in Colney Hatch. There is no legal remedy—as yet. I am told that a man in Oxted has not spoken to his wife for five years, except once about valves—and that was an oversight for which he apologised. When remonstrated with, he replied: "I used to ask her about grid bias, but she wouldn't answer. Is that the way to treat a man?"

**Courting Under Difficulties**

A cousin of mine, courting, was cursed with a prospective pa-in-law who insisted on extending the loud speaker to the drawing-room. If they switched it off, the old fool kept butting in to see what was wrong; and if they kept it on, they couldn't hear any one coming, so that all he could do was to hold her little finger and listen to Walford Davies, etc. He got so sick of her finger that he began to think. And thinking is fatal to "loaf." In the process of thought he realised how like her mamma she was growing—and that she had papa's chin. So he got himself sent to New Caledonia, or somewhere like it, for six years. She gave her little finger to a man who played the triangle at the P.S.A.

When I consider what ruin outside aerials have wrought upon the bliss of domestic hearths I am tempted to

agitate for their prohibition. We trample her favourite flower-beds. We blot out the light of heaven with a wire. We rear a mast, maybe, like a cheap-looking clothes-line prop. Yes, and we are told that Mr. Jones next door manages to have his wireless without making the garden into a pigsty. She omits to say that Mr. Jones' wireless sounds like an ass braying into a well, or that Mrs. Jones urges him to bury his set and buy a cockatoo, "because you can understand what they say sometimes." And as for accumulators and carpets, the two are natural enemies. It's just nature, and we can't alter that. Better get a nice plain lino!

Now, to sound a pleasanter note, gather round and listen to the true story of Bob Green, his fair lady, Gert White, and how wireless worked in their favour against the heavy parent who looked with disfavour upon their loves.

**In Pa's Black Books**

Whenever Pa White saw Bob he got a pain in the neck. They were not at all suited to each other. Something about Bob's ears, perchance, or maybe his trousers! The very first day that they met Bob struck sparks off Pa White by praising the old chap's marigolds. Now, when you consider that those marigolds were the bane of the White family, and that Pa had spent years of his life in trying to blot them out (the more he blotted the better they spread), you understand that Bob's congratulations fell with a dull sort of thud upon Pa's mind.

He thought that Bob's sense of humour was warped—like Ma White's—and that sent Bob down to the bottom of the class in one jump. Pa didn't relish the idea of having him dropping in on Sundays to crack jokes of that calibre.

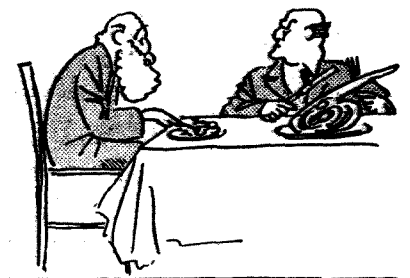

"A kind of feeder Pa hated."

Besides, Bob's father was a vegetarian, a type of feeder which Pa White hated. Pa's eldest daughter had married a veg-fiend, and whenever they came to supper on Sunday this fellow used to bring his own nuts and celery. It put Pa clean off his cold

## A Peculiar Succession of Failures

beef to hear the champing and snuffing that went on over a few nuts.

And so the union of Green (Bob) with White (Gert) did not appear to be a foregone conclusion. These twain (American film caption!) were forced to meet under the clock anywhere, rather than in a well-found sitting-room complete with stuffed birds and "Presents from Margate." As Pa had as good as said that Bob was death to his eyesight, Bob had as much chance of wooing the old man as a terrier has of convincing a hippo. However, the job had to be done, and the two spent all their working hours, and much of their own time, in cogitating the problem.

Then Bob tried lending books to Pa. He did not know that the only writer Pa could stomach was Mrs. Henry Wood; consequently Edgar Wallace's books were hurled about the room and finally kicked under the mangle. They tried the old fellow with gifts of pipes and tobacco—which was asking for trouble. Trouble promptly came their way.

### His Business Boss

Don't run away with the idea that Bob did not mean to wed his Gert in spite of Pa. He was bent on his fate and steered towards it as the sparks fly upwards. (Poetic touch!) Bob's trouble was that Pa, White was his business boss. A ghastly situation, what?

Pa had a radio set. Bob was a "fan." Pa was decidedly *not* a "fan," but his set was almost as good as if he were. No hope there. Pa never would take advice; he could at all times be relied on to



The Great Idea came:

resent it. And as to letting Bob show him how a few little alterations would turn the set into something akin to the famous "Greased Lightning" Four—why, the idea was fantastic. Meanwhile, at the office,

Bob had to endure Pa's balderdash boasting to the "travellers" about that goldanged, dodbrasted, tin-plated, meccano radio set which was fit only for fools, fathers-in-law and futile fatheads.

Then came winter, and meeting under the clock was a chilly business, though the wintry solitude of the quieter streets was not without its advantages to Bob Romeo and Gert Juliet.

Nevertheless they saw that without the old man all this hand-squeezing play got them nowhere.

### The Great Idea

Gert was inclined to be tearful at parting, and then Bob would say something equivalent to "Love will find a way," and go home to listen moodily to 2 X A D. Gert went home and stood powdering her nose with violent dabs, as Pa White said:

"Ha! Out with that young Green, I'll be bound?"

"Well, and what of it?" (*Tears. Exit.*)

That night (favourite film caption), as Bob fiddled amongst his batteries, the Great Idea came with a wallop. Its beauty, its simplicity, its eminent feasibility, staggered him.

A week later Pa White's radio set was struck dumb. Pa was prepared to say on oath that at eight-fifteen p.m. it was as right as rain. At nine-five, after supper, not a blessed croak! The set had not been touched, etc., etc. Too bad!

On the following day the local wireless wizard was called in. Result! Nothing whatever wrong with the set. Working beautifully. Half-a-crown. Thank you. Pa was blowed, he said.

On the next night the set behaved, till after supper. The rest was silence. Pa tore his hair and ordered in the dealer again. Result? Set quite O.K. One shilling. *Merci*. Pa was again blowed, but much more blowed than before.

### Pa Pulverised

Followed three nights and days of perfect harmony, broken only by chamber music. Then the after-supper silence fell upon the loud speaker. Once again the dealer called and demonstrated that the set functioned as requisite, a fact which Pa could not deny. One shilling, Ta! Pa was not only fully blowed,

but busted, as he in his coarse way expressed it.

Two nights later a great hush fell upon the White radio equipment. Pa said a wicked word, repeated with variations, and went out to the Liberal Club. He was through.

Next night Bob came in and put the set right. Ma beamed and said he had his mother's eyes. Later, after Bob had gone, Pa drifted home and heard the news. He didn't like it.

"But father," said Gert, "Robert really *is* clever at this radio and he

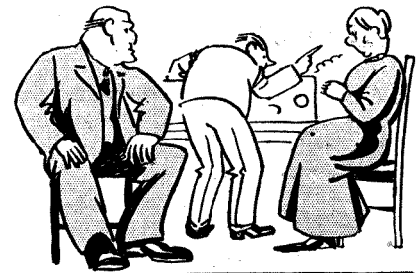

... Bob came in and put the set right.

says that with a few more opportunities for investigation he can put the thing right for keeps."

"I sh'd say so," replied Pa. "Let him try."

"Oh, thank you, darling," cried Gert, and she stole out to 'phone Bert.



The following evening the set was as dead as John Brown, and Bert was solemnly ushered in, amidst considerable tension. Gert discreetly disappeared.

### The Lovers' Secret

"Ah," said Bert, after certain motions, "I see that your plumber has overlooked the fact that the potential of the Kathode varies as the differential of the magnification value. You can't expect artisans to understand that. Now—ah—that, I think, solves the mystery." He footled with a few terminals and switched on. All O.K.

Suffice it to say (see "Instructions to Novelists") that thereafter the set gave no more trouble and Bob came into the White *ménage*—on the ground floor.

A little monkeying with the aerial wire where it connects with the lead-in is sufficient to blot out any programme. If you put it right—say at about midnight—the set will work quite properly next day. This simple truth paved the way for Bob and Gert, and when last I heard the twins were doing jolly fine.

**RADIO NOTES AND NEWS OF THE MONTH**

—continued from page 186

Conservatorium. He was on the musical staff of the Royal Opera in 1914, and afterwards conducted the British Symphony Orchestra. In 1919 he joined the teaching staff of the Royal College of Music.

**North's New Regional**

Although no definite information has yet been obtained regarding the site for the Northern Regional broadcasting station, a good deal of speculation is rife as to whether the B.B.C. will choose Pole Moor, Slaithwaite, near Huddersfield. This district has recently been carefully examined by the B.B.C., and the Clerk of the Urban District Council has met the B.B.C. and Post Office engineers regarding a proposed underground cable which would serve the suggested station if the site were fixed upon.

**Highly Satisfactory**

Pole Moor is in a very elevated position, and we understand that experimental transmissions which have been carried out by the B.B.C.'s

mobile van have proved satisfactory. As a plentiful supply of water is essential, it is interesting to note that on Pole Moor there exists a 12-in. water main, which would come in extremely useful if the station were built there.

**Marconi Royalties**

As our readers know, Mr. Justice Luxmoore recently allowed two appeals by the Marconi Wireless Telegraph Co. from decisions of the Comptroller-General of the Patent Office.

The first case was in respect of certain patents relating to the construction of valve sets. The Marconi Company were unable to grant the application of the Brownie Wireless Co. for a licence on the terms suggested, and consequently the Brownie Company later petitioned the Comptroller-General of the Patent Office, who made an order that a compulsory licence should be granted on the payment of stated royalties.

**The Decision**

The Marconi Company appealed, with the result that the Judge held that there was nothing in the evidence or the circumstances which showed that it was in the public interests that the Brownie Company should be granted this compulsory licence.

The Judge pointed out that that alone was enough to decide the case, and he also found that the Marconi Company had not acted unreasonably in the conditions sought to be imposed, and that the trade of the Brownie Company was not prejudiced by the Marconi Company's refusal to grant a licence on the terms requested by the Brownie Company.

**The Loewe Appeal**

There was also a second case, in which the Comptroller-General of the Patent Office had ordered that the Marconi Company should grant the Loewe Radio Co., Ltd., a licence to make in this country triple and double valves for wireless sets, on the payment of stated royalties.

The Comptroller-General considered that the royalties asked by the Marconi Company were too high, but Justice Luxmoore decided that there had not been a definite refusal by the Marconi Company to grant a licence, and that the time had not arrived for the Loewe Company to be in a position to apply for a compulsory licence on the ground that the licence offered was unreasonable, because its terms had never been discussed.

(Continued on page 192.)

A NEW

**KIPLING**

STORY

appears in the

Enlarged Holiday Number of The

**LONDON**

MAGAZINE

Buy a Copy To-day

1/-



SAY 'T.C.C.'

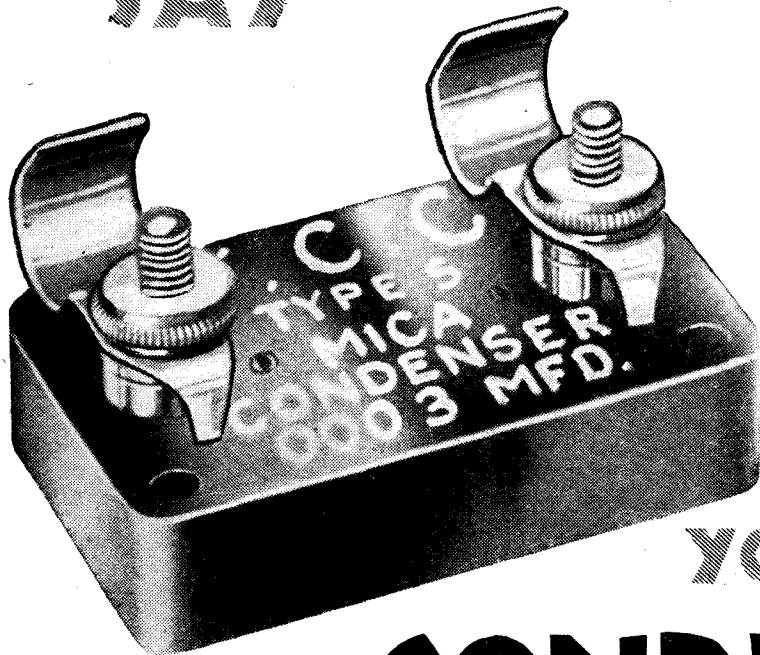

WHENEVER

WHEN you think of Condensers, think of T.C.C. — and you won't go wrong. For, because T.C.C. have made nothing but Condensers for over 22 years, the letters T.C.C. on a Condenser are recognised throughout the World as the undisputed hall-mark of accuracy and dependability.

Remember, there is a T.C.C. Condenser for every purpose. Here is an enlarged illustration of the Flat Mica Type. All Wireless Dealers stock it—in capacities from .0001 mfd., 1/10 to .01 mfd., 3/6.

YOU WANT

CONDENSERS!

Adv. Telegraph Condenser Co., Ltd.,  
Wales Farm Rd., N. Acton, London, W.3.

9551

THE 100% Broadcast Receiver  
BUILD and OPERATE in ONE EVENING

FORMO Screened Grid



BRITISH Components Throughout  
Send for Catalogue.

FAMOUS FORMO COMPONENTS as used in this Set and in ALL NOTABLE PUBLISHED CIRCUITS

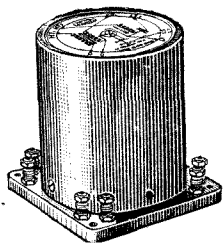

TRANSFORMER-OUTPUT FILTER CHOKE 25/-

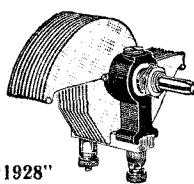

"1928" LOG CONDENSER 5/-  
'0005 '00085 '00925

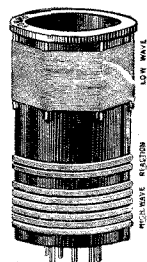

COILS SG 1 & 2. 10/6 each



FORMO-DENSOR 2/-  
In four variable capacities

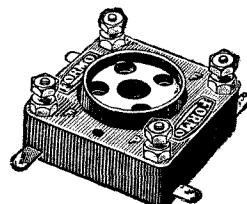

VALVE-HOLDER 1/3

THE FORMO CO., CROWN WORKS, CRICKLEWOOD LANE, LONDON, N.W.2.

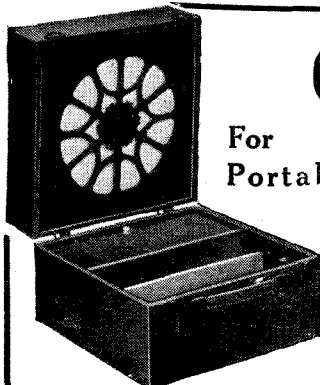

For Portable, Transportable and Cabinets of every description

As specified for "M.W." Portable 5. New "Roadside" Four. "Talisman" Portable.

Send for Catalogue to—  
The Carrington Manufact'g Co., Ltd.,  
Camco Works,  
Sanderstead Road, South Croydon.  
Telephone: Croydon 0623.

"RIVERSIDE" MODEL IN GOOD QUALITY LEATHERETTE, Price 45/-



FOR BEST RESULTS  
GOLTONE  
"TITAN"  
COIL UNIT

Approved by POPULAR WIRELESS.

A super-efficient and High-grade Unit for "TITAN" Circuits.  
List No. T.C./15. EACH 15/-  
From all first-class Radio Stores. Refuse Substitutes. If any difficulty write direct.  
Interesting Radio Catalogue FREE on request.

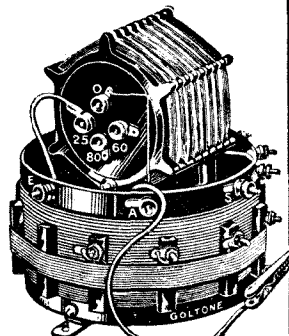

London Depot: 5 & 6, Eden St. Hampstead Rd., N.W.1.  
Phone: Museum 4032/3.



**RADIO NOTES AND NEWS OF THE MONTH**  
 —continued from page 190

**Effect on Trade**

As a result of this appeal, it seemed possible that the old royalties of 12s. 6d. per valve might be re-imposed, and consequently complete receiving sets, including portable sets, would be more expensive than has hitherto been the case.

Various meetings have been held among trade representatives lately, but at the moment of going to press there is no definite news as to whether the Marconi Company intend to claim, as they are entitled to do, the difference in royalties since the Comptroller-General ordered them to be reduced. The Marconi Company is, of course, legally entitled to claim this difference between the 12s. 6d. royalty originally in force and the new royalty, but the R.M.A. is at present negotiating for some sort of compromise.

**Radio Rogues**

It was reported in the "Daily Telegraph" recently that, by the adaptation of wireless to an old trick, a

gang of swindlers in Berlin have been defrauding German bookmakers of sums between £5,000 and £10,000. It is reported from Berlin that they had at their disposal a secret wireless station, by means of which they received French racing results before they were generally available elsewhere.

One of the gang was always at the receiver and, when he received the result, telephoned another member of

**NEXT MONTH**  
 There will be a constructional article in "M.W." describing a simple device of particular interest to people with D.C. mains.  
**ORDER YOUR COPY NOW!**

the gang. The latter then wrote the winning numbers conspicuously on a newspaper and, with this in his hand, walked past the open door of the bookmaker's office. A third confederate, who was waiting, would then make the bet.

It appears that this fraud might have gone on for a long time had not members of the gang started to swindle each other. Which seems to contradict the old saying that "there's honour among thieves."

**New Wave-Lengths**

The new Prague Wave-Length Plan which recently came into force doesn't seem to have caused much difficulty so far. General reports indicate that conditions with long hours of daylight are favourable, but what it will be like, of course, when winter sets in is another matter.

The B.B.C. reports only one case of interference with 5 G B; the offender was, of course, Langenberg, which is separated by only 9 kilocycles. The inconvenience at first was not very serious, but it led to readjustments.

**Small Alterations**

A last-minute change was in 5 G B's wave-length, as it was discovered that London listeners were going to experience considerable difficulty in getting 5 G B, owing to the wave-length being too close to that of London. Manchester is to work on 377 metres.

**A Trade Mark**

We are informed by Boynton & Co., Ltd., that the word "Hercules" in connection with wireless sets, etc., is their registered trade mark, and they have already marketed and advertised sets under this name. (Their address is 73, Stafford Street, Birmingham.)

**MAGNUM "TRANSPORTABLE" FIVE**

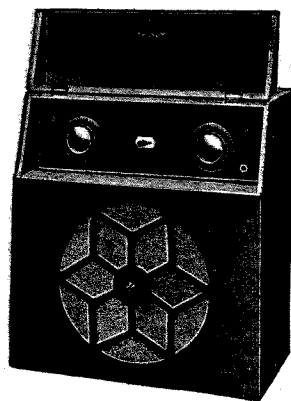

MAGNUM PORTABLE Receivers are high-grade instruments of amazing efficiency. Two types are available; The "Transportable" Five, as illustrated, and also The "Suitcase" Five.  
 Price of either model, complete and ready for use, including Royalties ... **18 Guineas.**

**Build the "FORTE" FIVE**  
 as described in this issue.  
 Kit of parts as specified, including Cabinet,  
**£11 : 15 : 0**  
 or Ready wired and tested, including Royalty,  
**£14 : 14 : 0**

Catalogue and comprehensive lists free on application.

**BURNE-JONES & CO., LTD.**  
 Magnum House, 296, Borough High Street, London, S.E.1.

The Trade Mark on our components is your guarantee. All our components are the outcome of careful design, skilled labour and British made throughout. With this guarantee you are safe in using

**WEARITE COMPONENTS**

**"SUMMERTIME" FIVE**  
 LOW-WAVE COILS (3 to set) .. .. . Each **13/9**  
 HIGH-WAVE COILS (3 to set), Litz Wire .. .. . **18/9**  
 BASES .. .. . Per Set of 3 **3/9**

**FIVE-VALVE PORTABLE**  
 BATTERY SWITCH, G22, with terminals.. .. . **1/-**  
 H.F. CHOKE .. .. . **6/6**

**"AUTO-TUNE" ONE**  
 "TITAN" COIL .. .. . **15/-**  
 WAVE-CHANGE SWITCH .. .. . **1/6**

**DUAL-RANGE TUNER as USED IN FERRANTI CIRCUITS**  
 LOW-RANGE, 190-500 metres } .. .. . **15/-**  
 HIGH-RANGE, 950-1900 " .. .. .

WRITE FOR LISTS.

**WRIGHT & WEAIRE, LTD.,**  
 740, HIGH ROAD, TOTTENHAM, N.17.  
 Telephone: TOTTENHAM 3847-3848.

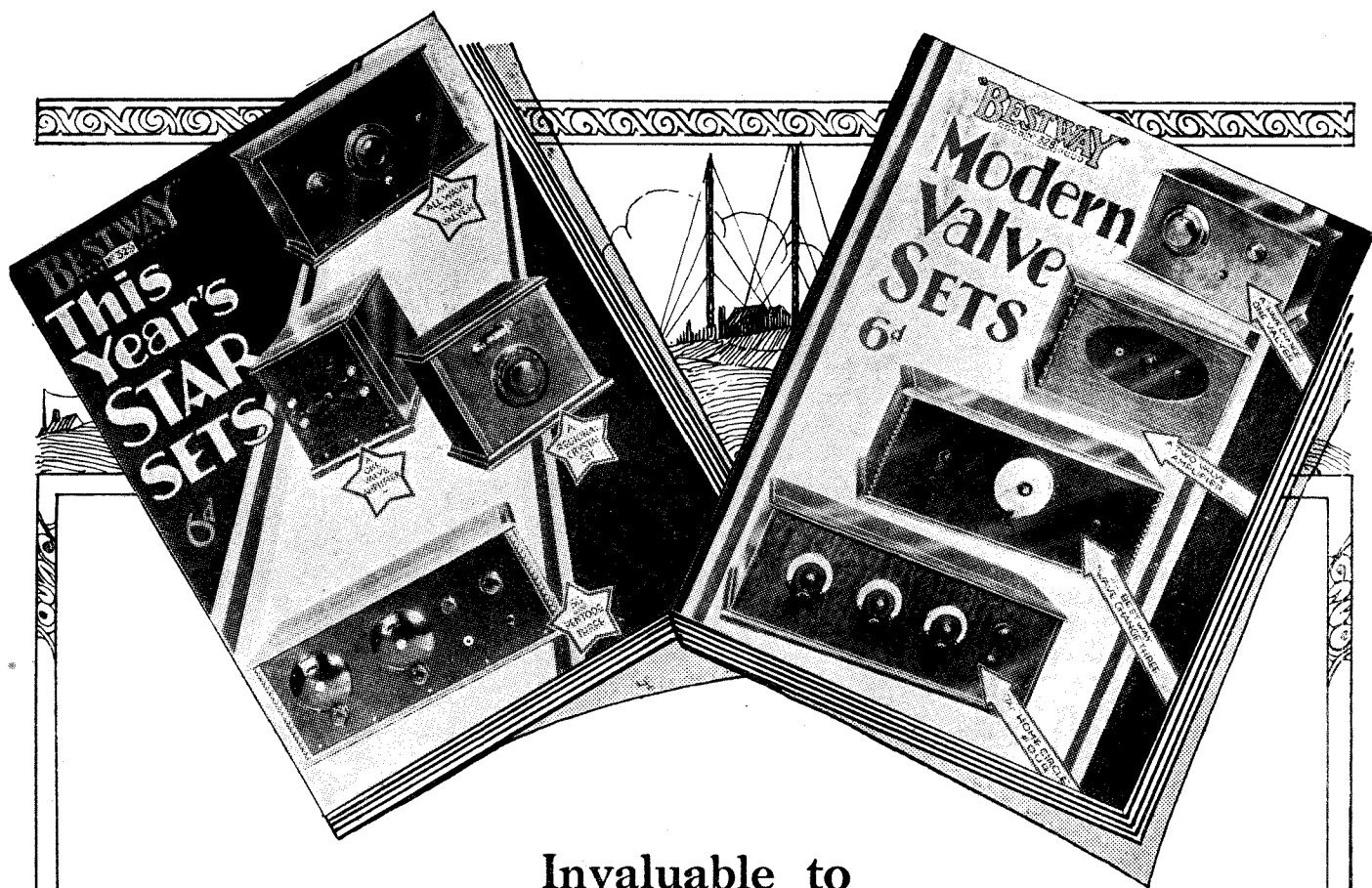

Invaluable to  
**THE HOME CONSTRUCTOR**

Two New  
**"BEST WAY" WIRELESS BOOKS**

**"Best Way" No. 328.—Modern Valve Sets.** Contains full constructional details of four receivers. A "WAVE-CHANGE ONE-VALVER" to cover long and short waves by the operation of a switch, a "TWO-VALVE AMPLIFIER," the "'BEST WAY' WAVE-CHANGE THREE," and "THE HOME CIRCLE FOUR," a set specially designed for family use.

**"Best Way" No. 329.—This Year's Star Sets.** Tells you how to build another four specially-designed receivers. "AN ALL-WAVE TWO-VALVER" which covers all wave-lengths from 2,000 to 20 metres, "A ONE-VALVE AMPLIFIER," "A REGIONAL CRYSTAL SET," and the "S.G. AND PENTODE THREE"—a receiver of the most up-to-date type, capable of remarkable results.

**EVERY SET MINUTELY DESCRIBED**

*On Sale Everywhere.*

*PRICE 6d. EACH.*

# SOME ACCUMULATOR PROBLEMS

By H. REES.

"How long will my accumulator charge last?" "How can I get it to last a month?"

These are questions that I am often asked, and although numerous articles have already appeared on the subject, it seems that no apology is required for writing another.

The second of the above questions can best be answered through the first. What is really meant by the second question is, of course, "What capacity accumulator do I require in order that the charge may last a month?"

Now the time a charge will last depends upon (1) the capacity of the accumulator, and (2) the discharge rate.

Perhaps the *condition* of the battery should be added to these, but as this is an indefinite factor, it can only be assumed that the full-rated capacity is given out.

## The Capacity

The capacity is given by the product: amperes by hours, when the cell is discharged at a continuous rate. For example, if a cell can deliver a steady current of 3 amperes for 20 hours, its capacity is 3 by 20 = 60 amp.-hrs.

This capacity is constant for a given accumulator, whilst the discharge current may have any value up to the maximum permissible discharge rate specified by the makers. This is usually stated on all cells of reputable make, and is sometimes called the "normal discharge rate."

In the above 60-amp.-hr. cell, for instance, if the maximum current required is only 1.5 amp., then since the capacity is constant:

60 amp. hrs. = 1.5 amp. by time in hrs.

$\therefore \text{time} = \frac{60}{1.5} = 40 \text{ hrs.}$ —i.e. the time the charge will last is doubled.

Similarly, if the discharge rate is only 0.5 amp., the charge will last  $\frac{60}{0.5} = 120 \text{ hrs.}$ , and so on.

As just stated, however, there is a maximum discharge rate for every accumulator which must never be

exceeded if the battery is to be kept in good condition. Thus it would not be permissible to discharge the above cell at 6 amps. in 10 hours, for the maximum discharge rate is only about 4 amps.

## Charging Rates

All this, of course, applies also to the *charging* of accumulators. Here again there is a maximum charging rate, which must not be exceeded. If the maximum charging rate of the 60-amp.-hr. accumulator is 5 amperes, it would be fully charged in about  $\frac{60}{5} = 12 \text{ hours.}$

But if the charging current is only 3 amperes the time required to charge it is  $\frac{60}{3} = 20 \text{ hours,}$  etc. Again, it should not be charged at a rate of 6 amperes in 10 hours.

It will be observed that nothing has been said about the *voltage* of the accumulator. This is because there is no relation between voltage and ampere-hr. capacity. A 60-amp.-hr. cell may be 2, 4 or 6 volts, or even more. The voltage is obtained by connecting the cells in *series* and this makes no difference whatsoever to the capacity.

The capacity is, however, increased when the cells are connected in *parallel*, but then the voltage remains equal to that of one cell. Thus if our 60-amp.-hr. accumulator is made up of 3 cells in series, giving a total voltage of 6, the capacity would be increased to 60 by 3 = 180 amp.-hrs. with the cells in parallel; but the voltage would be reduced to 2.

## Cells in Parallel

This suggests a useful method of lengthening the life of a charge. If a given receiver is fitted with 4-volt valves, and a 30-amp.-hr., 4-volt accumulator, the charge lasting say a fortnight, the capacity would be increased to 60 amp.-hrs. by connecting the cells in parallel, and the charge would now last a month.

But this would, of course, mean substituting 2-volt valves, and whether or not this would be justifiable depends on the cost of charging,

distance of charging depot, etc. It should be noted, however, that when the cell is to be charged, the series connection should be restored, otherwise the time and cost of the charge would be doubled.

## The H.T. Accumulator

It should be clear also that there is nothing to be gained by connecting H.T. accumulators in parallel, because in most ordinary receivers the primary consideration here is *voltage* and not *current*. In fact, the practice of doing so is to be deprecated, because the voltage of the cells may differ, and although this difference may be quite small, the internal resistance of the cells is also small, so that, in proportion to their capacity, comparatively heavy discharge currents may circulate through the cells themselves.

Otherwise, all that has been said above applies equally to H.T. accumulators, except that the current and capacity are now measured in milliamps. and milliamp.-hours respectively.

A few practical examples will now make the foregoing clearer.

1. The first three valves of a four-valve receiver take a filament current of 0.1 ampere each, and the fourth 0.25 ampere. Assuming the set to be used on an average four hours a day, how long would a 60-amp.-hr. charge last?

$$\begin{aligned} \text{Total filament current} &= 3 \times 0.1 + 0.25 \\ &= 0.55 \text{ amp.} \end{aligned}$$

$$\begin{aligned} \text{Since } 60 &= \text{amps.} \times \text{hrs.} \\ &= 0.55 \times \text{hrs.} \end{aligned}$$

$$\therefore \text{Hrs.} = \frac{60}{0.55} = 109 \text{ hrs.}$$

As the set is in use about four hours each day, the cell would require charging about every  $\frac{109}{4} = 27 \text{ days.}$

## Further Practical Examples

2. The filaments of a three-valve receiver take 0.15 ampere each. Set used on an average five hours each day. What should be the capacity of an accumulator in order that the charge may last a month?

Assuming 30 days in a month:

$$\begin{aligned} \text{Total time set is in use per month} &= 30 \times 5 = 150 \text{ hrs.} \end{aligned}$$

$$\begin{aligned} \text{Total filament current} &= 0.15 \times 3 \\ &= 0.45 \text{ amp.} \\ \therefore \text{Amp.-hr. capacity} &= 150 \times 0.45 \\ &= 67.5 \text{ amp.-hrs.} \end{aligned}$$

The nearest stock size would be 70 amp.-hrs.

3. A three-valve receiver is fitted with valves taking a filament current

(Continued on page 195.)

**SOME ACCUMULATOR PROBLEMS**  
—continued from page 194

of .35 ampere each (the older type dull-emitter). Accumulator 50 amp.-hrs. Set used on average four hours a day. Compare time charge will last with what it would be if modern dull-emitters, taking .1 ampere each, were substituted for the above.

(a) Old valves.

$$\text{Total filament current} = .35 \times 3 = 1.05 \text{ amp.}$$

$$\therefore \text{Charge lasts } \frac{50}{1.05} = 48 \text{ hrs. approx.}$$

$$\text{i.e. } \frac{48}{4} = 12 \text{ days.}$$

(b) New valves.

$$\text{Total filament current} = .1 \times 3 = .3$$

$$\therefore \text{Charge lasts } \frac{50}{.3} = 167 \text{ hrs. approx.}$$

$$\text{i.e. } \frac{167}{4} = 42 \text{ days}$$

$$\text{Ratio} = \frac{42}{12} = 3.5.$$

It will be observed that this ratio could easily have been obtained more directly by comparing the filament currents; thus it equals

$$\frac{.35}{.1} = 3.5$$

**H.T. Current**

4. If the total anode current of a set is 12 milliamps., what should be the capacity of an H.T. accumulator in order that the charge may last three months? Set used five hours a day.

$$\text{Total current} = 12 \text{ milliamps.}$$

$$\text{Assuming again 30 days per month : Total hours set is in use} = 5 \times 30 \times 3 = 450$$

$$\therefore \text{Capacity} = 450 \times 12 = 5,400 \text{ milliamp.-hrs.}$$

Nearest stocked size is about 5,000 milliamp.-hrs.

As previously stated, attention should always be given to the normal discharge rate as well as the capacity. Generally speaking, a battery of the above capacity will safely take a discharge rate of 12 milliamps.

In working these problems the filament current can be measured by putting an ammeter in one of the two L.T. leads, and the anode current by a milliammeter in — H.T. If the time the receiver is in use is carefully computed, any considerable discrepancy between the calculated and practical results indicates a lowering in the efficiency of the battery.

**THE MEETING PLACE OF ALL THE EXPERTS OF THE WORLD**

IS THE

**GREAT GERMAN WIRELESS EXHIBITION**

30th August - 8th Sept., 1929

Extended space—  
enlarged contents

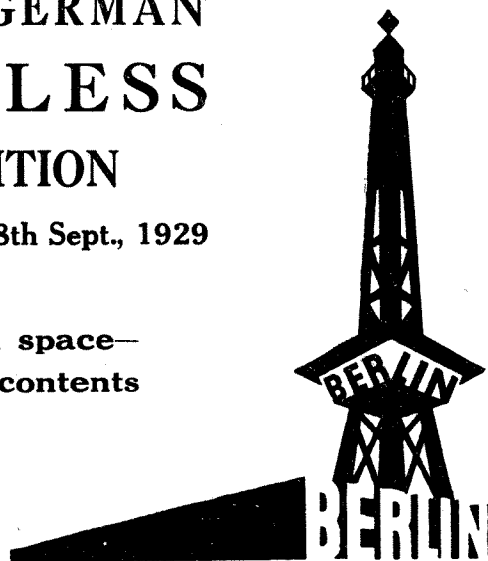

INFORMATION AND PRINTED MATTER TO BE OBTAINED FROM THE "AUSSTELLUNGS-, MESSE- UND FREMDENVERKEHRSAMT DER STADT BERLIN," KÖNIGIN-ELISABETH-STRASSE 22, BERLIN-CHARLOTTENBURG, GERMANY.

**TITAN COIL UNIT**  
**15/-**  
**"FORTE" FIVE**

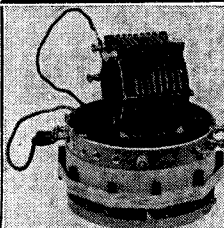

Standard Screen, 10" x 6" (as specified)  
Aluminium ... .. 2/-  
Copper ... .. 4/-  
H. F. Chokes, each, 3/6

**E. PAROUSSI,** 10, Featherstone Bldgs. High Holborn, W.C.1. Phone. Chancery 7010.

ALL APPLICATIONS for ADVERTISING SPACE in "MODERN WIRELESS" must be made to the Sole Advertising Agents, **JOHN H. LILE, LTD.,** 4, LUDGATE CIRCUS, LONDON, E.C.4.

**CLIX HOOK TERMINAL**



This new Clix product is just the thing for certain and quick make-and-break connections to terminals. The hook design prevents this connector shooting away when screwing down or loosening terminal. It incorporates, of course, the Clix patented method of wiring which ensures a strong grip, a perfect connection and no exposed wires. Lead-coated or Nickel-plated.

Write for the Clix Catalogue containing details of 25 aids to perfect contact.

**LECTRO LINX, LTD.,** 254, Vauxhall Bridge Road, London, - - - S.W.1. **2<sup>D</sup>.** EACH.

The Picture Paper with the MOST News  
**:: SUNDAY GRAPHIC ::**



# Ready Radio

## SELECTIVITY UNIT (PATENT PENDING)

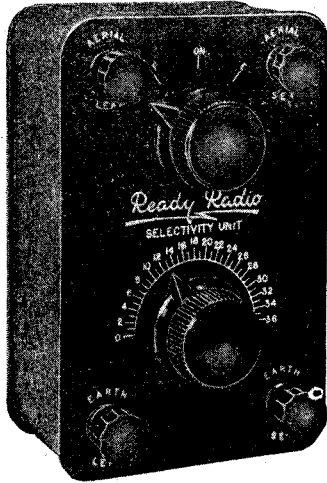

**PRICE 20/-**

### HERE ARE TEN GOOD REASONS WHY YOU SHOULD GET IT!

- R**esearch carried out by experts for many months has resulted in the evolution of an entirely new principle which makes this unit three times as effective as an ordinary wave-trap.
- E**xtra purity of reproduction is assured because all interference and background noise is cut out. "Listening" is given a new meaning.
- A**s long as it is in use reception of more than one station at a time—a fault that is common with unselective receivers—becomes impossible.
- D**oubles the range of nearly every set because stations which were previously blotted out by interference become audible as soon as the unit is added.
- Y**ou can attach this unit without any alteration to your existing receiver and enjoy at once all the advantages it gives.
- R**equires no extra batteries or valves; there is nothing that needs replacement. The construction is robust and there are no loose parts to get broken.
- A**n ideal unit for improving the selectivity of any ordinary set, no matter how many valves are employed, including portables with aerial and aerial and earth terminals.
- D**oes all that is claimed without adding complications. Like most useful inventions, simplicity is one of its outstanding features.
- I**t does not derange the tuning of the receiver, a serious drawback common to other devices that have endeavoured to overcome the selectivity problem.
- O**wing to its small dimensions—4½ inches long, 3 inches wide and 1½ inches high—it can be added to any set without detracting from its appearance.

**THE UNIT EMPLOYS A NEW PRINCIPLE, WHICH INCORPORATES A VARIABLE CAPACITY BETWEEN ASTATIC COILS, TOGETHER WITH AN ALTERNATIVE H.F. BY-PASS**

**READY RADIO  
159, BOROUGH HIGH ST.,  
LONDON BRIDGE, S.E.1.**

Phone: HOP 5555.

## GOOD SOLDERING

**W**HEN you are soldering very thin wire you should be careful not to apply too much heat, as otherwise the wire may be burnt through. On the other hand, insufficient heat is often the cause of bad soldered joints. Do not forget that both the pieces of metal you are soldering together must be raised to the temperature necessary to complete the operation.

If the one piece is fairly substantial it will take some time for it to acquire the necessary heat. You will have to hold the iron in position steadily for some few seconds. To do this job properly you want a nice hot iron, large enough to retain its heat for a few minutes.

A gas fire is better for heating soldering irons than a coal fire, because it is cleaner. One of the rings on a household gas stove is a very convenient thing for heating soldering irons. But watch the iron carefully, as otherwise it will be raised up to a red heat. This will cause the surface of the bit to become oxidised and this will militate against its proper tinning.

A good indication for correct heat is to watch for a blue flicker in the flame over the bit. When this appears, remove the iron, wipe the end quickly with a thick wad of rag and then "tin" it in the usual way. At this point I always give the bit a quick rub with a file and this spreads the tinning excellently. At the same time it no doubt removes a bit of the copper, but not enough to cause real wastage. I have been doing this with one favourite iron for years and it is still of a respectable size!

G. D.

## FOR YOUR NOTEBOOK

One advantage of square wire for set-building is that it offers a larger surface for screw-down connections.

When a set has to be used in a rather dark corner it is not a bad plan to arrange a flashlamp bulb near the tuning dial, with a simple switch which puts it on when required.

Speaking generally, wave-traps are more efficient on the lower waves than on the long-wave band, and

consequently 5 X X interference is more difficult to cut out than the short-wave "local."

If you are arranging for dance music do not forget that a room full of people takes a lot more volume to fill than the corresponding empty room.

When connecting up voltmeters, ammeters, etc., remember that they are marked for polarity and should always be connected the right way round.

As an H. T. battery tends to recover a little when not in use, voltage tests should be made after it has been working a little while, or the reading may be misleading.

If you are building a set embodying two low-frequency transformers remember that these should be of different types, as all sorts of troubles are liable to arise if the same type of L.F. transformer is used in both cases.

A reduction of the filament voltage on the detector valve of a short-wave set will often help to cure threshold howl.

## THE "MAGNETIC" TWO

—continued from page 127

If you wish to increase the selectivity, use the aerial terminal A<sub>1</sub>, which brings the small .0002-mfd. condenser into circuit, or alternatively use a smaller aerial coil. With the average small L.F. valve working on 100 volts you will require about three to four and a half volts negative grid bias, and if you are using a small power valve you can increase this grid bias to 7½ or 9 volts. Your grid battery, incidentally, can be mounted on the inside of the cabinet or placed along the edge of the baseboard. A 9-volt grid battery should be quite adequate and should be tapped at every 1½ volts.

To receive 5 X X, insert a No. 75 or 100 coil in the aerial socket and a No. 200 in the secondary socket. For reaction it is difficult to say which size of coil will give the best results, but, generally speaking, a No. 100 or 150 should be quite O.K. You will probably find that a No. 150 is somewhat large, and you may have to reduce the value of H.T. on the detector valve down to about 30 volts

(Continued on page 197.)

**THE "MAGNETIC" TWO**

—continued from page 196

before you can obtain smooth reaction control.

Remember that every time you move the reaction coil it is advisable to vary the tuning very slightly, since the movement of the reaction control has indirectly an effect upon the setting of the tuning condenser. The effect, of course, is very slight.

This variation is usually when the reaction coil is moved nearer to or farther away from the secondary coil, and is something which one has to get used to, especially if one has been in the habit of using a condenser-controlled reaction receiver. For instance, with two stations whose wave-lengths are very close together a small alteration in the position of the reaction coil might alter the tuning sufficiently to produce interference from the station on the nearby wave-length.

**Slow Motion Dials**

To the beginner this might be very puzzling, but the effect is readily corrected by a readjustment of the tuning condenser. It is in cases such as this where a slow-motion dial or other device is so very valuable. A slow-motion dial enables one to obtain a small movement of the condenser vanes, and therefore a very small change in capacity for a relatively large movement of the adjusting knob. Thus it is often possible to get a much better result on distant stations with a slow-motion device than without one.

It should be remembered that as you bring the moving coil nearer to the secondary the variation in tuning will be such that the capacity of the tuning condenser must be decreased slightly, and vice versa.

**A Small Variation**

The effect of moving the reaction coil nearer to the secondary is to increase the capacity of the secondary circuit, thus less tuning condenser capacity is needed. The difference is, of course, very small indeed. Usually it does not amount to more than, at the most, two degrees on the tuning condenser dial.

When the variation in the reaction setting is only slight, then the movement of the dial required is much less still. If these points are remembered, then a little practice will soon enable the constructor instinctively to

counteract the effect of the reaction coil by the necessary readjustment of the tuning control.

Like all reaction detector receivers which are not preceded by a stage of neutralised high-frequency amplification, a set such as this can cause very serious interference with one's neighbours. Therefore, the reaction applied should never be great enough to make the set oscillate, or in fact be near enough to the point of oscillation to produce distorted signals. If this is remembered and carried out in practice, then no interference will be caused with neighbouring sets.

**Transformer Ratio**

The constructor may be in a quandary when it comes to choosing the most suitable low-frequency transformer ratio. Now, for all-round results it is always advisable to choose one with a ratio of about 3 to 1. In general one might say that ratios between 2.5 and 3.5 to 1 are quite satisfactory. Even 4 to 1 will give good results, and will, in fact, probably give more amplification, but from the point of view of quality a ratio not higher than 3½ to 1 is advisable. Practically all of the modern transformers at present on the market are of the low-ratio type.

Then, again, it is very important to employ the correct grid bias on the L.F. valve. One reason is that unless adequate grid bias is used distortion will occur, particularly if the signals are loud enough to operate a loud speaker. Secondly, unless sufficient grid bias is used, the valve will be passing a much higher anode current than it should do, and in consequence the drain on the H.T. battery will be very heavy, and the cells will quickly run down.

**Grid Bias**

Moreover, this heavy anode current will tend to decrease the life of the valve itself, and these two factors combined will, of course, put up the running costs of the set very considerably. It should be remembered that grid bias costs practically nothing to use—that is to say, no current flows from the grid-bias battery. It is therefore just as economical from the point of view of grid bias alone to use 7½ or 9 volts as it is to use 3. In any case, the smallest grid-bias battery in general use is a 9-volt unit.

So carry out the makers' instructions and see that you are using sufficient grid bias for the particular H.T. voltage you are applying to the

(Continued on page 198.)

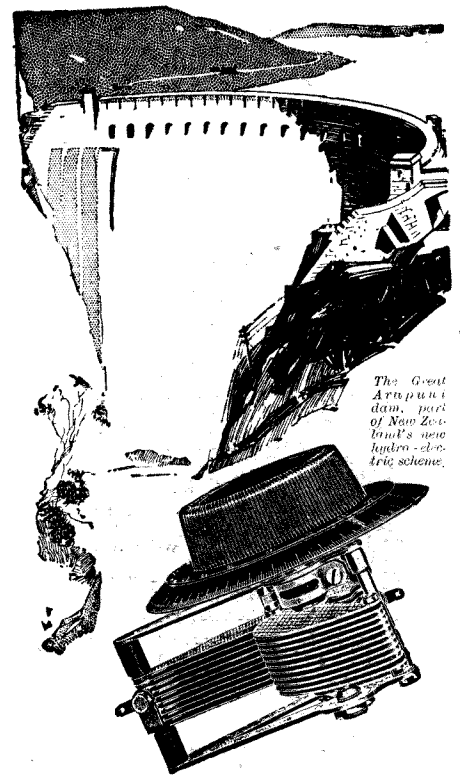

The Great Arapu dam, part of New Zealand's new hydro-electric scheme.

**ENGINEERING PRECISION..**

Imagine the genius, the inspiration, the tireless labour expended on this vast dam—a supreme achievement of modern engineering. One flaw in design, one slip in workmanship, might cause untold disaster. With wireless instruments such inaccuracies would lead to a defective set—surely damage enough—damage, however, that can be prevented by using J.B. precision instruments.

The J.B. Log Condenser (Plain Type), illustrated, is the last word in high-class design, possessing great mechanical strength combined with the highest possible electrical efficiency. An important feature of this model is the Variable Friction Brake, by means of which the turning tension of the rotor may be varied to suit individual requirements, while at the same time the movement of this condenser is extraordinarily smooth.

Prices, complete, 4-in. Bakelite Dial:—  
 '0005 .. 11/6    '0003 .. 10/6  
 '00025 .. 10/-    '00015 .. 10/-



**PRECISION INSTRUMENTS**

Advt. of Jackson Bros., 72, St. Thomas' St., London, S.E.1. Telephone: Hop 1837.

# OH BOY!

## KESTER ROSIN CORE RADIO SOLDER

IS NOW AVAILABLE.

Kester Radio Solder is the one safe combination of solder and flux. The pure rosin inside of this genuine solder makes wiring of radio sets a pleasure. Kester Solder is recommended and used by leading engineers and manufacturers.

**REQUIRES ONLY HEAT.**  
In handy tins from all wireless and hardware dealers.

1/6 per tin.

Also in 1-lb. spools and 18-in. sticks for manufacturers.

If you have difficulty, write to the exclusive distributors:

**ROTHERMEL CORPORATION LTD.**

24, MADDOX STREET, LONDON, W.1.

Telephone:  
MAYFAIR 0578-9



**"REQUIRES ONLY HEAT"**



**For the Best in Radio**

**WILL-DAY LTD.**

(THE BEST IN THE WEST)

19 LISLE STREET, LEICESTER SQUARE, LONDON, W.C.2.

OPEN TIL 7 P.M. Telephone: 3636, 3637, 3638, 3639, 3640, 3641, 3642, 3643, 3644, 3645, 3646, 3647, 3648, 3649, 3650, 3651, 3652, 3653, 3654, 3655, 3656, 3657, 3658, 3659, 3660, 3661, 3662, 3663, 3664, 3665, 3666, 3667, 3668, 3669, 3670, 3671, 3672, 3673, 3674, 3675, 3676, 3677, 3678, 3679, 3680, 3681, 3682, 3683, 3684, 3685, 3686, 3687, 3688, 3689, 3690, 3691, 3692, 3693, 3694, 3695, 3696, 3697, 3698, 3699, 3700.

WRITE FOR YOUR CATALOGUE POSTAGE 6d FREE TO CALLERS

Make **The DAILY SKETCH** YOUR Picture Paper

**THE ONLY UNIVERSALLY STANDARDISED COMPONENT IN RADIO!**

TYPE 'B' 6d.  
TYPE 'M' 4½d.  
TYPE 'R' 3d.

Type 'B'

**BELLING-LEE TERMINALS**

BELLING & LEE, LTD., Queensway Works, Ponders End, Mds.

PLEASE be sure to mention "MODERN WIRELESS" when communicating with Advertisers. **THANKS!**

THE "MAGNETIC" TWO  
—continued from page 197

anode of the valve. The makers always specify the grid bias to be used on the pamphlet which is supplied with every valve carton, or alternatively it can be found quite easily by reference to the makers' lists.

It is interesting to note that a coil of the X type can be used in the secondary socket of this set if desired. This point is mentioned in case readers have an X coil of the correct size on their hands, and should they wish to try it the procedure is as follows: Remove the existing secondary and aerial coils, and insert the X coil in the secondary socket. Join the aerial lead to one of the tappings on the X coil instead of to the alternative aerial terminal. This only applies, of course, if the pin of the coil holder is joined to earth, as shown in the diagram.

**Grid Leak Values**

Although smooth reaction control is very largely dependent upon the size of the reaction coil and the value of high-tension applied to the detector valve, there is another factor. This is the value of the grid leak. Now the set will work perfectly satisfactorily with a 2-megohm grid leak, but it is frequently possible to obtain louder signals and smoother reaction control, particularly on distant stations, by increasing the grid-leak value to 4, or even 5 megohms.

Grid leaks can be bought very easily these days, and it is very instructive to try various values in order to see what effect these have on the reception of distant signals. With a small set an alteration in the value has a much greater effect upon the working of the receiver than would be the case in a powerful set with high-frequency amplification.

A MODERN CRYSTAL SET  
—continued from page 154

connections in words, to assist you in checking your leads over against the wiring diagram as you go along. Here are the actual connections. Connect the moving vanes of the variable condenser to the lower end of the coil (i.e. to the 60-turn point). Connect the fixed vanes to the upper

end of the coil. Connect a short piece of flex to the aerial terminal and place in its other end a tapping clip of the spring type.

Wire the earth terminal across to the lower 'phone terminal and to the centre-tap on to the coil—that is to say, the 30-turn tapping point. Connect the upper 'phone terminal to one side of the crystal detector, and finally attach another piece of flex to the opposite side of the crystal detector. To the end of this flex again attach a clip.

**Preliminary Testing**

The set is now finished and you can proceed to give it the first test. Connect up the aerial and earth and telephones, place the cat's-whisker lightly upon the crystal (omit this step if you are using a permanent type of detector, of course), and then proceed to set the tapping clips. For the first test place T<sub>1</sub> on the 10-turn tapping, and T<sub>2</sub> on the 50-turn.

Now proceed to turn the variable condenser slowly, and see if you can pick up the local station. If not, try another setting on the crystal detector until you find it. Having found it, tune it in to the loudest, and then proceed to adjust the crystal detector accurately.

Having satisfied yourself that you have got a fairly good setting on the detector, you can proceed to adjust the aerial tapping clip. Try it on the 5-, 10-, and 15-turn tappings, remembering to retune on the condenser.

**The Crystal Tap**

Having found the best tapping point for the aerial, you can next proceed to experiment with the crystal tap, namely, the T<sub>2</sub> clip. Try it, first of all, on the 45- or 50-turn taps, noting which is the loudest tap. Having found the loudest one, just check the tuning and make sure that the condenser is at the best setting.

Next proceed to try the T<sub>2</sub> tapping clip on the various taps on the aerial side of the coil, that is to say, on 5, 10, and 15, and see how these compare with the other taps. In this way you will soon be able to make up your mind which is the best setting for the local station for your particular conditions, and the set is then adjusted for regular use.

You will probably find that signal strength is best when the aerial tapping is so placed that there is a fair amount of coil between the clip and earth, that is to say, on the 5- or 10-turn points. For higher selectivity, however, you may quite likely find it necessary to put the T<sub>1</sub> clip on the 15-turn point.

THE "FORTE" FIVE  
—continued from page 119

coming in useful also on very powerful stations such as the local and 5 G B. In these latter cases it may be helpful to turn the filament of the screened-grid valve down considerably, detune a little on the three circuits, and carry out the final control on the low-frequency volume control on the right of the panel.

**A Good De-Tuning Method**

With regard to detuning, by the way, it is best to proceed as follows to obtain the best results. Detune the first condenser until you are a few degrees above the true wave, the middle one a little below the true wave, and the third one a little above once more. Alternatively, of course, you can detune the first one below the wave, the second one above, and the third below again, this scheme of alternate tuning giving a very satisfactory control without running into other stations by accident.

Constructionally the set is a very straightforward job, and there is probably only one point calling for explanation. This is the placing of the split-primary transformer of the neutralised stage in such a manner as to take full advantage of the screening effects of the vertical partitions.

We have followed our usual method of attaching the socket for this coil to the side of the first screen, so that the coil lies horizontally in its compartment, its stray fields being thereby cut off and prevented from wandering about. By judicious placing of the various types of coils in the set, very effective separation of each stage has been arranged with only a very limited amount of actual screening.

**Mounting the Coils**

The first and third coils are mounted in the usual way on the baseboard, but the second, as we have noted, is of the cylindrical type, so arranged on its pins that it must be placed horizontally in its compartment to get the desired screening effect. The photos and wiring diagram will give you an idea of the method of mounting used. You require first a block of wood about 3 in. square and  $\frac{3}{8}$  in. or  $\frac{1}{2}$  in. thick, and this is attached to the side of the screen with a couple of screws passed through holes in the screen into the wood. Upon this

block you then mount the six-pin coil socket, and you will find all this easiest if you do it before fixing the screen in place on the baseboard.

**Valves and Voltages**

Now for some practical working data for the finished set. The valves should be as follows: First H.F. and detector, both H.F. type valves of about 20,000 ohms impedance. The screened-grid must be of the newer type, with the anode brought out to a terminal on the top of the valve, and can, of course, be of any well-known make, e.g. Cossor, Mullard, Marconi, B.T.H., Osram, Ediswan, Six-Sixty, etc. The first L.F. valve should be of the "L.F." or "G.P." type, with an impedance of 10,000 to 15,000 ohms, and the last valve should definitely be a super-power, since it has to handle really strong signals.

Working voltages should be these: H.T.+1 (both H.F. valves and screening electrode of the S.G.), 120 or 130 volts. H.T.+2 (detector), 50 to 70 volts (adjust for smoothest reaction). H.T.+3 (L.F.), 120 volts or more, according to the rating of the super-power valve.

Coils: For the lower band the "X" coil should be a No. 60; the split-primary one for the 250-550-metre band; and the "super" coil a "C.S.P.5," with a No. 6, 8, or 10 interchangeable primary. For long waves you require a No. 250 "X" coil, a split-primary for 1,000-2,000 metres (of the binocular type this time), and a C.S.P.20 with primaries 16, 18, or 20 (different degrees of amplification and selectivity).

**Easy to Neutralise**

Finally, about the preliminary neutralising adjustment. For this operation we recommend the standard "reaction demands" method introduced for use with "M.W." sets. As a rough guide you will find that if you set the "neut." condenser at about one-third capacity, the set will be fairly stable, and if you then bring up the reaction gradually with all three dials in tune, you will soon find a setting for the neut. which gives maximum stability, i.e. at which you have to use the greatest amount of reaction to produce oscillation.

**TECHNICAL QUERIES**

If you are in trouble with your set, why not write to our Technical Query Department for assistance? Full details of the procedure will be found on page 162.

A Postcard Will Do!



**LIGHTNING SWITCH**

Safeguard your set and home by fitting an EELEX LIGHTNING SWITCH. It is fitted outside the house although operated from within. Even if you forget to switch off, your safety is assured as a spark gap is incorporated. This switch is incorporated in a lead-in tube and is easily fitted.

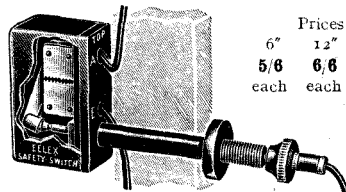

Prices:  
6" 12" 18"  
5/6 6/6 7/6  
each each each

**EELEX EARTH BOWL**

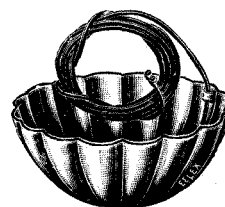

The Eelex Earth Bowl collects and holds all available moisture, improves with age and, being entirely buried, is not subject to atmospheric conditions. Supplied with 9 ft. of heavy rubber-covered wire and connector, 5/6 each. Postage 9d.

Write for Booklet S.71. Free on request.

**J. J. EASTICK & SONS**

Bunhill Row, Chiswell St., London, E.C.1

Phone: Clerkenwell 9282-3-4.

A  
Bureau  
for  
Your  
Wireless!

**ADAPTABLE TO ALL SETS!**

Nothing to touch! The snug way those untidy, dusty parts, trailing wires and batteries are compactly enclosed will delight you. As a beautiful piece of furniture, the "RADIOLO" will add pride to the home because it is modern and stylish. Already over 3,000 delighted users. Highly recommended by the Radio Press and leading experts. "Radiola" de luxe, from £5.5 to £11.11. "Popular" Oak Model, from £3.15.

Cash or Easy Payments. A stately British-made Cabinet, trade-marked and guaranteed, sent on APPROVAL. (If you wish to part with it we will willingly refund FULL MONEY and pay return carriage too!)

Full particulars, Booklet and Photographs FREE (they will interest you!) from the actual makers: **PICKETT'S, WIRELESS FURNITURE MAKERS.**

"M.W." WORKS, BEXLEY HEATH, KENT. Established since the beginning of Broadcasting.

**Advertisements**

As far as possible all advertisements appearing in "Modern Wireless" are subject to careful scrutiny before publication, but should any reader experience delay or difficulty in getting orders fulfilled, or should the goods supplied not be as advertised, information should be sent to the Advertisement Manager, "Modern Wireless," 4, Ludgate Circus London, E.C.4.





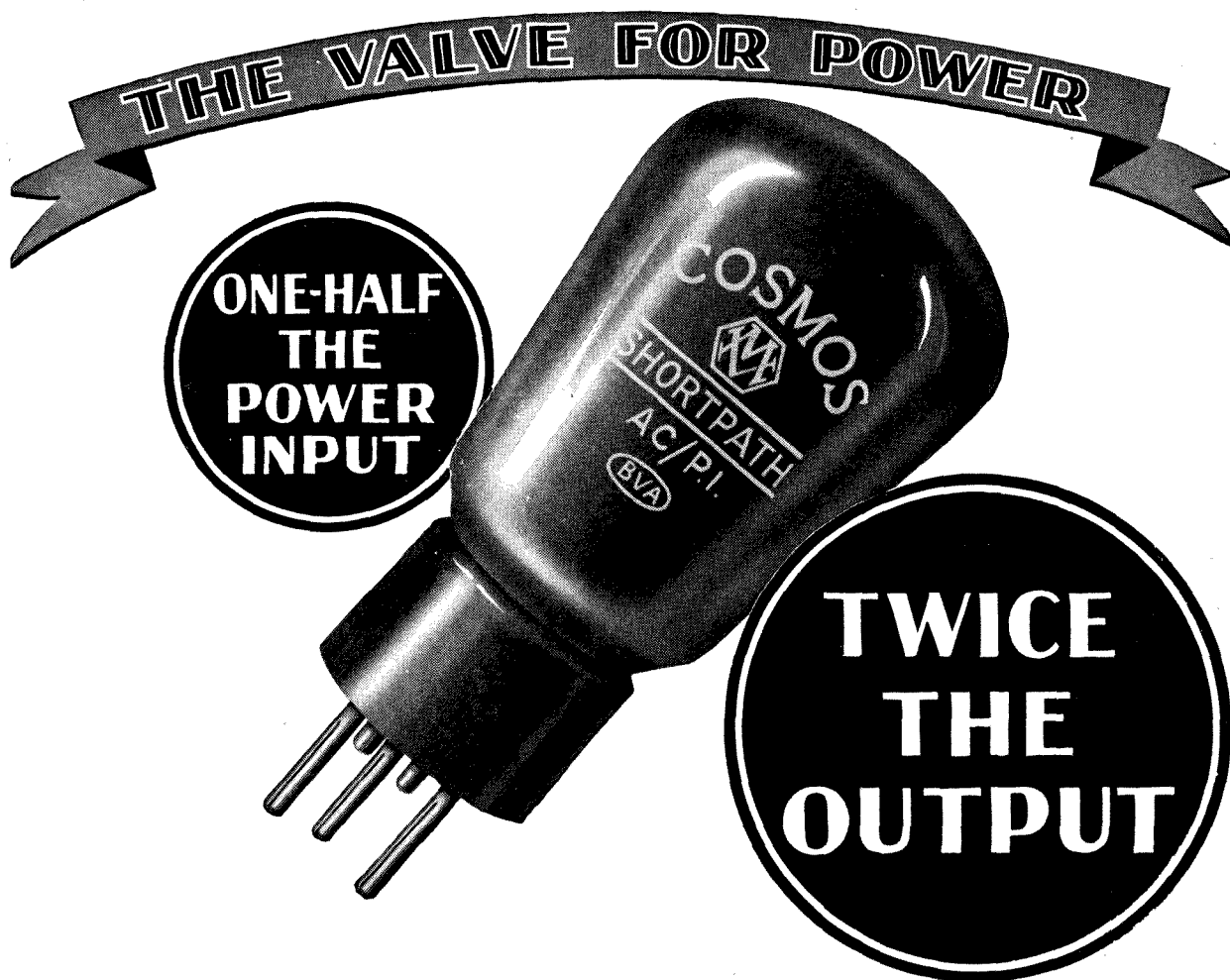

FOR the final stage of a low frequency amplifier operating a large loud speaker the valve to use is a—

## COSMOS AC/P1 POWER VALVE

An exceptionally high mutual conductance enables this valve to deliver twice the output for the one-half the power input required by the ordinary Public Address Valve.

The AC/P1 is a low impedance power amplifying valve, employing an A.C. Cathode heated by alternating current from the supply mains.\* It is fitted with the standard Met-Vick five-pin cap.

### SPECIFICATION

Filament Volts .. .. .	4'0
Filament Amps.. .. .	1'0
Anode Volts (max).. .. .	200
Amplification Factor .. .. .	5
Mutual Conductance, M/a per volt 2'5	
Anode Impedance ohms .. .	2,000

**Price . . . 17/6**

\*As in the case of Met-Vick AC/G, AC/R and AC/S (Screened Grid) Valves.

**For Power with Clarity—AC/P1**

Metro-Vick Supplies,

Metro-Vick House, 155 Charing Cross Rd., London, W.C.2

(Proprietors: Associated Electrical Industries Ltd.)



