

BRITAIN'S LEADING RADIO MAGAZINE

MODERN WIRELESS

1/4
MONTHLY

Edited by
NORMAN EDWARDS

Vol. X. No. 22.

OCTOBER, 1928.



Olympia

SPECIAL EXHIBITION NUMBER

THE "OLYMPIC" THREE

Here is one of the splendid sets described this month. Easy to build, inexpensive, no coil-changing, long-distance loud-speaker results—in fact, a "Modern Wireless" triumph.

AHEAD IN RESEARCH
AHEAD IN MANUFACTURE
AHEAD IN PERFORMANCE

THE 1929 MULLARD
P.M. RADIO VALVES



Mullard

THE · MASTER · VALVE

NATIONAL RADIO EXHIBITION, OLYMPIA. SEPT. 22-29.
STANDS 88, 89, 90, 97, 98, 99, 133.

CONTENTS

Vol. X. No. 22. MODERN WIRELESS OCTOBER, 1928

	Page		Page
Editorial	317	The "James" H.T. Unit	357
Glass Panels	318	In Our Test Room	363
Imperial Radio	319	Aerial Tuning	365
The "Olympic" Three	321	Television Notes of the Month	368
The Exhibition	325	Broadcasting in New Zealand	369
Questions Answered	334	On the Short Waves	372
L.T. from A.G.	335	Home Charging	373
Inside the Valve	341	The "High-Bias" One	379
The "Thomas" Short-Waver	343	Valves for this Month's Sets	384
Tetrode Characteristics	347	Operating the "Constant" Three	396
Breaking Battery Connections	350	The Action of Reaction	410
Clipping Carriers	351	My Broadcasting Diary	414
Random Remarks on Short Waves	353	Radio Notes and News	418
Valves at Olympia	355		

SPECIAL SUPPLEMENT, " RADIO AND THE GRAMOPHONE " PAGES 391-408

As some of the arrangements and specialities described in this Journal may be the subject of Letters Patent, the amateur and trader would be well advised to obtain permission of the patentees to use the patents before doing so.

Edited by NORMAN EDWARDS.

Technical Editor: G. V. DOWDING, Grad.I.E.E.

Scientific Adviser: J. H. T. ROBERTS, D.Sc., F.Inst.P

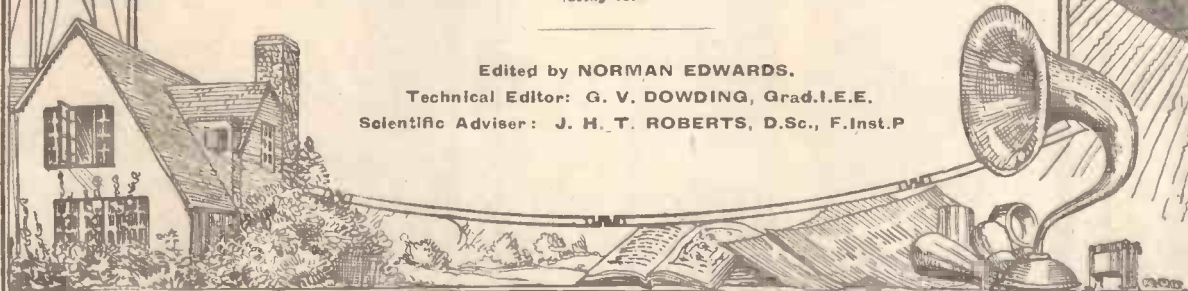

Definition

Amplion reproduction, rich and full, gives you clearly, definitely the music and speech of the broadcasting studio.

The prices from 37/6 to £7-0-0, covering a wide range of instruments, give listeners choice without parallel.

AMPLION

LOUD SPEAKERS

GRAHAM AMPLION Ltd. SLOUGH

London Showrooms: 26, Savile Row, W. I.

An exhibition

See the Wonderful B.T.H. Display on STANDS 86 & 101

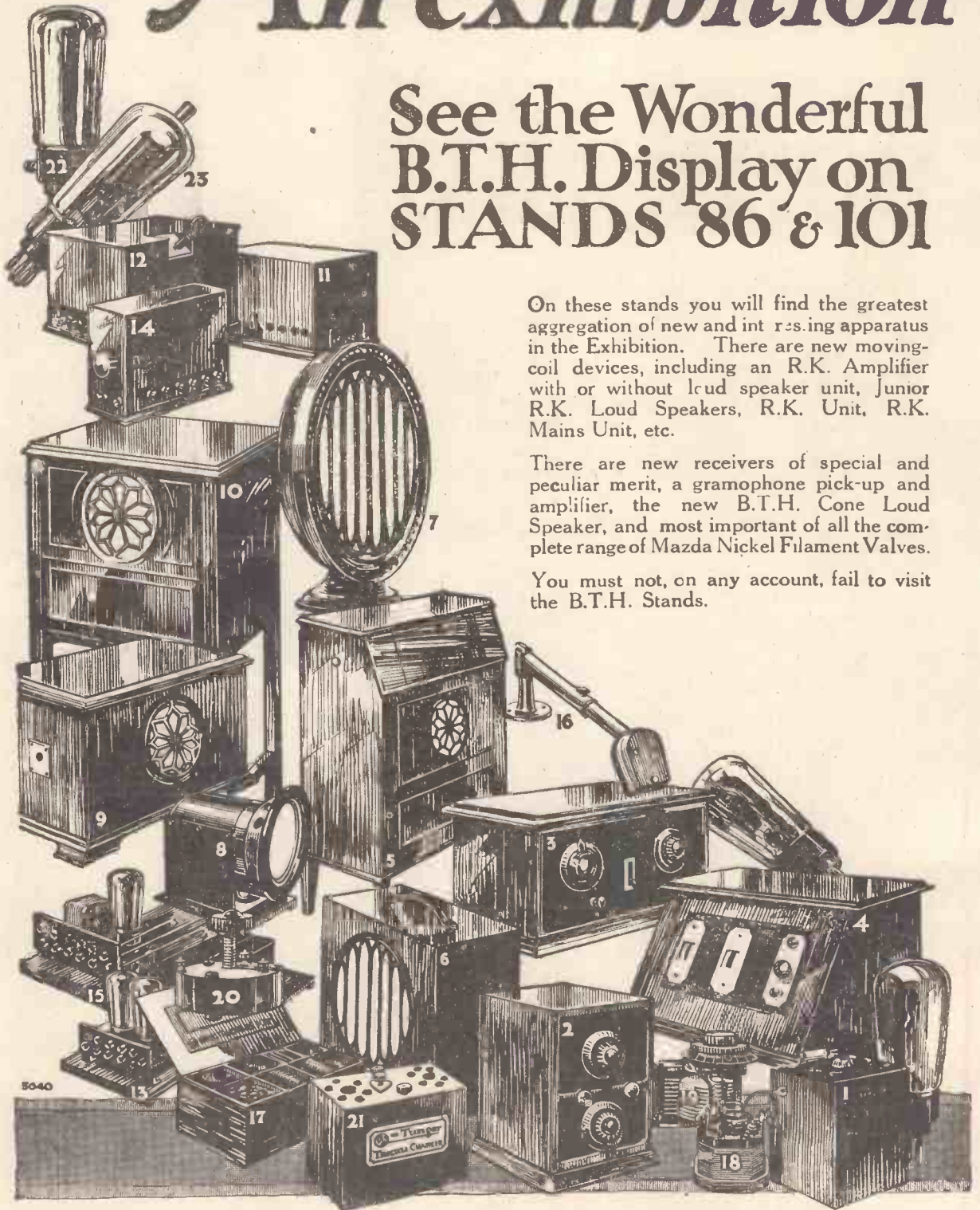

On these stands you will find the greatest aggregation of new and interesting apparatus in the Exhibition. There are new moving-coil devices, including an R.K. Amplifier with or without loud speaker unit, Junior R.K. Loud Speakers, R.K. Unit, R.K. Mains Unit, etc.

There are new receivers of special and peculiar merit, a gramophone pick-up and amplifier, the new B.T.H. Cone Loud Speaker, and most important of all the complete range of Mazda Nickel Filament Valves.

You must not, on any account, fail to visit the B.T.H. Stands.

in itself! NEW B.T.H. PRODUCTS

Below are given the titles of the new apparatus. Make a point of seeing and asking about these wonderful instruments.

1. Bijou Crystal Receiver.
2. Two Stage Receiver.
3. Three Stage Receiver.
4. Four Stage Receiver.
5. Five Stage De Luxe Receiver.
6. Portable Receiver.
7. Cone Loud Speaker.
8. R.K. Moving-Coil Loud Speaker Unit.
9. Junior R.K. Loud Speaker (A.C. & D.C. models).
10. Senior R.K. Loud Speaker.
11. 5 m.a. H.T. Battery Eliminator.
12. 10 m.a. H.T. Pattery Eliminator.
13. R.K. H.T. Battery Eliminator (A.C. & D.C. models).
14. Pick-up Amplifier, Scratch Filter & Volume Control
15. R.K. Amplifier (without R.K. unit.)
16. Pick-up and Tone Arm.
17. Constructor's Kit.
18. Two Stage Unit.
19. Variable Condensers
20. Flexible Aerial Unit.
21. Trickle Charger.
22. Two Stage Valve.
23. Screen Grid Valve.

The Complete Range of MAZDA NICKEL FILAMENT VALVES

Type	Max. H.T. volts	Ampl. Factor	Imp. (ohms)	Slope
TWO VOLTS				
G.P. 210	120	13	14,000	0.90
H.F. 210	150	20	28,000	0.70
R.C. 210	150	40	86,000	0.47
L.F. 215	120	7	7,000	1.00
P. 227	120	4	2,900	1.40
FOUR VOLTS				
G.P. 407	120	14	14,000	1.00
H.F. 407	150	18	21,000	0.85
R.C. 407	150	40	100,000	0.41
L.F. 407	120	8	5,700	1.40
P. 415	120	5.5	2,900	1.90
SIX VOLTS				
G.P. 607	120	14	12,500	1.10
H.F. 607	150	20	20,000	1.00
R.C. 607	150	40	90,000	0.45
L.F. 607	120	9	5,300	1.70
P. 615	120	6	2,600	2.30
P.X. 650	200	3.5	1,750	2.00

The prefix letters indicate the purpose of a valve, and the figures which follow, the filament volts and amperes. For example:—L.F. 215 represents a 2-volt low frequency amplifying valve taking 0.15 ampere.



The New Cossor Melody Maker

LONGER RANGE

ENORMOUS VOLUME

KNIFE EDGE SELECTIVITY

BETTER TONE

The Greatest Step Forward in the History of Radio

Now! A wonderful new Cossor Melody Maker—more powerful, more handsome, more selective and costing even less than its famous predecessor.

Send at once for the FREE Constructor Envelope (containing a 32-page book and a large 8 page chart) which tells you all about it—how it will cut out your local station—how it works on a small frame aerial—how it will bring you programmes from at least 23 stations—everything there is to know about the most sensational Receiver ever offered to the public.

Even if you know nothing about Radio you can build the new Melody Maker in 90 minutes. It's as simple as Meccano—no drilling—no soldering—no blue print. Nothing like it has ever been known in the history of Radio. Post the coupon to-day.

SIMPLE AS MECCANO

LOWEST COST

Fill in this coupon Now!



Built in 90 minutes

Please send me one of your Constructor Envelopes which gives full details of the New Cossor "Melody Maker."
Name.....
Address.....
M. W. Oct.



MODERN WIRELESS

Vol. X. No. 22.

October, 1928.

Star Sets for the Month—Radio Royalties—The National Radio Exhibition.

By The EDITOR.

"M.W." Star Sets

IN this special Exhibition Number of MODERN WIRELESS we present to our readers further additions to the list of "M.W." star sets. The first we would mention is the "High-Bias" One, which is an original receiver of a particularly efficient nature specially designed and described to MODERN WIRELESS by Mr. C. P. Allinson.

Our readers will note that it is more than usually cheap, and a brief perusal of Mr. Allinson's article and layout of the diagrams will indicate that it is also an easy set to build and operates on remarkably low H.T. voltage—in fact, from 9 to 12 volts will be found quite sufficient.

The "Olympic" Three is another star receiver which we commend to the attention of potential constructors. This set is the result of a considerable amount of experimenting on the part of the MODERN WIRELESS Research and Construction Department. The problem to solve was that of simple wave-change in H.T. circuits, and the "Olympic" Three, comprising one stage of H.F. and the original and highly effective system embodied in it, has the effect of completely eliminating one of the two tuning controls, when, by a simple switching operation, the set is taken over to long waves. The scheme embodied in the "Olympic" Three provides neutralised tuned-anode coupling for medium waves, and R.C.C. for long waves.

On test, this set has given excellent results in the "M.W." laboratory, and, despite considerable sensitivity, the action of the receiver will be found most stable.

We feel that this receiver is well worth bringing forward prominently to the notice of our readers, as it is in our opinion one of the most original and successful three-valvers we have yet published in MODERN WIRELESS.

A Powerful Mains Unit

The "James" H.T. Unit is a powerful mains unit using the new dry rectifier. It will be found capable of supplying H.T. to the largest of receivers (A.C. mains). As its name implies, it has been built and is described fully in this issue by the well-known expert, Mr. W. James.

The special edition of the "Thomas" Short-Waver which we also include in this number is published owing to a very large demand on the part of those readers who require a three-valve short-wave set of a highly efficient nature and design. Mr. L. H. Thomas, the author and designer of the set, is also the well-known short-wave expert whose transmitter, 6 Q B, is one of the best-known short-wavers of to-day. His set, which is described fully in this issue, is of a particularly efficient nature.

Sets of the Future

IN next month's MODERN WIRELESS we wish to inform our readers we shall publish five sets additional to mains units, etc.

Briefly the programme includes:

A new and novel crystal set.

A two-valver suitable for all wave-lengths.

A special three-valver by Mr. Percy W. Harris.

A four-valver (H.F., Det., and 2 L.F.), a first-class production of the "M.W." Research Department.

A five-valve set which will be the result of a special effort on the part of the MODERN WIRELESS Research Department. It consists of 2 H.F., Det., and 2 L.F., and it is the opinion of those who have experimented with the set that it will stand head and shoulders above anything yet which had matured in the nature of five-valve sets in the MODERN WIRELESS laboratory.

A special effort has been made to keep the cost down to minimum, and it can be taken for granted that the set will be designed and described in a perfectly straightforward way, and will include a novel scheme originated by the "M.W." Research Department, which will give it power and stability in a remarkable degree.

Radio Royalties

As the result of a finding of a Special Tribunal of the Patent Office, it has been announced that the Marconi patent royalty fee of 12s. 6d. per valve holder is to be reduced to 5s. for the first valve and 2s. 6d. for each additional valve in a set. Alternatively, the royalty fee may be 10 per cent on the wholesale price of the complete wireless set without accessories.

How this will work out will be seen as follows:

Sets	Old Fee			New Fee		
	£	s.	d.	£	s.	d.
1 valve	0	12	6	0	5	0
2 valve... ..	1	5	0	0	7	6
3 valve	1	17	6	0	10	0
4 valve	2	10	0	0	12	6
5 valve	3	2	6	0	15	0

The finding of the Tribunal was the result of an application made by the Brownie Wireless Company for a compulsory reduction in licence fees. The Brownie Company alleged that there had been an abuse of monopoly rights. In its finding, the Tribunal agreed with this view, and stated: "We have found that it is in the public interest

(Continued on page 432.)



GLASS PANELS

Have you ever tried a Glass Panel? This article tells you how it is done.

By A. BETTS.

THE use of glass as a panel is generally avoided by amateurs on account of the supposed difficulty in handling it. It must be admitted, in fact, that the amateur who likes to experiment with his set, and who contemplates adding to or altering any of the panel components, would be well advised to stick to ebonite. But the experimenter who intends his set to be both permanent and ornamental, and who is prepared to take a little more care than usual, will find that glass offers many advantages over the more orthodox panel.

In the first place it ranks with the best ebonite as regards insulating properties, and it is far superior to the cheap and shoddy ebonite that is sometimes sold. It is naturally much cheaper than ebonite, and a 16 in. by 8 in. panel of quarter-plate glass should not cost more than a shilling purchased from a large hardware or a decorator's stores. In use it will not deteriorate like ebonite and will always present a neat appearance, in contrast to ebonite, which sometimes fades in a short time.

Like Framing a Picture

To obtain the best results, more than usual care must be taken in preparing the panel, and it may be necessary to modify to some degree the layout of your set.

Suppose, for example, you have a cabinet, American style, with front inside measurements 16 in. by 8 in. (an ordinary size for two-valve cabinets). You will require about 5 ft. of picture beading of the type shown in Fig. 1. The dimensions of the glass

will depend upon the width of this beading. With the beading shown, of course, the glass should be 14½ in. by 6½ in.

Briefly, in fact, we proceed merely as in framing a picture, the outside frame measurements to be 16 in. by 8 in., with the glass taking the place of the picture. The beading cut to length, the corners should be mitred with extreme care. Every care should be taken to ensure that the frame is a perfect fit into the cabinet. The frame made, we can turn our attention to drilling the glass.

Method of Drilling

In order to lighten this part of the task, it is best to bring all terminals to an ebonite strip at the rear, even at the cost of altering the layout. This done, the average owner will find that he has only three, or perhaps four, holes to drill, each perhaps ⅜ in. in diameter. Place the glass on a perfectly flat surface, to obviate all risks of breaking or scratching it. A geared drill is preferable, as the drilling must be done slowly.

The question of drills is of paramount importance. Ordinary drills are useless. Specially prepared drills can sometimes be obtained, but per-

To keep abreast with radio week by week you ought to read

Popular Wireless

Every Thursday - Price Threepence

sonally I prefer three-cornered files, ground smooth and pointed. Drill slowly, bearing gently but firmly. For large holes it is best to drill an ¼-in. guide hole, as it proves quicker in the end. A compound of camphor and turpentine applied to the point of the drill will help matters considerably, while ordinary oil is better than nothing. The drills should be sharpened frequently with a small file. When half-way through, turn the glass and recommence on the opposite side.

Final Fixing

The glass drilled, it can be placed in the frame and fastening strips screwed on. It is not essential to mitre these, but the top of the strip should not protrude above the level of the beading on the other side of the glass. Small brackets may be fixed on

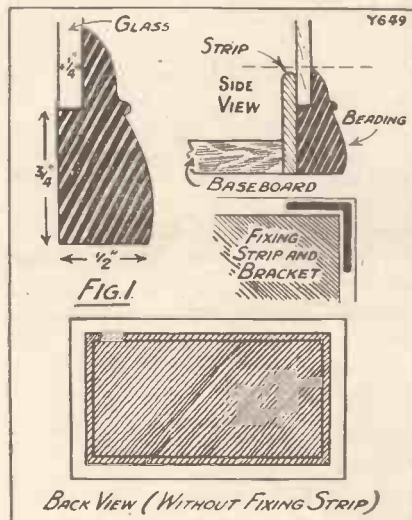

the corners, as shown. All fixing strips and brackets should, of course, be screwed from the inside.

The panel should now be ready for fixing to the baseboard. The constructor can judge for himself the number and size of the screws, but it is generally wise to add angle brackets, whatever the size of the panel.

To aid the neat appearance, beading of a similar nature should be fixed round the edges of the cabinet. Special care should be taken with the wiring; covered wire being advocated. Unless you are extremely handy with the soldering iron, it is preferable to screw all joints, and the wiring, as far as possible, should be kept at the back of the set. When fixing your components to the panel it is advisable to place a thin leather washer between the glass and the fixing nut. In any case, do not screw up too tightly.



The history of the development of a great Empire scheme.
 By *LT.-COL. CHETWODE CRAWLEY, M.I.E.E.*

THE idea of linking up the Empire by a network of radio stations first took shape in 1912, when the Government decided to proceed with a scheme for the erection of a chain of high-power spark stations in England, Egypt, East Africa, South Africa, India and Singapore.

In the following year a contract was made by the Post Office with the Marconi Company for the erection of these stations, but work on the English and Egyptian ones had only just commenced when war broke out and changed the whole course of events. The contract was cancelled, and nothing further was done towards the erection of Imperial stations for inter-communication until after the end of the war.

The Admiralty, indeed, did set up a number of spark and arc stations during the war at various strategic points throughout the Empire, but these were designed primarily for communicating with ships, and none of them was of the calibre required for commercial inter-communication

These strategic stations were for the most part erected by the Marconi Company as contractors.

It was, of course, due to the fact that our supremacy at sea ensured the safety of the vast cable network which connects all parts of the Empire that the policy of providing Imperial radio stations could be postponed, and it was the possession of this cable network in peace-time that had allowed us to dally so long before the outbreak of war with the idea of an Imperial wireless chain.

It was obvious that the Empire needed wireless communication from the commercial point of view, but there was a general feeling that radio technique was improving so rapidly that delay was justifiable

The war, however, altered the whole outlook, and it is easy now to see that high-power stations throughout the Empire would have seriously hindered Germany's naval activity abroad in the early stages of the war, and that in all probability millions of pounds would have been saved by the timely expenditure of thousands.



A view of India's Beam transmitting station at Poona, showing four of the five 275-ft. masts.

Germany, on the other hand, when war broke out had made considerable progress with a colonial wireless network which proved of the greatest value to her so long as she was able to hold it. The United States and France had also made a start with high-power schemes which, as their needs were different from ours, they continued to develop throughout the war, and by 1919 they were both far ahead of us in this respect.

How the Beam Began

In 1919 the Government appointed a committee, under the chairmanship of Sir Henry Norman, to draw up a new scheme for Imperial wireless communication, and this committee recommended that stations should be erected in England, Egypt, Kenya, South Africa, India, Singapore, Hong Kong and Australia, as well as possibly two in Canada for transatlantic and transpacific communication.

The result of this decision is that we have had in operation at Rugby since the beginning of 1926 the most powerful station in the world, capable of transmitting messages to any part of the Empire. The total cost of this station was about £480,000.

Meanwhile, early in 1924, Mr. Marconi had published the results of his experiments on the Beam transmission of short waves, and in July, 1924, the Home Government, in co-operation with the Governments of the Dominions and India, made a contract with the Marconi Company for the erection of Beam stations in England, Canada, Australia, South Africa, and India for direct communication with England.

The sending stations were to have an input of at least 20 kw., with an aerial system designed so as to concentrate the emitted waves within an angle of 30 degrees, the receiving stations to have a similar system designed to focus the received waves. The maximum sum to be paid



The aerial "lead-out" at the Rugby station. Note the huge insulators supported on a framework resembling miniature masts.

for the stations in this country, exclusive of the cost of sites, was to be about £50,000 for the first English unit, and about £31,000 for the others.

The royalty paid to the Marconi Company was to be 6 1/4 per cent of the gross receipts so long as any Marconi patents essential to the working of the stations were employed. The English stations were to be worked by the Post Office, the others by the company or associated companies, and the rates charged for messages were to be fixed after consultation with the companies. Duplex communication at a speed of 100 five-letter words a minute each way was guaranteed for a daily service of 18 hours with Canada, 12 with India, 11 with South Africa, and 7 with Australia.

Recent Developments

No provision has yet been made for wireless telephone services, but experiments are now being carried out with apparatus for operating two high-speed telegraph circuits simultaneously with a duplex telephone circuit, using the same transmitter, aerial and wave for the three circuits.

All the telegraph services have been in operation for several months, and on June 15th last a similar Beam service was opened between Australia and Canada. On the same day, too, the Post Office opened a short-wave service, but not on the Beam system, between this country and Kenya Colony.

The rates charged for telegrams by all these services, with the exception of the Canadian service, are substantially lower than the cable rates, and as cable receipts are being adversely affected: a committee was appointed by the Government some months ago to consider the whole question of Imperial communication, and its report will still be fresh in the minds of the public.



The main tuning inductance at the great Rugby station

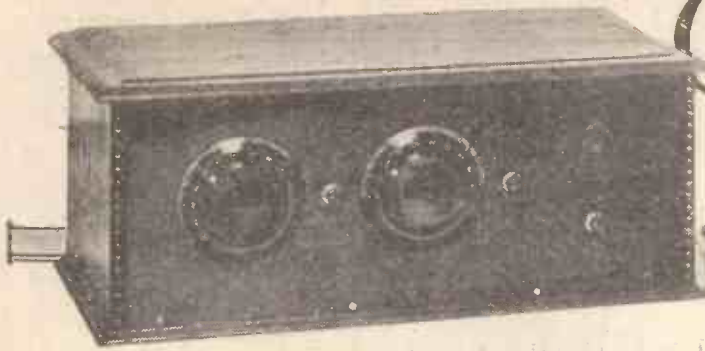

The Olympic THREE

By G. P. KENDALL, B.Sc.

Simple to construct and covering long waves as well as the ordinary broadcasting without coil-changing, this magnificent long-distance set was specially evolved by the "M.W." Research Dept. for the man who wants radio de luxe reception at the lowest possible cost.

THE design of "wave-change" sets of the simpler type without H.F. stages is now becoming a fairly straightforward matter, with the aid of standard loading coils and certain special switching schemes which have now been reduced to very simple forms.

In cases where a stage of H.F. is involved, however, the difficulties are admittedly considerable, and an active search is still proceeding for simpler and better methods.

One of the greatest difficulties is that of finding a method of intervalve coupling which shall involve the smallest possible number of connections to alter in switching over from the ordinary broadcast waves to long waves and vice versa, and in which the neutralising adjustment shall remain set for both wave ranges. This last is a particularly awkward point, and in many wave-change sets

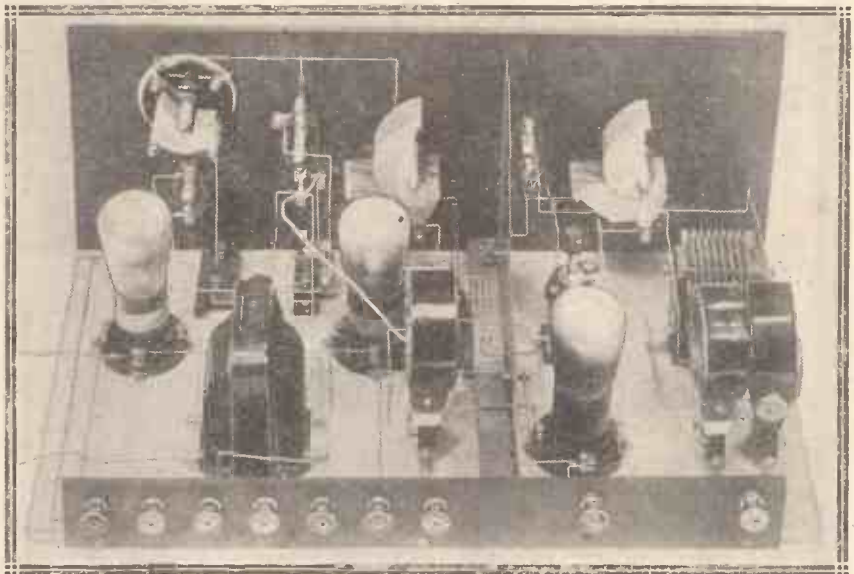

For such a really remarkable programme-puller the simplicity of layout and straight forwardness in wiring are two exceptional advantages of The "Olympic" Three.

COMPONENTS AND MATERIALS

- | | | |
|-------------------------------------------------------------------------------------------------------------------------------------------------------------------------------------------------------------------------------------------------------------------------------------------------------------------------------------------------------------------------------------------------------------------------------------------------------------------------------------------------------------------------------------------------------------------------------------------------------------------------------------------------------------------------------------------------------------------------------------------------------------------------------------------------------------------------------------------------------------------------------------------|-------------------------------------------------------------------------------------------------------------------------------------------------------------------------------------------------------------------------------------------------------------------------------------------------------------------------------------------------------------------------------------------------------------------------------------------------------------------------------------------------------------------------------------------------------------------------------------------------------------------------------------------------------------------------------------------------------------------------------------------------------------------------------------------------------------------------------|--------------------------------------------------------------------------------------------------------------------------------------------------------------------------------------------------------------------------------------------------------------------------------------------------------------------------------------------------------------------------------------------------------------------------------------------------------------------------------------------------------------------------------------------------------------------------------------------------------------------------------------------------------------------------------------------------------------------------------------------------------------------------------|
| <p>1 Panel, 14 in. × 7 in. × $\frac{1}{2}$ in. or $\frac{3}{8}$ in. (Original was Resiston). (Any good branded material, Ebonart, "Kay Ray," Becol, Trelleborg, etc.)</p> <p>1 Cabinet to fit, with baseboard 10 in. deep. (Note.—This is the size used for the three-valve "Solodyne" and other sets, and thus should be readily available in any of the well-known makes, Camco, Raymond, Bond, Pickett, Makerimport, Caxton, Artercraft, etc.)</p> <p>2 .0005-mfd. variable condensers (Formo in set. Any good make as desired, Lissen, Cyldon, Raymond, Igranic, J.B., Bowyer-Lowe, Marconiphone, Utility, Geophone, etc.). (Note.—Plain dials were used on the original, but if much distant reception is to be done it is a great help to fit good slow-motion dials, such as the Igranic, Lissen, Utility, etc.)</p> <p>1 .0001- or .00015-mfd. reaction</p> | <p>condenser (Igranic, Cyldon, Bowyer-Lowe, Peto-Scott, etc.).</p> <p>2 Push-pull on-off switches (One of these must be of the type commonly used for wave-change switching, with two side contacts and a central plunger to which a third lead can be soldered. Examples are the Lissen and Lotus).</p> <p>1 Lotus push-pull jack switch, No. 8, double-pole on-off.</p> <p>1 Standard loading coil (Burne-Jones, Wearite, Paroussi).</p> <p>3 Single-coil sockets (Lotus, Burne-Jones, Peto-Scott, etc.).</p> <p>1 Neutralising condenser (J.B., Bowyer-Lowe, Peto-Scott; Burne-Jones, Igranic, etc.).</p> <p>3 Sprung valve holders (Lotus, Igranic, W.B., Redfern, B.T.H., Marconiphone, Burne-Jones, Burndept, Bowyer-Lowe, Formo, Wearite, etc.).</p> <p>1 2-meg. and one $\frac{1}{2}$-meg. grid leaks,</p> | <p>with holders (Lissen, Dubilier, Mullard, Igranic, Ediswan, etc.).</p> <p>1 H.F. choke (R.I.-Varley, Burne-Jones, Lissen, Igranic, Dubilier, Lewcos, Colvern, Bowyer-Lowe, Cosmos, Marconiphone, Climax, etc.).</p> <p>1 .0003-mfd. and one .001-mfd. fixed condensers (Lissen, Mullard, T.C.C., Dubilier, Igranic, Burne-Jones, Goltone, Marconiphone, etc.).</p> <p>1 L.F. transformer of fairly low ratio (New Lissen in set. Any good make, R.I.-Varley, Mullard, Ferranti, Marconiphone, Philips, Igranic, etc.).</p> <p>1 Copper or aluminium screen, 12 in. × 6 in.</p> <p>1 Terminal strip, 12 in. × 2 in. × $\frac{1}{4}$ in., and 9 engraved or indicating terminals (Eelex, Igranic, Belling & Lee, etc.).</p> <p>Wire, flex, G.B. plugs, etc.</p> |
|-------------------------------------------------------------------------------------------------------------------------------------------------------------------------------------------------------------------------------------------------------------------------------------------------------------------------------------------------------------------------------------------------------------------------------------------------------------------------------------------------------------------------------------------------------------------------------------------------------------------------------------------------------------------------------------------------------------------------------------------------------------------------------------------------------------------------------------------------------------------------------------------|-------------------------------------------------------------------------------------------------------------------------------------------------------------------------------------------------------------------------------------------------------------------------------------------------------------------------------------------------------------------------------------------------------------------------------------------------------------------------------------------------------------------------------------------------------------------------------------------------------------------------------------------------------------------------------------------------------------------------------------------------------------------------------------------------------------------------------|--------------------------------------------------------------------------------------------------------------------------------------------------------------------------------------------------------------------------------------------------------------------------------------------------------------------------------------------------------------------------------------------------------------------------------------------------------------------------------------------------------------------------------------------------------------------------------------------------------------------------------------------------------------------------------------------------------------------------------------------------------------------------------|

other methods of stabilising are chosen simply to dodge it, a common expedient being to use a parallel-feed circuit with the feed tap located fairly low down.

Another scheme, again, is to neutralise on one wave-band and use some other method of stabilising on the other wave-band, as in the "Quick-Change" Four.

A Retrograde Move?

It has recently been found in the course of our experimental work in developing new designs that a very effective solution of these two problems (simple wiring to the switches, and stability on both wave-bands), with many valuable advantages, is to be found in the use of resistance coupling for the H.F. valve on the long waves. This may seem something of a retrograde step to those readers whose memories go back far enough, but a moment's reflection will show that it is nothing of the sort.

The reason why R.C. was dropped for general H.F. work some few years ago was that wave-lengths were growing shorter and shorter, and the efficiency of R.C. for H.F. in a normal circuit was rather low below about

came to a fairly definite end, and we have heard little of it, save in L.F. circuits, since.

Now that the general demand is

coupling for the long-wave stations, for example, we immediately simplify our wiring greatly, and also get rid of the neutralising difficulty, since a

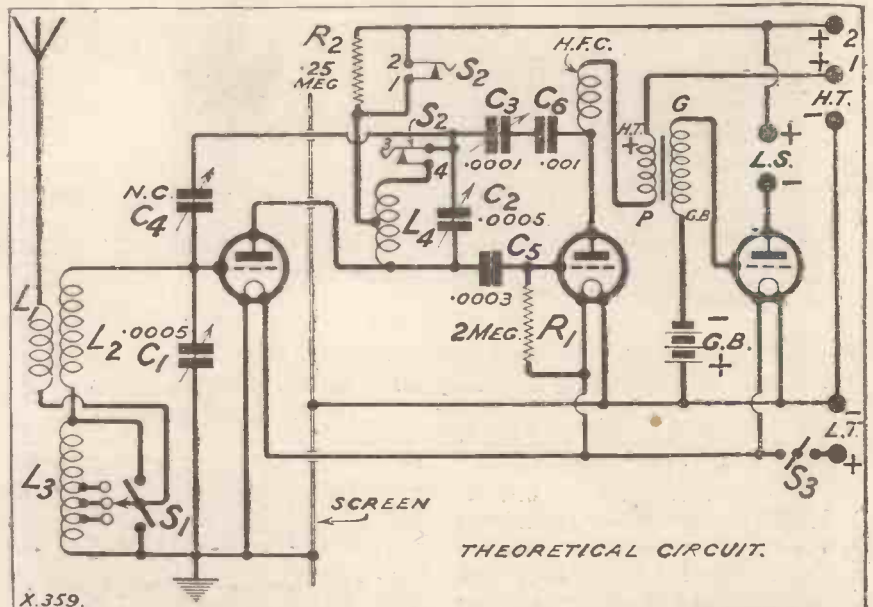

The circuit employed, showing the screening and the simplicity of the wave-length changing switches.

for a set to cover both high and medium waves by switching instead

single stage of R.C. properly arranged is normally stable, and requires added reaction to make it oscillate. Further, when we go over to the long waves the intervalve circuit is untuned, and we can set the appropriate condenser to minimum and do all tuning on the aerial condenser.

The natural result is that the set is particularly simple to handle, and probably approaches very close indeed to the ideal arrangement for general domestic purposes. Selectivity on the long waves will not be so high as with a set using a tuned intervalve circuit, but we have found it quite adequate for all normal purposes.

Adequate Selectivity

A very high order of selectivity is not necessary on the 1,000-2,000-metre band, and we find that so long as a reasonably good aerial and secondary circuit is used the results are quite satisfactory. As an indication of the selectivity to be expected it may be mentioned that in the London area there is no particular difficulty in separating Radio Paris and 5 X X on a receiver of this type. Amplification on the long waves has been found to be decidedly good; much better, indeed, than we expected—a result, no doubt, of the great improvement in valves which has taken place since R.C. was abandoned for H.F. purposes.

The "Olympic" Three is a set on

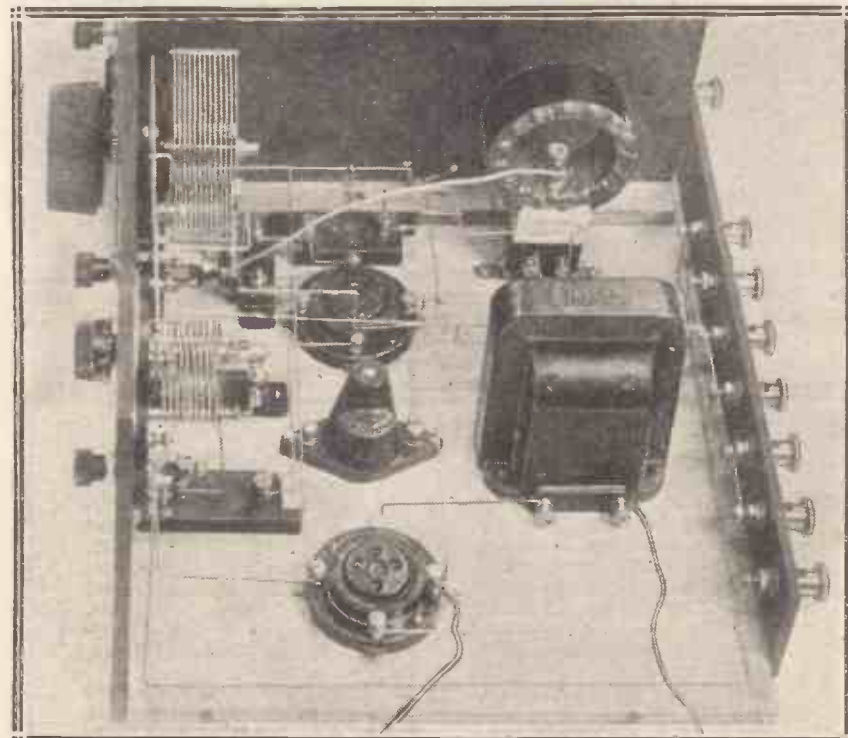

This view of the low-frequency end of the set shows that phenomenally few wires are necessary for this remarkably efficient wave-change scheme evolved in the "M.W." Research and Construction Department.

1,000 metres. Consequently, when our main interest became confined to a band between 250 and 500 metres, the use of this method of coupling

of coil changing, however, it is evident that R.C. possesses some very interesting potentialities.

By changing over to this method of

these lines, and since it will be something of a novelty to most readers, we have gone into these general points rather fully. The method seems to be a very promising one for wave-change sets, and it is thought that a few designs on this basis are likely to be welcomed by a considerable proportion of our readers.

It is true that the amplification on long waves falls a little (but only a little) below that obtainable with a set using fully-tuned intervalve circuits working at its best (i.e. correctly neutralised and handled with a certain amount of skill). It must be remembered, however, that a set of the more complicated type calls for a definite

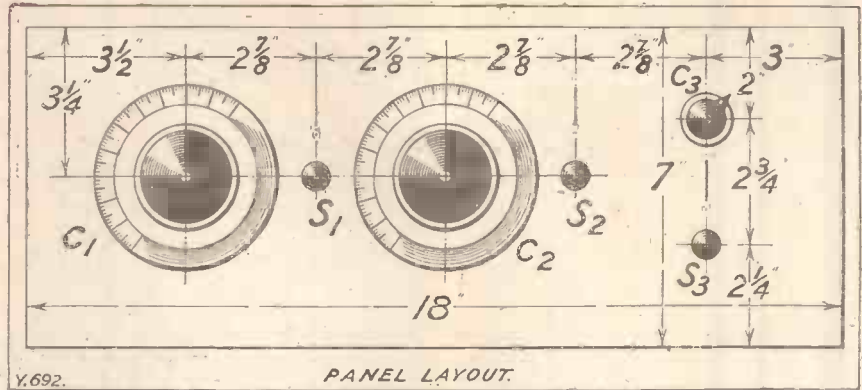

this, of course, is scarcely possible when we switch in the resistance.

a particularly simple but effective one having been chosen for use in this, the first of the type to appear in "M.W."



Beside each tuning dial is a wave-change switch, whilst to the right is the on-off switch, and above it the reaction condenser.

degree of skill on the part of the user, and in the hands of the non-technical members of a household may quite possibly give poorer results than such a receiver as the "Olympic" Three. Add to this the fact that most of the long-wave stations are very powerful and are easy to receive, and you will realise that a set using R.C. on the long-wave band is worthy of serious consideration.

The Reaction Difficulty

A number of interesting points call for attention in producing a design for such a receiver, and one of these should perhaps be explained in some little detail, for it is one of those little factors concerning the actual working of the set which we most of us like to understand in any set we undertake to build.

A moment's reflection will show that there is likely to be some little difficulty in making arrangements for reaction on both wave-bands when R.C. is used for the long waves, since the normal procedure nowadays is to react upon the intervalve circuit, and

Well, sundry schemes have been devised for overcoming the difficulty, as the reader will see in future issues,

The Tuned Coupling

In the "Olympic" Three the neutralised form of the split tuned anode is used for intervalve coupling on the lower wave-band, since this lends itself particularly well to a switch-over scheme to bring in a resistance for long-wave working. In this circuit reaction is produced by connecting the usual small variable condenser back from the anode of the detector to the "free" end of the split tuned-anode circuit. The reaction currents then pass through half the anode coil, out at the centre-tap, and then to filament via the H.T. battery, so giving the well-known Hartley type of reaction.

Now, if we arrange a switch to bring in the resistance for long waves,

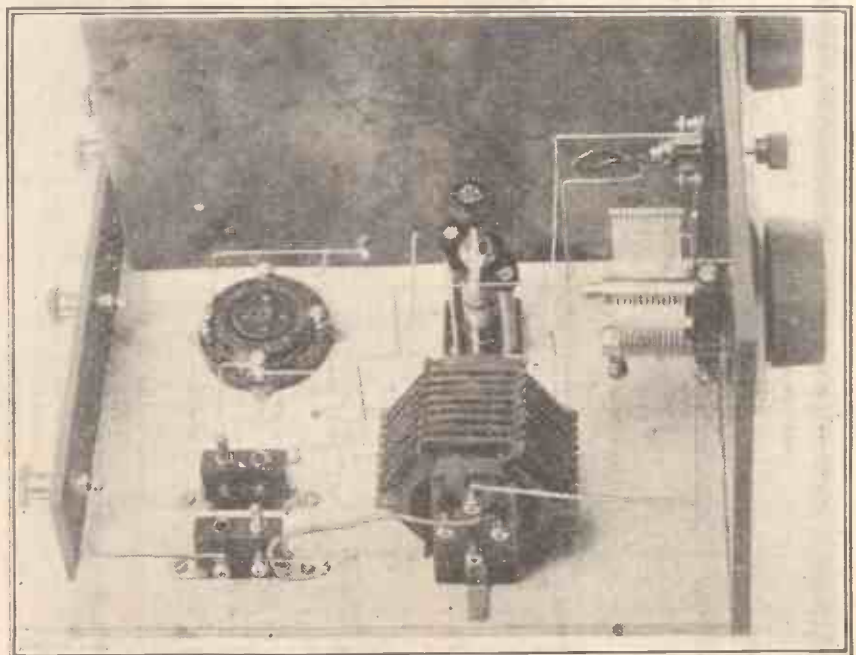

The high-frequency end—a model of straightforward simplicity in screening and wide wave-length range.

and at the same time to break the connection to the free end of the anode coil, we shall automatically produce another reaction circuit which has been found to function very pleasantly. The potentials fed back by the reaction condenser can now no longer take the previous path through the upper half of the anode circuit, and so pass through the neutralising condenser to the grid circuit of the H.F. valve, where they produce the desired reaction effects. This, of course, is true capacity reaction, which is rarely used in modern sets, but chances to suit the present type very well indeed.

A Good Reaction Method

It is found to be very smooth and gradual in practice, and although it

is open to the objection that it produces reaction upon the aerial circuit, and so is liable to result in interference with neighbouring listeners if the set is allowed to oscillate, yet is not felt that this is a really serious point, since the extent of such interference is relatively slight on long waves, and the comparatively strong signals of most long-wave stations greatly reduces the temptation to abuse reaction. Just a little care on the part of the user should render the arrangement quite innocuous.

An incidental advantage of the particular form of this arrangement which has been used in the "Olympic" Three should perhaps be mentioned. In the connections used in this set the anode tuning condenser automatically

becomes a *negative reaction control* on the long waves, and thus if you find that the particular valve you are using tends to oscillate very easily, you can check it very simply. Instead of setting the anode condenser at zero for long waves, just increase the reading a few degrees and you will find the set becomes more controllable at once. (This is only likely to be needed with a very freely oscillating valve indeed.)

How It Is Done

How all this is worked out may be followed on the circuit diagram, to which reference is suggested at this point. You will see that the necessary change of connections for long-wave

(Continued on page 436.)

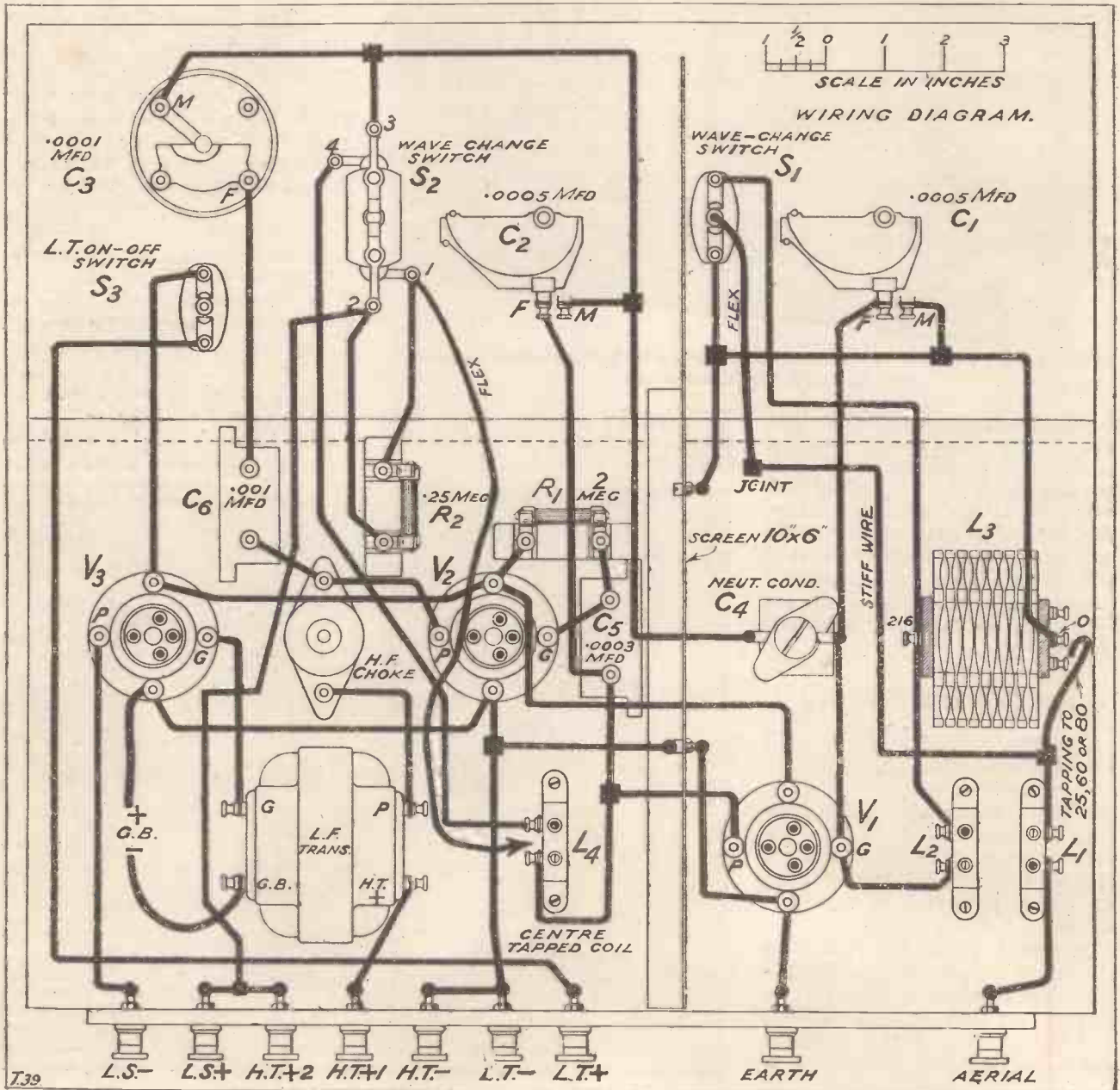

THE EXHIBITION

A brief review of the main exhibits to be seen at Olympia during the National Radio Exhibition now in progress.

Amalgamated Press, Ltd. (135 and 166.)

These accessibly situated stands constitute a kind of Mecca for the real radio enthusiast, for here is focussed one of the greatest forces of modern radio progress—namely, the leading wireless journals. MODERN WIRELESS will be on sale here, together with the associated journals and envelopes which have played such a great part in the realisation of the radio hopes of Britain.

No visitors at Olympia should fail to call at this stand, where arrangements have been made for experienced technicians to be in attendance to deal with any readers' problems or difficulties that can be cleared up better by a heart to heart talk than by correspondence. The originals of many famous receivers will be on view at these stands, and we hope this year to meet many more thousands of our friends and fellow radio men, to talk over with them the greatest hobby in the world and, in fact, to cement the cordiality and friendship which has always existed amongst the readers of these famous journals and the editorial and technical staffs to which they are entrusted.

Belling & Lee, Ltd. (220 and 221.)

These two stands will, as usual, be devoted almost exclusively to a display of the famous Belling-Lee indicating terminals. There will be no actual new models but the following new indications on terminals will be added: pick-up, screen, field, mains+, mains-, and A.C. mains, so that all the requirements of the latest developments in radio are fully met by the Belling-Lee terminals. An outstanding feature of this stand will be the tremendous reduction in price and this should come as a great boon to all those constructors who have coveted this type of terminal but have not been able to afford it.

The Benjamin Electric, Ltd. (171.)

When anyone hears the name Benjamin Electric he naturally thinks of anti-microphonic valve holders, and the exhibits on this stand will fully live up to the reputation gained by this firm for well-made valve-holders. But besides these holders (among which a new one is to take its place at the remarkably low price of 1s. 6d., but containing all the advantages of the 2s. model though being slightly smaller in size) there will be battery switches, new ones at 1s. being shown, and a special improved earthing device which it is claimed will give results 60 to 80 per cent better than previous types, will be marketed at 5s. 9d. Readers will learn with regret that the Majestic Eliminator for A.C. mains is being taken off the market.

Brandes, Ltd. (118.)

Quite a large programme is being put out by this firm for the next radio season, and representative exhibits will be shown from that programme. These will include Matched tone headphones, the Table Talker, Table Cone, transformers, condensers, high-tension and low-tension batteries, while early in the season the following additions to the existing range will be made: a four-valve set, a popular price model of cone loud speaker, and a new transformer.

Be sure to visit us
on Stands
135 and 166.

British Ebonite Co., Ltd. (38.)

In addition to Beool Ebonite Formers, which are being shown in a large range of sizes, a comprehensive display of ebonite panels of various kinds will be shown. These include black ebonite sheets with matt finish, with polished finish and raven black, ebonite sheets with polished finish and standard size ebonite panels of the three finishes already referred to.

Brown Brothers. (177 and 178.)

It is, of course, impossible to mention all the lines which can be handled by a wholesale firm of the size and reputation of Messrs. Brown Bros. All sorts of sets and crystal receivers, valve receivers of all descriptions, batteries, cabinets, aerial equipment, variable condensers, loud speakers, moving-coil parts, gramophone pick-ups, plugs and sockets and all components of every description will be shown on this stand.

A. F. Bulgin & Co., Ltd. (203 and 204.)

Many new lines are shown here, while the majority of the old lines now well known to readers are also on view. Of the new lines perhaps special mention should be made of the filament tester, which is a neat, handy device for easily finding out whether the filament of a valve is intact or not by simply plugging the tester into the valve holder. A station direction locator will also be a great attraction. This comprises a neat wallet, containing two maps with a special compass with full directions as to how to locate a direction of all the largest broadcasting stations in Northern

Europe. This should be very valuable to the man with a large receiver, and especially so to the owner of a frame aerial set.

Burne-Jones & Co., Ltd. (86.)

Readers of the WIRELESS CONSTRUCTOR need no introduction to this firm, makers of the famous Magnnm components. A representative collection of these famous components will be on view at Olympia, and among the well-known assortment of valve holders, rheostats, screening boxes, coils, chokes, etc., will be a number of new lines and several complete sets. A push-pull power amplifier has made its appearance, specially designed to operate a moving-coil speaker. The "Purity" Three, which was introduced last year, has been improved and now incorporates several new features, including a new design of cabinet of the fall-front type. The cabinet also houses the loud speaker L.T. and H.T. supply, thus making the whole thing self-contained. No changing is necessary, this being obtained by means of a simple switch. With an outdoor aerial, loud-speaker reception of excellent quality is obtained from the principal British and Continental stations. A moving-coil loud-speaker outfit, including the B.T.H. Rice-Kellogg unit, will also be shown, and this should prove of tremendous interest in view of the fact that the prices of moving-coil speakers have come down within the reach of the average constructor.

Bowyer-Lowe, Limited. (51.)

As in the past, the Bowyer-Lowe Company have managed to give an extremely attractive display at their stand. All the latest products of this famous Letchworth firm are represented, as well as many of the famous old favourites which in the past have made the name "Bowyer-Lowe" one to conjure with.

Amongst the components shown the new "White-Line" valve holder is particularly interesting. This component is not only electrically efficient, but is mechanically robust, and, selling for the moderate price of 2s. 3d., is sure to make a great appeal to those who do not mind paying a fair price for a good component.

The Baird Television Development Co., Ltd. (11, 13 and 14.)

Visions of television will attract visitors to these stands, where the Baird Television Development Company, Ltd., have on view the long-looked-for combined wireless receiver and television set, due to Mr. J. L. Baird. Tremendous interest has centred around television, and the public have been on the tip-toe of expectancy ever since this Company announced that it proposed to commence broadcasting its own programmes to those who

HOW TO

From the London Termini.
—In every case the various underground systems, although the visitor may have to change trains at certain points, are connected direct to Olympia by means of Addison Road station, to which destination he should book. In many cases direct travel without change of railway can be effected, notably from Liverpool Street, King's Cross, St. Pancras, Paddington (Bishop's Road), Victoria, and Charing Cross.

Underground connection with Olympia can also be effected from a number of points other

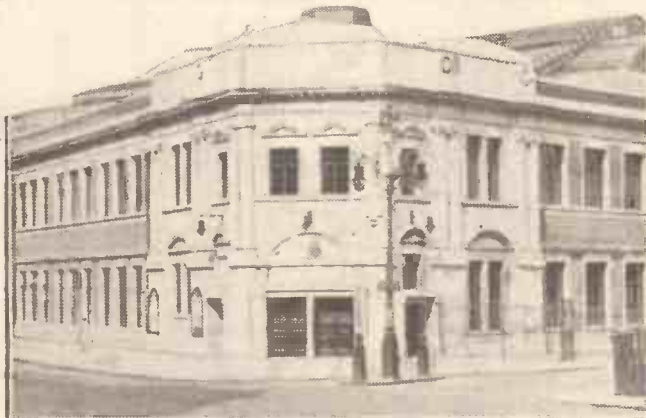

The Home of Exhibitions—Olympia.

—GET THERE

than the termini, either directly or by changing at one or two stations.

By Bus.—A large number of bus routes from various parts of the metropolis actually pass the door of Olympia. The following routes stopping just by the entrance: Nos. 9, 27, 33A, 92, 102, 173A, 206B, and 291. Some pass just over the railway bridge, about 50 yards from Olympia at the corner of Holland Avenue, at which point the visitor to the exhibition should alight.

owned the new Baird dual set. Orders for these combined "Listen and Look" sets will be taken at the Exhibition at Stands Nos. 13 and 14, where full particulars can be obtained.

S. G. Brown, Ltd. (155 and 158.)

All the favourite and well-tried productions of Messrs. S. G. Brown, Ltd., of Acton, are again in evidence this year at Olympia. In addition to old favourites there are several notable additions to the range of this firm's products, and one particularly interesting innovation in the form of the Brown L.F. Transformer. So famous is this

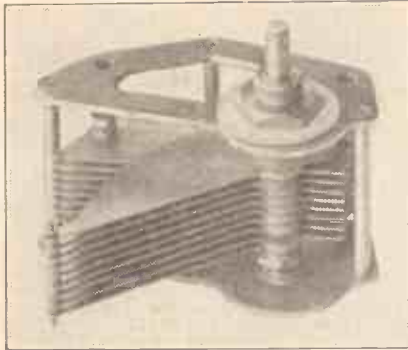

The well-known Dubilier K.C. condenser, an example of a well-made job at a reasonable price.

firm in the loud-speaker line that its entry into a new field of radio research and experiment, as evidenced by the production of this L.F. transformer, will sure to create a great deal of interest. Certainly the transformer will have to be a good one if it is fully to live up to the great reputation associated with the other activities of Messrs. S. G. Brown.

In the loud-speaker field the most interesting newcomer is the Cubist Moving Coil Loud Speaker—a magnificent example of this type of instrument. Another edition of the Mascot Loud Speaker is an interesting innovation, and the name given to this, the "Duckling" (for obvious reasons not the "Ugly Duckling") will, we venture to think, be endorsed by thousands of owners who will look upon this instrument as a Little Duck. This model is being marketed at an extremely attractive price.

C. F. Burton, Ltd. (184 and 185.)

"Simplicity" two- and three-valve sets form the main exhibit on this stand, the receivers being designed with the idea of obtaining the highest possible frequency with simplicity of operation, this being carried out by tuning one dial only. In addition to these there are some long-range three- and four-valve sets which should be examined by all visitors to the stand. Mains units also will be seen on this stand, and will be in two types. The large model for providing more than 25 milliamps and a small model for the two- and three-valver requiring something less than this for satisfactory operation.

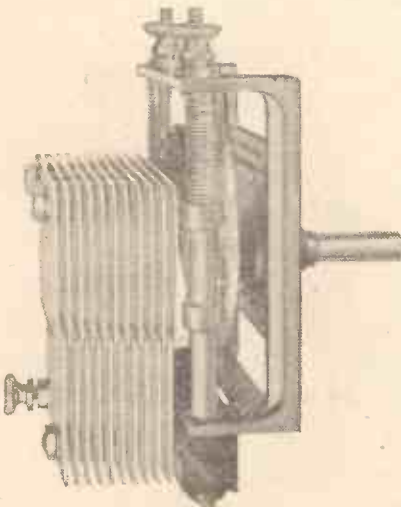

The Ripault lateral-action variable condenser.

British Thomson-Houston Co., Ltd. (86 and 101.)

It will come as a surprise to many that the present range of B.T.H. valves is being augmented by an entirely new range, and B.T.H. valves in future will be designated as "MAZDA" radio valves, after the celebrated Mazda lamps which are made in the same factory at Rugby. The main feature of this new valve is that it embodies a superlative nickel filament, which permits of the electrodes being constructed vertically, thus allowing a longer filament to be inserted, and resulting in greater all-round efficiency.

There is a full and complete range of the valves for the 4- or 6-volt user, and the marking on each of the new valves clearly indicates its purpose and characteristics. At this stand an unusually large number of new products catch the eye, and mention must be made of the sound-reproducing devices of which a most comprehensive range is in evidence. All "quality" enthusiasts should make a special point of inspecting these.

Another extremely important exhibit is the famous R.K. loud speaker, of which several very attractive models are being shown. The Senior R.K. instrument—a wonderful cabinet affair—is now supplemented by two new models called the "Junior R.K." loud speakers. The Junior R.K.1 is a table grand, and the other is a de luxe model. As in the case of the senior model they embody an L.F. amplifier, together with a battery insulator, to enable them to be operated direct from the electric light. Either a radio receiver or an electric gramophone pick-up will operate this equipment, which is certain to prove one of the greatest attractions in the exhibition.

In addition to the complete instruments, the R.K. loud-speaker unit and the Junior R.K. amplifier are available in component form for home construction, the latter being neatly mounted upon a wooden chassis ready for building into the cabinet. Battery eliminators, the B.T.H. pick-up and tone-arm, the B.T.H. electrical gramophone motor and the B.T.H. cone loud speaker are other great attractions here, and in addition there is a complete and comprehensive range of receiving sets as well as components for home construction.

DON'T FORGET
to visit us at
Stands Nos. 135 & 166
to see
The "Olympic" Three
which is fully described in
this issue.

Brownie Wireless Co. (104.)

Many new lines are to be seen on this stand, the main item of which is perhaps the three-valve set. This is contained in an effective mahogany wood polished cabinet, a neatly arranged panel and terminals with all connections at the back. A special feature of this set is the incorporation of an aerial-tuning unit covering 200-2,000 metres wave-length, and operated by a single selector switch which obviates coil changing. It is claimed that from a practical point of view almost the whole of Europe's broadcasting is available using the Brownie three-valver.

Burndep Wireless, Ltd. (112 and 113.)

In addition to a very complete range of complete receivers, a wide variety of accessories and components will be on view at these stands. The short-wave receiver is worthy of special mention, and in addition to the well-known Ethodyne Mark II, there are several screened sets, covering a comprehensive range of wave-lengths, which will sure to prove attractive to purchasers.

Amongst the accessories there are specially attractive loud speakers, and recent radio developments are well represented by the electrical sound-box, portable turntable, auto-transformer, loud-speaker output unit, etc. Components are too numerous to mention in detail, but the Etho-Vernier Dial is specially interesting to the home constructor, who will also find on this stand variable condensers, terminals, transformers, potentiometers, switches, H.F. chokes and a thousand and one other components so dear to the heart of the set builder.

The Camden Engineering Co., Ltd. (152.)

The special features here are the copper and aluminium screens which can be obtained in all varieties of polish, shape and sizes. Screens and boxes for practically every set that have been published in MODERN WIRELESS can be obtained from this well-known firm.

Catesbys, Ltd. (25.)

This firm are showing a representative selection of receivers, forming an interesting exhibit.

Celestion Co., Ltd. (19 and 20.)

The Woodroffe type gramophone pick-up is one of the chief things to be seen on this stand. It is not new, but it should certainly be seen by all those interested in gramophone reproduction. In addition to this, of course, a tremendous range of Celestion loud speakers, which have long been famous on the wireless market, will be shown.

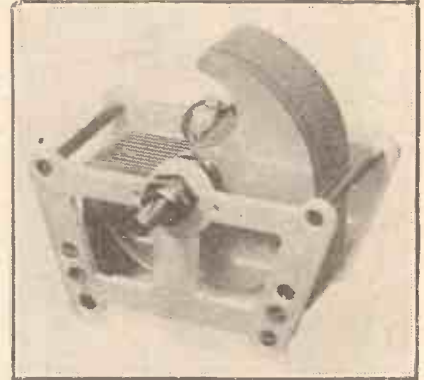

One of the popular Raymond condensers which sells for 6/11 (.0005 mfd.).

Chloride Electrical Storage Co., Ltd. (33 and 40.)

In addition to the full range of Exide Batteries for high- and low-tension wireless purposes, some extremely interesting new lines are on show. Of special interest is the new series of Exide Patent and Mass Cells, specially designed to give maximum capacity in the small space available in modern portable sets, at the same time ensuring that the plates are completely immersed in all operating positions. The well-known mass type of low-tension battery is shown in a full range of both glass and celluloid containers, and in addition there is an entirely new Exide H.T. battery with a capacity of 10,000-milliamper hours, built up of units consisting of 5-cell multi-compartment glass containers.

A selection of loose plates, separators and other component parts will also be exhibited, and in addition to the batteries there is a complete new range of Exide trickle chargers for A.C. mains which will be on exhibition for the first time. These chargers have been designed to fill the long-felt want of a reliable and efficient trickle-charger which can be sold at a reasonable price, so that altogether the Chloride people are making a bold bid for everyone who is considering the problem of current supply.

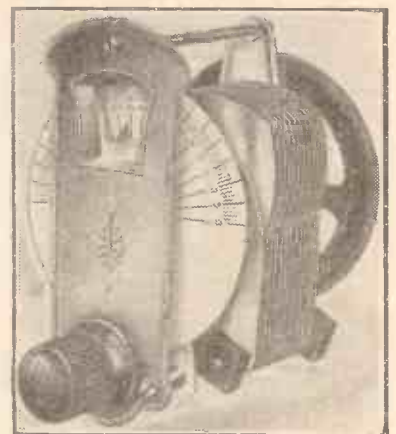

The Lamplugh "Epicyclic Visor" condenser, which is made of aluminium with specially shaped plates.

Climax Radio Electric, Limited, (80.)

Here again an amazingly fine performance is being put up concerning aerial-earth fittings of the most complete description, the famous Climax "chello" loud speaker in various forms, auto-bat units, mains components, chokes, and a new model of portable receiver which can be used for mains operation and of which the price has not yet been fixed.

E. K. Cole, Limited. (48, 49 and 50.)

It is impossible to go through the whole range of E. K. Cole's Ecko eliminators, which need no introduction to readers of MODERN WIRELESS. All sorts, the D.C. and A.C. range, are shown here, while rather than mention any particular one or two of them, it will perhaps be advisable to say go and see the stand and judge for yourself.



One of the new A.F.5 push-pull input transformers made by Messrs. Ferranti, Ltd.

Collinson Precision Screw Co., Ltd. (91.)

The Colvern screened-grid valve holder is one of the new items to be seen here, in addition to an imposing array of Colvern coil formers and coils. The valve holder can be mounted direct on to the screen by means of two screws, clamping the two halves of the bracket together, or the end contact pieces can be arranged so that they are remounted on to the bracket in such a position as to allow the bracket to be passed through the panel or baseboard. This holder is a most convenient item, and is suitable for either the upright or horizontal type screen-grid valve.

Cooks Wireless, Ltd. (254.)

The exhibit on this stand is given wholly up to valve receivers, the largest of which is a five-valve portable or self-contained set which can be obtained in mahogany, complete with turntable, waterproof cover and carrying strap, which is detachable. One special point about this is that all controls are mounted horizontally on a sunken panel at the top of the set, thus making it extremely easy to operate when stood on the ground, no undue stooping being required. In addition to this set is a two-valve popular model, a three and four-valve popular, and a three and four-valve de luxe with revolving shutter front, will be shown. All these models cover wavelengths from 250-2,000 metres, without any change of coil, and all cabinets are of oak or mahogany.



A useful choke which is placed on the market by Portable Utilities, Ltd.

A. C. Cossor, Ltd. (116, 117, 231, 250.)

The Cossor Company are endowed with the meritorious idea of service. First of all they set out to provide a really good radio valve for the public. Having achieved their purpose, they noticed a great many of their supporters found a difficulty in deciding upon the exact kind of set they required, so Cossor's launched out and gave them the famous Cossor Melody Maker—an instantaneous success.

Cossor's have now produced a very handy booklet entitled "How to Get the Best from Your Cossor Melody Maker." It is an extremely interesting production which tells you how to bring in those distant stations, how to look after your battery, how to get greater volume, and, in fact, how to get the maximum enjoyment with the minimum expenditure. Full of hints and tips about the ever-engrossing subject of radio reception, this booklet alone would make a visit to the Cossor stand worth while; but do not forget that at the back of all this there stands the Cossor valve organisation, alive to the needs of the valve user, and catering not only for the ordinary 2-, 4-, and 6-volt straightforward valves for straightforward sets, but also for the latest developments in screen grids, indirectly-heated cathodes, and other triumphs of radio technique.

The Carrington Manufacturing Co., Ltd. (107.)

Housewives, honeymooners, woodworkers, and all those who know a good piece of furniture when they see it, will be found in clusters round the stand of the Carrington Manufacturing Co., Ltd., where all kinds of cabinets are displayed. In view



A really good output choke—the new 28/14 R.I.-Varley instrument which can successfully deal with 100 milliamps.

of their extremely wide popularity, it seems almost unnecessary to praise the Camco cabinets; but even if at the moment you are not expecting to purchase anything of the kind, it is worth visiting this stand in order to see the handsome style in which radio receivers are now being placed upon the market. All the popular designs are here, and there is such a wide variety of style and price that, no matter what your requirements are, you will find something of real interest and knowledge.

Dubilier Condenser Co., Ltd. (102, 103.)

Various types of condensers for high-power radio and amateur transmitting work and ordinary use will be shown, in addition to a tremendous range of components now marketed by this well-known and popular firm. The well-known K.C. condenser will be obtainable in two models, either with vernier dial or without, at prices of 12s. and 8s. respectively. Other models and a rigid variable condenser and neutralising condensers will also be available. Thick mica condensers and Mansbridge condensers, resistance holders, and all the hundred and one little things which go to make up a wireless receiver, can all be found on this stand.

A novel addition to the Dubilier ranks is the Westminster portable radio gramophone receiver, which is a portable radio gramophone costing thirty guineas, and upon which perfect radio reception and perfect gramophone reproduction can be obtained by means of a change-over switch for use with a gramophone or vice versa, the change being made in a second.

The volume of both is controllable, and the set, which is completely portable, contains not only

an aerial but also a gramophone turntable and pick-up, and pick-up arm which fits on top of the box, and the pick-up plug leads into the panel face of the receiver. Another feature is the loud speaker itself, the wooden fretwork being a silhouette of the Houses of Parliament and when the set is switched on the clock face of Big Ben which forms the centre of the speaker mask, is illuminated by a small lamp in the filament circuit.



Messrs. Edison-Swan, Ltd., cover a wide field of components and valves—this is one of their intervalve transformers.

The gramophone turntable and pick-up support are held in a suitable compartment at the back of the cabinet, and the set has the appearance of an ordinary wireless receiver of the portable variety. On the radio side one dial unit operates the receiver.

J. Dyson. (1.)

Famous for Airmax coils and components, Messrs. Dyson are showing a very comprehensive array of accessories. Chief are the Airmax high-frequency choke, Godwinex valve holders, and eliminators of which the new model for A.C. mains should be of exceptional interest. Low-tension accumulators and the Godwinex high-tension battery also demand attention.

Edison Bell, Ltd. (129.)

Portable sets form the chief exhibit here besides a range of various components, the portable sets being of the three- and five-valve variety. Perhaps the "three" should be described as a transportable set, because it is fixed into a cabinet of either oak, mahogany, or hand-painted Japanese lacquer, with a lift-up lid in which the loud speaker is situated. It contains all its batteries in the rear of the set, so it is absolutely self-contained. The portable five-valve one is of the attaché-case type, and weighs only 26 lb. It is capable of receiving

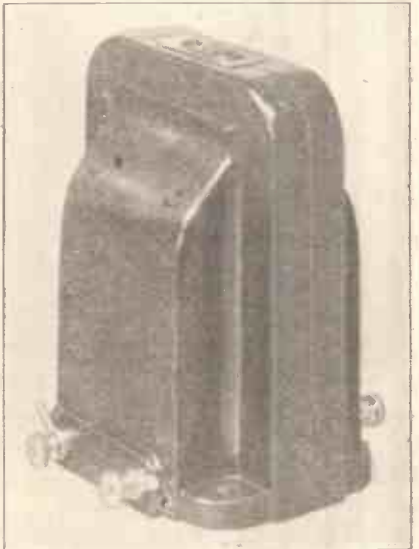

The latest Lissen development takes the form of a really excellent L.F. transformer, as shown above.

on high and low wave-lengths, the change-over being made by means of a switch; and there are only two controls, one for tuning and one for reaction.

J. J. Eastick & Sons. (218 and 219.)

Well known as the manufacturers of Ecelet terminal plugs and sockets, we find once again that this stand has a comprehensive display of these small but very vital components, suitable for the up-to-date wireless receiver.



Small in size, but stout of heart—a C.A.V. 2-volt L.T. unit.

Edison Swan Electric Co., Ltd. (43.)

The famous "R.C. Threesome" has been redesigned, and in its up-to-date form the receiver embodies several striking improvements. The present "A" type unit can now be replaced by an inductor unit, which has the inductance winding for both long- and short-wave mounting, so that by means of a single switch either long- or short-wave broadcasting can be received. Circuit No. R/3, 3-valve resistance capacity coupling throughout, is strongly recommended to those to whom purity of reproduction is of utmost importance, while Circuit No. R/3T, 3-valve with transformer coupling in the last stage, is designed for greater selectivity and volume. High-tension eliminators and L.T. battery chargers combined will be shown on this stand, together with an amazing variety of valves of all descriptions. Chief amongst these must be mentioned the series of screen-grid valves for 2 and 4 volts; the P.V.225, a new 2,700-ohm super-power valve for 2-volt accumulators; the P.V.625, a 3,000-ohm super-power valve for 6-volt accumulators; and a screen-grid valve of the upright variety for 6 volts. A number of the older models of Edison Swan valves have been redesigned and now have greatly improved characteristics. We would certainly advise our readers not to miss this stand, and to pay it the attention which the exhibits here really deserve.



The T.C.C. stand at Olympia displays a bewildering array of condensers.

The Ever Ready Company (Great Britain), Ltd. (44a.)

A wide range of Ever Ready batteries for all wireless purposes has in the past been tested by numerous listeners, and the high reputation which this firm has won will ensure that anything shown upon this stand is well worthy of the attention of the battery buyer. All types of batteries are available, from large low-tension types to small

grid-bias batteries suitable for use in little portable sets.

Particular attention is called to the complete range of high-tension batteries and high-tension accumulators shown by this firm, which in the past has won an extremely enviable reputation in this field (acknowledged to be one of the most exacting that a radio manufacturer can cater for). As one satisfied purchaser was heard to say at last year's Exhibition: "There's one thing about the Ever Ready batteries; they ARE ever ready."

Ferranti, Ltd. (84 and 85.)

It is, of course, impossible to give a complete list in the space at our disposal of the various exhibits put upon the market by this well-known and popular firm. As is to be expected, the main objects to be seen are transformers of all types and varieties. Some of the latest special push-pull transformers, which are fully licensed (and the purchase of which does not render the purchaser under any liability for further licence), deserve careful examination. Audio-frequency transformers, including the A.F.5, are shown, gadgets of all descriptions, wire-wound resistances, and various other components. Besides all these, the Ferranti loud speaker and the Ferranti permanent L.T. trickle charger (which has become very popular during the last few months), radio meters (of which the Ferranti models have earned world fame for accuracy at a low price), and the permanent metal rectifiers and transformers for use therewith, are shown. Also complete instructions for building eliminators from Ferranti components are being published, these eliminators having been most carefully thought out by the Ferranti technical staff, though it is not the intention of the Ferranti Company to provide eliminators giving output voltages greater than 250, as the firm feels very strongly that the practice of re-

When at Olympia be sure to visit

MODERN WIRELESS

—AT—

Stands 135 and 166,

where we shall be showing many famous sets, including the original model of

THE "OLYMPIC" THREE

commending the use of voltages higher than this is likely to be dangerous in the hands of the man who does not know too much about radio or electrical engineering. The Ferranti stand will certainly be one of the most enticing of the whole Exhibition, and none of our readers should miss having a really good look at it.

Forno Company. (140.)

One of the most interesting features upon the Forno stand is the new dual intervalve coupling device which consists of a two-stage low-frequency unit. So far as we are aware there is nothing else of the kind in the Exhibition, for instead of the ordinary R.C. or transformer coupling, it incorporates one stage of resistance impedance coupling followed by a stage of ordinary low-frequency transformer coupling. This unit is very attractively put up for easy insertion in a set, and the fact that its circuit arrangement is a little out of the ordinary need deter no builder, for a very clear diagram of the connections is incorporated as a part of the component, thus making the wiring a very easy matter.

There are many other new Forno products as well as a comprehensive range of already-popular components, but special mention must be made of the new de luxe variable condenser. This is a most intriguing little affair with every evidence of very careful design and workmanship. A particularly pleasing feature is the method of making contact between the moving vanes of the variable condenser and the rest of the circuit, this being carried out very effectively by means of a little concealed pigtail which gives an absolutely unvarying degree of continuity in operation.

G. Forster. (3.)

Advance three-valve portable and transportable sets, all of which are capable of tuning over two ranges of broadcasting, are to be seen on this stand, the change-over of range being carried out by means of a single switch.

Garnett, Whiteley & Co., Ltd. (115.)

With the redesign of screened-grid valves and the introduction of the Pentode valve, portable receivers have taken on quite a different

aspect. Both portable and transportable sets are being exhibited by this famous firm, who are well-known sellers of good-class components.

Both sets are of the three-valve variety, using the Mullard screened-grid valve and a Pentode L.F. valve, the prices of the sets being about thirty guineas each. In addition to these receivers all sorts of components are on show, including mid-line variable condensers, vernier dials, radio jacks, jack plugs, jack switches, push



This type of Philips H.T. unit includes an independent grid-bias supply. It is designed for use with A.C. mains.

pull switches, and all kinds of high-class components of the latest pattern.

General Electric Co., Ltd. (28, 29, 46, 47 and 225.)

Those listeners who have electric light from the A.C. mains will have a great difficulty in tearing themselves away from the G.E.C. stands, as amongst the many attractive items shown here is a complete range of valves for the man with A.C. mains in the house. These new valves are a radical departure from ordinary practice, inasmuch as they are intended to be used without batteries, the whole power coming from the electric light supply. Full details of the valves are available and they should on no account be missed by the man whose situation permits him to take advantage of this latest development in radio progress.

A full range of the Osram valves is one of the main features of the G.E.C. display, and though the ordinary types for standard use are so well known that they hardly need mentioning, the stand is worth a visit on account of the fact that the range is so comprehensive that the valves have to be seen "to be believed." There is no doubt, however, that these new valves will cause a great stir in the exhibition, and the G.E.C. have several startling surprises "up their sleeve" on these stands.

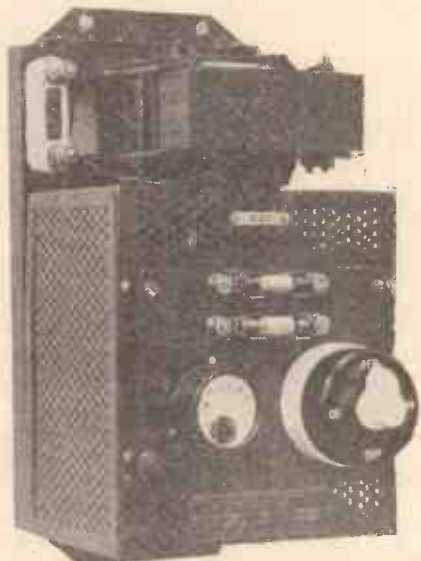

One of the many Westinghouse exhibits—the 12-14-volt, 3-amp. charging unit for 220-volt A.C. mains.

A particularly interesting example is the F.215, which is a new screen-grid valve for the 2-volt user. The current consumption of this valve is only .15, but it has an amplification factor of 170, which means to say that it is an extraordinarily successful distance-tetter. It will be remembered that it was from the Osram stand that the F.625, the pioneer of the screen-grid valves, was introduced last year to the public, and now there is a similar kind of valve for the 2-volt user. The price of the F.215 is 22s. 6d.

Finally, the G.E.C. people are arranging for an Osram Pentode, and these wonderful new 5-electrode power valves will shortly be placed on the British market. Apart from the valves, there is an extraordinarily comprehensive display of the various G.E.C. products which should on no account be missed by the visitor.

George Bowerman, Ltd. (213)

As one would expect, this firm is making a fine show of the "All British" headphones which are claimed to be a masterpiece of perfection, and which are available at the price of 12s. 6d.—a remarkable low figure.



The "Ekco All-Power" unit for D.C. mains.

Goodman's. (289a.)

To the minds of a great number of wireless constructors the name Goodman will be associated with the wonderful quality of reproduction which is only obtained with the moving-coil type loud speaker. Goodman's were one of the first firms to place upon the market loud speakers by means of which the constructor could build for himself a moving-coil instrument of really satisfactory performance, and as the Goodman organisation is continually improving its products, the quality obtainable with the instrument of to-day is really surprising. Of special merit is the special centring device, by means of which the moving coil can be so arranged within the pot that it is assured of perfectly free movement, thus obviating the distortion and the "dither" which accompany any unnatural strain imposed upon the mechanical response of this part of the instrument.

Graham Amplion. (30 and 31.)

So well known are the different Amplion loud speakers, and so great has been the appreciation of their quality of reproduction, that the chief interest in the display at these stands will undoubtedly be provided by the different new models introduced by this firm to meet the most modern requirements of radio reception. All sorts of loud speakers are showing, from the Junior Cone type, which sells at the modest figure of 37s. 6d., to the De Luxe Model for home use, and the enormous power loud speakers for public address system equipment. A particularly handsome model amongst the many engaging examples of Amplion workmanship is a Chippendale Mahogany Cabinet specimen. Full particulars of these and of all the other Graham Amplion lines can be obtained upon application, and as this firm has a reputation for courteous service, a visit to this stand is sure to prove of interest and benefit.



The Ferranti trickle charger which incorporates a dry metal full-wave rectifier.

Halcyon Wireless Co., Ltd. (16, 17 and 18.)

Portable receivers capable of giving consistently good results and reproduction on long or short waves are the main features of this stand, and the improved Halcyon five-valve portable. The complete price of this is thirty-five guineas.

Hart Accumulator Company. (95.)

More and more it is becoming recognised that the heart of radio reception is the provision of an absolutely unblemished current supply to the valve. The Hart Accumulator stand bristles with batteries for radio purposes, and no matter what type of receiver you have, or are thinking of installing, Hart Accumulators are ready to supply the current for it. As this firm has long specialised in this particular branch of radio, the range of products here can be relied upon to provide satisfaction to the purchaser.

Hart Bros. Electrical Manufacturing Co., Ltd. (215.)

Special "Easyfix" battery cords, loud-speaker leads and instrument wires, all marketed under the well-known name of Harbros, are to be seen here and form a very interesting little exhibit.

W. J. Henderson & Co., Ltd. (258.)

Among the new lines to be seen here are four- and five-valve portable receivers, both in attaché cases and as cabinet models, also high-tension battery eliminators, battery switches and other components. The main features, of course, are the portable and transportable receivers which are being shown in various styles, and the battery eliminators for alternating current mains.

Hobday Bros. (173 and 174.)

As one of the foremost wholesalers in the wireless industry, this firm is showing a very comprehensive range of all the latest developments, with a special show of portable sets by leading manufacturers. A special representative or attendant will be able to deal with the various and numerous inquirers who are sure to ask questions of all descriptions at this stand, which is one stocked full of interest.

Houghton Butcher, Ltd. (136 and 137.)

Chief amongst the interesting things to be found here must be mentioned a "Best Seller" competition. This should be of immense help in gauging the requirements of the trade for the



A D.C. model receiver by Simpler Wireless, Ltd. 200/240-volt mains.

coming season, and is being organised for the benefit of the Radio dealer. Cash prizes are being offered to dealers who forecast correctly, or nearly so, the order of popularity of any twelve lines of the Exhibition. Very few lines will be actually exhibited on this stand; those which are exhibited being star lines, having features of special interest to both the public and the wireless dealer.

A. H. Hunt, Ltd. (273.)

Unfortunately the chief line of this well-known firm, namely, the Hellesen battery, is not eligible for Exhibition purposes at Olympia, being of Danish origin, but Messrs. Hunt are making a fine show of safety plugs, loud-speaker jacks, and meters, among other components for which this firm is noted.

Jackson Bros. (105.)

Variable condensers are the attraction of Jackson Bros.' stand, and here is to be found every type of this class of instrument to satisfy the most exacting purchaser. Since last season this firm's experts have devoted the whole of their time to the design of new instruments for the use of really modern and up-to-date receivers. There are a number of new items that are really outstanding in this display, one particularly interesting one being the new Vernier Drum Dial for fine simultaneous tuning.

For those who favour the condenser control of reaction and those on the look-out for a really small but thoroughly efficient condenser of low variable capacity, the new J.B. midget condenser is sure to make a great appeal. This component is supplied complete with a pointer and knob at prices ranging from 4s. 6d. for the .0001 model to 5s. 9d. for the .00025 model, whilst larger capacities can be supplied if required.

In addition, there are all sorts of slow-motion straight-line frequency condensers, and these,

together with the old favourites, make it an extremely interesting display for everyone who is interested in precision tuning.

The Jewel Pen Co., Ltd. (261.)

There is no particularly new line to be seen here, except a very interesting detector which has been made and will be on view. In addition to the permanent detector which is already known, there is a new switch, which has recently been redesigned and is now looked upon as being among the best upon the market.



One of the interesting series of mains units shown on the Cosmos stands (Metro-Vick Supplies, Ltd.).

J. R. Wireless Company. (228.)

Bearing in mind their new slogan for next season, "Buy the coil with the purple winding," we naturally expect this stand to live up to that slogan, and it does in no uncertain fashion. All sorts of coils for every circuit will be seen here.

Junit Mfg. Co., Ltd. (93.)

The Junit Manufacturing Co., Ltd., will be remembered amongst the pioneers of straight-forward soldering, and to them are due some very interesting gadgets designed to simplify the way of the home constructor who is not too well acquainted with the handling and use of soldering equipment. The Junit wire is already well-known and deservedly popular with set-builders, and the Junit soldering iron is sure to create a great deal of interest, incorporating, as it does, a really efficient soldering bolt combined with a gadget for keeping the surface of the iron clean while the operation of soldering is in progress. The newcomer to radio, and those who find difficulty in making a nice job of their home construction, should certainly not fail to visit the Junit Manufacturing Company.

S. A. Lamplugh, Ltd. (81 and 106.)

This well-known firm will again be featuring a comprehensive range of their popular products which in the past have proved so acceptable to the radio public. In addition to former favourites, there will be several improvements on show to keep pace with the latest advances in radio technique, such as the epicyclic visor variable condenser, which is illustrated upon another page in this section.

Lissen, Ltd. (71, 72, 57 and 58.)

The whole range of the famous Lissen products is on view at these stands, and even the most cursory glance at the display cannot fail to reveal to the interested spectator a number of bargains, such as is invariably hoped for when the name of this enterprising firm is mentioned. No matter



Messrs. Partridge & Mee have brought out the above H.T. supply unit for A.C. mains.

what the radio requirement is, this firm seems to have the happy knack of being able to supply it at a price well within the capacity of the average pocket.

All the usual lines are well in evidence, including the ever-popular Lissen Fixed Condenser, which has won considerable credit for itself for its remarkably constant coincidence with the value that is marked upon it. The Lissen New Process H.T. and the Grid-Bias Battery, too, are still going strong, as is also the ever-popular little Lissen Transformer, which created quite a sensation in the Exhibition last year, when it was shown under water, but unimpaired!

Talking of transformers, the new Lissen Super Transformer which retails at 19s. is sure to create something of a sensation. The ratio of this

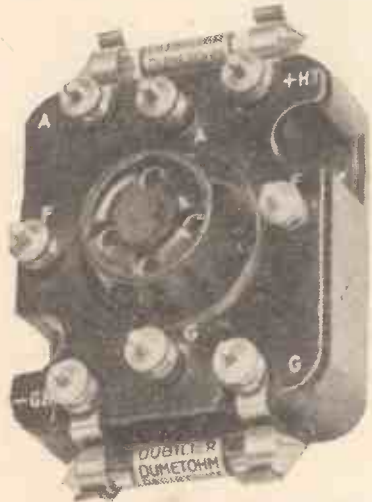

The new Dubilier combination valve holder and R.C.C. unit with interchangeable resistances.

instrument is 3½ to 1, and the results are really super, which for an L.F. transformer at a cost of less than £1 is an achievement that this firm can really be proud of. In order to meet the demands of country and provincial readers who are not able to get this transformer direct from the dealer, the firm has inaugurated an "order by postcard" scheme by means of which the instrument can be sent, cash on delivery, by return of post.

Many other Lissen innovations will catch the eye and lower the pocket at these stands, but particular mention must be made of the new Lissen Vernier Dial, and of the Lissen Variable Condenser, two components which so exactly meet the needs of the home constructor that there was a rush upon them immediately they were

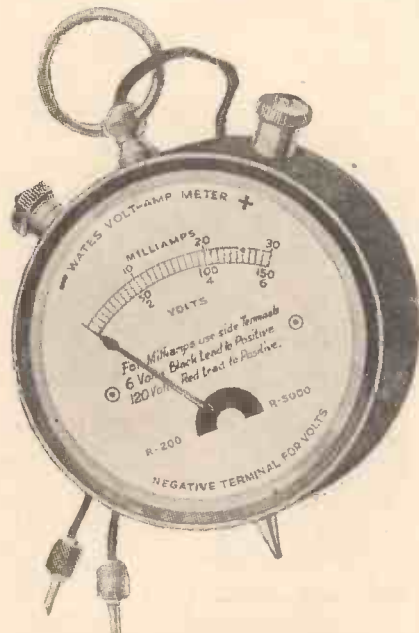

A new addition to the meter world, the Wates combination volt-amp. meter.

introduced to the public. But Lissen's are used to rushes!

For the radio listener who likes to provide his own programme when broadcasting is not on, the Lissen Gramophone is sure to make a great appeal both on account of its performance and price. With this the Lissen gramophone pick-up may be used, (and, of course, the latter may be employed in conjunction with any gramophone, to provide music from the radio loud speaker, with all the volume necessary to provide dance music in a large room, if an ordinary powerful L.F. amplifying set is in use. Not only can volume be greatly enhanced, but the purity of reproduction obtainable with an electrical gramophone arrangement is so exceptionally good that any owner of a gramophone should not fail to investigate the possibilities of this source of music. At the close of the Exhibition last year it was generally acknowledged that Lissen's stand provided one of the most interesting exhibits at Olympia, and there is every reason to suppose that this distinction will again be realised at the present show.

Lectro Linx, Ltd. (236.)

For some years the famous Clix plugs and sockets have had unrivalled popularity in the Radio world, and this year we shall welcome them once more to the show, in addition to several new types and models which have been brought out for this next radio season. At first sight, visitors to this stand may be a little bit bewildered by the mass of plugs and sockets which will greet their gaze, for as the makers say, "There is a Clix plug and socket for every set."

E. J. Lever (Trix), Ltd. (255 and 256.)

Accessories form the outstanding note on this stand, but worth extra attention are the new five-valve portable receivers in leather and mahogany cases.

The Lithanode Co., Ltd. (226.)

Of especial interest to amateurs is the new Lithanode accumulator, which is sold complete with interchangeable parts, i.e. detachable positive and negative slabs, glass container, terminals, etc., and these cells can be obtained for the sum of 7½d. a volt. They enable anybody possessing these accumulators to scrap any cell which may go off colour, and replace it with a new cell without having to destroy the whole block.

Everything in the Home Assembly Accumulator, as it is called, is replaceable, a fact which is of great importance. Other items include different patterns of unspillable accumulators, especially suitable for use in portable sets.

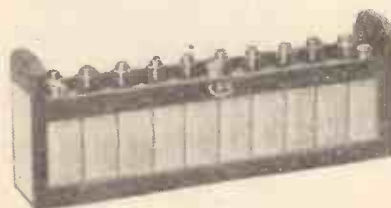

One of the C.A.V. 20-volt H.T. accumulator units (C. A. Vandervell, Ltd.).

London Metal Warehouses, Ltd. (79.)

A full range of aerial wire, copper plain and enamelled, copper and aluminium, together with a comprehensive range of brass couplings, as used for the trade, will be on show here.

The London Electric Wire Co. & Smiths Ltd. (110.)

This famous firm, the manufacturers of Lewcos components, need no introduction to our readers, and it is certain that all MODERN WIRELESS readers will pay considerable attention to the exhibits, which include all sorts of coils and coil formers, and an endless variety of wire.

The Mainten Manufacturing Co. (206.)

This go-ahead little firm, manufacturing battery eliminators, have many new lines to be shown at the Radio Exhibition. All the units, both D.C. and A.C., are capable of working any average set, and are guaranteed. Unwanted coupling in the eliminators is obviated by the use of a fixed resistance for each coupling, which enables a constant output and absence of hum to be obtained.

The Marconiphone Co., Ltd. (59, 60, 61, 68, 69, 70, 232 and 233.)

A new portable receiver is one of the main things to be seen on this series of most interesting stands, in addition to a marvellous display of valves, receivers, and set components, and this portable set is of conventional design and extremely efficient. On test it has given a greater range than any other tested by its makers. A great thing in this set is that the total H.T. consumption is only 7 to 9 milliamperes. A new

short-wave receiver is also added to the range of the Marconi sets, this special model having been very thoroughly tested even to the extent of having been taken on a voyage to Singapore, during which journey regular programmes from 5 S W, P C J J, and American short-wave stations were received. And, of course, valve and components are to be seen in innumerable quantities.

McMichael, Ltd. (128.)

Well-known for their extremely efficient portable receivers, McMichael, Ltd., have now improved these sets by the use of the screened-grid and



The Ferranti combination meter, having three ranges. This is fitted with a switch at the top of the instrument.

Pentode valves. The new 1929 portable represents an outstanding achievement in the application of advanced design.

It can also be obtained as a mains-driven receiver, the whole set being merely connected to the mains in the same way as an electric iron or fan is plugged in. In addition, this firm is putting on the market a specially designed gramophone pick-up, with which it is claimed almost negligible damage is done to the records, and from which point of view special care was taken in the design. The sensitivity is higher than in most instruments, and can be varied to suit individual taste.

Metro-Vick Supplies, Ltd. (32 and 41.)

No wireless exhibition would be complete without the wonderful exhibits to be seen on the Metro-Vick stands. A very great percentage of the exhibits on these stands this year will, of course, be formed by the famous Cosmos mains-operated receivers. Metro-Vicks, for a long time, have specialised in mains-operated valves of the indirectly-heated cathode type, and these receivers represent the last word in Metro-Vick design. In addition, of course, all sorts of components and valves from the Cosmos factories will be on view.



The Ediswan home charger works from A.C. mains and costs £2 17s. 6d.

Mic Wireless Company. (9.)

The new Zampa loud speaker unit, which is said to be an advance upon many of those on the market, is shown here in addition to the Zampa Tamer, while a permanent-magnet loud speaker of the moving-coil variety will probably appear on the market before very long.

Mullard Wireless Service Co., Ltd. (88, 89, 90, 97, 98, 99, 133 and 267.)

Everybody knows Mullard's, and most of us recall that though originally valve-makers, this firm has a knack of scoring successes in other lines of radio production. This year, not only the valves, but the components and the accessories are displayed; so that although the Mullard Wireless Service Co. is one of the largest stand-

demanded in up-to-date receivers. The Oldham range of batteries of all kinds has been designed to cover every requirement of radio, so, no matter in what exceptional circumstances you may be placed as regards re-charging, etc., you can with confidence obtain particulars at these stands of the particular Oldham product which is most suited to supply your needs.

Ormond Engineering Co., Ltd. (138, 182, 163.)

Short-wave enthusiasts who dabble especially on the high frequencies, where very fine tuning is absolutely essential to success, will again be found clustering round the show of the Ormond Engineering Co., who are famous for their success in catering for tuning devices. Variable condensers of every type are to be seen here, and not only is there a wide and complete range for tuning, neutralising, reaction, and all the various circuit requirements, but there will also be found here slow-motion dials and other requisite paraphernalia.

and, in addition to lines which have scored successes in the past, there are a number of new and interesting features. Long experience of catering for radio requirements has enabled this firm to meet the needs of the set-builder to a nicety, with the result that a very large number of the components are of the "just-what-I-need" variety.

As in the past, coils and condensers are a very strong feature of the display, some of the condensers being particularly pleasing in their compactness and in their smoothness of operation.

Portable Utilities, Ltd. (144.)

Eureka! This stands for everything that is good and reliable in radio components, so that Messrs. Portable Utilities, Ltd., are sure of a good crowd of enthusiastic constructors on their stand.

Besides the very well-known Eureka condensers transformers, and so on, several interesting new lines are making their appearance at Olympia on the 22nd, noteworthy of which are the three- and four-valve receivers and a special mains transformer and mains choke. The three- and four-valve sets, known as the Orthodyne, are of the portable variety, and are claimed to have amazing efficiency. On the three- over thirty stations, several of which have been received at good loud-speaker strength; have been logged without external aerial or earth. At twenty-five guineas for the three-valver and thirty guineas for the four, these receivers should command a ready sale among flat-dwellers and people who wish to instal this type of wireless receiver. The range of the four-valver seems to be something unlimited, as every one of the well-known European stations, as well as several Americans; have been received at good loud-speaker strength. In spite of the sensitivity, only two tuning dials are included on the set, together with a volume control which enables the strength of reception to be varied; and the change from long to short waves, and vice versa, is done by convenient switching.

The Radiarc Electrical Co., Ltd. (6.)

The popular Liberty Supersonic unit and battery eliminator, already well known to the public, of course takes a prominent position on this stand, and is accompanied by a new gramophone pick-up and a complete gramophone amplifier.

Rees Mace Manufacturing Co., Ltd. (268.)

The Pentode three-valve portable receiver, using one stage aperiodic H.F. and detector, with a Pentode L.F. and the double-cone loud speaker, forms the main exhibit here. Also another set, of the same dimensions as the Pentode three, and incorporating two aperiodic H.F. stages, an L.F. and a power choke-coupled stage with the loud speaker, and a grand model five-valve set will be on view.

Records, Ltd. (173.)

Portable receivers of various descriptions and a new Crystophone loud speaker are shown on this stand.

(Messrs. Crystophone have taken over the Pelican four-valve portable set which used to be placed on the market by Messrs. Cahill and Company, Ltd.)

L. H. Reid and Company. (214.)

Gripso Bakelite Indicating Terminals, with changeable labels, spade ends, thin ends, wander plugs, etc., will be shown on this stand.



The B.T.H. "R.C.C." Unit comprises also a spring valve holder. The unit can be had in a variety of resistance values.

holders in the Exhibition, there is not a square inch of space too much to show the representative lines which make up the activities of this enterprising and successful concern.

First and foremost, of course, are the valves; all sorts, all kinds, for all voltages, all types of sets, and all pockets. As well as a remarkably fine range of valves for ordinary purposes of reception, there are all kinds of special valves, screened-grid valves, Pentodes, etc., to delight the heart of the keenest radio enthusiast. Builders of the "Master Three" will find themselves catered for with exceptional thoroughness, and so comprehensive is the display that the visitor is almost obliged to collect literature obtainable at this stand, for he cannot hope to observe all the interesting tit-bits that are exhibited for his benefit here.

Oldham & Son, Ltd. (125 and 128.)

This firm, long and firmly established in the public favour, is showing a large variety of batteries of all kinds for radio purposes. No matter what your radio requirement may be in the way of current, whether for lighting the filaments of a multi-valve set or of a small low-consumption portable receiver, you will find that these stands are representative of a range of batteries suitable for supplying exactly what you require.

In addition to the larger accumulators for which this firm originally became popular with radio men, a speciality is made of high-tension accumulators designed to give an absolutely steady voltage and current of the kind which is absolutely essential to the perfect quality

A.C. valves are rapidly becoming popular and the example illustrated here (Cosmos) is typical of the best of the indirectly-heated cathode types (Metro-Vick Supplies, Ltd.).

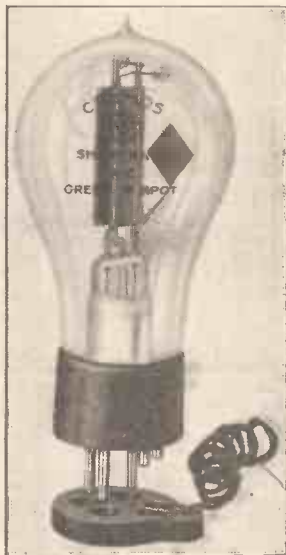

E. Paroussi. (272.)

Parex products have for some time been known to our readers, and a fine show is made on this stand, valve holders, all types of screen-grid valves, junior valve holders, screening boxes, copper screens for the new H.F. unit, and special coils for all circuits being laid out in a tasteful scheme.

The Parex screened-grid valve holder, by the way, is now made to fit not only the old S625 Marconi and Osram screened-grid valve, but it is also suitable for the new upright four pin types of S.G. valves being placed on the market by a number of valve concerns.

Peto-Scott, Ltd. (142 and 143.)

A very wide and attractive range of components is exhibited at the stands of Peto-Scott, Ltd.,

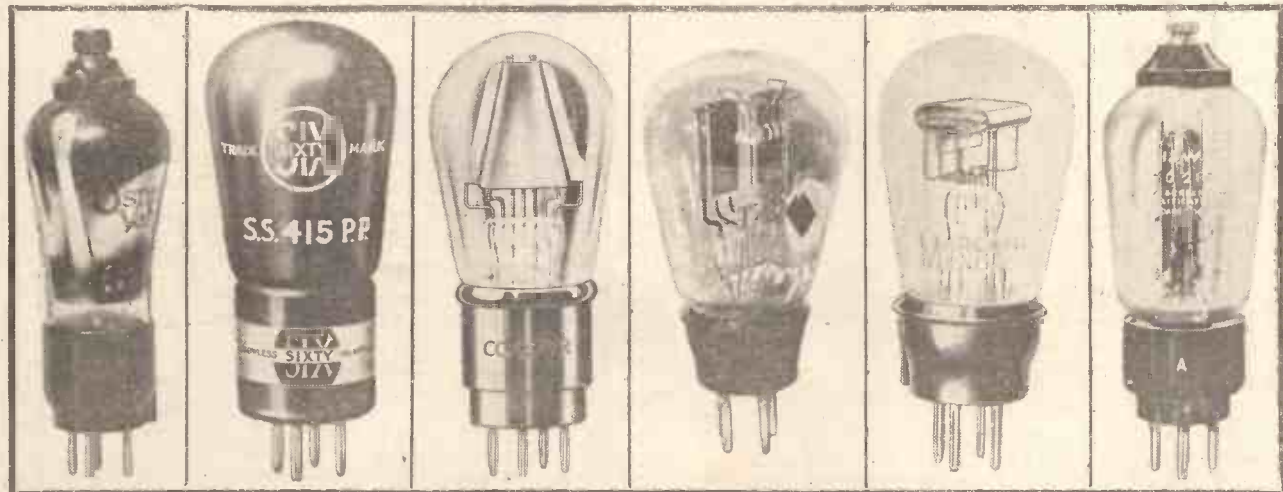

An interesting range of valves. Left to right—the new Osram 2-volt screened-grid valve; the 4-volt power valve marketed by the Electron Co.; the Cossor Stentor Six, an old favourite; the U.5 (Marconi), a full-wave rectifier; a Marconi 2-volter, and the Ediswan screened-grid 2-volt H.F. valve.

The Regent Radio Supply Company. (62.)

Dependable battery eliminators for A.C. and D.C. mains form the chief attraction on this stand, all sorts of models available from prices of £2 10s. to £19 10s. being on show. This latter model has a continuously variable output giving 0 to 100 volts, one higher still, and one 400 volts, giving an actual maximum D.C. output of 400 volts and 100 milliamps, and incorporating a rectifier. This is obviously suitable for even the largest receivers.

In addition there is a high-tension and low-tension model for £14 10s., giving a total of 200 volts H.T., and 2 to 6 volts L.T. at half an amp.

Ripaults, Ltd. (24.)

The main features on this stand are the special lateral action condensers and the new ebonite panels. The condenser is well known to our readers, having been incorporated in quite a few sets. In addition, of course, there is a series of H.T. batteries and new drum-drive condenser complete with a front panel cover plate.

Siemens Bros. and Co., Ltd. (164 and 165.)

The name of Siemens Bros. and Co., Ltd. of Woolwich, has been for over fifty years associated with the production of primary batteries, and at these stands is a very comprehensive and representative display of those products. In the way of small-capacity H.T. batteries there are both standard and popular types, whilst for large-capacity H.T. batteries there is the power type which is capable of supplying quite a heavy current such as is required by the powerful type of multi-valve receiver of to-day. For super-quality receivers there is the extra-large-capacity super-radio battery, and in addition there are high-capacity batteries for portable sets.

A special section of the stand is devoted to batteries for overseas, which should prove of particular interest to the export trader and buyers who anticipate going abroad, or who are interested in the provision of radio reception under the trying conditions obtaining outside this country. In addition to provision for grid-bias and L.T. requirements, a very interesting line of radio testing instruments is on view here.

Another interesting feature of the exhibit is the display of ebonite in the form of sheets, mouldings, etc., a number of samples of which will be shown. The Company have had very considerable experience in the manufacture of this material, and enormous quantities are turned

out annually from the Siemens' factory at Woolwich.

In conclusion, the fact that the Siemens' batteries are of British manufacture throughout is well worth mentioning.



The B.S.A. large cone model is a powerful loud speaker of the ornamental type.

Mainly noted for their variable condensers, this firm is introducing a new drum-drive variety complete with a front panel cover plate. A compact neutralising condenser of new design will be shown; it is said to be an advance on the models now on the market.

Sylvex, Ltd. (175.)

In addition to the Sylvex synthetic type of crystal and the permanent detectors made by this firm, the new Sylvex cone material, retailed at 1s. 6d. per envelope, is introduced to the public at this exhibition. This material is very strong and is said to be better than most of the fabrics now on the market.

The Telegraph Condenser Co., Ltd. (121.)

It is difficult to remember when this firm did not exist, for they were in being long before the days of wireless or broadcasting, and any mention of fixed condensers, especially of the large variety, always conjures up before one's mind the initials T.C.C. Consequently one is not surprised to find fixed condensers are the exhibits on this stand; condensers of all sizes and kinds up to several hundred mfd. will be shown. In this group, also, will be introduced a new mica fixed condenser, also transmitting condensers of various sizes will be shown, including those for high-frequency work and able to stand pressures up to fifty thousand volts. Battery eliminators and high voltage condensers and also electrolytic condensers of the new type suitable for working on voltages not exceeding twelve will be shown. This should prove a very instructive and fascinating exhibit to many, and should certainly not be missed by any of our readers.

Thomas de la Rue & Co., Ltd. (235.)

The exhibit here generally is a very comprehensive display of Bakelite, fireproof and plastic mouldings. They are produced by modern multi-way methods at the rate of many thousands per week per article from hardened steel dies. To demonstrate the vast capacity of this firm mouldings from 1/2 in. diameter up to 3 ft. 6 in. are shown, and special attention should be given to the range of upwards of twenty-four types of moulded low-tension battery boxes, suitable for accumulators of from 2 to 12 volts. Readers will find this a very interesting stand and should not fail to visit it.

Trelleborg Ebonite Works, Ltd. (224.)

Turned and machined components manufactured from Trelleborg's genuine ebonite, including panels, aerial lead-in tubes, and all sorts of shapes and sizes of work will be shown on this stand. A new feature of Trelleborg ebonite is the wavy surface similar to that of moiré silk which gives a completely new appearance to any receiver.

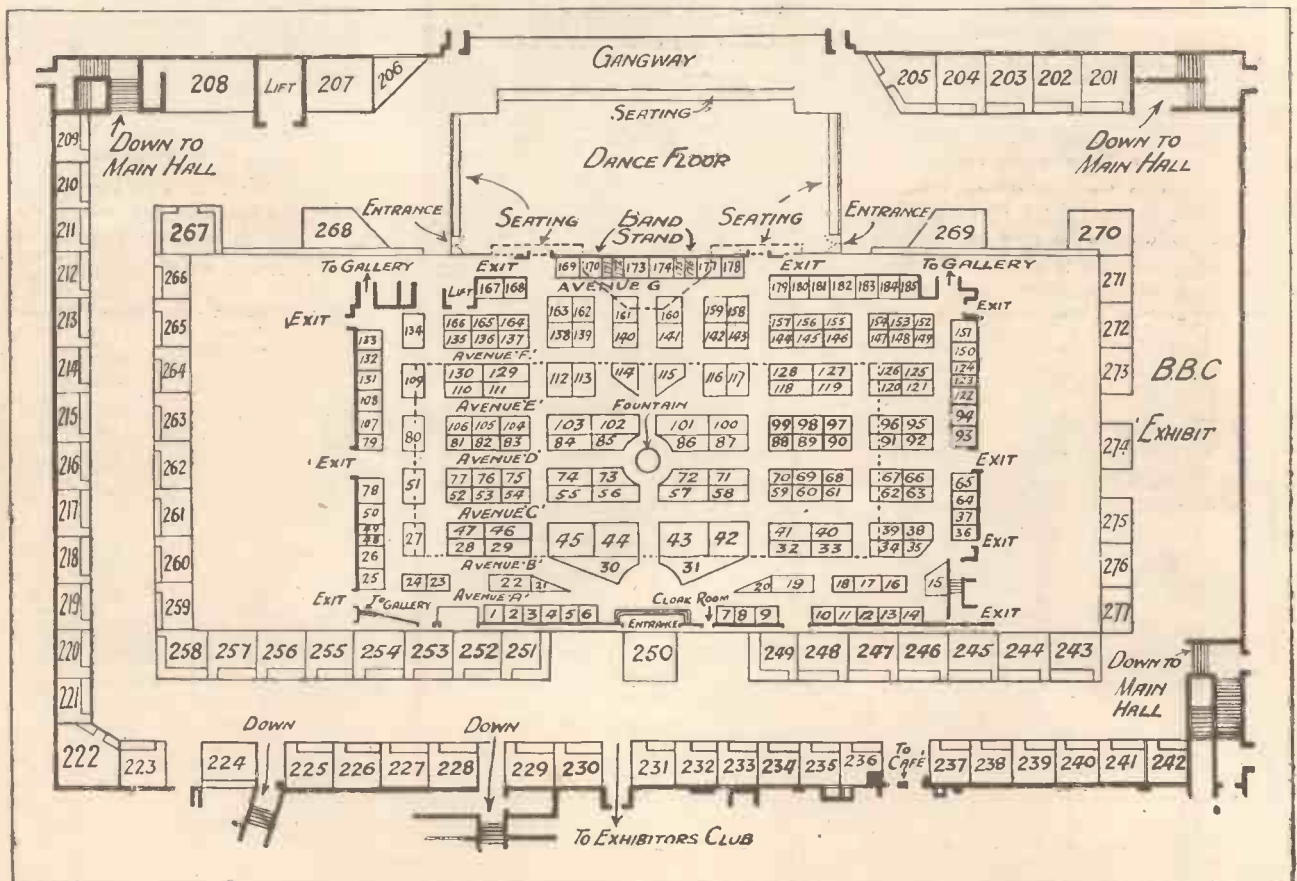

The Tudor Accumulator Co., Ltd. (249.)

Although comparatively newcomers to the Radio battery field, this company is one of the best known manufacturers of batteries for the heavier branches of electrical engineering, particularly in connection with large power station



The G.E.C. Gecophone cabinet cone loud speaker, Model B.C.1694.

batteries. This is the first time they have shown at Olympia, and are providing an exhibit of very comprehensive type, covering sixty types of low- and high-tension batteries. These include a standard range of two-, four- and six-volt batteries in celluloid cases up to twenty ampere hours capacity, and H.T. batteries in twenty, forty, sixty and eighty-volt units are also being shown, together with 2,250 and 4,450-milliamper-hour 7-volt model units of the new type, for which it is claimed a complete elimination of all the usual battery troubles.

Turner & Co. (234.)

Radio components in various forms will greet the constructor here, including the new tuner, which consists of a tuned circuit and reaction circuit in one unit, being mounted at the back of the panel.

C. A. Vandervell & Co., Ltd. (114.)

A bewildering array of batteries of both high- and low-tension type, ranging from 4s. 6d. upwards, will be shown here. The new massed



The Brown Universal type loud speaker, one of many models by the same firm.

plate L.T. accumulator being a novel feature. This type of battery is recommended for operating dull-emitter valves and other apparatus requiring low rates of current, and is sold in two-volt units, having an actual capacity of twenty ampere hours. It is supplied in dry-charged condition and only requires to be filled with acid to make ready for immediate use.

R.I.-Varley, Ltd. (56, 73 and 222.)

It is impossible to give anything but a very brief idea of the various new things shown on this stand. Perhaps if we mention the chief ones it will be the best guide as to the activities of this

firm. The complete range of Westinghouse Rectifier Generator Units, both H.T. L.T., and also H.T., L.T. "Grid-bias" are shown, the Rectifiers being sold separately if desired. Another new line is a new Power transformer, giving 350 volts and 100 milliamperes, suitable for use with the R.H.I. A new L.F. choke, the 28/14, giving from 28 to 14 henries inductance when it has 0/100 milliamperes, passed through it.

A new pick-up, having little mechanical resistance to needle vibration, and what is known as plectrum, or dual mass suspension, thereby lessening the wear on the record to a minimum amount, are also among the main items which are brought out for the first time this month.

Watmel Wireless Co., Ltd. (157.)

In addition to the already well-known Watmel components, an all-mains receiver complete with gramophone pick-up is to be on show at this stand and should be carefully examined by all visitors to Olympia.

The Western Wireless Co. (262.)

Here an interesting range of components is being shown, all of which will be available for cash or hire-purchase from this well-known Ealing wireless firm.

The Westinghouse Brake and Saxby Signal Co. (78.)

Among the new lines being introduced by this firm is the low-tension metal rectifier, Type A3. Another new line is the H.T. unit, which is suitable for an output of 300 volts and 1 amp., and has



A Six-Sixty cone loud speaker which is becoming very popular. (Electron Co., Ltd.)

been placed upon the market in order to satisfy the demands of users of L.S.5A valves. Another use to which these eliminators can be put is the excitation of the magnet windings of moving loud speakers for which the Westinghouse unit is specially suitable.

Wilkins & Wright, Ltd. (153.)

Many new lines are being shown by these manufacturers, famous for their "Utility" components; special features being a new anti-capacity switch, drum-control condensers, drum-control plain dials, vernier dials, and aluminium shielding boxes and panels, and also a special combined drum control with vernier dials giving a ratio of twelve to one. And besides all this you will see the full range of "Utility" components—too well known to need description here.

Williams & Moffat, Ltd. (265.)

Manufacturers of Simpicon Radio products, Messrs. William and Moffat have redesigned their short-wave receiver, the new design of which is on view at Olympia, and incorporates several new features to ensure efficient working; also a condenser with ball-bearing spindle of extremely rigid construction and a low price is being shown. For use with this condenser a new vernier drive, which is also adaptable to other types of condensers, is provided and is available in two different ratios of either 100 to 1 or approximately 260 to 1 upon special order.

Wright & Weaire & Co., Ltd. (251 and 252.)

The Wright & Weaire stands are in the gallery of Olympia, and although the ardent purchaser

may have wearied somewhat by the time he reaches the gallery, his eyes will brighten when he sees the many bargains which are on view there. For instance, at the two stands occupied by this well-known firm we find a galaxy of interesting components, including some new fixed condensers, plugs, and jacks, wire, a very efficient anode filter unit, a new type of neutralising condenser, and a series of clip-in wire-wound resistances of exceptional interest. There is also a high-frequency unit suitable for connecting to any standard set.

Coils are another strong line of this firm, and it is noteworthy that the Wearite people specialise in the supply of complete sets of coils for the

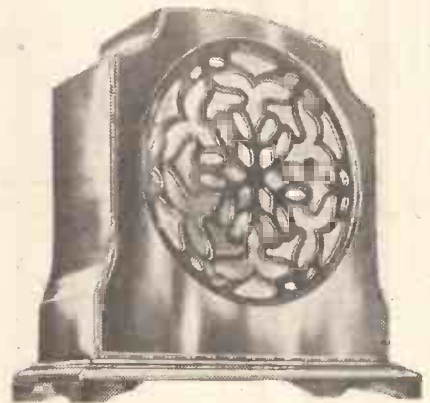

One of the many interesting loud speakers made by Graham Amplion, Ltd.

various poplar receivers which have been described from time to time in MODERN WIRELESS.

Of very exceptional interest, too, is the Wearite flux gun, which packs into a repair kit as easily as a soldering iron. This instrument has a long, fine nozzle which will reach any possible place of your set where your fingers cannot get, and there it deposits just the correct amount of flux—little or much, just as you desire—at the very centre of operation. By any of the old-fashioned methods, up to 50 per cent of the flux is wasted by being accidentally applied to the components, fingers, etc., but with the Wearite Flux Gun every drop of flux can be used up and there is no need to throw away half a tin of flux because of matches, pieces of wire, etc. The price of this handy little gadget is only 1s. 6d., and beside it you will find the Wearite Wire Winder, another extremely handy little device, also of outstanding merit and interest to the set builder.



A suitable companion to the "Master Three" is the Mullard "Pure Music" loud speaker, which has the novel feature of alternative impedances which are provided by the three loud-speaker tags.



Questions Answered

Valves in Parallel

A. T. (Longbridge).—"I have a low-frequency amplifier normally consisting of an R.C. stage followed by a transformer and choke-filter output. I have recently connected an additional valve holder so as to be able to employ two output valves in parallel.

"I notice that when the second output valve is inserted the milli-ammeter reading does not become double. Does this indicate a fault?"

If you are using a filter choke of the standard medium duty type it is probable that it has a D.C. resistance of about 300 ohms or so. Naturally a drop in volts takes place across the winding, since by Ohm's Law the voltage drop is equal to the current in amperes multiplied by the resistance of the choke in ohms.

When you insert the second valve the current increases, and with it the voltage drop, because the D.C. resistance remains constant.

This voltage drop produces a decrease in the anode voltage applied to the valves, and so you will see that the anode current cannot be doubled unless the H.T. voltage is increased upon the insertion of the extra valve.

The "Constant" Three

G. T. K. (Weybridge) is in some difficulty with the coils for the "Constant" Three, described by Mr. Dowding in the September issue.

There are two coils in the set, viz., an aerial coil and an H.F. transformer. The secondary windings are in two halves of 40 turns each, laid on in opposite directions. The primary winding of the H.F. transformer is also wound in two halves over the secondary. The words, "Same on all three units," which occur in the coil data on page 238 of the September issue, do not apply to the coils used in the "Constant" Three, but the actual data itself is perfectly correct.

Spark Interference

F. B. (Margate) is troubled with severe Morse interference from ships in the Channel and nearby coast stations.

He asks whether there is any simple remedy for this nuisance, since whenever he listens to 5 G B he suffers from continuous spark interference.

We are afraid that this trouble is one of the most difficult to overcome. Even with a highly selective receiver it is practically impossible to cut out these spark transmissions.

THE TECHNICAL QUERIES DEPARTMENT

Are you in trouble with your set?

Have you any knotty little Radio problems requiring solution?

The MODERN WIRELESS Technical Queries Department has been thoroughly reorganised and is now in a position to give an unrivalled service. The aim of the department is to furnish really helpful advice in connection with any radio problem, theoretical or practical.

Full details, including the revised and, in cases, considerably reduced scale of charges, can be obtained direct from the Technical Queries Department, MODERN WIRELESS, Fleetway House, Farringdon Street, London, E.C.4.

A postcard will do: on receipt of this all the necessary literature will be sent to you free and post free, immediately. This application will place you under no obligation whatever. Every reader of MODERN WIRELESS should have these details by him. An application form is included which will enable you to ask your questions, so that we can deal with them expeditiously and with the minimum of delay. Having this form you will know exactly what information we require to have before us in order to solve your problems.

A wave-trap may help matters a little, but F.B.'s best plan is to listen to 5 X X on 1,600 metres, and in addition to do all he can to improve the selectivity of his set by increasing the number of tuned circuits.

Improving Selectivity

H. D. (Dartford).—"Three years ago I built a detector and 2 L.F. receiver with a simple parallel-tuned aerial coil and magnetic reaction.

"The receiver has given every satis-

faction, but I do not find it sufficiently selective for modern conditions. What can I do to improve this state of affairs without seriously modifying the set?"

Your simplest scheme, H.D., is to purchase a No. 60 "X" coil and to insert this in the aerial socket in place of the existing aerial coil. Connect the aerial lead direct to one of the tappings on the "X" coil.

There is one point to note, and that is the pin of your coil-holder (i.e. the socket of the coil) must be connected to earth, the grid end of the circuit being joined to the socket of the coil holder.

You will probably need a smaller reaction coil. A No. 250 "X" coil should be used for 5 X X and similar long-wave stations.

Short-Wave Reception

R. T. (London).—"I am very interested in short-wave reception, but I am not in a position to erect a good outdoor aerial. Do I stand any chance of hearing such stations as 2 X A D, etc., on an indoor aerial?"

Yes, every chance, R.T. An outdoor aerial is not necessary for short-wave reception. Usually a length of wire across a room is quite adequate, and if used in conjunction with an efficient 2- or 3-valve short-wave receiver should bring in a number of stations at good strength. Usually it will be found that an outside aerial is no advantage on wave-lengths in the neighbourhood of 20 metres.

Interaction Between Aerials

C. P. (Eltham) states that when his neighbour switches on his set his signals are badly weakened and frequently become very distorted. He asks whether there is any remedy for this kind of interference.

Cases of this kind, cannot, as a rule, be cured by one party only, but the co-operation of both parties concerned is desirable. The trouble generally arises from the use of small sets which necessitate the use of a large amount of reaction, and as a rule the only certain cure is for both parties to build larger sets, preferably employing neutralised H.F. stages. Sometimes a cure can be effected by making sure that a different earth is used by each receiver, and sometimes the use of a small condenser in series with each earth lead will improve matters.

The only really direct cure is to separate the aerials to as great a distance as possible, and to refrain from using reaction even in such a way as to cause the set almost to oscillate.

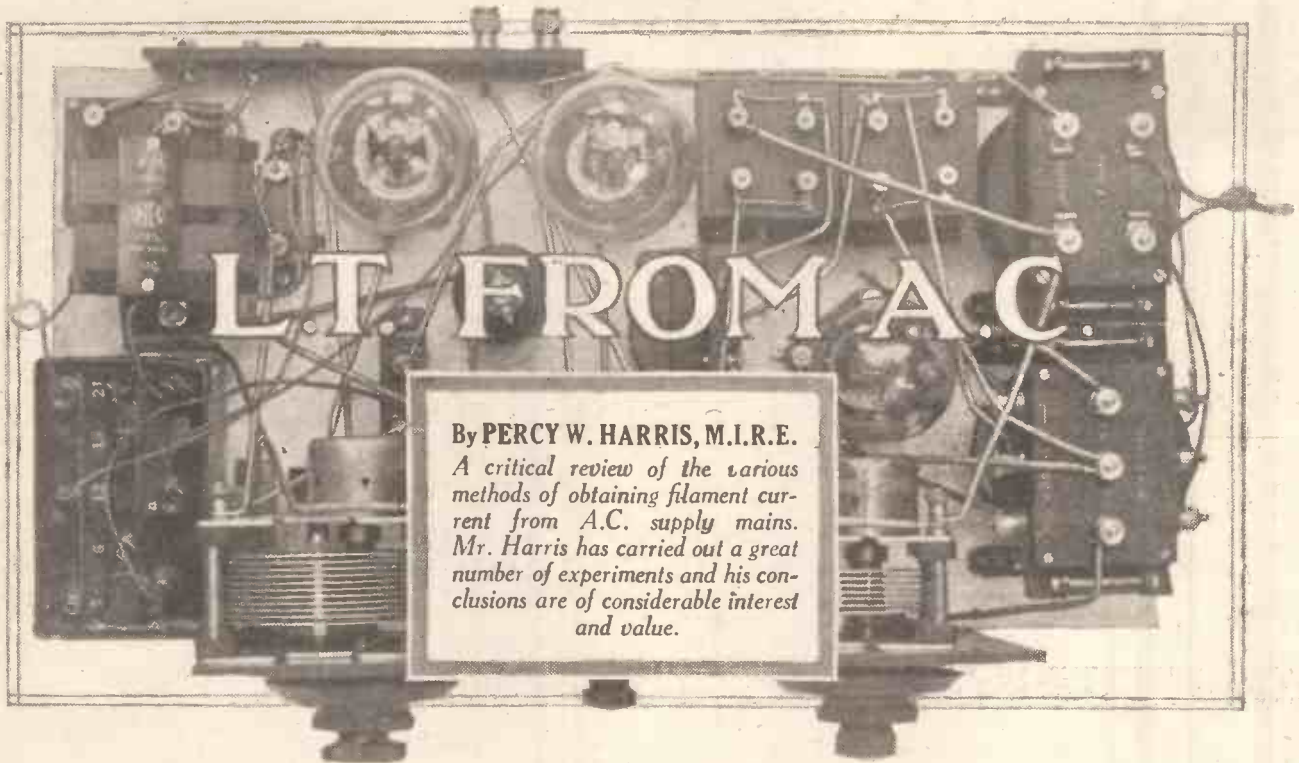

By PERCY W. HARRIS, M.I.R.E.

A critical review of the various methods of obtaining filament current from A.C. supply mains. Mr. Harris has carried out a great number of experiments and his conclusions are of considerable interest and value.

It is significant that almost the first question asked by the newcomer into the radio field is: "Why cannot I run my set entirely from the electric light system?" To the uninitiated this seems the obvious source, for as the filaments are lit by electricity, and an electric current is required to supply the need of the

mains, I shall confine myself to the practical side of the subject and explain how the sundry difficulties can be overcome.

Three Methods

There are three methods of running valve filaments from alternating current mains. These methods can be classified as follows:

1. Using special valves, using either (a) indirectly-heated cathodes, the heaters being run from the A.C. mains, or (b) Filaments run on raw A.C. but specially designed (usually with a high current at a low voltage) to maintain as far as possible a uniform heat with the fluctuating A.C.
2. Using "raw" alternating current on ordinary valve filaments, and
3. Using rectified and smoothed alternating current having characteris-

tics strictly comparable with the direct current supplied from an accumulator.

Of the above, No. 1, namely, the use of special valves with indirectly-heated cathodes, is already in practical use, for satisfactory indirectly-heated-cathode valves are now obtainable from several manufacturers. Valves

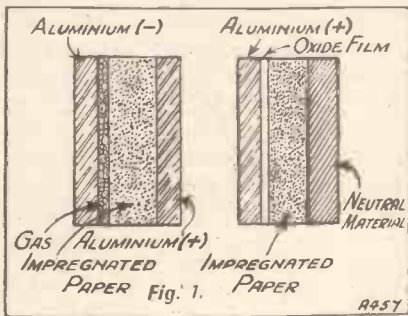

valve's plate circuit, why not take it all from the ubiquitous house supply?

I have never found it really easy to give a satisfactory and convincing non-technical answer to the question, for the difficulties which I am bound to point out sound so very easy of solution.

The Whole Problem

However, the majority of these difficulties are fully appreciated by readers of MODERN WIRELESS, and as it is the purpose of this article to record the results of my experiments and observations on the whole problem of running valves from A.C.

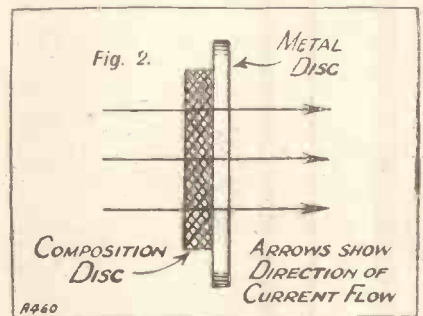

of this kind have been described from time to time in these pages, the first of these to become popular being the Marconi and Osram K.L.1. In this valve (which is shown in the photograph at the head of this page) the filament current is two amperes at 3.5 volts, while the K.H.1, a valve of higher impedance, has the same current and voltage.



The Westinghouse R4-2-2 unit.

A.C. Adaptations

The makers of the Cosmos valves supply two interesting examples of A.C. valves with a filament current of one ampere and a voltage of four, and excellent sets can be built up using

one or other of these makes. I should not be surprised if, by the time this article appears in print, other valve makers also are supplying the public with A.C. operated valves

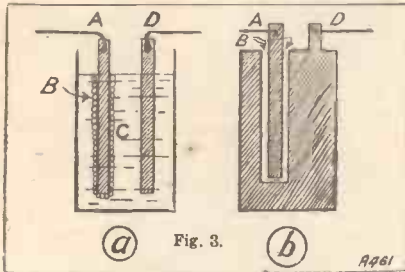

of the indirectly-heated-cathode variety. In order to run a set in this way it must either be specially wired for the purpose, or special adaptors must be fitted.

Good Transformer Required

In addition to the valves, one requires a transformer for stepping down the A.C. voltage from that of the mains to that required by the filament. The transformer must be well designed and must have good "regulation," by which is meant that the voltage must be substantially constant, at any load likely to be imposed upon it. To make this point clearer it should be explained that a poor transformer may supply, say, two valves at four volts, but the addition of a third may drop the voltage down to three.

Equally, a transformer which is giving four volts to three valves may give a dangerously high voltage to the heater if the third valve is switched out. A properly designed transformer will, however, give substantially the same voltage under all reasonable loads.

Although it is generally recommended to fit a potentiometer across the low-tension side of a transformer and to earth approximately the centre point through a condenser, this is not always necessary.

The Question of Cost

On the question of cost, these valves, at the time of writing, are sold at 22s. 6d. each, and thus, considering a three-valve set, the minimum cost of valves will be £3 7s. 6d., to which we must add the cost of a suitable transformer and possibly a potentiometer.

I should put the minimum cost of the additional parts (other than valves) necessary when operating on A.C. at £1, so we can say that three valves, plus the additional parts, will cost roughly £4 7s. 6d. I should say in fairness, however, that the actual efficiency of these A.C. valves is very high, the mutual conductance being usually much better than that of the ordinary types of accumulator-run valves.

Very excellent accumulator-heated valves can be obtained at 10s. 6d.

each, or 12s. 6d. for the output stage, so that, considering a three-valve set with ordinary accumulator-run valves, £1 13s. 6d. represents our total cost for valves, and no additional parts required. We are thus £2 14s. to the good when using accumulator-driven valves, or, put the other way round, if we want to change from an accumulator to A.C. valves it is going to cost us another £2 14s.

Obviously, to the man who is starting at the beginning, an accumulator has to be bought, but even so it will be considerably cheaper to buy an accumulator and suitable valves than A.C. valves and the transformer. On the other side of the balance sheet we must set off the great advantage of having no worry about falling voltage, or recharging troubles.

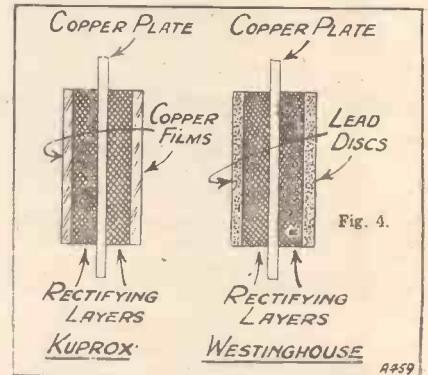

Both types of valves will have to be renewed after a time, and it is rather early to try and compare the average life of an A.C. valve with the average life of the older type. It should be remembered that while accumulators deteriorate, the transformer used to supply these valves will be as good as new when the accumulator is entirely worn out. There are thus advantages and disadvantages in both systems.

Carrying the Current

As we go up in the number of valves so will the A.C. valves become relatively more and more expensive, and with a multi-valve set running with these indirectly-heated-cathode valves of the present type, the actual filament current handled by the set wiring will be quite large. For example, with the K.L. type of valve taking two amperes, a five-valve set has to carry an L.T. current of ten amperes. This is a great deal, and good joints and heavy conductors are essential. It is, however, unnecessary to run all 2-ampere valves, as one can arrange, as will be explained later, to run the output valve from raw A.C. quite satisfactorily.

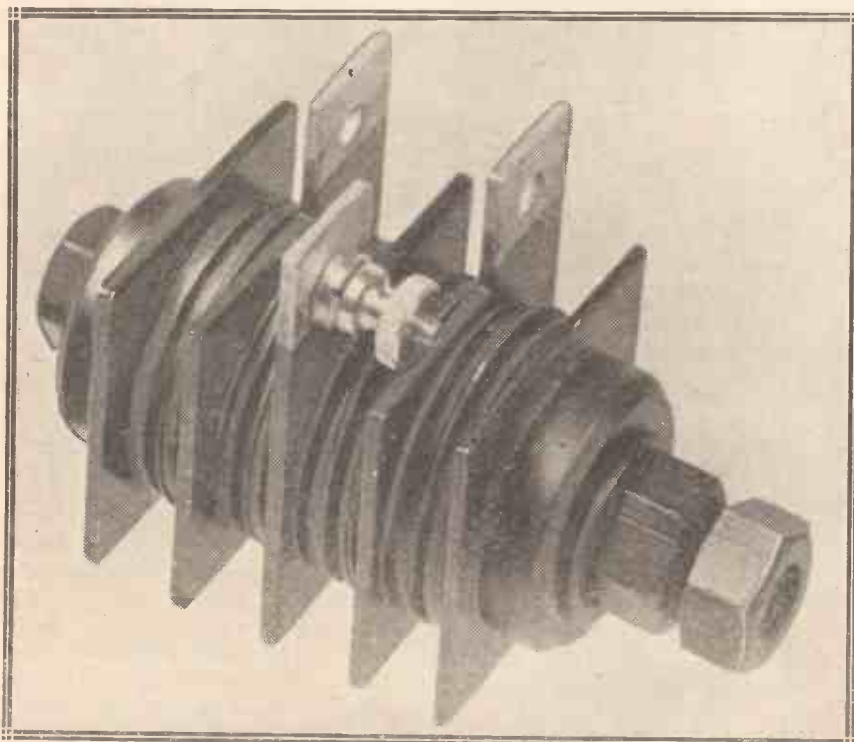

A typical sulphide dry rectifier. The two back lugs are connected to the A.C. supply. The central lug (with terminal) and the right-hand bolt are the D.C. connections.

We now come to the consideration of valves which run direct from A.C. Unfortunately, we cannot operate ordinary valve filaments with raw A.C., at least in the high-frequency and detector stages; but with valves such as the L.S.5 and L.S.5A., which have comparatively heavy filaments, it is found quite satisfactory to light these with raw A.C. in the output stages, as the heat-retaining powers of the heavy filament are such that it maintains a substantially uniform temperature in spite of the rise and fall of the alternating current. It is thus quite practical to make up a receiver with indirectly-heated-cathode valves in the earlier stages and heavy filament power valves in the output stage.

There will be a slight hum, but not such as will interfere with any ordinary reception. No further magnification follows the output stage, whereas if there was a slight

.....
 "There is still room for experiment in running many ordinary valves on raw A.C."

hum in the earlier stages, the magnification subsequently given would bring it up to a very uncomfortable value. There is, however, still room for experiment in running many ordinary valves on raw A.C.

The two main difficulties which arise when we endeavour to run ordinary valve filaments with raw A.C. are due, firstly, to the fluctuating temperature of the filament and, secondly, to the fact that the two ends of the filament change their polarity periodically. If, however, we choose a filament which is thick and does not cool too rapidly, then it will not appreciably change in temperature between alternations. Furthermore, we should aim to run our filaments at a temperature at which slight changes on either side of their working point will not greatly vary the emission.

The Grid Return

Filaments differ considerably in this respect, and with some a slight alteration of filament temperature will make a big change in emission. It is, however, possible to choose a filament which will change its emission only very slightly, with the slight fluctuations of temperature which occur with direct A.C. running. By taking the grid return wires to centre points on resistances across the valve filaments the "end

changes" will have a minimum effect.

Incidentally, the push-pull method of amplification is particularly favourable to raw A.C. filament running, as any hum caused by this source is automatically balanced out.

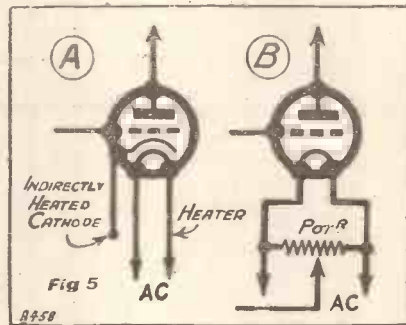

We now come to (3), or the use of rectified alternating current for supplying the filaments of the ordinary types of valves. If we can successfully accomplish this we obtain several very distinct advantages, for we can utilise existing sets, existing valves and the technique we have carefully built up around them. The number of types of A.C. valves now available is small compared with those of the D.C. types, and if a man has a set working satisfactorily with ordinary valves it is a great advantage to add something that utilises the existing set and valves when running from the mains.

Now assuming that we can rectify and smooth the current from the alternating-current mains for filament lighting, we have two methods of utilising this current. The first is by series connection of the filaments,

and the second by connecting the filaments in parallel. The first method has the advantage that the actual amount of rectified current taken from the mains need be only small (in practice it is limited by the maximum current required by the most greedy valve), and this being so our rectifying and smoothing problems are considerably reduced.

The disadvantage is that we must redesign and rewire our set. Other disadvantages are that unless our valves are carefully picked we shall have a lot of trouble and, furthermore, the "mixing" of the valves is awkward. Take, for example, the average modern set, the owner of which desires to get good quality reproduction. In most cases he will use a super-power valve in the output, and as these valves generally take at least a quarter of an ampere the filament current will have to go up correspondingly.

Overall Efficiency

This means that ordinary 1-ampere filaments will have to be shunted; in fact, as we have to obtain a quarter of an ampere from our rectifier, we might as well use quarter-ampere filaments throughout, and thus save troubles with shunting.

If we confine ourselves to 100-milliampere valves throughout then we can arrange for valve rectification followed by a suitable smoothing system and drop the unwanted voltage through a series resistance. This, of course, is a wasteful method and makes the overall efficiency of the job low. Satisfactory smoothing of a

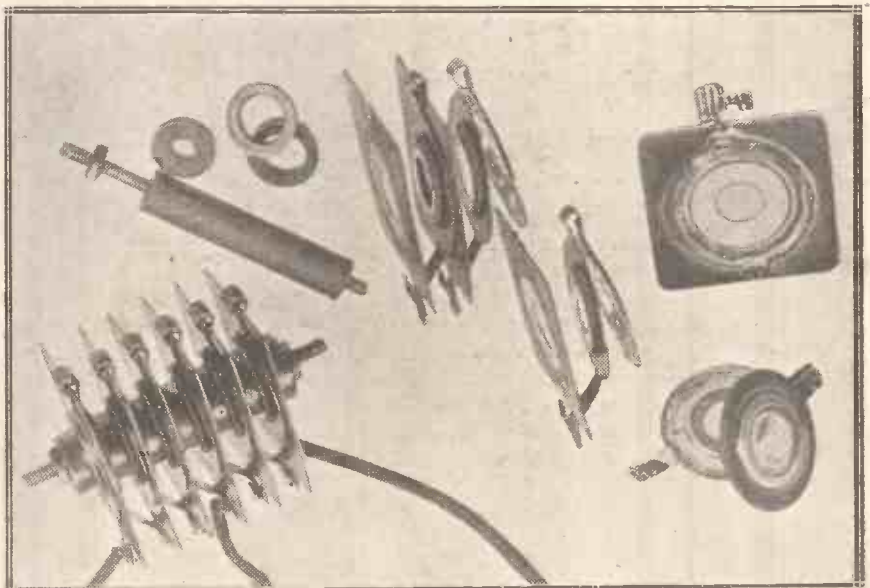

A disassembled Kuprox unit, showing oxidised plate (square), and circular contact discs. Each side of the square plate is oxidised. The small rings are made of insulating material.

100-milliampere current is not a very difficult task, but we must choose our chokes carefully and take care that these are of sufficient inductance *at the working load* to be really practical.

The condensers, too, must be larger than usual—that is to say, larger than those of the ordinary H.T. mains units. It is doubtful whether anything less than 20 mfd. altogether is of much use for hum-free operation, while if we endeavour to smooth 250 milliamperes we have a really difficult job.

Gas-Filled Rectifiers

It is worth while to consider what valve rectifiers are available for delivering 100 and 250 milliamperes respectively for such devices. Apart from the special transmitting rectifying valves, which are, of course, outside our scope for such uses as this, we can use a pair of such valves as the Mullard D.U.10 and obtain a 100 milliamperes or a little more, keeping well within the safe limits of the valve, or we can use one of the filamentless gas-filled rectifiers, such as the Raytheon, which is made in several models.

The type B.H. Raytheon will easily pass 110 milliamperes, while the type B.A. is rated to pass 350 milliamperes—more than sufficient for filament running of quarter-ampere valves plus the demands of the plate supply. At the same time, it must be remembered that in order to pass

these currents fairly high voltages are needed.

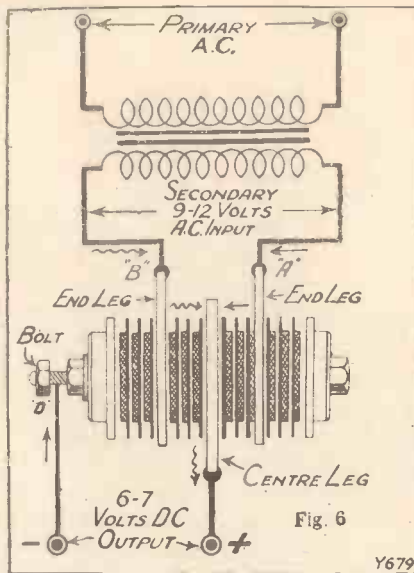

For example, the Raytheon B.H. requires a transformer with 300 volts each side of the centre-tap, this being a double-wave rectifier, while the type B.A. wants a transformer of 350 or more volts on each side. Allowing for the voltage drop in the rectifying valve and the filter we still have well over 200 volts output in either case, although all we actually need in, say, a five-valve set, using 6-volt valves, is 30 volts.

To cut down 200 volts to 30, when the current concerned is a quarter of an ampere, means that we must have a

680-ohm resistance in which we must dissipate no less than 42 watts as heat. In the case of the 100-milliampere type of valve, assuming the same voltage drop, then we must dissipate about 17 watts. Either method is very wasteful. Most types of Raytheon have a life of approximately a thousand hours, or about a year of average use, and the larger size valves are quite expensive.

The Smoothing Problem

When we come to consider the smoothing problem, the ordinary type of rectifying valve with heated filament gives an output which is slightly easier to smooth. In the case of the Raytheon gaseous rectifiers, these do not begin to function until the voltage applied to them has risen to quite an appreciable figure, when they suddenly become conductive. This sudden change gives rather a peculiar wave form, which is less easy to smooth than that of the filament types.

As there is no filament to burn out the reader may wonder just how the filamentless valve "wears out."

Towards the end of its life the output, which has been fairly uniform, suddenly begins to fall, due to increase of the internal resistance of the valve, possibly due to the absorption of the certain portion of the gas.

For the benefit of those readers who are not acquainted with the Raytheon type of rectifier, it may be said that briefly it consists of a glass bulb containing two small anodes and one large cathode. The electrodes are of nickel and the cathode is made in a shape very much like the "tin hat" of war time, except that the underside is also closed up with the exception of two small holes through which the anodes project.

How Helium Helps

The electrodes are thoroughly cleaned electrically, so as to get rid of all gases before insertion in the bulb, and then, after the bulb has been exhausted to a very high vacuum, a small quantity of helium gas is allowed to enter before sealing. When a pressure is applied between the cathode and one of the anodes the gas is ionised, and a liberal emission of electrons takes place.

If both anode and cathode were of the same size then the tube will conduct equally in either direction, but as one is made extremely small and the other is large, and as furthermore the cathode is specially treated to facilitate the emission of electrons, the current in one direction is much

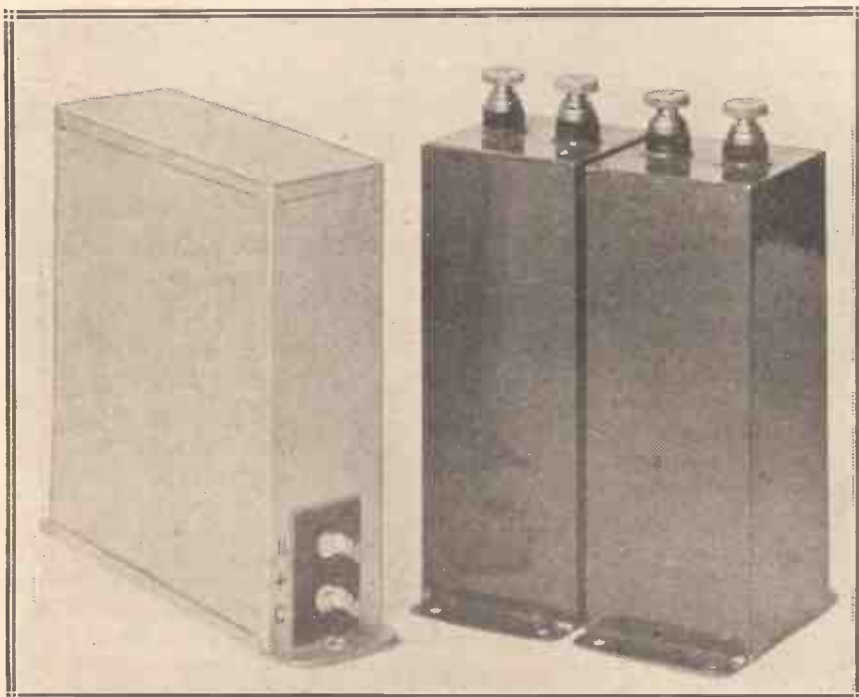

On the right are T.C.C. electrolytic condensers, one of Tobe-Deutschmann manufacture being shown on the left.

greater than that in the other. A certain reverse current occurs in all of these tubes, but this is very small compared with the current in the other direction.



A special transformer designed for the Westinghouse rectifying unit.

We thus see that even with the largest values of valve rectifiers it is not convenient to pass much more than a quarter ampere, and even this is rather a difficult matter if proper smoothing is to be obtained. We will now consider whether it is possible to step-down our alternating voltage to a low value, rectify at this low value, and pass sufficient current to operate valves in the normal manner, that is, in parallel. Furthermore, we shall see whether it is possible satisfactorily to smooth this rectified output, so that we can use it as we should the direct current from the accumulator.

The Harris "Stedipower" Unit

Some months ago I began the investigation in my laboratory along these lines, the experiments terminating in the production of the Harris "Stedipower" Unit, which has already been described in the "Wireless Constructor."

The problem, stated simply, was to take the alternating current from the mains, step it down to a voltage comparable with that used for a receiver, rectify and smooth it, and provide some arrangement by which the output voltage could be regulated to suit any number of 2-, 4-, or 6-volt valves up to a practical limit. The practical limit decided upon was one ampere, as the great majority of sets do not consume more than this.

Furthermore, for very powerful sets it is possible to use, as previously explained, raw A.C. on the filaments of such valves as the L.S.5.A.

There was, of course, no problem in stepping the voltage down, for transformers can now be designed with a high efficiency and low price.

The proper rectification with one ampere, however, was the problem beset with many difficulties. The requirements of the rectifier had to be a long life, robustness, freedom from any messy liquid, and reasonable cost. In the valve line nothing presented itself save the Tungar type of valve, which, however, is not designed for continuous running, but for intermittent accumulator charging. While a bulb of this type would pass the ampere we required, there were a number of practical reasons why it should not be used in this case.

There were many objections to the electrolytic rectifiers, for even the best of them require periodical attention, such as topping-up with distilled water; while they are, of course, messy and generally unreliable for continuous running. Vibratory rectifiers were out of the question, as were rotary types, so I was led to consider the comparatively recent "dry" rectifier of which there are several types available.

Dry Rectifiers

We have, for example, the copper oxide rectifiers, of which the Westinghouse and the Kuprox are two different examples. Then we have a whole series of sulphide rectifiers, none of which has appeared on the market in this country yet, but many of which are sold in the United States. The rectifying properties of copper oxide have been known for many years, and those who remember the early coherer experiments will call to mind certain experiments by Branly and Lodge.

There is, however, a distinct difference between the copper oxide coherer effect and the rectifying effect of the more modern copper oxide rectifiers; for whereas Branly's experiments were connected with the sudden fall in resistance of copper oxide film when exposed to the influence of an electric path, we deal in the modern copper oxide rectifier with a true unilateral conduction, the condition of which does not vary over very long periods.

"The number of types of A.C. valves now available is small compared with those of D.C. types, and if a man has a set working satisfactorily with ordinary valves, it is a great advantage to continue to use set and valves when running from the mains."

Numerous patents have been granted to various people on the subject of dry rectifiers both for the oxide and sulphide types, and in this as in many other aspects of radio, certain law cases will probably have to be fought before we know to whom proper credit must be given; but for the moment, considering both the sulphide and oxide rectifiers together, they all consist of a series of disc rectifier elements, and as each individual disc will only stand a few volts a number of discs are joined up in series in a suitable and convenient mechanical fashion. Where large currents are required, a number of such sets are joined up in parallel.

As a certain amount of heat is generated, provision has to be made for cooling; and practically all the

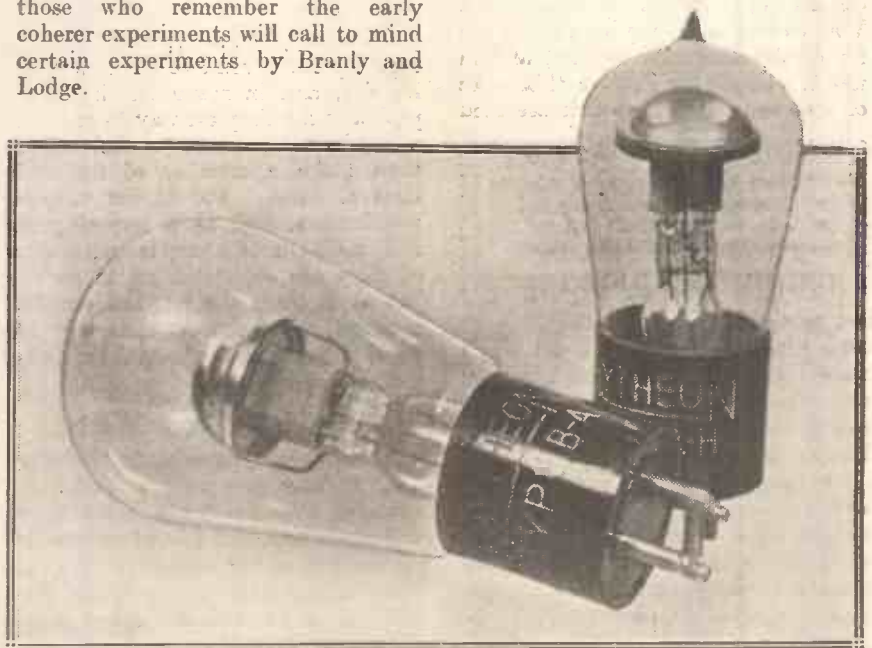

Two Raytheon rectifier valves such as figure in many "eliminator" designs.

modern dry rectifiers have metal discs larger than the rectifying discs, interposed between the units so as to facilitate the radiation of heat, much as do the fins of an air-cooled motor-cycle engine.

In the copper oxide rectifiers, discs of copper are taken and oxidised; in practice, both cuprous and cupric oxide being formed, the latter on the outside and the former next to the copper.

High Pressure Contacts

In manufacture the blank of copper in the form of a plate or disc is first chemically cleaned and is then heated in an electric furnace, in the presence of air, to a temperature in the neighbourhood of a thousand degrees centigrade. Heating is continued long enough to form a layer of cuprous oxide of sufficient thickness, and the thin coating of cupric oxide, which has a comparatively high electrical resistance, is subsequently removed.

A great deal depends upon the exact formation of this layer of cuprous oxide, for if it is too thick the efficiency of the rectifier will be low, while if it is too thin other troubles will arise. As soon as the heating treatment is completed the blank is removed from the furnace and suddenly cooled or quenched. The cupric oxide layer is removed and electrical contact is then established with the copper oxide.

It is a remarkable fact that while an electric current can pass freely from the oxide to the copper, and only with difficulty in the reverse direction, a contact established with the surface of the copper oxide conducts equally well in both directions. Various methods have been described for establishing this contact, and in the Westinghouse rectifier thin discs of lead under great pressure are used

“There is a whole series of sulphide rectifiers, many of which are sold in the U.S., none of which has yet appeared on the market in this country.”

for establishing this contact. Very high pressure is used and the whole assembly is tightly bolted together, any releasing of the bolt, and therefore of the pressure, ruining the operation of the rectifier.

In the Kuprox rectifier the discs are oxidised, thus obtaining the copper oxide rectifying surface, and then the outer surface of the copper oxide is reconverted into pure copper, to a very small depth, thus establishing intimate contact with the copper

oxide crystals. In this case, too, we have the peculiar fact that while the oxide-copper surface has unilateral conducting properties, the contact between the reconverted oxide (otherwise the pure copper) and the oxide itself passes current equally in both directions. No pressure whatever is required in the assembly of this rectifier, as it is extremely simple to make sound contact with pure copper.

In this case, too, a number of discs are connected in series. It will thus be seen that the differences between the Westinghouse and the Kuprox rectifiers are mainly in the method of establishing permanently electrical contact with the copper oxide, although both companies have a number of minor patents relative to the manufacture of these units.

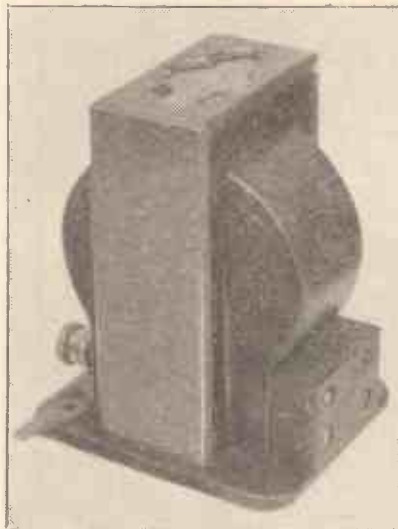

An Igranic filament transformer for K.L.I type valves.

Obviously, too, the current carrying capacity of a given disc depends upon its size, and in manufacturing it is probably the simplest way to connect a number of units in parallel rather than make a number of different sizes of discs. For higher voltage rectification, such as is necessary in H.T. mains units, a very large number of discs are connected up in series, but as in these the rectified current is small, it is not so necessary to provide large areas of metal for cooling.

Ten Times Too Much!

The Kuprox people state that the Kuprox unit can have a thousand per cent overload for a short time without injury, and I have personally in the laboratory subjected it to a three hundred per cent overload for half an hour without being able to trace ill-effects of any kind.

Similarly in the Westinghouse laboratories I have seen a Westinghouse rectifier short-circuited without damage, in spite of a huge overload. I so designed the “Stedipower” Unit in regard to the resistance of the choke that if the condenser should short-circuit the maximum current that will flow through the rectifier will not be greater than it can temporarily withstand without injury.

“Numerous patents have been granted to various people on the subject of dry rectifiers.”

Another very interesting class of dry rectifier utilises a different principle. Here we have two bodies which are relatively divergent in the electrochemical series, one being strongly electro-positive in relation to the other. In one type, the electro-positive electrode comprises a metallic element or compound, such as magnesium, while the electro-negative element consists of an electrode of brass or aluminium, with a disc-like cake of compressed material between them, this cake being usually of a metallic sulphide mixed with other substances, the whole being submitted to a tremendous pressure in order that proper contact may be established. The pressure, by the way, is somewhere in the neighbourhood of two tons per square inch!

A Bigger Problem

A dry rectifier of this type capable of passing one and a half amperes, which I have tested in my laboratory, is shown in the accompanying photograph. The two lugs on each side of the lug to which a terminal has been attached are connected to the A.C. supply, while one end bolt and the central lug fitted with a terminal represents negative and positive respectively, the central lug being positive and the bolt negative.

My tests on this type of rectifier indicate that while its efficiency when new is fairly high it is not so satisfactory for filament running as the copper oxide type, and deteriorates much more rapidly.

It thus becomes evident that we can obtain a dry rectifier adequate for the purpose and passing one ampere. Actually we take a little more than an ampere, counting both ripple and D.C. We now come to the much bigger problem of the smoothing, for if we use a full-wave rectifying arrangement with the dry rectifier we get an output which consists of

(Continued on page 433.)

INSIDE the VALVE



An interesting and informative chat about the materials used in the construction of that wonderful piece of electrical mechanism—the thermionic valve.

By J. F. CORRIGAN,
M.Sc., A.I.C.

THE modern valve, with all its reliability and efficiency, is by no means the product of any one inventive mind. On the contrary, it is an article which has passed through many evolutionary stages, so much so that the valve, as it stands nowadays, is not an evolutionary product merely in virtue of its design, but it is constructed from materials which have also been chosen as a result of much experience.

Take, for instance, the heart of any valve, to wit, its filament. Valve filaments in the very early days of radio used to be made of platinum. But platinum, besides its high cost, was found to be not entirely suitable for that purpose.

Filament Facts

Experience has shown that tungsten is about the best metal for filament production, for, in addition to being much cheaper than platinum, the metal, even in the form of the finest filament, is almost infusible, and it possesses also a high mechanical strength.

In the earlier receiving valve, the tungsten filament was about half as thick as a single human hair. Yet, despite the extremely small diameter of the filament, the metal can be drawn out, after a series of mechanical treatments, with perfect regularity. The photomicrograph of a tungsten valve filament shown at Fig. 2 will bear out the truth of this, for after an examination of the illustration,

it will be seen that the filament possesses perfectly parallel sides, despite its extremely small diameter.

The filaments of dull-emitter valves are of a somewhat similar size. In such instances, however, the pure tungsten filament is treated in one of two ways in order to render it more emissive at lower temperatures.

In one case, a small percentage of the metal thorium may be added to the tungsten during the earlier stages of its treatment, traces of this latter

metal in the tungsten enabling it to throw off electrons more readily and at lower temperatures.

On the other hand, a dull-emitter valve may contain a "coated" filament, that is to say, a filament which contains an inner core of tungsten, or thoriated tungsten, and which is coated on its surface with a thin layer of some highly-emissive rare-earth oxide.

Grid and Plate

Coming now to the metal from which the filament supports, anode and grid of the valve are composed, there are three main requirements which have to be fulfilled by any metal adopted for this use. In the first place, the metal must be relatively cheap. It must be capable of easy working into wire, sheet, or other form. And, lastly, the metal must be one which does not absorb and retain small traces of air which would have to be eliminated by a lengthy and tedious pumping process.

Experience has shown that the metal nickel fulfils the above three requirements about the best. The metal is reasonably hard, and it has a relatively high melting point of 1,450 degrees Centigrade.



Fig. 1. One of the older varieties of dull-emitter valves in which the cylindrical nickel anode was employed.

The metal supports for the filament, and the grid and anode make-up, therefore, are composed of pure nickel or nickel alloy, in most of the modern valves. Such components of the valve are illustrated in the "close-up" photographs, Figs. 1 and 4.

In the case of high-powered transmitting valves in which high temperatures are reached, and particularly in water-cooled valves, the metal, nickel, is too fusible for constructional use. A higher melting-point metal has to be employed, and this requirement is generally found in molybdenum, a tough metal which has a melting-point about the region of 2,500 degrees Centigrade. (In a few cases, too, tungsten is employed for the metalwork of transmitting valves.)

Good Glass

The glass out of which the bulbs of receiving valves are made has to be chosen with some considerable care. Ordinary glass may have been employed for the construction of some of the earlier valves, but the extremely high vacuum which exists in modern valves necessitates a glass which not only possesses considerable mechanical strength to enable it to resist the external atmospheric pressure, but a glass, also, which does not possess the property of absorbing considerable amounts of air on its inner surface, which would begin to leak out as soon as the valve was sealed, and thus destroy the high degree of vacuum obtained by the modern methods of pumping.

Lead glasses of good quality fulfil most of the above requirements. They have considerable strength. They do not absorb and retain large quantities of air, and, at the same time, they are soft enough to permit of the fairly easy insertion of the seal wires into the base of the valves.

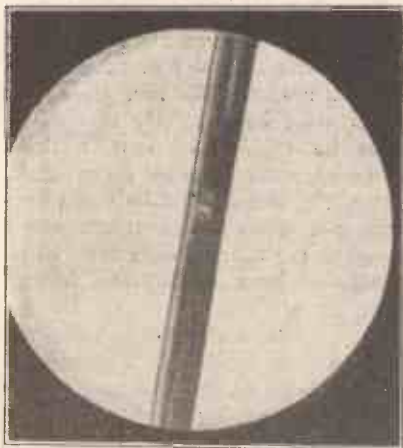

Fig. 2. A section of the magnified filament, referred to on a previous page.

Naturally, for high-temperature transmitting valves, glasses of this nature cannot be employed. In their place a very hard glass containing

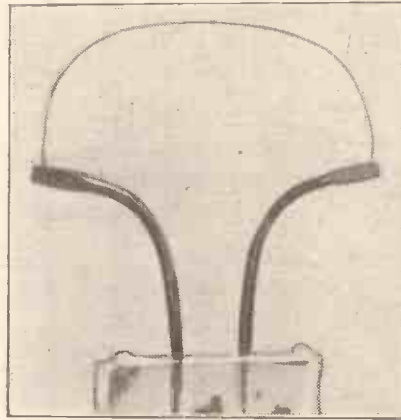

Fig. 3. The filaments of many valves resemble those of the metal electric lamp, in that they are made of tungsten and are fitted into the glass by means of nickel alloy supports.

boron and silicon ("boro-silicate glass") is employed, whilst for high-powered valves which handle large amounts of current and which are water-cooled, the use of glass is dispensed with altogether, and pure fused silica takes its place.

Problems of Sealing

Silica is a very useful material for the construction of high-temperature water-cooled valves, for not only does it possess an extremely high melting-point and a good mechanical strength, but it is not liable to crack or to develop flaws under the influence of rapid or uneven heating or cooling. In view of the increasing production and decreasing expense of this admirable material, the time may quickly come at which even the most diminutive of receiving valves may have their bulbs composed entirely of pure fused silica.

The "seal wires" of valves form an interesting point about which little is written. The early valves, in common with the early electric-light bulbs, had their seal wires, or wires running through the glass at the base of the bulb, composed entirely of platinum or some form of platinum alloy.

Search for Substitutes

Other metals could not be used for this purpose because they possessed a degree of expansion and contraction which was dissimilar to that of the glass used. Thus, seal wires composed of, say, copper, although they were effective whilst the glass of the bulb was hot and soft, became useless as soon as the glass cooled down, for

there was an uneven contraction between the glass and the seal wires. The latter broke away from the glass, and so allowed air to enter the bulb.

For a considerable time, platinum appeared to be the only metal which was suited for the purpose of providing seal wires for valve and other similar articles. Yet the ever-increasing expense constantly militated against its continued use.

A long search was made for a cheaper substitute. Platinum alloys were employed for a period, but even these proved to be too expensive. Eventually, however, it was found that a wire composed of a special steel-nickel alloy thinly coated upon its surface with an electrolytically-deposited layer of pure copper could act as an efficient seal wire, and it is from this material that the present seal wires of valves are made.



Fig. 4. The sealed "pinch" of a thermionic valve. (The centre support is for the unconnected end of the grid.)

Other seal wires contain only the nickel and steel alloy, whilst others still possess a certain proportion of lead in them. They are not so easy to insert into the glass as are wires of pure platinum, but, from a manufacturing point of view, wires of this nature comprise the only other materials available for the purpose.

POINTS WORTH WATCHING

When emptying a hydrometer after a reading has been taken be sure that you put the acid back into the correct cell from which it was taken.

When an accumulator is properly charged it starts to gas freely, and should be allowed to do this for about an hour before being taken off charge.

If accumulators are charged by means of direct current lighting mains, the accumulators should be connected in that lead which is earthed.

The "THOMAS" SHORT-WAVER

SPECIAL EDITION

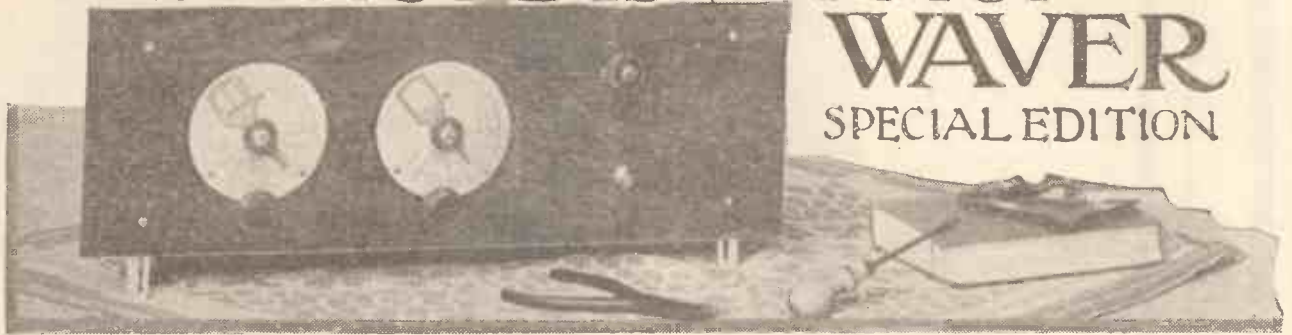

With the lengthening evenings short-wave stations are beginning to roll in again by the score. This specially-designed receiver will enable you to land a fine haul of D.X. short-wavers on any night without the slightest difficulty.

By L. H. THOMAS (6 Q B).

So universal has the short-wave receiver become, now that the short-wave regions are largely used for long-distance broadcasting, that the set that will receive regular programmes from America and the Antipodes is no longer either a work of art or a curiosity. It is, in fact, high time that our short-wave receivers were modernised to bring them up to a pitch of efficiency equal to that attained by the transmitting stations.

It was so exciting, a few years back, to be able to hear anything at all of telephony from America or greater distances, that we fell into rather an "anything-will-do" habit as far as our short-wave receivers were concerned, but for a short-waver to be a real success to-day it must do more than merely receive distant stations.

Special Features

The set described herewith is an attempt to make one or two real improvements upon its predecessors and also to break away from the common run of short-wave sets in order to attract the more discriminating reader.

I cannot refrain from using once

more my favourite quotation from QST—the short-wave dictionary.

"The point that we all lose sight of at one time or another is this—that what we are hunting for is *not* the strongest possible signal for a given number of valves, but the clearest signal, the signal most free from outside interference."

You will see, on thinking for a few moments, that if we make our ideal a signal, *no matter how weak*, which is entirely free from interference and outside noises, then once we reach that ideal we have perfect reception. We can amplify our weak signal up to whatever dimensions we like, and it will still be clear and free from interference. Far too many short-wave

LIST OF COMPONENTS

- 1 Ebonite panel, 21 in. × 7 in. × $\frac{1}{4}$ in. (Radion used for original. Any good branded material).
- 1 Ebonite panel, 18 in. × 7 in. × $\frac{1}{4}$ in. (Radion used for original. Any good branded material).
- 1 Short-wave condenser ('00015), 1 '00025 square-law condenser, and 2 dials (slow-motion) (Lissen, Ormond, J.B., Cyldon, Igranic, etc.).
- 3 Non-microphonic valve holders (Any good standard make, Benjamin, Bowyer-Lowe, B.T.H., Burne-Jones, Igranic, Lotus, Marconiphone, W.B., etc.).
- 1 Rheostat, 10 or 20 ohms (Igranic, Lissen, etc.).
- 1 On-off switch.
- 2 .05 mica condensers (Lissen, Clarke, Igranic, Dubilier, Mullard, T.C.C., etc.).
- 1 '0001 fixed condenser (see above).
- 1 250,000-ohm wire-wound resistance with holder (Dubilier, Mullard, R.I.-Varley, Lissen, etc.).
- 1 100,000-ohm wire-wound resistance (with holder).
- 2 5-megohm grid leaks (with holders) (Dubilier, Lissen, Igranic, Mullard, etc.).
- 1 5-megohm leak, with clips (see above).
- 15 brass terminals.
- Wire for wiring and coils, etc.
- Quantity of brass bolts.
- 2 Special panel brackets (Igranic).

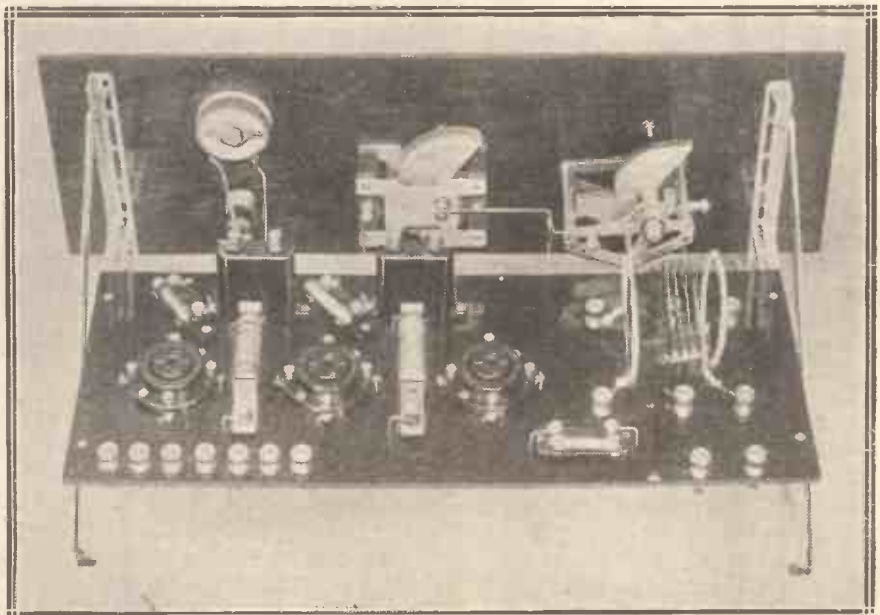

A general view of the receiver showing how the components are arranged on the panel and baseboard, the layout being easy to follow.

receivers are "interference amplifiers."

Now there are, unfortunately, many sources of outside interference which are quite beyond our control. Such nuisances as electric railways, vacuum cleaners, ultra-violet ray apparatus, not to mention our dear old friend static, are quite flatly tuned or "untunable," and frequently nothing will get rid of the interference picked up from such sources if one is unlucky enough to be fairly close to them. Screening the whole set helps, but in severe cases seems to have no result other than the reduction of the signal-strength all round.

"Tube Noise"

I have thought for some time past, however, that the gentle hissing noise which shows that the set is oscillating, and which many short-wave enthusiasts pass off lightly as "mush," might be cured. Much of this "mush" is caused by myriads of weak harmonics of long-wave commercial stations, while some of it is the cumulative effect of all the disturbances mentioned above and many more in a 'dition.

Then some of it is genuine "tube noise," as our friends in the States call it, and is particular to one particular valve; another of the same type giving a quieter or noisier background. Some of it is caused by a defective grid leak. I found in the course of experiments, however, that much of it disappeared when one did not use transformer coupling for the note-magnifiers. One cannot, of

former-coupled two-valver is, compared with the amplification on actual signals, out of all proportion to that heard on a detector alone.

I therefore tried resistance-capacity coupling for the note-magnifiers, and after considerable time spent on actually listening on both sets and making careful comparison, came to the conclusion that there is less mush to be heard on a set incorporating

set at this point, for the valve is always either oscillating or not oscillating, with a fairly definite point of division between the two states. We can, however, make the best of a bad job by obtaining the smoothest possible reaction control, and here, again, if there is no mush to worry us, we can make the best use of our control and keep the set working right on the best point.

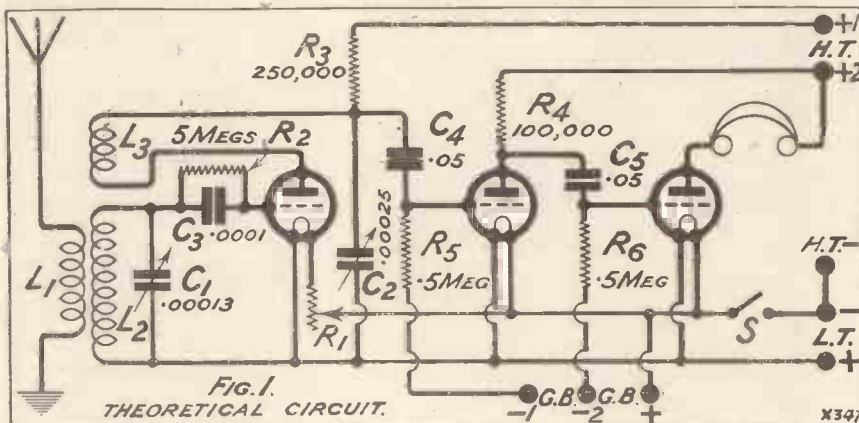

two R.C. note-magnifiers than on a set using one transformer-coupled stage, while the signals are considerably stronger with the three-valver.

Of course, it is vitally important to use wire-wound resistances of a reliable type, or one will have jumped out of the frying-pan into the fire. We all know the appalling row that a defective anode resistance can make if it tries, and to attempt to copy a weak short-wave station through this sort of noise is no mean feat!

The use of resistance coupling is, therefore, a double aid in reducing the mush and in helping us to obtain a smooth control which will enable us to appreciate the absence of this mush.

The circuit diagram, Fig. 1, shows the form of reaction control used, and there is nothing in the least unconventional about it. Series-feed is used for the H.T. That is to say, it is applied to the detector anode via the resistance and the reaction coil.

Resistance Values

From the "live" end of the resistance (that nearest the anode) a variable condenser is taken down to the positive filament lead, and this, by providing an alternative path for the H.F. currents which would otherwise have to flow through the resistance, forms a very convenient and smooth control of the degree of oscillation.

The values of resistances used are 250,000 ohms for the detector, and 100,000 ohms in the plate circuit of the second valve. The coupling condensers are .05 mfd. each, and here again it is essential that a reliable make be used, as the slightest leakage at these points will mean the introduction of positive bias on the grids of the amplifying valves, with consequent loss of amplification, distortion, and generally undesirable performance.

The grid leaks for both amplifiers have a value of .5 megohm.

Returning to the detector, the following points are perhaps worthy

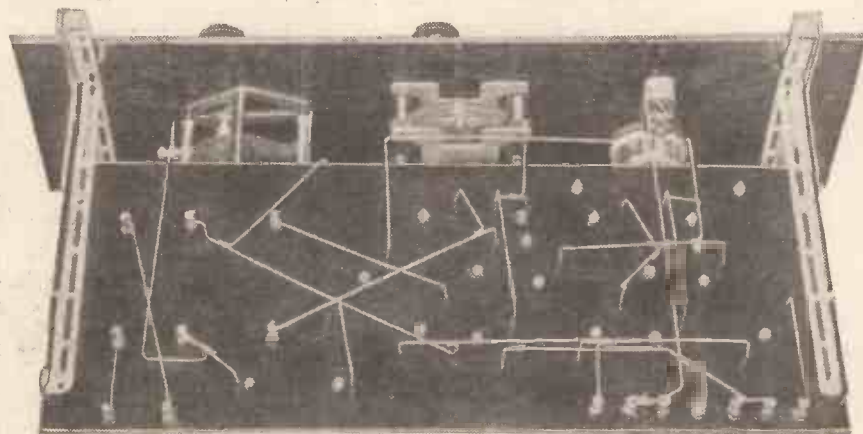

The wiring is extremely easy to carry out, as this photograph shows, all connections being made beneath the panel.

course, be certain, but it seems likely that the reason for this is that a certain amount of interference taking place on the long waves used by high-power commercials is picked up on the transformer primaries and amplifiers.

Certain it is that the amount of mush heard on an ordinary trans-

Another point to notice particularly in all short-wavers is, of course, the reaction control. Most of us know that the very most sensitive point at which to work a detector of the leaky-grid type is right at the point at which is just begins to oscillate

In practice, unless one uses a super-regenerator, one cannot operate the

of note. First, the grid condenser has a value of .0001 instead of the more usual .0003. The leak has a value of 5 megohms, although reaction control seems to be improved if even higher leaks than this are used.

Unfortunately, in my experience, commercial grid leaks often tend to become noisy as the rated value

on the panel out of their field. As will be seen from the photographs, although the coils are, if anything, towards the front of the baseboard, they are quite clear from any metal objects or other components.

Other advantages of this method of construction are that it is no longer necessary to use a terminal strip,

ever, gives extraordinarily good results, and a complete set of them can be wound in about twenty minutes!

You need nothing but some wire, cotton, and a 2-in. cardboard former. Wind the coil of the required number of turns on the former, let it spring off, bring out the ends to suitable positions for slipping under the terminals on the baseboard, tie it up with cotton in three places, and the coil is complete.

You will probably need two three-turn coils of this kind, and one four-, one five-, one six-, one eight-, and one twelve-turn coil. These should enable you to cover a range of the order of 18-100 metres, which includes practically all the interesting traffic.

The best plan, however, is to wind the coils as you find that you require them, for it is such a simple business that each one can be done at a moment's notice. In general, the secondary L_2 will be the biggest coil, the reaction coil being one size smaller and the aerial coil two sizes smaller.

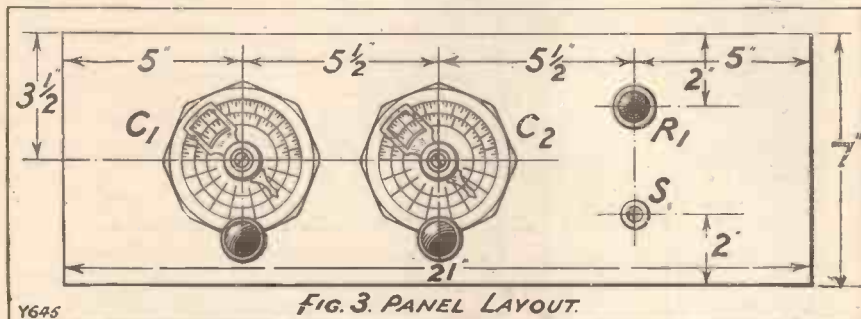

increases, and while all my 2- or 3-megohm leaks are faultless, I had to sort through half-a-dozen 5-megohm leaks before one was found that did not give rise to a continual hiss. Probably a trick worth trying is that of using two ordinary 3-megohm leaks connected in series.

An Elevated "Baseboard"

The main tuning control, it will be seen, is quite simple. Even so, the .00013 condenser is ample for the purpose of covering all the wavebands allotted for amateur use, and practically all the short-wave broadcast stations operate in one or other of these bands. The coils are entirely home-made and of the very simplest character.

Turning now to the actual constructional part of the work, there are one or two more points that may be emphasised. As a refinement and a change from the more stereotyped "breadboard" fashion, an ebonite baseboard has been used. This, in conjunction with special brackets, is held back a good two inches from the panel, and is also more than two inches above the table on which the receiver stands.

I always used to stand my short-waver on four valve-boxes, and quite a noticeable improvement was the result. Now, however, the panel brackets provide ample "lift" above the table, and keep the coils, etc., well above ground.

Constructing the Coils

It is also useful to have the baseboard set back from the panel in this way, as one can use a smaller baseboard, and one does not have to mount the coils at the extreme rear edge to keep the variable condensers

terminals simply being slipped right through the baseboard, and also that the mounting for the coils, while quite efficient, is simplicity itself. A rather neater appearance than the average also rewards the reader who makes up a set on these lines.

The coils in use with this set have been many and various, but those finally decided on as standard were the "hank-wound" variety which can be seen in the photographs. There is also in the latter one coil of another type which is rather easy to construct and gives good results.

It is simply an ordinary "space-wound" coil with No. 16 enamelled wire, two small celluloid strips being

Dead-Spots Dodged

It will be seen that a loose-coupled aerial circuit has been arranged. This scheme seems to be the safest one to recommend for general use, one of the greatest advantages being that if "dead-spots" are found at or near the aerial's natural wave-length, or a harmonic of this wave, they can be cured simply by slacking off the coupling.

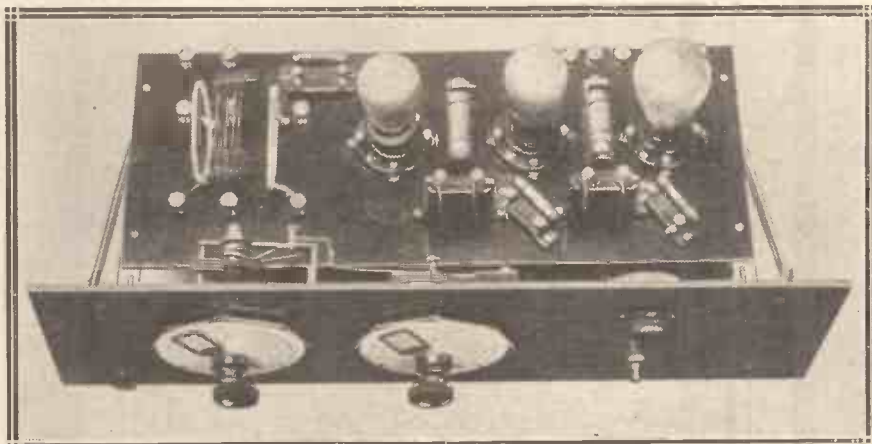

As all the wiring is carried out under the panel, the appearance of the set and the accessibility of the components are unique.

used as supporting material instead of the more usual ebonite. The strips are about 1 in. by 3/4 in., and two sets of holes suitably spaced are drilled near the two edges of the strip.

It is then bent and slipped on the coil, and makes a very rigid job. The "hank-wound" variety, how-

It is an advantage from other points of view to have variable coupling available, for when atmospheric conditions are bad the situation is almost invariably eased by loosening the aerial coupling off to a great degree and putting up with rather weaker signals: the atmospheric conditions will generally weaken

down to a much greater degree than the signals, thus helping us to adhere to our doctrine of "weak but clear" signals.

It will probably also be worth the reader's while to try reversing the aerial and earth connections; it can never be said definitely beforehand which method of connection will give best results, and if nothing is connected to the aerial coil but the aerial and earth it is a simple matter to reverse them.

No Hand-Capacity

The reader will probably have noticed by now that the filament circuit is not earthed. It has not been found necessary to do this on any occasion on which the set has been in use, and there has been no trace of hand-capacity effects whatever.

Both sets of moving plates, as will be noticed, are connected to the filament circuit, as are the only other two components on the panel—the rheostat and switch—and one can run one's hands up and down the panel without so much as changing the

beat-note of the incoming signal. Of course, in a properly designed short-waver it never has been necessary to earth the filament circuit, as it should automatically place itself at zero potential.

In cases where the reader has trouble, however, the only alteration

**THE NATIONAL
RADIO EXHIBITION**

DON'T FORGET TO VISIT

MODERN WIRELESS

Stands 135 & 166

necessary is the connection of the earth terminal to the L.T. + terminal.

Both variable condensers have been fitted with slow-motion dials which have metal screens incorporated, and it has not been necessary to earth these, or even to connect them to the moving plates and filament circuit!

The exact layout of the components may be judged very well indeed

from the back-of panel diagram. Incidentally, this has been drawn up, for simplicity's sake, exactly as if the set were one of the standard types with a wooden baseboard and all the wiring above it.

The only alteration in the actual wiring-up of the set is that each wire is taken through the ebony baseboard at the nearest possible point to the terminal or tag to which it is attached, and emerges again at the nearest possible point to the component to which its other end goes.

The Valves

With regard to the operating condition of the set, there is no reason why it should be critical as regards valves, voltages, aerial, etc., since on test it seemed to work under almost any conditions that were imposed upon it. The detector and first note-magnifier should, of course, be valves of the resistance-capacity type, with a fairly high impedance and amplification factor. The final stage may be almost any power valve.

(Continued on page 432.)

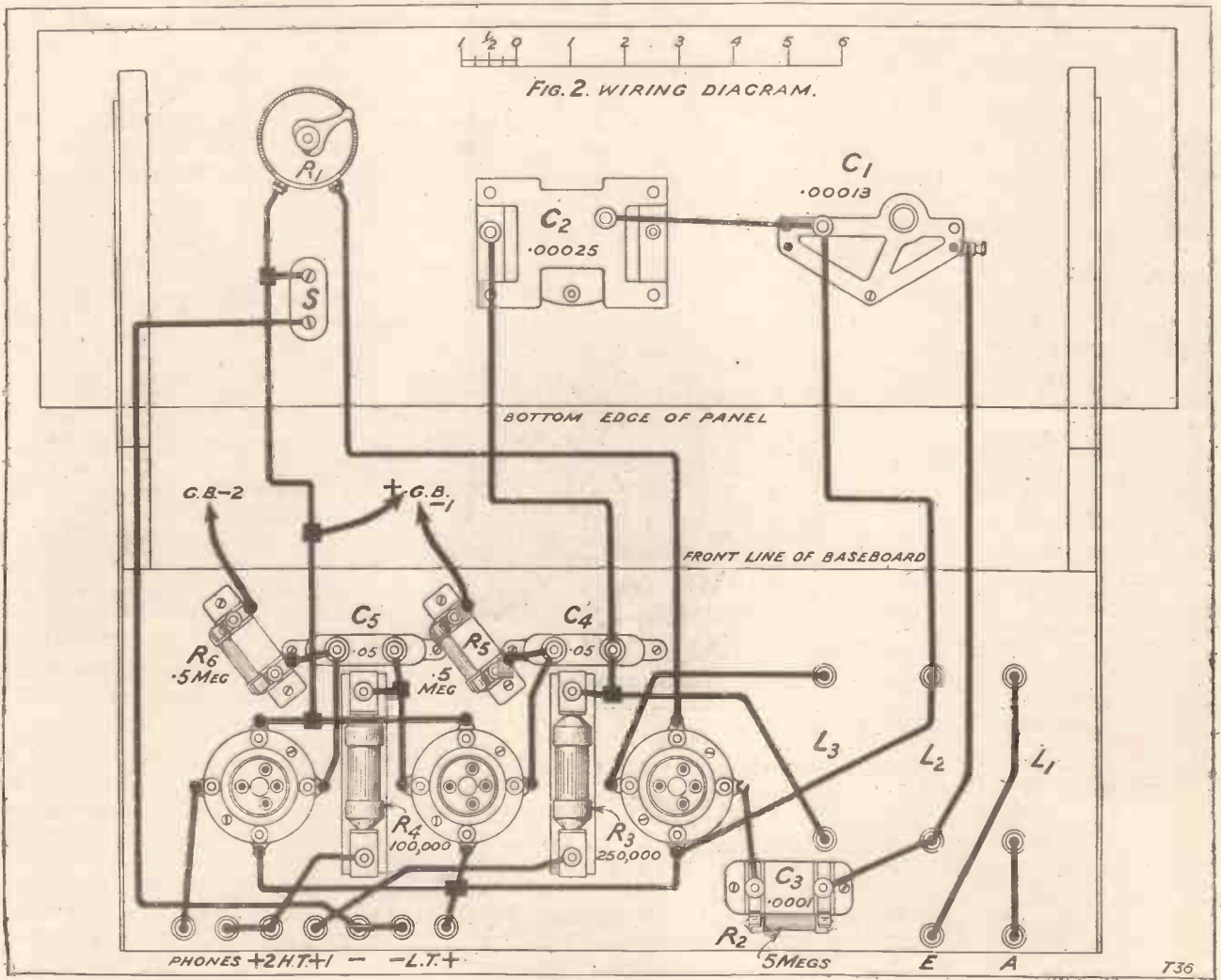

TETRODE CHARACTERISTICS

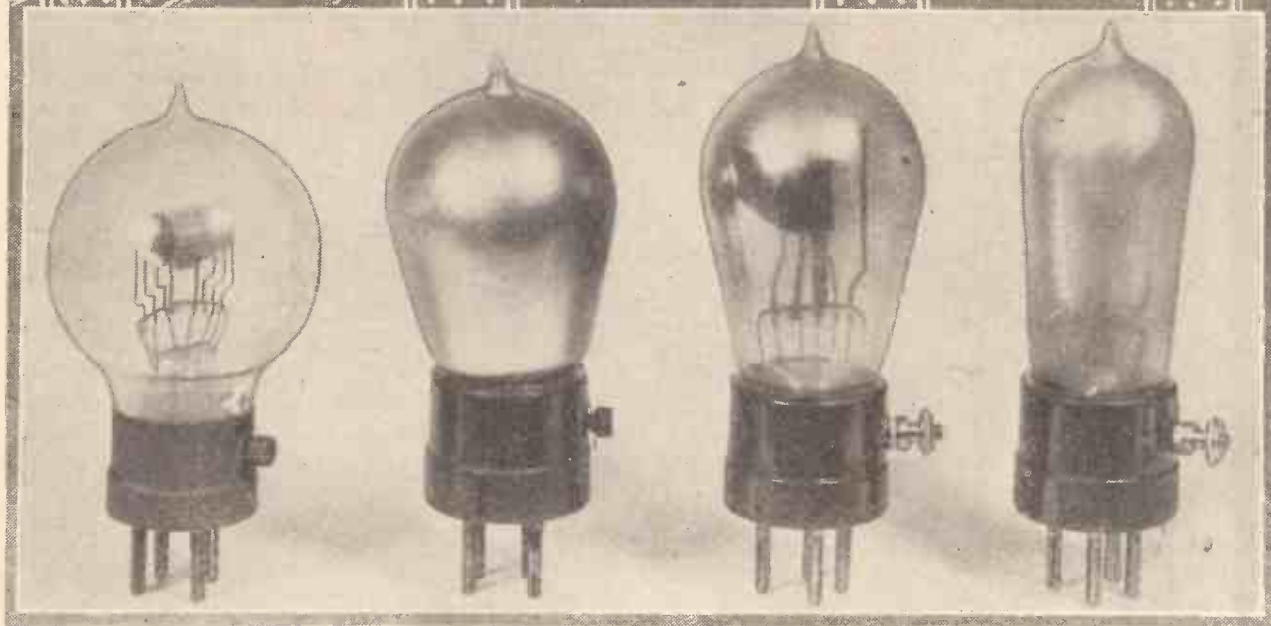

THERE is really nothing very new about the four-electrode, or tetrode, valve but for a long time it has been very much neglected, and its possibilities almost forgotten.

The present interest evinced by technicians and experimenters alike is due almost entirely to the recent production of various types of the tetrode of markedly improved efficiency, such valves possessing several distinct advantages over the three-electrode types while costing no more than the latter.

Fascinating Subject

The early tetrodes were little more than general-purpose valves, of an efficiency on a par with the old R type bright emitter. It is therefore no wonder they achieved little success when there appeared on the scene such a variety of highly efficient dull-emitter triodes of diverse types, H.F., L.F., R.C., etc.

At the present time, however, we can obtain many of those types in tetrode form, of equivalent and, in some cases, better efficiency, with the great advantage of reduced H.T. requirements. Then we have the "screened-grid" valve, a special type of tetrode designed, primarily for a degree of stable H.F. amplification not obtainable with the best of three-electrode valves.

Four- and five-electrode valves are rapidly gaining favour among set constructors, and the following article on the physical properties of the four-electrode valve will be of interest to all.

By J. ENGLISH.

In previous articles I have dealt in a general manner with the use of



The Interdyne valve has a multi-electrode arrangement specially designed to provide a self-neutralising effect.

the tetrode as L.F. amplifier and detector together with some of its applications in special circuits. For the benefit of those of you who are desirous of knowing more about the operation of the tetrode I propose in this article to tell you something about the characteristic curves of this type of valve.

I hope you will not conclude at this stage that the rest of this article is merely dry-as-dust theory. It certainly is theory but the study of tetrode characteristics is a fascinating subject of special interest to experimenters who wish to keep up to date.

Complicated Curves

A knowledge of these curves and all the information to be derived from them will enable you to obtain the best results from the new valves. Otherwise you will be working in the dark, for in certain circumstances the curves of the tetrode are quite unlike anything you have previously met with in three-electrode valves.

Now in the case of the tetrode the presence of the second grid gives rise to several complicating features, but, in order to provide a straightforward basis from which to lead up to more intricate curves, let us take the simple case of the tetrode as an ordinary L.F. valve where the inner grid (the one next to filament) is made positive

as in Fig. 1. Here the tetrode can be considered as an ordinary valve, the effect of the inner grid being disregarded for the moment.

Now in Fig. 1 the curve A is plotted with the inner grid connected to the positive terminal of the filament battery. From your knowledge of the curves of three-electrode valves you will see that the curve A represents a small type L.F. valve suitable perhaps for the first stage of an amplifier. Considering the low H.T. voltage of 30 used to obtain the readings, this curve is quite good.

Improving the Curve

Now let us increase the positive potential of the inner grid by taking it to a tapping on the H.T. battery, say, 6 volts positive. This results in the curve B, anode and filament voltage being the same as before. This curve is somewhat better, being equivalent to the curve of a three-electrode L.F. valve with an anode voltage of 30. We see from this the effect of the inner grid, a small increase of its positive potential producing an appreciable increase in anode current although the anode voltage remains unchanged.

grid voltage base about 9 so that the tetrode, under these conditions, is an exceedingly good L.F. amplifier capable of handling a fair input.

A point to notice about curve C is that it begins to bend over from -2 to 0 grid volts, showing that saturation is commencing. This is really due to the inner grid voltage being too high in proportion to the anode voltage. If the latter is increased to 60 volts, inner grid 15 volts then we obtain the curve of Fig. 2.

This is quite a surprising curve, in that we have converted the small first-stage L.F. valve of curve A into a really first-class power valve, capable of handling a grid swing of nearly 15 volts without distortion. This is an excellent performance considering that the anode voltage is half that required by a three-electrode power valve for the same grid swing.

Decreasing Resistance

The tetrode used to obtain the curves of Figs. 1 and 2 is really of the power type, the A.P. 412P, and the curve of Fig. 2 was plotted under the proper working conditions.

The main feature of interest demon-

strance is plotted against inner grid volts. Notice that between 0 and 6 volts positive, the resistance decreases very rapidly, slackening off after 9 volts positive.

From this curve we may conclude that a value of inner grid potential between 9 and 12 volts would give

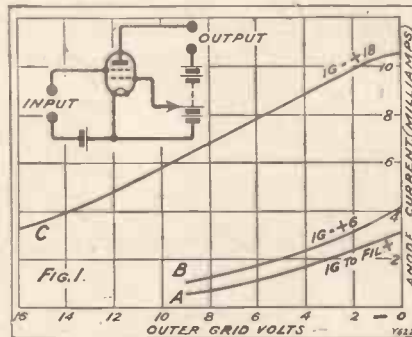

the best results with this particular anode voltage, and in practice this is found to be true. For higher anode voltages, it is found that the best ratio of inner grid to anode volts is increased, being about 15 per cent at anode volts 80.

Instead of using the inner grid as resistance "reducer" let us now make the outer grid (the one next to the anode) positive and then plot anode current against inner grid volts. This gives the curve A of Fig. 4, which also shows the curve B for the same valve where the inner grid is made positive as in Fig. 1. Notice that the slope of A is steeper than that of B. This means that the mutual conductance of the valve has been increased by making the outer grid positive.

Greater Magnification

If you consider the "inside" of the valve for a moment you will realise that this is because the positive outer grid is farther away from the filament and its effect as a "space-charge reducer" is thereby weakened. However, if the positive potential of the outer grid is increased in steps we get a family of curves like those of Fig. 1, but the decrease of internal resistance is not quite so marked.

Now there is a most important change in the behaviour of the tetrode when we make the outer grid positive. The amplification factor of the tetrode is actually increased, and it is found that where the amplification factor under the conditions of B is only 10 it becomes 18 under the new conditions of A. The resistance has also increased from 4,000 to 8,000 ohms.

The change brought about by making the outer grid positive is one

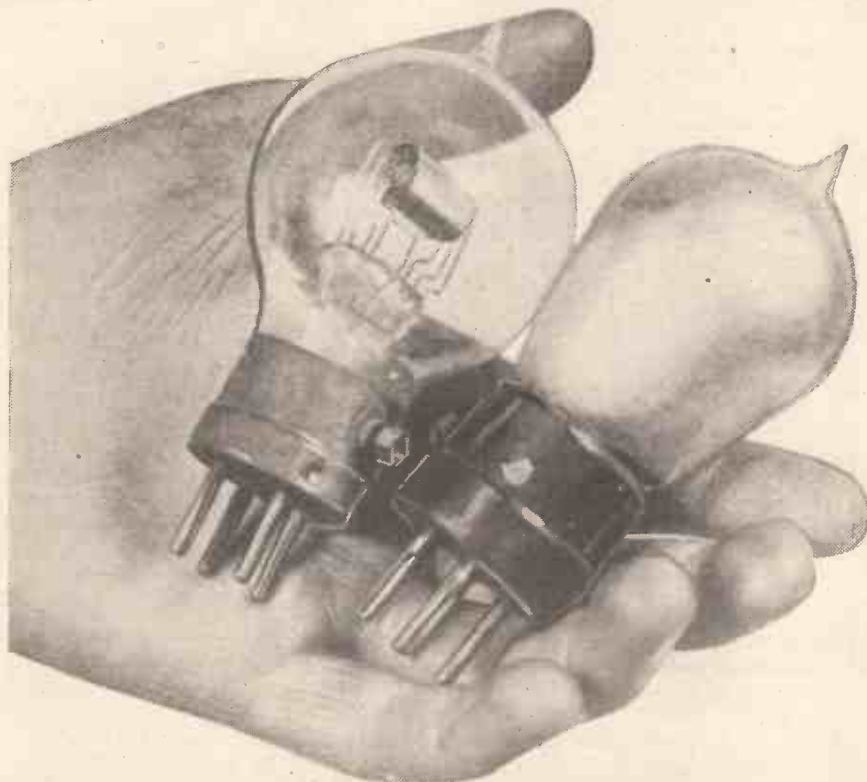

Examples of bright- and dull-emitter types of tetrode valves. Note the terminals on the bases provided for connection to the extra grid.

Raising the inner grid potential to 18 volts positive produces curve C which is a vast improvement on A and B. Notice that the straight portion of the curve now extends over a

strated by these curves is that increasing the inner grid potential produces a rapid decrease in the internal resistance of the valve. This is clearly shown in Fig. 3, where the internal

of the most important features of the tetrode and, as we shall see later, its behaviour under certain conditions is quite unlike anything observed with three-electrode valves.

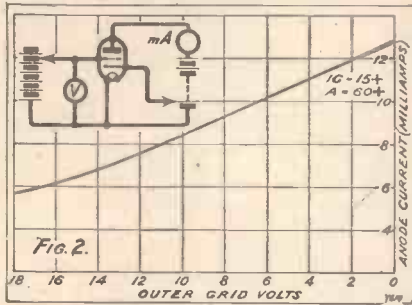

The special types of high-amplification tetrodes designed for H.F. and R.C. stages usually have the outer grid as positive electrode, the amplification factor being increased by suitable electrode design as in the three-electrode high-amplification valves.

Another Advantage

One result of using the tetrode in this manner is that higher anode voltages are required, as you will have gathered from Fig. 4. Even then the working anode voltage is barely half that required by a three-electrode valve having the same amplification factor. This is another concrete example of the merits of the tetrode.

Another very interesting set of curves is obtained by plotting inner grid and anode currents against outer

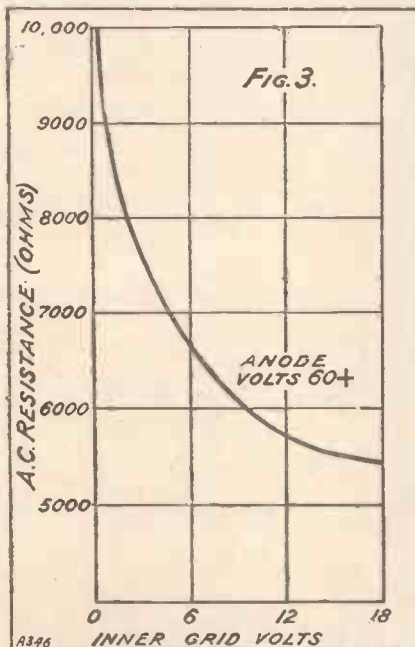

grid voltage as in Fig. 5. Notice that outer grid current decreases as anode current increases. This can be considered as being due to the greater

attraction of the inner grid for the electrons when the control grid (outer) is negative.

When this negative potential decreases, the electrons instead of being forced back upon the inner grid begin to feel the attraction of the anode until at zero and positive outer grid potentials the anode attracts nearly all the electrons.

Added Amplification

It will readily be seen from Fig. 5 that any fluctuation of control grid potential produces opposite variations of inner grid and anode currents. This property of the tetrode is turned to valuable advantage in special circuits, such as the Numans oscillator. Where the tetrode is used as an L.F. amplifier or detector with the inner grid positive, it can be seen from Fig. 5 that audio-frequency currents



The assembly of one form of the screened-grid valve—a tetrode of amazing capabilities.

For H.F. amplification the screened-grid valve takes a great deal of beating.

must circulate in the inner grid circuit as well as in the anode circuit.

This can be verified quite easily by inserting a pair of 'phones between the inner grid and its H.T. terminal when signals will be heard almost as loud as if the 'phones were in the anode circuit.

From this it is possible to develop a method of securing greater L.F. amplification by using a transformer

INTERESTING ITEMS

America's new Federal Radio Commission has "ordered off the air" one of the Illinois stations because the engineers were unable to prevent the wave-length wobbling, thus causing interference.

The Home Office not only approves the installation of broadcast receivers in reformatories, but recently contributed a sum of money towards such an installation.

Although the wave-length of ten metres has only recently been allotted to amateurs, two-way communication upon this has already taken place across the Atlantic, the distinction being shared by an American and a French amateur.

with two primary windings, one for anode current and one for inner grid current on the lines of "push-pull" amplification.

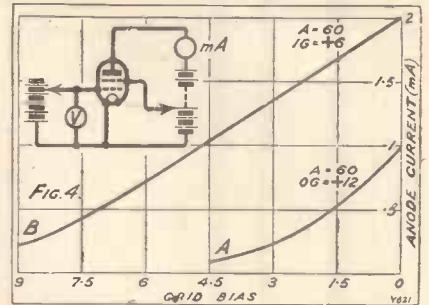

A circuit on this principle has actually been patented using a transformer with a centre-tapped primary, the tap being connected to H.T. and the two ends to anode and inner grid. In this circuit the inner grid

has the same potential as the anode, which would not appear to be productive of the highest efficiency. A very interesting form of H.F. amplification is also based on the curves of Fig. 5, but space does not allow me to give you fuller details here.

Altered Assembly

Curves similar to those of Fig. 5 are also obtained when the outer grid and anode currents are plotted against inner grid volts. However, much more interesting and valuable information is derived from curves showing these currents plotted against anode volts. These curves are quite unlike any obtainable with the three-electrode valve and a study of their intricacies has led to some important developments in the last year or so. These embrace the new redesigned "screened-grid" valve and other applications of the tetrode.

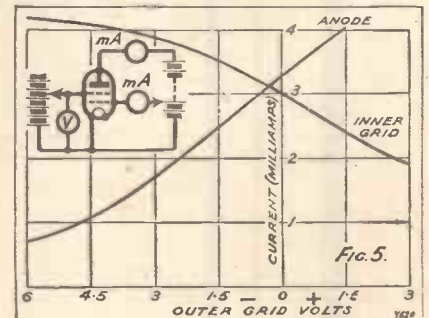

BREAKING BATTERY CONNECTIONS

By H. J. BARTON-CHAPPLE, Wh. Sch., B.Sc. (Hons.)

There are many users of wireless sets who religiously isolate their L.T. and H.T. batteries by disconnecting the leads to the set, either at the receiver or battery end, each time the set is to be "switched" off. They prefer this to an ordinary push-pull switch on the front of the panel, stating that they have experienced trouble in the earlier days as the result of leakage inside the set.

Complete Isolation

It is not deemed advisable to discuss the pros and cons of the procedure here, but rather to show how this "isolation" idea can be put into operation in an efficient manner, and gives, in addition, the advantage that all connections—H.T., L.T., and G.B. (if the last named is used outside the set)—are broken at the same time with extreme rapidity.

Instead of mounting terminals on the strip of ebonite generally provided for that purpose at the back of the cabinet fix into the hole positions small panel-mounting sockets and make the receiver connections for the batteries to the soldering tags at the back of the sockets. The number of sockets required will depend, naturally, upon the number of battery points brought out. As far as the battery leads themselves are concerned, they must be taken to an ebonite strip $\frac{1}{2}$ in. wide and $\frac{1}{4}$ in. thick, and whose length is governed by the number of terminals it replaces.

Avoiding Leakage

On this piece of ebonite must be mounted a number of plugs, the holes being drilled so that they coincide exactly with the socket positions. Connected to the nuts and screws at the back of these plugs we have the various battery leads, either arranged in the form of separate leads or as a multi-way battery cord, whichever fancy dictates.

The photograph accompanying the article illustrates the idea which has been used with success by the writer.

The strip holding the leads and plugs can be withdrawn bodily from the sockets when the set is finished with, and the set is then completely isolated, and by using good quality ebonite for the strip there is no likelihood of any leakage taking place between the respective plugs. The idea works admirably in practice.

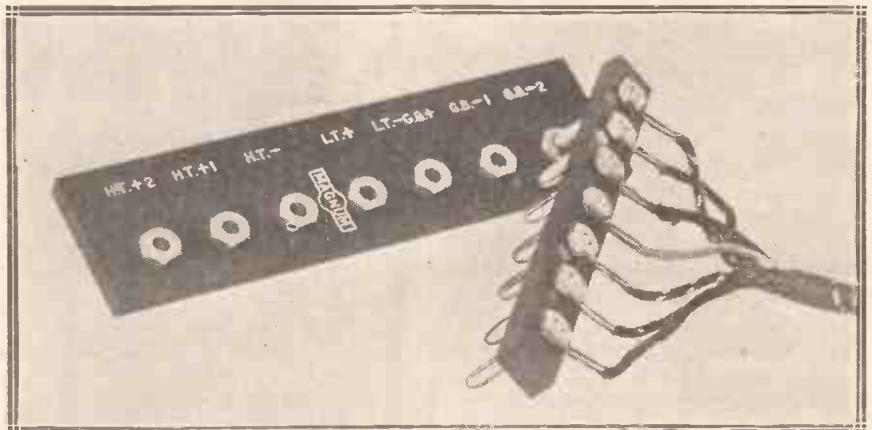

If the sockets are spaced not quite evenly, it will be impossible to plug-in, the wrong way.

 * ABOUT YOUR AERIAL *
 * From a Correspondent *

The following brief tips about the aerial and earth system cover the different faults which are generally met with in practice, and should be of assistance in ensuring maximum efficiency.

The down lead of the aerial should come either from one end of the horizontal span or from its centre.

Other aerials or telephone wires will act as a screen to an aerial, especially if they are parallel, so it pays to run your aerial at right angles, as far as possible, to such obstructions, even at the expense of height or length.

The lead-in should be kept away from walls and from the earth wire.

The fact that the legal limit for an aerial is 100 ft. length does not mean that this would be the ideal length for an aerial wire. Under normal conditions to-day the ideal aerial seems to be one about 40 ft. high and 30 ft. long—total 70 ft., or thereabouts.

There is very little, if any, advantage in using two wires instead of one for the aerial unless it is necessarily a very short one. When the length is 30 ft. or over, it is nearly always preferable to use one wire instead of two.

Effective Height

When not in use, an aerial should be connected direct to earth by means of a switch outside the house.

Not only walls and buildings, but trees form a fairly impenetrable screen for an aerial, this being especially true in the spring and summer, when trees are full of sap.

The effective height of an aerial is not its height above the ground necessarily, but the distance between it and the nearest earthed object; so that an aerial which is only 10 ft. above a lead roof is in effect only 10 ft. from earth, although it may be at the top of a very high building.

For short-wave work the aerial must be loosely coupled to the grid circuit or the set will fail to oscillate. (A neutrodyne condenser inserted in series with it is a very good way of securing these conditions).

If the lead-in insulator is arranged to slope upwards into the house the rain will tend to fall off the end of it instead of running along it and making it wet at the point where it enters the house.

Rope should not be used for stays from a mast or for halyards, owing to the considerable tightening which takes place when it is wet.



Clipping Carriers

A description of a new method of spacing transmissions in the ether to obviate interference between different stations.

By A SPECIAL CORRESPONDENT.

MANY suggestions have from time to time been advanced for coping with the ever-growing congestion in the ether. By international agreement, European broadcasting is restricted to two bands of wave-lengths, one covering the zone between 200 and 600 metres, and the other extending between 1,000 and 2,000 metres.

The actual carrier-wave is radiated at this value so long as it carries no signalling currents. Directly it is modulated with speech or musical frequencies at the transmitting station the carrier-wave develops a fringe of side-bands which extends over a considerable area on each side of it.

The width of the side-bands is directly related to the frequency range

The International Broadcasting Committee, in Geneva, have accepted a modulating range of 5,000 cycles as giving a reasonable standard of reproduction, and have therefore laid down a minimum "separation gap" of 10 kilocycles between different stations. In actual practice, however, to give satisfactory reproduction of a full orchestral performance a low-frequency range of at least 10,000 cycles is necessary, with a corresponding doubling of the side-band fringe.

All existing broadcasting stations, it should be stated, radiate a carrier-wave which varies in strength or amplitude, whilst the fundamental frequency is kept constant as far as possible.

Forming a "Fringe"

As a result of recent researches an alternative method of modulation has been discovered in which the amplitude of the carrier-wave is kept absolutely constant, the speech or musical currents being imposed on the wave in the form of frequency variations.

Fig. 1 shows diagrammatically the mechanism of ordinary "amplitude" modulation. The upper curve, A, represents the steady or unmodulated

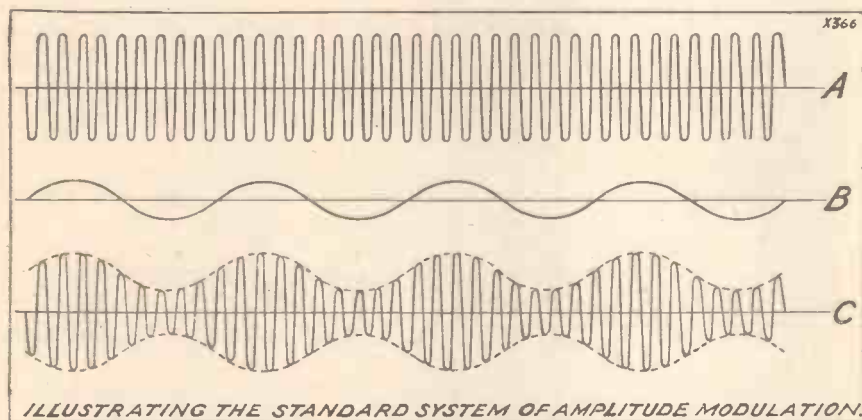

ILLUSTRATING THE STANDARD SYSTEM OF AMPLITUDE MODULATION.

Fig. 1, showing how amplitude is altered during a transmission.

The question immediately arises as to how the constantly increasing numbers of broadcast stations are to be accommodated within this limited area, having due regard to the claims of various countries to have access to the ether, based upon their size, population, culture, and other factors.

The outstanding difficulty is that in order to prevent "overlap," a separation of at least 10 kilocycles (or 10,000 cycles) is at present considered to be essential between any one station and its nearest neighbours on the wave-length scale.

The Crowded Ether

Although the various stations are allocated a single specific wave-length, such as 361.4 metres for 2 L O, and 491.8 metres for Daventry, this is in practice merely a figure of speech.

of the microphone currents used in modulation. If the low-frequency currents include frequencies from, say, 30 to 5,000, then the side-band fringe covers double this range.

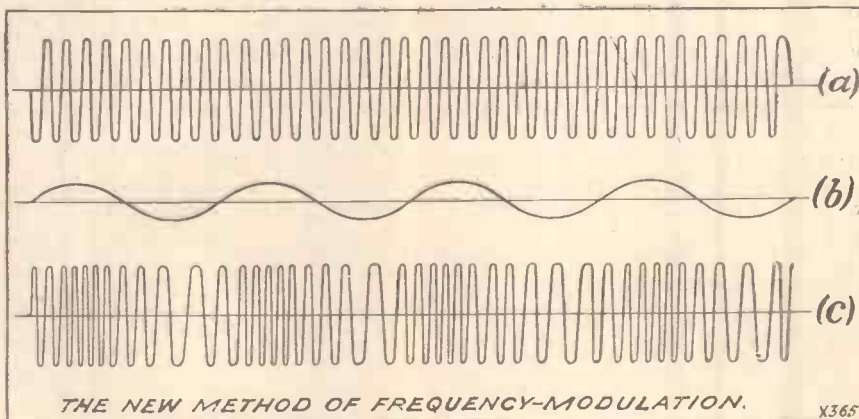

THE NEW METHOD OF FREQUENCY-MODULATION.

Fig. 2 shows how the amplitude can be kept constant.

carrier-wave, the centre curve, B, a low-frequency wave corresponding to a pure audible note, and the lower curve, C, the resulting modulated or radiated wave. It will be noted that the strength of the wave C, as measured by its vertical height, changes from point to point, whilst the frequency, as represented by the horizontal spacing between the points at which the curve crosses the centre line, remains constant.

The curve C does not show the actual frequencies which go to form the side-band "fringe." They can, however, be shown to exist either mathematically or by way of actual experiment.

It is not intended to enter into the field of mathematics beyond stating that the proof depends upon a famous theorem due to Fourier, which states that any periodic curve (such as C, Fig. 1) can be analysed into a number of simple sine curves having frequencies which are multiples one of another.

Side-Bands Abolished

Experimentally the presence of side-bands can be shown in the following way. By means of a valve oscillator generate a continuous wave of, say, 5,000 cycles. Modulate this by a buzzer note of, say, 500 cycles. Then if a wave-meter is brought near to the oscillator the following frequencies will be detected:

First the carrier frequency of 5,000 cycles. Next a frequency of (5,000 + 500) or 4,500 cycles, the so-called

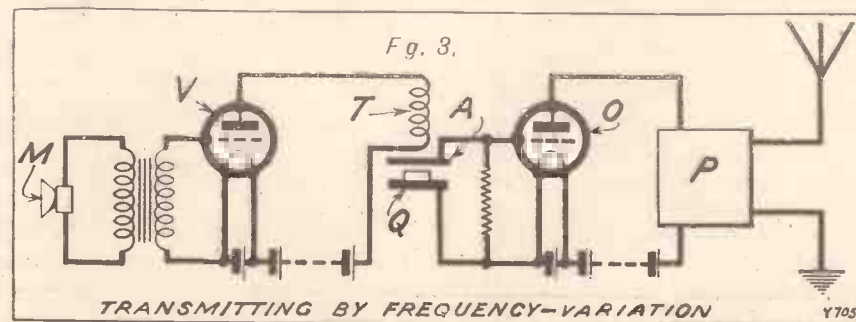

"difference" frequency. Finally a frequency of (5,000 + 500) or 5,500 cycles, known as the "summation" frequency. The original "pure" frequency of 5,000 has accordingly been "flattened out" or extended to cover frequencies between 4,500 and 5,500.

Whether the modulation is deep or slight makes no difference to the width of the side-bands produced. In all cases they are determined absolutely by the frequency-range of the modulating note and not by the "strength" of the signal.

Fig. 2 illustrates in similar fashion the working principle of the new method of frequency modulation. The upper curve (a) shows the steady carrier-wave, and the centre curve (b) a pure, audible note. In this case it will be seen that the resulting frequency-modulated wave (c) has an absolutely steady or constant amplitude, though its frequency, as represented by the horizontal spacing of the waves, varies from a maximum at the peak of the curve (b) to a minimum at the trough of that curve.

Quality and Quantity

It is clear, of course, that a band of frequencies must be involved in this method of modulation, otherwise reception would be impossible. But the width of the band has no relation whatever to the pitch or frequency of the modulating note.

For an audible note of higher pitch, the curve b will be somewhat shorter, and the crowded and spaced sections of the modulated wave c will not be so far apart. Otherwise the general effect remains the same.

The width of the frequency band produced by this system is dependent solely on the loudness or strength of the modulating note, but not on its pitch. It is a matter entirely under the control of the transmitting operator. He may make the band wide or narrow, depending entirely upon the "depth" of modulation necessary.

In other words, whilst amplitude modulation is handicapped by the fact that the width of the side-bands

determines tone quality, in the new system the side-bands can be controlled at will, and only affect tone quantity or signal strength.

Making More Room

Good telephonic communication can be effected by using a width of only 100 cycles on either side of the carrier-frequency, or a total width of 200 cycles. Comparing this with the width of from 10,000 to 20,000 cycles required for good-quality transmission by "amplitude" modulation, it will be seen that the ether space now

allotted to each individual station could be shared with double freedom by at least twenty-five stations under the new system.

Transmission.—The essential feature of frequency modulation so far as transmission is concerned is that

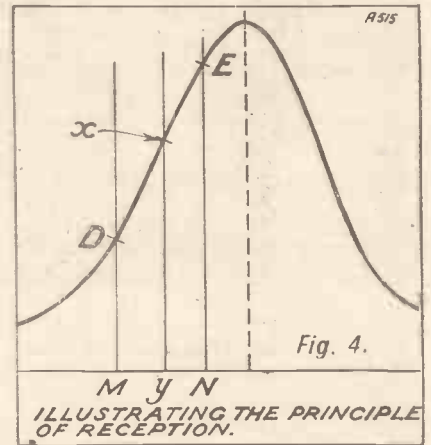

the microphone current is applied directly to a tuning element, such as a condenser coil or piezo-crystal, included in the aerial or main oscillation circuit, so as to vary rhythmically the frequency of the radiated oscillations.

For instance, if a valve oscillator is used, the microphone current may be passed through the coil of an electromagnet, the armature of which is attached to a diaphragm forming one plate of a tuning condenser. This should be of small capacity, and is preferably connected in parallel with the main aerial tuning condenser, so that the variations in frequency are only a small percentage of the carrier frequency.

How it Works

In the method illustrated in Fig. 3, the microphone currents are applied directly to a piezo-crystal.

The currents from the microphone M, after amplification by a valve V, are passed through the coils of a magnet T. The armature A of this magnet is formed as a thin diaphragm, which is spaced a short distance away from the piezo-crystal Q, which rests on a second fixed electrode.

It is well known that small variations in the air spacing between the crystal and its electrodes will vary the resonance frequency of the crystal.

The crystal is connected in the grid circuit of a drive oscillator O, which is coupled through power amplifiers P to the radiating aerial Q, so that the radiated waves alter their frequency in the rhythm of the microphone currents.

(Continued on page 431.)

RANDOM REMARKS ON SHORT WAVES

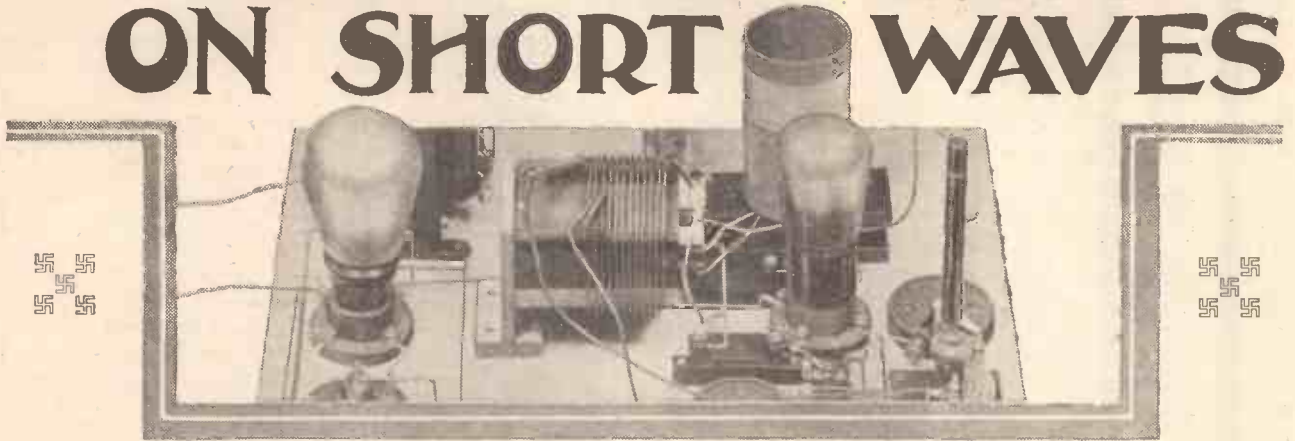

FROM A CORRESPONDENT.

THERE has always been a good deal of argument as to whether there is a close season for the wireless amateur, i.e. a season throughout the late spring and summer months when he more or less forgets all about wireless, until the opening of the Wireless Exhibition at Olympia.

This may be a habit peculiar to Britishers, for we do seem rather apt to divide up our energies and our interests into seasons. But, nevertheless, one thing is certain, and that is that short-wave interest is bound to revive, probably with intensified force, with the opening of the Wireless Exhibition, and that this year will see an ever-increasing number of amateurs taking more and more interest in the technical aspects of short-wave broadcasting.

Proof abundant has been collected to show that 5 S W, the B.B.C. short-wave station at Chelmsford, has proved a perfect godsend to British listeners in distant parts of the world abroad. But there is one aspect of 5 S W which is really rather serious, and that is its cost and maintenance.

It was pointed out the other day that 5 S W costs every penny of £10,000 a year, and that this expense is borne by the British listener. Now, the British listener in this country does not find very much to interest him in 5 S W. For technical reasons which need not be gone into here, but which every amateur knows to be a fact, reception from 5 S W in this country is not really worth while. Skip distance and other phenomenon come into the reason.

5 S W An Empire Asset

Nevertheless, 5 S W is a very fine Empire asset, inasmuch as it enables the British Dominions to receive from the Old Country not only concerts, etc., but general propaganda which makes the station in itself a worthwhile Empire ambassador.

But the question has been asked, and it certainly is a pertinent point: Why should British listeners pay for the cost of 5 S W? That £10,000 a year which is expended on 5 S W is obtained from the licence revenue, and although the station is primarily for the benefit of British listeners abroad, they do not pay one cent towards its upkeep. The least we should expect is that more interest should be taken in short-wave broadcasting in South Africa, Australia, Canada, and other Dominions and Colonies, and that some reciprocal service should be given. Or, at any rate, our Dominions Office in this country should contribute something towards the upkeep of 5 S W.

It is quite likely some contribution will be made, for we understand that the B.B.C. has already approached the Dominions Office on this very point, and it is hoped that before long some sort of an arrangement may be made whereby the Dominions Office will pay part of the expense of the upkeep of 5 S W.

Certainly it is not fair that 5 S W should be maintained for short-wave Empire broadcasting purely at the

expense of the British listener, who cannot get any benefit worth speaking of from the transmissions from the station.

Marcuse Carries On the Good Work

Mr. Marcuse, we understand, has now had his special licence extended for another three months from September 1st, and we would again offer our congratulations to him on his public-spirited enterprise in conducting such a valuable short-wave broadcasting service. Here again it should be pointed out that Mr. Marcuse carries out his special experiments entirely at his own cost, and it is high time that some official recognition was taken in a tangible form of his excellent services. Certainly it is a matter of which our friends in the Dominions should take cognisance.

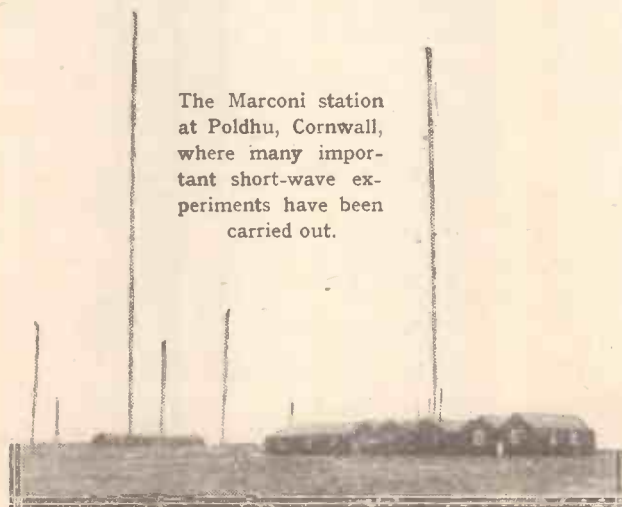

The Marconi station at Poldhu, Cornwall, where many important short-wave experiments have been carried out.

Not so many years ago short-wave circuits were regarded as complex and difficult arrangements only suitable for the advanced experimenter, and the scarcity of components available for circuits suitable for working below 100 metres was another factor which made short-wave broadcast reception a matter of some difficulty.

But the progress and the technique of short-wave work has been extraordinarily rapid of late; and, thanks to the work of Reinartz, short-wave circuits are now as simple to operate as an ordinary straightforward two-valver.

Short Wave Reception Now Easy

The amateur who is keen on short-wave work will find that the Reinartz circuit in one of its varied forms will be found in practically any short-wave receiving set. In the popular "Schnell" circuit, for instance, one set of vanes in both the tuning and the reaction condensers are at earth potential, and by arranging the circuit so that the low potential vanes are those connected to the spindles of the condensers, body-capacity effects can be almost entirely cut out on wave-lengths as low down as 20 metres.

Below 20 metres body-capacity effects are often to be encountered, for the frequencies involved below this wave-length are of such magnitude that it is impossible to eliminate body-capacity. But transmissions below 20 metres, although there are plenty of them, are not on the whole so very outstanding, and there are plenty of broadcasts above 20 metres in which the average amateur will find particular interest, and which he will be able to tune-in with amazing ease.

One of the reasons why short-wave broadcast reception has become so simple is the introduction of the slow-motion dial, which enables very fine adjustments on the variable condensers to be made even by those who are not expert in tuning-in.

The actual receiving set for a short-wave outfit is also very straightforward and simple, and it will be found that a detector and a low-frequency magnifier will prove sufficient. Two-note magnifiers can be used, but excellent results can be obtained with two valves only.

Controls in the short-wave set are simple; there are only two which require simultaneous adjustment—the grid-tuning condenser of the detecting valve and the reaction condenser.

How To Tune-In

The grid-tuning condenser having been set at zero, the reading of the latter is gradually increased until a slight "breathing" noise indicates that the set is either just on the point of oscillation or very gently oscillating. Gradually the reading of the grid tuning condenser is then raised, the receiver being kept oscillating very slightly by moving the reaction condenser.

Directly a carrier-wave is heard the reaction coupling is slightly loosened, and the grid of the rectifier is retuned by means of the grid tuning condenser.

Once the amateur picks up speech or music he can increase the signal strength by slight adjustments of both condensers, great care being taken, however, to see that the set is not actually oscillating.

SHORT-WAVE STATIONS

M.	Kc.	M.	Kc.
90	3,333—Nairobi (Kenya). Daily 5.30 to 8.30 p.m.	32.5	9,231—Paris, Eiffel Tower. F.L. Time Signal 8.56 a.m. and 8.56 p.m.
85	3,529—Zürich (Radio Club) E H 9 X D.	32	9,375—Zürich (Radio Club) E H 9 X D.
80	3,750—Nogent-sur-Seine (F 8 A V) 0.4 kw.	32	9,375—Melbourne (3 L O). SUN., 7.30 p.m. to 9.30 p.m.
70	4,285—Springfield (Mass.) W B Z.	32	9,375—Berne (Switzerland) E H 90 C.
70	4,295—Vienna (O H K 2). (Transmits on SUNDAY for 15 minutes after each hour from 6 p.m. till 1 a.m.)	32	9,375—Detroit (Mich.) 8 X A O, 0.75 kw.
67.05	4,434—Döberitz (A F K) 5 kw. MON., WED., and FRI. 11 a.m. to 12 noon and 7 to 8 p.m.	31.93	9,395—Bandoeng, Java (Radio Service) A N E. TUES. and THURS., 5.40 p.m. to 7.40 p.m.
66.04	4,542—Los Angeles (California) 6 X A L from 12 'midnight' 0.5 kw.	31.5	9,523—Helsingfors, 0.3 kw.
66.04	4,542—Cleveland (Ohio), 8 X F, 0.5 kw. from midnight.	31.4	9,554—Hilversum, Holland, P C J J. TUES. and THURS., 5—9 p.m. FRI., 12 midnight to 3 a.m. SAT., 4—7 p.m.
65.18	4,602—Newark (New Jersey) 0.5 kw. 2 X B A (S.W. of W A A M). Transmits between 12 midnight and 5 a.m. TUES., THURS., and SAT.	31.4	9,554—Schenectady (General Electric Co.), N.Y., 2 X A F, 10 kw. (Aer.). SUN., WED., and FRI., no transmission. MON., 11 p.m. to 5 a.m. TUES., 11 p.m. to 4.30 a.m. THURS., 11 p.m. to 5.30 a.m. SAT., 11 p.m. to 5 a.m. Relays W G Y.
65.18	4,602—San Diego (K F B C).	31.25	9,600—Bergen L G N.
64	4,687—Richmond Hill (New York) W A B C, 0.5 kw.	30.91	9,706—New York (2 X A L). TUES., 12 midnight to 5 a.m. WED., 12 midnight to 2 a.m. FRI., 12 midnight to 4 a.m. SAT., 12 midnight to 3 a.m., 0.5 kw.
63	4,762—Pittsburgh East (Westinghouse Electric) K D K A (U.S.A.) daily from 10 p.m.	30.75	9,750—Agen. TUES. and FRI., 10 to 11.15 p.m.
61.06	4,913—Council Bluffs (Iowa) 9 X U, 0.5 kw.	30.7	9,772—Madrid (E A M).
61	4,918—Paris (Radio L L) G C.	30	10,000—Bergen (Norway) L G N.
59.96	5,003—Bound Brook (N.J.) 3 X L, 30 kw.	23.5	10,526—Sydney (2 F C).
58.5	5,128—New York City (2 X E). Relays W A B C. Week-days 11 p.m. to 5 a.m. SUN. 3.50 p.m. to 5.30 p.m.	27	11,111—Pittsburgh (8 X K). MON. and THURS., 7 p.m. to 9 p.m., 40 kw.
56.7	5,291—Nauen (A G J) occasionally after 7 p.m.	26.92	11,144—New York (2 X A G).
54.02	5,553—Columbus (Ohio) 8 X J.	24.5	12,244—St. Assise (France) F W.
54.02	5,553—Coney Island (N.Y.) 2 X B H, 0.15 kw.	24	12,500—New York (2 X A B).
54	5,555—Brooklyn (N.Y.) W C G V, from 11 p.m.	24	12,500—Chelmsford (5 B W, 15 kw. Aer.). DAILY (except SAT. and SUN.) from 12.30—1.30 p.m. and from 7—11 p.m.
53.54	5,603—Portland (Oregon) 7 X A O, 0.1 kw. 1 p.m.	22.99	13,049—Houlton (Maine) 2 X A A, after 11 p.m.
52.05	5,763—Harrison (Ohio) 8 X A L, 0.5 kw.	22.8	13,153—Fort Wayne (Indiana) W O W O, 1 kw. after 11 p.m.
52.02	5,767—Cincinnati (Ohio) W L W. Relays medium-wave transmissions from 11.50 p.m. Except FRI. and SUN.	22.2	13,513—Vienna, 0.24 kw.
51	5,882—Casablanca. A I N. Weather reports 9.30 a.m. and 8.30 p.m.	22.1	13,575—Richmond Hill (N.Y.) 2 X E (S.W. of W A B C), after 11 p.m.
51	5,882—Bergedorf (Germany) A F L, 3 kw.	21.06	13,661—Schenectady (General Electric Co.), 2 X A D. SUN., 10.30 p.m. to 3.30 a.m. MON., 7 p.m. to 9 p.m. WED., 11 p.m. to 4.30 a.m. THURS., 7 p.m. to 9 p.m. FRI., 11 p.m. to 4 a.m. Relays W G Y WED. and FRI.
50	6,000—Karlsborg (Sweden) S A J.	18	16,668—Kootwijk (Holland) P C L L. WED., 3 to 5 p.m., and occasionally on MON. and FRI.
50	6,000—Moscow, R F N. TUES., THURS. and SAT., 1 and 2 p.m.	17.2	17,441—Nauen (A G C).
44.4	6,756—Vienna, 0.24 kw.	17	17,647—Bandoeng, Java (Radio-Malabar) A N H, 30 kw. SAT., 1.40 to 3.40 p.m.
43.5	6,896—Rome (Italy) I M A. SUN. 5—7.30 p.m.	16.02	18,726—Rocky Point (Long Island) 2 X G. MON. and FRI., after 7 p.m.
43	6,976—Pittsburgh East (Westinghouse Electric) K D K A.	15.93	18,832—Bandoeng, Java (Radio Service) A N E. MON., 1.40 to 3.40 p.m.
42.8	7,009—Constantine (Tunis)—9 K R. SAT., 10 p.m. to midnight.	15.5	19,354—Nancy (France).
40.2	7,463—Lyons (Rhône) Y R. Daily except SUN. from 4.30 to 5.30 p.m.		
37.65	7,968—Döberitz (A F K). MON., WED., and FRI. 7—8 p.m.		
37.5	8,000—Ibarakiken (Japan) J H B B.		
37.01	8,105—New York (W J D).		
37	8,108—Radio Vitus. WED., FRI. and SUN., 9 p.m. to 10 p.m.		
37	8,108—Vienna (E A T H). MON. and THURS., 10.30 p.m. to midnight.		
33	9,090—San Francisco (Cal.) 6 X A R, from 12 midnight.		
32.9	9,118—Perth (W.A.) 6 A G. 11.30 a.m. and 4 p.m.		
32.5	9,231—Sydney (2 B L).		
32.5	9,231—Copenhagen 7 M K. TUES. and THURS.		



NEVER before has a wireless exhibition, either in this country or in any other, been able to show such an array of valves as the one opened at Olympia on September 22nd, which enables the visitor to see what a tremendous advance has been made in both the manufacture and design of radio receiving valves in this country.

Some of the old types of dull-emitter valves introduced during the last eighteen months are there, but the majority of these have been re-designed and have got new characteristics.



*
The Mullard "Pentone," a five-electrode high-mag. valve similar in design to the pentodes placed on the market by others of the large valve concerns. The valve is available in 2- and 4-volt classes, the 6-volter being still under design.
*

A typical example of the redesigned valve is to be found amongst the Marconi and Osram group, in the D.E.L.610.

This valve came into being about a year ago, and had characteristics somewhere of the order of 13,000 ohms impedance, and a magnification factor of 13. It at once sprung into favour, and is used by a great number

Some of the most interesting stands at the National Radio Exhibition are those upon which specimens of the latest valves are to be found, and of which a few details are given below.

By KEITH D. ROGERS.

of people. It has now been re-designed so that although the magnification factor has been raised to 15, the impedance of the valve has been lowered to 7,500 ohms.

This gives it a much higher mutual conductance—a much higher efficiency, and goes to show that the valve designers are getting further and further advanced in their designs, and, of course, "results" are correspondingly improving.

S.G. Valves

Among the special valves must be mentioned the new screened-grid valve, which in many cases has been totally redesigned and bears no resemblance at all in external appearance to the S.G. valve of a year ago.

First upon the list of screened-grid valves was the S.625, which appeared last year. This valve is still retained for use in sets which have been built specially to accommodate this valve, which, as readers will remember, was of the horizontal mounting type, requiring a special holder. But in addition to this the Marconi and Osram companies have decided to put on the market a 2-volt valve, later to be followed, probably, by 4- and 6-volters, of the screened-grid type, but with upright mountings.

These valves have four pins in the base and a single terminal at the top of the bulb; the four pins at the base being for filament, main grid and screen grid, while the plate

terminal comes out at the top of the valve. This is in accordance with the Mullard design which was brought out some months ago, but not placed on the market, the Mullard valve now being released in a 2-volt and 4-volt variety.

Messrs. Ediswan have gone one further, and they are producing screened-grid valves for 2, 4, and 6 volts right away, also of the upright type, while Messrs. Cossor have taken off the market their horizontal 2-volt type and are putting on the 2- and 4-volt upright style instead.

*
In addition to the famous S.625, the first screened-grid H.F. amplifier to be placed on the British market, Messrs. Osram and the Marconi-phonograph Co. are both bringing out screened-grid valves of the upright, four-pin type as shown on the right. These are now available in the 2-volt class, and are wonderful H.F. amplifiers.
*



Sixty-Sixty valves also include the screened grid in their ranges, the only large manufacturers which are not marketing them at present being Metro-Vick and B.T.H. Metro-Vick, instead, have greatly improved their A.C. valves, while Messrs. B.T.H. are placing on the market a new range

of "Mazda" valves, including some very useful power valves.

Talking about power valves, the Marconi and Osram are putting on the market two very useful new



On the left is the Six-Sixty screened-grid 4-volt valve, and on the right the Cossor Pentode L.F. high-magnification amplifier.

models, the P.625 and the P.625a. The former has an impedance of 2,400 ohms and a magnification factor of 6, while the latter has an impedance of 1,750 ohms with a magnification factor of about 3. These are two very useful valves for output stages and deserve very serious consideration.

New A.C. Valves

In addition to these the directly-heated A.C. valves are making their appearance on the market for the first time this year. Up to the present it has been possible, and, of course, is still possible, to use such valves as the B.12, L.S.5a, D.F.A.7, etc., etc., direct on "raw" A.C., owing to their short filaments, but now a special range of 0.8 amp., 0.8-volt A.C. valves and special transformers for them will be placed on the market



The P.625A and P.625 power valves for output circuits.

by some of the firms. These valves have extremely short filaments in order to obviate any chance of hum occurring because of the A.C. filament supply.

These will not supersede the indirectly-heated types, such as the K.H.1, the K.L.1 and the Cosmos valves, but will form additions to the valve market.

H.T. Rectifiers

New rectifying valves for H.T. battery eliminators are also making their appearance, including the U.8, which is a specially large rectifying valve with a 7.5-volt filament, and handling an output voltage of 500 volts, and a milliamperage of upwards of 100 milliamps. For those who like really "big stuff" this valve will be ideal. It is, of course, of the double-wave rectifying variety.

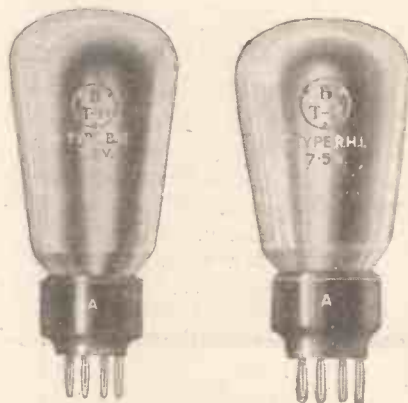

The B.T.H. B.12 power amplifier for moving-coil speakers, and the wave rectifier R.H.1. Both take 7.5 volts filament voltage.

Now let us turn to that valve which I have mentioned before in these notes, but which is certainly one of the outstanding features of the show, namely, the Pentode 5-electrode valve. This valve, as many readers know, consists of a filament, anode and three grids, one of which is used in the control grid, one as a screen grid, and the middle one of which is connected to H.T. positive.

The Pentodes

The impedance of this valve is high, but its magnification is also very high, and it is useful in the last stage, providing the input is not too great and about 15 m.a. are available for its H.T. consumption. It will be noticed that many receivers at the show, especially portable sets, use these valves. One screened-grid H.F., bringing the sensitivity of the set up

by a great deal; a detector, and the Pentode (5-electrode) valve is the general rule.

This latter on test gives results, as regards magnification, equal to those obtainable from two L.F. stages, the

Messrs. Edison-Swan have joined the ranks of the screened-grid four-pin valve manufacturers, and have added to their lists of H.F. valves the S.G.215, S.G.410, and the S.G.610 — three excellent screened-grid valves, each having magnification factors of 140, with impedances of 140,000, 115,000 and 100,000 ohms respectively.



drawback for portable work being the H.T. current required.

As I write I understand that valve prices will come down before the end of September, and probably during the exhibition. This is one more step towards the increased popularity of the British valve.

The Pentode will, I am afraid, be rather on the more expensive side, being somewhere about 22s. 6d., the same as the screened-grid valve, but both these valves give results so superior to the ordinary valve that they are really worth the money to the man who wants the absolute best for his set.



The P.R. 3s. 6d. valve, an excellent general-purpose "tube," and the new U.8 (Marconi or Osram), a full-wave rectifier for 500—0—500 volts, and capable of giving 120 milliamps.

The "JAMES" H.T. UNIT



An article in which full details are given of an easily-made instrument for obtaining a thoroughly adequate H.T. supply from A.C. mains.

By W. JAMES.

THE anode circuits of all valve wireless receivers have, of course, to be supplied with direct current at a suitable voltage. This current must be of such a nature

steady current. The current will not vary above or below its mean value, and it is, therefore, suitable for the anode circuits of valve receivers. Unfortunately, after a dry-cell battery has been delivering current for a time its voltage begins to fall, with the result that the current decreases.

is an extremely gradual one, and it follows that a dry battery is still a suitable source for the supply of current. Extremely gradual changes do not matter.

For Good Results

To proceed a stage farther, let us now assume that a signal is being received. The signal causes the current flowing from the high-tension supply

LIST OF COMPONENTS REQUIRED.

- 1 Metal rectifier, type R4-55-1 (Westinghouse Brake & Saxby Signalling Co., Ltd.).
- 1 Transformer for above, voltage and frequency to suit A.C. mains (R.I.-Varley, Regent Radio, etc.).
- 2 High-frequency choking coils (Any good make).
- 2 Low-frequency choking coils, about 10 henries each (Any good make, R.I.-Varley, Ferranti, etc.).
- 3 4-mfd. condensers, working voltage 200 D.C. (Mullard, Ferranti, T.C.C., Lissen, Dublier, Hydra, etc.).
- 2 2-mfd. Mansbridge condensers (see above).
- 1 Fixed resistance and holder, 10,000 to 20,000 ohms (R.I. & Varley).
- 1 Clarostat (Louis Holzman).
- 4 Engraved terminals (Belling and Lee).
- 1 D.C. milliammeter (Sifam in unit. Any make of reasonably small size).
- 2 Brackets.
- 1 Ebonite panel and a cabinet will also be required, with Systoflex and connecting wire.

that when no signal is being received no sound is emitted by the loud speaker. It is, therefore, obvious that the high-tension current must not only be direct or uni-directional, but perfectly continuous or steady as well. It must, besides flowing in one direction only, not fluctuate in value at all.

The most common source of high-tension is a dry-cell battery. A freshly-made one will give a perfectly

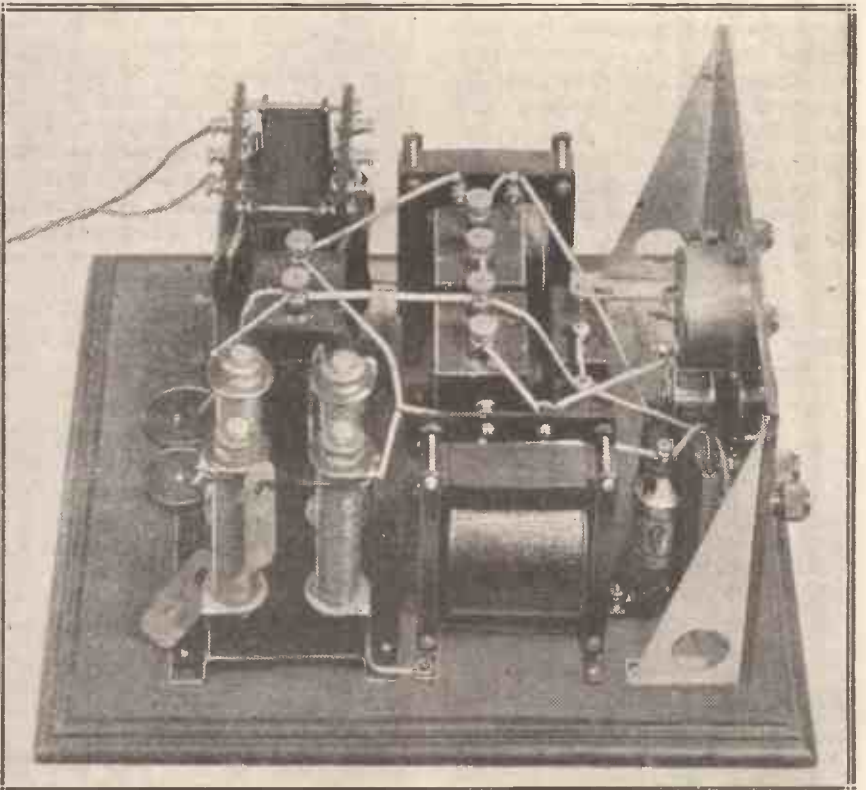

From the appearance of the completed unit it will be seen that the assembly and wiring is not a difficult task.

through the anode circuit of the first low-frequency amplifying valve to vary according to the voltage applied to the grid of the valve.

For good results the current in the anode circuit must vary precisely

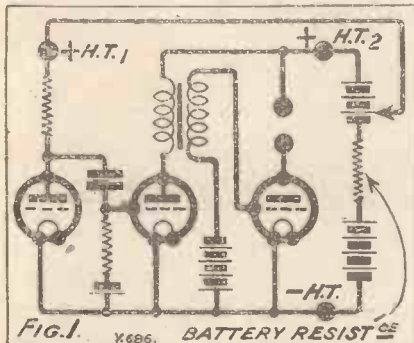

as the voltage applied to the grid, and the same remarks apply to the remaining valves.

But the current flow to the individual valves, when they all derive their current from the same source, cannot vary in a proper manner when there is a resistance in the common anode circuit. The varying current flowing in the anode circuit of the last valve, for example, causes a voltage, which also varies, to be in effect set up across the resistance.

The Ideal Supply

The voltage actually across the terminals of the dry battery therefore varies according to the current that is taken from it. As a consequence, a varying voltage is applied to the anode circuits of the remaining valves and the individual anode circuits are therefore coupled together. They are in effect connected together through the common resistance of the high-tension battery (Fig. 1).

The coupling may be sufficient to cause howling or "motor-biking," or it may only show itself by distortion. In the past it has been the

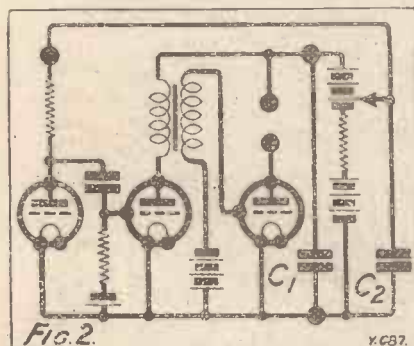

usual practice to connect by-pass condensers of 2 mfd. or more across the high-tension circuits. Condensers of large capacity offer a moderately low-impedance path to audio-fre-

quency currents with the result that they tend to reduce the inter-circuit coupling. This will be understood by referring to Fig. 2, where the condensers C_1 , C_2 , are shown as offering an alternative path for the speech frequency currents. They are not really effective, however, particularly when the low-frequency circuits are designed to magnify the very low notes, and it is now realised that for good quality it is necessary to use either a source of supply having a very low resistance or to provide filter circuits to connect between the supply and the receiver to more or less isolate one anode circuit from another.

The ideal supply for the high-tension circuits of a valve receiver must therefore give not only a perfectly steady current, but have a very low resistance or, alternatively, include apparatus which shall ensure that the voltage of the current supplied to the different anode circuits remains at a constant value when measured between the battery side of the apparatus connected in the anode circuits, and the negative terminal.

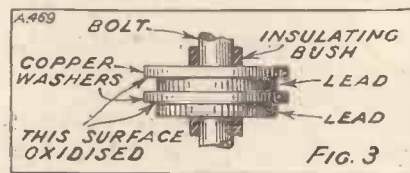

High-tension accumulators are generally very satisfactory, as they have a low internal resistance, but they must, of course, be of ample capacity for satisfactory working. Dry batteries are not nearly as suitable. A freshly-made dry battery may have a reasonably low internal resistance, but after it has been used its resistance rapidly increases. As the resistance increases the inter-circuit coupling increases with the result that signals are distorted, and finally a howl may be set up.

Batteries v. Mains

One of the chief failings of the dry battery is that its electrical characteristics vary during its life, and users are beginning to realise that consistently good reproduction cannot be obtained from such a changeable source. Moreover, quite apart from this factor, dry batteries have a useful life which cannot be determined with accuracy. One battery may last three months, and another one of the same type five or six months.

Users are, therefore, turning their attention to alternative sources for high-tension current. The most obvious one is the domestic supply of

electricity. Here is a supply which is always available, and it is relatively not very expensive.

Many houses have a supply of alternating-current electricity. An alternating current is one which flows first in one direction and then in the opposite. It is always changing in value from instant to instant. At a given instant the current may be zero and about to increase in a posi-

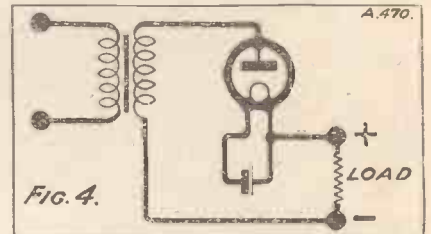

tive direction. It then increases until a maximum or peak value is reached, when it gradually decreases to zero again. The current then commences to increase in value once more, but it flows in the opposite or negative direction, and having reached its maximum value begins to fall again to zero.

Low Internal Resistance

This cycle continues. The current increases and decreases in a perfectly regular manner, and the frequency of the supply is actually equal to the number of positive or negative half-waves of current per second, or to the number of complete cycles per second. A supply having a frequency of 50 cycles, therefore, gives a current which has 50 positive and 50 negative half-waves per second.

A current of this nature is obviously quite unsuitable for the high-tension circuits of a valve receiver. Hence it is necessary to connect apparatus which, while using this current, gives out a steady direct current at a suitable voltage, and

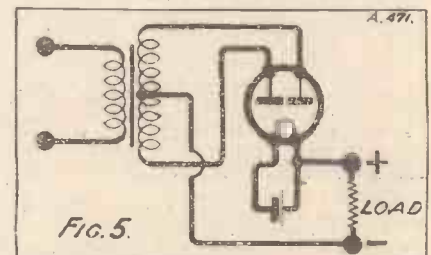

the apparatus must either have so low an internal resistance that the supply is comparable with that to be obtained from an accumulator, or means must be provided for separating the supplies to the different anode circuits.

It is not possible to build apparatus having such a low internal

resistance unfortunately, and devices always have to be included for feeding each anode or group separately.

Mains apparatus* for high-tension current, therefore, comprise three essentials. First, means for obtaining a uni-directional or direct current. Secondly, means for obtaining smooth continuous current from the uni-directional current, and thirdly, filter circuits for passing the anode current to the different valves.

It should be understood that the production, from an alternating-current supply, of a steady direct current demands two pieces of apparatus. First, a rectifier must be used, and, secondly, a filter or smoothing circuit, and the proper design of the one depends greatly on the design of the other.

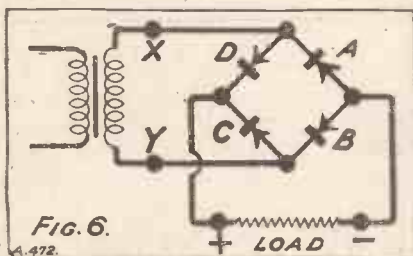

There are a number of devices for rectifying. In the past valves have generally been employed, but chemical and other rectifiers have also been used, and only lately have metal rectifiers been available. A metal rectifier of Westinghouse manufacture is included in the high-tension mains unit illustrated here.

Metal Rectifiers

It comprises a number of specially treated copper washers having one of their surfaces oxidised. They are suitably mounted with lead spacing washers on an insulating bush which fits over the assembly bolt. The particular rectifying unit employed has four sections, each of which includes 50 treated copper washers. The illustration (Fig. 3) shows the assembly of part of a rectifier unit. Each treated copper washer is about 3/4 in. in diameter and 1/16 in. thick, a complete unit comprising the four separate legs occupying a space approximately 3 in. by 3 in. by 5 1/2 in. high. Rectification occurs at the junction of the copper and copper oxide, but in practice a lead washer is included between adjacent discs in order that a good contact with the copper oxide shall be made.

The elementary principles of rectification will be understood by readers. To take the simplest instance, a valve connected as in Fig. 4 will pass current every time the anode is

positive with respect to the filament. Thus, when the supply of electricity applied to the primary winding of the transformer has a frequency of 50 cycles per second, the anode will be positive 50 times a second, and 50 pulses of current will pass through the valve and load resistance. The anode is also, of course, negative with respect to the filament 50 times per second, but no current flows during these periods.

"Full-Wave" Working

A load current comprising 50 pulsations of direct current per second is obtained with the arrangement of Fig. 4, but by connecting a second valve or by adding a further anode, and rearranging the transformer to give the circuit of Fig. 5, a direct current consisting of 100 pulses per second is secured.

This current flows first through one anode-filament path, and then through the other, and so on. With this new arrangement both half waves of the alternating current are used.

It is to be noticed that the secondary winding of the trans-

former comprises two parts, and that each part is equal to the single part of the transformer of Fig. 4. Each half of the secondary winding,

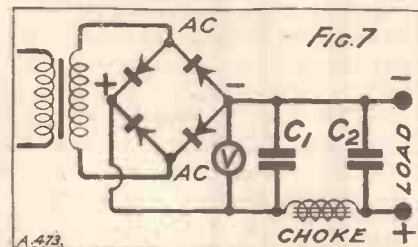

therefore, only carries a current 50 times per second, giving for the two halves 100 pulses. This is known as full-wave rectification.

A transformer giving approximately twice the secondary voltage, and having a centre tapping, is therefore required for full-wave rectification.

Direct Current Pulses

The Westinghouse metal rectifier provides full-wave rectification. Connected to a 50-cycle alternating-current supply it passes 100 pulses of direct current per second into a

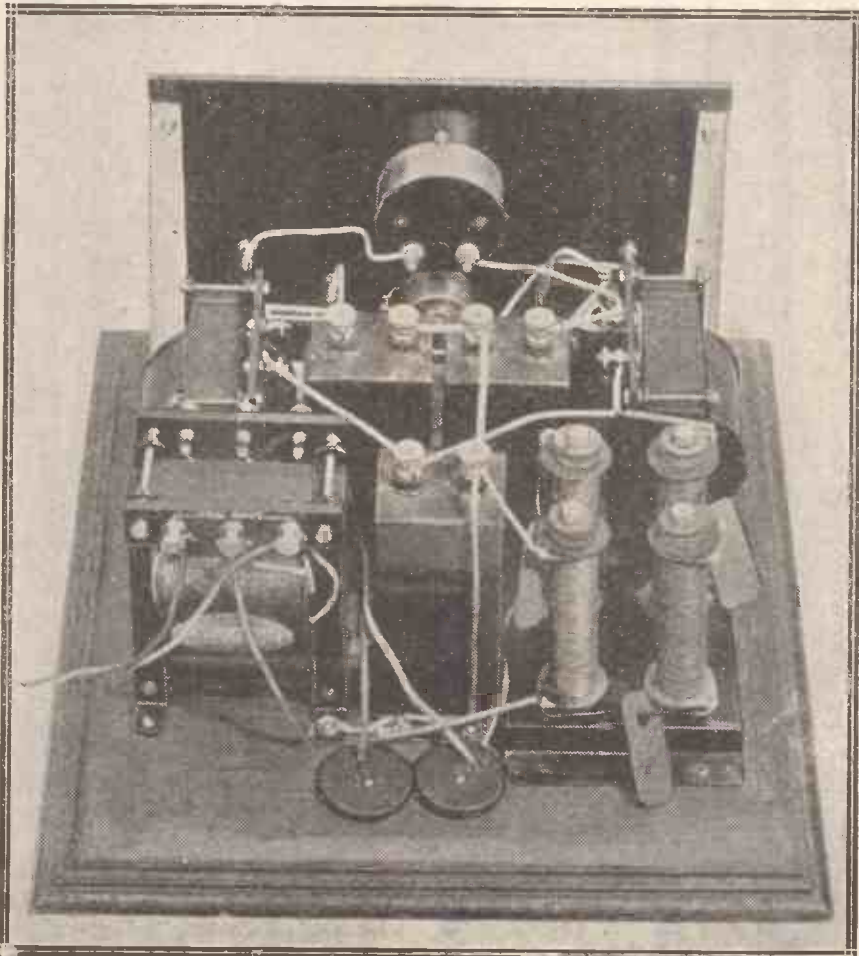

The two leads from the mains are those coming in from the left and going to the two outer terminals on the transformer.

resistance load. Naturally, the four equal parts of the metal rectifier unit are connected in a rather different though quite ordinary manner.

They are joined as indicated in Fig. 6, and we will carefully consider the behaviour of the arrangement. The four legs are marked A, B, C, and D, and the load is assumed to be a resistance. Let us suppose that the end of the secondary winding of the transformer marked X is positive with respect to the end marked Y. A current then flows from end X, through the rectifying contacts D, to the load. Passing through the load it flows through arm B, and so back to the end of Y of the transformer.

Negative and Positive

One pulse of current will, therefore, flow through the load resistance every time the end X of the secondary winding is positive with respect to the end Y. With a 50-cycle supply of alternating current the end X will be positive 50 times per second, and 50 pulses of current per second will flow through the load.

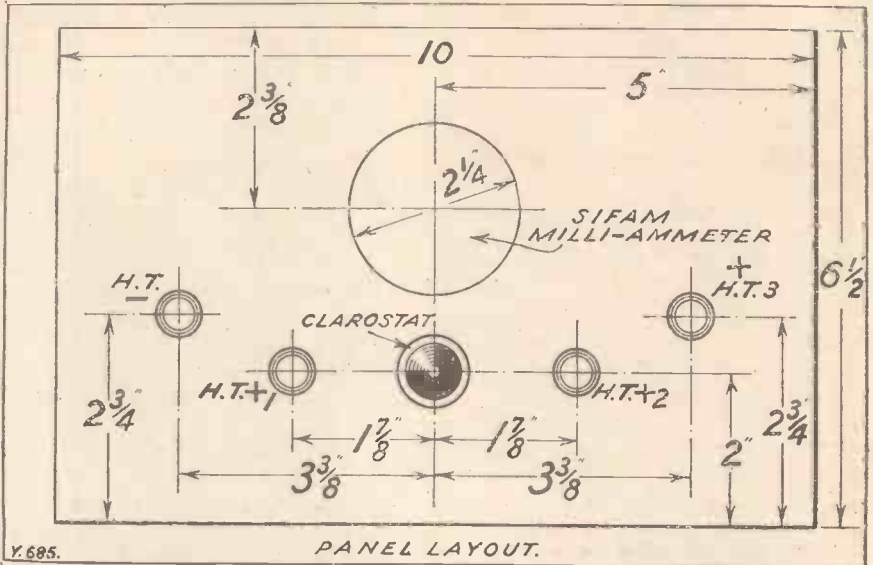

direction as before, and then passes through the arm A to the end X. Thus 100 pulses of direct current pass through the load per second.

It should be noticed that owing to the special connection of the four arms of the rectifier, a transformer having a single secondary winding is

several factors. The first of these is the electrical characteristics of the rectifier itself; and the second is, of course, the voltage applied to the rectifier by the transformer. The third factor is the resistance of the load. The Westinghouse metal rectifier used by the writer in the eliminator described below is of the R4-55-1 type. It may be used with an alternating voltage of 200 to 250, and it is rated to give an output not exceeding 200 volts 100 milliamperes of direct but unsmoothed current.

Voltage Values

For a given value of load resistance the amount of direct current passed will therefore depend on the value of the applied alternating voltage. As this is reduced, the output current will fall off. Similarly, if the resistance of the load is reduced in value, the current will increase. The resistance of the rectifier itself varies according to the voltage and current, but it is relatively low, being of the order of 50 ohms. This value of resistance is low by comparison with that of a full-wave valve rectifier, and constitutes a distinct advantage in favour of the metal rectifier.

A metal rectifier, like any other electrical appliance, will break down if it is abused. An A.C. voltage in excess of the maximum allowed by the makers will damage the rectifier,

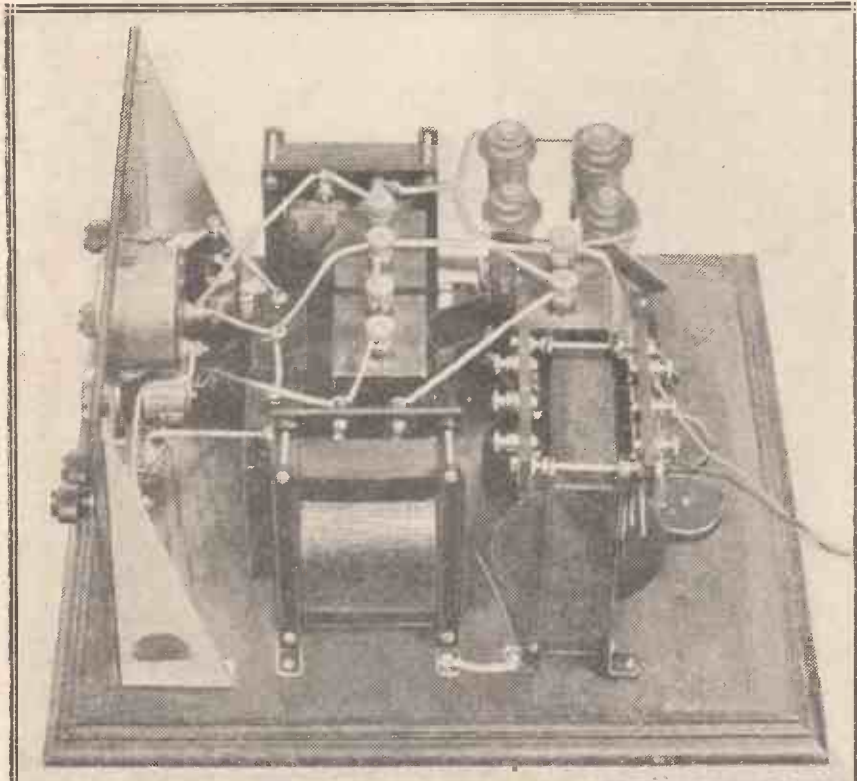

Most of the wiring is visible in this illustration, which should be compared with the wiring diagram on a following page, when wiring-up.

During the opposite half-cycles, however, end Y is positive with respect to end X. A current will, therefore, flow during these periods from Y through arm C to the load. It flows through the load in the same

used. Further, that the voltage set up across the load will be comparable with the alternating voltage of the secondary winding of the transformer. The current which flows through the load will have a value depending on

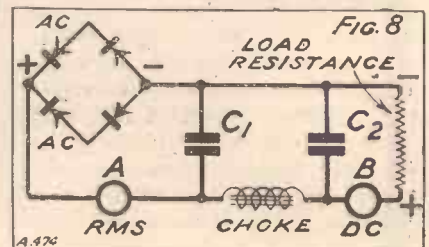

and so will a current overload. It is, therefore, necessary to take certain precautions, just as have to be taken when a valve rectifier is used.

resistance it is safe to take 100 milliamps. as measured by an alternating-current meter. The load current, comprising as it does pulsations of

of the power lost in it depends upon the root mean square value of the current, which can only be measured by an instrument of the alternating-current type such as the hot wire or thermo-couple.

The importance of this point cannot be minimised, for the load attached to the output of the rectifier in practice comprises a filter for smoothing the current, the various voltage-dividing circuits, and the load due to the valves. A simple filter for smoothing the output current may comprise two condensers, and a choking coil connected as in Fig. 7. This filter causes two effects.

Effect of Filter

Let us suppose that a voltmeter for reading D.C. voltages is connected as indicated in the figure. It will register, let us assume, 200 volts when the filter is disconnected. But when condenser C_1 is joined across the output the voltage immediately rises, and it might easily reach 300 volts, depending, of course, on the value of the alternating voltage and on the load imposed by the voltmeter.

When now the choking coil and the second condenser C_2 are connected, and the load, which we may assume to be a resistance, is joined across the output terminals, the voltage indicated by the D.C. voltmeter will fall from the peak value and may indicate a voltage of, say, 220.

This is explained by the effect of the filter. The condenser C_1 of the filter acts as a storage condenser as well as a by-pass condenser, and the

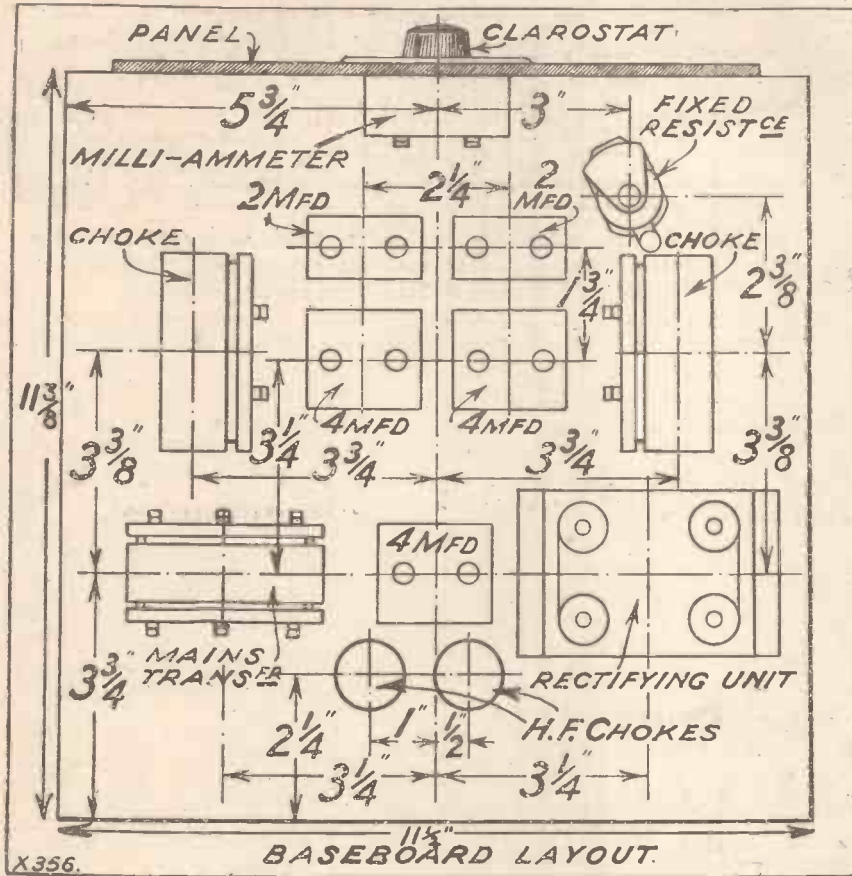

The first of these is that the value of the alternating voltage applied must not exceed 250. This value of voltage should be measured when the secondary of the transformer is disconnected from the rectifier. A transformer has losses. There are iron losses as well as those due to the resistance of the windings. It therefore follows that the voltage measured across the terminals of the transformer will be less when a load is connected than under no load.

Transformer Design

A user might be tempted so to design the transformer that it gave 250 volts when the rectifier was fully loaded. This would be quite wrong, however, for when the load was reduced or removed the secondary voltage would rise perhaps to as much as 300 volts with a small transformer.

This is the first important point that must be remembered, more particularly so as the load current taken by different wireless receivers is not constant.

The second point of importance is that too much current must not be taken. When the load is a pure

direct current, has a mean value which can be measured with a direct-current instrument. But the amount of heating of the rectifier as the result



The milliammeter is connected in the last valve's plate circuit, where it helps to show the user any distortion due to overloading.

voltage will naturally depend a good deal on the value of the condenser C_1 .

The second effect referred to concerns the current output from the rectifier as compared with the smoothed load current. If a suitable instrument for registering root mean square values is included in one of the wires from the filter to the rectifier, and a direct-current ammeter is connected in series with the load, a considerable difference in the currents will be noticed.

In order to make the matter more clear the instruments are shown connected in Fig. 8. Instrument "A" indicates much larger currents than instrument "B." In fact, instrument "A" may indicate a current

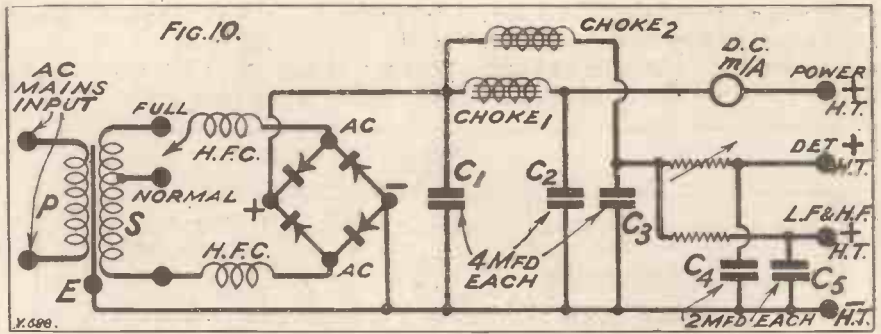

of 100 milliamperes, while instrument "B" will show that the smoothed load current is only 60 milliamperes.

Obviously, the rectifier is passing its full load current while the output is only 60 milliamperes. Why this

difference in the output load current and the output from the rectifier? The filter circuit is the cause of the difference. A good deal of current is being carried by condenser C_1 owing to the action of the choking coil and to the fact that the output from the rectifier is pulsating current.

The size of condenser C_1 and the inductance of the choking coil are factors of great importance. To ensure adequate filtering in order that the output current shall be quite smooth, condenser C_1 cannot normally be made less than 2 mfd. A better value from the smoothing point of view is 4 mfd. If a larger condenser is used the root mean square current indicated by instrument "A" will still further exceed the smoothed direct current shown by instrument "B." The writer, therefore, uses a condenser having a capacity of 4 mfd. at C_1 and a choking coil having an inductance of approximately 10 henries when the smoothed load current is 50 milliamperes.

The Total Output

The load offered by wireless receivers is a varying one, and no two receivers are alike. One receiver may be fitted with super-power valves, such that, with a high-tension of 190 volts, the total anode current is

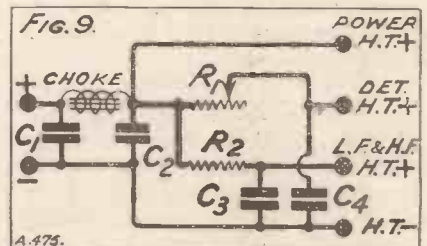

50 milliamperes. Another user may have a receiver with only one power valve, the current consumption of the set being only 25 milliamperes at 190 volts for the power valve. It is very necessary to bear these points in mind, because the second receiver which takes a much smaller current than the first one may have a voltage in excess of 200 applied to it.

(Continued on page 438.)

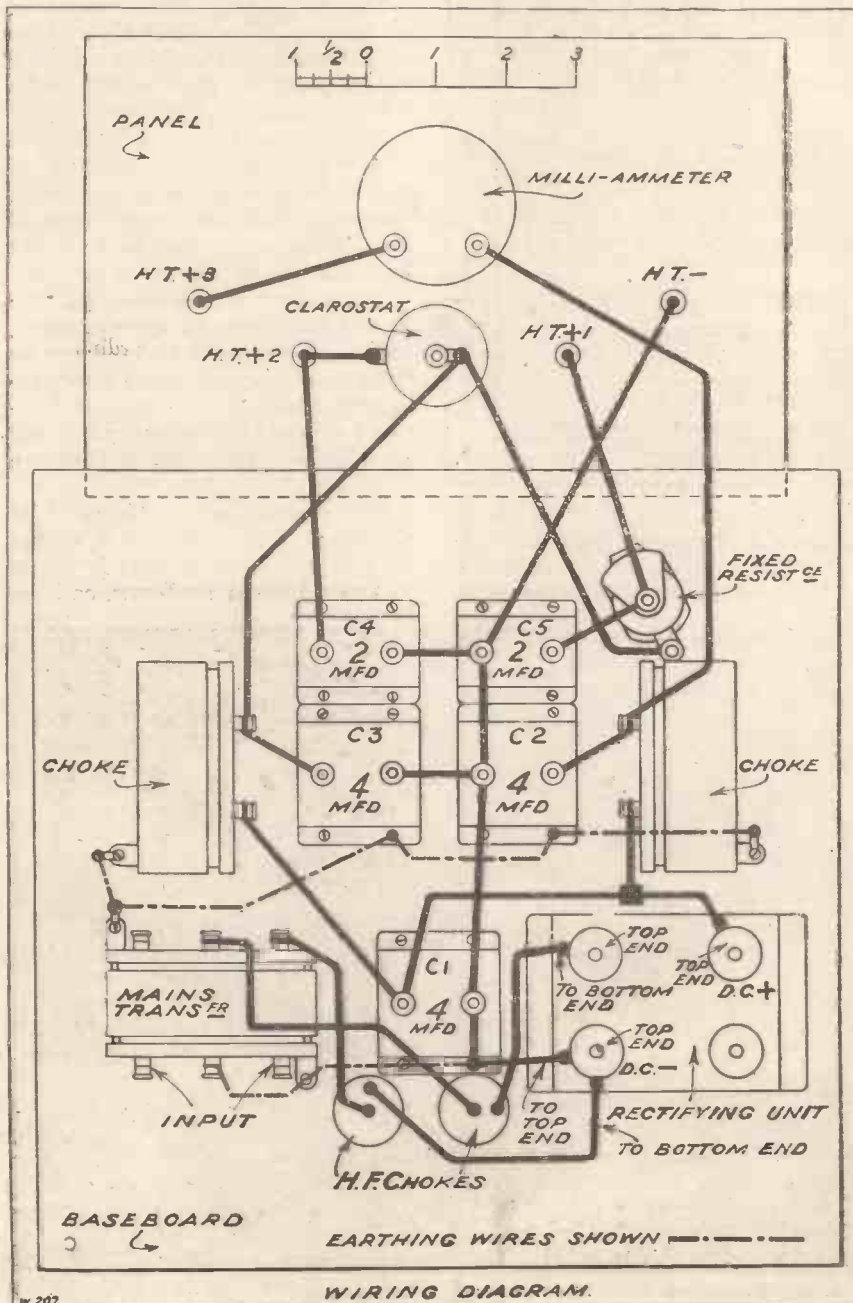

In Our Test Room



New Lissen Components—New R.I.-Varley Transformer—Pilot "Double-Drum" Control—An Automatic Trickle Charger—"Lewcos" H.F. Choke.

New Lissen Components

EVERY constructor who has bought and used Lissen productions knows that they are good and cheap, but it takes a careful test to reveal exactly what excellent value for money are Lissen components. For instance, we remember carefully checking the resistances of a range of Lissen grid leaks. From a pile of about fifty, twenty were chosen at random and carefully measured.

Remembering the prices at which these leaks were sold we were astonished at their remarkable accuracies. Leaks marked "two megohms" were found to have exactly two megohms resistance, and the same applied to the majority of the other values; where there were errors these were small and, to all intents and purposes, negligible. We should not have considered a 10 per cent variation

made in the following values: 10,000, 15,000, 20,000, 25,000, 50,000, 100,000, 150,000, 200,000, and 250,000 ohms. They are wire-wound and incorporate a special wire having a resistance of 100,000 ohms per foot.

They can carry currents up to 10 milliamps. Each resistance is made

Manufacturers and traders are invited to submit for test purposes radio sets, components and accessories to the "Modern Wireless" Test Room at Tallis House, Tallis Street, London, E.C.4. Under the personal supervision of the Technical Editor, all tests and examinations are carried out with the strictest of impartiality. Readers can accept the Test Room reports published monthly under the above heading as reliable guides as to the merits and demerits of the various modern productions of the radio industry.

But now a hook-up, particularly in regard to L.F. amplification, runs on more or less clearly defined lines. Therefore it has been possible for Messrs. R.I.-Varley to produce, in response to a number of requests, a four-terminal transformer having all the straight-line advantages of their famous multi-terminal type.

There will still doubtless be plenty of scope for their six-terminal model, but in the majority of ordinary receivers the normal version will give optimum efficiency.

The arrival of this simplified straight-line R.I.-Varley is an important event, and we feel that the makers have done wisely in bringing it forward. We have carefully tested the sample sent



One of the new Lissen anode resistances, shown in a holder, together with a view of another in which the end terminals are clearly visible.

up in the familiar cartridge form, but has the novel and very useful feature that there is a terminal at each of its two ends. The holder into which the resistance clips is designed so that it can be mounted either horizontally or vertically on the baseboard. These Lissen resistances have the usual sound construction and good finish one begins to look for as a matter of course in any Lissen production.

New R.I.-Varley Transformer

A year or two ago there was no real standardisation of circuit arrangements, and the well-known R.I.-Varley multi-range "Straight Line" L.F. transformer was something of a necessity to the serious constructor in that it offered him a choice of ratios and of primary impedances from which to choose in order to suit any particular circuit conditions.



The new R.I.-Varley Four-Terminal "Straight-Line" L.F. transformer.

us for this purpose, and it undoubtedly has all the fine characteristics of its six-terminal predecessor; and it is, in our opinion, definitely worth its 22s. 6d.

serious, for in some other well-known makes we have found as much as 25 and 30.

And the same surprising accuracy is to be found in the new anode resistances due to Lissen, Ltd. They are

Pilot "Double-Drum" Control

There are two more or less distinct types of drum control. In the one the adjustments are made direct on a milled edge of the drum. Mostly, this is supplemented by a vernier movement imparted by an adjacent milled disc. In the other type the drive is by means of a small knob, which protrudes through the panel. The movement is invariably a geared one. In this class is the Pilot "Double-Drum" Control, an American production which is handled by Messrs. Rothermel.

In our opinion it is the better scheme and makes for easier and closer adjustments. The mechanism of the Pilot "Double-Drum" Control is very good, the action being more than usually smooth even for this type of component. The reason for this is that the gear is not metal to metal, but metal to bakelite.

As its name implies, this Pilot device consists of two sections, these being separately controlled and mounted side by side. A handsome plate is provided for the front of panel. The engraving is bold and readings are clearly visible. These drum controls are much more difficult to mount than ordinary dials, such

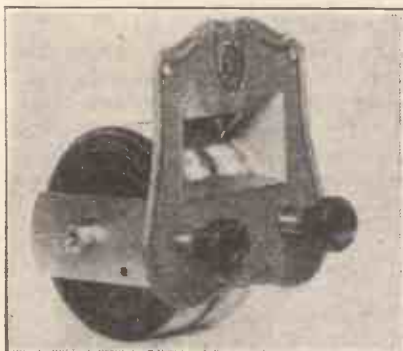

This is the Pilot control, complete with its panel plate.

as are seen in the majority of British sets, but they are attractive propositions, and it is probable they may eventually become very popular in this country, as they are at present in America.

An Automatic Trickle Charger

Trickle charging is a very sound and economical proposition, but the ordinary listener, in the usual course of events, must find it slightly complicated in operation. Especially must this be the case when an H.T. mains unit also is used. In switching the set on, first of all the trickle charger must be switched off, then the L.T. switched on to the set and, additionally, the H.T. must be switched on.

All this is accomplished automatically by the Runbaken Automatic Charger, a production of the Runbaken Magneto Company. Once it is fitted to a receiver it switches itself in and out of circuit when the ordinary filament on-off switch of the set is operated. Also, the ingenious relay incorporated in it simultaneously switches off an H.T. mains unit should such be used.

With such a device, trickle charging becomes extremely attractive. You can keep charged any 2-, 4-, or 6-volt battery, no matter what the size, from alternating current mains from 100 to 250 volts, without trouble and at negligible cost.



A robust but neat metal carrier is now supplied free with the Oldham O.V.D. 2-volt (10 actual A.H. capacity) accumulator cell. This battery costs 5s. 6d. The carrier snugly fits round a moulded shoulder in the glass cell case.

It is, in fact, an almost complete solution of the L.T. problem. And the Runbaken charger is a very neat, compact arrangement which can be tucked away behind the set or on a shelf, or which is by no means unsightly if lined up with the other gear.

It incorporates a Westinghouse dry rectifier, and there are no valves or liquids or anything else that requires attention or replacement.

Unfortunately, however, the sample submitted to us for test developed a fault after a few hours' use. The relay incorporated in it, and which cannot be adjusted, started to chatter and then failed to operate. But in fairness to the manufacturers it should be noted that these chargers can be obtained on a fourteen days' free trial arrangement, and there is no reason why, if the device should stand up to fourteen days' hard use, it should not reliably operate for a subsequent very long period.

New Lewcos H.F. Choke

The following is the explanation of the origin of the new Lewcos choke, made by the makers:

"An examination of the records of our Radio Service Department for the

past year has shown that when users of wireless sets have had to contend with uncontrollable oscillation on the one thousand to two thousand metre wave-band, the trouble in nearly nine cases out of ten has been definitely traced to the inefficiency of the H.F. choke. It is perhaps natural for users of such sets to suspect their H.F. transformers, but in view of our wide experience, there is an obvious need for an H.F. choke which will function as efficiently on the 1,000-2,000-metre wave-band as on the 250-550 band. Our engineers have therefore spent a considerable amount of time on the problem of H.F. choke design, with the result that we are now able to put forward the Lewcos H.F. choke with absolute confidence in its efficient performance on all wave-lengths from 2,000 down to 20 metres."

And it is a fact that hitherto there have been remarkably few H.F. chokes suitable for such wide wave-band operation. The two striking characteristics of the Lewcos choke are that it has a very low self-capacity and a natural wave-length of 5,400 metres.

Thus, while it can be perfectly efficient on the lowest wave-lengths, there are no peak effects to be encountered within any of the normal wave-bands.

Another good point in the design of the component is that the terminals

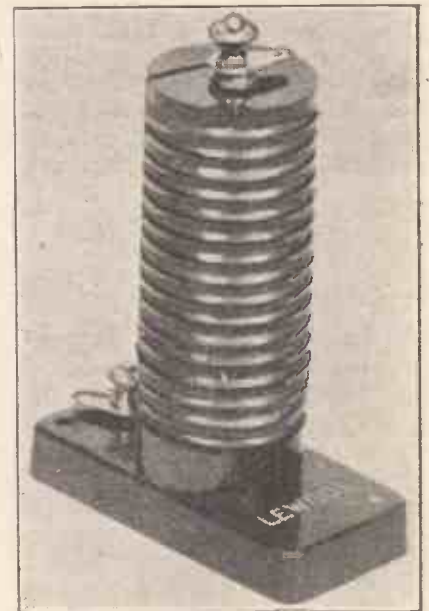

The "Lewcos" H.F. choke.

are placed at the extreme ends, thus tending to reduce to a minimum the risk of additional capacity being introduced by the wiring connected with it. The windings are, of course,

(Continued on page 428.)

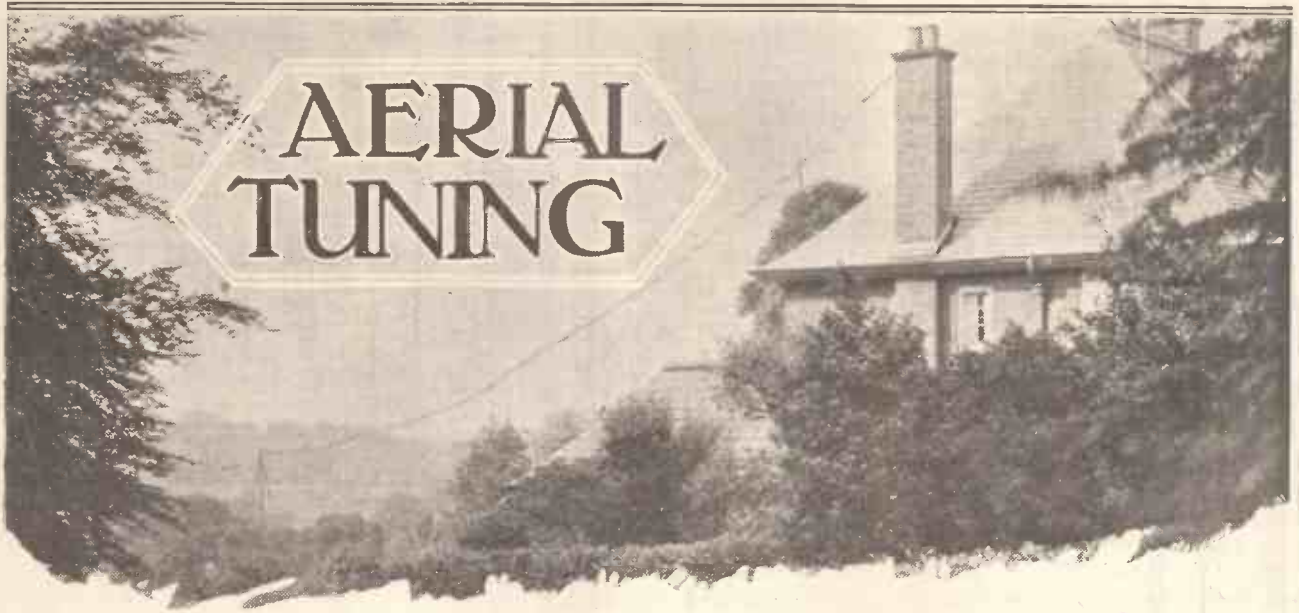

AERIAL TUNING

It is well-known that a plain wire aerial, i.e. one without added inductance or capacity, possesses a certain definite frequency. The natural wave-length of an unloaded aerial, for instance, is approximately equal to four and a half times the overall length of wire.

But electrical tuning cannot exist without the presence of inductance and capacity. Just as a pendulum swings at a definite frequency which is determined solely by the length of the suspending cord and by gravity, so the current in any tuned circuit oscillates at a rate which depends entirely upon the value of the inductance and capacity present in the circuit.

Loading the Aerial

In the case of the plain wire aerial, both the inductance and capacity are distributed throughout the length of the wire. The inductance is represented by the magnetic field, which is, so to speak, thrust out from the wire and stored up in the surrounding ether. The capacity, on the other hand, consists of the static field of force which extends between each element of wire and the adjacent earth.

This state of affairs is shown diagrammatically in Fig. 1, where the concentric loops surrounding the L-shaped aerial represent the distributed inductance, and the dotted-line condensers the distributed capacity.

It will be observed that the inductance is not quite evenly distributed, but increases progressively along the wire from the end A, where there is

An interesting article dealing with the effects of loading-coils or condensers when placed in aerial circuits.

By J. C. JEVONS.

little current flow, to the earthed end E, where the current is a maximum.

Similarly the horizontal branch of the aerial is more highly charged, i.e. it will be at a higher average potential than those parts near the ground where current flows readily, and so the "capacity" field is unequally concentrated as shown.

Unfortunately a plain aerial, though it will serve efficiently to transmit or

radiate wireless waves, cannot be used for reception. To receive signals satisfactorily, the energy of the incoming waves must be localised or concentrated so that it can be conveniently applied to the detecting valve or crystal.

In practice it is therefore necessary to "load" the aerial with a special inductance or tuning coil, so as to be able to supply the energy "lumped" around the coil directly to the input circuit of the receiving set.

The effect of loading an aerial with inductance is to increase its natural wave-length. It must not be forgotten, however, that the inherent or distributed capacity of the aerial still exists, as shown in dotted lines at Co, Fig. 2.

The Total Capacity

It will be seen that this distributed capacity is in parallel with the loading coil L. Now the effective value of a number of separate capacities in parallel is the sum of the separate capacities. The distributed small capacities Co can therefore be replaced by a single condenser CA, shunted across the loading coil, as shown in dotted lines.

One standard form of tuned aerial circuit consists of a variable condenser, such as C, Fig. 2, shunted across the loading coil L. This clearly has the effect of still further increasing the natural capacity of the aerial.

The shunt condenser C is in parallel with the natural aerial capacity CA, so that the total effective capacity of the whole system is now the sum of the two. Since the total capacity is increased the wave-length

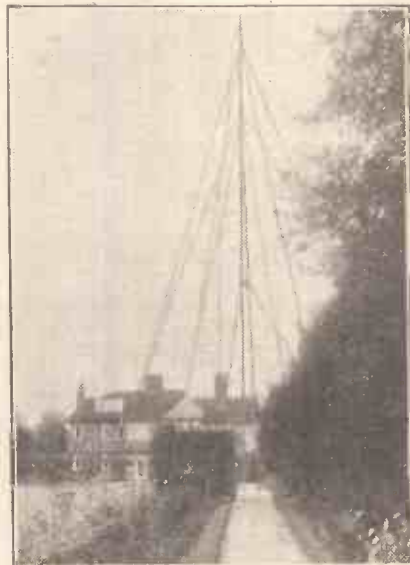

One of the aerial masts at 2 N M, the well-known amateur Empire short-wave broadcaster.

to which the aerial can be tuned also is increased.

If, on the other hand, we take a plain aerial and insert a condenser C in series with the wire, as shown in Fig. 3, a very different state of things will arise. In the first place, the natural aerial capacity, C_0 , still exists, but

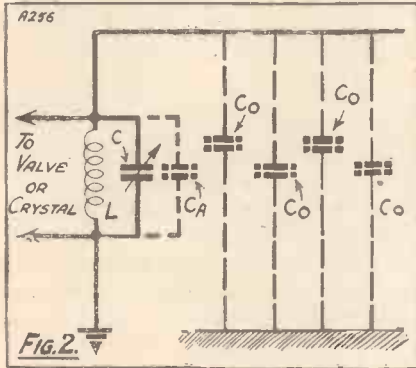

now the aerial current must pass through the condenser C before it can charge up the elemental capacities C_0 .

In other words, the condenser C and the resultant natural capacity (shown lumped together at C_A) are in series with each other.

A Condenser In Series

Now the resultant value of two or more capacities in series is always less than the smallest of these capacities. This may appear somewhat of a paradox at first sight, but it is an important and significant law in any consideration of tuned circuits. It is on all-fours with the more easily grasped rule that the effective resistance of a number of resistances arranged in parallel is always something less than the least of the group.

It follows that the effect of adding the condenser C, Fig. 3, is to reduce the overall capacity of the aerial to a value less than either C_A or C, whichever is the smaller.

Therefore the insertion of the condenser C cuts down the wave-length of the aerial below that of the plain or unloaded wire. The wave-length can, of course, again be increased simply by adding a lumped inductance L, with or without a parallel condenser C_1 , both in series with the condenser C, as shown in Fig. 4A.

Constant Tuning

If the condenser C is made sufficiently small, it acts as a kind of choke to dissociate the loop circuit from the rest of the aerial, and the signal current is then practically confined to the loop circuit formed by the coil L and condenser C_1 . This arrangement was originally put forward by Mr. Scott Taggart to ensure "constant tuning" irrespective of the particular size of aerial to which any given receiver may be connected.

The aerial wire is now acting simply as a collector, which feeds small impulses of current through the condenser C to the loop circuit, where the

coil L in the aerial and forms a shunt path on to the grid of the first valve.

An interesting point arises in the

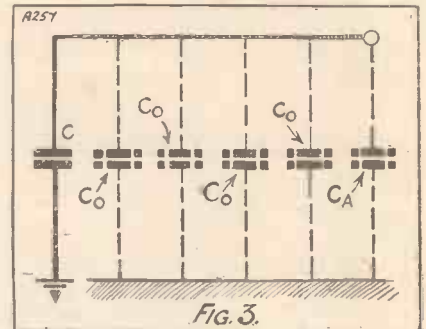

case where two inductance coils—L, L_1 —are used in series as shown in Fig. 5A. The general rule is that the effective value of two or more inductances in series is the sum of the separate inductances; but there is an important proviso to bear in mind.

If the two coils L and L_1 are widely separated as shown in Fig. 5A, so that there is no coupling or flux linkage



Probably the majority of these aerials will be tuned-in to the local station every evening. The effect of only one of them strongly oscillating throughout the programme can easily be imagined.

small impulses build up into a large surge current. The aerial does not oscillate freely as a whole.

The same principle is involved in the Lodge N circuit, only in this case the "surge" loop L_1 , C, Fig. 4B, is tapped off from an inductive choke

between them, the general rule holds good. If, however, they are placed close together, then the effect of mutual inductance comes into play.

The most familiar case is, of course, the variometer arrangement shown in Fig. 5B, which, as everyone knows, affords a very wide range of tuning. Here the rule is that if both coils have the same number of turns, the effective inductance of the combination will vary between zero and four times the inductive value of either coil, according to the closeness of the coupling between them and the relative "direction" of the coil windings.

Coil Couplings

More generally, if L and L_1 are the inductances and M is coefficient of the mutual coupling, then the total effective inductance of the combination is $L+L_1+2M$. If $L=L_1$ and the coupling is unity, or the closest possible, i.e. equal to L, this expression reduces to $2L+2L$, which is equal to

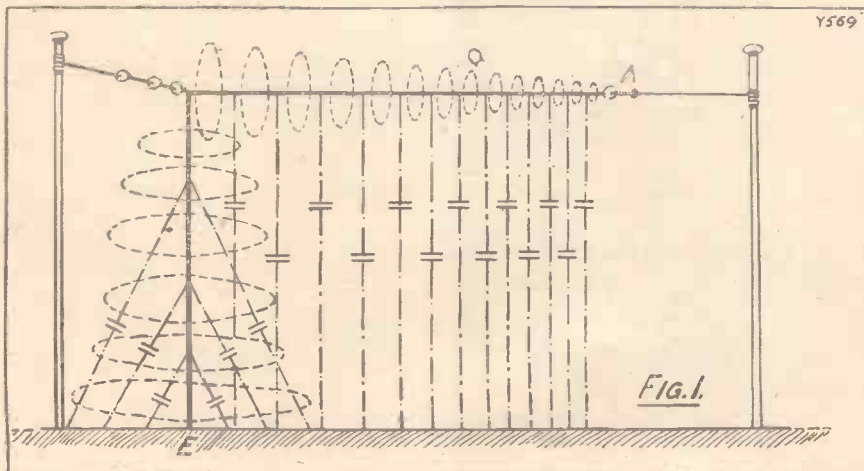

zero or 4L, according as the plus or minus sign is used, which in turn depends upon whether the sense of the coil turns is in the same or in opposite directions.

The maximum "loading" effect of a variometer is obtained when both coils lie parallel with each other and

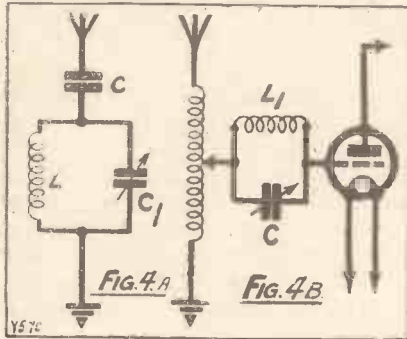

the "turns" run in the same direction. When one coil lies at right angles to the other, there is no coupling, and the total inductance is then equal to the simple sum of the two. When the coils again lie parallel, but with the direction of the windings reversed, the total inductance of the variometer approximates to zero.

The addition of a separate loading coil such as L1, Fig. 5C, to an existing tuned circuit such as L, C, may sometimes give rise to surprising results.

Double Tuning

If, for instance, the coil L is a heavy inductance, say of 150 or 200 turns, it will act as a "choke" to a short incoming wave. The effective aerial circuit then consists of the coil L1 and series condenser C, and this may easily form a tuned acceptor circuit for a short-wave broadcast station.

To take a practical example, the circuit L, C, consisting of a 150-turn coil and a condenser setting equal to approximately .0003 mfd., will on a standard aerial tune in the long-wave Daventry station.

For the shorter waves radiated by 2 L O the coil L will then act largely

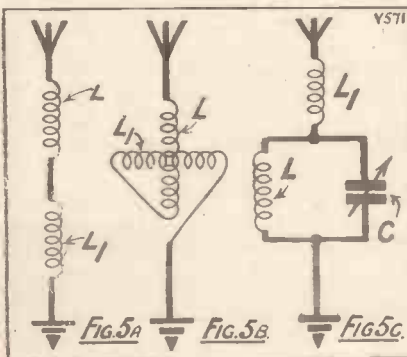

as a choke, but if a 75-turn coil is plugged in at L1, and the setting of the condenser C is slightly reduced, signal waves from 2 L O will build up in the series circuit L1, C. At the same time signal waves from Daventry will build up in the loop circuit L, C.

If both stations are transmitting the same programme, as is usually the case, a connection across the condenser C will utilise the energy from both sets of waves, and will therefore improve signal strength, say on a crystal set, or on a distant single-valve set where normal reception is poor.

Trouble In Tuning Out

A similar effect is liable to occur when a separate loading coil is used, say to bring in the medium-wave Daventry station 5 G B. If the aerial also comprises a "branch" circuit containing series inductance and capacity of a value likely to resonate to the local short-wave station, there



In every quarter of every town one can see radio aerials. But as you pass you will find it interesting to reflect on their electrical characteristics in view of height, length and form.

may be great difficulty in tuning out the latter, even at some distance, in spite of the difference in wave-length between the two programmes.

THE AERIAL—AND EARTH
 By N. A. S.

THE question of a periodic "clean-up" for the aerial system has come into more than usual prominence of late, and it has been mentioned that the B.B.C. engineers

set us the very good example of overhauling their antennae at least every six months. I think that we may safely assume a similar amount of care on behalf of the Corporation's earthing systems.

Clean Your Contacts

Frequently, however, the radio enthusiast, having managed to fix his aerial in a position which seems secure enough and gives fairly good results, is unwilling to go to the length of apparently undoing the good work as he could not be sure of knowing the best plan to work upon when the all-important length of wire is down. The same frequently applies to the earth.

Assuming that the aerial has been dismantled, the first and most obvious thing to do is to test the mechanical strength of masts, stays, pulleys, etc., and to make sure that the system will withstand the additional stresses of winter. When mechanical strength has been brought up to par, the next task is to ensure signal strength by well cleaning everything from A to E.

In the older installations, the next point for examination is the aerial connection to the lightning gap, for if (as is frequently the case) it is unprotected, much trouble may be traced to this point.

Another point which is frequently forgotten is that the aerial proper should on no account touch the aerial guys, whether these be of rope or of wire. The reason for this will be obvious.

The Earthing System

Now we come to the earthing system—another fruitful source of trouble. As in the case of the aerial, the lightning gap should be examined and the connections, if necessary, cleaned.

Next the earth proper (I am assuming that this is of the buried rod or sheet variety) should be overhauled. While the overhauling is taking place, it is sometimes a good plan to make sure that there is no better place than the one you are using. For instance, an excellent earth is a rod (or plate) buried near a drainpipe leading from the roof, for any rain that falls will assist in keeping your earth damp and, consequently, stabilising the level of reception. Another efficient method of assuring a good earth connection is to mix the soil surrounding the rod with coke or, better still, totally to embed the rod in it.

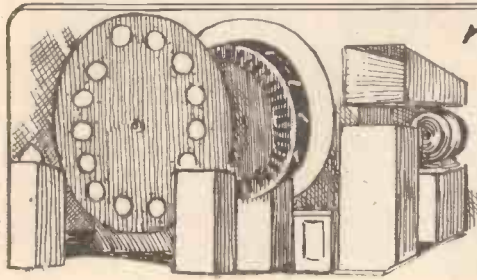

TELEVISION NOTES OF THE MONTH

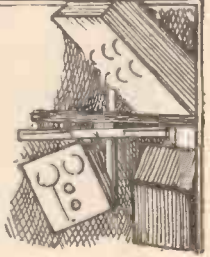

MODERN WIRELESS containing these notes will be on sale at the Radio Exhibition at Olympia during the important week which will mark the first stage of public television progress in Great Britain. I know for certain that those who order Baird televisors and expect to see Ascot from home will be disappointed. It is not likely that many people will pay a quarter of the price of a motor-car to test the new entertainment. But there will be set going in the minds of amateurs thoughts like this: "If television sets for the home are being sold, I'm going to make one!" Wouldbe flyers will come heavily to the ground, but there they will have something solid to build on.

Whose Fault?

By now the public are thoroughly cautious. I hear more things said against television than for it. If what progress being made is ignored, the exaggerators have themselves to blame. I still think that gramophones (with and without radio) and talking films will have their spells of popularity before television is ready to blossom as a public service. And it certainly has not been proved that holed discs or any other mechanical device can take television over the gulf between blurred images of moving figures and a race scene in full detail.

Good Work

Yet progress is being made. Present apparatus may have to be scrapped when television's thermionic valve comes, but principles are being established which will be useful however television is attempted. Baird's colour television is an oft-suggested idea carried out, and his new stereoscopic televisor proves again that most things can be improved by constant thought. With his new machine Baird gives depth to his images by using the long-known fact that it is because we have two eyes that we can see objects fully in relief.

The latest developments chronicled by **WILLIAM J. BRITAIN**, our Special Television Commissioner.

Two Images

Beams from two spotlights pass through a spinning disc perforated with two spirals of holes and then through two lenses, placed side by side. The face to be televised is scanned first by the beam from one spotlight and then by the beam from the other, in rapid succession. Photoelectric cells pick up the reflected light and pass through currents which at the receiver flash a neon tube in and out in the usual way.

At the B.A.

I took my place among the score or so watching the stereoscopic television machine which formed part of a Baird side-show to the British Association, on September 6th, the first day of the meeting. The received image, about as big as four

postage stamps, hardly showed the stereoscopic effects. All I saw was a blotched resemblance to a face with a gaping mouth. Then I went on to see the colour television apparatus. In the next room I had a look at the transmitter, and noticed a curious fact. The grinning dummy set up in a box before the transmitting disc had blue hair, a pinkish-white face, and a large green bow. The image of the dummy had a band of blue across the top of its head, a band of green across the middle of the face, and a band of red below. Who transposed the colours on the disc?

More Detail Coming

As I was leaving, Mr. George Mitchell, who took a large part in the foundation of the Television Society, said to me: "Of course, you won't have learned much from these. The disc of the commercial televisor will have three times as many holes." "And so more detail?" replied I. "Yes, it will be interesting to see the show at Olympia."

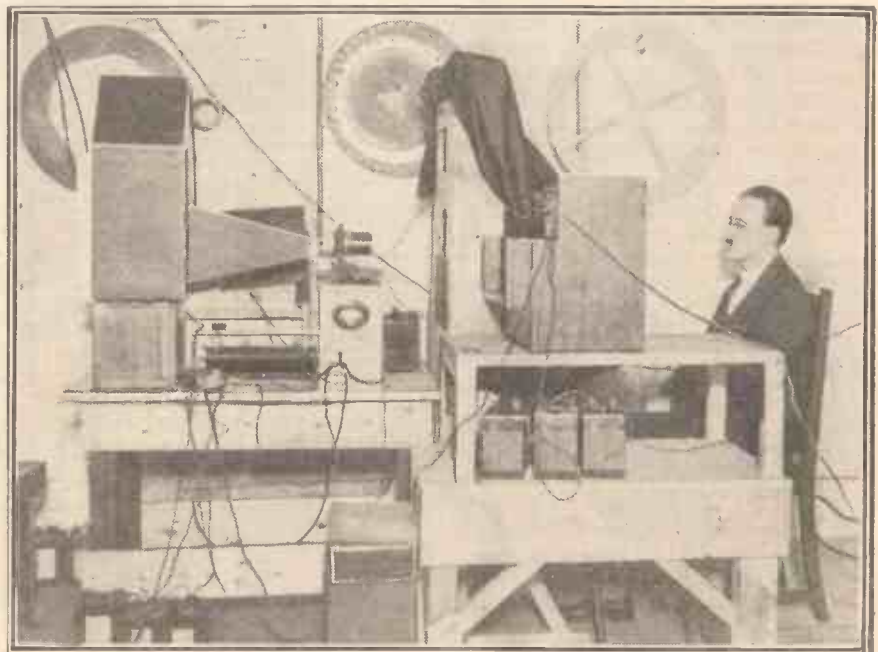

One of the new telescopic transmitters for producing "solid" images.



An interesting account of a personal visit to the N.Z. stations and of the impressions gained at first hand.

By our Special Representative.

NEW ZEALAND must have more gramophones per head of population than any other country in the world. Absolutely everybody owns a gramophone. Indeed, it must be a paradise for gramophone companies. Not only does everybody have a gramophone, but everybody also spends a considerable amount of money buying new records.

Ideal Country For Radio

Naturally, all this has a most important bearing on broadcasting, for by the gramophone the whole country is able to hear the very latest songs and music played by the world's best players. This craze for the gramophone has been steadily growing for the last decade. The result is a most critical country as far as music is concerned. In addition, many families have to choose between radio and the gramophone.

For instance, I am writing this on a 5,000-acre sheep station nearly forty miles from the nearest town. All around lie vast unexplored wastes where wild untamed horses roam the never-ending horizons, where one may ride for days and never meet a soul, where news comes slowly mouth to mouth and rumour takes a day or perchance a week to change to fact.

An absolutely ideal place for a wireless set—if ever there was one.

Problem of Local Talent

But if one day you happened to arrive there after the day's work was done you would hear no radio. Instead, the latest valse, the latest song, would come from the open windows of the bungalow—a gramophone, and a good one, too, costing more than many wireless sets.

So the Broadcasting Company of New Zealand has a

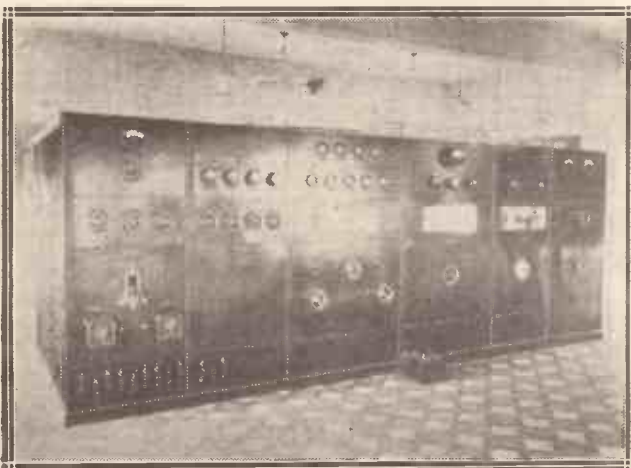

Two glimpses at the Wellington station. To the left is the transmitting plant, whilst to the right is shown a charming corner of the smoking-room.

problem before it rather different to the problems at home. Indeed, it is difficult to see how they are going to tackle the problem. For the most part, they have to rely on local talent for their programmes. Now some of the local talent is naturally good, but, remember, the total population is under 1½ million, scattered about two large islands somewhere in the vicinity of the size of Great Britain. Roads are not good, particularly in winter; travel is slow even by railway, which in many instances does not pass within 40 or 50 miles of a place.

So the talent problem is more acute out here than at 2 L O, for instance. Certainly from time to time well-known celebrities arrive in New Zealand. Sometimes they broadcast, sometimes problems of copyright and other complications prevent this. For the most part celebrities of the music world arrive on tour, generally under contract.

The result of all this, so far, appears to be that gramophone records play an important part in the broadcast programme. But this cannot be for long. Nobody is going to buy a wireless set to listen to gramophone records that they can hear at home on their own instruments without the bother of wireless at all.

The Listeners' League

But broadcasting is steadily forging ahead out here. At first the novelty of the mysterious voices coming out of nowhere sold sets. Then they sold for the music and news that was available more or less red-hot from the source. Then listeners clamoured for something better. The broadcasting company hid itself under a cloak of vagueness that caused a body called the Listeners' League to form and hold meetings. When I arrived in New Zealand feeling seemed to run high on the subject of broadcasting. In Auckland, for instance, the station director was changed several times a year, and the broadcasting company eventually made the spokesman of the Listeners' League station director. Now they have got somebody else...

So the problems continue. Two or three years ago a few amateurs started broadcasting on their own. They worked on low power, gave indifferent programmes, but from that all the broadcasting in New Zealand commenced. Thus was born the Broadcasting Company of New Zealand, upon whose shoulders now falls the problem of satisfying 35,000 listeners. It is a private company run under government supervision. The yearly licence costs 30s. The Postal authorities collect it, and retain for themselves a proportion of the fee. So in a country with a population



The lounge of 2 Y A, the Wellington station, is large and artistically furnished.

of just under 1½ million something like 2 per cent avail themselves of the programmes put out by the broadcasting company. Whilst on the subject of figures, it is significant that 600,000 people live in the fourteen main towns. Further, the proportion of men to women is about equal. Even in Great Britain the voice of her women is a factor not to be ignored. It will be interesting to watch the development of broadcasting under these conditions. At present there are four broadcasting stations covering all the larger centres of population from Auckland in the north to Dunedin in the south. With the exception of Wellington, all the stations work on comparatively low power. In fact, not much greater than the relay stations in England. Wellington is the star station with a power of 5 kw. in the aerial and a wave-length of 420 metres. The studio and offices are situated in the town itself, whilst the transmitter is sited on a commanding position some 600 ft. above. The site would seem to be ideal for a transmitter, being situated as it is on a narrow hill almost entirely surrounded by sea.

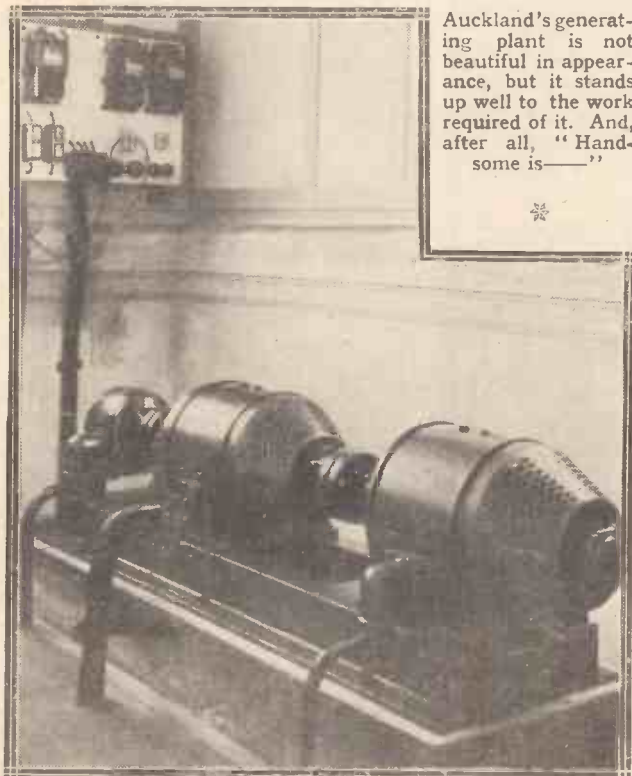

Auckland's generating plant is not beautiful in appearance, but it stands up well to the work required of it. And, after all, "Handsome is—"

"Too Much Centralised Control"

After visiting some of the transmitters, I could not help getting an impression of general tidiness. All the transmitting gear is the same in all the stations of similar power. It is all tucked away into less room than some of the British amateur's gear. It is controlled by very much fewer engineers than in England, and there is not that feeling of the vasty slowness of a Government-run corporation. There are no enormous passages full of numberless offices—but there certainly did seem to be far too much centralised control from headquarters. Even the minor announcements before an item are issued from headquarters. The actual station directors do not have so much scope for introducing their own atmosphere into an evening's entertainment.

Somehow this creates a feeling of uneasiness that at times is rather apparent.

Curiously enough, the nerve centre of broadcasting is not at Wellington, New Zealand's capital, but at Christchurch, some 200 miles farther south. Here I was introduced to Mr. Harris, the general manager of the broadcast company. It was evident that Mr. Harris was fully alive to the difficult problems of broadcasting in New Zealand.

Sporting Broadcasts

Mr. Allardyce, the official sports announcer, told me some interesting facts about outside broadcast. "You see," he said, "we don't have two announcers at a race meeting, for instance, like you do at home. I guess sometimes I have to go for it all out, everything seems to happen simultaneously. What do we feature in our outside broadcasts?—well, pretty nearly everything. Rigger, of course, is the national game out here. Last year we relayed the Ranfurly Shield match from all stations. This match would be the equivalent of England v. Scotland at home. In this match the rebroadcasting was done partly by landline and partly by wireless itself. The outlying stations picked up Wellington's broadcast and rebroadcast it. In this country we have to rely on

Sydney and Melbourne on the loud speaker simply won't sell at all, so I was told by one of the largest radio dealers in Auckland. He went on to complain to me about this point. "Naturally," he said, "we want to sell

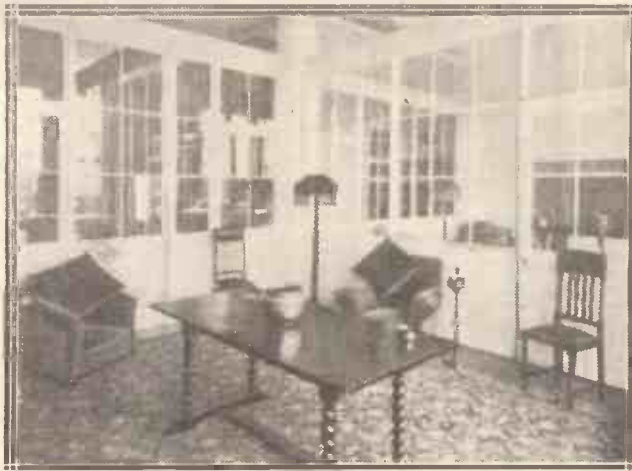

A view of the smoking lounge at Christchurch.



The main studio at Auckland, N.Z.

British stuff, but—!" Well, all the radio dealers I talked to ended up with that "but" until I got tired of feeling it coming.

So to-day the U.S.A. valve socket is standard out here. Why should it be? British radio gear is good, but—! Somehow the American gear is made to suit local conditions, and the country is flooded with it. Yes, it is good gear admittedly, but—well England can better it—but—!

There is an increasing number of locally-made sets being put on the market—made in nearly every case with American components. They are good sets and the demand for them increases.

Most certainly there is a growing market out here well worth cultivating by our British manufacturers. But it is no use sending out sets that will not do what U.S.A. sets are doing every night.

this system much more than you do in England. Other sports we broadcast include racing, trotting, hockey, boxing, swimming, tennis. So, you see, we aren't so far behind the B.B.C., are we?"

Naturally the visit of the Duke and Duchess of York was made a special outside broadcast. It is a tribute to the efficiency of the broadcasting company that these broadcasts went off without a single hitch.

Atmospherics and fading are very serious problems. Certainly static can be simply appalling—wipes out even loud signals.

American Components Standard!

Fading is very noticeable, but not much more so than in some cases in England. Curiously enough, the thermal regions of the North Island seem to produce fading and static effects of their own. Here nature would seem to have located her safety valves. Hot water gushes from springs, boiling mud spouts out from underground, whilst from time to time jets of boiling water shoot up into the air. Everywhere there is a smell of sulphur and bad eggs. No wonder weird things happen on the wireless in these regions.

The wireless sets that sell are those that can reach out to Australia. The cry is for distance. Partly to get other programmes and partly for sheer love of hearing from uttermost distances. A valve set that cannot get



The neatness in wiring, etc., remarked upon by our special representative is well illustrated in this view of Auckland's transmitting gear.

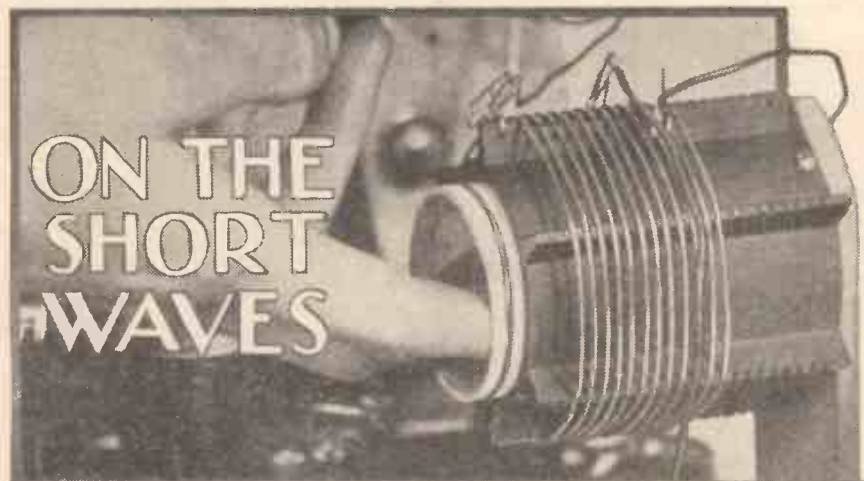

Notes of Interest on Short-Wave Receivers and Reception Conditions.

By W. L. S.

AMATEUR transmitters have by now been forcibly reminded of the conditions which will prevail next year by the arrival from the General Post Office of a memorandum on the new licensing conditions.

The principal points are as follow : New wave-length bands are allotted throughout, the use of "raw" A.C. is forbidden, holders of licences must satisfy the G.P.O. that they possess accurate wave-meters, and (a concession!) private messages of a "trivial" nature may be sent.

On the whole there is nothing to grumble about in the new conditions, except the unavoidable fact that the wave-bands are extremely narrow, considering the large number of stations in various countries to be accommodated therein.

The New Wave-Bands

The exact wave-lengths are as follow :

- 172.3 to 152.2 metres
- 42.53 to 41.35 metres
- 21.32 to 20.91 metres

and, where special justification is shown,

- 10.67 to 10.03 metres and
- 5.34 to 5.01 metres.

It is, to my mind, very significant that special justification has to be shown to obtain permission to use the two last, and shortest, wave-lengths, since it shows that the G.P.O. feels that there is more than a possibility that they may prove to be useful for something!

I should be very interested indeed to know which of the five wave-bands will be in greatest use this time next year. Personally, I prophecy the 10-metre band.

Judging from letters I have been receiving lately it seems as though 5 SW has made good with the listeners in the Dominions. I happen to know that the B.B.C. short-wave specialists are working daily on the station, and improvements are going on apace, and probably the B.B.C. headquarters have more correspondence on the subject of 5 SW than anyone would dream! No one can deny that correspondence of this kind is (sometimes) helpful, and several suggestions made by correspondents to me would, I am sure, have been considerably more useful if they had been sent to the B.B.C.

India still seems the poorest place, in many ways, for short-wave reception from this direction, and South Africa one of the best.

I have not heard anything officially about the wave-lengths that will be employed by the various short-wave broadcasting stations in 1929. Much conjecture has, of course, been going on, but I prefer to pay no attention to it until something has been heard which really comes "from the stable."

Incidentally, there will be a flock of good quartz crystals going at "rock-bottom" prices (please excuse the pun), since all the amateur wave-lengths are being completely changed and in many cases the crystals are already so thin and fragile that they will not bear further grinding down!

A Peculiar Aerial

What happens to the super-crystals used by some of the high-power commercials I really don't know, but I should imagine that most of them must die of old age. It is a hard life for a crystal to be fixed in a transmitter like WIK, that has been sending "A B C de WIK" twenty-four hours a day without a break for about three years!

Speaking of the high-power stations, I have been reading some very interesting details of the forms of aerial used by some of them. One of the favourite types in the States is a regular young draughtboard pattern, every side of each square being exactly half a wave-length long.



This photograph shows the crew of the "Southern Cross" plane, which flew from 'Frisco to Australia, inspecting the control room at 3 L O, the Melbourne short-wave station.

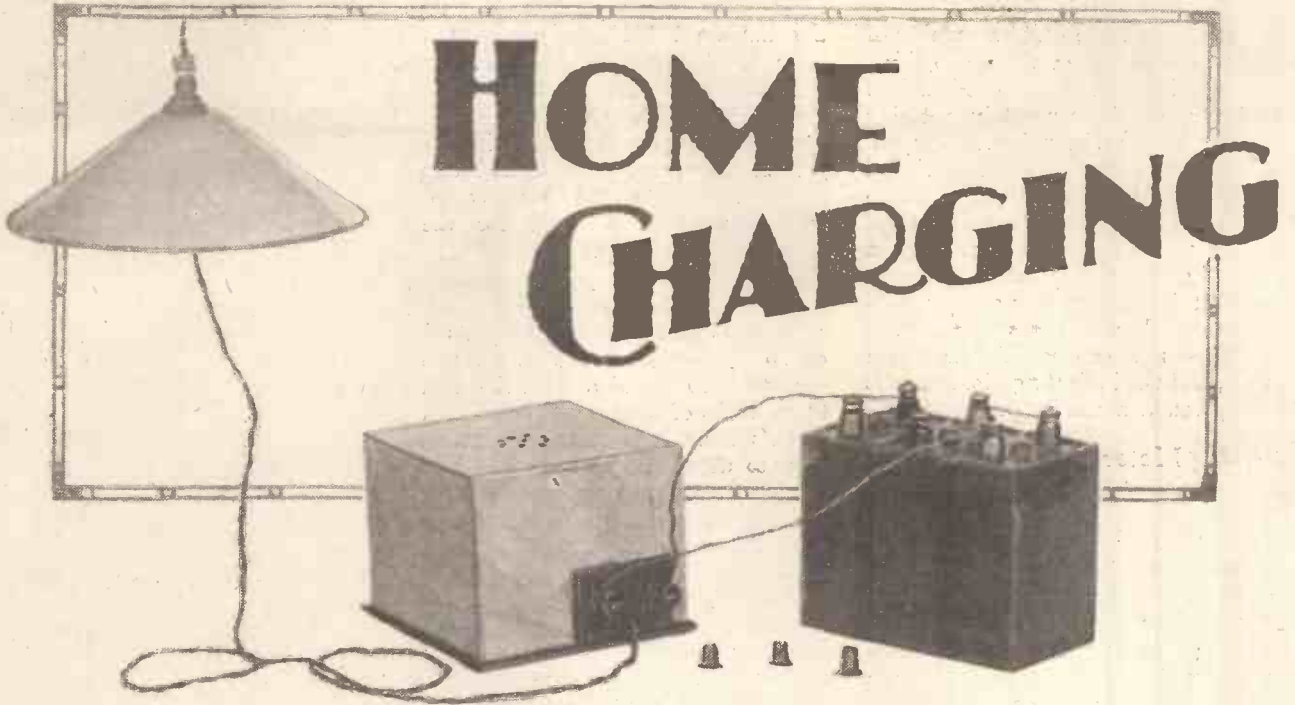

THE facts and figures which are to be given in this article are based upon practical data, and should prove distinctly interesting to those who are unacquainted with electrical matters and are consequently prevented from making use of those facilities which are at their disposal.

In many cases this is due to a certain amount of nervousness which is present whenever the question of the mains is raised.

Rules to Remember

One of the first things that should be considered by all house-owners and tenants is that there are certain laws and regulations which apply to all users of supplies from the electric mains for lighting or power purposes, and the first thing they should do is

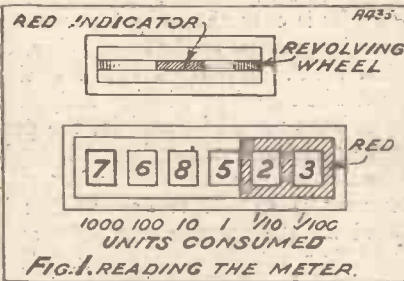

FIG. 1. READING THE METER.

to acquaint themselves with these rules in order to avoid any liabilities in which they may be involved. These, in brief, so far as the average consumer is concerned, are simple and are as follow :

An eminently practical article describing among other things the construction of a combined table lamp and battery charger.

By H. BRAMFORD.

Rule 1. No unauthorised person is allowed to connect, disconnect, or interfere in any way with the meter.

Remark.—This need cause no consternation, as there is no need whatever for anyone to touch the meter at any time for any purpose in connection with the charging or using of mains units.

Rule 2. No person must fraudulently abstract, divert, or consume current.

Remark.—It is naturally taken for granted that very few persons would wish to do so, but as this can only be done by either interfering with the meter or tapping off supplies before they reach the meter the use of any device is legal which is safe to use and which does not interfere with the mains system.

Rule 3. Notice of any extension in wiring must be given.

Remark.—This is a somewhat important point and the clause is really made in the interest of the consumer.

Where there is any doubt, therefore, in this direction, for whatever purpose such extensions may be desirable it is advisable to consult the inspector and be on the safe side in more than one respect.

However, on reviewing these simple

clauses with which many may not have been acquainted, it is obvious that no great difficulties are presented so far as the question of using the mains is concerned for such purposes as home charging, etc.

Charging From D.C.

The question of momentary interest is the charging of L.T. batteries from the mains. Where the mains supply is D.C., there is no need whatever to go to the trouble of taking the accumulator to the nearest station to be charged. It is very necessary to know something about the subject, however, otherwise one may quite easily find that the charging of a single cell has cost them two or three shillings.

In this respect, quite a number of

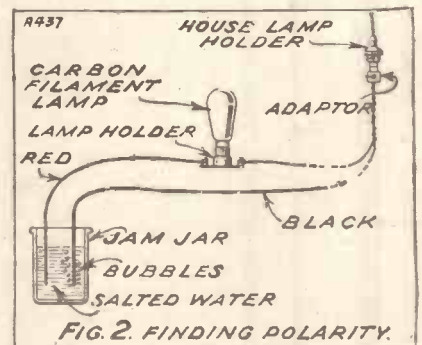

FIG. 2. FINDING POLARITY.

things have to be considered, but providing everything is done in a proper manner, the process is very economical indeed. It is advisable, therefore, before doing anything else, to acquaint oneself with the method

of taking readings from the meter. Strangely enough, quite a number of householders are not able to do this.

On all house meters will be found an index with six separately rotating figure plates, as shown in the diagram. The last two figures are usually ringed round with a red margin. When the current is switched on there is a wheel inside the meter (visible through a small glass panel) which rotates. When this wheel rotates completely a given number of times it indicates that one unit of electricity has been used, and the indicating dial numbers swing round accordingly.

Meter Readings

For example, on a 230-volt supply, the wheel might revolve, say, 6,000 times before 1 unit is consumed. The more current used, however, the quicker the wheel revolves. We may ignore the wheel for the purpose of reading the meter, but this detail was mentioned to show that the wheel has some bearing on the working of the figures on the dial, and that there is a mechanical ratio between the two (Fig. 1).

Supposing the figures visible on the dial are 108544, and we burn a lamp for 5 hours and then have a look at the dial again and find that the figures visible now read 108569. By subtracting one from the other we get an answer of 000025, and this figure represents the amount of current used in 5 hours for the burning of one lamp.

Finding Polarity

In units this answer represents $\frac{1}{4}$ or 25 hundredths. The last figure represents 100ths of a unit, the fifth figure 10ths of a unit, and the fourth figure units. It is quite easy, therefore, to determine at any time how much current has been consumed for a given purpose, and these figures also help for other simple calculations.

There is one other matter with which it is essential to become acquainted before proceeding to undertake any form of charging from the mains, and that is the ascertaining of the polarity of the mains. There are several ways of doing this, and there are also several gadgets on the market which assist in this direction, but the

simplest way of finding which mains lead is negative and which is positive is as follows:

Get an ordinary jam jar and fill it with water. To the water add a pinch

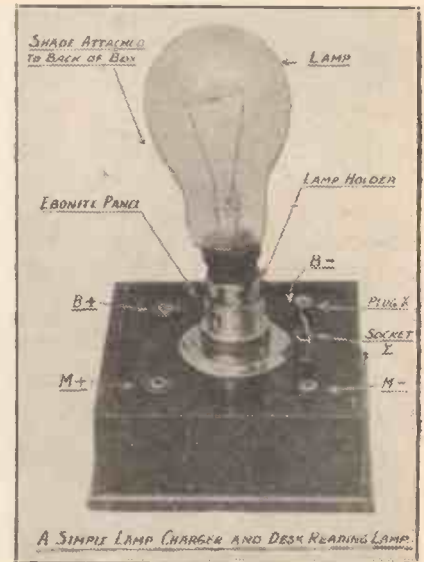

A useful home-charging combination which will appeal to practical amateurs.

or two of salt. Now fix up a gadget as shown in Fig 2 in which it will be seen that an adaptor, is plugged into a lamp holder and one of the flex leads is connected to one side of a further lamp holder, the remaining side being equipped with a short length of flex. The other flex lead from the house lighting adaptor is idle.

The Bubble Test

Now, if both the leads are immersed in the jam jar containing salted water (they must be prevented from touching in any manner), bubbles will be seen to rise from one of the leads in profusion, in comparison to the other, to the surface of the water when the current is switched on. This lead is the negative lead of the mains in every case, the other lead being the positive one. It is only necessary to trace the lead in question to the lamp holder to find which pin contact is the negative one. The experiment is absolutely safe.

A lamp should be used for the purpose and the bared ends of the leads should not be touched when the current is on. If two-colour flex is used for the purpose it will be easy to follow out the connections. The material described for this experiment will be required for other tests, and can be used for charging purposes, as will be dealt with later.

It is natural and obvious that the reader who wishes to charge his battery at home, in order to save the

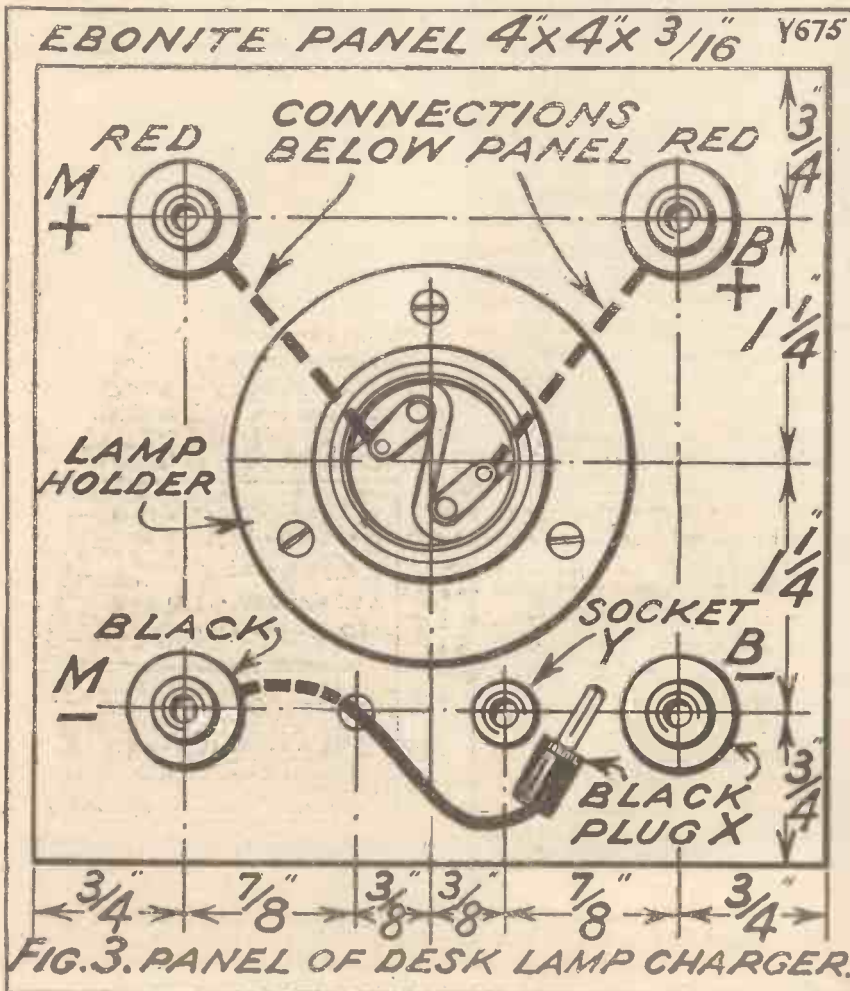

trouble of being dependent upon an outside source, would desire the apparatus to be both simple and inexpensive, and also easy to make. Expense, which is not great in either case, is a secondary consideration; but, nevertheless, the cost of home charging must be less, or at least no greater, than the expense of periodical station charging.

which may be estimated at an average of .1 amp. per valve. For one-, two-, and three-valve receivers, therefore, a 10-amp. (actual) battery is quite suitable, or a 20 amp. might be used for the latter; and where a super-power valve is used this figure might be exceeded. The essential idea, however, is not to choose a battery which will "outlast its useful functions."

The battery therefore should be capable of giving 25 hours use, under the specified conditions, and these figures may be easily worked out to accord as near as possible with what is

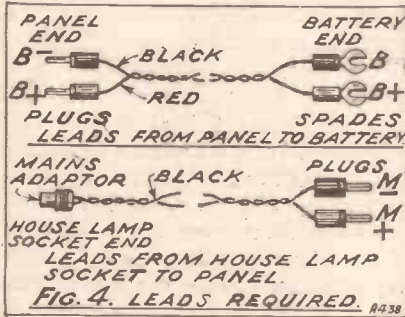

Information of considerable interest and value is given in this article which deals with the subject from practical angles not very frequently brought forward.

The special types of batteries to be recommended to suit any purpose are the long-life glass cells made by certain leading British manufacturers. These are actually capable of standing idle when charged, without deteriorating, for as long a period as six months.

How Long it will Last

To ascertain how much use a battery should give, under given working conditions, it is only necessary to observe the following simple formula:

Actual ampere hours at which battery is rated

Total filament consumption of valves used.

Example: 10-amp. hour (actual) battery used with receiver employing two valves rated at .1 amp., and one valve rated at .2 amp.

10 divided by .1, plus .1, plus .2, equals 10 divided by .4, equals 25 hours.

required before the battery is chosen. Before this has been decided upon, remember it is a distinctly good plan to have at hand two sets of batteries, so that one may be in use and the other ready for use. This is no great item, as the type advised are remarkably cheap, as compared with the heavier type of accumulator.

One Method of Charging

A common method of charging is by using a resistance in the form of a lamp, or a number of lamps in parallel with each other, but in series with the mains and the battery under charge. An experiment might therefore be tried using only one lamp, giving the battery a form of trickle charge. To do this the device described for finding the polarity of the mains is brought into practical use.

Knowing which lead is negative, and having traced it to its source as

The climax of these notes will be practically no expense at all and much better charging conditions for the batteries themselves, and by adopting this system individual attention is given to each battery concerned, which is by no means the alternative case, where batteries of all types and descriptions are often charged at one rate, whether suitable or not.

It is best to proceed with this subject stage by stage so that a fair idea may be gained in a practical manner as to the respective merits of various methods.

Choosing the Battery

The first thing of importance to consider is the battery itself. This detail is often not introduced into the calculations at all, as instances have been known to be common where a tremendous 80-amp. hour (actual) battery has been used to feed a small two-valve receiver running, say, 2-volt valves, which consume .1 of an amp. each.

The mistaken policy, it is believed, is that such an accumulator will run a long time; but it won't, as sulphation would set in long before its useful life had been expended, under such conditions. The battery, therefore, should be carefully chosen to suit the receiver and the valves which it has to operate. Its capacity in actual ampere hours should be as low as is feasible in conformity with what it has to do. (Assistance is always willingly given in the choice of batteries by the makers.)

Very few people use other than dull-emitter valves nowadays, and these have a filament consumption

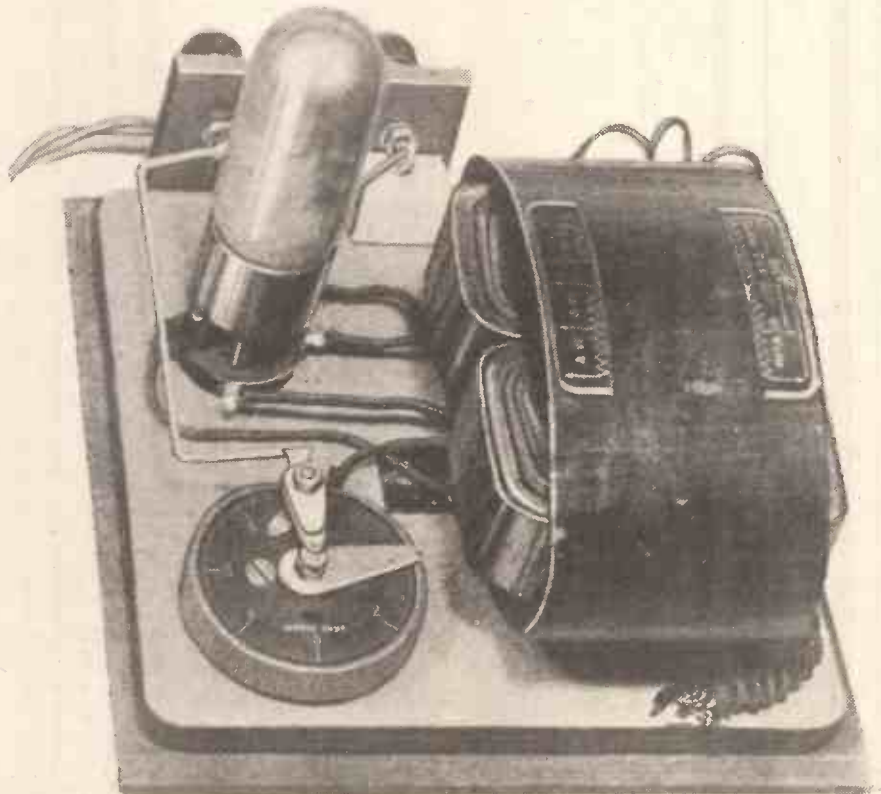

A simple A.C. charger. There is only a rectifying valve, a small power transformer, and a variable resistance in this simple but quite satisfactory unit.

far as the house lamp-holder, both holder and adaptor should be marked so that should the plug at any time be removed it will be easy to replace it the right way round, as if this operation is reversed the polarity of the leads to the charger will naturally be reversed also. In addition to this the leads should be either "two-colour" or the ends equipped with positive and negative colour spades (red, positive; black, negative).

Trickle Charging

The first thing to do now is to connect the negative tag to the negative terminal of the battery to be charged, and the positive tag from the lamp to the positive terminal of the battery. It is very important that the arrangement should be this way round, otherwise the battery will be discharged instead of charged. The lamp-holder of the charger, by the way, should generally be in series with the positive lead, as shown in the theoretical drawing.

Supposing we choose for our purpose a 60-watt carbon filament lamp, such

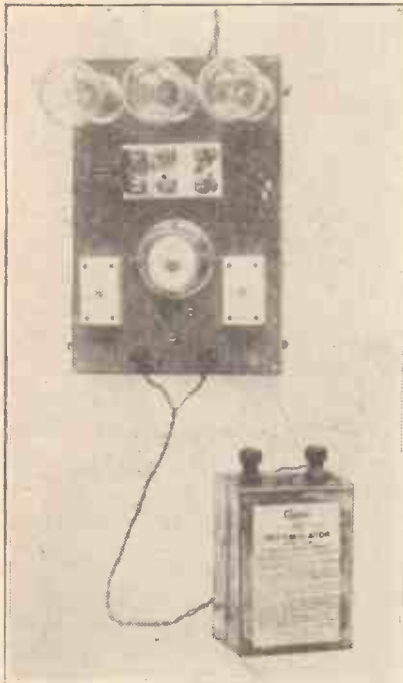

A simple charging board, of which many makes at reasonable prices are available, for D.C. mains.

as is frequently used for house lighting purposes, and assume at the same time that the charging rate specified for the battery is 1/2 amp. This rate of charging should not be exceeded, but on the other hand a slow charge is beneficial in many respects, and this form of charging is termed trickle charging. What we desire to know

now is at what rate will the battery be under charge, using the 60-watt lamp, the voltage of the mains being known. Here is the formula in simple form:

Wattage of the lamp used, divided by the voltage of the mains = Rate.

Example—Lamp, 60 watt, mains 230 volt = $60 \div 230 = .26$ amp., which is the charging rate.

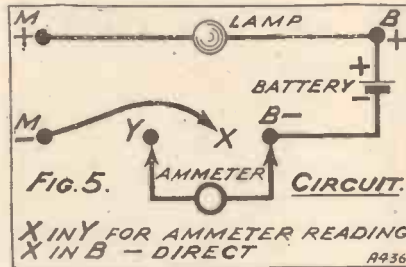

This formula applies in all cases, and where a lamp of lower wattage is used the charging rate is less accordingly, or where one lamp is used in parallel with other lamps the charging rate is increased, in proportion to the increased total wattage.

The idea of trickle charging, however, is to give the accumulator a good full charge, and then to keep it up to charge by treating it frequently after use, say every night. When both sets of plates of an accumulator on charge gas freely, it may be considered that the charge is sufficient.

The photograph and diagram shows clearly how to construct a novel and inexpensive battery charger of the type mentioned which can be applied while in use as a desk reading lamp. It can then be used while charging is going on, thereby "killing two birds with one stone."

THE NEW ELECTRICITY SCHEME.
How it will affect radio amateurs.

THE utilisation of power supply by radio amateurs for the operation of their valve receivers, and the elimination of dry and wet batteries, is rapidly coming into the foreground of receiver design.

It has been prophesied that the set of the future will be an "all mains" set, i.e. one which can be plugged straight on to the mains, having the battery eliminating parts with the receiver. Sets of this type can be of two kinds. (1) Those for use with A.C. systems; and (2) those for D.C. systems.

There are a number of different supply systems at present in operation. There are both D.C. and A.C., different voltages, frequencies, etc.; in fact, one street may have two different supply systems from different companies.

Now, in future, we are to have a common three-phase, three-wire A.C. supply throughout the country, with a grid-network of overhead transmission lines running through England, connecting up the main or central stations who will feed it.

High-Power Transmission

The voltage, it has been decided provisionally, will run into thousands (from 66,000 to 130,000) with the usual allowance for line volt. drop. This voltage will be reduced by transformer sub-stations to a suitable lower voltage and passed on to the consumer in the usual way. This method of transmission of power is exceedingly good, as it enables a smaller cross-section of wire to be used for a given power; thus to transmit a 1,000 watts A.C. we may have 1,000 volts and 1 ampere or, say, 100 volts and 10 amperes. It will be seen that wire to carry 1 amp. is much cheaper than that to carry 10 amps.

The frequency of the supply will be standardised to 50 cycles, the consumer's voltage depending upon the local supply company, since with A.C. any voltage may be obtained by using a transformer of suitable design. The great tendency appears to the elimination of direct-current.

Faults of the Future

Let us imagine this new system completed as it will be in about thirty years' time. There will be wires stretching from one end of England to the other, and open-air transformer sub-stations (with suitable switch gear) dotted about the towns and counties. These transformers will be fairly large, and will set up an appreciable alternating magnetic field, and might cause some interference with any local experimenter's apparatus. Suitable shields should lessen this interference. The transmission lines themselves may distort or even shield the waves transmitted from broadcasting stations. Now supposing a fault (short or earth) occurs on any section of the lines, there will be a sudden rush of current (before the protecting devices come into operation) which will induce voltages in any local inductive circuits such as aerials, telephone lines, etc. But, fortunately, the listeners of 30 years hence will be the ones to worry about that!

LISSEN offer you an advance in two standard components

LISSEN SUPER TRANSFORMER



Lissen promised that if a better transformer than the famous Lissen 8s. 6d. model could be obtained it would be added to the Lissen range.

And here it is—a transformer that gives crystal-clear reproduction of high notes and retains the deep sonority of the bass in a way that is startlingly true. A year ago this latest transformer could not have been made. It is incomparably better than any other transformer selling at any price at all. No transformer, however high in price, can even claim comparison with it unless that transformer has also been produced within the past few months.

For only now has the depth of radio technique yielded the knowledge which has made the latest Lissen Transformer possible. And in certain ways this latest Lissen Transformer will prove to have anticipated the advance experience of to-morrow. It represents value in high-priced transformers to the last degree. It represents a big saving in price to the transformer-buying public in comparison with every other high-priced transformer available. Ratio $3\frac{1}{2}$ to 1. PRICE **19/-**

The long-awaited LISSEN VARIABLE CONDENSER

It has taken years for Lissen to make a condenser which at last satisfies every Lissen requirement, and at a price which is in keeping with the Lissen tradition for fine value. But now Lissen has produced a condenser which for fine and facile tuning, for low loss, for universal use, is surely without a rival.

- You can use it as a standard condenser in any circuit.
- You can gang it—two or three of them together.
- You can use a drum control for it instead of a dial.
- You can mount it on a panel and it has feet for base-board mounting, too.
- One-hole fixing, of course.

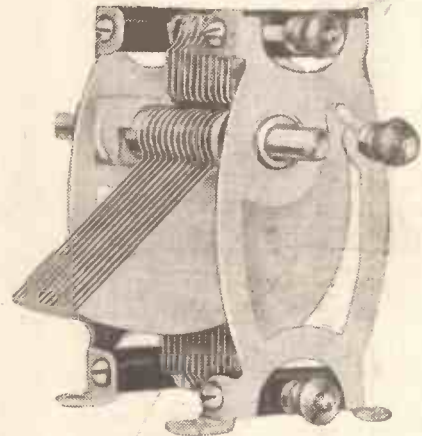

LISSEN UNIVERSAL SLOW MOTION DIAL

Made in Bakelite. An attractive slow motion dial at a keen price .. **3/6**

'0001	mfd. capacity	-	5/9
'0002	" "	-	5/9
'0003	" "	-	6/-
'00035	" "	-	6/3
'0005	" "	-	6/6

7 DAYS' APPROVAL

You can get the new Lissen components from practically every radio dealer.

LISSEN LIMITED, FRIARS LANE, RICHMOND, SURREY
(Managing Director: THOMAS N COLE.)

WE ARE EXHIBITING AT

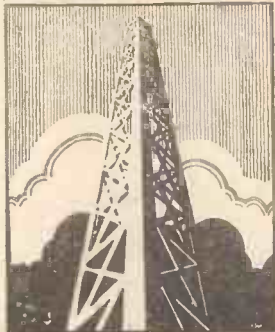

SEPT. 22nd TO 29th
THE NATIONAL RADIO EXHIBITION OLYMPIA
 HARRISON ROAD, WANDSWORTH, LONDON, S.W. 18
 STAND 0

37 STATIONS

definitely logged on Loud-speaker!

One of our Correspondents writes:—

London,
 13 June, 1928.

"I have pleasure in recording my results with your modified D.S.P. 3* coils. I am obtaining excellent results on both long and short wavelengths. The selectivity is remarkably good and I experience no difficulty in separating the various transmissions, even those quite close to the 2LO wavelength being heard, free from any distortion, using but one L.F. stage and a cone type loudspeaker.

SO FAR I HAVE DEFINITELY LOGGED SOME 37 STATIONS ON THE LOUD-SPEAKER.

Anybody who has a Solodyne type receiver need do no more than instal a set of your coils, and have a set capable of receiving any worth-while transmissions from the Continent without any fear of difficulty in operation."

DSP/3. One S.P. Aerial Coil and two Split Primary H.F. Transformers, the last with Reinartz Reaction, complete with panel control

£5

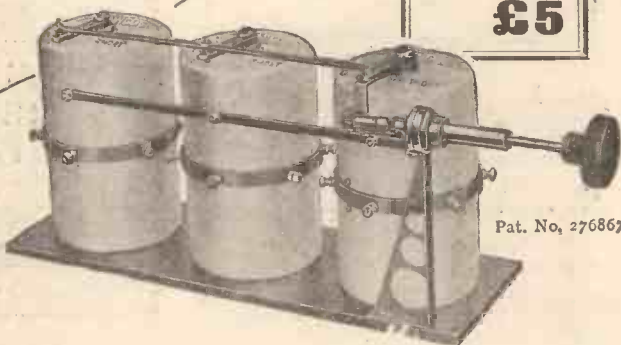

Pat. No. 276867

LEWCOS

(REGD.)

DUAL SCREENED COILS*

THE LONDON ELECTRIC WIRE COMPANY AND SMITHS LIMITED
 CHURCH ROAD, LEYTON LONDON, E.10

'Phone : Walthamstow 2531.

'Grams : "Lewcos Phone London."

THE "HIGH BIAS" ONE

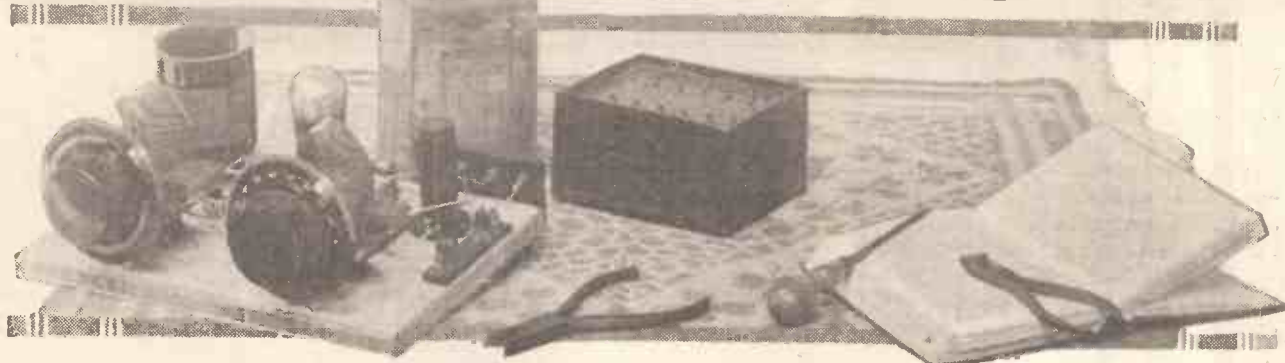

An ingenious receiver designed with the idea of increasing the efficiency of a detector valve as regards its low-frequency side.

By P. C. BAKER.

"WHAT a queer name for a set?" I can hear you say when you read the title—and I can quite understand that you may be puzzled. I was equally puzzled, however, to find a suitable title for this set, for the circuit used is a novel one, which to the best of my knowledge has not appeared before in any wireless periodical.

COMPONENTS REQUIRED

- 1 0005 log-mid-line variable condenser (This should be of the base-board mounting type, such as the Lissen and Formo).
- 1 0003 log-mid-line variable condenser (Formo).
- 1 Sprung valve holder (Lotus, Benjamin, Igranic, Bowyer-Lowe, W.B., etc.).
- 1 H.F. choke (R.I.-Varley, Colvern, Burne-Jones, Climax, Igranic, Sovereign, Cosmos, Lewcos, etc.).
- 1 Filament resistor (Cyldon, Burne-Jones, Bowyer-Lowe, etc.).
- 1 Six-pin former and coil base (Colvern, Lewcos, Peto-Scott, Burne-Jones, Bowyer-Lowe, etc.).
- 1 0003 fixed condenser (Lissen, T.C.C., Dubilier, Mullard, Goltone, Igranic, Clarke, Burne-Jones, etc.).
- Grid leaks having values of 5, 5, and 3 megohms (Lissen, Mullard, Dubilier, Igranic, etc.).
- Terminal strips, screws, and wire for connecting up, and wooden base-board 12 in. x 8 in.

The name decided on, I think you will admit, is a fairly apt one when you examine the circuit shown in the theoretical diagram in Fig. 1.

As you know, the function of a detector valve is quite a complex one. It does not only detect, for if reaction is used it also amplifies at high frequency. Apart from this, however, it also amplifies at low frequency, and it can be truly said that it does three jobs simultaneously.

The object of the present circuit is to increase the efficiency of the detector valve as regards the L.F. side. Obviously we cannot increase the H.F. amplification given by reaction beyond a certain point, if we attempt to do so the valve begins to oscillate. The rectifying efficiency is also fixed by a number of constants and the only way anything on these lines can be accomplished is by using a fairly high value of H.T., and this is limited by the fact that the control of reaction must be kept smooth and progressive.

Increasing the Magnification

The present circuit is the outcome of an attempt to increase the low-frequency amplification obtained. On consulting the theoretical circuit, it

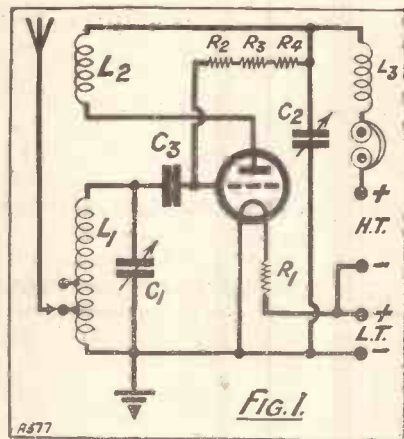

will be seen to consist of the usual tuned circuit connected between grid and filament of the detector valve,

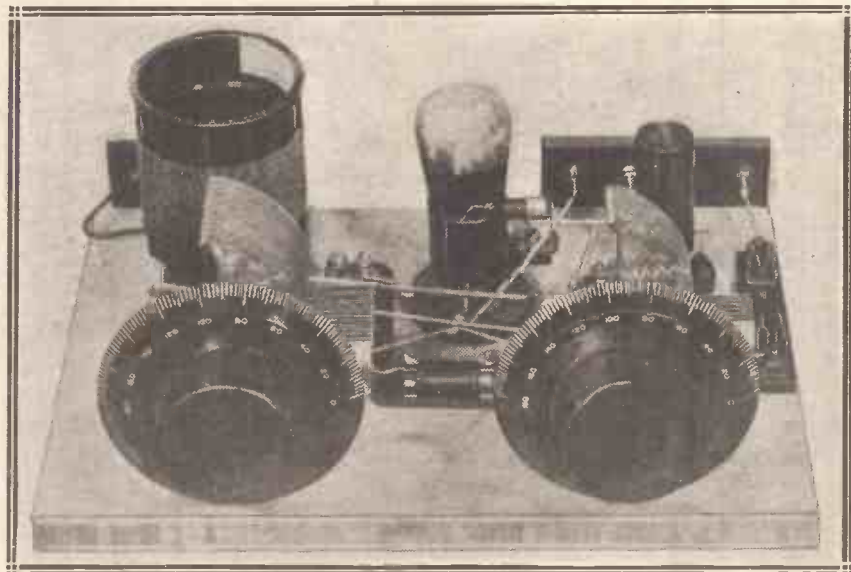

For economy's sake neither panel nor cabinet was used, though, of course these could easily be employed if desired

reaction being provided in the well-known throttle-control manner.

Instead, however, of the grid leak being connected between grid and L.T. positive, or across the grid condenser, it is connected between the grid and a point in the anode circuit of the valve, which results in a certain amount of L.F. feed-back being introduced.

The exact position in which it is connected was only decided after considerable experiment, and I would advise you to adhere strictly to the scheme found best. At the same time, the circuit certainly offers considerable scope to those who are experimentally inclined and those who like to try everything for themselves and thus enlarge their experience as to the behaviour of various out-of-the-way circuits.

Remarkably Small H.T.

The chief advantage of the circuit as finally used was found to be in the fact that it would give a very high degree of efficiency with only 9-12 volts H.T. A larger value did not appear to give a marked increase in signal strength, while backlash was found to become a serious matter.

In view of the fact that the particular position of the grid leak has the effect of applying a rather high positive bias to the valve, as well as producing a certain amount of low-frequency feed-back, it is important that it should have an exceedingly high value, far higher than that usually obtainable. I have, therefore, achieved the desired result by connecting three grid leaks in series.

The values of these are 5, 5, and 3 megohms, giving a total value of 13 megohms.

If you intend using the same variable condensers that I have made

time required to do this need not take you more than half an hour, and the wiring will not take as long again, although it may not seem very easy at first sight. It is as well to check

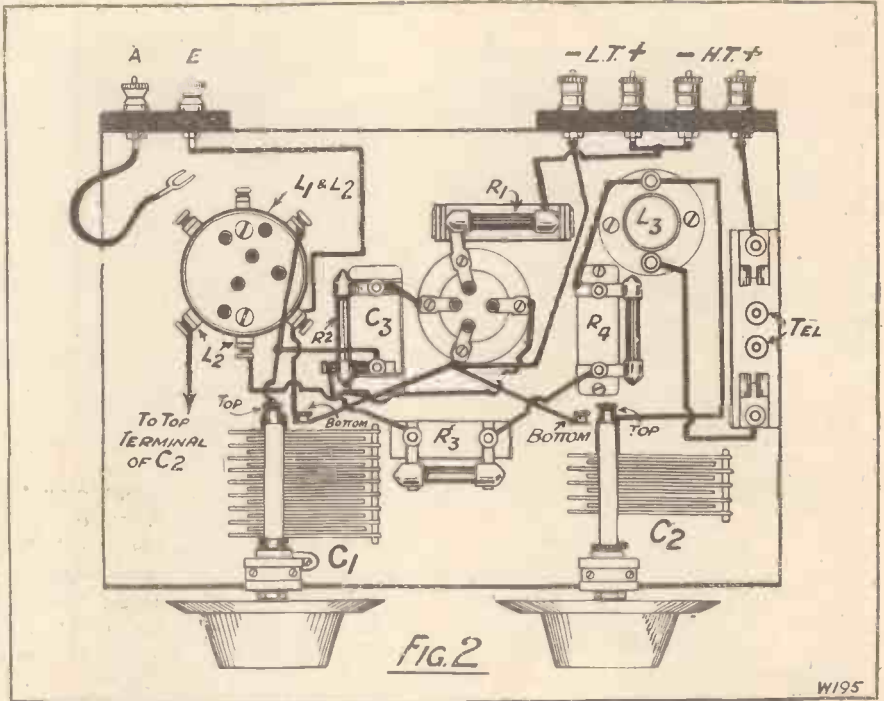

use of in this set, you will find that they are provided with drilled lugs by means of which they can be fixed to the baseboard. If not, it will be necessary for you to carry out your own ideas as to mounting them.

Then make up the terminal strips, fix them in position to the back edge of the baseboard and fix the rest of the components into place. The work and

over the connections before connecting the set up to its batteries, just in case a lead may have gone astray somewhere. This is advisable as the connections are not entirely simple and straightforward in this set.

We now come to the question of the coil to use. I have used throttle control in this one-valve receiver as it is efficient, and for the benefit of those who prefer this type of reaction circuit for its smooth and easy action. The coil I have used myself is wound on a Colvern featherweight former, which as you probably know is provided with an interchangeable former fitting inside.

Coil Details

This I have used for the reaction winding so as to allow of different numbers of turns being tried out to suit different conditions. The aerial can be tapped on to either of two tappings with which the grid winding is provided so as to allow of the best tapping being found according to circumstances.

With the former I have employed the winding for L_1 consists of 55 turns. Gauge 22 D.S.C. or D.C.C. may be used wound side by side, or else 26 gauge D.S.C. spaced one diameter. I am not going to suggest that you use Litzendraht, because of the fact that two tappings are taken

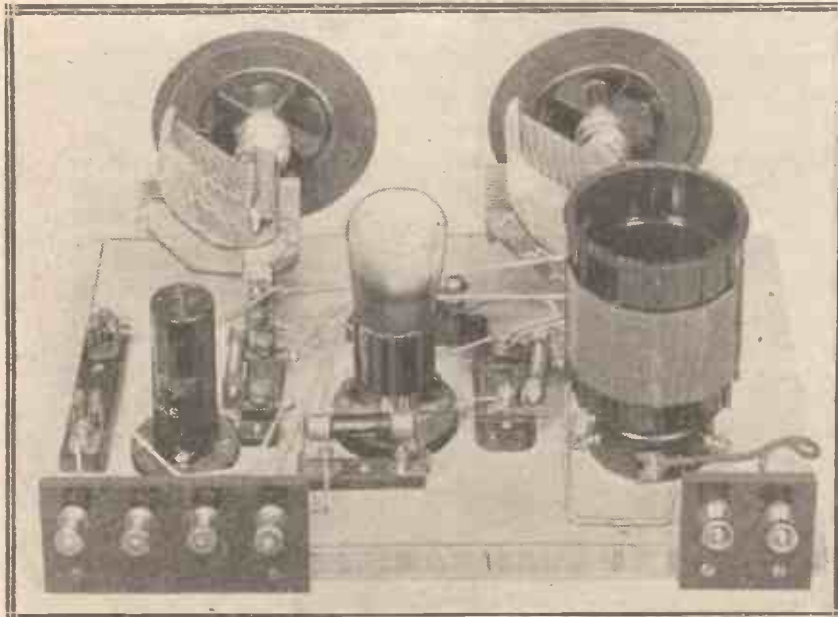

So simple is the constructional work that even the veriest novice cannot fail to make a success of it.



“NOBODY LOVES HER—”
but all the world laughs

You have a hearty laugh waiting for you if you can catch exactly the depressing tone of voice in which Wish Wynne tells her troubles to you, which she is going to do next on September 24th.

There are tens of thousands of users of the Lissen New Process Battery who are looking forward to her next performance. Has any one of them ever told you about the new purity of radio reproduction which you can get if you use the Lissen New Process Battery? If not, put one into your set yourself, and with the first few words of any single programme you will realise you have found a source of H.T. current which brings with it a clearer reproduction and far better tone than you have ever experienced before. This is due to the pure D.C. current which flows from the large cells of this battery. It flows steadily, smoothly, noiselessly, and the power lasts throughout months and months of the heaviest service you can give it. All the time there is perfect stillness in the background of your loud speaker utterance—no extraneous sound mingles with any transmitted item. Each word of speech and song and each note of music come through to you with a stereoscopic reality.

In the LISSEN Battery you not only get large cells, but a new process and new chemical combination which gives such clear reproduction and such lasting service that this battery has won for itself a sweeping public preference.

Put one into your set in time to hear Wish Wynne on September 24th.

10,000 radio dealers sell it. Ask for it in a way which shows quite clearly you want a Lissen and are determined to take no other.

- 60 volt (reads 66) .. 7/11
- 100 volt (reads 108) .. 12/11
- 60 volt Super Power .. 13/6
- 9 volt Grid Bias .. 1/6
- 4½ volt Pocket Battery .. 5d. each (4/6 dozen)



MADE
 IN
 ENGLAND

LISSEN LIMITED, FRIARS LANE, RICHMOND, SURREY

(Managing Director: Thos. N. Cole.)

at 10 and 15 turns from the bottom end, i.e. from that end of the winding that is connected to pin No. 2, these tappings being taken to pins 1 and 6 respectively. Pins Nos. 4 and 5 form the connections to the ends of the reaction windings.

way round it will be found impossible to get the set to oscillate.

Having got the set working normally, tune in one of the weaker distant stations and try the effect of using different values of grid leaks, not only as regards their effect on

and I feel sure that the circuit has interesting possibilities along these lines.

On the broadcast waves I have found this circuit to be exceedingly efficient and the stations I usually hear on a single-valve come in at a signal strength above the average when using the same value of H.T. on another type of detector circuit.

On the long waves it might be thought that the operation of the set might be a little tricky, but I have not found this to be the case in actual practice, and Hilversum, 5 X X and Radio Paris come in at excellent strength.

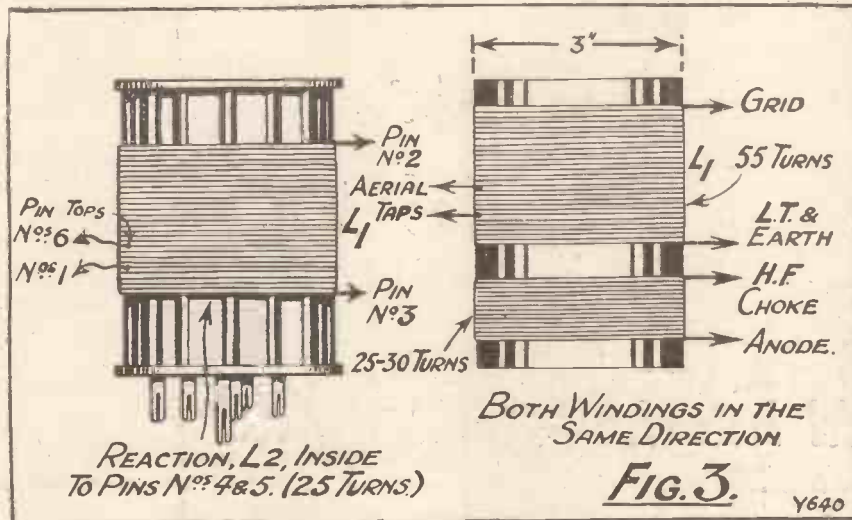

Fig. 3 gives the details of the coil, and will prove of use if you want to make your own coil up on an ordinary former instead of making it interchangeable. An alternative method of winding with the reaction winding alongside the grid winding is shown, a suitable number of turns for this former winding being indicated, as also the space that should be left between the two.

signal strength, but also on the smoothness of reaction. You will soon find that a certain total value gives the most satisfactory all-round results.

As regards real short-wave work, I would not care to say at the moment to what extent this circuit is suitable, as I have not yet had time to carry out prolonged or comparative tests. There is therefore room for experiment here,

- POINT-TO-POINT**
- Connect grid of valve to one side of grid condenser C₂ and to one side of grid leak R₂.
 - Connect pin No. 3 of coil base to earth terminal to moving vanes (bottom terminal) of C₁, to filament — and to moving vanes of C₂.
 - Connect other side of grid condenser to fixed vanes of C₁ and to pin No. 2 of coil base.
 - Connect other side of grid leak R₂ to one side of R₃, other side R₃ to one side R₄, and other side R₄ to one side of H.F. choke, as shown (i.e. end of choke which is connected to C₂).
 - Connect anode of valve holder to pin No. 4 of coil base. Connect pin No. 5 to fixed vanes of C₂ and one side of H.F. choke (see above).
 - Connect other side of H.F. choke to telephone terminal, and other telephone terminal to H.T. +.
 - Connect L.T. + to H.T. — and to one side of R₁, other side of R₁ to filament + socket.
 - Connect L.T. — to filament — socket.
 - Attach a flexible lead with spade tag or spring clip to aerial terminal.
 - This completes the wiring.

Operating the Set

For the long waves the grid coil will need to have 250 to 300 turns put on, the actual number will vary with the diameter of the former used and the way the turns are put on; tappings being taken at 75 and 100 turns approximately, and for reaction about 50 to 75 turns will be found sufficient in most cases where the coupling between the two windings is fairly tight. Reaction will need from 75 to 125 turns, depending to a certain extent on the method of winding, valve used, etc.

The circuit is not particularly critical as to the valve to use. I myself incline to the high- μ type as being the most efficient type of valve to employ with this circuit, and I find that a very low value of plate voltage is indicated as giving the best results.

When connecting the set up for the first time, put three grid leaks in the holders, totalling 12 to 15 megohms. Then see that the reaction control is functioning normally, for should you have wound one of the coils the wrong

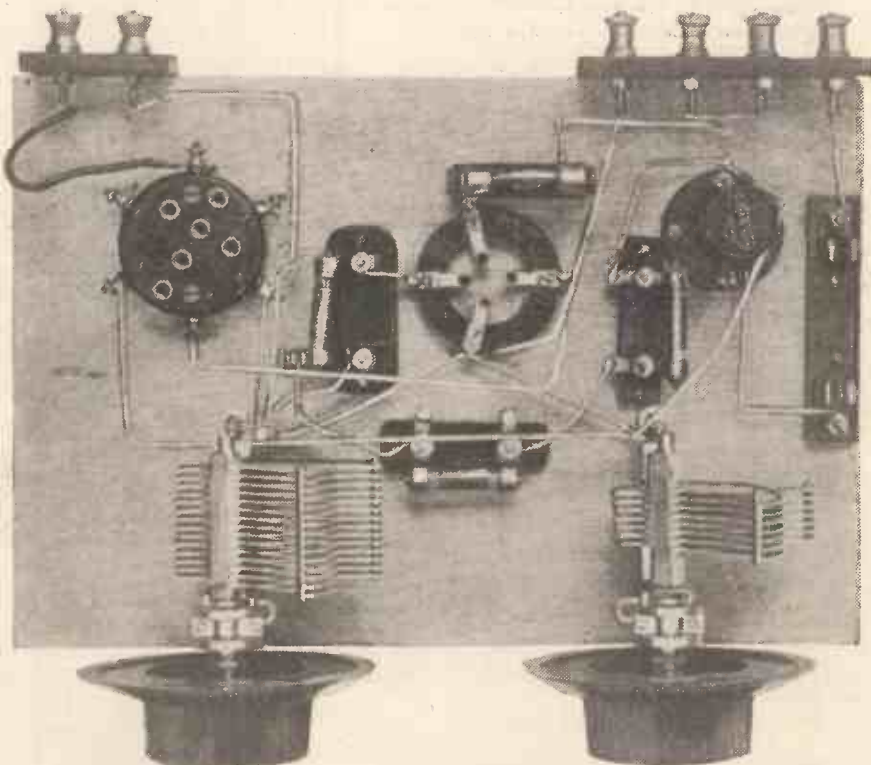

This plan view, in conjunction with the wiring diagram on the previous page (Fig. 2), enables all the wiring to be copied without difficulty.

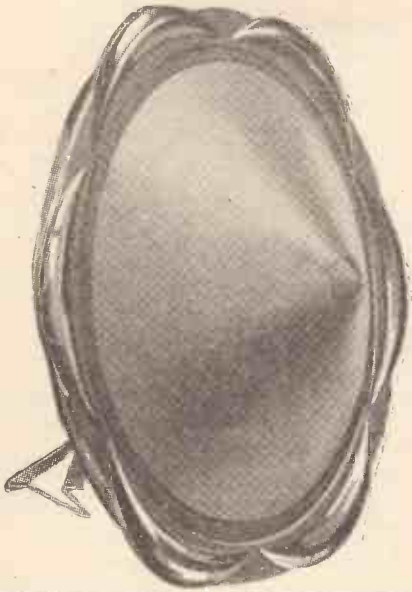

THE LONG VIEW

Take the long view—a set which does not give perfect reproduction need not be all wrong. Examined stage by stage—a better component fitted here, another there, will with each improvement bring you nearer the goal of perfection. Constructors who have fitted the Mullard "Permacore" Transformer in their receivers have discovered what wonderful tone and volume can be obtained with this transformer. It is generally admitted, too, that the Mullard P.M. Valve improves any receiver.

Now the new Mullard Pure Music Speaker marks a still nearer approach to perfection. Its wonderful sensitivity, its life-like reproduction and the tone control switch, by which the pitch can be raised or lowered and shrillness removed, all contribute to your greater enjoyment. Take an early opportunity of hearing it.

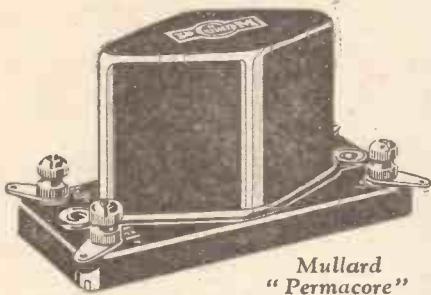

Mullard
"Permacore"
Transformer.
25/-



Use Mullard
Valves—with
the wonderful
Mullard P.M.
Filament.

The Mullard P.M. Speaker,
Model "C," suitable for
hanging or standing.

PRICE 53/6

OLYMPIA
STANDS 88, 89,
90, 97, 98, 99, 133

Mullard MASTER · RADIO

Valves For This Month's Sets

How to choose the best valves for the "M.W." receivers described in this issue.

By K. D. ROGERS.

THE choice of valves for the sets described in this month's MODERN WIRELESS is not a difficult one, especially as each set is capable of being operated on either 2-, 4- or 6-volt valves with high degrees of efficiency.

The "Thomas" Short-Waver, which consists of a 3-valve set resistance-capacity coupled, has very little in it to worry the man who decides to build it. The first valve, the detector, should, of course, be resistance capacity, in order to get the maximum sensitivity and amplification possible. The second valve can also be resistance capacity, so that magnification from that stage should be great. The last valve should be of the power type.

If it should be found that on the specially powerful short-wave signals a certain amount of distortion is obtained, then it would be better to use an ordinary H.F. valve in the first L.F. stage instead of the resistance-coupled valve, but for usual purposes I think it will be found sufficient and best to use the valves mentioned.

Plenty of H.T.

It should not be forgotten that a resistance-coupled short-wave set requires quite a good amount of H.T. in order to make it operate, and operate properly. If operation is difficult, perhaps the substitution of an H.F. valve instead of the R.C. detector would assist matters.

Suitable valves can be obtained from all the makers—Cossor, Mullard, B.T.H., Cosmos, Marconi, Osram, and Six-Sixty. It might be possible on average signals to use a Pentode in the last stage, but this should only be attempted by somebody who knows something about receivers.

The "Olympic" Three, designed by Mr. Kendall, consisting of an H.F., detector and L.F., requires a little care in the choice of valves in order to get the best out of the set without causing overloading or bad reproduction.

The H.F. valve need only be of the ordinary H.F. type, having an impedance of somewhere about 15,000 to 20,000 ohms; the P.M.5X, or the D.E.5B, would be quite suitable here, although this latter has an impedance

a little higher; the Six-Sixty H.F., Cossor H.F., B.T.H., Ediswan, Cosmos all have valves suitable for this circuit.

For the absolute maximum in signal strength, especially on longer waves where the resistance is switched on in place of the split-anode coil; it is possible to use an R.C. valve, but here again it should be left to the user. Personally I think I would prefer an H.F. valve here, though it might be possible to use one of the higher variety with success, but in the detector stage it would not be possible to use an R.C. valve with success, so an H.F. valve must be used here, owing to the transformer-coupling which follows it.

For Best Quality

The L.F. stage should be suitable for carrying the power required when working the set on the local station, and here again comes the point which is most to be considered when choosing the H.F. valve. I said just now that an R.C. type of H.F. valve could be utilised here; that is quite true, and it would be of benefit from the point

from his loud speaker, he had better use an H.F. valve in the H.F. and detector stage and a power or super-power—the latter for preference—in the last. If, on the other hand, he lives right away down in Devonshire, for instance, miles from any powerful station, he may find a resistance-coupled valve in the H.F. stage, and an ordinary L.F. valve, or even a Pentode, best in the last stage.

This is all very well for distance reception where you do not expect to get the same quality as you do for any of the nearby stations, and if you use this set quite a long way away from the station, then I think it would be well worth while trying those valves I mentioned. Otherwise, an H.F., followed by another H.F., would be the best combination for this receiver, followed by a power or super-power valve, the P.M.6, P.625, Ediswan Power, Cosmos, Six-Sixty Power Valve, B.T.H. Power, and so on.

Easily Suited

The "High-Bias" One is easily catered for. Here a good detector valve is really suitable. Usually an H.F. valve will give the best results under the circumstances entailed by this circuit, and it is an ordinary H.F. valve which I should prefer to use here.

It will thus be seen that it is not difficult to choose the valves for the sets described in this month's MODERN WIRELESS. Always when choosing

WHICH SHALL I USE?

A convenient method of storing valves. They can be picked out as required with the minimum of trouble and are perfectly safe and free from risk of breakage. They are therefore always safe and ready to hand when a set is to be tested or several valves tried to find out which is the most suitable under any given circumstances.



of view of sensitivity when long-distance results are being obtained, but from the point of view of reproduction when the local station is to be listened to, I would certainly rather have the H.F. valve, but it will rest with the constructor.

If he lives near a local or powerful station and he wants good quality

valves be careful to remember that you may be up against the problem of overloading if you go in for too great a magnification anywhere, and you will do best to find out from friends exactly what sort of results they are getting from the various stations, and what sort of signal strength they get.

FERRANTI

AT

OLYMPIA

AUDIO FREQUENCY TRANSFORMERS
 OUTPUT TRANSFORMERS
 RADIO METERS
 CONDENSERS
 CHOKES

PUSH - PULL TRANSFORMERS
 MAINS TRANSFORMERS
 ANODE FEED RESISTANCES
 TRICKLE CHARGERS
 SPEAKERS



COMPONENTS OF OUTSTANDING MERIT

Expert Engineers will be available at Olympia to advise constructors as to the correct use of Radio apparatus. If you have any technical difficulties we invite you to utilise the opportunity to discuss your problems with us.

FERRANTI LTD., HOLLINWOOD, LANCASHIRE

Operating THE "CONSTANT" THREE



It is a feature of the type of circuit in which a screened-grid valve usually figures that amplification increases with increases of wave-length. And the "Constant" Three is no exception to this rule. Efficient though you will find it on the normal wave-band, even greater degrees of sensitivity will be experienced on the 5 X X wave-lengths.

The coil details given in the previous article related to the normal wave-band, and the coils required for the longer wave-lengths are of a somewhat different structure. They also are coils which were designed for the 1928 "Solodyne" by Mr. G. P. Kendall, B.Sc., and can be obtained from any of the leading manufacturers of such devices, but the constructor can make them himself if he so desires, and he will find them perhaps somewhat easier to fashion than those required for the shorter wave-lengths.

The accompanying photograph will give a fairly clear idea of the way in which the coil is made. First of all is required a six ribbed former, such as the Becol No. 5A, about 3 in. diameter over the ribs and 3½ in. in length. This is fixed on the usual five-pin base by means of two short pieces of threaded brass rod and nuts. Cuts must be made along the ribs in the manner shown in the photograph.

The H.F. Transformer

In the case of the H.F. transformer both the primary and secondary windings are wound in two halves and in opposite directions, as before, and the same applies to the secondary winding of the aerial coil unit.

Details of the long-wave coils and further adjustment notes concerning the single-control set described last month.

By G. V. DOWDING, Grad. I. E. E.

Regarding the H.F. transformer, the secondary consists of 29 turns of No. 32 D.S.C. wire in each of the twelve slots, six being wound in one direction and six in the other. You will therefore see that the total

ing nearest to it. This slot is the one against the I.S. end.

When the secondary has been wound the wire in each slot should be covered with a few layers of silk or cotton thread. Above this should be wound the primary winding, consisting of fifteen turns per slot of No. 36 D.S.C. wire, wound in the same direction as the sections of the secondary winding beneath it.

The H.F. transformer you will note has thirteen slots, but as the aerial

This is the long-wave aerial coil. Twelve slots have to be cut in order to accommodate the windings and the spacings of these are given. The H.F. transformer needs an additional slot at the I.S. end (making thirteen in all) and in this the reaction winding is carried.

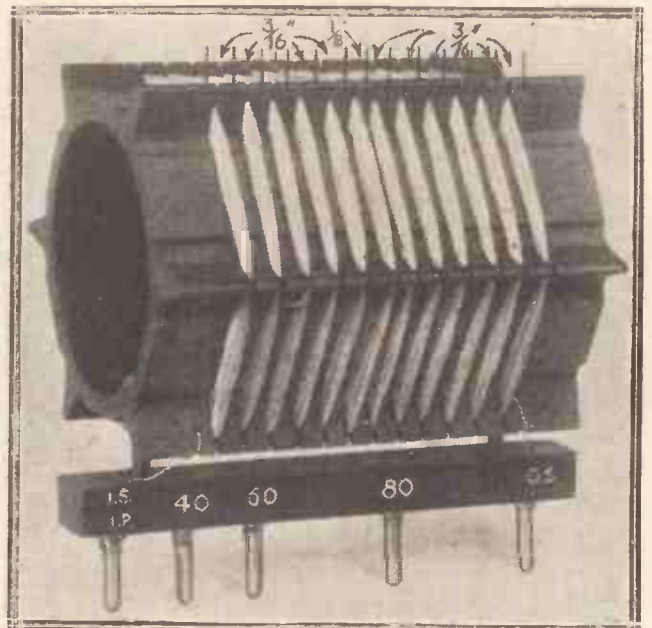

number of turns is 348. The reaction winding, consisting of 80 turns of No. 36 D.S.C., is wound in the thirteenth slot in the same direction as the section of the secondary wind

unit includes no reaction winding this will need only twelve slots. The secondary winding will be the same, but the primary should all be wound in the first four slots from the I.P. end.

LOW-PRICE

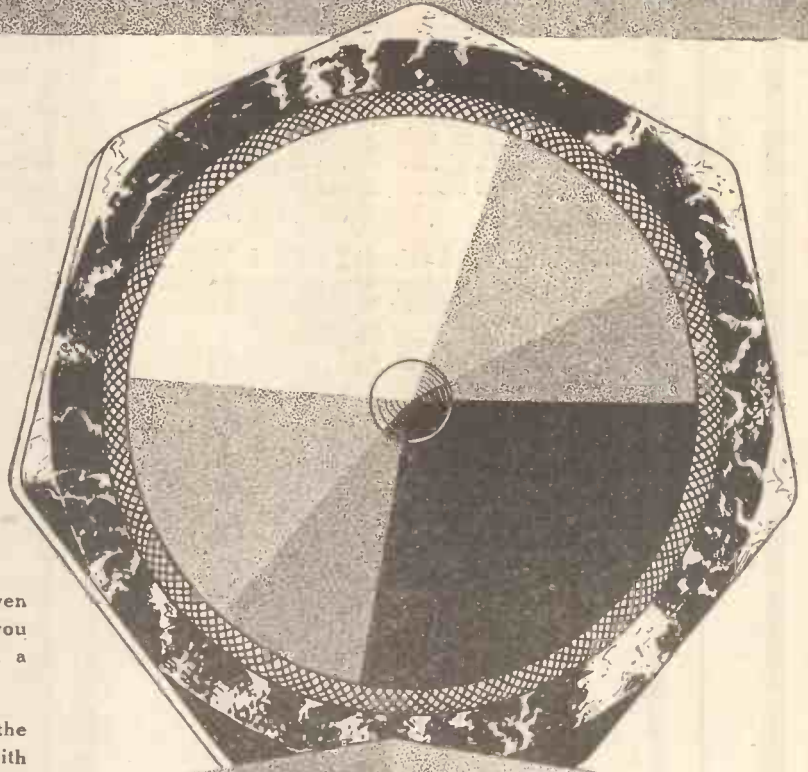

The constructional details of Philips Seven Cornered Loud Speaker will interest you because they are very unusual in such a low-priced instrument.

The electro-magnetic movement is of the balanced-armature type and is fitted with a cone of ample surface area, which retains its rigidity under all conditions. Consequently Philips Loud Speaker responds to an unusually wide range of frequencies, and maintains a very natural tone.

There is also a switch controlling a special device which enables you to obtain a suitable impedance.

As you see, Philips Seven Cornered Loud Speaker is something new in value, a first-class instrument which sets a new low-price standard. Call in at your dealers and ask to hear one—it will be a pleasure worth the asking.

PRICE 50/-

NATIONAL RADIO EXHIBITION,
OLYMPIA, Sept. 22 to 29.
STANDS Nos. 94 and 122.

PHILIPS

for Radio

This winding is of 80 turns, tapped at 40 and 60, No. 32-gauge wire being used.

You will probably find that you will be able to change over from the shorter to the longer wave-lengths quite successfully without referring to the reaction condenser adjustments. At the most a turn or two of the B condenser will be all that will be needed.

As the set is even more sensitive and the available stations fewer on the longer wave-lengths, you will not find it necessary to adjust the set for constant-reaction effects in order to tune in a number of the broadcasters by reference only to the one station selecting dial.

Although in order to go to the long waves the constructor will have to change the coils, he is not faced with the problem of re-neutralisation, but I must point out that the change-over may upset the reaction setting.

Condenser Settings

Although this can easily be rectified by a slight readjustment of the condenser B, it should be remembered that this is not provided with a dial, so that you cannot go back immediately to the original setting without a certain amount of experience. If the operation is not carried out hurriedly it will be found that a little practice will enable the return to original conditions to be carried

matter and one which will not cause the constructor much trouble.

By the way, it is worth pointing out that the filament rheostat controlling the current to the screened-grid valve makes a very fair volume control.

I have already received several letters concerning the "Constant" Three, and quite a few correspondents have commented upon the absence of certain bypass condensers which figure in the majority of sets employing the screened-grid valve. I am only too pleased to be able to reassure constructors on this point and make it clear that the omission is not accidental. Everything that I have found essential for the efficient functioning of the set has been included. The layout of the receiver and its minimum of components are the results of a fair amount of experimenting.

AMATEUR TRANSMITTERS' FIELD DAY



A large muster turned up for the field day of the Golders Green and Hendon Radio Society. The activities of the members were to locate hidden transmitters furnished by the 47th Divisional Signals Territorial Force. The above photo shows the concealed station at Stanmore.

But if your local conditions happen to be very poor, and it is necessary to work fairly close to the edge of oscillation in order to bring in all the stations you desire, then you will find that the constant effects can be obtained as readily as on the lower band. In such a case you may find it necessary to readjust slightly the H.T. voltage on the detector valve.

When Changing Over

It is worth recording that these long-wave coils are the result of a considerable amount of research. Owing to the greatly increased amplification obtainable with the screened-grid valve on the lower frequencies, coupling effects are likely to become more troublesome, but the coils are so arranged that while the long-range efficiency of the receiver can be enjoyed in respectable measure, stability is not sacrificed.

out in a matter of a few seconds.

With the original model I find that, when going on to the long wave-lengths on my home aerial, the small variable condenser B has to have its screw adjustment rotated to the extent of two and a half turns, and I have found I am now able to judge the exact degree of movement by the position of the cut in the screw.

This takes up an oblique position in both cases, and points directly at one of the terminals on the other small variable. The two and a half turns can be accurately gauged by remembering this fact and also it is a simple matter to return to the original setting.

On another aerial no adjustment is needed for the long waves. I am not quite clear as to why a difference in aerial conditions causes this slight variation in performance, but from a practical viewpoint it is a small

SOME ACCUMULATOR HINTS

Never stand an accumulator near a fire. (High temperatures should always be avoided, as they invariably shorten service.)

Not only should the plates of an accumulator be kept covered at the correct level, but only distilled water should be added to the accumulator for this purpose.

Do not lose the filling plugs from your accumulator; it is important that they should be in place.

Do not let the little holes in the filling plugs become stopped up, because a free air passage here is essential to the correct functioning of the accumulator.

The voltage of an accumulator should always be tested when the instrument is supplying current to the set. (A fictitious reading is often given if the valves are not alight when the voltage test is made.)

The voltmeter is not the only easy means of testing the condition of a battery, as this can be done quite as effectively by means of a hydrometer.

Do not rely on hydrometer readings which are taken immediately after distilled water has been added to the acid in an accumulator. The electrolyte naturally takes a certain time to settle down.

**NEW
PRECISION
INSTRUMENTS BY**



AT STAND 105 OLYMPIA

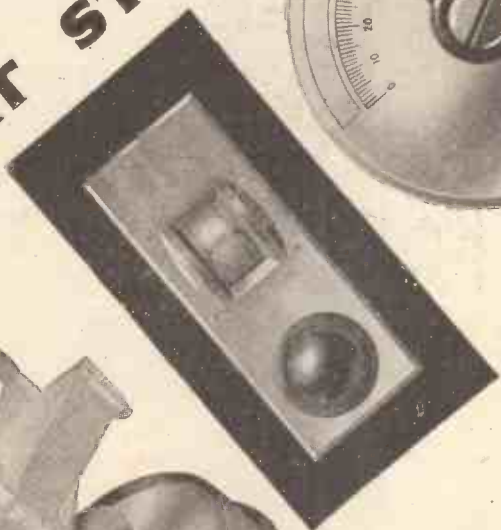

THE new range of J.B. Precision instruments now being shown at the National Radio Exhibition enhance still further the reputation of this famous firm. Every Radio man looks keenly at any new J.B. product, knowing that here is something really good. If anything, J.B. have this season surpassed themselves in the excellence of their new lines.

Reading from left to right on this page, the instruments illustrated are, firstly, the new J.B. Vernier Drum Dial. This is an exceedingly attractive job, which marks a terrific advance in the design of this type of instrument. For example, the dial protrudes through the panel, thus obviating the necessity for illumination as the scale can be read easily. Patents are pending for this arrangement. The dial is entirely insulated from the condenser.

Space forbids the mention of other numerous advantages, but briefly the J.B. Vernier Drum Dial is a wonderful engineering job and well up to the J.B. standard. The cost, exclusive of condensers, is 10/6.

The next illustration is that of the attractive Panel Plate in bronze finish which is supplied with the Drum Dial, and which gives a most artistic and refined appearance to the panel of a receiver.

Next is the new J.B. Vernier Dial, the most attractive and efficient of its class.

The new J.B. Vernier Dial is the only dial which is completely insulated.

This is an amazing advance over all older models. The illustration shows clearly what an added attraction the J.B. Vernier Dial is to any receiver. The price is only 5/6.

Then there is the new J.B. Slow Motion Model as shown. Radio fans need no reminding of the wonderful results yielded by J.B. S.L.F. and Log. condensers. Further additions and refinements take these famous instruments even further ahead.

Lastly comes the new J.B. Midget Condenser, the smallest and best yet designed. Low minimum capacity is ensured by specially shaped vanes and the elimination of end plates. The J.B. Midget occupies less panel space than any other of its kind.

If you are not at Olympia, write to us for fuller details of these new lines, enclosing your dealer's name and address.

JACKSON BROS
8, POLAND ST- OXFORD ST
LONDON - W.1. **B** Telephone: GERRARD 7414

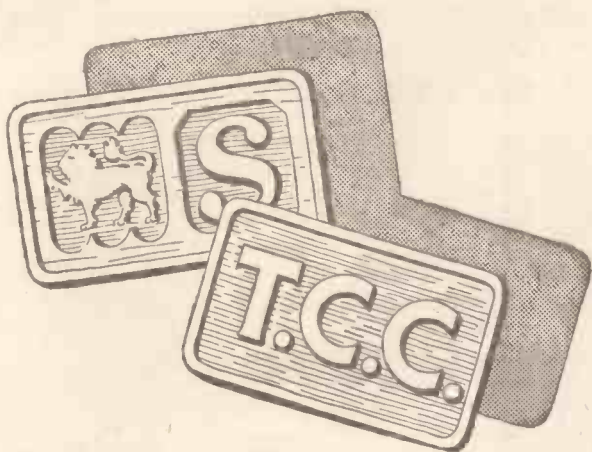

THEY BOTH TELL THE SAME STORY -

THE Hallmark on the silver leaves no doubt as to its genuineness.

What the lion means to silver the letters "T.C.C." mean to a condenser.

The condenser that bears the "T.C.C." mark has been carefully made and individually tested. It is backed by a reputation of nearly a quarter of a century. It will pay you to buy T.C.C. instead of unknown and untested condensers, which may be a copper or two cheaper. T.C.C. Condensers are fully guaranteed. They are minutely accurate and unfailingly reliable.

For 22 years "T.C.C." has been the condenser hallmark. Buy with confidence when you see it.

*Specified for the
Cossor "Melody Maker"*



T.C.C.

Adot. Telegraph Condenser Co., Ltd., Walrus Farm Rd., N: Acton, London, W.3.

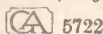

5722

**THE ALL METAL
WAY**

is the best way
to build your battery eliminators

**NO VALVES NOR
ELECTROLYTE** are required
with

WESTINGHOUSE

Metal Rectifiers

which give full wave rectification
with an efficiency of 60%.



TYPE H.T.1.

for incorporation in
H.T. eliminator or
charger.

Output 200-v. 1 amp.
Input 230-v. A.C.

Price 84/-

TYPE A 3.

for incorporation in L.T. battery
eliminator such as the "Stedipower"
Unit.

Price 23/6



THE ABOVE, AS WELL
AS VARIOUS OTHER
TYPES OF UNITS, ARE
ON VIEW ON

STAND 78

AT THE NATIONAL
RADIO EXHIBITION

Call and see them, and ask
for a copy of our book "THE
ALL METAL WAY," show-
ing how to build all types
of eliminators.

The Westinghouse Brake
& Saxby Signal Co., Ltd.
82, York Road, King's
Cross, London, N.1.

ALL BRITISH

Radio and the Gramophone

In this section of MODERN WIRELESS each month will be discussed both technical and other data of interest to the set owner who is also interested in gramophones.

Besides articles of a practical nature, a brief survey and critique of the latest gramophone records is included, making the section of vital interest to all music-lovers.

Conducted By KEITH D. ROGERS.

CONTENTS

	Page		Page
Pick-ups and Record Wear .. .	2	A "Radio-Gram" Six .. .	7
The question of pick-up weight and the wear caused by bad adjustment or unsuitable "balancers" should be carefully explored, and more will be said about this at a later date.		Details of a super-set suitable for radio reception or electrical gramophone reproduction with maximum volume and purity.	
Unbreakable Records .. .	3	Round the Turntable .. .	9
A great deal has been heard of late about various types of unbreakable records, some of which can be folded up and trampled on without damage occurring. Dr. Roberts gives some inside information on the manufacture of this class of record.		A collection of "odds and ends" of interest to radio and gramophone enthusiasts.	
Quality Programmes .. .	5	Recent Record Releases: .. .	10
Discussing the problem of providing alternative programmes by radio or gramophone with the maximum of purity and strength in reproduction and minimum of running costs.		Our regular review of a selection of the records published during the month, written from the point of view of their suitability or otherwise for electrical reproduction.	

Pick-ups at the Show

THIS is the month of all months for the world of radio, a time when D.X. is once more becoming worth while, when short-wavers are sitting up and taking notice, and last, but not least, the month of "the show"—the National Radio Exhibition.

So much has been written about the contents of Olympia in other pages of "M.W." that it is unnecessary for us to emphasise the wonders that you can see down there in the West of London, but we must just say a few words about the various pick-ups being exhibited.

Examine the Mechanism

It is but a short time—a matter almost of months—since the first pick-up was seen in this country; a crude affair with an insatiable liking for high notes and a chatter worse than that of a thousand sparrows, and now we have a choice of upwards of thirty of these "electrical sound-boxes," as one firm aptly terms them.

Unfortunately at Olympia you cannot even test a pick-up with a pair of 'phones, so you can but go and examine and form your opinions, to be proved or otherwise by actual test at a later date.

But don't judge a pick-up by its appearance

down there among the glitter and the crowd. Look at it carefully, see if it is well made, if the armature is properly centred, or if it is pulled unequally by the magnets, for if this is so it will tend to bear unevenly in the record groove. Test the damping and see if it is too much or too little—both may be injurious to record or quality unless some special form of suspension is employed.

An Important Point

And don't forget the *weight*. No pick-up should weigh more than 5 oz. unless it is going to be very hard on the record, or be used with a satisfactory counter-balancing arrangement. The effective weight of pick-up and tone-arm need not be more than 3 to 3½ oz. if it is well made and properly fitted.

Make a list of your favourite pick-ups and decide to hear and see them in action at an early date—any reliable firm will give you every opportunity for a thorough demonstration, where you can judge from the reproduction and behaviour to the record as to whether any instrument is really worth while. Never buy in a hurry, or you may have to repent at leisure and be many shillings the worse for your experience.

PICK-UPS AND RECORD WEAR

Are you sure your pick-up is properly adjusted and is not causing unnecessary wear on your records?

By K. D. ROGERS.

I RECENTLY had to test a little weight adjuster for a tone-arm, the adjuster being fixed upon the swivel portion of the tone-arm on the opposite side to the pick-up. It certainly does adjust the "weight" of the pick-up. By this adjuster, and by its position on the tone-arm, you can vary the effective weight of the pick-up on the record quite a deal, and by this means reduce the pressure on the record.

But there is one little snag in this little adjuster, as there is in several adjusters which are appearing on the market. If you have a tone-arm which is the slightest bit slack in the swivel portion the weight of this adjuster may push the pick-up slightly to one side, by an amount almost imperceptible to the eye, thus causing it to bear on one side of the groove of the record, causing unequal wear on that record, and eventual breaking down of the wall on the side which the pick-up needle presses most against.

Side-Thrust Is Harmful

Otherwise, the balancer is quite a useful little thing, and if adjusted to a tone-arm which cannot by any means "give" in any side direction,

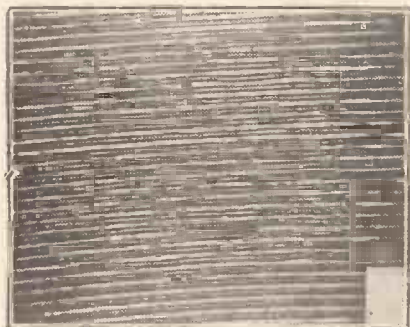

A photomicrograph of a new gramophone record. The fine white lines represent the bottoms of the grooves, while the broad white lines are the walls between adjacent grooves.

and thus allow the side thrust to come into play, it should be quite useful. Unfortunately, so far I have not found the tone-arm on which this "Balarm," as it is called, can be

adjusted without giving this disastrous thrust to one side.

The question of weight and torque on any tone-arm should be carefully gone into before it is decided to use any of the various types of weight adjusters, because any *twist* will make the records wear very badly indeed.

The trouble is that so many pick-ups are coming on the market exceeding about four and a half ounces in weight, and with the often very rigid type of design employed quite serious wear follows.

Too Much Damping

I have in mind a pick-up which appeared on the market some little time ago and which gave very good reproduction, but the wear upon the record was simply atrocious. The manufacturers truthfully advertised that "no chatter" from the pick-up was one of its great features. The pick-up did not chatter; it couldn't. It was far too rigid about the needle end for any annoying chatter to be produced, but that rigidity only meant that the little waves round the grooves of the record were very rapidly worn down and worn down unevenly.

That is the whole trouble; if the pick-up would wear the record evenly all round the groove then the record would last for a very long time, but with the majority of the pick-ups on the market the wear is *uneven*. The needle comes along, hits one side of an indentation in the groove and chips it on that side, leaving the other side altogether, passing on and almost bouncing on to the next "wave crest" on the next little wave. Here again it chips another piece off, and that is how it goes on, until after about four or five runnings the record is really useless for perfect reproduction.

Careful Adjustment Necessary

A word about pick-ups and wear on records. Readers should be careful in the adjustable type how they adjust them. Some of the pick-ups on the market are adjusted merely by means of a set-screw, others have rather more than the average adjustment

process to be gone through, but all of them should be carefully adjusted.

In many cases the set-screw merely alters the damping on the needle, and although lessening the damping may appear to render the pick-up more sensitive, as it certainly does to higher notes, care should be taken that the damping is not reduced to so great an extent as to cause the pick-up to chatter and thereby upset the tone of reproduction, and also cause unnecessary wear on the channels of the record. Too much damping can cause a lot of wear, but chatter can also cause wear.

Other pick-ups have their adjustments so arranged that any alteration

After bad wear, such as is caused by a badly made or wrongly adjusted pick-up, the record presents this appearance through the microscope.



of the damping of the needle causes it to have a permanent pull either to one side or the other, and so bear either on one side or the other of the groove of the record. This again causes uneven wear, and the record which is used with a pick-up that has a very definite bias on one side or the other will soon become useless.

Closely Examine Your Record

Most accurate adjustment of the pick-up and tone-arm is essential if really long life is to be enjoyed from any record, and with the price of records as they are to-day, one cannot afford to be careless about the amount of wear they are given.

Finally, I would advise all radio-gramophone enthusiasts to invest in a good magnifying glass, to examine their pick-ups in action. They will be amazed at some of the things they will see, and I am certain that if they were to choose their pick-ups according to magnifying glass tests, as well as according to the reproduction tests, they would be rewarded by a much longer life from their records. It is a heart-breaking process to know that one's favourite tune or item is rapidly "going west" because the pick-up is acting as a miniature snow-plough.

Don't forget to visit us on Stands 135 & 166



FOR PERFECT REPRODUCTION

TELSEN Radiogrand
L.F. TRANSFORMER
FOR BETTER RADIO RECEPTION



This is our highly popular standard model which is so firmly established in public favour that an output of vast proportions is necessitated to cope with demand. A fine instrument with wonderful amplifying powers without a trace of distortion.

Made in Ratios 5-1 and 3-1. Shrouded to avoid interaction. **12/6**

The "ACE," a smaller and lighter model especially designed for Portable Sets, 8/6.

Our new Season's models have detachable feet that permit the terminals being at top, bottom or sides, whichever is most convenient for wiring.

Entirely British Made and guaranteed 12 months.

TELSEN
ELECTRIC COMPANY, LTD.
207, Aston Road, Birmingham.

Phone: Central 5265.
Grams: Escort, Birmingham.

We are exhibiting at
OLYMPIA
STAND NO. 5

DUAL SALES

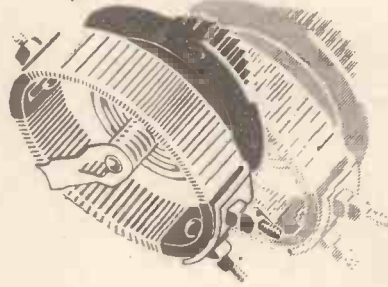

—and well on the way to triple sales!
This rheostat has been designed to meet the demand for a resistance to cover the needs of both bright and dull emitter valves. It has two windings, one of a resistance of 6 ohms, and a continuation of this on to a 30-ohm winding. One hole fixing.

Send for new Catalogue of all "Peerless" Products.

SEE US AT STAND 35, OLYMPIA

"PEERLESS" DUAL RHEOSTAT 3/-

The Bedford Electrical & Radio Co., Ltd.,
22, Campbell Road, BEDFORD.

GOOD NEWS FOR SET BUILDERS

In response to the urgent demand for first-class sets for family use, Mr. PERCY W. HARRIS, M.I.R.E., has now prepared the

Wireless Constructor Envelopes

The first two of this series are NOW on Sale, price 1/6 per envelope (by post 1/9).

Envelope No. 1.—THE RADIANO THREE (Recently reprinted). A famous loud-speaker set which you can build in an hour or two—no soldering necessary and a wide range of components to choose from.

Envelope No. 2.—THE CONCERT FOUR. Made of standard parts, all easily obtainable, this is a highly-sensitive, long-distance set, giving powerful reproduction of wonderful quality. Covering both long and short wave-lengths, with a switch for 3 or 4 valves, it is essentially a set to enjoy both in building and operation.

In each envelope you will find every detail of the set simply explained; photographic reproductions and diagrams are included, as well as a full-size Blue Print.

NOW ON SALE — Price 1/6

By post 1/9, from Wireless Constructor Envelopes, The Amalgamated Press, Ltd., Bear Alley, Farringdon Street, London, E.C.4.

Unbreakable Records

We have heard a lot lately about the unbreakable record, and here Dr. Roberts tells us some details concerning the construction of such records.

By J. H. T. ROBERTS, D.Sc.
(Scientific Adviser to "Modern Wireless.")

THE original type of gramophone record, and the one with which most of my readers will be familiar, is the "rigid" record made from the black shellac material, the general composition of which I described in a previous article. Perhaps I ought to say that the *really*



Showing various processes from wax master to commercial record. At the left-hand (top row) is shown in cross-section the wax master with hollow grooves. After copper-plating this gives the copper master (raised ridges) shown at the right on top row. This copper master (at the left-hand of second row) gives a series of copper mothers which now have hollow

grooves. Each of these copper mothers (one of them is shown at the left-hand of third row) gives a series of copper stampers, these having raised ridges instead of grooves. Each stamper gives a large number of commercial records, these now having grooves corresponding to the grooves in the original wax master.

original record was the so-called *phonograph* record, which was in the form of a wax cylinder.

Owing, however, to the inconvenience of storing cylindrical records, this type soon gave place to the flat disc, which is obviously of much greater convenience so far as storage is concerned.

Cylindrical Types

In these days when portable gramophones are so much in favour, the advantage of the flat disc record is still further emphasised, since it would be most inconvenient to carry a number of cylindrical records with a portable phonograph.

The cylindrical records are, however, still used with certain types of dictating machines—why, I do not know. Probably it is because the machines, being much more costly than a gramophone, and lasting a long time, it becomes virtually impossible

to depart from the type of record that has become standardised.

The original record is, of course, first cut on a cylindrical master, just as the disc record is first cut on a wax disc master. This cylindrical master is then metallised and electrotyped in the usual way for the production of a copper "mother." The impressions are now on the *inside* of the cylindrical copper mother, and the copper master has to be destroyed in getting it away.

Subsequent copies of the "mother" are made by pouring in a wax composition which contracts on cooling, the contraction being sufficient to allow of the wax cylinder clearing the "copper-mother shell." Further copies may be made in a similar way.

Much Lighter

But to return to the flat, disc type of record which is in almost universal use to-day; this type of record has also undergone considerable changes and improvements from time to time.

In the first place, it is not many years ago that the actual *weight* and *thickness* were little regarded. Provided a record "played" reasonably well and was not too expensive to produce, no one worried very much whether it weighed 8 ozs. or 12 ozs., or whether six or twelve records could be piled to the inch.

Now a great change has taken place, and the day of the bulky and heavy record is definitely past. To-day a record must be *thin* and *light*, so that a fair number of records can be stored to the inch of space, and a reasonable number easily carried about with a portable gramophone.

It is not so long ago that I recollect pointing out to an ambitious inventor, who wanted to interest me in a record "cabinet" capable of holding sixty 12-in. records, that the average person would be unable to *lift* sixty 12-in. records, anyway! In those days a 12-in. record weighed anything up to 16 ozs.

To-day there are special records that weigh no more than 2 ozs., and that can be stored twenty-five to the inch!

Search For Strength

The advent of the thin and light record has led manufacturers of what I may, perhaps, call the "ordinary" type of records to look for methods of minimising the thickness (and, therefore, also the weight) of their records without unduly lessening the *strength* of the record, or its resistance to breakage.

It is evident that with a record made of the "rigid" material there is a great danger of rendering the record fragile if its thickness (in relation, of course, to its diameter) be made too small.

Various methods have, therefore, been devised for increasing the strength or toughness of the record, and in consequence the "ordinary" record is to-day very much thinner and lighter than it was five years ago.

Oscillograph records showing the wave form of different types of sound. That at the top is the wave form from a tuning fork, and will be seen to be practically a single tone almost without any overtones; the second one is from the violin, and shows a considerable number of overtones; whilst the third is the human voice, in which overtones are very abundant.

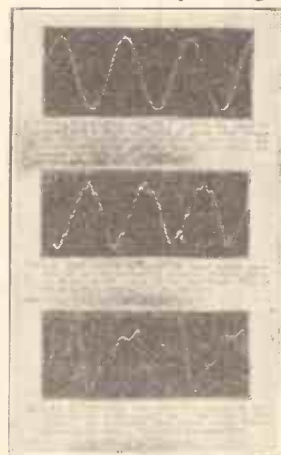

But there is obviously a limit to the reduction in thickness that can be made in a record of the rigid type, and consequently attention was turned towards the making of records from "flexible" materials.

The type of material that naturally occurs to one's mind in this connection is something of the "celluloid"

class—or, to be more accurate, of the "cellulose" type.

Perhaps I should remark here that the use of celluloid for records (both cylinder and disc records) is quite old, and I have read accounts of the making of such records by Edison so long as twenty years ago.

I have no actual experience of Edison's methods or his records (as I was a boy at school at that time), but I have had occasion to study his methods and specifications very carefully, and it is remarkable how closely he anticipated present-day practice in this as in so many other directions.

It appears to me that there were two main reasons why Edison's celluloid records did not "catch on."

Early Attempts

In the first place, there was not the requirement for the light records that there is to-day and the ordinary record material served the purpose quite well.

In the second place, "celluloid" was a somewhat crude and uncertain material in those days, as well as being very expensive. During the past few years there has been an enormous amount of scientific research devoted to the development of cellulose products (the most important of which is artificial silk), and to-day there is a range of cellulose preparations to choose from, almost any gradation of physical and chemical properties, within reason, being obtainable.

The position is thus very different from what it was when Edison, with his extraordinary vision, was struggling to commercialise the celluloid record, and it is not surprising that materials of the cellulose type should now be making great headway in this particular application.



Magnified cross-section of a commercial record showing what is known as the "V" shaped cut. Notice that the width of the cut is approximately equal to the distance separating one groove from the next.

The so-called "indestructible" records are mostly of the cellulose type, the materials employed being, of course, of the non-inflammable variety.

In making a "cellulose" record (I use the word "cellulose" rather than "celluloid," but neither of

them is really correct—I hope my chemical readers will not take me to task), it is clear that we have definitely abandoned the "rigid" feature of the record.

We have gone over to a material which is *flexible*, and therefore the record may be *bent without breaking*.

This is a very definite and very important departure from previously standard practice, and provided the record is non-inflammable, it is clearly entitled to be called "indestructible" in a general sense.

Very Thin Records

Moreover, the feature of flexibility means that there is, in a sense, no limit to the "thinness" of the record; in fact, the thinner the better! Of course, the record must be thick enough to take the impressions of the sound-grooves without perforation and—if a double-sided record—without the impressions on one side interfering with those on the other side.

As I said before, it has been found possible in practice to make records in this way that can be piled twenty-five to the inch, and that weigh less than 2 oz. apiece. This is obviously a most important achievement, and it is scarcely necessary to point out what it means to the user of a portable gramophone who wishes to take a selection of records with him to the country or seaside.

It is not less important to the manufacturer, who finds that the costs of packing and carriage (an important item with "ordinary" records) are materially reduced.

Cheaper to Make

Finally, there is the very important consideration of the actual cost of production of the "cellulose" record, and here again it is claimed that the "indestructible" record is at an advantage as compared with the ordinary rigid record. On this latter point, however, it is necessary to reserve judgment to some extent, as there have been all kinds of extravagant claims put forward lately in connection with new records which may or may not prove to be substantiated. The indestructible records are so new that it remains to be seen whether they will come up to expectations as regards price and quality.

As to the manufacture of this type of record, the usual process is quite a simple one (in principle) and consists in placing the discs of the record material between heated "stampers" for the requisite period, the record

material being thereby softened sufficiently to receive the impressions of the sound grooves, and subsequently hardening (or toughening) on cooling.

Another process, which economises "cellulose" material and thereby cheapens production, is to employ stiff paper "blanks," which are coated on both sides with the cellulose material (generally from the solution, but sometimes in the form of a thin adhesive sheet).



Magnified cross-section of commercial record showing the "U" cut. Some manufacturers prefer the "V" cut and some the "U" cut.

There are, of course, a multitude of variations and special tricks in connection with the different types of indestructible record, but in the present rather involved state of this comparatively new art, and also as I happen to be involved in it to some extent myself, it would perhaps be unwise to go into further details at present, for I should be giving away trade secrets!

Possibility of Illustrations

It is often stated as an advantage of this type of record that it can be folded up and sent through the post, but that is, to my mind, a very minor point and one that would not carry much weight if other requirements were in any way found to be lacking.

It has also been said that you can take one of these records and stamp on it or wipe your feet on it. As a form of amusement this may perhaps have something to recommend it, but it scarcely seems to be much of a real "talking point." The flexible record has such very definite and important advantages that it is, in my view, quite unnecessary to refer to its ability to withstand treatment such as this, to which (I hope) it is not, in the ordinary course of events, likely to be subjected.

The printing of pictures (such as a portrait of the artiste, or advertising matter) upon these cellulose records follows as a matter of course, and is extremely easily carried out without affecting the "playing" properties in any way. In the case of the coated paper records, the picture is printed upon the paper and shows through when impressed.

THE SENSATION OF THE SEASON

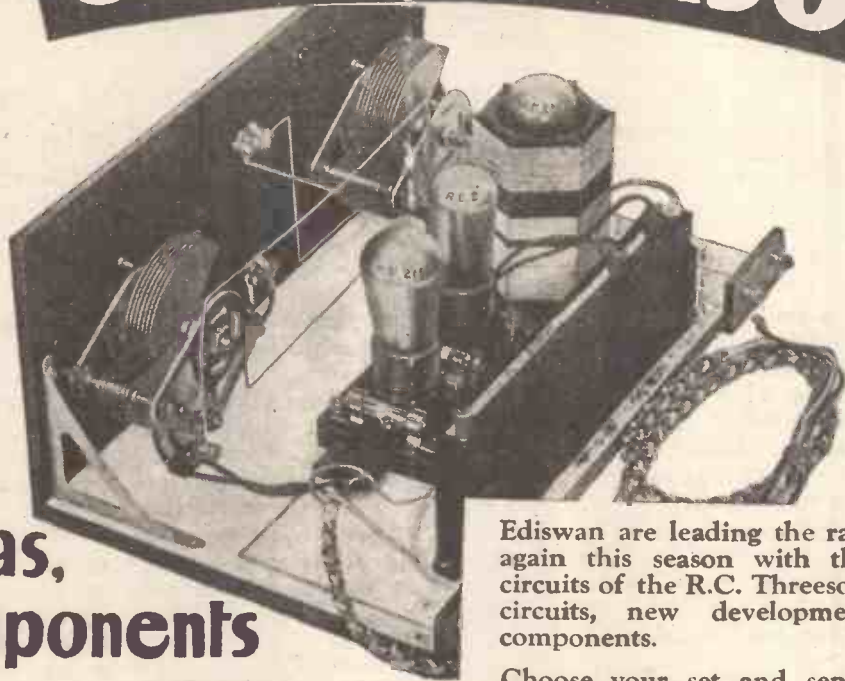

**New
Circuits,
New Ideas,
New Components**

Ediswan are leading the radio-world again this season with their 1929 circuits of the R.C. Threesome. New circuits, new developments, new components.

Choose your set and send coupon for FREE Full-size Paper Model and Instruction Book.

2 Standard 3-valve Circuits.

Circuit No. R/3 3-valve Resistance Capacity Coupling throughout, strongly recommended to those to whom purity of reproduction is of utmost importance.

Circuit No. R/3T 3-valve with Transformer Coupling in the last stage, for those who prefer this form of coupling.

Great selectivity—exceptional purity—no coil changing—easy and cheap to make.

These circuits are specially designed for the famous Ediswan Valves, H.F. 210, L.F. 210, R.C.2 and P.V.215.

COUPON		M.W. Oct.
To The EDISONSWAN ELECTRIC Co., Ltd. (Publicity Dept.), 123/5, Queen Victoria Street, London, E.C.4.		
Please send FREE Paper model and instruction Book as selected.		
Name.....	<input type="checkbox"/> R/3	<input type="checkbox"/>
Address.....	<input type="checkbox"/> R/3T	<input type="checkbox"/>
C.S./T.1. Please cross a 1st model required.		

EDISWAN

R.C. THREESOME 1929 CIRCUITS

Make a point of inspecting the R. C. Threesome and the range of new Ediswan Low Temperature Valves at Olympia, **Stand 43**, Main Hall.



The search for quality, both in radio and gramophone reproduction, without heavy upkeep expense in the way of batteries, is a fascinating business, and this article tells how good volume and pure reproduction on any type of speaker can be obtained with reasonable anode voltages.

By KEITH D. ROGERS.

“**W**HAT a rotten show on the wireless to-night! I wish we could get something different, without all those atmospheric and other noises. I suppose we shall have to shut down.”

How often remarks such as these are made from week to week in regard to broadcast programmes. Good as the B.B.C.'s efforts may be, they cannot possibly suit everybody's taste, for there is always someone ready to grumble and say that it is not worth listening to.

It is true that, except for elaborate receivers, there are very rarely more than two stations to which you can listen with any degree of pleasure. Certainly not more than two stations which you can rely upon getting without interference of some sort or other.

The local and Daventry (either 5 G B or 5 X X) are about the only alternatives the average man has, or will have, until the regional scheme gets going in full swing. Until then, therefore, he has got to listen to either his local station or the high-power station, or else close down, unless he has a set which is also capable of giving really good gramophone reproduction, and here is what I consider the main solution to the problem of poor programmes.

A Welcome Relief

Many a time have I switched off my wireless set and pulled out the switch to throw it over to pick-up “reception,” and have then turned to the gramophone to provide a musical programme for the rest of the evening.

One does not always want to listen to talks, nor does one always want promenade concerts or jazz; after

all, the ideal programme is one which suits your mood at the time, and it is unreasonable to expect the B.B.C. to provide a programme which would suit your every mood, exactly when you want it. The best alternative is to arrange your apparatus so that you can have your own programme how and when you like, but with the same quality of reception and reproduction as is provided by the best broadcasting.

Quite Simple!

The only way to do this is to have a set capable of reproducing broadcasting at its very best, or certainly to a quality which is in accordance with your taste, and then to provide a



A typical hornless type of loud speaker—the Celestion, with which excellent results can be obtained on both radio and gramophone reproduction.

gramophone pick-up arrangement to reproduce with the *same quality* the programmes from the gramophone.

As has been said many times before, you do not need a really elaborate gramophone. A reliable turntable

and motor is all that is required, and if the gramophone is to be in the same room as a loud speaker, then the instrument must be provided with a lid of some sort, in order to stop the pick-up from being heard and interfering with the music from the loud speaker.

“What,” you will say, “really constitutes a good set for gramophone reproduction?” This, of course, is not an easy matter to decide, for it depends upon the pocket of the constructor and upon the amount of volume which he wants to obtain.

How Much Volume?

For instance, if he wants to fill a big dance hall with either broadcast music or gramophone stuff, he must use a receiver similar to that shown in another portion of this supplement, under the title “A Radio-Gram Six.”

Alternatively, if he only wants small-room reproduction, he can use a detector and 2 L.F., which will give all he wants in the way of broadcasting and all he wants in the way of gramophone reproduction, when provided with a suitable loud speaker.

Now with the coming of push-pull amplification as a really practicable business, the trouble of providing sufficient H.T. for good volume is nowhere near as acute as it used to be, so the problem of providing distortionless reception and quite good volume is gradually becoming solved.

I think we can almost wash out the H.T. business altogether, providing we have an H.T. supply capable of giving 180 volts and up to 30 milliamps.

We will assume that you use anode-bend rectification, an advantage from the point of view of purity, making

New components to maintain Igranics' leadership

See them on
STANDS
53 - 54
and 75

at the National
Radio Exhibi-
tion, Olympia,
Sept. 22nd to
29th.

THE wonderful efficiency of these new Igranic components promises a new standard of performance for sets this year. They easily excel anything which has ever been produced in their particular line before.

Ask our representative at the Exhibition to show you how each will improve your set, and afterwards call at 28, West Kensington Gardens (adjoining Olympia), where the new Igranic receivers and other apparatus will be demonstrated throughout the Exhibition period.

Make certain of securing a copy of the new Igranic catalogue, List No. J.664. It contains full information on the complete Igranic range of components. If you cannot visit the Exhibition just post a card.

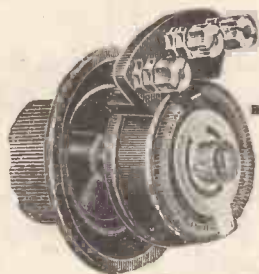

Igranic "Megostat."
A new variable high resistance with considerable advantages over the old types. 4 values.
Price 6/-

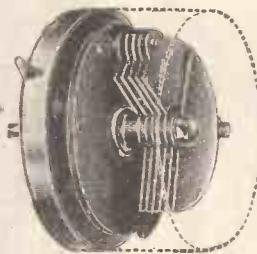

Igranic Screened Condenser. A specially designed reaction condenser that eliminates hand-capacity effects.
Price 9/6

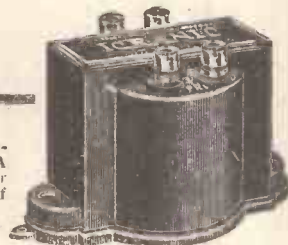

Igranic L.F. Transformer, Type "J." A new class of transformer of small size but of wonderful efficiency.
Price 17/6

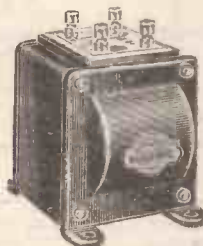

Igranic Dual Resistance-Capacity Coupling Unit. Two values of anode resistance can be obtained by operation of switch.
Price 17/6

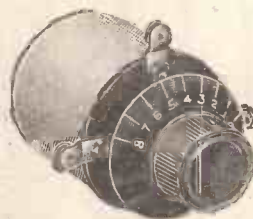

Igranic Wire-wound Variable Resistance. Gives 8 different values. For use as anode resistance, tapped series resistance or volume control.
Price
50,000 ohms 15/-
250,000 " 17/6

Igranic Dual Impedance Coupling Unit. An entirely new method of intervalve coupling giving a wonderfully straight curve.
Price 30/-



Whilst visiting Olympia make a point of **HEARING** Igranic receivers at 28, West Kensington Gardens (adjoining Olympia).



149, Queen Victoria Street,
LONDON, E.C.4

Works ———— **BEDFORD**

Branches:

MANCHESTER, BIRMINGHAM,
CARDIFF, NEWCASTLE, LEEDS,
BRISTOL, GLASGOW.

this valve the first L.F. when the gramophone is in operation.

The First Valve

This valve can quite suitably be one of 15,000 to 30,000 ohms with a magnification factor of 15-30.

In the next stage you must arrange for the valve to carry quite a big swing if you want a fairly good volume sufficient for dancing in a large room.

If you look at the circuit provided in this article, you will see that it consists, apart from an H.F. input for radio purposes, of a radio-gramophone switch going on to a valve which is resistance-coupled to the next stage.

In the second stage it will be noted

power valves would be quite suitable.

The whole object of using a big valve in this case is to enable a really big grid swing to be dealt with without distortion.

For really big work in a small way, so to speak, I prefer to use a valve of somewhere about 3,000 ohms here, with as high a magnification factor as you can get with that type of valve.

The P.625 has a magnification factor of 6—a remarkably good figure—and thus the valve has a fairly steep slope. It is, however, capable of dealing very well with large inputs, and with the choke feed does not saturate the transformer, and we get no trouble from that unfortunately frequent cause of distortion.

This brings it within the range of a big H.T. accumulator, or series of wet cells, or mains H.T. unit. It is not supposed that the man who can only provide the ordinary H.T. small battery should attempt anything on this scale.

Plenty of "Punch"

But the man who wants a little bit bigger volume can go in for something of the order I have suggested without having to go to the expense of building a specially large eliminator or obtaining massive banks of H.T. accumulators.

The man who wants to go a little bit farther and can supply a little

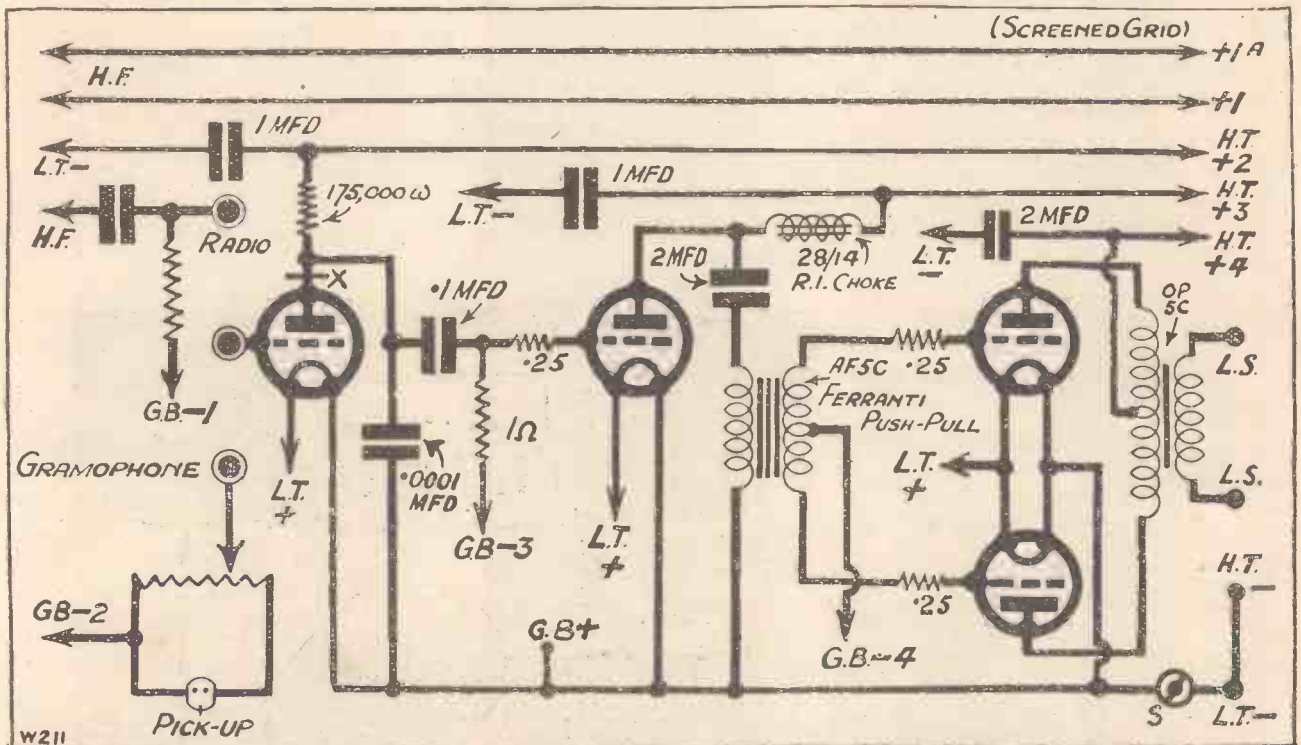

The circuit employed by the author for home use for gramophone reproduction and on the L.F. side of the "family" radio set. The valve impedances are, left to right, 30,000 ohms, 2,400 ohms, and two 1,750-ohm valves. An H.F. choke is placed at "X" for radio reception, though this is unnecessary for pick-up reproduction. It is possible, when Pentode valves are available in six-volt types, that two Pentodes will be used in the output stage, but experiments in this direction will be discussed later, as investigations proceed. Grid bias up to 30 volts is used at present, and 180 volts max. of H.T.

that choke feed is used, the L.F. impulses being fed via a 2-mfd. condenser through the primary of a push-pull transformer to earth. The reason for this choke feed is that then you can use a valve of quite large calibre and taking 10 or 12 milliamps if necessary without fear of saturating the transformer.

Thus in this stage I use a valve having an impedance of only 2,400 ohms. Incidentally this is one of the new P.625 valves issued by the Marconi and Osram people. Alternatively the P.M.6 Mullard, or appropriate Six-Sixty, the Ediswan, Cossor

The next stage will be seen to be push-pull and this obviates the need for any very great H.T. voltage, though it necessitates the use of two valves for the last stage when you might feel that you can do with one.

The Last Stage

In this stage I used valves of 1,700 ohms each, and these are provided with an anode voltage of 180 volts, and are biased a little bit below the middle points of their curves, so that the total milliamperage of the set does not exceed 30 milliamps or so.

more H.T. and L.T., can use the L.S.5A in the last stage, or the D.F.A.7, and he will find a marked increase in power, though perhaps not so much in actual volume. But it is not to the man who has limitless H.T. and a strong financial position that this article is addressed; he will find all he requires in the set described on another page.

Situated in the north of London, the set discussed in this article will give without distortion such volume as to be almost unbearable in a room, using only a screened-grid input before the detector stage shown.

EVERYTHING

The
G. E. C.
your guarantee

ELECTRICAL

DON'T TROUBLE TO MAKE YOUR OWN SET

When you can buy this famous GECOPHONE for less

- No diagrams*
- No wiring*
- No soldering*
- No home construction*
- No disappointment*

WITH the introduction of the "GECOPHONE" "VICTOR 3" home construction becomes an expensive hobby. You can now buy this remarkable 3-valve receiver for less than you can build a set of the same calibre, with certainty of the most satisfying results. It will receive a variety of stations at powerful loud-speaker strength.

The "VICTOR 3" is the most startling offer ever made to the wireless public.



PRICE
Complete with
Osram
Valves
£6.17.6
INCLUDING
ROYALTY



GECOPHONE
REGISTERED TRADE MARK
VICTOR 3

MADE IN ENGLAND. Sold by all Wireless Dealers.

WRITE for Folder No. B.C.4762 for full particulars of the "VICTOR 3," and Brochure B.C.4766 for information regarding all the new season's "GECOPHONE" Radio Receivers and Gramophone Reproducers, Loud Speakers, etc., SENT POST FREE on request.

NATIONAL RADIO EXHIBITION: GECOPHONE STANDS Nos. 28, 29, 46, 47 & 225.



"RADIOGRAM" SIX

A super-set specially built for powerful radio or gramophone reproduction.

By G. V. COLLE.

WHEN one has become tired of hearing dozens of stations battered by Morse and drowned by whistles emitted by neighbouring receivers, it is a foregone conclusion that one will either give up radio altogether or else devote one's energies to receiving the local station and just those few distant ones which give something like a real alternative programme. For this is a cycle of events which most of us go through at some period or other, and brings us at last to one fundamental objective, namely, that of obtaining true reproduction of the small number of real programmes available.

Why it was Built

Many problems, too numerous to name here, make contribution to the question of quality, in addition to those relating to the L.F. amplifier, which will determine the amplification at different frequencies, the

particular combination of anode resistance, grid condenser, and grid leak being the deciding factors, used with valves of the correct impedances. Transformers are ruled out, so far as the writer is concerned, owing to their inability to reproduce very low frequencies at their correct intensity.

The rather large set shown in the accompanying photograph and reproduced in a modified theoretical diagram is the outcome of much thought and research. It is the personal property of the writer, and it is intended to serve the following purposes: (1) To receive on high or low wave-lengths without changing coils, but by the movement of a switch; (2) to give a choice of no less than a dozen programmes without the use of reaction, on a moving-coil loud speaker; (3) work from a gramophone pick-up and give sufficient volume to fill a large hall for public demonstration purposes; (4) H.T. to be derived

from the mains, the eliminator not to be of any special type, the set being provided with H.F. stopping devices, etc., to prevent "motor-boating," so that any suitable mains unit may be employed. It will therefore be seen the set has been designed to meet nearly all contingencies which may arise when used under "foreign" conditions.

Everything in the set has been designed to give quality of reproduction, as readers will gather from a few interesting details regarding the construction and circuit arrangement.

Completely Screened

The back of panel, baseboard, top, sides, and back consist of $\frac{1}{2}$ -in. thick copper sheet, the metal weighing 23 lb. in itself, including the screening partitions. All sheets are held to a $\frac{3}{8}$ -in. brass angle framework by cheesehead brass screws. It is possible in consequence to remove any section of the copper in two or three minutes. This section of the work took the writer eight weeks, working about five hours a day. When it is mentioned he can construct an average four-valve set in about eight hours, some idea of the work involved may be gauged from these figures.

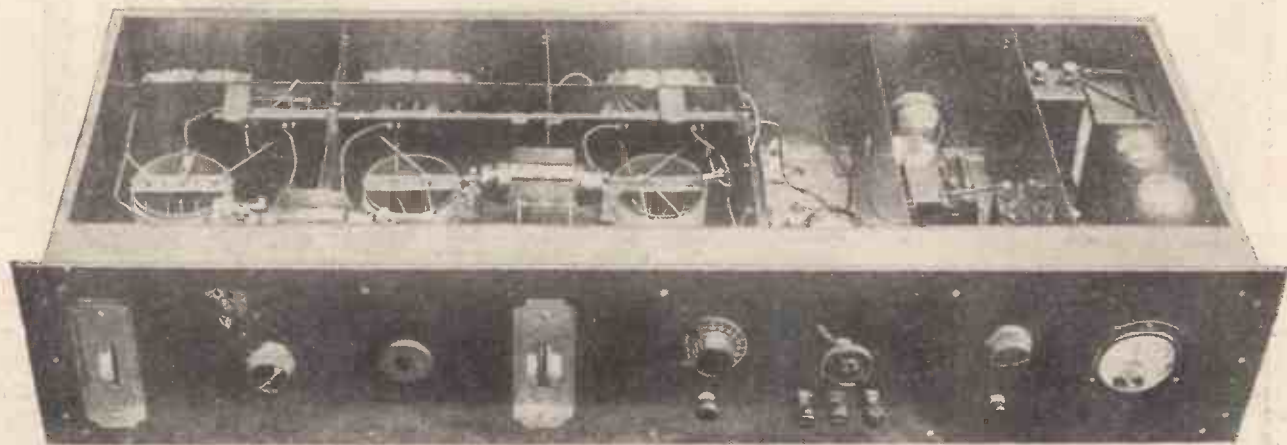

The stages are screened throughout the receiver so that interaction between them cannot take place. Gang control of the second H.F. and detector tuning is carried out, the aerial being separately tuned.

Leadership!

Radio's first Loudspeaker —still the finest

The moving coil type of loud-speaker was created by Magnavox in 1911. It is the only type of speaker that has stood through every period of speaker development. Supreme in the beginning—supreme to-day. Protected and controlled by Magnavox exclusive patents. There are nearly half-a-million Magnavox Dynamic Speakers now in use.

Realism—

You can hear the bowing of the strings of the double bass and the beats of the drum in their true tone-colour with a MAGNAVOX MOVING COIL LOUD-SPEAKER UNIT.

There are no jarring resonances, no "s" sounds missing, and the violin does not sound like a flute.

The unit is complete with input transformer, leads and field switch, ready for connecting right away to receiver or gramophone amplifier.

Models for A.C. or D.C.

TYPE D.80/1.	For operation from A.C. lighting mains, 100/120 volt, 50/60 cycle, A.C.	£11 11 0
TYPE D.80/2.	For operation from A.C. lighting mains, 200/240 volt, 50/60 cycle, A.C.	£11 11 0
TYPE R.5.	For operation from D.C. lighting mains, 100/240 volt D.C.	£10 10 0
TYPE R.4.	For operation from 6-volt accumulator or Trickle Charger. Consumption $\frac{1}{2}$ amp.	£9 10 0
TYPE M.7K.	Balanced armature unit	£3 2 6
New Belvedere	Fire Screen Baffle	£4 0 0

"THE GREAT VOICE"

"The Great Voice" is a 32-page booklet, profusely illustrated and written entirely in your interests with a view to enabling you to obtain those better results for which you have persistently longed. This booklet tells you all about moving-coil speakers, baffles, power amplifiers for A.C. or D.C. volume controls and gramophone pick-ups. Send for your copy to-day. Price 6d., post free.

THE
ROTHERMEL CORPORATION, LTD.,
24-26, Maddox Street, London, W.1.

Phone: Mayfair 0578-9, 4286.

Telegrams: "Rothermel, Wesdo, London."



MAGNAVOX

BOWYER-LOWE ANNOUNCE A RANGE OF EPOCH MAKING SETS AND NEW QUALITY COMPONENTS

"LOG MAJOR."

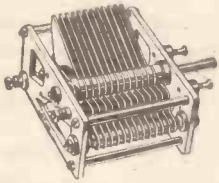

A new full size logarithmic condenser with cast steel spindle $\frac{1}{2}$ " diameter on cone type ball bearings. One piece, pig-tail.

List No.	Mfd.	Length Behind Panel.	
330.	.00025	2 9/16"	12/-
331.	.0003	2 1/2"	12/6
332.	.00035	3"	13/-
333.	.0005	3 1/8"	13/6

End Plate, $3\frac{1}{2} \times 1\frac{1}{8}$ ".

"LOG MINOR."

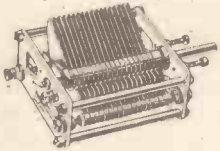

A miniature of the "Log Major" with spindle $\frac{3}{16}$ " diameter.

List No.	Mfd.	Length Behind Panel.	
334.	.0003	2 1/4"	7/6
335.	.004	3 7/16"	8/6
336.	.005	4"	9/6

Supplied with ebonite dielectric for portable sets.

List No.	Mfd.	Length Behind Panel.	
338.	.0005	1 1/8"	11/-

Made in any size for set makers.

ELFIN CONDENSER.

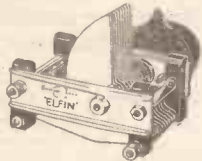

The smallest logarithmic condenser made. A precision instrument especially suited for sets where space is at a premium.

List No.	Mfd.		
311.	.0001	..	5/9
312.	.00015	..	6/-
313.	.0002	..	6/3
314.	.00025	..	6/6

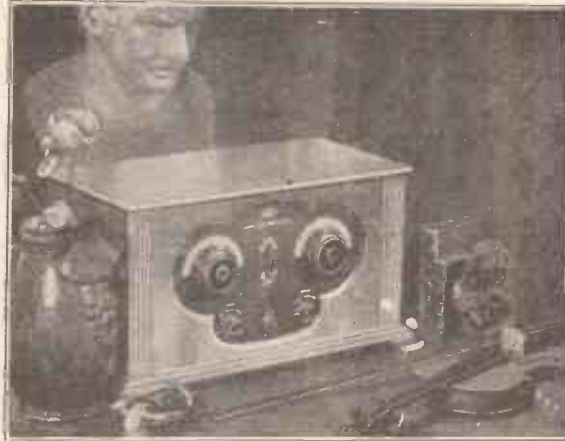

THE SCREENED VOX POPULI THREE.

"The Set of the Year." This Screened Three marks the biggest advance in set design and construction since the industry began. The quality of its reproduction is amazing and its selectivity is no less wonderful, utilising a screened grid H.F. valve and a 5 electrode Pentode for the amplifying stage.

List No. 339. Set in dark polished oak, beautifully finished, complete with grid bias and three special valves tested and matched to set. £19/-/- Marconi Royalty. 37/6

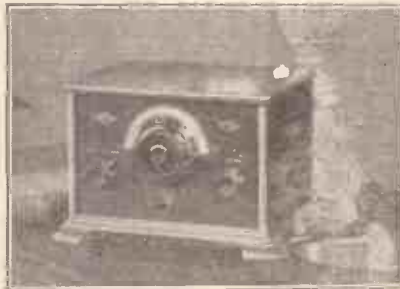

THE PENTOVOX TWO. A Two Station L.S. Set.

The Pentovox will be one of the most popular sets of the coming season. It is a two valve receiver using the new Pentode valve and, despite its luxury equipment and outstanding performance, is one of the cheapest

sets on the market—no coil changings, easy and simple control by slow motion dial.

List No. 329. Set £4/5/- in dark polished oak. Two Special Valves. £1/15/6 Marconi Royalty. 25/-

Bowyer-Lowe are introducing a Screened Vox Populi Four, a new Short Wave Receiver and a Cone Loud Speaker. Full descriptive details can be had on request.

LONG RANGE H.F. CHOKE.

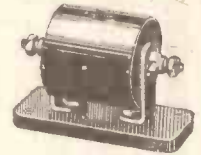

Operates over whole wave length range from 7 1/2 to 4,000 metres without flat spots. Set capacity of the order of 5 or 6 uuf. List No. 337. 7/-

"WHITELINE" VALVE HOLDER.

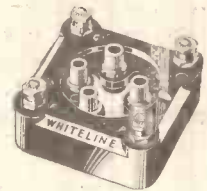

An instrument "mechanically and electrically perfect." Large initial amplitude to shock, but quick and smooth damping.

List No. 282. 1/9

VARIABLE RESISTOR.



For baseboard mounting in two ranges, 0-5 ohms and 0-30 ohms. Resistance wire is wound on non-shrinking former with bakelite base.

List No. 289. 0-5 ohms. 3/-
List No. 290. 0-30 ohms. 3/-



SETS • COMPONENTS • LOUD SPEAKERS
BOWYER-LOWE CO., LTD., ICKNIELD WAY, LETCHWORTH.

ROUND THE TURNTABLE



*A page of odds and ends
radio or gramo-*

*of interest and value to all
phone enthusiasts.*

THE speed of a record determines its brightness and its pitch, and also the accuracy of the playing, so that it is important to get the speed absolutely right.

When adjusting your pick-up's sensitivity, be careful to see that the adjustment does not alter the bearing of the needle upon the record. Some pick-ups have an adjustment which when loosened enables the needle to come apart from the bottom of the pick-up and bear unevenly upon the record, an important feature from the point of view of the life of the record.



Wear

Often when a record seems to be run too much for pick-up reproduction, use with an ordinary sound-box will enable a great deal more life to be got out of it. The little wear which becomes apparent when the pick-up is used may be unnoticed when the sound-box is employed.

The use of a magnifying-glass is a very valuable guide to the quality of a pick-up with regard to its wear of a record. When choosing a pick-up, if possible see that pick-up in action on the record, and have a look through a glass to see what sort of wear and damage it is causing to the record. This is almost as valuable a test of a pick-up as hearing the reproduction provided by that instrument.



Grid Bias

The actual wear on the sides of the grooves can often be seen through a magnifying glass, even if the latter is of the cheap variety and not very powerful. With a powerful one every little bit of damage can be viewed, and it is interesting as well as instructive to watch a pick-up in action on a record, and to see the pieces of record being scraped off by the needle.

Don't forget that grid bias is a most important feature of pick-up reproduction. A pick-up which merely

goes to the filament of the first L.F. valve very often will cause distortion. It is usually necessary to have one and a half to three or even four and a half volts grid bias on that valve, according

THE R.I.-VARLEY PICK-UP

THIS component has been devised after many months of intensive research into a troublesome problem. The well-known excessive damping, necessary in many pick-ups in order to prevent distortion, due to resonance of the various moving parts in the pick-up itself, which causes such excessive wear of the gramophone record, has been overcome in an ingenious manner.

A special method of suspension of the moving parts which are kept extremely light has been adopted. The mass factor is divided into two parts, one which adequately deals with the high frequencies, and one with the lower-audible frequencies.

Excellent Results Obtained

Each mass component is damped in a special way, each independent of the other, with the resonance of the one kept well below, and the resonance of the other kept well above, the audible frequency band.

From this it will be appreciated that one mass component will have a response curve rising at the low frequencies, whilst the other mass component will be rising in the very high frequencies.

Now, as the gramophone record usually has a flat peak characteristic in the middle frequencies, it will be observed that the whole combination should give substantially a straight-line frequency response.

On test excellent results were obtained, and the pick-up is extremely light on records and can be recommended to the attention of our readers. The price is £3 3s. 0d.

to the type of valve and the H.T. used.

The use of an R.C. valve in the first stage of a pick-up amplifier sometimes means disaster, because some pick-ups give such a great output that the grid of the valve is slightly overloaded right at the very beginning. This overloading distortion is amplified in the remaining stages until it becomes really serious in the loud speaker.



Tone

The writer prefers an H.F. valve in the pick-up stage, in order to obviate this trouble.

If permanent needles such as the tungstyle variety are used it should not be taken for granted that they will play the thirty items or so which they are claimed to be able to do without any damage.

It is best to examine each needle after the first five, to see that it has not become bent or in any way distorted.

Very often twenty to thirty records can be played perfectly with these needles, but occasionally it has been known for a needle to buckle up and become useless after two or three times. Therefore, frequently examine them to see that they are not becoming badly worn or distorted in any way.



Volume

The use of the ordinary steel needle for more than one side of a record is to be deprecated, especially where pick-up reproduction is concerned.

One of the greatest advantages of pick-up reproduction in gramophone music is the fact that the volume can be controlled to a very fine degree. Therefore use a really reliable volume-control. A cheap volume-control with unreliable contacts or of bad design will only cause trouble and upset the reproduction being obtained.

STOP!

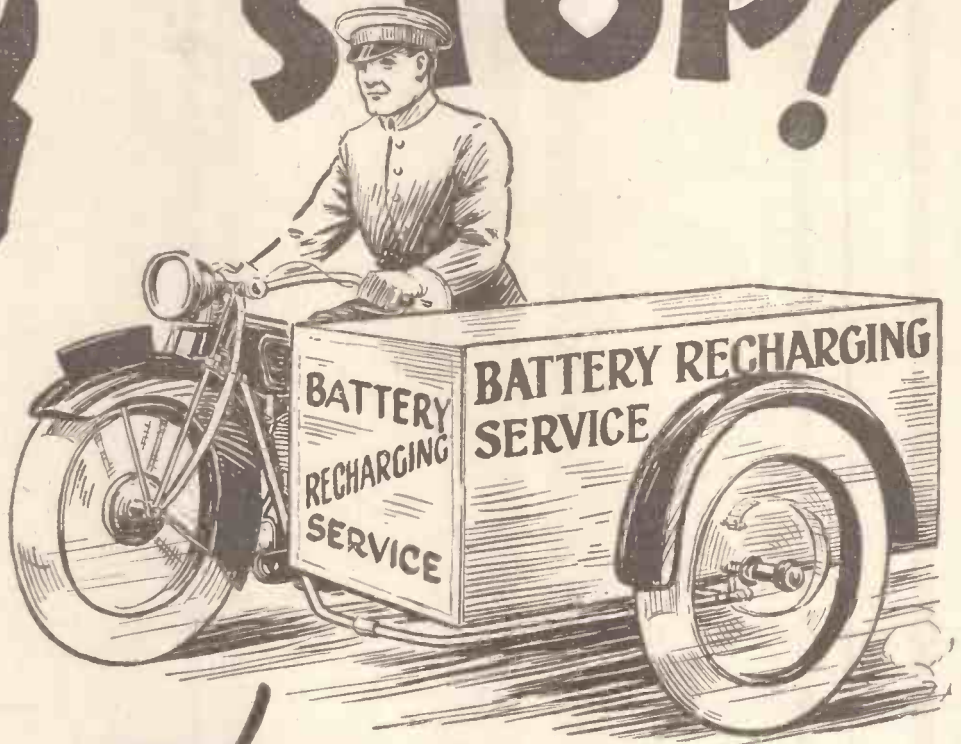

Stop all the expense and constant trouble from batteries, which at their best are short-lived, and install one of

"CLARKE'S ATLAS"

BATTERY ELIMINATORS

Which from the "flick of the switch" provide regular and silent power. Each model which carries the "Atlas" guarantee is priced to meet the pocket of the man of modest means as well as those to whom price is not so important.

All the information you want is contained in Brochure No. 32 (fully illustrated)—a copy sent you free on request.

See them at STAND No.

161

NATIONAL RADIO EXHIBITION, OLYMPIA



Model D.C.10 for Direct Current, suitable for 200/250-volt D.C. Mains. Maximum output 20 m/a. Price £3 15 0



Model A.C.56 for Alternating Current. Incorporating Westinghouse Patent Metal Rectifier. Gives all the H.T. required for a one or seven-valve. Suitable for 200/250-volt A.C. Mains, 30/120 Cycles. Price £8 15 0.



Model D.C.18 for Direct Current, suitable for 200/250-volt D.C. Mains. Specially designed, moderately priced pattern. Guaranteed to work any 3-valve and most 4-valve sets. Price £1 17 6.

H. CLARKE & CO. (M/CR.) LTD.,
ATLAS WORKS, OLD TRAFFORD, MANCHESTER

RECENT RECORD RELEASES



British Brunswick

Faust Fantasy and **Pearl Fishers**. Violin Solos by Mishel Piastro. (10262. 10 in. Blue Label.)

A record worth adding to the collection. The violin comes out perfectly clearly and with excellent timbre.

Thy Little Hand, Love (Don Giovanni), and **Smiles and Tears** (The Magic Flute). Duet in Italian by Rosa Raisa (Contralto) and Giacomo Rimini (Baritone). (Hall of Fame series. 10 in. 15135.)

Those two items are two of the best Hall of Fame series that we have heard. Excellent reproduction of both voices and orchestra is possible by means of a good pick-up.

Another class of song, but equally excellent in its way, is **Wherever You Are** and **My Angel**. Sung by Franklyn Baur (Tenor). The latter is the better of the two, if it is possible to differentiate between them. (3823. 10 in.)

Among the dance records released this month must be mentioned three splendid recordings from the popular musical comedy "Good News." Frank Black and his Orchestra play two of these—**The Varsity Drag** and **The Best Things in Life are Free**; both fox-trots (3810. 10 in.); and we prefer these to the rendering of **Just Imagine** (also "Good News"), by Fred Elizalde and his music. The other side of the record is a splendid rendition of **Wherever You Are**, from the "Girl Friend." (189. 10 in.)

The orchestrations in every case are of the straight variety.

Broadcast

First of all we come to the Broadcast "Twelve," that wonder record which is still rapidly gaining in favour, though we must confess

that the selection sent to us this month does not seem so suitable for pick-up reproduction as have past numbers. Three chief ones contain **E. Lucevan le Stelle** ("Tosca") and **Celeste Aida** ("Aida"), by Cantor G. Sirota (Tenor) (5017B), with orchestral accompaniment.

These are well sung and well accompanied, but the whole performance as in the two following "Concert Hall" records is too much in the background. All three records require "bringing forward" as it were. The other two are **Oberon** (Overture, Pts. I and II), by the Band of H.M. Life Guards (5020), and **Gems from Carmen**, in two parts (5018), with soloists, full chorus, and orchestra. The solo items of the ordinary 1s. 3d. Broadcast records are much better, that of Ridgway West (Tenor) singing **For You Alone** and Purcell's **Passing By** (288) being a beautifully full and well-balanced record.

The boy soloists, Kenneth Purves and James Dugan, with the Eton College Choir, in **I Waited for the Lord**, and the former singing **How Lovely Are Thy Dwellings** (280), form two good items, though the low notes of the first-named boy require strengthening, being outbalanced by the top register.

The Broadcast dance items are all good, though we wish Ciro's Band would use some drums occasionally instead of relying on the sousaphone and cymbals with a banjo to assist in the maintenance of the rhythm. It sounds very thin at times.

Teddy Brown's xylophone solos, **Under the Double Eagle** and **Soldiers' Chorus** (Faust) (290), with military band accompaniment, are disappointing. He would do better to record dance music.

Parlophone

Of the Parlophone releases, **It Don't Do Nothing But Rain** (F.T.) and **Don't Do That to the Poor Puss Cat** (F.T.) (R160), by the Roof Garden Orchestra, is the best of the dance records. The latter item is a real novelty record and is excellently played and "staged."

What Do We Care? and **Limehouse Rose** (R128) are two of Noble Sissle's items and are more attractive than some of his later efforts. He is in these, as in others, a little too exaggerated at times, becoming merely irritating instead of entertaining.

Finally, **Singapore Sorrows** (F.T.) and **Firefly** (F.T.), by the Roof Garden Orchestra (R159), form two good dance numbers.

The latter item is, in our opinion, the better, being very crisply rendered and perfectly recorded.

Pathé Records

Pathé Actuelle and **Pathé Perfect** are keeping up to their recent high standard of recording, and especially is this noticeable in the two 12-in. records recently issued by Pathé Actuelle. These comprise four excerpts from "William Tell." **Dawn, The Storm, The Calm**, and the famous **Finale**. (15261 and 15262).

They have the advantage over many "series" records in that each side is a complete musical item, the whole four being well recorded with fullness and realism through practically the whole of the musical scale, from the tympani to the highest wail of the violins.

Pathé Perfect (1s. 6d.) are still keeping their flag flying. Four dance numbers deserve mention. **Mother Machree** (W.), **Little Mother** (W.) (P394), by the Lennox Dance Orchestra, and **Jack in the Box** (F.T.) and **Rag Doll** (Novelty F.T.), by the Perfect Dance Orchestra (P400).

British Zonophone

Sir Harry Lauder has been engaged by the Zonophone Co., and his first songs include the famous **Roamin' in the Gloamin'** and **Flower of the Heather**, on G.O.80, a new series of red label records at 4s. 6d. (10 in.)

Salut d'Amour and **Simple Aveu**, Grand Organ Solos by Spencer Shaw, A.R.C.O. (5162), also deserve mention, being well recorded except in one or two places where peculiar resonance effects made themselves felt in the record which we heard.

Ave Maria (Gounod) and **Ora Pro Nobis**, by Esther Coleman (Contralto), are excellent items (5125).

Look for at **LOTUS** **OLYMPIA!**

NEWS at the Lotus Stand!

Two new components—two new sets being introduced by Lotus!

There is a new Variable Condenser and Vernier Dial, both typical Lotus quality. The condenser is mid-line and logarithmic. It is made with chemically-cleaned special brass vanes and end plates, with ample spacing and ball bearings.

The Lotus Vernier Dial is a slow-motion dial with machine-gear movement giving a ratio of 14 to 1. A closely-marked satin aluminium dial, reading 0-180, fitted to rear, fits flat against panel and a nickel-plated cursor is rotated by small knob round the dial.

The famous Lotus Remote Controls, Buoyancy Valve Holders, Coil Holders, Jacks, Switches and Plugs are also on view.

PRICES:

New Lotus Variable Condenser:

·0005	5/9
·0003	5/6
·00025	5/3
·00015	5/-

New Lotus Vernier Dial

Dial . . . 4/9

The New **LOTUS** Portable and Transportable Sets

The new Lotus sets are the latest wireless triumph. Using the new Mullard Screened and Pentone valves, the circuit is a combination of latest wireless discoveries and actually makes these three-valve sets capable of five-valve results. Transportable models in oak, 30 gns.; in walnut and mahogany, 31 gns. Portable models in real hide case, 30 gns. Installation terms. Write for booklet.

COME TO STAND No. 115

LOTUS COMPONENTS

GARNETT, WHITELEY & CO., LIMITED,
LOTUS WORKS, BROADGREEN ROAD - LIVERPOOL.

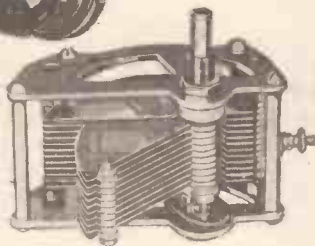

Remote Control Relay.



Lotus Valve Holder.



Lotus Coil Holder.

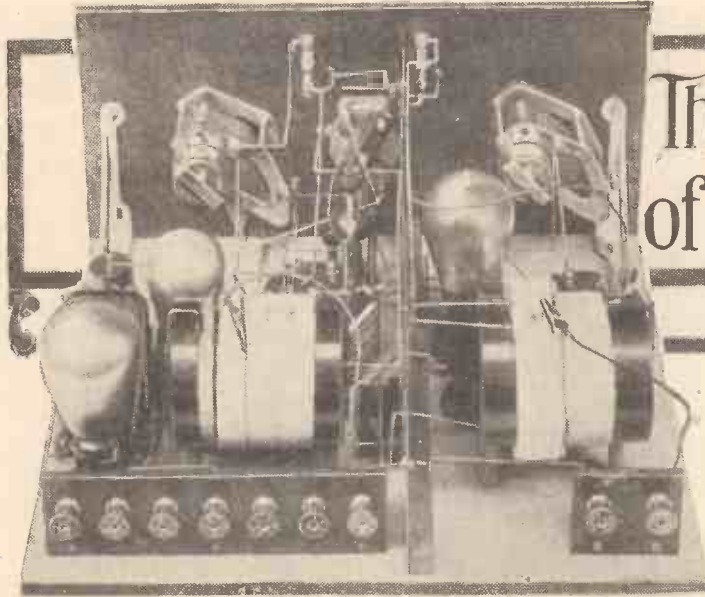

The ACTION of REACTION

An article dealing with that interesting property of a radio valve which enables us to listen to stations situated thousands of miles away.

By P. R. BIRD.

WHATEVER kind of valve set it is that you yourself use, the probability is that one of the controls on it is marked "increase," or "strengthen," or "reaction." This is the most fascinating control upon the receiver. By its means a very weak and far-off voice can be strengthened up into a shout, whilst careless handling of this part of the set will give rise to all sorts of weird and objectionable squeals and whistles, audible in your own set and in those of your neighbours.

By judicious reaction we can improve reception enormously, whilst its injudicious use will give rise to continuous trouble. Nowadays most listeners have a fairly good idea of how a valve operates, but the action of reaction is so interesting that it is well worth separate study.

Small Input But Large Output

If we take a tuning coil and variable condenser, as represented in the diagram by L_1 and C_1 respectively, and connect an aerial and earth lead to them as shown, the effect of any broadcasting picked up by the aerial is to give rise to voltage variations across this tuned circuit. If the earthed end of the tuned circuit is connected to the filament of the valve and the other end to its grid (in this case through a fixed condenser) these voltage variations will enable the valve to function as an amplifier. If a grid leak is connected between the grid and the filament as shown, the valve will simultaneously act as a detector of the wireless impulses.

When properly connected to its batteries, the valve can reproduce in its output circuit an enlarged replica of the broadcast energy fed into it by the aerial. On the input side, if no reaction is employed, all its energy must be derived from the distant broadcast station. The valve's output is enormously greater. This additional energy is derived from the batteries connected to the valve.

Where the Power Comes From

The absolutely astonishing sensitivity of the arrangement can only be appreciated if we remember and continually bear in mind that the initial power which works a broadcast receiver is picked up by the aerial and is derived solely and directly from the broadcasting station we are listening to. If the station were only a dozen or so miles away the thing would be sufficiently interesting. If, however, you have picked up European broadcasting stations

which are hundreds of miles away, on a one-valve set, you will realise that any energy which found its way direct down your lead-in from Milan, or Frankfurt, or wherever the distant station may have been, must necessarily have been exceedingly small in amount and exceedingly well-treated upon reception to have enabled you to hear that distant voice speaking!

Picking Up America On One Valve

Finally, if you have had the luck to be able to pick up American broadcasting on one valve, the mere fact that you got such a thrill when you heard the announcement will have proved to you that there was some stupendous sensitivity in an arrangement that could be operated in your house by the voice of a man speaking on the other side of the Atlantic.

Supposing the New York station was the one you heard speaking, three thousand miles away. If you draw a three-thousand-mile circle round New York and then try to imagine in that stupendous area the small space occupied by your own aerial over here in Britain, you can get some faint idea of what a tiny proportion of the total power used must have been received by your own particular aerial.

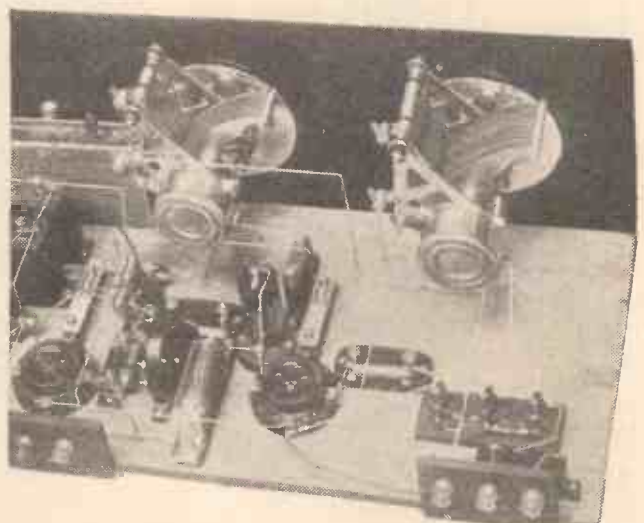

A typical receiver in which the degree of reaction is controlled by a variable condenser, in series with the reaction coil.

INTRODUCING FIVE NEW SPEAKERS

FROM 29/6 UPWARDS

M.P.A.

INCOMPARABLE AT THE PRICE

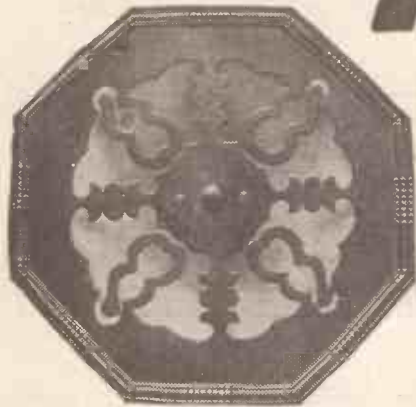

THE POPULAR PLAQUE

This is the cone speaker which has caused an upheaval in the wireless world. Never before has anything like its value been offered. And . . . it has recently been fitted with a new and improved centre adjusting movement. Such volume, such delicacy, such clarity of reproduction you would only expect from a model costing five times as much. Hear it! See it! Both its performance and appearance will make you desire it. It sells at an amazing price, in either dark mahogany or oak.

PRICE . . . 29/6

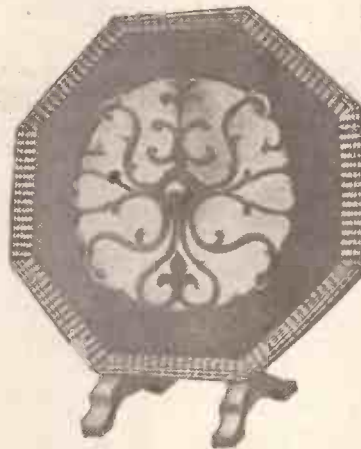

THE DE LUXE MODEL

Two inches larger than the Popular Model, the de Luxe Plaque has a "matched impedance" fret, is fitted with the new patented M.P.A. logarithmic cone, and has a wood base. Finished in either dark mahogany or oak, it not only gives astonishingly excellent results, but is unobtrusively handsome in appearance and will harmonise with any decorative scheme.

PRICE . . . 47/6



MOVING COIL SPEAKERS

You could search the World over without finding better reproduction than that of the famous M.P.A. Moving Coil Speakers, at whatever price you were prepared to pay. The result of years of painstaking research, they bear striking testimony to the skill of M.P.A. Wireless engineers. Here, indeed, is "Hearing that is almost seeing!" Exquisitely clear! Wonderfully lifelike! All models in beautifully polished mahogany, either mains driven or for use with accumulator, or accumulator combined with trickle charger. Costs 1d. a week or less to operate.

PRICES - 10 TO 15 GUINEAS

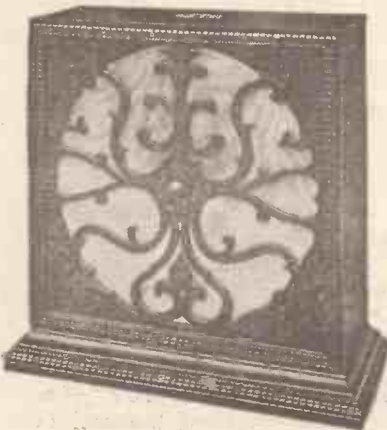

MAHOGANY TABLE CABINET SPEAKER

Another amazing example of M.P.A. quality and value! This Model is fitted with a centre adjusting movement and the renowned M.P.A. Patented Logarithmic Cone. It covers an exceptionally wide range of frequencies and in performance is in every way up to the high standard set by this House. The Cabinet is in handsomely polished mahogany with "matched impedance" fret attractively designed both sides.

PRICE . . . 5 GUINEAS



SEE ME
AT THE
RADIO
EXHIBITION
STANDS
21 & 22

HEAR THEM AT OUR
DEMONSTRATION
ROOM OPPOSITE
ADDISON ROAD
(OLYMPIA) STATION
OR ASK YOUR
LOCAL DEALER TO
DEMONSTRATE

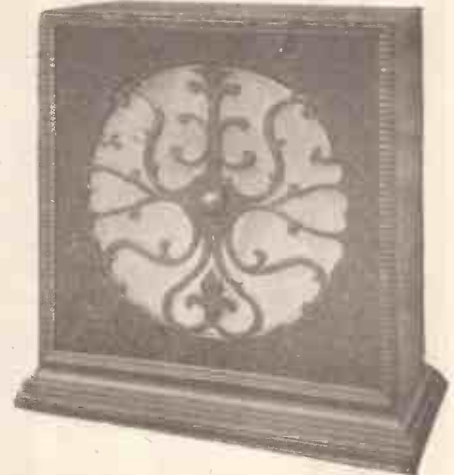

DUAL INDUCTANCE SELF-ENERGISING MOVING COIL SPEAKER

A Model which is miles ahead of anything of its kind. It places moving coil reproduction within the reach of all. Catches the most elusive cadencies of the human voice or instrument, and is startlingly lifelike. Fitted with a vastly improved type of movement exclusive to M.P.A. Speakers, no energising is required from either main or accumulator. The Cabinet is in beautifully polished mahogany fretted both sides. In every way an instrument of which anyone would be proud.

PRICE . . . 7 GUINEAS

★ M.P.A. WIRELESS LTD., 62, CONDUIT ST., LONDON, W.1. TEL. GERRARD 0844 ★

In such a case, the distance between transmitter and receiver is so great that, remembering the limited power it is possible to use in a broadcast station (even in America!) it seems incredible that any one-valve or two-valve set could be worked in this country by such an infinitesimal speck of energy. Nor could it have been without reaction!

The human ear is a very delicate piece of workmanship, and good telephones are extremely sensitive, but wonderful as these are in their different ways, they could never deal with and demonstrate the infinitely small amount of energy that can be picked up by your English aerial from a broadcasting station in America. The truth is that in such a case the energy required to make American sounds audible in Britain is practically all drawn from the batteries attached to the set here.

Small though it may be, it is very large compared with that tiny spark of energy which, crossing the Atlantic, and tickling up your aerial, sets in motion the whole series of events which results in your hearing America speak.

Action of the Aerial

Consider what that original energy, after crossing the Atlantic, has to do. It has to set up strains and stresses in your aerial sufficient to cause a tiny H.F. current to flow. That tiny current in turn has to energise a tuned circuit.

We cannot imagine that transatlantic traveller having sufficient strength to operate a pair of telephones. What, then, does it actually do? Actually it has to overcome several small barriers which tend to impede it (its flow across soldered joints, and the grid condenser, for instance), and finally it must charge up that tiny condenser which consists, on the one side, of the filament of the valve, and on the other of its grid. If the incoming energy has just sufficient "life" left to do this, just sufficient strength to start a series of operations, it will suffice.

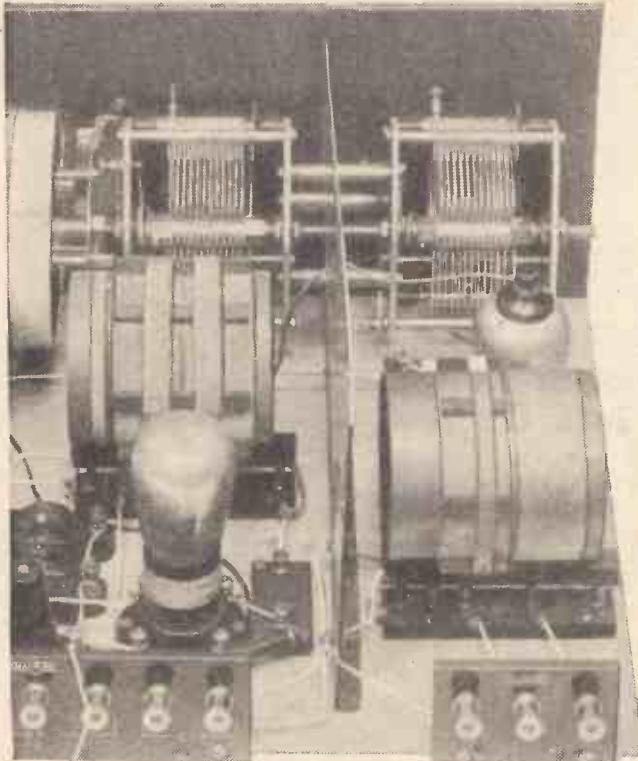

The H.F. end of the "Constant" Three, a receiver (described in last month's "Modern Wireless") in which the necessity for frequent readjustment of reaction has been overcome by special circuit design.

For perfectly controlled by the grid and filament of the valve is its plate circuit, wherein there is not only energy sufficient to work a pair of telephones, but such a superabundance of energy, so nimble, so well-harnessed, so completely amenable, that it can actually assist the

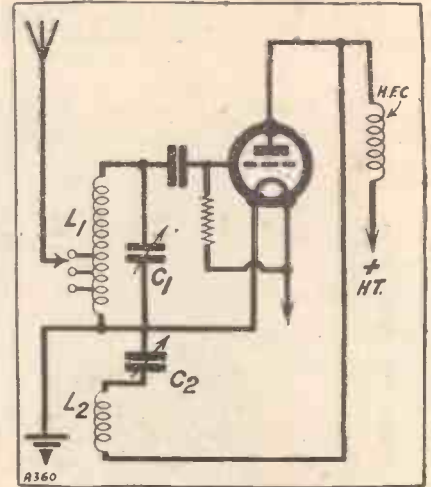

This diagram shows the main connections of a typical one-valve set, in which the reaction is controlled by a variable condenser, (C₂) Simple though it is, such an arrangement has frequently, here in Britain, picked up American broadcasting

incoming energy to "turn on the tap," so to speak, and thus assist to release itself!

Looking again at the diagram, we can visualise the incoming energy as flowing down the aerial on to one of the taps on the aerial coil, then through that portion of the aerial coil, to earth. Small though the energy is, it is sufficient to "kick off" the grid circuit, if this is properly tuned, and to thus set a minute oscillatory current flowing across C₁ and L₁. This energy is applied direct to the filament of the valve, and through the grid condenser to the grid.

At the bidding of a very few distance-impelled electrons on the grid, millions of local-battery-impelled electrons will land upon the plate. So speedy, so sure, and so accurate is their flow, that they can reinforce the incoming signals.

The Magnetic Interlinkage

The method of feeding these electrons back to the grid circuit (even by the so-called "condenser-controlled" or Reinartz reaction system) is a magnetic one. In the circuit shown in the diagram, for instance, we can imagine a crowd of electrons leaving the filament, and with permission of the grid passing through its meshes on to the plate, and then flowing on through the H.F. choke, through the telephones or other device, to the H.T. battery, and via H.T. negative to the filament again. But there is an alternative path. After passing the grid, part of the current will travel via the coil L₂ and the reaction condenser C₂. The chief obstacle to the "flow" of this current is the condenser C₂, and by varying its capacity we can vary the number of electrons, choosing this alternative path. As this controlled flow passes round the turns of the coil L₂ it sets up a magnetic field across the space between this and L₁ and thus gives the requisite magnetic interlinkage between the plate and the grid circuits.

The marvel is not that we can effect such a control, but that a magnetic interlinkage can bring so swift and so sure a reaction. The wonder lies not only in the energy that can leap the Atlantic and set a valve in operation; for after that tired traveller has landed himself upon the grid, an equally remarkable series of events starts in the local receiving set. And here, most of the credit for these wonderful feats is due to the action of reaction.

Four of the Factors in the Success
of this year's Radio Exhibition
4 of the new
DUBILIER COMPONENTS



DUBILIER FILTER UNITS
Made in four types 28/6.
47/6, 72/6, 142/6

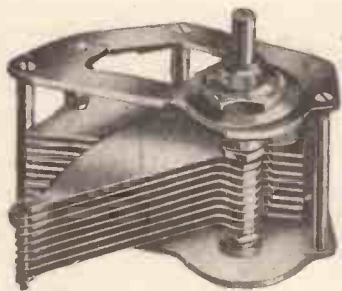

DUBILIER
K.C. CONDENSER
Without Knob, Dial or Slow-
motion device 8/-.
.0003 or .0005,

See them and
the other new
Dubilier
Products

at

STANDS
102/103



DUBILIER
CONDENSERS



DUBILIER
MIDGET CONDENSER
Made in two capacities
.0001 or .0002,
complete with Knob 5/6.



DUBILIER H.F. CHOKE
Finely moulded case protects
windings and gives it
a neat appearance. 4/6.

Dubilier built is better built

Advt. of Dubilier Condenser Co. (1925), Ltd., Ducon Works, Victoria Road, North Acton, W.3.

©177

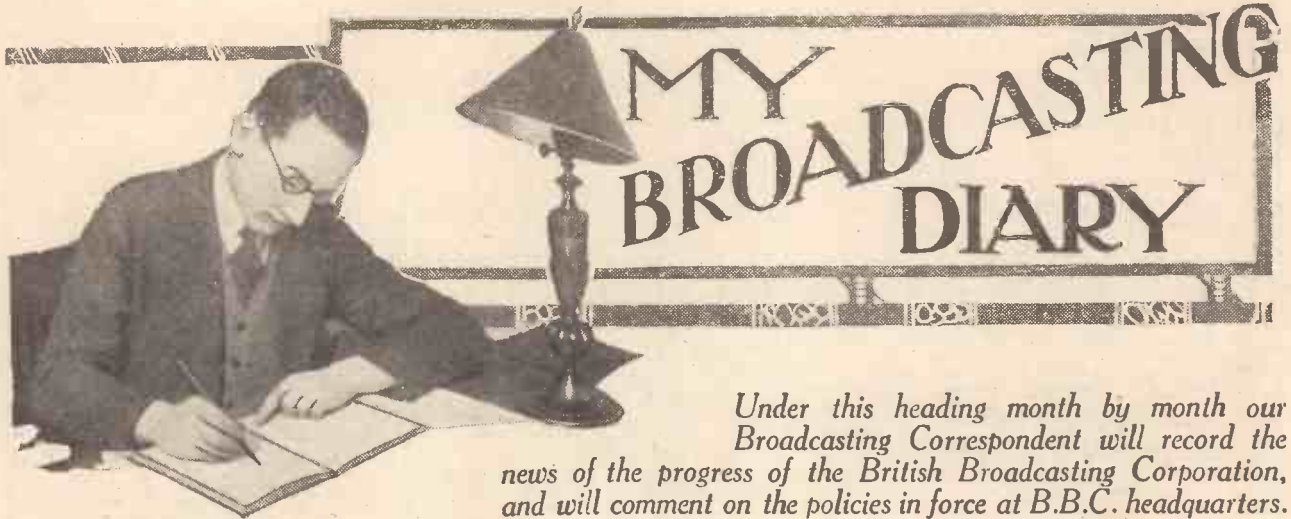

Under this heading month by month our Broadcasting Correspondent will record the news of the progress of the British Broadcasting Corporation, and will comment on the policies in force at B.B.C. headquarters.

Much Ado About Little

I AM bound to say that, in my opinion at any rate, the B.B.C. has made altogether too much heavy weather about the single wave-length working being applied to ten relay stations. It looks as if Savoy Hill either over-estimates the vogue of the relay station or is at a loss for publicity material. A real census of listening habits would amaze those who believe in the relays. I doubt whether five per cent of the total take their programmes in this way.

The crystal set is gradually being superseded now that the revision of royalties brings valve sets within the reach of the possessor of only slender means. Would it have imposed very much hardship on 95 per cent of listeners if instead of tinkering with relays the B.B.C. had closed down the lot? And think of the money that would have been made available for the improvement of the main programmes. It would seem that the decision was more "political" than "technical."

Progress with Regional Scheme

There has been no hitch so far at Brookman's Park. Work on the Pennines' transmitter begins this month. The Scottish and West Country stations will be put in hand in the spring. Thus with London opening in August, 1929, Pennines in December, 1929, and the other two before the middle of 1930, we shall really have a taste of regional twin-wave work by Christmas, 1930. Of course, the fifth is Belfast, but that is likely to be of one wave only, so that Newcastle may be kept on the map with the other wave.

New Blood at Savoy Hill

Among recent newcomers at Savoy Hill, the outstanding success is undoubtedly Mr. C. Graves, nephew of Viscount Grey of Fallodon. Mr. Graves was a soldier by profession, being Captain in the Royal Scots. He was taken prisoner in the first days of the war and had a particularly bad time "in durance vile." He is now "Programme Executive" of the B.B.C. This means that he is responsible for the detailed organisation of the whole of programmes under Mr. R. H. Eckersley, Captain Eckersley's brother. Mr. Graves is an exceedingly capable and ambitious official, and is expected to go far in the broadcasting business.

Picture Transmissions

The Fultograph transmissions from 5 XX, which are due to start in October, are attracting greater notice and

interest in advance than was expected at Savoy Hill. It looks as if the B.B.C. may have to fulfil its engagement to include picture transmissions in the regular programmes. But whose process or system should be favoured? Here is a thorny problem the solution of which I do not propose to tackle. I should think that it is up to the B.B.C. to give every reasonable process a fair chance, and then try to devise a transmission that would suit the majority of them. This would, at least, obviate the undesirable outcome of creating another monopoly, this time in pictures. Meanwhile, television is as far away as ever.

Future Programme Policy

There are signs that the B.B.C. is at work on programme plans under the regional scheme. The creation



The Berlin Conservatory of Music has recently installed radio sending and receiving apparatus to familiarise players with the presence of the microphone and to develop "radio touch." The microphone is suspended in the ring behind the harpists.

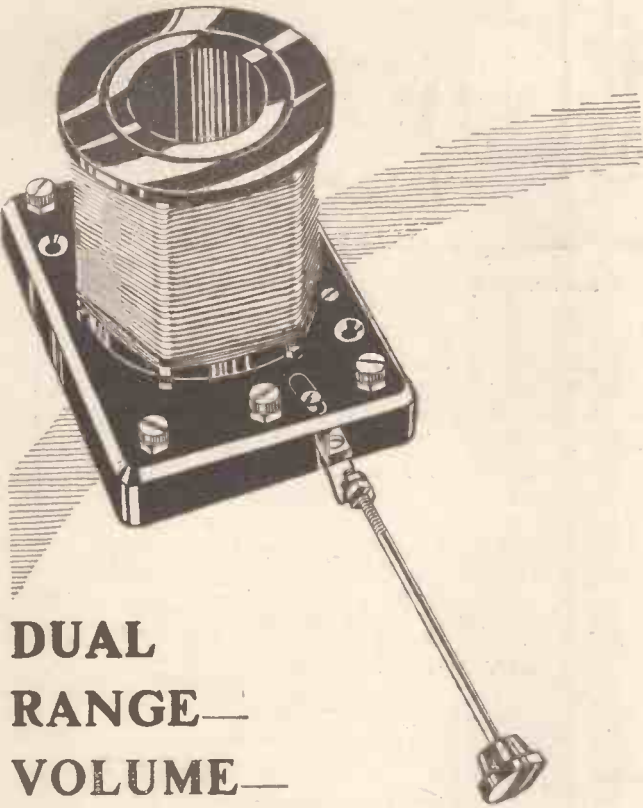

**DUAL
RANGE—
VOLUME—
SELECTIVITY—
CONTROL.**

**Radio Exhibition
OLYMPIA, 1928**

**VISIT
STAND No. 91**

to examine the new Colvern
Dual-Range Coil.

**COLVERN
ACCURATE SPACE WOUND
COILS**

Colvern Ltd., Mawney's Road,
Romford

**GREAT
REDUCTION IN
PRICES
of
BELLING-LEE
TERMINALS**

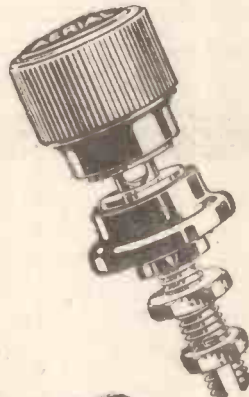

Last year, when Belling-Lee patented terminals enjoyed a popularity reached by no other terminals, we were obliged to extend our Factory premises in order to meet the overwhelming demand.

The result is that we have now increased our output by fifty per cent.

Increased efficiency and output, and the sacrificing of profit to turnover have enabled us to effect the following substantial reductions in price:—

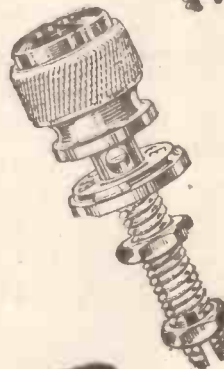

Type "B". Standard large insulated model (Polished black bakelite).
6d. each (formerly 9d.).

Type "M". Popular model, as type "B" but not insulated.
4½d. each (formerly 6d.).

Type "R". Low priced competitive model with rotating name.
3d. each (formerly 3½d.).



Send to-day for our new Season's illustrated Catalogue.

**STANDS 220 and 221
AT OLYMPIA**

**BELLING-LEE
TERMINALS**

Belling & Lee, Ltd., Queensway Works, Ponders End, Middlesex

of "Regions" in Scotland and the North of England is a step towards the new organisation.

Presumably another Region will be established in the West Country, including Wales. There is one point I would impress on Savoy Hill at this stage. This is that listeners are ready for much more sweeping measures of concentration effort than was the case even a year ago. Local broadcasts are so manifestly inferior to national transmissions that sentiment can no longer hold the fort. I believe the B.B.C. would be well advised to do all its programme work in London and reduce its main stations to relays, demobilising all provincial programme staff and all except a skeleton engineering staff. It will be interesting to see just what measure of concentration is adopted ultimately.

The King and Broadcasting

I wonder if the B.B.C. has thought about inviting the King to open Broadcasting House, when it is ready

JOAK's JIU-JITSU



"Outside" broadcasts are a feature of the Japanese programmes, and this photograph shows in the foreground the announcer broadcasting preliminary details of a wrestling match from JOAK (Tokyo).

in two years' time. This is obviously the right thing to arrange. His Majesty's well-known keenness as a listener indicates a favourable decision. *Verb. sap.*

Central Education Council

The tortuous ways of broadcast education organisation are not easy to follow; but it seems that the permanent Central Council recommended by the Hadow Report "New Ventures" is dangerously near appointment.

The council is to consist of representatives of no less

than 24 educational and social bodies, including the Tutors' Association, the Rural Community Councils, the Library Association, the Y.M.C.A., the Y.W.C.A., Workers' Educational Association, etc., etc. This formidable body of specialists in education is to be set up to plan and supervise the education transmissions of the B.B.C. and to recommend what money should be spent thereon. There are to be no less than fourteen area councils, all generously staffed and equipped; truly a gigantic organisation. But it is not on this account that listeners will be alarmed. The real danger, of course, is that such a body as this should get its stranglehold on programme time. The ten shillings licence fee is paid for amusement with a little admixing of serious instruction; it is not paid for the entire and permanent ossification of nearly half the available hours of programmes. Here is a danger which Parliament will do well to watch. The Board of Education is quite able to look after its own job without spoiling the broadcast service. It looks as if the B.B.C. has bitten off more than it can chew. It was pretty obvious early on that they were exploiting the educationists with tongues in cheeks. But the "victims" have proved nearly too wily for Savoy Hill.

Why Not Cochran ?

After André Charlot, then Albert de Courville. Where is Cochran? The time is surely ripe for the B.B.C. to invite Mr. C. B. Cochran to arrange and put on a series of super-broadcasts. There are rumours in the air which I fondly hope are true.

The Surprise Items

I imagine the introduction of the weekly "surprise" item on Friday evenings was an attempt to meet the criticisms of programme rigidity, and lack of peaks. Anyway, the new features have "made good" in every sense. They are a great tribute to the inventive faculty and executive capacity of Mr. R. E. Jeffrey, the Dramatic Producer at Savoy Hill. My only criticism is that he is trying to do too much. These should be once a quarter, not once a week. Unless they become less frequent they will inevitably sink to the level of the routine programmes.

The "Free Discussions"

This new form of semi-serious broadcast entertainment is well conceived and executed. As long as the people concerned are evenly matched, all will be well. But wait for the fun when the discussions are one-sided, and the popular cause is worsted in the argument as broadcast. Not that this will be a bad thing. The B.B.C. would do better to make more mistakes or "bloomers." Things at Savoy Hill tend to run with irritating smoothness for most of the time. If the discussions maintain their standard no one will regret the failure of the politicians to agree upon a scheme for party broadcasting.

Unemployed Broadcasters

The fate of the considerable company of B.B.C. officials who will be displaced by the regional scheme is not enviable. I hear that they will be treated as generously as possible by the B.B.C., but this cannot mean more than a few months' extra salary on termination. Broadcasting does not qualify people for other jobs, and, in the absence of competition, there is no alternative employment. It speaks well for the loyalty of the old B.B.C. staff that not one of them made a move to disturb the monopoly at the change-over to corporation, although their own interests were being sacrificed.

VIBROOLDER

Vibrolder is a better name for a better valve-holder. The new Benjamin Vibrolder will fit every type of British four-pin valve. It ensures perfect results as the point of contact between valve leg and valve socket is self-aligning. It is truly anti-microphonic in character, protecting the delicate filament from every trace of shock and vibration.

1/6

See the Vibrolder, the improved Benjamin battery switch and the whole range of Benjamin components on

**STAND 171
at OLYMPIA**

Due to its great popularity the original Benjamin anti-microphonic valve-holder is retained.

Price 2/-

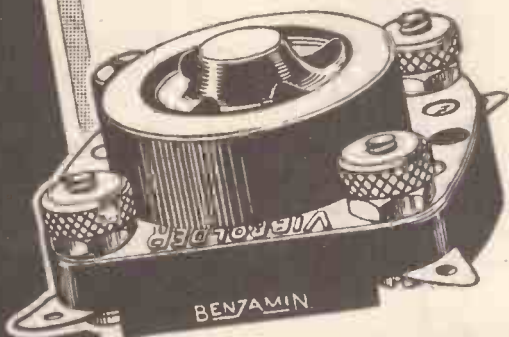

1,500,000
BENJAMIN
VALVE HOLDERS
have already
been sold.

BENJAMIN

**ELECTRIC
LIMITED**

Brantwood Works
TOTTENHAM, N.17



A new 'Blue Spot' speaker embodying the special 66K driving unit

The well-known Blue Spot supremacy of reproduction is here embodied in a speaker of exceptionally handsome design—Blue Spot one-o-one. Its appearance, no less than its interpretation, makes this speaker a notable addition to any set—the rim and cone shield faced throughout in Trolite; the pedestal shapely in form and solidly built.

The reproduction has the true-to-tone quality characteristic of all Blue Spot speakers. You have only to hear it and compare it to understand why even the most critical music lover finds its performance satisfying.

The new 4-pole unit embodied in the speaker—the secret of its delicate interpretation—is fitted with a special screw giving micrometer adjustment. Ask your dealer to demonstrate Blue Spot 101—**£3.13.6.** it is now showing everywhere at

For the benefit of constructors wishing to build their own cone speaker at home, the new 66K 4-pole balanced armature unit is sold with working instructions for building both free edge and floating edge cone. Price complete with two padded washers, 25/-.

The original non-adjusting unit. 66A is now available at the special reduced price, 21/6.

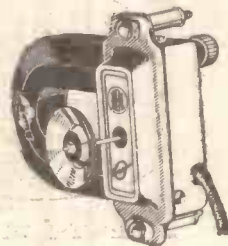

The **BLUE
SPOT**

101

CONE SPEAKER

F. A. HUGHES & Co., Limited
204-6, Great Portland Street, W.1.

MANCHESTER, 185, Princess Street.

Distributors for Northern England, Scotland and North Wales:
H. C. Rawson (Sheffield & London) Ltd., 100, London Road,
Sheffield; 185, Princess Street, Manchester.

"Ideal Blue Spot Cone Speakers are sold under full protection of the patents owned by Standard Telephones & Cables and the Hopkins & Lektrophone Corporations."

RADIO NOTES AND NEWS OF THE MONTH

A feature in which our Contributor brings to your notice some of the more interesting and important Radio news items.

Conducted by "G.B."

The Patent Decision

PROBABLY one of the most important wireless events in August was the announcement that the Special Committee of the Patent Office had approved an application by the Brownie Wireless Company for a compulsory licence in connection with the Marconi patents, with a reduction on the royalties paid on valve holders in wireless sets. A compulsory licence has been granted to the Brownie Company, and the royalties have been reduced from 12s. 6d. per valve holder in a one-valve set to 5s., and from 25s. in a two-valve set to 7s. 6d., and so on.

"Prejudicial To Trade"

The Tribunal, among other things, stated that: "We have found that it is in the public interest that a licence should be granted to the applicants,

and we have found that the terms on which the licence is offered are unreasonable terms prejudicial to their trade."

Cheaper Radio

A leading member of the wireless trade stated that the judgment was a win for the Radio Manufacturers' Association, and the whole trade sooner or later must be modified by the judgment, unless, of course, the Marconi Company are successful in appealing, as it is understood they intend to do. But if the Tribunal's judgment is upheld, its effect will inevitably be to cheapen production and to accelerate increased sales.

The Regional Scheme

The delay in getting on with the Regional Scheme stations seems to be entirely due to the Postmaster-

General's fear that under the new scheme many listeners will not be able to separate twin-wave transmissions of equal strength owing to the crudity of their receiving apparatus.

But it has been pointed out, and justifiably, that the majority of listeners in this country should not suffer because of the crudity of the receiving sets owned by the minority, and it is to be hoped that the Postmaster-General's fears will now be dissipated and that the B.B.C. will receive full sanction to proceed with the erection of the remainder of the stations.

Sir Thomas Beecham

As was pointed out in our contemporary, "Popular Wireless," a few weeks ago, Sir Thomas Beecham, the famous conductor, has been in negotiation with the B.B.C., and it is now definitely stated that Sir Thomas will conduct the first Symphony Concert given by the B.B.C. this season. It is quite likely in the future Sir Thomas will come to a regular and definite understanding with the B.B.C., as have Sir Henry Wood, Sir Landon Ronald, Sir Hamilton Harty, and other famous musicians.

(Continued on page 420.)

MAGNUM WIRE-WOUND R.C. UNIT



with self-contained Vibro Valveholder.

Price 17/6

MAGNASCREENS



As used in several "Modern Wireless" sets. Made in two sizes:

10 x 6 ins.	2/6
7 x 6 ins.	1/9

MAGNUM UNIVERSAL RECEIVER MAGNUM VOLUME CONTROL

15-2,000 metres.



The results obtainable with this receiver are truly astounding, and our confidence in its performance is such that a demonstration will be given in your own home within a 50-mile radius of London without obligation.

Prices £15 Valves and Royalty extra. Make a special note to inspect this and Magnum products at Stand No. 96, Olympia Radio Exhibition. We specialize in "Olympic 3," and all apparatus described in this issue. Send 1½d. stamp for new season's catalogue and lists.



as used in several modern receivers. Made in two values, 500,000 ohms and 2 meg. Price 7/6.

MAGNUM L.F. CHOKE



Specially designed for Power Output. A centre tap enables it to be employed for Push-Pull amplification. Inductance 20/40 henries. Price 21/-.

BURNE-JONES & CO. LTD.,
MAGNUM HOUSE
TELEPHONE: HOP 6257-8
288, BOROUGH HIGH ST.
LONDON, S.E.1

LISENIN POSITIVE GRIP TERMINALS

PATENTED

"I have now given your Positive Grip Terminals a fair trial and am more than satisfied with the result. I am discarding all other makes I have now in use in favour of yours, and have ordered a supply of them from my dealers. The fact of spreading the multiple wires over the cone makes a most secure and safe joint, giving absolutely perfect contact, besides making a nice finish to any set and a really attractive appearance."

Selkirk.

T. W.

From the sectional illustration it will readily be noted that the flex covering is splayed over the cone and gripped by the sleeve, overcoming unsightly frayed-out, ragged ends to leads.

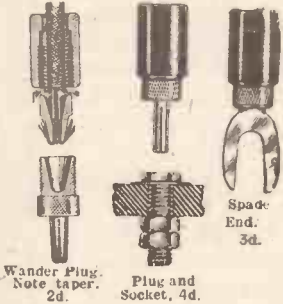

REDUCED PRICES.

LOOK FOR THIS OAK SHOW CASE ON YOUR DEALER'S COUNTER.

In certain districts it has been found that reception is not good, and in others facilities for good aeriels are lacking. THE LISENIN IMPROVED TAPPED MELODY MAKER COIL has been designed to overcome these troubles. It has two extra stages of reaction, and is fitted with a Positive Grip Plug and Sockets, which facilitates the change of reaction.

Price 7/6 each.

Obtainable of all Radio Dealers, or direct. Write for copy of our No. X1 leaflet, free.

The Lisenin Wireless Co., 1M, Edgware Rd., London, W.2.

A NEW CRESCENT

Something you have been wanting for a long time.

Price

7/3

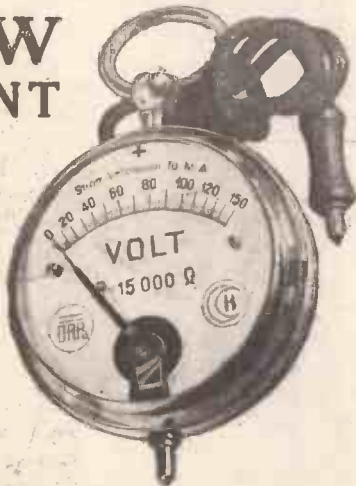

This new Crescent meter consumes no more than 10 m/a on full scale, and yet it is sold at the reasonable price of 7/3.

A very useful scale of readings: 0-150 volts

Obtainable from your dealer or

LOUIS HOLZMAN
34, KINGSWAY, LONDON, W.C.2.

During the Exhibition we should be glad to see you at our showrooms at above address.

THIS VALUABLE BOOK FREE!

Why Radio is better with Battery Power



Post Coupon To-day

The recently published Columbia brochure, "Why Radio is better with Battery Power," which is being given away to all readers of this journal, is packed full of useful information and is invaluable to every Radio man.

Don't miss this unique opportunity, but fill in the coupon now.

"Why Radio is better with Battery Power" solves all H.T. difficulties. Columbia experts have given you the benefit of their many years' experience in this book. Don't fail to obtain it.

Columbia RADIO BATTERIES

To J. R. MORRIS, 15, Kingsway, London, W.C.2.

Please send me a copy of "Why Radio is better with Battery Power."

Name.....

Address.....

M.W.

RADIO NOTES AND NEWS OF THE MONTH
—continued from page 418

Multi-Wave Relays

Before the end of the year it is likely we shall have had some interesting relays of American broadcasting concerts. It is likely that the short-wave transmissions from America will be picked up in this country on five different receivers.

The transmissions will also be made on five different wave-lengths from five different stations. At Keston, the five receivers, each tuned to one of the five transmitting wave-lengths, will be able to make up for any losses in fading, etc., which might occur on one specific wave-length.

The united production of the reception by the five receivers will then be fed into amplifiers, passed on to Savoy Hill, and then re-broadcast to British listeners. Technically, this method is considered the best way to avoid the fading of signals, which have marred many long-distance relay broadcasts.

New London Station

Work is now proceeding quite fast at the Potter's Bar site of the new B.B.C.'s high-power twin-wave station. Really, of course, this station is at Brookman's Park, which is about two miles south of Hatfield, and any of our readers motoring that way

According to the professor, he uses ultra-short waves, three metres and less, and he believes that also his discoveries will be of invaluable service to medicine.

Ultra-Short Waves

He has succeeded, he says, with a fraction of a watt, using ordinary valves, without aerials, in covering distances of nearly sixteen miles, and with higher energy he has covered two hundred and fifty miles. The professor also says he has succeeded in telephoning by use of these short waves.

The transmitter is stated to be no larger than a cigar-box, and he has constructed a receiver which solves with amazing simplicity the problem of detecting ultra-short waves. We hope a specimen of this set comes over to this country. It would certainly be interesting to investigate it.

"P.P.E." and Television

We notice that our contemporary, "Television," recently expressed annoyance and surprise that Captain Eckersley should have dared to give his views on television. In fact, our contemporary almost suggested that Captain Eckersley didn't know much about television at all!

(Continued on page 422.)

Do YOU Want
**GOOD RESULTS
AT LOW COST?**

IF SO,
POPULAR WIRELESS

will tell you how to get them.

Every Thursday. Price 3d.

to London will find it on the left-hand side of the main road. A large board has been put up announcing the name of the station.

Waistcoat Pocket Sets

Wireless in a waistcoat pocket is the latest news from Berlin. This claim has been made by a professor of Jena University, as the result of experiments he has carried out during the last twelve months.

Keystone

**COMPONENTS
ENSURE SUCCESS**

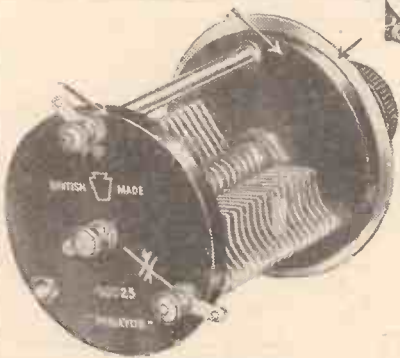

KEYSTONE MINATOR CONDENSER.

Ideal for all work where a precision condenser of medium capacity is required. Its extremely small dimensions ensure the very minimum of panel space being used, whilst a stout aluminium shield entirely eliminates all stray hand capacity effects. Invaluable for H.F. coupling, controlling reaction, etc. Capacity .00025 mfd.
Price 8/6

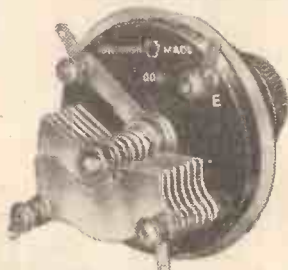

KEYSTONE MIDGET REACTION CONDENSER as used in the "OLYMPIC THREE" described in this issue.

Easily the most popular small capacity condenser on the market. Used extensively by all the leading contributors to radio journals. This condenser is fitted with an aluminium shield to prevent hand capacity effects. Rigidly constructed from the best quality materials.
Price . .0001 mfd. 5/-.
Price . .00095 mfd. 4/6

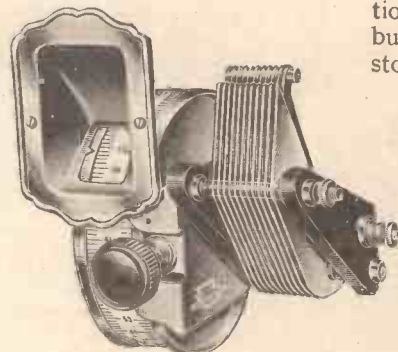

KEYSTONE DRUM DRIVE

Designed to fit all standard condensers, which can be mounted either on the left or the right of the drive. A delightfully slow motion drive gives a reduction of 9 to 1. Accurate tuning with a minimum of trouble is ensured. Drilling template supplied.
Price 9/-



KEYSTONE "HIGH-LOW" H.F. CHOKE.

The unique form of winding in this choke renders it especially suitable for all circuits. It has a negligible self-capacity and a very high inductance. Suitable for all wave-lengths from 20-2,000 metres.
Price 3/6

WRITE for List No. 24 which contains full details of the complete range of KEYSTONE Components.

PETO-SCOTT CO. LTD.
77, CITY ROAD, LONDON, E.C.1. and at
62, HIGH HOLBORN, LONDON, W.C.1.

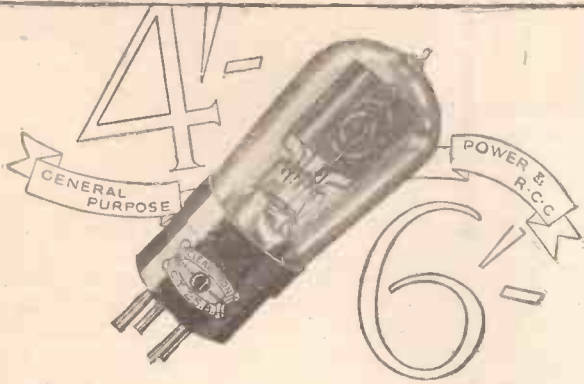

To pay more is to pay too much

Test Cleartron Valves against any other make you know and your own experience will prove their amazing efficiency.

Cleartron Valves are British. They are inexpensive for the same reason that every valve should be inexpensive—the present cost of materials and the high efficiency of modern plant makes it profitable to produce first-class valves and sell them at these prices.

To pay more is to pay too much.

Cleartron Valves are made in 2-, 4- and 6-volt types for every purpose in wireless; General Purpose Types cost 4/-; Power Types, 6/-. They are unsurpassed for signal strength, purity of reception, and length of life.

Dealers everywhere are stocking them. If they are not yet obtainable in your district, order direct, giving name of your usual dealer. Meanwhile, send the coupon for new descriptive brochure.

CLEARTRON ALL-BRITISH VALVES

New London Office and Store: 54/55, Fetter Lane, E.C.4.

FREE POST THIS COUPON
 CLEARTRON (1927) LTD.
 (Sales Dept. 8), 21, Cumberland St., Birmingham.

Please send me your new brochure describing the characteristics of all types of Cleartron Valves.

Name.....

Address.....

See this remarkable achievement in MOVING COIL SPEAKER DESIGN

STAND 269A



Only a few days ago, a leading wireless expert said, "This new 'Centrex' frame of Goodmans' is the biggest thing done in MOVING COIL Speaker design this year."

He realised this new improvement meant it was well-nigh impossible for anything to go wrong—the advantage of the separate member (supported on special springs adjustable by Wing Nuts) ensured correct tensioning and centring.

PRICE OF FRAME AND STAND, 32/6

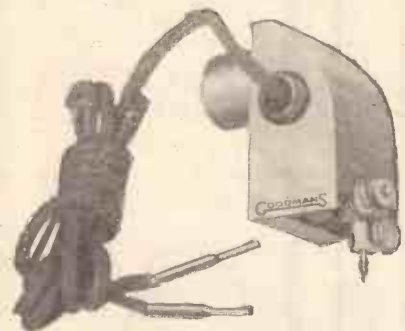

Here's the new GOODMAN PICK-UP, costing only 18/6. Will bear comparison with any other pick-up on the market, regardless of its low cost.

Beautifully finished in nickel case—light in weight, light on the record. Remarkable in its faithful reproduction of high and low frequencies alike. Volume adjustable on the instrument.

See this new product and our complete range of Moving Coil Speaker parts at the Exhibition, Stand 269a, or we will send you our illustrated descriptive lists giving full particulars of all our Loudspeaker Components.

GOODMANS

27 FARRINGTON ST. LONDON. E.C.4

Telephone: City 4472.

RADIO NOTES AND NEWS OF THE MONTH
 —continued from page 420

But those of our readers who read Captain Eckersley's article, which appears in "Popular Wireless" (Sept. 22nd), will no doubt realise that there is very little in the field of television Captain Eckersley is not acquainted with.

Russian Radio

The "Electrical Review" stated in a recent issue that broadcast radio telephone stations in service in Russia, and in the course of construction at the beginning of 1928, numbered sixty-four.

The wave-lengths used ranged from 60·12 to 1,700, ten stations using 100 metres or over, while the power used ranges from 0·02 to 40 kw. A factory in Leningrad has just completed a combined 25-kilowatt broadcasting station which can also work as a telegraphy station with a power of 35 kilowatts.

Progress in Russian radio has shown remarkable stimulation during 1928.

Patron Saint of Wireless

At a gathering of wireless operators

of the French Navy at Toulouse, Joan of Arc has been proclaimed the Patron Saint of wireless operators. Wireless men decided they must have a patron saint and so their choice fell upon Joan. The proclamation of the Saint of Wireless was marked by an elaborate historical procession.

WILL IT WORK?

IF IT IS A

MODERN WIRELESS

set there is no need to ask that question. Just hook it up and you can be sure that

IT WILL WORK

New B.B.C. Premises?

It seems pretty definite that before very long the B.B.C. will have to move to more commodious and more up-to-date premises. The offices at Savoy Hill are even now very overcrowded, and the present building is becoming inadequate.

According to a B.B.C. official, no definite decision has yet been made, nor has a site been selected, but we understand that Sir John Reith himself is engaged on planning out the new premises.

"Broadcasting House"

This new building, which will probably be named "Broadcasting House," will certainly be one of the most amazing buildings of its kind in the world. Its studios will be built on entirely novel plans, but based, of course, upon the experience gained by the B.B.C.'s years of broadcasting.

It is interesting to note that the largest studio at Savoy Hill is 44 ft. by 25 ft., and is hardly big enough to accommodate an operatic performance with a full orchestra, plus chorus and soloists and conductor.

Cost of 5SW

It was pointed out in the "Daily Telegraph" the other day that 5SW costs about £10,000 a year to run, and that this sum is entirely paid from the licence fees subscribed by British listeners.

As this service is primarily for the benefit of overseas listeners, and certainly is not of much value to listeners in this country, it seems only fair that the Dominions should contribute something towards its upkeep. It is understood that the B.B.C. is in touch with the Dominions Office on this very point.

THE **Brown**

ELECTRICAL PICK-UPS

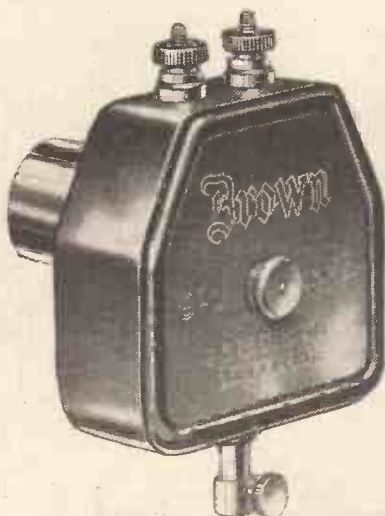

Helped by the Brown Pick-up your radio set and loudspeaker will reproduce your Gramophone records electrically. Consequent improvement of reproduction is amazing. Needle-scratch and extraneous noises are eliminated, you can control the volume from soft to very loud, and the music is clearer.



An adaptor (supplied free with No. 2) makes any alterations to the wiring of the set unnecessary.

- No. 1, De luxe model in polished aluminium .. £4
- No. 2, Complete with Adaptor .. 28/-

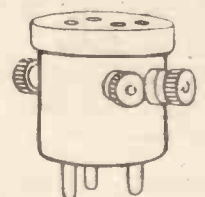

The Adaptor

Supplied by any first-class radio stores.

MAKE CONTACT WITH

WE ARE EXHIBITING AT

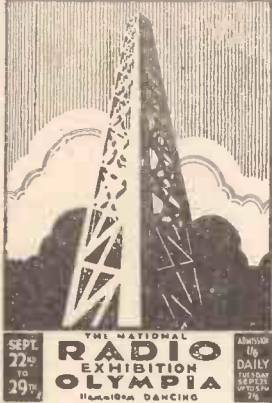

CLIX

at
 STAND
 No. 236
 OLYMPIA

"CLIX" practical aids to perfect contact are the outcome of careful study into the causes of those annoying interferences in reception which are invariably traced to bad contact.

Each and every one of the eight illustrated, will, if used by you, greatly increase your radio pleasure.



1. **CLIX PARALLEL PLUGS.** A boon to experimenters. 2d.



2. **CLIX SPADE TERMINALS.** Bury all contact troubles 2d.



3. **CLIX SPIRAL WANDER PLUGS.** Give full surface contact 2d.

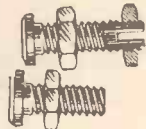

4. **CLIX PARALLEL SOCKETS.** Eliminate the use of solder 1d. & 1½d.



5. **CLIX TERMINAL BRACKETS.** Make plug contact simple 1d.



6. **CLIX PIN TERMINALS.** The pins with many uses. 2d.



7. **CLIX COIL PINS.** An all-purpose fitment . . 2d.



8. **CLIX-LOX WANDER PLUG.** The wonder wander plug 2½d.

OUR NEW CATALOGUE IS NOW READY

Ask your Dealer for a copy. It contains full details of all the above and also illustrations, including the following additional "Clix" products.

ACCUMULATOR KNOBS, PANEL TERMINALS, CONNECTORS AND THE "CLIX" MULTI-PLUG AND SOCKET.

Look for the "CLIX" Showcase on your Dealer's counter

LECTRO LINX, LTD.,

254, Vauxhall Bridge Road, Westminster, S.W.1.

See the famous WHITELEY-BONEHAM Range at Stand 120

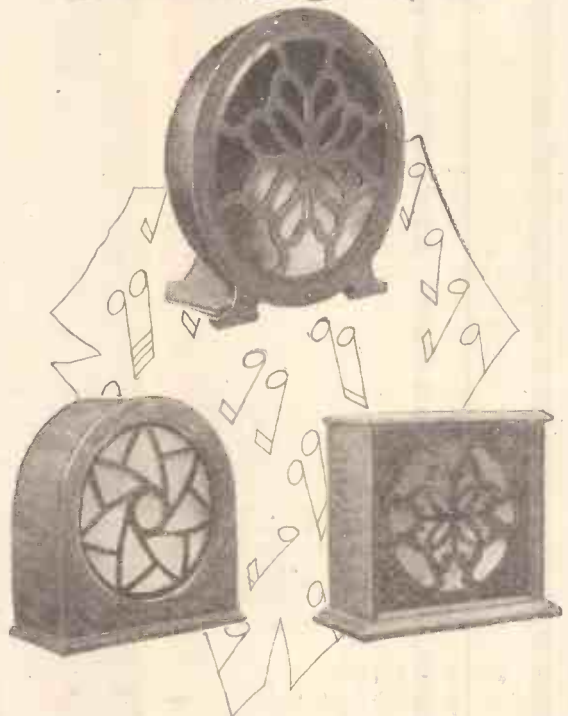

That's all we ask you to do. As you pass through the exhibition, stop for a few moments at Stand 120 and examine the Whiteley-Boneham Speakers. Your good judgment will do the rest.

Your new Season's speaker will be a Whiteley-Boneham.

Whiteley-Boneham Loud-speakers satisfy all the demands of the hypercritical listener attractive in appearance moderate in price and crystal clear in reproduction.

This perfect reproduction is made possible by the wonderful Whiteley-Boneham Cone unit with which every Speaker is equipped. The design of this unit is such that distortion and rattle are non-existent.

Whiteley-Boneham—Stand 120

If you are not at the exhibition ask your dealer, or write us for full particulars.

Whiteley, Boneham & Co., Ltd.
 Nottingham Rd., Mansfield, Notts.

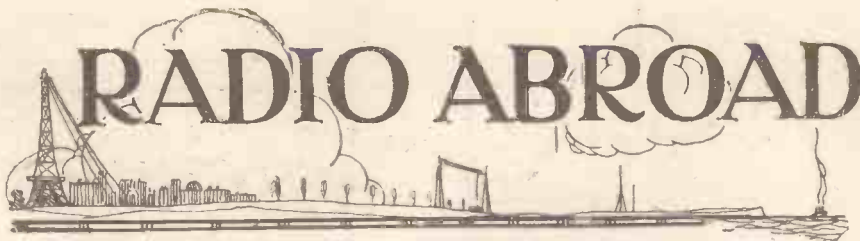

RADIO ABROAD

Aeroplane Radio

IF aeroplane service tests undertaken by the American Telephone and Telegraph Co., between the ground and a cabin aeroplane, develop as rapidly as some of the recent experiments in radio communication, it will soon be possible for anyone within reach of a telephone to communicate with anyone who may be travelling by aeroplane.

"It may be a matter of five years," one of the engineers of the above company stated, "and it may quite possibly be a much shorter time, before we achieve our object of an actual connection-service between an object moving through the air and a station on the ground."

In the present experiments, apparatus is being used by means of which the wave-length may be changed instantly, so that the most efficient

and least-congested channels may be found from moment to moment.

On Trains

The Radio Committee of the American Railway Association has recently requested that the Radio Commission reserve a wave-length band for train communication. This method of linking the engine and the guard's van has been mentioned before in these notes. A section approximately 140 k.c. wide is desired in the 2,250-2,750 k.c. region.

Since the range of the telephone equipment used on trains is limited, the interference set up by such transmitters will be very slight, and there is probably no reason why such a wave-length band should not be assigned for the purposes requested.

"Custom Building"

In a recent bulletin issued by the U.S. Radio Manufacturers' Association, it is stated that 20 per cent of

the sets in use in the States have been built by what they call over there "custom set builders," or what we might describe as skilled amateurs turning their spare time to the making of sets for their friends and those recommended to them by satisfied users.

Many of the so-called radio nuts and circuit hounds of a few years back have found in their hobby not merely a fascinating pastime, but a means of embarking in business on their own account, and many of them are enjoying incomes of 10,000 to 15,000 dollars a year.

No Competition

Curiously enough, the large manufacturers do not complain of the competition of these private builders, as it proves that these privately and specially made sets are generally ordered for locations where special conditions have to be met and arrangements have to be considered by the expert on the spot—in regions, for example, where extreme congestion on the part of broadcasters renders extra selectivity necessary.

Broadcasting Microphones

All kinds of broadcast microphones can now be obtained for experimental

(Continued on page 426.)

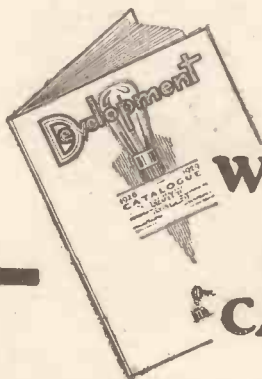

**WRITE OR CALL
FOR OUR
1928-1929
CATALOGUE**

Just published, containing particulars and details of all the latest lines exhibited at the Wireless Exhibition: 70 pages of Wireless and Gramophone accessories that are in everyday use by all experimenters, constructors, and amateurs.

Send 6d. to cover cost of postage for your copy—**FREE** to callers.

It always "pays to go to Day's" for all Wireless Accessories and parts.

|| STAND 248 ||

WILL DAY, LTD.

(THE BEST IN THE WEST),

19, Lisle St., Leicester Square, W.1.

Phone, Regent 0921 & 0922. Grams, Titles, Westrand, London

**Solve your
condenser problem
at STAND 159**

(NATIONAL RADIO EXHIBITION)

Cyldon Condensers set the highest standard of design and manufacture. Specified in leading receivers, standardised by leading manufacturers. Ask to see our **NEW MODELS.**

BEBE CONDENSER

Cyldon "Bebe" Condensers were primarily designed for use as reaction condensers—but the larger capacities are ideal as tuning condensers where space is limited. Specified for the "Olympic Three" and other leading circuits.

Made in five capacities:

'0001 - 7.6 '0015 - 8/- '0002 - 8/6

'0025 - 9.6 '0003 - 11/-

Complete with 2-in. knob and dial.

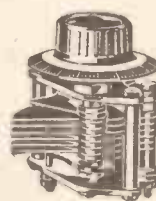

CYLDON

SYDNEY S. BIRD & SONS, LTD.

Cyldon Works, Enfield Town, Middlesex
Telephone: Enfield 2071-2 Telegrams: "Capacity, Enfield."

LAMPLUGH

THE TRIUMPH OF SIMPLE SET CONSTRUCTION

With the Lamplugh units, radio set construction is simplicity itself. The Panel Plate Tuner Unit—which is half a receiver, consists of a richly embossed Metal Panel in antique brass, on which are mounted coils covering wave-lengths from 250-2,000 metres, tuned by a S.L.T. Slow Motion Condenser. A Switch is provided for changing from high to low wave-lengths and a switch for putting off batteries, the whole being mounted on a special wooden panel of Oak, Mahogany or Walnut.

To provide the finest professional finish so much desired, the Collapsible Cabinet has been specially designed for the Panel Plate Tuner Unit.

Go now to your local Lamplugh stockist or send for Lists and Circuit Diagrams from manufacturers.

OLYMPIA—STANDS 81 & 106.



S. A. LAMPLUGH, LTD.,
KINGS ROAD, TYSELEY, BIRMINGHAM.
ESTABLISHED 1912.

COLLAPSIBLE
CABINET

28/-



PANEL PLATE
UNIT
INCLUDING
PANEL

35/-



ALL LAMPLUGH RADIO PRODUCTS are GUARANTEED for 12 MONTHS

*Most things move in circles
—Even the world itself.
Circular Motion is the
Secret of this wonderful new*



Anti-Microphonic VALVE-HOLDER 1/6 ONLY.

NO matter how much you may jar your set, the circular motion of vibration of the NEW GASON ANTI-MICROPHONIC VALVE-HOLDER guarantees safety to your valves. They will not swing sharply to and fro, but will rotate smoothly and without the least strain. Again, this wonderful device is so finely sprung that it ensures perpetual valve-motion, a necessity to the best reproduction.

GASON ANTI-MICROPHONIC VALVE-HOLDERS are guaranteed to be made of only the highest grade mouldings, insulated parts and springs.

Ask your dealer, or write for particulars NOW!

CASON MOULDINGS
CHISWICK ROAD, LONDON, N.9.

STAND 172

OLYMPIA—SEPTEMBER 22-29.

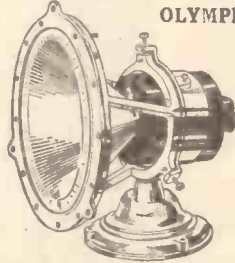

BAKER'S SELHURST RADIO

Moving Coil Loud Speakers give the best possible results.

Write for Illustrated Booklet:—

BAKER'S SELHURST RADIO
42, Cherry Orchard Road, East Croydon. (Telephone: Croydon 1618)

STAND 172

FREE

CABINETS

for
**PORTABLE CASES
MOVING-COIL AND
CONE SPEAKER
CABINETS**

A twenty-page catalogue showing our latest range of **CABINETS**. Send for a **FREE** copy.

OLYMPIA: Stand No. 107.
Carrington Manufacturing Co., Ltd.,
Camco Works, Sanderstead Rd., South
Croydon. Tel: Cranford 0623 (2 lines)



RADIO ABROAD

—continued from page 424

purposes from the Universal Microphone Co., Chamber of Commerce Building, Inglewood, California. These include the 2-button broadcast type at 15 dollars: this can be used with or without amplification, and operates on 5 to 15 mills per button. Full particulars may be obtained by writing to the firm mentioned at the above address.

Picture Transmission in U.S.

I have a letter from Mr. Edgar Felix, of the Radiovision Corporation, 62, West 39th Street, New York, N.Y., in which he tells me that Rayfoto broadcasting is extending rapidly in the United States, and the number of broadcasting stations going on schedule is increasing week by week. Stations in New York, Detroit, St. Louis, Milwaukee, Wilmington and Peekskill are already on schedule, and eight additional cities will be on the air within the next few weeks.

Gerald Marcuse (2 N M), the well-known English transmitting experimenter, is sending Rayfoto pictures

on short-wave for the benefit of experimenters in Europe.

L.T. Smoothers

I notice there is a growing vogue in low-tension smoothing devices, made up into a separate unit, so that they can simply be connected to "any good charger"; the "any

You get
**MODERN
Wireless Results**
if you build
**"Modern Wireless"
Receivers.**

Make sure of your copy every month.

Price 1/- On Sale Everywhere

Place an order now.

charger" is thereby converted into a low-tension supply unit. It sounds very good, but I have my doubts!

U.S. Amateurs

The U.S. newspapers credit the Radio Commission with following the advice of the American Radio Relay League (the A.R.R.L.) in removing from the so-called 80-metre band the

many amateur 'phone stations now existing and opening up the 20-metre band for radiophone communication. In addition, the U.S. amateurs have from 1,580 to 2,000 k.c., and a nice fat band between 56,000 and 64,000 k.c., for 'phone communication.

The new international regulations, probably in effect by 1929, narrow the so-called 40-metre band, but leave the other bands about the same as before. Into this 40-metre band all the amateurs of the world who once could be found from 30 to 50 metres will be pushed, and instead of listening for S. America and S. Africa on 27.5 to 33 metres, and England and France above the American band, U.S. amateurs may find themselves mixed up with the 8's and 9's which are so numerous in that country.

Broadcasting in India

Broadcasting is making slow progress in India, and the demand for wireless sets and components remains on a very limited scale. What business there is seems to be mostly in the hands of British business houses. The main trouble of the Indian Broadcasting Co. is the smallness of the area in this vast country which is open to reception on small and inexpensive sets.



The Heart of the Set

Regular transmission of current, steady smooth response to the extra demand, no "murmurs," these are the qualities which make these batteries with the sturdy, extra-thick plates the Premier Batteries for wireless sets.

Ask your dealer; or write for detailed list to

PREMIER

Accumulator Co. (1921) Ltd.,
Northampton
Estd. 1898

Ex-Ten Type Premier Battery

as illustrated, for low-tension supply, is built specially with larger plates to give greater capacity.



London: 53, Victoria St., S.W.

Z-Type Premier High-Tension Battery

is a distinct advance in radio efficiency and economy. It allows of critical H.T. adjustment by means of 2-volt tappings and is handsomely housed in polished teak crate.

Glasgow: 149, St. Vincent Street.

NOW! ALL STATIONS FROM 250—2000 METRES WITHOUT CHANGING COILS



Note these Special Features:

1. Easy two-hole fixing.
2. No friction joints whatever.
3. Improved bakelised former.
4. Reversible dial to allow of upright or horizontal mounting.
5. Knobs fixed by means of grub screw on spindle.

BRITISH GENERAL

AERIAL TUNING UNIT

PRICE **18/6**

From all wireless dealers of repute, or direct from **BRITISH GENERAL MANUFACTURING CO., LTD.** Brockley Works, London, S.E.4.

STAND 10 AT THE RADIO EXHIBITION

Positive Control

To secure that refinement in quality and selectivity you must have a perfect means of controlling both the High and Low Frequency sides of your receiver.

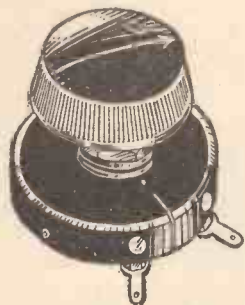

The GAM-BRELL VOLUVERNIA

This control for the L.F. side enables one to obtain the exact volume required and eliminates all the distortion which results from the common practice of detuning. It graduates volume from maximum volume to a mere murmur. It is also exactly suited for use with Gramophone Amplifiers. Resistance 0-1 megohm.

Price 6/9

The Gam-brell Neurovernia and Voluvernia will each give you positive control with a smoothness and graduation that results in a marked increase in selectivity, quality and volume of reproduction. Obtainable from all Dealers.

The GAM-BRELL NEUROVERNIA

This excellent component can be used as either a Capacity Reaction Control, Balancing Condenser or Neutralising Condenser

Price 5/6



See all our Components and new range of Mains Receivers on Stands 27 and 108 Olympia.

GAMBRELL RADIO LTD.

Buckingham House, Buckingham St., Strand, W.C.2

£300 A YEAR FOR YOUR SPARE TIME!

Wonderful New Invention YOU can Make and Sell under My Patent!

REALLY, genuinely, you can make at home and in your spare time a sum of extra money up to £300 per year, per licence. The work is of fascinating interest. It will open up to you new ideas, new vistas of money-making; provide many of those luxuries and necessities which you have so long wished for, and give you occupation just at those hours when time is apt to hang heavily on the hands.

to manufacture under my Royal Letters Patent, in order to ensure a fair market for all. Let me hear from you NOW before somebody else is granted the licence and the extra income that can so easily become yours.

Simply forward the coupon and, by return of post, I will send you every particular with which you may wish to be acquainted. It is those who seize opportunities who succeed. Take this opportunity NOW.



IN THE COMFORT OF YOUR OWN HOME YOU CAN DOUBLE YOUR INCOME. The work is a delight. You can keep at it just as long as you like each day or week. No "plant" or expensive machinery is needed. A spare room or even the kitchen table can serve as your profit-making "factory"—and the children can help too!

Others are doing this by working my enormously successful patents. Why not you? It costs you nothing to write for full particulars, and you can then see for yourself exactly what you can do.

My patents are in very great demand in the field of wireless and electricity—so much so that

I GUARANTEE

your profits, and further guarantee to protect you against any infringement or interference with your market. Only a restricted number of persons are allowed

"MONEY-AT-HOME" COUPON
 To THE ENGLAND-RICHARDS CO., Ltd.,
 105, King's Lynn, Norfolk.
 Sirs.—Please send me at once, and FREE, full details as to how I can Make Money at Home in my spare time. I enclose 2d. stamp for postage.
 Print your name and address boldly in capital letters on a plain sheet of paper and pin this coupon to it.
 Modern Wireless, October, 1928.

"PAREX" PRODUCTS PAR-EXCELLENCE

Build THE OLYMPIC THREE

and use

"PAREX" SCREENS & COILS

Standard Loading Coil, as specified, 7/6.

Copper Screen, 12 in. by 6 in., with flange ready to fix, 4/6.

All Screens are made of highly polished and mottled copper and are UNTARNISHABLE.

AT OLYMPIA

Visit Stand 272

and see our display of Screens, Coils and Screened Grid Valve Holders.

E. PAROUSSI, 10, FEATHERSTONE BUILDINGS, LONDON, W.C.1. Phone: Chancery 7010

IT IS IT!

THE LATEST

4 and 6 Pinless Contact Foolproof Becol Formers. Complete, ready for winding. NO PINS—NO WRONG CONTACTS.

Can be fixed in the dark.

FORMER 6-. BASE 4/6. Inland Postage and Packing, 9d. extra

Inside formers for above 13" x 13" x 21" 6d. each. Packing and postage, 3d. extra.

As described and illustrated in "Modern Wireless" January, 1928, issue.

Write for Handbook on Circuits and Windings, fully illustrated—Price 4d. post free.

Sole Makers:

THE BRITISH EBONITE CO., LTD., HANWELL, LONDON, W.7.



THE ONLY BRITISH VALVE WITH A WRITTEN GUARANTEE AS TO PERFORMANCE AND LIFE.

WHAT OTHERS SAY of P.R. VALVES

Type	Fit. Volts	Amp.	Imp. Ohms.	Amp. Fac.	
PR 1	2	*095	30,000	14	H.F.
PR 2	2	*095	28,000	13	Det.
PR 3	2	*095	15,000	8	L.F.
PR 4	2	*095	120,000	32	R.C.
PR 8	3.5-4	*063	23,000	15	H.F.
PR 9	3.5-4	*063	18,000	14	Det.
PR 10	3.5-4	*063	10,000	8-7	L.F.
PR 11	3.5-4	*063	88,000	40	R.C.
PR 16	5.6	*1	19,000	18	H.F.
PR 17	5.6	*1	18,000	17	Det.
PR 18	5.6	*1	9,500	9	L.F.
PR 19	5.6	*1	80,000	40	R.C.
PR 20	2	*15	7,000	6	Power
PR 40	4	*15	7,000	6	"
PR 60	6	*1	5,000	6	"

POPULAR WIRELESS, Sep. '8, says: "We have the P.R. valve which is sold at the remarkably low cost of 3/6, and which has remarkably good characteristics."
 AMATEUR WIRELESS, Mar. '14, says: "The characteristics of this Valve compare favourably with many well-known makes."
 "Unsurpassed for purity of tone and selectivity—the equal of any," is the opinion expressed in hundreds of letters from satisfied users—the originals can be seen at our offices.

Tell us your set—we will send correct Valves.

Matched Valves 1/- extra.

7/6 Each Post 4d. P.R. VALVES

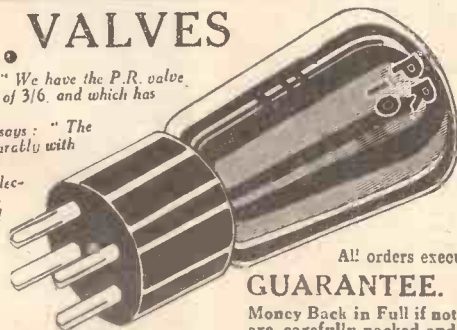

NOW ONLY 3/6 C.O.D. Phone: City 3783 Post 4d.

2 Valves for 6/9 Post 6d.
 3 Valves for 10/- Post 6d.
 4 Valves for 13/- Post 9d.

All orders executed by return of post. GUARANTEE. All valves despatched under guarantee of Money Back in Full if not satisfied. All valves are carefully packed and breakages replaced 17/8, Paternoster Square, LONDON, E.C.4.

IN OUR TEST ROOM
—continued from page 364

arranged sectionally and the construction of the device is sound and robust. The retail price is nine shillings.

Two Lissen Components

Remarkable value for money as is the 8s. 6d. Lissen transformer, it was not to be expected that Lissen, Ltd., would fail, sooner or later, to



The new valve holder due to Messrs. Lissen.

provide us with something of a senior quality in this regard. Consequently, we have now the new Lissen L.F. transformer which, at 19s., takes its place in line with the higher class varieties. It is in every respect a first-grade production, and we can say right away that constructors need have no hesitation in including it in the highest quality set designs.

On dissection, the internal construction of this device does not strike one, as happens in some cases, as a mere matter of fact assembly of windings and core. The design is distinctly scientific, the core stampings being arranged to give the intensest and closest magnetic circuit, and the windings are sectionalised to provide the tightest coupling with the lowest possible self-capacity. A fixed condenser (mica construction) is fixed across the primary winding for balancing purposes.

The transformer is enclosed in a cleanly moulded insulating casing. The results the transformer gave, on test, we have in so many words indicated. A close comparison shows that it has very few equals at any price, and there can be few transformers on the British market equal to any yet within shillings of it.

Another new Lissen component to hand is a valve holder. Made of first-class material of novel cut-away construction, its H.F. losses are remarkably low. It can be mounted either on a panel or baseboard by the same central hole. It is not provided with the usual sockets. The four contacts are made by four springs which are pushed outwards

(Continued on page 430.)

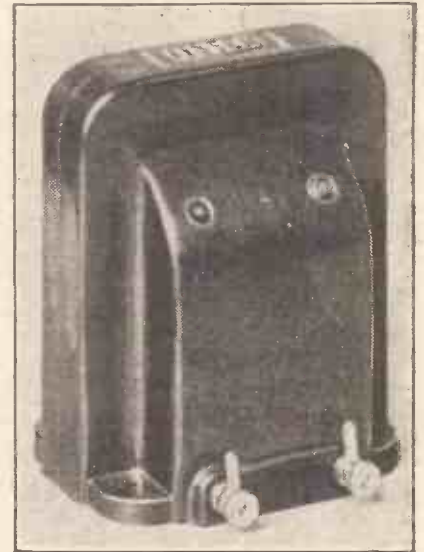

Lissen's new L.F. transformer.

Come out into the open!

The "Wireless World" says—
"We hope that other dry battery makers will follow Messrs. Ripaults' lead and come out into the open with details of the average life which may be expected from their cells."
—See page 478, May 2nd issue.

RIPAULTS SELF-REGENERATIVE H.T. DRY BATTERIES

Give 50 per cent. Longer Life.

STANDARD Capacity.		DOUBLE Capacity.		TRIPLE Capacity.	
60-Volt	10/6	60-Volt	15/6	60-Volt	19/6
99-Volt	18/6	90-Volt	22/6	90-Volt	29/6

RIPAULTS LEAD IN LIFE, EFFICIENCY AND VALUE

LIGHT ON THE H.T. BATTERY

We have always made a practice of giving to the Public the fullest information possible, so that they can independently judge the merits of the goods they buy. For the above reason we have spared no expense in producing a 24-page booklet which has been specially written for us by one of the best-known contributors to Radio publications who is recognised as an expert on H.T. Dry Batteries. This Booklet, which is extremely interesting and an easily understood treatise on H.T. Batteries, is chock-full of sound advice on the correct choice of batteries for all types of receivers.

All requesting a copy of this 6d. Booklet, and sending a 2d. stamp, mentioning *Modern Wireless*, will have one sent them post free.

STAND
236
OLYMPIA

Ripaults
Ltd.

STAND
236
OLYMPIA

1, KING'S ROAD, LONDON, N.W.1



Stand 62 Olympia

STEADILY INCREASING
BUSINESS BUILT BY
RECOMMENDATION

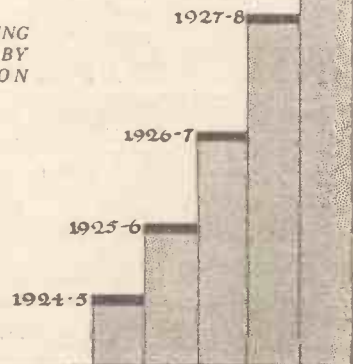

Adt. of Regent Radio Supply Co., 21, Bartlett's Buildings, E.C.4.



OLYMPIA SHOW FORECAST

THERE WILL BE PLENTY
OF MAKES OF MOVING
COIL SPEAKERS SHOWN.

There will be some which will
be much dearer,

There will be some which will
be a little dearer.

There will be some which will
be the same price.

There will be some which may
be even cheaper.

But you will not find one
moving coil speaker at any
price which can compare for
absolute perfection with the
3 NEW MODELS

of

EPOCH

MOVING COIL SPEAKERS

PRICES FROM

£2 : 10 : 0

COMPLETE

Don't fail to see them at

OLYMPIA

STAND No. 211

THEY WILL BE THE GREATEST
SENSATION OF THE SHOW.

*If unable to visit the Show, see them at or
get particulars from :*

EPOCH ELECTRICAL SOCIETY,
LIMITED,

53, Gracechurch St., London, E.C.3
or from any High-class Dealer

YOU CAN'T BUY A SET FOR THREEPENCE!

But you can do better—you can buy

POPULAR WIRELESS

This bright and breezy radio paper keeps you
right in touch every week with what is going on
in wireless invention and development.

COSTS THREEPENCE— BUT SAVES POUNDS

Full of Hints, Tips and Practical How-to-
Make Ideas, it is just the paper for the man who
wants to get the best value for his radio
expenditure.

Scores of regular readers have testified that one
copy of "P.W." has saved them pounds.

But make sure that you really get

POPULAR WIRELESS—THE PAPER THAT MADE WIRELESS POPULAR

Every Thursday

Only Threepence



STEP by step the world-famous group of Celestion Loudspeakers has advanced through scientific development to a position of unquestioned supremacy. No greater human effort could have been made to perfect every detail of "Celestion" construction than has been made.

The famous Celestion group consists of four models, in oak or mahogany, from the C.10 in oak at £5.10.0 to the C.24 in mahogany at £25.

Hear a demonstration without obligation at the new Celestion Showrooms, one minute from Victoria Station, or ask your dealer to demonstrate Celestion. Illustrated literature giving full particulars of all models and of the Celestion-Woodroffe Gramophone Pick-up, price £4.4.0, sent free on request.

Made under licence.

VISIT US AT STANDS
Nos. 19 & 20
NATIONAL RADIO EXHIBITION
OLYMPIA

CELESTION

The Very Soul of Music

Dept. H

Please note new addresses

THE CELESTION RADIO CO.,

LONDON ROAD, KINGSTON-ON-THAMES.

Tel.: Kingston 5656 (4 lines).

Showrooms:

106, VICTORIA STREET London, S.W.1

IN OUR TEST ROOM
—continued from page 428

by the legs of the valve. Obviously the connection is sound, and the action accompanying the insertion of the valve makes for clean contact.

Additionally, the scheme eliminates any probability of that gripping which makes the removal of a valve a precarious task.

In short, the Lissen valve holder is full of good points and should appeal strongly to discriminating constructors.

M.P.A. Loud Speaker

M.P.A. Wireless, Limited, recently sent us one of their new type "centre adjusting movements" popular plaque loud speakers. Its cone, which is coloured gold inside and out, is mounted in a distinctly novel fashion. The octagonal wooden front is artistically cut away, and slender coil sections terminate in cone fixings. These portions of the wood have considerable elasticity so that semi-free-edged mounting results.

The adjusting knob of the device protrudes from the front, and tends to add more to the attractiveness of its appearance and certainly makes for accessibility. The speaker is supported by an ornamental metal framework.

On test the instrument was found to be capable of pleasing results. It is sensitive and can be operated satisfactorily by two valve sets. The projection is good and there are no noticeable resonance effects. As a matter of fact, reproduction is bright and clean, there being in addition less coloration than in the majority of ordinary cones.

Magnum Components

One of the advantages of the electrical reproduction of gramophone records is that an efficient volume control can easily be arranged. And the most popular schemes necessitate the use of a high-resistance potentiometer. And such a component is also an essential item in several of the few satisfactory systems of controlling the volume of an ordinary radio receiver. There are not too many dependable high-resistance potentiometers available, although we can now add to these one due to Burne-Jones and Co., Ltd. This new Magnum product is supplied in two different maximum values, $\frac{1}{2}$ and 2 megohms.

Suitable for one-hole panel mounting, it is provided with a large bakelite knob and pointer. Its action is clean and positive, and its resistance was not found to change subsequent to its being subjected to long periods of rapid rotation. (It would not ordinarily be treated in this manner.) The list price is 7s. 6d.

The new Magnum "Vibro" valve holder, at 2s., appears to be excellent value. It is remarkably neat and compact in design. Fitted with the slotted terminals which now appear to grace every "Magnum" production, its springing is most effective. Its non-microphonic qualities were proved to the hilt by using with it a very noisy valve of early design which we keep by us for such occasions. The central portion of the holder is cleverly cut away and this has the effect of reducing the high-frequency losses of the component to a surprising degree.

Concerning Mains Units

Messrs. H. Clark and Company (M/cr.), Limited, recently sent us one of their new Eliminator Brochures, No. 32, in which is described and illustrated their new range of battery eliminators for direct and alternating current mains. Readers can obtain copies post free by writing direct to "Atlas" Works, Eastnor Street, Old Trafford, Manchester.

FIVE FINE SETS

will be fully described
in next month's

"MODERN WIRELESS"

Order Your Copy Now

Peerless Valve Holder

The Bedford Electrical and Radio Company, Ltd., Bedford, recently sent us one of their new Peerless shock-proof valve holders. This component sells at the very attractive price of 1s. 3d. Nevertheless, it is quite a sound proposition. Its anti-microphonic qualities are, we believe, rather above the average.

A novel feature is that the terminals are taken off from the side. This is a feature which will no doubt appeal to the practical constructor. Another good point is that each of the metal sockets and its connecting spring is fashioned from one piece of metal. Also the sockets are sunk and the centre portion of the holder is cut away. The whole assembly strikes us as being a cleanly produced and made component.

JUST WHAT EVERY ELIMINATOR USER HAS BEEN WAITING FOR

The



ELIMETER

THIS new Elimeter, with a resistance of 100,000 ohms, comes at a time when thousands of battery eliminator users are eagerly waiting for a voltmeter that will accurately indicate both total voltage and all intermediate tappings and—at a price within everybody's reach!

Mr. J. H. Reyner, the well-known radio authority, says: "The figures indicate a surprisingly high resistance, and I must congratulate you on the production of such an instrument at the relatively low price of 30/-."

When writing ask for particulars of the full range of popular priced meters. There is a Sifam Radio Meter for every radio measuring requirement.

Free Leaflet, "Detecting Distortion," from (DEPT. M.W.) THE

SIFAM ELECTRICAL INSTRUMENT Co., Ltd.

Radiometer Headquarters,

BUSH HOUSE, ALDWYCH, W.C.2.



SIFAM
ELIMETER

Heavy Nickel finish.
White Ivory board dial.
Calibrated up to 200 volts.

30/-

SIFAM LEADS AGAIN!

M.B.

The Picture Paper with the MOST News

∴ SUNDAY GRAPHIC ∴

The HOME for your WIRELESS SET

OUR STANDARD
CABINETS

are DUSTPROOF and house the whole apparatus, leaving no parts to be interfered with. All you do is UNLOCK AND TUNE IN. Made on mass production lines, hence the low price. Provision is made to take panels from 16" to 30" wide. Carriage paid and packed free England and Wales. Thousands supplied with full satisfaction.



From £4 15 0. Write to-day for descriptive pamphlet and suggestions for adapting your receiver or panel in our Standard Cabinets. Immediate Delivery.

MAKERIMPORT Co.
Dept. 2.
9, York Street, LIVERPOOL.

CLIPPING CARRIERS

—continued from page 352

In order to ensure that no accidental variation is set up in the *amplitude* of the radiated waves, the modulated wave may first be passed through a current-limiting valve.

Receiving Apparatus.—In reception the essential point is to convert the incoming "frequency" variations into equivalent "amplitude" variations. Once this is done, the ordinary processes of detection and low-frequency amplification are available.

Now the response curve of any selective receiving set is of the form shown in Fig. 4, where the current flowing in the circuit is plotted vertically against changes in frequency shown horizontally.

The curve is, of course, the ordinary resonance curve of any tuned receiver, and shows a peak with sloping sides, the steepness of which is a measure of the sharpness of tuning (or selectivity) of the set. If now the receiver is adjusted slightly out of tune, say, to the point X of the resonance curve, then slight variations of the incoming frequency between the limits D, E, on the diagram will produce changes of current in the receiver corresponding to the difference in height between D, M, and E, N.

The Resonance Response

These changes will be greater the more sharply the receiving circuit is tuned, so that in practice the high-frequency circuits should be as near self-oscillation as possible.

When the incoming wave is of the order of 1,000,000 cycles per second, and the modulation varies this frequency between 999,900 and 1,000,000, it would probably be difficult to tune a standard receiver sufficiently sharply to obtain a reasonable response.

This difficulty can, however, be overcome by using a super-heterodyne receiver so as to produce an intermediate frequency, which is then passed on to the detector.

This at once gives a much larger percentage variation of frequency, amounting to perhaps twenty times the first, in which form the signals are readily detectable.

Quite apart from the advantages of the new system of transmission and reception in connection with existing broadcast congestion, it may have a very definite influence over the future of television when the time comes to transmit moving pictures over the ether.

Reduced in price

This is news indeed! The world-famous W.B. Anti-phonic valve holder, as specified by all the leading designers of the day, is reduced in price to:—

1/6 Complete with terminals

1/3 without terminals.

Now why are W.B. valve holders chosen time after time for the premier circuits? Because they do definitely exclude microphonic noises.

Sprung on specially shaped springs, W.B. Anti-phonic valve holders ensure really pure reception.

COME AND SEE US AT
OLYMPIA — STAND 120.

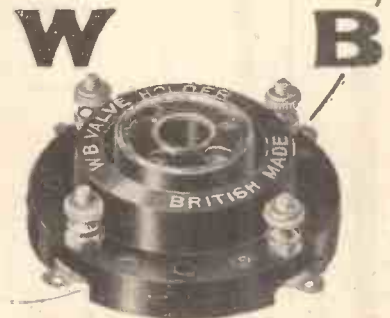

ANTI-PHONIC VALVE HOLDER

WHITELEY, BONEHAM & CO.,
LIMITED,
Nottingham Road, Mansfield, Notts.

EDITORIAL

—continued from page 317

that a licence should be granted to the applicants, and we have found that the terms on which the licence is offered are unreasonable terms prejudicial to the trade."

It is not expected that the effect of this finding will be immediate, as many of the manufacturers who are under licence by the Marconi Company have to give a year's notice before the licence can be terminated, but it is a step in the right direction towards cheaper wireless which will undoubtedly prove of great benefit to all interested.

The Radio Exhibition

THE Wireless Exhibition at Olympia this year is again the Mecca of all those interested in the great hobby of radio, and if you have not already paid a visit to Olympia make up your mind to do so at once.

This issue of MODERN WIRELESS, although it will be on sale soon after opening of the exhibition, will also be on sale after the exhibition has closed, but for the benefit of those readers who buy this magazine directly it is published, we would point out that the Wireless Exhibition at Olympia runs from September 22nd to September 29th, and that unless you pay a visit and examine the latest productions of the hundreds of British manufacturers who are exhibiting there you will not be able to form a clear idea of the extraordinary progress which has been made in the

technical development of radio components during the last twelve months. The new Pentode valve, the latest loud speakers, condensers, and other components are remarkable tributes to the efficiency and progress of the British radio manufacturers, and it is also a very pleasing thing to note that prices this year show on the whole a highly satisfactory readjustment, and that the man with only a little money to spend can undoubtedly purchase sufficient radio components to build himself a set which five years ago would have cost him four or five times as much, and which would have given him results amazingly far short of those he can obtain to-day.

The exhibition comes but once a year, so make up your mind that whatever happens you will visit Olympia before it closes on September 29th.

THE "THOMAS" SHORT-WAVER

—continued from page 346

A separate H.T. terminal is provided for the detector, and this, coupled with the separate filament control, gives maximum flexibility and a good chance of obtaining just the ideal reaction control.

Careful adjustment of the detector filament voltage will always be found worth while. About 65-80 volts was normally used on the detector, the voltage drop across the 250,000-ohm resistance naturally ensuring that a much lower potential than this actually reaches the anode.

For the other two valves about 100-120 volts is generally used, grid-bias values being adjusted to suit the particular valve in use. A 9-volt grid battery will generally provide suitable potentials, and, in general, 3 volts on the first grid and 6 or 7½ on the second will give good results.

A Further Advantage

A further great advantage of the resistance coupling which the reader will probably appreciate when he reaches this stage is the complete absence of any tendency towards "threshold howl." Unless you have owned a previous short-wave set you will not know what delights you are missing, but when threshold howl once starts on some sets nothing whatever seems to stop it!

However, in my belief it is always largely due to the transformer, and by dispensing with transformers we also dispense with a very undesirable trouble.

There is no need to say very much about the actual results obtained with this set, since, as I said at the beginning, any short-waver will receive the Antipodes nowadays. However, I think you will find a set of this type "just a little better" in many ways, and it will probably bring in signals that have never been heard before, even if the usual signals are no stronger than they were on your previous set.

That, at least, has been my experience. Suffice it to say, as a small indication of the capabilities of the receiver, that over seventy different stations owned and operated by amateurs in Australia and New Zealand were received in the space of just over one week.

"Utility" Thumb-Control Condensers

If desired our Standard Logarithmic and Square Law aluminium pattern Condensers can now be supplied as the illustration, complete with special end plates for panel attachment and a wonderfully smooth thumb control tuning device. The small knob which drives the semi-circular wire segment can be plainly seen in the illustration.

The ratio is about 12 to 1.

PRICES:

Cat. No.	Cap.	With T.C. Adjustment.	Condenser only.
191	.0005	13/-	8/6
192	.0003	12/-	7/6
193	.0002	11/-	6/6

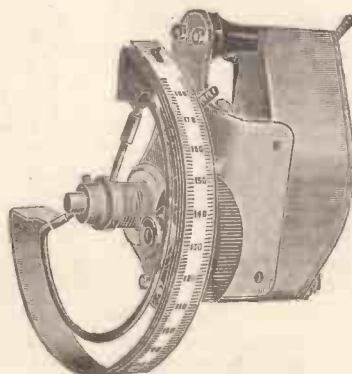

"Utility" Components are still preferred by critical listeners. You should ask your local Wireless Dealer to show you the Condensers, Switches and Dials that we make. They are fully guaranteed against defect.

Write for complete Catalogue.

Utility
GUARANTEED
COMPONENTS

WILKINS & WRIGHT, Ltd.,
'Utility' Works, Holyhead Road, Birmingham.



**EVERY-
THING
FROM
THE
MAINS.**

THE HOME CHARGER

As illustrated in "Modern Wireless," October.

Complete Charger. Model A2- **42/6**

Set of Component Parts - - - **32/-**

(Comprising Transformer A2, 17/6;
Valve No. 451, 12/6; Resistance, 2/-)

L.T. ELIMINATORS

L.T. accumulators abolished. Parts required comprise Model A2 Rectifier, 42/6; 2 Chokes, 12/6 each; Condenser, 3,400 mfd., 25/-; Resistance, 2/-.

H.T. ELIMINATORS

Absolute success with our components is a guaranteed certainty. Any output supplied from 100 to 500 volts, as required.

Largest and most varied stocks in London of L.T. & H.T. Components and Meters.

F. C. HEAYBERD & CO.,

8/9, Talbot Court, Eastcheap,
London, E.C.3.

(One minute from Monument Underground Station.)

Cabinets of Quality
for every Set.
Full illustrated particulars from the Actual Manufacturers, V. O. Bond & Sons, 61, Hackney Grove, Mare St., London E.9.

PERPETUAL POWER

2 "Unibloc" Cabinets 86 volts assembled complete.
8/1 down and five monthly payments of 8/1.
Cash Price £2 : 6 : 5

NOW—permanent power with the wonderful Standard Wet H.T. Battery. It recharges itself overnight ready to supply abundant H.T. whenever you want! Never any worry about run-down batteries—in the morning it is as fresh as the dawn. Write now for free booklet which tells you all you want to know. Halford's Cycle Stores, Curry's Stores, and all Radio Dealers supply on deferred terms. NO REFERENCES. NO DEPOSIT.

STANDARD
WET BATTERY CO.
(The Wet H.T. Battery Co.) Dept. F.
Head Offices, Showrooms and Warehouse:
184-188, SHAFESBURY AVENUE, W.C.2.
Stand No. 7, Radio Exhibition, Olympia.

PLEASE be sure to mention
"MODERN WIRELESS"
when communicating with
Advertisers. THANKS!

L.T. FROM A.C.
—continued from page 340

pulsating D.C. current with 100 pulsations a second, the current rising and falling to zero at that frequency.

An examination of the ordinary type of filter, as used with a high-tension mains unit, will show that the amount of charge that can be stored in a condenser increases in proportion to the voltage. For example, ten times the capacity will be needed to assure the same amount of charge at 10 volts as at a 100 volts. We thus have two difficulties with regard to our condensers.

POPULAR WIRELESS
- IS -
The Leading Radio Weekly

Not only is the current to be smoothed at least ten times as large as it is generally required to be smoothed in high-tension units, but we also need very much larger condensers owing to the lower voltage. The problem, indeed, on closer consideration seemed insuperable, as it was not practicable to obtain the ordinary types of condenser sufficiently high in capacity for our purpose. Quite apart from theoretical considerations, practical experiments showed that even 50 mfd. made not the slightest reduction to the hum—in fact, it was impossible to tell when it was connected and when it was not.

Choke Resistance Problems

There were certain problems, too, in regard to the choke, for while it is comparatively simple to obtain a high inductance with 50 or 100 milliamperes, it is much more difficult with a 1,000 milliamperes. Furthermore, owing to the voltage, the ohmic resistance had to be kept very low. After a number of experiments I chose an inductance of 50 millihenries and a D.C. resistance of 1 ohm each for the two chokes. The D.C. resistance of the chokes could have been made lower, but I kept to this figure for a purpose which will be explained later.

After the transformer, rectifier and choke had been worked out, and the simple series resistance scheme worked out for controlling the output voltage, the problem was held up for the arrival of a suitable high-capacity

(Continued on page 434.)

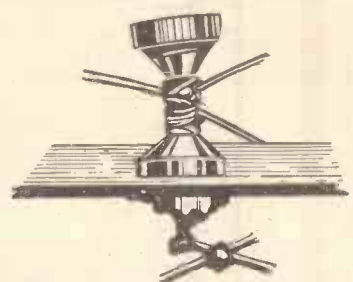

**THE CENTRE OF LOSSES
IN YOUR SET ARE OFTEN
IN THE—
TERMINAL CONNECTIONS**

Loose joints, flux and too much solder, are the little things in radio that make the difference between mediocre and excellent reception.

Write for this
Free Booklet



and learn about the Eelex gnomes of efficiency that make terminals the centre of industry in your set and ensure improved reception.

By using



TREBLE DUTY TERMINALS
the possibility of a wrong or accidental connection is practically eliminated.

Every Wireless constructor, experimenter, and amateur should write for a copy. A post card brings it to-day.

VISIT STANDS—
218 & 219 in the Gallery
Wireless Exhibition, September 22—29

J. J. EASTICK & SONS
Eelex House, Bunhill Row,
Chiswell Street, London, E.C.1

MODERN WIRELESS

DURING EXHIBITION TIME
DON'T FORGET TO CALL ON

K. RAYMOND

27 & 28a LISLE ST., LONDON, W.C.2
Come to Leicester Square Tube.

This address is at the back of Daly's Theatre.
Phones: Gerrard 4637 and 2821.

WE ARE OPEN

ALL DAY SATURDAY
ALL DAY THURSDAY
ALL DAY EVERY DAY
Hours: 9 a.m. to 8 p.m.
Sat.: 9 a.m. to 9 p.m.
Sunday morning: 11-1.

LISSEN

Valve Holders, 1/-; Fixed Con., 1/-, 1/6; Leaks, 1/-; Switches, 1/6, 2/6; Latest 2-way Cam Vernier, 4/6; Rheostats, 2/6; B.B., 1/6; Lissenola, 3/6; L.F. Transformers, 3/6; Coils, 60 X, 5/4; 250 X, 9/9; 60-v. H.T., 7/11; 100-v., 12/11; Super 60-v., 13/6; Grid Bias, 1/6; 4-5, 5d.

"Dario" Valves

(Genuine Radio Micro)
Best in the World.
BI-LOUD 2-v. -05, 5/6;
Loud Speaker Valve, 7/6;
R.C. -05 1-B, 5/6; 3-5
-05, 5/6; Loud Speaker
Valve, 7/6; 3-5 R.C. -07,
5/6. Post 6d. each.

M.W. and P.W.
Loading Coils, 7/6

Orders for abroad or outside U.K., additional carriage and packing, insurance, etc., must be included

COSSOR MELODY MAKER

£4:10:0 kit. As COSSOR Specification

Leaflet free. (Wattmeter Choke included)
2 Ormond -0005; 2 Do. S.M. Dials; 6 T.C.C. Condensers; 2 B.B. Clips; B.B. Rheostat; 3 Dubilier Leaks; 3 Lotus V.H.; Ferranti A.F.3; 2 Switches; 1 Cossor Wound Coil; Terminals, Glazite, Grid Bias, Wabool Choke.
Handsome Oak Cabinet, 12/8. FREE with parts
With baseboard. Carr. 2/-
Also Cabinets at 15/11, 18/11.
and Mahogany Polished, at
20-. Carriage 7/-.
COSSOR VALVES 2, 4, or 6-Volt for above. L.F.
D., R.C., or H.F., 10/6 each. Power, 12/6.

LEWCO'S PRODUCTS

O.T. Coils, 40, 50, 60, 75, 3/8 each 100, 150, 200, 5/3 each Glazite, 10d. 10 ft. Litz Wire, 9/38, 4/- 50 yds., 9/38, all silk, 5/6 50 yds. Also in 20 yard reels, Litz, 27/42, 1/16 50 yds. Frame Aerial Wire, 3/8 100 ft. Babney, Brown's, Stevens, 5/6; 5/6; 6-way, 7/6; 7-way, 8/6. All Binocular Coils.
"Q" Coils, 21/- Aerial, 15/- in stock.

C.O.D. Orders despatched same day as received where possible. Send ORDER with instructions and pay Postman. (U.K. ONLY.)

We stock Igranite, Climax, Ever-Ready, Hellesen, Siemens, Formo, Ferranti, Werrite, Ormond, J.B., Benjamin, Lotus, Mullard, Dubilier, Lissen, Lewcos, Utility, Magnum, Peto-Scott, Peerless, Burndept, Pye, Marconi, McMichael, Cosmos, Carborundum, R.I., Varley, Gambrell, Brown's, Stevens, Amplicon—in fact, everything it is possible to stock.

KITS of parts for all CIRCUITS. Make out LIST for keen quotation. DON'T worry, if it's Wireless WEHAVEIT.

TOM TIT TWO

(Pop. W., 15/9/28)
Raymond -0005 used in set), 8 11 (with 4" dial); -0001 Reaction, 5/6; Push-Pull, 1/6; 4 Coil Mounts at 1/-; D.F.D. Anti-Lo Switch, 5/6; 2 W.B. Valve Holders at 1/6 or various makes; R.I.-Varley G.P.L.F. at 15/-. Lissen parts: H.F. Choke, 5/6; -002 fixed, 1/6; 2 -0003 and Clips at 1/-; 3 meg. leak, 1/-.

FREE C.O.D. (U.K.) £2 1s. 5d.
With Ten marked and insulated Terminals, 2 Terminal Strips, Wander Plugs, Wire, Above Flex, Screws.
Handsome Oak Cabinet, with baseboard, 14 x 7 x 9, and panel, 16/11. Carriage 2/-.

OLYMPIC THREE

(Modern, Oct., '28).
2 Formo -0005 at 5/-; 2 good 4" Dials at 1/- each; Reaction -0001, 5/6; 1 Push-Pull Switch, 1/6; 1 D.H.T. with side contacts and central plunger for soldering thru lead, 1/6; Lotus No. 8 P.P. Jack Switch, 3/6; Standard Loading Coil, 7/6; 3 Coil Sockets at 1/-; 3 W.B. Valve Holders at 1/6; Lissen 2 meg. 1 meg. -0003 and -001 fixed at 1/- each; Holder, 6/3; R.I.-Varley Choke, 9/6; Lissen new type, L.F. at 15/-.
C.O.D. 70/-.

FREE Copper Screen, 12 x 6, wire and wood screws, grid bias plugs, flex. Ebonite Panel, With 18 x 7, strip 12 x 2, both drilled (first-class quality), 9 Terminals, engraved and insulated. Cabinets, 18 x 7, 16/11, Oak, Carr. 2/-.

L.T. FROM A.C.

—continued from page 433

condenser, and then, fortunately, the new dry electrolytic type of condenser arrived.

I saw an announcement of the manufacture of these in the United States in an American technical journal, and obtained some early specimens by cabling. The first specimens I received was a block made up of two condensers, one with about 750 mfd. and the other with about 3,000 mfd., the whole being in quite a small compass. How this enormous capacity is obtained in a small space calls for some explanation.

The ordinary types of condenser as used in mains units consist either of long strips of foil separated by long strips of suitable paper, the whole being compressed and sealed, or, in what is known as the Mansbridge condenser, of a long strip of suitable paper on each side of which a coating of metal is deposited, the whole being rolled up and forming, of course, a condenser consisting of the two metal surfaces with the paper dielectric.

A Novel Idea

Years of experience have taught manufacturers how to produce such condensers very satisfactorily, but it is quite impossible to produce by this method a condenser of, say, 3,000 mfd. much smaller than a cube with about 15 in. sides, while the cost of such a unit would put it quite out of the bounds of practical politics for our purpose.

Seeing the principle of all condensers is the same—namely, the use of two conducting surfaces with an insulating space between them—the only way we can make very large capacity condensers in a very small space is by bringing the two conducting surfaces as close together as possible. It is well known that when two electrodes are immersed in certain liquids, and these electrodes connected to a source of electricity so that a current flows from one plate to another, a film of gas bubbles will appear on one of the plates. As soon as this non-conducting gas film spreads over the whole of one conducting surface, the current will, of course, cease to flow.

Indeed, by immersing suitable electrodes in suitable liquid a cell can be formed which will pass a current through an external conductor connected between the two plates until

such a time as the current is interrupted by the formation of the gas film, when the cell is said to be polarised. In "dry" cells (which are really moist cells), one of the electrodes is surrounded by material which brings about the dissipation of the gas film as fast as it is formed, the material being known as a "depolariser."

Some time ago it occurred to certain experimenters that if two plates were immersed in a conducting liquid and a current passed into the cell so formed, so as to produce a polarising gas film on one of the plates, then, owing to the film being of extremely thin formation, a condenser would be formed of very large capacity.

Electrolytic Condensers

Fig. 3 shows the general principle of this condenser, in which we have (a) the surface on which the gas film is formed, (b) the gas film, (c) the conducting the liquid, and (d) the other electrode immersed in this liquid. Redrawing the diagram, we see that here we have a condenser with one electrode A, and another large electrode B, this latter being a composite electrode made up of the conducting plate and the liquid, which can be considered as all one for our purpose.

BUY

POPULAR WIRELESS

The paper that made

WIRELESS POPULAR

Every Thursday :: Price 3d.

The first electrolytic condensers were made with actual liquid, but later it was found that a practical condenser could be made as in Fig. 1, where we have, between the two aluminium plates, a layer of impregnated paper which is made moist and the gas film formed as before. Such condensers can be built to have an enormous capacity—two or three hundred times the capacity being obtainable in the same space as taken by the Mansbridge type. Several forms of this condenser have appeared in America, sundry modifications being introduced from time to time in the general design.

Fig. 1 shows a section of the Tobe-Deutschmann condenser which is practically bone-dry, there only being a slight "tackiness" upon the surface of the foil. In this condenser it is claimed that the dielectric is practically limited to the oxide film on the

(Continued on page 435.)

L.T. FROM A.C.
—continued from page 434

surface of the aluminium positive plate and that special means are taken to prevent, as far as possible, formation of too thick a gas dielectric film. In this condenser it is possible to obtain a total capacity of 5,600 mfd. in space 5 in. by 5½ in. by 1½ in., or 43 cubic inches.

The breakdown voltage of this condenser is in the neighbourhood of 50 volts, far above that we need to impress upon it in a filter for our purpose. I have done a good deal of experimenting with this particular make for my "Stedipower" L.T. unit described in the WIRELESS CONSTRUCTOR.

While this unit was designed to work with the Kuprox rectifying unit, the transformer and other details being worked out to suit it, it is adaptable to existing Westinghouse rectifiers; but in such a case slight variations in chokes and transformer are necessary. If the Westinghouse rectifier type R4-2-2 is inserted in this in place of the Kuprox, the maximum A.C. voltage of nine should be applied to it.

Smooth L.T. Obtained

In such circumstances it will not be possible to obtain 1 amp. of output at 6 volts due to a certain voltage drop in the chokes. While it is possible to make the chokes of a lower resistance, they were deliberately made of 1 ohm, so that in the event of a short-circuit occurring on the output side of the filter the Kuprox unit would not be subject to a too injurious overload for the time being.

Incidentally, the choke made up to my specification for this unit gives better smoothing than those supplied in the United States to go with this condenser.

Space does not permit of a description of the choke-resistance type of L.T. filter which enables smoothing to be obtained without condensers.

It is interesting to note that the Telegraph Condenser Company, Ltd., in England, are developing a very interesting electrolytic condenser which will shortly be available for use with this unit. I have done a good deal of experimental work with the advance models of this condenser, and have found that they smooth just as well as the American types.

A SUCCESS



One stage RESISTANCE and one stage TRANSFORMER in sealed Bakelite moulding

"Two Stage" L.F. Unit

DELIGHTFULLY CLEAR REPRODUCTION AND VOLUME



30/-

Terminals very conveniently arranged, making the components extremely simple to wire.

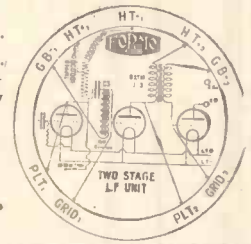

Reproduction of label on top of moulding.

FREE Booklet "L.F. AMPLIFICATION" with Blue Print **ASK** your dealer of 3-Valve Receiver incorporating "Two Stage" unit or send P.C.

VALVE HOLDER ANTI-MICROPHONIC SHOCK ABSORBING

Price 1/3

1st QUALITY BAKELITE throughout, including BASE PLATE. Practically DUSTPROOF.

The springing is such that even rough usage will not affect its liveliness. The "float" is recessed on top, thus making easier the manipulation of valve when plugging into holder. As will be seen from illustration, Terminals are provided as well as soldering tags.



"De Luxe" CONDENSER

TWO-RANGE TUNER

(Reinartz)

FROM HIGH TO LOW WAVE WITHOUT CHANGE OF COIL

A very neat and efficient Aerial Coupler with 6 pins in standard position, this can be used with any standard 6-pin base.

PRICE 10/6

Base 2/-

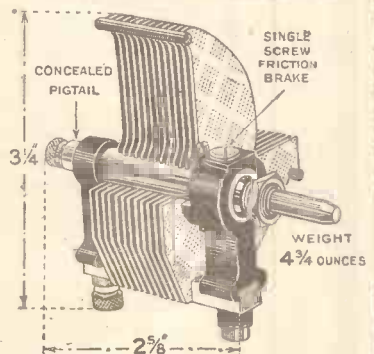

This Condenser has an Capacity ingenious NOISELESS '0005 "PIGTAIL" incorporated '00035 in a manner unobtainable '00025 in any other Condenser. '00015

Price 6/- each



Visit STAND 140, OLYMPIA, Sept. 22-29

CROWN WORKS, CRICKLEWOOD LANE, N.W.2
Telephone: Hampstead 1787

Here is a Panel that will not split or break or crack



and can be sawn, drilled or tapped with ease.

Resiston Panels, like Radion, are made from nothing but pure rubber. They are tough without being brittle. They can be sawn with ease, they can be drilled without fear of fracture, and when tapped will take a good thread.

With Resiston, the home constructor runs little risk of ruining his panel. Its strength, its perfect insulation, beauty of surface and colour permanence are lastingly assured.

Send for new booklet.

Please send me, free, a copy of your new booklet, "The Panel Makes all the Difference."
M. W. Oct.

NAME

ADDRESS



3790

American Hard Rubber Co., Ltd., 13a, Fore St., E.C.2

THE "OLYMPIC" THREE

—continued from page 324

working is apparently done by two on-off switches, both marked S_2 , and it should be explained that these are really the two parts of a single switch. This is actually a double-pole on-off switch of the push-pull type, and the contacts are numbered to correspond with the wiring diagram.

Aerial Switching

Another switch, marked S_1 , attends to the alteration of the aerial and secondary circuits according to the wave-band on which it is desired to work, and this uses a three-contact on-off scheme with which the reader is probably now familiar, since it has been used in a number of our recent sets.

It is simply a push-pull on-off switch of the type with two side contacts and a central plunger to which a third connection can be made by the soldering of a piece of flex, and its function is to control a standard loading coil in the manner now widely used for the aerial and secondary circuits of wave-change sets.

The rest of the circuit is quite straightforward, and we need not linger over it. The L.F. stage is transformer-coupled, and no output filter circuit is provided. If, of course, you intend using a super-power valve in the last stage it would be as well to incorporate the usual scheme of an output choke and 2-mfd. condenser, either on the baseboard of the set or as a separate unit, to protect the loud speaker from the large steady anode current.

The Special Screen

The practical arrangement of the set will be found fairly simple, since there are no special coils to wind and the screening used is very simple, consisting of a plain sheet of copper or aluminium, which you can buy ready cut to size and prepared for mounting if desired. (Messrs. Paroussi, Burne-Jones, etc.) In connection with the screen, note carefully that there are three insulated leads which pass through holes and make no contact with the metal, while at two other points small screws and nuts are inserted in suitable holes and leads are soldered direct to these for earthing purposes.

Plug-in coils were chosen for the aerial, secondary and anode circuits on the lower wave-band, since it was considered that a considerable proportion of the prospective builders of the set would be likely to possess such coils and would welcome the opportunity of using them up in a modern design.

Coil Sizes

Coil L_1 is the aerial or primary, and the size will depend on the degree of selectivity desired (small coil, high selectivity). The usual sizes for an outdoor aerial are Nos. 25 and 35, although for the loudest signals on stations at the upper end of the 250-550-metre band a No. 50 may be a help, except on large aeriels, where it would flatten the tuning unduly. For small aeriels a No. 40 or 50 will usually be correct.

L_2 is the secondary coil, and this should be a No. 60. (A No. 75 will

BUY THE BEST.

All the articles in "Popular Wireless" are written

BY THE BEST

radio contributors and set designers. Why not get "P.W."—and authoritative details.

Every Thursday. Price 3d.

do at a pinch, although it will not tune down to several interesting stations below 300 metres.) For the anode circuit you will require a No. 60 centre-tapped coil, and if you use the same size in the secondary circuit (L_2) you will find that the two tuning condensers require roughly the same setting for any given station.

A variation of selectivity on the long wave-band can be obtained by placing the flex lead shown on a suitable tapping terminal on the loading coil, since this varies the degree of aerial coupling. Terminals "60" and "80" will suit most aeriels, but for high selectivity on a large aerial you should also try "25."

By the way, an incidental advantage of the use of plug-in coils in this set should perhaps be mentioned here. The point is that if you desire for some special occasion to get a little higher amplification and selectivity on the long waves you can do it by treating the set as one of the old-fashioned type, and proceeding

(Continued on page 437.)

**THE "OLYMPIC"
THREE**

—continued from page 436

as follows: Leave the right-hand switch at the "low wave" position (i.e. with the knob pulled out), and simply change the anode coil for one of size 250, centre-tapped. The left-hand wave-change switch should, of course, be pushed in, as for ordinary long-wave work. You will then probably need to re-neutralise a trifle, but since this is a procedure you will not often adopt the extra trouble will probably not worry you unduly.

How to Neutralise

Detailed instructions for building a set like this would probably be a waste of space and the reader's time, since there are no special points involved anywhere, and the diagrams and photos should make everything quite clear. Turning to operating details, it may first be pointed out that suggestions as to suitable types of valves will be found elsewhere in this issue, in the form of notes by our valve expert.

The first adjustment required is that of neutralisation on the lower wave-band, and the procedure for this operation is as follows: Set both the wave-change switches with their knobs in the "out" position, then adjust both the reaction and the neutralising condensers to minimum. Set the left-hand tuning condenser to a mid-dial reading, and revolve the right-hand one through the whole scale, noting whether the set oscillates anywhere. It probably will do so, but if not increase the setting of the reaction condenser slightly until it does.

A Simplified Method

Now proceed to increase the setting of the neut. condenser very gradually until you find that the set just ceases to oscillate, whatever the position of the right-hand tuning dial. Note roughly the setting of the neut. and then go on increasing it carefully until the set starts to oscillate again, when the right-hand tuning condenser is brought into step. Note the new position of the neut., then go back half-way to the one at which you previously found oscillation ceased, and you will have found the right adjustment with a very fair degree of accuracy.

(Continued on page 438.)

DARIO VALVES

"No Radio without Dario"

Radio Micro's New and Astounding
1929 Dark Emitter Valves.

**LOWER
PRICES
THAN
EVER**

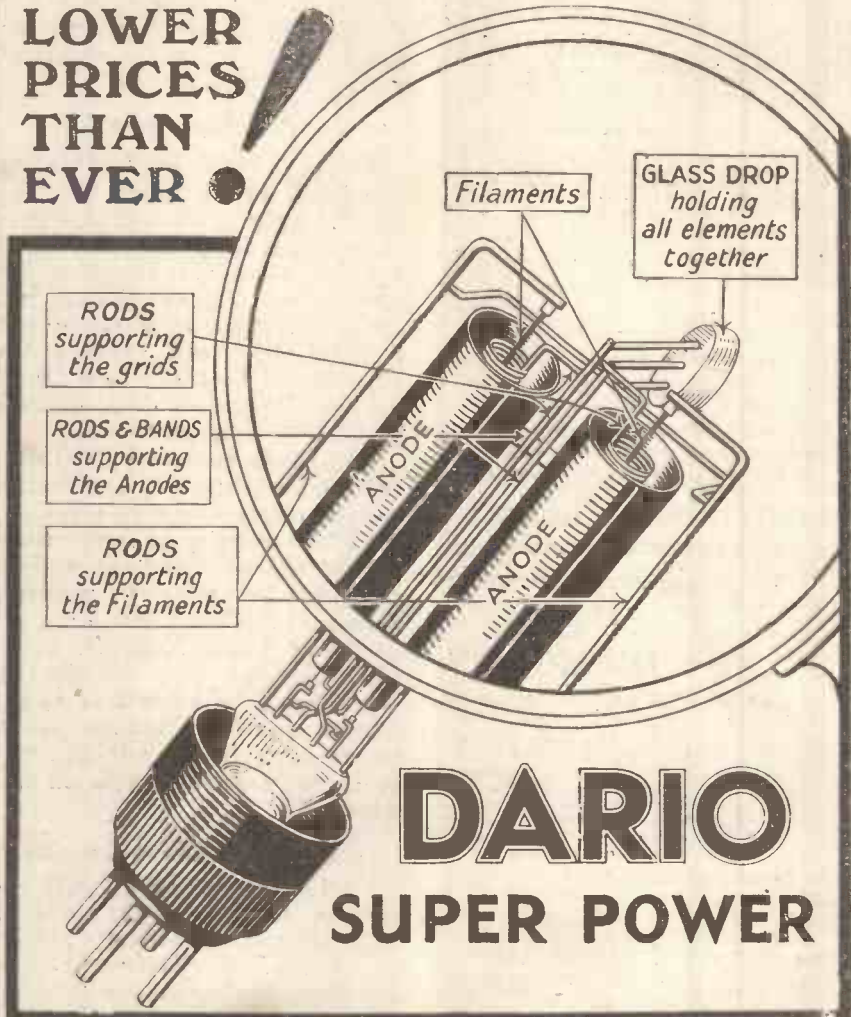

**DARIO
SUPER POWER**

**HIGHEST QUALITY — PERFECT
FINISH — LOWEST PRICES**

ALL BECAUSE Dario Valves are the products of the biggest valve organisation in the world to-day. The huge Dario output enables prices to be kept down to the lowest possible, and vast research keeps Dario design and finish ahead at all times.

2 v General Purpose, .05 amp. 5/6
 0 R.C.C., .06 amp. - - - 5/6
 L Super-Power, .18 amp. - 7/6

4 v General Purpose, .05 amp. 5/6
 0 R.C.C., .07 amp. - - - 5/6
 L Super-Power, .1 amp. - 7/6

From your dealer, or direct:—

IMPEX ELECTRICAL, LTD., 538, HIGH ROAD, LONDON, E.11.

READY RADIO SUPPLY CO.

41, Newcomen Street, London Bridge, S.E.1

Telephone: HOP 6767.

PRICE LIST OF ALL THE CORRECT PARTS

as used in the original

"OLYMPIC THREE"

	£	s.	d.
1 Panel, 14" x 7"	1	2	6
1 Ready Radio Cabinet, with 12" baseboard	1	10	0
2 0005 Formo Variable Condensers	15	0	0
2 Igranic Slow Motion Dials	7	6	0
1 Oydin -0001 Reaction Condenser	1	1	8
1 Push-Pull On-Off Switch	1	1	8
1 Lissen Wave Change Switch	3	6	0
1 Lotus No. 8 Push-Pull Jack Switch	7	6	0
1 Magnum Standard Loading Coil	5	5	0
3 Lotus Coil Holders	5	3	6
1 Peto-Scott Neutralising Condenser	5	3	6
1 Lotus Spring Valve Holders	1	1	0
1 Lissen 2-meg. Grid Leak and Holder	1	6	0
1 Lissen 25-meg. Grid Leak and Holder	1	9	0
1 R.I. Varley H.F. Choke	1	1	0
1 Lissen -0003 mfd. Fixed Condenser	1	1	0
1 Lissen -001 mfd. Fixed Condenser	1	9	0
1 Lissen L.F. Transformer	3	6	6
1 Copper Screen	1	3	6
Terminal Strip	1	3	6
9 Belling-Lee Terminals (as specified)	2	2	6
Glazick, Flex, G.B. Plugs, etc.	1	13	6
3 Valves (as specified)	1	13	6
1 Lewcos Coll. No. 25	3	3	6
1 Lewcos Coll. No. 60	3	3	6
1 Lewcos Coll. C.T., No. 60	3	3	6
	£8	15	3

Write, wire or 'phone (HOP 6767) your order.

Any of the above parts can be supplied separately. Drilling free. The set can be supplied complete for an extra charge of £6. Royalties paid.

Apply for detailed price lists of remaining sets.

INLAND: All orders POST FREE.

OVERSEAS consignments carefully packed and insured.

EVERYTHING WIRELESS



"RED DIAMOND"

RD 40 2/-

THE RECOGNISED DETECTOR FOR ALL CIRCUITS USING CRYSTAL RECTIFICATION. By insured Post 2/3, or 2/9 with shield. Can be mounted on brackets or through panel. Once set always ready. Not affected by vibration. Each one is tested on broadcast before despatch, and is perfect.

RD 39. Pull and Push Switch.

Robust construction. Definite "on" and "off" positions. No shaking. Perfect contacts. Terminals for easy fitting. Price 1/3. By Insured Post, 1/6.



Of all high-class Radio Dealers, or Sole Makers:
JEWEL PEN CO., LTD.
(Radio Dept. '0).
21-22, Gt. Sutton Street, LONDON, E.C.1.

ASTONISHING BARGAINS

in our NEW CATALOGUE

72 Pages, well illustrated and offering the greatest choice obtainable in radio products. Get a copy. Post Free 4d.

ELECTRADIX RADIOS,
218, Upper Thames Street, London, E.C.4.

ALL APPLICATIONS FOR ADVERTISING SPACE in "MODERN WIRELESS" must be made to the Sole Advertising Agents, JOHN H. LILE, LTD., 4, LUDGATE CIRCUS, LONDON, E.C.4.

THE "OLYMPIC" THREE

—continued from page 437

As regards H.T. voltages, you will not find the set at all critical. Terminal H.T.+2 supplies both the H.F. and L.F. valves, and the usual 100 to 120 volts is advised here. For the detector a voltage of the order of 40 to 60 will usually be right, but this should be found by experiment, the aim being to secure the smoothest possible control of reaction.

A Severe Test

Finally, as to results. The receiver was tested on an indoor aerial of fair size hung in the loft of a two-storey house, the down lead running out of doors down to the set on the ground floor. This was probably just about equivalent to a pretty bad outdoor aerial, and provided the adverse conditions we choose for all our standard tests. The distance from 2 L O was about 15 miles.

Under these conditions 2 L O gave full volume on the loud speaker with the reaction condenser at minimum, 5 G B also came in at good volume on the speaker with just a little reaction. By using a moderate amount of reaction (safely below the oscillation point), Hamburg, Stuttgart, Toulouse and, occasionally, Berne, could be brought in on the speaker after dark. On the 'phones twelve other foreign stations came in at really good strength on this wave-band.

Good Long-Wave Results

On the longer waves, 5 X X was good on the loud speaker, and by using again only a moderate amount of reaction Radio-Paris was brought in without interference from Daventry. Three other stations were heard at good 'phone strength, while Hilversum was just up to speaker strength and Zeesen was quite strong.

Quality of reproduction with the "Olympic" Three is of a decidedly high order, so long as you take care not to abuse reaction trying to get weak stations up to full speaker strength. Of course, it is chiefly on the local and 5 G B that high quality really matters, and here the set was found eminently satisfactory.

Indeed, in an emergency it has been used to work a moving-coil speaker, and acquitted itself so well that it was kept at this work for several weeks.

THE "JAMES" H.T. UNIT

—continued from page 362

This is because there is a loss of voltage in the transformer, rectifier, and filter choke, with the result that, as the load current is increased, the voltage falls a little. It is, therefore, necessary to provide means for regulating the output. The easiest method is to tap the secondary winding of the transformer, and to use, say, nine-tenths of the full secondary voltage when the receiver does not require a very heavy high-tension current.

This point is more fully dealt with in the description of the unit below. Having provided a rectifier and smoothing circuit for giving smoothed direct current from a source of alternating current, it is necessary to consider how to obtain the outputs required for the different valves in the receiver, and at the same time how

If you want to keep in touch with radio technique—

If you want to read the radio news while it is news—

If you want to get real value for your money—

Spend 3d. every Thursday

on

POPULAR WIRELESS.

to prevent one anode circuit influencing another as the direct result of their high-tension currents all coming from the same supply. The easiest and most satisfactory method is to connect resistances and by-pass condensers as indicated in Fig. 9.

In this circuit we show three high-tension positive connections. That for the power valve is taken from the filter condenser C₂. For the detector valve a supply is obtained through an adjustable resistance R₁, having a by-pass condenser C₃ connected. The actual voltage between the negative and positive terminals of the detector-valve tapping will depend upon the value of the resistance R₁, the capacity of the condenser C₃, and the amount of current taken by the detector valve. Sometimes the voltage applied to the detector has to be very carefully adjusted, and one is able to do this with an adjustable resistance, as shown at R₁.

(Continued on page 439.)

THE "JAMES" H.T. UNIT

—continued from page 438

For the low-frequency and high-frequency anode circuits a supply is obtained through a resistance R_2 , which is shunted by condenser C_3 . It is hardly worth while using an adjustable resistance at R_2 ; one can quite easily choose a resistance value for R_2 which will provide a suitable high-tension. Thus, if the valves connected to the high-tension terminals marked "L.F." and "H.F." require 4 milliamperes at 120 volts and the voltage across condenser C_3 is 190, the resistance R_2 must have such a value that it absorbs 70 volts when the current flowing is 4 milliamperes—in other words, its resistance must be 17,500 ohms. As a matter of fact, the resistance could have a value of 15,000 ohms when the high-tension voltage would be a little more than 120.

The Maximum Output

If the grid bias of the H.F. or L.F. valves is changed, the anode current will alter and so will the high-tension voltage, but not by a material amount. It is naturally of the greatest importance that the grid bias to the power valves be not varied while the high-tension is connected.

The high-tension current must not exceed 50 or 60 milliamperes or the rectifier will be overloaded.

In the instrument described a milliammeter having a range of 0 to 50 is used in order to help a user not to overload, and, incidentally, as it is connected in the power tapping only, it serves to show up distortion caused by overloading the power valves.

Additional Chokes

A slightly different circuit is used in the instrument illustrated in order to obtain the finest possible results. The circuit of Fig. 9 is quite satisfactory, but when an additional choke is used, as in Fig. 10, the experimenter who has a receiver and loud speaker arranged to give the best possible quality will have an eliminator of the same superior standard.

As a matter of fact, very few receivers and loud speakers will show any difference in results as between the eliminators of Figs. 9 and 10, but Fig. 10 is really the better one.

In the circuit of Fig. 10 will be seen two high-frequency choking

(Continued on page 440.)



Don't Worry

An ohmite anode resistance isn't superstitious; it's only rated to carry 10 milliamperes, and 13 is reputed to be unlucky, but if it burns out at this we will replace it, but no Ohmite has ever been burnt out yet!

That's why

GRAHAM FARISH ANODE Ohmite RESISTANCES

are Better than Wire Wound!

PRICE ANY SIZE UP TO 1/2 MEG **2/3**

GRAHAM FARISH of BROMLEY, KENT
STAND No. 119 AT THE RADIO EXHIBITION

ALEXANDER BLACK, The Wireless Doctor.
will call and cure your set (London and Home Counties). A specialist in quality reproduction. Sets repaired, and modernised.
2a, Woodville Grove, N.16. St. Anne's 5105. Gillsold 3657.

RELIABILITY WIRELESS GUIDE
Send for New Edition No. T.99, with Electrical Supplement. It's FREE. Packed full of good things at keen prices for Wireless Constructors. Trade enquiries solicited.
J.H. TAYLOR & CO.
6 RADIO HOUSE, MACAULAY ST., HUDDERSFIELD

Make or buy a Gramophone or Cabinets only for Wireless at a quarter shop prices. Size 32 x 30 x 16, with double spring motor, 12 in. Velite table, swan tone-arm, soundbox, horn, cups, £5 15s., carr. paid. All the above fittings less Cabinet, £1 18s. 6d. Motors 9s. Accessories, List Free. 64-pg. Drawing and How to Make Gramophone, 3d. Regent Fittings Co., M.W., 120, Old Street, London, E.C.1.

No. 12A £5 15s.

Sideboard Rifaanco Phone

WET H.T. BATTERIES
Solve all H.T. troubles. SELF-CHARGING, SILENT, ECONOMICAL
JARS (waxed) 2 1/2" x 1 1/2" 1/3 doz. Zincs, New type, 1 1/2 doz. SACS 1/2 doz. Sample doz. (18 volts), complete with bands and electrolyte, 4/3, post 6d. Sample unit, 6d. Illus. booklet free. Bargain list free.
AMPLIFIERS, 30/- 2-VALVE SET, 24/-
M. TAYLOR, 57, Studley Rd., Stockwell, London.

The "RADIOLA"

Modernises your Set →

Moving Coil L.S. and → Batteries

A STately HOME!

From £5.5.0

In many sizes.

Fully Guaranteed.

"RADIOLA" De Luxe

WINS HIGHEST APPROVAL of Radio Press, leading experts and over 3,000 delighted clients.

3 ft. high. Rich solid oak or mahogany. A STately HOME! Taking your loud speaker also. LET US HELP YOU.—Suggestions and FULL PARTICULARS FREE. Send now.

PICKETT'S CABINETS

M.W. Works, BEXLEYHEATH, Kent.

TWO VOLT VALVES OF CHARACTER

Don't engage a Valve without a good character!

Cosmos-Met-Vick Valves are each supplied with a written character that will bear the closest scrutiny. It tells of the Valve's ability to do the work for which it is designed, its conduct (on test) and its qualification for a situation in your set.

You can have the fullest confidence that the characteristic curves of a Cosmos-Met-Vick "Shortpath" Valve are closely in accord with the inherent character of the Valve.

Here are some of the details of the two-volt family:—

S.P. 16/B BLUE SPOT	S.P. 16/G GREEN SPOT	FILAMENT VOLTS 2	S.P. 16/R RED SPOT	S.P. 18/RR DOUBLE RED SPOT
0.09	0.09	FILAMENT CURRENT (amps)	0.09	0.3
35	16	AMPLIFICATION FACTOR	9	6.5
0.5	0.95	SLOPE (M.A. PER VOLT)	0.9	1.4
70,000	17,000	IMPEDANCE (OHMS)	10,000	4,500
10/6	10/6	PRICE	10 6	12 6

The Booklet 4117/3 (M.S. 4667) gives the complete information showing why Cosmos-Met-Vick Valves give HIGH AMPLIFICATION, PURE TONE, NO DISTORTION!

Ask your dealer for a copy.

METRO-VICK SUPPLIES LTD.
(Proprietors: Metropolitan-Vickers Electrical Co. Ltd.)

155, Charing Cross Road,
LONDON, W.C.2.

COSMOS SHORTPATH MET-VICK VALVES

Call and see us at
STANDS
32 & 41,
OLYMPIA,
SEPT. 22 to 29

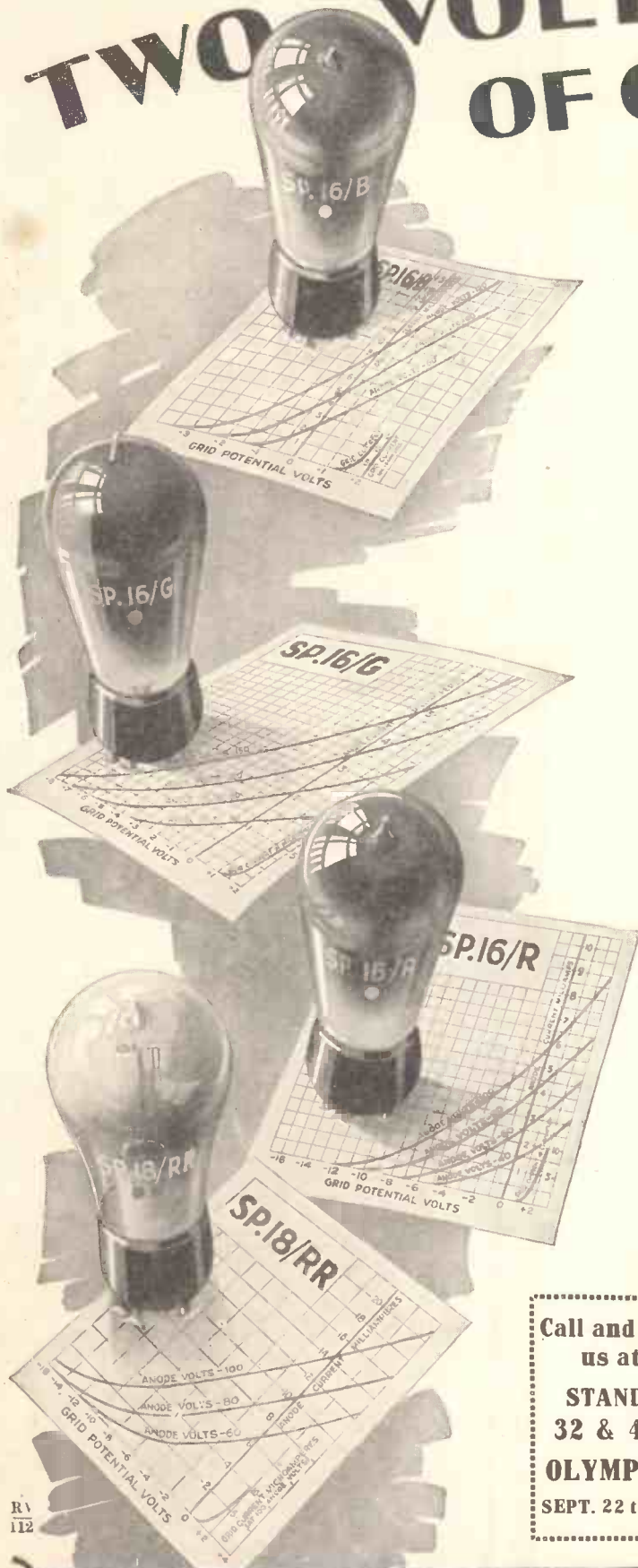

RV
112

REAL ENGINEERING JOBS!

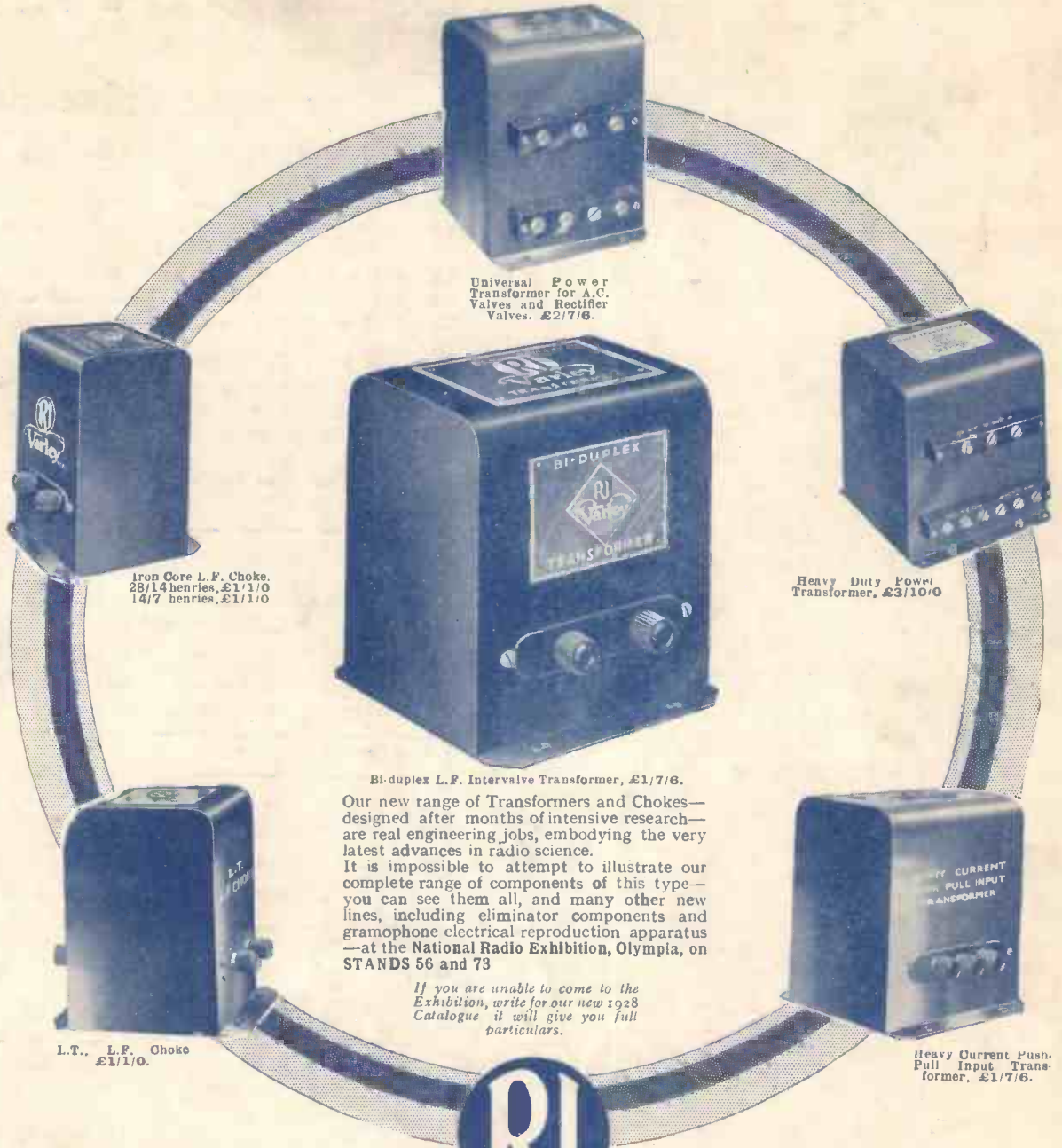

Universal Power Transformer for A.C. Valves and Rectifier Valves. £2/7/6.

Iron Core L.F. Choke. 28/14 henries, £1/1/0 14/7 henries, £1/1/0

Heavy Duty Power Transformer. £3/10/0

Bi-duplex L.F. Intervalve Transformer, £1/7/6.

Our new range of Transformers and Chokes—designed after months of intensive research—are real engineering jobs, embodying the very latest advances in radio science. It is impossible to attempt to illustrate our complete range of components of this type—you can see them all, and many other new lines, including eliminator components and gramophone electrical reproduction apparatus—at the National Radio Exhibition, Olympia, on STANDS 56 and 73

If you are unable to come to the Exhibition, write for our new 1928 Catalogue—it will give you full particulars.

L.T., L.F. Choke £1/1/0.

Heavy Current Push-Pull Input Transformer. £1/7/6.



THE MARK OF Varley LTD. BETTER RADIO

Kingsway House, 103, Kingsway, London, W.C.2.

Telephone: Holborn 5303