

No. 2

INSIDE! DESIGNS FOR SPLENDID WALL CABINET

HOME
CRAFTS
WOOD
WORKING
MODEL
MAKING
AMATEUR
MECHANICS
ETC. ETC.

Hobbies AND PRACTICAL WIRELESS

2^d

February 13th,
1932.
No. 1895.

Published every
Wednesday.
Distributed by the
G.P.O. for Post
mission by Quad-
ruple Magazine Post

INSIDE :
HOW TO MAKE
THIS ALL-WAVE
THREE-VALVE
STATION GETTER!

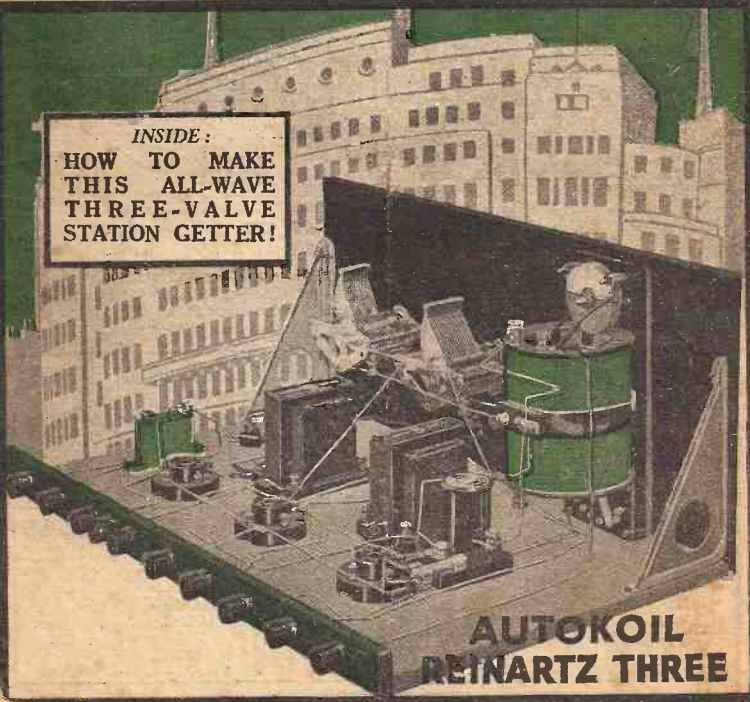

AUTOKOIL REINARTZ THREE

30
acc
men

6d. PACKETS OF SIMPLE FRETWORK DESIGNS



A TOY RAILWAY
A complete set of models. Full size patterns for ten different parts. Any fretworker can cut them out easily.

10 Designs for 6d.

DESIGNS FOR THE BEGINNER.

A set of designs with full size patterns for eight useful and simple articles. Can be made from odd pieces of wood.

8 Designs for 6d.

These packets of designs are of everyday useful articles and models which can be made in an hour from odd pieces of wood. Full size patterns with instructions on cutting, printed on strong paper. Real bargain packets at the price.



Obtainable from any Hobbies branch or agent. Also sent by post (fd. extra) from Hobbies Ltd., Dereham, Norfolk.

HOBBIES

BRANCHES AND AGENCIES. LTD.

Below are the addresses where Hobbies goods can be purchased. In addition all leading stores and ironmongers stock or can obtain in any form of fretwork and woodwork, designs, wood, turned legs, mouldings, polish, and these accessories, etc., etc.

HOBBIES OWN BRANCHES—

LONDON · 65 NEW OXFORD STREET, W.C.
LONDON · 147 BISHOPSGATE, E.C.
LONDON · 83 NEWTON BUTTS, E.C.11.
GLASGOW · 326 ARGYLE STREET.
MANCHESTER · 101 PICCADILLY
BIRMINGHAM · 94 HIGH STREET
SHEFFIELD · 4 ST. PAUL'S PARADE.
L. BRISTOL · 10 QUEEN VICTORIA STREET.
SOUTHAMPTON · 25 BERNARD STREET.
L. BIRMINGHAM · 68 LONDON ROAD.
CANADA · 844 YONGE STREET, TORONTO.

HOBBIES AGENCIES—

Aberdeen—Jas. Math, Ltd. 47 Broad Street; Bedford—Murray, T. & Co. 105 Midland Road; Blackburn—Mr. H. T. & Co. 15 and 15 Manchester Road; Cambridge—Mr. H. & Driver, 28 Hills Road; Canterbury—Mr. T. D. Goddard, 33 Bargepole Street and 16 St. George's Street; Cardiff—J. Hall (Took), Ltd. 51 Morgan Lane; Croydon—J. H. Turle, Ltd. 6 Green Hill; Dover—Mr. E. F. Bockham, Queen's Gardens, Dublin—Mr. J. J. McMillan, 36, Chapel Street; Dundee—Mr. J. Phil, 45, Murray Gate; Folkestone—Mr. W. Alworth, 16 & 18, Guildhall Street; Hastings—Mr. W. H. Mowley, 4 York Buildings; Hull—Mr. C. F. Walker, 17 & 18 George Street; Leicester—Mr. Frank Berry, 3 Lonsdale Lane; Liverpool—Mr. O. Lucas, 35 Manchester Street; London—Messrs. H. Goun, 166 Aldersgate Street, E.C.3; Newport, Mon.—J. Hall (Took), Ltd. 81, High Street; Reading—Mr. W. J. Harlett, 44 West Street; Swansea—J. Hall (Took), Ltd. 8 Dover Street; Wick—Mr. Thorpe, 3, St. Cleopas, 22 Standishgate; York—Messrs. J. H. Spinkman & Sons, 137, Micklegate.

HEAD OFFICE AND WORKS:
DEREHAM, NORFOLK

LITTLE THINGS THAT COUNT

How many times have you been "hung-up" for a single screw, or just one certain hinge? Don't repeat such an experience, but have a supply at hand. A stock of popular sizes in all three subjects is no ill store at any time. The quality can be relied upon and the price is right.

STRONG BRASS HINGES

These hinges are well made and specially suitable for Boxes, Cabinets, etc. Although thin, they are strong and are guaranteed to give satisfaction in any service.

2½ 1½ 1¼ 1 ¾ ¾-in.
Prices 4d. 2d. 1½d. 1d. 1d. 1d. per pair
Postage 1½d. extra.

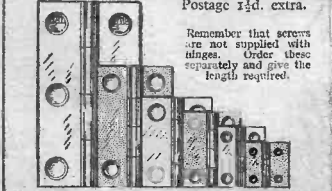

Remember that screws are not supplied with hinges. Order these separately and give the length required.

From all Hobbies Branches or Agents all over the country, or from

HOBBIES LTD., DEREHAM, NORFOLK.

BRASS AND IRON NAILS

These are special fretwork nails—very thin but very useful and quite strong. They are supplied in brass and iron 1-in., 1½-in., 2-in., 2½-in., 3-in., long, and are always a boon to the fretworker.

6d. per Box.
Postage 2d. extra.



BRASS AND IRON SCREWS

Fretworkers require special thin-shank screws for their work and these are specially made for them. Made in brass or iron with round or flat heads. In useful sizes—½-in., ¾-in., 1-in., 1½-in., 2-in., or 2½-in. State all details when you order.

IRON: 1½d. dozen. 1/2 gross.
BRASS: 2½d. dozen. 2/2 gross.
Postage 1½d.





Vol. 73. No. 1,895

Published Every Wednesday

FEBRUARY 13th, 1932

THIS WEEK'S CLEVER IDEAS

An Ingenious Spanner.

THERE seems to be no end to the number of new spanners produced for the convenience of handymen. Here is the latest. It will be seen that it is of the set spanner variety, and its chief appeal resides in the fact that only one holder is necessary. The gap in the jaw, it will be seen, takes a number of interchangeable jaws, each of which will suit a particular style of nut. The jaws spring into place and stay there. A slight pressure on the tail-piece removes them.

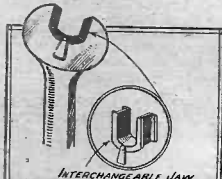

A set spanner with interchangeable jaws.

A Practical Chemistry Outfit.

THE correspondence we receive from readers shows that chemistry is a fascinating and popular hobby. The famous firm of Lotts Bricke, Ltd., have recently marketed a number of chemistry boxes at prices varying from 3s. 6d. to 10s. 6d. They have been planned by a practical chemist, and each box contains a generous supply of all those chemicals which can safely be used at home by young and old alike for the performance of a number of fascinating chemical experiments. By means of these chemical outfits the reader will be able to perform all of those experiments detailed from time to time by our Chemistry contributor—experiments such as growing coloured trees, making flares, making big crystals, etc., etc. Box No. 1, at 3s. 6d., contains 18 chemicals, a number of accessories, and an illustrated handbook of 42 experiments. Box No. 2, at 6s., has 22 chemicals, a Bunsen burner, accessories, and a book of 80 experiments. Box No. 3, at 10s. 6d., has 30 chemicals, a Bunsen burner, extra accessories, and a book of 131 experiments. The makers supply spares.



A cheap "dim and bright" cycle lamp.

A New Gramophone Sound-box.

THE gramophone sound-box here illustrated, and known as the "Big Ben," costs 8s.-6d., and is fitted with a stylus bar running in miniature ball bearings. It has a metal diaphragm of aluminium and gives far greater volume than the average sound-box.

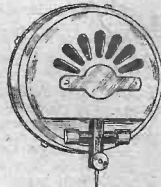

A new metal diaphragm gramophone sound-box.

A New Cycle Lamp.

A VERY powerful cycle lamp having a two-way switch, giving a dim and bright light, is shown at the foot of this page. The case only costs 3s. 6d., or complete with two pocket lamp batteries, 5s. It is strongly made.

Safety-First Armlet.

A SIMPLE device, consisting of an elastic armlet, with red reflector at the back and a yellow one in front, has recently been marketed at 6d. (by post 7d.). It is intended to be used by pedestrians who have to use dark country roads, as well as by hikers and campers. It may easily be carried in the pocket when not in use.

Making Perfect Joints.

WE are often asked which is the most effective means of making satisfactorily stuck joints for models, etc. In our experience the use of an adhesive such as

Secotone gives excellent results, with very little trouble and at little cost.

Secotone will stick and repair practically everything. It is recommended to the readers of Hobbies because we have known and used it for nearly forty years. It sets hard as a rock and a neat joint is always made. It can be obtained everywhere in tubes 4d., 6d., and 9d. An interesting booklet describing the uses of Secotone can be had from the manufacturers.

The address of the manufacturers of items mentioned on this page can be obtained on application to the Editor.

NOTES AND NOTIONS from our READERS

An Electric Switch for a Motor-boat Engine.

AN ingenious electric switch which also adds to the appearance of the motor-boat is that shown in the sketch. The two contacts should be fitted as shown, and the contact arm

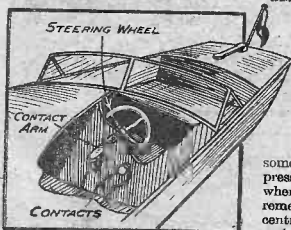

An electric switch for a motor-boat engine.

is attached to a dummy steering wheel. By turning the wheel, contact is made and the engine will start.—H. GILMORER (12, Boleyn Road, East Ham, E.6).

A Wireless Valve Tester.

IF you are unfortunate enough to fuse a wireless valve, do not throw it away, but remove the glass bulb and all the interior until you have left the hollow base and four pieces of wire attached to the legs. Break off the two wires that are joined to the grid and plate legs and solder the two remaining wires to a 3.5 volt torch bulb. The bulb can be fixed in the base with candle grease or pitch.

If you desire to test out a new set insert the tester into the valve socket, and if this wiring is all right the bulb will light. If something is wrong with the wiring—well, a twopenny bulb is a better loss than an old shilling valve.—C. PORTER (1, Colenso Road, Clapton, E.5).

A Simple Gramophone Pick-up.

TAKE out the inner rubber ring and mica sheet from your sound-box and obtain a round piece of ebonite that will fit into it. On to this fit the two coils from a 'phone

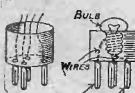

A valve tester for wireless enthusiasts.

ear-piece. Make two holes in the ebonite for the leads which are connected to the coils. In place of the mica put the diaphragm into

THAT DODGE OF YOURS?

Why not pass it on to us? We pay Five Shillings for every item published on this page. Mark your envelope 'Notes and Notions'. Put your name and address on every item. Every notion sent in MUST be original.

the sound box. Next put the coils in and complete the pick-up as shown in the sketch.—(No name.)

A Fretting Table Hint.

READERS who have fret-machines with "side wings" have no doubt experienced difficulty with the table, which sometimes slips to one side, when pressure is put on either wing, even when tightly screwed. A simple remedy is to bore a hole in the centre of the semi-circular clamp under the thickness of a strong screw 2in. long. Another hole should then be bored in the top arm, where the

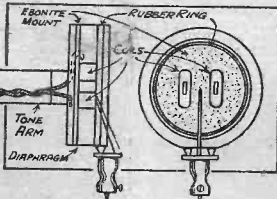

A simple gramophone pick-up.

clamp grips. Fix the screw into this hole, and file the head of the screw away, as shown in the sketch. When the clamp is placed on again, put the protruding end of the screw into the hole in the clamp, thus preventing the table from slipping.

THIS WEEK'S MENTAL NUT.—No. 4.

THREE books will be awarded each week for the first three correct solutions opened. Mark envelopes "Mental Nut No. 4."

A MAN entered a post office, handed over 5s., and said: "Please give me some 2d. stamps, five times as many 1d. stamps, and make up the rest of the money in 2½d. stamps." How many stamps did he receive?

Answer to Last Week's Problem.

THE man must have commenced with 3s. 6d.

An Easily-made Morse Buzzer.

A REALLY good morse buzzer can be made from an old door bell. First of all, remove the long arm holding the ball which beats against the bell. Care should be taken, when doing this, not to distort the spring on the steel arm. When this has

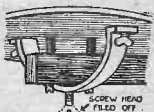

Preventing the fretting table from slipping.

been done, the contact screw will need an adjustment in order to obtain a high-pitched note. A simple key can easily be made with a piece of clock spring, as shown in the sketch. It mounted on a wooden box, the buzzer will sound much louder. A battery can be fitted inside.

A lamp for signalling can be worked off the same battery. All that is required is a simple switch for the change over from sound to visual. This can also be made from a piece of clock spring, a terminal, and two contact studs. The wiring is shown in the sketch.—F. BOND (Moathouse Lodge, Stanley, Nr. Wakefield).

A Useful Fire-lighter.

TO make a simple and permanent fire-lighter, knead together a lump of pipe-clay with about the same amount of sawdust and shape it into the form and size of a bottle cork. Make a hole through it to receive the wire handle, and then leave it to get thoroughly dry. Having reached this stage, it should be placed in a fire and allowed to bake until white hot. This will burn out the sawdust, leaving the clay in a very porous condition. When cold the wire handle should

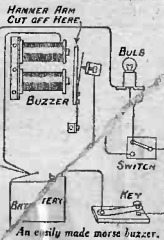

An easily made morse buzzer.

THE "AUTOKOIL REINARTZ THREE"

A Blueprint showing the wiring of this set may be obtained for 1/- post free from the publisher, Geo. Newnes Ltd., 8-11, Southampton St., Strand, W.C.2.

As the problem of jamming in wireless reception is an acute one nowadays, and as our preliminary tests with the Autokoil Unit on standard circuits (see the Autokoil All-Wave Three, December 12th, 1931, and the Autokoil Two, January 23rd, 1932) showed that this special all wave tuner solves the problem in an entirely satisfactory way, we decided to incorporate it in the well-known Reinartz Circuit, which, as most readers know, is renowned for the volume obtainable from three valves. The great problem with selectivity is to cut out jamming without reducing the range of the set. Quite a number of devices produced to increase the selectivity of the set do so by the simple process of making most of the stations disappear altogether! With the Autokoil, however, we found that knife-edged selectivity was obtained and that we were still able to get all of the jamming stations. Our experience with the Autokoil in the Reinartz set shown in the photograph on this and the next page confirms our conclusions, for this set is equal in volume and range to any five-valve set. The volume is truly remarkable, and as it is an extremely simple set to make, and as also the fewest possible components are employed in the making, it is a set we can thoroughly recommend our readers to make. We have already

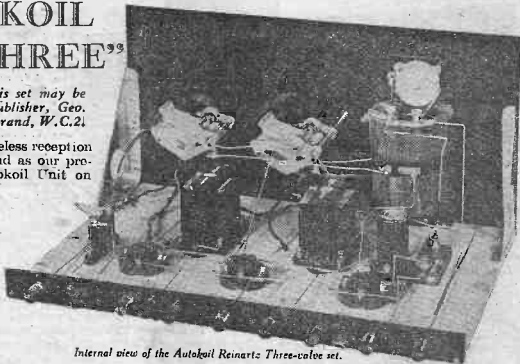

Internal view of the Autokoil Reinartz Three-valve set.

explained in the two issues referred to above how to use the Autokoil, and we do not propose, therefore, to make further reference to that very satisfactory unit which for 12s. 6d. provides you really with half this circuit. The full circuit is shown at the foot of this page and the list of components on the next. Those readers who wish to buy a complete set of parts should consult advertisers in this issue. A full-sized blue-print wiring diagram of this set may be obtained from the Publisher, Geo. Newnes, Ltd., 8-11, Southampton Street, Strand, W.C.2, for 1s. post free.

It takes about two hours to mount the components and wire them up, as it is scarcely possible to make a mistake in the wiring as the Autokoil is clearly marked

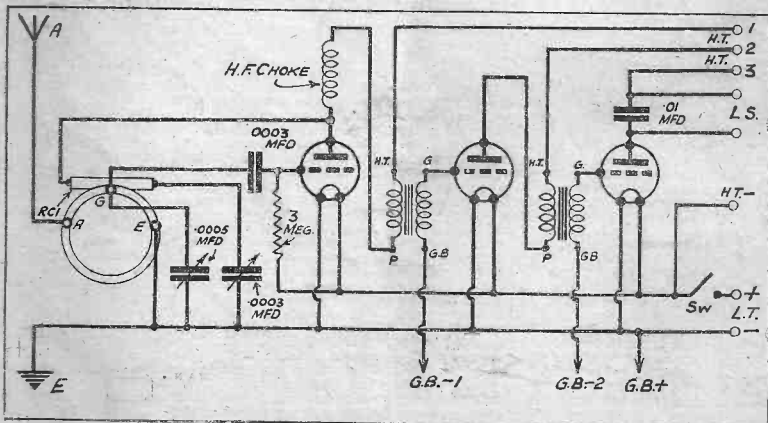

Circuit diagram of the Autokoil Reinartz Three-valve set.

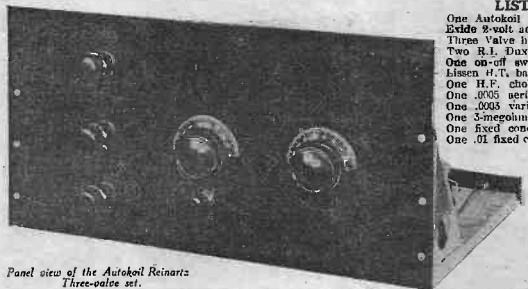

Panel view of the Autokoil Reinartz
Three-valve set.

to correspond with the letter references in the circuit diagram. It will be seen in the photograph that the Autokoil is mounted vertically, with the compensating condenser knob at the top, in which position the reaction knob is the central one and the wave-change knob the lowest of the three. In operating the set, therefore, first adjust the lowest knob to the wavelength band on which it is desired to tune, remembering that with the switch arm in the extreme left position (viewed from the panel) the set will receive on the lower wave band, and in the extreme right position the highest wave band. The Autokoil tunes from 200 to 2,000 metres.

LIST OF COMPONENTS.

One Autokoil All-Wave Tuner.
Eddie 8-volt accumulator.
Three Valve holders (Clix or Lotus).
Two R.I. Dax L.F. Transformers.
One on-off switch (Lissen).
Lissen H.T. battery.
One H.F. choke (Lissen).
One .0005 aerial-tuning condenser (Polar).
One .0035 variable condenser (Polar).
One Smerglun grid leak (Dial Hfr).
One fixed condenser .0003 (T.C.C.).
One .01 fixed condenser (T.C.C.).
Terminals: aerial, earth, I.T. positive, I.T. negative, H.T. positive 1, H.T. positive 2, H.T. positive 3, H.T. negative, Loud-speaker positive and negative, grid bias positive, grid bias negative 1, grid bias negative 2 (Clix).
One ebonite panel, 15in. by 7in., baseboard 15in. by 7in. (American Hard Rubber Co.)
Two panel support brackets (Cameo).
One terminal drip.
Wire for connections.
One Cam o callinet.

Next, adjust the aerial tuning condenser until a station is received, then adjust the reaction knob, next the compensating condenser knob, and finally the .0003 variable condenser. It will probably be found that this set works best with H.T.1 plugged into about 30 to 30 H.T. volts, and a little experiment with the other tappings will adjust the purity of the reception. Similar adjustments should be carried out with the grid-bias tappings.

The set is simple to operate and if the circuit diagram is carefully followed requires a minimum of adjustment.

WHEN one considers the amount of time members of the Royal Family have to devote to social duties, one wonders that they can find time for hobbies, and still more, that many of them harbour the insatiable spirit of the collector.

The Prince of Wales has probably the largest range of pastimes, which group themselves under the two main headings of sport and music, except for stamp collecting, which taste he has inherited from his father. When the Prince was up at Oxford he played soccer for the Magdalen 2nd XI, but since then he has developed a keen interest in riding and big-game shooting, and has lately taken to speed-boat racing.

A leaning towards music is strongly evinced in the Royal Family, and the Prince is an adept with the saxophone and ukulele, and is learning to play the banjo.

Besides these instruments he plays the bagpipes, and has a large collection of gramophone records kept well up to date, and he never travels without the gramophone given to him by Queen Alexandra.

When Princess Mary is visiting Yorkshire she does not spend all her time hunting. She gives many hours to practice at the piano.

Another royal pianist is Prince George, who confines himself to light music. He has a keen ear and sense of rhythm, and can play most of the popular tunes by ear. A tan impromptu dance His Royal Highness played jazz while the gramophone was being mended.

The Duchess of York's love of music takes her to the old world instruments, and she plays the spinet with considerable ability, and is having lessons on the harp.

Possibly the vogue for doing tapestry work is due to the Duchess, who amused herself thus when convalescing after influenza some time ago. The Duke, however, shows more interest in engineering than music, and has

ROYAL HOBBIES

the deft hands of a mechanic, which enable him to work at the lathe set up in his study at 145, Piccadilly. He has also begun a collection of model engines and has twenty tiny brass replicas of noted locomotives kept in a cabinet, referred to by Princess Elizabeth as "Daddy's toy cupboard."

In a top room at Buckingham Palace is housed the largest and most perfect collection of British and Colonial stamps in the world. The King is often incorrectly described as a collector of foreign stamps, but in those two hundred volumes there is not one stamp which was not issued in the British Empire.

His Majesty has a special interest in his book of errors and curiosities which are, naturally, more valuable than the perfect specimens owing to their rarity. Errors are not, as might be imagined, presented to the King, for it is the duty of specially-appointed examiners to destroy all stamps which are printed imperfectly, and all the King's stamps are obtained by means of exchange or through sales and agents. Many times stamp enthusiasts have been commanded to the palace.

Another of the King's hobbies is collecting old clocks, and he also adds to the collection of music originated by George III and Queen Charlotte.

Curios and antiques occupy the spare time of the Queen, particularly English and Chinese lacquer. The Chinese room in Buckingham Palace proved such a success that Her Majesty determined to decorate one similarly at Windsor, but Sandringham is her favourite residence, where her apartments are furnished with Chippendale, Hepplewhite, and Sheraton. It is from here that the Queen chooses her exquisite pieces for exhibition and here also that she has her favourite piano and her collection of miniatures of the Royal Family when they were children.

SCIENTIFIC EXPERIMENTS

By W. Richardson

Previous articles on this subject appeared in "Hobbies"
Nos. 1872, 1875 and 1886.

Fig. 4.—A revolving lamp shade worked by hot air.

WE stated in the first article of this series that heat is transmitted in three ways, namely, by conduction, convection and radiation. We have given examples of conduction and shown how some substances are better conductors than others. Let us now make some experiments in convection and radiation.

In heating liquids convection plays an important part. For instance, water which is a poor conductor, would take far longer to heat than the fact that as at the bottom of heated it rises to

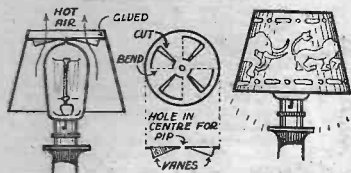
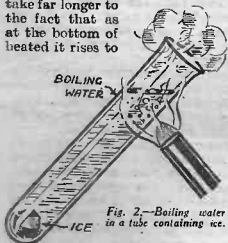

Fig. 2.—Boiling water in a tube containing ice.

heat were it not for soon as the water the vessel becomes the top and allows some of the colder water to take its place. This cold water in turn becomes heated and rises, and so the cycle goes on until all the water is brought to the same temperature.

To Show the Convection Currents in Liquids.

Fill a glass flask or beaker with water and drop in a few crystals of potassium permanganate. Heat the beaker over a small flame. The water above the heated spot becomes warm and ascends, coloured by the permanganate. When it reaches the top it spreads out and then descends on the outside as shown by the arrows in Fig. 1. Now if we can arrange to heat the water in such a manner that convection cannot take place, only that part in contact with the source of heat will become warmed. This is because water, like most liquids, is a very poor conductor.

To Boil Water in a Tube Containing Ice.

Fill a test tube with water into which has been placed a small piece of ice. If you cannot get ice a piece of candle wax will serve to demonstrate the point. Now heat the bottom *only* of the tube. The ice or wax quickly melts and the water boils. The contents of the tube and perform the experiment again, but this time heating the tube near the *top* of the water as in Fig. 2. The water will soon boil at the top but will remain cold at the bottom, boiling water and ice being present in the tube at the same time. In the first case the whole of the water becomes heated, due to convection. In the second case, however, convection does not take place since the hot water is already at the top and therefore cannot rise any farther. Engineers are careful when designing boilers, radiators, and hot

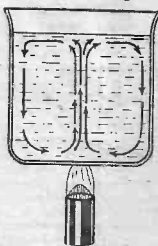

Fig. 1.—Showing the convection currents in liquid.

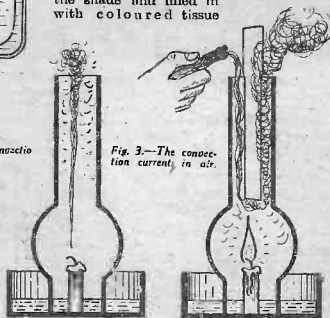

Fig. 3.—The convection current in air.

water systems etc., to see that full use is made of convection. For instance, boiler tubes are not made horizontal, but rise slightly from the furnace, end so as to set up proper circulation and thus distribute the heat. The hot water from the water jacket of a motor car engine is led to the top of the radiator, where it becomes cooled and sinks to the bottom. It is then led back to the bottom of the water jacket to go through the same process again.

Convection occurs in gases in much the same way as in liquids. Here is a simple experiment:

To Show Convection Currents in Air.

Place a lighted candle in a shallow dish and just cover the bottom with water so as to make an air-tight joint with a lamp glass which is now placed over the candle. The candle flame will become smoky and go out (see Fig. 3). Relight the candle and replace the glass but, this time, before the candle goes out, slide a strip of card down the lamp chimney. The candle will immediately brighten up and continue to burn in a normal manner. The reason is that, whereas in the first case the flame is extinguished for the want of air due to the lack of circulation, in the second case the hot air rises up one side of the card division and fresh air depends the other side to take its place. If a piece of smouldering paper is held as shown in the illustration the smoke from it will pass down one side of the card and emerge from the other, clearly showing the path of the air currents. Here is another interesting experiment.

To Make a Revolving Lamp Shade, Worked by Hot Air.

This is a very cute device, sometimes used for advertising and is extremely simple to make. It consists of a light card shade which is supported on the "pip" of an electric bulb fitted to a table lamp. It is constructed as shown in Fig. 4, and depends for its action on the rising currents of hot air from the bulb. These drive the vanes and so revolve the shade. Dainty designs may be cut in the sides of the shade and filled in with coloured tints.

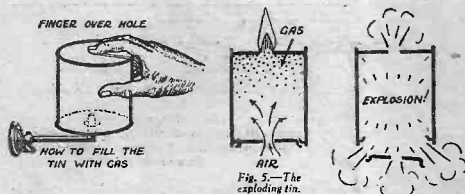

Fig. 5.—The exploding tin.

paper. A couple of such lamps do much to brighten the table at dinner or at a birthday party.

Before turning our attention to radiation we are going to tell you of a rather exciting experiment which is not strictly concerned with convection. It is dependent on the rising of coal gas, due to its lightness rather than to its being heated.

The Exploding Tin.

Pierce a hole about $\frac{1}{2}$ in. in diameter in both the lid and the bottom of a tinscan or custard-powder tin. Turn the tin upside down and, placing a finger over the hole in the bottom, fill it completely with coal gas by holding it over a gas jet so that the burner enters the hole in the lid (see Fig. 5). Hold it in position for some seconds to expel all the air. Turn off the gas and remove the tin. Hold it upside down still and apply a match to the hole in the bottom. The gas will light and continue to burn steadily but the flame will gradually get smaller and smaller until at last you will think it is going out. Just as it gets to its lowest, however, there is a loud explosion and the lid of the tin flies off on to the floor! The explanation is this: The gas, owing to its lightness, gradually rises and passes out of the hole in the bottom of the tin where it burns steadily. At the same time air enters through the hole in the lid and takes its place. Presently a state is reached where the tin contains not gas only but a highly explosive mixture of gas and air. It is then that the flame "lights back" and explodes the contents. Just a word of caution: Make certain the tin is properly full of gas as, if there is still air present, it is likely to explode directly you hold the match near the hole, possibly very violently at that. We will now turn our attention to **RADIATION**.

Heat radiations and light are very similar. Both are wave motions in the ether and have the same velocity. The difference lies in the wave length. Light waves are short; violet light having the shortest wave length and red the longest. Longer waves than these are light but heat, and longer still are wireless waves!

Apart from the fact that heat can be reflected by mirrors and lenses in the same manner as light, one of the most interesting things about it is the way in which some surfaces absorb it and others reject, or rather reflect it. For instance, a black surface absorbs heat readily, thus a black coat gets very hot and uncomfortable on a hot, sunny day. A light or silvered surface, however, reflects it, hence a white garment is more suitable in summer.

A good experiment to illustrate the distinction can easily be performed as shown in Fig. 6.

The Mysterious Dagger.

On one side of a stout piece of tin-foil or a thin piece of tin-plate draw the shape of a dagger with ordinary students' lamp black as in Fig. 6. The use of candle smoke will serve even better if a clear outline of the dagger is made by masking the tin or by wiping away the unwanted black. Now grind up some mercuric iodide, which is a scarlet powder, with a little gum water and paint the back of the tin-foil with it. Heat a flat piece of iron to redness and hold it about two inches from the front on which you have the outline of the dagger. Gradually you will see a yellow dagger appear on the red side of the tin. On removing the hot iron the dagger will disappear, leaving a plain red surface again. What happens is that the black dagger absorbs more heat

from the iron than the bright tin, thus the mercuric iodide opposite the dagger also becomes heated and as it turns yellow on heating a yellow outline of the dagger appears.

A surface which absorbs heat readily also forms a good radiator and a surface which reflects it is a poor radiator. This is why a bright polished teapot does not get cold so quickly as a dark one. It does not radiate the heat so readily. To prove this fill a tin box with hot water. One side of the box is covered with lamp black and the opposite side is bright tin (see Fig. 7). Two glass tubes with bulbs at one end are connected as shown with a "U" tube which contains some coloured water. The bulbs, which are previously blacked, are arranged on either side of the tin box so that one is opposite the black side and the other opposite the bright side. The water in the tube which would naturally be the same level in each limb, will be seen to go down one side and up the other. This is due to the fact that the black surface radiates more heat than the polished and therefore heats the bulb opposite to it more than the other one. This causes expansion of the air in the bulb and drives the water down the tube and up the other side. The apparatus with the bulbs and "U" tube is known as a differential air thermometer and is well worth making. It will detect very small differences in temperature and is very useful in experiments on radiation. In our next article we shall conclude our experiments on heat and light and describe some dealing with sound.

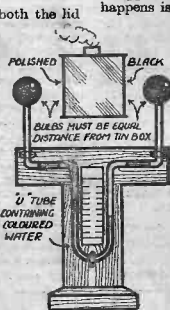

Fig. 7.—A differential air thermometer.

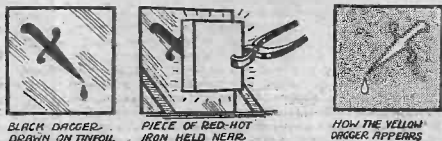
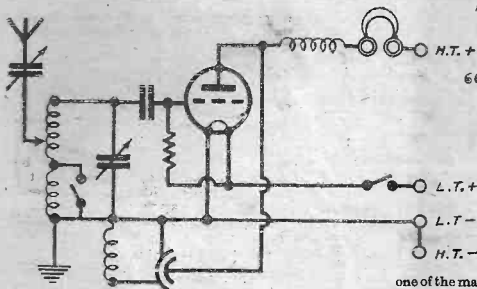

Fig. 6.—The mysterious dagger.



THEORETICAL CIRCUIT

I THINK it is no exaggeration to say that a well-designed one-valve used with a good pair of 'phones will give practically the same range and generally far better quality of reproduction than the average loud-speaker "three"; then again, the difference in running costs is another point which cannot be overlooked.

The HOBBIES British One-Valver is a quality set which I am sure will more than uphold its own amongst the many receivers of this class in existence. It is a receiver which will appeal alike to the novice and experimenter, and in order to make its construction as simple as possible we have had prepared a full-size blueprint of the lay-out. With this print, which, by the way, you can obtain from HOBBIES Blueprint Dept. for a shilling, the problem of assembly is practically solved.

How to Use the Blueprint.

You simply lay the print on the baseboard, place each component in its proper position on the print, start the holes for the holding-down screws with an awl, remove the print and screw the parts in place. In the case of the panel, you mark where the holes are to be drilled in just the same way. Quite simple, isn't it?

An All-Purpose Receiver.

I have just stated that this set would appeal both to the novice and experimenter. You may argue that this is rather a rash statement since the average experimenter seems to judge a set by the number of knobs it has, his idea being that the more adjustments that can be made, the better! On the other hand, the novice, or for that matter, the average listener, likes the controls to be as simple as possible. Well now, how have we overcome such a difficulty? Simply like this: on the front of the set there are just the usual two knobs and switches, these being the only controls the average listener need worry about. Inside, however, you will find two means of controlling volume and selectivity, which will be appreci-

THE "HOBBIES" BRITISH "ONE-VALVER"

You may obtain a blueprint showing the wiring of this set for 1/- post free from the Publisher, Geo. Neames, Ltd., 8-11, Southampton Street, Strand, W.C.2

ated by the enthusiast desirous of exploring the full possibilities of the set.

The Circuit.

This is quite straightforward. For tuning and reaction I have chosen the best quality plug-in coils in preference to one of the many dual-range coil units on the market because the latter, although excellent in multi-valve sets, are mostly somewhat too sharply tuned for a one-valver, with consequent loss of signal strength. Reaction is obtained by means of one coil only. It is so positioned as to be effective on both the medium and long waves. Smooth action is assured by the use of a differential reaction condenser. Wave changing is accomplished by short-circuiting the long wave coil with a simple switch. No coil changing is necessary! Incidentally, "shorting" this coil brings it at earth potential and being some distanced from the medium wave coil will not cause any "dead end" effect when tuning on the lower band. The aerial, it will be noticed, is connected to a semi-fixed condenser, the other terminal of which is joined to one of the three tappings on the aerial coil, thus providing the two means of adjusting selectivity previously mentioned.

LIST OF COMPONENTS.

- One .0005 MFD Polar No. 2 variable condenser.
- One .0005 MFD reaction condenser (Polar Compax).
- One Clix Type "B" low loss valve holder.
- One .0005 Lissen fixed condenser.
- One 2 Meg. Lissen grid leak with clips.
- Two Lissen "on-off" switches.
- One Telsan H.F. choke. One panel 5in. by 5in.
- One baseboard 5in. by 7in. Battery cords.
- Four Clix Viegrip terminals. Two terminal mounts.
- One semi-fixed "Formodenser" max. .0005 MFD.
- Three Lissen baseboard coil holders.
- Two Clix fit-all spade terminals.
- Two Clix wander plugs. Hydrotone cabinet (J. J. Eastick).
- One Eia valve No. B12010 detector.
- One Lissen H.T. battery.
- One Exide L.T. accumulator.
- One pair headphones. Coils: 1 Lewcoo 50X, 1 Tunewell 60, and 1 250.
- Wire for connections.

coil holder, the connections will be made the wrong way round. Regarding the wiring, it will be noticed that no soldering is necessary, all wires being taken direct to the terminals on the various components. The battery leads should be secured to the base by means of a small brass strip as shown, then there will be no chance of accidentally wrenching them off.

Having gone over the connections carefully to see that everything is in order, join up your aerial, earth, 'phones and batteries. Now plug in your coils connecting the lead from the pre-set "Formodenser" to No. 2 tapping on the X coil. The knob on the Formodenser should be screwed down half way. Lastly, insert the "Eia" detector valve and switch on the filament. The wave-change switch should be set for the medium waves and in for the long waves.

No. 1 tapping gives greatest selectivity, No. 2 gives medium selectivity, and No. 3 gives greatest volume.

Previous articles appeared in Nos. 1854, 1855, 1856, 1858, 1861, 1866, 1868, and 1873.



CHEMISTRY FOR AMATEURS

By H. Welton

THE SIMPLE PROCESS OF DISTILLATION.

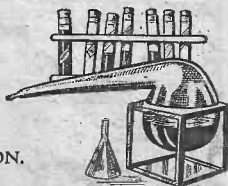

A CHEMICAL process of great utility and interest is that of distillation. By its means, highly purified products are obtained from crude substances. For instance, modern lubricating oils are distilled from crude petroleum, while "Scotch Shale," subject to the same process, provides us with paraffin (medicinal), paraffin wax and soft paraffin (white and yellow, known usually as petroleum jelly). And thus we might continue with illustrations, whisky and spirits, raw alcohol, benzene, and a multitude of other commodities—all these manufactured by a distillation process.

The operation is simple—it consists merely of converting a liquid into its vapour and then recovering it by condensing the vapour against a cool surface.

A few moments consideration will make it evident

that the distillation process may be employed to separate a liquid from solids dissolved in it, to separate two liquids of differing boiling-points—the alcohol may be distilled over from a mixture of water and alcohol, leaving the water in the still, or again we may utilise the distillation process to obtain a liquid the vapour of which is produced by heating some other substance. Of this last application a good example may be seen in the preparation of chloroform, to be described in a later issue of this paper.

There are numerous modifications of the distillation process in common use. Perhaps the amateur chemist has already encountered such expressions as "distillation in vacuo," "fractional distillation," and "distillation in steam." A few words on these processes would not be out of place, perhaps.

Distillation under Reduced Pressure (or In Vacuo).

The temperature at which a liquid boils and passes into the gaseous state is dependent on the pressure to which it is subject. Water, for instance, under normal atmospheric pressure (nearly fifteen pounds per square inch) boils at a temperature of 100° Centigrade approximately. Now, if we reduce the pressure below that of the atmosphere, the water boils and passes into

vapour before a temperature of 100° is attained. This explains why

Eggs Cannot be Boiled on Mountains.

Although the subject of egg boiling seems a far cry from the more technical subject of distillation, it is an admirable illustration of a lowered boiling point caused by a reduction in pressure and is proved without the use of a thermometer. Egg albumen (the "white"), is coagulated at the temperature of boiling water under normal pressure. Below 100° it is coagulated only with difficulty. The higher we ascend from the earth, the lower becomes the atmospheric pressure. Coupling these two facts you will realise that on a high mountain boiling water is too low in temperature to successfully boil an egg.

Fractional Distillation.

This is a method used in separating two or more mixed liquids whose boiling points lie close together, and

consists of distilling carefully at the boiling point of the more volatile liquid. This portion of the distillate (known as the first fraction) is set aside and a second fraction collected at a slightly higher temperature. A third and more fractions are collected until the volatile vapours cease to be evolved.

The first fractions contain practically all the more volatile liquid and little of the other, whereas the final fractions contain the reverse. Each fraction is very carefully redistilled perhaps several times until complete separation is effected. This is a method used in separating the water from alcohol in the manufacture of the latter. I shall describe shortly in this paper how to make a small quantity of alcohol, and if you have a thermometer you will be able to purify it by fractional distillation.

Distillation in Steam.

Many liquids boil at a lower temperature in contact with water with which they are immiscible. The reason for this is somewhat involved and calls for no explanation here. The operation either consists of heating the liquid and simultaneously passing steam through it, or heating the liquid and water together. In each case the distillate contains both water and the liquid under treat-

(Continued on page 504.)

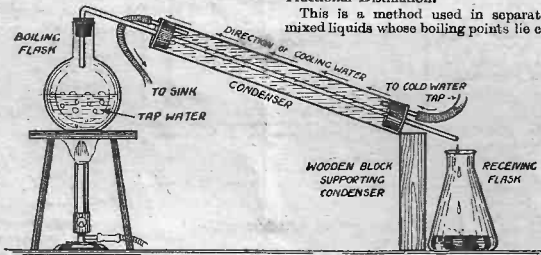

Fig. 1.—A simple distillation apparatus

AN EFFICIENT AERIAL EARTHING SWITCH

By A. J. BUDD

A switch which entirely isolates the receiver from the aerial and earth.

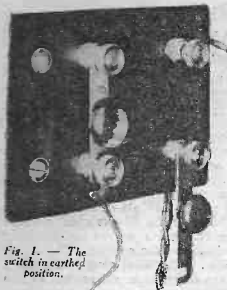

Fig. 1.—The switch in earthed position.

of the set being directly connected to earth all the time. A much better arrangement is to use a switch which entirely isolates the receiver from the aerial and earth when placed in the earth position.

A simple switch, which answers the purpose very efficiently, is shown in Figs. 1 to 5. The materials required to make it consist of a piece of $\frac{1}{2}$ in. ebonite, $4\frac{1}{2}$ in. long by 3 in. wide, four stout terminals with clamping nuts, a strip of sheet brass, $5\frac{1}{2}$ in. long by $\frac{1}{8}$ in. wide and $\frac{1}{16}$ in. thick, two brass screws $2\frac{1}{2}$ in. long, and a wooden bobbin.

Constructional Details.

Mark out the ebonite as indicated in Fig. 4, and drill six holes through, the two to take the fixing screws being countersunk.

To make the switch pieces of equal length and set out the position of the holes and slots according to the dimensions given in Fig. 5. The slots are made by first drilling holes in the centre lines and then, with a hack-saw, cutting away the metal not required. Clean out the slots and round the ends of the arms with a fine-out file.

Having screwed the four terminals in position, slip on the two arms and see that the slots engage smoothly with their respective terminal stems. Any tendency to bind can be put right by slightly filing the inside of the tight slot. A small ebonite or orinoid knob

A COMMON practice with many amateurs is to use a single-pole switch for earthing the aerial when their wireless set is not in use, the earth terminal of the set being directly connected to earth all the time.

can be screwed to the centre of each arm as shown.

The supports for the ebonite base are made from a wooden bobbin of the kind that instrument wire is wound on. Select one that is about $2\frac{1}{2}$ in. long over the ends, and cut it across the centre of the core with a tenon saw. File the base of the switch in position on the side of the window frame, having previously made holes in the latter to receive the fixing screws. After passing the screws through the base-piece, the half-bobbins are slipped on the screws, and on screwing home the latter tightly quite a rigid fixture results.

It will readily be seen that the wooden distance-pieces provide ample clearance behind the base for the terminal stems and connections. In making the connections with the various leads, the ends of these can either be placed between washers and clamped by the end nuts, as shown in Figs. 2 and 3, or they can be soldered to the terminal stems before finally screwing the switch in position.

Operation.

As shown in the photograph (Fig. 1), the switch is in the earthed position, the receiver being completely isolated. When the set is to be used, each terminal head (Continued on page 506.)

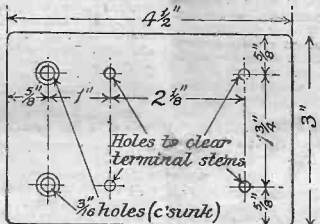

Fig. 4.—How to mark out the ebonite base.

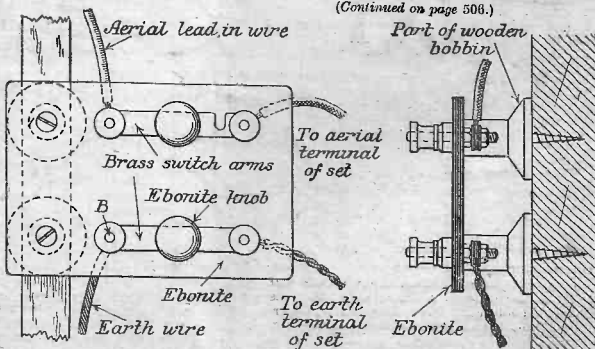
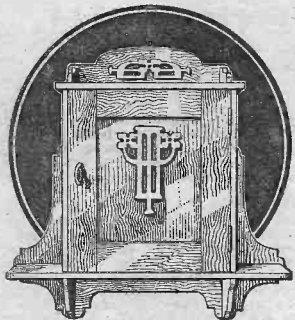

Fig. 3.—A front elevation.

Fig. 2.—A side elevation.



For full size patterns see centre pages.

THE making of a wall cabinet is quite a simple affair for any owner of fretwork tools if he uses the patterns printed in the centre pages of this issue. These patterns are shown full size and make the work straightforward when they are pasted down to actual fretwood ready to cut out with the fretsaw in the ordinary way. They are even more simple because the door is supplied ready made. A piece of work like this looks well in oak, and the parts are all cut from this material, so that they can be stained when it is complete. The framework is cut from $\frac{1}{2}$ in. boards, the two overlays are $\frac{1}{4}$ in. and the plywood back is $\frac{1}{8}$ in.

The Construction.

Actually there is no solid back in the ordinary patterns, but on the same size and shape as the door is glued in to fill up the aperture. The pattern of the sides has to be extended to a complete length of 11 in., whilst the top and floor have to be drawn out on the wood to the dimensions given. The two sides halve into the floor at the joint marked A, and it is essential that the cutting of this is carried out accurately to make a rigid framework. When these three pieces are put together the top can be added. This piece comes flush with the back edge, but projects $\frac{1}{2}$ in. over the sides and front.

The Outside Frame.

Glue it and screw it in place, taking care that the inside aperture is large enough to hold the door (9 in. x 8 in.). This rough case is framed up and strengthened with ornamental side pieces and brackets. A recess in the floor allows an upright side piece to be glued and screwed so that it comes flush with the back. The actual position of the back of the shelf is shown by the dotted lines. In addition to glue, a short screw can be added through the narrow neck of wood at the top. Beneath the floor and between the two projecting sides is put the back shaped rail. This comes between the sides and in addition to gluing on to three edges can be screwed like the former part.

The Fancy Top.

Above the top is an ornamental shaped back—the pediment rail—and this stands level with the back edge to set just over $\frac{1}{2}$ in. inwards from each side. A small ornamental overlay is required for this part, and this, like the one on the door, is merely cut from $\frac{1}{2}$ in. piece of wood and glued in the place shown by the

A HANGING WALL CABINET

dotted lines on the design patterns. In front of this pediment rail, and at right angles to it, is the long thin piece which is glued and screwed in the right angle at the joint shown B. Be careful to get this square, and if necessary drive in a small screw at the front end. The whole framework of the cabinet is complete, but a back of $\frac{1}{8}$ in. plywood is cut to fill the aperture and glued in place up to triangular or square blocking fillets of glued round the inside of the cabinet. The detail at Fig. 1 illustrates this. The fillet must, of course, be put in $\frac{1}{4}$ in. from the edge, level all round, so the plywood rests and is glued close up to it with the back face flush with the rest of the work. The door has a central overlay glued on, is fitted with an ornamental catch on the left-hand stile, whilst two hinges are screwed on to the right-hand edge. The other portion of the screw is fixed on the inner surface of the side so that the door will be set back slightly between the top and floor.

General Hints.

All the parts should, of course, be cut first, cleaned up, and then tested in their proper place. Having obtained a good fit, they are glued strongly together, light markings having been made to show the actual positions. Strengthen up if necessary with blocking pieces inside, and be sure to get the whole cabinet square so the door may hold properly. Glue the overlays carefully so that the adhesive does not squeeze out over the background. If it does, the stain will not "take" and the white surrounding patch will show. The door-knob is fitted with a catch behind, and a small niche must be made in the side to accommodate it when closed.

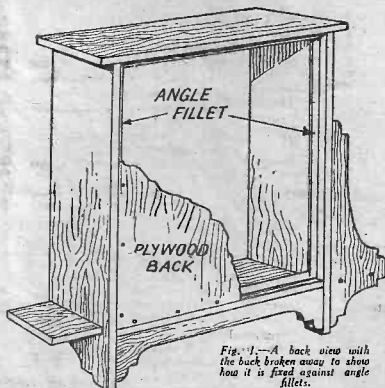

Fig. 1.—A back view with the back broken away to show how it is fixed against angle fillets.

AN EXTENDING LADDER

WHERE it is difficult to store a long ladder, a place can usually be found for an extension ladder in an outhouse or shed. If it be of fairly simple construction and can easily be taken apart, each part can be used separately, thereby serving a number of purposes. The extension ladder described consists of two separate ladders, one of which slides inside the other, the inner one being $\frac{1}{2}$ in. narrower than the inside measurement of the outer ladder to allow for free sliding movement.

The Material.

The ladder sides should be cut from prime straight-grained red deal, planed as straight as possible, free from twist and finished $2\frac{1}{2}$ in. by $1\frac{1}{2}$ in. A $\frac{1}{2}$ in. by $3\frac{1}{2}$ in. plank will cut these economically. Should there be any camber when the pieces are planed, they should be set out in pairs and arranged in such a manner that the sides, when framed, should tend to pull each other straight; if the edge should be convex, set out the sides and the position of the rungs so the convex edge faces the user, thereby causing the sides to straighten when in use.

Cutting List.

The wood required for the outside ladder is as follows: Two red deal sides, $15\frac{1}{2}$ ft., planed as straight as possible and free from twist to $2\frac{1}{2}$ in. by $1\frac{1}{2}$ in., seventeen oak or ash staves, $16\frac{1}{2}$ in. long, $1\frac{1}{2}$ in. wide, and $\frac{1}{2}$ in. or $\frac{3}{4}$ in. thick. For the inside ladder, two sides of red deal are required, planed as straight as possible, free from twist, to $2\frac{1}{2}$ in. by $1\frac{1}{2}$ in., fourteen oak or ash staves, $13\frac{1}{2}$ in. long, $1\frac{1}{2}$ in. wide, and $\frac{1}{2}$ in. or $\frac{3}{4}$ in. thick.

Setting Out.

Place the ladder sides together in pairs, as shown in the sketch (Fig. 1) and set out rungs for a 10-in. tread or rise. The outer ladder should be $15\frac{1}{2}$ ft. long and the inner $12\frac{1}{2}$ ft. 6 in. Set the mortise gauge to a $\frac{1}{2}$ in. mortise chisel and gauge the mortises on the upper and convex side of the centre line. The idea of this being to cut the mortises on the compression side of the timber, thereby

gaining strength and substance to carry the weight when in use. If desired, the mortise may be set out $\frac{1}{2}$ in. above the centre-line; this would improve the balance of the ladders. Set out the rungs for the wider and narrower ladders, as per sketch (Fig. 2), and gauge for the tenons.

Construction.

Cut the mortises in the ladder sides and the tenons of the rungs. In cutting the mortises allow for hardwood wedges. Fit the tenons in the mortises and round off



Fig. 1—Marking out the two long sides of the ladder.

the corners of the rungs. Clean up the rungs and inner sides, glue, clamp, test for squareness, and wedge the rungs. When the glue is set, clean up and round such

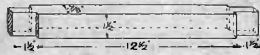

Fig. 2—The dimensions of the two sets of rungs.

of the corners as are shown in the plan for the iron clips. Chamfer or round off the ends of the ladder sides.

The Clips.

Sketches are shown at Fig. 3 of the side and stove clips. They may be made from wrought iron or mild steel. The side clips are made out of $1\frac{1}{2}$ in. by $\frac{3}{4}$ in. material, and the stove clips out of $1\frac{1}{2}$ in. by $\frac{1}{2}$ in., both are drilled for screws and a bolt which precludes the possibility of an accident which might be caused by the strain withdrawing the screws.

Putting Together.

The ladders are fixed by threading the top of the inside ladder through the iron clips of the outside ladder, sliding the inner one to the desired height and dropping the shouldered irons on to their respective staves. Should it be desired to raise the upper ladder with a rope over a pulley, fix a small side pulley near the top (see Fig. 4), and at the back of the lower ladder, tie the rope to the bottom rung of the shorter ladder and raise as desired.

The ladders should be finished with a coat of size and two coats of varnish. All ironwork should be enameled black.

It should be possible to obtain the wood from a local builder, the staff being rough sawn to the required dimensions. A blacksmith or tinsmith will make the support clips for you quite cheaply.

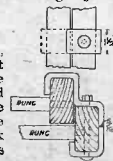

Fig. 3—Elevation and plan of side clips for extending the ladder.

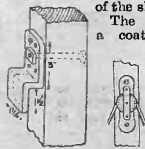

Fig. 4—The pulley.

FEB.
13,
1932



DESIGN

No.
1895

A HANGING CABINET

Instructions for making on page 498.

Suitable for a small first aid cupboard—being 13 $\frac{1}{2}$ in. high, 14 in. wide and 5 in. deep. Built in oak or mahogany $\frac{1}{2}$ in. thick, with $\frac{1}{4}$ in. overlays and $\frac{1}{4}$ in. plywood back.

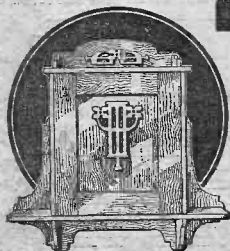

DOOR.
Supplied ready to hang (No. 000B) 9 in. high, 5 in. wide.

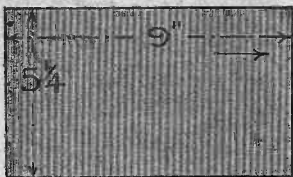

DOOR OVERLAY.
 $\frac{1}{4}$ in. thick.

TOP.

Cut to size given.



BRACKETS.

Cut two and fix to Top and Pediment rail.

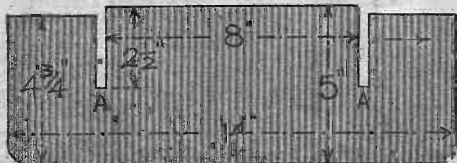

FLOOR.
Cut one to the dimensions given.

MATERIALS REQUIRED.

Planned oak boards of the required thickness, a door ready to hang (600B) and sufficient angle fillet costs 5/- (postage 9d.). A pair of hinges, catch (No. 5383) and two wall hangers, 10d. The whole lot for 6, 7 post free.

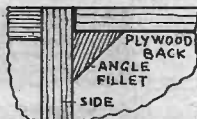
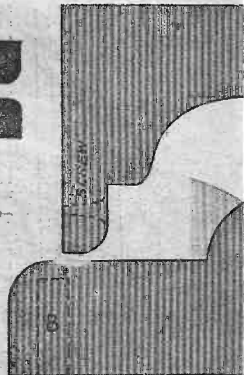

This is how the back is fixed.

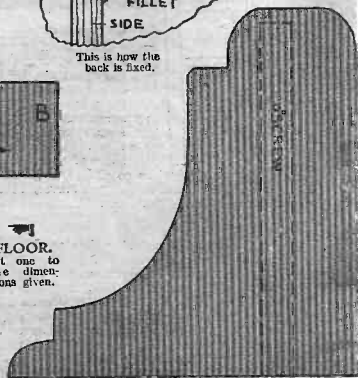

OBTAINABLE FROM—

All the necessary parts are obtainable from
 Hobbies Ltd., Dereham, Norfolk. Branches:
 St. 65, New Oxford St., W.C.—83, Newing-
 ton Butts, S.E.11—147, Bishopsgate, E.C.
 London—376, Argyle St., Glasgow—104,
 Piccadilly, Manchester—94, High St.,
 Birmingham—4 St. Paul's Parade, Sheffield—
 20 Queen Victoria St., Leeds—25, Bernard
 St., Southampton—68, London Rd., Brighton.
 844, Yonge St., Toronto, Canada.

**OVERLAY
 ON PEDI-
 MENT RAIL.**

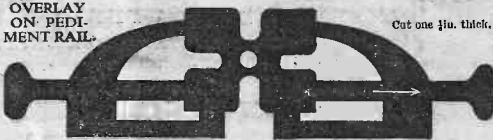

Cut one 1/16" thick.

BACK RAIL.

Glue 1/16" angle fillet to floor and top inside cabinet as door stops.

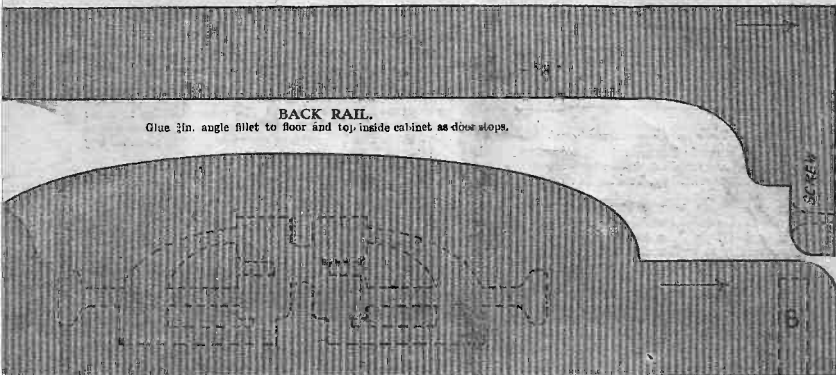

PEDIMENT RAIL.

Glue overlay to dotted lines.

BACK.
 This consists of a
 piece of 3/16 in. ply-
 wood 5 in. by 8 in.

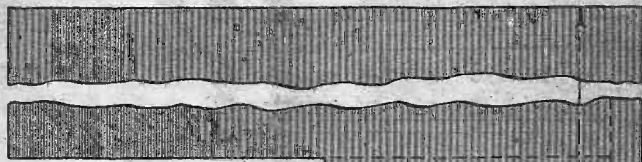

**SIDE
 BRACKETS.**
 Cut two.

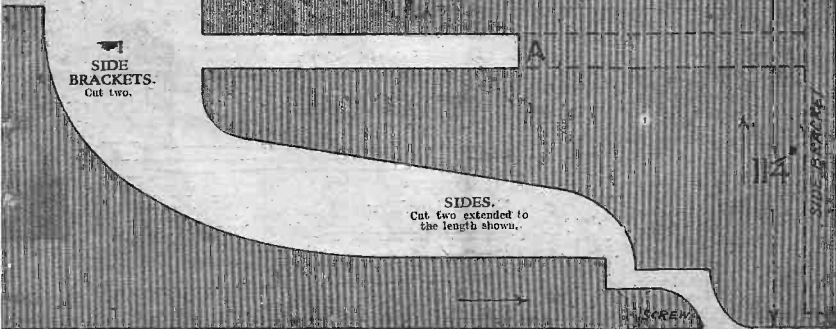

SIDES.
 Cut two extended to
 the length shown.

SIDE BRACKET

SCREW

MAKING MODEL ENGINE PARTS FROM SHEET METAL

IN constructing a small model steam engine, the amateur, especially the beginner, often finds that for various reasons he cannot use castings and has to resort to the use of built-up parts as substitutes. With a little care and patience, however, a number of model

By "Home Mechanic"

edges should be filed quite square with the sides and finished with a fine-cut file, the file marks being afterwards removed by means of a piece of fine emery cloth stuck on the end of a narrow flat strip of wood. If two rods are required, they can be marked out at the same time on a strip of sheet brass of sufficient length.



Fig. 1.—Two views of a small connecting-rod.

engine parts can be made from sheet-brass, iron and steel, which, when properly finished, would be quite as serviceable as if made from castings, besides having the advantage of being lighter.

The writer explains in this short article how such parts as connecting-rods, bearing blocks, and eccentrics can easily be built up from odd pieces of sheet metal, such as are usually to be found in the scrap box.

Small Connecting-Rod.

First of all take the small connecting-rod shown in Fig. 1. This can be fashioned from a strip of sheet-brass or gunmetal $\frac{1}{16}$ in. thick and $\frac{1}{8}$ in. wide. A line is scribed down the centre of the strip and the centre of the holes for the gudgeon and crank-pins centre-punched at the required distance apart. After carefully marking out the shape of the rod, hold the strip in a vice and proceed to file away the metal down to the scribed line.

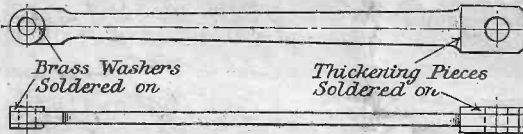

Fig. 3.—Connecting-rod for a model locomotive or horizontal engine

The centre part of the rod should be filed down at the sides so that it is made thinner than the ends.

A method of holding the rod while this operation is performed is shown in Fig. 2. The rod is placed on a piece of hard wood, about $\frac{1}{16}$ in. thick, and held in position by a number of small brads driven into the wood and touching the rod all round, so that the tops of the brads come just below the level it is desired to file down to. Old gramophone needles answer the purpose quite well. The block of wood can now be held in the vice, and the filing down of one side of the rod proceeded with. After finishing one side, reverse the rod and file down the other side in the same manner. The

Locomotive Type Connecting-rod.

Assuming that two of these are to be made, the outlines can be carefully marked out side by side on a piece of sheet brass or iron of suitable width and thickness, and after separating with a hacksaw, each one can be filed to shape all round the edges in the manner before described. Rectangular pieces of brass about $\frac{1}{16}$ in. thick can be soldered on to each side of the "big

end" to form *Small Brads or Used Gramophone Needles* as shown in Fig. 3, and small brass washers should be soldered on each side of the "small

end" for the same purpose. Drill the holes through for the gudgeon and crank pins, file round both ends to remove any superfluous solder and finish off with fine emery paper.

Forked Connecting-Rod.

Strong and serviceable connecting-rods of this type can be made from strips of sheet metal in the manner illustrated in Fig. 4. Having decided the length of rod, mark out the two side plates to the shape shown at A, and after filing to the outline, bend each piece, as at B. The parts of the strips between C and D, which are shown in contact, can now be tinned.

Clamp them together with a small screw clamp so that they register correctly, and then sweat them together. (To be concluded next week.—E.D.)

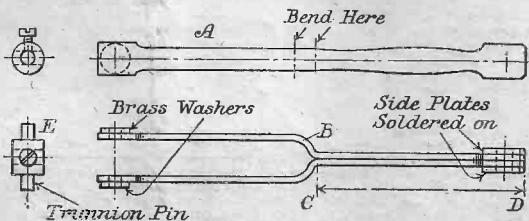

Fig. 4.—Details of the construction of a forked connecting-rod.



Putting Music in a Groove!

MOST people no doubt think that a record is just a black disc which will talk, sing, or play whenever it is placed on the gramophone. But how do they put the music in the grooves? The organization and equipment required is just as complicated as that needed for the manufacture of much more imposing-looking things—motor-cars for instance.

The original recording is the most spectacular but not by any means the most difficult part of the business.

It is carried out on a large wax blank, about 14 in. in diameter and 2 in. thick. To make a single blank takes twenty hours or so, for the wax used has to go through many refining processes before it is moulded into shape and the surface highly finished by a sapphire cutter on a special machine. There must not be the tiniest blemish.

In the recording-room this wax blank is set on a turntable that is rotated at exactly seventy-eight revolutions per minute by means of a weight—the only form of driving power that will remain absolutely constant. A tiny sapphire cutter, attached to a kind of glorified telephone receiver, is lowered until it cuts a little groove in the revolving blank.

By means of gearing, the turntable is arranged in such a way that besides rotating it gradually moves along bodily under the cutter. So the cutter is a shade nearer the centre at the end of each revolution, and forms a spiral of grooves. On a full-time record—a 12 in. playing for 4 minutes 40 seconds and a 10 in. for 3 minutes 30 seconds—there will be no less than ninety-nine grooves to the inch, but there is no need to set them so closely together in every case.

Recording the Artist's Voice.

Directly the cutter is started on its journey the operator in the recording-room gives the "commence" signal to the artists, who occupy an adjoining studio. The sounds from there are picked up by a microphone, which is connected through suitable amplifiers and controls to the "telephone receiver" above the turntable.

The sapphire cutter is thus made to vibrate sideways in sympathy with these sounds, and in doing so it cuts an irregular groove in the wax blank. Tiny waves are made, the number varying according to the note recorded. For a high note there may be as many as 500 of these waves made over an inch of track; for a low note, only one wave over 2 in. The track is cut at a speed of

two miles per hour, and 840 ft. of it is needed for a full 12 in. record.

Tests Made on Wax Blanks.

Before the final recordings are taken one or two tests are made on wax blanks, and played back so that any faulty rendering can be corrected. The principle involved in playing back is exactly the same as with the finished record. A steel needle, fitted in this case to an electrical pick-up, is run along the track, whose waves set up in its identical vibrations to those caused by the original sounds. These vibrations are amplified, as they would be by an ordinary gramophone, and reproduced through a loud speaker.

The actual master record—a duplicate is always taken in case of accidents—cannot be played back, for a steel needle run over the soft wax surface is bound to damage it to a certain extent. So directly they are completed and the machine has cut the final quick spiral into the centre—the one that works the automatic stop on a gramophone—they are packed off in carefully-padded boxes to the works.

Turning Out Duplicates.

Having made two records that mustn't be played, the gramophone people have before them the task of turning out any number like them that can. It is no simple problem, for the surface impressions of the duplicates must be identical with one of the originals in every respect.

Even a variation of a thousandth of an inch, which is considered a fairly fine limit in engineering practice, would be fatal in this case.

There is plenty of room for trouble, because the original wax master has to be copied through five stages before the final record is obtained. First it is hung inside an immense safe, fitted with massive chains and padlocks. Inside it, tiny particles of pure gold are hurled against the face of the wax by electrical forces. In time they form a thin layer of gold which, when peeled away, gives a faithful negative copy. The wax is afterwards useless, but it has done its bit.

The gold master, as it is called, is next dropped into an electroplating vat, and covered with a deposit of silver. On separating the two metals, the silver has a positive face—it exactly matches the original wax. Several silver "mothers" are generally made.

(To be concluded next week.)

TWENTY-FIVE YEARS AGO

Issue dated January 26th, 1907.

It was in this issue twenty-five years ago that one of the most popular designs ever produced appeared. This is the Home, Sweet Home Design, No. 559. This is still available to readers, is still mightily popular with a large number of workers, and has had to be reprinted more than half a dozen times since its original appearance. The same issue gives an interesting chapter on the arms of Church dioceses, and the early stages of electricity of those days are well shown by the construction of a small Wimhurst machine. The usual features also appeared.

What a remarkable difference is evidenced when we compare these early issues with the latest copy!

CHEMISTRY FOR AMATEURS (continued from page 496).

ment, and as they are immiscible they are readily separated. Many essential oils used in medicine are obtained in this way, the leaves of the plant, which contain the oil, are treated by either of the above methods. The oil passes over with the steam and finally is separated in the distillate from the water upon which it floats.

And now to the amateur chemist's laboratory, where, having grasped the theory of distillation, he will no doubt wish to satisfy himself of its truth.

The apparatus required for distillation consists of the still boiler, the condenser and the receiver.

The Still Boiler.—This consists of a glass flask. The capacity is immaterial, if much distillation is to be done, then a larger flask is necessary to avoid constant refilling. A bored cork closes the mouth of the vessel.

The Condenser.—

For this you will require about a foot of glass tubing about an inch in diameter. Any good chemist will obtain this for you if he does not actually stock it. You will also need a yard of ordinary thin glass tubing and two bungs which will fit the ends of the wide tubing. It is unnecessary to describe in any detail the construction of the condenser, as it will be quite evident from Fig. 2. The glass tubing is cut with a three-cornered file as described in the first article of this series. Two holes are bored in each bung. These must accurately fit the narrow tubing which they house, otherwise the contraption will not be watertight. In use, the condenser is connected to the tap, the overflow pipe returning the water to the sink after it has traversed the water jacket. The inner tube of the

jacket enters the bung or stopper to the boiling flask.

Three-quarters fill the boiling flask with tap water and arrange the apparatus as shown in Fig. 1. The boiling flask or still rests over the bunsen on a wire gauze and tripod and is connected to the condenser. The outlet end of the latter passes into the receiving flask. Turn on the heat until the water in the still is boiling vigorously, then turn down the flame, keeping the water steadily boiling. The liberated steam will be seen condensing in the condenser inner tube.

The first portion of the distillate is used to rinse the receiver and is then thrown away. It is not pure distilled water as it contains the more volatile impurities and dissolved gases always present in tap water. This precaution having been observed, proceed to collect the distillate now coming over until about two ounces of water only remain of

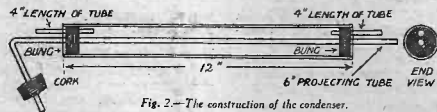

Fig. 2.—The construction of the condenser.

the still boiler. At this point cease to collect the water now coming over as it will contain the less volatile impurities.

The simple type of still employing a Liebig type condenser such as I have described, is not capable of delivering large volumes of distillate in a few minutes, but, nevertheless, is quite adequate in output for most small laboratory purposes. On the larger scale, continuous forms of still are employed in which the cooling water in the jacket, becoming warmed by contact with the condenser pipe or "worm," is passed on to the boiler which is automatically kept at a constant level. Some saving in heat is thereby effected, and there is no risk of the still running dry.

HOBBIES CROSSWORDS £5 CASH FOR CORRECT OR NEAREST CORRECT SOLUTION

1	IS	3	4	5	6	AB
7	F	9	10	11		
12		13	14			
15					GYSU	
16			S			
17	GH					
18						
19	D					
20						
21	A					
22			A			
23	D					
24						
25	O					
26						
27			L			
28			S			

CLUES.

- Across.
- Opposite of empty.
 - Four and one.
 - The king of birds.
 - Short for Daniel.
 - A theatrical entertainment.
 - Female bird.
 - Rub out.
 - Belonging to EH.
 - The first man.
 - A silver.
 - Sit mostly.
 - Half of two.
 - Not young.
 - Puls.
 - Appear.
 - Opposite of "gain."
- Down.
- A football team.
 - A marsh.
 - Conducted.
 - Biggest.
 - Charity.
 - "Feral" of "beau."
 - A weathercock.
 - Light-hearted.
 - A powder.
 - To soothe.
 - 20 quires of paper.
 - A telephone greeting.
 - An adult male.
 - Opposite of "my."
 - The sun's nickname.
 - Depart.
- Pin 1/2d. Stamp to each coupon used.

1	IS	3	4	5	6	AB
7	F	9	10	11		
12		13	14			
15					GYSU	
16			S			
17	GH					
18						
19	D					
20						
21	A					
22			A			
23	D					
24						
25	O					
26						
27			L			
28			S			

Name

Name

Address

Address

(H.C.W.22)

(H.C.W.22)

Post your entries to reach us not later than Friday, February 26th, 1932, addressed "HOBBIES," "Crosswords," No. 22, Competition Dept., 39, King Street, Covent Garden, W.C.2.

RULES.

1. Attempts must be on coupons from this or next week's "Hobbies."

2. Postage stamp value 1/2d. must be pinned to each coupon. 3. In the event of ties the prize will be equally divided.

4. Entries (or members of their families)

of George Newman Ltd., or its associated companies, are not allowed to compete. 5. The Editor's decision is final in all matters relating to this competition.

Can you make INVISIBLE INK ?



YES, if you have Lott's Chemistry set.
You can develop it, too, and grow Chemical trees and big crystals and change the colours of liquids. An absorbing hobby, chemistry.
All the experiments in Lott's Chemistry have been arranged by a Doctor of Science. You can spend many exciting hours in your own home "lab"!
Lott's Chemistry is supplied in 3 boxes: Box 1 with 15 Chemicals, accessories and book of 42 experiments. Price 3/6. Box 2 with 22 Chemicals, Bunsen Burner, accessories and book of 80 experiments. Price 8/-. Box 3 with 30 Chemicals, Bunsen Burner, extra accessories and book of 131 experiments. Price 10/8. Spares supplied. Obtainable from leading toy dealers and stores.
Lott's Chemistry is perfectly safe to handle.

Has 1, complete with chemicals, Bunsen burner, magnesium ribbon, book, etc., etc. 3/8. Write for descriptive booklet to Dept. H.2. **LOTT'S BRICKS LTD., WATFORD**

LOTT'S CHEMISTRY

Ask your Newsagent for
NEWNES'
HOME MECHANIC BOOKS
entitled
"TWENTY-FIVE TESTED
WIRELESS CIRCUITS"
and
"TOY MAKING FOR AMATEURS"
Now on Sale. Price 1/- each.

SECOTINE
IS BRITISH

You will stick to
SECOTINE
because it sticks so well

For all sticking jobs, you will do best to stick to Secotone. The Admiralty instructions on it! So does the Air Force! Obsolete everywhere in tubes, 3/6, 6/6, 9/6 and 9/6.
Ask your Dad to write for FREE BOOKLET from Dept. L.

McCAW, STEVENSON & ORR, Ltd., BELFAST

FIRMS

Heat Secotone for use where articles contain hot water
Ed. a tube

GUARANTEED KITS for "HOBBIES" CIRCUITS!

"Autokoil Reinartz Three"

Components, exactly as specified.

	Kit of
1 "Autokoil" All-wave Tuner (Hambling)	£ 12 6
3 Valve Holders (Clix or Lottis)	0 2 6
2 Dux L.F. Transformers (R.L.)	0 13 6
1 On and Off Switch (Lissen)	0 1 6
1 H.F. Choke (Lissen)	0 5 6
1 Aerial Tuning Condenser .0005 (Polar)	0 6 6
1 Variable Condenser .0003 (Polar)	0 6 6
1 5 meg. Grid Leak and Holder (Doblier)	0 2 3
1 Fixed Condenser .0005 (T.C.C.)	0 1 6
1 Fixed Condenser .01 (T.C.C.)	0 3 0
10 Terminals engraved (Clix)	0 2 6
7 Vicegrip Wauder Plugs (Clix)	0 0 10
1 Ebonite Panel 14" x 7"	0 4 0
1 Baseboard 14" x 7"	0 1 6
2 Panel support brackets (Camco)	0 1 6
1 Terminal strip 14" x 1"	0 1 6
Screws and Wire for connections	0 2 0

(Any part sold separately) CASH PRICE **£3-9-4**

3 Cossor Values 27s. 6d., or 3 E.T.I. Values 22s. 9p. Volt H.T. 9s.
9-Volt G.B. 1s. 2-Volt L.T. Accumulator 8s. 6d. Speakers from 20s. each.

"HOBBIES" "BRITISH ONE-VALVER"

Kit as specified £2 4 7
Cossor Valve 8s. 6d. 60-Volt H.T. 5s. 6d. 2-Volt L.T. 8s. 6d.

"HOBBIES" (JAN. 23RD) CIRCUITS

Kits of Components Guaranteed as Specified.

"AUTOKOIL ALL-WAVE TWO"	£2 5 4
"BABY GRAND THREE"	£2 13 0
"ROUND THE WORLD THREE"	£4 7 2

Valves, Batteries and Loudspeakers extra.

APPROVED SUPPLIERS FOR "HOBBIES" KITS



Price
12/6
Post Paid

"AUTOKOIL" ALL-WAVE TUNER

200 to 2,000 Metres.
No coils to change. Just switch over to desired waveband.

We will quote you for KIT of Components for ANY set described in "Hobbies."

"KITS" ON EASY TERMS IF DESIRED.

Terms: Carriage Paid on all cash retail orders.
C.O.D. charges paid on all orders over £1.

SATISFACTION GUARANTEED.

A. W. HAMBLING, A.M.I.R.E.

104, HIGH HOLBORN, LONDON.

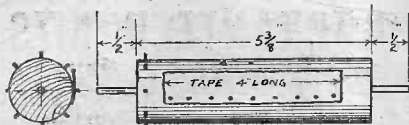

Fig. 11.—Details of the "beams."

NEXT cut the wires at the back, thus leaving 65 single wires, all parallel and stretched across the frame. Screw the frame on to its wooden support and fix the hinges on to the baseboard halfway between the main frame and the supports for the cloth beam. The screw eyes are for use as handles.

The "beams" are made from four pieces of becomstick 1 1/2 in. diameter, as shown in Fig. 11. The spindles are made from nails with the heads cut off. You will find it very difficult to get the wood true on the spindle if you drive the nail in without special precautions. A good method is to mark off the centre carefully and drill a hole of the same diameter as the nail about 1 in. deep. Ask an assistant to watch the drill to make sure you are holding it upright. The drilled hole then forms an effective guide for the nail which should be driven in about 1/2 in. further to fix it firmly.

For the cloth beam drive in eight small brads and cut off the heads leaving 1/2 in. projecting, as shown in Fig. 11. This provides a simple form of ratchet arrangement, the brads engaging a hole in a flat brass spring which can be seen in Fig. 3. There is no need to give a drawing of this spring, for the photograph shows all that is required. A small block of wood holds the bottom end of this spring.

A piece of strong tape 1/2 in. wide is tacked along one edge only to the round wood, as shown in Fig. 11.

The warp beam is the same as the cloth beam except that the tape is tacked along the other edge, and, instead of the eight brads, a single round-head screw is fitted.

A rubber band is hooked over the screw on the warp beam, wrapped once round the beam and hooked on to a screw eye in the baseboard to provide tension on the

A WORKING MODEL HAND LOOM

(Continued from page 468, February 6th issue.)

threads; this rubber band can be seen near the left of Fig. 2.

The only item now to be made is the shuttle which is illustrated in Fig. 12. This is best cut out of a piece of bone about 1/2 in. thick, though 1/4 in. fretwood will do quite well: all the edges and corners should be well rounded, smoothed off and polished, so that the shuttle shows no tendency to catch any of the warp threads.

Ordinary darning wool is good material to weave on this loom. The warp beam is fixed, temporarily, about a yard behind the machine and the wool is stretched on to the piece of tape of the cloth beam, threaded through the reed, then through the central eye in one of the twisted wires of the front head and stitched on to the

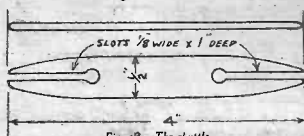

Fig. 12.—The shuttle.

tape of the warp beam. The second thread passes through the next space in the reed, but is threaded through an eye in the back head instead of the front one. Alternate threads go through an eye on the front head and the threads between go through an eye on the back head. The warp threads are then all rolled on to the beam at once and pushed into the 1/2 in. hole in each support to hold it in place.

The shuttle is wound in the slots with as much wool as it will carry easily. Press one of the head levers to raise and lower the warp and pass the shuttle through the resulting "shed" then pull the reed towards the front to push the weft into position. Now depress the other lever to reverse the position of the heads and pass the shuttle through the shed again in the opposite direction, press the weft up close to the previous thread with the reed, and you will find the cloth grow as these operations are repeated.

OUR WIRELESS BLUE PRINT SERVICE

You can now obtain the following blue print wiring diagrams from the Publisher, HOBBIES, George Newnes, Ltd., 8-11, Southampton Street, Strand, W.C.2. Other blue prints are in preparation.

Blue Print No. 1. "Hobbies" Crystal Set . . . 6d. Post Free.
Blue Print No. 2. "Hobbies" British One-Valve . . . 1/- " "
Blue Print No. 3. "Hobbies" All Station Two . . . 1/- " "
Blue Print No. 4. "Hobbies" Road-the-World Three . . . 1/- " "

Blue Print No. 5. "Hobbies" Long Distance Four Valve 1/- Post Free.
Blue Print No. 6. "Hobbies" Beginner's Three Valve 1/- " "
Blue Print No. 7. "Hobbies" Autokoi Three Valve } 1/- " "
Reinartz

AERIAL EARTHING SWITCH (continued from page 497).

is given a slight turn and the top switch arm moved round, until the end slot engages with terminal stem (Fig. 3). The lower switch-arm is moved upwards until the slot near the end engages with terminal stem B, after which the terminal heads are screwed down.

One advantage of this type of switch is that a positive-contact is maintained, not only when the receiver is in use, but also when the aerial is earthed.

It will be noticed, with reference to

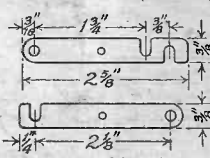

Fig. 5.—Details of the switch arms.

Fig. 3. that different kinds of wire are indicated leading to the switch terminals. The aerial lead-in wire and the lead to the aerial terminal of the receiver are of heavy rubber-covered stranded wire. The earth wire to the switch is 7/22 copper wire, and the earth lead from the switch to the receiver is ordinary twin flex. This arrangement has been found to work very well in practice, reception being much better than when smaller gauge wire was used.

REALISTIC TOY LOCOMOTIVES AND HOW TO MAKE THEM-3

By E. W. Twining

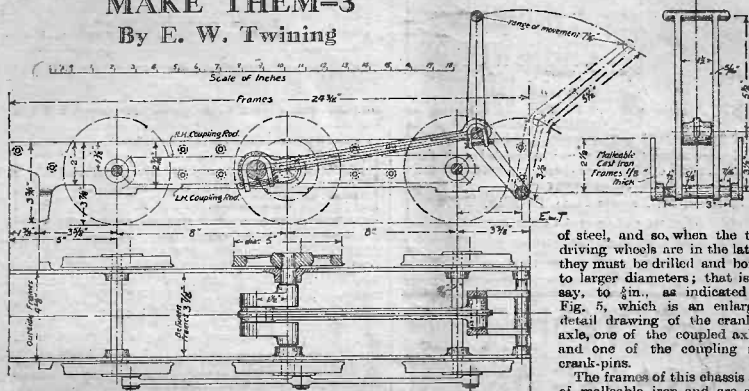

Fig. 4.—General arrangement of chassis with propelling gear.

FIG. 4 is a general arrangement of the chassis of the propelled model, the motive power being the muscular action of the juvenile driver. From the drawing it will be seen that the centre axle is cranked like a full-size locomotive, except that one large-throw crank is provided instead of two. A connecting rod from this is carried back to the cab, where the little end is attached to a double lever, which is operated by hand, a pushing and pulling motion being applied, thus revolving the crank and with it the driving and coupled wheels of the engine. Nothing could be much more simple than this, either in operation or in construction, for, with regard to the latter, there are only three parts (seven with the frames and coupling rods), and these are all cast in malleable iron, including the crank axle.

This axle is bigger all over than those for the coupled wheels, because malleable cast iron does not possess the stiffness

of steel, and so, when the two driving wheels are in the lathe, they must be drilled and bored to larger diameters; that is to say, to $\frac{1}{16}$ in., as indicated in Fig. 5, which is an enlarged detail drawing of the cranked axle, one of the coupled axle, and one of the coupling rod crank-pins.

The frames of this chassis are of malleable iron and are also heavier than in the simple engine. They are cast with bosses to form bearings for the axles. In this driven engine larger bearings will obviously be necessary than in the undriven model, in order to reduce wear, especially on the journals (the parts of the axle which run in the bearings).

The Crank Axle.

This will need to be turned in the lathe on the wheel seats and journals, but it should not be necessary to turn the crank-pin on which the connecting rod will work. This can quite well be finished by filing, testing with callipers from time to time for roundness.

The crank webs need not be touched unless there happens to be any abnormal lumps and roughness projecting which might foul or interfere with the free working of the connecting rod.

From Fig. 4 it will be seen that I have shown the main inside crank dividing the right-angle between the outside or coupling rod crank-pins. That is to say, the outside crank-pins will each make an angle of 135 degrees with the main crank. One leading, or in front of, and the other behind, the main crank.

The axles of the other pair of wheels and all the coupling rod crank-pins are of steel; they are to be made to details shown in Fig. 5, and exactly as in the simple chassis except for the differences in lengths, i.e. the measurement over all and that over the shoulders between the wheel seats.

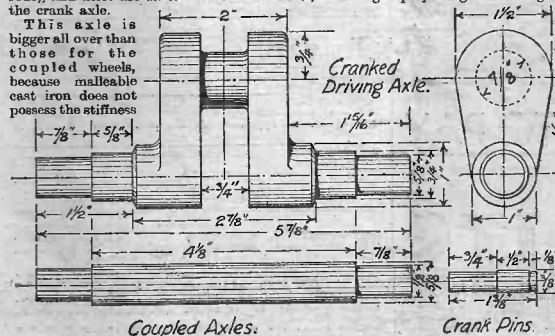

Coupled Axles.

Crank Pins.

Fig. 5.—Details of crank, axles, etc.

(To be continued.)

D	A	W	A	B	E	S			
U	S	E	P	L	I	N	T	H	
G	A	L	T	O	D	A	Y		
E	V	E	B	L	A	V			
S	T	E	E	R	A	S	K	S	
H	A	D	O	D	D	S	O		
A	M	I	D	E	A	R	S	H	
R	E	L	I	E	L	I	O	N	S
P	E	A	R	F	L	O	R		
F	A	K	E	T	O	R	E		

Correct Solution.

Only one correct coupon was submitted and the Cash Prize of £5 has been awarded to the following reader:-

E. Draper, 56, Regenta Place, Swindon, Wilts.

Payment will be sent in due course.

Another Easy Puzzle appears on page 504.

"HOBBIES" CROSSWORDS No. 19 RESULT

IS YOUR
NAME IN
"TIT-BITS"?

150
MONEY PRIZES
AND
USEFUL GIFTS
given weekly

NOTHING TO PAY
see

TIT-BITS

On Sale Everywhere - Twopence

Geo. Heuze, Ltd.

THE TURK PACKET FREE.

All applicants for my new approval sheets sending 1d. postage will receive 15 TURKISH stamps free. Includes a surcharge, etc., usually sold at 1s. 3d. Additional free set to customers giving collectors' addresses.

H. WATKINS,
Dept. H.2, 60, Leicester Road, East Finchley, N.2.

BLUSHING

Free Book, sent privately under plain sealed cover. Explains how you can quickly cure Blushing, Nervousness, Depression, Self-consciousness, Truancy, etc. Write NOW - STOPPING TREATMENT, Dept. H.E., 28, Deau Road, London, N.W.2.

SALE and EXCHANGE

Advertisements are accepted for this column at the rate of 6d. per word, prepaid. Address communications to the Advertising Manager, "Hobbies", Southampton Street, Strand, London, W.C.2.

CINEMATOGRAPH FILMS, Machines, Accessories.—Lists Free. Sample Films, 1s.—Filmeries, 57, Lancaster Road, Leytonstone.

PATENTING INVENTIONS.—Handbook free.—King's Patent Agency, Ltd., Wardrobe Chambers, E.C.4.

"HANDYMAN'S ENQUIRE WITHIN"—96 pages, hundreds of illustrations, thousands of practical ideas and hints on every practical art, craft, and hobby. 1s. from all newsagents.

GRAMOPHONE Fittings.—Wholesale prices, 6s. price catalogue, London.
How make Gramophones." 3d.—Regent Hob, 120, Old Street, London.

ALL SMALL FITTINGS for the handyman. Hinges, knobs, bolts, bolts, locks, etc. Reliable and cheap. Call at Hobbies branches or send requirements to Hobbies, Ltd., Dereham, Norfolk.

CONJURING CATALOGUE FREE.—Vandy Pastimes, East-Ins.

"MODEL BOAT BUILDING."—Practical instructions on building 11 model power and sailing—96 pages—131 illustrations. 1s. from all newsagents.

GRAMOPHONE SALK.—Motors, Tonearms, Soundboxes, Horns, Amplifiers, Gramophones and Cabinets at gift prices. Catalogue free.—H. Bart, 185, High Street, Deptford, S.E.8.

FRETWOOD of all kinds. Superior to plywood. Planed both sides. Beautifully figured. Free from knots and shakes. Also cheap parcels.—Write for lists, Hobbies Ltd., Dereham, Norfolk.

SLOAN-DUPLOY SHORTHAND, the rapidly-spreading "fish-speed" system, saves a year's study. Read booklet of wonderful records and obtain free lesson.—Sloan-Duploy Society, Dept. 8, Ramsgate.

"THE HOME WOODWORKER"—96 pages—141 illustrations, explains how to make overmantle desks, steps, tables, picture frames, and other useful household articles. 1s. from all newsagents.

TROUSER PRESS FITTINGS, 24" x 12" 2/9, Stretcher, 1/3; 28" x 14" 3/8, Stretcher, 1/6. The Press Fittings, 1/1 set, 12 sets 7/6.—British Co., 1, Waterloo Street, E.C.1.

HAVE A FACTORY at home with Hobbies fret machines. From 35s. upwards—ready to use. Makes money in your spare time. Cuts wood and metal for all kinds of jobs. Try one at any Hobbies branch.—Free illustrated list from Hobbies Ltd., Dereham, Norfolk.

CINEMATOGRAPH, FILMS, CHEAP.—Lists.—"Movies," 109, Kenner, Footing.

"SIMPLE ELECTRICAL APPARATUS AND EXPERIMENTS"—96 pages—138 illustrations. Explains how to make all types of electrical apparatus, and how to use them. 1s. from all newsagents.

PATHSCOPE FILMS.—Hire, sale, exchange. List free.—Gino Film, 11, Bae-cade, Lincoln.

METAL CUTTING FRETSAW BLADES, for the metal worker. Fine to coarse 5d. per doz. Heavy fretsaws for thick wood, 9d. per dozen. Postage 1d. extra.—Write or call Hobbies Ltd.

STAMPS.

100 DIFFERENT, including 10 CHILL, free to genuine applicants for approvals, enclosing 3d.—Court Stamp Co., Court Place, Guernsey.

SUBSCRIPTION RATES.

"Hobbies" will be forwarded by post to any reader at the following prepaid rates: Twelve months, 13s.; Six months, 6/6; Three months, 3/3. Registered at the G.P.O. for transmission by Canadian Magazine Post.

STAMP COLLECTING



DURING only a dozen of its long years of history did Crete enjoy the distinction of issuing its own stamps, but in that time—1900-1912—it succeeded in making an unmistakable mark on the annals of philately. An island of elongated

form, 160 miles long from east to west, and from 35 to 37 1/2 miles across, it is distant only about sixty miles from the southernmost tongue of the Greek peninsula.

Diana in a crotaline. Taken from a Cretan coin of about 2500 B.C.

the great majority of the people are Orthodox Christians of the Greek Church; yet from 67 a.c. till 1912—nearly 2,000 years—the island was in alien hands. In this respect Crete resembles that other distressful Mediterranean island, Cyprus, except that 2,500 years have elapsed since Greece held sway there.

For two hundred and fifty years prior to 1897 Crete had belonged to Turkey, and the notorious misrule of the unspcakable one resulted in such disorders that the great European Powers decided to act the part of policeman. The Turks were expelled, and Crete was granted a measure of independence which was only slightly affected by a nominal Turkish suzerainty (without payment of tribute) and the watchful eye of the Powers. Prince George of Greece was appointed High Commissioner, and the island entered, in 1900, upon a period of peace which it had not known for centuries.

Cretan Culture.

It happened that the more stable government gave particular satisfaction to one of our own countrymen, the celebrated archaeologist Arthur Evans, who had been engaged, since 1894, in unearthing the relics of pre-historic Cretan culture. The

THE MUSEUM STAMPS OF CRETE

By P. L. Pemberton

Turkish authorities, when not actually hostile to Evans, had rendered him very little assistance, but with the advent of the Grecian prince, the work went forward at a great pace. The subjects chosen for the designs on the Cretan stamps of 1900 and 1905 give a panoramic record of some of the remarkable finds which Evans made in the course of his excavations at Knossos, Phaistos, and elsewhere.

The Palace of Minos.

Like that of Greece, with which it is closely bound, the story of Crete is rooted far into the pre-historic past. Archaeologists are able, from an examination of pottery, gems, and coins unearthed in the ruins of ancient cities, to infer the existence in the island of a cultural state



Landing of Prince George of Greece at Suda Bay in 1895.

dating back to 3400 a.c. This civilization, to which Evans gave the name Minoan age, had already passed into tradition at the dawn of historical times. Yet the Cretan stamps, specially those of 1905, throw light on the manners and habits

FOR THE FIRST TIME

THE IMMORTAL
GILBERT and
SULLIVAN
—OPERAS—

WORDS & MUSIC
IN FORTNIGHTLY PARTS

Part 1 Ready Feb. 12th 1/3

Mark all envelopes containing stamp queries with the word "Stamps" in the top left-hand corner.

of those ancient citizens of a forgotten world. On the 3 dr. stamp we see the ruins of the magnificent palace of Minos at Knossos, which was uncovered and restored by Evans, and is, surely, one of the wonders of the world! Covering six acres, the ground floor contains twenty-two rooms around a large central courtyard, which is 200 ft. long. The frescoes, ornaments, and coins found here paint the history of the time in vivid colours. Carved on a gem was the picture of King Minos, seated on his throne, which is reproduced on the 2 dr. stamp of 1900. Ariadne, his daughter, taken from a coin, appears on the 50 lepta of 1905.

Feminine Fashions.

The 2 lepta throws some light on feminine fashions in dress in the year 2500 a.c. Here we have a view of the mythical Diana with her hunting dogs; the costume, however, would not suit the sportswoman of to-day. The skirt is tight-fitting and pleated above, and branches out below into a crotaline. For the most part, the subject, which are taken from coins and gems, are mythical, and include such characters as Hermes, Hera, and Talos. Strangely enough, that notable monster the Minotaur, legendary native of Crete, has been overlooked. According to the ancient tale, this fearful creature, which had the body of a man and the head of a bull, lived at Knossos, and devoured, once every year, six young men and six maidens who were sent from Athens as a sacrifice.



The Cretan King Minos on his throne.

When real history began Crete was a place of little importance—a mere province of the Athenians, who had small respect for its inhabitants. Was it not a Greek poet who was responsible for the well-known line which described all Cretans as liars? Was it not, also, a Greek who, at a later date (tenth century), wrote of "the three accursed K's" the Cretans, the Cappadocians and the Cilicians?

A MODERN PICTURE FRAME

ALTHOUGH the new-art style does not appeal to everybody, it nevertheless must be said for it that furniture and hangings designed and carried out in this style always present a very striking appearance, and are generally very attractive. The sketch shows clearly the character of the frame, which is made, from $\frac{1}{2}$ in. wood, of two side rails of simple outline, a lower shaped rail, and a wide, decorated pediment rail. The whole is decorated with tapering overlays of thin wood. In commencing to make the frame, mark out the two side rails first.

The Principal Dimensions.

On the right-hand half of the diagram (Fig. 1) are the dimensions for marking out the rails, which measure 20in. long, tapering in width from 4in. at the top to 2 $\frac{1}{2}$ in. at the bottom. Cut out one side rail and then use this as a template for marking round for the other side rail. When both rails are cut, smooth up the edges and round off the outer corners.

The bottom rail measures 17in. long and 4 $\frac{1}{2}$ in. wide in the centre. Square up the piece to these dimensions and then set down 3in. from one long edge and connect up these points with the centre point. Take care to get the ends of this rail perfectly square, so close joints result after the side rails are fitted. The top rail is set out from the dimensions given, the length being 17in. and the width in the centre 6 $\frac{1}{2}$ in.

Form the step like outline by following the measurements at this point, and square up the lines before cutting with the fretsaw. Clean up all the rails, and then place them together, temporarily keeping to the interior measurements of 17in. and 12in. Mark across where the dowels will be put (see Fig. 1).

Take the frame apart and run the lines of the dowels down across the thickness of the rails (see Fig. 2) and bore the holes $\frac{1}{2}$ in. diameter down to a depth of $\frac{1}{2}$ in.

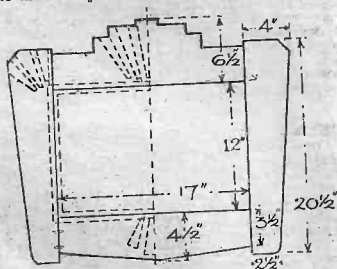

Fig. 1.—Dimensions and details for marking out.

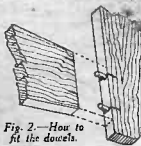
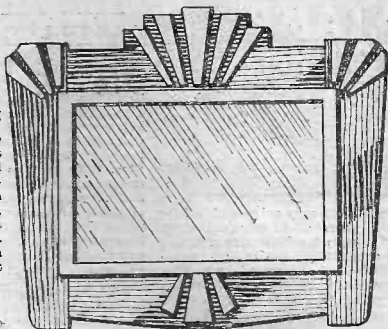

Fig. 2.—How to fit the dowels.



Pieces of hardwood rod lin. in length are next prepared and driven in the side rails, the ends of the dowels being previously dipped into hot glue. Care must be exercised to keep the dowels perfectly square and true, so that when the other rails are driven in the whole frame will lie flat and even. Bring the joints well together and clamp them up until the glue has hardened.

If proper metal cramps are not available an improvised one can be formed by stout cord and a wood or metal winder for twisting it. Pass the cord twice round the top and bottom of the frame and insert the winders just within the opening of the frame.

The strips which are glued on form the rebate for the glass, etc. Two strips 18 $\frac{1}{2}$ in. long by 1in. wide, and two strips 13 $\frac{1}{2}$ in. long by 1in. wide are planned up from $\frac{1}{2}$ in. thick stuff. The ends are mitred to 45 degrees

so they fit accurately and allow a margin of $\frac{1}{4}$ in. for the support of the glass, etc. In Fig. 3 is shown a section through the frame and the strip with glass and backing board complete.

The Decorative Overlays.

These are very simple in outline and may be drawn from the lin. squared diagrams (Fig. 4). Wood $\frac{1}{2}$ in. thick would be preferable for the overlays, but there is no reason why $\frac{1}{4}$ in. wood should not be used.

A piece of 21oz. sheet glass (17in. by 12in.) is held in place by a thin plywood backing board of the same size. It is held in place to the frame by picture-framer's sprigs or fine headless nails. Cover the whole back finally with stout brown paper, and screw in a pair of screw-eyes with rings for hanging.

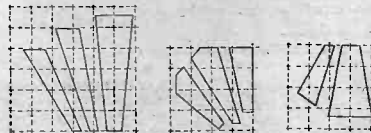

Fig. 4.—Squares to enable the worker to mark out the overlays.

Odds & Ends

WHAT a strange assortment of Hobbies there must be in the world. Cigarette cards, stamps, fret-working, etc., are just everyday ones, but what about the odds and ends of pastimes in which some fellows glory. There's the man who collects door knobs—goodness knows why. There is the London accountant who has spent twenty years visiting the forty-nine cathedrals in England and Wales. This meant a deal of happy travelling—even to the cathedral city of St. David's in Wales, where the nearest main line



The hold-up!

is sixteen miles away. Quite a number collect covers of matchboxes, and a firm of match makers have thousands of varieties from all parts of the world.

MAY we say "Thank you" for the greetings we had from readers at Christmas and the New Year? Our desk was littered with cards of all kinds, little gifts of calendars, boxes, etc., as well as a number of interesting picture annuals from friends overseas. It is nice to have these kindly greetings from unknown readers who think in such practical terms of the work and effort of their Editor. Thank you very much!

THERE is little nowadays to remind us of valentines except the date. A few shops make a "splash" of gifts for suitable females, and George, the office boy, has been found writing some stuff which he calls poetry. But years ago, of course, Valentine's Day was a great event, and although it did not carry enough weight to close the schools, it meant great fun. The idea was to put the present on a doorstep, knock, and run away, so the recipient was unaware who had left the present.



Our correspondence.

But then, some of the naughty lads of those days used to knock and run away without leaving a present. Too bad altogether. That is one of the things you must not make a hobby of on February 14th.

WE are wondering who is saying unkind things because he didn't get his competition model back. Really, it's his own fault, because although he sent stamps for its return he altogether forgot to add his own name and address. By the way, those who did not want their

jigsaw competition pictures back may like to know what happened to them. They were despatched to a Children's Home in time to arrive with Santa Claus and so provide a little amusement for Christmas Day.

HOW many of you can turn? No, not like Dick Whittington, but turn wood and metal on a lathe. Legs, spindles, rails, all sorts of things are done this way by the amateur, and those who are expert at turning should get particulars of a competition being held by the Worshipful Company of Turners of London in April. There are special sections for amateurs, apprentices, scholars and technical students, with money prizes of several pounds each. If you are keen and capable, write for particulars to The Clerk, The Worshipful Company of Turners, Broad Street House, Old Broad Street, London, E.C.2.

HAS any reader got a design of the Giant Bracket, No. 38 Special? That is the one nearly 3ft. high with Father Time on guard over rabbits, birds, etc., and the molars of the year cut out in different parts. Mr. J. Fox, of Upper Fennor, Oldcastle, County Meath, wants



The giant.

one rather badly, so perhaps some reader who can spare his copy will sell it to this reader. Thank you.

READERS in the Wolverhampton District should make a note of a Hobbies Exhibition to be run at the Boys' Club, Mander Street, Wolverhampton, on March 19th. Competitions and exhibitions will cover games, toys, models, philately, sketches, etc., so some of you will undoubtedly be interested. Write to the address given for further particulars.

WHO says fretwork designs don't sell? Listen. A gent eman strolled into the Hobbies Store in Manchester, and bought different designs to the value of £1. 1. 9. He had, he said, received a list of these from a Scoutmaster friend of his in Australia who lived near the bush and could not obtain them there. Can you not imagine the delight on the arrival of the designs—the eager anticipation of the hours of enjoyment such design's would bring to a lonely fellow way down under? More power to h e elbow, say we. It is astounding how many readers keep in touch with the home country through the medium of Hobbies.



Why and Replies

Let Your Editor Help You. Address your letters and queries to The Editor, "Hobbies," Geo. Newnes, Ltd., 8-11, Southampton Street, Strand, London, W.C.2, enclosing a stamped address envelope. All letters and queries must bear the full name and address of the sender.

New Imperial Competition Result Next Week.

I HAVE almost completed the judging of the model New Imperial competition, and the full results, with the names and addresses of the prize-winners, will be given next week. Your newsgroup, of course, has your standing order. I know!

Another Special Wireless Number.

OUR issue dated February 27th (the week after next) will be another special wireless feature number. Our last wireless number (January 23rd issue) was such a success, particularly as it contained details of our "Baby Grand," together with a free gift wiring diagram of it, that readers have urged me to produce this second radio number. Make a note of the date! February 27th issue.

"Mental Nut" Prize-winners.

THE first correct solution to be opened in connection with the Mental Nut contest appearing in our January 23rd issue was sent in by B. Waite, 10, Newell's Villas, Miston, Doncaster, to whom a book has been sent.

Congratulatory Letters.

I CONTINUE to receive from all parts of the world letters of praise and letters containing constructive criticism. The change in the style and format which we instituted with October 4th, 1930, issue evidently met with universal approval, for we have multiplied our circulation rather more than five times since that event. This is a remarkable achievement, and it is a glowing testimony to the happy reader co-operation which the paper has earned for itself. Hobbies to-day is the only paper of its type; it has no competitors. In spite, however, of this cloistered position, the paper is produced at a competitive price which all can afford, and it gives full value for money. There is also the valuable Free Advice Bureau of which hundreds of readers each week

avail themselves. Our free gift schemes have exceeded in value and number anything which has ever been done before. Each week the paper is eagerly snapped up. Perhaps that is why so many thousands of readers have taken my advice and placed a regular order with their newsgroup.

NEXT WEEK.

Free Design Sheet for
MODERN HALL MIRROR

PRACTICAL AERIAL
ERECTION

WEAVING ON
OUR MODEL LOOM

SHARPENING SAWS.

PRINTING FROM
LINOLEUM BLOCKS
EXPERIMENTS WITH
SPARK COILS

A SIMPLE STEAM
TURBINE

Stamps, Electric, Model Aeroplane
Topics, Model Railways,
Cottages, Etc., Etc.

1932 "Tit-Bits" Year Book.

THAT handy compendium of reference, the 1932 "Tit-Bits" Year Book, again makes its welcome appearance. It is impossible to find a more comprehensive digest of all those facts and figures regarding sports, holidays, education, banks, fishing, dogs, death duties, the law about children, income tax, flying, motor records, etc., etc., which when wanted are hard to find. These are but a few of the subjects mentioned in this Year Book, and we cannot find better value, with its 192 pages at 1/-. It is a book which everyone should have at hand, for a maximum amount of information has been packed into it.

Printed by NEWNES & BEARSON PRINTING CO., LTD., EXMOOR STREET, LADBROKE GROVE, W.10, and published by GEORGE NEWNES, LTD., 8-11, SOUTHAMPTON STREET, STRAND, W.C.2. Sole Agents for Australia and New Zealand: GORDON & GORCH, LTD., SOUTH AFRICA: CENTRAL NEWS AGENCY, LTD.

QUERIES AND REPLIES.

Exchange Wanted.
Mr. F. Cunningham, 44, McLellan Street, Plantation, Glasgow, has a box of Carpenter's Tools which he would like to exchange for a pair of Prismatic Binoculars.

Book on Model Engine Building.
Full instructions on making a powerful steam engine appear in "25 Simple Working Models," obtainable from this office for 1s. 2d. This is in reply to W. Tracey, 10, Hilslop Old, Norwich.

Weight of Ebony.

Ebony weighs 77lb. per cubic foot. W. T. (Brighton). We are not quite clear as to what you mean by silver can. Perhaps you will let us have further details. Sheet ebony 1in. thick weighs 13oz.

Grid Condenser and Leak Valves.

The grid condenser should have a value between 3000 mfd. and 5000 mfd. The grid leak usually has a resistance of from 1 to 5 megohms. J. C. (Cork).

Stamped Envelopes Required.

John L. McArdle, Park Cottage, Cult Terrace, Costridge, N.B., wishes to collect covers bearing stamps of more than one country.

Stripping a Film by Heat.

A well-known method of stripping the film from a glass negative, L. H. (Bristol), consists in impregnating the film with an alkaline hardening solution, drying and then immersing in an acid solution; the separation of the gelatin film then follows as the result of the formation of carbon dioxide under the film. The negative is hardened in the following bath: Formaline 300 c.c.s., Glycerine 40 c.c.s. and water to make 1,000 c.c.s. If the negative is treated before drying, 60-90 seconds' immersion will be sufficient; if it is dry, 20 minutes is advisable.

The Gauge of Wire for Aerial and Lead-in.

Stranded 22rd gauge enamelled wire is recommended for aerial and lead-in, H. K. (Darlington). Where the lead-in is liable to touch carbonised bodies H.T. cable is recommended. H.T. current travels on the surface of wires, not through them. The earth lead should also be stranded wire.

Fixing Crystals.

A cap with a screw cap is best for mounting crystals, J. D. J. (Sass Harb), the crystal being packed in lead foil. We do not advise the use of solder, but if you prefer this method use Wood's metal.

Book on Making Fireworks.

I recommend you to obtain a copy of "The Complete Art of Making Fireworks," published by Chatto and Windus, at 5s. Probably Messrs. W. and G. Foyie will let you have a second-hand copy, J. T. (Coatbridge).

Lubricant for Prints.

This lubricant is used when burnishing prints with a steel roller, M. B. (Manchester). Petroleum jelly 50 grs. (5 grains) and Alcohol 10oz. (1,000 c.c.s.).

Repairing Cracks in Ebony.

Cracks in ebony of black composition accumulators, F. D. (Kilkeany), can be repaired by melting into the cracks a mixture composed of 3 parts resin and 1 part of finely shredded gutta percha. This compound will set and harden in the same of heat, preferably a piece of heated steel rod, is removed.

Preventing Developer Stain.

As a means of preventing staining of the fingers with developer, K. S. (Greenock), rub "Vanguard" Boracetolene into the fingers and over the nails before putting the fingers into the developer. The preparation in no way harms any sensitive surface.

No. 1

FREE INSIDE! THREE-VALVE WIRING DIAGRAM

HOME
CRAFTS
WOOD
WORKING
MODEL
MAKING
AMATEUR
MECHANICS
ETC. ETC.

Hobbies

2nd

January 23rd,
1932,
No. 1892.

Published every
Wednesday
Registered at the
G.P.O. for
transmission by
air as registered mail

FREE INSIDE

Designs for this Splendid
All-in "Baby Grand" 3

THIS WEEK:

THE
WIRING
DIAGRAM



NEXT WEEK:

THE
CABINET

Something NEW in Carpentry Sets

Every amateur woodworker will find a delight in these new tool sets. They contain a happy combination of carpentry tools for everyday jobs, and fretwork tools for the more decorative work undertaken by the handyman. Their selection has been undertaken with care; every tool was chosen for its value and usefulness. They are something quite new in tool sets, at a price which will be as popular as the outfits themselves.

The XL Outfit - - 16/6

The tools are fixed to an attractive card in a well-finished wooden box measuring 15in. by 14in. by 1 1/2in. They include a 10in. Hand saw, Hammer, 2ft Folding Rule, 1in. Chisel, small Plane, Finest Bradawl, Screwdriver, 12in. Fretting frame, 1 dozen blades, Drill with two points, Sandpaper Block, Cutting Table and Cramp.

You can see them at any Hobbies Branch—65 New Oxford St., W.C.1; 147 Bishopsgate, E.C.; 83 Newington Barts, S.E.1; 326 Argyle St., Glasgow; 106 Piccadilly, Manchester; 9a High St., Birmingham; 214 West St., Sheffield; 10 Queen Victoria St., Leeds; 25 Broad St., Southampton—68 London Rd., Brighton. Or obtainable by post (1/- extra) from Hobbies Ltd., Dereham, Norfolk.

British
all
through



Also The Handikit 23/6

STRIPWOOD MODELS

are so easy to build and so realistic that every reader of Hobbies will enjoy making them. The wood is ready planed in 2ft. lengths in all necessary sizes. The cutting table is provided with fences and saw guides which ensure the wood being cut accurately. You'll enjoy model making, and can build no end of things from the designs available.

Bundle of 50 feet of
various kinds 2/6.

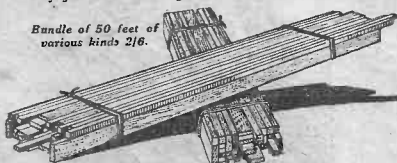

STRIPWOOD CUTTING TABLE

This table is specially made and provides a fence for cutting strips at 50, 45, 60 and right angles. A plain rule is marked on the back, so any number of strips can be cut the exact lengths required.

Price 3/6
Postage 9d.

Ask for Hobbies goods at any leading ironmonger or stores. Hobbies own branches in London, Glasgow, Manchester, Birmingham, Sheffield, Leeds, Southampton, Brighton.

STRIPWOOD

Strips are cut in 2ft. lengths and there are 24 in a bundle. Postage is extra to the prices given.

1/4in. x 1/4in.	1/6	1/4in. x 1/2in.	3/3
1/4in. x 1/2in.	1/6	1/2in. x 1/2in.	3/11
1/4in. x 3/4in.	2/3	1/2in. x 3/4in.	4/3
1/4in. x 1in.	2/3	1/2in. x 1in.	4/-

You can't go
wrong with it.

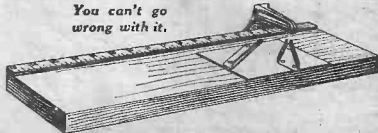

HOBBIES LTD.,
DEREHAM,
NORFOLK

MAKES MASTER MINDS

"Graham Seton's" Tribute to Pelmanism.



Vaughan and Fennell

Lt.-Col. G. S. HUTCHISON, D.S.O., M.C., who says at Pelmanism makes master minds, and urges every reader to take it up. A book describing this famous system will be sent free to everyone who writes for it to-day to the Pelman Institute, 63, Pelman House, Bloomsbury Street, London, W.C.1.

"Following the excitement, tragedy, victory and disillusionment of the Somme," he writes, "and finding myself committed for a third winter to the stagnation of dug-out life, I undertook a course of Pelmanism. Many times since my first enquiry have I referred back to the 'Little Grey Books,' to the notes which I made during the Course, and to the library of works which I built as the result of Pelmanism, in order to stimulate and further the original thought provoked by the Course.

Unique and Scientific System.

"Pelmanism came to the rescue then. It has come, and to tens of thousands of others will come again, to save us from becoming one-track merchants, dull operatives, routine workers, men and women without imagination, with the spark of genius extinguished, hope obliterated and the joy of living gone.

"Pelmanism is a science founded upon the certainties of Psychological research and knowledge. The 'Little Grey Books' lift the mind from its trench of convention, and, as it were, in some swift-flying aeroplane, shows to it the whole panorama of world thought. The mind, as the pilot, is free to make a landing where it will. And since the brain-cells, if they are activated and stimulated, commence immediately to develop, so through Pelmanism a succession of new interests is awakened, and the mind is enabled to become a master not of one problem, but of many; not of one department of knowledge and experience, but of a host.

Boredom Vanished.

"It is such variety of life which produces interest, prevents boredom and a feeling of hopeless purposelessness, and, since the creative instinct is in all of us, and is, too, the greatest of all joys, so also Pelmanism instantly produces Happiness. Yet it is not a conjuring trick, but Science. By means of this system, unique and acclaimed by all who have studied it, master minds are made.

"I have a recommendation to make as one who has been not unsuccessful, whether in obtaining the

LIEUT.-COL. G. S. HUTCHISON, D.S.O., M.C., better known, perhaps, as "Graham Seton," author of "The 'W' Plan," which has been described as "the greatest spy story of the war," publishes a stirring message to-day to everyone who wishes to get on in life and to lift his or her mind out of the rut of stagnation and routine.

He appeals to every reader to take up Pelmanism and to make it "the foundation stone of Success." For being a Pelmanist himself, he is anxious that the benefits it gives should be shared and appreciated by others.

"Following the excitement, tragedy, victory and disillusionment of the Somme," he writes, "and finding myself committed for a third winter to the stagnation of dug-out life, I undertook a course of Pelmanism. Many times since my first enquiry have I referred back to the 'Little Grey Books,' to the notes which I made during the Course, and to the library of works which I built as the result of Pelmanism, in order to stimulate and further the original thought provoked by the Course.

utmost fun out of life, or in the more worldly victories of commerce, and this is to urge every young man and woman to make of Pelmanism the foundation stone of Success.

"In each of its students Pelmanism discovers qualities and capacities unknown; the Course gives life to the germs of latent capacity and interest. The Pelmanist has neither time nor place for morbid brooding, nor can he be the victim of futile, introspective hallucination and fear. The mind is on the tip of eagerness and desire, alert, enquiring, interested, with the will to conquest and a passionate love of life.

"So I have found it, and I commend it to you."

Thousands of men and women are taking up Pelmanism to-day in order to train their minds and their senses, to banish Depression, Nervousness and Morbid Thoughts, to strengthen their Wills and develop their powers of Initiative and Concentration, to increase their Efficiency and Earning-Power, and to cultivate a keener appreciation of the beauties of Art, Nature and Life.

Latent Powers Developed.

Pelmanism brings out the mind's latent powers and develops them to the highest point of efficiency. It banishes:—

Depression	The "Inferiority Complex"
Timidity, Shyness	Indecision
Forgetfulness	Weakness of Will
The Worry Habit	Procrastination
Unnecessary Fears	Brain-Fog
Mind-Wandering	which interferes with the effective working power of the brain, and it develops:—

—Concentration	—Organising Power
—Optimism	—Directive Ability
—Cheerfulness	—Presence of Mind
—Observation	—Courage
—Perception	—Self-Confidence
—Judgment	—Self-Control
—Initiative	—Tact
—Will-Power	—Reliability
—Decision	—Driving Force
—Originality	—Salesmanship
—Resourcefulness	—Business Acumen
	and a Reliable Memory

all qualities of the utmost value in every walk of life.

Pelmanism is quite easy and simple to follow, is exceedingly interesting, and takes up only a short time daily.



Write to-day to the Pelman Institute, 63, Pelman House, Bloomsbury Street, London, W.C.1. and by return you will receive a free copy of "The Efficient Mind," which contains a full description of the Pelman Course and shows you how you can enrol on especially convenient terms. Call or write for this free book to-day.

Readers who can call at the Institute will be cordially welcomed. The Chief Consultants will be delighted to have a talk with them, and no fee will be charged for his advice.

Overseas Branches: PARIS: 25 Rue Boissay 4 Angles. New York: 11 West 45th Street. HELSINKI: 265 Wilhelms Lane. DUBLIN: Total Bank Chambers. DELHI: 10 Alipora Road. CALCUTTA: 67 Park Street.

STUDY AT HOME

YOU CAN HAVE A COLLEGE TRAINING IN ALMOST ANY CAREER FOR A FEW SHILLINGS MONTHLY.

IN YOUR SPARE TIME

FOUNDED 1900. 31 YEARS OF SUCCESS.



LET ME BE YOUR FATHER

In many trades and professions there are more vacancies than trained men to fill them. We do not profess to act as an employment agency, but our gigantic organisation certainly does tell us where the demand exists, thus enabling us to give



WE TEACH ALL BRANCHES OF VOCATIONS AND SPECIALISE IN ALL EXAMINATIONS CONNECTED THEREWITH.

FATHERLY ADVICE ON ALL CAREERS AND THE POSSIBILITY OF EMPLOYMENT. FREE

Accountancy Examinations
Advertising and Sales Management
A.M.I., Fire E. Examinations
Applied Mechanics
Army Certificates
Auctioneers and Estate Agents
Aviation Engineering
Banking
Beliefs
Book-keeping, Accountancy and Modern Business Methods
B.S.C. (Exec.)
E.S.E. (Public Management)
Building, Architecture and Clerk of Chemistry (Works)
Civil Engineering
Civil Services
All Commercial subjects
Commercial Art
Concrete and Structural Engineering
Dungunnamah all branches
Engineering, All branches, subjects and examinations
General Education
Etching and Yachtbuilding
Insurance
R.O.T. Notes

Maintenance
Metallurgy
Mining, all subjects
Mining Electrical Engineering
Motor Engineering
Municipal and County Engineers
Naval Architecture
Pattern Making
Police, Special course
Preceptors, Colours of Pumps and Pumping Machinery
Road-Making and Maintenance
Salesmanship
Sanitation
Secretarial
Shipbuilding
Sheetmetal (Fitzmaur)
Structural Engineering
Surveying
Teachers of Handicrafts
Town Planning
Transport
Weights and Measures "Imp."
Wireless Telegraphy and Telephony
Work Management

IF YOU DO NOT SEE YOUR OWN REQUIREMENTS ABOVE, WRITE TO US ON ANY SUBJECT.

IT COSTS NOTHING TO ENQUIRE

WE TEACH BY POST IN ALL PARTS OF THE WORLD

Also ask for Our New Book (FREE OF CHARGE),

THE HUMAN MACHINE Secrets of Success

Notes Address Carefully:

THE BENNETT COLLEGE, Ltd.
(Dept. 62), SHEFFIELD.

YOUNG MEN physically fit should join the Police. Study at home in four spare time. We have special courses for Routine and Promotion; 1s. per week brings success. Full Particulars free, or advice about other careers. Commercial, Technical or Civil Service, free. Apply to the above address.

THE TUBE PACKET FREE.

All applicants for my new approval sheets sending 1ld. postage will receive 15 TURKISH stamps free. Factorial, War, Jubilee, Saracened, etc., usually sold at 1s. 5d. Additional free set to customers giving collector's address.

H. WATKINS

(Dept. H.2), 60, Leicester Road, East Finchley, N.E.

SALE and EXCHANGE

Advertisements are accepted for this column at the rate of 3s. per word, per pair. Address communications to the advertisement manager, "Hobbies," Southampton Street, Strand, London, W.C.2.

CINEMATOGRAPH FILMS, Machines, Accessories. Lists Free. Sample Film, 1s.—Filmmatics, 37, Lancaster Road, Leytonstone.

PATENTING INVENTIONS.—Handbook free.—King's Patent Agency, Ltd., Warbrooke Chambers, E.C.4.

ALL SMALL FITTINGS for the handyman. Hinges, knobs, hooks, bolts, locks, etc. Reliable and cheap. Call at Hobbies branches or send requirements to Hobbies, Ltd., Dereham, Norfolk.

GRAMOPHONE FITTINGS.—Wholesale prices, 64-page catalogue. G. "How make Gramophones." 3d.—Regentbox, 120, Old Street, London.

CONJURING CATALOGUE FREE.—Vandy Postimes, Hastings.

SALESMAN WANTED. Spare time only, 20s. weekly easily earned.—Richard, 0, Snow Hill, London.

GRAMOPHONE SALE. Motors, Tonearms, Soundboxes, Horns, Amplifiers, Gramophones and Cabinets at gift prices. Catalogue free.—H. J. Hart, Ltd., High Street, Duford, S.E.8.

"TOY MAKING FOR AMATEURS."—96 pages—hundreds of illustrations: explains how to make every form of mechanical toy—clockwork, steam, and electric. 1s. from all newsagents.

SLOAN-DUGLEY SHORTLAND, the rapidly-spreading high-speed system, saves a year's study. Read booklet of wonderful records and obtain free lesson.—Sloan-Dugley Society, Dept. S, Hamgate.

"25 SIMPLE WORKING MODELS."—98 pages—117 illustrations. Describes 25 electric, steam, and clockwork models. Many ingenious and practical designs.

10,000 SETS.—Petrolmotor castings—9s. 9d. each. Catalogue 3d. Parts tool.—Butters Works, Wado Street, Littleover, Derby.

TROUSER PRESS FITTINGS. 2 1/2" x 18", 20, Sirocher 1/3; 28" x 1 1/2", 3/8, Sirocher, 1/3d. Tie Press Fittings, 1/2 set; 12 sets 7/6.—British Co., 1, Waterloo Street, E.C.1.

IF you want to increase your income at home without interfering with your present occupation, let us send you particulars of our new plan which any ambitious man can start using at once. Small capital only needed; no rent, rates or canvassing. No stamps or outfit to buy. Send for free booklet to-day to: Business Service Institute, Dept. 501, 6, Carmelite Street, F.O.1.

METAL CUTTING PRETSAW BLADES, for the metal worker. Fine to coarse 3d. per doz. Heavy fretsaws for thick wood 6d. per dozen. Postage 1ld. extra.—Write or call Hobbies Ltd.

TELEVISION.—Scanning Discs—and parts supplied for Amateur Constructors.—John Satter, Member Television Society, Featherstone Buildings, Holborn, W.C.1.

CINEMATOGRAPHS, FILMS, CHEAP. Lists—"Movies," 109, Kenil, Tooting.

STAMPS.

100 DIFFERENT, including 10 Child, free to genuine applicants for approval, enclosing 3d.—Court Stamp Co., Court Place, Guernsey.

100 DIFFERENT STAMPS FREE! Request Approvals.—Clarke, 4, Morling Road, Old Trafford, Manchester.

SUBSCRIPTION RATES.

"Hobbies" will be forwarded by post to any reader at the following prepaid rates: Twelve months, 13/-; Six months, 6/6; Three months, 3/3. Registered at the G.P.O. for transmission by Canadian Magazine Post.

FREE DESIGN SHEET FOR OUR "BABY GRAND" CABINET NEXT WEEK !

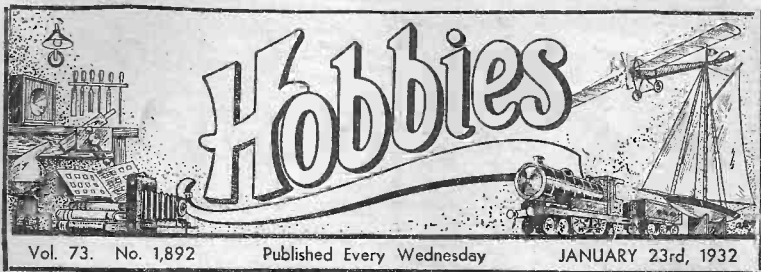

THIS WEEK'S CLEVER IDEAS

New Moving Coil Loudspeaker Unit.

MODERN loudspeakers may be broadly divided into four types: the moving coil, the reed, the dynamic inductor, and the balanced armature. These are all, of course, of the one variety, the exponential or logarithmic types of horn speaker now being practically obsolete. The moving-coil types of speaker are at present by far the most popular. In spite of the fact that hitherto they have been somewhat expensive. Considerable interest, therefore, attaches to the introduction by a well-known wireless firm of a new moving-coil unit at 6s. 6d. Equipped with a large permanent magnet, this speaker is extremely sensitive, for it has a matching transformer provided with three different ratios for high, medium and low impedance values.

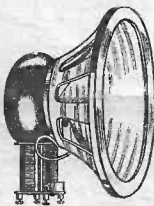

A new moving coil loudspeaker unit.

A Practical Voltmeter for Radio.

AS this is a special wireless number the moment is opportune to draw the reader's attention to the value of that excellent little device the voltmeter and milliammeter, a combined form of which is marketed at 8s. 6d. by one of the advertisers in this issue. One scale measures up to 5 volts, another scale up to 160 volts, and a third scale will measure high-tension current drain up to 22 milliamps. These devices are rightly termed the detectives of radio. Every wireless enthusiast should have one. Another model without the milliammeter reading costs 7s. 6d.

A New Wireless Coil.

A NEW wireless coil for which is claimed great selectivity and exceptionally wide tuning range (180 to 2,000 metres) has just been marketed. It is illustrated at the foot of this column. It is mounted on an ebonite former and costs 4s. 6d.



A selective wireless tuning coil.

Machine-Made Minds.

IN these days there is too much thinking in the mass. The individual tends to become standardized and allows some other person or persons to do his thinking for him. Every person who really intends to make a success of life must beware of the machine-made mind. Individuality must be retained at all costs. Some hundreds of thousands of people have succeeded in doing this by taking up a course of mental training by means of Pelmanism. They realize that their own minds have not hitherto had a real opportunity of complete development, and they act upon the testimony of many eminent persons who themselves have proved that Pelmanism is the best kind of mental training.

We advise all interested readers to write for a copy of a remarkable book called "The Efficient Mind." This can be obtained post free from The Pelman Institute, 63, Pelman House, Bloomsbury Street, London, W.C.1. "The Efficient Mind" contains a complete synopsis of the Pelman Course, together with conclusive evidence which shows how thousands of men and women throughout the world have, by its aid, won success in business, social and public life. A copy will be sent free to any reader of this journal on application to the address given above.

Useful Direction Indicator for Cyclists.

A USEFUL direction indicator for cyclists is illustrated at the bottom of this page. Although it only costs 6s. it makes signalling at night as sure and certain as in daylight. It fits under the expander bolt in the centre of the handle-bar. When the arm of the director is swung to the side required, the signal automatically becomes illuminated by means of an ordinary micro-torch battery and bulb concealed inside the signal.

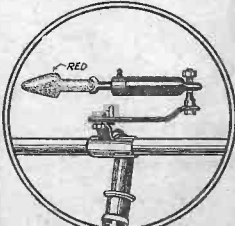

Useful direction indicator for cyclists.

The address of the manufacturers of items mentioned on this page can be obtained on application to the Editor.

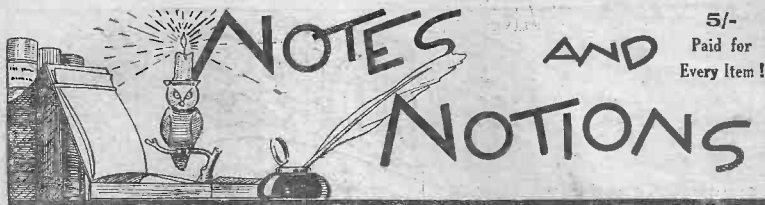

5/-
Paid for
Every Item!

A Frost Warning.

OBTAIN a large porcelain jam-jar and a large cork, and fill the jar to within $\frac{1}{2}$ in. of the top. A wire is then inserted into the cork and out through the top as shown. It is then floated in the water and the wire is then led away to the positive terminal of a small battery. Cut a

TIN PLATE

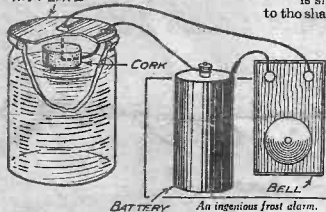

BATTERY An ingenious frost alarm.

metal disc from a piece of tin and place it over the jar, allowing a small hole for the wire connected to the cork. Another wire is then soldered to the tin and connected to the negative terminal, and an electric bell is connected in series inside the house. When the water freezes it expands, thereby completing the circuit and thus ringing the bell.

—T. JONES (88, Manor Road, Manselton, Swansea).

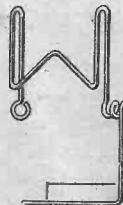

A simple book marker.



THAT DODGE OF YOURS?

Why not pass it on to us? We pay Five Shillings for every item published on this page. Mark your envelope "Notes and Notions." Put your name and address on every item. Every notion sent in **MUST** be original.

An Ingenious Bookmarker.

AS can be seen by the sketch, it is simply a piece of wire bent to the shape shown. The size of the marker is left to the discretion of the reader according to the size of the book. When completed the m-shaped piece is slipped over the cover and the arm springs down on the page. Stout piano wire should be used which can be enamelled with a piece of ribbon.—W. DORRINGTON (47, Glyn Rd., Clapton, E.S.)

An Electric Motor.

THE armature consists of a large cork with a pin in each end and wound with about 10ft. of No. 28 S.W.G. wire. The bearings are made from 2 corks and 4 pins as shown. The motor is assembled with two bar magnets at each side of the armature. The north pole of one magnet should be placed next to the armature, and the south of the other magnet to the opposite side. Connect two wires with a dry cell, and make them just touch the two ends of the wire on the armature and it will re-

volve.—No name (34, Newton Road, High Heaton, Newcastle-on-Tyne).

Improving a Cinematograph.

MOST readers have no doubt noticed that cinematographs have only small reels for holding and taking up film, and that these

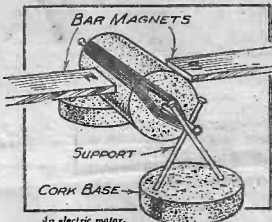

An electric motor.

reels are not completely detachable. Here is a simple way of making the reels capable of holding about 300ft. of film. Cut four fairly thick cardboard discs about 6in. in diameter. In the centre of these reels cut holes about $\frac{1}{4}$ in. in diameter, or of the size to fit tightly on to the spindle of the metal reels. With these cardboard discs on the reels it is possible to put on large reels of film as shown in the sketch.—C. SCOTT (305, Deggsthorpe Rd., Peterborough).

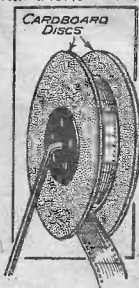

Enlarging the film reel on a cinematograph.

THIS WEEK'S MENTAL NUT.

A BOOK will be awarded each week for the first correct solution opened. Mark envelopes "Mental Nut."

BY what fractional part does four-fourths exceed three-fourths?

Answer to Last Week's Problem.

THE first day of a century can never fall on a Sunday, nor on a Wednesday or a Friday.

OUR "BABY GRAND" THREE

How to make the attractive set forming the subject of this week's FREE GIFT CHART

The cabinet will form the subject of next week's FREE DESIGN CHART.

THE receiver described this week is an entirely self-contained piece of apparatus in an original cabinet. It will be seen from the illustration that this takes the form of a small grand piano. The pediment at the bottom accommodating the loud-speaker. The cabinet work is quite simple and should present no difficulty to the average handyman.

Range of the Set.

The actual receiver consists of a three-valve circuit completely decoupled, so that no instability will be experienced, even with a run-down H.T. battery. It will give quite a comfortable volume of sound from a number of stations, on both long and short wave lengths, and it will also receive many of the Continental stations at good loud-speaker strength. The construction of the cabinet will be dealt with next week.

Obtain the parts as specified in the list of components and do not substitute any parts for those named. Alternative makes are given in some cases, and this allows sufficient choice to be made to suit various purses. We do not recommend any other components than those stated. Drill the panel as shown in the panel layout, the holes being large enough to take the one-hole fixing bushes supplied with the parts specified. This is usually $\frac{1}{8}$ in.

Mount the various parts on the baseboard, keeping to the arrangement as shown in the wiring diagram. One of the terminal mounts is fixed at the side of the baseboard, and if you decide to

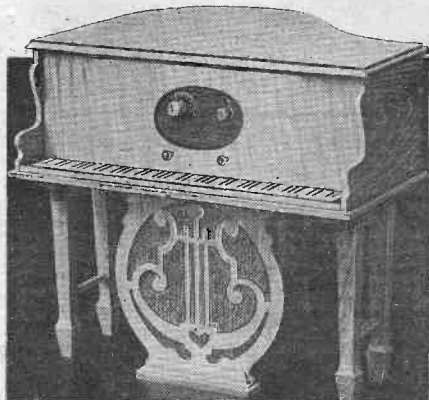

This photograph shows the completed set. Next week's Free Gift Sheet will enable you to make the Cabinet, which stands 21 in. high, 24 in. wide, and 14 in. 10 in. from back to front.

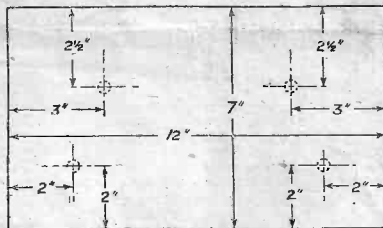

PANEL LAYOUT

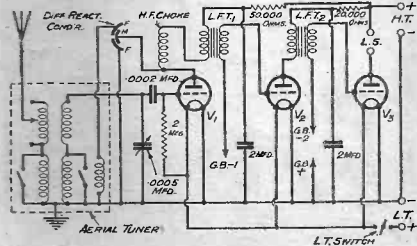

THEORETICAL CIRCUIT.

dispense with this mount and use a piece of ebonite, you will need to take a piece of the baseboard out equal to the thickness of the ebonite, in order that the baseboard may fit in the strip of wood at the bottom of the cabinet. This piece of wood may be omitted, but the receiver will be able to move about if you use nothing to act as a stop at each side of the baseboard.

When all the parts are screwed down, you may proceed to wire up. The only points of interest here are the short flex battery leads, and the two Spaghetti resistances. The latter are attached by means of the ring ends to the terminals on the transformers, and a short screw is then passed through the rings at the opposite ends of the resistances. This is then screwed to the baseboard, but before tightening it up a length of glazite and a short length of flex are passed between the ring ends of the resistances. When the screw is driven right home the two leads will be firmly held between the resistances and the whole job will be firm. Fix the lengths of flex, equipped with the necessary wandler plugs and spade ends, to the wires as shown. If you do not wish to solder these, they may be attached to the valve-holder terminals in the case of the H.T., L.T., and G.B. + leads.

Having completed the wiring, plug the detector valve into the holder nearest the tuning coil, the L.F. valve in the centre holder, and the small power valve into the remaining holder. The H.T. + plug goes into the 120-volt socket of the H.T. battery, the Spaghetti resistances serving to reduce the H.T.

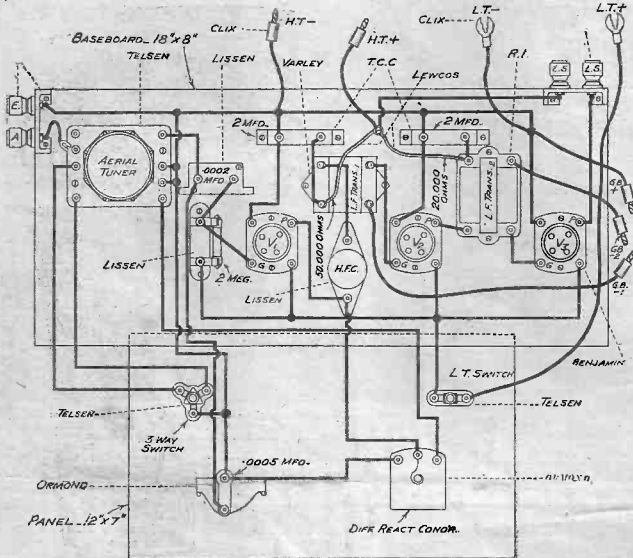

WIRING DIAGRAM.

applied to the two first valves, and at the same time to act as decouplers. Two leads from the loudspeaker terminals should be passed through a hole in the bottom of the cabinet and joined to the loudspeaker unit, which with the

LIST OF COMPONENTS, ETC.

.0005 variable condenser (Ormond).
 .0003 differential condenser (Ormond).
 .0002 fixed condenser (Telsen, Lissen, etc.).
 Two 2 mfd. fixed condensers (T.C.C., etc.).
 2 meg. grid leak and holder (Lissen, Telsen, etc.).
 50,000 ohm Spaghetti resistance (Lissen, Lewcos, etc.).
 20,000 ohm Spaghetti resistance (Lissen, Lewcos, etc.).

Telsen new type aerial tuner.

Three valve holders (Benjamin, etc.).
 H.F. choke (Bulgin, Lissen, etc.).
 Two terminal mounts with terminals.
 On and off switch (Telsen, Bulgin, etc.).

Three-point wave-change switch (Telsen, Bulgin, etc.).
 Vorley Nicore I transformer.
 R.I. Dux transformer.
 Resistor carbonic panel, American Hard Rubber Co. Ltd., 12in. by 7in.

Wooden baseboard, 18in. by 8in. Few yards of flex.

Three black wander plugs. } Clr.
 Two red wander plugs.
 Two spade connectors.

Glass, screws, etc.
 Ormond L.S. unit and small chassis.
 Three Cassor valves (detector, L.F. and small power).
 Lissen H.T. battery, 120-volt type.
 2-volt Ezide accumulator.
 9-volt Lissen grid bias battery.

"HOBBIES" "BABY GRAND THREE."

Parcel of Materials Supplied.

A parcel containing all of the components, but without batteries, valves, or loud speaker, may be obtained from any branch of Hobbies Ltd. for 30s., including royalty, or from Hobbies Ltd., Dereham, Norfolk, for 81s. The Ormond Chassis costs 5s. extra, the Ormond Loudspeaker Unit 12s. 6d. extra, the accumulator 4s. 6d. extra, the H.T. battery 11s. extra, and the grid bias battery 1s. 3d. extra. Three valves can be supplied for 27s. 6d.

The Cabinet.

Next week's free design sheet will be of the cabinet. A parcel of materials for making this can be obtained from Hobbies Ltd., for 21s. carriage forward.

The Baseboard and Panel.

A baseboard of plywood and a padouk front panel can be obtained from Hobbies Ltd. for 1s. 9d., or post free for 2s. 3d.

SPECIAL NOTES—This set will only function satisfactorily when the specified components are used.

chassis is secured to the back of the pedestal. Lengths of flex should be attached to the aerial and earth terminals at the back of the cabinet and taken along inside the cabinet to the two terminals on the baseboard. Don't use twisted flex for this purpose, but take two separate wires and allow them to be separated by a couple of inches or so.

Upon switching on you should now be able to readily hear the local station, and in any part of the country it should be possible to tune in the two local stations with no overlap or jamming. This is possible even within a few miles of Brookmans Park, owing to the efficiency of the aerial tuner. A number of foreign stations will be heard after dark, even

with the twin transmitters working, but remember the old advice: don't oscillate in order to bring in a very faint station, and thereby spoil the reception of your neighbours.

Used by the Designer " of the "Baby Grand 3"

Don't take chances on the performance of your "Baby Grand 3." Make sure of the same range, the same tone and selectivity as the Designer obtained in his extended tests of this fine Receiver—use Cossor Valves throughout. Because of their famous "Mica Bridge Mounting" Cossor Valves are absolutely true to characteristics. "Mica Bridge Mounting" ensures maxi-

imum efficiency and life-long consistency of performance. Use Cossor and be sure.

—follow his lead, use these types of COSSOR Valves and ensure maximum performance :—

Detector	COSSOR 210 L.F.
1st L.F. Stage	COSSOR 210 L.F.
Output	COSSOR 215 P.



COSSOR

ALL-BRITISH
VALVES

A. C. Cossor, Ltd., Highbury Grove, London, N.5.
Depots at Birmingham, Bristol, Glasgow, Leeds,
Liverpool, Manchester, Newcastle, Sheffield and
Dublin.

♡ 9693

To Messrs. A. C. COSSOR LTD., Highbury Grove, London, N.5.
Please send me the price of the following valves and valves book 321.
Name: _____
Address: _____
K.L.28/1/32

How to build this fine RADIO GRAM CABINET

This cabinet will take a set with an 18in. by 9in. panel and a baseboard 12in. wide. Wood and fittings are supplied for the whole of the parts required.

THE tendency now is for those who possess both a gramophone and a wireless set to house them together in one cabinet and so use the loud speaker in place of the usual gramophone trumpet when playing off the records. We give here details of a really up-to-date cabinet built in oak and of simple design and construction. It has three distinct compartments—the lower one accommodates the loud speaker and the batteries, the middle one takes the set, and the top section to hold the gramophone and pick-up. A large baffle board front is provided which will take the speaker unit and chassis, and it is suggested that to be in keeping with the design of the cabinet the frosted panel of Hobbies Design No. 182 Special be pasted on and cut out. A full-size design for this front appears on one of the design sheets given with Hobbies 1932 Catalogue.

The motor of the gramophone is in the same chamber as the set, but the table and tone arm are in a compartment beneath the lid. The leads from the pick-up go through to the loud speaker unit in the lowest portion. The set can have a panel front up to 18in. by

9in. with a baseboard 16in. wide and 14in. deep.

The Construction of the Cabinet.

The main dimensions of the cabinet may be got from the front view (Fig. 1) and the section (Fig. 2) while the disposition of the various rails connecting the legs is in the skeleton diagram (Fig. 3).

The legs have one side grooved to take the plywood sides, and the rails are to be dowelled to the legs. Allow two dowels for each end of the wide rails and one dowel each end for the narrower and less important rails.

Trim off square the tops of the legs 2ft. 11in. long, and then take the rails and glue in the dowels. Mark the positions of the rails accurately on the legs and bore the holes and insert the dowels. Put each pair of side legs together with their rails, and then build in the long front and back rails. When the framework is together treat the whole for squareness and add some screws to strengthen it where possible and glue in one or two angle blocks cut from old pieces of soft wood.

Adding the Sides.

The positions for these angle blocks are shown in Fig. 3. The exact size of the plywood sides is now ascertained, and the wood cut, the grooves coated with glue and the sides then slid down from the top. Add one or two small screws and edunternik. The two back rails are flush with the outside faces of the legs, so the back of the cabinet (consisting of one piece of plywood) may be screwed on. Round-headed brass screws should be used so that the back may be easily removed. Some workers may prefer to form a door in the lower part of the back with hinges and catch complete, as shown in design No. 182 Special.

The Speaker Compartment.

The floor consists of stout plywood supported by the side rails, the back rail, and the fillet nailed to the back of the front rail.

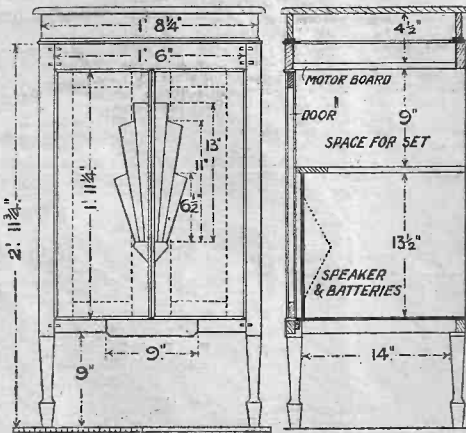
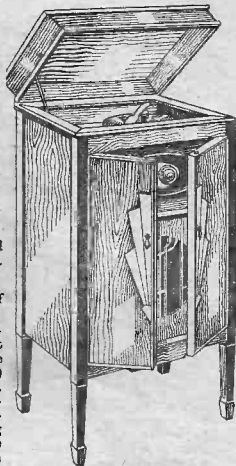
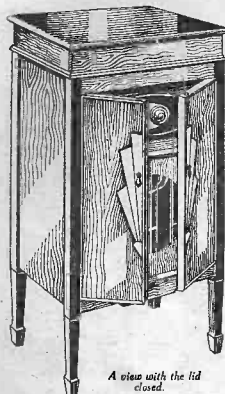

Fig. 1.—A front view with helpful dimensions.

Fig. 2.—A side view showing construction.



A view with the lid closed.

sists of four pieces to form the front, back and sides, and one large piece for the top, which should have its edge moulded or rounded off as shown. The side rails of the lid fit in between the front and back rails, and are glued and screwed together. A piece of two of angle fillet is added to the corners inside to give added strength. Around the bottom of the lid a narrow edging is secured, mitred at the corners, and rounded off on its outside edges.

The Doors.

There are two doors and each is made up upon a framing of 1 1/2 in. by 1/2 in. thick deal or chestnut, and covered back and front with plywood. The four rails for each door are cut to their proper lengths, according to the cutting list given, and halved at the corners and glued and screwed together. Right-angle blocks are glued into the interior of the frame to stiffen it. The outside face of each frame is covered with oak-faced plywood out to the exact

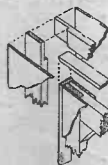

Fig. 4.—The door construction.

The corners are notched out to fit the legs. The board to hold the motor is 1/2 in. thick, screwed firmly to the top rails by countersunk screws. Before fixing this board, however, the motor should be laid in position on it and the holes made for the screws and the body part—the motor being hung beneath the board.

The top of the cabinet is finished off with an edging of 1/2 in. by 1/2 in. stuff which is mitred at the corners above the legs and screwed to the rails.

The Lid.

This is of simple construction and consists of four pieces to form the front, back and sides, and one large piece for the top, which should have its edge moulded or rounded off as shown. The side rails of the lid fit in between the front and back rails, and are glued and screwed together. A piece of two of angle fillet is added to the corners inside to give added strength. Around the bottom of the lid a narrow edging is secured, mitred at the corners, and rounded off on its outside edges.

size of the frame and cleaned up carefully all round. It should be glued to the framing and a number of 1/8 in. screws put in from the back. The backs of the frames are similarly treated with cheaper plywood.

See that the edges are clean and square, ready for the oak edging strips. These are planed up 1/2 in. wide and 1/2 in. thick. Lay each strip in place and carefully mark and cut the mitres for the corners, and then glue and screw the pieces on. The detail (Fig. 4) illustrates how the doors are made. The decorative overlays on the doors are all cut from 1/2 in. wood; their simple shape may be got from the front view of the cabinet (Fig. 1).

Finishing Up.

All the woodwork should be cleaned up at completion and stained to the desired tone and french polished with Hobbies Lightning Polish.

The two ball catches, No. 5482, should be let in carefully to the tops of the doors, the thin plates to engage them screwed on beneath the top rail of the cabinet. The drop handles for the doors (No. 5391) are so placed that they engage inside with the middle front rail beneath the set.

In fitting the set and the baffle-board in place, a piece or two of plain fillet wood and some small blocking pieces should be allowed for, but as these may consist of cheap wood only no provision has been made for them in the special parcel of wood. For those of our workers who have difficulty in setting out the true shapes of the overlays for the doors, Hobbies will supply, free of charge, an outline of each on thin paper ready for transfer to the wood. A stamped and addressed envelope should be enclosed with the request.

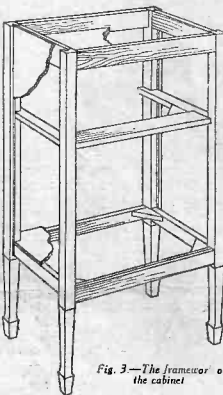

Fig. 3.—The framework of the cabinet.

CUTTING LIST OF PARTS

CARCASE.				IN SPANISH CHESTNUT.				MOTOR BOARD.			
	Length	Width	Thickness		Length	Width	Thickness		Length	Width	Thickness
2 rails	18 in.	1 1/2 in.	3/8 in.	1 piece	18 in.	1 1/2 in.	3/8 in.	1 piece plywood	20 in.	20 in.	3/16 in.
2 "	14 in.	1 1/2 in.	3/8 in.								
2 "	18 in.	2 1/2 in.	3/8 in.								
1 rail	14 in.	2 1/2 in.	3/8 in.								
1 rail	18 in.	2 1/2 in.	3/8 in.								
1 back plywood	25 in.	15 in.	3/16 in.								
1 door	27 in.	15 in.	3/16 in.								
2 pieces	21 in.	1 1/2 in.	3/8 in.								
2 "	17 in.	1 1/2 in.	3/8 in.								
4 legs (No. 523C)	26 in.	4 in.	1 1/2 in.								
LID.											
2 pieces	20 1/2 in.	2 1/2 in.	3/8 in.								
2 "	14 1/2 in.	2 1/2 in.	3/8 in.								
1 piece	21 1/2 in.	1 1/2 in.	3/8 in.								
1 piece	20 in.	1 in.	3/8 in.								
2 "	16 1/2 in.	1 in.	3/8 in.								
DOORS.											
2 pieces plywood	27 in.	15 in.	3/16 in.	2 drop handles, No. 5391.	2 No. 5482 ball and catch.						
2 "	23 in.	8 1/2 in.	3/16 in.	3 pairs hinges, 1 1/2 in. brass.	1 cabinet lid support.						
2 "	21 in.	1 1/2 in.	3/8 in.								
2 "	17 in.	1 1/2 in.	3/8 in.								
2 "	21 in.	1 1/2 in.	3/8 in.								
2 "	17 in.	1 1/2 in.	3/8 in.								

A completed parcel of Spanish chestnut, suitable for finishing like oak, with grooved legs and the fittings named, is supplied by Hobbies Ltd. for 35/-. A suitable speaker unit and chassis are also obtainable from the same source.

HOW TO BUILD THE "AUTOKOIL TWO"

IN our issue dated Dec. 12th, 1931, we explained how to make an All-Wave Three Valve Set utilizing the very efficient and ultra-selective Autokoil Tuning Unit, which encompasses a tuning range of 200 to 2,000 metres. So impressed were we with the knife-edge tuning which this coil provides, and having in mind the difficulty so many readers experience in separating some of the broadcast programmes that we built up the All-Wave Two shown in the photograph. The results were truly remarkable, for Southampton Street, almost at the top of the B.B.C., is hardly a suitable place to test a wireless set. Notwithstanding this handicap we were able to cut out London with a two-degree movement of the tuning condenser. We can, therefore, recommend the construction of this set.

The two-valve circuit depicted shows how simple it is to use the Autokoil all-wave tuner. Just a few connections are made in order to associate its five terminals (each plainly marked) with the necessary ingredients of a straight receiving circuit.

Wiring is executed without soldering from terminal to terminal. Each line in the diagram indicates a connection that has to be made in the set. The dotted line shows where the baseboard and panel are separated.

An ordinary detector valve is used in the first (left) holder and a power valve in the second.

Power Supply.
The Autokoil Two may be operated from batteries or from an eliminator. All power leads are flexible and are conducted from the components concerned direct to the batteries or eliminator as the case may be. A H.T. battery is connected to the three H.T. leads—negative and positives Nos. 1 and 2.

Reaction is obtained by adjusting "R.C.," the middle knob of the unit. If too severe or inclined to be "ploppy," H.T. positive No. 1 should be lowered

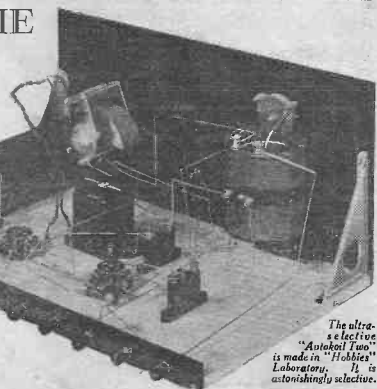

slightly but not to a point where volume drops considerably. If "R," the 1,000 ohm variable resistance, is adjusted carefully, ample reaction can be obtained.

Finding Stations.

"W.B.S." is the knob control used to determine the waveband in which it is desired to work. On the first (extreme left) stud, stations working from 200 metres upwards will be found. When the full capacity of the .0005 has been used with this stud engaged, the arm should be moved forward to the second stud and so on till, with the fifth engaged, stations working up to nearly 2,000 metres will be found. When and as each stud is engaged, the vanes of the .0005 should be turned all out and then moved slowly inwards while "R.C." is used to keep the set sensitive.

"C.C." is a compensating condenser. As a rule it should be adjusted so that its vanes are half-way out when tuning in the broadcast band, or right in when tuning in the long-wave band.

If the aerial is long or the set unselective, or if a receiver is worked at the end of a long lead-in, the vanes must be turned outwards till conditions are accommodated.

If it is found difficult to tune very low, that is, to about 200 metres, the vanes must be turned outwards till wavelength is reduced as aerial capacity is reduced. As this condenser exercises so decided an effect it should be handled with care and should not be used as a tuner. All tuning should be done with the .0005 variable condenser.

The components we used were as follows:—

1 Autokoil Unit; 1 Polar Condenser .0005 mfd. (variable, No. 2); 3 Clix baseboard mounting and valve-holders; Clix Vico-grip terminals; 1/18in. by 1in. Resistor panel (American Hard Rubber Co., Ltd.); 3 T.C.C. condensers (.01 mfd., .0003 mfd., and .002 mfd.); 1 2-megohm grid leak; 1 1/2vt transformer (Radio Instruments); Eta Valves, Nos. BY2010 (detector), BY1304 (amplifier); Exide 2-volt accumulator; 1 oak cabinet, Camco (Carrington Manufacturing Co.); Blue Spot inductor type loud-speaker; 1 Lissen H.T. battery.

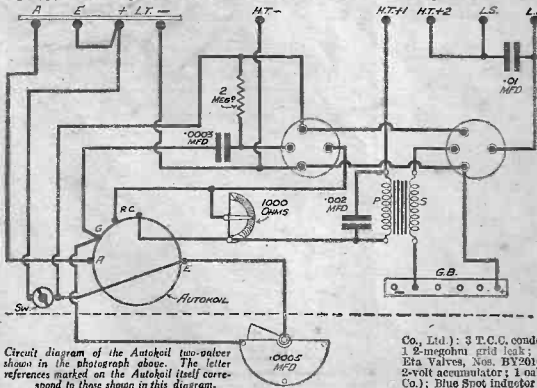

Circuit diagram of the Autokoil two-valve set shown in the photograph above. The letter references marked on the Autokoil itself correspond to those shown in this diagram.

ALL MECHANICS WILL HAVE

FLUXITE

IT SIMPLIFIES all SOLDERING

IF YOU HAVE A HOBBY see that

FLUXITE and SOLDER are always by you—in the house, garage, workshop—anywhere, where simple, speedy soldering is needed. They cost so little, but will make scores of everyday articles last years longer! For Pots, Pans, Silver and Brass-ware; RADIO; odd jobs in the garage—there's always something useful for Fluxite and Solder to do.

OF ALL HOBBIES DEPOTS and Ironmongers, Electric Tins, etc., 1/4 and 2/8.

NEW "JUNIOR" SIZE 4d. per tin.

FLUXITE SOLDERING SET
Simple to use and lasts for years in constant use. Contains special small-space soldering iron with non-heating metal handle; pocket blow-lamp. Fluxite, Solder, etc., AND FULL INSTRUCTIONS. COMPLETE, 7/6, or LAMP only, 2/6.

ANOTHER USE FOR FLUXITE
Hardening Tools and Case
Hardening. Ask for Leaflet on improved method.

FLUXITE, LTD.

(Dept. H)

ROTHSCHILD
S.E.16.

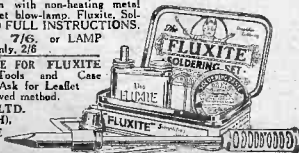

MAKE YOUR
HOBBY
A
PROFITABLE
ONE!

ELEX

YOU WILL BE CERTAIN
OF GETTING THE BEST
RESULTS WITH ELEX



THE 2DM SIDE-ENTRY PLUG.
This plug has many uses in the home—constructed set. Supplied in 6 colours. Type 2DM, side-entry. Price 2d. each.



T.14 PLUGS AND SOCKETS.
These Plugs and Sockets are invaluable to the home constructor. Finished in six colours and supplied with forty different kinds of name-plates. They are the last word in efficiency. Price: Sockets 1d. each. Plugs 2d. each; Nameplates 1d. each.

NEW! Improved Elex Testing Prods

Invaluable for testing a wire-rod receiver and eliminating all fused out valves or damage to other components. In red and black. 3/8 per pair.

BYLUDURONE

The easy method of home cabinet building. Write for particulars.

Write for List

J. J. EASTICK & SONS,
Telephone: Metropolitan 0314/56.

GI

ELEX HOUSE,
118, BURNHILL ROW,
LONDON, E.C.1.

A WISE CHOICE!

When building your first Radio Receiver you will be wise in choosing a simple yet very efficient circuit, one in which economy can be practised without loss of efficiency. Such a circuit is the

"AUTOKOIL ALL-WAVE TWO"

Fully described in this issue.

After you have built this and have proved the pleasure of Rad o, you can, if you wish, use the "Autokoil" and other components for a more progressive circuit.

WONDERFUL results were secured under severe conditions in the heat of London, when the "Autokoil All-Wave Two" was tested out. Set activity and Loud-speaker volume was all that could be desired.

If you already have a set and are using a L.C. IN. Coils, replace them with an "Autokoil" All-wave Tuner (no coils to change, just switch over to any wavelength from 200 to 2,000 metres). You will be more than pleased with the increased selectivity you gain from using the "Autokoil."

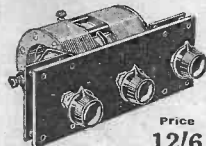

Price
12/6

Order through your Dealer. If you directly, send order direct to Dept. "H", Mission "Hobbies."

200 to 2,000 metres.
Leaflet "H" Free.
Full instructions in every "Autokoil" box.

A. W. HAMBLING, A.M.I.R.E.
104, High Holborn, LONDON.

You MUST HAVE

THE S.T. ENGINE

- S.T. Engine Parts - 5/-
- Finished Boiler - - 8/-
- Finished Plant on
Fireproof Base 17/6



It is utterly different from the ordinary Toy Shop model engine.

In the first place you have the pleasure of building it yourself. You need have no fear, we GUARANTEE it will work when you have built it.

Secondly, like all Stuart models it is made on correct engineering lines and therefore has POWER. The Boiler is of Copper, brazed throughout and tested.

Send a stamp for List 14H, which describes this and several other models, or better still, write for the "H" catalogue (price 6d. post free) which contains particulars of all our Model productions, all fully illustrated and described.

STUART TURNER, LTD.,
HENLEY - ON - THAMES.

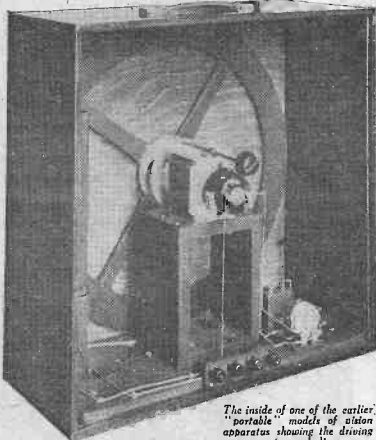

The inside of one of the earlier, "portable" models of television apparatus showing the driving motor and disc.

WE have dealt at fair length with the transmitting side of television and appreciated the difficulties encountered, so we must now pass to the receiving end. In many respects this is perhaps the most fascinating aspect, for although it is wise to have a working knowledge of how the vision signals are brought into existence, it is at the receiving end where the bulk of the amateurs will be able to display their constructive capabilities. Just as in normal aural wireless reception one can build apparatus to give results, so with television the same statement holds good, except that the final appeal will be to the eye as well as to the ear.

Since at the moment the wireless receiver does not enter into the principles involved in the transformation of the signals into intelligible images, we will focus our attention on the apparatus acting as the "vision recorder." First of all a short list has to be compiled of the essential component parts which must be employed. These are four in number and consist of:—

1. A light scanning disc complete with its spiral of holes to conform geometrically with that used at the transmitting end.
2. A small motor to drive the disc at its correct speed.
3. Some form of neon glow lamp.
4. A lens assembly to magnify the size of the image so that it can be watched in comfort.

In addition to these four items there is another important one whose inclusion, while not essential, makes a material difference to the success of the reception. I refer to some form of synchronizing mechanism to "hold the image," an expression about which more will have to be said later in the series.

The Construction of the Disc.

Let us deal with each of these in turn. The disc should be made from fairly light material—No. 32 S.W.G. sheet aluminium is very satisfactory. In order to still further aim at this factor of small weight, it is

TELEVISION FOR AMATEURS

By H. J. BARTON CHAPPLE, Wh.Sch., B.Sc. (Hons.),
A.C.G.I., D.I.C., A.M.I.E.E.

(Continued from page 368, January 9th issue.)

better to make it up with spokes, five or six in number the space between the spokes being removed.

At first sight a disc made up in this manner may seem "flimsy" and will bend easily, but when run up to speed on the motor shaft it will whip out flat and function just as a solid flat disc. A diameter of 20in. will be found very suitable. The spiral of holes should turn towards the centre of the disc in a clockwise direction. Then when the disc is rotated in its correct direction, namely anti-clockwise, the scanning operation will be in order, that is, hole movement from bottom to top and strip direction from right to left.

One very important point arises with the scanning disc and that is the accurate positioning of the holes. If thirty holes are used then each hole will lie on a radii separated by an angle of 12 degrees. In addition, the outside edge of one hole must be in line exactly with the inside edge of the preceding hole. If this is not watched lines will show up, or in other words the junctions between individual light tracks become visible.

Suppose we let P and Q represent two adjacent holes (see Fig. 1), the vertical lines being the limits of the light track created by these holes. Now the track made by the inner edge of P does not coincide with the track made by the outer edge of Q. This gives us the condition known as underlapping, and the result is an unpleasant black line running from top to bottom of the picture, the width of the line depending upon the magnitude of the underlap existing between these two consecutive disc holes.

The Light Strip Holes.

Fig. 2 represents the opposite condition, namely, overlap. The light strip edges of holes P and Q now overlap one another and a narrow white line is produced, and while not so bad as the black line, the combined effect of these black and white lines, if pronounced, is often sufficient to mar the whole image. Every effort

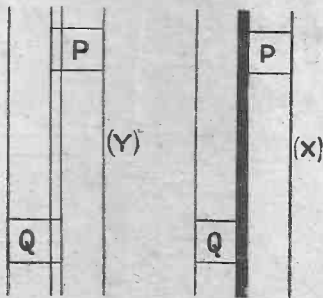

Figs. 1 and 2.—Details of the light strips

WORLD THREE

Set. Cheap and Efficient.

that it is thick enough to carry the current consumed by the three valve filaments.

The Volume Control.

The volume control takes the place of what would normally be the grid-leak to the first L.F. amplifier. The grid itself goes to the slider of the volume control potentiometer, and a very smooth, silky action is obtained by this scheme. It is preferable, too, to control the volume early in the set instead of leaving it to the last stage.

About the latter there is nothing to be said, except that a good make of L.F. transformer is used to couple into it.

One rather unusual feature of the set is that efficient "de-coupling" between stages has been provided, so that only one H.T. positive terminal is required. This eliminates much fiddling with wander-plugs, and also

ensures that the whole of one's battery receives an equal discharge load. This is an important point, since batteries are sometimes left in use after a few cells have got into a poor state, and although the voltage may look all right, the results certainly suffer.

The "de-coupling" mentioned is effected by two 2mfd. condensers and two resistances of the convenient "Spagheti" type. 20,000 ohms is used for the first valve and 5,000 for the second. The coupling resistance between the two valves is also a "Spagheti" of 100,000 ohms.

The valves required are simply two of the "general-purpose" type (for the detector and 1st L.F.) and one power valve. The detector may be one of the special "detector-only" types now on the market, but an ordinary general-purpose, or "HL" type, appears to serve just as well.

With these valves in use, and with a high-tension voltage of about 120, the first L.F. valve will probably need about 1½ volts bias, and the last valve 9 to 12 volts. In any case, it is advisable, to adhere strictly to the valve-maker's recommendations in this respect. (To be concluded next week.)

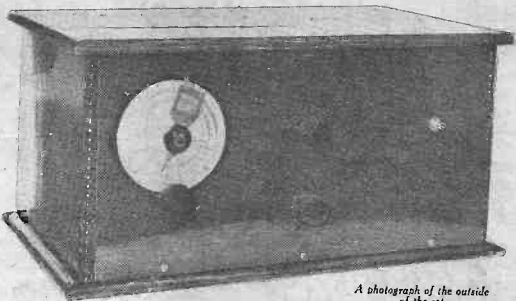

A photograph of the outside of the set.

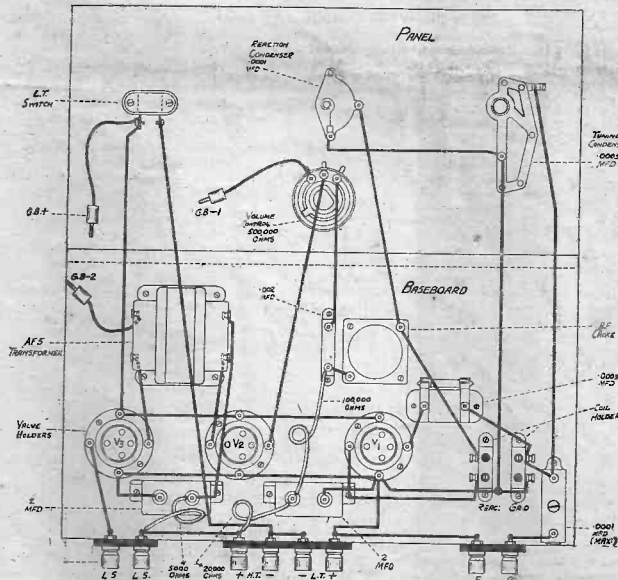

The wiring diagram.

"HOBBIES" ALTERNATIVE STATION CONTROL

By "Broadcast"

(Continued from page 378, January 9th, 1932, issue.)

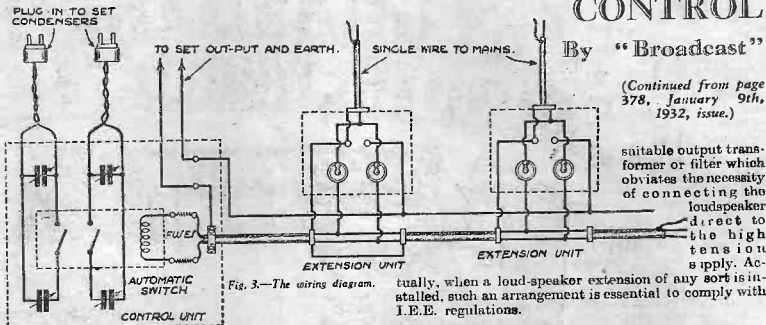

Fig. 3.—The wiring diagram.

NEXT secure the pre-set condensers on the baseboard, grouping them in such a way that a clear space is left at one of the edges where the lead-covered cable can be brought in. As both the leads of this cable will be connected to the mains, a pair of safety fuses will be needed. These fuses are easily made by mounting two terminals—the insulated type are best—1½ in. apart on ¼ in. ebonite strip. Distance pieces keep the fuses clear of the baseboard, and they are fitted on mesh or so away from the edge at right-angles to it. The remaining two terminals, which will be used for the loud-speaker connections, can conveniently be mounted on ebonite in a similar way and fixed parallel to the edge of the board.

The Wiring.

This is shown in Fig. 3. One of each pair of pre-set condensers is fitted with a twin-flex lead of suitable length, terminating in a two-pin plug which will engage one of the sockets fitted in the set. In addition, one of its terminals must connect it to its partner and the other to a fixed contact on the automatic switch. The corresponding moving contact is coupled to the unoccupied terminal of the partner.

The cable is secured at the edge of the baseboard by means of a small clip, which must make good connection with the lead-covering. The two leads are taken one to either fuse, the second terminals of the fuses being attached to the two wires from the automatic switch coil. In both cases, the circuit is completed through a piece of 2-ampere fuse wire joining the two terminals. From either of the fuse terminals carrying the coil wires, a lead is taken off for subsequent connection to the mains input of the set.

Only the two output terminals remain, but before dealing with them it is necessary to inspect the set again. Most D.C. all-mains instruments are provided with a

usually, when a loud-speaker extension of any sort is installed, such an arrangement is essential to comply with I.E.E. regulations.

An Output Transformer.

Make sure, then, that the output terminals of the set are fed from a transformer or through condensers. If you find that one of them runs direct to the plate of the last valve and the other to L.T., an output transformer must be added. There are plenty of suitable ones on the market, and they are not expensive—but it pays to buy a reliable brand. The transformer can be fitted either inside the set or

suitable output transformer or filter which obviates the necessity of connecting the loud-speaker direct to the high tension supply. Accordingly,

"HOBBIES" 25 YEARS AGO.
Issue dated January 19th, 1907.

THE fretwork design of the week is an elaborate archway bracket decorated extensively with handsomely coloured metal ornaments of birds—two pheasants, two parrots, two cockatoos, etc. Evidently the design appeared very strongly, for it did not appear in Catalogues much afterwards. Football, gardening, photography and philately claimed the major portion of the interests of the readers. An interesting four-line note runs, "The German army has a portable wireless outfit, weighing only 300lbs. in which a 45-volt generator is driven by a soldier who sits on a bicycle frame and pedals." And that was twenty-five years ago!

Ordinary bolt wire will do, but single rubber-covered flex is much better. Incidentally, this is the best stuff to use for wiring the Control Unit and Extension Units.

The Extension Unit.

Presumably an Extension Unit will be wanted in the same room as the set, so that full advantage can be taken of the alternative station idea. These units consist of two ordinary tumbler switches and a loud-speaker plug-socket mounted on standard blocks, as used for electric

(Continued on page 432.)

for THE 'BABY GRAND' THREE & THE 'ROUND THE WORLD' "3"

The ORMOND No 6 *Slow Motion* CONDENSER

Depth behind
panel 2½ ins.



When an "extra special" component is required it is only natural that you should specify ORMOND. For everyone knows that in all ORMOND Productions there is that extra quality which spells success and makes them indisputably superior.

This Ormond Condenser is constructed of brass and is very robust. The vanes are perfectly rigid, being firmly secured to slotted spindles. A slow-motion device, ratio approximately 9 to 1, is incorporated in the condenser and is controlled by the upper small knob, direct drive being obtained on the dial, which is engraved 0 to 180 degrees.

**NEAT
RIGID
ROBUST
PRECISE**

Capacity.	Price.
.00025	6/6
.00035	6/6
.0005	6/6

This condenser is also available constructed of aluminium without slow-motion movement, and less dial, in similar capacities at 4/- each.

THE ORMOND ENGINEERING CO. LTD.
Ormond House, Rosebery Avenue, London, E.C.1

Telegrams: Cleveantell 5224-S-6 & 5244-S-6.

Telegrams: "Ormondeng, Teleng."



"HOBBIES" ALTERNATIVE STATION CONTROL (continued from page 430).

lighting (see Fig. 4). Before going ahead with the extension wiring, it is best to get this first Extension Unit in action. The block can, of course, be fixed in any convenient spot in the room, not necessarily anywhere near the set. A very convenient place to put it is on the skirting board, where it is easily wired and can be tucked out of the way—the switches being kicked off and on.

With all Extension Unit wiring, provision should be made to run the lead-covered cable and single wire right through the block where possible, looping in the required connections. Where this is not convenient a tapping can, of course, be taken off the extension cable, at any point by fitting an ordinary lighting junction box and off the loud-speaker feed wire.

Where the lead-covered cable runs into the block it is again secured by a clip, connected to one of the loud-speaker sockets. The other loud-speaker socket is fed from the single wire. The two cable leads run one to each switch, the other two switch connections being joined together. If the cable is being continued through the block, another clip is used at the outlet and connected to the first one, so that the earth connection will be maintained.

Last comes the feed cable from the mains. This is a single lead-covered cable—if none is available some of the double variety can, of course, be utilised—running from the inter-connected switch terminals to the nearest suitable plug or switch. The covering is earthed on entry to the block by the usual clip connection.

The question of a suitable pick-up point for this feed cable is rather an important one. If the set is being run from the power mains, only a power plug will serve. But where the lighting current is being used—as it is in most cases—almost any lighting plug or switch will meet the case.

Let us take it that the Control Unit and first Extension Unit are in position—the only wires remaining disconnected being this feed wire to the block and the mains lead from the Control Unit to the set. Just plug the loud-speaker into the block and switch on the set to see that it is alive. Now for a few experiments.

Experimenting.

If you intend to feed all the Extension Units from plugs where either main can be picked up, there will be nothing to bother about. You need only disconnect one of the existing feed wires to the set and replace it by that from the Control Unit. Then, with one of the tumbler switches down, try the single cable from the Extension Unit first in one socket and then the other of the nearest plug—taking care that it is lighting or power, as the case may be. In one case the set will come alive—and it only remains to make the connection permanent.

But if you want to pick up from a switch anywhere, you must make certain that the right main will be available. Generally only one of the mains runs to the switch—but if the house wiring has been carried out systematically it will always be the same one. Proceed exactly as before, and try the single cable on the nearest switch terminals—with this particular switch off—instant of in the plug sockets.

There are even chances that you will be lucky, and the set will come alive in one case. If it doesn't, the lamp will probably light dimly. This is a sure sign that the wrong main is the only one available, but fortunately it is easy enough to change over at the set. Simply replace the feed wire you disconnected and put the lead from the Control Unit in place of the other one. Then try again. You should be all right this time.

The Setting of the Control Unit.

The extension leads are continued and the other Extension Units wired in exactly the same way, the single cable being tried on either terminal of the nearest switch or plug. But when you are testing out, make certain that the only Extension Unit switch in action is the one from which you are working. If another switch has been left on and you pick up the wrong main, you will get a "dead short" instead of the usual "no effect." Of course, in carrying out this part of the work you will be careful to switch off from the main wienover necessary and keep an eye on the lead-covering of the cable when making temporary hook-ups. It must not make any stray contact with a plug or switch.

Finally comes the setting of the Control Unit. See that all Extension Unit switches are off, plug the loud-speaker into the block near the set and try the two switches in turn. The set will come alive in either case but the automatic switch on the Control Unit will only click down in one instance. With the automatic switch out of action, tune in, by means of the pre-set condensers plugged into circuit, one of the stations you want—the one working on the lower wavelength. The variable condensers on the set should, of course, be at zero.

When the station is obtained satisfactorily, change over to the other circuit, bringing the automatic switch into use, and with the second group of pre-set condensers increase the wavelength and adjust the reaction if necessary for the second station required. After a little readjustment you should be able to get either station immediately at just the right strength by putting down the appropriate tumbler switch.

Switch On from Any Room.

From any room you will now be able to switch on either station—if several switches are on at the same time any low wavelength one will take predominance. Only one loud-speaker is needed, but if others are left plugged in they will be in circuit whenever the set is alive. No tuning will be necessary, so you can hide the wireless set away in a cupboard if you like.

If an outside station is wanted at any time and the wavelength is above that of the lower wavelength "chosen" station you will be able to tune it in with the variable condensers on the set—switched on and off from any low wavelength switch. Alternatively, the plugs can be removed in an instant and the set tuned normally if you feel like station hunting. In this case any extension switch will serve.

Be careful after any expedition of this sort to replace the plugs and set the variable condensers to zero.

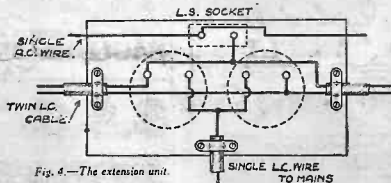

Fig. 4—The extension unit.

IT'S PURE VEGETABLE GLUE!

THE GLUE THAT GRIPS!

STIE-FIX

ODOURLESS—COLOURLESS

For joinery, fretwork, leather, paper, cloth, photo frames, model making, repairing pottery, glassware, toys, and for all purposes where a very powerful adhesive is required.

In tubes, 2d., 6d. and 9d.
Made by the Proprietors of

Stephens' Inks
57, ALDERSGATE STREET, LONDON, E.C.1

Firm as a rock

NEW RADIO SELECTIVITY AERIAL TUNER

The **UNIVERSAL**

PRICE 10/6

From your nearest Radio Dealer.

Chakophone

This new Tuner is a fine job, built of beautiful mouldings, wound with best green silk-covered wire, with a fine panel plate.

It can be used in straight or screen-grid circuits. A splendid circuit diagram is included with each Tuner. Covers Long or Medium wave-bands using a .0005 Var. Condenser.



ENTIRELY BRITISH MADE BY
EAGLE ENGINEERING Co. Ltd.
WARWICK.

3-prong Spring Grip

Stays put, even in portables under vibration. Top permanently lettered—12 indications. Side-entry: the whole flex gripped—copper rubber and braiding. Loaded without tools. Resilient. Hard draws spring wire prongs (not soft brass). Grips every battery socket: each plug tested in sockets smaller and larger than any known. 1.1 battery socket.

Write for complete **FREE LIST**.

WANDER PLUG

2d

BELLING-LEE
FOR EVERY RADIO CONNECTION

40th, of Belling & Lee Ltd., 100, Cannon Row, Fenchurch St., London, E.C.3

S.S.S. "PUP"

1/11
Guaranteed to fly



Price 2/6 Post 6d.

THE FAMOUS THREE IN ONE VOLTMETER

is a most accurate instrument and will register 0/8 volts, 0/100 volts, 0/82 millamps. Every wireless enthusiast should possess one as they are essential for perfect reception.

L. WILKINSON & Co. City Road, LONDON, E.C.1

MAKE YOUR OWN GRAMOPHONE

at Quarter Price.

Order set as shown. Double speed motor, 10 in. Veloc Graphic, Brown Arno Metal Sound Horn, Nipper Cup, 2 1/2 - 1 1/2 - 0/1, or buy Kit complete for 2/6, extra 1/6. Nipper 2/6. Repair parts. Lists free. 61 to 181, Cannon Row, E.C.3 with reduced prices. Drawing and how to make Gramophone 2d. Desk, 2/6 years.

RECENT FITTINGS CO., NOBBY,
120, Old Street, LONDON, E.C.1

PORTABLE GRAMOPHONES 1/6.

A Perfect Aeroplane that pocket-money will buy

Get the S.S.S. Pup with your next two-shilling tip. It is a splendid flyer—stunts, loops the loop and takes off from the ground. Wing Span 16 ins. Weight under 1 lbs. Perf. of performance is assured by a special ball-joint bearing to the tip, unbreakable propeller. You can't buy a better plane for the money.

Obtainable at all stores, toy shops and W. H. Smith's branches.

FREE! Send for S.S.S. List No. 1/32.
SEAGULL SCIENTIFIC SPORTS CO.
1133, London Rd., Leigh-on-Sea, Essex

Other S.S.S. Models:
Dash 2/6
Red Imp 4/6
Dive Bird 4/6
Royal 7/6
Fleet 5/6
Special Competition Model (Wing Span 2 1/2) 2/6.

COILS AND WAVE-CHANGING

By "Piper"

Three previous articles on this subject appeared in "Hobbies," Nos. 1879, 1882, and 1883.

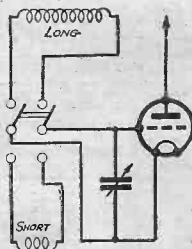

Fig. 1—Switching arrangement for changing from long-wave coil to short-wave coil.

It has already been pointed out in this series of articles that, unless one wants to explore the unknown regions of the ether, one does not really need more than four coils, at the most, or two for a receiver without reaction.

Each of the recognized broadcast wave-bands (one from 230-550 metres, the other from 900-2,000 metres) can easily be covered with one coil. Thus, what can be simpler than to install the two necessary coils permanently in the set and indulge in the lazy man's pastime of "wave-change switching"?

Anything that tends to make radio simpler is to be praised, in this age of complications, and, unless you are a genuine experimenter, there is no earthly reason why you should have to plug and unplug coils in all directions when you wish to change over from London Regional to Daventry National, for instance. The natural method that would occur to one for changing from one coil to another is that shown in Fig. 1. A double-pole double-throw switch is required. This is all very well for a single-tuned circuit, but in the case of a single-valve set with reaction, the latter coil will obviously need changing as well, and two separate double-pole double-throw switches will considerably increase the price of the set. Added to this, the wiring is complicated and the whole thing clumsy.

The First Step of Simplification.

Here the low-potential or "earthly" side of the two coils is left untouched, and only the "live" side switched (see Fig. 2). We have thus halved our switching at once, without loss of efficiency. Note, by the way, that the tuning condenser must, of course, be connected to the centre contact of the switch, so that it is across either coil when required.

We can now go further into the simplification business. One way that occurs to one of effecting a rapid change in wavelength is to short-circuit a number of turns in a coil. Thus, the entire coil would be constructed so as to tune to the long-wave band, and such a portion shorted out that the remaining turns covered the short waves.

We have always been told of the loss of efficiency due to "shorted turns," but the preachers of this doctrine appear to have overlooked one point. The "shorted turns" need not cause one any worry whatever unless they are coupled to the live ones. Thus, if we build our coil in two halves, planning so that the two in series cover our 900-2,000 metre band, and that

the smaller one of the two (when the larger one is short-circuited) covers the 230-550 metre band, we have brought down our switching to an ordinary single-pole single-throw affair!

A similar switch for the reaction coil (likewise wound in two sections, and on the same formers as the other two) completes the scheme (Fig. 3). The two sets of coils should be mounted at right-angles to each other if possible.

The Reinartz Circuit.

We can, luckily, go one step further before definitely settling down to details of coil sizes and so on. Nearly everyone knows the Reinartz circuit nowadays, and this is peculiarly suited to simple wave-change methods because one end of the reaction coil and one end of the grid coil are common (see Fig. 4). This suits our purpose very well. Naturally, we require a smaller reaction coil for the short waves; in other words, at the same time as we short out the long-wave section of the grid coil winding we want to short out some of the turns in the reaction coil.

By arranging that the short-circuited turns are, in each case, at the earth end of the coils, we can do this with one switch only. Unfortunately, the ordinary single-pole single-throw switch will not manage it, but the almost equally simple type that has two contacts, both of which are connected to either a third contact or the frame of the switch, when the switch is pulled out, will serve very

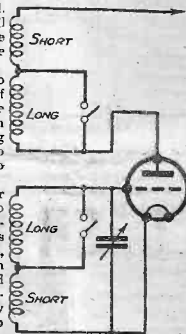

Fig. 3—A single-pole single-throw switch.

noted to either a third contact or the frame of the switch, when the switch is pulled out, will serve very well. Another variation of this is a switch with a metal plunger and three separate contacts. When the knob is pulled out all three contacts are joined together by the plunger.

Fig. 5 shows the use of a switch of this type for wave-changing in a Reinartz type

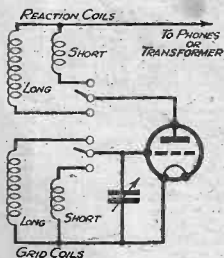

Fig. 2—A simplified method of switching without loss of efficiency.

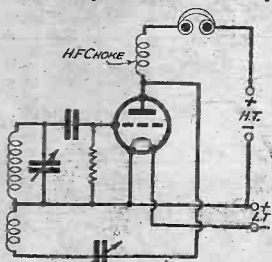

Fig. 4—The Reinartz circuit.

circuit. The plunger makes connection with both contacts 1 and 2. In the diagram (a) is the long-wave and (c) the short-wave portion of the grid coil; (b) is the long-wave and (d) the short-wave portion of the reaction coil.

The construction of the coils presents no difficulty, but it should be understood that, although in the diagram the whole affair is shown as one continuous coil, (a) and (b) are wound on one former, with (c) and (d) on another one, mounted at right-angles to the first. The coils may be home-made, of any of the types already described. The turn-numbers should be roughly as follows, although slight alterations may be necessary to suit your individual requirements:

(a) May be 280-300 turns of 2 $\frac{1}{2}$ dia. wire, and (b) seventy-five turns, mounted on the same former, but with a gap of at least $\frac{1}{4}$ in. between the two windings.

On the second former (c) has sixty turns, and (d) thirty-five turns, with a gap of about $\frac{1}{2}$ in. between them. If basket or basket-weave coils are used, this gap can only be arranged by winding the coil in two sections and mounting them that distance

apart. The only points remaining are: arrange your two coils, with due respect for the placing of your other components, so that the wiring to the switch is as short as possible. Also, arrange so that the planes of the two coils are as nearly at right-angles as possible. These points having been checked, the risk of failure is small.

If it is found that the set will not oscillate on one of the bands, you have probably made a slip and wound one or both of the reaction coils in the wrong direction. This is easily remedied.

In describing this, one of the simplest of wave-cum arrangements, it is assumed throughout that the set does not include one or more stages of H.F. amplification. In sets of this description it would be difficult, as well as inadvisable, to attempt to do the whole thing with one switch. This being so, the problem is merely one of shorting out turns in each tuned circuit in the same proportion as has been arranged in the coils (a) and (c). To go into full details is, however, rather outside the scope of an article of this kind.

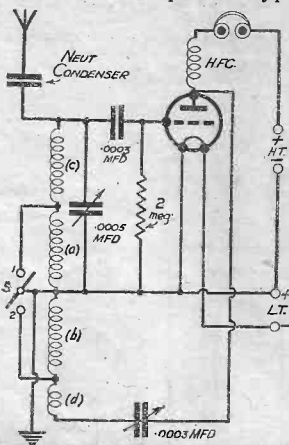
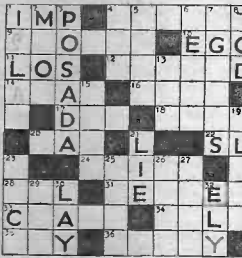

Fig. 5.—Circuit employing a switch with a metal plunger and three separate contacts.

HOBBIES CROSSWORDS £5 CASH FOR CORRECT OR NEAREST CORRECT SOLUTION



- CLUES.**
Across.
1. A little racial.
4. A tall hat.
9. Earlier.
10. Personality.
11. Anchors.
12. On board.
14. Plural of "era."
16. Recuse.
17. Feast.
18. Reverse "see."
20. A knock.
22. Southern League (abbr.).
24. A native of Switzerland.
28. To lubricate.
31. Heal again.
33. Kind of bird.
34. Mercy.
35. Opens a lock.
36. A donkey.

- Down.**
1. Surrounded by water.
2. A native of Morocco.
3. An Arab.
4. Kind of plant.
5. Plural of "orb."
6. To tire.
7. Consents to.
8. An ivy-leaf.
13. Horn-seat riddle.
15. Drinks slowly.
19. In a sly manner.
21. A falsehood.
23. A place for ships.
25. A small bird christened "Johnny".
26. Furnished with shocs.
27. To despatch.
29. Race.
30. To deposit.
32. Cathedral city.

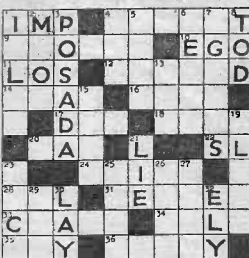

Name

Address

(E.C.W.20)

on coupons from this or last week's HOBBIES.

YOU MAY SEND ANY NUMBER OF ATTEMPTS

Name

Address

(E.C.W.20)

Post your entries to reach us not later than Friday, January 29th, 1932, addressed "Hobbies," "Crosswords," No. 20, Competition Dept., King Street, Covent Garden, W.C.2.

RULES.
1. Attempts must be on coupons from this or last week's "Hobbies."

2. Postage stamp value 1d. must be pinned to each coupon. 3. In the event of ties the prize will be equally divided.
4. Employee's (or members of their families)

of George Newnes, Ltd. or its associated companies, are not allowed to compete.
5. The Editor's decision is final in all matters relating to this competition.

A UNIVERSAL ONE-VALVE AMPLIFIER

THE amplifier here described is called "Universal," as it is so wired that it may be connected to any existing receiver, whether crystal or valve. A glance at the wiring diagram (below) will show that no terminal has been provided for the H.T. negative lead, and also that a grid bias battery is supplied for the amplifier. These two facts are easily explained, however. In any valve receiver the H.T. - wire is connected to one or other of the L.T. terminals, and therefore, when the two L.T. terminals on this amplifier are joined to the corresponding terminals on the receiver with which the amplifier is used, the H.T. - lead is automatically joined in circuit. The existing receiver may employ

a grid battery, but in this case there is not the slightest objection to having a separate battery for the amplifier, especially as a valve will be needed in this case taking a higher value of bias, and then two of the 9-volt batteries may be joined in series, and the higher value of bias obtained in this way.

The above remarks apply, of course, only to the use of the amplifier with a valve set. In the case of a crystal receiver being used, the H.T. - lead is joined to the L.T. - terminal, and, in addition, a lead is taken from this terminal to earth. Having explained the design of the amplifier, we will now deal with its construction, which is of the very simplest, and should cause no trouble even to the very youngest novice.

Components Required.

The only components are a transformer, valve-holder, switch, terminal strip and terminals, wire for wiring-up, grid bias leads, and wandor plugs. The ratio of the transformer will depend on the use to which the amplifier is put. If added to a crystal set, the transformer should have a ratio of 7 to 1. If used after a single detector valve, the ratio may be 5 to 1; whilst if added to a receiver employing two or more valves, then the ratio should not be more than 3 to 1.

The Panel.

The panel of the amplifier may be constructed from 3-ply or any other wood, although, if you wish to match your present set you may employ ebonite. This is an unnecessary expense, however. In the centre of the

panel mount the on-and-off switch. The transformer and valve-holder are screwed down to the baseboard as shown in the wiring diagram, leaving sufficient space at the right-hand side for two grid bias batteries side by side. The terminal strip with the six terminals fitted is then screwed to the rear of the baseboard. Use Glazite or some similar wire for wiring up, and take care that the two leads to the primary of the transformer (that is, those lettered P. and H.T.) are connected to the input terminals, so that when these latter are connected to the 'phone terminals of your present set, they will be in the correct direction. For this reason it is preferable to use the type of terminals which have engraved lettering, so that no mistake can occur. The rest of the wiring is quite straightforward. The input terminals are then joined to the 'phone or L.S. terminals of your present receiver, and if this is a valve set, two insulated leads should then be joined from the two L.T. terminals on the amplifier to the corresponding terminals on the set. A separate flexible lead is joined to the L.S. + terminal on the amplifier to an appropriate tapping on the H.T. battery. If added to a crystal set, a separate lead should also be joined to the L.T. - terminal, and this lead should

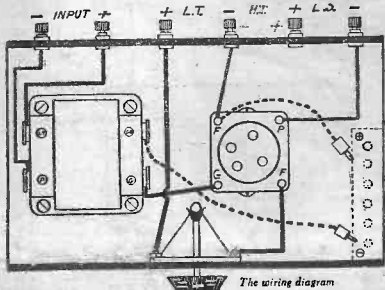

be plugged into the H.T. - tapping. Adjust the grid bias tapping according to the H.T. value and the valve-makers' instructions, and if only one valve or a crystal is employed in front of the amplifier a valve of the L.F. type should be used. If added to a multi-valve set, the valve should be of the small power type.

A Few Words of Warning.

If your present set also has an on-and-off switch, do not forget to operate the switch on the amplifier as well when switching off, or the valve will be left burning, perhaps all night.

List of Components.

- 1 L.F. transformer (Telsen, etc.).
- 1 Valve-holder (Telsen, etc.).
- 1 On-and-off switch (Bulgin, etc.).
- 6 Terminals (Eelex, etc.).
- Ebonite strip.

Wire for connections, screws, wandor plugs, etc.

A FLASH-LAMP bulb mounted into the base of an old valve and plugged into the valve holder, makes a very handy testor for checking L.T. connections. Bristol board of the kind known as two-sheet makes a very good diaphragm for a cone speaker.

Good reproduction from a loud speaker depends greatly upon the part of the room where it is

PRACTICAL WIRELESS PARS.

situated. A few experiments will determine the position at which it is best.

When removing the diaphragm for any reason from a telephone earpiece, it should be slid sideways and not pulled up from the magnets, as this may damage it.

On small sets troubled with interference, a hank of wire of fifteen turns or so, tied to the grid coil by cotton, joined to earth at one end and aerial lead at the other, often gives improved selectivity.

Among common causes of distortion are batteries running down, unsuitable valves, insufficient H.T., L.T., or G.B., and a grid leak of unsuitable value.

A NOVEL RADIO STATION CHART

A NOVEL method of registering various stations which you log from time to time on your wireless set is provided by building the cabinet illustrated here. As can be seen, it is a sloping desk cabinet, the centre of the front having a slot with the name and reading of the station appearing on it. These station names are supplied printed on a spool of paper which is turned up or down by means of handles, so that the names pass in front of the slot:

All Parts Provided.

Patterns for this ingenious logging device are given on the centre pages of this issue, where details of the actual material required are also found. The parts are all cut from one thickness of wood, so that one piece only is required $\frac{3}{4}$ in. thick. One of the Hobbies' B panels of mahogany is quite suitable, and the method of pasting the patterns to the wood is illustrated at Fig. 1. The construction of the actual article is clearly seen by the detail at Fig. 2, where the front of the cabinet has been omitted and a portion of the side broken away to show how the actual mechanism is fitted in.

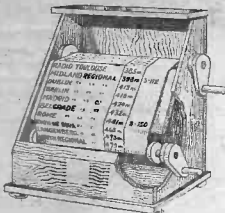

Fig. 2.—A view of the working parts.

bored for the revolving spindles which are to be placed later. The top of the cabinet is a flat, narrow strip, whilst the back is a plain rectangle of wood $\frac{3}{4}$ in. high and $\frac{5}{8}$ in. wide, glued and screwed to the edge of the sides. The top overhangs the back slightly, and more still at the front.

The Two-piece Front.

The front is shown as a complete pattern, but when the interior work has been got out and the outer edges sawn round, the saw cuts along the white line $\frac{1}{4}$ in. from the top edge. This makes the strip upon which the hinge for the lift front is fixed. Owing to the slope of the sides this front will not lie flush under the top, and it is therefore necessary to chamfer the edge slightly to obtain this result.

Before fixing on the actual front, it is as well to complete the interior mechanism, and if the cabinet is at all "shaky," small blocking pieces can be easily glued into the corners inside to make it quite rigid. Cut the two lengths of spindle $\frac{6}$ in. long and smooth them down

Patterns and prices given on the centre pages.



so that they turn easily in the holes cut in the sides. Put one end through one side, and then slide on two of the washers, gluing them in place just inside the side, with one end of the spindle flush with the outside of the cabinet, and leaving a projection on the right-hand side long enough to take another washer and handle.

The Handle.

Outside the cabinet another washer is glued on to the spindle just tight enough to prevent side play. The handle can be formed by an ornamental knob or made up as provided for on the patterns. There is a shaped shank which goes over the end of the spindle, and which has in turn another short piece of dowel stuck into the other end to make the winding gear. Fig. 2 shows these quite clearly.

To get the paper to lie flat behind the front aperture, glue in the back board. This is a plain piece fitting between the sides and set back about $\frac{1}{4}$ in. from the front edge. Its position is shown by dotted lines on the pattern of the sides themselves. A list of stations printed on a long strip of paper ready for gluing is supplied by Hobbies Ltd., and one will be sent if you forward to them a request and a 1/4 stamp. The space between the washers on the spindle is $\frac{1}{4}$ in. and the station strip is glued centrally between. Glue one end of the paper firmly, carry the rest over and glue the other end to the other spindle.

The two-piece front is now fixed, the thin strip being glued and nailed below the top and the lower piece hinged on to it. This should bring the name slot in line with the winding strip on the spindle. The cabinet will look better if four small toes are added beneath the corners at the bottom.

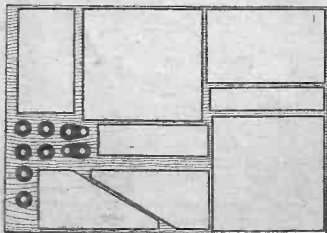

Fig. 1.—The patterns on a panel of mahogany.



AMONG the numerous questions we answer, there are many on the use of the various grades of fretsaws. These tiny blades are, as most readers know, obtainable very fine and gradually thicker until they are very coarse. The 00 grade is the finest and is suitable for the work of a delicate nature. Size 2 is a medium blade which comes in generally useful, whilst for rough cutting the coarsest grades—Nos. 5 and 6—are the best to use. Remember, of course, that the finest saws will not stand the same pressure as the thicker ones made of stouter metal.

Model makers will be interested in the attached photograph of a model machine one of our readers made up. It is a perfect little piece of work, which is only about 6in. high and yet actually works. Painted black and silver, like its prototype, it was an excellent example of delicate and admirable work done with a fretsaw. One of our Indian workers, Cureshji R. Ghysa, of Bombay, has made one even smaller than that. This is an "Imperial" standing hardly 3in. high, in which matchsticks have had to be used. We have asked our friend to send a photograph—it sounds a wonderful miniature.

The latest thing in fretwork is to drive a machine by electricity. An entirely new motor and bracket have been evolved by Hobbies engineers and this can be fitted to any of the ordinary fret machines quite easily. The motor drives at 230 volts, and is suitable for either A.C. or D.C. mains. All you have to do is to plug in your bayonet holder and then pull over the switch provided on the motor platform. The saw goes cutting merrily without any trouble, and the worker merely puts his wood up to it to get it shaped out. Quite the latest thing, this. One reader, Mr. C. Riley, of Smethwick, who didn't know this, rigged up his own

"Triumph" to a motor and says: "It speaks volumes for the soundness of Hobbies machines when I state I have coupled one to a motor. It makes 750 cuts per minute, and I have run it for some weeks several hours per day for six days per week, and several hours on Sunday. This is on 1in. thick ply, and it has stood up to it well." Just shows how much a fret machine is worth if you go about it properly.



By the way, if you are wanting any books on fretwork, carpentry, metal work, etc., don't forget we can tell you the best to buy, and at most suitable prices. Our reference library has a wide range of the latest books on all subjects, and are full of hints which the worker will do well to know. If you want a suitable book at any time, write and ask us, and we will recommend the best for you.

Did you see a letter in a Manchester paper a little while ago from a reader asking for a good hobby to take up for two or three nights a week? What a pity somebody did not show him Hobbies! If we knew where he lived we could send along our scrap album of photographs of en-

thusiastic fretworkers.

The hobby of fretwork and woodwork often definitely influences the life of the reader. He takes it up because he likes it—then finds it so interesting he wants to be a cabinet maker or a carpenter. And finally makes it his job in life and becomes a first-class craftsman, earning good money at it. We had a case in point recently, when a Scottish reader found his hobby so interesting—after six years of it—that he wanted to become a craftsman in wood. Could we help him? Of course we did, and put him on the right path for what should be a jolly fine career. And it all began because he was keen on fretwork!

This splendid doll's house was made from Honours Design Sheet No. 1828, by Mr. C. Parish of Blackheath, who, with the aid of his son, completed the whole work of the house and the furniture for inside it. Further than that, Mr. Parish added fire-grates, overmantels, a staircase and rail and other incidental parts. This was his first piece of work and is certainly very creditable. Congratulations to father and son for their excellent beginning. By now, no doubt, they have done other good work.



FREE



BASSETT-LOWKE "DUKE OF YORK"

Get the best... and get it FREE!
The Bassett-Lowke "Duke of York"
scale model loco... yours... for
200 B.D.V. Coupons. Length 14½ ins.
Weight 2lb. 9oz. Forward, reverse
and stop levers. Supplied in L.M.S.,
S.R., L.N.E.R., or G.W.R. colours.
Price in shops 25/-. FREE TO
YOU. Begin saving B.D.V.
coupons to-day.

200

COUPONS

B.D.V.

CIGARETTES

each Coupon worth 3
TIMES other coupon values



EVEN LESS COUPONS REQUIRED FROM B.D.V. TOBACCO—EACH
TOBACCO COUPON BEING WORTH 12 CIGARETTE COUPONS.

Issued by the Proprietors, Godfrey Phillips, Ltd. Est. 1844



*Old King Cole was a merry
old soul
And a merry old soul
was he.
He called for his pipe
He called for a light
And he called for
his B.D.V.*

GET
THE
GIFT BOOK

To Godfrey Phillips, Ltd
(Dept. H),
39 Commercial St., London, E.1

Please send me the amazing
B.D.V. Gift Book in full colour,
with five free coupons, showing 275
treble-value gifts.

Name.....

Address.....

GPB3



Whys and Replies

Let Your Editor help You. Address your letters and queries to The Editor, "Hobbies," Geo. Newnes, Ltd., 8-11, Southampton Street, Strand, London, W.C.2, enclosing a stamped address envelope. All letters and queries must bear full name and address of the sender.

Your Wireless Queries.

SO many readers have asked for a special wireless issue that I hope this particular issue meets with their approval. I have dealt in this issue with subjects of popular appeal, and from now on I hope also to include wireless subjects forming the subject of persistent recent requests.

Our "Baby Grand" Three.

[AM certain that many hundreds of my readers will make up that splendid, specially designed "Baby Grand" Three-Valver, forming the subject of this week's free gift sheet. Another free gift sheet next week will enable you to make the cabinet to complete it. There can be no doubt whatever that this set is the very latest thing in all-in radios, and we are particularly proud of the fact that, whilst many other papers are still retailing to their readers instructions on building sets five years old in design and necessitating separate batteries and loudspeaker, we should take the lead in radio design. Our "Baby Grand" Three is a piece of furniture as well as a wireless set, and you may rest assured that its performance provides everything that could be desired.]

A Fairy Tale.

[NOTICE that the Editor of "The World's Press News" has a tilt at me in a recent issue, for in a panel in the centre of a page, and headed "A Fairy Tale," appears the following: "What can I do with my spare time?" signed the Editor of Hobbies. Evidently my journalistic friend presumes that the Editorship of this paper is one vast round of pleasure, punctuated by a goodly proportion of amusement with the latest novelties. Fortunately, however, his paragraph is headed "A Fairy Tale" to New Readers.

To New Readers.

A HEARTY welcome to the many hundreds of new readers who have entered the Hobbies circle during the past month. Week by week my already enormous circle of readers expands: those readers who

make their acquaintance with the paper for the first time this week I hope will bear in mind that this is not a normal issue. It is a special wireless number: ordinary issues of the paper contain a fair blending of practical instructions on every hobby interest. We reply to hundreds of letters through the post every week—letters dealing with queries on every conceivable hobby. This service is extended to you; if you find yourself in difficulty with some point concerning your hobby, don't let it

NEXT WEEK.

Free Design Sheet
for our
"BABY GRAND"
CABINET

A FINE
TRAVELLING CRANE

MAKING REALISTIC
TOY LOCOMOTIVES

A TOY FORT
ACCUMULATOR
CHARGING

A PING-PONG SET

Stamps, Electrics, Model Aero-
plane Topics, Model Railways,
Coins, Etc., Etc.

trouble you for days, address a query to me in accordance with the instructions appearing at the top of this, and helpful advice will be in your possession almost by return of post.

Our Blue-Print Service.

[I WANT here to remind readers that I can now supply blue-prints of all the wireless sets appearing in Hobbies. These blue-prints show the wiring full size and in a clearer form than is possible in the paper itself. Each blue print costs is. post free.

QUERIES AND REPLIES.

Foreign Stamp Correspondent Wanted.
Mr. S. J. Trevor, "Eliside Gardens, High Barnet, Herts." would be interested to receive letters from readers who are collectors of foreign postage stamps and coins with a view to exchanging.

French Correspondent Wanted.

Donald I. Buchanan, Cardonian, Birleton, Kirkcaldy, Glasgow, would be glad to hear from a French reader with whom he could correspond for the purpose of mutual improvement in language study.

The Hour Cycling Record.

The hour motor-paced record is 70 miles, 560 yards, by H. Bradford. This distance represents the netal mileage covered in one hour. The 24 hours motor-paced record is 315 miles, 1,405 yards.

Coins as Weights.

Coins (TODAY) wants to know how he can use coins as weights. A quarter ounce equals one halfpenny; one threepenny equals one farthing; 10z. equals three pennies (or five halfpennies); 2oz. equals six pennies (or six halfpennies). Threepenny piece equals 2.8 grains; sixpenny piece equals 43.6 grains; a shilling piece equals 87.2 grains; a fourpenny piece equals 17.4 grains; and a half-crown piece equals 215 grains.

Gold-lining Picture Mounts.

To a solution of strong gum arabic add a small quantity of nickel sugar, and strain through muslin. Dip (slowly), into the solution, a ruler, where the line is required, with a quill make a full line of gum. In a few minutes the gum will become "tacky," and gold leaf, cut in very narrow strips, may be applied with a tip, dabbed down, and allowed to dry in the usual way. This process may be repeated on the line. Gold lines made by applying gold paint turn black in a very short time. Should, however, gold not be available, use small silver dots where the lines are to end. Make the lines with a strong solution of gum, and when this is "set," breathe gently on the lines and dust on the powder.

Size of a Hockey Field.

It is a hockey field, K. O. (Torquay), should be 100 yards by 55 to 60 yards.

Cementing Tortoiseshell.

Make a cement by mixing a small quantity of Canada balsam in the cream with which it is allowed to become cold, it is quite hard. T. P. (Darlington). Now melt it by the aid of gentle heat, and in it dip the joints of the article to be joined, and bind them with wire until the next day; then remove the wire and shave off the excess of Canada balsam with a sharp penknife.

Extracting Oil from Leather.

Leather is sometimes saturated with grease and oil, which, while acting as a preservative, also has the effect of increasing the durability of the leather. To remove the mass of grease, H. C. (Southgate), mix 1 quart of hot water with 2oz. of soda, and a handful of whitening to a creamy state; apply this with a brush all over the leather, and leave on for an hour or so; then wash with clean, lukewarm water, and hang up to dry in the open air.

Filling Cracks in a Blackboard.

As a filling for cracks and holes in a wooden blackboard, if the crack is $\frac{1}{16}$ or more in width, a slip of wood should be fitted and glued in the opening and afterwards planed down to the surface of the board. J. A. (Rocham). But if the crack is less than $\frac{1}{16}$ in wide it can be filled in with a mixture of plaster-of-Paris, glue, and a little lampblack. This should be allowed to dry, and then scraped and glasspapered flush with the surface of the board.

HOBBIES

BRANCHES AND AGENCIES. LTD.

Below are the addresses where Hobbies goods can be purchased. In addition all leading stores and ironmongers stock or can obtain your requirements in fretwork and woodwork, castings, wood, turned, etc., moulding, polish, wireless accessories, etc., etc.

HOBBIES OWN BRANCHES--

- LONDON . . . 63 NEW OXFORD STREET, W.C.
- LONDON . . . 147 BISHOPSGATE, E.C.
- LONDON . . . 35 NEWINGTON BUTTS, S.E.11.
- GLASGOW . . . 205 ARGYLE STREET.
- MANCHESTER . . . 104 PICCADILLY.
- BIRMINGHAM . . . 65 HIGH STREET.
- Sheffield . . . 214 WEST STREET.
- LEEDS . . . 10 QUEEN VICTORIA STREET.
- SOUTHAMPTON . . . 23 BERNARD STREET.
- BRIGHTON . . . 65 LONDON ROAD.
- CANADA . . . 844 YONGE STREET, TORONTO.

HOBBIES AGENCIES--

- Aberdeen--Jas. Mutch, Ltd. 47 Broad Street; Bedford--Messrs. T. S. Carpenter & Co. 105 Midland Road; Blackburn--Mr. W. Meyer, 68 Harven Street; Bradford--Messrs. T. Underwood & Co. 15 and 16 Manchester Road, Cambridge--Mr. R. G. Driver, 28, Hills Road; Canterbury--Mr. T. D. Goodman, 33 Burgess Street and 16 St. George's Street; Cardiff--J. Halls (Tools) Ltd. 31, Market Arcade; Glasgow--L. E. Torrie, Ltd. 63 Crown Hill; Dover--Mr. E. F. Bockham, Queen's Gardens; Dublin--Mr. J. A. McQuillan, 38 Canal Street; Dundee--Mr. J. Pinn, 45 Murray Gate; Folkestone--Mr. W. Allworthy, 15 & 16 Cathedral Street; Hastings--Mr. W. H. Mozley, 4 York Buildings; Hull--Mr. G. F. Walker, 17 & 18 George Street; Southampton--Mr. Frank Berry, 5 Lobby Lane; Liverpool--Mr. C. Lucas, 35 Manchester Street; London--Messrs. H. Gossard, 111 Abchurch Lane, E.C.4.; Newport--Messrs. J. Halls (Tools) Ltd., 81, High Street; Reading--Mr. W. J. Sargent, 44 West Street; Swansea--J. Halls (Tools) Ltd., 2 Grove Street; Wigan--Mr. T. H. J. A. Clepan, 22 Standishgate; York--Messrs. J. H. Shonksmith & Son, 125 Micklegate.

HEAD OFFICE AND WORKS:
DEREHAM, NORFOLK

BE TIDY!

Don't leave your tools lying all over the table or bench. These tool holders are cheap, easily fixed, and keep everything in its place. They are made of steel with spring clips which grip any handled tool tightly, but keep it always handy to use.

TOOL CLIPS



No. 1. 2s. each
1/3 Per doz.
Post 1/4d.

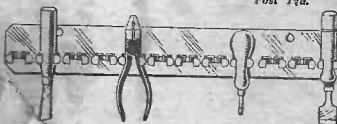

Any
7s
OL
RES: CKS
13in. LONG . . . 1/- Post 4d.
18in. LONG . . . 2/- Post 6d.

Depress
Timidity
Forgetful
IES LTD., DEREHAM, NORFOLK
Hobbies own Branches and agencies or any leading ironmonger as stores

Bargains in Fretwork Tools

Three popular and reliable fretwork tools of sound British make. Modern cutting tables are made of metal, and the handframe is a new type with special handle and lever movement.



A TILTING CUTTING TABLE

Specially made with a tilting top for bevel cutting or autofret. Will slope either way and can be fixed big enough to undertake large work. Easily fitted.

The TRIPLEX HANDFRAME

A handframe with a special comfortably spaced handle and three levers which make the saw tension quick and simple. A big advance in handframes.

12in. 4/6 14in. 4/3

Postage 6d. extra.

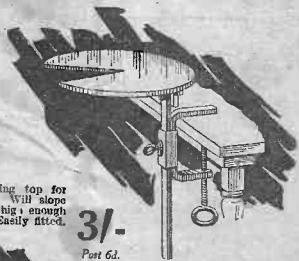

3/-
Post 6d.

THE FAVOURITE CUTTING TABLE

This table is always a popular one. It is a modern steel fretwork table with an ingenious and simple method of fixing. Made of cast metal, with strong fixing clamp.

2/3
Post 6d.

These are obtainable through Hobbies usual supplies or Branches. By post direct from Hobbies Ltd., Dereham, Norfolk.

A factory at home for 2/6 a week

Any handyman can make money in his spare time with a HOBBIES Treadle Machine. Under the new easy payment system he can earn enough money to pay the small instalment of 2s. 6d. weekly. Think of the carpentry jobs, the wireless cabinets, the models and toys you can make. Trays, statuettes, calendars, boxes—heaps of things easily cut out and sold for a profit. Any HOBBIES machine makes your home a factory with little outlay or upkeep. It isn't hard work either; a sheer pleasure for any fellow who likes handling tools.

Suitable
for
all kinds
of
woodwork.

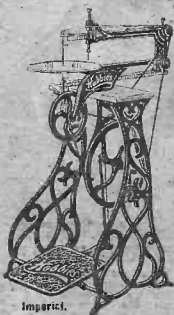

Imperial.

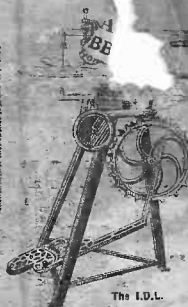

The I.D.L.

Electric Motor Attachment.

The modern machine is electrically driven by a special motor for A.C. or D.C. mains, and usual voltages. A list of prices of machine's extra motor or the motor supplied for your own machine, is obtainable free on application to Hobbies, Ltd., De Khan.

HOBBIES Machines supplied by leading ironmongers or stores. See them at HOBBIES Branches in London, Glasgow, Manchester, Birmingham, Salford, Leeds, Southampton, Brighton, or direct from the factory, HOBBIES, Ltd., Dersham, Norfolk.

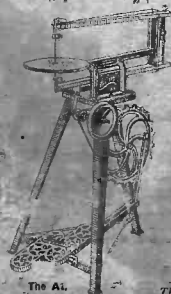

The A1.

These machines are the outcome of 20 years' practical experience. They are built of steel with arms to accommodate long work and tables that can be tilted for bevel cutting. The treadling is easy and leaves both hands to operate the work. The fretsaw is gripped between special jaws, and the tension obtained instantaneously by a simple eccentric lever movement. The I.D.L. and Imperial have a drilling attachment which operates from the treadle and drills at enormous rate without any trouble.

The A1. - 50/-
The I.D.L. - 60/-
Imperial - 90/-

All machines supplied with saws, spacers, tuning instructions, etc. Ready to use. Those sent by rail are carriage forward.

FREE LISTS.

ILLUSTRATED
LISTS OF
MACHINES
AND PRICES
FREE ON AP-
PLICATION TO
HOBBIES, LTD.,
DERSHAM,
NORFOLK. OR
FROM ANY
HOBBIES
BRANCH.

This is the cost of a very nice piece of furniture you can turn out with a fret machine. There are dozens of others being constantly shown in these pages, and in HOBBIES 1931 Catalogue.



HOBBIES FRET MACHINES

No. 3

FREE INSIDE! DESIGN SHEET FOR A FINE HALL MIRROR

HOME
CRAFTS
WOOD
WORKING
MODEL
MAKING
AMATEUR
MECHANICS
ETC. ETC.

Hobbies AND PRACTICAL WIRELESS

2^D

February 20th,
1932.

No. 1896.

Published every
Wednesday.
Registered at the
G.P.O. for Trans-
mission by Con-
sular Magazine Post

SEE INSIDE!

AERIAL
ERECTION —
ALL TYPES

CONTAINS
PRACTICAL
INSTRUCTION
ON EVERY
HOBBY!

CHEAP BRITISH FRETWORK SETS

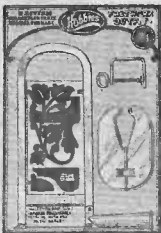

The H2.
CONTENTS —
12IN. HANDSOME AND RARE
STEEL CUTTING TABLE
2IN. FIBROUS GLASS
METAL DRILL AND BIT
6IN. FILE
1 DOZ. FRETSAW BLADES
FIBROUS DRAWING
WORKING INSTRUCTIONS

The H2.

CONTENTS —
12IN. HANDSOME AND RARE
STEEL CUTTING TABLE
2IN. FIBROUS GLASS
METAL DRILL AND BIT
6IN. FILE
1 DOZ. FRETSAW BLADES
FIBROUS DRAWING
WORKING INSTRUCTIONS

2/6

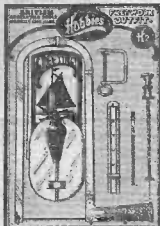

If you cannot obtain
locally send postal order
(plus 6d. for postage) to
Hobbies Ltd., Dereham,
Norfolk.

HOBBIES OWN MAKE

From leading manufacturers, direct and
all Hobbies branches and agencies.

HOBBIES

BRANCHES AND AGENCIES. LTD.

Below are the addresses where Hobbies goods can be purchased. In addition all leading stores and ironmongers stock or can obtain your requirements in fretwork and woodwork, designs, wood, turned legs, mouldings, polishes, wirework accessories, etc., etc.

HOBBIES OWN BRANCHES—

LONDON * 95 NEW OXFORD STREET, W.C.
LONDON * 147 BISHOPSGATE, E.C.
LONDON * 83 NEWINGTON BUTTS, S.E. 1.
GLASGOW * 326 ARGYLE STREET,
MANCHESTER * 10 FICCADILLY,
BIRMINGHAM * 98 HIGH STREET,
SHEFFIELD * 4 ST. PAUL'S PARADE,
LEEDS * 10 QUEEN VICTORIA STREET,
SOUTHAMPTON * 25 BERNARD STREET,
BRIGHTON * 68 LONDON ROAD,
CANADA * 84 YONGE STREET, TORONTO.

HOBBIES AGENCIES—

Aberdeen.—Jas. Mutch Ltd., 47 Broad Street; Bedford.—MORSE,
F. S. Carpenter & Co., 105 Midland Road; Blackburn.—Mr. H.
Meyers, 68, Darwen Street, Bradford.—Messrs. F. Underwood &
Co., 15 and 15 Manchester Road, Cambridge.—Mr. H. S. Driver,
55, Hills Road, Canterbury.—Mr. J. D. Goodwin, 35 Buzell
Street and 16 St. George's Street; Gardin.—J. Halls (Toys), 11, 13,
31 Market Arcade, Graydon.—J. H. Turle, Ltd., 6 Opera Hill,
Dover.—Mr. E. P. Beckham, Quaco's Gardens; Dublin.—Mr.
J. J. McQuillan, 36 Capel Street; Dundee.—Mr. F. Han, 35
Struth Gate; Folkestone.—Mr. W. Alsworth, 18 & 19, Finchill
Street; Hastings.—Mr. W. H. Mayne, 4 York Buildings; Hull.—
Mr. G. P. Walker, 17 & 18 George Street; Leicester.—Mr. Frank
Barry, 3 Leasby Lane; Liverpool.—Mr. O. Lucas, 55 Manchester
Street; London.—Messrs. H. Benson, 106 Abchurch Lane, E.C. 4;
Newport, Mon.—J. Halls (Toys), Ltd., 81, High Street;
Reading.—Mr. W. Skelton, 45, St. James Street; Swansea.—
J. Halls (Toys), Ltd., 8 Dover Street; Wigau.—Mr. T. 750, J. S.
Cephan, 12 Standishgate; York.—Messrs. J. H. Ashoksmith &
Sons, 132 Midlegate.

HEAD OFFICE AND WORKS:
DEREHAM, NORFOLK

Can be bought
for cash down
or easy pay-
ments of 2s. 6d.
weekly.

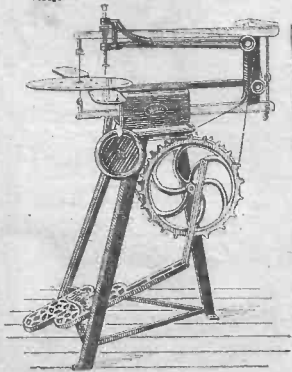

"Paid for itself more than twice"

"Allow me to tell you the I.D.L. has paid for itself more than twice since I bought it. I find no trouble at all in selling things I make."—W. Skinner, Jr., Radford, Coventry. That unasked testimonial is the best advertisement we could have. The machine costs 60/-, and is a perfect factory at home for all kinds of woodwork.

Complete illustrated lists of machines, from 35/- to £20, free on request to Hobbies Ltd., Dereham, Norfolk.

HOBBIES IDL FRET MACHINE

See one at a Hobbies Branch in London, Glasgow, Manchester, Birmingham, Sheffield, Leeds, Southampton, Brighton. *Or ask our leading ironmongers.

Make yourself a Ukelele

H.J.M., of Anfield, made one and wrote:—"I have made ukelele and it is a great success. In fact, I have taken it to the Liverpool Examiner for the Banjo, Mandolin and Guitar, and he said the tone was as good as any that he has heard."



Why pay a pound for a ukelele when you can make one for yourself for 4/-? Everything is supplied ready for the handyman to complete, and anyone with a few fretwork tools can do it. The design sheet has full-size patterns and cutting instructions, the wood is supplied planed and cut in the boards required, pegs and strings are included in the parcel. Hundreds of these full-size playing instruments have already been made by delighted readers.

Ukelele Banjo No. 1825. Design 34. Parcel of wood 2/9 (postage 6d.), pegs and strings 1/5 (post 1d.).

Ukelele No. 156 Special. Design 35. Parcel of wood 6d. Parcel of wood 2/- (post 6d.), strings and pegs 1/6 (post 1d.).

If you prefer, a neck already shaped is supplied for 1/5. An instruction handbook on how to play, price 1/-. Complete illustrated construction details for either, price 2d. (postage 1d.).



No. 1825.

No. 156 Special.

All the parts, designs, etc. are obtainable from Hobbies branches in London, Glasgow, Manchester, Birmingham, Sheffield, Newcastle, Brighton. Or from your usual stationery store. Sent by post direct from Hobbies Ltd., Dereham, Norfolk.

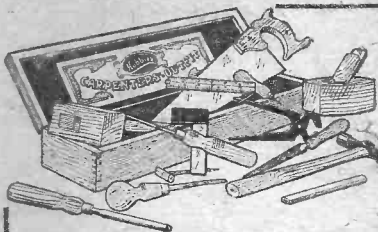

CARPENTRY OUTFITS



**BRITISH MADE
AND RELIABLE**

Those who are fond of woodwork will welcome these splendid tool sets. Most Outfits contain cheap inferior tools which are of no practical use. These, however, are splendid value, because every tool is well made, strong and a real serviceable article. Each set contains a useful amount of tools to meet every day woodworking requirements.

No. 1.

This useful little set contains a number of serviceable tools of general utility. There is a hand saw, hammer, screwdriver, 1/4 in. chisel, 2 1/2 in. folding boxwood rule, Bradawl, gimlet, and a carpenter's pencil.

7/6
Post 9d.

No. 2.

Contains a wider range of tools of equally good quality—each one reliable and useful. Included is a 16 in. hand saw, hammer, screwdriver, Bradawl, 1/4 in. chisel, gimlet, pliers, 2 1/2 in. boxwood rule, file, mallet, and a carpenter's pencil.

11/6
Post 9d.

No. 3.

A comprehensive set of tools for any amateur carpenter. The outfit includes a hand saw, mallet, smoothing plane, hammer, 1/4 in. chisel, file, square, screwdriver, pliers, 2 1/2 in. folding square.

27/6

London: 65 New Oxford St., W.C.1; 147 Bishopsgate, E.C.2; 85 Newington Bk., S.E.11. Glasgow: 224 Argyll St. Manchester: 10a Piccadilly. Birmingham: 3a High St. Leeds: 10 Queens Victoria St. Southampton: 25 Bernard St. Brighton: 68 London Road. Sheffield: 214 West St. or by post from Hobbies Ltd., Dereham, Norfolk. Canadian Depot: 814 Yonge St., Toronto, Ontario.

HOBBIES NEW 1932 CATALOGUE

300 PAGES

*This Book puts
pounds into your pocket*

It shows you how to **earn** money. Every page is packed with useful information, and the editorial section has articles on pastimes. Clock-making, a model aeroplane, wireless puzzles, model making, woodwork and fretwork are all dealt with for the amateur. You can turn 1/- into £1



There are over 300 pages to interest you showing over a thousand things any fellow can make. Five free designs are given with every copy, and it is a better book of hobbies than anything ever published. Hobbies should have a copy. Its pages have re-written and heaps of new lines added for the hobbist.

*Value
for Money*

two large free designs for making a modern All-in-Wireless Cabinet and a most Christmas type of quaint new Calendar Picture in colours, a working model toy and a pine rack pattern are also given free. They alone are worth 2/6.

Get your copy now

From any newsagent, bookstall or ironmonger. With large free designs, price 9d. complete. Or from any branch of Hobbies Ltd. in London, Glasgow, Manchester, Birmingham, Sheffield, Leeds, Southampton, Brighton.



By getting your copy now you will find plenty to do as the long evenings come on. Don't wait until Christmas before. This Catalogue shows you all kinds of ways to be happy in your spare time.

If you cannot procure a copy locally, send a postal order. D. & C. Hobbis, Norfolk, and one will come along post paid by return.

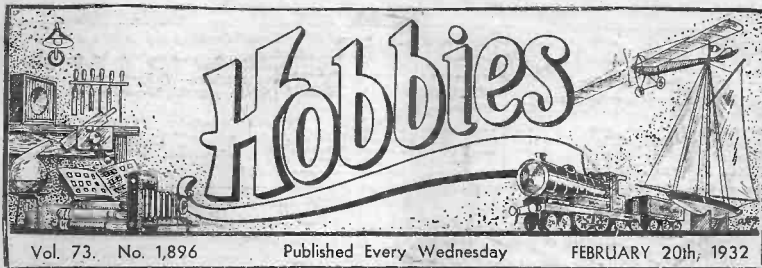

THIS WEEK'S CLEVER IDEAS

Combined Coat-Hanger and Brush.

A NEAT accessory for the wardrobe consists of the combined coat-hanger and brush illustrated here. It will be seen that it folds into a useful clothes hat brush. It occupies small space when travelling, and at its low price of 1s. should command a ready market.

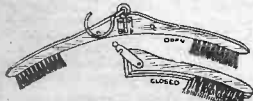

A folding coat hanger and brush.

Aluminium Wireless Valve Screen and Base.

THE popularity of the screen grid valve has created a demand for a valve screen and base. That shown in the centre of this page has a telescopic adjustment enabling it to be used in conjunction with all types of screen grid valves. It will also accommodate the majority of valve-holders. It is 2 1/2 in. in diameter and costs 2s. 9d.



A neat wireless valve screen and base.

A Screwdriver and Screw-holder.

A WELL-KNOWN firm of screw manufacturers has recently marketed the combined screwdriver and screw-holder shown in the illustration at the foot of this page. It grips the screw whilst it is being turned, and it can therefore be used with one hand only. It will be found ideal for working in awkward places, as the blade cannot slip out of the screw-slot. Additionally, it dispenses with the need for a gimlet or bradawl hole in ordinary woods and it is suitable for metal or wood screws. It is made in three sizes: No. 1 accommodating Nos. 0 to 6 gauge wood screws, 10 to 4 BA. screws, and Whitworth screws 1/16 in. to 9/64 in. diameter; No. 2 size suits 4 to 9 gauge wood screws, 5 to 3 BA. screws, and 1/16 in. to 5/32 in. Whitworth screws; No. 3 caters for 8 to 14 gauge wood screws, 2 to 0 BA. screws, and 1/8 in. to 1/4 in. Whitworth screws. No. 1 size is suitable for wireless or model purposes, and is made in all-steel, No. 2 is a householder's model, and No. 3 a carpenter's and engineer's model.



A screwdriver and screw-holder combined.

any: see if by twisting the knob of the switch you can increase or decrease volume. If the switch makes any noise at all you will know that the contacts are faulty. Cleaning the switch will remedy the trouble for a time. It is much better to fit a good quality switch of the "snap" type, such as the Utility Snap, which costs 2s. 6d., occupies less than a 1/4 in. cube at the back of the panel, is a baby in size, and has a current carrying capacity of at least 3 amperes.

For Stamp Collectors.

A FAMOUS firm of stamp dealers has inaugurated an excellent free gift scheme to introduce its approval sheets. Every applicant sending 2d. to cover postage, and requesting "Approvals" to Victor Bancroft, Matlock, England, will receive a Philatelic Casket, containing a watermark detector, tweezers, perforation gauge, transparent envelopes, and the Lebanon Flying Post stamp. If 4d. be sent, a powerful magnifying-glass in a folding frame will be enclosed as well.

Neat Battery Cords.

MOST wireless sets employ at least seven battery connections, two for the low-tension, three for the high tension, and two for the grid bias. One and two valve sets usually make use of a smaller number. Messrs. Belling and Lee, Ltd., makers of the well-known terminals bearing their name, have produced a series of all-way, five-way, six-way and seven-way cords, with wires of various colours (for identification purposes) braided together. The use of one of these cords tidies up the set considerably, and eliminates the risk of attaching the low-tension to the high-tension, or vice versa. Some of these leads include a fuse in the low tension negative lead. They cost a few shillings each, and are well worth it. This price, of course, includes the battery terminals and wander plugs. The reverse ends of the wires are left blank, ready for the attachment of either spade or spike terminals.

A New Wireless "On-Off" Switch.

QUITE a lot of wireless troubles emanate from a faulty on-off switch. Most of the cheaper varieties have very poor contacts, resulting in considerable resistance. Here is a simple test you can apply straight

The addresses of the manufacturers of items mentioned on this page can be obtained on application to the Editor.

NOTES AND NOTIONS from our READERS

Improving a Small Iron Plane.

THOSE readers possessing a small iron plane similar to that shown herewith can improve it by having a 7/32in. hole bored in the pillar and having it tapped in. Whitworth. The hole must be at

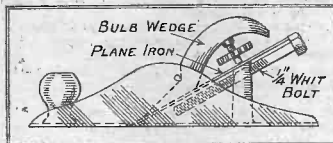

Improving a small iron plane.

the same angle as the top of the pillar. Into this place a 1/4in. bolt, so that the head pushes the iron down, as shown. The blade can then be adjusted to the required cutting depth.—J. BROWSE (1. Larnara Park, Larnie, Co. Antrim).

A Simple Football Lacer.

READERS possessing footballs have, no doubt, experienced difficulty when lacing the ball without the aid of an awl. This simple tool can be made quite easily from the key of a sardine tin. Cut off the head of the key and also the projecting piece of the eyelet as shown. It should next be trimmed with a file and then inserted into a suitable should make the construction quite clear.—H. MAUER (Bridge Street, Noston).

Removing Stubborn Jar Caps.

SOMETIMES the caps of fruit jars are very hard to remove. By making the simple lever shown, you will overcome this difficulty. Obtain a piece of hard wood, 1 1/2in x 1 1/2in x 1in, and bore two 1/8in. holes in the positions shown. Pass a piece of cord or leather through the holes and make

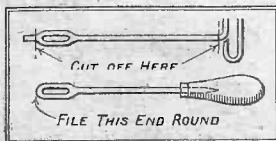

A simple football lacer.

THAT DODGE OF YOURS?

Why not pass it on to us? We pay Five Shillings for every item published on this page. Mark your envelope "Notes and Notions." Put your name and address on every item. Every notion sent in MUST be original.

it secure.

The thong should be about 30in. long.

To use the device, place the screw cap in the loop, draw the cord tight, and grasp it tightly round the handle. Hold the jar firmly and apply enough force to start the cover. Always arrange the wrench so that the turning of the cap tends to put tension on the fixed end of the cord.—E.

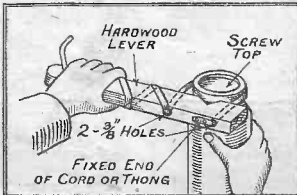

Removing stubborn jar caps.

DOWSETT (12, High Street, Teddington, Middlesex).

A Useful Pair of Tweezers.

CUT both ends off an old worn-out pair of tweezers. Place a washer between them to a point. Place a washer between the two ends and then rivet

THIS WEEK'S MENTAL NUT—

No. 5.

THREE books will be awarded each week for the first three correct solutions. Mark envelope No. 5.

A MAN left a hundred acres of land to his three sons, A, B, and C. The land was to be fairly divided between A and B.

Answer to Last Week's Problem. THE man received 5 2d. stamps, 30 1d. stamps, and 8 3d. stamps, which represent a total of 5s.

together.—W. FLEMING (5, Stonehill Av., Anfield, Liverpool).

An Efficient Wall Plug.

MAKE the plug circular so that it fits the hole exactly, say a piece of 1/4in. dowelling for a 1/4in. drilled hole. Make a saw cut at the

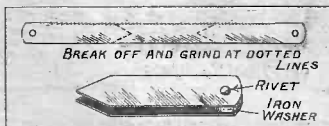

A useful pair of tweezers.

ent of the plug and slightly open the saw cut with another close to it, as shown in the sketch. Prepare a flat wedge the exact width of the diameter of the plug. When ready to insert the plug, cover the wedge with glue and place it in the saw cut. The more you drive in the dowel the more firmly will the plug grip.—H. DALE (Soundess, Henley).

Automatically Charging Accumulators.

THE above device, illustrated in "Notes and Notions" (January 30th issue, page 412) consists of an alarm clock, two pieces of wood, a knife switch, and the resistance bulb. The switch handle is tied to the striker and is fitted so that any motion of the striker

The clock is started at, say, twelve o'clock, and if the battery has to charge for three hours, then set the alarm for three o'clock. After three hours the alarm will ring, the knife switch will fall and the current will be turned off.

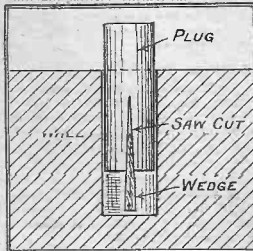

An efficient wall plug.

MAKE YOUR OWN PRINTING BLOCKS FROM LINOLEUM

By M. Bywater, A.R.C.A. (Lond.)

An interesting and practical article by an expert.

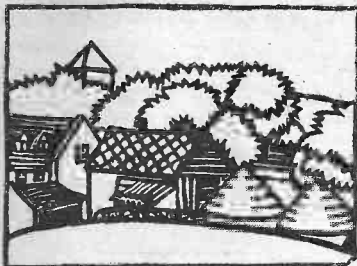

Fig. 1.—A typical example of linoleum printing.
The original of this illustration was printed from a linoleum block.

LINO-CUTS, being reproductive, have many advantages over other crafts. Any number of prints can be taken from one block. The entire process is very straightforward and can be carried out with a few simple tools and appliances.

Attractive end-papers and cover-designs, printed from blocks cut to repeat as an all-over pattern, are sometimes added.

Lino-cuts have also great pictorial qualities. A landscape or almost any other subject looks very well on a wall if correctly mounted.

It is a useful means of printing an unlimited number of Christmas cards and book plates (see Fig. 1), though lettering (cut on the block the reverse way of suitable) should not be attempted by beginners.

Designing for a Block.

The first design should be thought of in bold masses of black and white to simplify it for cutting.

Do not be afraid to leave out details because they exist in reality. Intricate cutting clogs when the block is inked.

Always carry your design to a finish on paper first so that it has the appearance of a print (see Fig. 2).

The rule of simplicity applies to work both in outline and in shading.

Tools and Materials.

cracks, and all other blemishes, and which is about one-eighth of an inch in thickness should be used. Cork lino will not give successful results. It is not necessary to mount your lino, though, if mounted on three-ply or (in larger work) seven-ply wood, the blocks are easier to handle.

The ink and frame to be mentioned in this article are

A sandbag made of two circular pieces of leather about five or six inches in diameter, well filled with block on (see Fig. 3).

Chinese white and Indian ink (or ordinary writing ink) will be needed, also Japanese mulberry fibre paper.



Fig. 3.—Sandbag.
Fig. 4. (right).—Roller for inking.

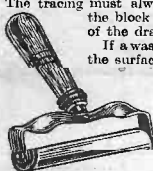

a V-shaped tool for line work, and small and large gouges for removing waste surfaces.

The cutting tools are not absolutely essential, as whole blocks have been very successfully cut with a sharp pocket knife. All cutting tools must be sharp.

Leather workers and students of stencilling will already have a rubber roller, which is very good for rolling out the printing ink on sheet glass and distributing it evenly over the face of the block (see Fig. 4).

The Japanese use a baren or rubbing pad for taking a print, but any smooth-handled instrument or the back of a dessert spoon will answer the purpose.

Indian ink can be substituted for proofing ink if preferred. Equal quantities of Indian ink and smooth flour paste are put out in separate saucers, and the block first inked with a brush.

A very little paste is then brushed over the surface so that it mixes with the ink while it is still wet.

Transferring the Drawing to the Block.

The tracing must always be laid face downwards on the block or the print will be the reverse of the drawing.

If a wash of Chinese white is taken over the surface of the lino, satisfactory as pencil marks cannot be made on an unprepared surface.

Sometimes the tracing is pasted (face downwards) on the block, and the Chinese white need not be applied.

When any air pockets are pressed out with a roller and the gum is dry, the unprinted portion of the design is cut away and the block washed to remove the ink and gum.

If using the method of inking in the printing surface (the part of the block which is not often prevented), apply (To be continued.)



Fig. 2.—A "repeat" design printed from linoleum.

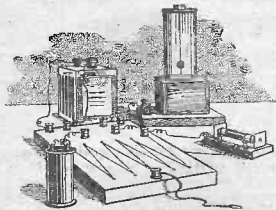

THIS instrument is to the electrician as important as the balance to the chemist, and, therefore, is very useful to have.

It consists of a board 12in. by 8in. of very dry oak. If you care to go to a little more expense you can use ebony.

Mount nine brass terminals upon it in the positions shown in Fig. 1. At 20, 40, 60, 80 are brass pins driven into the base 1½in. apart. At a distance of 7in. from this row of pins is a row of five more, 10, 30, 50, 70, 90, the same distance apart, and arranged alternately with the top row as shown.

The zigzag line is a length of bare Eureka resistance wire of 22 gauge. The same kind of wire that was used for the resistance box can be used if it is bare, but Eureka resistance wire can also be bought here. Fasten one end under terminal R, and stretch it lightly in a zigzag manner round the brass pins as shown, finishing off under terminal X1.

Rule eleven horizontal lines across the board, as shown, ⅞in. apart, and number the intersections of these lines with the resistance wire.

Board Connections.

The dotted lines represent connections at the back of the board with thick copper wire. Be careful to join up the correct terminals—R to B, B1 to X1, R1 to X, G1 to Z, G to the middle of the R1X wire. Solder all connections if possible, but remember that a good screwed-up connection is better than a badly-soldered one. A battery is joined up between B and B1, and the galvanometer between G and G1.

The instrument is used commonly to find the resistance of a wire or given circuit.

Suppose we want to find the resistance of a certain piece of wire. Connect it up between X and X1. Between R and R1 connect up a standard resistance coil, say 5 ohms.

To the terminal Z is connected a length of flexible wire, with a short tag of stiff copper wire soldered to the end of it.

When everything is connected up, touch the zigzag wire with this flexible lead. The galvo needle moves violently. Try different spots on the zigzag

MAKING A WHEATSTONE BRIDGE

By W. B. Thompson.

This instrument is commonly used to find the resistance of a wire or given circuit.

wire and you will eventually find one where the galvo needle is unaffected.

The Formula.

Note the number of this spot by means of the parallel lines and figures. Suppose the spot is 25.

By using the following formula you find the resistance of the wire—

$$100 - N \times R = \frac{N}{N}$$

where N = the number on the board, R = the standard resistance.

then $100 - 25 \times 5 = x$

$$25 \times 5 = x$$

$$75 \times 5 = x$$

$$25 \times 5 = x$$

whence the resistance of the wire is 15 ohms.

If the unknown quantity is suspected of being high resistance, a high standard resistance should be used. We can easily make our standard resistances, remembering

TWENTY-FIVE YEARS AGO.

Issue dated February 2nd, 1907.

IN view of the expense of illustrations in those days, the pages of HOBBIES did not carry many pictures, and all are in black-and-white line drawings. There are only twenty one in this issue, for instance, and the pages lack unusually bare. A drawing lesson on how to draw a flower, scalloped edges for ladies' brass rubbing, and a page of hints for home workers are included. It is interesting to note in the Stamp Collecting pages that the number of varieties of postage stamps of the world up to that time was 20,490, of which 6,000 were issued in the British Empire. Now—in 1932—the varieties issued number 53,476.

that our Eureka 22 gauge is 1 ohm per 33in. For 5 ohms, cut off 165in. plus 1 in. for connections. Coil this round a small cardboard cylinder, leaving 2in. free at either end for connections. When placed in the bridge arm of the wire should go under each terminal to give the correct resistance between the terminals.

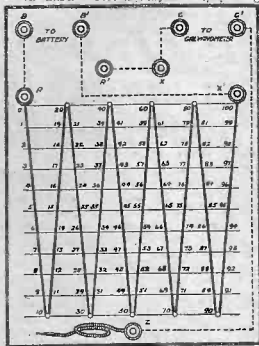

Fig. 1.—A detailed sketch of the Wheatstone Bridge, showing its construction.

OUR WIRELESS BLUE PRINT SERVICE

Blue Print No. 1. "Hobbies" Crystal Set	6d. Post Free.
Blue Print No. 2. "Hobbies" British One-Valver	1/- " "
Blue Print No. 3. "Hobbies" All Station Two	1/- " "
Blue Print No. 4. "Hobbies" Round-the-World Three	1/- " "

You can obtain the following blue print wiring diagrams from the Publisher, HOBBIES, Geo. Newman, Ltd., 8-11, Southampton St., Strand, W.C.2. Other blue prints are in preparation.

Blue Print No. 5. "Hobbies" Long Distance Four Valver 1/- Post Free.
Blue Print No. 6. "Hobbies" Beginner's Three Valver 1/- " "
Blue Print No. 7. "Hobbies" Autokoll Three Valve 1/- " "

Reinartz 1/- " "

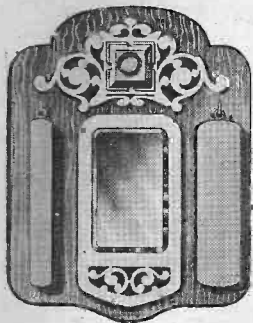

A HALL MIRROR AND BRUSH RACK

THOSE who want to make up something useful for their own home, or as a present for a friend, should certainly undertake the piece of work illustrated here, the patterns for which are given on the

free design sheet this week. The Hall Mirror and Brush Rack is just the sort of thing to make in a couple of spare evenings, and the wood and material is neither costly nor intricate. The whole thing is 13in. high and 10in. wide, and is specially designed so it can be made without a lot of undue trouble. The whole of the work can be undertaken with a fretsaw, drill, sand-paper, and a little glue. The wood, of course, can be bought ready planed and in the sizes required, as shown on this page, but some may be able to make it from other fretwood which they have in stock. That supplied, however, consists of beech, because this is the same material as the backs of the brushes and the wood ornament supplied for the top.

The Back.

The main board which forms the back is in 3/4in. wood, but all the other is 1/2in. thick. The fact that the main portion is thicker than usual need not deter the young worker from undertaking the work, because there is only the outline to cut with the fretsaw, and this is perfectly straightforward with only a curved edge at the top and bottom. The pattern is pasted down to a large board, and it will save time if one of the straight sides of the part is put close to the edge of the wood. This will then save the work of cutting. The other three patterns are all in 1/2in. wood, and can, therefore, be easily cut from one board. Remember to get the grain running in the direction indicated by the arrow, and a useful way of pasting them down with the least waste is indicated at Fig. 1.

How to Use Paste.

One of the failings of some workers is to apply the paste too thickly in putting the patterns down. It should cover the surface entirely, must be put on the wood, and should be worked out thinly, so that it holds the paper without making it sappy. In the case of a large pattern like that of the back, it is a good plan to roll it round a piece of broomstick or dowelling, and then roll it direct on to the pasted board. This prevents the likelihood of the paper becoming creased or muddled. It is essential, of course, in all cases of pasting down, to get the paper correctly in the centre, and then pat it gently outwards with a duster to take away all air

bubbles. If a crease gets in it will often spoil the shape, and will always throw out a joint which may have to be cut.

Back and Two Overlays.

At Fig. 2 the complete section of the mirror is shown. Here it is perfectly clear how the parts are made up. Instead of cutting an opening in the backboard for the mirror to lay in, the backboard is left whole and the mirror laid in an overlay forming a recess. This overlay is a simple piece of 1/2in. wood glued to the background, and the mirror is held in place from the front by an even more simple overlay rim glued over it. The main overlay (A) is glued midway between the two sides and 1/2in. upwards from the bottom edge. It is, of course, first cut and cleaned both back and front, so that no remains of the paper pattern are to be seen.

Mark Round the Mirror.

Any little errors in the actual fretwork can, too, be cleaned up with the small fretwork file, but it should be the aim of every worker to be able to undertake fret-cutting without the use of these implements at all. It is a good plan to have the mirror, which is to be used. Then, by laying it on the pattern which is to be cut, a pencil mark is drawn round the edge to ensure that it will fit in the opening.

Remember always to clean up the back of the work before gluing it on anywhere else. Another point, too, is to get the glue on quite evenly without spreading it over the edges of any fretted pieces so that it shows when put in position. It is not the amount of glue put on the wood which holds it, but rather the fine skin of adhesive which is rubbed into the wood, and from which all air bubbles are taken out. Squeeze the glue from the tube evenly as a ribbon, and then rub it all over the surface with the tip of the finger. It is surprising how little glue is really required to make a good joint. If it does happen to squeeze out over the edge, wipe it away immediately and carefully. In putting the overlay down, have its position marked out on the wood beforehand. It can then be laid direct in place

THE MATERIALS

A special parcel of beech, the correct thickness, costs 2/6. A bevelled mirror (No. 5753) is 1/-, and well made brushes and tools 3/- the pair. A complete parcel sent post free for 6/3. Get them at any branch of Hobbies or by post (postage extra) from Hobbies Ltd., Dereham, Norfolk.

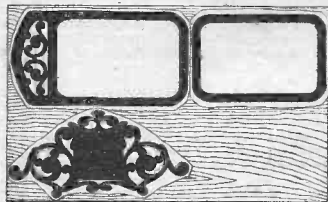
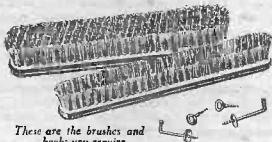

Fig. 1.—Put the patterns on the wood without waste of room.

without having to be slid all over the wool. Press firmly in position, and then weight down or clamp between two other pieces of wood until the glue is set.

The mirror itself is laid in the recess formed by the overlay (A), and the narrow rim (B) projects sufficiently over the aperture to hold the glass in position. This narrow rim must be cut carefully or it will break across the end where the grain is narrow. Clean up equally carefully, and then glue in position over the bevelled



These are the brushes and hooks you require.

edge of the mirror. Do not forget to put the mirror in first. Try the glass out for thickness, and if the overlay (B) does not hold it flat and steadfast to the back, pad the part out with blotting paper or a piece of hartz or similar material. The mirror should be held tight when the overlay is glued on, and it will take two or three layers of blotting paper to do this. This overlay, of course, must be weighted down to hold it tight to the other, after it is finally placed in position.

The Fretted Overlay.

The only real piece of fretwork in the whole article is the ornamental scroll design which appears across the top of the mirror and above the brushes. This is cut from a single piece of jin. wood with the grain running across. It is advisable to cut the inside frets first to give greater strength to the whole board. The outer edge is cut last. The centre of the overlay is solid to form a background for the ornamental carving—No. 226—which is glued on. This piece of fretwork will stand up more than anything else, and it is essential therefore, that it be well out. There is not a large amount of detail in it, but one should watch carefully that the design is in its proper proportion both sides of a centre line.

Hints in Cutting.

That is, if one is cutting to the right of the centre square, it is advisable to watch at the same time the similar fret on the opposite side of the square to see they are both coming exactly alike. The curves of the scroll work can be made or marred by the effect of each part cut. The continuity of the curve must be preserved very carefully so that a ragged and unsightly line is not made. The link pieces which join the design up should also be kept to a standard size, and the saw should not be allowed to run further into one link piece than into another. This is one of the points which always stand out in a competition piece, and one which soon gives the judges a good idea of the worker's ability.

After all, the best result can only be obtained by putting in the best work, and this does not mean that

as soon as the cutting is finished the whole of the article is completed. Far from it. As much time should be put into the cleaning and finishing as into the cutting. Measure up the work carefully, to see that all adjoining parts are put on at their correct distance and place. Clean up all parts and glue them with care and attention, so that the whole effect is good. Go over each piece before it is finally put in position, and check it off back and front to see there is no error in the cutting or in the fitting itself. As a case in point: the two hooks which are to be screwed in the back to hold the brushes, in this instance, should be exactly in line with the top of the mirror, and placed at an equal distance from the outer edge—1 in.

The Brush Hangers.

All these things go to the proper finish of an article, and we cannot stress too much the importance of neatness and finish in all pieces of work undertaken. If one's patience begins to wear out before the job is completed, it is better to put it aside until another day rather than go on with the work and get careless or spoil it. The brush rack itself is formed by the addition of a hat brush and a clothes brush, both of which have polished beech backs and suitable stiff hair for their purpose. Nickel-plated hooks with short screws are also supplied for fixing into the back, and the position of these should be marked on from the dotted lines of the pattern before the paper remains are sandpapered off. Make a small hole for the screws, and then turn them home so the end of the hook is upright.

The overlay at the top having been glued in position, it is further decorated by one of the wood ornaments—also cut in beech. It is glued in the middle, with the grain in the same direction as the board upon which it is mounted.

A Suitable Finish.

If the work is intended to be stained and polished, it is advisable to undertake each of the parts separately before they are glued together. Then, of course, one is able to get a perfectly flat surface of polish. Remember to scrape off any polish where glue is to be applied. The glue itself will not hold on a polished surface, but if it is scratched or scraped or sandpapered away, a good joint can be made. It is not, of course, essential to polish up this work, as beech can be easily rubbed over with linseed oil and brought down to a semi gloss without a great deal of trouble by this process. Suitable linseed oil is obtainable from Hobbies, 5d. a bottle, and is rubbed over the work on a pad until the grain stands out more clearly and a striking effect is obtained.

Methods of Hanging.

The article can be hung by cutting a circular hole at the top to take a nail in the wall, or two wall hangers can be screwed on to the back in the position shown on the patterns by the small circular dotted lines projecting above the curved corners at the top.

"staggered" over the baseboard the wire may be threaded between, or through, these, and the desired tension may be obtained.

In the event of a breakdown in a H.F. choke, any large tuning coil may be used temporarily as a stop-gap.

TO find the approximate grid-bias voltage required by an L.F. or small power valve, divide the high-tension voltage by the magnification factor.

A stick of black Glitterwax or black sealing wax, or shoemaker's bootball, or substances which may be

PRACTICAL WIRELESS PARS. Used to fill unwanted panel holes.

If a fairly large nail is driven up through an old baseboard, a reel of wire may be placed over this when coil winding is carried out. And, if three or four small staples are

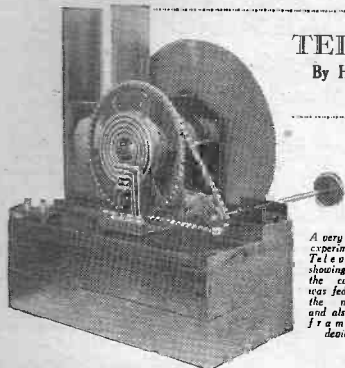

Fig. 2.

TELEVISION FOR AMATEURS

By H. J. BARTON CHAPPLE, Wh.Sch., B.Sc. (Hons.), Etc.

(Continued from page 444, Jan. 30th issue.)



A very early experimental Telscope showing how the current was fed into the motor, and also the framing device.

NOW the term "synchronism" is one which is often confused owing to a failure to comprehend its *exact* meaning. It can perhaps be explained best by giving one or two simple examples.

First of all, imagine two clocks, one of which is situated in America and the other in your own home here in England. If their accuracy is beyond dispute, both the minute and the hour hands of each clock will go through similar movements or, in other words, the angular movements of the hands will be identical. There will be a difference, however, in the times registered by the individual clocks at the same instant, for noon in America occurs at a different time from noon in England.

The condition which has been satisfied under the facts mentioned is known as *isochronism*. Now imagine both the clocks housed under the same roof. They will not only show the hands moving at the same rate, but will point to the same time at every instant. They are said to be "in step" and bear the same "phase" relationship to one another as well as possessing identical speeds. It is this double condition which needs to be satisfied for synchronism to be established.

For our second example, let us refer to Fig. 1, where we see illustrated two wheels revolving in the same direction at the same number of revolutions per minute—say two wheels of a bicycle on a straight run. Spoke No. 1 of the left wheel, however, is not in the same angular position as spoke No. 1 of the right wheel.

At X, therefore, we illustrate the condition of isochronism, or equal speeds, and we must look at Y for showing our equality of both speed and phase which is the requirement of synchronism. Not only are our speeds identical, but spoke No. 1 of each wheel has the same angular position at every instant of the motion.

Isochronism.

We see, therefore, that while it is possible to achieve isochronism without being in synchronism it

is impossible to establish synchronism without having first brought about isochronism. In our television system we really achieve isochronism through the agency of the mechanism incorporated in the apparatus, and this is done automatically, but the question of phasing has to be undertaken by each individual operator.

In the development of television it is only reasonable to suppose that many schemes have been proposed to bring about synchronism. One of the first ideas was to use alternating current synchronous motors, and under limited conditions this is quite successful; but the limitations mean that both the transmitter and receiver motors must be run from the same mains supply, and a moment's reflection will show that the area over which results can be achieved is necessarily small. This condition of affairs will be simplified when the electricity being developed for Great Britain is brought to another promissive of



Mirror helix comprising 89 sections, coupled to a 25-watt synchronous motor, synchronising being from the mains.

Another promissive of being developed for Great Britain is brought to another promissive of definite frequency and tune both the receiver and transmitter mechanisms to the signal. Apart, however, from the practical difficulties and the high power that would be required, we are faced with the necessity of providing an extra communicating channel to bring the scheme to a successful issue. This is, therefore, a retrograde step, for two channels

already are required, one for sound and one for vision, and any addition to these would meet with strong opposition from an already congested ether.

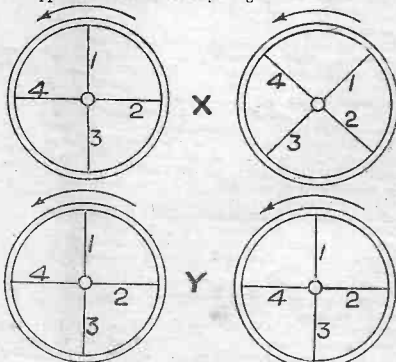

Fig. 1.—Diagram X shows conditions of isochronism in two wheels of equal diameter, and Y indicates equality of both speed and phase.

SHARPENING SAWS

By A. Westera

Useful hints on the care and maintenance of saws.

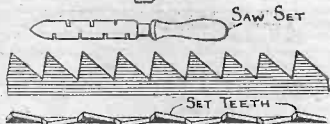
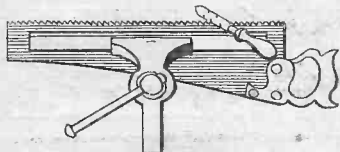

Fig. 3.—How the teeth should be set with a saw set.

Of all the tools used by the woodworker the saw is the most difficult to sharpen and keep in good condition. Our object is to describe in plain, non-technical language the way to sharpen ordinary hand and tenon saws, to enable the amateur craftsman to undertake the work for himself instead of having to engage the professional saw sharpener, even supposing there may be one in his district.

Special Saw-sharpening Vice.

The saw to be sharpened must be held in a special saw-sharpening vice, or in an ordinary vice in which

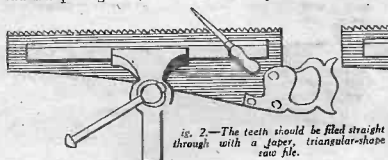

Fig. 2.—The teeth should be filed straight through with a taper, triangular-shaped saw file.

two long wood battens are placed with the saw to make it rigid for working, as shown at Fig. 1. The first thing to do is to examine the cutting edge to ascertain its shape. It should be straight, or slightly rounded, but never hollow, and as the middle part will naturally come into use more than the ends, the slightly rounded edge is the best. Any fault in this respect may be easily remedied by running a long, flat and fairly fine cut file along the teeth, and even if the shape is correct this operation is necessary to bring all the teeth to the same height. The file should be run over the teeth front end to end until there is a bright flat space on the top of each tooth.

When this has been done the teeth should be filed straight through with a taper, triangular-shaped saw file, as shown at Fig. 2, the object being to shape and sharpen the teeth flattened in the previous operation. The file is held exactly at right angles to the saw blade, each tooth is carefully treated, and, of course, it may be necessary to file some teeth more than others.

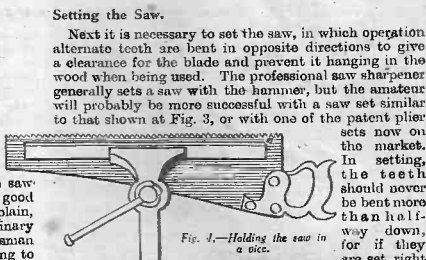

Fig. 4.—Holding the saw in a vice.

sets now on the market. In setting, the teeth should never be bent more than a half-way down, for if they are set right or too

down to the bottom they may be broken off, or the blade may be bent. Any little unevenness in setting may be regulated by lightly running a file along the sides of the teeth, the saw being placed flat on the bench first. The most important thing to bear in mind is not to give the saw too much set, for the blade is generally ground and tapered towards the back edge, and a very small amount is necessary to enable it to be worked freely.

The final operation is sharpening the teeth, in which those set away from the sharpener are filed from one side, and the saw is reversed to file the other teeth. The front edges of the teeth should be filed in this operation, and the file is held at an angle varying from 60 degrees to 45 degrees to the blade as shown at Fig. 4, the former being the angle most suitable for hard woods, and the latter for soft woods. The file should also be slightly out of the horizontal, as shown in the same illustration. Special care must be taken to hold the file at the same angle for each tooth, and especially so after the saw has been reversed, while the same number of strokes should be given with the file, two, or at the most three, being found sufficient.

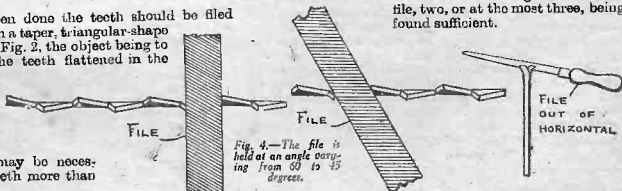

Fig. 4.—The file is held at an angle varying from 60 to 45 degrees.

Try your hand at TRAY MAKING—



and with little expense. The ordinary tray, when you examine it, is no more than a piece of board with a moulded edge and a pair of handles. The sizes vary, of course, and there is no standard table of dimensions which can be given.



Fig. 1—Tray Moulding.

can pick up odd sizes quite they are just O.K. for a tray.

Few Tools Required.

The work involved in making only calls for a few tools, such as to be found on any amateur's bench. A small tenon saw is needed to cut the wood, and a mitre tool of some kind to ensure the correct angles for the moulding.

Beyond that, a ruler, square, screwdriver, sandpaper, and glue are the only requirements. The most essential tool, of course, is the mitre tool, for it will be impossible to make a frame of moulding for the base without it. The Hobbies Catalogue illustrates several kinds from 9d. upwards, but undoubtedly the best is the mitre-cutting tool and clamp here illustrated. It is the one normally used in picture-framing, and so will always come in useful.

A Useful Tool.

Its big advantage is that instead of having to hold the moulding by hand, it is gripped by a movable vice which takes any ordinary width. The tool is screwed down to the bench and the length of moulding held tightly. A special saw guide holds the tenon saw in its jaws, and is so fixed that an accurate cut of 45 degrees is made. This is very essential, because if the end of the moulding is not cut correctly a true corner right-angle cannot be obtained. It is no use trying to pare it off with a chisel, or by the use of a file. The moulding must be sawn accurately, or else planed to the proper angle on a shooting-board.

General Sizes.

Before buying your plywood and moulding, work out

TRAYMAKING is one of those profitable side-lines which many wise readers undertake at odd times to add to their income, because they can be turned out easily

They largely depend on the size of the ply wood panels obtainable, for very often one cheaply, and find

the sizes of tray you are going to make. A small one, suitable for wine-glasses or two cups of tea, measures 12in. by 7in. Other useful sizes are 12in. by 10in. or 12in. by 18in., whilst for the largest size, 20in. by 15in., is quite useful. These sizes are of the baseboard, and good quality plywood is required. Do not use the common birch wood, as this will not stain down nicely. Obtain either mahogany or oak plywood, 3/4in. thick for the small trays and 3/2in. thick for the large ones.

The moulding for the edges is also obtainable in oak or mahogany to match the plywood base. Two long and two short pieces are required, and in measuring up, allow about 1/4in. for waste. If you order by post, keep the lengths as short as possible to prevent the parcel being too long. The shape of the moulding can be seen in the picture (Fig. 1), which shows how it stands flat on base where it is glued and screwed in place.

The Edging.

Look along the length of moulding to see there is no twist in them; if there is it can never be fitted to a true corner joint. Put one end in the mitre tool and saw off carefully with a small, sharp tenon saw. Now

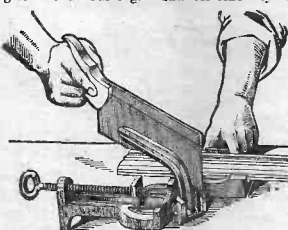

The way the moulding is cut for the corners.

stand the moulding in its position on the baseboard, setting it inwards 1/4in. from the edge and getting the mitre a similar distance from the end. Then mark the length of the moulding required, so it will be cut off 1/4in. short of the other end (see Fig. 2).

Sawing the Lengths.

Put the moulding the opposite way round in the clamp and cut off that end at 45 degrees. Test its length on the base and then turn to the second piece. Lay the latter along the piece already cut and mark off the exact length, to get the two parts alike. Saw off as before and you have two of the tray sides. Cut off a length of moulding for the

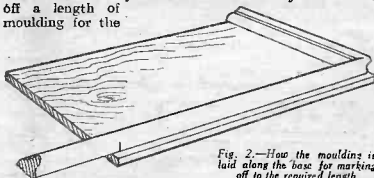

Fig. 2—How the moulding is laid along the base for marking off the required length.

An interesting and instructive article for the handyman with tools.

Hobbies can supply all the materials required.

third side, and mark it off by putting in position when the first two have been laid on the baseboard. This part, too, will also be set inwards $\frac{1}{8}$ in. from the edge. This, by the way, is to give the screws a better grip underneath, with less likelihood of splitting out the sides.

If the four lengths have been accurately cut off, they will form a perfect rectangle on the baseboard. Use a square to see they are true, and then mark round

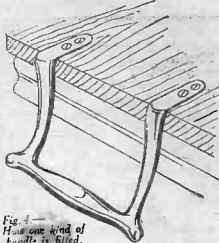

Fig. 1—How one kind of handle is fitted.

with a pencil where the moulding meets the base. Take away the moulding and bore two holes along the shorter sides and three holes on the longer ones to take the screws. These, of course, will be driven upwards from the underside, and if the heads are large, the wood must be countersunk to take them. If the parts are to be hand polished, it should be done now before they are put together. It is, however, quicker to put the polish on with a brush if several trays are being undertaken. In any case, the wood should be stained down to one shade. Spirit stain should be used, because it will not raise the grain, and yet dries very quickly. The ends of the plywood will soak up more than the rest, but it will not, of course, be necessary to treat the ends of the moulding. Lightening Polish—either colour or transparent—can be put on by hand, or with a brush, until a bright glossy surface is obtained. The polish should not, by the way, be used if the tray is to have anything hot stood upon it, as this will immediately ruin the surface.

Gluing-up.

When the tray is ready to be put together, rub the underside of the moulding with glue to get a thin, even coat. Lay it in the correct position round the edge, not forgetting a dab of glue on the ends of each strip. Have a loop of string and some paper ready. Put the string round the frame of moulding, using the paper to pat out the corners. Pull the string tight to keep the corners firm, and tie up without loosening off. Get a large board to stand over the framework of moulding, and weight it down heavily to hold the base and edging together.

Afterwards, turn the whole tray over and drive home the screws, for which holes had been previously made.

Adding the Handles.

Now we have completed the tray itself, but have yet to add the handles. These are obtainable to fit to the back of the moulding itself, or to the underside of the tray base. The former are easier to fix, but where they fit the moulding it will have to be

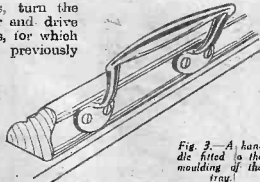
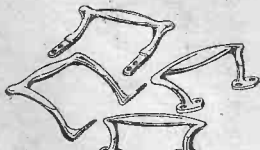

Fig. 3—A handle fitted to the moulding of the tray.



A group of different handles.

flattened down with a chisel or file to take the ends. The method of fixing is shown at Fig. 3. The kind that fits under the tray is shown at Fig. 4 and, as can there be seen, it is necessary to let the projection sink into a recess cut on the underside of the base with a chisel. If this is not done, four circular feet must be added to the corners of the baseboard to prevent the handle piece scratching the table.

Transfer Decorations.

The trays can be decorated with suitable transfers if desired. A small shell ornament or similar subject should be used, whilst a special pattern is also obtainable to fit the corner close to the moulding. Of course a more elaborate design can be made by use of the ribbon marquetry bandings. In any case, a final coat of polish or varnish should be added over the transfers to prevent them getting scratched.

For those who do not want to bother over measuring up baseboards and moulding, special parcels are made up by Hobbies Ltd. with four trays of various popular sizes. These contain not only the moulding and baseboard, but also suitable transfers and handles. Prices and all particulars are given in the Hobbies 1932 Catalogue.

A FREE DESIGN FOR THIS EASY HANGING CLOCK NEXT WEEK.

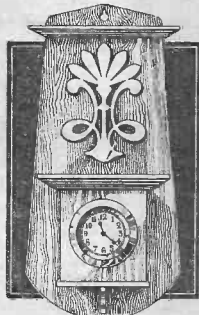

NEXT WEEK!

THE LISTENER'S PENTODE THREE
SOMETHING NEW IN TWO-VALVERS
A BEGINNER'S THREE-VALVER

MAKE YOUR
OWN LOUD-
SPEAKER
HORN.

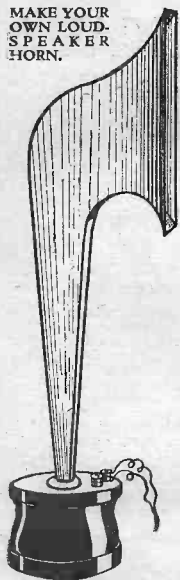

LOUD-SPEAKER HORNS

The illustrations on this page show various types of exponential loud-speaker horns.

By "Hobbies" Radio Expert

Some useful and interesting facts about loud-speaker horns and their design.

IN these days of moving-coil loud-speakers, and other types of cone reproducers, the horn type of speaker has practically disappeared from the market. In spite of this, however, some of the best-known talkie installations employ a horn type of loud-speaker, and this has caused quite a number of wireless fans to wonder which is actually the better type—the horn or the hornless. Experts are divided on this question, some holding that the moving-coil speaker, correctly designed, is the best reproducer, and others hold that the horn type is unbeatable, provided it is of the right shape, and this means that it has got to be very large, as the following figures will show. In order that a horn may reproduce with a perfectly even response all the notes in the musical scale, it must be of a certain shape and of a definite length.

The shape will have to follow what is known as the exponential (or logarithmic) law, that is to say, the cross-sectional area of the opening will have to double at equal intervals throughout the length of the horn. An example will make this clear. Supposing we have a horn, the entrance (or throat) of which has an area of one square inch. If at one foot along the horn the area is two square inches, then at two feet it will have to be four square inches; at three feet, eight square inches; at four feet, sixteen square inches, and so on.

This rate of expansion determines the lowest frequency at which the horn will maintain its straight-line reproduction, or in other words, it governs the "cut-off" frequency. The following table shows these figures:—

Area doubling every 6 inches, cut-off frequency is 128 cycles.
Area doubling every 12

inches, cut-off frequency is 64 cycles.
Area doubling every 24 inches, cut-off frequency is 32 cycles.
and so on.

To understand what this means, we must remember that the middle note on the piano has a frequency of 256 cycles, and the lowest note a frequency of 20.6 cycles. If, therefore, we wish our horn loud-speaker to reproduce the lowest note of the piano with the same degree of amplification as middle C, it must double its area every two feet. So far we have only decided upon one figure in the design of the horn, and we have yet to determine its length. This is governed by the size of the opening, or mouth. This must be of such a size as to permit the air column which is standing in the horn from having too great a damping effect on the diaphragm which is actuating it. The most satisfactory size for this opening will be obtained if we make the diameter equal to one-quarter of the wavelength of the cut-off frequency of the horn. This sounds a bit involved, but it is really quite simple to work out. The velocity of sound in air is 1,120 feet per second. We have seen above how to work out cut-off frequency, and, therefore, to find the wavelength of this, we have only to divide 1,120 by the frequency, and that will give us the wavelength in feet. Dividing this by four will give us the diameter of the opening, and we must, therefore, make our horn of such a length that it terminates when that diameter is reached.

Supposing we wish to construct a horn with a cut-off frequency of 64 cycles, and the unit for the speaker has a fitting with an area of one square inch. The rate of expansion will be every 12 in., and the mouth 4 feet across. This means that the horn would have to be over 6 ft. long. It becomes obvious from these figures, that the old-fashioned type of table loud-speaker was a very poor performer as far as the bass was concerned, and it also accounts for the size of the talkie horns.

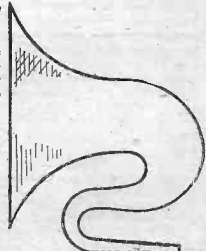
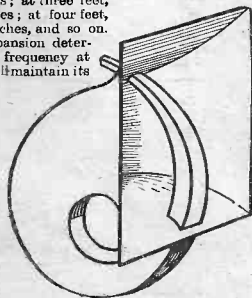
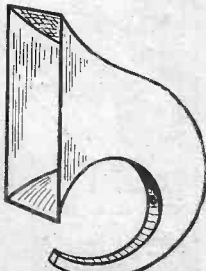

(Continued on page 520.)

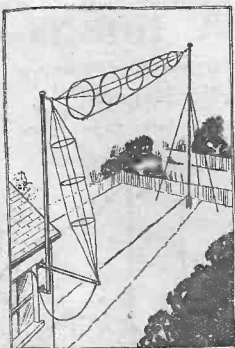

CAGE TYPE AERIAL

It is a tribute to the progress in the design of valves, transformers, and other radio components, that whereas five years ago even moderate reception on a three-valve set required a very efficient aerial 100ft. long, to-day we can get greater volume from the same set by using an aerial no more than 60ft. long. Indeed, it is inadvisable to use an aerial exceeding this length, for a long aerial destroys the selectivity of the set and is responsible for station jamming. Those readers employing multi-valve sets who are troubled with jamming should try shortening their aerials before carrying out alterations to the set itself.

The Length of the Aerial.

If you are situated close to a broadcasting station the aerial need be no longer than 25ft., and an outdoor aerial under such circumstances is not necessary. In fact, it is desirable to use an indoor aerial if you are using a three-valve set, or a set employing more valves, close to a broadcasting station. The tendency in wireless design is to get rid of the outdoor aerial altogether. Whilst, however, we are compelled to use them, they should be made as efficient as possible, for too often the set is blamned when a poor aerial or a poor earth is at the root of the trouble. An outdoor aerial should be erected as high as possible, and the earth lead should be as short and direct as possible.

Aerial Types.

The illustrations on these pages show various systems of aerial erection, from which it should be possible to select a system to meet your particular

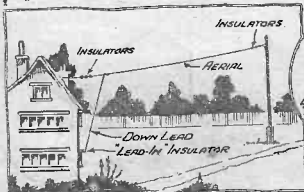

L TYPE AERIAL. KEEP FREE OF TREES. SEE THAT DOWN LEAD IS CLEAR OF GUTTERS, ETC.

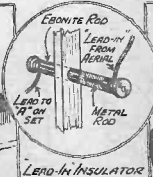

LEAD-IN INSULATOR

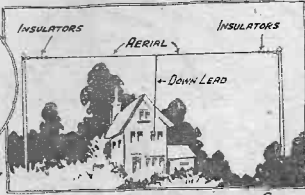

T TYPE AERIAL. DOWN LEAD TAKEN FROM CENTRE OF AERIAL WIRE, CLEAR OF ROOF, TO LEAD-IN.

PRACTICAL AERIALS

A POOR AERIAL is the CAUSE

DON'T ALWAYS

By F.

requirements. The most common forms of outdoor aerials are the "L" type and the "T" type. For maximum volume these aerials should be erected in a direct line with the nearest broadcasting station, if that is the main station one desires to listen in to. If you are using a twin wire aerial it is important to ensure that each wire is of the same length, otherwise sharp tuning will be out of the question.

The "T" aerial will receive stations at about equal volume in both directions, that is to say, if the aerial is running from east to west the reception from an eastern station will be equal to that from a western station, providing that the stations are of equal distance from the receiving station. Cage aerials are not advised, as they are of use only for transmission purposes, since they have a very high self-capacity.

Wire for Aerials and Earths.

Stranded 7/22 insulated copper wire is best for both aerial and lead-in. It is not generally known that high-frequency currents travel on the surface of the wires, therefore, the more wires we include in the aerial, within reason, the greater will be the surface on which these currents can travel and the lower will be the resistance to their passage. The earth should be for preference short as possible and of the high-tension cable used for the sparking-plugs of motor-cars. More current, of course, flows in the earth portion of the aerial system, hence need for using a heavier gauge of wire.

Useful Hints.

The lead-in should be kept as far as possible from earthed objects. The aerial itself should be situated at right-angles to any adjacent telephone wires or overheadway cables. If the aerial is fixed parallel to the wall it will be screened and reception will be difficult and



BIRDCAGE

HAND

Each of
MODERN
 25 Test
 Toyman
 Model
 25 Sim
 Handy
 The H
 Simple
 Publish
 911, 50c

IAL ERECTION!

MANY WIRELESS TROUBLES

BLAME THE SET! set will suffer from considerable interference.

GAMM

A vertical aerial, that is to say, one suspended from the top of the pole, is extremely efficient, although it is often not possible to erect a mast of the desired height. It is not necessary to-day to use multiple wire aeriels. It is important to note that local authorities object to the erection of an aerial passing over a street or other highway. The electric bell system may be used as an aerial if a variable condenser is connected between it and the set.

The Earth Connection.

As already stated, the earth lead should be as short as possible. A main water-pipe makes the best earth, but if it is not convenient to make such a connection an earthing tube driven into the soil may be used. It is important with this sort of earth to keep the soil around the earthing tube moist. With our damp climate nature frequently attends to this for you! The connection to the earth tube frequently corrodes and needs periodic attention.

Another form of earth consists of soldering the earth-wire connection to a sheet of zinc or an old galvanised-iron bath and burying it at least three feet

beneath the surface. We do not recommend a gas pipe for an earth, for in the event of it being struck by lightning the gas pipe will be fractured, with possible risk of fire.

Provision should be made for protecting the set from lightning. An aerial and earthing switch may be purchased quite cheaply. If such is not fitted, the aerial and earth terminals should be disconnected from the set, and the two ends twisted together.

Separating the Stations.

There still seems to be a number of readers who are having trouble in separating the twin transmissions from Brookmans Park, and who are not very keen on rebuilding

their sets or buying extra apparatus to convert the set into a more modern design. It is not a very difficult job, however, to make quite a marked improvement for the outlay of only a few coppers and about half an hour's work. We are assuming, of course, that your set consists of the old-fashioned two-coil holder type of set, with one of the coils used for reaction; or a single coil wound on a cylinder of cardboard used with either a crystal set or a very simple valve set. The improvement will consist in adding what is known as an "aperiodic" aerial coil.

This is actually a small coil, one end of which is connected to the aerial, the other end being earthed. This is placed near the secondary coil (which is the coil that is tuned by the tuning condenser), and the signals in this way are induced into the coil instead of being conducted into it. Here is the way to make the coil. Obtain a quantity of No. 26 D.C.C. wire. About 2oz. will be enough. This must then be wound in a bank of the same diameter as the coil to which it is eventually to be coupled. The simplest way to do this is to wind it round a bottle or some similar object and then slip it off afterwards. Wind on a total of thirty turns, making tapping loops at the fifth, tenth, fifteenth, twentieth, and twenty-fifth turns. Now tie this finished bank on to the present coil, and connect one end of it permanently to the earth connection. From the aerial terminal a short length of flex should be connected, and this must be joined to one of the tapping loops, the particular one to use depending on the degree of selectivity required.

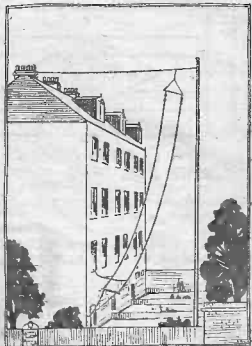

AERIAL FOR USE IN RESTRICTED AREA.

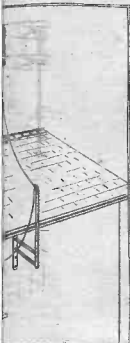

TYPE AERIAL.

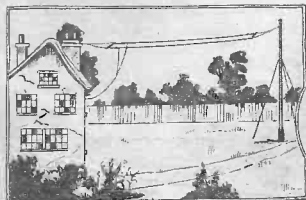

TWIN "L" TYPE AERIAL WITH WOODEN SPREADERS.

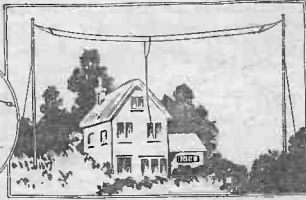
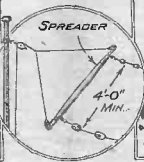

TWIN "T" TYPE AERIAL.

BOOKS FOR

IN 1/- EACH
post 1/2

100 pages and
10 illustrations.

PROPLANES
AND AIRSHIPS
Workable Circuits
for Amateurs
Building Models
of Engines Within
Woodworker
Electrical Apparatus

George Newton, Ltd.,
100, St. Martin's Lane, W.C.2

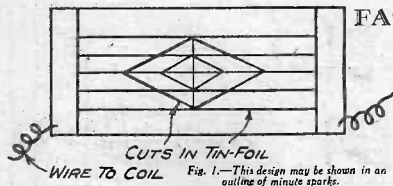

THE experiments which may be performed with an induction coil may be divided into two kinds—firstly those which depend directly on the charge from the coil, and secondly those requiring other pieces of apparatus as well as the coil.

A word of warning on taking shocks from a spark coil will not be out of place here. It is unsafe to take a shock from any spark coil, but if it is desired to use one for this purpose let a large number of people join hands.

Join two wires to the terminals of the coil and put them on a glass plate beyond sparking distance. Start the coil and breathe on the plate. A spark will immediately pass and with careful adjustment a spark twice the ordinary length may be obtained. A similar result may be obtained by warming the gap with a flame. A spark will jump through the flame and cease when it is removed.

Arrange two wires as before and sprinkle very fine iron filings between them. Thousands of minute sparks will be observed when the coil is started. The same effect is apparent when ordinary pencil lead is used. A similar effect may be obtained by pasting a sheet of tinfoil on to a plate of glass and allowing to dry. Cut a design in the foil with a sharp penknife and connect the plate up to the coil. The design will show outlined by a series of minute sparks (Fig. 1).

Igniting Gunpowder and Petrol.

Gunpowder and petrol may be ignited by the secondary discharge from a spark coil. Soak a small piece of paper in benzine and place it in the spark gap when the latter is about $\frac{1}{2}$ in. Start the coil and the paper will immediately ignite. Gunpowder may be ignited by making a small holder as follows. Obtain a piece of hard wood about 2 in. by 2 in. by $\frac{1}{2}$ in. and drill a half-inch hole for a depth of $\frac{1}{2}$ in. in its centre. Drive two 2 in. nails in from opposite sides so that their points are about $\frac{1}{2}$ in. apart in the centre of the hole. Connect the nails to the secondary terminals of the coil and fill the hole with gunpowder. Keeping the hands and face well clear of the gunpowder, start the coil. One cannot be too careful when igniting gunpowder, so have the explosive mixture at least a yard from the coil and switch (Fig. 2).

The most beautiful experiments may be performed by using a vacuum and Geissler tubes. These tubes may

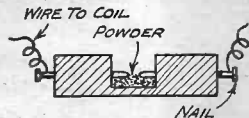

Fig. 2.—Igniting gunpowder by means of a spark.

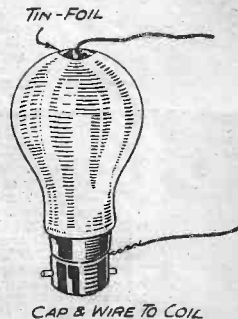

Fig. 3.—This lamp will emit a bluish light when the coil is started.

FASCINATING EXPERIMENTS WITH SPARK COILS

By H. F. Atkinson

be bought in a variety of shapes and sizes, and are quite cheap. The tubes are connected in series with the secondary terminals of the coil and should not be run for too long at a time, because the electrodes will fuse and drop off.

A similar experiment may be performed by using a vacuum electric light bulb. Glue a small piece of tin-foil to the end of the bulb and to it solder a length of wire. Connect the cap of the bulb and the wire to the coil. The lamp will emit a weird bluish light when the coil is started (Fig. 3).

The number of vacuum tubes is almost too great to describe, but a few of them are illustrated here.

Bird and Flower Tubes.

These are of different types, but they all contain either a bird or bunch of flowers, which glow in natural colours when the tube is connected to a coil. Besides being amusing, these tubes are very instructive, and illustrate the properties of the Cathode ray. In the Maltese Cross tube a cross is mounted so that when the tube is worked a definite shadow is produced on one wall of the tube. The cross is hinged so that it may rest in either a vertical or horizontal position. When the coil has been running for a few minutes the cross is made to fall into the horizontal position. The shadow is still seen on the end of the tube (Fig. 4).

X-Rays.

This is one of the most interesting branches of spark coil work. A 4 in. spark coil will be required to produce any reasonable results, although some makers supply tubes to work off 2 in. spark coils. For serious work a 10 in. to 12 in. coil should be used.

An X-ray tube is a glass bulb fitted with electrodes, and containing a very high vacuum. The smaller tubes have two electrodes, the anode and the cathode (Fig. 5).

(Continued on page 528.)

(Continued on page 528.)

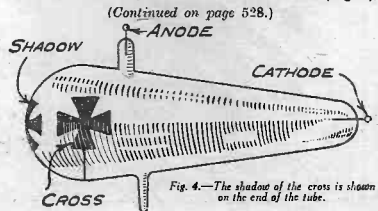

Fig. 4.—The shadow of the cross is shown on the end of the tube.

WE HAVE SEARCHED THE WIDE WORLD

KOLSTER-BRANDS "MASTERPIECE"

We tested dozens of new 2-valve sets. Our experts examined every set that claimed to compete with the K-B "Masterpiece," and not one surpassed the standard set by Kolster-Brands.

The K-B "Masterpiece" is the finest value offered! A revelation in 2-valve radio. Get your K-B quickly and enjoy the pick of the winter programmes . . . free . . . by saving B.D.V. coupons—from to-day.

500 COUPONS...

B.D.V.

CIGARETTES

each Coupon worth **3**
TIMES other coupon values



EVEN LESS COUPONS REQUIRED FROM B.D.V. TOBACCO—EACH TOBACCO COUPON BEING WORTH $1\frac{1}{2}$ CIGARETTE COUPONS.

ISSUED BY THE PROPRIETORS, GODFREY PHILLIPS LTD. ESTABLISHED 1848

SPECIFICATION.

The Kolster-Brands "Masterpiece." The most compact 2-valve set in existence! Over-all dimensions 7 1/2 in. x 7 1/2 in. x 7 1/2 in. Highly sensitive regenerative receiver. Pure-toned loud speaker built into the lid. Polished dark figured mahogany finished case in Bakelite. Complete with two "Fotos" valves and complete instructions.



The writer of this advertisement has himself received 22 stations in London, on the K-B "Masterpiece" set, using only a 15ft. indoor aerial.

NAME.....
ADDRESS.....

GET
THE
GIFT BOOK

To Godfrey
Phillips Ltd. (Dept.
H.), 29, Commercial
Street, London, E.C. 1

Please send me the amazing
B.D.V. Gift Book, in full
colour, with 5 free coupons,
showing 273 treble-value gifts.

G.P.O.

FASCINATING EXPERIMENTS WITH SPARK COILS (continued from page 526).

while those a size larger have an anode, cathode and anti-cathode. The anode and anti-cathode have terminals outside the tube so that they can be joined together at will.

The tubes just described are only used by amateurs; those used in laboratories are enormous pieces of apparatus fitted with water-cooled anti-cathodes, softening devices for increasing or decreasing the vacuum.

X-rays themselves are invisible, but when a tube is working a queer greenish light is visible. X-rays cause phosphorescence in barium platino-cyanide, and this property is made use of in the screen.

Connect the tube to a good coil and arrange it so that the X-rays are projected horizontally.

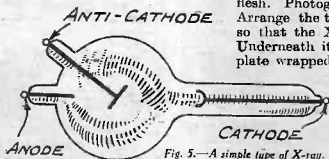

Fig. 5.—A simple type of X-ray.

Hold the hand close to the glass and place the screen near to the hand. A shadow of the hand is immediately seen on the screen, the bones being darker than the flesh. Photographs may be taken as follows. Arrange the tube about 4in. above the bench so that the X-rays are projected downwards. Underneath it place an ordinary photographic plate wrapped in black paper, place the hand on the plate and start the tube.

The time of exposure will vary, depending on the size of the tube and coil, but for a 2in. coil about fifteen minutes will be necessary. It is essential to keep the hand perfectly still during this or else the outline of the bones will be blurred. Other objects which make very interesting photographs are the bones of the foot, a frog, mouse or bird, a nail in a piece of wood and keys in a purse.

PUTTING MUSIC IN A GROOVE

(Continued from page 503, February 13th issue.)

AFTER the electroplating process described last week, back goes the "mother" into the plating vat, to have nickel grown on to her. And this nickel forms the final "stamper" shell. After being separated from the silver and backed by a heavy metal plate it is ready to make or break records. The face is, of course, negative, for the final discs must be positive to match the original wax. Any number of stampers can be made and fitted up in the presses ready for action.

1,111 Records Produced in Ten Hours.

Once this stage of the proceedings has been reached, a gramophone record can be turned out in about a minute. In fact, a presser, out to break the record for making records, once succeeded in producing 1,111 in ten hours.

The disc itself actually starts life as powder in sacks. It is composed largely of resin and gums. This powder is ground, mixed, cooked, ground again, and generally knocked about by half a dozen machines before it finally arrives on a conveyer belt at the presses in the form of neat square pieces of material looking rather like an attempt at black pastry making. If the record is to be of the ordinary type, this composition will be the only material used in its manufacture. But when a special scratch-proof surface is provided, a second conveyer belt feeds to the presses brown paper discs that have been shelled and sprinkled with a powder containing mica and graphite.

In front of the presser is a heavy metal box in whose base is fitted one of the stamper discs. If double-sided records are being made, the lid holds another stamper disc. A metal peg projects from the centre of the base, and on to this peg he puts first a label, face downwards, next a paper disc, also face downwards. After that comes a lump of the black "dough," followed by another paper disc and label—face upwards this time.

How the Records are Produced.

Directly the box is closed it is automatically drawn inside the press and subjected to a pressure of sixty tons. Steam is circulated round a jacket inside the box, so that both the core and surface disc for the record are thoroughly softened and a true impression is obtained. After a few seconds, cold water takes the place of the steam, and the composition hardens. The press then obligingly ejects the box, whose lid flies open to reveal a gramophone record.

The stampers may be good for anything up to 25,000 records. On the other hand, they may develop defects after turning out only 500. It all depends on the recording. So every twentieth record made is taken off to the testing-rooms for examination. The remainder are sent to the finishing-rooms, where they are pounced upon by girls who clean the edges, polish the surfaces, check the numbers, inspect the discs for faults, and then pop them into envelopes. And they do it all so quickly that without a slow-motion camera the only thing you can see is a blur and an occasional addition to the "duds" pile.

What happens to the duds? A good many of them are spirited away by the girls who do the testing. Each has her own compartment, rather smaller than a telephone-box, where she sits all day with telephones glued to her ears, or her head half inside a gramophone horn. A constant stream of records will pass through her hands, and her machine will never be silent for more than a few seconds.

Mind you, most of these duds are perfectly good records to the untrained eye and ear. Perhaps there is a tiny scratch somewhere on the surface—nothing that would affect the playing. Or the label may be a little faded or creased. For anything like that they will be sent back to the mills to be broken up by the huge pounding machines, and later returned to the presses again as mere "centre ore."

IMPORTANT NOTICE! All correspondence intended for the Editor or Advertisement Manager MUST be addressed to "Hobbies," Messrs. Geo. Newnes, Ltd., 8-11, Southampton St., Strand, W.C.2

REALISTIC TOY LOCOMOTIVES AND HOW TO MAKE THEM—4 ——— By E. W. Twining

THE cast frames will be clamped together just as the plate frames were, back to back, marked off and drilled for screws and axles, making the driving axle holes $\frac{1}{16}$ in. diameter and those for the coupled axles $\frac{1}{8}$ in. The screw holes will be countersunk on the outside as before.

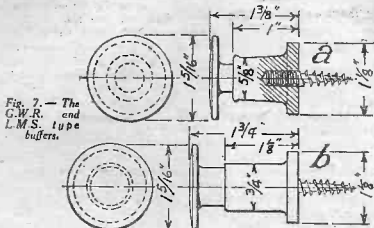

Fig. 7.—The G.W.R. and L.M.S. type buffers.

When driving the wheels on to the cranked axle care must be taken not to bend the axle, and the best way to avoid doing this is either to place a bar, which will pass freely between the crank webs, across the vice jaws and let this bar take the shock of the hammer blows, or to wedge a block of steel between the webs and then let the opposite end of the axle take the shocks, but the former is much the safer way, because one cannot be sure that by the other method the wedge block is not itself straining the axle and so tending to bend it out of truth. Since there are no detachable axle boxes the frames will again have to be slipped over the journals before the wheels are driven on.

The Connecting-Rod.

This is shown in detail in the drawing, Fig. 6, and will require very little done to it by way of fitting; merely filing with half-round files where the two ends fit on the main crank and the hand-lever at big and little ends respectively. They are retained in place

by split pins passing through holes drilled in the forks. When the engine is finally erected the forks are to be placed downwards.

The hand-lever also will only need a little filing up on the bearing pins where they fit into holes drilled in the lugs on the back ends of the frames and around the pin where the little end of the connecting rod fits. Should the cross-bar at the top of the lever be somewhat rough, that, too, can be smoothed down a little so as to make it more comfortable to hold when driving.

So far we have been dealing with the parts for simple and propelled models which will be applicable to both the Great Western and the L.M.S. engines, of which views were given in the first article (Figs. 1 and 2); but a point has now been reached where I have to refer to the two types separately, but I think it will be best to continue with metal work for both engines before I go on to the woodwork. The remainder of the metal parts will be the buffers, chimney, dome, and safety valves in the case of the L.M.S. engine, and buffers, chimney, and safety valve casing for the G.W.R. model.

The buffers are shown in detail in both engines in Fig. 7, a being one of the pair for the Great Western and b for the L.M.S. These are castings either in malleable iron or aluminium. They are made solid, of course, it being quite unnecessary that they should be fitted with springs.

As they will be attached to wooden buffer-beams, the best and easiest way to fix them will be to saw off the heads of wood screws and cut a metal thread on the smooth shank of the screw. Drill and tap the buffer socket and insert the screws all as shown in the drawing.



Fig. 6.—Details of the connecting-rod.

It will not be necessary to do any turning. If the screw shanks are held in the chuck of the lathe the buffer heads can be finished by filing with a sufficient degree of accuracy. They should be polished with emery cloth when all roughness of the casting has been removed, then laid aside to await the buffer beams.

(To be continued.)

LOUD-SPEAKER HORNS (continued from page 523.)

For those of our readers who are by now sufficiently interested in the exponential horn, and would like to carry out some experiments, we will give some hints on construction. In the first place, for simplicity of construction, we would point out that there is no audible difference, on an ordinary home receiver, between a horn of round or square section. The latter is certainly very much easier to construct. Any wood may be used, and this should, theoretically, be thick to avoid resonance. (Do not employ metal because of resonance troubles.) However, ply-wood $\frac{1}{4}$ in. thick may be used, and if resonance is noticed, putty lumped on at different spots

will damp out the resonance, or at least, make it low enough to be unobjectionable. The horn may be curved and bent back upon itself to avoid cumbersome, but—and this is important—avoid angular bends. Endeavour, if possible, to get nice steady curves of the swan-neck type to avoid "echoes." Joints should be well screwed and glued, any unavoidable gaps being filled with putty. Several different types of speaker horn are illustrated.

Speaker units for use with this type of horn should, naturally, be capable of themselves reproducing all frequencies equally, and for this reason balanced armature or moving-coil units should be used.

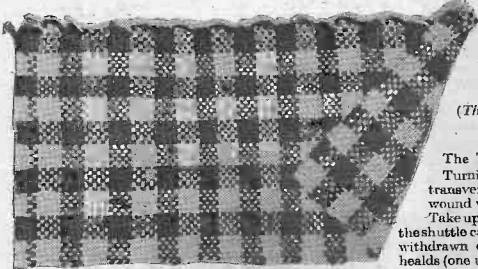

A specimen of the cloth woven on the hand loom.

BRIEF instructions for weaving plain cloth were given in the article describing the construction of the Hobbies Loom, but cloth having check and stripe patterns can also be woven on this loom.

To produce this kind of cloth, first obtain four two-penny cards of darning wool, two black and two white. Of course, you can choose other colours if you prefer, say, brown and white, or light and dark brown.

Setting the Warp Threads.

Set the first six warp threads as described in the previous article by temporarily fixing the warp beam about a yard from the loom (or farther if a longer length of cloth is required). Then thread a length of about 2yds. of the white wool into a darning needle, knot one end of the wool and stitch it through the tape on the cloth beam; thread a single strand of the wool through the reed, then through the first eye of the front head, after which pass the needle through the tape of the warp beam. This makes the first warp thread. With the wool still in the needle lead it back through the first eye of the back head, then through the reed, in the opening next to the first thread (i.e., leave one wire between the threads) and secure the end to the tape of the cloth beam, taking care that the tension is as near as practicable equal in both threads. This makes the second warp thread. Thread the needle again and repeat the above sequence of operation, of course using the next eye in each head, and the proper openings in the reed, thus completing four warps. Fix two more white warps, making six altogether, then change the white wool for the black and set up six black threads. Continue setting six white and six black, alternately, until the width of the loom is filled. Take care to keep the tension as even as possible, otherwise the warps may break later on; also keep the threads as nearly parallel as you can.

Now take up the warp beam and by turning it in the hand, wind all the warps on to it in such a direction that they run off the top side of the beam towards the loom, and fix the beam into its bearings. Do not let the side-threads spread outwards on the beam while winding them up or they will be too slack when wound; guide them in towards the middle slightly as you turn the beam. Fit one or more rubber bands round the beam and catch the other end of the bands on the hook provided on the base, to give the required tension. This should be carefully adjusted by choosing suitable rubber bands, for if the tension is not sufficient the warps are likely to cling together so preventing the formation of a clear "shed" to pass the shuttle through; but, on the other hand, if the tension is too great, some of the warps may break, causing considerable trouble to the amateur weaver.

WEAVING WITH THE "HOBBIES" HAND LOOM

(The construction of the loom was described in "Hobbies" Nos. 1894 and 1895.)

The Transverse Threads.

Turning our attention now to the "weft" or transverse threads, two shuttles are required, one wound with black wool and the other with white.

Take up a position at the front end of the loom so that the shuttle can be entered into the shed with one hand and withdrawn conveniently with the other. Move the heads (one up and one down) by means of the operating lever and see if a good clear shed is formed by the warp threads; if the warps show a tendency to cling to one another owing to projecting fibres of wool catching the neighbouring warp, move the reed to and fro once or twice. This will probably effect an improvement, but if the shed is still not well defined, add more tension by altering the rubber bands.

Moving the Shuttles.

Now, with the reed pushed back to its limit, take one of the shuttles, say the white one, and after unwinding a few turns of wool, pass the shuttle through the shed from right to left, say, then pull the reed towards you so as to push the weft right up into the angle of the shed. Next, return the reed to its backward position and change the position of the heads. If necessary, move the reed to and fro to clear the shed, then pass the shuttle back again from left to right, but do not pull the weft tightly. Pull the reed forward to drive the weft home, and while the reed is still in its forward position, draw the weft through until it folds neatly over the extreme warp thread. If you do not do this, the selvedge (i.e., the edge of the cloth) will probably be uneven and untidy. After a little practice you will find that you can carry out the whole procedure quite quickly.

After weaving six white threads, leave the shuttle laying on the base and wave six threads of black, and continue changing shuttles after every six threads. There is no need to cut off the threads when changing shuttles.

After you have woven an inch or two of cloth you will find the shed getting too small to allow the shuttle to pass freely. When this occurs wind the newly-made cloth on to its beam by turning the beam towards you, of course lifting the flat spring on the left while you do so, afterwards making sure that the spring catches one of the pins again before you let go of the cloth beam.

Producing New Designs.

The amateur weaver has plenty of scope for the exercise of his ingenuity in producing other patterns. For instance, with the warp set as above, and one shuttle only in use, a cloth with longitudinal stripes would result. Transverse stripes can be obtained by using two shuttles, with warps all of one colour. Smaller or larger checks and stripes are, of course, made by changing the colour of the threads (either warp or weft, as the case may be) more or less often than every six.

It is not possible to obtain herringbone or twill patterns on a loom with two head frames and the provision of three or more would complicate the model considerably.

If desired, other material than wool may be woven into cloth, say silk or cotton.

TYPE "B"

37 Permanent Engravings
Name does not rotate.
Head cannot come off.
Terminal cannot twist loose.
Fully insulated.
Soldering unnecessary.
Price 6d. each

THE
PERFECT
TERMINAL

BELLING-LEE
FOR EVERY RADIO CONNECTION

idea of Belling & Lee, Ltd., Queensway, Plumstead, Kent, Eng.

Write for
complete
price
list.

THE TURK PACKET FREE.

All applicants for my new approval sheets sending 1d. postage will receive 19 TURKISH stamps free. (Pictorial, War, Jubilee, surcharged, etc., usually sold at 1s. 3d. Additional free set to customers giving collectors' addresses.

H. WATKINS
(Dept. H.2), 60, Leicester Road, East Finchley, N.2.

SALE and EXCHANGE

Advertisements are accepted for this column at the rate of 1d. per word, per line. Address communications to the "Hobbies" Magazine, 2, Southampton Street, Strand, London, W.C.2.

CINEMA TOGRAPH FILMS, Machines, Accessories.—Lists Free. Sample Films, 1s.—Filmrics, 57, Lancaster Road, Leytonstone.

PATENTING INVENTIONS.—Handbook free.—King's Patent Agency, Ltd., 4, Waterloo Chambers, E.C.4.

CONJURING CATALOGUE FREE.—Vandy Pastimes, Hastings.

GRAMOPHONE SALE.—Tectors, Tonarins, Soundboxes, Horns, Amplifiers, Gramophones and Cabinets at gift prices. Catalogue free.—H. Burt, 185, High Street, Deptford, S.E.8.

SLOAN-DUPLOY SHORTHAND. the rapidly-spreading high-speed system, saves a year's study. Read booklet of wonderful records and obtain free lesson.—Sloan-Display Society, Dept. S, Ramsgate.

TROUSER PRESS FITTINGS. 2 1/2 x 1 1/2, 2/0, Stretch, 1/3; 2 1/2 x 1 1/2, 3/8, Stretch, 1/3. Tie Press Fittings, 1/- set; 12 sets 7/6.—British Co., 1, Waterloo Road, E.C.1.

CINEMA TOGRAPH FILMS, CHEAP.—Lists.—"Movies," 109, Kenil, Tooting.

ART—MAKE MONEY If you sketch or write showcards, in own time! Write for free booklet.—Art Studios, 12, 13, Henrietta Street, Strand, W.C.2.

WANTED 600 B.D.Y. Coupons, exchange bicycle, P.M.O. or reasonable cash price per 100.—McIvor, West Street, Drogheda, Ireland.

1 HORSEPOWER Petrolmotor, Castings, 9/9 a set. Interacting catalogue. 3/1.—Butlers, Wade Street, Litchfield, Derby.

ARCHAIC APPRENTICES.—250 vacancies are now available for boys of good education (between 15 and 17 years of age on August 1st, 1932), for training as skilled craftsmen. Good training, pay and prospects. Examination at local centres. Full particulars from Royal Air Force (Aircraft Apprentices) Dept. H.O.) Gwydyr House, Whitehall, London, S.W.1.

STAMPS.

100 DIFFERENT STAMPS FREE. Request Approvals.—Clarke, 4, Morland Road, Old Trafford, Manchester.

120 DIFFERENT STAMPS from duplicates. 30 lots only, 1/3 each. No approvals.—Husley, High Street, Astwood Bank, Warrackshire.

SUBSCRIPTION RATES.

"Hobbies" will be forwarded by post to any reader at the following prepaid rates: Twelve months, 13/-; Six months, 6/-; Three months, 2/2.
Registered at the G.P.O. for transmission by Canadian Magazine Post.

IT'S
PURE
VEGETABLE
GLUE!

THE
GLUE
THAT
GRIPS!

STE-FIX



ODOURLESS—COLOURLESS

For joinery, fretwork, leather, paper, cloth, photo frames, model making, repairing pottery, glassware, toys, and for all purposes where a very powerful adhesive is required.

In tubes, 2d., 6d. and 9d.

Made by the Proprietors of

Stephens' Inks

57, ALDERSGATE STREET,
LONDON, E.C.1.

ALL MECHANICS WILL HAVE

FLUXITE

IT SIMPLIFIES all SOLDERING

IF YOU HAVE A HOBBY

see that
FLUXITE and SOLDER are always by you—in the house, garage, workshop—anywhere, where simple, speedy soldering is needed. They cost so little, but will make scores of everyday articles last years longer! For Pots, Pans, Silver and Brassware; RADIO; odd jobs in the garage—here's always something useful for Fluxite and Solder to do.
OF ALL HOBBIES DEPOSITS and Ironmongers, Fluxite in tins, 8d., 1/4 and 2/6.

NEW "JUNIOR" SIZE 4d. per tin.

FLUXITE SOLDERING SET

Simple to use and lasts for years in constant use. Contains special "small-space" soldering iron with non-heating metal handle; pocket blow-lamp, Fluxite, Solder, etc. AND FULL INSTRUCTIONS. COMPLETE, 7/6, or LAMP only, 2/6

ANOTHER USE FOR FLUXITE
Hardening Tools and Case
Hardening. Aid for Lead
on improved method.

FLUXITE, LTD.

(Dept. H),

ROTHESMITH

S.E.16.

MAKE YOUR
HOBBY
A
PROFITABLE
ONE!



MAKING MODEL ENGINE PARTS FROM SHEET METAL

(continued from February 13th, page 502)

A SMALL rectangular piece of sheet brass can be soldered on to each side of the "big end," and a small brass washer or disc should be soldered on each side of the forked end of the rod, as indicated in the drawings. Drill the holes through

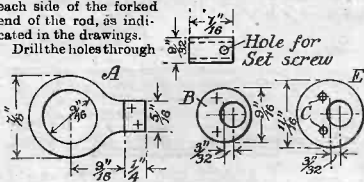

Fig. 8.—Component parts of a built-up eccentric.

for the crank pin and crosshead, and then remove all superfluous solder and finish off as previously mentioned. The crosshead E had better be turned up from a short piece of iron or brass rod, and a hole drilled right through for the piston-rod. Another hole at right angles to this one must be drilled and tapped out to receive a set-screw for clamping the crosshead firmly to the piston-rod. The forked end of the rod can be sprung into position on to the trunnion pins of the crosshead.

For making the piston-rod guide, F, Fig. 5, two pieces of sheet brass can be used, shaped as shown and soldered together, after drilling holes for the fixing screws and piston-rod.

Bearing Blocks.

Simple bearing blocks can be made from two pieces of brass or gunmetal, as depicted in Fig. 6. The top part forming the bearing can be cut out of brass strip $\frac{1}{16}$ in. to $\frac{1}{8}$ in. thick, according to the size of bearing required, and a hole drilled through to suit the shaft. The base piece should be about half the thickness of the top part, and the two holes should be drilled clearing size for the fixing screws. Square up the edges of the two pieces with a fine-cut file, and



Fig. 5.—Piston-rod guide.

then "tin" the centre part of the base piece on one side and also the bottom edge of the top part of the bearing. Now clamp the two parts together by means of a screw clamp, as shown in Fig. 7, and hold in a Bunsen flame to run the solder, so sweating the parts together. When cool, finish with a file and emery stick to remove the discoloration and superfluous solder.

Eccentric and Rod.

A strong and efficient eccentric, strap and rod can be made from strip brass and a short piece of tubing. Two views of the finished eccentric and rod are given in Fig. 9, the dimensions being right for an eccentric having a throw of $\frac{3}{32}$ in.

First of all take a piece of flat sheet brass of a suitable size and mark out on it the shape of the strap piece A with the aid of a pair of compasses. Drill the central hole, and if possible reamer it to size. If a reamer is not available, carefully file the edge of the hole to the scribed line with a fine-

cut half-round file. Roughly cut out the strap to the outer line with a cold chisel and finish with a file, and after filing the rebate in the projecting piece, drill the two rivet holes $\frac{1}{16}$ in. diameter.

A brass disc will now be required, which must be a good fit in the hole in the strap, and on this disc mark the centre and also the centre of the hole to take the piece of tube. It will be noticed that the distance between the two centres corresponds to the throw of the eccentric as indicated at B. The disc should be slightly thicker than the strap. Two discs E will also be required for forming the flanges which keep the strap in position. These discs need only be about half the thickness of the centre disc B, and about $\frac{1}{16}$ in. larger in diameter. Mark the positions of the two centres on one disc and clamp them together for drilling the hole through for the piece of tubing, and also mark the centres of the two holes C on one disc.

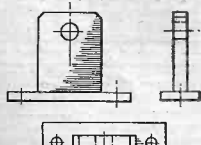

Fig. 6.—The bearing block.

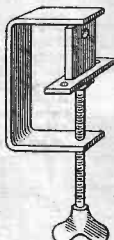

Fig. 7.—Methods of holding the parts together while soldering.

After assembling the parts, slip the tube in position and adjust the outer discs till they are concentric with the strap, and then solder the tube to each outer disc, leaving one end of the tube projecting on one side to take the set-screw D as depicted. Two $\frac{1}{16}$ in. holes can now be drilled right through the discs to take copper wire rivets for clamping the parts forming the eccentric sheave firmly together. Instead of rivets, countersunk-headed screws may be used, which would enable the discs to be more easily taken apart for the purpose of replacing a worn strap.

For the rod, a strip of brass about the same thickness as the strap can be used. This can be filed to a taper, as shown, and the narrow end drilled and rounded. File a rebate at the other end of the rod to fit the projecting end of the strap, and lightly solder in position and drill the rivet holes through. After riveting all superfluous solder and smooth over the joint with a file.

Although by no means exhausting the possibilities of built-up model engine parts, the foregoing examples give a good idea of what can be accomplished in this direction without the use of castings.

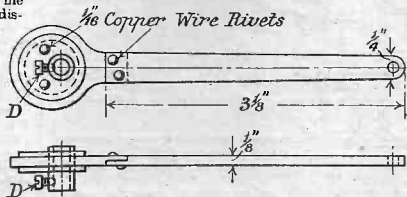

Fig. 9.—Side elevation and plan of the finished eccentric, strap and rod.

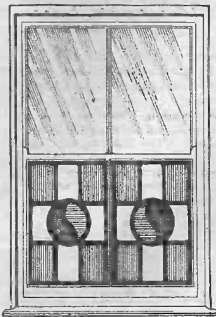

Fig. 1.—Decorating a large window.

the rich, glowing colours of the beautiful stained-glass windows in many of our churches and public buildings, and probably not a few have a wish for representing them in a simpler way and adopting them as a means of introducing colour into the home.

Real stained glass work is a specialised business, necessitating the use of chemically treated glass to get the colours, and the cutting of it to the various shapes, and the framing in with strips of lead. All this means special tools and appliances, to say nothing of the time lost and wastage of material due to experimenting.

Imitation Leading and Glass.

An excellent representation of stained glass may be made by using thin plywood to take the place of the lead and coloured papers in place of the tinted glass. The uses to which the idea may be put are varied, and they may include the upper portions of folding screens, the ordinary fireplace screen, and, chief among them, as a screen for the lower portions of bathroom or kitchen windows. Other suggestions may occur to our readers for the further use of the idea, and in this respect it might be added that it can be adapted to almost any circular, elliptical or irregular shaped space. The one thing to bear in mind, however, is that before commencing on a job like this, a perfectly accurate outline of the space to be filled must be obtained, so that the wood may fit properly when cut.

Two Methods of Treatment.



Fig. 3.—Coloured paper on plywood, with the second piece ready to go in place.

The two sketches (Figs. 1 and 2) show how the lower portions of a four-light and a two-light window may be very effectively decorated. First of all take accurate measurements of the space occupied by the glass, between the moulding of the frame immediately abutting on the glass. Set these measurements out on to a piece of plywood. If the size be greater than 15in. by 12in., $\frac{3}{4}$ in. plywood should be used, but if below this size, wood $\frac{1}{2}$ in. thick will be suitable. Another point should be early decided upon,

MAKING IMITATION STAINED GLASS

Use imitation stained glass for your fan-light or bathroom window. All you need is some thin plywood, coloured paper, a fretsaw and glue. This article shows how easily it is done.

and that is whether the worker is going to get out his design in pencil direct upon the wood, or whether he desires to put it upon paper in the usual way and then to stick this to the wood.

A simple outline like Fig. 1 might well be drawn direct upon the wood, whereas the more intricate design of the ship shown in Fig. 2 would be better plotted out on white paper, and then stuck down. The ingenious fretworker can adapt almost any of his designs to suit the space which he wishes to fill. Fretwork patterns having animals or birds are most appropriate and look charming when picked out in various colours.

Suitable Patterns.

We have chosen a few suitable simple patterns from the catalogue, and if he should have difficulty in setting out any particular piece, by sending the size of his panel and any other particulars that would assist, Hobbies will send a tracing from which he may get his full-size patterns. A stamped and addressed envelope should be enclosed with the request and particulars. The under-mentioned patterns appear in Hobbies' 1932 catalogue, Nos. 1607, 1664, 1678, 1586, 1647, 1610.

Plywood of good quality should be used, and that sold by Hobbies at 3d. per foot for $\frac{1}{2}$ in. thick stuff, and 4d. per foot for $\frac{3}{4}$ in. thick, is strongly recommended. Fortunately, for work such as that in hand, should a bad knot be encountered it would be quite possible to avoid it in the designing of the pattern so that it is cut away in the waste wood. The outer margin or frame all round the design should be about $\frac{1}{2}$ in. to $\frac{3}{4}$ in. wide, the other "ties" constituting the design itself are $\frac{1}{2}$ in. wide for a small panel and correspondingly wider for a larger panel. This width of "ties" again would be influenced by the type of pattern.

Cutting the Shapes.

Having decided upon the type of pattern to be used, and completed it upon the board, the next thing to do will be to nail another board of the same thickness to the back of it, so that two distinct fretted panels remain after the usual cutting out with the fretsaw has been completed. Each panel will now be somewhat flimsy to handle, but as the subsequent work is done while they are lying upon the table, little fear of breakage need be anticipated. Strength is regained when the panels are

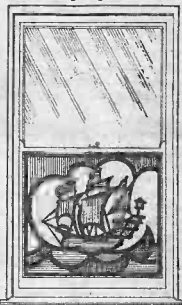

Fig. 2.—Suggested design for a smaller window.

ultimately glued together and the paper filling the open spaces added. One side of each panel must now be coated with stain or ebonizing solution and the edges of the openings also treated. Bottles of stain and ebonizing solution may be purchased from Hobbies, the stain at 8d. per bottle and the ebonizing solution at 1s. per bottle. Allow the work to dry before commencing to stick on the coloured paper.

The Colour Effect.

Choosing and cutting the paper is a simple matter. Bright colours should be adopted, such as greens, blues, vermilion, yellow etc., and some little care should be given to the choosing of appropriate colours for certain openings. The sea, for instance, in Fig. 2, should be in two shades of blue or green, while the lantern at the stern of the ship and the flags should have a touch of vermilion to add brilliancy.

The Paper Shapes.

Fig. 3 shows how the paper is gummed to one panel of wood, with the second panel ready to glue on. In preparing the paper, lay a sheet of the particular tint required under the panel and then lightly pencil round the opening. Now remove the paper and cut round this shape, allowing a margin of about $\frac{1}{16}$ in. extra all round

Suitable thin plywood for this class of work is supplied quite cheaply in panels by Hobbies Ltd. Full particulars of price are obtainable on application.

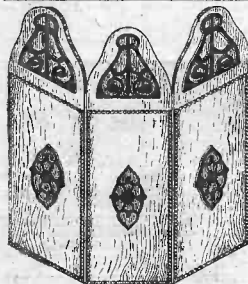

them to offices. They will, however, particularly appeal to the private house-owner who objects to the telephone instrument being an unsightly object on some side table or shelf. Make one of these up as a sample, and you will find that they have a ready sale at a price which leaves an excellent profit for the making. Cut out in fretwood with the fretsaw, and nicely finished off, stained and polished, they are the sort of novelty that always appeals.

Made with the Fretsaw.

There is a steady demand for a neatly-made telephone screen and the one illustrated is just the thing for any fellow to attempt with the aid of a fretsaw and a supply of glue. The construction is so simple that any beginner has an equal chance with the advanced worker, and this is made possible by the use of special ornamental frets already cut and supplied by Hobbies, Ltd., which form the decoration of the screen folds.

for fixing to the wood. If the wood "ties" are narrow, the two shades of paper may lap one upon the other and so get a firm hold.

Do not choose crepe paper or paper that is rippled; this will not straighten out nicely. Should the paper chosen be sufficiently firm to allow, a little water is smeared over it before gumming down, so that in the drying a tightly stretched surface results. The gum, too, should be applied to the wood and the paper, then laid on and smoothed out with a dry duster or rag. When all the openings have been filled in with the different coloured paper the second panel of wood may be glued on. Coat each "tie" and the outer border with the glue and then add a few screws to bring the two layers tightly together, care being taken to keep the edges of the panels flush with each other.

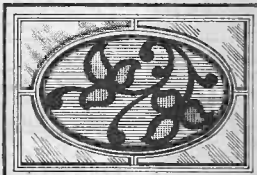

Fig. 4.—How to fill in an elliptical space with the imitation glass.

Fixing the Work.

It only remains now to fix the completed "stained glass" panel in place. A few short brass nails will do this or, if a better job is required, strips of wood about $\frac{1}{8}$ in. square can be nailed to the sides of the window.

The suggestion (Fig. 4) is interesting as it shows the possibilities of filling an elliptical space.

A FOLDING TELEPHONE SCREEN

THOSE friends who have the telephone will be delighted to buy the suitable small screen illustrated herewith, whilst the keen fretworker should also be able to sell

Any popular wood may be used to make the screen and the article looks quite attractive in mahogany. The screen is constructed with three folds, and these are cut in the following manner. First, trim the three pieces of wood to size, 12 in. by 4 in. by $\frac{1}{8}$ in. thick, and mark the end of one piece into $\frac{1}{2}$ in. squares, as shown in Fig. 1. Next, mark off the shape of the end by following the points through the squares, and then cut round with a fretsaw. Having cut the end of one fold, the other two are cut in the same way, the marking being done by using the one just cut as a template.

The Edging.

Now glue strips of $\frac{1}{8}$ in. half round beading round the edges of the folds and a strip across the fold $\frac{1}{2}$ in. up from the bottom edge, as indicated in Fig. 1. Fix an ornamental fret with glue in the centre of the panel formed by the beading on each of the folds, and likewise fix frets on the face of the curved tops, as clearly seen in the finished screen. Each fold is made smooth and then finished off with a coat of stain. Complete the screen by hinging the folds with hinges supplied by Hobbies Ltd.

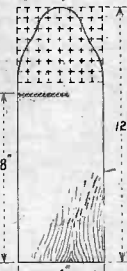

Fig. 1.—One of the folds.

MODEL "NEW IMPERIAL" COMPETITION RESULT.

New Imperial Motor Cycle.—N. R. Kay, The Hollies, High Lane, Stockport, Cheshire.

Hobbies A1 Free Machine.—Ernest R. Duck, 41, Canmore Gardens, London, S.W.16

Two Lion Construction Sets.—G. Morrison, 12, Clifton Rd., Aberdeen; J. Laker, 48, Crossby Rd., Walsley-on-Sea.

Ten Warford Aeroplanes.—G. F. Males, St. Margaret's, 61, Whitefriars Ave., Wexhampton, Middlesex; F. Eufinger, 75, Southfield Rd., Woking; W. A. Stacey, 93, Park St., Castleton, Sunderland; S. I. Broadley, Harefield, Parslo, Sealing, Nr. Faversham, Kent; H. E. Asplen, North Rauceley, Nr. Shefford, Lincolnshire; Charles Groves, Corhampton House, Corhampton, Southampton; Leonard C. Lovelley, 39, Hamstead Way, N.W.11; L. G. Brown, William IV Cottages, Kenwin Rd., Truro, Cornwall; Arthur H. Kirkpatrick, 48, Brecks Rd., Evertton, Liverpool; C. A. Buck, 101, Mayo Rd., Willesden, N.W.10.

Hobbies A2 Boxed Free Work Outfit.—W. J. Hughes, Harelock, 189, Cabra Rd., Dublin.

Two Hercules Engine Construction Sets.—Geo. E. Hicking, 251, Radford Rd., Hylson Green, Nottingham; Andrew Carny, 82, Shakspeare St., C-5051, Manchester.

Hobbies No. 2 Carpenter Set.—W. G. Chovies, 8, Horn St., Winslow, Blechley, Bucks.

Two Clockwork Launches.—W. N. Smith, 65, East Ave., Cowley Rd., Oxford; F. C. Fowler, Mopes Farm, Chalton St., Peter, Bucks.

Hobbies A1 Boxed Free Work Outfit.—H. T. Covill, 36, Lion Grove, Newark, Notts.

Hobbies No. 1 Carpenter's Outfit.—C. D. Davis, The Laurels, Old Farleigh Rd., Sanderson.

An Empire Boxed Free Work Outfit.—F. Zanelli, 90, Sun St., Finsbury Sq., London, E.C.2.

Three Marine Engines on Bases.—Richard B. Halse, 20, Admiral Seymour Rd., Well Hall, Etcham, S.E.2; Dennis S. Drury, 334, Manchester Rd., St. Helier, E. J. G. Dewby, Kenilworth Rd., Fleet, Hants.

Hobbies No. 2 Boxed Free Work Outfit.—William Currey, Skutter-shie, Hutton Rusby, Yorkshires.

Hobbies Ensign Free Work Outfit.—S. Piekard, 10, The Crescent, Hinchbury, Colford, Nr. Bath, Somerset.

Three Hobbies No. 6 Planes.—E. W. Cheadle, Peveril Cottage, Castle Hill, Duffield, Derby; F. W. Turner, 312, Merton Rd., Southfields, S.W.18; H. L. Hanson, Field House, Tynwald Rd., Peel, Isle-of-Man.

Six Hobbies Polishing Outfits.—E. R. Cox, The Rosary, Whitehill, Bordon, Hants; R. Smith, Junr., 120, Canal Crescent, Perth, N.B.; H. J. Clifford, 19, The Cottages, Wilmore, Stratford-on-Avon; Harold Butler, Ravensfield, Nr. Rotherham; Fred Cronk, 3, Glenleigh

Ter, Nettlestead, Maidstone; S. T. Kirkby, 2, Mill St., Whitechurch, Shropshire.

Twenty Hobbies H2 Free Work Outfits.—C. A. Hawley, Walgreen, Trysall Rd., Merry Hill, Wolverhampton; A. E. Hevis, 519, Highgate Rd., Old Basford, Nottingham; L. N. Jeffries, 24, Main St., Cadroxton, Barry, Glam.; C. Short, 66, Victor Rd., Holloway, N.7; C. R. Cumper, Gomball, Surrey; H. Singleton, 34, Stockwell Drive, Knaresborough, Yorkshire; N. Jackson, 107, St. Saviour's Rd., Leicester; W. I. Tolcarne, St. Mawg, So. Colum Minor, Cornwall; Thomas McDermott, Holywryth, Castle Baldwin, Boyle, Co. Roscommon; B. Wright, Clonbeg, Clonbeg, Nr. Norwich, Norfolk; A. Kinder, 42, Willoughby St., Edge Hill, Liverpool; W. Peary, Town Gate, Clifton, Bridgese, York; W. Kemp, 43, Hugo St., Green Lane, Leeds; J. Feildale, 18, Mendip Rd., Ellingham, Stockton-on-Tees; G. Marshall, 4, Church Grove, Braithwell, Nr. Rotherham; G. White, The Deers Hut, Griggs Green, Liphook, G. Lonsdale, 121, Queens Drive, Stoneycroft, Liverpool; E. Hyman, 35, Seafield Rd., Clontarf, Dublin; R. Russell, 11, Salcombe Gardens, Clapham Common, S.W.4.

Two Sets "Home Mechanic Series."—Dennis Durrant, 18, Market Place, Stratford, E. Yorks; C. Charlewold, Ross Glen, Park Ave., Parkbrook, Hants.

Six parcels of Assorted Free Work.—R. Graydon, 14, Clatter St., Oldham; H. Williams, 10, Stratts Cottage, Holbrook Moor, Nr. Derby; H. Jeffries, 199, Doncaster Rd., Gaddesbore, Yorkshire; H. Bull, Sycamore, Hayes Crescent, Cheam, Surrey; H. McGoilin, 61, Holmscroft St., Greenock; F. Burkill, 179, Upper Union St., Dunstable.

H1 Free Work Outfits.—N. Mackay, 18, Portman Street, Glasgow; J. Brimble, 171, Kingsland Rd., London, E.3; David Kelly, 5, Main St., Llanarbach, P. West, Brexton, Carmarthenshire; B. Bealey, Heathy F. Bellamy, 42, Ellison St., Bourne, Nr. Doncaster; G. Glover, 115, Willow Park, Baghill, Pontefract; James White, 111, Western Rd., Jarrow, Co. Durham; L. E. Smith, Clapham, Nice Mile Ride, Wokingham, Berks; E. Corby, 19, Sturminster, Ipswich, Nice Mile Ride, Alton Villa, Salisbury Ave., Stanford-le-Hope; F. Archer, Main St., Haveringham; J. Hollis, Thistleton, Oakham, Rutland; W. Bent, 29, Acornbury Close, West Derby, Liverpool; H. Matheson, Glance, 38, Anwick Avenue, Northumberland; S. Gibbons, Elsemere House, Broughton Astley, Leicester; T. Raymond, 29, Stibington, Wansford, Nr. Peterborough; H. Johnson, 3, Blyth Gardens, Worsall Rd., York; J. Nichols, 21, Colcovey Rd., Hill St., Peckham, S.E.; L. Voyls, 5, Railway Ter., Cockett, Boreham, Swanses; R. Candy, The Hingulog, Gedyney, Llanaboch, Denbigh. (Other consolation prize-winners unavailably held over until next week.—Ed.)

HOBBIES CROSSWORDS £5 GAS FOR CORRECT OR NEAREST CORRECT SOLUTION

CLUES.									
Across.					Down.				
1.	2.	3.	4.	5.	1.	2.	3.	4.	5.
6.	7.	8.	9.	10.	6.	7.	8.	9.	10.
11.	12.	13.	14.	15.	11.	12.	13.	14.	15.
16.	17.	18.	19.	20.	16.	17.	18.	19.	20.
21.	22.	23.	24.	25.	21.	22.	23.	24.	25.
26.	27.	28.	29.	30.	26.	27.	28.	29.	30.
31.	32.	33.	34.	35.	31.	32.	33.	34.	35.
36.	37.	38.	39.	40.	36.	37.	38.	39.	40.

Fill in Stamp to each coupon used.

YOU MAY SEND ANY NUMBER OF ATTEMPTS

on coupons from this or last week's HOBBIES

Name Address (H.C.V.22)

Post your entries to reach us not later than Friday, February 26th, 1932, addressed "Hobbies," Crosswords," No. 22, Competition Dept., King Street, Covent Garden, W.C.2.

RULES.

1. Attempts must be on coupons from this or last week's "Hobbies."

2. Postage stamp value 1/2 must be pinned to each coupon. 3. In the event of a tie, the solution will be equally divided.

4. Entries by (or members of) the family of George Newsome, Ltd. or its associated companies, are not allowed to compete. 5. The Editor reserves the right to deal with all matters relating to this competition.



Let Your Editor Help You. Address your letters and queries to The Editor, "Hobbies," Cox, Newnes, Ltd., 8-11, Southampton Street, Strand, London, W.C.2, enclosing a stamped addressed envelope. All letters and queries must bear the full name and address of the sender.

Model "New Imperial" Competition Result.

HOW unenviable is the task of a judge in a model-making competition such as that set in our issue dated November 28th, 1931, in which we gave a set of parts for making a model of the New Imperial motor-cycle? An enormous entry was received, and the skill displayed far exceeds that exhibited in our previous competitions. The process of judging has, therefore, demanded considerable time and care. By a gradual process of elimination the models were weeded down to fifty, and a careful re-scrutiny reduced the finalists to ten. A final and exhaustive examination of these eliminated eight, the two remaining models being the work of N. E. Kay, The Hollies, High Lane, Stockport, Cheshire, and Ernest R. Duck, 41, Canmore Gardens, London, another very closely indeed, and finally, the motor-cycle was awarded to the former, who had carried out entirely in cardboard. The cylinder was built up correctly to scale and so was the magneto, dynamo, crankcase, and many of the other parts. Photographs of the winning models will appear next week. The full prize list is as given on the preceding page.

This Week's Mental Nut Prize Winners.

THE three following readers receive a book each, as their solutions to the problem set in Jan. 30th issue were the first to be opened: C. Gittins, 50, Hermitage Road, Haringey, N.4.; S. K. Mundy, 67, Albany Road, Chadwell Heath, Essex; J. Reynolds, Wheatley House, Dipton, Newcastle-on-Tyne.

Special Wireless Feature Number Next Week.

NEXT week's issue will be a special Wireless Feature Number in which we shall deal with the construction of a number of sets. We

shall also deal with valves, tuning coils, loud-speakers, cabinets, and tests of a very popular three-valve kit.

Handy Books for Handymen.

ALL handymen should purchase those handy books known as "Newnes' Home Mechanic Series," in which there are at present eight titles: "Simple Electrical Apparatus"; "25 Tested Wireless Circuits"; "Toy Making for Amateurs"; "25 Simple Working Models"; "Model Boat Building";

NEXT WEEK.

DESIGNS FOR A HANGING CLOCK

SPECIAL WIRELESS FEATURE NUMBER!

CHOOSING YOUR VALVES

COILS—LOUDSPEAKERS

CHOICE OF A CIRCUIT

Stamps, Model Aeroplanes, Coils, Etc., Etc.

"The Handyman's Enquire Within"; "The Home Woodworker"; "Model Aeroplanes and Airships." Each volume is profusely illustrated, and costs 1s. from all newsagents, and by post from this office 1s. 2d., and contains ninety-six pages.

"Hobbies" Keeps You Young.

A PRACTICAL hobby keeps you young in mind and body. I have abundant proof of this from readers over sixty years of age who frequently write to me. Only the other day I received a letter from

Mr. William H. Marr's of Rosemary Villa, 2, Empire Road, Torquay, Devon, who is eighty years young! He has just taken up wireless construction, and in the course of an interesting letter says: "I wish wireless had been discovered in my young days. I am, however, going fairly strong, and hope to last out longer to be interested in this marvellous discovery." From the tenacity of purpose evinced in his letter, I am certain Mr. Marr's will, and I hope to receive a letter from him in 1952.

QUERIES AND REPLIES.

White French Polish.

Procure 1lb. of white shellac from a druggist (in form of resembles peppermint rock sweet), crush it up small, and spread out for a few hours in a warm room on clean paper, B. F. (American Common). Turn it occasionally until it feels quite free from moisture, then place in a stone jar and cover with 1 pint of methylated spirits. Cover the jar with a canvas, place in an oven, and bring up gently to blood heat; stir occasionally until all is dissolved, and then strain into clean bottle. If too thick for use, dilute by adding spirit.

French Correspondent Required.

Mr. John G. Black, c/o, South 20, Schoolhill, Aberdeen, would like to correspond with a French reader in order that he may improve his knowledge of the language.

Fretwork Correspondents Required.

Mr. G. Colton, 37, Ashbourne Road, Derby, would like to get into touch with readers who are interested in fretwork.

Hands-Across-the-Sea.

Mr. John Wigmore, of Thorold, Ontario, Canada, would like to hear from other readers of HOBBIES.

Cementing Cinematograph Films.

scrap of clean film free from emulsion (or a 3in. length), in 1oz. of methyl acetate or of amyl acetate mixed with ether, N. G. (Bristol). Cut one end of the film square across so as to leave a strip with one cut perpendicular with the line. Cut off the extreme corners, but leave the perforations whole. Wet the emulsion on the tag, scrape it off when softened, brush a quantity of varnish on the emulsion and then also on the other film, being together, and apply pressure until set.

Largest River in the World.

The Amazon is the largest river in the world. It is 3,000 miles in length. It rises in the Andes, and flows through Brazil into the Atlantic Ocean. Its basin is nearly as large as Europe, and it receives an immense number of tributaries, many of which exceed a thousand miles in length.

Leather Varnish.

For making a leather varnish in which it is not desired to employ the white of an egg. II. V. (Clomble), mix 1 pint of methylated spirit, 5oz. of resin, and 5oz. of shellac. Powder the resin and mix it with the shellac; place the mixture in a jar and add the methylated spirit; stir at intervals until dissolved and then leave to settle. Strain the mixture through canvas, allow to stand for about twelve hours, and pour off all the sediment which remains. This should be the best of the varnish. Stir the sediment and use it for rough work. The varnish should be used as soon as it is dry. The leather should be perfectly dry and warm before applying the varnish. The varnish can be stained to any color by means of an aniline dye soluble in spirit.

The latest thing in fretsaw frames

A new device which gives the sawblade the proper tension without any trouble. Just reverse the handle and the blade is tight. The handle itself is of polished bakelite, comfortable to use and properly shaped to the hand. There is no other frame like it; it is streets ahead of any other make.

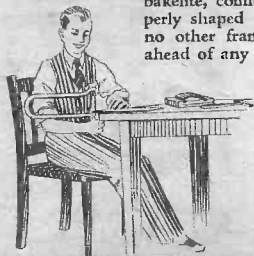

Made throughout
of best materials

ASK FOR THE NEW HOBBIES BAKELITE HANDFRAME

Obtainable from the usual Hobbies Agencies and their own branches in London, Glasgow, Birmingham, Manchester, Sheffield, Leeds, Southampton, Brighton. Or by post (6d. extra) from Hobbies Ltd., Dereham, Norfolk.

HANDY TOOLS FOR THE HANDY MAN

The best
for value
NO. 10

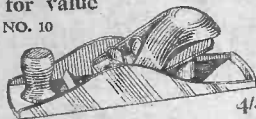

A Popular Size for General Use.

KEYHOLE SAW

ADD
POSTAGE
WHEN
ORDERING
BY
POST

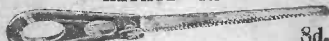

8d.

A new pattern saw—a big advance on the old style. Strong steel handle and sharp-toothed blade. For many jobs in carpentry.



METAL-CUTTING SAW.

A small saw with 5in. blade specially hardened and tempered for cutting metal. It has a comfortable handle and is well finished and reliable.

No. 126 - - Price 10d.

BRITISH METAL PLANES

Well made and finished metal planes fitted with sharp cutting irons and comfortable handle. Bound quality in every part. With 1 1/4in. blade.



A SMALL HAMMER

A handy little hammer for fretwork and small jobs. With polished wooden handle and balanced metal head with polished face. Price 4d.

STRONG PLIERS



These pliers are useful on lots of occasions; for many odd jobs. With wire cutters. Well made and finished—sound value. Price 1/6



SMALL TENON SAW

A sound, reliable saw of general usefulness for all kinds of odd jobs. A reliable tool with 6in. blade and comfortable handle.

No. 125 - - Price 1/3



The Hobbies goods are obtained from leading manufacturers and more from the branches of Hobbies Ltd. or by post from Hobbies Ltd., Dereham, Norfolk.

Modern Fretwork

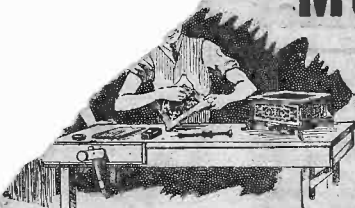

Your people and friends would be delighted with gifts like some of these, wouldn't they? They are quite easy for the handyman to make because full size paper patterns, You can't go

wood and all accessories are wrong in the construction, and anybody with a fretwork set can go ahead with the making. Get them from Hobbies Ltd. All particulars are given and the wood is obtainable ready to use.



WORK TABLE

2ft. 6ins. high. Design No. 1770—4d. Mahogany parts and a set of grooved legs, with ornamental moulding, 14/5, post 1/3. Two pairs hinges, 2d.



UMBRELLA STAND

Stands 3ft. 6ins. high. Design No. 1725—1d. Mahogany boards, legs and moulding, 7/6, postage 1/-. A Draining tray (2144), 1/2, post 2d.

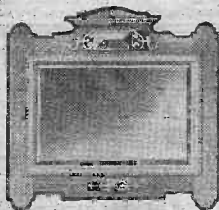

A SMALL OVMANTEL
10ins. square. Design No. 1507. Price 4d. Wood, ornaments and leading, 4/5. Mirror (No. 6747), 8/3. Postage 4/-.



CLOCK

6 1/2ins. high. Design for clock and a dressing-table tray No. 1798—4d. Mahogany for both, 8/2, post 6d. A 3-hour clock 5/- Transfer and knob, 5d. postage 6d.



SLIPPER BOX

Stands 16 1/2ins. high. Design No. 1781—4d. Parcel of oak, with grooved legs, corner posts, moulding and fancy wooden ornaments, 15/- complete. Carriage forward.

PALM STAND

Stands 2ft. 6ins. high. Design No. 1505—4d. Oak boards and turned Jacobean legs with all ornaments supplied for 12/6, post 2/-.

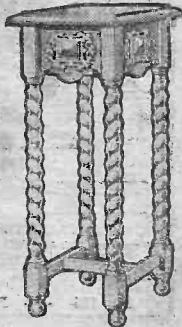

Hobbies 1932 Catalogue contains particulars and illustrations of over 1,000 things to make, with free designs for a Service Wagon, a Clock, a Working Toy, a comic Calendar and two Chip Carving designs. Editorial articles on 20 subjects. 309 pages. Of any messenger or ironmonger. Price 6d.

Branch addresses: 65 New Oxford St., W.C.; 14, Bishopsgate, E.C.; 83 Newington-Bells, S.E.11; 32, Argyle St., Glasgow; 2a High St., Birmingham; 11a Finsbury, Manchester; 214 West St., Sheffield; 10 Queen Victoria St., Leeds; 25 Bernard St., Southampton; 68 London Rd., Brighton. Or direct from Hobbies Ltd., Dereham, Norfolk.