

# THE MARCONI REVIEW

No. 51.

November-December, 1934.

Editor: H. M. DOWSETT, M.I.E.E., F.Inst.P., M.Inst.R.E.

Assistant Editor: L. E. Q. WALKER, A.R.C.S.

## MARCONI'S PLACE IN HISTORY



THE early history of wireless was romantic in the speed with which one development followed another, and many important half-forgotten episodes were recalled by the Chairman, Mr. H. M. Dowsett, in his speech at the Marconi Veterans' 1934 Reunion, which is given below:—

“ To you who have devoted at least 25 years, and some of you as many as 36 years, to the service of the Marconi Companies, and have participated at least to some extent in many of those events in the history of radio which have marked the progress of Marconi's great career, there is little that I can say about his work or his personality which you do not already know. Looking back over the years, however, it is possible to-day to view his achievements in true perspective, and it is on this aspect that I propose to say a few words.

“ First, let me state a well-known fact. The fame of Marconi is world-wide, and in consequence his work—like that of every other outstanding figure of the day—receives the occasional attention of the critics. Friends

and critics, however, agree on one thing: there is no man alive to-day who is more representative of the art of radio communication than is Marconi. His recent election as Rector of St. Andrews University is symptomatic of the verdict of history.

“ In 50 years' time there will be an art of radio communications and one name will have survived and be associated with it; that of its founder, Marconi. We can now understand the reason for this. The radio art has been built up from three main factors:—

- (1) The discoveries and inventions of the physicists.
- (2) The development of the telegraph services and associated inventions by engineers.
- (3) The harnessing and control of the ether channels involved in radio communication.

The last mentioned, which is the most vital factor of the three, is pre-eminently the work that Marconi has made his own. He has blazed the trails for which the physicists in the main prepared the ground and the engineers have since consolidated. Let me remind you how this was done.

“ In 1895 when Marconi made his first experiments in Italy, he was working then on the fringe only of what was thought to be the illimitable ether, with the radiation proceeding, it was believed, in straight lines from the transmitter. You will remember, in those days, the Heaviside layer had not been thought of. In 1896 Marconi came to England and carried out tests for the Post Office, first over 100 yards, and then over a mile and three-quarters. He was increasing

## *Marconi's Place in History.*

his grip on the ether. In 1897 tests were resumed first over three miles, then over four miles, and then over eight miles, but as kites were used, the ranges were practically optical and conditions in the medium, as far as could be judged at that day, were explainable by the accepted theory. He then returned to Italy and was able to transmit from Spezia to the Italian cruiser 'San Martin' over a distance of 10 miles. At this distance the ship was below the horizon; the rays must have been bent to a certain extent. Marconi recognised this with its implication that as theory could not explain this result perhaps it was not the illimitable ether of the whole of space which was involved in these transmissions. He returned to England, and transmission was effected over a distance of 34 miles between Bath and Salisbury. This involved the use of a kite again. Test stations were erected 14 miles apart between the Needles and Bournemouth. This was an optical distance, but communication was later effected between the Needles and a steamer some 18 miles distant, the ship again below the horizon. Scientific opinion was inclined to doubt these results. In order to demonstrate that reliable communication could be established over a long period, Marconi established a service in 1898 for Trinity House between the East Goodwin Lightship and South Foreland, over a distance of 12 miles. Then, early in 1899, communication was established between Wimereux and South Foreland over a distance of 30 miles, and the first important demonstration was given to the Navy in the autumn of that year when communication was established between three ships, the 'Alexandra,' 'Juno' and 'Europa' over a distance of 74 miles, when all ships were well out of sight of each other and there were walls of water more than two hundred feet deep between. This test demonstrated conclusively that the rays were not travelling in straight lines but were somehow bent towards the earth, and if this was so, then the ether involved in the communication must be definitely limited in extent.

"Marconi was determined to put this question to a stringent test by attempting to span the Atlantic, and in face of much opposition the erection of some twenty 210-foot masts to carry the aerial was begun at Poldhu in 1900, and a similar group of twenty 210-foot masts was erected at Cape Cod, Massachusetts. Impatient to get further confirmation of his belief, in February, 1901, Marconi effected communication between Niton and the Lizard, an actual distance of 196 miles, with no less than one mile and a quarter depth of earth curvature in between. There was no doubt after this that the rays were bending and the ether involved was no longer the illimitable ether of space, but was limited in some way to that near the earth's surface. Then bad weather came to the aid of Marconi's critics and a heavy gale wrecked the 20 masts at Poldhu, and later another heavy gale wrecked the 20 masts at Cape Cod, but Marconi's answer to this setback was to take passage for St. John's, Newfoundland, and in the depth of winter to make a test from there. You will remember that his kite-flown aerial picked up the famous 'S' signals from Poldhu on the 12th and 13th December, 1901, and thus he succeeded in demonstrating that radio transmission followed the curvature of the earth; a fact which he confirmed beyond any doubt in 1902 by receiving signals from Poldhu on the s.s. 'Philadelphia' up to a distance of 2,099 miles. It was some months after the Poldhu to St. John's test that Kennelly in the United States and Heaviside in this country suggested that there might be a conducting and rectifying sheet of ionised gas in the upper atmosphere to account for the great transmission distances achieved by Marconi; but the physicists were not able to prove their case theoretically although there were many attempts made by Poincare, Nicholson, MacDonald and Love, until an hypothesis was put forward by Eccles in 1912 which in time was accepted as a plausible explanation of the reason for the radiation from the transmitting aerials following the curvature of the earth. At this date Marconi was actually receiving on the s.s. 'Principessa Mafalda' over a distance of 4,000 miles by day and 6,735 miles at night from Ireland.

"In one of his books, Sir Oliver Lodge has said that Marconi advanced the art of radio by some 10 years. This was a tribute to his intense energy, initiative and singleness of purpose in applying Hertzian waves to telegraphy, but the facts I have just quoted indicate that if the introduction of long-distance radio telegraphy had depended not on Marconi's experimental work but on physicists being first convinced that the waves would bend round the earth these services would have been delayed not ten but fully fifteen and probably twenty years.

"The inevitable setbacks which accompanied the pioneer work in establishing a reliable service across the Atlantic caused Marconi's advisers to argue against further expenditure on long-distance transmission, and suggested that his activities should be limited to the successful ship-to-shore service which had been established by the International Company and also by the Belgian Company, as these services could be made to pay.

"But Marconi's objective was not primarily to establish a successful business: that work he left to his associates, and as the years went by the ranges of his tests increased and became more competitive with cables. In time the Marconi Company itself became converted to the long-distance transmission point of view, and a number of schemes were put forward for connecting

## *Marconi's Place in History.*

---

up all the Dominions with the mother country. Mr. Gray, I believe, was responsible for the first of these in 1896, and others were due to Mr. R. N. Vyvyan. The distances to be covered were to be achieved first in hops of 1,000 miles, then 2,000 miles, then 6,000 miles, and finally by direct transmission, when the estimated power to the aerial amounted to something like 1,000 kW, the stations were to cost over one million pounds apiece, the wavelengths used were to be of the order of about 18 miles, and the aerials were to be carried on towers about 800 feet high.

“If all this power were needed, it was obvious that only a small fraction of the ether that was receiving the radiation from the transmitter was being used, and figuratively one might say the coupling to the ether channels concerned was very weak indeed, and it was not surprising therefore that a leading physicist—Dr. Eccles—should have remarked at that time that wireless had apparently reached saturation point. This was true as regards the particular long wave method then employed, but so far as Marconi was concerned the situation simply revived his old pioneering outlook which suggested to him that a new and more efficient method of exciting the ether must be found, which would prove effective over great distance. This resulted in that wonderful series of tests between Poldhu and the yacht ‘Elettra’ in 1923/4 in which Mr. Franklin played such a useful part and which finally enabled Marchese Marconi to make an offer to the Post Office on behalf of his Company to establish communication with the Dominions, using one-fiftieth of the power, involving one-twentieth of the cost, and providing a speed of working at least three times that possible on long waves. The offer was accepted, and you will remember the extraordinary success of the services provided by the short wave Imperial Beam Stations from the time they were opened, the volume of traffic leaping and mounting to an unexpected high level.

“With these antipodal services Marconi had succeeded in utilising to the best advantage the concentric ether shell round the earth, which is effective for radio transmission. The beam services have been the greatest achievement in wireless history, and although the ether still provides a field of research for other methods of attack, such as by ultra short waves and micro waves, as such methods when applied to commercial uses can only be considered in their effects on the ether between stations which are within optical distance of each other, no spectacular results comparable to those associated with the introduction of the Imperial Beam Services need be anticipated. It has been through the installation of the present vast network of radio services all over the world that the art of radio communication has been created, and we hope that its founder, Marchese Marconi, will long be spared to enrich this art by his further discoveries.”

All our readers, we know, will join us whole-heartedly in echoing this last wish.

# A PIEZO-ELECTRIC PEAK VOLTMETER

*The difficulties of obtaining true peak voltages of a modulated carrier wave are well known, particularly when the depth of modulation varies with the low frequency input. The use of a cathode ray oscillograph to determine these peak voltages is not new. A method is described below by which high voltage modulated carrier waves in the order of 20,000 volts can be measured with the aid of the cathode ray oscillograph. It introduces a piezo-electric transforming device which serves to reduce the supply voltages in a predeterminable ratio to voltages which can be applied across the deflector plates.*

## Requirements of a Peak Voltmeter.

**P**RACTICALLY all peak voltmeters do not give a true indication of the peak voltage; this has to be computed from the reading of the instrument. This is particularly the case with the valve voltmeter. In order to obtain a measure of the peak volts it is essential that the wave form of the supply is known. Any sudden variation in the peak voltage would not record on the instrument. It would seem that the obvious solution to this problem lay in the employment of a cathode ray oscillograph. But even this device is unsuitable if the peak voltages to be measured are in the order of thousands of volts.

If we are concerned with the problem of measuring peak voltages of a transmitting aerial, the first requirement necessary is that no power should be consumed by the measuring device. Or at least so little power as will not interfere with the correct operation of the transmitter. The capacity of the device must therefore be a very small fraction of the aerial capacity and has thus to be in the order of a few micromicrofarads. The cathode ray oscillograph fulfils this condition, but as some potentiometer would be required to step down the voltages, this would introduce the undesirable capacities into the device. We have, therefore, to abandon the potentiometer arrangement, and with this object in view a transformer has been devised which serves to step down in a determinable ratio the transmitter aerial voltages to voltages which the cathode ray oscillograph is capable of handling. The transformer ratio is independent on the frequency and the power consumption from the aerial is negligible.

## Description of Instrument.

The device consists essentially of two parts:—

- (1) The piezo-electric transformer.
- (2) Cathode ray oscillograph.

The transformer consists of two slabs of quartz cut with the electric axis of the crystal normal to the slab faces. These two slabs are provided with electrodes and clamped together tightly by means of a conveniently constructed press. (See Fig. 1.) The upper slab, which we shall call the primary slab, is stimulated by the high tension voltages which we require to measure. This stimulation across the electric axis will produce a dilation in that direction, and as this slab is initially under compression this dilation will show itself in the form of extra force acting along the electric axis and also along the axis of the press. This stimulated mechanical force will be communicated to the secondary quartz slab, which, in its turn, will liberate charges on its faces in proportion to the forces to which it is subjected. Now the charges developed on these surfaces can be measured very

conveniently as they will be interpreted by voltages in accordance with the expression  $V_s = \frac{Q}{C}$ ,  $Q$  being the charge and  $C$  the capacity of the electrodes. In this manner it is possible to transform the high voltage applied to the primary slab to the comparatively low voltage on the secondary slab. Hence the transformer serves to transform the immeasurable high voltage to the measurable low voltage without

any appreciable consumption of power. The secondary voltages can be measured in the usual way, with the aid of the cathode ray oscillograph or alternatively with a valve voltmeter, the valve in this case being the electrometer triode as explained later.

**Cutting of Crystal.**

The crystal forming the primary and secondary slabs in the press should be so cut that all natural frequencies along the three axes are lower than the fundamental frequency of the radio frequency voltages which have to be measured. This means that the fundamental frequency and all its harmonics will be higher than any of the natural frequencies of the quartz. For this reason, there will be no fear of the slabs flying to pieces when the instrument is in operation. If it is desired to operate on a transmitter of 100 metres, the natural frequencies of the crystal in terms of the three axes,  $e$  (electric),  $t$  (mechanical) and  $o$  (optic), are given as follows:—

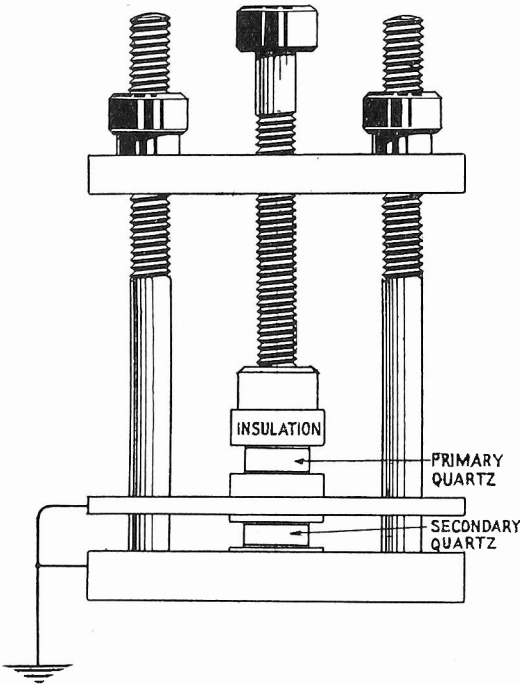

FIG. 1.

Electric.	Mechanical.	Optic.	Observer.
$\frac{272}{e}$	$\frac{272}{t}$	$\frac{312}{o}$	Theoretical values.
$\frac{287}{e}$	$\frac{272}{t}$	$\frac{383}{o}$	Hund.
$\frac{273}{e}$	$\frac{273}{t}$		Parkin.

The dimensions are in centimetres. If, then, we apply the device to a transmitter of 100 metres wavelength, the electric axis must not be of thickness less than 3 mm. and the thickness of the slab containing the optic axis should not be less than 4 mm. The resistance along the electric axis is of a particularly high value and 3 mm. should stand about 6,000 volts per mm. In practice the sample for the primary slab was 5 mm. in thickness and the thickness in the other two directions was about 20 mm. This slab worked on a supply of 20,000 volts.

**Theoretical Determination of Transformer Ratio.**

To determine the voltages appearing on the faces of the secondary crystal we write down the Curie formula for the direct piezo-electric effect, that is:—

$$Q = HF \text{ e.s.u.}$$

H is the direct piezo-electric constant and F is the force in dynes exerted by pressure across the electric axis of the crystal. If C is the capacity of the electrodes enclosing the crystal, then

$$V_s = \frac{Q}{C} = \frac{HF}{C} \text{ e.s.u.}$$

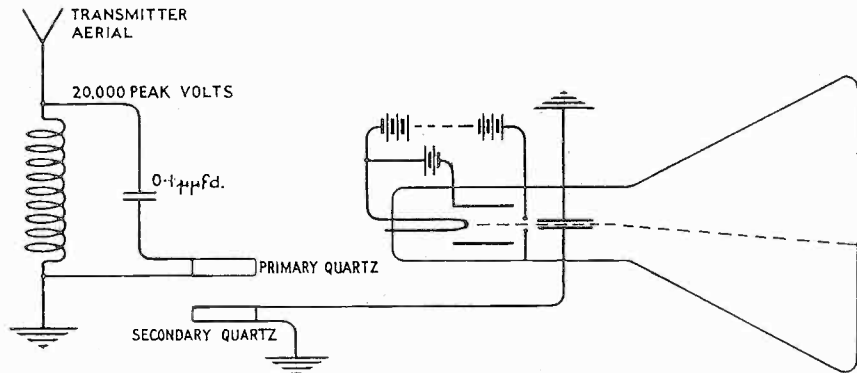

FIG. 2.

If A is the surface area of one of the electrodes and t is the distance between them, then we have

$$V_s = \frac{HF}{kA} 4\pi t \dots \dots \dots (1)$$

k being the dielectric constant.

We have now to find an expression for F. This pressure is due to the piezo-electric expansion of the primary quartz slab. In accordance with the formula for the converse piezo-electric effect the expansion along the electric axis is given by

$$e = HV_p$$

The strain, therefore, will be

$$\text{Strain} = \frac{HV_p}{e} = \frac{HV_s}{e}$$

The stress exerted on the secondary crystal will therefore be

$$\text{Stress} = \text{Strain} \times E = F/A$$

where E is the modulus of elasticity and A the area of the electrode.

On substitution we have

$$F = EHV_p A/e$$

On further substitution for F in the equation (1) we find

$$V_s = \frac{H^2 E V_p 4\pi t}{ke} \dots \dots \dots (2)$$

*A Piezo-Electric Peak Voltmeter.*

Note that the surface area of the electrodes has cancelled out. This shows that

$$V_s = PV_p \quad \dots \quad \dots \quad \dots \quad \dots \quad \dots \quad \dots \quad (3)$$

where P is a constant.

To determine this constant for a particular case we put :—

- E =  $8 \times 10^{11}$  dynes/cms.<sup>2</sup>
- H =  $6.48 \times 10^{-8}$
- k = 4 (for quartz)
- t = 0.3 cms. (thickness of secondary crystal)
- e = 0.5 cms. (thickness of primary crystal)

For this case we find then that  $P = 1/158$ .

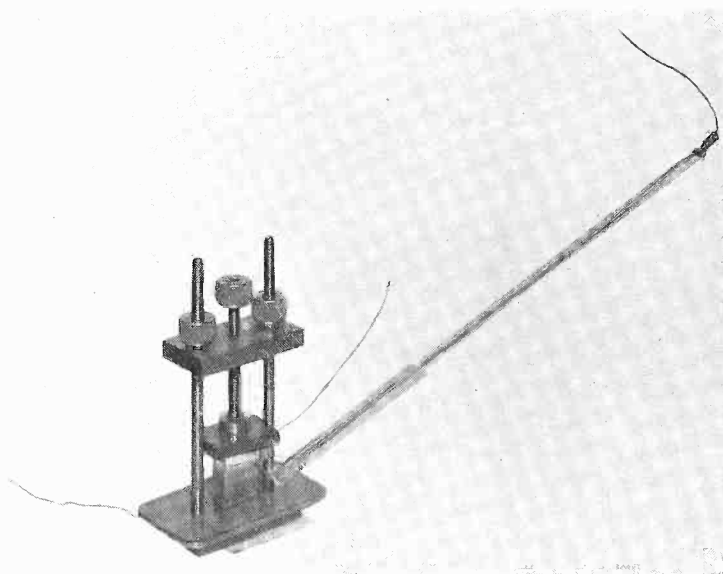

FIG. 3.

The application of 10,000 volts to the primary crystal therefore develops a potential difference of 63.3 volts on the secondary crystal.

**Capacity of the Voltmeter.**

As far as we are concerned the capacity of the voltmeter is the capacity of the primary crystal. The area of the electrodes of this crystal need not exceed 0.25 cms.<sup>2</sup> and as the thickness in this case is 0.5 cms., we have for the capacity

$$\frac{kA \times 1.11}{4e} \text{ micromicrofarads.}$$

which is

$$0.18 \text{ micromicrofarads.}$$

In order, however, further to reduce the capacity of the device it is advisable to introduce a series condenser between it and the aerial. A diagrammatic sketch

of the device is shown in Fig. 2 and a photograph of the piezo-electric transformer is given in Fig. 3. It is essential that an earthed plate should be introduced between the primary and secondary components of the press in order to eliminate the possibility of stray field giving rise to spurious and undesirable effects. Apart from the high tension leads to the primary quartz, all leads should be well shielded.

**Method of Observation.**

The electrodes of the secondary quartz are led to the deflector plates of the cathode ray oscillograph. Three plates of the oscillograph may be earthed and the fourth connected to the unearthed electrodes of the primary quartz. When the voltage is not applied the spot should be roughly in the centre of the field. As the carrier wave comes on, the spot begins to lengthen out into a line and it is the

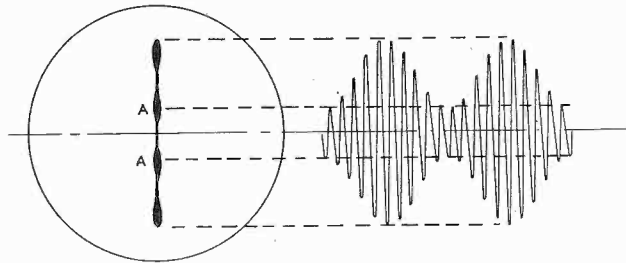

FIG. 4.

end of this line which determines the peak voltage on a calibrated scale across the face of the cathode ray screen. As the line lengthens it is noticed that the extremities are much brighter. This is due to the fact that here the velocity of the electron is zero. As the voltage is raised, the line continues to lengthen until maximum carrier wave voltage is attained.

As soon as modulation is applied to the carrier wave the two spots at the end of the line travel towards the centre and a second pair of spots originating at the ends of the line continue to travel outwards as the line lengthens further. The second pair of spots indicates the peak voltage of the modulated carrier wave, but the first pair of spots indicates the depth of modulation. These two spots arise at the points AA in Fig. 4. Here the electron possesses minimum velocity and this is at the trough of the modulated wave. The base of this trough sinks down to the zero line when the modulation approaches 100 per cent. When this is the case the spots recede to the centre.

Although we have for simplicity termed the brighter portion of the line spots, it must not be imagined that they are very sharply defined spots in the accepted sense of the word. They are sufficiently defined, however, to observe whether or not the carrier wave is modulated and very roughly the amount of modulation.

The cathode ray oscillograph for this purpose is of the hard type and such a device has been applied successfully to the observation of modulation on a three metre transmitter.

At the other end of the scale the device can be employed to observe the peak voltages on 50 cycles.

L. M. MYERS.



## ULTRA HIGH FREQUENCIES IN THERAPEUTIC RESEARCH

*A description is given below of a generator of ultra high frequency oscillations with a range of 2.3 to 8.5 metres employing a magnetron oscillator. This apparatus is intended for use in exploring the possibilities of this type of electromagnetic radiation for therapeutic purposes, especially in the curing of certain types of malignant diseases.*

*It is proposed to follow up this article by a theoretical description of the magnetron.*

SOME three years ago the writer was approached by a medical body to develop an ultra high frequency set for pathological research experiments in connection with the possible cure of malignant diseases. As a result of this contact certain apparatus was produced and a search made of current literature dealing with the subject. This showed that although information was meagre, considerable attention was being directed to the subject by electro-medical men in different parts of the world. Since this time a considerable amount of spasmodic research work has been carried out of the physiological effects of ultra high frequencies, principally on the Continent, but it is evident from a most casual reading of recent literature on the subject that the effect of such radiation is not really known. For instance, certain workers have stated positively that curative effects have been obtained by exposing malignant growths to ultra high frequencies; others that harmful effects have been obtained, secondary growth in particular "lighting up" under the influence of the radiation.

One or two Continental workers report that ultra high frequencies have most marvellous curative properties, and further that there are "magic" frequencies, and it is only a matter of short experiment before it will be possible to choose the "magic" frequency for the cure of any particular disease.

A careful study of the work that has been accomplished appears to suggest the following facts.

First, that the actual physiological effect of ultra high frequencies is unknown from a therapeutic point of view. Secondly, that considerable internal heating is generated by their application, much more than can be obtained by lower radio frequencies, in spite of the greater difficulties of application. Thirdly, that although one can state almost positively that there is no "magic" frequency, that is from the point of view of resonance of different parts of the body to different frequencies, there is at the same time a selective heating effect, but this selective heating is probably purely a question of the changing electrical constants of matter.

It will be appreciated that in the case of the human body, conductors and dielectrics are inextricably mixed together. Now, as the dividing line between conductors and dielectrics at very high frequencies is a small one, the influence of a field may vary as the applied frequency is varied, not only because of the changing constants of the matter through which the currents pass, but also because these changing constants influence the shape and intensity of the field through the matter. It is because of this that we may expect selective heating. This selective heating

action is easy to demonstrate, but it is difficult to prove positively that effects so produced are not merely attributable to heat.

What effects ultra high frequencies may have besides heating cannot yet be stated with any certainty, but we do know that they appear different from the effects of lower frequencies, and for this reason much more research work seems indicated before apparatus is pressed into general service, even when only diathermy is desired.

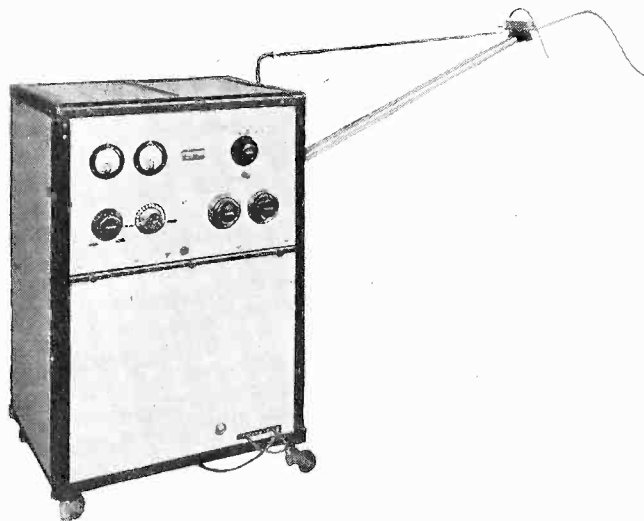

FIG. 1.

In order to research fully, it is necessary to explore as wide a range of frequencies as possible, although frequencies between 100 megacycles and 50 megacycles seem to have attracted most attention, possibly because at higher frequencies the production of strong fields becomes difficult. Further we should know what frequency is being used at the time.

As to power required, this is unknown until more evidence is collected, but at such high frequencies it is possible to produce destructive effects with medium power, and a small

power only may be sufficient for therapeutic work.

In designing the present research set the foregoing points have been kept in mind and to produce high frequency power a magnetron valve has been used, as with this type of generator it is possible to get to lower wavelengths than with the ordinary triode valve; and higher conversion efficiencies from D.C. to A.C. are also obtained. Further, the operation of the valve is very simple.

A short description of the set produced by the Marconi Company will be followed by a theoretical discussion of the magnetron.

The complete set, which is portable, consists of a trolley framework into which slide the supply units and magnetron proper, so that if necessary the units can be detached from the frame and mounted separately. A feeder connects the set proper to the patient circuit, Figs. 1 and 2 giving general views of the whole arrangement.

### **The Trolley.**

The trolley consists of a strong base plate mounted on rubber tyred caster wheels, this base plate supporting the main framework. The frame, which is built of special delta metal extrusions bolted to duralium corner pieces, is braced by brass angles, these bracings also forming ledges on which the various units can slide. The framework is boxed in with aluminium screening panels at the sides,

and a back panel having louvers let in for ventilation ; removable perforated metal screens are fitted on the top of the trolley so that the set can easily be got at without withdrawing the unit. Attached to this trolley is a support and balance weight for holding the feeder arm connecting the magnetron to the patient circuit (shown in Fig. 1), a hole being let in the side of one panel for passing the feeder through and allowing it to be moved in any direction.

Fig. 2 shows the back view of the set with the screen removed so that the various units can be seen. These consist of the power transformer tray, bottom left-hand corner, filament and field supply, bottom right-hand corner, H.T. rectifier in the centre tray, and the magnetron proper on the top tray, the set being designed to be mains operated from the usual 50 cycle A.C. supply.

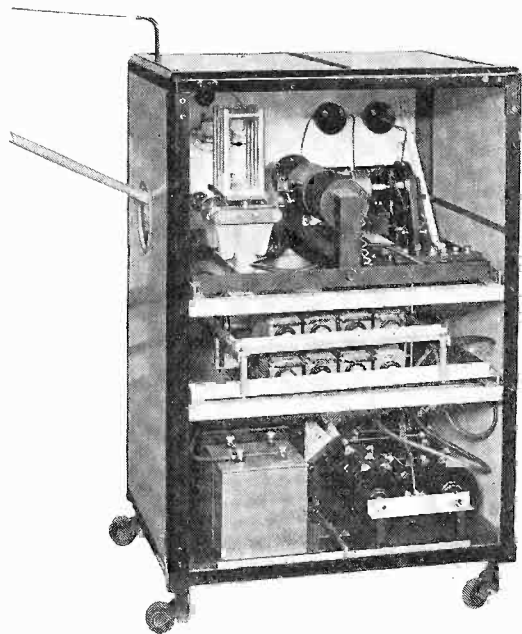

FIG. 2.

liberal rating in order that they can be run quite cool, and the unit is designed to slide into the tray underneath the magnetron, flexible connections being provided to couple it to the other units of the set.

#### **Filament and Field Supply.**

Underneath the H.T. rectifier and beside the power supply is a tray containing the filament and field supplies. The filament, which is lit by A.C., is supplied from a transformer, which gives an output of 6 volts 6 amps. The field is run from rectified A.C. supply, the transformer giving an output of 45 volts. The output of the transformer is connected through a copper oxide rectifier to the output, which in turn is connected to the field connections of the magnetron. No smoothing is provided with this field supply, because with the high inductance of the magnetron system of the magnetron itself no smoothing is necessary.

#### **Power Supply.**

The power supply consists of a mains transformer supplying power to two condensers set for voltage doubling through two rectifiers.

The secondary of the power transformer is tapped so that three different secondary voltages can be selected, this giving a wide range of power supply to the set. The selection of these voltages is by means of a selector plug which can be seen at the bottom right-hand corner of Fig. 1.

#### **H.T. Eliminator.**

Above the filament supply transformer tray is the H.T. eliminator. This consists of a series parallel arrangement of copper oxide rectifiers for voltage doubling circuit.

These rectifiers have been given a

It should be observed that the power transformer and both transformers supplying filament and field are arranged with a number of primary tappings from 200 volts up to 250 volts in 10 volt steps, so that the set can be used on different supply circuits.

### **The Magnetron.**

The magnetron set proper, which is a self-contained unit, is built on a brass angle tray holding the magnet and windings, the valve and associated controls, and the closed H.F. circuit with its wave-changing coil and condenser. The units are all housed on this angle framework, but controls and meters are fixed to a front aluminium panel which is firmly bolted to the framework and magnet system. The general arrangement of this unit is shown in Fig. 3. The core of the magnet system is of Lohmore iron, in order to prevent saturation with the high flux used and has adjustable poles. The coil windings each contain 1,500 turns of No. 18 gauge wire,

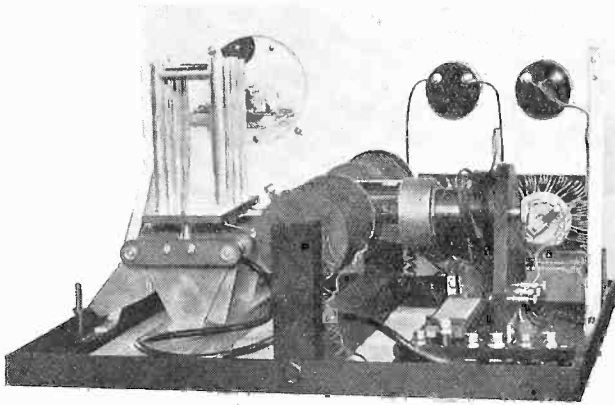

FIG. 3.

the coils being connected in series. An ebonite base board, to which is fixed an adjustable valve holder, is placed in such a position that the anode of the valve is correctly disposed within the space between the magnet poles, and the valve itself is capable of rotation over a small arc so that the valve can be correctly oriented to produce even heating on the valve anodes.

In series with the magnet windings is a graded resistance which enables the voltage on the magnet to be varied between 45 volts and

zero, thus enabling a large range of magnetisation to be obtained, the resistance being graded so as to accommodate the varying currents encountered on the different adjustments, a dial control for this field variation being fixed to the front panel of the set. The filament, which is lighted from A.C., has connected in series with it a variable resistance so that its voltage can be controlled within the limits necessary, the voltage being measured by a voltmeter on the front panel, and the control being fixed on the front panel below the voltmeter. The H.F. circuit consists of a variable inductance formed of "U" tubes in parallel with a small variable condenser. This coil-condenser assembly is mounted on a glass bar held in a frame on a rubber fixing, and the wavelength is changed by means of sliding the "U" tubes up and down a series of vertical members. There are four complete "U" tubes, and these can be used either with the bridge at the bottom, giving minimum inductance, or with the bridge at the top, giving maximum inductance. A small Vernier condenser is employed to give a fine tuning control. Coupled to the same coil condenser unit are two condensers which form coupling condensers to the feeder circuit.

Fig. 4 is a front view of the magnetron panel and shows the various controls. The filament control is to the left below the filament voltmeter. The field control is next, and above it is a meter to show the amount of anode feed. Next in line are the Vernier condenser control and coupling to output previously mentioned, and above on the right-hand side of the panel is a wavemeter which will cover the complete wave band of the set. This wavemeter has two ranges:—

- (1) A range from 8.5 metres to 4 metres;
- (2) A range from 5.5 metres to 2.3 metres;

the ranges on the wavemeter being obtained by sliding a small tubular bar from one end of the fixed loop to the other. This wavemeter will give a correct calibration

if it is used as an absorption meter, but a neon tube attachment is also provided for visual indication, and if the neon tube is inserted, the calibration will be altered by an amount dependent upon the glow in the neon tube. An indication is given on the front of the wavemeter of the alteration of the calibration due to the neon tube, so that, with or without the neon tube in use, it is possible to obtain a correct idea of the wavelength being worked.

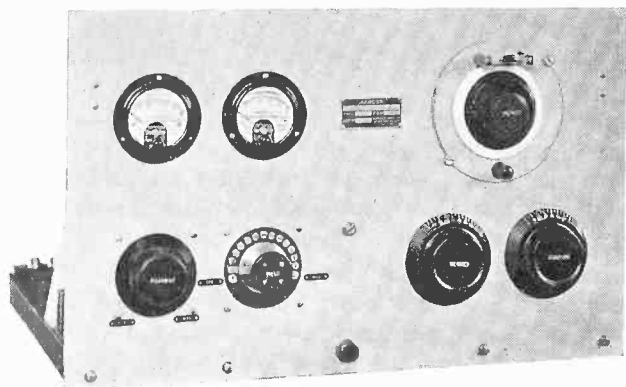

FIG. 4.

#### **Safety Arrangement.**

For the safe operation of magnetron sets it is necessary to operate from a maximum field condition to one of lesser value, and not to increase the field from zero. This is because, with no field, the current through the valve represents dead loss, and this would exceed the valve anode dissipation when operating on a normal anode voltage. To ensure that this procedure is automatically carried out, a safety device has been incorporated. This consists of breaking the main H.T. supply by a coil operated contactor, the operating coil being controlled through contacts associated with the field switch. Thus until the field is brought up to the maximum the contactor remains open and is made only when the field is set to maximum. On reducing the field the contactor is held on by an auxiliary contact, but when reduced to the "off" position, the main is tripped by a second pair of contacts and the process must be repeated. This renders the operation of the set extremely simple and quite proof against accidental overload.

A. W. LADNER.

# THE APPLICATION OF HIGH FREQUENCY CURRENTS IN MEDICINE AND SURGERY

*In view of the increasing interest in the application of high frequency currents in the art of healing it is proposed very briefly to survey the field, but it is emphasised that in this article only a general outline can be given.*

**T**HE terms diathermy, radio-thermy and radio-therapy have been used when discussing the application of high frequency currents for medical purposes.

For our purpose, however, we shall use the term diathermy, which means "through heating," as the effect of applying high frequency currents to the body is to cause the heat to penetrate right through the tissues, so that it is not merely localised on the surface of the skin.

In this respect, heating by diathermy differs from ordinary heating by radiation, as by this method heat is radiated from an external source and allowed to impinge upon the body, and this heat, or even visible radiation above the infra-red—except, of course, the highly penetrating rays further up the spectrum—is soon absorbed by the skin and subcutaneous tissue just below the surface, and before the maximum temperature which can be tolerated below the surface is reached, the application of heat must be discontinued, otherwise the skin would be injured.

The use of high frequency currents in medicine was first suggested by Nicola Tesla, and later on d'Arsonval made some investigations; Von Zeyneck and Nagelschmidt also made early contributions to the Science. Some ten years ago the writer was engaged upon research work with the object of improving diathermy apparatus, and also of using high frequency current for surgical purposes.

Since those days, knowledge of the thermogenetic value of high frequency currents has been steadily accumulating and to-day diathermy is looked upon with increasing favour by physicians as a healing agent for many diseases and ailments, and latterly high frequency currents have been used in the art of surgery about which more will be written later following the term "Electrosurgery."

But before proceeding further to the physical aspect of the subject, we must invoke the reader's patience to review very briefly the elementary biological principles which are involved in order that what follows may be more easily understood.

As is well known, organs and tissues of the body are built up of cells, and in unicellular organisms there are combined in the single cell the following functions:

The structural basis of the organism. Food assimilation, with all the subsidiary processes of secretion of enzymes necessary to that end. The catabolism of food and the excretion of catabolic products. Sensitiveness to change of environment, responsiveness to these changes, and the co-ordination of appropriate responses to changes. The function of movement, of growth, and of reproduction.

But in multicellular organisms the above functions are each performed by the organs, or systems of tissues, composed of cells very unlike each other in their physical properties, in form and chemical constitution.

But all these dissimilar organs and tissues have their origin in the single undifferentiated cell. That is in the fertilised ovum. So that theoretically every single cell has the potential capacity for performing all the functions necessary to life.

In order that all the cells of which our complex systems are composed shall function harmoniously, nature has planned an elaborate and sensitive nervous system, which corresponds to external environment and which also co-ordinates the internal changes caused by the activity of the cells.

The nervous system also has to perform the special function of regulating the metabolism of the body as a whole.

Metabolism is a term used to express the sum total of chemical changes that occur in living tissues, such as drawing upon the fat as a reserve fund of fuel to keep the body warm, and the giving up to the tissues carbohydrates, etcetera, from the blood.

Living organisms are chemically unstable, building up on the one hand, and breaking down on the other, hence the term metabolism.

Coming now to protoplasm, upon examination the histologist finds this to be a mass of material differentiated into cytoplasm and a nucleus, and it generally contains granules, vacuoles, etcetera.

We cannot go fully into the chemistry of protoplasm, but it will suffice for our purpose in this article to state that the bio-chemist upon investigation finds that the substances it yields are 75 per cent. of its weight in water and proteins. Such research offers great difficulties, as the investigation can be made in the dead state only.

A protein substance consists of carbon, hydrogen, oxygen, with sulphur and phosphorous in small quantities. As a familiar substance we may consider the white of an egg. As far as is known at present, protein material is never absent from the living substance.

Since, apart from water, protoplasm is chiefly composed of materials such as proteins which form colloidal solutions, protoplasm itself may be in the nature of a complex colloidal dispersion; but it is not simply a colloidal dispersion, for upon analysis it is found to contain some organic salts and some of these are free in the dispersion medium and are adsorbed to the colloidal particles. These free salts and ions will be osmotically active.

Those which are adsorbed will not be osmotically active, but they will influence the degree of aggregation of the colloidal particles.

The colloidal and organic components of protoplasm must be continually changing with metabolic changes, both within the cell and also in the surrounding cells and fluids.

We may say, therefore, that protein metabolism is the most essential characteristic of vitality.

It is quite obvious, upon microscopic examination, that the cell membrane divides the vegetable cell, but in the case of animal cells the membrane is often not visible. There is no doubt, however, that the animal cell is functionally differentiated to form a semi-permeable membrane. In proof of this it will be sufficient if we consider the following points:

As the cellular protoplasm is liquid, there would be nothing to limit its dispersion if no such membrane existed.

In order to limit the dispersion it must be impermeable to colloids.

The passage of water across the membrane must be possible.

Inward passage of nutrient material must be allowed, and excretory products must pass out.

In order to allow of cell growth the cell membrane must be elastic.

The membrane will change with the composition of the cell.

When there is a change of hydrogen-ion concentration in the cell or its environment this change will also tend to influence its permeability by virtue of its influence upon the degree of colloidal aggregation.

As the membrane is colloidal it will carry an electric charge opposite to that of its environment, and may thus hinder or promote the diffusion of ions.

When living cells are excited their permeability is increased, and here an explanation is offered of the production of electric currents which always accompany protoplasmic activity.

Considering now, very briefly, the properties of the blood, this is known to be a fluid which holds in suspension solid particles which are called corpuscles, of which there are two kinds, namely, red and white. The fluid which holds the corpuscles in suspension is called plasma. It is richly albuminous, and one of the proteins which it contains is called fibrinogen.

The red corpuscles are much more numerous than the white. In man, the red corpuscles average  $5 \times 10^6$  per cubic millimetre. The proportion of red corpuscles to the white ones is about 600 to 1. These red corpuscles average about .0003 inches in diameter, and they are about .00008 inches thick, and the white ones are about .0004 inches diameter.

Average blood consists of about 66 per cent. plasma and 33 per cent. corpuscles. Its normal temperature is about  $37^{\circ}$  C. and its specific gravity about 1.055. About one-quarter of the blood is distributed in the heart, lungs and large blood vessels, one-quarter in the liver, another quarter in the skeletal muscles, and the remainder in the other organs of the body.

The function of the blood is to supply nourishment to all parts of the body and to take away waste matters. It feeds all the various tissues, and it is essential to life that there is a free exchange of nutrient materials from the blood and of excretory matter to it.

During life, the blood is in constant movement ; it leaves the heart by the vessels called the arteries, and returns to the heart by the veins. The arteries terminate in the tissues, and it is there that the veins commence. The veins are connected to the tissues by small tubes called capillaries ; it is from these that the leakage of the blood plasma occurs. This fluid which is exuded is called lymph, and it conveys the nutrient from the blood to the elements composing the tissue, and it also removes the waste products.

The lymph courses through the lymphatics and ultimately converges to the main lymphatic, which is known as the thoracic duct. From this duct the lymph flows into large veins near to the entrance to the heart, and is thus returned to the blood.

When blood is shed it quickly becomes viscous, and then sets into a jelly, this jelly then contracts and exudes a yellowish fluid called the serum. The formation



of fibres of solid protein called fibrin constitutes the essential act of coagulation, or clotting, and these fibres engage with the corpuscles to form the clot.

When considering "Electrosurgery" later in the article it will be of interest to us to bear in mind that a temperature above about 40° C. accelerates the coagulation of the blood, whilst a low temperature has the effect of retarding it.

The various organs of the body are grouped together in what is known as systems. The system through which the blood circulates is known as the circulatory system. That which functions in the digestion of food is called the digestive system. The excretory system is responsible for getting rid of waste products, whilst the muscular system provides energy and takes control of movement. Supporting the more delicate and softer parts of the body we have the skeletal system. Finally, the most important of all the systems is the nervous system, involving the brain, the spinal cord, and the nerves. All the other systems are controlled by this nervous system, so that this is the master system.

Anatomical analysis goes to prove that the organs are made up of various textures, which are called elementary tissues, and they are known as epithelial, connective, muscular, and nervous tissues.

In general, epithelial tissues are divided into two main classes, one of which is called the simple epithelium and consists of one layer of cells, and the other is the compound epithelium consisting of more than one layer. Epithelium has no blood vessels, but it is nourished by the lymph. Generally, the epithelium is destitute of nerves.

Connective tissue is composed of cartilage, bone, adipose tissues, elastic tissue and many other tissues.

Muscular tissue is composed of a large number of cylindrical fibres, and the muscles themselves may be regarded as a means of converting the chemical energy derived from food stuffs into kinetic energy for doing mechanical work; the muscular motor efficiency is never more than about 25 per cent. Further detail is outside the scope of the article. The structure of nerve fibres is also too wide and complex a subject to enter into here.

The central nervous system is in communication with the remote parts of the body surface by what are known as sensory nerves, the ends of which are very sensitive and communicate impressions to the central system.

The foregoing biological considerations will, it is hoped, assist us in our attempt to explain the behaviour of high frequency currents when applied to the human body, and so we leave this aspect of the subject bearing in mind that the protoplasm which the cell membrane contains is richer in ions than the membrane itself, also, the intercellular fluid contains more ions than the membrane, so that the liquids act as condenser plates, and the cell membrane constitutes the dielectric of a condenser. Therefore, in considering Diathermy, it should be borne in mind that from a physical aspect the body is composed of a complex system of impedances, and, furthermore, the blood and lymph streams effect the distribution of heat.

The difference between metallic conductors and those rich in ions must also be considered, for in dealing with animal tissue we are naturally concerned with con-

ductors of the latter kind, as we have shown already that here we have proteins, corpuscles and electrolytic fluids which contain ions. The muscles and blood are rich, and the fat and bones poor in these properties.

We are from now onwards concerned only with the physics of Diathermy; further biological considerations must be left to physicians and surgeons.

As is well known from ordinary high frequency practice, when a current flows through a straight metallic conductor, owing to the streams of electrons oscillating rapidly through the conductor, and their consequent rapidly fluctuating magnetic fields, the current is confined to the outer surface of the conductor, due to distortion, so that virtually the sectional area of the conductor is diminished and the resistance is thereby increased, and the resistance is a function of the frequency.

We therefore have the well known "skin effect." Considering now the effect of an applied electromotive force on the molecules composing an electrolyte we know that the effect is to split it up with ions, or carriers of electricity, as these ions become charged either positively or negatively as they have lost or gained an electron. So far the electron is conceived to be the smallest indivisible unit in nature; its mass is  $1/1850$  of that of the hydrogen atom, which is the lightest atom known to science.

The mass of the electron is  $9 \times 10^{-28}$  grams; its electrical force of repulsion is  $4.2 \times 10^{42}$  times its gravitational mass of attraction. One electron carries a charge of  $4.774 \times 10^{-10}$  electrostatic units.

The ion which carries a negative charge against the current is known as an anion, and that which carries a positive charge with the current, as is well known, is called a cation.

Every anion which is chemically monovalent carries the same negative charge of  $4.774 \times 10^{-10}$  E.S.U.'s, and every monovalent cation carries a similar positive charge. Divalent ions carry  $\pm 4.774 \times 10^{-10} \times 2$  E.S.U.'s, trivalent ions  $\pm 4.774 \times 10^{-10} \times 3$  E.S.U.'s, and so on.

If the electrolytic fluids are in a state of combination to form neutral molecules, that is, if the positive and negative charges of electricity are equal, the application of an electric field, however small, across the fluid, will cause some current to flow, and the electrolyte now becomes ionised.

We are indebted to Arrhenius for a satisfactory account of the process of conduction in electrolytes. His explanation is that the current is due to the motion of the ions in the electric field between the electrodes, the conductivity being proportional to the number of free ions present.

If we suppose that the average velocities of the positive ions be  $p+$  and that of the negative ions be  $-n$ , and that along the path between the electrodes there are  $x$  ions per unit length of the path, then, if  $v$  be the valency of the ions, and  $e$  symbolises the electric charge of  $\pm 4.774 \times 10^{-10}$  E.S.U.'s, we may write that there passes in one second through a cross section of the electric field  $p+x$ , positive ions each carrying an electric charge  $ve+$ , and in the opposite direction  $-nx$  negative ions each carrying a charge  $-ev$ .

It therefore follows that the total current is given by

$$I = xve (p + n) \quad \dots \quad \dots \quad \dots \quad \dots \quad (I)$$

In general we may write that

$$p_+ = K_1 E \quad \dots \quad \dots \quad \dots \quad \dots \quad (Ia)$$

$$\text{and} \quad n_- = K_2 E \quad \dots \quad \dots \quad \dots \quad \dots \quad (Ib)$$

where  $K_1$  and  $K_2$  are constants for the particular electrolyte, and  $E$  is the electric field.

It will be obvious that if an electric field is applied to the electrolyte fluids of the body in the same direction continuously, there would be a tendency to dissociate the fluids, which would be harmful. When a high frequency alternating current is applied, however, no such dissociation takes place owing to the rapid change of polarity.

Bearing in mind that the human body possesses the property of capacity, it will be of interest here to remind the reader of the factors which determine the capacity of a simple parallel plate condenser. It is well known that if  $A$  is the area of one side of one plate in square cms.,  $d$  the thickness of the dielectric, also in cms., and  $K$  the dielectric constant, then the capacity in micro micro farads =  $\frac{KA}{4\pi d} \times 1.11$  or  $0.08841 \frac{KA}{d}$ .  $K$  for air is practically unity, and for water, blood and aqueous solutions it is about 80.

Now, owing to the different chemical constitution of different organs and substances of the body, the dielectric constant will vary accordingly, and it is due to this variation, and therefore the variation of capacity of different organs and regions of the body, which tends to cause selective absorption at ultra high frequencies, to be discussed later.

It is hardly necessary to remind the reader that the higher the capacity of a circuit the lower the impedance offered to a current of given frequency, other factors remaining the same, and if  $I$  be the current in amperes,  $V$  the applied voltage,  $f$  the frequency and  $C$  the capacity in  $\mu\mu F$  then

$$I = \frac{V2\pi fC}{10^{12}} \quad \dots \quad \dots \quad \dots \quad \dots \quad (2)$$

The values of  $K$  for different substances of the body, of bacteria, and of malignant organisms, offer a subject for further research

Now, the current given by equation (2) must be resolved into two components, one of which Maxwell called the displacement current, and which causes polarisation of the dielectric and is analogous with electric conductivity. This may be denoted by  $I_p$ . It is not the same for alternating current of high frequency as when a D.C. voltage is applied to a condenser, as it is a function of the frequency  $f$ .

In the case of alternating current we have  $I_L$  causing dielectric loss, the instantaneous value of

$$I_L = \frac{AV \cos \omega t G \omega}{l} \quad \dots \quad \dots \quad \dots \quad \dots \quad (3)$$

where  $A$  is the plate area and  $V$  is the voltage amplitude.

$G\omega$  is the conductivity and  $\omega = 2\pi f$ , and  $l$  is the length of the dielectric path, and  $t$  is the periodic time.  $I_L$  will be in phase with the applied volts, and it is due to this component that heat is generated in the dielectric contents of the body. The heat generated will be according to Joule's Law which states that the heat in calories

$$= .24 I_L^2 RT \dots \dots \dots (4)$$

where  $R$  is the pure resistance value in ohms in the path of the working component  $I_L$  of the current, given by equation (3), and  $T$  is the time in seconds during which the current is flowing.

But it is almost impossible at present to predetermine what temperatures will be reached in various parts of the human body owing to the complex network of impedances and other factors which cannot be assessed, as we should require to know the specific heat and densities of the tissues, and also the cooling effect of the blood on every organ or region.

The only known safe guides to heat distribution are the thermometer and pyrometer in its various forms.

If the output wattage of a diathermy machine is measured accurately it does not tell us exactly how much energy is absorbed by the body of the patient, as in addition to the in phase component indicated by equation (3) we have the current charging the condenser plates. This component is also sinusoidal, but it leads the applied voltage by ninety electrical degrees and produces the counter E.M.F. This component can be expressed thus :

$$I_C = \omega CV \sin \omega t \dots \dots \dots (5)$$

In addition to this, there will also be some radiation.

We will now consider very briefly some of the factors which cause dielectric absorption. These may be divided into three main groups : Firstly, the ions may be in motion. Secondly, there may also be motion of the dipoles molecules. And, finally, there may be motion of the electrons inside the molecules.

Considering now the first group, these losses are caused mostly by low frequency currents.

At what is generally termed " high frequency " dipole action takes place, and at the frequencies of light and above those of the visible spectrum the electrons in the molecules are disturbed in their orbits.

We are indebted to Maxwell and Wagner for investigating the losses due to low frequency currents.

In the work of Debye we have an explanation of the action of dipoles, and Lorentz has explained why light wave frequencies disturb electrons in molecules.

FIG. 1. It should, perhaps, be explained that a dipole (Fig. 1) is conceived to be a mathematical configuration of two opposite charges of electricity at a mathematically finite distance apart. If  $y$  symbolises this distance and  $e$  the electrical charge, then the dipole moment is given by

$$M = ey \dots \dots \dots (6)$$

In the Debye Dipole Theory we have proof that the dielectric constant of materials which can be polarised is in general higher than those materials which cannot be so polarised because the dipole action contributes to the polarisation of

the dielectric. If under the influence of an electric field of force the individual dipoles are given a turning moment they each contribute this turning or polarisation effect to the total turning moment of the dielectric, causing it to become polarised in the direction of the field.

From elementary theory the polarisation can be expressed by the equation :

$$P = \frac{3}{4\pi} \frac{K - 1}{K + 2} \dots \dots \dots (7)$$

where P is the polarisation and K the dielectric constant, and PX is the electric moment per unit volume when a field of intensity X is applied.

It will be obvious that this is analogous with the magnetic moment of a magnet.

When an electric field is applied there is a tendency for the dipoles to set themselves parallel to the field of force, according to the well-known principle that the potential energy of a system tends to become a minimum.

But not all the molecules are permanently orientated in the direction of the field because, due to motions caused by heat, the turning moment from mathematical infinity will not be equal to zero.

However, according to the theory that Debye has established there will be some polarisation of the dielectric causing a moment of finite magnitude, which is given by the equation :

$$M = \frac{N\mu^2\rho}{3WZT} \dots \dots \dots (8)$$

where N is Avogadro's number, which is  $6.06 \times 10^{23}$ ,  $\rho$  is the density of the liquid at the absolute temperature T, W is the molecular weight, and Z is Boltzmann's constant of  $1.37 \times 10^{-16}$  ergs per degree C.

This is true, however, only when currents of low frequency are applied, as the velocity of orientation of the molecules is finite.

In considering the time necessary for the full orientation of a molecule of a polarisable substance the time constant of the dipole orientation is given by the expression

$$t_0 = \frac{4\pi\eta r^3}{ZT} \dots \dots \dots (9)$$

where  $\eta$  is the viscosity of the liquid, and  $r$  is the radius of the dipole molecule.

It will be seen that the speed of orientation of a dipole molecule varies inversely as the temperature, and if  $\eta$ , the viscosity of the liquid is high, this will have the effect of increasing the time  $t_0$  of orientation, as the size of the molecule will vary accordingly.

Now if the frequency period  $t_f$  of the applied field is low in comparison with  $t_0$ , a complete setting of the molecule takes place ; but it will be obvious that if the frequency  $t_f$  is high in comparison with the natural period of orientation  $t_0$ , then full orientation cannot take place because, just as the dipole has commenced to rotate, the field causing rotation will be reversed, thereby causing rotation in the opposite direction.

Therefore, P, and consequently the dielectric constant K, will, in general, decrease with increasing frequency.

When a D.C. field is applied, from foregoing considerations, the dielectric will be totally polarised. Let the D.C. polarisation be denoted by  $P_{D.C.}$ , and let  $P_E$  be the polarisability at high frequencies. Then, if  $K_O$  is the dielectric constant which corresponds with  $P$  at direct current, and  $K_E$  that with  $P_E$ , we then have

$$K_P = K_E + \frac{(K_O - K_E)}{1 + \omega^2 t_0^2} \dots \dots \dots (10)$$

where  $K_P$  is the dielectric constant of polarisability at the given frequency.

This formula is deduced from  $P$ , the polarisation as given in equation (7), where polarisation of space charges is neglected, and  $P$  is then resolved into two components, thus  $P_E + P_D$ , where  $P_E$  is the polarisation due to the electrons and  $P_D$  that due to dipoles.

Now bearing in mind that the human body is composed of a complex system of capacities and resistances, and neglecting any inductive property due to the nervous system when applying high frequency currents of  $5 \times 10^6$  cycles, and of lower frequencies, we may conceive the body as a whole to consist of a condenser and resistance in parallel as in Fig. 2.

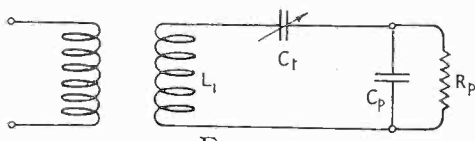

FIG. 2.

Here  $C_P$  and  $R_P$  represent the capacity and resistance respectively of the patient's body, which will vary considerably in their natural capacity and resistance, according to the ionic content of the substances composing their bodies.

Accordingly, it becomes necessary to compensate for these varying capacities of the human body by means of the variable condenser  $C_t$ , which is the tuning condenser, and by this means the patient is tuned in to resonate with the oscillating circuit, which is coupled to the output circuit. This tuning condenser is also used to control the current through the patient by detuning, and is an important feature in the diathermy machine developed by the Marconi Company.

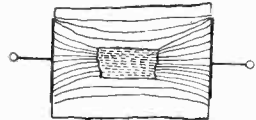

FIG. 3 (K).

The following figures indicate how the current would be distributed through a homogeneous dielectric when high frequency current is applied to plate electrodes of different forms :

Fig. 3 (K) gives an idea as to how the current distribution may vary when the biological substance is heterogeneous, and this will be of interest to us when considering ultra short wave therapy.

Figs. 3 (A), (B), (C), (D), (E), (F), (G), (H) and (J) give an idea of the current distribution in a homogeneous substance with plates of different forms.

It is well known to physicians and surgeons that the maximum temperature which can be tolerated by a patient before discomfort is felt at the skin is about  $45.5^\circ \text{C}$ . or  $114^\circ \text{F}$ .

The following experiments were carried out by Dr. E. P. Cumberbatch at St. Bartholomew's Hospital, and they indicate in a general way what may be expected from diathermy treatment.

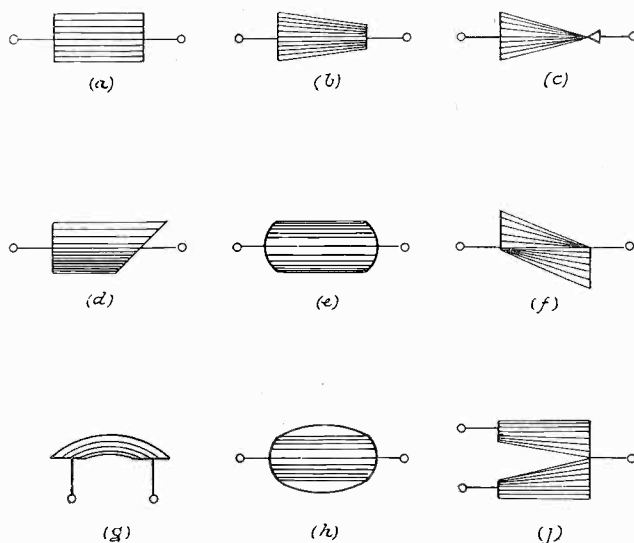

FIG. 3.

A current of 0.4 amperes was passed from hand to hand for twenty minutes, the electrodes were of metal and cylindrical in form. The temperature was not allowed to reach toleration point, and the following elevation of temperatures was noted :

Region.	Temperature Rise.	Temperature Range.
Front of wrist .. .. .	6° Fah.	94 — 100° Fah.
Front of elbow .. .. .	4° „	95 — 99° „
Axilla .. .. .	2.4° „	98.8 — 101.2° „
Mouth .. .. .	2.6° „	97.6 — 100.2° „
Groin .. .. .	1.2° „	98.8 — 100° „
Popliteal space .. .. .	3.0° „	98 — 101° „

The curve shown in Fig. 4 has been plotted from experimental data obtained by the writer at the Marconi Works at Chelmsford. The mean values of the impedances from hand to hand of several persons have been taken in plotting the curve.

The law of the curve relating impedance to frequency is given by  $Z = 5.628 \times 10^7 f^{-.8}$  where  $Z$  is the impedance and  $f$  is the frequency applied. This law is, of course, only applicable to normal persons when gripping cylindrical electrodes. The electrodes used were 2.5 cms. in diameter giving a contact area for each hand of about 60 sq. cms. The law will vary according to whether the arms are flexed or unflexed, and it may be assumed that it would not hold good for ultra high frequencies.

It will be obvious that an infinite number of curves may be obtained by investigating the impedance of different parts of the body, and the different shapes and different areas of the electrodes will also influence the results obtained.

Hand-to-hand measurements were made for convenience, but the useful application of diathermy for treatment is not only from hand to hand where the impedance is of the order of 400 ohms at  $3 \times 10^6$  cycles, but more often in those regions of the

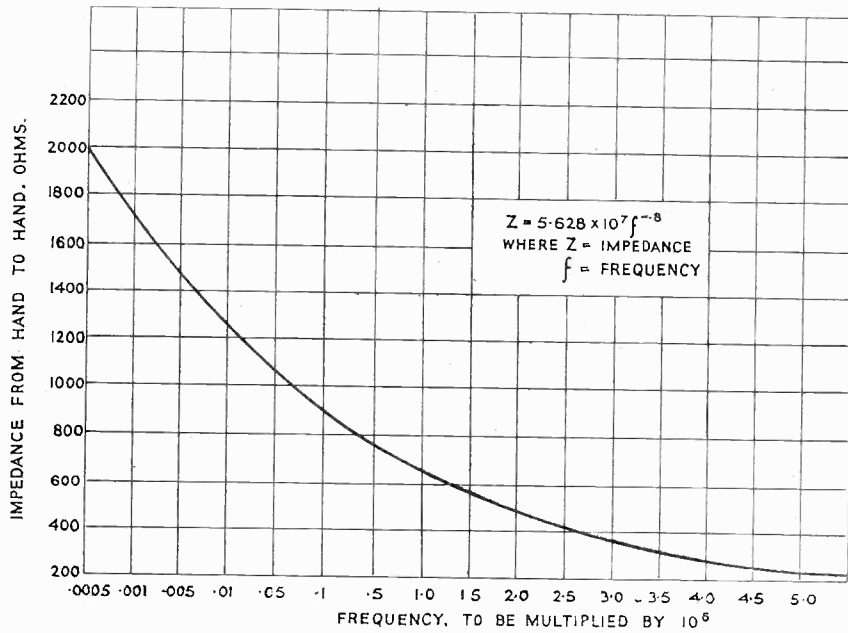

FIG. 4.

body where the impedance is of the order of 15 ohms, say, for the thorax when using  $20 \times 20$  cm. plates, to about 100 ohms for other regions of the body.

A high frequency current of about 3 amperes can be tolerated for a short time through the thorax, but 3 amperes causes the temperature to rise rather quickly, and in general a lower current would be applied.

It is therefore not a good criterion of a diathermy machine to test the output from hand to hand, as the greatest efficiency is required over the most useful working range.

The energy equation giving

$$W = I^2 R \quad \dots \dots \dots (II)$$

should be applied, where R is the resistance, I the current, and W is the wattage output.

From what has been written already concerning the circulation of the blood, the reader will readily understand that when current passes through an organ or region of the body, the working component of the current causes heat to be generated and the tendency of the blood is to convey heat away from the region, by virtue of the fact that the blood is continuously streaming through it. The tissue is therefore



exposed to the heating effect for a longer period than the blood is, so that the temperature of the tissue rises first, and then there is thermal conduction from the tissue to blood.

The blood, therefore, acts as a cooling system which tends to reduce the temperature of the tissue to the normal value.

It will be obvious that the cooling effect also depends upon the flow of current in relation to the blood stream, for if the current is in the same direction as the blood stream, then the cooling effect will be less than if the blood were flowing across the direction of the current.

The circulation of the blood through an organ or region of the body is accelerated when it becomes heated, as the heat diminishes the viscosity of the blood according to the law

$$\eta = \frac{.01794}{(1 + 0.23120 t)^{1.5423}} \quad \dots \quad (12) \text{ approx.}$$

where  $\eta$  is the viscosity and  $t$  is the temperature in degrees Centigrade, so that when heated the blood flows easier, and more passes in a given time.

Furthermore, underneath the skin where the electrodes are applied, the temperature of the sensory nerve endings rises and reflex action causes the blood supply to this part to be altered.

As everyone is not sensitive to heat to the same degree, it is advisable to test the sensitivity of the patient to heat before applying the current, or serious damage may be done.

The relative impedance of different parts of the body when applying high frequency current of  $5 \times 10^6$  cycles and lower frequencies appears to be in the following order: Fatty tissue, brain, lungs, liver, skin and muscle.

In this article we cannot go fully into the beneficial effects of diathermic treatment of many ailments and diseases; but the applications are now manifold, such as the sedative effects of the treatment are the relief of pain and cramp and a soothing effect upon the sensory nerves.

It has a beneficial effect upon the stomach and intestines; also upon rheumatism, sciatica, lumbago, arthritis and similar ailments.

Medical research workers have found that cholera, vibriones and gonococci can be destroyed by the application of diathermy. These bactericidal effects are thought to be in part due to the indirect production of hyperæmia and increase of lymph stream.

Statistics prove the value of diathermic treatment of pneumonia. In the U.S. Marine Hospital 47 cases were treated by diathermy, and the mortality was 17.1 per cent., and in another series of cases where diathermy was not administered the mortality was 42.9 per cent. In 22 other cases where diathermy was applied, and where the ages of the patients ranged from 15 to 82 years there was only one death.

By lowering the viscosity of the blood and thus causing it to flow easier, relief is given to ailments of the cardio-vascular system.

Ailments of the lungs and pleura, of the alimentary system, the muscles, the ears and of the nose also respond favourably to treatment.

It has hitherto been the experience of physiologists when investigating galvanoreflexes that the light spot slowly drifted from zero to the left of the scale, and it was found that a patient previously responsive offered no response at all at the time of the investigation.

G. G. Blake has shown that the drift can be controlled, and also that a normal subject can be sensitised by the application of diathermy. A normal subject being one not in the habit of taking drugs.

We will now leave the physician's use of high frequency currents to consider very briefly and in a very elementary manner what we may term :

### **Electrosurgery.**

In the art of surgery, high frequency currents are now being used for the excision and destruction of abnormal tissue, including all forms of malignant growths such as cancer.

It has the cardinal virtues of considerably diminishing hæmorrhage by sealing up the capillaries, and of coagulating the ends of large vessels, so that in many operations hemostasis is almost complete. In consequence, the time of operations is considerably shortened as the number of ligatures necessary in major operations is considerably reduced.

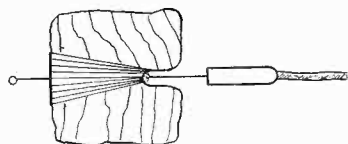

FIG. 5.

It also offers the advantages of a clearer field of operation for the surgeon, and by sterilising malignant and bacterial infection the risk to the operator and

the liability to distribute the infection is very much diminished.

In surgical operations using high frequency currents, specially shaped electrodes displace the surgeon's scalpel, by virtue of the fact that if suitably shaped instruments are charged with high frequency current of proper value and wave form, a film-like arc precedes the operating instrument in its course, and this severs the tissue as the instrument follows the course directed by the surgeon.

Fig. 5 gives an idea of how the tissue is cut.

This arc, as is now known to surgeons, has the important property of being able to seal up the small blood capillaries and lymphatics as it severs the tissue, thereby tending to stop hæmorrhage, and therefore, in the case of malignant growths, of diminishing the dissemination of malignant cells over the unaffected regions.

In surgery the applications of high frequency currents may be divided into three main purposes, namely : cutting, coagulation, and dehydration.

The cutting effect depends upon the intense concentration of heat, which, of course, depends upon the current density at the point of the operating instrument ; it also depends upon the wave form, of which more will be written later.

Many surgeons who have now employed electrosurgery state that far less pain, shock, and trauma follow than when the ordinary scalpel is used.

By the elimination of excessive bleeding it shortens the time of the operation.

When operating with high frequency currents surgeons exercise great care not to allow the tissue to reach a high oxydising temperature, otherwise it becomes charred.

One of the chief virtues of electrosurgery is that it promotes hemostasis, or, in other words, lessens bleeding, and this, of course, depends upon the degree of coagulation, or clotting of the blood, by heat which can be safely allowed.

The active electrode is usually in the form of a narrow blade, or needle, but electrodes of varying shapes are now coming into use.

The earth plate is usually of pliable metal of large area—about 200 to 300 sq. cms. ; therefore, it collects current at low density, and consequently there is very little heating effect where this plate is applied.

At the moment when the electrode touches the tissue, an arc is formed, and it is this arc which severs the tissue and seals up the small blood vessels. The instrument does no cutting mechanically.

The depth of coagulation of the tissues on each side of the cut depends upon the value of the current, and also upon the speed of cutting.

If the operating instrument is moved along its course at a speed just sufficient to allow the arc to sever the tissue, the coagulation will extend to a fraction of a millimetre only and the tissue whitens ; but if it is allowed to dwell too long at any point in its course, the coagulation will be very heavy and the tissue will then be charred.

If, however, the active electrode is drawn across blood vessels of large size, at the normal cutting rate, the ends of these vessels may not be sealed, but by seizing them with the hemostatic forceps and placing the active electrode in contact with the forceps, a heavier current will flow, causing the ends of the blood vessels to coagulate, thus stopping bleeding.

Another surgical application of high frequency currents is for the dehydration of tissue *en masse*. This method is superseding cauterisation by hot metal.

Diathermy actually generates heat in the part to be destroyed, whereas when the cautery burner is used its penetration below the surface is limited owing to the poor thermal conductivity of the tissue, whereas, the electrical conductivity is relatively high, which allows a diathermy current of high value to flow through the tissue and therefore the heat penetration is deep.

To dehydrate abnormal tissue by diathermy a temperature of from 60° to 100° C. is necessary. In order to reach these temperatures intense heat and therefore intense current concentration is necessary, so that disc electrodes of small area are applied to the tissue to be destroyed, and a current of several amperes used.

By using a metal disc of 2 cms. diameter with a current of 4 amperes it is possible to dehydrate tissue 2 cms. at least below the surface. After a time the tissue will be boiled dry and sparks will then appear over the edge of the active electrode. When this happens further dehydration is not possible.

Dehydration by the use of high frequency current is quite distinct from the destruction of tissue by the electro-chemical methods. It also has the advantage over the hot metal method in that at frequencies of the order of  $3 \times 10^6$  cycles the tissue proteins do not undergo such a profound chemical change.

Tissue which has been dehydrated by the method of "electrosurgery" forms a slough which gradually separates from the surrounding parts, and granulation tissue fills the resulting cavity and an epithelium grows over.

When a minor operation is performed on small portions of tissue in less sensitive regions, and the time taken is only a few seconds, an anæsthetic is unnecessary, but if large masses of tissue are to be destroyed an anæsthetic is necessary.

It is hardly necessary to add that ether should not be administered simultaneously with the application of high frequency currents as the ether vapour might explode with serious results.

High frequency current is of high value to surgeons for operations upon carcinomatous growths, tumours, warts and many other abnormal growths.

It has a very important application in the destruction of various growths in the bladder. For this purpose a catheterising cystoscope is used, through which is

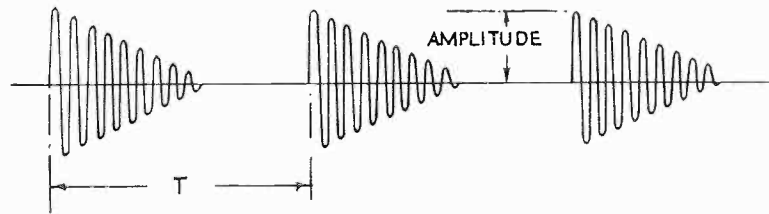

FIG. 6.

passed an insulated electrode with a bare metal end. The intensity can thus be controlled and the point of application directed, and in the hands of experienced operators there is little danger of the wall bladder being injured.

Hæmangiomata, intravesical and intraurethral papillomata and hæmorrhoids have also been treated successfully.

By using suitable instruments charged with high frequency current, successful operations upon the eyes have been carried out by skilled oculists.

Successful operations have also been carried out recently on intra-cranial tumours, on the mucous membrane of the nose, and by dental surgeons in dealing with stumps.

Disfigurements such as fungi, facial warts and tattoo marks have been corrected, and superfluous hair has been removed. The cosmetic results are excellent, and these operations can be carried out without interfering with the patients' normal activities.

The uses of "Electrosurgery" are being gradually extended by surgeons; but we cannot here enter into further details.

It will now be appreciated that in the application of high frequency currents for medical purposes great care must be taken to ensure that currents of proper value and of most suitable wave form are used.

It will be immediately obvious to the reader that a damped wave as shown in Fig. 6 is not ideal from physiological considerations, as this will tend to shock the nervous system when used for therapeutic purposes, thus causing Faradism.

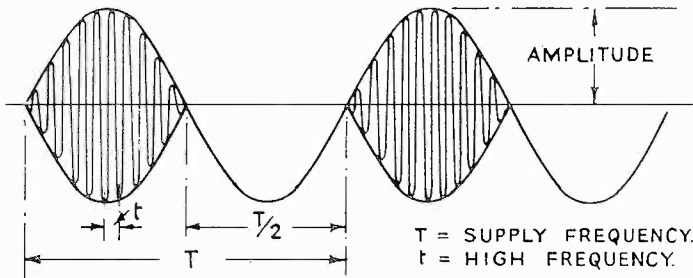

FIG. 7.

Also, if damped wave current were used in "Electrosurgery" the effect would be a saw-like action and consequent deep coagulation of the tissues when it should be very light to facilitate primary union. It will be obvious that a surgical instrument charged with such current and moved at a uniform speed would be charged

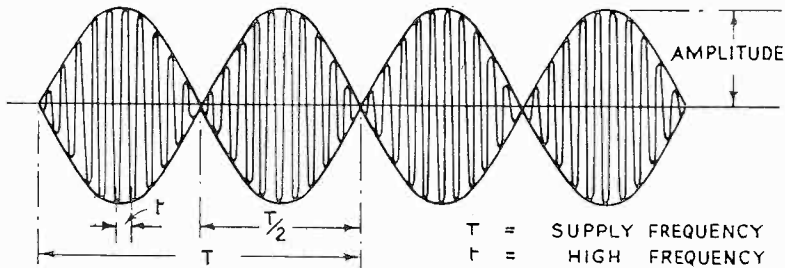

FIG. 8.

during some intervals only, and during those intervals where the wave has died out there will be a tendency to drag upon the tissue. Even during those intervals where there are oscillations, the impulses, and therefore the cut, would not be uniform.

*(To be continued.)*

## MARCONI VETERANS' ANNUAL REUNION AND DINNER

THE Sixth Annual Reunion and Dinner of the Marconi Veterans—members of the staff of the Marconi Company and its associates of 25 years' service and over—was held at the Criterion Restaurant, London, on the 17th November, 1934. Mr. H. M. Dowsett occupied the Chair, and supporting him were H.E. the Marchese Marconi, Mr. M. Travailleur, Mr. A. Hubert, of the Belgian Marconi Company, the Marchese L. Solari, of the Italian Company, Mr. R. C. A. Kroes, of Radio Holland, Mr. F. S. Hayburn, Mr. Andrew Gray, Mr. A. H. Ginman, Mr. C. E. Rickard, Mr. G. E. Turnbull and Capt. H. J. Round, the total number present being 67.

An especially happy start was given to the Reunion which preceded the Dinner by the presence of the Marchesa Marconi, who accepted a bouquet of carnations from the Chairman, and was then introduced to a number of Veterans. The assembled company gave her a rousing cheer as she left.

Dinner followed and the cross-toasting kept the Wine Stewards, Messrs. W. B. Cole, W. J. Collop, W. M. McGhee and E. J. Wagstaff, fully occupied.

The Chairman read telegrams and messages of good wishes and regrets for absence from Mr. H. Jameson Davis, Mr. H. W. Allen, Mr. C. S. Franklin, Mr. G. J. Boome, at Aden, Messrs. Ludwig and Delasse, at Barcelona, Messrs. Perier, Vanderpooten, Poupart, Verbrugghen, Fournier, Maernoudt, Tastenoy, Cammaerts, Van Embden and Mme. Koenig, of the Belgian Company, and many Veterans scattered throughout the United Kingdom.

After the toast of the King, the Chairman proposed that of His Excellency Marchese Marconi, which was given with musical honours. In an interesting address, reported in full elsewhere, he emphasised the distinctive feature of the Marchese's researches from 1895 onwards, which was to extend the range of communication to the greatest limit possible. So by degrees the shell of ether surrounding the earth, which is made use of for radio communications, became fully harnessed for this purpose.

Marchese Marconi, in his reply, said he would like to confirm the historical accuracy of the Chairman's remarks, and he appreciated the sympathetic insight with which the subject had been dealt with. He himself always considered that wireless offered an inexhaustible subject for research. Much had been done; he believed that much yet remained to be done, particularly in various applications of ultra short waves and micro waves. In expressing the great pleasure he experienced in once more attending a Veterans' Reunion, he laid stress on the fact that he was Veteran No. 1.

Mr. Travailleur, in proposing the toast of "The New Members," emphasised the long association of Belgium with the activities of Marchese Marconi and his Companies, and continued:

"Permit me to add, in my name, and in the name of all the Belgian members of this association, how deeply we appreciate the honour of being connected with such a wonderful achievement as that which is due to the genius of H.E. the Marchese Marconi.

"When we behold the existence of all the important companies devoted to international tele-communication, with their networks now concentrated in one great joint organisation, we cannot but appreciate what radio has achieved in the past. As to the future, if we keep a little of that enthusiastic spirit and imaginative power which is so needed when engaged in a business of this kind, we must hope, and believe, that there is still some other new achievement which can be realised by such co-operation, not only for the benefit of each individual engaged in the business, not only for the country in which these companies are registered, but, going a little further or a little higher, for the benefit of the community. Indeed, when you speak of tele-communication, if that industry is to be developed to its fullest extent, you must look beyond the frontiers and remember that we are working as a world-wide enterprise. The world, after all, is so small. See what happened the other day. British airmen flew from London to Melbourne and girdled half the world in less than three days, and the following night the British

Marconi Veterans' Annual Reunion and Dinner.

1895  
His Excellency Marchese Marconi.



1897

Col. H. Jameson Davis, H.W. Allen.

1898

P.W. Paget, C.E. Rickard

1899

W. Densham, Andrew Gray, H.M. Dowsett, R.T. Munson, F.S. Stacey

F. Woodhouse, C.S. Franklin, P.J. Woodward, A.B. Blinkhorn, M. Travailleur, G. Perier

1900

W.H. Corby, R.N. Vyvyan, A.J. Clark, F. Archer, J. Harvie Clark, Sir Ambrose Fleming, A.H. Atkinson, E.E. Triggs,

1901

W.S. Entwistle, W.J. Willey, G.H. Green, A. Eve, Capt. C.V. Daly, G. Pells, E.G. Tyler

F.E.D. Periera, F.K. May, A.H. Ginman, A. Vanderpooten, R. Poupart, H.E. Dunn, F. Huff,

1902

E. Berry, W.F. Thomas, R.D. Bangay, F.E. Burrows, W. Davies, Capt. H.J. Round, R.G. Kindersley

H.A. Ewen, E.C. Richardson, A.A. Kift, J. Lewis, H.E. Watterson, R.G. Newman, W.M. Simpson, G.E. Turnbull,

1903

D.W. Tulloch, J.R. Stapleton, F. Jones, J. Harvey, A.J. Huff, H.T. Worrall, E.T. Hills, L. Verbrugghen,

1904

H.J. Tattersall, A.J. Irvine, T. Iddon, W.A. Taylor, W.I. McGhez, J.R. Robinson, W. Platt, W.J. Collop,

W.N. Ball, F.S. Hayburn, A. Cappelaere, W. Tasker, H. Cornwall, F. Delasse, W.J. Gray, G. Ludwig,

1905

S.C. Parish, J.N. Johnson, W.B. Cole, E.J. Wagstaff, C.A. Manson, C.A. Mason, H.M. Burrows,

C. James, F.W.M. Herring, P. Treacy, A.C. Lewis, D. Macdonald, F.R. Pells, E. Horton,

1906

C.J. Ketteridge, Marquis L. Solari, F. Beatson, A.J. Chesterton, E. Hill, A.M. Young, D. Sutherland,

S. Stansbridge, Seton Smith, A. Ashley, W. Rogers, F. Baker, S.C. Hills, C.C. Rowe, H.D. Humphries, T.E. Hobbs,

J.C. Hawkhead, S. Kent, A. Fournier, A. Maernoudt, Annie König, M.J. Tastenoy, R.C.A. Kroes,

1907

H. Caswall, C.G. Rattray, T. Cox, J.H.T. Leggett, J. Connell, J.T. Marler, R. Cox, T.H. Stubbs,

E.J. Moore, C. Newar, H. Nicholls, A. Hubert, E.C. Montague, A. Cobham, S.T. Dockray,

1908

A.E. Merritt, W.J. Baden, J.F. Menear, W.D. Lacey, W. Shore, I. Atkinson, P.L. Outred, J. Campion, J. Hance, E. Dyer,

1909

J. Torry, N. Palmer, E. Prall, T. Cox, S.A. Cumberland, P. Dumenil, A.E. Martin, E.W. Hynes, P.B. May, G.G. Chapman,

C.T. Sanders, B. Wheeler, C.H. Norris, R.C. Quick, R.K. Rice, R.H. White, G.J. Boome, R.H. Strickland, N.S. Calder,

H.E. Shaw, T. Webb, G.S. Whitmore, G.H. Magnee, L.F. Mayer, R. Stroink, C. Cammaerts, J.M. Van Embden.

1910

## *Marconi Veterans' Annual Reunion and Dinner.*

---

newspapers reproduced photographs of what had happened a few hours earlier on the arrival of these airmen at the other side of the globe. This was really marvellous and holds out great hopes for future developments."

In concluding his toast to the Marconi organisation and the health of the new members, "Our Junior Veterans," he expressed the hope that the Reunion and Dinner might one day be held in Brussels.

Replying for the new members, Mr. G. S. Whitmore mentioned that quite early in his service with the Marconi Company he was impressed by the manner in which Mr. Marconi, as he then was, shared in the work, even the minor jobs, which indicated, in every sense of the word, that he was a great man. It was such collaboration, together with Marconi's consideration for his staff, which produced that spirit which enabled the Marconi organisation in the old days to overcome difficulties which might well have been regarded as insurmountable.

The Marchese Solari, on being called upon, said that he was doubly pleased that he came over from Italy to find himself among so many friends, first as a Marconi Veteran, and second for the honour now being paid to his great countryman, the Marchese Marconi. He had many pleasant recollections of years gone by which linked him in bonds of friendship with several of his colleagues who were present. In particular, he remembered the first time he met Mr. Gray. This was in 1901 when as a delegate of the Italian Government he came to London with the object of resuming relations on behalf of the Italian Navy with Marconi. Before leaving for Italy he placed the first order for four wireless stations, which were the first stations to give regular wireless service in Italy. It was on account of the good results given by them that the Italian Government put at the disposal of Marchese Marconi the s.s. "Carlo Alberto," of the Italian Navy, for the purpose of the famous experiments carried out on that ship, first in the Mediterranean and then later across the Atlantic to Canada.

The toast of Absent Members was proposed by Mr. Platt. He referred to those of whom we now had only affectionate memories—Mr. G. S. Kemp, Mr. R. Leith and Mr. W. J. Baden; to those who were absent through sickness and to whom the assembled company desired to send heartfelt wishes for speedy recovery, and to those who for various reasons other than health could only be present in spirit. He expressed the hope that many who were unavoidably absent on this occasion would be able to be present at the next Reunion.

In proposing "The Chairman," the final toast of the evening, Capt. H. J. Round recalled that Mr Dowsett was a pioneer of military wireless, as he was operating field sets in 1899 during the Boer War. Various incidents of his early career abroad were mentioned, and his long service at the Chelmsford Works, where he was loved by his staff. He had recently returned from a mission to Australia, and, judging from present appearances, Mr. Dowsett could still look forward to many years of active service in wireless.

The Chairman replied in suitable terms, and after a very enjoyable concert programme the proceedings terminated.

At the Annual General Meeting which preceded the Reunion, M. Travaillleur, of Brussels, was elected Chairman for 1935, and Capt. C. V. Daly, Deputy Chairman.

A vote of thanks was accorded to the members who had retired from the Standing Committee since 1932, namely, Messrs. C. S. Franklin, F. S. Hayburn, J. Lewis, Capt. H. J. Round, G. E. Turnbull and R. N. Vyvyan.

The following members were elected to the Standing Committee for 1935: Messrs. H. W. Allen, J. Connell, H. M. Dowsett, H. A. Ewen, Andrew Gray, A. H. Ginman, A. Hubert, A. A. Kift, W. Platt, and C. E. Rickard. A very hearty vote of thanks was accorded to the Hon. Sec., Mr. F. K. May, on whom had devolved most of the business connected with the Reunion, and to Mr. W. J. Collop, Hon. Treasurer.