

# THE MARCONI REVIEW

---

No. 45.

November-December, 1933.

---

---

Editor: H. M. DOWSETT, M.I.E.E., F.Inst.P., M.Inst.R.E.

---

---

## A NOTE ON TESTS OF THE "FLOATING CARRIER" METHOD APPLIED TO A BROADCASTING TRANSMITTER

*The orthodox method of amplitude modulation, whilst eminently satisfactory in many ways, possesses unavoidable disadvantages which have led to much experiment with a view to devising other and more efficient methods of modulation. Among these may be quoted many proposed systems of phase and frequency modulation, the majority of which have not been developed beyond a theoretical basis. An improved method of modified amplitude modulation in which the carrier power is automatically adjusted to suit the modulation is described below, and the results of some tests which have been carried out to determine its practical value are given. The system should prove of considerable interest as it enables a large saving of power to be effected.*

THE large amounts of power which are now considered essential for satisfactory service from the principal broadcasting stations and the fact that the types of transmitters normally employed for this purpose operate with a rather low efficiency, has naturally enough turned the attention of technicians towards devising methods aiming at reducing the electric power consumption, which obviously becomes an increasingly important factor with increase of transmitter power.

The Marconi Company has recently been experimenting with a power saving method which has been called the "Floating Carrier" system,\* or in other words, an automatic carrier control arrangement.

In this system, both the carrier power and the input power are small in the absence of modulation or in the presence of low degrees of modulation, which latter condition is the actual effect existing throughout the major period of a broadcasting transmission, whereas higher modulating voltages automatically increase the carrier power, with a consequent increase of the input power, to a value enabling the higher modulating voltages to be correctly reproduced.

---

\* Brit. Pat. Application No. 28359 (13.10.33).

*Tests of the "Floating Carrier" Method applied to a Broadcasting Transmitter.*

---

---

Preliminary measurements of proportionality, distortion and frequency response, in addition to observations by cathode ray oscillograph, having proved satisfactory, arrangements were made to radiate test transmissions from an outside aerial, and these trials took place at Chelmsford during the nights of October 4th, 5th and 18th.

The trials consisted of transmitting speech, piano music and various sound effects with the transmitter adjusted alternately for the normal constant carrier arrangement and for the "floating carrier" control. The aerial power during the normal adjustment was approximately eight kilowatts, which for the "floating carrier" method was reduced to less than 2 kw. in the absence of modulation.

Various observers stationed at distances ranging from a few yards up to some eight hundred miles, reported on the comparative "quality" produced by the two methods.

These listeners were not previously advised as to which system of operation was in use at a given time. Different types of receivers were employed, some incorporating automatic volume control and others of simple design.

The reports received were not unanimous in their conclusions, but the general inference seems to be to the effect that the difference, if any, between the two methods is very slight, and on some receivers certainly not detectable.

The new method is obviously interesting and may become of importance in future practice, so it has been considered worth while to place on record the dates of these preliminary trials.

W. T. DITCHAM.

# GRAPHICAL METHOD FOR DETERMINING FUNDAMENTAL WAVELENGTH OF A BROADCAST AERIAL

*In the following article the graphical methods adopted for practical filter and transmission line calculation are brought to bear on the design of aerials, and an ABAC has been developed which gives the wavelength of a broadcast aerial as a function of its dimensions.*

*The author points out that the valuable contributions to aerial theory which have been published from time to time have not proved to be entirely suitable for practical computation by installing engineers, and it is hoped that the present method of attack will afford all the assistance necessary in such cases.*

A PROBLEM which frequently faces the radio engineer concerned with the design of aerials and transmitting plant for use with medium and long waves is the predetermination of the fundamental, or in other words, natural wavelength of a projected antenna. For example, if the fundamental wavelength is known or fixed beforehand, it is an easy matter to calculate the additional inductance or capacitance necessary to increase or decrease the working wavelength, but usually the height and separation of the masts are fixed by local conditions or circumstances and the problem then becomes one of calculating the constants of the aerial, and in particular its capacitance and fundamental wavelength.

Prof. G. W. O. Howe conferred a great benefit on radio engineers in his paper read before the British Association in September, 1916, on the calculation of the capacitance of Radiotelegraph Antennæ and in his many subsequent articles, and his work enables us to predetermine with sufficient accuracy the capacitances of most types of antenna. Also, in an article in the Wireless Year Book for 1917, he treated in considerable detail the subject of inductance, capacitance and frequency of aerials.

His methods have not been adopted for daily office use, perhaps, to the extent that they merit, possibly because engineers engaged in commercial affairs have a predilection for simple formulæ or short cuts to the answers to aerial problems which continually present themselves. In particular, the calculation or predetermination of the natural wavelength of a projected antenna design still remains in practice largely a matter of guesswork, based on practical experience, and it is the object of the present note to facilitate the predetermination of fundamental wavelengths as far as possible by means of an ABAC.

It may be said that it is generally accepted theory and practice nowadays to treat the transmitting antenna as a simple or composite (as the case may be) open circuited transmission line, the sending end being normally at the earth connection.

When the aerial consists of a straight conductor of uniform characteristics, its fundamental wavelength is easily calculated, this being theoretically equal to 4 times the length of the conductor. In practice, it is approximately  $4.2 \times l^*$  due to the fact that the electric and magnetic fields extend slightly beyond the ends of the

\* See "The Distribution of Current in a Transmitting Antenna," R. Wilmotte, Proc. I.E.E., Wireless Section, Vol. 3, No. 8.

conductor, the antenna behaving, in fact, in a way similar to an open organ pipe whose wavelength is a fraction greater than twice the length of the pipe.

In the case of the composite antenna, we have usually a vertical, and one or more approximately horizontal members, the surge impedance of the vertical part differing from that of the horizontal member or combined members. The T or umbrella aerials, Fig. 1a and b, can be reduced to equivalent "L" types, Fig. 1c, by making the length "t" of the horizontal part equal to the length of one arm of the umbrella or T, and ascribing to it an inductance and capacitance equal to the joint inductances and capacitances of the arms in parallel.

Treated in this way we arrive at a composite transmission line, Fig. 1d, with one part (the vertical) having a length  $h$  and surge impedance  $Z_{oh} = \sqrt{\frac{L_h}{C_h}}$  and a second part (horizontal and open circuited) having a length "t" and surge impedance  $Z_{ot} = \sqrt{\frac{L_t}{C_t}}$

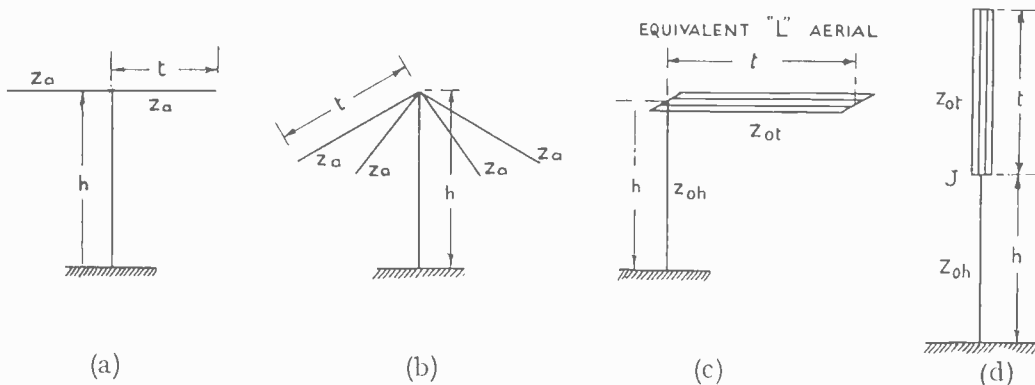
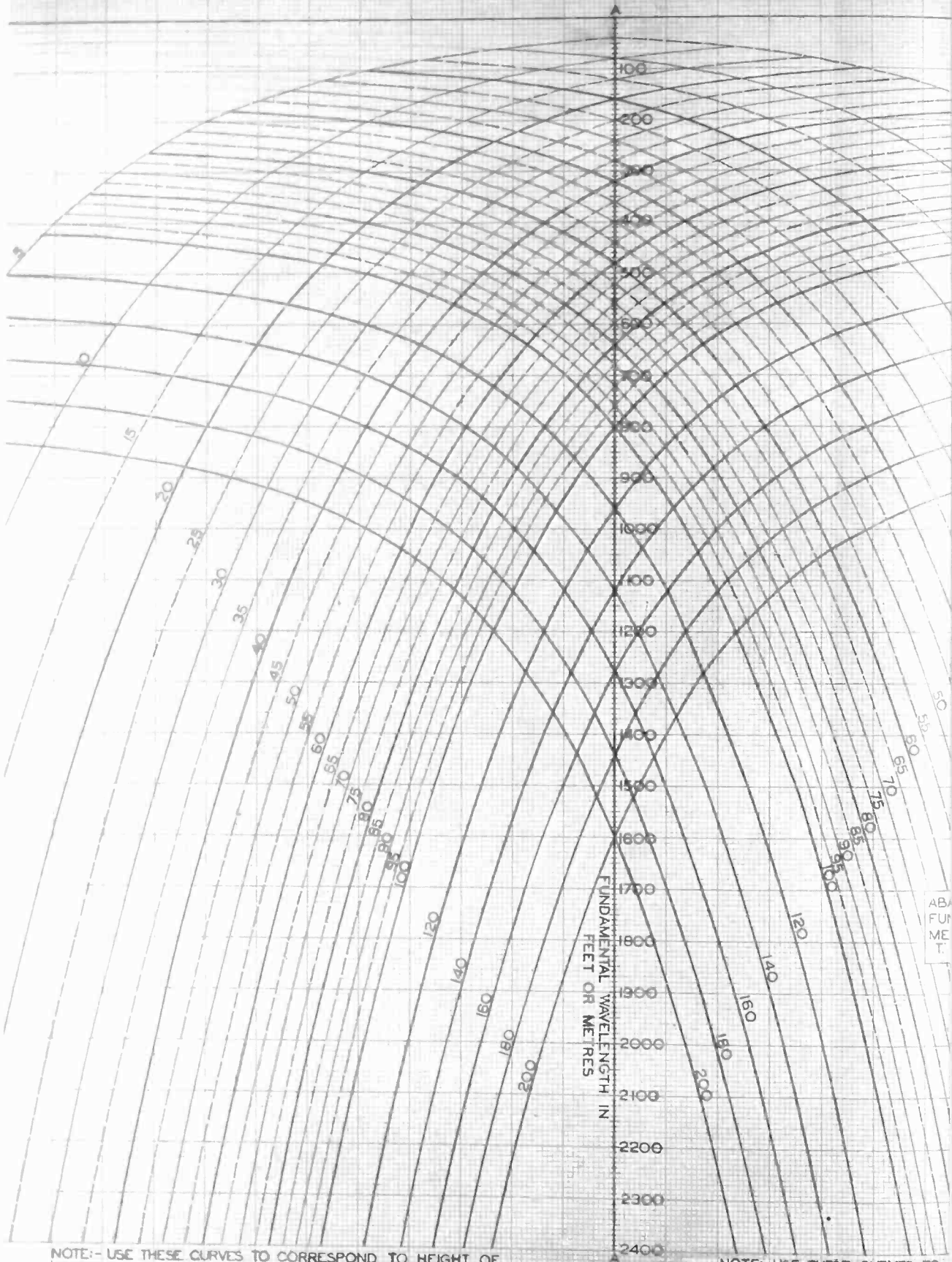
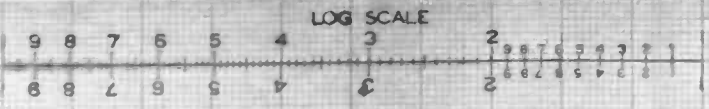

FIG. 1.

In the case of "T" aerials, if  $Z_a$  represents the surge impedance of each arm, then the surge impedance of the equivalent top of the "L" aerial will be approximately  $Z_{ot} = \frac{Z_a}{2}$  since the two arms are in parallel. Similarly for an umbrella aerial with say 6 arms the surge impedance of the equivalent top of an "L" aerial will be approximately  $Z_{ot} = \frac{Z_a}{6}$  where  $Z_a$  is the surge impedance of each rib of the umbrella.

We have thus a composite transmission line of which the sending end impedance is zero when tuned to resonance, and of which the far end is open circuited, with receiving end impedance infinity.

At the junction point "J" looking towards the open circuited end, the apparent impedance of the top  $t$  will be  $Z_J = \frac{Z_{ot}}{\tanh \beta_1 t}$  and looking towards the short



NOTE:- USE THESE CURVES TO CORRESPOND TO HEIGHT OF VERTICAL COMPONENT OF AERIAL IN FEET OR METRES.

NOTE:- USE THESE CURVES TO CORRESPOND TO HORIZONTAL COMPONENT OF AERIAL IN FEET OR METRES.

ABA  
FUR  
ME  
T.

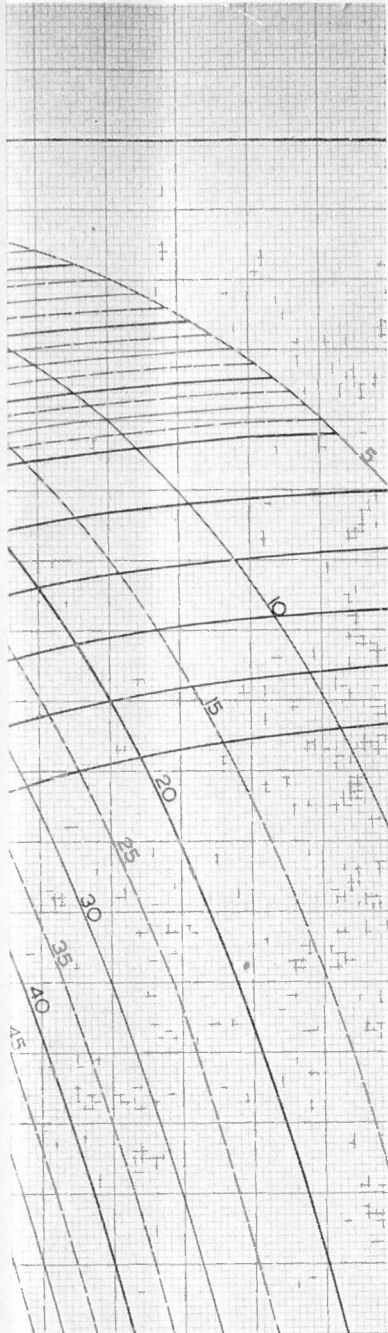

AC FOR DETERMINATION OF  
 NDAMENTAL WAVELENGTHS OF  
 DIUM AND LONG WAVE COMPOSITE  
 L AND UMBRELLA AERIALS.

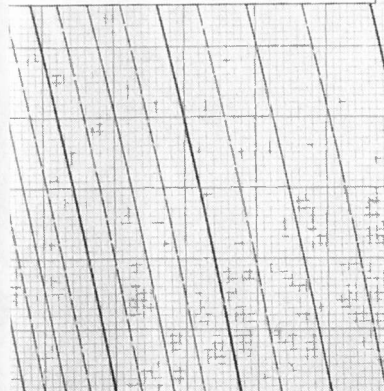

CORRESPOND TO LENGTH OF  
 AERIAL IN FEET OR METRES.

*Graphical Method for Determining Fundamental Wavelength of a Broadcast Aerial.*

circuited or sending end at the foot of the member "h," the apparent impedance will be

$$Z_J = -Z_{oh} \tanh p_2 h$$

where  $p_1$  and  $p_2$  are the respective propagation constants of the members "t" and "h" ( $p_1 = j\omega\sqrt{L_t C_t}$  and  $p_2 = j\omega\sqrt{L_h C_h}$ )

$$\text{and } \frac{Z_{ot}}{Z_{oh}} = -\tanh p_1 t \tanh p_2 h$$

$$= -j \tan j p_1 t \cdot j \tan j p_2 h = \tan \frac{2\pi t}{\lambda_0} \tan \frac{2\pi h}{\lambda_0}^*$$

$$\text{Hence } \log \frac{Z_{ot}}{Z_{oh}} = \log \tan \frac{2\pi t}{\lambda_0} + \log \tan \frac{2\pi h}{\lambda_0}$$

If we now draw a series of curves corresponding to  $\log \tan \frac{2\pi t}{\lambda_0}$  and  $\log \frac{2\pi h}{\lambda_0}$  above and below a zero line corresponding to values of  $t$  and  $h$  from say 5 up to 200 metres, plotted for all values of  $\lambda_0$  from 0 up to say 2,400 metres, we can by the use of a simple abac, solve the trigonometrical equation for the unknown fundamental wavelength  $\lambda_0$  when  $t$  and  $h$  and also the ratio of the respective surge impedances  $\frac{Z_{ot}}{Z_{oh}}$  are known, or alternatively we may rapidly determine "t" or "h" when the fundamental wavelength is fixed and either "h" or "t" are given.

The abac can be easily drawn by plotting values of  $L \tan \frac{2\pi y}{x} = L \tan \frac{360^\circ \times y}{x}$  on squared paper to 1 inch or 1 cm. scale, above and below a zero line corresponding to  $L \tan 45^\circ = 10$ . Thus the logarithmic values,  $\log \tan \frac{2\pi t}{\lambda_0}$  and  $\log \tan \frac{2\pi h}{\lambda_0}$  can be automatically added together by extending a strip of paper, from "t" curve to "h" curve at right angles to the  $x$  or  $\lambda_0$  axis. On 1 inch squared paper the curves can be rapidly plotted to four figure accuracy, and wavelengths are easily read on a scale corresponding to 1 inch = 100 metres.

**Instructions for use of ABAC for Predetermination of Fundamental Wavelengths of Composite Antennae.**

This abac, Fig. 2, makes use of the formula

$$\frac{Z_{ot}}{Z_{oh}} = \tan \frac{2\pi t}{\lambda_0} \tan \frac{2\pi h}{\lambda_0}$$

$$\text{or } \log \frac{Z_{ot}}{Z_{oh}} = \log \tan \frac{2\pi t}{\lambda_0} + \log \tan \frac{2\pi h}{\lambda_0}$$

in order to determine the fundamental wavelength  $\lambda_0$ , when the length and surge impedances of the vertical and horizontal members of an antenna are known.

*Procedure (a)* Calculate the ratio  $\frac{Z_{ot}}{Z_{oh}}$  of the surge impedance  $Z_{ot}$  of the top-arm of the aerial, to the surge impedance of the vertical member  $Z_{oh}$ . Let this ratio be =  $x$ .

\* See G. W. O. Howe, Wireless Year Book, 1917.

*Graphical Method for Determining Fundamental Wavelength of a Broadcast Aerial.*

(b) Measure  $x$  on the log scale along a strip of paper and apply the strip to the curves corresponding to height and length of top, as shown, keeping the slip of paper at right angles to the zero line AA.

(c) The point of intersection of the paper strip and the zero line AA indicates the fundamental wavelength of the antenna (Fig. 4).

*Example I.* Uniform single conductor "T" antenna, or "L" aerial with two conductor top, where  $t = 20$  m. and  $h = 80$  m. (Fig. 3a and b.)

NOTE.—Arms of top are in parallel

$$\text{Hence } \frac{Z_{ot}}{Z_{oh}} = \sqrt{\frac{\frac{1}{2}L}{\frac{2}{L}C}} = \sqrt{\frac{1}{4}} = \frac{1}{2} = x$$

$$\text{Log } x = -\text{log } 2$$

*Result.*—Fundamental wavelength = 470 m. (theoretical value). Adding 5 per cent. for end effect  $\lambda_0 = 470 \times 1.05 = 484$  m. =  $4.84 (h + t)$ .

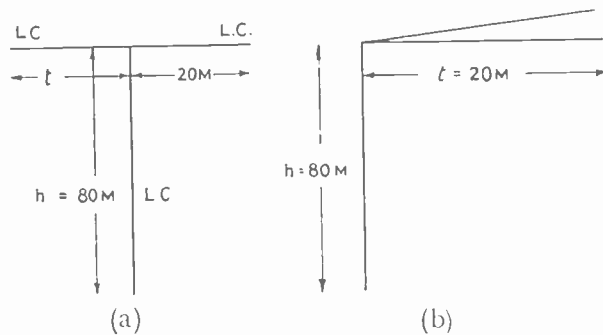

FIG. 3.

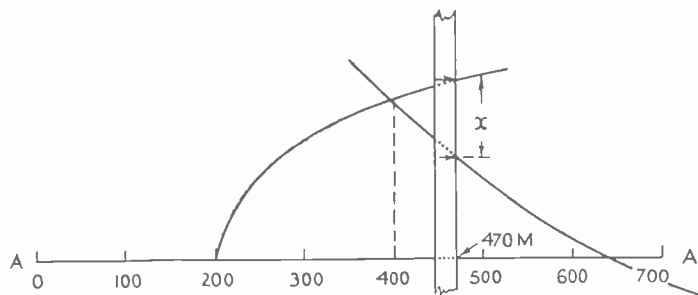

FIG. 4.



*Graphical Method for Determining Fundamental Wavelength of a Broadcast Aerial.*

*Example II.* "T" Antenna (Fig. 5), with top consisting of 10 wires, each 250 metres long, and 5 mm. diameter, spaced 2.5 metres apart, and with vertical limb consisting of 10 wires, fan shaped, 100 metres high, diameter of wires 5 mm.

Applying Prof. Howe's method of computation we find :—

$$C_l = .122 \text{ cms. per cm. of length for each arm} = .244 \text{ cms. for both arms.}$$

$$L_t = 8.2 \text{ cms. per cm. of length for each arm} = 4.1 \text{ cms. for both arms.}$$

$$C_h = .094 \text{ cms. per cm. of length.}$$

$$L_h = 10.64 \text{ cms. per cm. of length.}$$

$$\text{Hence } \frac{Z_{ot}}{Z_{oh}} = \sqrt{\frac{L_t}{C_l}} = \sqrt{\frac{4.1}{\frac{.244}{\frac{10.64}{.09}}}} = .385 = x = \frac{1}{2.6}$$

*Result.*—From curves  $\lambda_0 = (1,280 \times 1.05) = 1,344 \text{ metres} = 6 \times (h + t) \text{ approx.}$

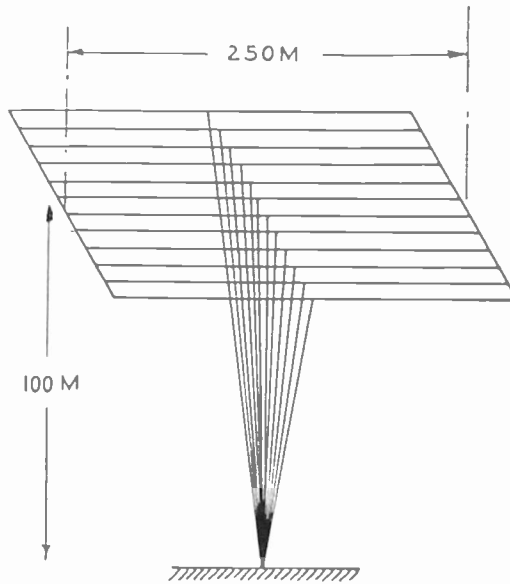

FIG. 5.

C. E. RICKARD.

## THE M.G.8A FREQUENCY METER

*The demand for fairly simple measuring apparatus of still greater accuracy and discrimination than was necessary only a few years ago has once again caused the Marconi Company to carry out investigations with a view to producing a transportable frequency meter to meet specific requirements.*

*These investigations have resulted in the production of a meter covering the band of 100 to 3,000 kcs. (3,000 to 100 metres), with a discrimination of not less than 1 part in 10,000 at any part of the frequency band, with visual indication, ease of operation, low temperature co-efficient, the instrument being not too large nor too heavy to be moved by the staff using it.*

THE instrument consists of a two part variable condenser shunted by fixed condensers, to which condenser system can be connected the inductances completing the calibrated circuit. Each inductance is arranged to select automatically the appropriate condenser with which it has been calibrated. To this circuit is connected a four electrode valve, taking little power from the measuring circuit and having a peculiar anode circuit which permits of high sensitivity, and also avoids the necessity of a grid bias battery.

The complete system is contained in an aluminium alloy screening case, with apertures for the valve, measuring inductance, battery and input leads, and with a window for observing the condenser scale position. The galvanometer indicator is secured in the top of the instrument, as are also certain other details of the entire unit. As the instrument is well screened it is impossible to present the measuring circuit directly to the frequency to be measured, and the introduction of this frequency to the instrument is arranged by means of a small "exploring" or "pick-up" circuit connected by a low capacity screened cable to a winding weakly coupled to the measuring circuit. The various details, briefly described above, will be more fully explained.

The diagram, Fig. 1, shows the complete connections of the instrument with an inductance for the higher frequencies in position. It also shows the connections of the mid and lower frequency ranges which illustrate the method by which automatic selection of the correct condenser is made.

In this diagram is shown the two-part variable condenser with the common electrode connected to the valve filament or earth point, and each part shunted by an appropriate fixed condenser. All condensers of the calibrated circuit are air dielectric, as are also the detuning condensers, and the small coupling condenser from the high potential end of the circuit to the detector valve. Shunting condensers of the valve circuit are of solid dielectric.

The condenser in such an instrument as this must be of superior construction and maximum robustness. Further, to ensure substantially equal discrimination at any part of the complete frequency band, the condenser must follow a definite law.

The condenser employed has a full swing of 180 degrees, which arc is divided into 200 main divisions and further divided by means of a vernier to 2,000 divisions. Of these 2,000 divisions, 1,500 are useful, the other 500 being partly available for

The M.G.8a Frequency Meter.

overlaps between adjacent ranges and partly useless on account of "end effects" where the law of the condenser does not hold good.

If the discrimination is to be 1 part in 10,000 per vernier division of scale, then the limits of any one range can be found from the formula:  $F=I(1+d)^n$ , where

- F is the final frequency of a range;
- I is the initial frequency of a range;
- d is the discrimination per vernier division;
- n is the number of useful vernier divisions.

In the case under discussion,  $d=1/10,000$ ,  $n=1,500$ ,  $I=100$  kcs.,  $F=116.17$  kcs.

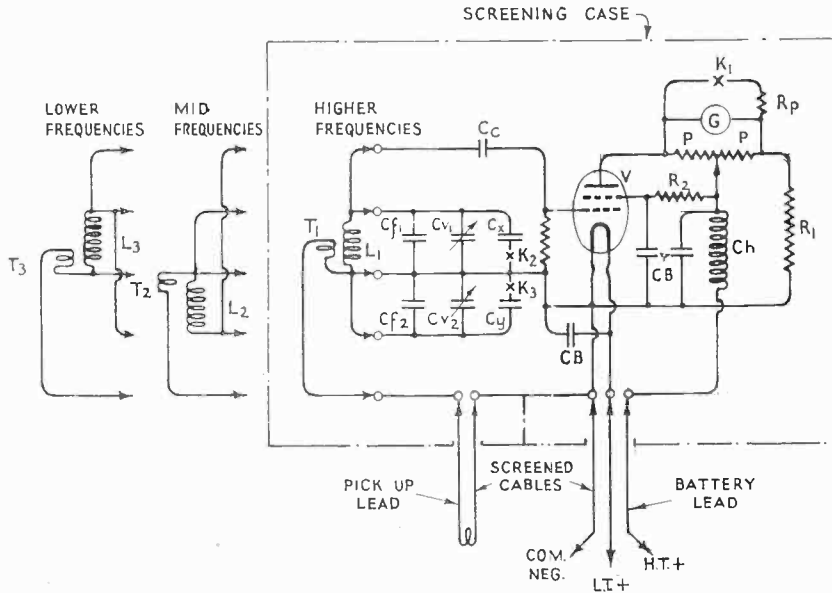

FIG. 1.

The total number of ranges for a given band width can be found from the formula:  $I(R)^T = Ff$

- where I is the initial frequency of the complete instrument;
- Ff is the final frequency of the complete instrument;
- R is the range factor;
- T is the number of ranges.

For the band width of 100 to 3,000 kcs., T becomes 22.7 approximately.

Now, it is well known that the range factor will change slightly with different inductances in use. Therefore the number of ranges has been increased to 25.

When using 25 ranges the range factor  $\frac{F}{I} = 1.14548$  in the ideal case, but in the real, some latitude must be allowed on account of such items as "coil capacity" if a total of 25 ranges is to be maintained.

The condenser has therefore been designed to have such a law so that the discrimination at any point in the useful scale shall not be less than the desired 1 part in 10,000 per vernier division.

# THE MARCONI STABILOVOLT CURRENT SUPPLY SYSTEM—PART II

*The first part of an article which deals with a system of stabilising the power supply obtained from rectified A.C. or other sources of current which are liable to fluctuation appeared in the September-October number of THE MARCONI REVIEW.*

*The concluding part of the article is given below.*

## The computation of maximum voltage fluctuations due to fluctuations in the mains supply.

(A) *With common series resistance.*

WHEN the supply voltage varies by  $\pm \Delta U_G$ , the output voltage from any gap varies by an amount

$$\pm [\Delta U] \cong \pm \Delta U_G \frac{w}{R} \dots \dots \dots (2)$$

If  $\Delta U_G$  is a periodic function (2) will indicate the filtering effect of the divider. In this case R is to be considered as the A.C. resistance of the series circuit.

*Example:* The supply voltage given in the example on p. 25 M.R. 44, where  $U_G = 500$  volts varies say  $\pm 10\%$ , i.e., an amount of  $\Delta U_G = \pm 50$  volts. This variation of the supply voltage causes in a glow gap divider the following output voltage variation:

$$\pm [\Delta U] \cong \pm \Delta U_G \frac{w}{R} = \pm 50 \frac{20}{5400} \cong 0.185 \text{ volts}$$

that is  $\pm 0.26\%$ .

In what follows methods will be described by which these low variations are further reduced.

Formula (2) shows that the constancy of voltage of the stabilised supply against supply voltage variations increases as the value of resistance R is increased. There are, however, other reasons making a higher resistance and consequently an increased feed voltage  $U_G$  desirable. When the feed voltage varies, the glow gap divider voltage remains constant, but the potentiometer current passing the glow gap divider varies, as the total variation is taken up by the series resistance. Now, care has to be taken that, with the lowest voltage which may happen to be the feeding voltage, the minimum requisite potentiometer current passes the glow gap divider.

These conditions can best be explained by an example. In the case of the normal mains voltage of 500 volts, a voltage drop of  $500 - 285 = 215$  volts is applied to the series resistance R. As the mains voltage can vary  $\pm 50$  volts, but as, on the other hand, the voltage in the glow gap divider of 285 volts remains constant, the voltages fed into the series resistance, in the extreme cases amount to 265 volts or 165 volts respectively. When  $R = 5400$  ohms, this will mean that the input current with the highest feed voltage

$$I_{max} = \frac{265}{5400} \approx 49.1 \text{ mA, with a normal feed voltage}$$

$$I_{norm} = \frac{215}{5400} \approx 40 \text{ mA and with the lowest feed voltage}$$

$$I_{min} = \frac{165}{5400} \approx 30.6 \text{ mA. So, the generator current, with an average value}$$

of 40 mA, varies  $\pm 9$  mA. Thus if in operation an under voltage of 10% can occur, we must no longer take into account the 9 mA. computed above as reserve current. Now, with normal voltage a minimum potentiometer current of about 20 mA. must pass the glow gap divider, in order to ensure that, with the slightest under voltage, the required minimum potentiometer current of 10 mA passes the glow gap divider. With a higher value of R, and consequently with a higher feed voltage value of  $U_G$ , the conditions become more favourable. Thus, circuit arrangements with simple Ohmic series resistance are useful in general only in those installations where low current intensities (say up to about 30 mA) are required, while the over, and under

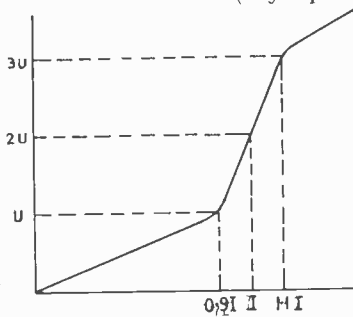

FIG. 7.

current intensities occurring due to the supply voltage variations are only of low value. For higher output current intensities suitable circuit arrangements are specified below.

(B) Barretters used as series resistances.

In stabilised power supply equipments for higher current intensities, it is useful to apply ballast lamps as series resistances. The combination of a glow gap divider and a barretter has proved specially efficient, as by their use the current intensity variations in the generator circuit, which originate from the variations of the supply voltage, are practically

eliminated. This further improves the constancy of the stabilised voltages with mains voltage variations.

Fig. 7 shows the voltage/current curve of a barretter resistance. The regulating range of barretters is 1 : 3 ;  $u$  indicates the voltage at the lower regulating range, consequently  $3u$  is the voltage of the upper range. The barretter does not give an ideal regulation, i.e., the current intensity is not absolutely constant, but varies within the regulating range by an amount of approximately  $\delta = \pm 8\%$  relative to the current intensity  $I$  with medium operating voltage  $2u$ . Now, the barretter, with normal feed voltage, should operate so much above  $u$  that, when the feed voltage drops to its minimum value, the operating voltage of the barretter does not drop below the value  $u$ . Therefore, when the amount of feed voltage variation is called  $\Delta U_G$ , by experiment\*

$$u > (\Delta U_G + 30) \text{ volts} \dots \dots \dots (3)$$

The resistance of a barretter with current variations, as will easily be found from

\* When a feed voltage of sufficiently high value is not available we can use the value  $u \geq (\Delta U_G + 10)$  volts. There is, of course, no objection from the electrical point of view against a higher voltage  $u$  than the value resulting from formula (3). For economic reasons the use of such a higher voltage is not desirable, especially when the D.C. voltage required is derived from rectifier valves and smoothed by condensers.

Fig. 7. will be

$$W_h = \frac{2u}{0.16} = 12.5 \frac{u}{1} \dots \dots \dots (4)$$

This value  $W_h$  should be inserted into formula (2) as series resistance when calculating the constancy of the stabilised voltages against feed voltage variations. When a choke of ohmic resistance  $R_L$  and a rectifier of internal resistance  $R_i$  are inserted before the glow gap divider,  $R$  in formula (2) should be replaced by

$$R = R_i + W_h + R_L \dots \dots \dots (5)$$

and thus

$$[\Delta U] = \pm \Delta U_G \cdot \frac{u'}{R_i + W_h + R_L} \dots \dots (2a)$$

Equation (2a), due to the thermal of the barretter, is only valid for slow variations of voltage. Variations of the useful voltage due to the quick supply voltage variations occur in accordance with formula (2) where  $R$  is the instantaneous resistance of the series circuit. In practice, a choking coil will usually be connected in series with the barretter, by which arrangement quick variations of the supply voltage will be reduced.

The following table shows the standardised types of barretters :—

Type	Current Intensity passing at $2u$	$u$	$\delta$	$W_h$	$R_h$
H 85-255/60 ...	60 mA $\pm$ 7%	85 V	$\pm$ 8%	17,700 $\Omega$	650 $\Omega$
H 85-255/80 ...	80 mA $\pm$ 3%	85 V	$\pm$ 8%	13,300 $\Omega$	550 $\Omega$
H 85-255/100 ...	100 mA $\pm$ 3%	85 V	$\pm$ 8%	10,600 $\Omega$	500 $\Omega$
H 20-60/80... ..	80 mA $\pm$ 3%	20 V	$\pm$ 8%	3,150 $\Omega$	130 $\Omega$
H 125-375/220 ...	220 mA $\pm$ 3%	125 V	$\pm$ 8%	7,100 $\Omega$	350 $\Omega$

The first three are specially suited for type STV 280/70 and STV 280/80 glow gap dividers, while the fourth is provided for the operation of two 70 volt gaps of a 200-240 volt D.C. mains supply. The fifth is for glow gap divider STV 600/200.  $R_h$  is the Ohmic resistance of the barretter measured immediately after disconnecting the latter, i.e., whilst still in warm state. These values must be taken into account when calculating the ignition condition. Barretters having any other characteristics can easily be manufactured. The lowest current limit is 60 mA.

*Example:* Fig. 8 shows an arrangement of an A.C. battery eliminator with a type STV 280/80 glow gap divider. A type H 85-255/80 barretter is used, and  $W_h=13,300 \Omega$  (*v.* Table.)

In order to save the wear of the barretter, let us keep the operating voltage below the value of  $2u$ , viz., at 155 volts. Let the chokes have a total value of  $R_L = 500 \Omega$ . Thus they cause a drop of approximately 40 volts. A voltage of

$$U_G = 285 + 155 + 40 = 480 \text{ volts}$$

should therefore exist at the first condenser of the rectifier. Experiment has shown that this D.C. voltage is obtained with a transformer voltage of  $2 \times 480$  volts. When the voltage on the first condenser varies  $\pm 10\%$ , i.e.,  $\Delta U_G = \pm 48$  volts, the useful voltage in a glow gap varies by an amount

$$[\Delta U] = \pm \Delta U_G \cdot \frac{w}{W_h + R_L} = \pm 48 \cdot \frac{20}{13,300 + 500} = \pm 0.0695 \text{ volts}$$

which, compared to approximately 70 volts, is nearly 0.1%.

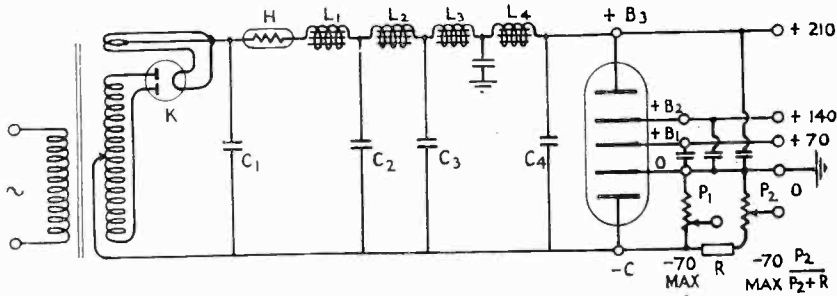

FIG. 8.

**The calculation of voltage variations in the glow gap divider, due to load variations.**

(A) *Self-influence.*

The voltage variations in a gap, caused by the variation of the useful current passing in a circuit parallel to that gap, is called its self-influence.

When the useful current derived from a gap varies for the amount  $\Delta i$ , the voltage in this gap varies by

$$\Delta U = \Delta i \cdot w. \quad \dots \quad \dots \quad \dots \quad \dots \quad (6)$$

$w$  being the A.C. resistance of the glow gap divider gap.

*Example:* If the current of a partial voltage varies by  $\Delta i = 25 \text{ mA}$ , then, with an A.C. resistance of  $20 \Omega$ , the partial voltage varies by

$$\Delta U = \Delta i \cdot w = 25 \times 10^{-3} \cdot 20 = 0.5 \text{ volts}$$

i.e., with a gap voltage of 70 volts a variation of 0.72%. If we calculate now the voltage variation for each gap, each gap being loaded with a combination of different loads, then  $\Delta U_1 + \Delta U_2 + \dots$  is the total variation of the glow gap divider. As the A.C. resistance of each individual glow gap divider lamp is not accurately  $20 \Omega$ , but varies slightly, these figures are only approximate. In stabilised power supplies, consequently, there will be a voltage variation of only 0.7% when a useful load of 25 mA is added or disconnected. The glow gap divider itself consumes only a potentiometer current of approximately 15 mA. Should it be desired to obtain the same degree of constancy with the old ohmic voltage division method as described in the examples, the potentiometer with 280 volts ought to have an ohmic resistance of  $4 \times 20 \Omega$  in case the power supply possesses a large internal resistance. Such a potentiometer, however, would consume alone a potentiometer current of 3.5 amps., against the 0.015 amps. consumed with the glow gap divider.

(B) *Mutual influence.*

The mutual influence is defined as the voltage variation in a gap due to the variations of the useful current derived from one or more other gaps. If current is derived from an ohmic voltage divider, the other partial voltages are known to be strongly influenced, i.e., in the case of ohmic voltage divisions the mutual influence is very great ; it is, however, of negligible value with glow gap dividers, being

$$\Delta\Delta U = \frac{w}{R} (\Delta U_1 + \Delta U_2 + \dots) \dots \dots (7)$$

where  $\Delta U_1 + \Delta U_2 + \dots$  is the sum of the self influences of all gaps from which varied currents are taken.  $w$  is a small value of say 20  $\Omega$  ;  $R$ , however, is a relatively high value of say 5,000  $\Omega$ . The interdependency of the individual part voltages is therefore only very low.

*Example :* In a type STV 280/40 glow gap divider, connected to a power supply through a resistance of  $R = 5,400 \Omega$  (see Fig. 5), a load of 25 mA is connected or disconnected between the electrodes +  $B_3$  and O. This causes in the gap O-C of the glow gap divider a voltage variation of

$$\Delta\Delta U = \frac{w}{R} \cdot (\Delta U_2 + \Delta U_3 + \Delta U_4) = \frac{20}{5400} (3 \times 0.5) = 0.00555 \text{ volts,}$$

i.e., with a gap voltage of 70 volts the voltage variation occurring will be 0.008%. This figure is of the order of the variation of the discharge current and shows clearly that single partial voltages are practically independent of one another.

**Ignition voltage of the glow gap divider.**

Each glow gap has another characteristic constant, its ignition voltage. The potential  $E + e_z$  (Fig. 6) requires a gap in order to operate. Each glow gap divider gap requires for ignition an excess voltage of  $e_z = 50$  volts. The use of ignition resistances ( $Z_1, Z_2, Z_3$  in Fig. 5) which connect the different electrodes with the most positive or with the most negative electrode, enable one or more glow gap dividers, when connected in series, to require no more excess voltage for ignition than 1 gap alone. Therefore, when 4 gaps are used, we do not require  $(4 E + 4 e_z)$  but only  $(4 E + 1 e_z)$ , thus in a type STV 280/40 glow gap divider the ignition voltage is  $285 + 50 = 335$  volts. The effect of the ignition resistances is that the different gaps do not ignite simultaneously but one by one, consequently only the last gap requires an excess voltage for the ignition ; for the others a voltage is available higher than necessary. Of course, the ignition resistances, when several glow gap dividers are connected in series, should be connected to some end point (either to the most positive or to the most negative input wire). The ignition resistances carry only very weak currents ; high resistances of about 200,000 to 300,000  $\Omega$  should be used (of low, say 0.5 watts, loading capacity). The loss of current in these is negligible. (In the case of several glow gap dividers connected in series, the ignition resistances should have still higher ohmic values ; they should carry a current of approximately 0.5 to 1 mA only.)

When firstly the feed voltage  $U_G$  and later on the useful load have been connected, the question of ignition needs no further examination. We can take out any important part desired of the generator current  $I$ . If, however, the load is



connected simultaneously with the glow gap divider, care must be taken to have a voltage of sufficient value available from the potentiometer formed by series resistance  $R$  and the various load resistances, in order to obtain proper ignition.

If  $n$  is the number of the glow divider gaps connected, and  $m$  the number of gaps bridged by a consumer, the lowest resistance to be connected simultaneously with the glow gap divider is :

$$x = R \cdot \frac{mU + e_z}{U_G - nU - e_z} \quad \dots \quad \dots \quad \dots \quad (8)$$

$U$  being the constant voltage of the individual glow gap divider gaps.

There is no question that a low series resistance is better for the ignition process than a high one, if the glow gap divider is to be connected simultaneously with the load. The best results are obtained with barretters, which in the sizes employed for this special purpose have a resistance, before connecting or re-connecting of max.  $R_h$  as per table (cold or not yet cooled). With barretters used as series resistances the highest load can be connected simultaneously without difficulty if no larger ohmic resistances are connected with them in series. Other factors have to be taken into account when calculating the values of the series resistances. After calculation it should, however, be ascertained whether the glow gap divider ignites in the case where it is connected simultaneously with its load. This can be done by calculation or experiment, by interrupting the power supply of the gap to be tested, and by measuring with a voltmeter inserted at the points where the glow gap divider gap is connected, whether the necessary ignition voltage exists. An examination to find whether one glow gap divider ignites in a certain circuit is insufficient for band manufacture, as it is possible that the trial tube may have a lower ignition voltage.

*Example :* Suppose we need to find how great the derivable currents might be chosen for the arrangement given in the example on p. 14 if that circuit is to be connected with its useful load. The ignition control is to be carried through with the minimum under-voltage

$$U_G - \Delta U_G = 480 - 48 = 432 \text{ volts.}$$

(a) For a load resistance  $r'$ , which is to be inserted between — C and O ( $n = 4, m = 1$ ) the inequality

$$r' \geq x = (R_h + R_L) \cdot \frac{mU + e_z}{(U_G - \Delta U_G) - nU - e_z}$$

should be fulfilled ; the experimental value of  $R_h$  being 550  $\Omega$  (v. table) and  $U$  being the average value of

$$\frac{285}{4} = 71.25 = 71 \text{ volts.}$$

Now  $r' \geq x = (550 + 500) \frac{1 \times 71 + 50}{432 - 4 \times 71 - 50} = 1,310 \Omega$ , consequently the

current  $i' \leq \frac{U}{x} = 54 \text{ mA.}$

The minimum potentiometer current, when the equipment is connected under load for the first gap O-C, will be about  $80 - 54 = 26 \text{ mA.}$

(b) For a resistance  $r$  inserted between O and  $B_3$  ( $n = 4, m = 3$ )

$$r \geq x = (R_h + R_L) \frac{mU + e_2}{(U_G - \Delta U_G) - nU - e_2} =$$

$$= (550 + 500) \cdot \frac{3 \times 71 + 50}{432 - 4 \times 71 - 50} = 2850 \ \Omega$$

so the current  $i \leq \frac{3U}{x} = 75$  milliamps.

The minimum potentiometer current, while the equipment is connected under load  $r$ , is for the gaps O to  $+B_3 = 80 - 75 = 5$  mA. This value of 5 mA, for other reasons, is, of course, low.

Theoretically there is the possibility that this calculation will result in an output current greater than the current fed into the glow gap divider in operation. The explanation is that at the moment when it is connected, a much higher current is fed into the glow gap divider by the "cold" barretter lamp. Such a paradoxical result only means that, from the ignition point of view, the total current intensity of the glow gap divider can be derived.

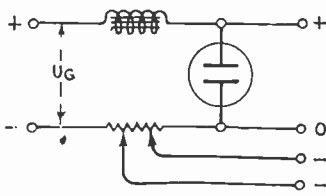

FIG. 9.

**On the practical application of the glow gap divider.**

Practice has taught that battery eliminators equipped with glow gap dividers show excellent results when supplying power to commercial sets for telegraphy and telephony reception, for picture telegraphy and television equipment, etc. The most complicated receivers which are built for battery operation and which could not be supplied by the

usual battery eliminators, can be operated without difficulty from battery eliminators equipped with glow gap dividers. In plants, in which the breakdown of the supply voltage would cause intense difficulties, a small petrol engine with generator or alternator can be used, thus avoiding the use of storage batteries.

Fig. 8 shows the circuit arrangement of the plate and grid supply. The cathodes of the thermionic valve are connected to electrode O. The various plate voltages are derived from  $+B_1, +B_2,$  or  $+B_3$  respectively, whilst the grid bias is taken from gap O-C. The grid bias is tapped from ohmic potentiometers connected in parallel to this gap. As the potentiometer terminals are at constant voltages, it is possible to provide these potentiometers for static grid bias with a volt scale by linear subdivision, so that the constant grid bias—in the same way as the plate voltage—becomes directly adjustable without using a measuring instrument. As regards the size of the grid bias potentiometer, it should be noted that the resulting resistance of the potentiometers connected in parallel must not become so low as to prevent ignition of the O-C gap (see example (a) on page 17). Such difficulties will not occur, unless more than one-third to one-half of the total generator current is taken out from the O-C gap by the potentiometers. The constants of the plate voltages and grid bias in the case of supply voltage variations can be determined by formulæ (2) and (2a) (see examples on pp. 12 and 14). The dependence of plate voltage on

plate current variations is given by formula (6), see example on page 15; of the grid bias on plate current variations by formula (7), see example on page 16. We find that the grid bias derived from the glow gap divider is practically independent of the plate current variations, even when abrupt signals of any duration are amplified. However, the method of deriving grid bias as shown in Fig. 9 is absolutely faulty. Even neglecting the fact that the voltage drop in the series resistance can vary by several per cent. (if the plate current varies), and that consequently the decoupling

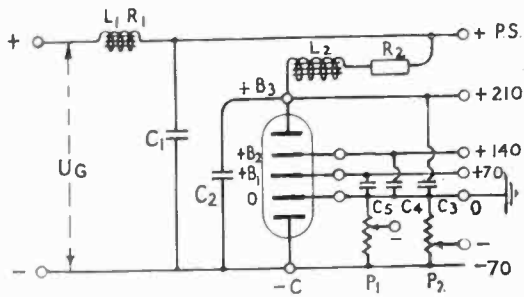

FIG. 10.

succeeding stages. By supplying power from glow gap dividers for the plate voltages and grid bias of transmitter input stages without quartz crystal modulation, a frequency stability of 1 in  $10^5$  can be attained. This property of the tube is valuable in those transmitters which have frequently to change their wavelengths, e.g., ship type transmitters, where the use of crystals is impossible. It is useful to use as the master oscillator an indirectly heated valve with a barretter used as filament current regulator. The voltage pulses often

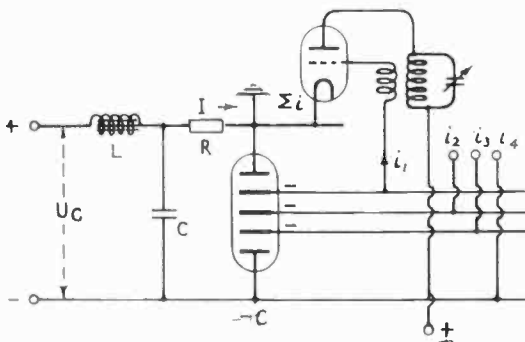

FIG. 11.

In transmitting arrangements, the outputs of which are not stabilised, circuit arrangements as Fig. 10 are usually chosen. The plate voltages of the sensitive first stages are derived from glow gap dividers, and it is possible also to take grid bias of the succeeding stages from a divider gap. Glow gap dividers are not only well suited for output of useful currents, but also for their input. The glow gap divider

can (see Fig. 11) be energised from a current source having relatively low current intensity, e.g., 20 mA. Additional grid current increases the load on the glow gap divider, but the individual grid bias remains stable. Thus it is possible to use a power supply of low wattage for the grid bias of a transmitting plant. It is possible, also, to derive all grid bias, including bias for the transmitting system and for the modulating system, from one supply by using several glow gap dividers. The modulation amplifiers of transmitters can also be fed with advantage from glow gap dividers.

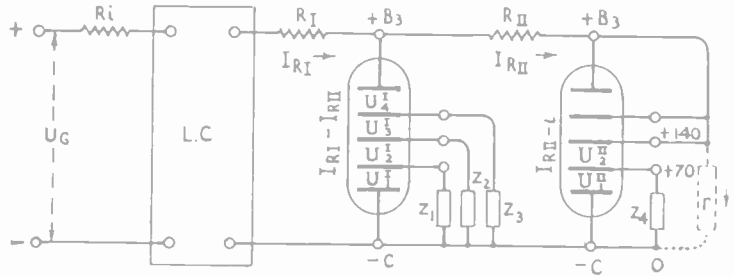

FIG. 12.

All power amplifier supply systems (e.g., in cinema installations) are of similar design as Fig. 10 and are supplied with advantage from glow gap dividers. Telephone repeater stations, especially those having small plate current consumption (up to 100 mA) can use battery eliminators stabilised by glow gap dividers, with advantage. For the larger stations a subdivision of current supply is, of course, possible without difficulty.

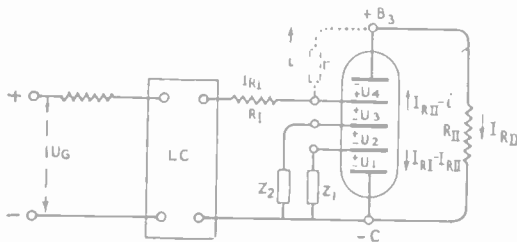

FIG. 13

the supply voltage, so-called cascade (Fig. 12) or dual circuit arrangements (Fig. 13) can be used. In principle this consists of the two-fold application of stabilisation. In the dual circuit the gaps of one glow gap divider are used instead of applying two separate glow gap dividers. Thus in Fig. 13 gaps  $U_1, U_2, U_3$  are used instead of the first divider tube, and gap  $U_4$  in the place of the second

Relays and remote measuring equipments are also supplied from glow gap dividers with advantage. Photoelectric cells and their pertaining amplifiers, etc., can be supplied from glow gap dividers instead of storage batteries, without difficulty. Floating storage batteries, the voltage of which—as is generally known—can vary to some extent, are often, especially for purposes of high frequency telephony along lines, supplemented by glow gap dividers. Battery charging equipments can also be designed with glow gap dividers. The circuit arrangement of Fig. 14 offers the

following advantage: the battery can never be overcharged; its voltage is kept accurately constant. If the glow gap divider should be withdrawn by mistake, or should its glass bulb break accidentally, the regulation would break down, but there would still be no overcharge, the power supply becoming disconnected as Gap O-C would then become a non-conductor. The dry plate rectifier Re, in the case of a breakdown of power supply, prevents the battery from being discharged. Thus, glow gap dividers can be used wherever voltage stability for relatively low output capacities is desired.

**Theory.**

The formulæ which are used in the first part are derived in connection with a general glow gap divider having  $n$  gaps in the following pages. The glow gap divider is connected to a current supply of  $U_G$  volts through a series resistance  $R$ . The electrodes, in all their combinations, are loaded with currents  $i_{pq}$ . Suffixes  $pq$  indicate those electrodes to which consumers are connected. The loading currents can also assume the value 0; an upper limit is given inasmuch as no divider gap must remain without current.

An ideal discharge gap—neglecting the first part of its characteristic—is described by the equation (also see Fig. 6),

$$U_k = E_k + I_k \cdot w_k \quad \dots \quad \dots \quad \dots \quad \dots \quad (9)$$

$U_k$  being the terminal voltage of the gap,  $I_k$  the gap current,  $w_k$  the A.C. resistance, and  $E_k$  the initial potential which is intercepted on the potential axis by the extension of the straight part of the intercepted characteristic. Accordingly, either of the discharge gaps can be replaced by an e.m.f.  $E_k$ , and a resistance  $w_k$  connected to it in series. The electric replacement circuit diagram for the circuit as in Fig. 15 is shown in Fig. 16.

**Influence of the supply voltage variations.**

When the supply voltage varies, the current in the glow gap divider varies also. A voltage variation on the glow gap divider can only occur due to current variations at the internal resistances. The constant starting voltages cannot play any part in the voltage variation. The series resistance  $R$  and the internal resistances

$\sum_{k=1}^n w_k$  form a potentiometer, and therefore, with unloaded glow gap dividers,

$$\pm [\Delta U_t] = \pm \Delta U_G \cdot \frac{w_k}{R + \sum_{k=1}^n w_k} \quad \dots \quad \dots \quad (10)$$

$R \gg w_t$ , by which fact the supply voltage variations are considerably reduced. In practice, the upper limit

$$\pm [\Delta U_t] < \pm \Delta U_G \cdot \frac{w_t}{R} \quad \dots \quad \dots \quad (10a)$$

should be applied. It is assumed—inasmuch as the curvature of the characteristic is negligible—that the output voltage variations which may occur due to supply voltage variations are *smaller* with loaded glow gap dividers than with unloaded. When a resistance of  $r_{k, k+1}$  is connected in parallel to the  $k$ -th gap (i.e. gap No.  $k$ ), and when no other useful load is connected in parallel with the  $k$ -th gap, then,

$$U_k = r_{k, k+1} \cdot i_{k, k+1} \quad \dots \quad \dots \quad \dots \quad \dots \quad (11)$$

$$I_m = I_k + i_{k, k+1} \quad \dots \quad \dots \quad \dots \quad \dots \quad (12)$$

combining this with (9)

$$U_k = \frac{r_{k, k+1}}{r_{k, k+1} + w_k} \cdot E_k + \frac{r_{k, k+1} \cdot w_k}{r_{k, k+1} + w_k} \cdot I_m \dots \dots (13)$$

Thus,  $U_k$  is composed of two components, the first one of which is reduced from voltage  $E_k$  by the potentiometer formed by  $w_k$  and  $r_{k, k+1}$  (see Fig. 16), while the second is the voltage drop of the generator current at the resistance  $w_k$  and  $r_{k, k+1}$  connected in parallel.

$$[\Delta U_k] = U_k' - U_k'' = \frac{r_{k, k+1} \cdot w_k}{r_{k, k+1} + w_k} \cdot (I_m' - I_m'') \dots (14)$$

$[\Delta U_k]$  has its maximum when  $r_{k, k+1} = \infty$ , i.e., when no load is connected at all. This consideration holds with any load connected. This proves the validity of formula (10) for the case of a loaded glow gap divider. As the derived upper limit conforms well with the real voltage variation value  $[\Delta U] = \pm \Delta U_G \cdot \frac{w}{R}$  (quoted for a general gap) as already applied, is right.

**The calculation of self influence.**

For the  $k$ -th part voltage

$$I_m = I_k + \sum_{p=1}^k \sum_{q=k+1}^{n+1} i_{pq} \quad (k = 1, \dots, n) \dots \dots (15)$$

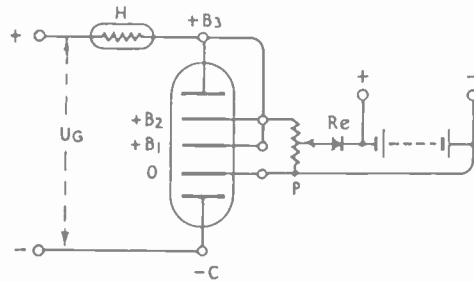

FIG. 14.

and by (9)

$$U_k = E_k + (I_m - \sum_{p=1}^k \sum_{q=k+1}^{n+1} i_{pq}) w_k \dots \dots (16)$$

moreover

$$U_G = \sum_{k=1}^n U_k - I_m \cdot R \dots \dots (17)$$

and by (16)

$$I_m = \frac{\sum_{k=1}^n E_k \cdot \sum_{k=1}^n \sum_{p=1}^k \sum_{q=k+1}^{n+1} i_{pq} \cdot w_k}{R + \sum_{k=1}^n w_k} \dots \dots (18)$$

The right hand side of equation (18) consists of known members. So  $I_m$  can be accurately determined when the glow gap divider is loaded. For practical calculations, however, only equation (1) is used.

The voltage variation  $\Delta U_t$ , which is caused on the  $t$ -th discharge gap by taking out from the  $p$  and  $q$  electrodes different currents  $i_{pq}^{(1)}$  and  $i_{pq}^{(2)}$  is expressed by

$$\Delta U_t = (I_t^{(1)} - I_t^{(2)}) w_t \cdot \dots \dots \dots \quad (19)$$

$I_t^{(1)}$  and  $I_t^{(2)}$  being those glow gap divider gap currents belonging to the load currents  $i_{pq}^{(1)}$  and  $i_{pq}^{(2)}$ . As long as  $p < t < q$ , the potentiometer current of the  $t$ -th discharge gap decreases due to increase of useful load. The self influence is voltage decrease. From (19) (15) and (18)

$$\Delta U_t = \left[ \sum_{p=1}^t \sum_{q=t+1}^{n+1} (I_{pq}^{(2)} - i_{pq}^{(1)}) \right] w_t + \frac{w_t}{R + \sum_{k=1}^n w_k} \left[ \sum_{k=1}^n \sum_{p=1}^k \sum_{q=k+1}^{n+1} w_k \cdot (i_{pq}^{(1)} - i_{pq}^{(2)}) \right] \quad (20)$$

The first member of equation (20) represents the algebraic sum of the variations of all currents flowing off in parallel as useful currents from the  $t$ -th gap, multiplied by the A.C. resistance of the  $t$ -th gap. Now, introducing the expression:

$$\sum_{p=1}^t \sum_{q=t+1}^{n+1} (I_{pq}^{(2)} - i_{pq}^{(1)}) = \Delta i_t \dots \dots \dots \quad (21)$$

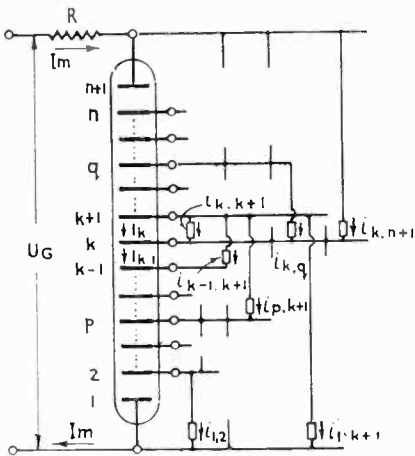

FIG. 15.

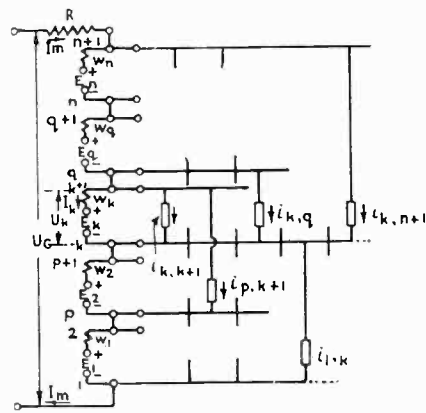

FIG. 16.

one obtains

$$\Delta U_t = \Delta i_t \cdot w_t - \frac{w_t \sum_{k=1}^n \Delta i_k \cdot w_k}{R + \sum_{k=1}^n w_k} \dots \dots \dots \quad (20a)$$

As  $i_{pq}^{(1)} < i_{pq}^{(2)}$ , the second member of equation (20) will always remain negative and

$$\Delta U_t < \Delta i_t \cdot w_t \dots \dots \dots \quad (20b)$$

The neglected number of equation (20b) is very small. Correspondingly it can be applied to the general gap  $\Delta U = \Delta i \cdot w$ , as already mentioned. The result (20b) can also be obtained without calculation in the following way: When the current of a glow discharge gap varies by an amount  $\Delta i$ , the voltage at the terminals of that gap will vary by  $\Delta i \cdot w$ . However, when the current taken out is  $\Delta i$ , the gap current will always change for an amount less than  $\Delta i$ , as the generator current, due to load, will slightly increase. Thus the voltage variation will always be smaller than  $\Delta i \cdot w$ .

**The computation of mutual influence.**

The load current varies between electrodes  $p$  and  $q$ . The voltage variation is calculated in accordance with the  $z$ -th gap lying outside the electrodes  $p$  and  $q$ . Let it be assumed that in parallel with the  $z$ -th gap, the load current has not varied at all. Equation (20a) applied to the  $z$ -th gap, leaving out those members becoming zero, becomes

$$\Delta \Delta U_z = - \frac{w_l \sum_{k=p}^q i_k \cdot w_k}{R + \sum_{k=1}^n w_k} \quad \dots \quad \dots \quad \dots \quad (22)$$

Applying the absolute values

$$\Delta \Delta U_z < \frac{w_l}{R} \sum_{k=p}^q \Delta i_k \cdot w_k \quad \dots \quad \dots \quad \dots \quad (22a)$$

The links mentioned underneath the  $\Sigma$  mark are the approximate values of self influence between electrodes  $p$  and  $q$ , whereby with relation to a general gap equation

$$\Delta \Delta U = \frac{w}{R} \cdot (\Delta U_1 + \Delta U_2 + \dots) \text{ is to be applied.}$$

**The computation of the ignition voltage.**

For the special case as stated on p. 16 the following inequality should be complied with

$$[U_G - (n-m) U] \frac{x}{R} \geq mU + e \quad \dots \quad \dots \quad \dots \quad (23)$$

This has its origin in that the  $n-m$  gaps not bridged by the useful load ignite immediately, and that the supply voltage with the operating voltage  $(n-m) U$  for the other gaps is decreased. This residual supply voltage, reduced by the potentiometer formed by the load and the series resistance, should still be sufficient for igniting the bridged  $m$  gaps.

From equation (23)

$$x \geq R \frac{m U + e}{U_G - nU - e}$$

as already used in (8).



# THE DESIGN OF LOW FREQUENCY, TRANSFORMER COUPLED AMPLIFIERS

*In the following article, the design of audio-frequency transformer-coupled amplifiers is examined from the viewpoint of wave filter theory in such a way as to ensure linear response over a wide band of frequencies. The effects resulting from component imperfections are treated in this manner, and an example is given of the performance obtained from an amplifier designed from such considerations.*

IT is well known that the causes of non-linearity in transformer-coupled amplifiers are :—

- (1) The shunting effect of primary inductance, causing loss of the lower frequencies.
- (2) The series choking effect of leakage inductances, causing loss of high frequencies.
- (3) Resonance effects due to leakage inductance and self-capacity of windings.

It is proposed to deal with these in order and to consider the best means of minimising or eliminating entirely their undesirable effects, but it may be as well to say now that a high- $\mu$  cored transformer has less leakage inductance and requires less turns for the same primary inductance. It is therefore better in every respect than a Stalloy core. Resistance and choke-fed transformers only are considered.

## Low Frequency Response.

The low frequency response can be improved by treating the transformer, choke, and coupling condenser as a high pass filter section, or, if resistance coupling be used, as a half-section.

As there is no advantage to be gained by using resistance coupling, except a slight saving in space and cost, and there is considerable loss in stage gain, the choke-fed transformer seems most attractive.

A circuit diagram of such an amplifier and its equivalent filter network are shown in Fig. 1A and B.

As the circuit is to be treated as a filter section, it must be terminated by a resistance. This resistance may be placed across either the primary or the secondary of the transformer. If placed across the primary, it must be made equal to the valve impedance ( $=Z_0$ ). If across the secondary, it must be made equal to  $K^2Z_0$ , where  $K$ =transformer step-up ratio.

The stage gain will then be  $K\mu/2$ , where  $\mu$  is the valve amplification factor.

To determine the values of  $2L_r$  and  $C$ , a lowest required frequency must be fixed ( $f_c$ ). It is better to decide first the value of  $C$ , as this can then be modified to a convenient value and  $f_c$  modified accordingly.

According to filter theory,

$$C = \frac{I}{4\pi f_c Z_o}$$

$$f_c = \frac{I}{4\pi C Z_o} \quad (\text{Modified value of } C)$$

$$L_1 = Z_o^2 C \quad (\text{Modified value of } C)$$

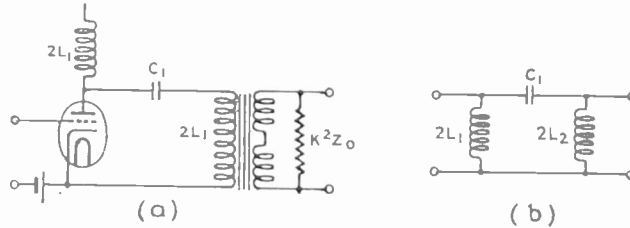

FIG. 1.

Thus, the primary inductance and choke inductance, with required value of D.C. flowing, must be  $2Z_o^2 C$ .

Frequencies below  $f_c$  will be rapidly attenuated.

To find what has been gained by this treatment, consider a similar choke and transformer with no terminating resistance and a (relatively) very large coupling condenser.

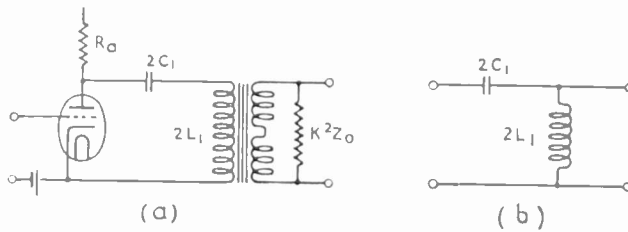

FIG. 2.

From the above, at  $f_c$ ,

$$L_1 = \frac{Z_o}{4\pi f_c}$$

$$\text{Then } j\omega L_1 = j2\pi f_c \times \frac{Z_o}{4\pi f_c} = j \frac{Z_o}{2}$$

( $L_1$  representing equivalent inductance of choke and transformer primary effectively in parallel).

Then the voltage loss will be represented by

$$\left[ \frac{jZ_0}{2} \right] \div \left[ Z_0 + \frac{jZ_0}{2} \right] = \frac{jZ_0}{2Z_0 + jZ_0} = \frac{j\mathbf{1}}{2 + j\mathbf{1}} = \frac{j2 + \mathbf{1}}{4 + \mathbf{1}}$$

$$\frac{\sqrt{2^2 + \mathbf{1}^2}}{5} = \frac{\sqrt{5}}{5} = .446 \text{ or } 7 \text{ db. at } f_c \text{ and will vary considerably with}$$

frequency, tending towards 0 db. as  $f$  increases.

On the same basis, neglecting the effective resistance of reactances, the arrangement first proposed would give a loss of 6 db. independent of frequency in the pass band.

In Fig. 2 is shown the circuit diagram of a resistance-fed amplifier and its equivalent half-section filter. This is treated in exactly the same way as the choke-fed circuit, the only differences being that the coupling capacity will now be twice as large as before and  $Z_0$  will be equivalent to the valve impedance in parallel with the anode resistance.

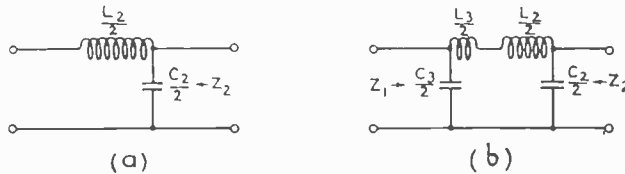

FIG. 3.

### High Frequency Response.

A relatively sharp cut-off and the absence of high frequency peaks can be obtained by treating the leakage inductance and effective self-capacity as a half section of prototype low-pass filter. This self-capacity occurs, of course, chiefly in the transformer secondary and in the valve.

An equivalent circuit of this arrangement is shown in Fig. 3A.

From filter theory,

$$Z_2 = \sqrt{\frac{L_2}{C_2}} \qquad f_c = \frac{Z_2}{\pi L_2}$$

Remembering that  $L_2$  is *twice* the leakage inductance, this will probably mean that the terminating resistance will be higher in value than that required for (1), but this can be overcome in either of two ways.

(A) By increasing  $\frac{C_2}{2}$  until  $\sqrt{\frac{L_2}{C_2}} = K^2 Z_0$

or (B) By connecting a resistance,  $R_p$ , across the primary, which, when in parallel with  $\frac{Z_2}{K^2}$  will be equal to  $Z_0$ . The former method has the disadvantage of reducing the cut-off frequency and reducing sharpness of cut-off, due to high coil losses, whilst the second gives an incorrect input impedance to the L.P. half-section. This, however, does not seem to be very disadvantageous.

Should a sharper cut-off be required, it can be obtained, with slightly increased cut-off frequency, by connecting a condenser across the transformer primary to form a full  $\pi$  section.

In this case the incorrect input impedance cannot be neglected and it appears reasonable to make the first half-section to match the input impedance and the second half-section to match the terminating impedance. This was also supported by experimental results.

The equivalent circuit is shown in Fig. 3B.

$$\begin{aligned} \frac{C_3}{2} &= \frac{Z_2}{Z_1} \cdot \frac{C_2}{2} & Z_2 &= \sqrt{\frac{L_2}{C_2}} \\ \frac{L_3}{2} &= \frac{Z_1}{Z_2} \cdot \frac{L_2}{2} & Z_1 &= \sqrt{\frac{L_2}{C_3}} \\ f_c &= \frac{Z_1}{\pi L_3} = \frac{Z_2}{\pi L_2} \end{aligned}$$

As it is rather difficult to find the exact values of  $\frac{C_3}{2}$  and  $Z_2$  from the above formulæ, possibly the most practical thing to do is to find  $Z_2$  for the half-section (as in Fig. 3A) and, according to the ratio of this and  $K^2 Z_1$  make it somewhat larger, or, more probably, the nearest convenient value.  $\frac{C_3}{2}$  can then be obtained from the above formulæ, or by experiment. If this is done intelligently, there should be no deviations from level of more than a fraction of a db. up to the frequency of cut-off.

Should the value of  $Z_2$  be less than  $K^2 Z_0$ , a lower impedance valve must be chosen and  $C_1$  modified accordingly. This will lower the bottom cut-off frequency.

### Example Design.

Input not to exceed two volts peak swing.

Required gain — 32 db. or 1 : 40.

Lowest required frequency — 30 cycles.

Highest required frequency — 12,000 cycles.

Valve chosen — MH4, 11,100 ohms impedance,  $\mu = 40$ .

Transformer ratio must therefore be 1 : 2.

$$Z_0 = 11,100 \text{ ohms.}$$

$$\begin{aligned} C_1 &= \frac{1}{4\pi f_c Z_0} \\ &= \frac{10^6}{4\pi 30 \cdot 11,100} \mu\text{F} \\ &= .230 \mu\text{F} \end{aligned}$$

Nearest convenient value is .25  $\mu\text{F}$ .

Then

$$L_1 = Z_0^2 C = 1.22 \times 10^2 \times 0.25 = 30.3 \text{ H}$$

The Design of Low Frequency, Transformer Coupled Amplifiers.

Therefore choke inductance and transformer primary inductance are each equal to  $2L_1$ , which is 60.6H.

Secondary leakage inductance was found to be 1.13H.

Natural secondary resonance with primary shorted—20 kc.

This gives self-capacity of secondary plus valve capacity as

$$.000056\mu\text{F} = \frac{C_2}{2}$$

$$\begin{aligned} Z_2 &= \sqrt{\frac{L}{C}} \\ &= \frac{1.13}{5.6 \times 10^{-11}} \\ &= 143,000 \text{ ohms.} \end{aligned}$$

$$\begin{aligned} f_c &= \frac{Z_2}{\pi L} \\ &= \frac{111100}{\pi \cdot 1.13} \\ &= 20 \text{ kc.} \end{aligned}$$

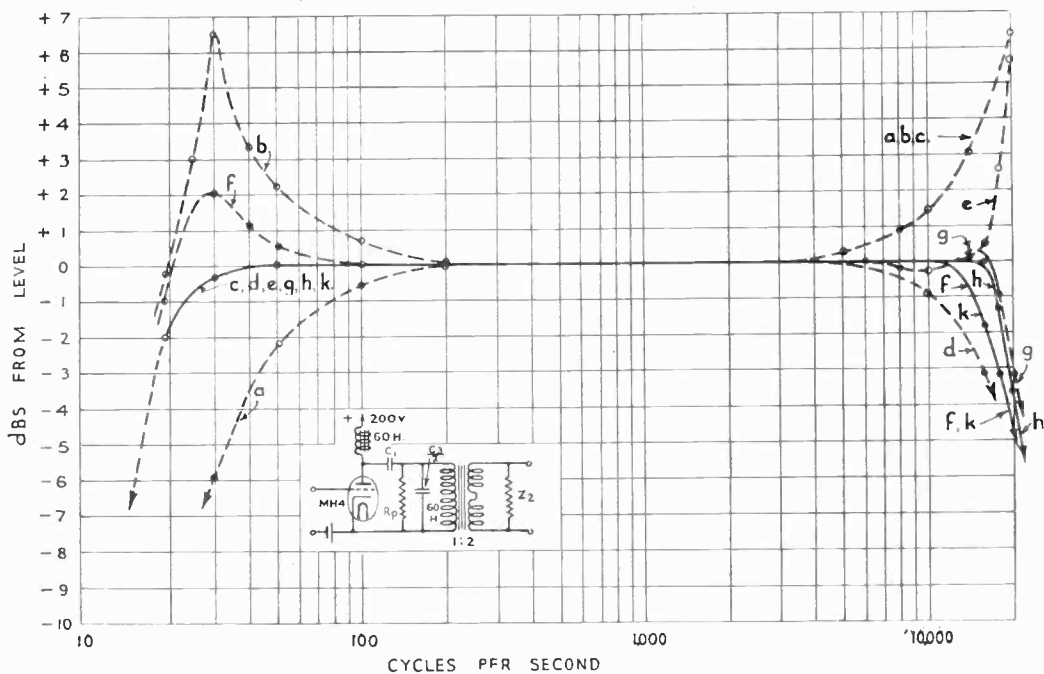

FIG. 4.

KEY TO FIG. 4.

Curve.	C	$\frac{C_3}{2}$	$R_p$	$Z_2$	Gain at 1000 $\sim$
(a)	10 $\mu\text{F}$	0	$\infty$	$\infty$	38 dB.
(b)	.25 $\mu\text{F}$	0	$\infty$	$\infty$	38 dB.
(c)	.25 $\mu\text{F}$	0	11,100 $\Omega$	$\infty$	32 dB.
(d)	.25 $\mu\text{F}$	0	$\infty$	44,400 $\Omega$	32 dB.
(e)	.25 $\mu\text{F}$	0	$\infty$	44,000 $\Omega$ + 1.9H	32 dB.
(f)	.25 $\mu\text{F}$	0	$\infty$	100,000 $\Omega$	35 dB.
(g)	.25 $\mu\text{F}$	0	$\infty$	200,000 $\Omega$	36.5 dB.
(h)	.25 $\mu\text{F}$	.002 $\mu\text{F}$	15,000 $\Omega$	200,000 $\Omega$	32 dB.
(k)	.25 $\mu\text{F}$	0	20,000 $\Omega$	100,000 $\Omega$	32 dB. } as designed,

The nearest convenient value larger than this was 200,000 ohms.

This gives the effect of a resistance of  $\frac{200,000}{K^2} = 50,000$  ohms across the primary and as the required value here is 11,100 ohms another resistance,  $R_p$ , must be connected in parallel with the primary circuit. This value can be found from the formula for parallel resistances.

$$R_p = \frac{\frac{Z_2}{K^2} \cdot Z_o}{\frac{Z_2}{K^2} - Z_o} = \frac{50,000 \times 11,100}{38,000} = 14,200 \text{ ohms.}$$

The nearest convenient value is 15,000 ohms.

Then

$$\begin{aligned} Z_1 &= \frac{R_p \times Z_o}{R_p + Z_o} \\ &= \frac{15,000 \times 11,100}{26,100} \\ &= 6,300 \text{ ohms.} \end{aligned}$$

Then

$$\begin{aligned} \frac{C_3}{2} &= \frac{Z_2}{Z_1} \cdot \frac{C_2}{2} \\ &= \frac{200,000}{6,300} \times 0.000056 \mu\text{F} \\ &= 0.0018 \mu\text{F.} \end{aligned}$$

The nearest convenient value is 0.002  $\mu\text{F}$ .

As can be seen from Fig. 4h, this transformer gave a practically straight-line response between 30 cycles and 17,000 cycles, beyond which it cut-off rapidly. The writer has no doubt that the use of more nearly correct values would have made the upper cut-off frequency the theoretical value of 20 kc., but as 12 kc. was all that was required, no investigations were made in this direction.

Although, in this particular case, the amplifier is preceded by a L.P. filter circuit to cut-off at 12 kc., it was considered advisable to lower the transformer cut-off slightly, whilst not making use of any refinements to obtain a sharp cut-off (in the interests of economy).

This was done experimentally by making  $Z_2=100,000$  ohms., necessitating a modification of  $R_p$  to 20,000 ohms, and the removal of  $\frac{C_3}{2}$ .

The result was a more gradual cut-off at about 13 kc. (see Fig. 4k).

It should always be remembered that when the transformer is to drive two valves in "push-pull," as in the present case, the secondary load resistance should be centre-tapped and by-passed to the cathodes. Otherwise the small capacity which exists between primary and secondary windings may be sufficient to "push both grids up and down" in the same phase.

In conclusion, it is believed that this method of treatment is original, and the results appear very satisfactory. They are, in fact, equally as good as resistance-capacity coupling, over the aural range, whilst having the advantages of greater gain and of being applicable to a push-pull circuit.

W. S. MORTLEY.

# MARCONI NEWS AND NOTES

## JAPAN HONOURS MARCHESE MARCONI.

**W**ORLD-WIDE acknowledgment of Marchese Marconi's unique position in modern science as the man whose fundamental inventions and discoveries have made wireless communication possible has again been demonstrated by the almost regal reception accorded to him by Governments and scientific authorities in every State that he has visited during his present tour of the United States of America and the Far East.

To mark the occasion of his recent visit to Japan, His Imperial Majesty the Emperor of Japan conferred upon Marchese Marconi the Grand Cordon of the Order of the Rising Sun. In bestowing this honour the Emperor has made a notable departure from the general precedent in accordance with which this class of the Order is reserved for Royal Princes or the highest ranks of the diplomatic corps in Japan.

Among past honours conferred upon Marchese Marconi are the honorary knighthood of the Grand Cross of the Royal Victorian Order, bestowed upon him in 1914, his Italian Marquisate, and numerous foreign orders and awards. He is President of the Italian Royal Academy, and a Member of the Council of the Fascist Party and of the Italian Senate, and has been presented with the freedom of numerous cities, including Rome. Among the many scientific awards granted to him are the Nobel Prize for Physics in 1909, the Medal of the Franklin Institute, Philadelphia, U.S.A., and the John Fritz Medal, awarded jointly by the Institutes of Electrical Engineers, Civil Engineers, Mechanical Engineers and Mining Engineers in the United States of America "for the invention of wireless telegraphy," the Kelvin Medal of the British Institution of Civil Engineers, and the Goethe Medal and Diploma presented to him by President von Hindenburg last year. He also holds honorary degrees of many Universities, including Oxford, Cambridge, Bologna, Glasgow, Aberdeen, Liverpool, Columbia, Pennsylvania and Louisiana.

Marchese Marconi is President of the Marconi Company, and is in general charge of the Company's research and technical activities.

### **Television Demonstration at Cambridge.**

**A** LECTURE on the Theory and Practice of Television, with special reference to the Marconi 50 line system, was given by Mr. H. M. Dowsett, Research Manager of Marconi's Wireless Telegraph Company, before the Cambridge University Wireless Society on November 13th. It was illustrated by some 30 slides in addition to an actual demonstration in the lecture theatre; a transmitting studio and screen receiver equipment being employed which projected a head and shoulders

or three-quarter length image on a screen about 2 ft. square. This was the first public demonstration of television to be given at Cambridge and it proved to be exceedingly popular. The audience was greater than the capacity of the hall, and a second demonstration was given at a large overflow meeting.

### **Short-Wave Wireless for Aircraft.**

**A** FURTHER example of the remarkable results obtainable with well designed short-wave wireless equipment both for ground-and-air communications over considerable distances and as a simple and reliable means of contact between aircraft flying in formation, is contained in the report of Colonel Zuloaga, Director-General of Army Aviation in Argentina, on the performance of the Marconi Type A.D.24d equipment installed in his aeroplane when he took a flight of Argentine aeroplanes from Buenos Aires to Rio de Janeiro on the occasion of the recent visit of the Argentine President to Brazil.

The flight covered a distance of 2,100 kilometres and the Director-General reports that telegraphic contact was maintained throughout with the terminal aerodromes although the Argentine station had only a two-valve receiver. Positions were reported every ten minutes and telephonic contact maintained with the rest of the units of the flight. Signals were always clear and powerful and no difficulty or delay of any kind was encountered.

The Marconi Type A.D.24d short-wave transmitter is designed particularly to meet the requirements of military and naval aircraft, and can be used with either a trailing aerial or a fixed aerial system. It provides both telephone and telegraph transmission over the waverange of 50-100 metres, and the stability of the transmission—of particular importance with short-wave apparatus—is assured by the independent drive method of frequency control.

It is arranged to take its power from the normal aircraft 12-volt lighting accumulator, a rotary transformer being used to provide high tension for the anode circuits.



# THE MARCONI REVIEW

---

No. 46.

January-February, 1934.

---

Editor: H. M. DOWSETT, M.I.E.E., F.Inst.P., M.Inst.R.E.

Assistant Editor: L. E. Q. WALKER, A.R.C.S.

---

## THE MARCONI-STILLE RECORDING AND REPRODUCING EQUIPMENT

*Among the many systems for the recording and reproduction of speech and music, the magnetic system evolved by Stille, and further developed by the Marconi Company, is proving of great utility, and it is felt that an article that briefly sets forth some of the features in the processes of magnetic recording and reproduction will prove of interest.*

THE general principle of magnetic recording was discovered as long ago as 1900 by V. Poulsen, who used it in the "Telegraphone." This instrument was developed primarily for the recording of high-speed telegraph signals, which were transcribed from the magnetic record by running it at a slower speed so that the reproduced signals were received at speeds normal for aural transcription. The possibilities of the system for recording and reproducing telephony were recognised by many scientific workers soon after Poulsen's original discovery, but the advent of methods of amplification and frequency correction using thermionic valves, alone made practical the utilisation of these possibilities, as the advent of broadcasting provided the incentive to develop them. To the German engineer Herr Stille must be given the great credit of developing the system with the aid of amplifiers up to the point where it could be practically applied for broadcasting purposes, whilst the engineers of the British Broadcasting Corporation, in collaboration with Mr. Von Heising, of Stille Inventions, Ltd., by applying frequency correction circuits to the system as developed by Stille, first succeeded in producing an arrangement which satisfactorily met the stringent conditions as to quality of reproduction which broadcasting imposes. The Marconi Company have further developed the system of amplification and correction used, and research work is being carried out in order to effect improvements in the magnetic materials and processes.

Before describing the apparatus, it would seem advisable briefly to outline the theory of magnetic recording. It will be clear upon a little consideration that whereas in mechanical recording it is possible to make a record directly from sound waves, it is necessary with magnetic recording first, by the use of a microphone and its associated circuits, to convert the acoustic speech waves into their equivalent electrical speech currents (for broadcasting this is done as part of the regular broadcasting process and the speech currents are already available). The speech currents are then made to produce corresponding magnetic flux changes in a moving "carrier" of suitable magnetic qualities such as retentivity and coercivity. This "carrier" may be in the form of relatively fine steel wire or of thin flexible steel ribbon or tape.

or three-quarter length image on a screen about 2 ft. square. This was the first public demonstration of television to be given at Cambridge and it proved to be exceedingly popular. The audience was greater than the capacity of the hall, and a second demonstration was given at a large overflow meeting.

#### **Short-Wave Wireless for Aircraft.**

**A** FURTHER example of the remarkable results obtainable with well designed short-wave wireless equipment both for ground-and-air communications over considerable distances and as a simple and reliable means of contact between aircraft flying in formation, is contained in the report of Colonel Zuloaga, Director-General of Army Aviation in Argentina, on the performance of the Marconi Type A.D.24d equipment installed in his aeroplane when he took a flight of Argentine aeroplanes from Buenos Aires to Rio de Janeiro on the occasion of the recent visit of the Argentine President to Brazil.

The flight covered a distance of 2,100 kilometres and the Director-General reports that telegraphic contact was maintained throughout with the terminal aerodromes although the Argentine station had only a two-valve receiver. Positions were reported every ten minutes and telephonic contact maintained with the rest of the units of the flight. Signals were always clear and powerful and no difficulty or delay of any kind was encountered.

The Marconi Type A.D.24d short-wave transmitter is designed particularly to meet the requirements of military and naval aircraft, and can be used with either a trailing aerial or a fixed aerial system. It provides both telephone and telegraph transmission over the waverange of 50-100 metres, and the stability of the transmission—of particular importance with short-wave apparatus—is assured by the independent drive method of frequency control.

It is arranged to take its power from the normal aircraft 12-volt lighting accumulator, a rotary transformer being used to provide high tension for the anode circuits.

---

# THE MARCONI REVIEW

---

No. 46.

January-February, 1934.

---

Editor: H. M. DOWSETT, M.I.E.E., F.Inst.P., M.Inst.R.E.

Assistant Editor: L. E. Q. WALKER, A.R.C.S.

---

## THE MARCONI-STILLE RECORDING AND REPRODUCING EQUIPMENT

*Among the many systems for the recording and reproduction of speech and music, the magnetic system evolved by Stille, and further developed by the Marconi Company, is proving of great utility, and it is felt that an article that briefly sets forth some of the features in the processes of magnetic recording and reproduction will prove of interest.*

THE general principle of magnetic recording was discovered as long ago as 1900 by V. Poulsen, who used it in the "Telegraphone." This instrument was developed primarily for the recording of high-speed telegraph signals, which were transcribed from the magnetic record by running it at a slower speed so that the reproduced signals were received at speeds normal for aural transcription. The possibilities of the system for recording and reproducing telephony were recognised by many scientific workers soon after Poulsen's original discovery, but the advent of methods of amplification and frequency correction using thermionic valves, alone made practical the utilisation of these possibilities, as the advent of broadcasting provided the incentive to develop them. To the German engineer Herr Stille must be given the great credit of developing the system with the aid of amplifiers up to the point where it could be practically applied for broadcasting purposes, whilst the engineers of the British Broadcasting Corporation, in collaboration with Mr. Von Heising, of Stille Inventions, Ltd., by applying frequency correction circuits to the system as developed by Stille, first succeeded in producing an arrangement which satisfactorily met the stringent conditions as to quality of reproduction which broadcasting imposes. The Marconi Company have further developed the system of amplification and correction used, and research work is being carried out in order to effect improvements in the magnetic materials and processes.

Before describing the apparatus, it would seem advisable briefly to outline the theory of magnetic recording. It will be clear upon a little consideration that whereas in mechanical recording it is possible to make a record directly from sound waves, it is necessary with magnetic recording first, by the use of a microphone and its associated circuits, to convert the acoustic speech waves into their equivalent electrical speech currents (for broadcasting this is done as part of the regular broadcasting process and the speech currents are already available). The speech currents are then made to produce corresponding magnetic flux changes in a moving "carrier" of suitable magnetic qualities such as retentivity and coercivity. This "carrier" may be in the form of relatively fine steel wire or of thin flexible steel ribbon or tape.

*The Design of Low Frequency, Transformer Coupled Amplifiers.*

---

The nearest convenient value larger than this was 200,000 ohms.

This gives the effect of a resistance of  $\frac{200,000}{K^2} = 50,000$  ohms across the primary and as the required value here is 11,100 ohms another resistance,  $R_p$ , must be connected in parallel with the primary circuit. This value can be found from the formula for parallel resistances.

$$R_p = \frac{\frac{Z_2}{K^2} \cdot Z_0}{\frac{Z_2}{K^2} - Z_0} = \frac{50,000 \times 11,100}{38,900} = 14,200 \text{ ohms.}$$

The nearest convenient value is 15,000 ohms.  
Then

$$\begin{aligned} Z_1 &= \frac{R_p \times Z_0}{R_p + Z_0} \\ &= \frac{15,000 \times 11,100}{26,100} \\ &= 6,300 \text{ ohms.} \end{aligned}$$

Then

$$\begin{aligned} \frac{C_3}{2} &= \frac{Z_2}{Z_1} \cdot \frac{C_2}{2} \\ &= \frac{200,000}{6,300} \times 0.000056 \mu\text{F} \\ &= 0.0018 \mu\text{F.} \end{aligned}$$

The nearest convenient value is 0.002  $\mu\text{F}$ .

As can be seen from Fig. 4h, this transformer gave a practically straight-line response between 30 cycles and 17,000 cycles, beyond which it cut-off rapidly. The writer has no doubt that the use of more nearly correct values would have made the upper cut-off frequency the theoretical value of 20 kc., but as 12 kc. was all that was required, no investigations were made in this direction.

Although, in this particular case, the amplifier is preceded by a L.P. filter circuit to cut-off at 12 kc., it was considered advisable to lower the transformer cut-off slightly, whilst not making use of any refinements to obtain a sharp cut-off (in the interests of economy).

This was done experimentally by making  $Z_2=100,000$  ohms., necessitating a modification of  $R_p$  to 20,000 ohms, and the removal of  $\frac{C_3}{2}$ .

The result was a more gradual cut-off at about 13 kc. (see Fig. 4k).

It should always be remembered that when the transformer is to drive two valves in "push-pull," as in the present case, the secondary load resistance should be centre-tapped and by-passed to the cathodes. Otherwise the small capacity which exists between primary and secondary windings may be sufficient to "push both grids up and down" in the same phase.

In conclusion, it is believed that this method of treatment is original, and the results appear very satisfactory. They are, in fact, equally as good as resistance-capacity coupling, over the aural range, whilst having the advantages of greater gain and of being applicable to a push-pull circuit.

W. S. MORTLEY.

# MARCONI NEWS AND NOTES

## JAPAN HONOURS MARCHESE MARCONI.

**W**ORLD-WIDE acknowledgment of Marchese Marconi's unique position in modern science as the man whose fundamental inventions and discoveries have made wireless communication possible has again been demonstrated by the almost regal reception accorded to him by Governments and scientific authorities in every State that he has visited during his present tour of the United States of America and the Far East.

To mark the occasion of his recent visit to Japan, His Imperial Majesty the Emperor of Japan conferred upon Marchese Marconi the Grand Cordon of the Order of the Rising Sun. In bestowing this honour the Emperor has made a notable departure from the general precedent in accordance with which this class of the Order is reserved for Royal Princes or the highest ranks of the diplomatic corps in Japan.

Among past honours conferred upon Marchese Marconi are the honorary knighthood of the Grand Cross of the Royal Victorian Order, bestowed upon him in 1914, his Italian Marquisate, and numerous foreign orders and awards. He is President of the Italian Royal Academy, and a Member of the Council of the Fascist Party and of the Italian Senate, and has been presented with the freedom of numerous cities, including Rome. Among the many scientific awards granted to him are the Nobel Prize for Physics in 1909, the Medal of the Franklin Institute, Philadelphia, U.S.A., and the John Fritz Medal, awarded jointly by the Institutes of Electrical Engineers, Civil Engineers, Mechanical Engineers and Mining Engineers in the United States of America "for the invention of wireless telegraphy," the Kelvin Medal of the British Institution of Civil Engineers, and the Goethe Medal and Diploma presented to him by President von Hindenburg last year. He also holds honorary degrees of many Universities, including Oxford, Cambridge, Bologna, Glasgow, Aberdeen, Liverpool, Columbia, Pennsylvania and Louisiana.

Marchese Marconi is President of the Marconi Company, and is in general charge of the Company's research and technical activities.

### **Television Demonstration at Cambridge.**

**A** LECTURE on the Theory and Practice of Television, with special reference to the Marconi 50 line system, was given by Mr. H. M. Dowsett, Research Manager of Marconi's Wireless Telegraph Company, before the Cambridge University Wireless Society on November 13th. It was illustrated by some 30 slides in addition to an actual demonstration in the lecture theatre; a transmitting studio and screen receiver equipment being employed which projected a head and shoulders

or three-quarter length image on a screen about 2 ft. square. This was the first public demonstration of television to be given at Cambridge and it proved to be exceedingly popular. The audience was greater than the capacity of the hall, and a second demonstration was given at a large overflow meeting.

#### **Short-Wave Wireless for Aircraft.**

**A** FURTHER example of the remarkable results obtainable with well designed short-wave wireless equipment both for ground-and-air communications over considerable distances and as a simple and reliable means of contact between aircraft flying in formation, is contained in the report of Colonel Zuloaga, Director-General of Army Aviation in Argentina, on the performance of the Marconi Type A.D.24d equipment installed in his aeroplane when he took a flight of Argentine aeroplanes from Buenos Aires to Rio de Janeiro on the occasion of the recent visit of the Argentine President to Brazil.

The flight covered a distance of 2,100 kilometres and the Director-General reports that telegraphic contact was maintained throughout with the terminal aerodromes although the Argentine station had only a two-valve receiver. Positions were reported every ten minutes and telephonic contact maintained with the rest of the units of the flight. Signals were always clear and powerful and no difficulty or delay of any kind was encountered.

The Marconi Type A.D.24d short-wave transmitter is designed particularly to meet the requirements of military and naval aircraft, and can be used with either a trailing aerial or a fixed aerial system. It provides both telephone and telegraph transmission over the waverange of 50-100 metres, and the stability of the transmission—of particular importance with short-wave apparatus—is assured by the independent drive method of frequency control.

It is arranged to take its power from the normal aircraft 12-volt lighting accumulator, a rotary transformer being used to provide high tension for the anode circuits.