

# THE MARCONI REVIEW

---

No. 42.

May-June, 1933.

---

Editor: H. M. DOWSETT, M.I.E.E., F.Inst.P., M.Inst.R.E.

---

## THE CRYSTAL DRIVE OF THE EXPERIMENTAL SHORT WAVE BROADCASTING STATION G5SW

*The experimental station, G5SW, situated at the works of the Marconi Company, Chelmsford, was leased by the British Broadcasting Corporation for use in its preliminary experiments in High Power Short Wave Empire Broadcasting. The station finally ceased working on broadcast transmissions when the B.B.C. Imperial Short Wave Station opened at Daventry.*

*The experimental nature of G5SW rendered it particularly suitable for the trial of circuit modifications, one of which, a crystal control circuit, is described below.*

THE crystal drive which was fitted to the short wave station G5SW late in 1932 was the result of a number of experiments, on the subject of Quartz controlled transmitters, and although many stations have been fitted with Quartz oscillators, the drive which was installed at G5SW embodied improvements which had been tested out in the Laboratory, but had not yet been used on a station working a daily service.

The frequency of the station G5SW was conveniently high to permit of a number of difficulties being encountered in producing and installing a drive of a new type, which difficulties might not be so evident on a station of lower frequency, such as in the common broadcast band. Also, as the production of a quartz crystal of 11,750 kcs. cannot be undertaken at the present state of the art, the fitting of the station with a crystal drive gave an opportunity of starting with a crystal of comparatively low frequency, and by means of a chain of frequency doublers, multiplying the initial frequency to that of the output frequency.

Whilst it is the usual practice to use an oscillator system of  $1/n$ th the carrier frequency on most types of constant frequency drives, it is not very often that the frequency of the master oscillator is as low as  $1/64$  of that of the final. Usually, for the ordinary broadcast band, the master oscillator frequency is one half that of the output, and in the case of "short waves," down to say 15 metres, the factor is of the order of  $1/8$ th, but in the case of the station under discussion the low frequency was chosen as it permitted information to be gained on a very wide range of frequencies and the apparatus used in obtaining those frequencies.

The points which had been dealt with in the Laboratory and were embodied in the complete drive are as follows :—

- (1) A Quartz crystal of very low temperature coefficient.
- (2) A new type crystal holder in which alterations due to temperature change are reduced to a low order.
- (3) Non-luminous heaters in the thermal chamber.
- (4) A new adjustable mercury thermostat.
- (5) The mercury vapour valve, or Thyatron, as the switch for the heater system of the thermal chamber.
- (6) A.C. lighting of all valves of the system.
- (7) Screened grid valve as the crystal maintaining valve.

The foregoing points need some elaboration. In 1929 the Marconi Research Department had, after a number of experiments, produced Quartz crystals whose temperature coefficient per degree Centigrade was of a very low order. These experiments had shown that the ratio between axial dimensions of the crystal not only has a bearing on the frequency, but also is responsible for the temperature coefficient of the crystal. By suitably proportioning the dimensions of the axes of a crystal cut from the natural body in a certain direction, it is possible to arrange that the crystal shall have a positive or a negative temperature coefficient for a certain frequency, and by very careful adjustment of the axes the coefficient can be reduced to such a small value as to be beyond the limits of ordinary measurement. Unfortunately, owing to the dimensions of such a "no temperature coefficient" crystal, the frequency band at present capable of being covered is limited, being roughly between 160 and 320 kcs., but in the case of G5SW this was of no serious importance as it was desired to start at a low frequency and finish at a much higher one.

On account of the information at hand it was decided to produce a crystal of low temperature coefficient, and use it on the drive.

The second point to be decided was the holder for the crystal. It had been shown that a crystal standing on one of its edges could be caused slightly to change its frequency as the holder was rocked and the crystal caused to "heel" over from one electrode to the other. This frequency change due to "heeling" is evident even though the air gap between crystal and electrodes is reduced to a fine order.

This information had resulted in the production of a crystal holder in which the crystal rests on one of its faces and is retained about its mid section to prevent rotation and side play. Such a holder has been illustrated and described in the MARCONI REVIEW (No. 37, 1932, The Quartz Oscillator, Fig. 10).

A holder of this type on account of its many advantages over the more simple type, was used in the Crystal Drive for G5SW.

The third point for consideration was the type of heater to be used in the thermal chamber. Up to the time that this drive was designed it was the usual practice to use ordinary carbon incandescent lamps for the purpose, and whilst it must be admitted that there is something to be said in favour of such a system, it cannot be denied that the use of lamps entails the construction of a large thermal chamber, and that as a general rule such a heating system is inefficient and only capable of rather poor regulation. The one great point in favour of lamp heating is that lamps can be easily obtained in practically any part of the world, and delays are not of long duration should a breakdown occur.

A useful alternative to the lamp heating is that afforded by the resistance mat manufactured by the Cressall Company. These mats are well known in many branches of the Electrical Industry, and need no description here. By employing this system of heating the thermal chamber can be much smaller than a chamber

in which lamp heating is used, the mats can be arranged to closely enshroud the inner metal chamber, and a much more uniform temperature within the inner chamber is maintained. Therefore on account of size, efficiency, and even distribution, lamps were discarded and Cressall Resistance Mats used instead.

The Thermostat next required attention. Two types of instrument had been used in other apparatus. They were the Toluene Regulator, and the more common bi-metal device.

The temperature stability obtained by the Toluene Regulator had been well demonstrated, but its size and liability to fire precluded its use in the present case.

The bi-metal scheme can be made to give fine regulation, but its adjustment is necessarily coarse, and the whole device is generally clumsy.

About this time the Marconi Company had succeeded in making elegant seals of copper into glass, and when the thermostat was designed, they produced a number which were tried out, and one of which was used as the thermal controller for the heated chamber. The thermostat is a mercury thermometer consisting of the usual capillary tube terminating at one end in a long cylindrical bulb with a platinum wire sealed therein. At the other end the tube is opened out into a short thistle funnel and into this funnel is sealed a short piece of copper. This copper is fashioned at one end in a manner suitable for sealing into the glass, and the other end is drilled and tapped. Through this tapped hole is run a steel screw which is drilled throughout its length, and down this hole is passed a fine steel wire. The head of the screw carries a simple gripping device so that the wire can be held securely, and a lock-nut is run on the screw thread.

Figure 1 shows the general scheme of the thermostat. To adjust, one slacks off the grip on the wire and withdraws or inserts as required, locking after the operation. This is a rough adjust-

ment, and it is followed by slacking off the lock-nut and rotating the screw, re-locking after each adjustment. This is the final fine adjustment. It is very easily handled, and a temperature can easily be regulated to better than one tenth degree Centigrade.

The question of switching the heater currents was next decided.

An alternating current supply being always available, there appeared to be no objection to using a Thyatron with A.C. lighting and anode supply, and D.C. grid cut off. A small Thyatron will pass rather more than .25 ampere anode current

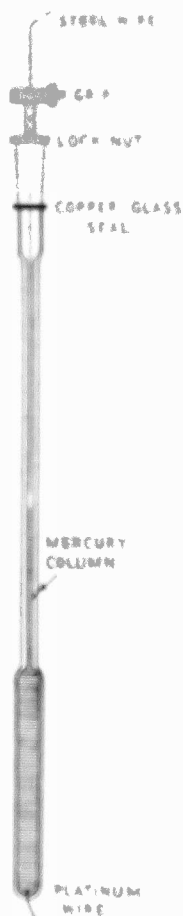

FIG. 1

through a suitable protective resistance at voltages up to about 1,000. If the anode supply is alternating, the anode current can be cut off by the use of a D.C. voltage applied to the grid.

Such a system as this appeared ideal, but in actual practice it was found that the Thyatron in action modulated the H.F. generated by the crystal system to an alarming extent, even though the crystal was encased in a metal holder separated from the anode resistance (heater mats) by a completely closed copper cylinder which was earthed.

At the beginning of the work the modulation caused by the Thyatron was intense, but this was finally reduced to zero, by enveloping the resistance mats in an electrostatic screen, and by the manufacture of two special screened leads connecting the crystal to the maintaining valve.

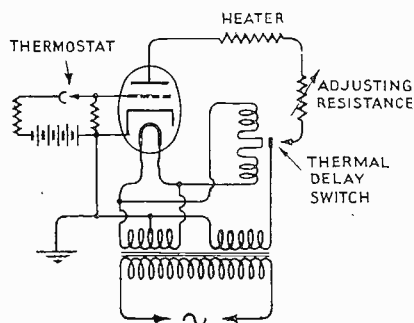

FIG. 2.

Figure 2 gives the diagram of connections of the Thermostat, Heaters and Thyatron. The current at the thermostat contacts is almost 20 microamperes, and the heater current is .18 ampere at 230 volts at the transformer terminals.

Here will be seen the indirectly heated A.C. lighted Thyatron, and with A.C. supply through the resistance, or heater mats, the D.C. grid bias, resistances, and thermostat, and the thermal delay switch to prevent the anode supply being switched on before the cathode has arrived at correct heat. There is no need to go into the action of the Thyatron here;

this has been described by others; all that need be said is that as the rise of temperature urges the mercury up the capillary tube a negative voltage is applied to the grid, cutting off the anode supply at the negative half cycle, and holding it off until a fall of temperature reduces the height of the mercury column and so removes the negative potential on the grid.

The use of alternating current for heating of filaments was largely in the nature of an experiment. It was desirable to avoid low voltage, high capacity secondary batteries, and as certain indirectly heated valves were available, it was decided to make use of these to find whether A.C. lighted valves on such a system could be successfully used and what precautions had to be taken to avoid "hum." Actually it was found that "hum" could be reduced to such a low order as to be entirely negligible.

All valves up to the final amplifier are indirectly heated, but in that amplifier there are four valves, and these are directly heated.

A single potentiometer is connected across the filaments of all the valves and is earthed at the correct point from the slider. This slider can be adjusted to any position of the potentiometer and by careful handling a point of balance can be found at which all A.C. hum is removed. Direct current from batteries was used for anode and grid supplies simply because batteries were already in the station.

*The Crystal Drive of the Experimental Short Wave Broadcasting Station G5SW.*

---

The use of screened grid valves as the crystal oscillator maintaining valve is not entirely new, although up to this time they had not been used on an actual station. Experiments had been carried out in the Laboratory at an earlier date on this matter, and it had been found that the use of the four electrode valve in conjunction with a crystal resulted in a more certain and efficient oscillator.

This point is of importance in such cases where the crystal is thick and heavy, and as the type of low temperature coefficient crystal used is both thick and heavy, and as the anode voltage was only of the order of two hundred it was distinctly

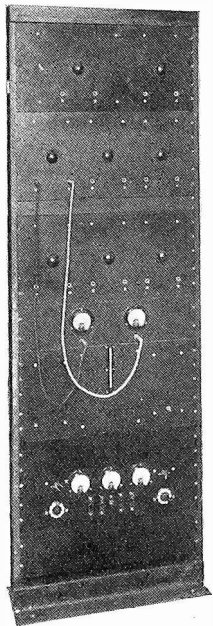

FIG. 3.

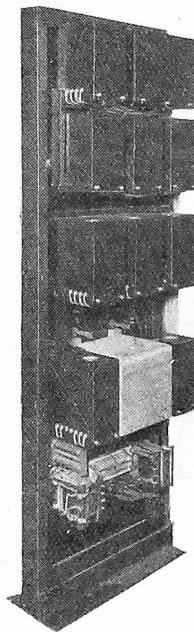

FIG. 4.

advantageous to use a valve whereby easy oscillation and good output could be obtained on a "crystal oscillator" and not on a "crystal controlled self oscillator."

Rack mounting of the whole drive recommended itself as being a cheap and easy way of assembling all units, and at the same time leaving each unit in a very accessible position.

Figures 3 and 4 are respectively photographs of the front and back of the complete drive.

On the panel at the lower extremity of the rack are mounted, a transformer for supplying lighting and anode currents to the thyratron, filament resistance for thyratron, a transformer for supplying lighting currents to all valves, potentiometer across all valve filaments, line resistances to transformers, main and secondary switches for A.C. and D.C., A.C. voltmeter with range selector switch, D.C. voltmeter with similar switch, A.C. ammeter for thyratron anode current, input and output supply terminals.

Above this panel is mounted a second panel which carries at its centre the thermal chamber. This chamber is a simple wooden case lined with felt. Within this case is mounted a copper cylinder with detachable ends, and this cylinder is again felt lined. In this copper cylinder is placed the crystal in its holder. About this copper cylinder, and close to but insulated from it, are the heater mats covering ends and cylindrical surface. Again about these mats but insulated from them is the electrostatic screen. The thermostat is held in a stout copper tube rigidly fixed to the copper cylinder, and the upper extremity projects through the top of the chamber so that adjustment can be made without disturbing the interior of the chamber. By so placing the thermostat the temperature variation of the copper cylinder is caused to operate the controller, but this temperature is of the outside

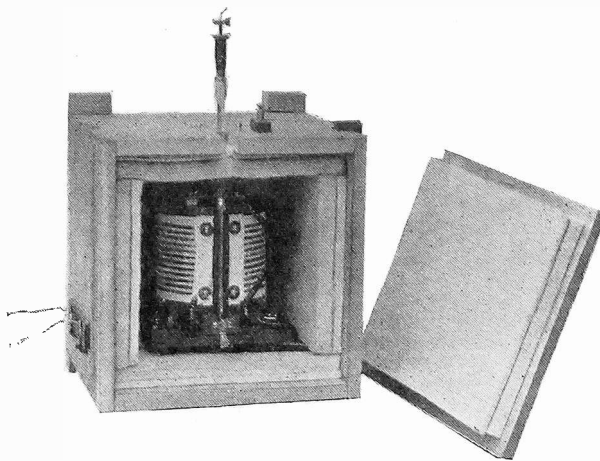

FIG. 5.

of the inner chamber, and the internal lagging of this cylinder smooths out the temperature variation of the exterior and applies a well regulated temperature to the crystal holder, which being massive in itself again tends to promote greater smoothing and the heat applied to the crystal is of a very constant order. Screened leads consisting of short porcelain beads encased in copper braiding connect the crystal through the copper cylinder, outer wall of the thermal chamber, and screened case of the oscillator valve unit direct to the valve. This braiding is earthed and

so also are the copper cylinder and electrostatic screen. Terminals are provided for the heater system and thermostat. Figure 5 gives a general idea of the thermal chamber, without electrostatic screen, and Figure 6 shows the chamber dismantled. Both of these have been previously published in *THE MARCONI REVIEW*, No. 37, 1932. On the right of this chamber and on the same panel (Fig. 4) is the thyatron with its grid resistances, anode current regulating resistance, and thermal delay switch, and on the left of the chamber in its screening case is the crystal oscillator maintaining valve and associated circuits.

The circuit employed is of the well-known type using a four electrode valve with an H.F. transformer in the anode circuit and is shown in Fig. 7.

The transformer is deliberately tuned to a frequency lower than that of the crystal, and the crystal is in consequence working at a point on the frequency/H.F. voltage output curve where the power delivered is small, but the strain on the crystal is feeble.

Above this panel are two others each carrying three frequency doubler circuits, each in its own screening case.

Each doubler consists of a single valve circuit with anode transformer with tuned secondary output.

The diagram in Figure 8 is typical.

Each circuit is arranged to give an output frequency of twice that of the input, and the transformer windings are so adjusted that the higher frequency of the output has not an excessive lower frequency component. Further, the ratio of the fixed to the variable portion of the condenser is so arranged that the correct tuning position is approximately at the middle of the condenser scale.

From the final frequency multiplying circuit the output is taken to a low power amplifier of a single valve. This circuit is as before in its own screening case, and is on the left of the top panel.

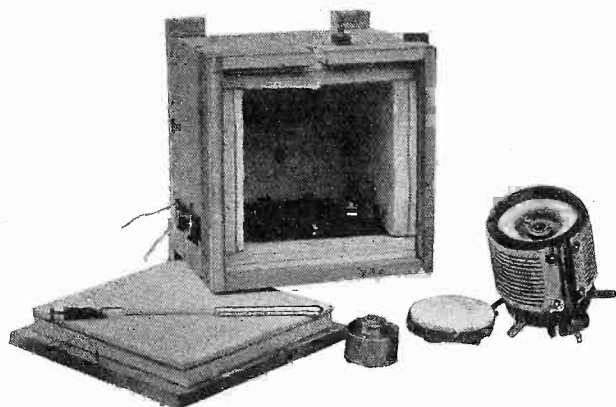

FIG. 6.

The circuit of this amplifier is of the well-known type with tuned input and output transformers.

This unit being an amplifier and not a frequency doubler had to be neutrodyned, and this was done in the usual manner by variable condenser from one end of the transformer primary back to the grid. The primary is centre tapped for H.T. supply.

From this unit the power is taken to the final amplifier, which consists of four valves,

with neutrodyne or balancing condensers from the anodes of one pair of valves to the grids of the other pair, and from the grids of the one pair to the anodes of the other pair.

This is the only circuit employing directly heated valves.

This was done to avoid an undue number of small valves, and at the same time keep the H.T. voltage and filament supplies of the same value as in the previous stages.

The insertion of directly heated valves on an A.C. supply at this stage caused some fear as to whether A.C. hum would arise, but in practice after balancing the centre point of the supply and earthing, the hum was far too low in intensity to cause any trouble.

The circuit terminates in a primary tuned transformer, the secondary of which is connected via a feeder of 80 ohms to the main set.

The total output is about 6 watts to the feeder.

All supplies are taken to the various units via screened cables. All H.F. connections between successive units are taken by conductors enclosed in metal screening cases. Those screening cases connecting units on the same panel are simple telescopic tubes. These can be collapsed upon themselves when necessary, leaving the greater part of the conductors exposed to view. The screening cases for connections between panels are rectangular sectioned channels, the outer plate of which is removeable for inspection when necessary.

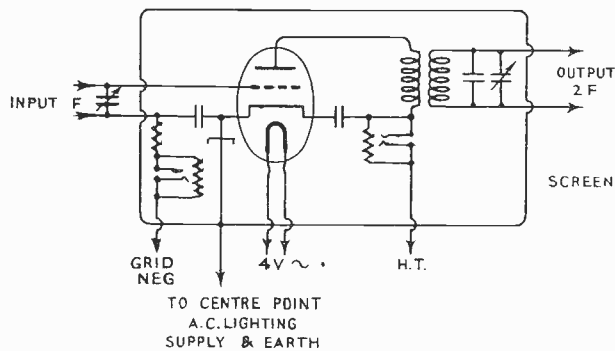

FIG. 7.

All screening cases of units are built as rectangular based prisms, split down the diagonals of two opposite faces. A generous metallic overlap is provided at the surfaces where one portion of the case fits the other portion. The one portion, carrying all the gear of a unit, is fixed to the panel, the other portion is removeable. The removeable portion is secured to the fixed by the simple means of two L shaped hooks at the top and two nuts at the bottom of the portion.

When closed the whole is rigid and of good screening. In spite of these precautions some interaction occurred between units, especially at the higher frequencies, but this was finally overcome by using screened leads for the internal wiring of the higher frequency units, and earthing the screening.

Some difficulty was also experienced in balancing the amplifiers, and this trouble was eventually traced to "carry through" of the lower frequencies. This difficulty was overcome by careful adjustment of the primary and secondary winding of each transformer and this permitted a very fine balance condition being attained.

Other troubles concerned the change of power due to change of high tension voltage. It had been the original intention to run all valves free of grid current. With such an arrangement a small change of anode supply was sufficient to cause a severe change of power at the output of the final frequency doubler, but by carefully graduating the anode feed and permitting a small grid current in valves after the second frequency doubler circuit this difficulty was overcome.

The valves used are :—

Oscillator .. .. .	V.M.S.4, 4v. Fil., 200v. Anode, 80 screen grid
All doublers and 1st Amplifier..	M.L.4., 4v. Fil., 200v. Anode.
Final Amplifier .. .. .	4 P.X.4., 4v. Fil., 200v. Anode.

In each unit it is possible to measure anode current by means of a milliammeter and a plug, plugged into a jack connected in the unit. This jack is shunted by a small resistance which is the shunt of the milliammeter for that particular unit. Thus the insertion or removal of the plug does not break the anode circuit of the valve.



*The Crystal Drive of the Experimental Short Wave Broadcasting Station G5SW.*

Similarly each grid circuit except that of the oscillator has a jack shorted by a resistance making the measurement of grid current possible on a single galvanometer, again without breaking the circuit.

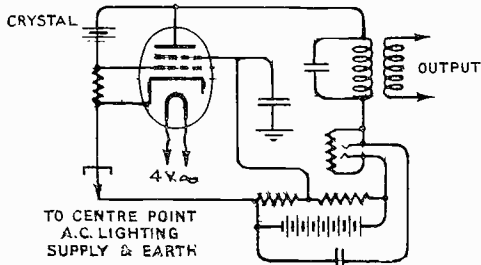

FIG. 8.

The tuning of all circuits is easily accomplished by plugging in millimeter and galvanometer into the following circuits and watching the deflections obtained.

Observations on the stability of the frequency of G5SW were taken, whenever convenient, by the Laboratory.

To include all these measurements would require a great deal of space; a typical record of the frequency of the drive taken at hourly intervals is, however, given here:—

10.00	G.M.T.	..	..	..	11,750.22kCs. (Unmodulated).
11.00	"	..	..	..	11,750.25 "
12.00	"	..	..	..	11,750.25 "
13.00	"	..	..	..	11,750.28 "
14.00	"	..	..	..	11,750.28 "
15.00	"	..	..	..	11,750.22 "
16.00	"	..	..	..	11,750.22 "
17.00	"	..	..	..	11,750.22 "
18.00	"	..	..	..	11,750.25 "

The mean values of various daily observations are given below. These measurements were generally taken on the mid-day programme five days per week.

1932					
Oct.	21st	..	..	Mean value	11,750.29 kCs. (Modulated).
	25th	..	..	" "	11,750.27 "
	26th	..	..	" "	11,750.25 "
	28th	..	..	" "	11,750.30 "
Nov.	1st	..	..	" "	11,750.29 "
	2nd	..	..	" "	11,750.27 "
	3rd	..	..	" "	11,750.24 "
	4th	..	..	" "	11,750.26 "
	7th	..	..	" "	11,750.29 "
	9th	..	..	" "	11,750.22 "
	10th	..	..	" "	11,750.27 "
	11th	..	..	" "	11,750.24 "
	14th	..	..	" "	11,750.24 "
	15th	..	..	" "	11,750.21 "
	16th	..	..	" "	11,750.24 "
	17th	..	..	" "	11,750.24 "
	18th	..	..	" "	11,750.21 "
	21st	..	..	" "	Aerial down
	23rd	..	..	" "	11,750.23 kCs.

Measurements temporarily stopped.

*The Crystal Drive of the Experimental Short Wave Broadcasting Station G5SW.*

---

Dec. 12th	..	..	Mean value	11,750.29 kCs.
13th	..	..	„ „	11,750.24 „
14th	..	..	„ „	11,750.27 „
15th	..	..	„ „	11,750.27 „
16th	..	..	„ „	11,750.24 „
17th	..	..	Station closed.	

The limits of these values are 11,750.30 and 11,750.21, which can be regarded as a stability of  $\pm 4$  parts in  $10^6$ .

These daily observations were taken when the station was actually transmitting a programme, and in consequence include such errors as those due to scintillation and also any errors on the part of the observers.

It must also be stated that no attempt was made to control voltages to filaments or anodes. The first was via transformer direct from the A.C. town supply, and the second from a storage battery charged during the station hours of silence.

The designers of the drive and the observers had no control over the station, and it was agreed between those people and the station engineers that, with the exception of temperature observations, no undue care should be taken of the drive. No choice of position was permissible for the drive; it had to be installed where space permitted. This was in a large room housing the complete station and its machinery. This room is open immediately behind the drive to a short corridor which terminates with a door opening to the outside. In another wall of the room is another door again opening to the outside. No restrictions could be placed on the opening or shutting of these doors as a fair amount of necessary traffic passes through the station. The heating of the room is adequate, but not extravagant, and largely localised about the desk of the engineer on watch. No attempt was made to maintain room temperature to a definite figure.

The drive has given no trouble in service.

Only one valve has had to be replaced. This replacement was due to loss of emission.

The Thyatron is still the original one used on tests at the Laboratory, during the service at G5SW, and since the closing of the station it has been kept in use continuously for twenty-four hours per day. This now amounts to about 7,000 hours, and it is to be remembered that this valve is an experimental one. This record is good.

Since the closing of G5SW as a Broadcasting Station, the original crystal has been removed and a new one of different frequency fitted. The circuits have been tuned to the new frequency and the station is now employed for Television Research.

T. D. PARKIN.

## NEW OPTICAL ASSEMBLY FOR TELEVISION PROJECTION RECEIVERS

One of the most successful methods of converting the variable electrical impulses received by a television receiver into light variations which, when projected in the correct fashion, will form the received picture, is by making use of the Kerr effect. This, briefly, is the property that a dielectric has of becoming doubly refracting when placed in an electric field. The overall efficiency of the system in the methods generally used is limited by the fact that half of the light available from the primary light source is lost after polarisation. In the method developed by the Marconi Company and described hereunder, this defect is overcome by making use of both ordinary and extraordinary beams, and the overall efficiency of the system is greatly increased.

This method was demonstrated in the apparatus shown for message projection on a 7' x 1' 6" screen at the Television Society's Exhibition, held at the Imperial College of Science and Technology, South Kensington, on April 5th and 6th, 1933.

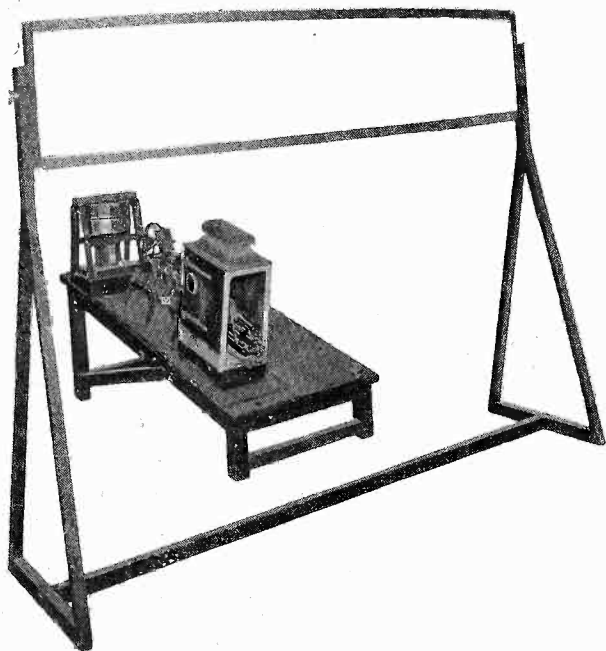

*Marconi Message Projection Receiver demonstrated at the Television Society's Exhibition, Imperial College of Science and Technology, South Kensington, April 5th and 6th, 1933.*

prisms, and, finally, there is the complete loss of the ordinary ray.

IN the standard Kerr Cell method of obtaining television images there are required two elements of importance, the polariser and the analyser. It is the usual practice to employ nicol prisms for these purposes. These, however, have considerable disadvantages which can be avoided by the use of the method to be described below.

The first disadvantage is that there is a limit to the amount of light that can be used owing to the effect of the heat generated on the canada balsam cement used in the manufacture of nicol prisms. Secondly, there is the inclined face of the prism resulting in severe loss by reflection. Thirdly, only a small angle of field is accepted by the nicol

The first and fourth limitations are overcome by the use of a single piece or several pieces of Iceland Spar (see Fig. 1) cut so that the optic axis is at right angles to the path of the light, that is, so that maximum separation of the ordinary and extraordinary rays takes place. A single piece is used where a low power light source is used, but for greater light intensities cooling is facilitated by the use of two or more crystals placed so that their effects are additive, in which case they act as one crystal equal in size to the sum of the separate pieces. The first effects of the use of such a simple crystal assembly are that both beams are available and there is no cementing surface to consider.

After emergence from the liquid in the Kerr Cell the light is brought to a focus or rather two foci, one from the ordinary beam and one from the extraordinary. It is necessary then to extinguish both these beams by means of analysers. Here two small Thompson prisms are used. The first is arranged to extinguish the ordinary ray and the other to extinguish the extraordinary ray. By placing one above or beside the other at or near the two images of the aperture, complete extinction is obtained with no stress on the liquid.

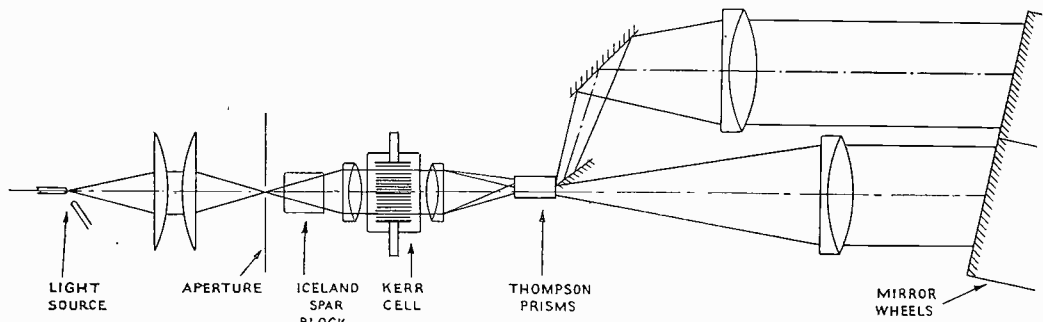

FIG. 1.

Then in order to bring these two images to one on the screen, one beam is reflected by a small mirror upwards or sideways to another mirror which reflects it horizontal again. There are now two horizontal parallel beams, which are caused to scan the screen by means of two mirror wheels. In the case of vertical scan these mirror drums are placed side by side on the same horizontal shaft. For horizontal scanning the drums are placed one above the other also on the same spindle.

In order to cause the two images to superpose exactly, the two stationary mirrors which reflect the second beam are in adjustable mounts. These, however, do not give accurate superposition without distortion of the image. The two mirrors are therefore arranged to bring the second image as close as possible to the first without distortion and the final adjustment is made by means of the mirrors on the mirror drum itself.

There is obtained as a result a definite advantage over the usual practice since the full light from the source is used.

N. LEVIN.

# A LONG WAVE SINGLE SIDEBAND TELEPHONY RECEIVER FOR TRANS-ATLANTIC WORKING

By C. J. W. HILL and H. PAGE

*The following is a reprint of a paper delivered by the above authors before the Institution of Electrical Engineers Students' Section on January 31st, 1933.*

*The paper deals with the receiver recently constructed by the Marconi Company for the Post Office and installed at Baldock.*

## Introduction.

AS its name implies, the single sideband telephony system consists in the transmission of intelligence by wireless telephony, utilising a single sideband only. Normally, when a carrier of frequency ( $k$ ) is modulated by an audio-frequency ( $s$ ), three frequencies are produced, the carrier frequency ( $k$ ) and its upper and lower products of modulation ( $k+s$ ) and ( $k-s$ ) respectively. These two frequencies ( $k+s$ ) and ( $k-s$ ) are called the sidebands of the modulated carrier. In the single sideband system only one sideband is transmitted, the carrier and other sideband being suppressed at the low power end of the transmitter.

There are two main advantages of the system :—

- (A) The band width of the circuit is reduced to less than one half.
- (B) There is a saving of transmitted energy, and hence the power amplifiers need only be large enough to cope with the energy in one sideband. The actual saving in energy in the case of a 100 per cent. modulated carrier is 66 per cent.

The theory of the single sideband system was first developed by Carson in 1923, and has been used almost from the inception of experiments on Trans-Atlantic telephony working. In 1923, when a commercial circuit was first contemplated, reception tests were carried out at Bridgewater, on signals of different wavelengths from America ; it was found possible, by using the single sideband system, to transmit more power in the sideband, and thus improve the signal to noise ratio, the figure which determines the merit of the circuit commercially. In 1925, the Rugby transmitting station being completed, two way tests were carried out between Rocky Point and Houlton in America, and the corresponding transmitting and receiving stations in England, namely, Rugby and Wroughton respectively.

The frequency band decided upon as a result of these measurements was 50 to 75 kc., and at present Rugby is transmitting on a suppressed carrier frequency of 66.5 kc., whilst Rocky Point transmits on a suppressed carrier frequency of 58.5 kc.

In the reception and detection of a single sideband, the essential function of the receiver is to re-introduce the suppressed carrier, and also to eliminate interference from stations other than that to be worked. Unfortunately it is not possible to detect the audio-frequency component of a single sideband without this re-introduction.

In practice two methods of re-supplying the suppressed carrier are used, the first being called single demodulation, and the second double demodulation.

Single demodulation consists in re-supplying the carrier by means of a single local oscillator, and is adopted for receivers working on a fixed frequency.

Double demodulation consists in re-supplying the carrier in two stages, by means of two local oscillators, and thus the receiver can be used to cover a frequency range ; the receiver to be described is of the double demodulation type, and the advantages of this system as compared with single demodulation will be seen more fully later.

In order to explain very simply this demodulation process, let us consider the reception of a single sideband signal, which we shall call  $(k+s)$ , as in Fig. 1.

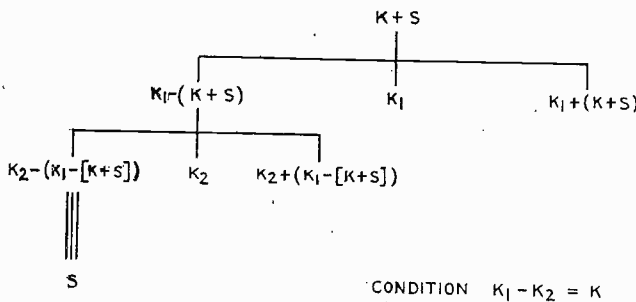

FIG. 1.

CONDITION  $K_1 - K_2 = K$

This single sideband signal enters the first demodulator, and is allowed to beat with the first local oscillator, which we shall call  $(k_1)$ . Then, as in the normal super heterodyne receiver, we have three main output frequencies from the first demodulator, as shown, namely :—  
 $k_1 - (k+s)$      $k_1$      $k_1 + (k+s)$

The balanced demodulator eliminates  $(k_1)$ , whilst the intermediate frequency filters remove the upper product of this first demodulation, as well as any remaining  $(k_1)$  and other undesired products.

Thus instead of  $(k+s)$ , we now have  $(k_1 - (k+s))$  or  $(k_1 - k - s)$ .

Having passed through the intermediate stage of the receiver, the signal, now  $(k_1 - k - s)$ , enters the second, and final demodulator, to beat with the second local oscillator, which we shall call  $k_2$ .

As before, we have three main products of demodulation :—

$$k_2 - \{k_1 - (k+s)\} \qquad k_2 \qquad k_2 + \{k_1 - (k+s)\}$$

Again the local oscillator is suppressed by the action of the balanced demodulator, and the upper product of demodulation removed by audio-frequency band-pass filters.

On considering the remaining term  $(k_2 - k_1 + k + s)$ , which can be re-written as  $(k - (k_1 - k_2) + s)$ , it will be seen that if  $(k_1 - k_2)$  is made equal to  $(k)$ , the original suppressed carrier, then the remaining term becomes  $(s)$ , the required speech frequency, and as such passes unattenuated through the audio-frequency filters, the detection being complete.

In order to avoid distortion of the received signal, two conditions should be satisfied, namely :—

## *A Long Wave Single Sideband Telephony Receiver for Transatlantic Working.*

- (A) The frequency of the re-supplied oscillator should be exactly equal to that of the suppressed carrier.
- (B) The phase of the re-supplied oscillator should be the same as that of the suppressed carrier.

The first condition is fulfilled by the use of stable oscillator circuits, whilst the second is not, in general, fulfilled. This means that the phase of the audio-frequency components, relative to each other, is not the same as in the original input modulation. The human ear is very insensitive to phase distortion, however, and so this fortunately does not produce any audible distortion of the detected signal.

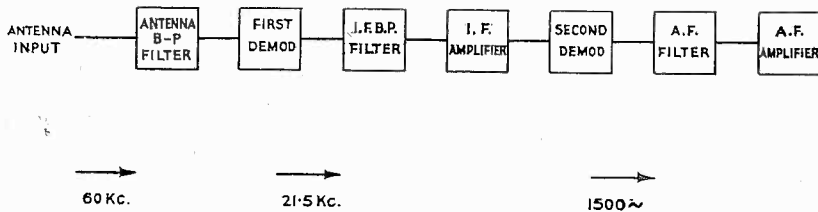

FIG. 2.

In order to see clearly the process of detection in the present case, let us consider a block schematic of the receiver, from the antenna input to the final audio-frequency amplifier, as shown in Fig. 2. In this we assume that the suppressed carrier of the incoming sideband is 58.5 kc., and the audio-frequency modulation is constant at 1,500 cycles. Hence the incoming sideband has a frequency of 60 kc. This first passes through the antenna band pass filter, which passes only the band of frequencies required, namely, 50 to 75 kc. Thus the signals reaching the first demodulator are confined to those within the normal working band of the receiver.

From this filter the signals pass to the first demodulator, the local oscillator of which will be set at 81.5 kc. The three main output frequencies will thus be 21.5, 81.5 and 141.5 kc., and as the pass band of the intermediate frequency filter is 20.25 to 22.75 kc., only the first frequency mentioned is allowed to proceed to the second demodulator via the intermediate frequency amplifier. Thus the signal, which now has a frequency of 21.5 kc., enters the second demodulator, the local oscillator of which is set to 23.0 kc., and therefore the three main output frequencies from this demodulator will be 1.5, 23.0, 44.5 kc.

Immediately following the second demodulator is the audio-frequency band-pass filter, passing only those frequencies between 200 and 3,000 cycles. Hence only the audio-frequency term will be passed, and this, being 1,500 cycles, the original modulation frequency of the suppressed carrier, the detection is complete.

### **2. Component Units.**

Having described the functioning of the receiver as a whole, we shall now proceed to consider the component units of the receiver in greater detail.

#### **Demodulator.**

It is in the demodulators that the re-introduction of the suppressed carrier is accomplished by the use of a local oscillator.

The schematic diagram of a demodulator is shown in Fig. 3, and it is seen to consist essentially of an oscillator applied to push-pull detectors,  $V_1$ ,  $V_2$ . The input signal is applied to the detector grids via transformer I, and the output taken from the plate circuit via transformer II.

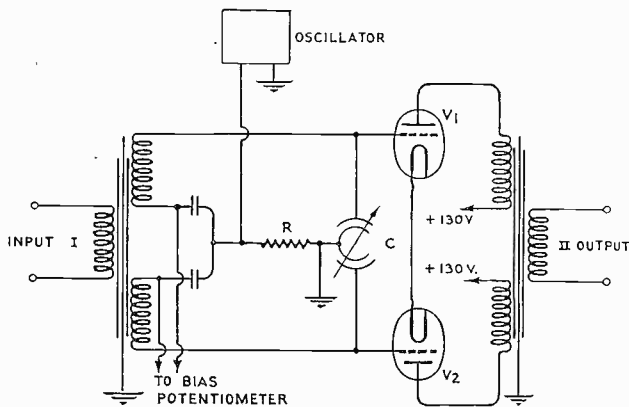

FIG. 3.

Considering any input frequency  $(k+s)$ , if the oscillator frequency is  $(k_1)$ , the output frequencies are as before, namely:—

$$(k_1 - (k+s)), \text{ and } (k_1 + (k+s))$$

It should be noted that if the detectors are accurately balanced, the local oscillator, although amplified in each plate circuit, will have no resultant at the output of transformer II. Balance is achieved by two adjustments:—

- (A) The bias of  $V_1$  and  $V_2$  are adjustable over a small range, and thus the amplitudes of the local oscillator in the plates of  $V_1$  and  $V_2$  can be made to approach equality.
- (B) A differential condenser C, of small value, connected directly to the grids of  $V_1$  and  $V_2$ , adjusts the phase of the local oscillator current in the plates of  $V_1$  and  $V_2$ .

Hence, having obtained an amplitude and phase balance, there will be no resultant local oscillator output from the demodulator; in a similar manner square law terms are also eliminated. The balance of the detectors is achieved in practice by adjusting the bias and capacity controls until minimum local oscillator is obtained at the output, and carrier balances of the order of 50 decibels are thus obtained.

An important condition to be observed, in order to avoid distortion of the demodulated signal, is that the local oscillator amplitude should be much greater than that of the input signal. This can be proved mathematically, but the result of variation of the amplitude of the local oscillator is more easily seen from the curves in Fig. 4.

Curve A represents the modulated carrier, and curve B the corresponding transmitted single sideband. Considering the reception of this single sideband, curve C represents the audio-frequency output from a demodulator utilising a weak local oscillator, from which it will be seen that obvious distortion has occurred. Curve D shows the result of demodulation using a strong local oscillator, and it will be seen that the envelope corresponds very closely with the initial input modulation.

In a practical case, of course, the local oscillator magnitude is much greater than that of the received signal, and it merely remains to apply this to the detector grids in the correct manner, it being possible to vary the amplitude by varying the detector common grid resistance. For this purpose the oscillator is switched off,



and the bias of the detectors adjusted so that the valves are operating as anode bend detectors. The resistance is then adjusted so that the oscillator drives up the detectors to the linear part of their characteristic. In this condition minimum distortion occurs, whilst at the same time this represents the optimum condition for prevention of overload of the detectors.

### Oscillators.

The oscillator used in the demodulator is important, as it is readily seen that the success of single sideband working depends to a large extent on the frequency constancy of the oscillators entailed. Also owing to the use of privacy equipment, involving frequency changes of the transmitted and received speech, still greater demand is made for constant frequency oscillators.

The use of double demodulation assists greatly in the production of a resultant carrier of almost constant frequency. It will be remembered that in the detection of a single sideband, we had as our final term:—

$$(k_2 - k_1 + k + s)$$

which equals  $(s)$ , the required audio-frequency when  $(k_1 - k_2) = k$ .

It is evident that if  $k_1$  and  $k_2$  are made to have the same number of cycles change with variation of battery voltage, and temperature, then  $(k_1 - k_2)$  will be constant.

Hence the first oscillator ( $k_1$ ) has been made as constant as possible, without over-elaboration, whilst the second oscillator has deliberately been made to have a greater

percentage change of frequency with supply variations, etc. It is then evident that any change in  $(k_1)$  and  $(k_2)$  results in a much smaller change in  $(k_1 - k_2)$ . Actually under normal conditions, the maximum change of re-supplied carrier frequency is less than 6 cycles per second.

The oscillator circuit used is shown in schematic form in Fig. 5. The change of frequency of oscillators with supply voltage variations is due mainly to the change in impedance of the valve, which acts as a damping resistance across the oscillatory circuit. This effect is greatly reduced by the introduction of a resistance  $R$  in series with the tuned circuit, which thus reduces the effect of variations of the valve constants. Hence the resistance  $R$  is made as large as possible, consistent with the production of oscillations. It is thus possible to obtain oscillators, of which the change in frequency with  $\pm 5$  per cent. variations of supply voltages, is of the order of  $\pm 0.002$  per cent.

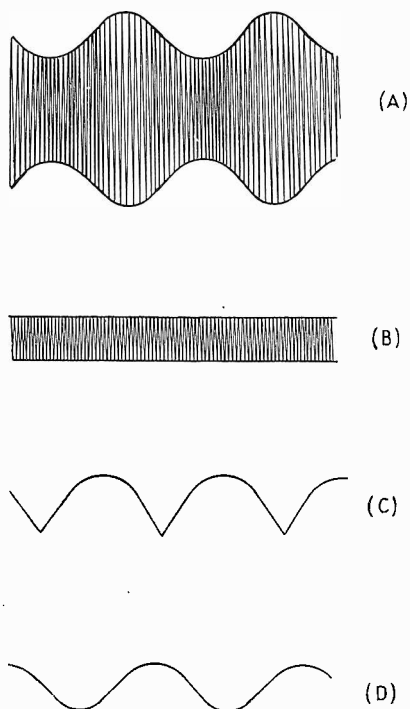

FIG. 4.

**Filters.**

In conjunction with the demodulators, it is obvious that the filters play a very important part in the eventual output, for discrimination between wanted and unwanted signals must be great, in order to overcome the large differences in level of these signals. An interfering station may easily be 60 to 80 decibels higher in received strength than the required signals from New York, and whilst directive

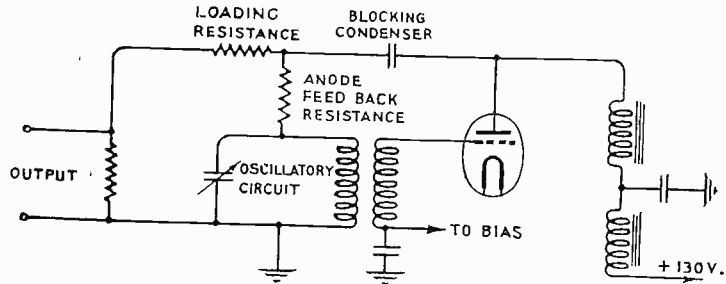

FIG. 5.

arrays tend to reduce this difference, some cases still remain in which the unwanted signal is 50 decibels up on the required signal, due to their being almost in line with the directive system.

Whereas in broadcast telephony one allows for an audio-frequency range of 30 cycles to 9,000 cycles, in commercial telephony it has been found amply sufficient for intelligence of speech to transmit only audio-frequencies between 250 cycles and

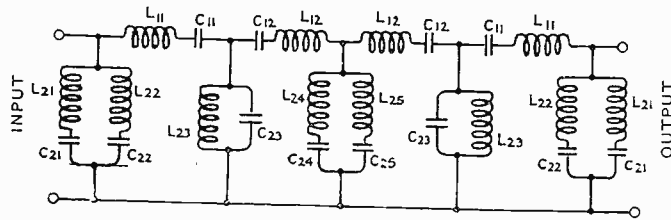
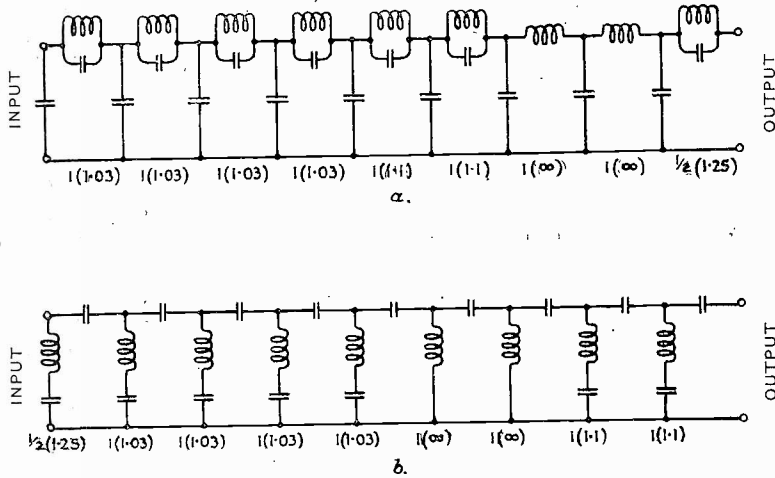

FIG. 6.

2,750 cycles, that is, the width of the sideband is 2,500 cycles, and hence the necessary width of the receiver filters is only 2,500 cycles.

The first filter in circuitual order is the antenna band-pass filter, passing all frequencies between 50 and 75 kc. whilst attenuating those frequencies outside this band by more than 60 decibels. The object of this filter is to eliminate all signals

outside the required frequency range of the receiver; thus avoiding, as far as possible, intermodulation troubles in the first demodulator. The filter is of the band-pass type, and consists of two prototype, one full M derived, and two half M derived T sections, as shown in Fig. 6.



(A) *Low pass intermediate frequency filter.*  
 (B) *High pass intermediate frequency filter.*

FIG. 7.

The next, and most important, filter is the intermediate frequency band filter, which is inserted between the first demodulator and the intermediate frequency amplifier. The filter consists of high and low-pass sections in tandem, as shown in Fig. 7.

High and low-pass sections in tandem are used in preference to a band-pass filter, for reasons of practical design. In the case of a band-pass filter of small percentage band width, at frequencies above 10 kc., coils become unreasonably large, and the course adopted in this case was the result of theoretical comparisons of the two types of filters.

It should be noted that in the case of a single demodulation receiver, the pass band of the antenna filter is made 2,500 cycles, and thus working is restricted to a single frequency.

In the case of a double demodulation receiver, however, the 2,500  $\sim$  band width is obtained in the intermediate frequency filter, the second oscillator being set at the extreme band frequency. Thus by varying the first oscillator a band of frequencies may be received, depending only on the band width of the antenna filter, which is 25 kc. in this case. It is evident, too, that it is much easier to obtain a filter having a band width of 2,500  $\sim$  at the intermediate frequency than at the signal frequency. Thus double demodulation simplifies greatly the practical attainment of a narrow pass band.

## A Long Wave Single Sideband Telephony Receiver for Transatlantic Working.

The audio-frequency filter consists of a high and low-pass filter in tandem, balanced to earth, as shown in Fig. 8. The resultant pass band of the filters is 200 to 3,000  $\sim$ . These have a rather wider pass band than the intermediate frequency filter, in order that it shall not greatly affect the attenuation of the extreme band frequencies, whilst attenuating some 40 decibels all unwanted products of demodulation from the second demodulator.

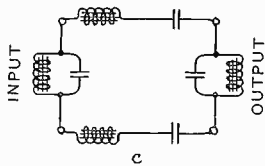
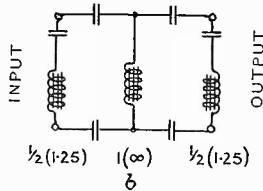
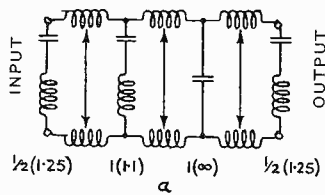

FIG. 8.

Apart from the filters incorporated in the actual receiver, a narrow band-pass filter is provided for telegraph working. This filter passes a frequency of 1,000  $\sim$ , and attenuates greatly all frequencies outside the band of  $\pm 60 \sim$  relative to the mid-band frequency. It is used only should atmospheric conditions render the circuit uncommercial for telephony, when contact is established by telegraph.

### Intermediate Frequency Amplifier.

The intermediate frequency amplifier follows the intermediate frequency filter in circuitual order, and provides the whole of the effective gain of the receiver.

(A) Low pass audio-frequency filter  $Z_o = 600\omega$ .

(B) High pass audio-frequency filter  $Z_o = 600\omega$ .

(C) Narrow band pass audio-frequency filter  $Z_o = 600\omega$ .

$$\sqrt{v_1 v_2} = 1,000 \sim$$

$$B.W = 100 \sim$$

It consists of five stages of transformer coupled valves, and incorporates attenuators giving a range of 80 decibels variation in gain. The effective overall gain of the amplifier is approximately 85 decibels and as the valves used are of the V.T. type, giving long life with constant emission, it has been found that the gain varies only slightly over a long period of time.

### Audio-Frequency Amplifier.

The audio-frequency output from the second demodulator is raised to the necessary line level by means of a two valve transformer coupled amplifier, and from this amplifier is transferred to the terminal junction at London.

### Volume Indicator.

A volume indicator is paralleled across the output of the audio-frequency amplifier, in order to indicate the level of the outgoing speech. The input impedance of this instrument is high, and hence the loss caused by this shunt permanently across the line, is small.

### Monitoring Facilities.

High impedance monitoring coils are also connected across the audio-frequency equipment at various points, in order that the receiver may be monitored continuously, while on traffic.

### 3. Receiver Characteristics.

The use of the various demodulators, amplifiers, filters, etc., has now been explained at some length, but no idea has yet been given of the characteristics of these separate units, or of their combined characteristics. These can be divided into three groups, namely, radio-frequency, intermediate frequency, and audio-frequency.

Considering the radio-frequency portion of the receiver proper, we have the antenna band-pass filter, and the first demodulator. Both of these have a frequency characteristic over the band of 50 to 75 kc., which is almost straight; at any of the normal working bands the deviation over a 2,500 cycles width is less than  $\pm 0.1$  db.

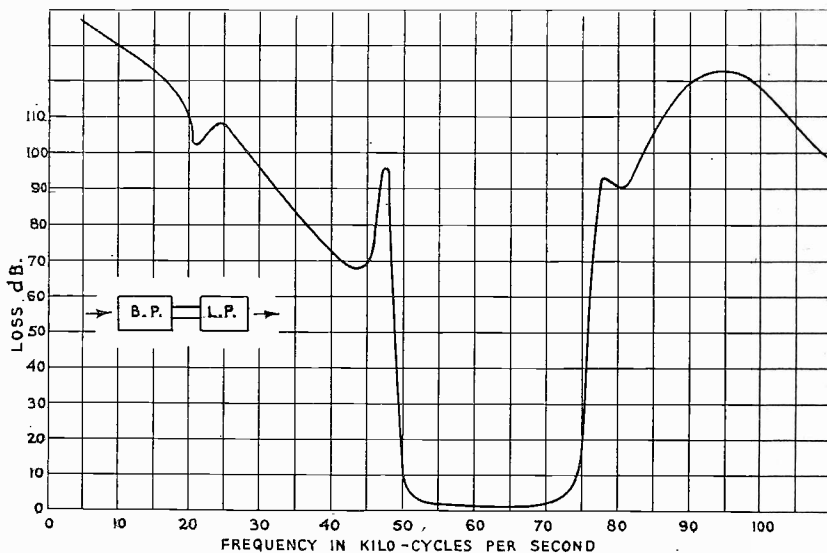

FIG. 9.

A frequency characteristic of the antenna band-pass filter is shown in Fig. 9.

In the case of the intermediate frequency equipment, characteristics are not so simple, for whilst the intermediate frequency amplifiers and the second demodulator are substantially linear over their band, the filters introduce considerable "rounding off" at frequencies near the edge of the pass-band. This is due to the impossibility of designing filters to give high attenuations, and yet maintain a straight pass region. Fig. 10 shows the pass region of the intermediate frequency equipment, and it will be seen that the attenuation at the edges of the band is as much as 13 decibels greater than at the centre of the band. The limit of audio-frequency equalisation being 8 to 9 decibels, it becomes necessary to insert a simple form of equaliser to bring the pass band within these limits. The equaliser consisted of a single series resonant circuit, connected across the output of the first intermediate frequency amplifier; it will be seen from the curve, shown in Fig. 11, that the effect of this equaliser has been to make the intermediate frequency pass-band fall within the  $\pm 4$  decibel limits.

The audio-frequency apparatus, consisting of audio-frequency filters, and repeater, have reasonably linear characteristics, such that when measured as a whole, the maximum variation over the pass-band does not exceed  $\pm 1$  decibel.

The overall characteristics of the entire receiver, from the input of the antenna band-pass filter to the output of the repeater has been equalised to within  $\pm 1$  db. by the insertion of an audio-frequency equaliser. Fig. 12 shows the form of equaliser used. It consists of two Bridge T sections, and the measured characteristic of the equaliser is shown in Fig. 13. Fig. 14 shows the effect of this final equalisation, which holds good for any of the normal working bands of the receiver.

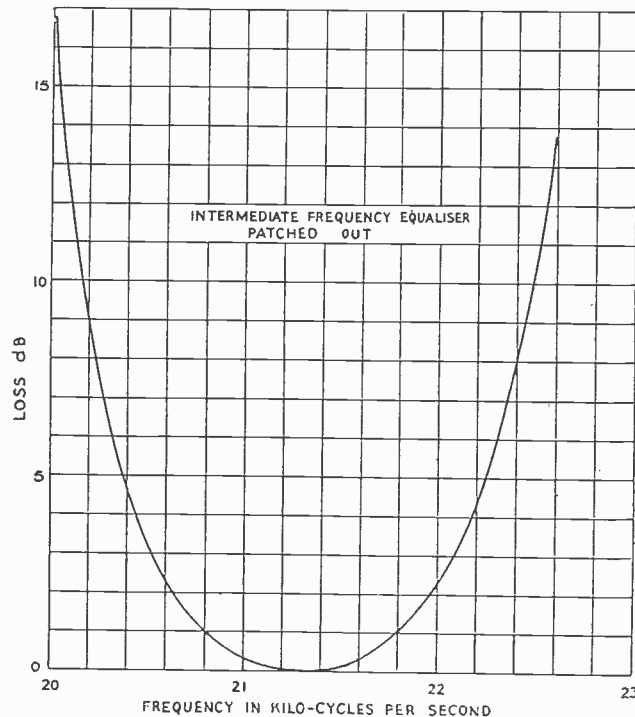

FIG. 10.

#### 4. Antennae System, and Antennae Combining Equipment.

It will be of interest next to consider, very briefly, the antennae system used in conjunction with this receiver, and built by the British Post Office. In all modern commercial radio circuits, directive arrays are used, these arrays having a greater receptive power in the direction of the transmitter than in any other direction. By this means the signal to noise ratio of the circuit is greatly improved.

Before proceeding to consider the type of array used with this receiver, let us examine the principles upon which it is based.

#### Derivation of the Polar Diagram.

The fundamental basis on which the production of the polar diagram rests, is the cardioid directive diagram obtained by using a loop aerial combined with a vertical aerial.

*A Long Wave Single Sideband Telephony Receiver for Transatlantic Working.*

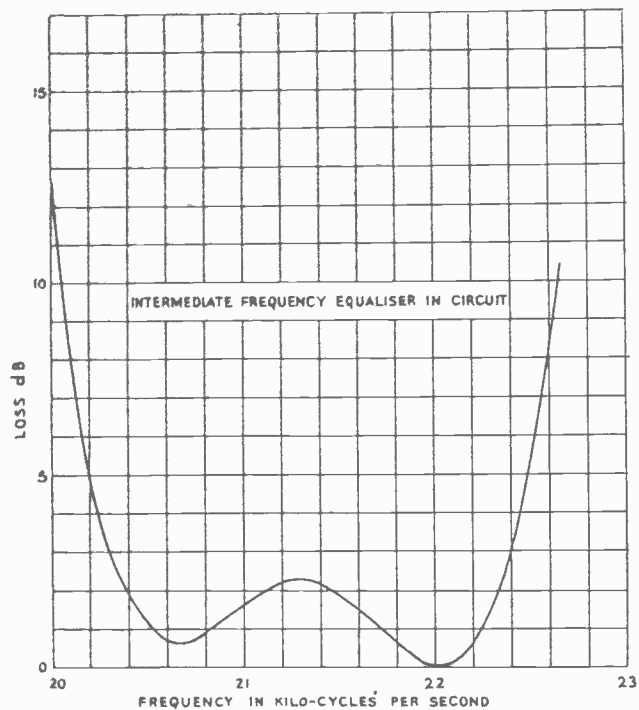

FIG. 11.

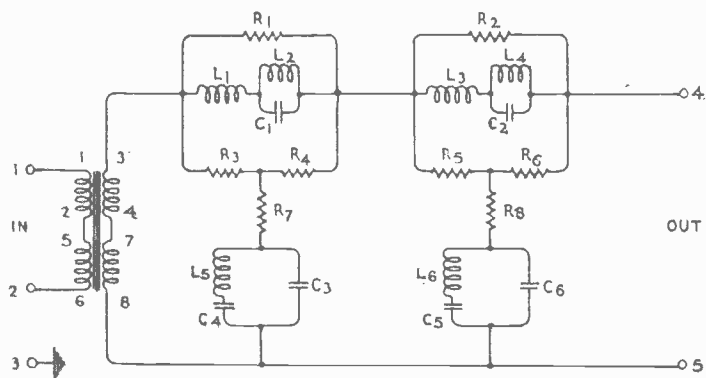

FIG. 12.

*A Long Wave Single Sideband Telephony Receiver for Transatlantic Working.*

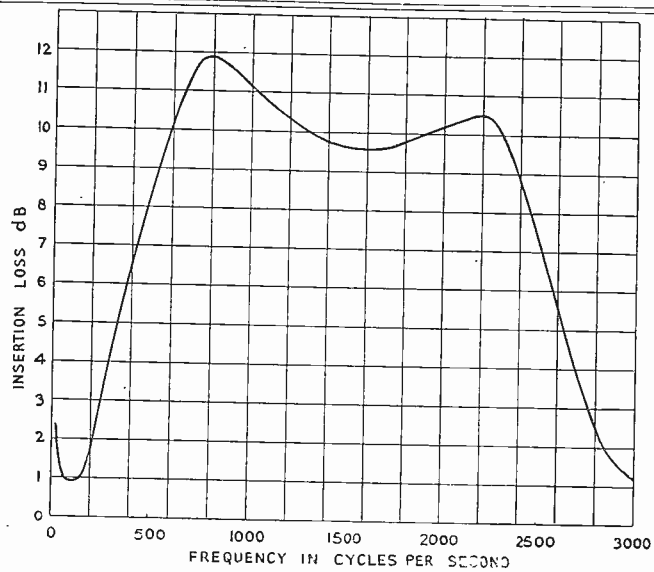

FIG. 13.

A loop is tuned to the carrier frequency, and the output combined with that of a vertical, also tuned to the same frequency, into which a 90 degree phase lead is introduced.

Under these conditions, if the voltages developed in the loop and vertical are

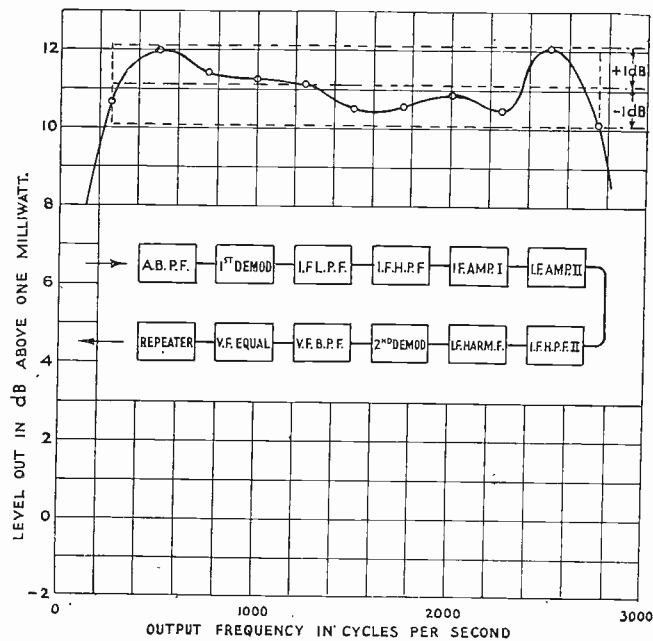

FIG. 14.



the same for a given signal, a cardioid receptive diagram is obtained, as shown in Fig. 15.

This is not sufficient in itself for two reasons:—

Firstly the angle of blank reception is small, and secondly the curve as a whole is too broad.

These two features will be considered separately.

In order to increase the angle of blank reception, that is, the angle over which the system is non-receptive, "staggering" is adopted. For this purpose two loops plus verticals are spaced a distance of one quarter of a wavelength apart, in the direction of the received signal, and the phase of the forward loop is lagged by 90 degrees.

The combined output from two such loops is shown in Fig. 16, and it is evident that the resulting polar diagram has a much smaller receptive power from the backward direction. However, the diagram is still rather broad, although "staggering" does, to some extent, narrow the receptive curve.

In order to make the polar diagram narrower in the forward direction, "broad-siding" is used, that is, similar systems are used along the normal to the line of the signal. This gives a figure of eight as the broadsiding factor, and a spacing of one

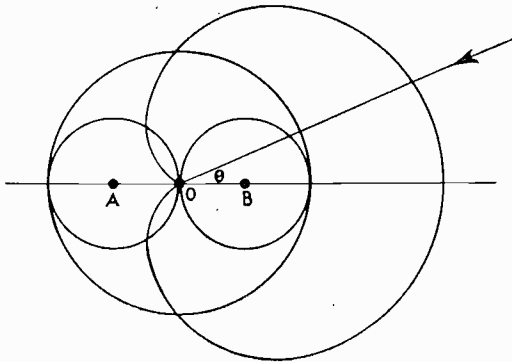

FIG. 15.

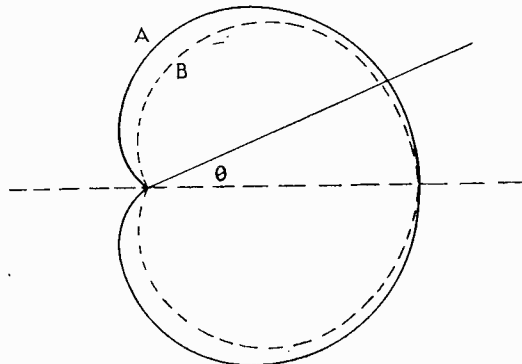

FIG. 16.

(Not to scale.)

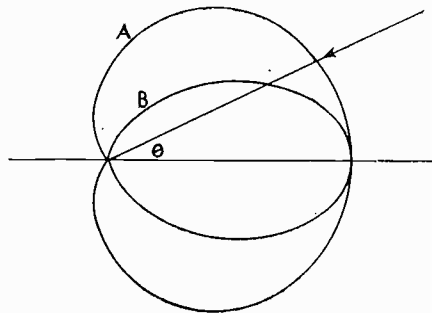

FIG. 17.

(Not to scale.)

half of the wavelength is used to give a distorted figure, and thus a more suitable broadsiding factor.

Thus we broadside two staggered systems, and obtain a resultant polar diagram as shown in Fig. 17.

*A Long Wave Single Sideband Telephony Receiver for Transatlantic Working.*

A complete representation of the antenna system is shown in Fig. 18. Here, 1A, 1B, and also 2A, 2B, are the staggered loops, whilst 1A, 2A, and also 1B, 2B, are the broadsided loops.

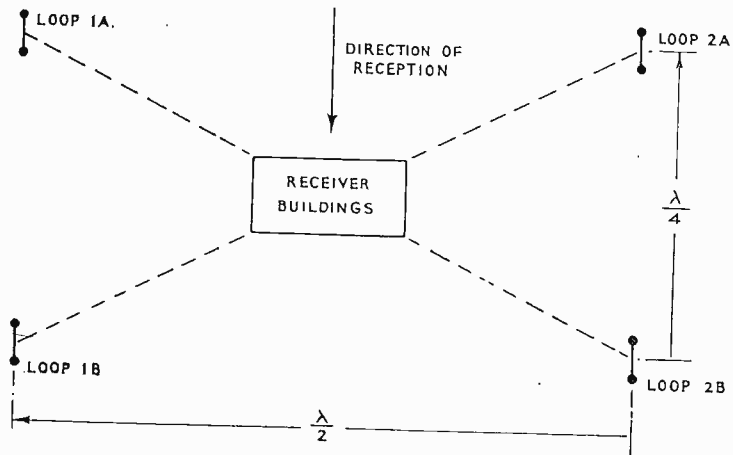

FIG. 18.

Summarising, we may say—

The loop plus vertical, giving a cardioid diagram, is used as the fundamental basis for the system. Two such systems are "staggered" at  $\lambda/4$  to increase the angle of blank reception. Broadsideing at a spacing of  $\lambda/2$  narrows the forward receptive diagram.

*(To be concluded.)*

# THE USE OF THYRATRONS AS RELAYS IN HEATER SETS

*The following article describes a modification in a thyatron circuit used for controlling the heaters of crystal incubators which has been found to be very satisfactory in practice.*

HITHERTO when using thyratrons as relays for the switching on and off of the A.C. current for heaters used in crystal incubators, a separate D.C. battery in conjunction with a thermostat has been used on the grid to cut on or off the anode current at the correct time. The diagram given in Fig. 1 gives the usual connections.

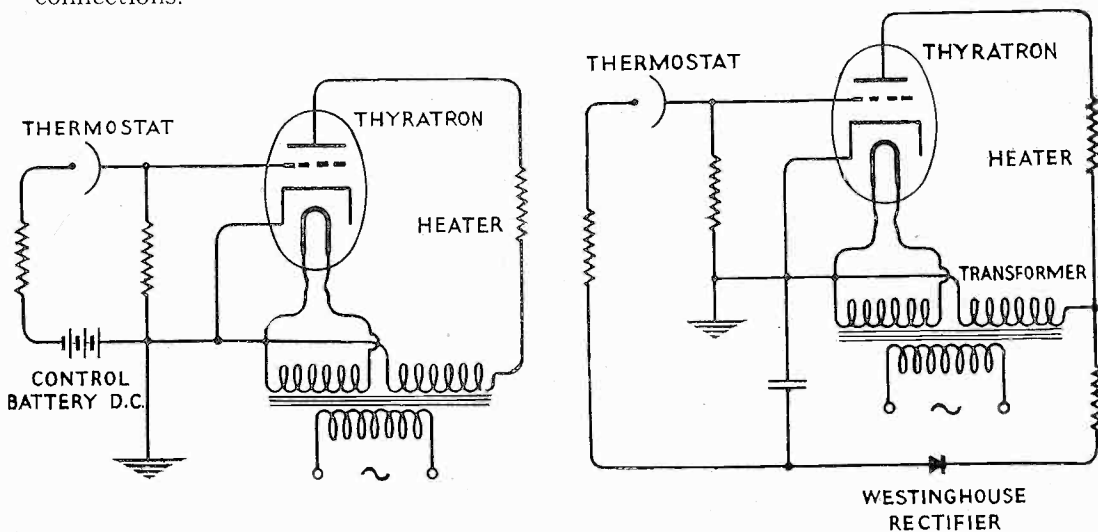

FIG. 1.

FIG. 2.

Rectified A.C. could, of course, be used in place of the control battery, and the usual way would be to provide a third secondary winding with rectifier, etc., to supply the control voltage. This means that the transformer must be made larger to accommodate the extra winding.

In certain cases the space available may be limited, and under these conditions it may be found useful to use the anode voltage supply for the dual purpose of anode and grid control after rectification. The connections now become those shown in Fig. 2. The scheme operates very successfully, the current taken by the rectifier being small and of the order of less than 10 milliamperes, and the voltage delivered after rectification as grid control is sufficient for the work, being about 50 volts when using 210 volts A.C. supplied through 50,000 ohms and  $.5 \mu\text{F}$ .

The advantages of the new arrangement are (A) no increase in size of the transformer is necessary, and (B) the use of a D.C. control battery is eliminated.

# MARCONI NEWS AND NOTES

## ARGENTINE LISTENERS HEAR MARCHESE MARCONI.

**M**ARCHESE MARCONI addressed Argentine listeners on June 29th through the new Radio Excelsior Broadcasting Station near Buenos Aires.

He spoke from the Board Room at Marconi House, London, over the British Post Office-Transradio (Argentina) telephone circuit to Argentina, and his words were re-broadcast from Radio Excelsior.

After sending a greeting and a message in Italian to the people of Argentina, and the three million Italian immigrants in that country, Marchese Marconi continued in English :

“ I wish to greet the National Authorities of Argentina—and particularly the Postmaster-General and the Chief of the Wireless Service—through whose sympathetic assistance you have been able to secure what I believe to be the most powerful broadcasting station in South America ; its aerial, supported by two 700-foot masts, is probably the highest aerial in the world devoted exclusively to broadcasting, so that its signals should be heard not only throughout Argentina, but in neighbouring and far distant countries as well. In saying this, I am not forgetting the size of your country, but the first test transmissions from your station were actually heard by engineers of the Marconi Company at Chelmsford over a distance of 6,000 miles.

“ Radio Excelsior, Buenos Aires, represents international co-operation in a tangible manner, for it was mostly constructed at Chelmsford, Essex, and the installation of its British equipment is a reminder of the vital commercial relationship that exists between your country and England.

“ Your new station will undoubtedly stimulate your interest in broadcasting, and enable many millions to enjoy the programmes broadcast from the famous Colon Gran Opera.

“ In conclusion, I should like to send a personal greeting to the 70,000 British in Argentina—many of whom are intimately connected with the scientific and commercial development of that country. I am sure that the interests of Argentina have been furthered through the efforts of the Argentine Trade Commission which visited London this Spring, and which Englishmen were so glad to welcome.”

The Radio Excelsior Station, which was erected by the Marconi Company, has an aerial energy of 20 kilowatts.

“ Excellent retransmission ” of the address was reported from Argentina.

### **Marconi Equipment for New Aircraft.**

**I**N THE MARCONI REVIEW, No. 39, we published the news that the first four of the “ Atalanta ” type aircraft supplied to Imperial Airways Limited for the African and Indian air routes were to be fitted with the new Marconi combined medium and short wave aircraft equipment, Type A.D.37a/38a.

We are now able to announce that, following exhaustive tests, Imperial Airways Limited have decided to fit the entire fleet of eight "Atalanta" type aircraft with this equipment.

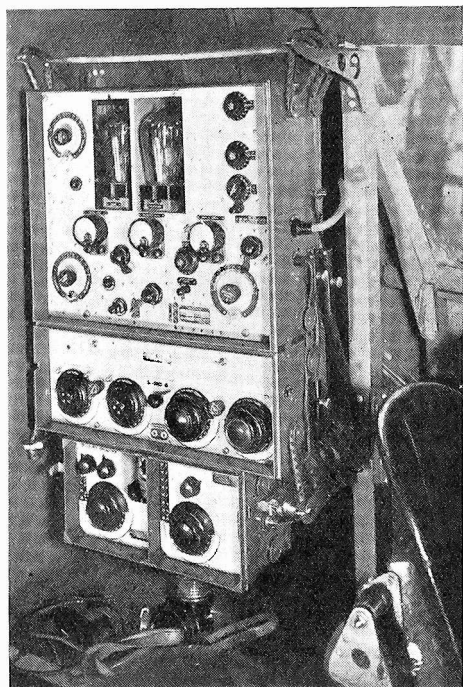

*Marconi combined medium and short wave aircraft equipment.*

This decision is a practical tribute to the success of the Marconi Company in overcoming the difficult conditions prevailing over the African air route and in providing a new type of equipment whose performance under actual service conditions has been in every way outstanding, establishing new records in range and quality of aircraft communication.

Short wave communication over distances up to 2,000 miles, from Cape Town to M'beya, Tanganyika, are reported consistently. When the emergency equipment for ground working was tested at Cape Town on medium waves, using a 12-foot ladder as a support for the trailing aerial, two-way telegraphic communication was maintained with Victoria West at 380 miles, and the aeroplane's messages were received at Germiston (Johannesburg) at a distance of 830 miles.

A fixed aerial is available for short wave communication, and it is quite usual to switch on to this aerial and transmit telephony or telegraphy immediately on winding in the trailing aerial. In this way signals are received from the aeroplane while it is still running across the aerodrome after landing. In the case of a forced landing such means of communication would obviate all anxiety.

As an additional refinement, a small attachment to the receiver provides a simple and convenient direction finding service, enabling pilots to set their course by the ground wireless stations along the route, with which "perfect homing" is reported at distances up to 240 miles.

#### **Manchester Air Port Station.**

**T**HE Marconi station erected for the Air Ministry at the Manchester Air Port came into regular operation on May 1st.

This is the first fully equipped wireless station to be erected in a municipal air port in Great Britain and represents a co-operative effort for the advancement of

British civil aviation on the part of the Air Ministry, whose personnel are operating the station and for whom the Marconi Company designed and installed the wireless

transmitting equipment, and the Manchester Corporation, which has provided the station site and buildings.

The Air Ministry has also established a complete meteorological office at the air port for the issue of official weather reports.

The wireless installation is able to provide civil aircraft operating in the north-west and Midlands of England with the various classes of wireless service that have proved of value in enhancing the safety and efficiency of the Continental and Imperial air routes, including ground-and-air communication by telephone or



*Marconi transmitter at Manchester Air Port.*

telegraph, meteorological broadcasts, wireless direction finding, and inter-aerodrome communications. It also has sufficient power and range to keep in touch with aircraft making the Irish Sea crossing to Belfast or Dublin.

The equipment installed, all of which is of the most modern design, comprises a Marconi ground station transmitter of approximately three kilowatts power input and a Marconi direction finding receiver. The arrangement of the receiving station and direction finder is similar to that at the London Air Port, Croydon, which has provided a valuable aid to air navigation on the Continental air routes.

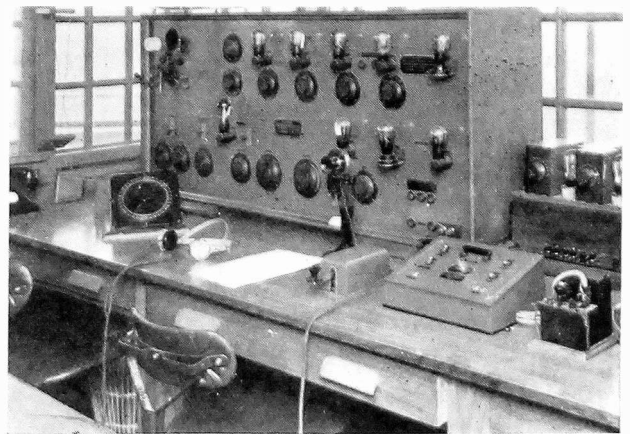

*Marconi directional receiver at Manchester Air Port.*

### **Derby Day Traffic Control.**

**D**ERBY DAY traffic on the roads leading to Epsom was again this year controlled from the air by an autogiro aircraft fitted with Marconi apparatus.

Scotland Yard traffic experts in the autogiro kept a constant watch from the air on the flow of traffic along the roads below and were able successfully to obviate heavy traffic jams by maintaining constant wireless communication with their colleagues on the ground, whom they warned of the likelihood of undue congestion at any point. They also transmitted information as to any clearer alternative routes that were available so that the police on the roads could divert and control the traffic to the best advantage.

The ground station was established somewhere near Epsom, and its equipment, like that of the autogiro, consisted of a short wave Marconi transmitter and receiver for two-way telephone communication.

The decision to use a Marconi-equipped autogiro on Derby Day this year was a result of the very successful application of this novel method of traffic control on the crowded Epsom routes last Derby Day.

### **Wireless for Isolated Communities.**

**T**HE value of wireless communications to highly developed countries has been so widely demonstrated in recent years, during which a vast network of radio telephone and telegraph services has been established between practically all the principal nations of the world, that, paradoxically enough, the special value of wireless to isolated communities is less emphasised to-day than in the earliest period of Marconi's inventions. Yet modern wireless apparatus has attained a degree of efficiency and reliability, combined with simplicity of operation, that renders it an essential part of the equipment of any settlement that is outside the world's established communications systems.

A typical example of such a community, and the utility of wireless to its members, is the small British settlement on Christmas Island, in the Indian Ocean. Christmas Island lies some 800 miles south of Singapore and 1,000 miles north-west of the Australian Continent. It is served by no cables and it is far from the regular shipping routes.

Without wireless, its inhabitants would be isolated from contact with the outside world except through the medium of trading ships.

#### **Two Stations for Christmas Island.**

The Christmas Island Phosphate Company, however, has recognised the importance of communications to the island, both for social and commercial intercourse,

and for some time past has maintained a small wireless station. The island's wireless services are now being extended and modernised by the Company through the provision of two up-to-date Marconi stations for direct communication with Singapore and with distant ships.

The link with Singapore is by short-wave wireless, utilising a Marconi Type S.250 transmitter. This transmitter represents the latest development in medium-power short-wave equipment, covering the waveband of 20 to 100 metres, with a power to the aerial of 250 watts when operating continuous wave telegraphy, for which it is particularly designed. Singapore being the principal supplies base for Christmas Island, an efficient communications channel of this kind is particularly valuable, enabling a great deal of time to be saved in requisitioning and obtaining new supplies and replacements.

For working with ships on medium wavelengths, a special 200 watt transmitter has been supplied from the Marconi Works, Chelmsford, enabling the islanders to communicate with vessels passing far over the horizon and also to keep in touch with the Christmas Island Phosphate Company's ships approaching and leaving.