

THE MARCONI REVIEW

No. 36.

May-June, 1932

Editor: H. M. DOWSETT, M.I.E.E., F.Inst.P., M.Inst.R.E.

ECHO SIGNALS IN TRANSATLANTIC PICTURE TELEGRAPHY.*

By H. M. DOWSETT.

PART II.

The Paper describes the various types of multiple signals and their causes, the influence of the Heaviside layer, and then gives a history of investigations carried out by the Marconi Company into short wave propagation phenomena covering the period from 1925 to 1931.

The first part of the Paper was published in THE MARCONI REVIEW, No. 34, and dealt with the production of echoes during the propagation of short waves through the atmosphere. The concluding part of the Paper deals with the recent investigation of such echoes by the use of facsimile methods of reception.

Recent Investigation of Short Wave Propagation Phenomena.

The main conditions affecting the propagation of short waves, which, as the result of extensive research work on the character and behaviour of the upper atmosphere have been found to exist, have been stated, and with this survey completed, it is proposed now to describe briefly the general sequence of investigations carried out of late years by the Marconi Co., on the propagation of short waves, the results of which have contributed so materially to the present accepted theory.

When short wave working was first applied to the commercial traffic services, it was immediately recognised that if we could obtain reasonably approximate values for the height, ionic density, and attenuation constant of the refracting layer or layers, and a measurement was made of field strength received from a station at a known distance radiating a known power from its aerial on a known wavelength, it should be possible to modify the theory of propagation accepted for long waves so that it could be applied to short waves; and then by the aid of this revised theory it should be possible to calculate the strength of signals at any distance on any wavelength on which signal strength measurements at a fixed distance had been taken, and to interpolate values for intermediate wavelengths.

* A Paper read on December 9th, 1931, before the Television Society at University College, London. The blocks for these illustrations are kindly loaned by the Television Society.

(I)

PROPERTY OF
CANADIAN MARCONI CO.

Echo Signals in Transatlantic Picture Telegraphy.

With this end in view, the systematic observation of the signal strengths of commercial short wave stations was begun at Chelmsford, which, together with the records of the preliminary tests of the beam stations covered the two-year period 1925-27, and as a result enabled the Marconi Co. to publish early in 1928 the two sets of curves shown in Fig. 2 and Fig. 3, for estimated signal strength at different distances up to 10,000 miles, covering a range of wavelengths from 6 metres to 100 metres; Fig. 2 giving the results for all daylight transmission and Fig. 3 for all darkness transmission.

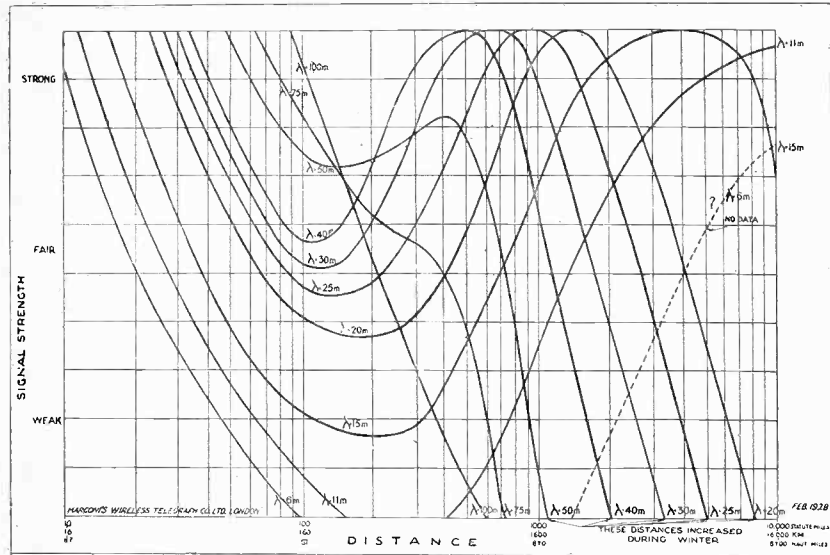

FIG. 2.—Distance-Signal strength curves. Short Wavelength transmission during daylight.

Their compilation was noteworthy, as it was the first attempt ever made to predict the strength of signals received at a great distance by the indirect ray, and over a wide range of wavelengths.

The curves were based on the signal strengths estimated in arbitrary R units by the operators employed on interception duty, where R₁ indicated a signal that was just audible, and R₉ a signal strong enough to be heard when the telephone was held away from the ear. They provided a first approximation to field strength values, no suitable apparatus for the quick and accurate measurement, as distinct from aural estimate, of field strength being at that time available.

The importance of this investigation having been recognised, arrangements were made for a period of continuous interception of short wave signals on wavelengths between 14 metres and 50 metres from stations all over the world, which varied in number increasing towards the end of the period up to a maximum of 120. This interception was carried out from October, 1927, to October, 1928. The signal intensities were again estimated in R strengths, and observations on the directions of the incoming signals were also made at the same time.

The analysis of the results provided the material for two valuable papers,* published in 1929, dealing with the various problems of world-wide communications, including echoes, scattering, attenuation, fading, magnetic storm effects and skip effects, and also the construction of shadow charts, which enabled the transmission range on different wavelengths to be calculated, not only under all daylight conditions or all darkness conditions, but also with the sun at any position of elevation relative to the great circle direction considered.

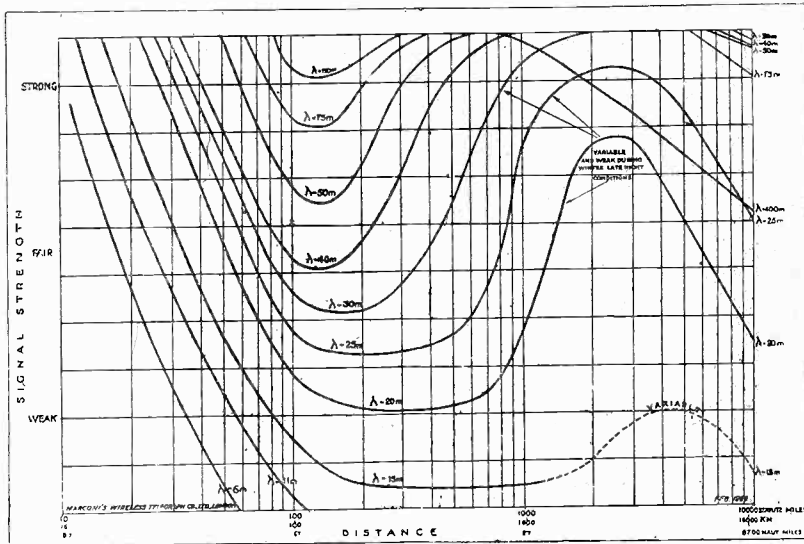

FIG. 3.

Distance-Signal strength curves. Short Wavelength transmission during darkness.

Then from August, 1928, to January, 1929, the facsimile echo tests between Somerton and New York on 22 metres, to which reference has already been made as having provided such useful information on very short echo times, height of refracting layer, ionic density in the layer and ionic re-combination factor, were carried out.

Several of the figures employed in this paper to illustrate the 22 metres results were first published in Eckersley's 1930 Multiple Signals Paper.

Marconi-Wright Facsimile Apparatus.

An illustration of the Marconi-Wright facsimile apparatus employed on the Transatlantic tests is shown in Fig. 4. This gives a view of the general assembly at the transmitter end, the apparatus on the right comprising an aperture disc for chopping up the light, with its driving motor. In the centre is the controlling switchboard, with the optical rotor and lens system in front. On the left is a panel carrying the amplifiers, the electrically maintained tuning fork control being mounted on a rack which is not shown.

* T. L. Eckersley, "An Investigation of Short Waves." Journal I.E.E. Vol, 67, p. 992, 1929.

T. L. Eckersley and K. W. Tremellen, "World-wide Communications with Short Wireless Waves." World Engineering Congress, Tokio, 1929.

The general appearance of the facsimile receiver equipment is similar to the above.

A schematic view of the optical parts of the transmitter is shown in Fig. 5. A is the light source, C the chopper disc, and PQ the optical rotor which causes the light beam from the lens H to scan the surface of the picture to be transmitted,

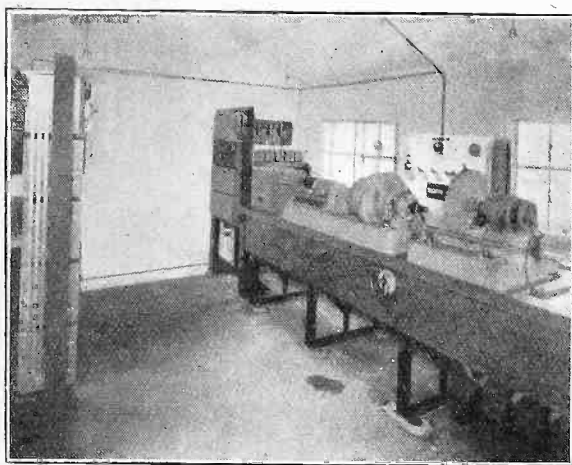

FIG. 4.
*Marconi-Wright facsimile apparatus.
Transmitter assembly.*

through a slot in a stationary brass cylinder. The picture is held down on the cylinder by means of a flexible band supported by a hinged carrier, and the carrier is made to move slowly forward carrying the picture over the optical slot by means of a lead screw. The scattered light from the picture surface is conveyed through the lens J and prism K to a photo-cell, and the current fluctuations which result pass through an amplifier system to the line and thence to the modulating system of the radio transmitter.

The optical parts of the facsimile receiver used on these tests is shown in Fig. 6, where L is the light source, B a Nicol prism polariser, K a Kerr cell for modulating the light, E a Nicol prism analyser, through which the modulated light passes to the prism and scanning lens in the optical rotor. The sensitised paper is held down on the cylinder M by a flexible band and carrier, and is made to traverse the optical slot along which the scanning spot moves by the motion of the carrier on the lead screw. A photographic record is thereby obtained on the paper, which requires to be developed to complete the process.

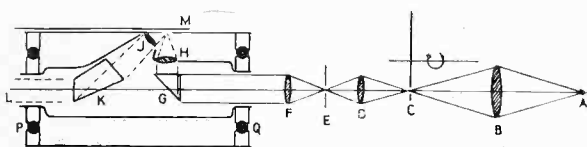

FIG. 5.
*Marconi-Wright facsimile apparatus. Diagram
of transmitter optical assembly.*

The speed of the scanning spot, which is controlled by the fork, was adjusted for most of these tests to 30 ins. per minute, which was sufficient to distinctly separate signals of short duration such as of the order of 0.002 sec., having time intervals between them of less than 0.001 sec.

Then if a single thin line is drawn on a sheet of paper transverse to the direction in which it is to be scanned on the facsimile drum, and conditions are suitable for echo, two, three or more thin lines will appear on the receiver print. It is usual to call the first line the main signal and the remaining lines echo signals. The speed of the scanning spot being known, the complete echo duration can be obtained

from the distance between the first and last lines ; and the intervals between the separate echoes in a series, from the distances between the different lines.

**Some Results of Facsimile Echo Tests on 22 Metres Somerton—
New York Circuit.**

The echo intervals are irregular, but occasionally a series is repeated many times within the period of a few minutes.

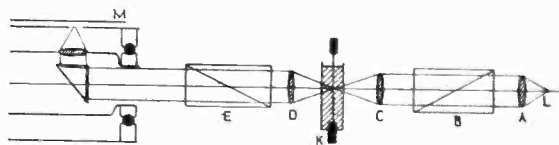

FIG. 6.

*Marconi-Wright facsimile apparatus.
Diagram of receiver optical assembly.*

was due to a ray inclined less than 5° from the horizontal, the second to a ray having an angle of $16^\circ 45'$; the third to a ray inclined at $21^\circ 34'$; the fourth a ray inclined at $29^\circ 32'$; and the fifth a ray leaving the transmitter at an angle to the ground of $34^\circ 36'$.

He reasoned that these rays travelled as in Fig. 8, from A to a distant point by successive reflections, and he was able to enforce this conclusion by calculating the height of the reflecting layer to account for the echo times measured, with the result that three out of the five echoes gave figures for the height as follows :—

Echo No.	Height.
3	343 km.
4	338 km.
5	340 km.

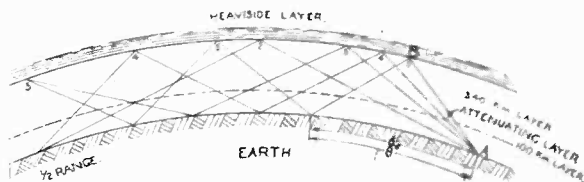

FIG. 8.

The production of multiple echoes by rays leaving the transmitter at different angles.

midnight when the signals were weakened by the falling off of some of the high

T. L. Eckersley takes a typical case of such echoes obtained on a facsimile print when transmitting a single thin line as described. As many as five signals were received for one signal sent at certain portions of the line, and several of these series of five signals when plotted on the same time scale almost coincided, as shown in Fig. 7. He was able to show that the first signal

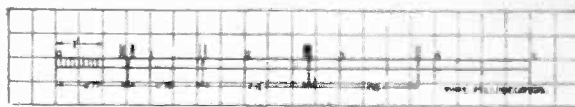

FIG. 7.

The periods of several multiple echoes superposed on the same time scale.

and these results agreed with those obtained by Kenrick and Jen, when employing a pulse method at night on 67 metres, which indicated a layer of 344 km.

The effect of echo on facsimile prints made at different hours in the day is illustrated in Figs. 9, 10 and 11. Fig. 9 was taken at a speed of 30 ins. per minute, the length of the picture being 8 ins. It was taken near

Echo Signals in Transatlantic Picture Telegraphy.

angle echoes. Fig. 10 is a better picture, because it was taken in the early morning when echo is least, and also because the scanning speed had been reduced by half.

Fig. 11, taken in the afternoon when echo was prevalent, demonstrates that if the scanning speed is sufficiently reduced such as to a speed of 10 ins. per minute, so that the echoes overlap, the picture is clear and signals are strong, although a reduction in speed of the required order may render the traffic channel commercially unprofitable. By increasing the speed to 30 ins. per minute, the signals forming

the different characters in the message were made to open out, with the result that intelligibility was lost.

In general, the duration of the echo signal is directly proportional to the field strength of the main signals. Thus the curves of Fig. 12, taken at Somerton during the facsimile tests on 22 metres with New York in 1928, indicate that echo was negligible when signals were only just readable at 6.0 a.m., but had maximum duration at 6.0 p.m., when the field strength of the main signal was greatest.

Now it was hoped that every year the conditions of propagation would repeat themselves. Such, however, has not proved to be the case.

When the 1928-29 observations were used as a basis to estimate best wavelengths in 1930-31, the wavelengths found best in practice proved to be longer than those estimated, especially during the night.

Any doubts which existed regarding a possible change in conditions have recently been set

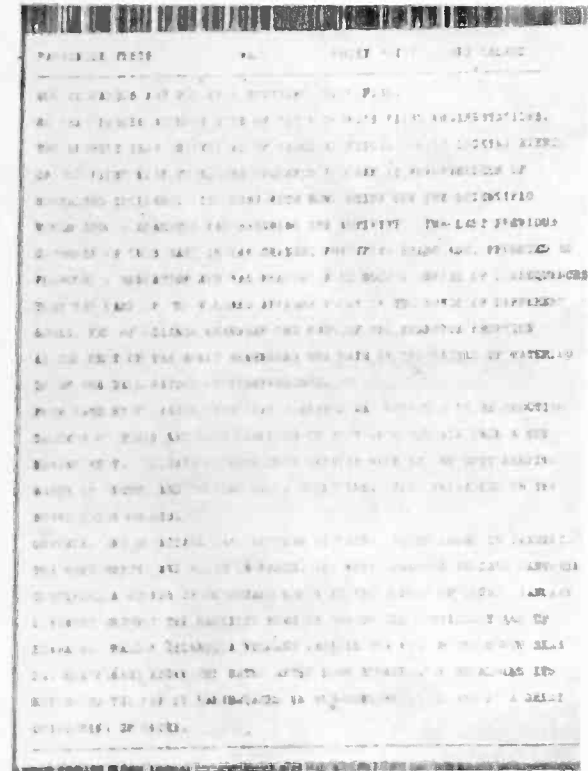

FIG. 9.

Effect of echo on a facsimile sent from New York to Somerton on 22 metres, speed 30 ins. per minute, at 2335 G.M.T., October 21st, 1928.

at rest as the result of a further period of twelve months continuous observations on the transmissions of the world short wave stations, which concluded in September, 1931. Actual measurements of field strengths were taken in this series of tests, as distinct from the estimated field strengths judged by the intercepting operators, on which reliance had to be placed in the earlier tests.

Confirmation has been obtained that at the present time there is a progressive increase each year in the values of wavelengths which give best results.

Further Long Distance Facsimile Tests.

Finally, in the middle of this last mentioned period, that is from March to June of this year, there took place the second group of facsimile echo tests on 15 metres and 30 metres between Somerton and Montreal, and also between Somerton and Cape Town, which have given results complementary to the field strength tests,

showing that the ionic density for the same period in the year, day or night, has fallen considerably from the 1928-29 values. This explains the increase in the values of optimum wavelengths, and observations suggest that there is a connection between these changes and solar activity.

It is now the conclusion of Marconi research engineers that an eleven-year cycle will ultimately be found to exist for the best wavelengths for any given distance, corresponding to the eleven-year sun-spot cycle.

Specimens of the facsimile records obtained in the 1931 tests and the facts they disclose will now be discussed.

The signal transmitted by facsimile was a thin line drawn on the paper normal to the direction of the scan, and by running the receiver facsimile drum at 57.6 ins. per second, which was four times the speed of the transmitter drum, the line received was made four times the width transmitted, and it was cut up into sections and the prints became striped, as shown in the figures which follow.

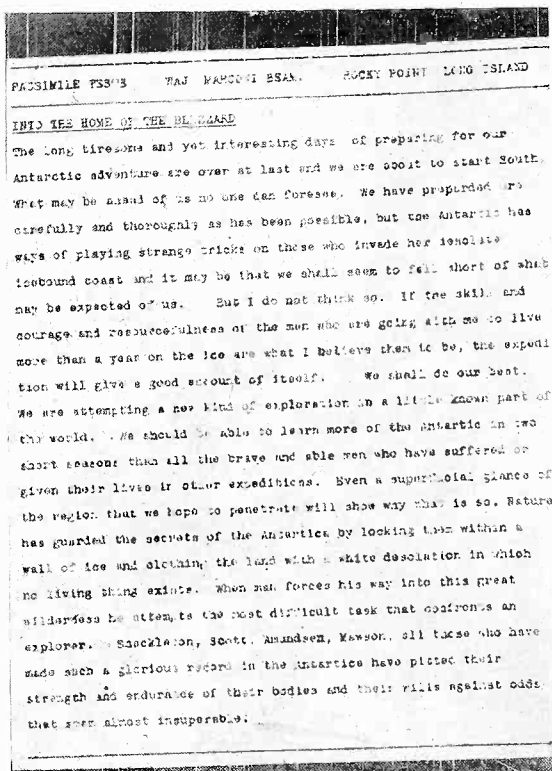

FIG. 10.

Effect of echo on a facsimile sent from New York to Somerton on 22 metres, speed 15 ins. per minute, at 0620 G.M.T., October 22nd, 1928.

It may be mentioned here, that although the picture transmitted consisted of several lines transverse to the direction of scanning, which were drawn one below the other and well spaced apart, the illustrations shown are typical sections of one such line only from each print. Also the wavy character of the line, which appears in some of these illustrations, is not material, as it was produced by slight variations in the speed of the scanning spot from four times the normal, for which due allowance could be made when measuring echo duration.

Facsimile Tests Somerton—Montreal 32 Metres and 16 Metres.

The first of these, Fig. 13, gives a series of results received at Somerton from

Echo Signals in Transatlantic Picture Telegraphy.

Montreal on 32 metres, commencing at 8.45 p.m. on the 10th May and ending at 4.05 a.m. on the 11th May.

FASSIMILE TEXTS	WAG	ROCKY POINT	LONG
FIRST TRANSMISSION OF THIS		SUBJECT SUNDAY NOVEMBER	
DEAR WHITE, VERY MANY THANKS		FOR YOUR VERY INTERESTING	
RECEIVING LAST NIGHT. THERE		IS NO DOUBT I SHOULD	
AM DOING FINE AND THAT AT		PRESENT YOU KNOW MORE	
HAVE RECEIVED THAT WE NEVER		DID BEFORE. I AM WRITING	
AGAIN. I WANT YOU A LETTER		FOR A WEEK AGO REPLYING	
YOUR QUESTIONS. I ADDRESS		ED THIS TO CHELSEA	
STIONS TO FORWARD IT TO YOU		AT SOMERTON IF YOU KNOW	
I RECEIVED YOUR SERVICE THIS		MORNING AT 11.00.00.	
BT THAT YOU HAD RUN INTO A		VERY BAD PATCH BECAUSE	
GOING OUT NORMALLY HERE.		ALL OUTGOING RADIO IS	
STOPPED (MONITORED) ON A		LOUDSPEAKER AT MY SHACK	
ESSENTIAL THESE DAYS AS THERE		IS NO PARTICULAR	
TO WATCH WAS. I TRIED		TO RECEIVE WAG IN MY	
AM APPARENTLY IN A FULL POSI		TION FOR I HAVE NEVER	
AND GET GAMBLED OUT BY WIL.		I NOW LEAD A SIGNAL	
INIER PLACED NEAR THE TALK		MITTER AND PASS THE	
LINE TO THE SHACK. I HAVE		NOW GOT MY MORNIN	
ON ONE HUNDRED CYCLES.		MY MAXIMUM STABLE FEED	
AMP AND I FIND THAT IT IS		BETTER TO REDUCE THE	
A.C. MOTOR. SYNCHRONOUS		SHOULD BE CONSTANT	
AS NO GRID CURRENT IN PRE		SENT IN THE COUPLER ST	
FREQUENCY. WEATHER HAS		BEEN VERY BAD HERE	
SO REAL NOVEMBER TOUCH ABO		UT IT, MISTY AND WET	
THESE MONTHS, 44 DEGREES		IN THE SHACK. WE ARE	

FIG. II.

Effect of echo on facsimile sent from New York to Somerton on 22 metres and speeds of 15 ins., 10 ins., and 30 ins. respectively at 1415 G.M.T., November 8th, 1928.

claimed that one method of reducing echo was to employ a shorter wavelength, because more high angle rays would pass through the layer and would therefore be lost from the signal than would be the case with a longer wavelength. The actual gain to be expected by decreased total echo duration as a result of employing a wavelength of 16 metres instead of 22 metres, he illustrated by the curve shown in Fig. 15. It was not possible to demonstrate this at the time, but

It will be noticed that there is one main band of signals, which varies in width according to the hour of the day, and this is the original line signal, which has been broadened to a greater or less extent by the multiple echo effects of rays leaving the transmitter at different vertical angles.

There is also a broken secondary line shown in the first three prints following the main signal band. This is produced by a distinct group of rays leaving the transmitter at a higher angle than the main signal group. More than one explanation can be offered for the absence of rays between the two groups.

It will be noticed that in the evening the echo is strong, as the ionic density is still very high, whereas in the early morning, when the ionic density is at a minimum and more rays escape through the layer, the signals are almost free from echo.

A very interesting comparison is given in Fig. 14 between the normal echo conditions on 32 metres and on 16 metres. In his multiple signals paper, when discussing the results obtained on 22 metres,* Eckersley had

* T. L. Eckersley, "Multiple Signals in Short Wave Transmission." Proceedings Institute Radio Engineers. Vol. 18, No. 1, January, 1930.

now the comparison of the 32 metres with the 16 metres, as shown in these prints, has confirmed his assumption.

**Facsimile Tests Somerton
—Cape Town 32 Metres and
16 Metres.**

Now all the facsimile signals so far discussed have been received in an East and West direction. It was expected that some difference might be observed when working facsimile in a North and South direction, and this has been confirmed, the facsimile records obtained at Somerton from Cape Town on 32 metres and on 16 metres giving less echo, different echo times, and other effects which are still under analysis to determine why they differ from the Canadian results.

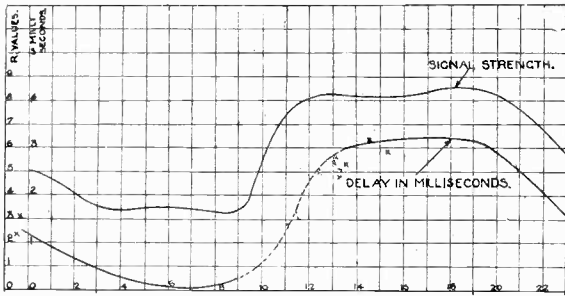

FIG. 12.

*Echo duration and Signal strength at Somerton.
New York transmitting on 22 metres, October
—November, 1928.*

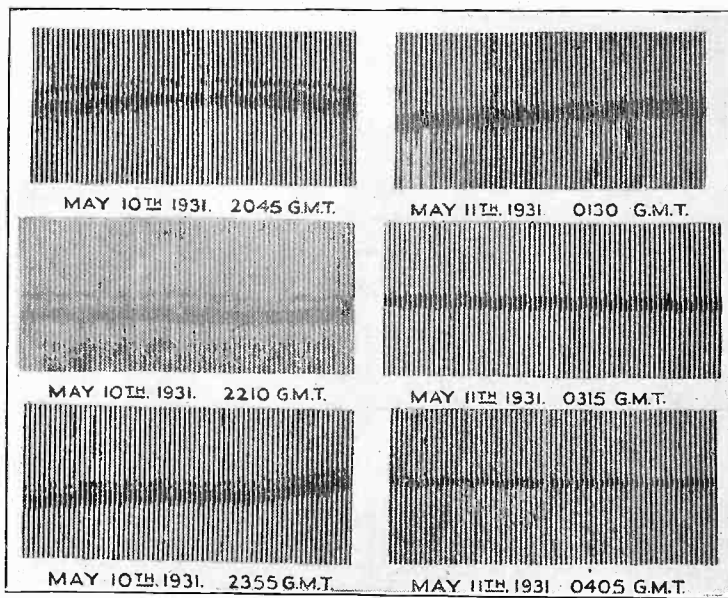

FIG. 13.

Facsimile echoes received at Somerton from Montreal on 32 metres, May 10th-11th, 1931.



Echo Signals in Transatlantic Picture Telegraphy.

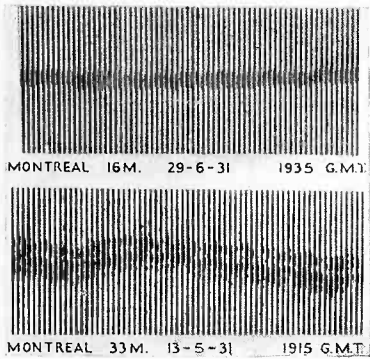

FIG. 14.

Comparison of facsimile echoes received at Somerton from Montreal on 33 metres, at 1915 G.M.T., 13th May, 1931, and on 16 metres, at 1935 G.M.T., 29th June, 1931.

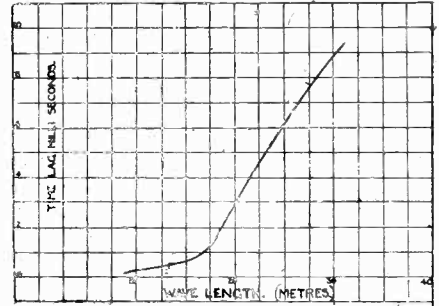

FIG. 15.

Estimated multiple echo duration at different wavelengths.

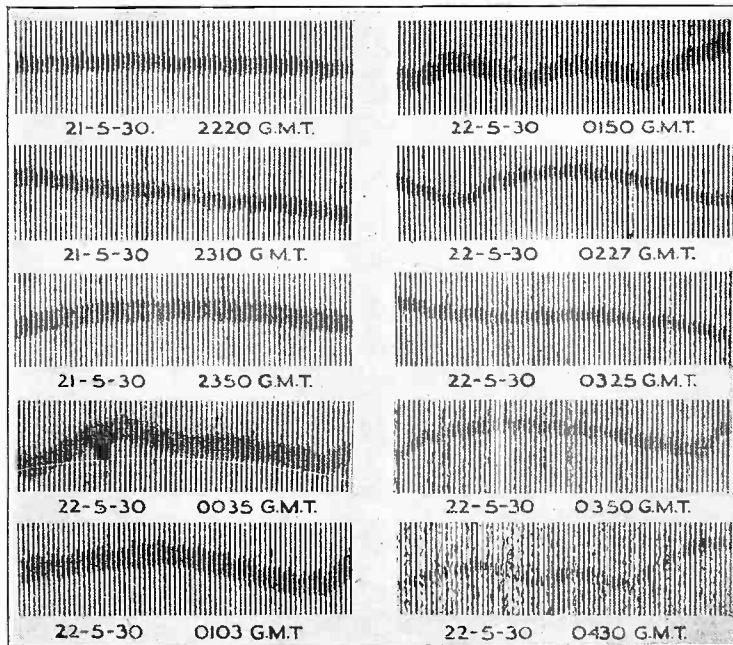

FIG. 16.

Facsimile echoes received at Somerton from Cape Town on 32 metres, from 2220 G.M.T., May 21st, to 0430 G.M.T., May 22nd, 1931.

It may be mentioned that in addition to being North and South instead of East and West, the signals from Cape Town travel almost twice the distance of those received from Montreal—the great circle distances being 9,500 km. and 5,500 km. respectively—also the Cape signals travel mostly overland, while the Montreal signals travel mainly over sea, so that without more evidence one hesitates to give all the credit for the improved results to the direction of transmission.

A typical example of the normal variation of echo during the night on 32 metres is shown in Fig. 16. It will be seen that towards the early morning the echo disappears, due to the increase in the layer absorption, but so also does the strength of the signal disappear, and at 4.0 a.m., the facsimile may be free from multiple effects, but it may also be too weak to give a good print.

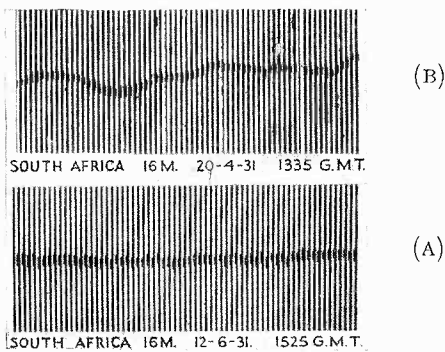

FIG. 17.

Facsimile signals at Somerton from Cape Town on 16 metres at 1525 G.M.T., June 12th, 1931. Good normal conditions. Also on 16 metres, at 1335 G.M.T., April 20th, 1931. Unexplained high angle wipeout at this hour.

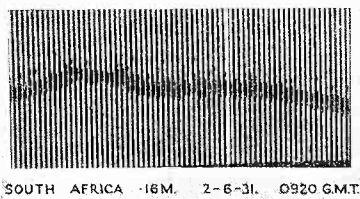

FIG. 18.

Facsimile echoes at Somerton from Cape Town on 16 metres at 0920 G.M.T., June 2nd, 1931, due to scattering.

At 5.0 a.m., signals had completely faded out. Of course, in practice, the stations have by this time switched over to the day wave of 16 metres, and Fig. 17(A) gives an example of good normal conditions on this wavelength, which is suitable for facsimile and probably for television.

The other facsimile on the slide No. 17(B) illustrates one of the puzzle effects on the South African circuit which up to the date when this paper was written, had yet to be explained. Judging from the height of the sun at the hour when this facsimile was transmitted, that is at 1335 G.M.T., the ionic density should have been a maximum, as this state is reached about 1 hour 40 minutes after the sun passes the zenith of the great circle between the transmitting and receiving stations, and therefore the echo effects should also have been a maximum. Instead of this, signals show very little echo.

Fig. 18 illustrates another abnormal case, the type of echo received from scattered signals, that is fairly long period echoes of the order of .01 sec., which have no definite direction or time relation with the main signal, and the effects of which are in consequence difficult to make provision against.

Then there are peculiar results produced by magnetic storms. One such storm took place on the 14th-15th May, and its effects are illustrated in Fig. 19. At twenty-five minutes before midnight on the 14th May the magnetic

disturbance caused all the high angle rays to be absorbed, which weakened signals and removed echo as shown in Fig. 19 (A), only glancing angle rays coming down to earth again. Five minutes earlier there had been a temporary fade-out. One hour and thirty-five minutes later, that is at 0115 G.M.T., on the 15th May, the same magnetic storm caused the very strong echo and scattering effects shown in Fig. 19 (B).

Fig. 20, shows a result obtained during the same magnetic storm on the 15th May, but on the Somerton-Montreal circuit on 33 metres. It shows the same effect occurring on this route as on the Cape Town circuit, the magnetic storm causing the high angle rays to be absorbed, and in consequence reducing the echo effects.

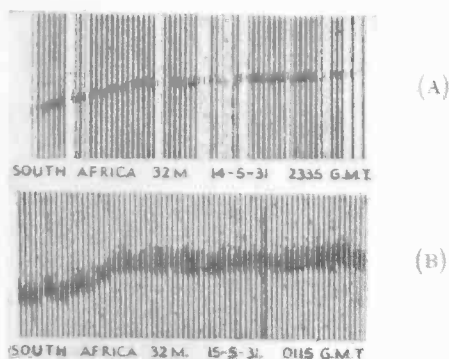

FIG. 19.

Facsimile echoes at Somerton from Cape Town on 32 metres, at 2335 G.M.T., May 14th, 1931, and 0115 G.M.T., May 15th, 1931. Magnetic storm effects.

at other times, the resulting signal may be too weak for good facsimile or television, but if it is due to the higher angle rays getting through the layer, leaving only the glancing angle rays to come down to earth again without experiencing too much absorption, then the echo-free signal may be strong enough for facsimile or television purposes.

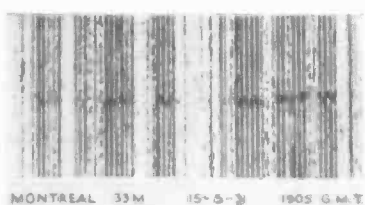

FIG. 20.

Facsimile signals at Somerton from Montreal on 33 metres, at 1905 G.M.T., May 15th, 1931, showing magnetic storm high angle absorption effect.

Conclusions.

Now what conclusions can be drawn from these facsimile tests?

First, that multiple echo effects over long distance are met with on all short wavelengths, but there is much less echo on 15 metres than on 30 metres, and there should be still less echo on a shorter wavelength than 15 metres.

During the twenty-four hours there is usually some period when the echo is not troublesome.

If this is due to the absorption of the medium being greater at this time than the medium being greater at this time than at other times, the resulting signal may be too weak for good facsimile or television, but if it is due to the higher angle rays getting through the layer, leaving only the glancing angle rays to come down to earth again without experiencing too much absorption, then the echo-free signal may be strong enough for facsimile or television purposes.

Clearly if it is possible to employ the direct ray only, this is the best condition for echo-free facsimile and television.

Wavelengths of 1,000 metres to 3,000 metres, which lose all their high angle rays by absorption, could be employed provided the frequency band required by the facsimile or television transmitter were not too wide, and the necessary width of channel were available.

Aerial design should proceed on those lines which concentrate the radiation in a narrow beam at a vertical angle which tests, such as those described by Eckersley, indicate as most suitable for the best results to be

obtained at the distance required. The narrower the beam in the vertical plane, the less echo may be expected, although no transmitting aerial design has yet been devised which is capable of concentrating the radiation in one sheaf of rays only.

Although it may be expected that the echo times at a great distance are longer than at a shorter distance, owing to the increased difference in the lengths of the paths traversed by the different rays, and also that at a great distance there may be less echo due to more echo rays being absorbed than when they pass over the shorter distance, further observation on these points is necessary to establish what actually happens.

Should it prove to be true that there is an eleven year cycle depending on solar activity, then for the next three years one may expect :—

- (A) Less day absorption, as the bottom of the layer will not be so low down.
- (B) Less echo on all wavelengths as more high angle rays will penetrate the layer.
- (C) In consequence weaker signals on any given wavelength.
- (D) To obtain the same field strength at a given distance, the wavelength will have to be increased.

While these changes are in progress, it is hoped that it will be possible to make further tests on a Transatlantic or other long distance radio facsimile circuit, which should enable valuable information to be obtained in support of, or amendment of the theories of the Heaviside layer which have been briefly dealt with in this paper.

MARCONI PORTABLE FIELD STRENGTH MEASURING EQUIPMENT

It has been apparent for a considerable time that a need exists for a portable field strength measuring equipment and the set described in this article has been designed to meet this need.

It is believed that no other similar equipment exists which is capable of such a high ratio of maximum to minimum field intensity measurement over such a wide range of wavelengths—namely 14 to 2,000 metres.

THE Marconi Type 205 Field Strength Measuring Equipment which has been available for some two or three years, while being quite satisfactory for use at a fixed point, is unsuitable for use where rapid field intensity measurements have to be made at a number of points such for example, as are required for the determination of polar diagrams or coverage of broadcasting stations and the checking of fundamental to harmonic field strength ratios, etc.

The new portable equipment has been designed to cover a waverange of 14 to 2,000 metres. This range, it will be observed, covers both the upper and lower broadcast bands and permits in addition the measurement of harmonics down to the limit of 14 metres.

A necessity arising from the use of a measuring set for the purpose outlined above is the measurement of much higher field intensities than those of which the Type 205 is capable without detracting in any way from the ability to measure field strengths of two or three micro-volts per metre. That the Portable Field Strength Measuring Equipment meets these requirements quite successfully is shown in this article. See Figs. 1 and 2.

Physical Dimensions.

The physical dimensions of the equipment are as under :—

Height (excluding frame aerial) 2 ft. 4 ins.

Height (including frame aerial) 5 ft. 9½ ins. + 3 ins. with short wave frame.

Width (overall, but excluding ledges) 1 ft. 8 ins.

Width (including ledges) 2 ft. 10½ ins.

Depth (front to back overall) 1 ft. 1 in.

Approximate weight 180 lbs.

Marconi Portable Field Strength Measuring Equipment.

Fig. 3 gives a schematic diagram of the layout of the equipment the units being numbered 1 to 14 are here tabulated.

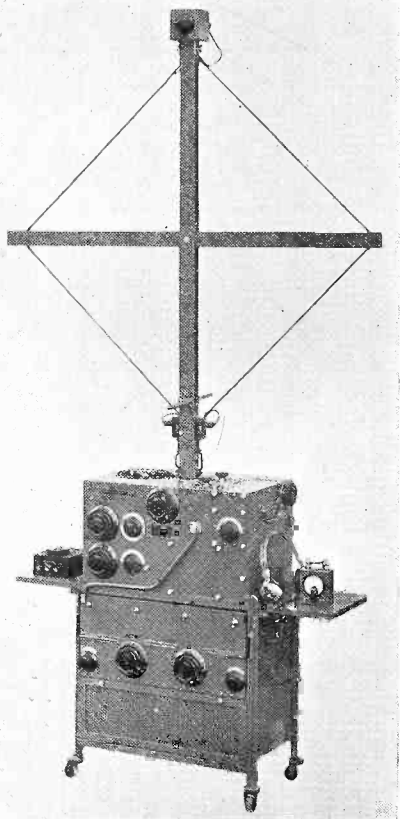

Marconi Portable Field Strength Measuring Equipment.

- No. 1 = Radio Frequency Generator.
- No. 2 = Radio Frequency Attenuator.
- No. 3 = Radio Frequency Potentiometer.
- No. 4 = Mutual Coupling.
- No. 5 = Frame Aerial Socket.
- No. 6 = Aerial Tuning Capacities.
- No. 7 = Receiver Coupling.
- No. 8 = R.F. Generator High Tension Battery.
- No. 9 = High Frequency Amplifier.
- No. 10 = 1st Detector and Change Frequency Oscillator.
- No. 11 = 1st Stage Intermediate Frequency Amplifier.
- No. 12 = 2nd Stage Intermediate Frequency Amplifier and 2nd Detector.
- No. 13 = Receiver High Tension Battery.
- No. 14 = Two Adjustable Ledges.

NOTE.—The low tension batteries are located inside the R.F. Generator and Receiver compartments respectively.

Radio Frequency Generator.

A Hartley type circuit is used for this unit, the output being controlled by fixed coupling coils contained within the interchangeable range blocks and these in turn are shunted by a 200 ohm variable potentiometer. This arrangement requires very little space in which to operate and eliminates the separate substitution of different coupling coils with a change of waverange and provides a fairly smooth output current variation. An easily accessible thermo-junction in series with the output is contained within the R.F. generator compartment and the output current is read on a "plug in" Cambridge type "L" galvanometer. Two thermo-junctions are supplied with the equipment with ranges of 0—25 milliamperes and 0—50 milliamperes respectively. The 0—25 milliamperes junction is for general use and the 0—50 milliamperes for use when it is desired to measure field intensities at or approaching the maximum of which the equipment is capable, it being noted that

Marconi Portable Field Strength Measuring Equipment.

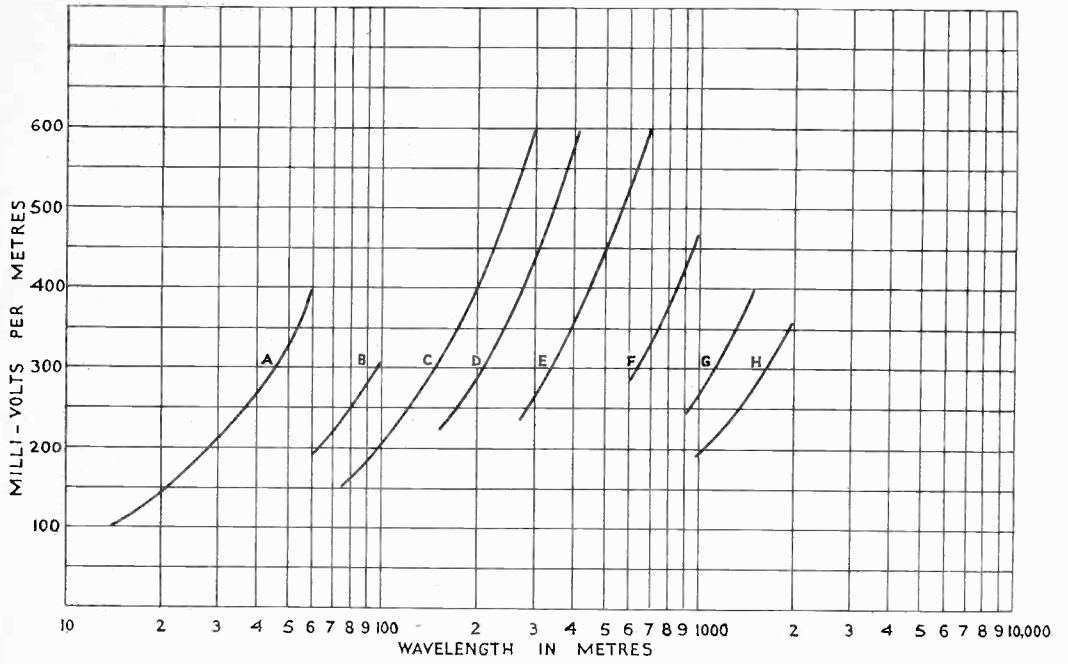

FIG. 1.

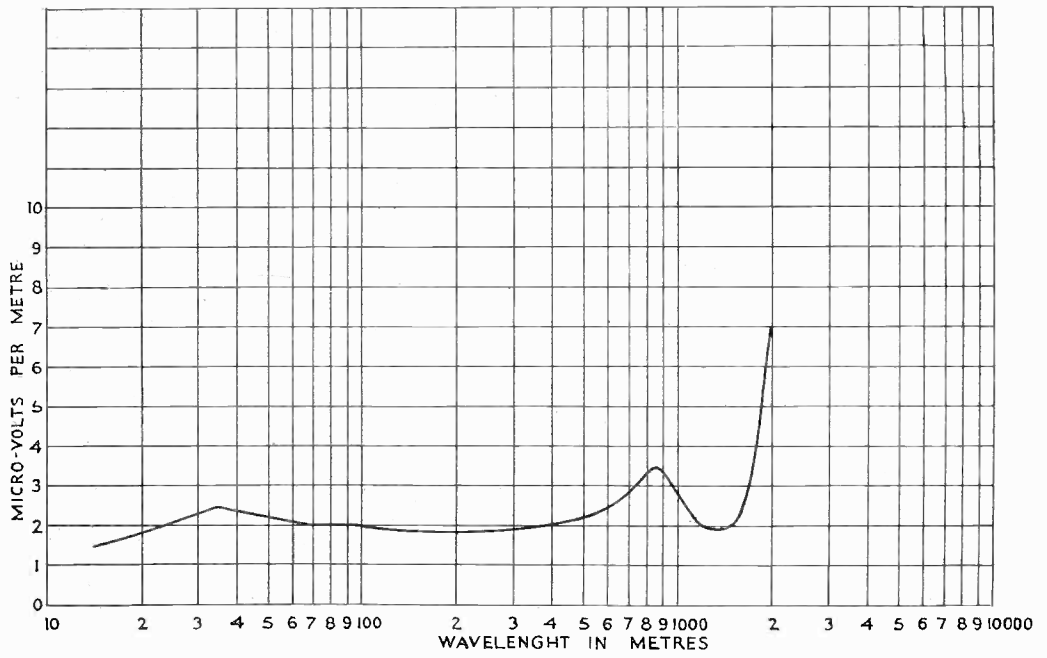

FIG. 2.

Marconi Portable Field Strength Measuring Equipment.

the output of the attenuator varies directly as its input current. The valve used in the R.F. generator is Type P.215.

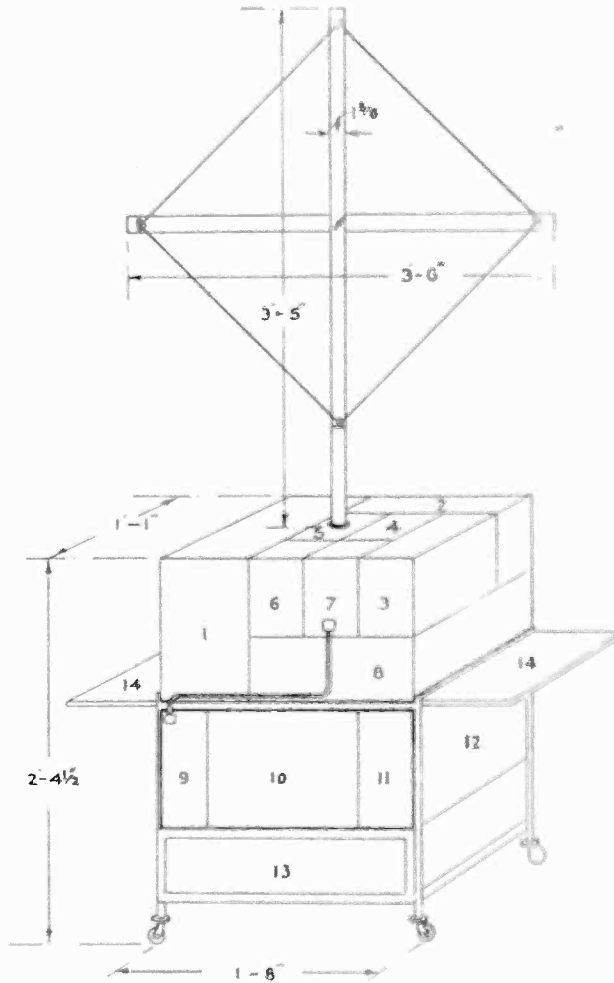

FIG. 3.

The Radio Frequency Attenuator.

This unit is based upon the Type 205 attenuator which is fully described and explained in "Short Wave Signal Measuring Apparatus." I. and II., by T. L. Eckersley, in THE MARCONI REVIEW of May and September, 1929, respectively. Although theoretically identical with that used in Type 205 this unit has been completely re-designed mechanically, resulting in a very large saving of space and weight, greater accessibility and more straightforward operation. The whole series

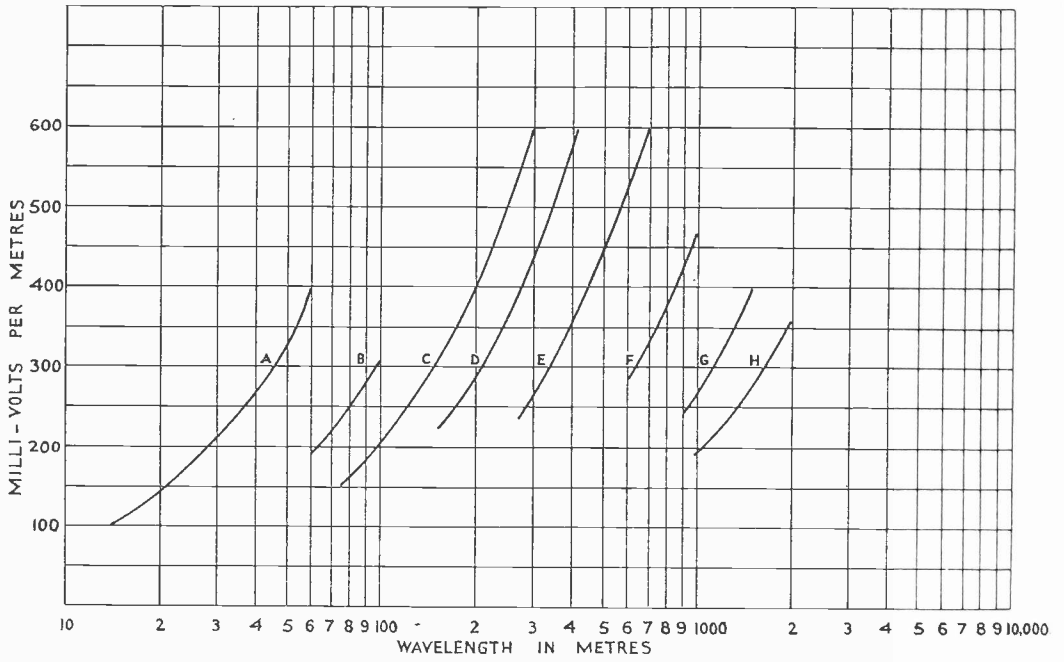

FIG. 1.

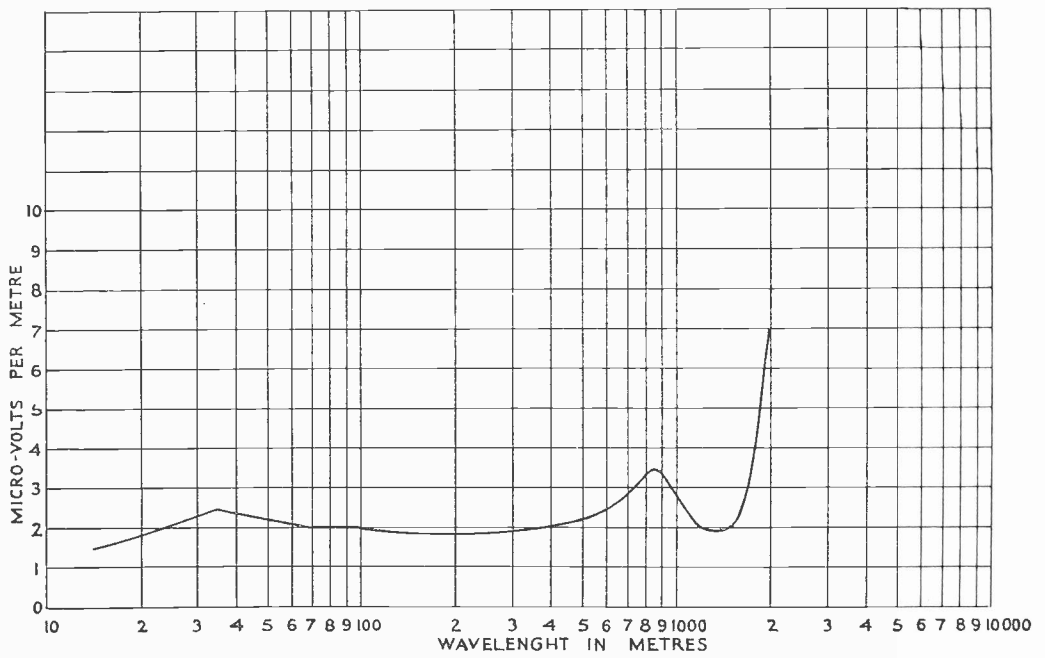

FIG. 2.

Marconi Portable Field Strength Measuring Equipment.

the output of the attenuator varies directly as its input current. The valve used in the R.F. generator is Type P.215.

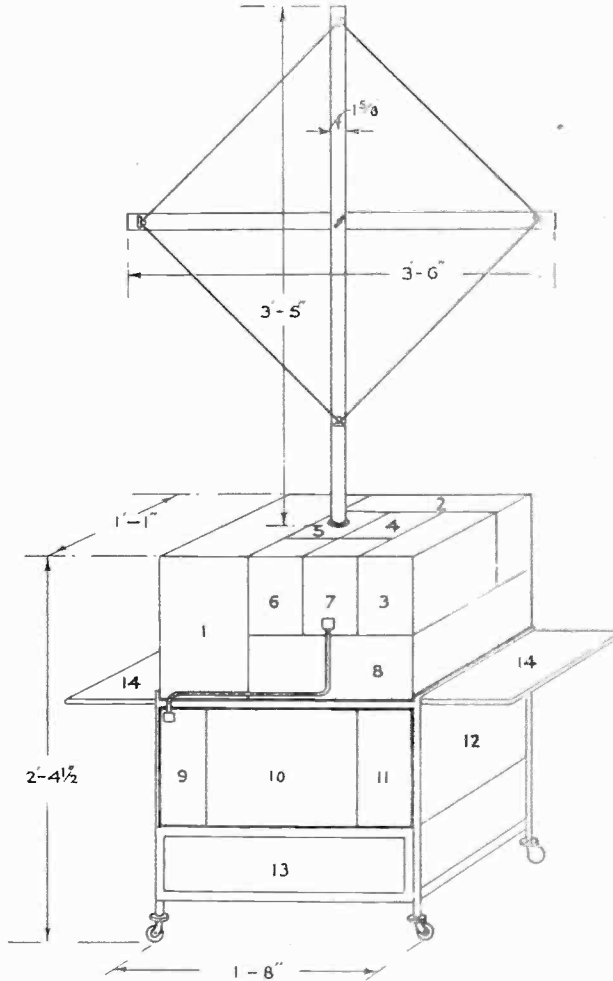

FIG. 3.

The Radio Frequency Attenuator.

This unit is based upon the Type 205 attenuator which is fully described and explained in "Short Wave Signal Measuring Apparatus," I. and II., by T. L. Eckersley, in THE MARCONI REVIEW of May and September, 1929, respectively. Although theoretically identical with that used in Type 205 this unit has been completely re-designed mechanically, resulting in a very large saving of space and weight, greater accessibility and more straightforward operation. The whole series

Marconi Portable Field Strength Measuring Equipment.

portion of the "T" network is in two units (instead of five), both of which can easily be withdrawn after releasing connections should the necessity arise.

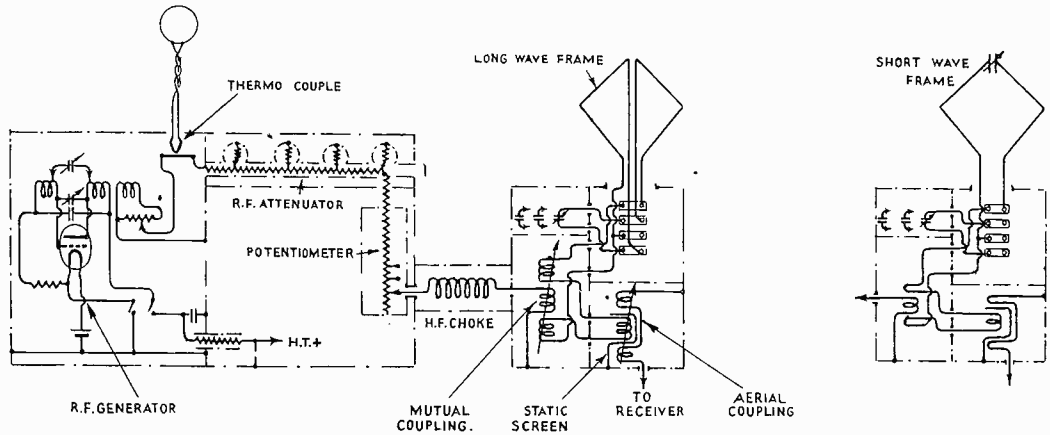

FIG. 4.

The shunt resistances also easily accessible, are operated by a cam shaft through a control handle, which is clearly marked for each position, at the end of the unit. The output potentiometer and choke coils remain as those in Type 205.

Mutual Couplings.

The physical dimensions of these have been kept very small and designed to be quickly interchangeable. Three different values of these are supplied.

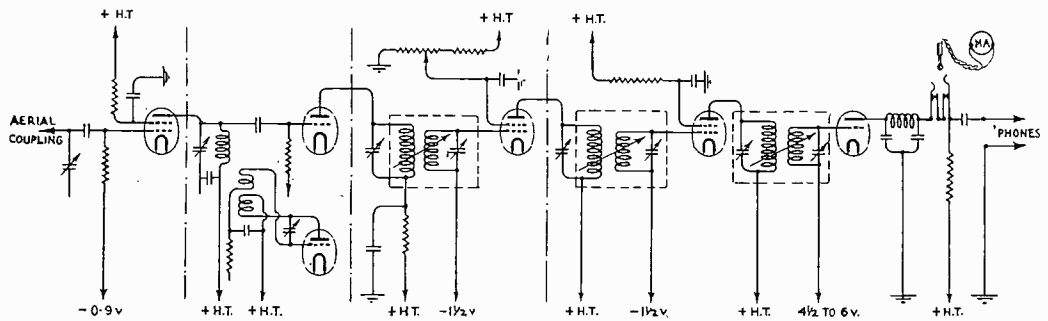

FIG. 5.

Aerial Frame Loops and Tuning Capacities.

The frame is more or less of skeleton construction, light in weight and designed to fold into a minimum of space for transportation. The flexible interchangeable loops are readily attached to the frame and easily folded into small space when not

in use. Six aerial loops are required to cover the range 14—2,000 metres. The aerial tuning capacities, with suitable control switch, are contained in the body of the R.F. generator and attenuator unit. For wavelengths below 75 metres the tuning capacity is attached to the top of the frame.

Superheterodyne Receiver.

In this unit one stage of high frequency amplification, the grid and anode circuits of which are gang tuned, precedes the first detector. The high frequency valve (S.22) anode winding and the change frequency oscillator windings are carried on a single former so that both are changed in one operation. The change frequency oscillator circuit is similar to that of the R.F. generator and uses a P.215 Type valve. Both detector valves are Type H.L.2 and the intermediate frequency valves are Type S.21. Two volt valves being chosen from considerations of weight and space required by L.T. batteries. The intermediate frequency amplifier operates on a frequency of 110 kilocycles with band pass intervalve couplings. No low frequency circuits are included in the circuit as the receiver is sufficiently sensitive to give the required deflection on a 0—500 microammeter in series with the 2nd detector anode on very weak signals. Output is controlled by screen grid voltage variation on the first I.F. valve.

Operating Features.

An outstanding advantage of the superheterodyne receiver as used in this equipment is the greater speed of operation as compared with the Type 205 equipment. The check of the equality of frequency between the incoming signal and the R.F. generator is quickly and easily accomplished, by tuning the latter to zero beat with the former. Alternatively, if the receiver is accurately tuned to the incoming signal and the signal be then removed (by swinging the frame to zero position) the R.F. generator is easily and accurately tuned to the correct frequency against the deflection of the receiver output meter. Far more accurate measurement of I.C.W. or tonic train signals is also possible with this equipment. The operator has no need to move from his seat throughout the process of taking a field strength measurement.

MARCONI SHORT WAVE RECEIVER

TYPE Rg.31a

Until comparatively recently short wave radio channels have fallen naturally into two broad groups.

- (A) *First class commercial circuits, comprising duplex high speed telegraph and duplex telephone services.*
- (B) *Simple installations for simplex working (e.g., ship telegraph channels, field stations, aeroplane equipments, etc.), nearly all of which employ a simple receiver, embodying usually one high frequency stage, a self-oscillating detector, and one or more L.F. stages.*

There is now a rapidly growing demand for services falling between the two types mentioned above.

Such a case is that of a liner fitted for ship-shore telephony. The short wave telegraph receiver in such circumstances has to carry on reception through the short wave telephony transmissions, and with exacting conditions of space and frequency separation.

The simple type of receiver hitherto satisfactory is now inadequate for the purpose, and it is precisely for this type of demand that the type Rg.31a duplex short wave receiver described below has been developed.

It is primarily intended for headphone reception, but embodies provisions for the addition of another unit for recording on secondary commercial circuits. In this form it is known as the Rg.32a.

General Description.

THE Type Rg.31a receiver is of the double detection type, and covers a waveband of 15/200 metres, by means of five sets of plug-in coils. It is suitable for use with a simple harmonic aerial, or balanced feeders. It can also be supplied to take concentric tube feeders and may therefore be used on land installations with a simple aerial array.

It is designed for bench mounting and is provided with lugs for bolting down on to shock absorbers.

The upper half of the receiver (see photograph) contains five separately screened compartments housing the signal frequency circuits.

The lower half contains the separately screened compartments of the intermediate frequency amplifier, the second detector and second heterodyne, and a stage of low frequency amplification.

Taking the signal frequency circuits first, they comprise :—

Marconi Short Wave Receiver.

- (1) The feeder terminating tuned circuit. A variable magnetic coupling via an electrostatic shield is provided between this circuit and
- (2) An intermediate tuned circuit coupled by means of a small variable condenser to

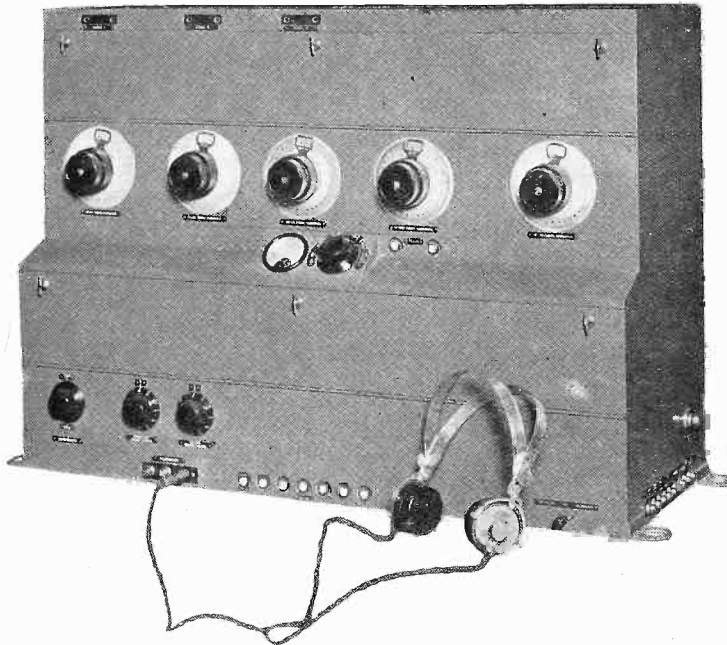

Marconi Short Wave Receiver, Rg.31a.

- (3) The tuned grid circuit of a signal frequency amplifying stage.
- (4) The first detector and the tuned transformer coupling it to No. 3 above.
- (5) The first heterodyne. This is mounted as a unit sprung as a whole with reference to the main container to lessen vibration troubles.

The first heterodyne changes the frequency of the received signal to 100 kcs., i.e., the mid-frequency of the intermediate frequency filter amplifier.

This consists of four circuits coupling the first detector output to the second detector input via three stages of screen-grid amplification.

The required form of intermediate frequency response curve is obtained by combining three single tuned circuits and one double tuned circuit, and it may be stressed that these intermediate frequency tuned circuits incorporate lumped

Marconi Short Wave Receiver.

resistances of such a value as completely to mask variations in the resistance of the coils themselves. Variations in the intermediate frequency amplifier performance due to climatic and other conditions are thereby minimised.

The second detector valve holder is duplicated and the second heterodyne inducing into the grid circuit may be used :—

- (1) In the standard Rg.31a, to beat the signal to the desired audio-frequency, after which it passes to the telephones via the transformer-coupled L.F. stage, or

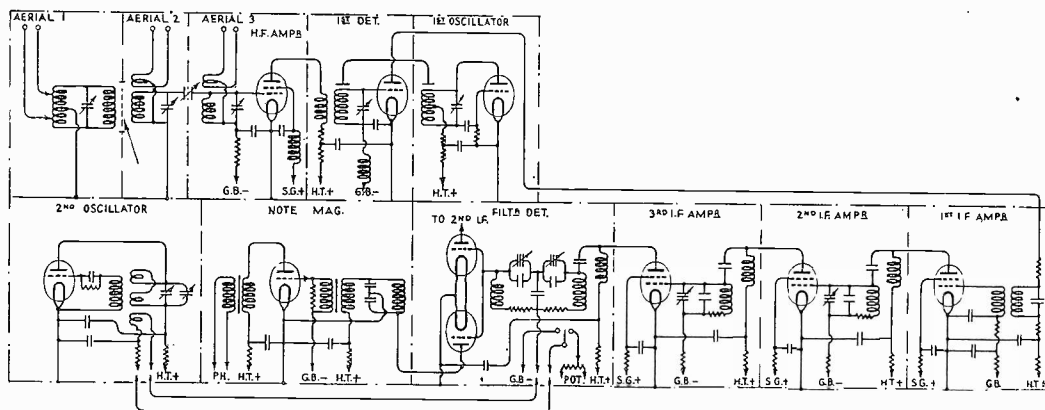

FIG. 1.

- (2) To beat the signal to a second intermediate frequency at which it is again amplified and rectified by a second unit. This corresponds to the type Rg.32a outfit, and the auxiliary second detector valve is then inserted and used to feed the second unit, the normal telephone output being available as a monitoring point. Reference to the circuit diagram, Fig. 1, will make this clear.

Thorough de-coupling is provided in all supply leads entering the separately screened compartments.

The components in each compartment are assembled in unit form on a small base held in position by a single knurled knob. Full inspection of any component can therefore be obtained by removing either the top or bottom half of the front panel and withdrawing the unit, after freeing the feeding connectings.

Full metering facilities are provided in a simple form by the meter seen mounted on the receiver. This may be switched to read :—

- (A) Individual valve feeds as selected by push-buttons.
- (B) L.T. volts.
- (C) H.T. volts.
- (D) Feeds and supplies to the additional optional recording unit when fitted.

Selectivity.

In a double-detection receiver the attenuation of unwanted signals must be specified for cases where :—

- (A) The interfering signal lies on the same side of the first heterodyne as the desired signal.
- (B) "Image signal" interference occurs, i.e., a signal lying on the opposite side of the first heterodyne to the wanted signal beats with the former to the intermediate frequency.
- (C) Two unwanted signals enter the first detector and beat together to the intermediate frequency, i.e., second channel interference.

To type (A) interference, the selectivity of the receiver is practically that of the intermediate frequency filter amplifier. It is a fact that cannot be fully discussed here that with this type of filter-amplifier it is easier to obtain the required gain and band-width the *lower* the intermediate frequency.

Interference of types (B) and (C) can be attenuated only at the signal frequency, and for a given signal frequency response curve the attenuation will be higher the *higher* the intermediate frequency.

The compromise intermediate frequency usually adopted to meet these two conflicting requirements is of the order of 150-200 kcs., but in the type Rg.31a receiver the value chosen has been 100 kcs. This has been deemed essential in order to keep the intermediate frequency below the lowest transmission frequency used in ship work, bearing in mind that the receiver will in many cases be housed in the same cabin as a ship's long-wave transmitter.

The intermediate frequency response curve has a bandwidth of 6 kcs. at 6 db. down from maximum gain, and at 40 db. down from maximum gain is only 20 kcs. wide.

Such a response curve is capable of passing adequately all commercial speech frequencies in cases where telephony reception is required, but still gives ample attenuation of signals only 10 kcs. away from the desired signal.

With reference to "Image Signal," attenuation, measurements show that at 5,200 kcs. (57.69 metres) this is approximately 60 db. ; at 1,700 kcs. (17.65 metres) the attenuation is approximately 20 db.

Sensitivity.

The detailing of the receiver gain at various frequencies is of little real help in relating field strength and output, but the distribution of the overall gain may be of interest, and is as follows :—

Signal frequency—varying from 5 db. at the highest frequency to 20 db. at the lowest.

Intermediate frequency—85 db.

Audio-frequency—20 db.

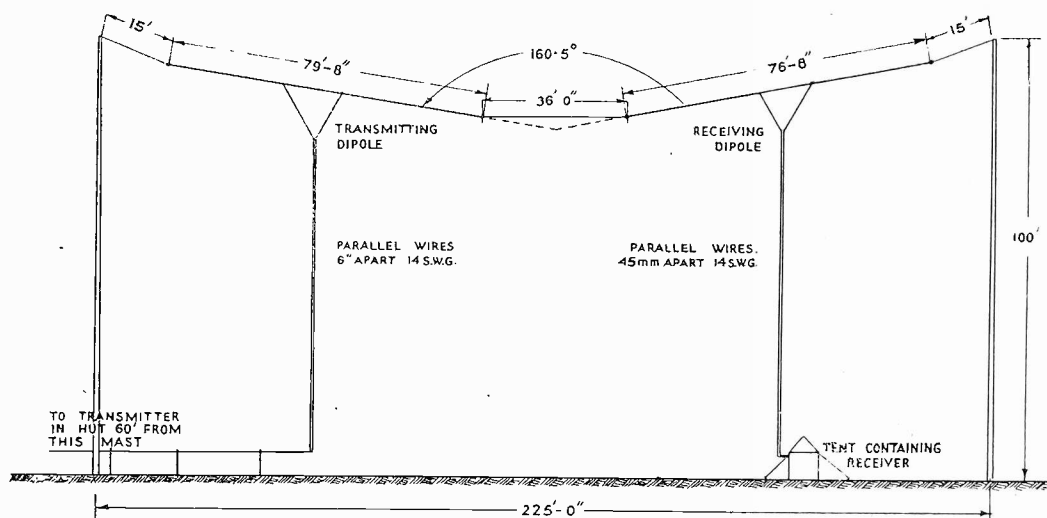

FIG. 2.

For more informative definition of the overall sensitivity of the receiver it is necessary to relate the signal field strength (inducing in a correctly terminated half-wave aerial) and output.

Assuming that sensitivity to telephony reception is in question, it is usual practice to give the relation between carrier field strength and micro-amps push-up in the second detector. For a given modulation percentage the audio output to a 600 ohm line can be then easily determined.

Measurements made in connection with this point show that if the second detector is biased to an idle current of 200 micro-amps a push-up of 100 micro-amps is obtained with carrier field strengths between 2 and 20 micro volts/metre, according to the received frequency.

Marconi Short Wave Receiver.

When however considering C.W. telegraph signals as read in the head-phones, the final and only practical criterion of sensitivity must relate field strength (with the assumed aerial) and the signal heard in the phones at full voice-frequency gain.

Measurement has determined that comfortable C.W. signal strength (R7) is obtained with field strengths considerably below one micro-volt/metre.

Manipulation.

The receiver is simple in operation. When searching for a station the aerial or feeder, as previously stated, may be plugged into the radio frequency amplifying stage, in which case the tuning controls consist of the tuning condensers of the radio frequency amplifier, the first detector and the first heterodyne.

Having found the required station the aerial may be plugged-into the second tuned circuit and then to the first tuned circuit.

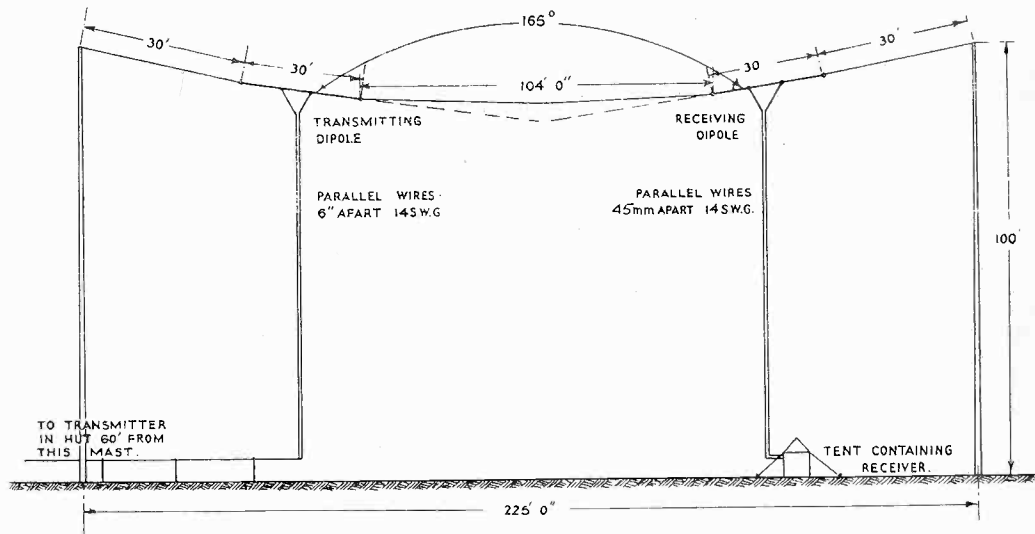

FIG. 3.

The remaining controls of the radio-frequency circuits consist of the continuously adjustable feeder termination and the variable mutual between the first and second tuned circuits.

Apart from the radio frequency controls, separate volume controls are supplied for both the intermediate frequency and the low frequency gain. There is also, of course, a condenser tuning control for the second heterodyne and this covers a frequency range of from 80 to 120 kcs.

For aural beat reception the second heterodyne is set to either 99 or 101 kcs., i.e., to give a 1,000 cycle note with the mid-frequency of the intermediate frequency amplifier.

(25)

PROPERTY OF
CANADIAN MARCONI CO.

When, however, the second recording unit is supplied, the second heterodyne must be adjusted to either 85 or 115 kcs. This will beat the signal to 15 kcs. which is the mid-frequency of the second intermediate amplifier embodied in the recording unit.

A switch is provided to switch off the second oscillator when it is desired to receive telephony or I.C.W.

Duplex Working.

By confining by far the major portion of the gain to the intermediate frequency filter amplifier, it has been possible to introduce three tuned circuits between the aerial and the first valve. By thus minimising shock excitation effects it is possible to carry out duplex reception with very small percentage separations from a nearby transmitter.

Tests have been carried out to determine the performance of the receiver in this regard and Figs. 2 and 3 show the aerial arrangements which were used for these tests.

The power in the transmitting aerial was 2 kw. and it was possible to read an R6 signal having a frequency separation from the transmitter frequency of rather less than one per cent.

This test was made at frequencies of 5,200 kcs. and 17,000 kcs.

For the former frequency the aerial arrangement of Fig. 2 was used and for the latter that of Fig. 3.

The above results would only be possible, of course, with a transmitter employing a method of keying which did not produce heavy key clicks, and with the usual precautions to minimise noise from machines and stray currents in stays, etc.

In addition to these tests the receiver has been installed on the "Empress of Britain" and proved capable of carrying on the ship's short wave telegraph reception with complete immunity from interference by the ship's short wave telephone transmitter. Frequency separations of the order of 2 per cent. are involved.

Valves and Supplies.

The standard type Rg.31a receiver employs 4 volt valves of the 0.1 amp type, the L.T. consumption being approximately 1.0 amp.

The H.T. consumption is approximately 25 milliamps at 130 volts.

Grid negative is obtained from a potentiometer across which must be connected a 10 volt battery. The potentiometer takes 25 milliamps, so that a H.T. supply of 140 volts with an earth tap at +10 may be used and will be uniformly discharged.

POLISH NATIONAL BROADCASTING

Information received from Poland indicates that the broadcast transmitter, installed by Marconi's Wireless Telegraph Company, at Warsaw, provides an efficient service over the whole of Poland.

The field strength distribution of this station and the broadcast facilities of Poland are briefly discussed in the following article.

THE problem of providing a National Broadcast service is exercising the minds of many Radio Technicians at the present moment.

The difficulties to be overcome are different for each country. Physical characteristics, density of population, Language and Finance, are among the problems encountered.

In dealing with any new project it is of value to know how others have dealt with a similar problem and particularly the results obtained.

We are thus indebted to the Polskie Radio for one of the most complete signal strength distribution surveys ever made.

This Survey was undertaken under the direction of the Technical Director of the Polskie Radio, Mr. Wladislaw Heller, and carried out by Engineer, Mr. Tadeush Znanieki.

All measurements were made in full daylight and in over 350 different places.

The results obtained were finally checked in a simple and practical way by sending to all Postmasters a Questionnaire in which they were requested to record to what extent crystal reception of the Warsaw Programmes was possible in their particular districts.

An analysis of the returned questionnaires showed that Warsaw was receivable all over Poland with Crystal Receivers there being remarkably few exceptions.

An important fact has thus been established, that it is possible to provide a truly National Broadcast service in a large country like Poland by means of a single Broadcast Station.

None the less it must be recognised that this excellent distribution is in part due to the wavelength employed, i.e., 1,411 metres, the height of the aerial supporting structures; 200 metres, the Power used; 120 kw. carrier wave energy with linear 80 per cent. modulation, and perhaps not least an almost perfect site, all contributing to the result. This site is 22 km. from the city of Warsaw, and the Station is built on fine hard sand with water flowing underneath at a depth of about 1 metre.

In Fig. 1 we reproduce the Field Strength Signal Chart as obtained by the Polskie Radio.

Polish National Broadcasting.

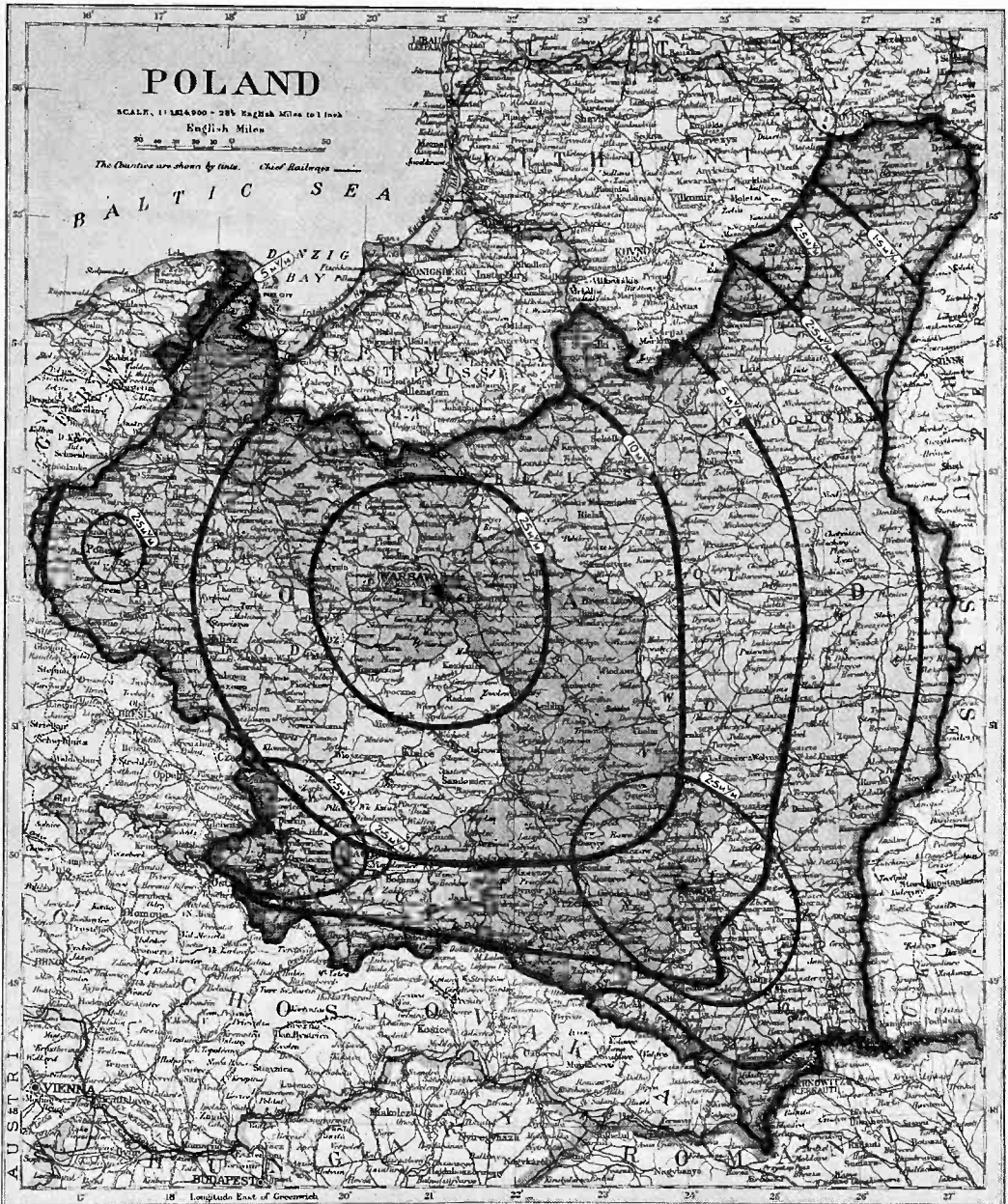

Map of Poland indicating field strength distribution of Warsaw broadcast transmission.

The original chart has been reproduced on another map showing the principal towns and places named in accordance with common usage in order that the various towns may be easily recognisable by Continental and English readers.

Polish National Broadcasting.

The chart shows a remarkably uniform field strength distribution within the 10 milli volt per metre boundaries, although on the 5 and 2.2 m.v. boundaries the effect of the Carpathian Mountains is clearly shown.

The Regional stations in the vicinity of the towns of Lwow (Lemberg), Vilna and Katowice, show vastly different field strength distribution curves although the powers of the Local Transmitters are of the same order. Lwow and Vilno are each of 16 kw. and Katowice of 10 kw. carrier wave energy, all of which transmit on the Medium Band of Broadcast wavelengths.

It may be of interest to record that Lemberg and Katowice are often heard in England at about the same strength as the Warsaw High Power Station but only on occasion thus showing the unreliability of the medium wavelength transmission for wide area national services.

Fading, the bugbear of Radio Broadcast, is ever present in some degree, but as is well known becomes of less and less importance as the length of the transmitting wave is increased. For Warsaw the fading radius is about 230 kilometres. The fading radius increasing during the summer months to an amount which extends beyond the frontiers of Poland.

This has an important advantage, in so much that it is now a normal practice for the Regional Stations to retransmit the Warsaw programme by the means of direct Radio Relay. In fact 95 per cent. of all Polish simultaneous transmissions are carried out by Wireless, even although an excellent system of telephone lines exist connecting Warsaw with Lwow, Vilna, Katowice, Pasma and Lodz.

MARCONI NEWS AND NOTES

KELVIN MEDAL AWARDED TO MARCHESE MARCONI

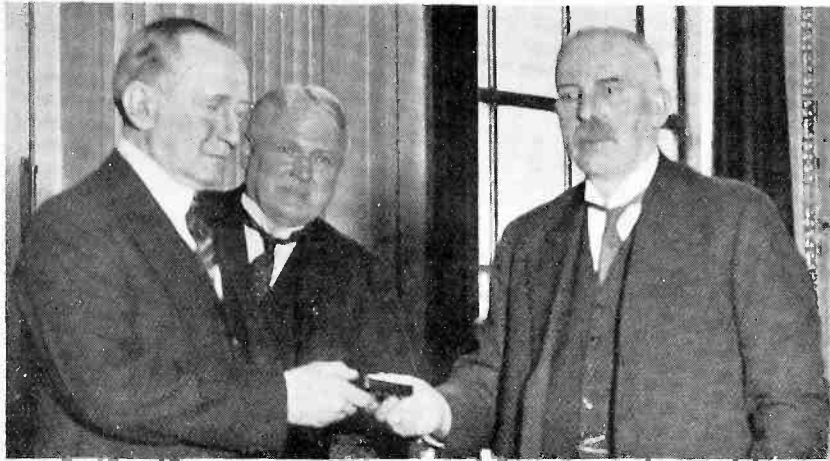

Electrical Review

Lord Rutherford presenting the Kelvin Medal to H.E. Marchese Marconi.

THE Kelvin Medal Award Committee, after consideration of representations received from the leading engineering societies and organisations in all parts of the world, have awarded the Kelvin Medal for 1932 to His Excellency Marchese Marconi.

The presentation was made by Lord Rutherford in the Great Hall of the Institution of Civil Engineers, London, on May 3rd. Sir Cyril Kirkpatrick, President of the Institution, presiding at this function, said that in his view the honour was the highest which could be bestowed on a member of the engineering profession.

In presenting the medal, Lord Rutherford said that in an age of great scientific advance no development had excited more interest than the practical application of electrical waves for signalling through the ether to all parts of the earth. Marchese Marconi was a pioneer in this conquest of nature who had done more than any other man to make possible this system of rapid world-wide inter-communication.

Traffic Control by Wireless.

MARCONI apparatus, which has solved many varied problems of communication, was called upon to assist the London police in the control of traffic on the crowded roads leading to the Epsom Downs on Derby Day (June 1st).

An Autogiro, a type of aircraft which can be made to hover almost stationary over any particular spot, was fitted with a Marconi short wave portable telephone transmitter and a Marconi aircraft receiver. Traffic control experts flew in this machine above the roads leading to Epsom and telephoned instructions to their colleagues on the ground who were able to obviate traffic jams which threatened at cross roads and other possible danger spots. The unimpeded flow of traffic was thus greatly facilitated.

The ground station consisted of a motor van fitted with a Marconi short wave aircraft receiver, Type A.D.27a, and a Marconi short wave telephone transmitter, and excellent two-way communication was maintained with the Autogiro throughout the busiest hours on the roads.

Train-Aeroplane Wireless Telephone.

THE enormous advance made during recent years in wireless communication for moving vehicles was graphically demonstrated by an experiment carried out on May 20th by the Marconi Company in co-operation with Imperial Airways Limited and the London & North Eastern Railway Company.

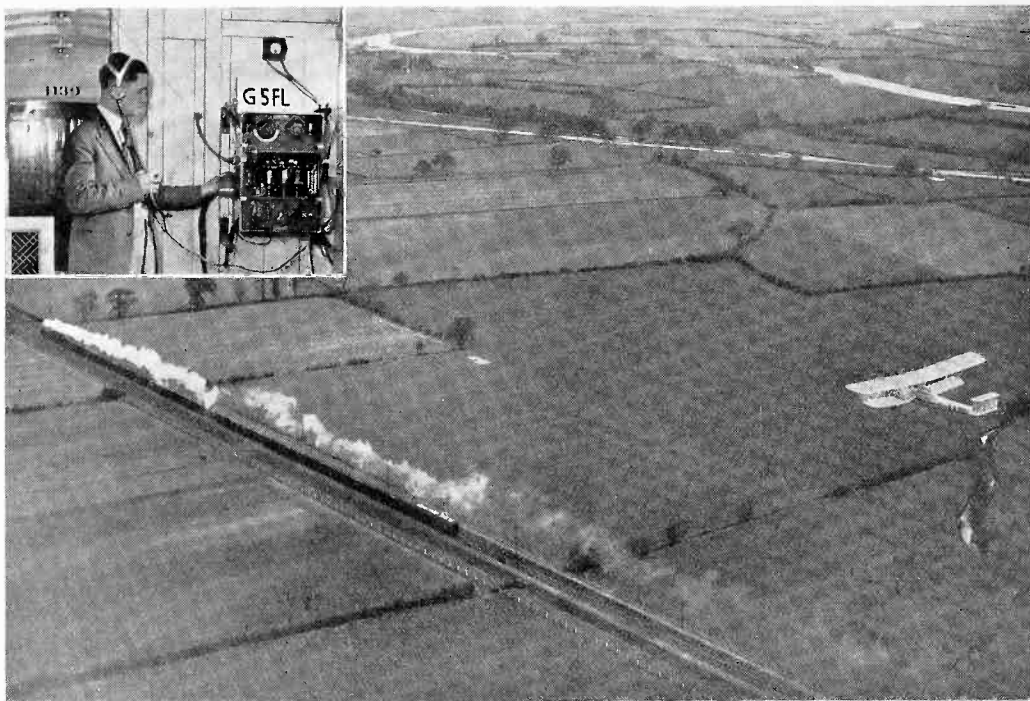

Imperial Airways liner "Heracles" flying above the "Flying Scotsman" during the wireless telephone tests.

A Marconi aircraft transmitting and receiving equipment was installed in a rail van 60 feet in length, which was attached to the "Flying Scotsman," one of Britain's fastest express trains, leaving London at 10 a.m. for Edinburgh, Scotland. The 42-seater Imperial Airways liner "Heracles," which carries Marconi wireless apparatus as part of its standard equipment, left the London Air Port, Croydon, at 11 a.m. on Friday for Glasgow, Scotland.

The aeroplane overtook the train near Grantham, just over 100 miles north of London, and while the train and aeroplane were travelling at speed, wireless



*Prince George (right) at the Marconi Works,
with H.E. Marchese Marconi.*

telephone communication was established between them and a number of conversations were exchanged. Communication was maintained continuously for more than half an hour and all who took part in the experiment, including representatives of the principal British newspapers, commented upon the clarity and distinctness of the speech both in the train and in the air.

Prince's Visit to Marconi Works.

PRINCE GEORGE, youngest son of H.M. King George V., visited Chelmsford on May 25th, and during a busy day in the town inspected the Marconi Works.

At the entrance to the Works, Prince George was received by His Excellency Marchese Marconi, President of the

Company, Lord Inverforth, Chairman of the Board, and Mr. H. A. White, General Manager.

The Prince made an extensive tour of the Workshops and was shown various types of wireless stations which were being manufactured for export to several countries of the Far East, South America, and Continental Europe. He expressed great interest in the construction and workmanship of Marconi broadcasting transmitters and special classes of Marconi equipment such as Direction Finders.

Mr. St. John Philby.

THE congratulations of the Marconi Company are extended to Mr. St. John Philby on his accomplishment (January-April, 1932) of one of the most remarkable Arabian desert journeys on record.

Mr. St. John Philby, who is an adviser to King Ibn Saud and an outstanding authority on Arabia, was mainly responsible for the introduction of wireless telephone and telegraph communication between the principal cities of the Hedjaz and Nejd. For these services eleven Marconi fixed stations and four Marconi mobile stations, fitted in lorries, are being installed.

Mr. Philby's recent journey of exploration, in the course of which he crossed 350 miles of waterless country, extended from Hasa, on the Persian Gulf, to Mecca.