

# THE MARCONI REVIEW

No. 28.

January-February, 1931.

Technical Editor: H. M. DOWSETT, M.I.E.E., F.Inst.P., M.Inst.R.E.

General Editor: W. G. RICHARDS.

## REVIEW OF COMMERCIAL WIRELESS DEVELOPMENT (Continued)

By C. E. RICKARD, O.B.E.

*We publish below the second, and concluding part of the address delivered by Mr. C. E. Rickard, O.B.E., M.I.Mech.E., M.I.E.E., Deputy Chief Engineer of the Marconi Company, before the Institution of Electrical Engineers on November 5th, 1930, on his election as Chairman of the Wireless Section of the Institution for the year 1930-1931.*

*The first part of this article was published in THE MARCONI REVIEW for December, 1930.*

### Frequency Control.

THE need for constant carrier-frequency emission on all services becomes more and more evident every day. A step in advance from the international point of view was made at the Hague last year, when certain recommendations were made for the permissible tolerances in the various frequency bands, and administrations and manufacturers are in the main endeavouring to conform to them. The standard was not set too high for achievement in the majority of cases, but experience shows that there is a great difference between the measure of constancy a master oscillator is expected to maintain and what is experienced in actual practice. Many a constant frequency device has given promise in the laboratory of a frequency constancy of, say, 1 in 50,000 or 1 in 100,000, but in service spread over a week or a month its figure of merit has been found to be no better than, say, 1 in 10,000, or less.

It is not sufficient for a master oscillator to keep within a certain percentage of its mean frequency at any given time; it must also not wander from its allocated frequency, that is to say the official frequency on which it is required to work. A carrier frequency which is stable, but inclined to drift, can be followed at the receiver end until it approaches a neighbouring station frequency and interference arises. On the other hand, an inherently unstable frequency, or, in other words, a wobbler or scintillator, is fatal to good telephony or broadcasting quality.

The three best known constant frequency devices in commercial use are the tuning fork, the quartz crystal, and the valve master oscillator.

*Tuning Forks.* The tuning fork has long been used as a sub-standard of frequency, and many of the frequency measuring sets employ tuning forks as a basis of measurement which can be checked from time to time.

( 1 )

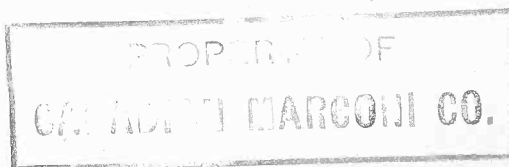

Where synchronisation has been required, as in picture transmission for example, tuning forks have been used for some time. Forks made of elinvar have been found sufficiently stable, without temperature control, to allow of the device being used with considerable success on long wave transmitters.

For the maintenance of constant frequency with forks of other materials it is indispensable to employ temperature control apparatus, capable of maintaining the fork at constant temperature to within approximately 0.1 degree F., if the best results are desired. Under these circumstances the results obtained have been remarkably good. The 10 tuning fork devices employed by the British Broadcasting Corporation to control the transmission of the relay stations on a common frequency of 1,040,000 are, I understand, still maintaining their high reputation for constancy after many months in service, and I believe their constancy can still be defined as about  $\pm 1\frac{1}{2}$  in 100,000.

The principle of tuning fork control is being extended to high frequencies, *i.e.*, short waves, where the difficulty of avoiding undesired modulation of the final frequency is more acute. This trouble has led to the use of a chain of doubling stages in preference to any other method.

Developments in the method of maintaining a fork in vibration are in the direction of minimising the effects of supply voltage fluctuation on the frequency, and the elimination of any possibility of unwanted degrees of freedom.

*Quartz Oscillator.* The study of the quartz oscillator has revealed the fact that if the section is suitably dimensioned the temperature co-efficient of the plate and its holder can be made positive or negative as desired. By adjusting the dimensions it is possible to change the temperature co-efficient from one sign to the other at the expense of some slight change in the frequency due to the cutting. Further, by very careful adjustment of the dimensions it has been found possible to produce quartz oscillators of a given frequency the temperature co-efficient of which is of the order  $\pm 2$  or 3 parts in 1 million per degree C. change of temperature.

Unfortunately, whilst this result has been obtained on crystals of a frequency as high as 250,000, at still higher frequencies the crystal itself is thin, and its behaviour becomes spasmodic.

With crystals of ideal dimensions laboratory tests have shown that changes of valve voltages of the order of  $\pm 5$  per cent. have produced such small frequency changes that to make an absolute measurement is a matter of great difficulty.

Some measurements of three quartz-driven stations working on a common wave of about 1,318 kilocycles per sec. have shown that between A and B stations there was a frequency change of from 0 to 16 cycles per sec., whereas between A and C stations there was a frequency change up to 80 cycles per sec. These changes are therefore of the order of 1 to 5 in 100,000.

*Valve Master Oscillators.* With this type of constant frequency device the main difficulties to be overcome are the variations of frequency due to dimensional changes of the oscillatory circuit, that is to say condenser and inductance, due mainly to changes of temperature or flow of the material, and changes of supply voltages to the valve filament, anode and grid. Several circuits are known which take care of

the valve problem, but the attainment of stability of the oscillation constant of the condenser inductance circuit over long period, even when maintained at constant temperature, is a problem of considerable difficulty.

Mr. C. S. Franklin has made a special study of short wave constant frequency devices and has developed one in which the condenser inductance circuit is of particularly robust construction, of special materials, and in which the principle of automatic correction for temperature variation is applied.

INITIAL FREQUENCY DRIFT OF BEAM TRANSMITTERS  
 CURVE 1 GLW  $\lambda = 15.707$  M. (19101 KC.)  
 CURVE 2 GLG  $\lambda = 15.740$  M. (19060 KC.)  
 CURVE 3 GLL  $\lambda = 21.962$  M. (13660 KC.)  
 CURVE 4 GLY  $\lambda = 26.269$  M. (11420 KC.)

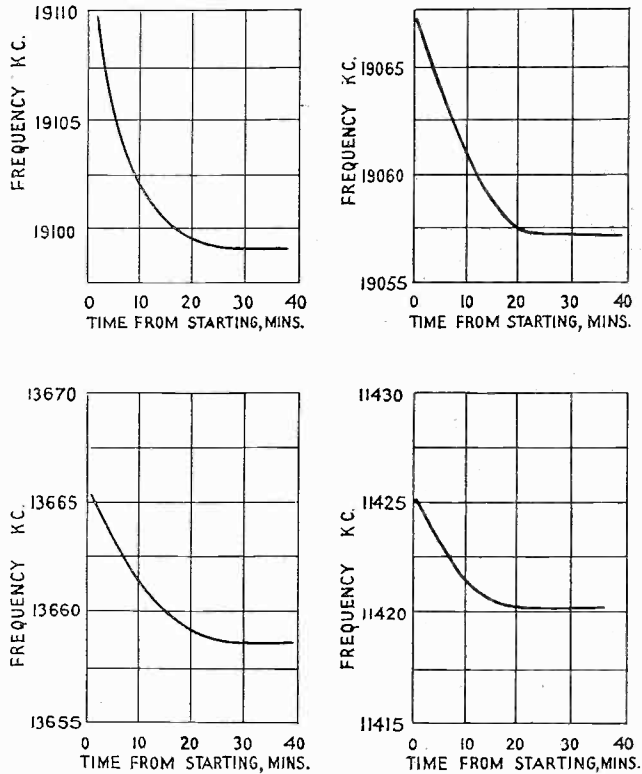

FIG. 2.

At this point one must distinguish between the transmitter fitted with an ordinary valve drive and the type developed by Mr. Franklin, in which the constant frequency device is composed of a number of stages, including doublers, on exactly similar lines to the quartz crystal constant frequency device, so much so that in the new device a crystal may be inserted in the circuit if so desired.

Taking ordinary valve drives first, much can be done in the interests of frequency stability by eliminating vibration, by using accumulators for filament lighting and employing a very constant H.T. supply to the master oscillator, together with the use of as low a power as possible and an isolator stage, and by careful screening of the master oscillator and isolator stages from the rest of the circuits. To this must be added the use of inductances and condensers of robust and inflexible design, the whole maintained at as even a temperature as possible. Such was the design of the beam station transmitters, the note of which was for a long time recognised as the most constant of those in regular service.

Valve drives of the normal type suffer, however, from drift, due to starting-up conditions (principally temperature variations). The short wave marine transmitter with or without a master oscillator is a bad offender in this respect, and when such stations are started up they may drift over 10 to 50 kilocycles per sec. during the first half-hour. This constitutes a great difficulty in short wave ship communication because, as a rule, the normal ship station *does not require to work* for more than half an hour at a time.

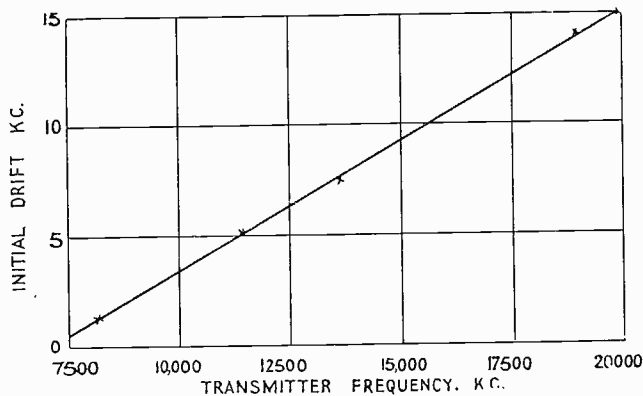

FIG. 3.

Where special precautions are taken, as in the beam stations, the drift on starting-up may still be as much as 10 kilocycles per sec. in 20,000 or 1 in 10,000 if the transmitter is left unattended.

Some observations made by Mr. Pannett at the Dorchester station illustrate the effect of changes of filament and anode voltages and of temperature on the frequency on well designed valve-driven transmitters.

Fig. 2 shows the effect of temperature during starting-up conditions, no adjustments being made during test to correct the frequency.

Fig. 3 shows the drift observed on a number of different frequencies. It is a straight line and shows that initial drift is roughly proportional to frequency.

Fig. 4 shows the effect of varying the anode voltage on three different transmitters.

Fig. 5 shows the initial drift on a transmitter compared with the rise of temperature measured in different parts of the master oscillator chamber.

Fig. 6 shows the effect on the frequency of varying the filament voltage. The vagaries of these curves vary with individual valves.

Normally the engineer on watch makes the necessary adjustments during the starting-up period by checking against his standard wavemeter, and the outgoing frequency is kept within the prescribed limits. Obviously the provision of a good wavemeter or frequency measuring device is an absolute necessity in normal valve-driven stations, whether long or short wave, and the reputation of such stations depends largely on the reliability and precision of the wavemeter and the attention of the engineer-in-charge.

In the new constant frequency device two oscillator valves are used in combination and the principle of differential expansion between the insulating material constituting the former on which the coil is wound, and a brass rod carrying a small condenser of the vernier type, is made to compensate for changes in the L and C values of the oscillating circuit due to expansion or contraction. With this apparatus temperature control of the chamber in which the device is contained becomes unnecessary.

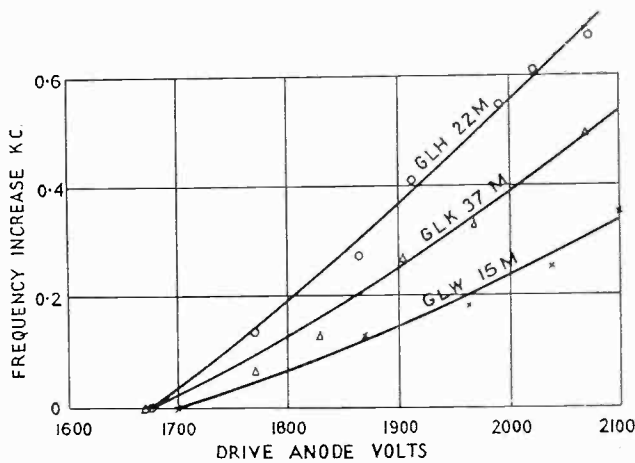

FIG. 4.

Adjustment of the compensator is made to correspond to the centre of the scale, but it is found to be accurate over the whole scale of the standard instrument, which in one of its forms covers a 2,000 cycle range on a 15 m. wave.

The curves in Fig. 7 show the variation of frequency, with variation of high tension supply to the two master oscillator valves. It will be noted that a variation of about  $2\frac{1}{2}$  per cent. in H.T. voltage corresponds to a change of 100 cycles in 11 190,000, or about 1 in 100,000. The four curves show the behaviour with various combinations of valves of the P 610 and L 610 types.

Fig. 8 shows the effect of varying the filament voltage. As might be expected the lack of absolute uniformity among valve filaments shows up here, and the curves have diverse shapes. A variation of 0.5 volt in the standard voltage applied to the 6 volt filament in no case makes a change greater than 100 cycles, or 1 in 100,000.

Fig. 9 shows the change in frequency of such an oscillator working on 15,050 kilocycles per sec., or approximately 20 m. waves, when heated in a cabinet from the room temperature of 21°C. up to 46° C., and then allowed to cool again to a room temperature of 18° C.

During the first hour's heating the temperature of the cabinet rose rapidly to its final temperature 46° C., yet there was no observed change in frequency of the oscillator as checked against a standard frequency meter. This is an important point as it shows that the frequency of the oscillator is not affected by sudden changes of temperature produced by draughts of air.

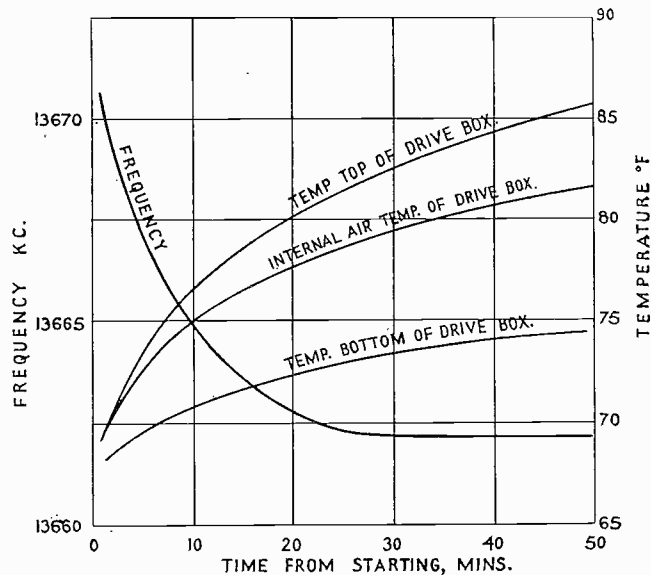

FIG. 5.

After about 5 hours' heating a small drift of approximately 250 cycles per sec. was noticed ; this, however, did not change after a further 2 hours' heating. This change indicates that the oscillator is slightly over-compensated, and is noticeable only when the heat has penetrated right into the materials, especially into the insulating material, which has a low thermal conductivity.

After 7 hours the heaters were switched off and the oscillator cooled down slowly, overnight, in the cabinet. A measurement of the frequency made the next morning indicated no change. During the heating the temperature of the frequency meter rose 1° C., and a correction of minus 100 cycles per degree C. rise has to be made to any observed drift. As the scale of the frequency meter will only permit reading to 250 cycle divisions on its vernier, there is thus a probable error of  $\pm 250$  cycles in the actual observation of the oscillator drift measurement over 25 degrees. Thus the drift of the oscillator was  $150 \pm 250$  cycles for a temperature rise of 25° C., or, in other words,  $+6 \pm 10/15$  050,000 cycles per degree C., roughly about 1 in 1,000,000.

### Broadcasting.

One of the outstanding events in broadcasting transmitter technique during the past year or so has been the tendency in Europe to adopt high-power transmitters. At international conferences a year and a half ago at Prague and last year at the Hague, arguments were put forward recommending the restriction of antenna power to about 100 kw.

The political and cultural value of broadcasting is so recognised among the nations that notwithstanding the splendid and successful efforts of the Union International de Radiophonie in adjusting to the best advantage the wavelengths, or should I say frequencies available for broadcasting, the total number of carrier frequencies allocated appears under present circumstances to be insufficient for the peculiar needs of

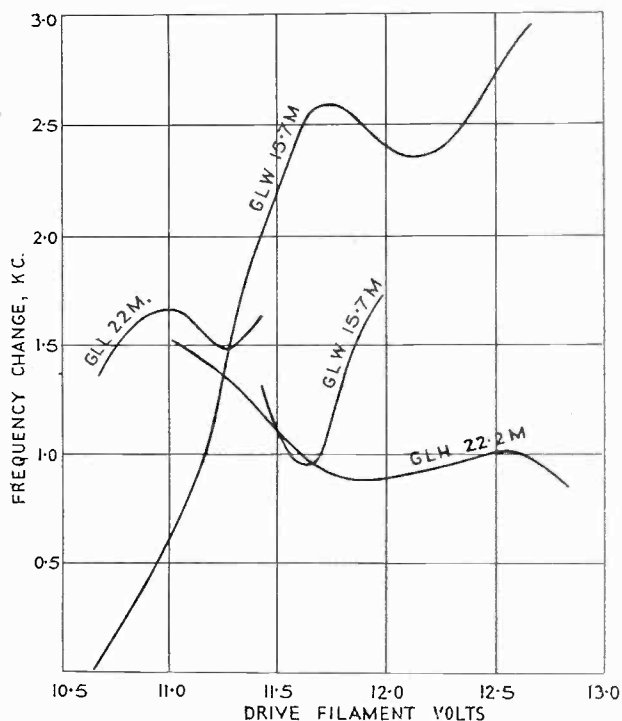

FIG. 6.

our densely populated Continent with its great diversity of tongues. As a result some of the nations are being obliged to make shift with a minimum number of exclusive frequencies and to increase the power and radius of their stations.

Notable high-power stations already working in Europe with C.C.I.R. aerial rating of 60 kw. or more are Spanga, Rome, Oslo and Moscow, and Prague and Warsaw are in course of construction.

High-power transmitting valves have made their commercial appearance in the design of broadcasting stations and perhaps some particulars of the new Marconi

100 kw. valve, which I understand have not yet been published, will be of general interest. The valve, known as the C.A.T.10, which is rated at 100 kw. input to the anodes on a telegraph load, stands about 3 ft. 6 in. high, its overall dimensions being  $108 \times 17$  cm. The filament current is 225 amperes at 30 volts, and the anode voltage 10,000 to 15,000, the continuous anode dissipation being 50 kw. At 12,000 volts to the anode with zero grid bias the amplification factor is 45 and the impedance 3,500 ohms.

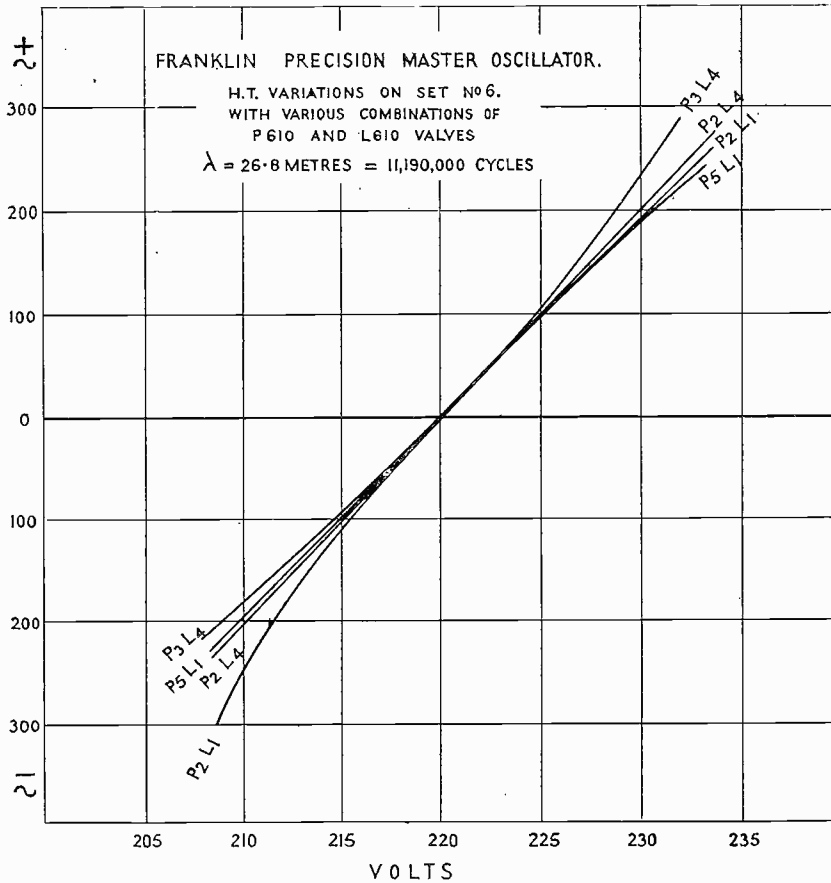

FIG. 7.

Working on long waves the normal operating conditions are :

Telegraphy .. 8 amperes at 10,000-15,000 volts.

Telephony .. High-power modulation, 5 amperes at 12,000 volts.

Low-power modulation, 5 amperes at 12,000 to 15,000 volts.

A point of interest with regard to such valves is the problem of keeping down the glass temperature at the filament seal, the difficulty being that, owing to lack of space, such heavy filament currents as are required have to pass down into the tube through conductors of minimum cross-section. In this valve the problem has been solved by water-cooling the external portion of the valve filament leads.



In the lantern slide\* the inlet and outlet tubes are clearly shown on the filament leads. Water flows down each lead to a point just above the seal, and returns again up the filament leg to the outlet tube.

Test figures for a broadcasting transmitter employing 8 of these valves, set for 80 per cent. modulation and with an anode input of 405 kw. at 12,000 volts, gave a carrier output to aerial of 120 kw., showing an efficiency of 29.6 per cent.

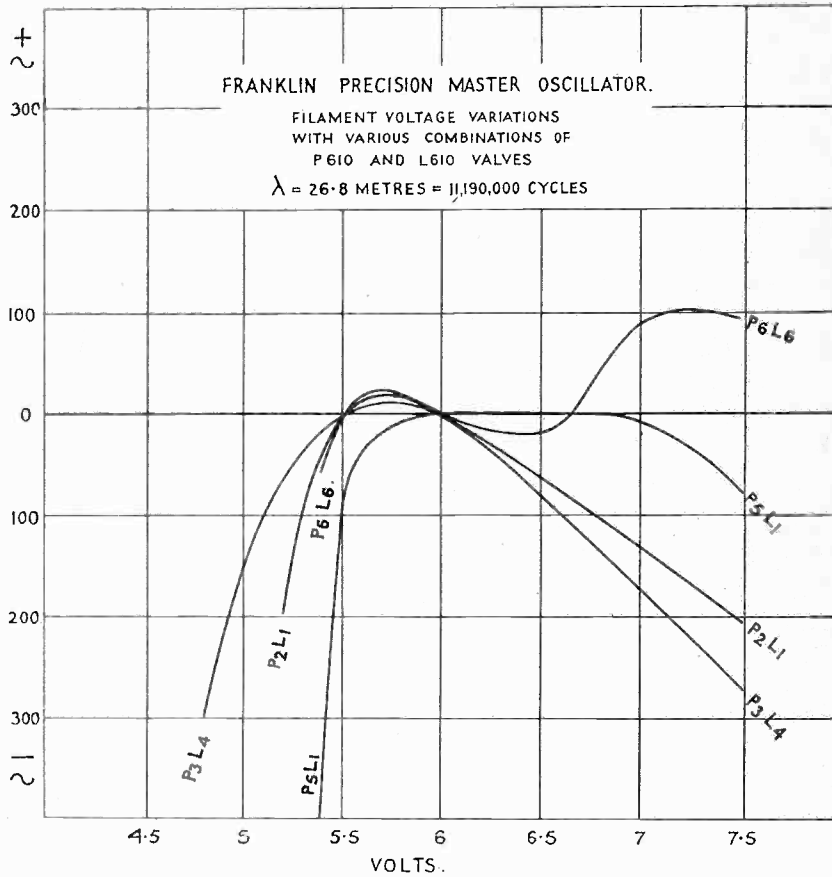

FIG. 8.

The artificial load employed for the test consisted of a morganite resistance of 465 ohms carrying 33.8 amperes.

A recent development in the design of high-power broadcast transmitting stations is the use of mercury rectifiers. Their high efficiency is an attractive feature in considering the maintenance costs of broadcasting stations, where the power to anodes runs into such figures as 400 to 600 kw. Three types of mercury rectifier are in use, viz., the mercury-vapour tube developed in America, the glass-bulb mercury-arc rectifier, and the Brown-Boveri type in steel cylinders.

\* Not reproduced.

In the transmitter test I have just mentioned the Brown-Boveri type was used and showed an overall efficiency of approximately 95 per cent.

As a point of special interest I might mention the rectifier employed at the Moscow high-power broadcasting station, which I believe is the largest in use employing glass-bulb mercury-arc rectifiers. The photographs\* show the construction of the rectifier panel, which consists of 12 three-phase rectifiers, each capable of handling about 30 kw. with an efficiency of about 96 per cent. Power from the 6,500-volt 3-phase supply is taken to two transformers having star-connected outputs phased to give, in combination, a 6-phase supply to the rectifiers. The normal working load of this rectifier panel is 250 kw. at 10,000 to 12,000 volts, with 8 bulbs in service.

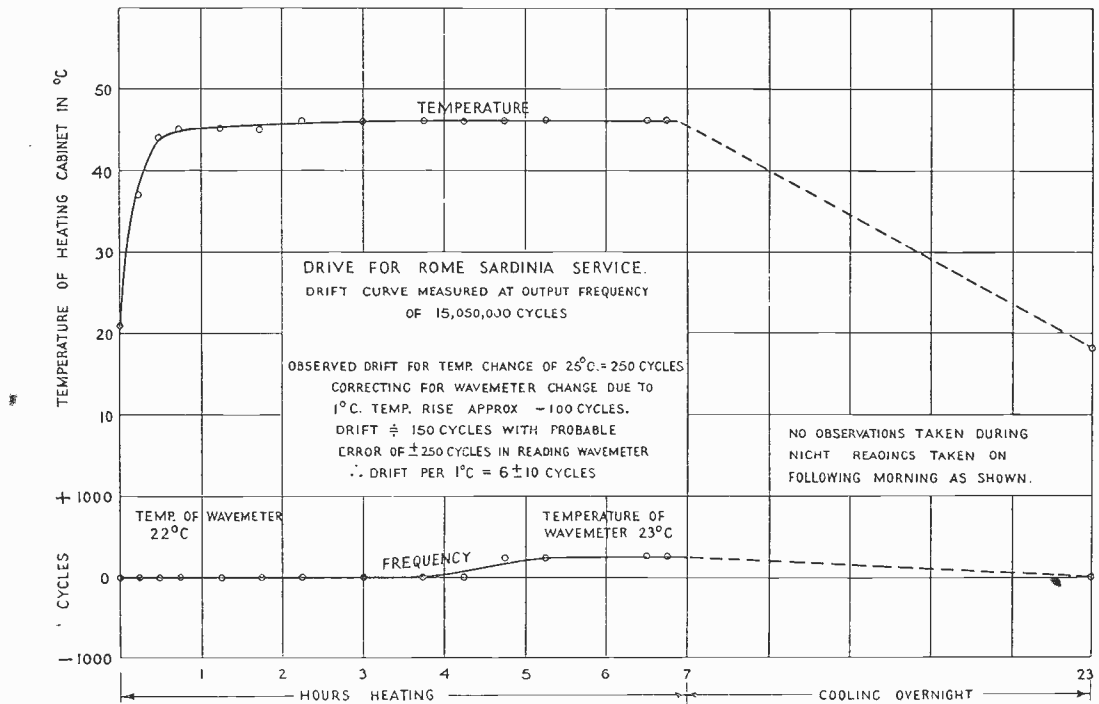

FIG. 9.

In the design of high-power transmitters, whether for broadcasting or long-wave point-to-point communications, special precautions to prevent the radiation of harmonics become more and more necessary as the power is increased.

Apart from the use of astatic coils, capacity coupling between stages, and screening to prevent interaction between units, it becomes necessary on very long-wave working, as for the new 150-kw. station at Ongar, to place the transmitter in a large room with copper screening to prevent the direct radiation of harmonics.

In large broadcasting stations it is becoming the practice to insert low-pass harmonic filters between transmitter output and aerial feeder circuit, and to screen

\* Not reproduced in Journal.

all interconnections between the panels of the transmitter in earthed trunks to prevent jump over, which would stultify the action of the filter.

### **Land-Line and Control Equipment for Broadcasting.**

Referring to the land-line and control equipment field, the present trend of development in the design of speech amplifiers consists in giving careful attention to details and to individual parts of apparatus. By so doing a great improvement in overall frequency response has been effected.

It will be readily understood that a moderate deviation from uniform response, which might be tolerated in individual pieces of apparatus taken separately, would become serious if such apparatus were used as part of a chain, and for this reason a much higher standard is required from individual parts of a chain than is required for the overall performance.

A study of the magnetic and electrical properties of the new series of nickel irons has led to improvement in the design and production of transformers to meet the stringent conditions already mentioned, and it has also made possible the use of much smaller and lighter transformers than hitherto.

By the use of carefully selected iron, built up in thin laminations, it has become possible to produce transformers having a uniform frequency response over quite a wide frequency spectrum, operative on radio frequencies, and it seems probable that this type of transformer may find many useful applications. Distortion arising in iron-core transformers will be largely eliminated as the conditions producing them are becoming understood and avoided.

By the use of new types of valves an economy in valve and battery use has been effected, accompanied by greater range of power output with distortionless working. Improved flexibility of control and switching has been obtained by the use of apparatus mounted on racks, and simple and effective means of mixing programme sources have been produced.

Improved methods of indicating the instantaneous amplitude of the speech currents have made possible the more effective control of the depth of modulation at the transmitters, thus securing a greater average depth of modulation with less blasting, caused by momentarily exceeding the distortionless modulation depth.

### **Conclusion.**

In conclusion, and touching once again on the shortage of broadcasting wavelengths, and the tendency in Europe to employ high-power stations, it is interesting to note that there is a development taking place in the form of the establishment of local receiving stations, the function of which is to pick up the programmes of the high-power stations and re-broadcast them. This is done either on a low-power transmitter working on a common wave, or on a very short wave below 10 m. or the received signals are distributed to the houses in the locality through a system of house-to-house wiring.

Short waves below 10 m. have been found quite useful for local re-broadcasting. The range is small and unlikely to cause interference at a distance, and, subject to the obvious precaution of erecting the aerials on tall buildings clear of obstacles, good results are obtained. In this way first-quality broadcasting can be received in districts not normally served by the high-power stations.

The service of programme distribution through a house-to-house system is already in use in England and is considerably developed in several Continental countries, in particular in Russia, where for a small monthly subscription one can obtain the use of a good loud speaker of the cone type and two programmes. It has been suggested that it would be cheaper to wire up a whole village and supply each house with a loud-speaker than to supply an equivalent number of receivers. Many of us might prefer not to be tied to the B.B.C. programmes, good as they are, and the fascination of listening to foreign stations is not to be despised. Nevertheless, I believe, if I may venture to prophesy, that we shall ultimately have wireless laid on in our houses, in the same way as the water, the gas, the electric light and the telephone. By then, however, it will no longer be wireless !

I am afraid that in attempting to review so wide a subject as radio communication and practice, I have only been able, as it were, to scratch upon the surface of things. I feel certain that I have omitted to mention important developments in some branch or other and I can only make the confession that specialisation in the many branches of wireless design or exploitation is the order of the day and that it is becoming increasingly difficult to co-ordinate the various branches of investigation and development. Engineers are becoming specialised in the study of transmitting or receiving apparatus, long or short waves, direction finding, valve manufacture, low-frequency apparatus, marine and aircraft apparatus, transmission and propagation phenomena, both with and without wires, even, as I have already mentioned, in the study of frequency allocations and the exploitation of channel in the ether, to say nothing of the erection of buildings, masts, plant and machinery. As a result, the erection of a station of importance is no longer a matter involving the selection for duty of a competent all-round engineer ; it often involves the services of specialists in the final tuning-up and adjustment of a modern station.

Surely the lot of a radio engineer is varied, and his study, if he is interested in his profession, all-absorbing.

I should like to express my indebtedness to my colleagues of the Marconi Co., in particular to Messrs. Franklin and Wright, for assistance in collecting data for this address.

R 355.404

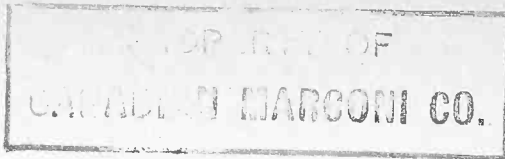

# MARCONI SHORT WAVE TRANSMITTER

## TYPE S.3

*The set described below has been designed to meet the ever growing demand for a medium power general purpose short wave transmitter, which, whilst covering a great range of frequencies, should also embody the requisite apparatus for maintaining constant the radiated frequency to within narrow limits and for securing instantaneous rigidity of the carrier frequency during modulation of the transmitter, without which serious distortion of received speech is commonly experienced.*

*Other requirements of such a transmitter, all of which have been embodied in the S.3, are : the alternatives of C.W. or I.C.W. telegraphy or telephony, high speed keying and facilities for quickly changing from one radiated frequency to another.*

TWO editions of the transmitter have been designed, namely, the S.3A and S.3B, the difference between them consisting only in the range of frequencies covered : that for the former being 18,750-4,000 kcs. (16-75 metres) and for the latter 15,000-3,000 kcs. (20-100 metres).

The aerial power on C.W. telegraphy is nominally 250 watts.

On telephony the nominal carrier aerial power is 135 watts, the degree of modulation being 70 per cent.

For I.C.W. the telephone carrier is modulated 80 per cent., thus giving a nominal aerial power of approximately 180 watts.

Over the greater part of the frequency range the powers are considerably in excess of these figures, and somewhat below it at the highest frequencies.

Before going on to describe particularly the circuits and constituent parts it might be as well first to give a broad outline of these.

The transmitter then, is controlled by a master oscillator, A, Fig. 1, contained in a chamber kept at a fixed temperature to within narrow limits.

The output of this oscillator is amplified by a six stage amplifier B, Fig. 1, in which are embodied an isolating stage and two frequency multiplying stages. All but the last stage of this amplifier employ low filament consumption receiving valves and take their filament and anode supplies from the batteries which provide these supplies for the master oscillator. The anode supply to the last stage is taken from a machine and its filament supply from that used for the power stages.

The output of the master oscillator amplifier controls the first of the two main power stages C, Fig. 1, which, in turn controls the second and final stage D, Fig. 1.

The anode supplies for these last two stages are taken from a common machine, the voltage at the anodes of the first being reduced by a series resistance.

Modulation is effected by the direct current grid method described in the June Number of *THE MARCONI REVIEW*. In this method modulation is applied to the grids of the final stage, and I.C.W. is obtained by impressing the output from an audio frequency valve oscillator on the grid of the modulating valve. The various components for telephony and I.C.W. are mounted in the Unit E, Fig. 1.

Keying of the transmitter for C.W. and I.C.W. telegraphy is accomplished by a method which provides for speeds up to 150 words per minute with a minimum of apparatus.

The transmitter is designed in such a manner that all adjustments can be made from the front. The time to change from one frequency to another need in no case exceed five minutes.

Having thus briefly outlined the transmitter a more detailed description of the circuits and component parts will now be given.

#### **Master Oscillator.**

The Master Oscillator circuits provide for two alternative types of control, namely, by a valve maintained inductance capacity circuit, and by quartz crystal.

The former includes a variable condenser, thus permitting the transmitter to be adjusted to any frequency within its range; whilst the provision of four quartz crystals allows of this type of control on any chosen four spot frequencies.

Changing from the inductance capacity circuit Master Oscillator to any one of the four quartz crystals is effected by a selector switch. This switch can clearly be seen below the vernier control of the variable condenser of the inductance capacity circuit on the front of the Master Oscillator chamber A, Fig. 1.

A calibration chart for the inductance capacity circuit is fixed inside a hinged door in the outer cover of the Master Oscillator compartment. This may be seen in Fig. 3.

Two P.610 valves are provided, both being connected permanently in circuit, except that the positive filament supply of one or the other is broken by a two-way switch external to the Master Oscillator chamber.

This arrangement obviates the necessity of having to open the chamber to replace a faulty valve, an operation which, in addition to interrupting transmission for some minutes, would have the more serious result of cooling the Master Oscillator components, with a consequent considerable drift in frequency which might take some hours to reach stability again.

*Marconi Short Wave Transmitter. Type S.3.*

As it is, in the event of a valve failure the alternative valve may be switched on and the transmission continued at once without any appreciable change in frequency.

The chamber consists of a brass box lined with heat insulating material and is maintained at an even temperature by heater lamps. These are switched on and off by a relay which has the contacts of a thermostat connected in series with its energising coils.

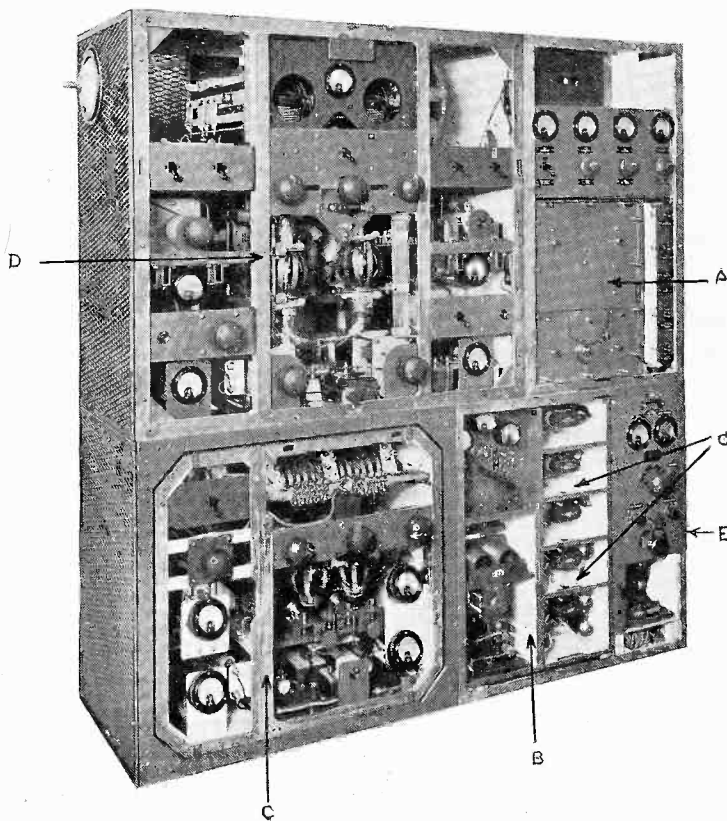

FIG. 1.

In order to cater for very wide variations in room temperature, switches are provided to connect one, two or three heater lamps in circuit. A baffle plate is fitted beside the heater lamps to prevent direct radiation from them striking the Master Oscillator components and thus giving rise to slight rapid changes in frequency each time the thermostat operates.

*Marconi Short Wave Transmitter. Type S.3.*

A thermometer fixed to the side of the chamber, with its bulb well inside, gives a visual indication to the operator that the temperature control is functioning correctly. The thermometer can be viewed through the window F, Fig. 3, in the outer cover of the Master Oscillator compartment.

The filament and anode supplies for the Master Oscillator valve are provided by batteries. As the battery voltages fall during discharge the filament and anode voltages of the valve can be maintained constant at 5.5 and 220 respectively by means of variable resistances. Suppressed zero instruments, giving good discrimination, enable the operator to maintain the valve voltages to within extremely close limits. The instruments and resistance controls are mounted at a convenient height just above the Master Oscillator chamber.

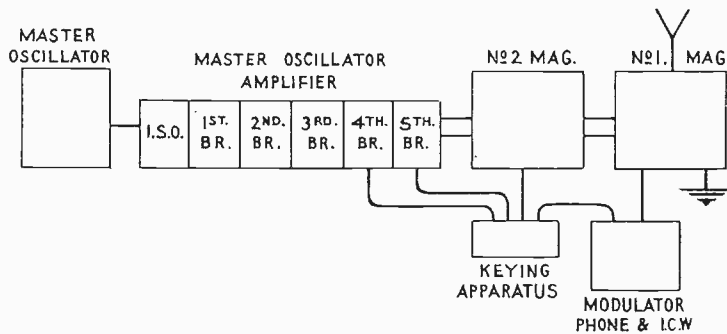

FIG. 2.

As a result of the provisions made for temperature and voltage control and due partly also to the robust and careful design of components, the frequency of the Master Oscillator, whether inductance capacity circuit or Quartz crystal, can be relied upon to remain constant for long periods to within one part in ten thousand after a steady temperature has been reached.

Over short periods of 6 hours or so during which the room temperature and therefore also the temperature gradient through the walls of the Master Oscillator chamber, remain reasonably steady, a constancy of frequency within one part in twenty thousand may be expected. This assumes that the heater lamps have been switched on for at least twenty-four hours to ensure that all the components will have reached a steady temperature. In practice, of course, the heater lamps would never be switched off between transmissions.

Owing to the large range of frequencies covered it is not possible to set the inductance capacity circuit from the calibration chart with a very high degree of discrimination.



The actual discrimination is as follows :—

- Between 4,000 and 7,500 k.cs. average discrimination is 1 in 500.
- Between 15,000 and 4,000 k.cs. average discrimination is 1 in 1,000.
- Between 18,750 and 15,000 k.cs. average discrimination is 1 in 1,500.

Herein lies the usefulness of the four quartz crystals, for they equip the transmitter with four radiated frequencies which will repeat themselves to within limits which the figures above show to be unapproachable with the inductance capacity circuit.

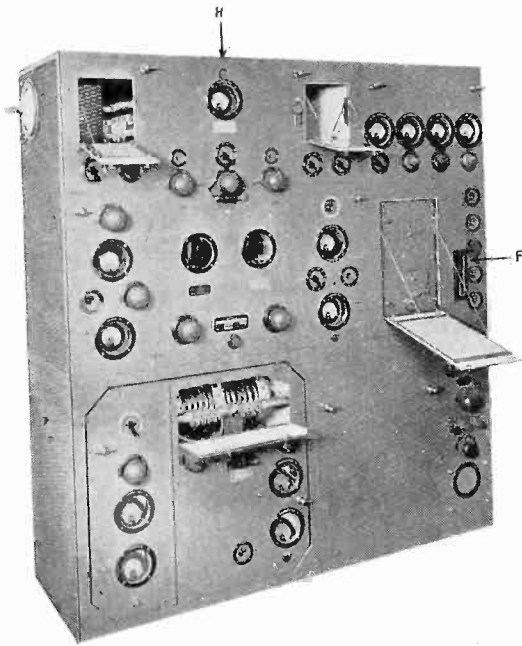

FIG. 3.

by inspection through the hinged door the whole of the interior may be withdrawn as a unit for a thorough inspection and test.

#### Master Oscillator Amplifier and Frequency Multiplier.

This unit B, Fig. 1, comprises six valve stages and an instrument panel, the latter mounting three instruments and a jackfield, whereby provision is made for a visual indication of correct tuning and neutralising adjustment of all six stages.

In Fig. 2 the six stages of the amplifier are indicated as follows :—Isolator, 1st, 2nd, 3rd, 4th and 5th Bridges.

The valve of the Isolator stage is of the four electrode type, S.610, and it is arranged that the grid current of this stage is negligibly small. This ensures that

If the station equipment includes a precision frequency meter then greater accuracy of setting can of course be obtained, the calibration chart being used as a first guide in that case.

Referring to Fig. 1, it will be observed that the upper part of the front cover of the Master Oscillator chamber is hinged, and thus by removing the seven clamping screws around its edge access is gained to the interior for the insertion of valves, heater lamps or crystals.

All the components are mounted on a micalex base rigidly fixed to the lower part of the front cover, so that in the event of a fault occurring which cannot be localised

anode or grid current variations in later stages, due to keying or modulation, cannot react on the Master Oscillator and cause a variation of frequency.

The valves of the Bridges 1 to 4 are 2-HL.610, 2-HL.610, 2-P.625 and 4-P.625 respectively; and take their filament and anode supplies from the Master Oscillator batteries.

The drain from the L.T. battery is 2 amps. and from the H.T. battery 150 milliamps.

The valves of the 5th Bridge are 2-DET.1 S/W. Their filament supply is taken from that for the power stages, and their anode supply from an independent source of 600 volts 50 watts.

The anode circuits of the Isolator and 1st Bridge are tuned always to the third harmonic of the Master Oscillator frequency in the S.3A, and alternatively to the second or third harmonic in the S.3B. The anode circuits of the 2nd Bridge and of all subsequent stages in the S.3A are tuned to the first, second or third harmonic of the frequency to which the Isolator and 1st Bridge circuits are tuned, and to the first or second harmonic in the S.3B. Thus the final radiated frequency in the S.3A may be the third, sixth or ninth harmonic of the Master Oscillator frequency, whilst in the S.3B it may be the second, third or sixth harmonic.

By this means it has been possible to arrange that the frequency of the Master Oscillator never exceeds 2,500 k.c. This is an important point, for it ensures that a quartz crystal for any radiated frequency shall be robust and reliable.

Mention has been made of the instrument panel for the Master Oscillator and Master Oscillator Amplifier. This can be seen in the top left-hand corner of the Master Oscillator Amplifier Unit B, Fig. 1.

Its object is to provide means of tuning and neutralising all stages of the amplifier with a minimum of instruments. The three instruments, two milliammeters and a galvanometer, are brought out to a three-point plug which may be inserted in any of the six positions of the jackfield.

If, for instance, it is inserted in the position marked 1st Bridge, and the press-button switches up to and including the one above that line of jacks be closed, thus completing the anode supplies up to the 1st Bridge, then one milliammeter reads the feed to the 1st Bridge, the other reads the grid current of the 2nd Bridge, and the galvanometer is included in the grid circuit of the 3rd Bridge, and will show a reading if the 2nd Bridge is unbalanced.

Thus by advancing the three-point plug one position at a time from left to right all stages of the amplifier may be tuned and neutralised.

This process only needs to be carried out once for neutralising, since the extreme electrical symmetry of the circuits ensures the balance being sensibly independent of change of frequency within the frequency range of the transmitter.

Also, once the tuning condenser settings have been noted down for any particular frequency, the circuits may be reset for that frequency with sufficient accuracy from the calibration chart without resort to the instrument panel.

The tuning condensers are operated by thumb quadrants, the scale readings being observable through small holes G, Fig. 1, in the inter-stage screening partitions.

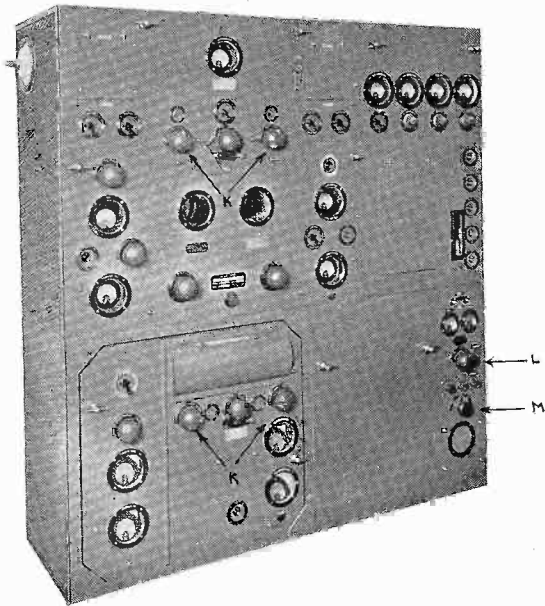

FIG. 4.

The average feed to the two valves over the frequency range is 100 milliamps, and thus the working anode voltage is 1,500 volts and the average anode input power 150 watts.

The output from the No. 2 Magnifier drives the final Power Amplifier, D, Fig. 1. It employs two MT.12 valves. The full load C.W. anode input is 500 watts at 2,500 volts and the average aerial power on C.W. over the frequency range of the transmitter is 290 watts.

In the two Power Amplifiers plug-in coils are not employed, the necessary variations in inductance for the different sub-divisions of the frequency range being

For the stages of the Master Oscillator Amplifier more than one value of inductance is required to cover the complete frequency range of the transmitter and plug-in coils are provided for this purpose, the ones not in use being housed in a box which may be seen in Fig. 1 above the Master Oscillator chamber.

#### Power Amplifiers.

The output of the 5th Bridge of the Master Oscillator Amplifier drives the first of the two Power Amplifiers, C, Fig. 1.

This is denoted as No. 2 magnifier in Fig. 2, and mounts 2-MT.11 S/W valves. Their anodes are fed from the main 2,500-volt supply through a breakdown resistance of 10,000 ohms.

accomplished by switches on the inductances themselves. Access to these switches is provided by hinged doors which are shown open in Fig. 3. Calibration charts giving the positions of the switches for each sub-division of the frequency range are fixed to the inside of the doors.

The tuning condensers each comprise a variable condenser having a vernier drive and a semi-variable condenser which may be switched in parallel with the former, one plate at a time. This arrangement results in a very large ratio of maximum to minimum capacity, thus enabling a good average ratio of inductance to capacity to be maintained over the frequency range.

On the handles, K, Fig. 4, for operating the switches of the semi-variable condensers arrows are engraved which point to indicating numbers that register the number of plates in circuit.

Instruments for reading anode feed, grid current and filament voltage of both Power Amplifiers are mounted behind windows, in addition to an H.T. voltmeter and a low reading thermo-ammeter; the last is included in the tuned anode circuit of No. 1 Magnifier and is used for neutralising that stage.

On power the thermo-ammeter is short-circuited and a press-button is provided to remove the short circuit when it is desired to neutralise the No. 1 Magnifier. In order to avoid the instrument being burnt out by inadvertent removal of the short circuit on power a hinged cover plate, H, Fig. 3, is fixed over the press-button and connected by Bowden control to the "Power-Neutralise" switch.

As an indicator for neutralising No. 2 Magnifier the grid current meter of No. 1 Magnifier is used. A press-button underneath the instrument removes a shunt, thus making possible a very critical adjustment of the neutralising condensers.

### **Aerial.**

In the design of the aerial coupling arrangements of this general purpose transmitter attention has been paid to the possibility that in some cases, *e.g.*, when installed in a ship, it may be necessary from practical considerations to use one aerial for the complete frequency range. This implies an harmonic aerial, with resulting great variations in the required electrical constants of the terminating circuit over the frequency range.

For instance, at the lower frequencies, when the length of the aerial is such that a voltage node exists at the aerial terminal, then a parallel circuit of comparatively large values of inductance and capacity is required; whilst for a current node at the higher frequencies a series circuit of much smaller values of inductance and capacity would be necessary.

*Marconi Short Wave Transmitter. Type S.3.*

To provide the necessary flexibility three switches are mounted on the front of the transmitter having the following respective functions : to select a larger or smaller variable condenser ; to connect the selected condenser in series or parallel with an inductance ; to select two values of inductance by connecting two coils either in series or parallel.

The inductance coils also provide the coupling between the anode circuit of the No. 1 Magnifier and the aerial.

Even with this degree of flexibility it will sometimes happen that with a particular combination of frequency and aerial length it is impossible to tune exactly the aerial circuit and in order to provide for such cases the coupling coils are designed to make possible a very tight coupling, to ensure always that sufficient energy can be transferred to the aerial fully to load the No. 1 Magnifier.

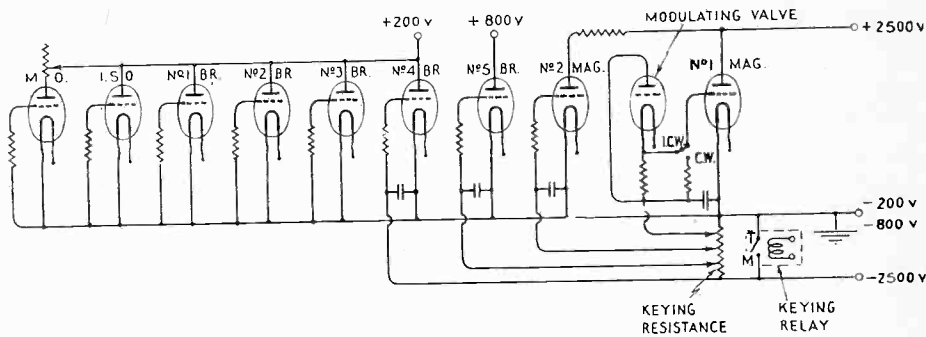

FIG. 5.

A simple harmonic aerial, whilst minimising installation difficulties in certain cases, is not an efficient radiator, and for land stations, once definite working frequencies have been decided upon, a suitable half-wave or multi-half-wave aerial would be used for each frequency.

### Telephony and I.C.W.

The type of modulation employed is that known as the Direct Current Grid method, in which the No. 1 Magnifier grid bias resistance used for C.W. telegraphy is replaced, for telephony and I.C.W., by the filament anode resistance of a small triode.

On the grid of this triode is impressed the speech frequency voltage in the case of telephony or the output from an audio frequency valve oscillator for I.C.W.

*Marconi Short Wave Transmitter. Type S.3.*

---

A dry cell battery of about 80 volts provides the grid bias for adjusting the filament anode resistance of the modulator valve to the value required to set the No. 1 Magnifier to the carrier anode input.

The modulator valve is an L.S.5 and its filament is heated by A.C. from a small combined motor alternator and D.C. generator. A.C. is used for this purpose because, with this method of modulation, the anode of the modulator valve is at earth potential and A.C. heating avoids the inconvenience of an insulated battery. A complete balance for hum is obtained by means of a potentiometer connected across the valve filament.

The D.C. generator provides the anode supply for the L.S.5 valve of the audio frequency oscillator whose output is impressed on the grid of the modulator valve for I.C.W. telegraphy. A choice of three notes (600, 900 or 1,200 p.p.s) is available, the selection being made by a three-position switch, M, Fig. 4, on the front of the Modulator panel.

Selection of the type of transmission, whether C.W. telegraphy, I.C.W. telegraphy, or telephony, is effected by means of a seven-pole three position switch, L, Fig. 4, which performs the following operations: on I.C.W. and telephony it disconnects the No. 1 Magnifier grid circuit from the C.W. grid bias resistance and connects it to the filament of the Modulator valve and starts up the combined motor-alternator and generator; it connects the primary winding of the line-to-grid transformer to the speech input for telephony and to the audio frequency oscillator for I.C.W., completing the filament circuit of the oscillator valve in the latter case; on telephony it short circuits the keying resistance, thus putting the transmitter permanently on "mark."

A galvanometer in the grid circuit of the modulator valve serves as an indicator of over modulation.

In the I.C.W. position of the transmitter selector switch this galvanometer is short circuited to avoid damage from the grid current which is permitted on I.C.W. for the sake of deep modulation, but which of course is inadmissible on telephony.

Provision is made for local microphone or line input by a two-way switch. The unequal impedances of the line and local microphone are allowed for by connecting the latter to a suitable tapping point on the line-to-grid transformer. Sockets are provided on the front of the panel for the local microphone.

All the components for obtaining telephony and I.C.W. modulation, with the exception of the motor alternator and the grid bias battery, are contained in the one unit, E, Fig. 1. Connections for the supplies are by flexible leads, thus allowing the unit to be withdrawn from the main framework for inspection and the location of faults.

The average value of the telephone carrier aerial power over the frequency range of the transmitter is 150 watts, and the degree of modulation obtainable without running into grid current in the modulating valve is 70 per cent.

As has previously been stated, grid current is permitted on I.C.W. telegraphy and the degree of modulation consequently is about 80 per cent. The average aerial power on I.C.W. telegraphy is therefore approximately 200 watts.

### **Keying.**

The outstanding advantages of the well-known method of absorber keying are : (1) stabilisation of anode supply voltage by providing a spacing load equal to the marking load, (2) elimination of effects due to the transit time of the keying relay, and (3) making the keying of a transmitter a voltage operation and therefore sparkless.

Unfortunately, for a medium power transmitter such as the S.3, the additional apparatus and filament power required for absorber keying can hardly be justified for reasons of both cost and space.

However, the method of keying employed in the S.3 provides completely for (2) above, and to a very considerable extent for (1) and (3), whilst the additional apparatus required consists only of a tapped non-inductive resistance of about 1,000 ohms and, of course, a high-speed keying relay. The actual resistance used is two woven mat resistances, each six inches square.

Briefly, the method consists in allowing the power magnifier valves to take a dead loss feed on "space," thus working them as absorbers, and to use the voltage arising from this feed flowing through the keying resistance both completely to "block" an early stage, so that the driving voltage is removed from all subsequent stages and to set the latter at that point on their characteristics where they will be dissipating the maximum permissible anode loss.

A simplified diagram illustrating the arrangement is shown in Fig. 5.

It will be observed that the low potential end of the grid bias resistance of the stage to be "blocked" is connected to the negative end of the keying resistance, which is connected between the negative side of the main H.T. supply and "earth." The grid bias resistances of the subsequent stages are connected to tapping points on the keying resistance such that the voltage between each tapping point and "earth" is the value required to set each stage as described above.

The contacts of the keying relay are connected across the keying resistance, so that on "mark" the resistance is short-circuited and the grid bias resistances are then connected to earth in the usual manner. The small value of resistance between

the tapping point and "earth" on "mark" is negligible compared with the value of the grid bias resistances.

In the S.3 it is the 4th Bridge of the Master Oscillator Amplifier which is "blocked" on "space." The Master Oscillator and the Isolator and 1st, 2nd and 3rd Bridges of the Master Oscillator Amplifier continue to function as on "mark," which fact makes for complete stability of frequency during keying.

The load on the main H.T. machine on "space" is about 45 per cent. of the load on "mark," and with average machines a voltage regulation of about 6 per cent. may be expected between "mark" and "space."

The transmitter will key satisfactorily up to 150 words per minute.

Keying for I.C.W. telegraphy is accomplished in the same manner, the anode of the modulator valve being connected to the keying resistance.

In order to allow the negative voltage from the keying resistance to arrive at the No. 1 Magnifier grids on "space" a high resistance leak is connected from anode to filament of the modulator valve.

#### **Time Required for Changing Frequency.**

The time required to change from one frequency to another depends upon whether a complete calibration of all adjustments has been made for the new frequency and also whether or not the two frequencies lie in the same sub-division of the frequency band.

If a calibration exists, then, in the worst case, that is, one in which the greatest number of coil changes and so on have to be made, five minutes is sufficient; on the average four minutes is enough and three minutes in the most favourable case.

F. C. LUNNON.



R 113.105

## THE UNEQUAL FADING OF CARRIER AND SIDE BANDS

*The Technical Editor of THE MARCONI REVIEW has much pleasure in publishing the following correspondence which he has received on the above subject which was discussed in Mr. A. W. Ladner's article entitled "The Phase of Carrier to Side Bands and its relation to a Synchronous Fading Phenomenon," which appeared in THE MARCONI REVIEW for August, 1930.*

"Sir,—I was very interested in your August number of THE MARCONI REVIEW with particular reference to the article which begins on page 25 and shows the oscillograph results of artificially shifting the phase of side bands with respect to carrier.

2. The phenomenon of unequal fading of the carrier and the modulated components has been noticed by me on many occasions, particularly on the long distance reception. It has been observed on signals from 5SW towards the arrival of daylight at this end, when signals are beginning to fade out completely, and on the approach of darkness at the transmitter when signals are just beginning to be audible here. I have also noticed it on American signals under somewhat similar conditions.

3. It would be interesting to know whether any such effect is heard on a system which uses a single side band with suppressed carrier, where the carrier is reintroduced in the demodulator. If Mr. Ladner's explanation is the correct one, there should be no trace of such effect on for example the London-American telephone circuit via Rugby and a transmission on this system should be subject to uniform fading only, a much easier condition to compensate. I look forward with interest to further articles on the subject, and should be very glad to know the answer to my query, if Mr. Ladner could find time to answer it. I am particularly interested in the single side band system as I have carrier current telephone channels in use here which work in this manner. Incidentally it is found that a considerable shift of the carrier when reintroduced at the demodulator can be tolerated on speech before serious distortion is noticed."

Posts and Telegraphs,

Ipoh, Federated Malay States.

27th October, 1930."

G. WILDE.

"Sir,—With reference to Mr. G. Wilde's letter of the 27th October, 1930, I do not think there is very much I can add to what has previously been written, except that, as Mr. Wilde surmises, recent experiments on single side band work on very short waves do indicate that such a system is more immune from the type of fading described. It is not observable on the long wave Rugby-America service because this type of fading is not in evidence anyway on these long wavelengths, and on the very short wavelengths there is no regular single side band service working because of the difficulty of getting a sufficiently constant frequency; but experiments that Messrs. Langridge and Wilson carried out at Terling where they attempted to work single side band did indicate that receptions were much better from the fading point of view.

## The Unequal Fading of Carrier and Side Bands.

It is interesting too—that Mr. Wilde has observed the same type of fading. It might be of interest to note that with ordinary speech considerable shift of carrier can be tolerated and considerable change of frequency also when the modulation is ordinary speech, but no such changes can be tolerated if music is transmitted as the combination tones are changed as well as the main tones.

Marconi College, Chelmsford.

December 31st, 1930."

A. W. LADNER.

" Sir,—On analysis I find Mr. Wilde's letter a little difficult to understand.

The difficulty turns on the interpretation of the phrase in the first sentence (2) i.e. 'Modulated Components.'

If this refers to the side wave alone as it seems to—paragraph (3) is unintelligible for in a suppressed carrier system it is meaningless to talk of unequal fading of carrier and side bands if the carrier is absent.

I therefore imagine what he calls the 'Modulated Component' is the rectified beat tone between the side waves and the carrier.

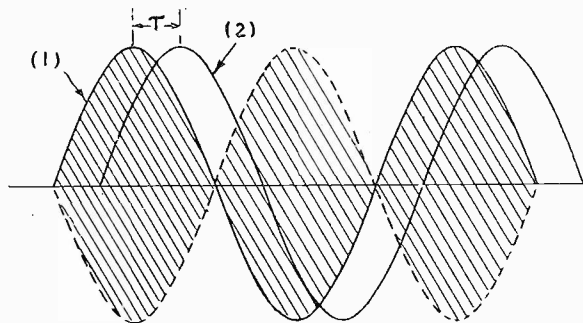

If this is the case the 'Modulated Component' which depends on the product of the intensities of the side bands and the carriers—as well as their relative phases certainly fades in a different manner from the carrier alone. But this relative fading is not only caused by a change of phase of the side bands relative to carrier but also on the relative change of intensity of the side band.

Suppressed carrier will cure the first form of fading but not the second.

With regard to the question in paragraph (3). Suppressed carrier transmission is used at Rugby on long waves (5000M) where effects of fading are much less marked than on short waves, and I personally have not observed the transmission sufficiently to judge if the above effect exists.

On short waves where the effect of unequal fading of modulated components and carrier is well known, suppressed carrier transmission has not been successful and, as far as I am aware, attempts that have been made have failed on account of insufficient frequency stability. Whether the main cause of the unequal fading of 'Modulated Component' is different amplitude fading of the side waves relative to the carrier or is due to a relative phase shift I am not prepared to say, but there is an effect akin to the one discussed which I am convinced is due to relative phase shift of the side bands. It shows itself as an apparently more or less permanently

## *The Unequal Fading of Carrier and Side Bands.*

---

reduced 'Modulated Component' as compared with the carrier, and is especially liable to occur within the skip distance.

The explanation of this effect is based on the relative phase shift of side bands and carrier. In a scattering field the resultant is the sum of a number of contributions which travel by various devious paths.

If curve (1) represents the received modulated signal by one path and curve (2) that by another path, where  $T$  is the delay time, then on the face of it, it is quite obvious that the modulation on the two signals together is reduced by the filling up of the second signal. To interpret this as an effect of the relative phase shift of the side waves it is sufficient to note that a phase shift of the side waves produce a corresponding phase shift of the modulated envelope. Curve (2) therefore represents the effect of a phase shift in the side bands.

We have therefore to expect that in a scattered field the phase of the side bands is changed by a random amount.

Since there is a decrease in 'Modulated Component' for all changes in phase from the normal arrangement the resultant 'Modulation Component' must always be decreased in comparison with the carrier. This effect is very marked at times in the skip distance.

It is to be remarked that a frequency modulation may produce an audio note in a receiver which will fade differently from the carrier.

Research Department,  
Marconi's Wireless Telegraph Company,  
Chelmsford.

T. L. ECKERSLEY.

*January 17th, 1931."*

*(Note by Technical Editor.—An article on this subject by Mr. T. L. Eckersley will appear in the next issue of THE MARCONI REVIEW, in which he amplifies the views stated above.)*

PROPERTY OF  
CANADIAN MARCONI CO.

# MARCONI NEWS AND NOTES

## THE VATICAN WIRELESS STATION



*Marchese Marconi (extreme left) with Father Gianfranceschi, Director of the station (third from left), and officials in the transmitter building at the Vatican wireless station.*

**T**HE short wave broadcasting and wireless telephone and telegraph duplex station which has been supplied by Marconi's Wireless Telegraph Company to the Vatican City and which was formally inaugurated by His Holiness the Pope on February 12th, has a world-wide range.

The new transmitter, which in its main features follows the design of the famous Marconi short wave high-speed Beam transmitters which are used in the British Imperial Beam stations, was manufactured at the Marconi Works at Chelmsford.

The complete installation consists of four main panels, and is designed for telephony and high-speed telegraphy on either 19.84 or 50.26 metres. The first of the four panels is the main magnifier unit for both waves. The second panel contains the intermediate magnifiers and the new Marconi-Franklin valve master-

drive unit for the shorter wavelength. The third panel comprises the intermediate magnifier units and master-drive unit for the longer wavelength, while the fourth

panel is a combined modulator for telephony and absorber keying unit for high-speed telegraphy.

**Rating on Telegraphy and Telephony.**

On telephony the transmitter is rated to deliver from 8 to 10 kw. of unmodulated carrier wave energy to the aerial feeder system, the output depending slightly on the wavelength used. The normal degree of modulation is 80 per cent.

The rating on continuous wave telegraphy is 13-15 kw. to the aerial feeder.

Two transmitting aerials of the Marconi "Uniform" type are provided, one aerial for each wavelength. This type of aerial has been developed recently by the Marconi Company and is an improved type of vertical short wave aerial.



*Masts and aerials of the Vatican wireless station.*

Both aerials are suspended and insulated from a triatic slung between two self-supporting lattice steel towers 61 metres in height and 90 metres apart.

The energy from the transmitter building is conveyed to the two aerials by two separate concentric copper tube feeders similar to those used in the British Imperial Beam stations. The transmitter building itself is situated near the railway terminus in a part of the grounds in the Vatican which is surrounded by a Roman wall 45 feet high, whilst the masts are placed outside this wall. In order not to destroy the amenities of the Vatican gardens a tunnel 43 metres long passing under the Roman wall has been constructed to accommodate the aerial feeders.

Every effort has been made to harmonise, as far as possible, the transmitter building and aerial towers with the graceful surroundings of the Vatican City. The transmitter building is of sober but pleasing architectural design; and the tops of the masts are finished off to give a Bishop's mitre effect which greatly enhances their appearance in silhouette.

The transmitter building contains a spacious transmitter room with land-line control tables, an amplifier control room, receiver room, accumulator room, machine room, valve and general stores and general office.

**Reception.**

A special receiver, partly made of standard parts of the normal telephone and high-speed Marconi receiver and telephone terminal four-wire two-wire equipment, will secure good telephone and telegraph duplex communication between the Vatican City and any part of the world. This receiver is situated in one of the rooms of the transmitting station and utilises a vertical aerial placed at a distance of only a few yards from the sending aerial. This receiving aerial is suspended from the same triatic which carries the sending aerial and its length is adjustable from the receiving room.

The new wireless station which may be considered to represent the latest word in short wave technique, to which such far-reaching contributions have been made by Marchese Marconi and his able assistants, has been erected by Italian engineers under the personal supervision of Marchese Marconi. It will not only provide the Vatican City with a radio telegraph and telephone link with distant parts of the earth, but when required will also enable the voice of His Holiness the Pope to be broadcast throughout the world.

During tests which took place during the week preceding the opening, the Vatican station carried out good clear telephone communication with Australia, India, South Africa, Argentina, Canada and the United States, and with London, Paris, Berlin, Madrid and other European capitals.

**Wireless Beacon Stations.**

**T**HE extension of facilities for navigation by wireless through the installation of automatic wireless beacon stations has become an accepted practice in the leading maritime countries. Experience in operation has shown that this type of wireless beacon provides the most suitable and economical form of assistance for the many ships now fitted with wireless direction finders—an instrument which in accordance with the Safety of Life at Sea Convention signed by 18 nations, will in July this year become compulsory equipment on passenger vessels of more than 5,000 tons.

Marconi automatic wireless beacons can be installed in lightships and lighthouses or in other positions already familiar to navigators, from which they broadcast in all directions a distinctive signal at stated periods so that direct bearings can be taken. The transmitters are automatically controlled and require no skilled personnel for their operation.



*The Marconi automatic wireless Beacon at North Saddle Island, China.*

They have been adopted for use by the British coastal authorities and are becoming increasingly used abroad, a station of this type having been recently completed at North Saddle Island, near Hongkong, China. Further Marconi beacons are now to be installed at the Roumanian Port of Constanta on the Black Sea coast, and on Kennery Island at the mouth of the harbour at Bombay, India.

The beacon station at Constanta will be the second erected to the order of the Roumanian authorities, one being already in operation at Cap Caliacra, approximately 55 miles to the south. The distinctive signal for the Constanta beacon will consist of the Morse call “— · — ·”, repeated five times during a period of twenty seconds, and then a pause of ten seconds. This signal will be repeated nine times in  $4\frac{1}{2}$  minutes, followed by a silent period of  $15\frac{1}{2}$  minutes, except in bad weather when it will be transmitted continuously.

The Kennery Island beacon is the first to be installed in Indian waters.

Both the new beacon stations are to be of the standard Marconi W.B.2 Type, operating on a power up to 1 kilowatt, that for Kennery Island being specially arranged for tropical service.

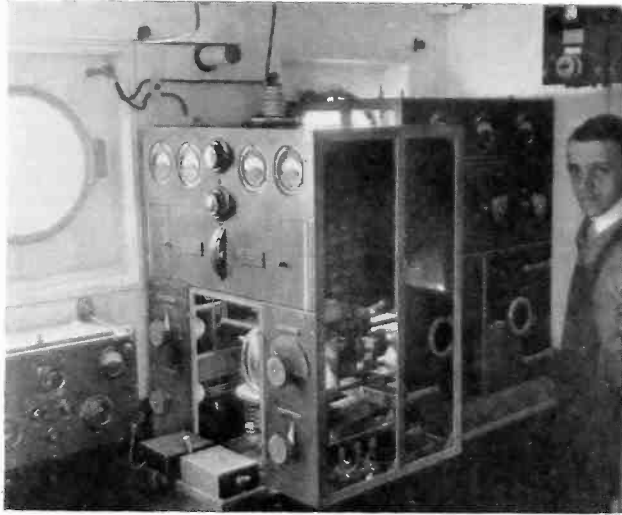

*Marconi short wave transmitter installed on the s.s. "Oropesa" for the use of the Prince of Wales.*

#### **Keeping the Prince of Wales in Touch.**

**A** MARCONI short wave wireless transmitter and receiver which has been specially installed for the use of the Prince of Wales on the Pacific Steam Navigation Company's liner *Oropesa*, on which he is travelling to South America, will enable him to maintain throughout the voyage constant and direct communication with this country through the short wave wireless coast station at Portishead near Bristol.

Although an increasing number of ships now carry short wave equipment for direct communication over long distances, no ship fitted with short wave wireless apparatus for communication with England has yet made the voyage along the Pacific coast of South America. Recent experience in short wave wireless communication at sea indicates, however, that at no time during the voyage should the Prince of Wales find any difficulty in maintaining direct communication with England.

With such apparatus, for example, the Australian liner *Jervis Bay*, when docked in London has communicated direct with Sydney, and the Royal Mail liner *Asturias* regularly exchanges messages with the Portishead station when off Buenos Aires.

While the short wave wireless set on the *Oropesa* is carrying out communication with Great Britain the normal wireless equipment will be used for navigation and the exchange of messages with local ship and shore wireless stations on the run through the Caribbean Sea, the Panama Canal, and down the South American coast.