



BRITAIN'S BEST SELLING ELECTRONICS MAGAZINE

No. 50

ELECTRONICS

The Maplin Magazine

FEBRUARY 1992 • £1.60

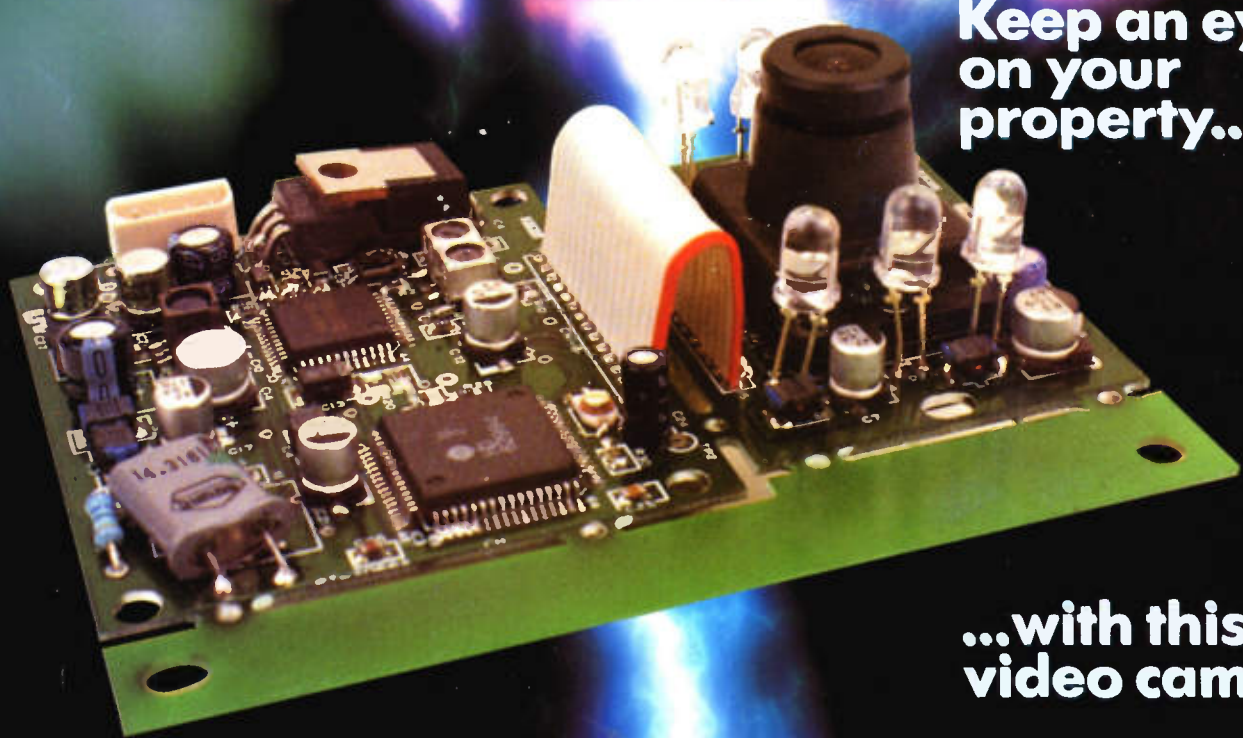

SECURITY!
Keep an eye
on your
property...

...with this
video camera

**BEGINNERS
START HERE!**



- * **Explained: the Intel 386 & 486 processors**
- * **Save energy with a versatile digital timer**
- * **Find out about personal communications**
- * **How to avoid leaving your car lights on!**
- PLUS! How to... Design digital logic and power supply circuits, Receive world news, Build a tracking regulator, and much, much more!**

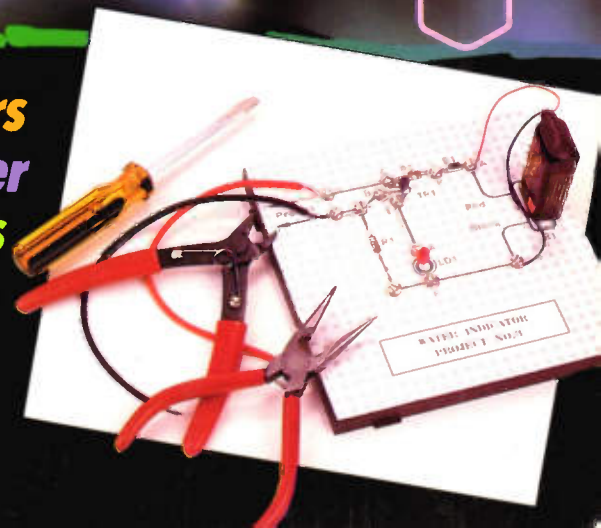

IT'S A JUNGLE OUT THERE.



MEET ONE OF THE KINGS!

There are more new radio-controlled cars and accessories available now, than ever before. In fact, it's a jungle out there! Now you can own one of the kings of that jungle.

High performance, ready-built, 1/10 scale racers whose only limit to performance is your imagination.

The Jet Cat (GL41U, featured above), is a great introduction to the world of modular model racing, the concept of which allows you to build up a radio-controlled model with components that meet your specification and budget.

Two other models complete the 'racing pack'. Radicator (GL36P, see below), is a 2-wheel drive racer with a chassis constructed from strong T-6 aluminium and special engineering plastics to keep the weight as low as possible, ensuring quick, agile handling. Radicator is tough enough for the entry-level driver, yet versatile enough to be a challenging platform for the experienced driver.

The Bullet (GL37S, see below), lives up to its name and is a real 'gold edged' winner. The Bullet utilises gold anodised, aircraft grade T-6 aluminium for the chassis, motor bracket and shock absorbers.

In its first-ever American regional R.O.A.R. off-road competition, a pre-production prototype of the Bullet defeated all comers and turned in the fastest lap in 2WD competition!

All three racers come unpainted (paints not supplied), so you can choose your own individual design.

All you need to add to the cars is the 2-channel radio transmitter and receiver set (XJ47B), a Ni-Cad racing pack, e.g. (YP90X) and a racing motor of your choice. See the 1992 Maplin Catalogue for the full range of radio-controlled models and accessories or call in to your local Maplin store for helpful, expert advice. Prices for cars from as low as £59.95, phone 0702 554161 now. All items subject to availability.



EDITORIAL

■ Hello again and welcome to this month's issue of 'Electronics'! In this issue there is a wide range of projects to suit everyone's taste. For motorists the Car Lights-On Indicator will help prevent the frustration of a flat battery. For the security conscious home owner, our Monochrome Video Camera can be used to keep a watchful eye over your property. The Digital Timer Module has numerous applications including, energy saving time control of immersion heaters and central heating, or even switching of security lights. For the experimenters amongst you, the subject of this month's Data File is a tracking regulator that provides a $\pm 15V$ supply - ideal for powering Op-amp based circuits. The Funtronics series of beginners' projects continues with a water alarm. A special feature by Martin Pipe takes a look at the Belgian company, Velleman, whose kits have been recently introduced into the Maplin range. The 386 and 486 processors are examined by Frank Booty, and asks if the processing power provided by these devices is worth the price tag, to find the answer, you'll have to read his article! Personal Communications Networks are hailed as the practical answer to the problem that cellular phones tried to address; that of low-cost, good quality portable communications for the masses. Peter Ramsdale from Unilel looks at the implementation of such a system. Plus, there's all the usual features and regulars too, so I hope you enjoy reading this issue as much as the 'team' and I have enjoyed putting it together for you!



ABC 33,837

- Editor Robert Ball
- Project Development Chris Barlow, Gavin Cheeseman, Tony Bricknell, Alan Williamson.
- Technical Authors Mike Holmes, Martin Pipe.
- Consultant Author Alan Simpson
- Technical Illustrators Paul Evans, Lesley Foster, Ross Nisbet
- Production Co-ordinator Alan Wright.
- Print Co-ordinator John Craddock.
- Advertising Co-ordinator Kathy Peters
- Publications Manager Roy Smith.
- Development Manager Dave Goodman.
- Advertising Manager Vic Sutton
- Drawing Office Manager John Dudley
- Art Designers Peter Blackmore, Jim Bowler.
- Published by Maplin Electronics Plc.
- Colour Separations Shiring Graphics Ltd., 16-22 West Street, Southend, Essex SS2 6HJ.
- Printed by Eversen Valley Press, Caerphilly, Mid Glam CF8 3SU.
- Distributed by United Magazine Distribution Ltd., 1-11 Benwell Rd, London N7 7AX.
- Mail Order P.O. Box 3, Rayleigh, Essex SS6 8LR.
- Retail Sales: (0702) 554161, Retail Enquiries: (0702) 552911. ■ Trade Sales: (0702) 554171.
- Cashlet: (MODEM) (0702) 552941.
- General: (0702) 554155.
- Fax: (0702) 553935 ■ Telex: 995695.

Copyright. All material is subject to worldwide copyright protection, and reproduction or imitation in whole or part is expressly forbidden. All reasonable care is taken to ensure accuracy in preparation of the magazine, but Maplin Electronics plc cannot be held legally responsible for its contents. Where errors occur corrections will be published as soon as possible afterwards. Permission to reproduce printed circuit board layouts commercially or marketing of kits must be sought from the publisher.
 © Copyright 1992 Maplin Electronics plc.
 Front Cover Picture: © Copyright Phil Jude/Science Photo Library.

PROJECTS

8 CAR LIGHTS-ON INDICATOR

■ Warns you against inadvertently leaving car lights switched on.

16 MONOCHROME VIDEO CAMERA

■ This module uses charge coupled technology, ideal for surveillance use.



32 DATA FILE: $\pm 15V$ TRACKING REGULATOR

■ An application circuit for the 4195 regulator IC.

48 DIGITAL TIMER

■ A versatile timer module with a digital display.



76 WATER DETECTOR

■ An ideal beginners' project.

FEATURES

4 ELECTRONICS IN AVIATION

■ Looks at airspace and air traffic control.

19 SEQUENTIAL LOGIC

■ Dealing with the design and application of digital logic circuits.

24 THE BELGIAN CONNECTION

■ Maplin's newest range of kits.



26 MICROCOMPUTER TESTING

■ Alan Pickard continues his series about testing and fault-finding.

36 PREDICTING WAVESHAPES

■ Examines the inductor-resistor-capacitor circuit.

40 PERSONAL COMMUNICATIONS NETWORKS

■ Telecomms technology has opened up a new means of keeping in touch by phone.

44 BOOLEAN ALGEBRA

■ Continues to explain the mathematics behind digital electronics.

52 THE 386/486 DEBATE

■ Are computer salespeople recommending the best processor-base for *your* needs?

56 FOOD, DRINK & EPOS

■ How does electronics benefit the paying customer.



60 DC POWER SUPPLIES

■ John Woodgate presents a computer program for aiding power supply design.

64 CABLE NEWS NETWORK

■ How up-to-the-minute world news is made possible.



73 VIDEO-CONFERRING

■ An electronic means of holding business meetings.

REGULARS

- 2 NEWS REPORT
- 13 SUBSCRIPTIONS
- 14 ORDER COUPON
- 15 AIR YOUR VIEWS
- 18 NEWSAGENTS COUPON
- 23 CLASSIFIEDS
- 31 TOP 20 KITS
- 39 NEXT ISSUE
- 47 COMPETITION WINNERS
- 67 CIRCUIT MAKER
- 72 NEW BOOKS
- 79 STRAY SIGNALS
- 80 TOP 20 BOOKS

CORRIGENDA

■ October 1991 Vol. 10 No. 46
 MIDI Switch Box
 Page 7, the M3 nuts required to secure the PCB to the case have been omitted from the Parts List, these will, however, be supplied in the kit.
 ■ November 1991 Vol. 11 No. 47
 Low Cost PSU
 Pages 66 and 71, the values of resistors R7, R13, R14 and R15 are shown incorrectly in Figure 3 and the Parts List. The correct values are as follows: R7 = 10k Ω , R13 = 3k Ω , R14 = 750k Ω and R15 = 10k Ω .
 Amplifier Monitor
 Page 25, PCB track, Issue 1 PCBs are incorrect; an amendment sheet is supplied with Issue 1 PCBs detailing the necessary modification. Issue 2 PCBs or later will have this error corrected.
 Page 26, Circuit Diagram, the -12V supply is shown connected to D1-D4/R3 and D101-D104/R103, which is incorrect, it should be connected to C2(-) /YTR1(e) and C102(-) /YTR101(e).

Prices shown in this issue include VAT at 17.5% (except items marked *NV* which are rated at 0%) and are valid between 3rd January 1992 and 30th April 1992.



A Photocopier with an IQ

The photo (above) shows the Panasonic FP2670, the latest in the company's 'IQ' range of black-and-white copiers. Designed for reliable copy quality and easy maintenance, this machine can deliver a copy in 5.5 seconds. Featuring a host of user conveniences, the system is highly flexible with a modular, expandable design – as it should be with a £3400 price tag for the basic model! Nevertheless, if a generous Panasonic rep is reading this, we could do with any spare one you may have, to replace our 20-year old monster which leaks chemicals whenever it is used! Details: Ruth Lloyd (034) 853910.

CPD from TEC

The Engineering Council is targeting a leaflet campaign at the 235,000 engineers and technicians on its UK register. Its aim is to encourage such people into 'Continuing Professional Development' (CPD). The leaflet promotes a free brochure that shows how engineering staff and their employers can benefit. The scheme, as developed by the council, will enable individuals to 'update their knowledge and skills', while helping 'industrial companies to improve their performance'. CPD's aims include: career path planning, the updating of technical knowledge through continued education, the gaining of commercial awareness, and the development of communication and management skills. Funding for the national scheme includes £450,000 from the Department of Education and Science, through its PICKUP (Professional, Industrial and Commercial Updating) initiative. Contact: (071) 240 7891.

Automating the Home of the Future

According to research by the National Economic Development Council, the next major consumer electronics growth area will be that of home electronic systems – where clever microprocessor-controlled circuitry will enable people to have more control over their domestic environments. In the future, an individual will have the freedom to remotely operate heating systems, program the VCR, arm/disarm the security system, or turn on the oven to cook a pre-prepared meal – and all this will be achieved from anywhere within reach of a telephone!

To stimulate interest among young engineers in this field, the National Economic Development Office and the Institution of Electrical Engineers are co-sponsoring a competition for university and polytechnic students to design a home automation product or service. Teams of students will be sponsored

by companies including BT (surprise, surprise!), Schlumberger, Eastern Electricity and Honeywell Control Systems. Prototypes of their ideas will be demonstrated at the competition's final in September. Further details: Michele Shemming (071) 217 4131.

The End of Steam Radio as we Know it?

The BBC has announced that the broadcasting of Radio Three on the medium-wave (MW) band will cease on February 28th, the service becoming FM-only after this date. The frequency space that will be liberated is reserved for the second national commercial radio station, whose franchise will be awarded later this year by the newly-formed Radio Authority (no doubt, to the highest bidder!).

In addition, MW transmitters used by the following BBC local radio stations will close: Cleveland (1548 kHz); Northampton (1107 kHz); Nottingham (1521 kHz); and Oxford (1485 kHz). Details: Alan Lafferty (081) 752 5432.

Paperless Power

Covering an area stretching from Chesterfield to Milton Keynes and Coventry to Kettering, East Midlands Electricity serves a population of some five million. But what makes it special is the fact that it is the first in the country to utilise a fully-blown Network Information Management System (NIMS). When the system is completed at the end of the year, East Midlands Electricity will be able to manage its network without the use of wall-charts and paper information systems. This flexible arrangement will help to coordinate the organisation and presentation of information, of which there is clearly a lot in the case of a power distribution network. These benefits will eventually be passed back to the customer as a significantly improved service, after all, important decisions on its day-to-day (and long-term, come to think of it) running can only be made when there is sufficient information available to base them on. Important features that NIMS will introduce to East Midlands include the automation of planned and on-demand switching schedules, feeder and dead zone tracing, safety checking, and the automatic generation of safety and operational documentation.

The contract, which is worth around £2 million, to supply the equipment was awarded to Ferranti International. This decision was influenced by the chosen system's flexibility; it is designed to open standards (the computer system, for example, is UNIX-based, using X-Windows, Motif graphics and an Ingres relational database). In addition, the system can communicate with existing equipment via Ethernet, and, as you may expect, many emergency features have been incorporated. A back-up system is installed at a remote location, and each workstation is capable of managing the entire network should a major incident arise. Details: (061) 499 9900.

Radio Times

The Radiocommunications Agency has announced that the contract for amateur and citizens band (CB) radio licensing has been awarded to Subscription Services Ltd, a wholly owned subsidiary of (wait for it) the Post Office. From 1st April 1992, all new licences will be issued by SSL, and that owing to the fall in demand, licences will not be available over the counter from post offices after that date.

Fully Comprehensive Payphones

Undismayed by the lack of Ministerial understanding, BT has signed an initial contract worth more than ten million pounds for several thousands of new payphones. These will accept a combination of payment methods – coins, BT Phonecards and credit cards. At present most BT public payphones accept either coins or BT Phonecards, and a thousand also accept credit cards. The announcement comes at a time when BT's quality of service results show more than 95% of its 97,000 payphones are working at any one time.

Meanwhile, it's become a tough trading time for BT. The past six months saw BT having only a small increase in profits, thanks to increasing competition, the tough RPI –6.25% formula on prices, and the effects of the recession. Price formula or no, it has not stopped BT from posting a draft of new prices. However, the industry watch-dog OFTEL has expressed agreement with the increases, which it says are broadly in line with the

price control formula. As only OFTEL and, hopefully, BT understand the formula, this is hardly reassuring. Especially as OFTEL now says it is to undertake a complete review of the formula early this year. OFTEL will also be taking a close look at BT directory enquiry services.

But at least we now know why the BT chairman wanted that large pay rise – to help pay for his lunches. According to a BT publication, in 1960 a three-minute call to America cost more than a slap-up dinner at the Savoy. Now it costs less than a glass of mineral water at the bar.

Chips with Everything

US company Cirrus Logic has introduced a \$45 chip set which, according to 'Computergram', can enhance a laptop computer with capabilities for fax, electronic mail and voice answering techniques. The new communicator is about the size of two postage stamps and already several laptop producers are considering using the two-chip set.



PICTURE CAPTION CHALLENGE

Now why would BT be planting a phonebox in mid river? What is going on? Is it:

- ★ BT launches their new floating marina phonebox;
- ★ BT finding itself in the deep end after delivering a watertight phonebox;
- ★ BT responding to a request from the local sub-mariners club;
- ★ BT engineer gets water-logged when installing the worlds first

under-river phonebox. Supplied of course COD.

Still not sure? Well it is a photo of the BT engineer updating the remotest phone kiosk in Norfolk. Three panels, featuring the company's controversial new Pan-style logo, made from specially strengthened glass, were transported by boat to the isolated cardphone kiosk at Berney Arms, near Great Yarmouth.

What's On and Where

Open until 19 January 1992. Doctor Who has extended his travel through time and will be appearing over Christmas and the New Year. Museum of the Moving Image, South Bank, London. Tel: (071) 928 3232.

Open until 19 January 1992. Michael Faraday 1791–1867. National Portrait Gallery, London. Tel: (071) 306 0055.

Open until the end of January. Japan's National Space Development Agency. Science Museum, London. Tel: (071) 938 8000.

4–6 February. Portable Computer Communications Show, Wembley. Tel: (071) 383 3323.

14–15 February. The Universe Comes to London, The European AstroFest., sponsored by 'Astronomy Now'. Kensington Town Hall, London. Tel: (071) 580 2104.

23 February. Northern Cross Radio Rally, Rodillian School, on A61. (GOFLX). Tel: (0532) 827883.

25–28 February. The IBM User Show, Birmingham. Tel: (071) 404 4844.

4–5 March. The Networked Economy. A major conference which brings together the individuals with the power to shape the telecommunications future'. Paris. Tel: (081) 868 4466.

31 March–2 April. CD-ROM Europe '92, Brighton. Tel: (0895) 622233.

7–10 April. The Which Computer? Show + Communications '92. NEC. Birmingham. Tel: (081) 940 3777.

13–15 April. Cable and Satellite Olympia, London. Tel: (081) 940 3777.

24–26 April. The Third MIDI Music Show, Hammersmith, London. Tel: (081) 549 3444.

Please send details of events for the Diary Listings to The Diary Editor, 'ELECTRONICS'.

In today's crowded skies, the ability to talk with ground controllers is essential to safety in the air, and to support this need for reliable air/ground communication, the last fifty years have seen the growth of a massive air-traffic control system spanning the entire globe. It is a system in which electronics play a major role, through the medium of radio. In 1910, aviators in America were the first to discover the value of radio for passing information between air and ground; those early

signals were transmitted at HF. Whilst those frequencies are still in use today – particularly for trans-oceanic communication – the work-horse over land is now VHF, with much use made of the international aeronautical allocation 118 to 137MHz.

That is certainly the case in the United Kingdom, where a network of remote transmit/receive stations dotted around the country enable controllers at West Drayton, Prestwick and the Manchester sub-centre to

maintain contact with aircraft flying through our airspace. To appreciate how this communications network operates, it is first necessary to understand how the UK's 'controlled' airspace is organised.

Division of Airspace

For Air-Traffic Control (ATC) purposes, the country is divided into two Flight Information Regions (FIRs) – London and Scottish. The boundary between them is the 55°N line of

ELECTRONICS IN AVIATION

Part Two Air-Traffic Control by Chris Yates

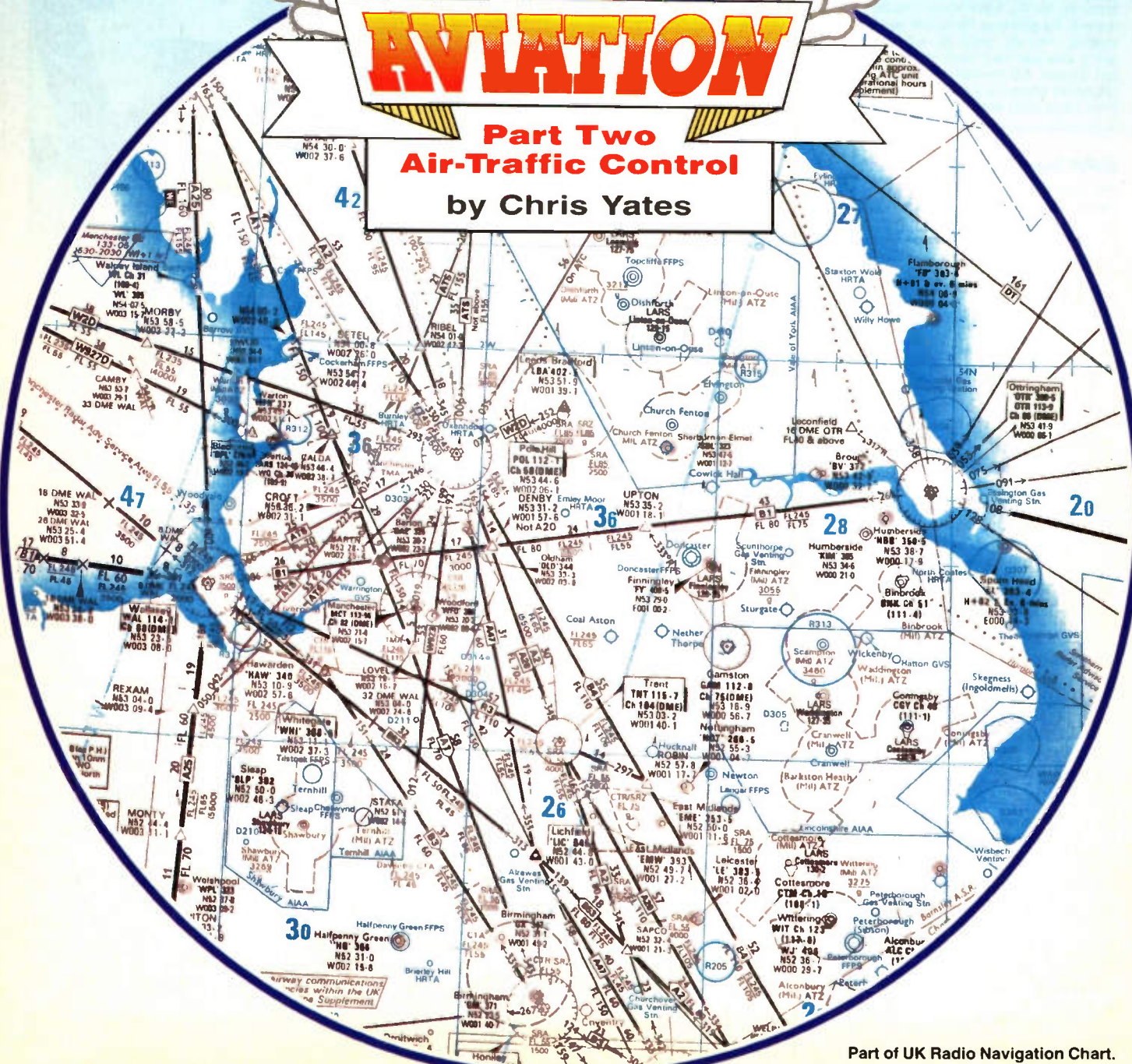

latitude, roughly the Scottish border. Cutting across these FIRs are the Airways. Each is ten miles wide with a base between 5,000 to 7,000ft. and extending upward to 24,500ft. – FL245. Airways are like motorways in the sky, and link the UK's airports with those of other countries. The airspace within them is arranged so that aircraft flying in one direction are at odd thousands of feet, those going the opposite way at even thousands.

Where several meet – usually in the vicinity of one or more major airports – Terminal Control Areas are arranged. These are vast chunks of airspace which protect the Airway intersections. Below a specific altitude, aircraft descending through the Traffic Manoeuvring Areas (TMAs) enter an Aerodrome Control Zone or its military equivalent MATZ – Military Aerodrome Traffic Zone. A pilot wishing to transit these zones, is required to request permission from the relevant ATC unit before entering.

High Flying

Above FL245 the FIR becomes an Upper Information Region (UIR) and the airspace is designated a Special Rules Area (SRA). That means all aircraft are subject to a full and mandatory air-traffic service. The airways extend upward into the SRA and become Upper Air Routes. However, where possible high flying aircraft operate on direct routings to conserve fuel. For military pilots much SRA is also a Mandatory Radar Service Area, and they are required to receive a radar control service.

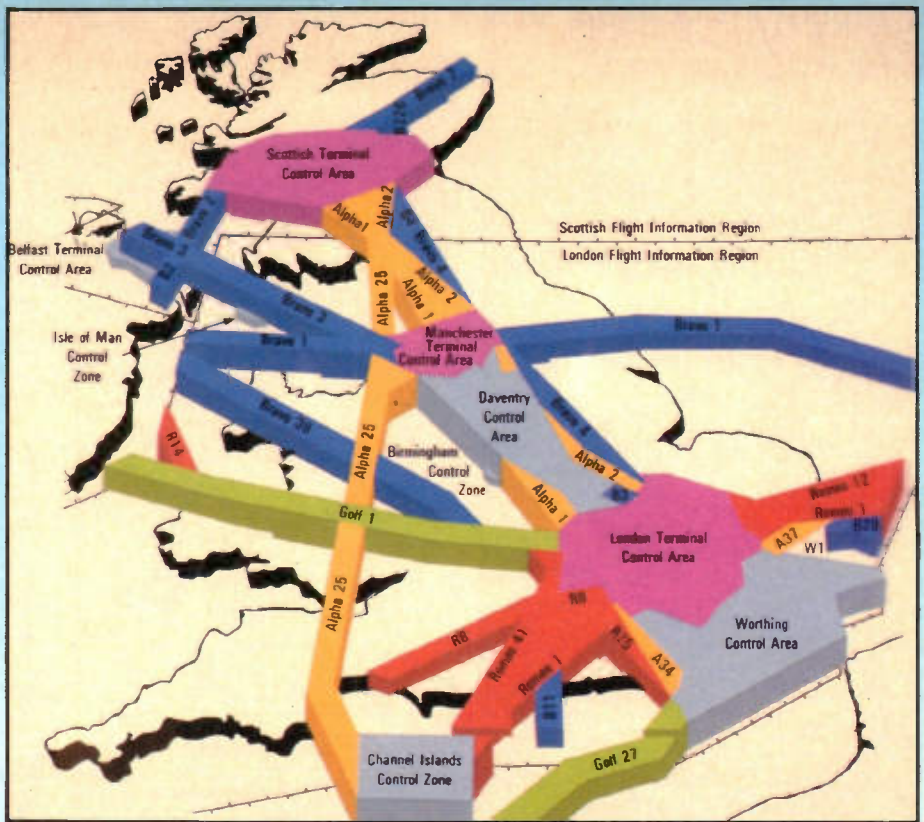

The UK Airways System 1989.

Sectors

All this adds up to a phenomenal amount of radio traffic, and to help controllers handle it safely and efficiently the FIRs/UIRs are split into sectors, each with their own frequencies and area of responsibility.

During daylight hours it means that an aircraft flying through UK airspace could be handled by as

many as eight different controllers. As traffic lessens these sectors are banded together, and at night the same pilot may only talk to two controllers.

Division of Responsibility

Traffic flying within Airways, Terminal Control Areas or Special Rules

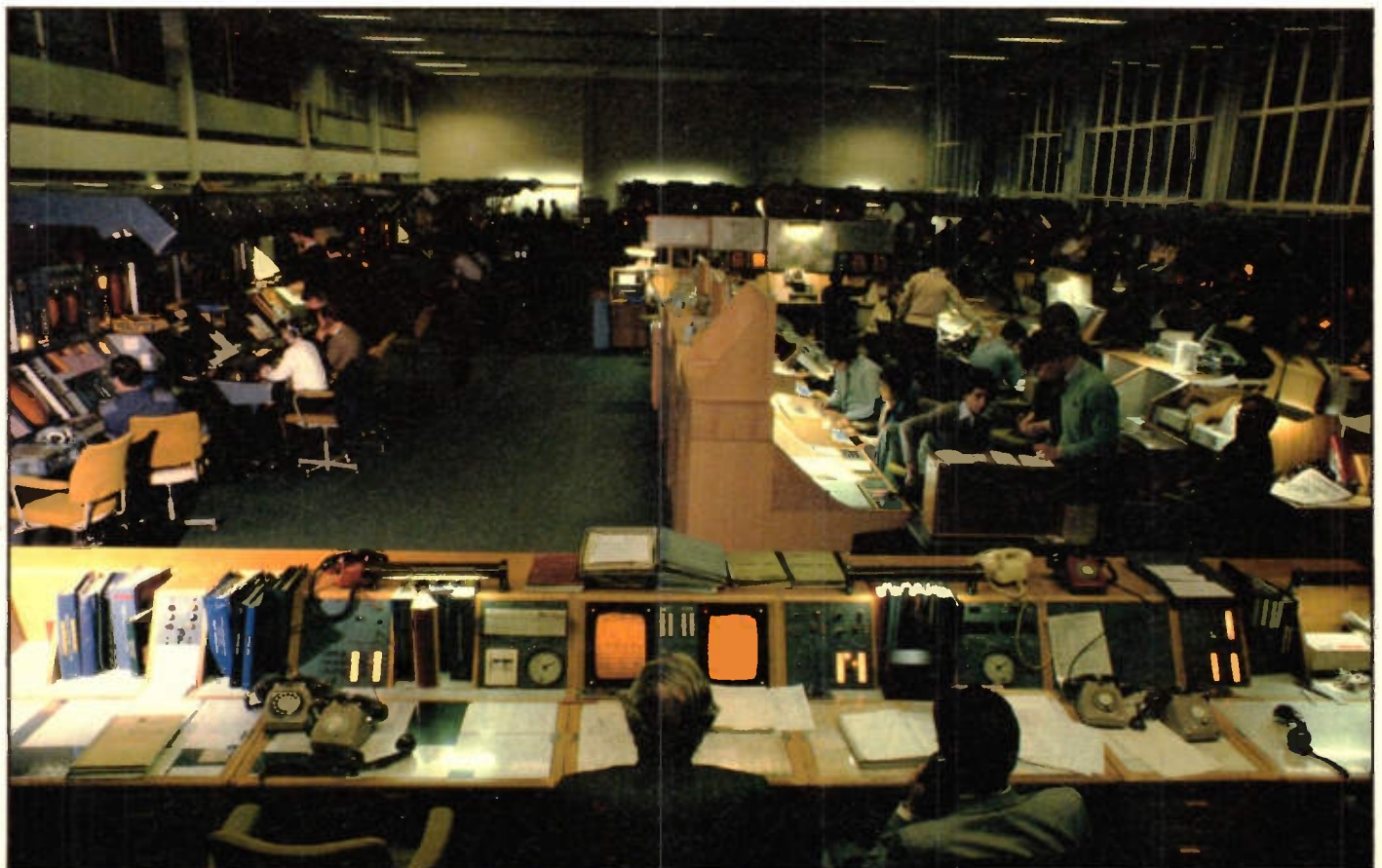

London Air-Traffic Control Centre Operations Room.



Trimmingham VHF Radio Transmitter.

Airspace come under direct control of London and Scottish ATC centres. In addition the Manchester sub centre – technically part of London Air-Traffic Control Centre (LATCC) – handles all aircraft in the busy airways over the North-West and Irish Sea up to 19,500ft. – FL195.

Controllers must keep aircraft within their sectors separated by five miles horizontally and 1,000ft vertically. Pilots are expected to follow the controllers instructions implicitly.

In the descent and nearing an Aerodrome Control Area, the responsibility becomes that of airport controllers.

Approach Control

The hand-over point between Airways and Approach Control is kept deliberately flexible so that controllers can react to differing traffic flows. As a result it could be a time, flight level or geographic location, and is not always obvious from radio transmissions. Once that point has been reached, Approach Control issue initial clearances, and if the airport is busy, instructions to enter a 'stack' are given.

'Stacks' are based on radio beacons with the aircraft flying in an oval pattern around them, but at different altitudes. Once the way is clear for an approach to the field, the

controller gives Radar headings to enable the pilot to intercept the Instrument Landing System (ILS) radio guidance system.

The ILS transmits two directional radio beams called the glide path and localiser. Once the pilot reports 'locked on' to these beams, control is passed to the tower.

Aerodrome Control

The Aerodrome Controller sits in the Tower – also known as the Visual Control Room – and is responsible for the safe passage of arriving, departing and transiting aircraft.

Using Distance from Touchdown Indicator equipment he can check on an arriving aircraft's position in relation to runway threshold and centre-line, and issues landing instructions, wind checks and other vital information. At small airfields he may also control the movement of aircraft and vehicles on the ground, but at our biggest airports this duty falls upon the Ground Movement Controller.

Heathrow ATC

Because of the vast number of aircraft using London Heathrow, air-traffic control at the airport is markedly different to anywhere else in the UK. All inbound aircraft are directed by LATCC to one of four holding points. These are located at Bovingdon, Lambourne, Biggin and Ockham.

Two Approach and two Radar controllers are responsible for aircraft within these stacks, and give



Scottish Air-Traffic Control Centre Operations Room.

pilots constant instructions regarding altitude heading and speed. As each aircraft exits at the base of the stack, it is passed over to a Number Two Radar controller, who has the unenviable task of organising them all into one stream of traffic heading toward the runway.

Around six to eight miles from touchdown – once each aircraft has locked onto the ILS – control is transferred to Air Arrivals in the Tower. Even Ground Management Control differs at Heathrow, in that duties are split between two controllers instead of the more usual one or none!

Oceanic Control

Aside from its domestic ATC service, the United Kingdom is responsible for air-traffic control over a sizable portion of the Atlantic Ocean. It is a duty shared with Canada, the USA, Portugal and Iceland.

Because of the limited range potential of VHF communications, these give way to HF beyond the 30°W line of longitude. As VHF cannot be used, it follows that neither can Radar. Instead, pilots flying the Atlantic are afforded the protection of the 'Oceanic Tracks' system.

The 'tracks' are reconstructed every 12 hours, to accommodate as many aircraft as possible on their most economic flight paths, and

taking full advantage of prevailing winds. Over much of the Ocean, the airspace between 27,500ft and 40,000ft is known as Minimum Navigation Performance Specification airspace. Aircraft flying within it must carry a level of navigation equipment that will enable them to be flown with a high degree of accuracy. In the crowded 'tracks' system, such a level of accuracy is essential, and the slightest deviation from planned routes could spell disaster. Position reports and forward estimates to the next reporting point are used to keep separation between aircraft.

In any system there are always exceptions to the rule, and in this case it is Concorde. Supersonic flights operate via their own fixed tracks – Sierra Mike is used Westbound and Sierra November or Sierra Oscar Eastbound.

Flow Control

There is a finite limit on how many aircraft can be accommodated safely in 'controlled' airspace, and the rapid expansion of European air-traffic has left many ATC units stretched to the limit. To ensure the airspace does not become unsafe, limits are placed on how many aircraft can enter any given sector at any one time. The system is called 'Flow Management' and means that flights are held on the ground until their destination and

runway time slot are clear.

It all adds up to horrendous delays for travellers, but when one balances safety against an extra few hours in 'transit', I know which I would choose!

To be Continued...

In next month's issue, Chris Yates takes an in-depth look at monitoring air-traffic control, and the equipment to use.

Post Script

All change at London ATCC

It is widely recognised that the airspace over the South-East of England is the busiest in the world, and is getting busier all the time. With this in mind, the question of creating more airspace has been exercising minds over recent years. Now though, the planners have evolved a radical new system of air-traffic control for the South-East called Central Control Function (CCF).

CCF will re-organise sectors of airspace into tunnels in the sky. All traffic in any given tunnel will be moving in the same direction, and each of the major South-East airports will have its own tunnels for inbound and outbound aircraft. One controller will be responsible for each tunnel, and it's believed there will be no need for the criss-crossing of

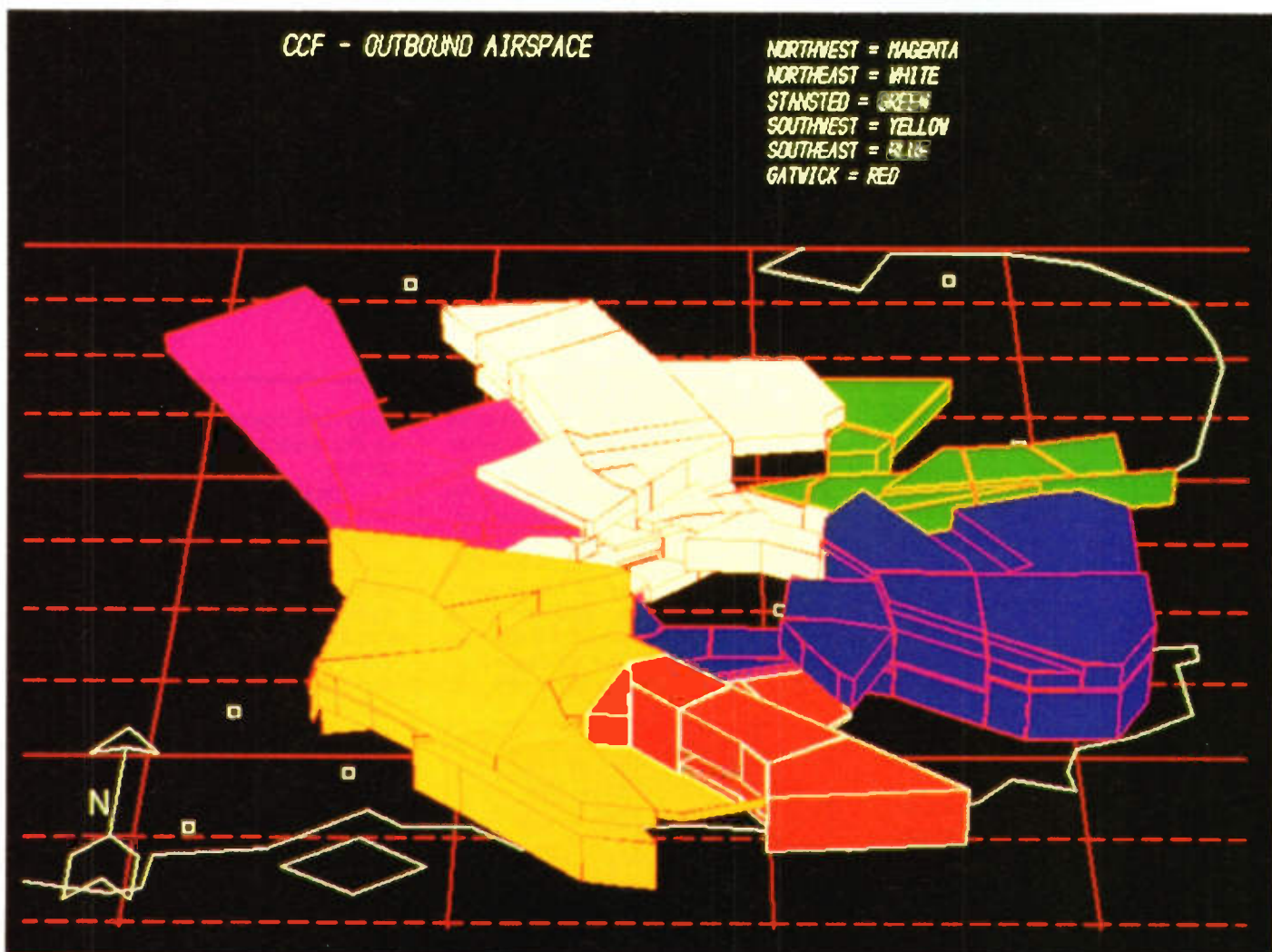

Central Control Function Outbound Airspace diagram.

Continued on page 11.

CAR LIGHTS-ON WARNING INDICATOR



ACTUAL
SIZE

If your car is not fitted with some kind of 'lights-on warning', the chances are that you will (if you have not already done so!) leave your lights switched on. Murphy's law dictates that when you do so, your absence from the car will be of sufficient duration to ensure that the battery will be well and truly flat. Of course Murphy, not content to do things by halves, will ensure that it happens when you are late for some important occasion and that there is no one else around to give you a push or a jump start!

Modern cars further aggravate the situation as many of them, being fitted with electronic ignition or electronic engine management systems, just plain refuse to be push-started!

It is amazing that such mechanically advanced cars often *do not* have a lights-on warning indicator of some kind. To illustrate this, the prototype was installed in a 2.0 injection Ford Sierra Estate – despite being a 'Ghia', there was no lights-on warning device!

Various warning devices are avail-

able, however, some become a nuisance because they sound continuously when the lights are deliberately left on. For instance, whilst the driver is waiting in the car at night, with the engine switched off.

Some more sophisticated devices will not sound if the lights are switched on again *after* the ignition has been switched off, i.e. for parking lights. However, this fails to warn the driver if he inadvertently 'knocks' the light switch on when leaving the car – as is the case with

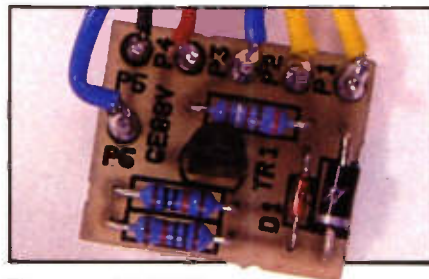

The assembled PCB.

by Joe Fuller

FEATURES

- ★ **Low-cost and small size**
- ★ **Easily fitted to most negative earth cars**
- ★ **Buzzer sounds when lights are left on**

many cars having the light switch 'stalk' on the driver's door side of the steering column.

The Lights-On Warning indicator will emit a clearly audible buzzing sound when the car lights are left on, the ignition switch is turned-off and the driver's door opened. In this manner the buzzer will only sound when the driver is genuinely about to leave the car.

Now that you are thoroughly convinced that for the sake of a few pounds, you need not be caught out in the future, why not build this handy accessory (which the manufacturer should have included as standard) and fit it into your car? Enterprising readers may wish to offer this 'add on' to friends, relatives and neighbours for a suitable fee (don't forget to tell the tax man!). A personal tale of woe and the assurance that, "I've got one and it has stopped me from getting caught out again!" is sure to win a few favourable responses.

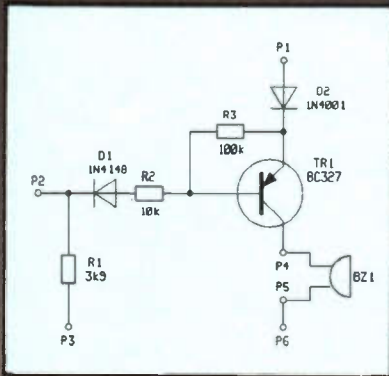

Figure 1. Circuit diagram.

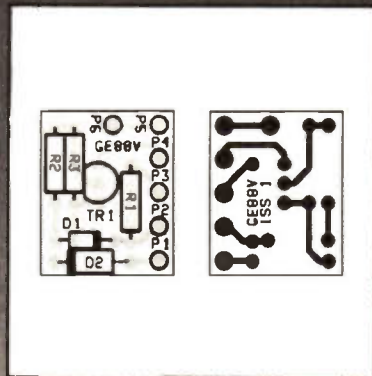

Figure 2. PCB legend and track.



The Lights-On unit attached to a convenient surface.



Photo 1. Connections to the sidelight circuit (left) and accessory circuit (right).

Circuit Description and Operation

The circuit of the Lights-On Warning Indicator is very simple, as can be seen from Figure 1. However, it is worthwhile to know how the circuit operates as this will help, should problems occur.

P1 of the unit is connected to the

sidelight circuit of the car and provides power to the circuit only when the lights are switched on. The sidelight circuit is live when either sidelights or headlights are switched on.

P2 is connected to the accessory circuit and when the ignition switch is off, P2 is pulled low via R3 (P3 is connected to 0V). D1 is forward biased and turns on

TR1 via R2. Note that the internal resistance of accessories (i.e. radio-cassette) may be sufficiently low to make the connection to P3 unnecessary; this can be determined by experimentation.

P6 is connected to the driver's door switch, thus when the door is opened, a complete path to 0V is provided by the door switch, allowing the buzzer to sound.

When the ignition switch is on, P2 is pulled high, reverse biasing D1. R3 ensures that TR1 is held in the off state. The positive supply to BZ1 is removed and thus prevents it from sounding, regardless of whether the driver's door is open or shut.

When the lights are off and the car doors are closed, the polarity of the supply to the unit is effectively reversed. D2 prevents damage to the circuit under this condition.

Construction

Assembly of the unit is simplicity itself, however, the complete beginner is referred to the Constructors' Guide supplied with the kit, which contains useful information on construction techniques.

Referring to Figure 2, it is advised that the PCB pins are fitted first, followed by the resistors and the diodes and finally the transistor. Make sure that the transistor is fitted fairly close to PCB otherwise the PCB will not fit into the case.

Next solder the buzzer's wires to the PCB pins, red (+V) to P4, black (-V) to P5. Attach the connecting wires to the PCB pins and label the free ends so that you can identify the wires after the PCB has been fitted into the case!

The PCB simply lays in the case, the wires protruding through the aperture provided. Screw the case together and affix the buzzer onto the lid of the case using one of the double-sided adhesive pads. The other pads can be placed onto the underside of the case ready for fitting into the car.

Although it is unlikely that there will be any problems with the unit, it is advisable to test it before fitting into the car. It is easier to take remedial action on the work bench than underneath the car dashboard! Using a 9 to 14V supply (i.e. PP3 battery, battery eliminator, etc.) connect P3 and P6 to 0V, then Connect P1 to +V, the buzzer should sound. Connect P2 to +V as well, this should silence the buzzer.

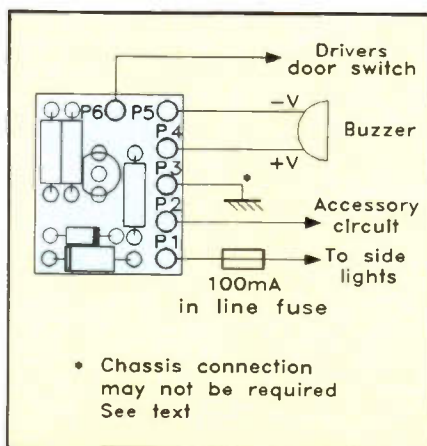

Figure 3 (above). PCB connections.

Photo 2 (left). Connections to the door switch circuit.

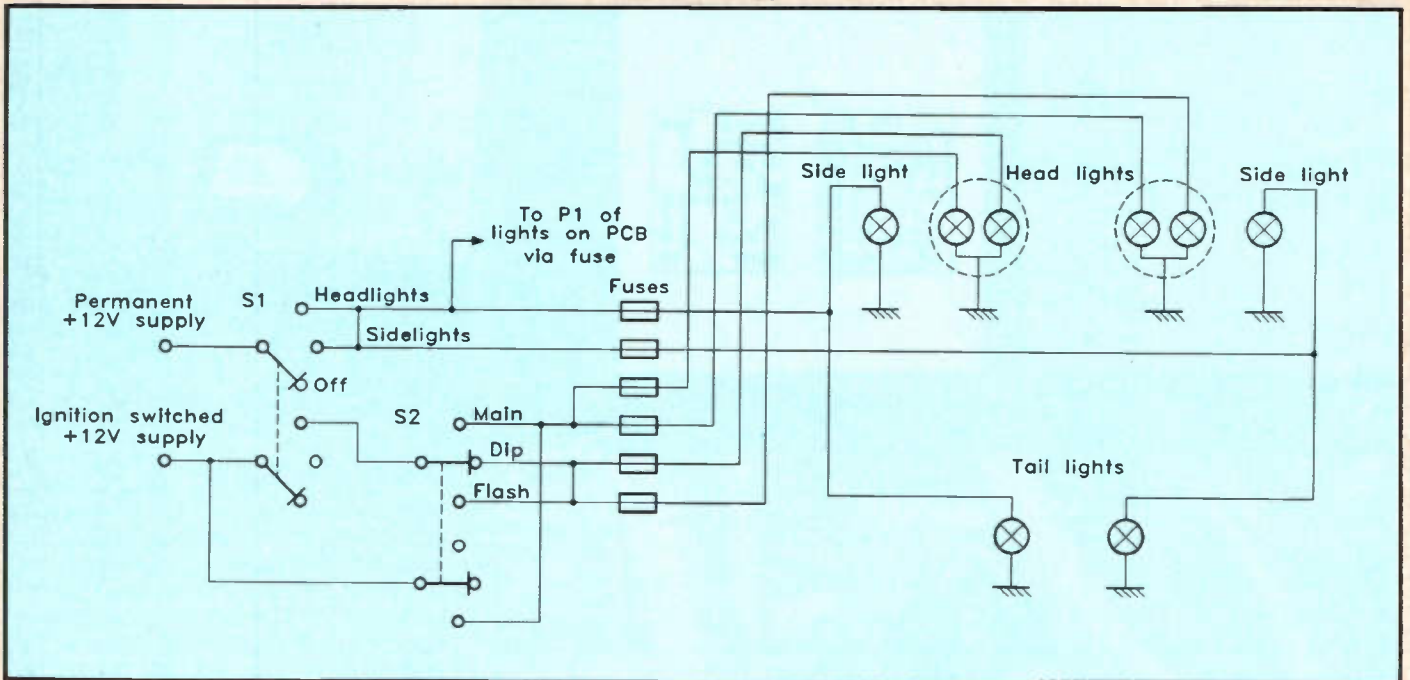

Figure 4. Typical lighting circuit and connections.

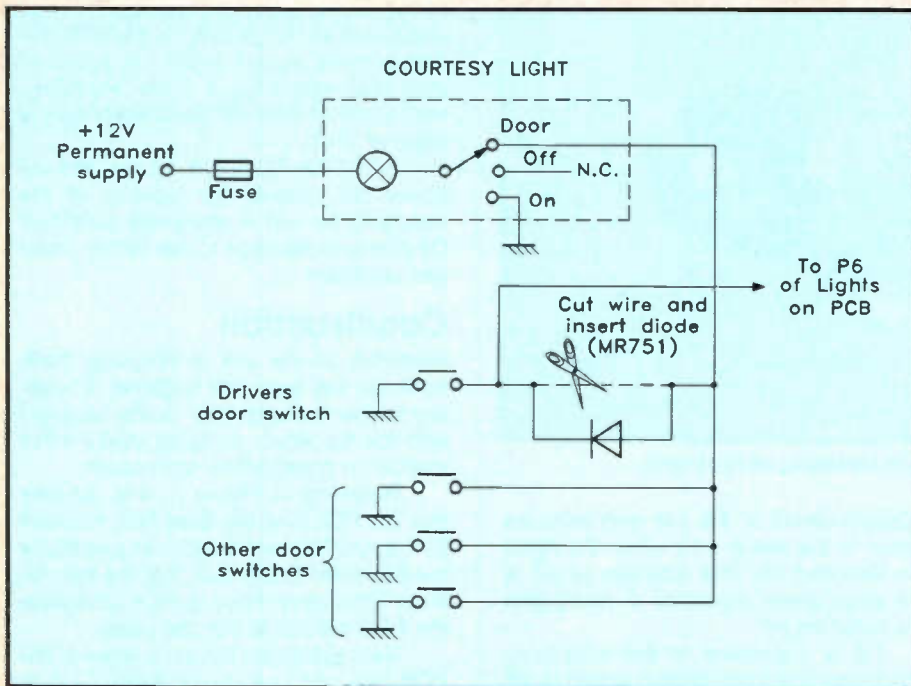

Figure 5. Typical courtesy light circuit and connections.

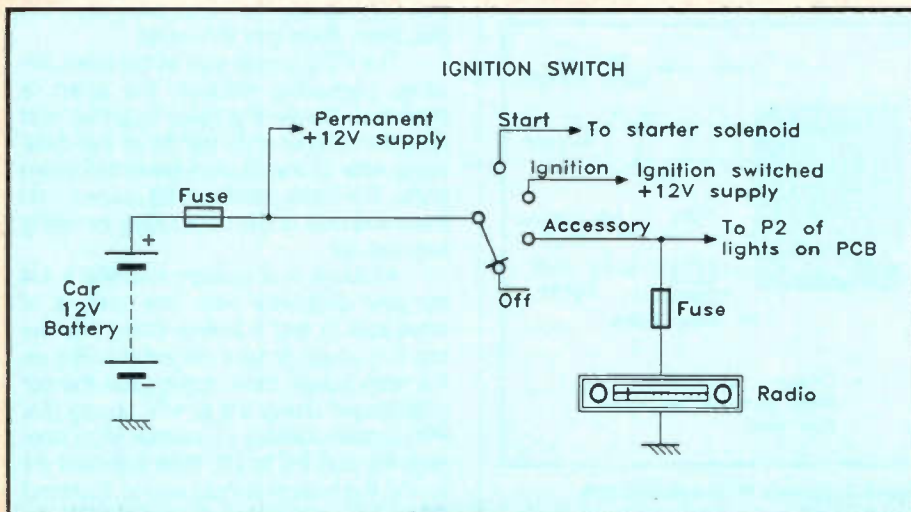

Figure 6. Typical Ignition switch circuit and connections.

Installation

Refer to Figures 3, 4, 5 and 6. It is necessary to gain access to the car's wiring, which will undoubtedly involve removing the underside of the dashboard, trim panels, etc. It is advisable to refer to a workshop manual, e.g. of the 'Haynes' variety; if you do not have one, either buy one – as it will be useful anyway, or borrow one from your local library. A workshop manual will also help you ascertain the correct wires to connect to – otherwise it will be a case of tracing the correct wires with a multimeter.

Important Notes: disconnect the car battery before making connections to the wiring. Connections to existing wiring can be made using 'snap lock' connectors or terminal blocks of adequate current rating – remember the Lights-On unit draws very little current, but two 55W headlamp bulbs draw considerably more! Ensure that the new wiring will not become entangled with any controls, especially the brake pedal and steering column. To prevent short circuits, make sure that all connections are properly insulated, use adhesive electrical tape.

Connect P1, via a fuse and fuseholder, to a point in the wiring which becomes live when the sidelights are switched on (Figure 4 and Photo 1).

Connect P6, to the driver's door switch (Figure 5 and Photo 2). To prevent other doors from operating the buzzer, install an MR751 diode in series with the wire to the courtesy light.

Connect P2 to a point in the wiring which becomes live when the ignition switch is turned to 'accessory', i.e. +V supply to the radio (Figure 6 and Photo 1). Alternatively, if there is no 'accessory' position, connect P2 to a point in the wiring which becomes live when the ignition switch is turned to 'ignition'.

Connect P3 to the car's chassis (0V) or to a point in the wiring which is

permanently connected to the car's chassis. Note that this connection may be unnecessary if the internal resistance of any accessory is sufficiently low. This may be ascertained by testing the unit with P3 left unconnected and all accessories switched off. If in doubt connect P3 as previously described.

Double-check connections, reconnect the car battery.

Testing

Switch lights on, leave ignition switched off and open the driver's door; the buzzer should sound.

With the driver's door shut, opening any other door should *not* cause the buzzer to sound.

With the ignition switched to 'accessory' or 'ignition', opening the driver's door

should *not* cause the buzzer to sound.

With lights turned off, the buzzer should *not* sound with any combination of ignition switch positions or doors open or closed.

Assuming the unit is working correctly, refit underside of dashboard and trim panels.

Happy Motoring!

LIGHTS-ON WARNING PARTS LIST

RESISTORS: All 0.6W 1% Metal Film

| | | | |
|----|------|---|---------|
| R1 | 3k9 | 1 | (M3K9) |
| R2 | 10k | 1 | (M10K) |
| R3 | 100k | 1 | (M100K) |

SEMICONDUCTORS

| | | | |
|-----|--------|---|---------|
| D1 | 1N4148 | 1 | (QL80B) |
| D2 | 1N4001 | 1 | (QL73Q) |
| TR1 | BC327 | 1 | (QB66W) |
| | MR751 | 1 | (YH96E) |

MISCELLANEOUS

| | | | |
|------|---------------------------|---------|---------|
| BZ1 | Buzzer 12V | 1 | (FL40T) |
| P1-6 | Pins 2145 | 1 Pkt | (FL24B) |
| | In-line Fuse Holder 1½in. | 1 | (RX51F) |
| | 100mA 1½in. Fuse | 1 | (WR08J) |
| | PCB | 1 | (GE88V) |
| | Mini Box and Base | 1 | (JX56L) |
| | Quickstick Pads | 1 Strip | (HB22Y) |
| | Instruction Leaflet | 1 | (XT11M) |
| | Constructors' Guide | 1 | (XH79L) |

OPTIONAL (Not in kit)

| | | |
|---------------------------|---------|---------------|
| 16/0.2 Wire | As Req. | (FA26D-FA36P) |
| Snap Lock Cable Connector | As Req. | (JR88V) |
| Terminal Block 5A | As Req. | (HF01B) |

The Maplin 'Get-You-Working' Service is available for this project, see Constructors' Guide or current Maplin Catalogue for details.

The above items (excluding Optional) are available as a kit, which offers a saving over buying the parts separately.

Order As (Lights-On Reminder) LP77J Price £3.95.

Please Note: where 'package' quantities are stated in the Parts List (e.g. packet, strip, reel, etc.) the exact quantity required to build the project will be supplied in the kit.

The following new item (which is included in the kit) is also available separately, but is not shown in the 1992 Maplin Catalogue.

Lights-On PCB Order As GE88V Price 80p.

Electronics in Aviation Part Two continued from page 7.

routes which hampers the present system.

CCF is based on a system already in use in the United States, and is expected to result in a 30% increase in the number of aircraft, controllers can handle safely. A major feature of CCF is that Approach and Radar control for the airports will move to West Drayton, greatly simplifying co-ordination. Once the system is up and running, the centre will become responsible only for the South-East. A new air-traffic control centre is currently being constructed at Fareham in Hampshire, and will handle air-traffic over the remainder of the UK.

Becoming an Air-Traffic Controller

Because of the vast increase we are seeing in European air-traffic, the recruitment of new controllers has been increased significantly in recent years. Around 240 applicants per year are being accepted onto the National Air-Traffic Services training programme every year, and that level is expected to remain static for the foreseeable future.

The 'cadets' undergo training at the CAA College of Air-Traffic Control in Bournemouth, and once licensed, are posted to either West Drayton, Prestwick or Manchester.

As air-traffic control is provided on a 24-hour basis, controllers work to a watch system, and for every two

hours on duty they have a half-hour break. For experienced controllers the average wage is currently £33,000 per annum. Prospective candidates must be educated to a minimum A-level standard, with at least one pass in the Sciences.

For more information and an

application form contact the Civil Aviation Authority at the address below.

Civil Aviation Authority,
CAA house,
45-59 Kingsway,
London.
WC2B 6TE.

Electronics in Aviation Terminology

| Term | Meaning |
|--------|---|
| HF | High Frequency. Often referred to as Shortwave. Frequency Range 3 to 30MHz |
| VHF | Very High Frequency. Range 30 to 300MHz |
| ATC | Air-Traffic Control |
| FIR | Flight Information Region |
| UIR | Upper Information Region |
| Airway | A corridor of airspace connecting the Terminal Manoeuvring Areas to the Airways of other countries. Each is ten miles wide. |
| ILS | Instrument Landing System. Often called the localiser. In its simplest form this is nothing more than a VHF radio signal, beamed down the centre-line of a runway, and gives pilots an indication of whether they are right or left of an ideal track. |
| CCF | Central Control Function. A system of air-traffic control based on tunnels in the sky. CCF is currently being phased in for ATC in the South-East of England. |
| TMA | Traffic Manoeuvring Area. A designated area of airspace surrounding an airport (5 to 10 nautical miles radius and up to 3,000ft. above the airport). Designed to protect air-traffic within that area. Aircraft wishing to cross the TMA need to request special VFR clearance. |
| VFR | Visual Flight Rules. Pilots must be able to see other traffic within the zone that the aircraft is flying. The pilot must be able have 3 nautical miles of visibility; and keep 1 mile horizontally, and 1000ft. vertically, from cloud. |

Jingle bells, Jingle bells,
Jingle all the way, oh! what fun it is to ride in a.

**WHEN CHRISTMAS
RUNS OUT...**

**...MAKE SURE
YOUR BATTERIES
DON'T!**

Duracell batteries, available from Maplin stores nationwide. Plus! Ever Ready, Panasonic, Yuasa, Fuji and Uniross batteries. See the 1992 Maplin Catalogue for the full range of replacement and rechargeable batteries.

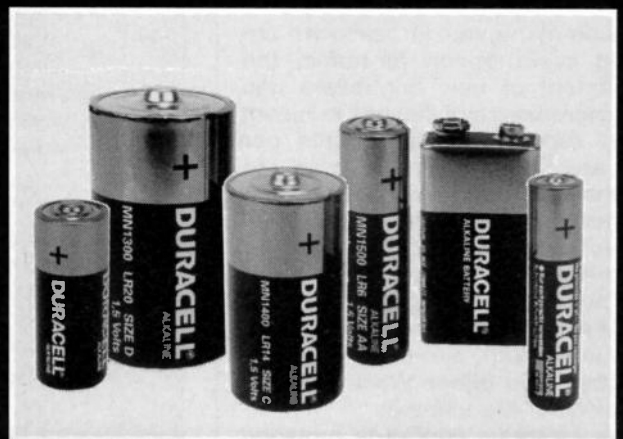

SUBSCRIBE TO



- * Save over £1! Yes, save money by taking a subscription, it's cheaper than buying each individual copy.
- * TWO FREE ISSUES if you agree to subscribe by Direct Debit or Continuous Credit Card.
- * FREE delivery to your door, there are no additional carriage charges.

- * It's bursting at the seams with projects and interesting features to read.
- * It's streets ahead of its rivals, with full colour pages and far less advertising space.
- * Plus – News, reviews, readers letters, competitions and lots, lots more besides!

To subscribe just send a cheque postal order for £8.58 made payable to Maplin Electronics, P.O. Box 3, Rayleigh, Essex SS6 8LR. OR you can take advantage of our offer of two free issues by completing the coupon below and agreeing to pay by Credit Card or Direct Debit. The two free issues offer only applies if you use one of these two methods of payment. Simply fill in the 'Payment by Credit Card' or 'Payment by Direct Debiting Mandate' and return it to Maplin. Every time, about 1 month before your subscription is due, we will send you a letter giving details of the subscription rate and telling you the date on which we will charge your Credit Card or debit your bank account. If you do not wish to continue your subscription, you have until that date to let us know, and we will then cancel your authority to bill your Credit Card or cancel your mandate. Otherwise, if you do nothing, your subscription will continue. The authority or mandate you give us does not allow us to charge anything other than the Maplin Magazine subscription. The benefit to you is that you no longer need to remember to re-new your subscription or send off any more cheques or postal orders. Payment is made automatically.

OVERSEAS SUBSCRIBERS

Subscription rates for 6 issues are: £11.00 (or 30 IRC's) in Eire, Europe and surface mail outside Europe; £25.00 (or 68 IRC's) Air Mail outside Europe.

TAKE THE NEXT 2 ISSUES OF THIS MAGAZINE FREE!!

Because we're so certain that now you've seen the Maplin Magazine you'll want to receive it regularly, we're offering to send you the next two issues free of charge with absolutely no obligation to continue. Just fill in the details below and if after receiving two issues you do not wish to continue, just let us know at least one month before the next issue is due and we will cancel your subscription. The two free issues will be yours to keep whatever you decide. If you already have a subscription, fill in the details below and we'll add two issues free of charge to your current subscription. SEND NO MONEY NOW. About 2 weeks before the third issue is due, we will charge you £8.58 for the next six issues, unless you have cancelled. This offer is not available to those already paying by Direct Debit or Continuous Credit Card or those who have stopped payment by either method within the last two years. Please start my subscription with issue 51. THIS OFFER IS OPEN TO RESIDENTS WITH U.K. ADDRESSES ONLY.

EITHER

★ PLEASE ADD YOUR ADDRESS, SEE BOTTOM RIGHT ★

PAYMENT BY CREDIT CARD. Please charge my Credit Card Account

Customer Number (if known)

Access Visa American Express

I authorise you until further notice in writing to debit my CREDIT CARD account by £8.58 and in future, with any amounts which, after notification, MAPLIN ELECTRONICS PLC may debit thereto in respect of my subscription to the Maplin Magazine.

| | |
|-------------|------|
| Account No. | |
| Signature | Date |

OR

PAYMENT BY DIRECT DEBITING MANDATE in favour of Maplin Electronics plc, P.O. Box 3, Rayleigh, Essex SS6 8LR.

Direct Debit payment option is only open to customers with bank accounts in the U.K. including Channel Isles, Isle of Man and N. Ireland. Please note: Instructions cannot be accepted to charge Direct Debits to a Deposit or Savings Account.



| | |
|----------------|---------------------|
| Bank Sort Code | Bank Account Number |
|----------------|---------------------|

Name of Account to be debited

The Manager

I authorise you until further notice in writing to charge my account, with you, any amounts which MAPLIN ELECTRONICS PLC may debit thereto by Direct Debit in respect of my subscription to the Maplin Magazine.

I will inform the bank in writing if I wish to cancel this instruction.

I understand that if any direct debit is paid which breaks the terms of this instruction, the bank will make a refund.

| | |
|-----------|------|
| Signature | Date |
|-----------|------|

Enter your address and Maplin customer number, if known.

| | |
|-----------|--|
| | |
| | |
| | |
| | |
| Post Code | |

If you wish, you can put this form in an envelope and address it to: Maplin Electronics, Freepost, P.O. Box 3, Rayleigh, Essex SS6 2BR.

MONOCHROME CAMERA

Features

- ★ 12V Operation
- ★ Compact Design
- ★ Low Current Consumption
- ★ CCD Technology
- ★ Sensitive to Visible Light and 940nm Infra-red

Applications

- ★ Security
- ★ Remote Monitoring
- ★ Video Doorphones
- ★ Video Digitising

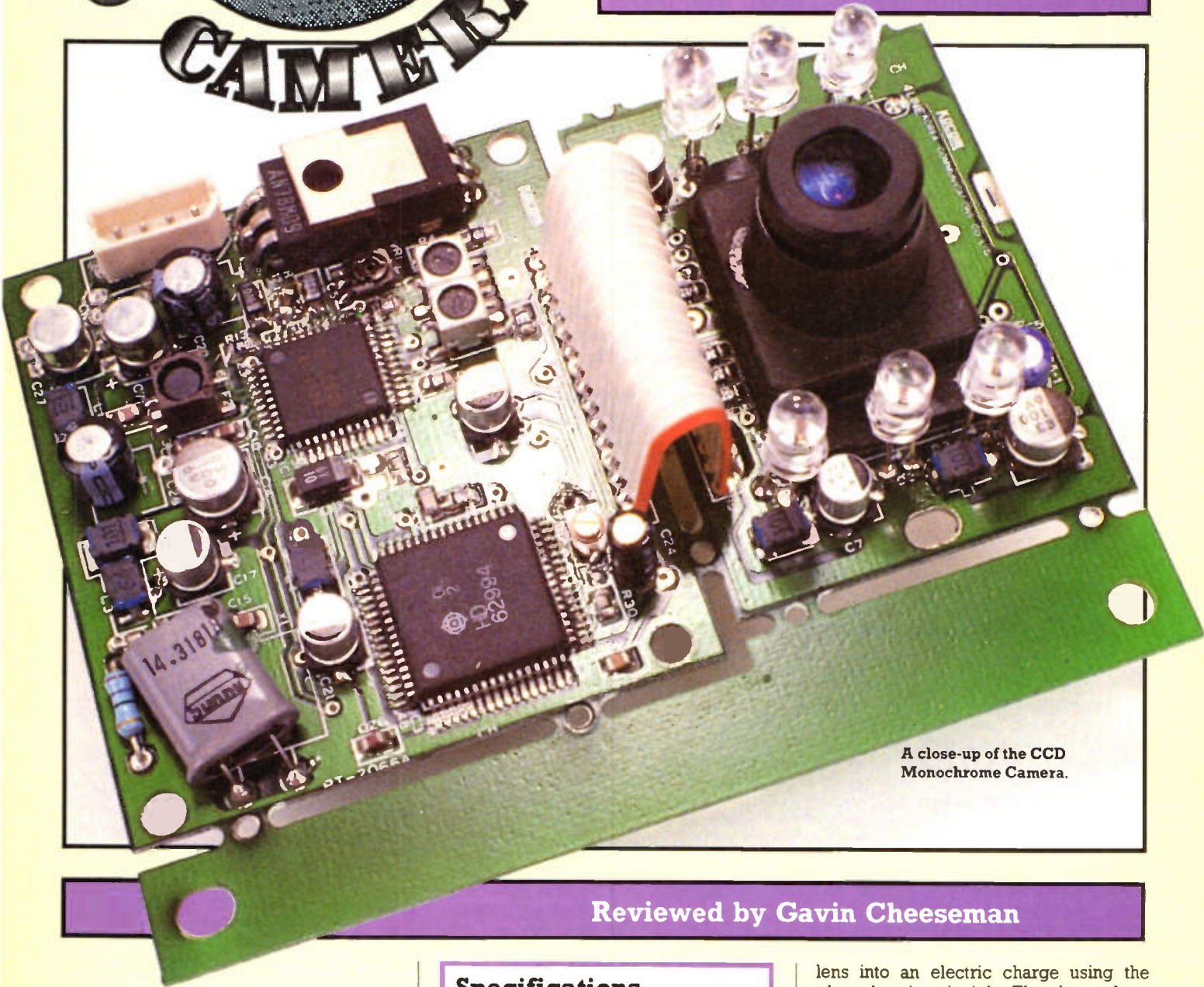

A close-up of the CCD Monochrome Camera.

Reviewed by Gavin Cheeseman

In recent years, CCD (Charge Coupled Device) technology has revolutionised the design of the video camera. Before the advent of CCD systems, most video cameras were based around vacuum tubes. Modern CCD technology offers the advantage of compact size, low power consumption and portability. In addition, the CCD is much more robust and typically has a much longer operat-

Specifications

| | |
|-------------------------------|--------------|
| Power supply voltage: | +10V to +14V |
| Power supply current: | 120mA |
| Composite video output level: | 1V Pk to Pk |
| Output drive capability: | 50Ω |
| Video bandwidth: | 4MHz |

ing life than its thermionic predecessors. CCD systems are based on an image unit, which converts light focused by a

lens into an electric charge using the photoelectric principle. The charge for a whole line (or frame, depending on the model) is transferred at high speed (usually during the vertical blanking period) to a storage unit, and is output in a serial form scanning horizontally, line by line, at a speed compatible with the video system for which the unit is designed. Using CCD technology, the blurring effect produced by moving objects is much reduced because the camera 'shutter speed' is not governed by the

frame rate, as is the case with conventional systems. Much higher shutter speeds can be implemented because the entire frame can be transferred to the storage unit in a very short period, and then transmitted at a slower speed corresponding to the required frame rate of the final video signal.

CCD Monochrome Camera

A general purpose monochrome camera incorporating CCD technology is available from Maplin Electronics. The camera, suitable for use in security and other monitoring applications, is fitted

with a fixed focus, wide angle lens. Six high-power infra-red emitter diodes are fitted to the camera, facilitating short-range use in dimly lit environments.

The camera requires a 12V power supply which is capable of delivering at least 200mA. Power supply regulation is provided by on-board regulators. Although the camera provides a high degree of power supply regulation, it is recommended that the input is properly decoupled so that a suitably clean supply voltage to the unit is guaranteed. This reduces the possibility of a poor quality picture due to noise introduced by the power supply.

The composite video output from the

camera is suitable for driving a monitor directly without an additional video buffer, as long as its input impedance is 50 ohms or greater. However, an additional output buffer will be necessary if the camera is required to drive more than one 'terminated' monitor. Either a monochrome or colour monitor with a composite video input may be used, but as the camera output is monochrome, only a black-and-white picture will be produced on a colour monitor.

A standard composite video output level of approximately 1V peak-to-peak is produced by the camera. The cable between the camera and the monitor should be kept as short as possible to reduce losses, thereby preserving picture quality. A cable recommended for this purpose is Miniature Coax XR88V. It is possible to transmit a usable signal over distances in the order of tens of metres if high quality, low loss cable is used, e.g. Low C Cable XR19V. Screened cable should always be used for this purpose to prevent unwanted radiation of the video signal and to reduce the pick-up of unwanted external noise.

Both power supply input and video output use the same connector; connection information is shown in Figure 1. The most convenient method of connection is to solder wires onto the back of the PCB for the power supply and video output. Care is required to make sure that the pads on the PCB are not shorted together during soldering.

The module is supplied pre-aligned and should require no additional alignment. The camera is suitable for use with most lighting arrangements, usually normal room lighting will be adequate. Of course if the light level is too bright, the camera will tend to saturate and in any case, the lens should never be pointed directly towards the sun or irreparable damage to the unit could otherwise result.

The camera uses a fixed wide-angle lens which is mounted over the CCD chip on the PCB; this lens is preset at the factory and is not intended to be interchangeable. It is not advisable to remove the lens as the performance of the camera will be impaired if the surface of the CCD chip is marked in any way or contaminated with dust. The field of view using this lens is theoretically over 50 degrees, but in practice it may be somewhat less than this.

Provision is made for the PCB to be broken into two separate parts if required, allowing the module to be folded and housed in an unobtrusive compact enclosure. Care should be taken, when separating the individual parts of the PCB, that the wiring between each section is not damaged as this is easily broken; very little force should be required to separate the PCB. As supplied, there are two pieces of excess PCB, which must be removed before the main sections of the PCB can be folded. It is recommended that the PCB sections are separated by carefully cutting the inter-connecting strips, using a pair of

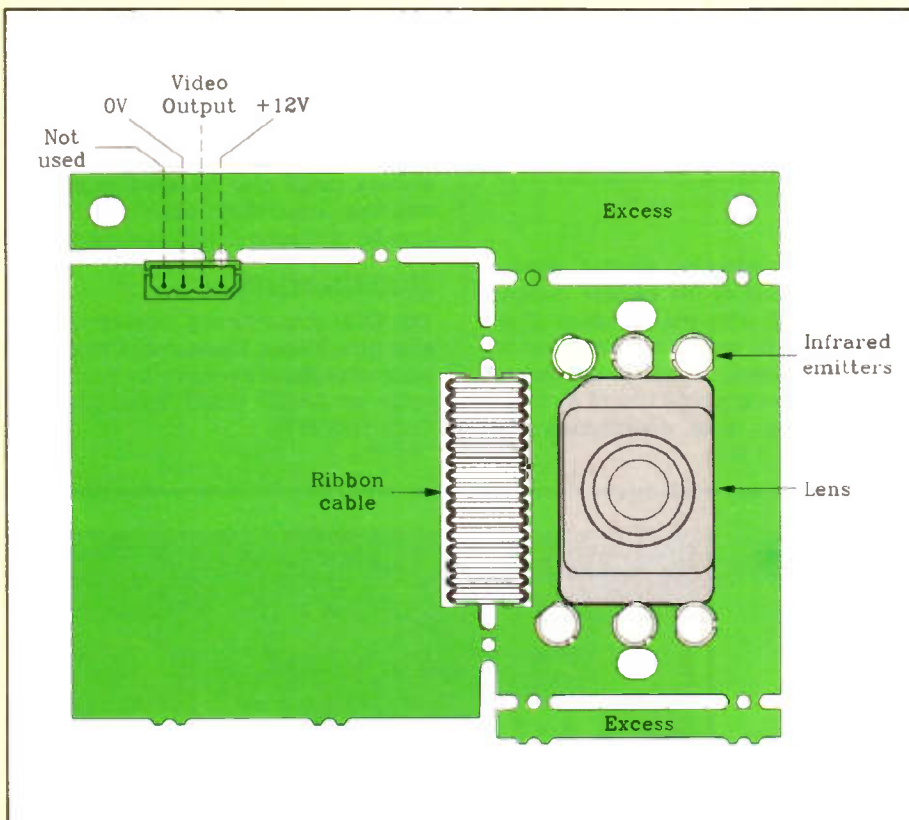

Figure 1. Layout of the camera showing wiring information.

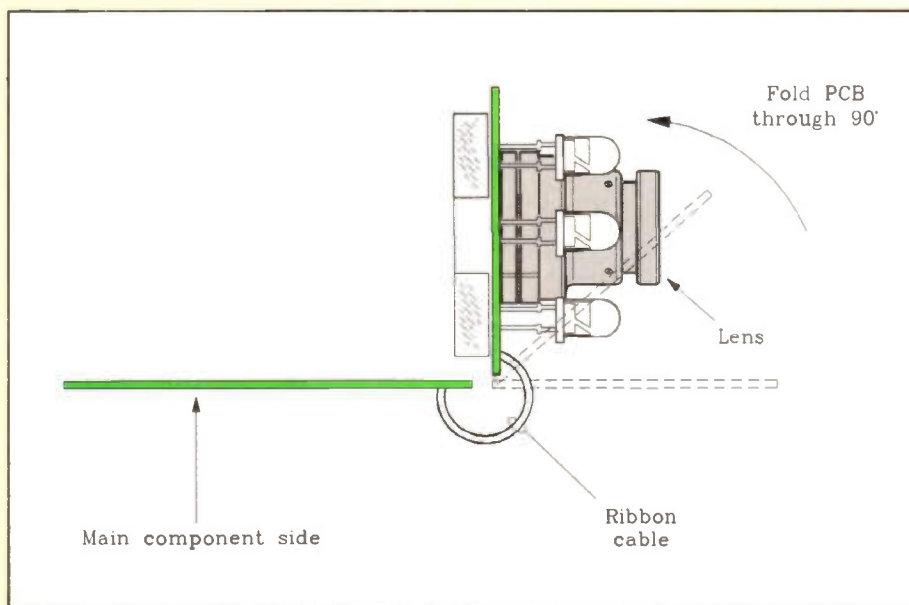
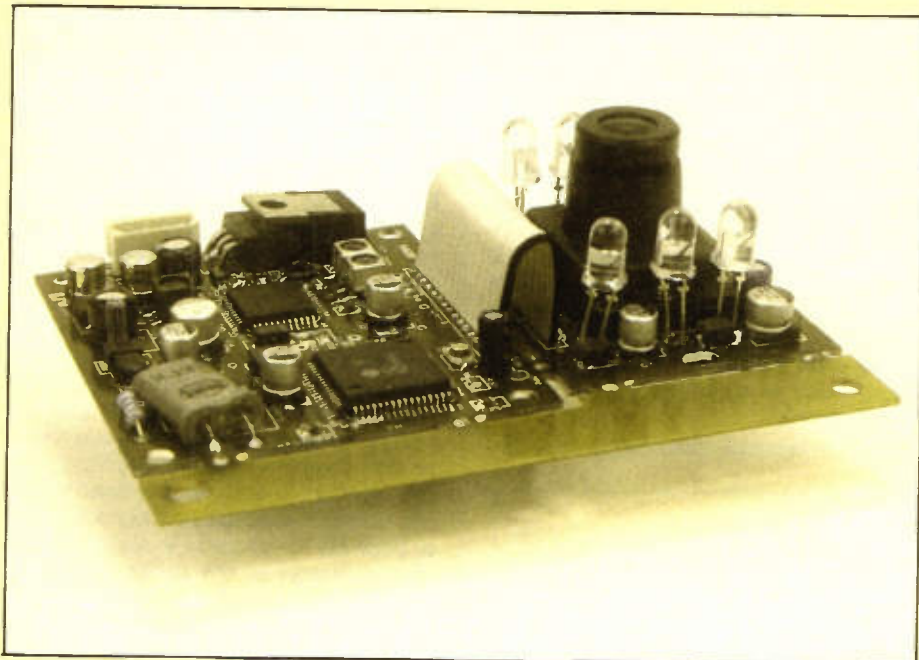

Figure 2. Folding the PCB.



The CCD Monochrome Camera, as supplied.

sidecutters. It is important to make sure that the main PCBs are not damaged during this operation. It is not essential that the PCB is separated into sections and many users may wish to use the camera as supplied. Figure 2 shows how to fold the PCB.

The six infra-red emitter diodes which form part of the camera module radiate enough infra-red energy to allow the camera to be used at very short range in poorly lit areas. A typical application for this camera (making use of its infra-red sensitivity) is in doorphones and

video intercoms where only a limited field of view is required. Of course, it is possible to mount additional infra-red emitters in positions remote from the module to increase the range. A lens could be used to focus the energy from a bunch of infra-red emitter diodes to light a specific area where the camera is pointing, effectively creating an infra-red 'spotlight'. Infra-red emitters which radiate at a peak wavelength of 940nm are suitable for this purpose.

Other Applications

In addition to the security applications previously mentioned, there are a host of other applications for the camera, many of which lie outside the scope of this article. Users may like to experiment with use of the camera in conjunction with a video digitiser, which will allow the picture to be stored in digital form (in computer memory or on disc) and displayed on a computer monitor. The camera could also be used to monitor remotely controlled equipment which may be operating in inaccessible places.

Availability

The CCD monochrome camera is available from Maplin Electronics through our chain of regional stores, or by mail order, order as ZA35Q (CCD Video Camera) Price £129.95 



- ▶ Do you have difficulty in getting hold of your copy of 'Electronics – The Maplin Magazine'?
- ▶ Does your Newsagent always sell out before you can get your copy?
- ▶ Are you fed up with braving the onslaught of wind, rain and keep fit fanatics in your ceaseless quest to find a copy of your favourite electronics magazine?



- ▶ Do you say to your family and friends, "I'm just going outside, I may be gone a little while?"
- ▶ Does your dog hide when you return empty handed?
- ▶ Do you resort to reading the Beano, Dandy, Viz or other well known 'comics'?

Then why not ask your friendly local Newsagent to reserve or deliver every issue of 'Electronics – The Maplin Magazine'? Fill out the coupon (below), hand it to your Newsagent and you need never miss an issue of 'Electronics – The Maplin Magazine'.

Dear Newsagent

Please reserve/deliver (delete as applicable) each issue of 'Electronics – The Maplin Magazine' for me.

Name

Address

Signature

'Electronics – The Maplin Magazine' is published monthly and is distributed through your wholesaler by: United Magazine Distribution Ltd., 1 Benwell Road, London N7 7AX. Telephone: 071-700-4600.

**FROM 1/4 PAGE
TO A FULL PAGE.**

**ADVERTISE IN
THE UK'S No.1
ELECTRONICS
MAGAZINE.**

**TEL: (0702) 554155
Ext. 209**

Design and Application of SEQUENTIAL LOGIC

PART TWO

by Graham Dixey
C.Eng., M.I.E.E.

The distinction between asynchronous counters (the subject of this article) and synchronous counters was made in the last issue, in the first part of this series. However, it will do no harm to state again what is meant by an asynchronous counter before considering how to design one.

The asynchronous counter is also known as a 'ripple through' counter, or simply a 'ripple' counter. It is so called because, when it is clocked, those flip-flops that are required to change state do so one after another, the effect apparently 'rippling through' the successive stages of the counter. It is evident from this that each stage (except the first which is directly clocked from the source of pulses) is clocked from the output of the previous stage. It is, therefore, dependent upon the latter for its input and will wait for the appropriate change at its clock terminal. For the master-slave type of flip-flop commonly employed, the change required at a clock terminal is a negative going one; that is a transition of the clock level from logic 1 down to logic 0.

When JK flip-flops are used, it is usual to wire them in the 'toggle mode' (both J and K inputs wired to logic 1) so that the flip-flop changes state whenever clocked in the manner described. A constant stream

of pulses at the clock input of a flip-flop will cause that flip-flop to toggle back and forth perpetually. However, the square waves produced at the Q output of such a flip-flop will be at half the frequency of those at the clock input. In this way the toggle mode JK flip-flop acts as a divide-by-two circuit.

So much for the revision. The above theory leads to the simplest type of asynchronous counter, the pure binary type, the stages, starting from the left (the least significant bit) successively dividing by two. In the five stage counter of Figure 1, and taking the clock pulse input as the reference, stage E divides by 2, stage D divides by 4, stage C divides by 8, stage B divides by 16 and stage A divides by 32.

In the general case of a counter of this type, the overall division ratio is always 2^N , where N is the number of stages. The figure obtained in this way is known as the 'modulo' of the counter. In the case of the counter of Figure 1, the modulo is 32.

Whatever the frequency of the pulses input to the first stage, the output frequency from the final stage will be equal to:

$$f_o = \frac{\text{input clock frequency}}{\text{counter modulo}}$$

This immediately highlights a limitation of this particular circuit. The division ratio is

always a 'power of two'. But there are many occasions when we would like to divide by a number that is not such a power. Examples include division ratios of 10 (useful for denary arithmetic) and 60 (for digital clocks, to convert seconds to minutes and minutes to hours). Since a flip-flop, the smallest element of the counter after all, can only perform a divide-by-two operation, it would seem impossible to produce a counter with a non-binary modulo. We know that it isn't true, of course, so the question is, 'what is the secret'?

Consider the two sequences below:

| Decade Counter | Modulo-16 Counter |
|------------------|-------------------|
| 0000 | 0000 |
| 0001 | 0001 |
| 0010 | 0010 |
| 0011 | 0011 |
| 0100 | 0100 |
| 0101 | 0101 |
| 0110 | 0110 |
| 0111 | 0111 |
| 1000 | 1000 |
| 1001 | 1001 |
| 0000 ← RESET | 1010 |
| Sequence repeats | 1011 |
| | 1100 |
| | 1101 |
| | 1110 |
| | 1111 |
| | 0000 ← RESET |
| | Sequence repeats |

The sequence on the left is that of a decade counter (modulo-10), the other for a pure binary modulo-16 counter. What is the difference between the two sequences? Perhaps that seems a trivial question but it is also a very relevant one. Because the answer is, 'they are identical up to the state 1001, when the decade counter then resets while the binary counter continues up to 1111 before resetting', and this statement gives the essential clue as to how a decade counter can be derived from the modulo-16 counter. The obvious way is to 'force' the binary counter to reset on the count following the state 1001 instead of going on as usual. It will, therefore, have to be made to skip the states 1010 - 1111 inclusive just as if these six states didn't exist.

How can we make the counter reset when we want it to? If we can find a way of forcing a reset at any point in the sequence

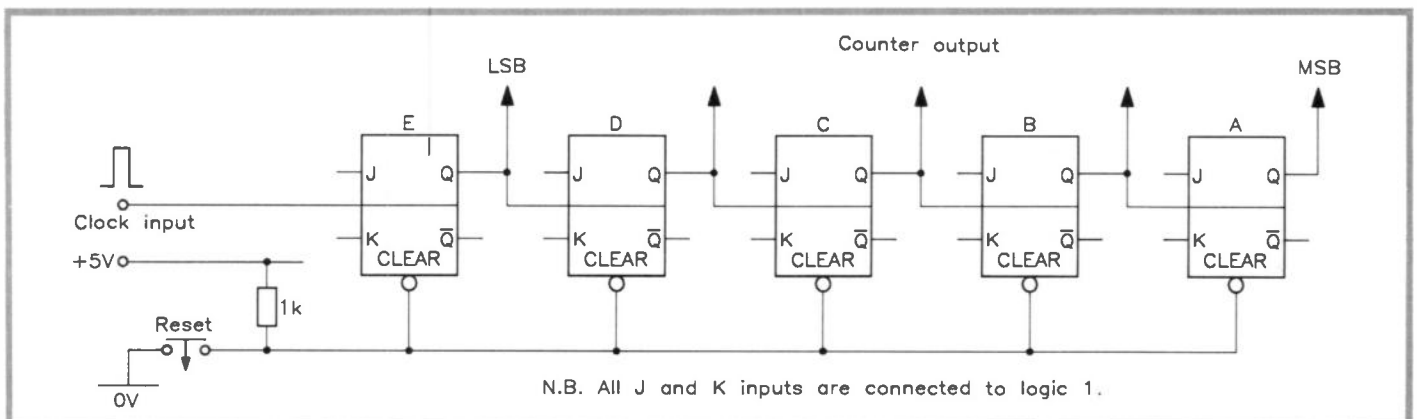

Figure 1. A 5-stage, modulo-32, asynchronous counter.

NEWS

Report



Maplin Help for Romania

Staff at both the Maplin Head Office and the Distribution Centre at Wombwell have been involved in fund-raising and collecting medical and other supplies which are urgently needed in Romania. Along with sponsorship from other sources, enough money was raised to enable a party of three, Sandra Skipworth (a Maplin buyer), Pam Foreman and her sister to spend a week helping in the orphanage for children with special needs in Brasov. All preparations completed, passports, insurance, visas and many injections later, the Maplin van was loaded with twelve big boxes of aid, and headed for Heathrow in the early hours of Sunday, 20th October 1991.

Miraculously, they were able to persuade Tarom Airlines to accept 296kg of aid on their flight to Romania. At Bucharest airport there were three taxis to collect nine passengers, all with a suitcase and hand luggage, plus the twelve boxes of aid - no chance, they thought - but somehow it all went in!

After a frightening three hour drive

over mountainous terrain, they reached Brasov at 11.30pm.

Conditions in the orphanage were as bad, if not worse, than they had anticipated. The smell was atrocious; 38 children sleeping and 'living' in one room where the toilet and washing facilities were archaic. There was no sign of any baths or showers, and hot water is regarded as a luxury.

The youngsters went wild when the 'English ladies' arrived and all demanded instant attention. They just wanted to be picked up and cuddled - someone to give them a bit of love. The next few days were spent drawing, cutting out, playing with balloons and bubbles, singing endless songs and of course more cuddles.

The week went by all too quickly and it was heart-breaking to leave the children as they waved and shouted from the locked windows - it was a pitiful sight.

There is a lot more to be done, but it all takes time and money. Conditions can only improve. A very big thank you to all who helped us to help them.

Reverse Charges

A new firm offering discounts of up to 75% on international calls is denting the cosy world of the major telephone carriers. International Discount Telecommunications allows subscribers outside the US to reverse the charges in order to take advantage of the lower international charges from the US. Using a toll free number, callers dial IDT and hang-up. Within seconds, IDT call back with an open line allowing the caller to ring any international number, paying the standard US carrier rates. Since the call effectively originates from New York, it side-steps any price or regulatory legislation in the users' own country.

But the carriers are not happy, seeing a potential dent to their profit from what is a highly lucrative international telephone market. Even the US international carriers are not keen on the innovative service, even if it

does generate them a lot of extra traffic revenues. The US firms are wary of jeopardising their relationship with the PTTs, who can gain them tens of millions of dollars with one stroke, says 'Communications News'. Some carriers are using spoiling tactics, but with no legislation in place to prevent users from taking advantage of the service, the carriers may have to resort to making a legal challenge. In which case, it would be a real David and Goliath story.

The David in the project is Howard Jonas, President of IDT, who says that his small entrepreneurial start-up firm has, with one stroke, introduced international rate de-regulation and price competition worldwide. It literally means, a \$50 billion a year saving, claims Howard Jones. If the scheme really does take-off, Howard should be able to claim some of those billions.

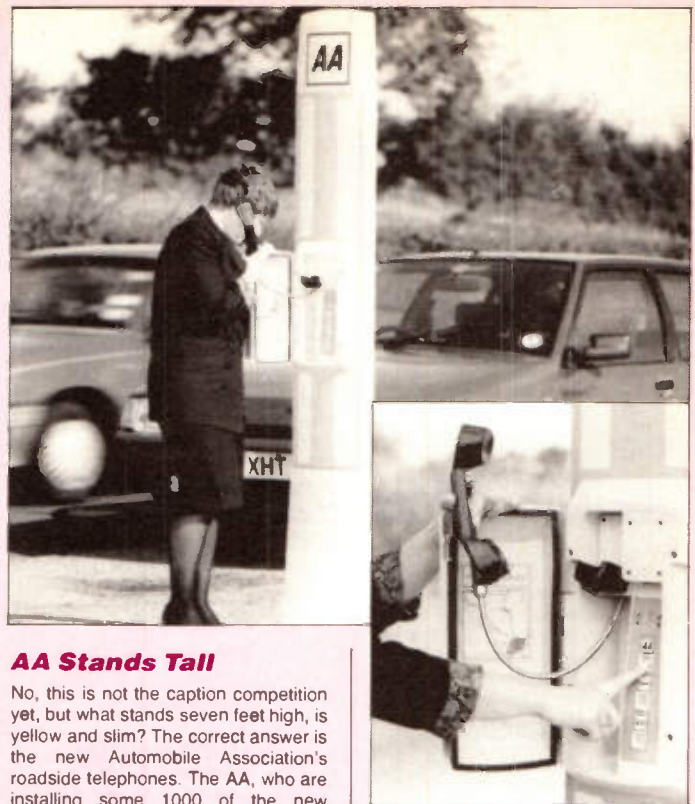

AA Stands Tall

No, this is not the caption competition yet, but what stands seven feet high, is yellow and slim? The correct answer is the new Automobile Association's roadside telephones. The AA, who are installing some 1000 of the new phones over the next five years, believes that the design will reflect the image of the modern AA (?).

In designing the system, the AA opted for a familiar handset, instead of a hands-free unit, to give stranded drivers a greater feeling of certainty and to assist deaf drivers to use Minicom S, the comms system for the

hard of hearing. The handset is located behind a protective door, located to suit people of all heights (including presumably ET should he wish to 'phone home').

Back at base, the AA control-room operator will be able to see, on a screen, the exact location of the caller.

Always Look on the Bright Side of Life . . .

The 'fact' that we are nearing the end of the recession remains a debatable point; despite this, there is some good news for those in the North - continued foreign investment. On November 28th, Queen Elizabeth II officially opened Fujitsu's European manufacturing centre in County Durham, creating around 1,200 jobs. The Japanese company, which employs 145,000 people worldwide, also has a design centre in Manchester. According to chairman Sir Ron Dearing: "The coming of Fujitsu to County Durham was described by the Financial Times as one of the economic coups of the decade . . . it was achieved because the North operates as a team, in a way no other region does".

. . . Unless you Live in the South

Yet more depressing figures reinforce the opinion of many people that the South of the country seems to be suffering under the recession to a greater degree than the north. Yet more jobs went from GEC-Marconi, as a result of internal re-organisation, the recession, and the slowly dwindling military market. In addition to 800 redundancies announced by Ferranti Defence Systems, 130 jobs were lost at Marconi Communication Systems in Chelmsford, Essex. That once-British bastion of consumer electronics, Ferguson, is closing its last remaining UK manufacturing site in Gosport, Hampshire, with the loss of around 750 jobs. However, the Ferguson facility in Middlesex, responsible for R&D and sales/servicing, will remain. French-based Thomson Consumer Electronics, bought Ferguson from Thorn-EMI in 1987.

And Yet More Gloom and Despondency

In addition, a further estimated 2,200 jobs will go following the loss of the four television companies which lost their right to broadcast as a result of the Independent Television Commission's controversial, franchise auction fiasco. The four who will be replaced by new contractors in January 1993 are TV-am, TSW, TVS and the largest, Thames.

The way in which the licences were awarded has been the subject of much criticism. 40 bidders competed after 16 franchises and were required to bid blind against each other, that is, by having no idea how much the other bidders were bidding, for no other reason it seems except to generate extra revenue for the treasury.

In each TV region the franchise was to be awarded to the highest bidder, provided, that is, that the commission was satisfied that the programmes would match up to their required quality level, and that the company would be able to maintain its proposed service for the duration of the licence period.

The greatest shock/horror was Carlton TV's defeat of Thames Television, whose programmes include *Minder* and *The Bill*. Carlton's £43 million bid undercut Thames' £54 million, Thames of course having no idea what Carlton bid in the first place. Richard Branson's CPV-TV was even cheaper at £45 million, but wasn't good enough to pass the commission's quality threshold.

The upshot will be that the treasury will gain an extra £40 million a year as a result of the auction, while we, the punters, will suffer with the lowering quality of the programmes as the hitherto established stations wind down their operations. Ghastly American style junk TV threatens a bleak future.

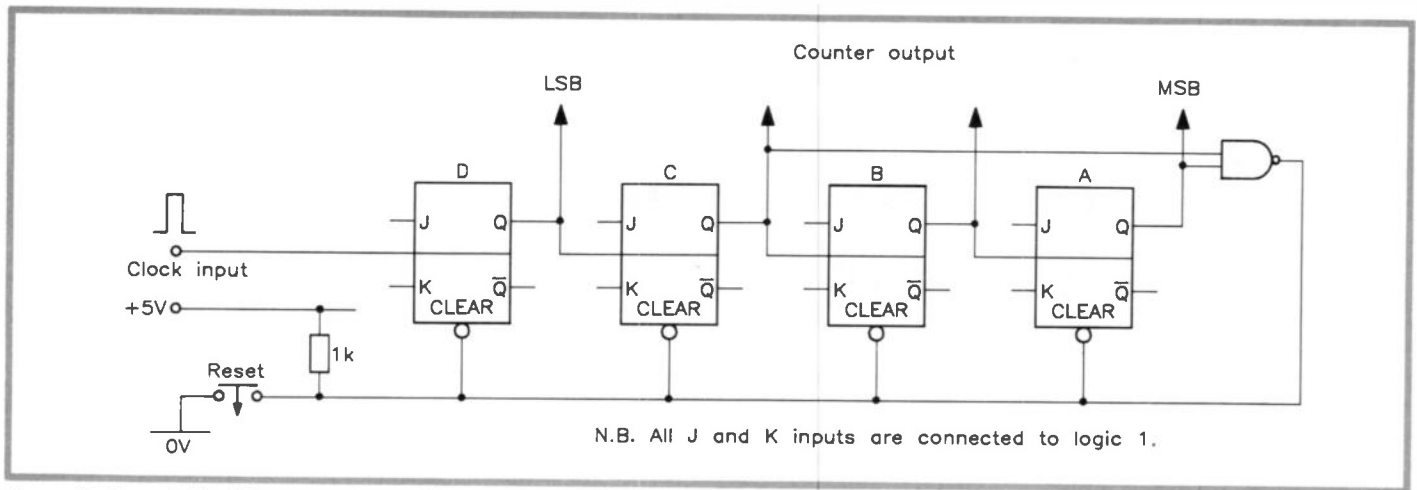

Figure 2. A modulo-16 counter 'gated' to act as a 'modulo-10' (decade) counter.

that we like, then we shall have a universal method for making a counter to any required base.

Using the Clear Facility

The JK flip-flop has a pin marked CLR, standing for 'clear'. This is a negative acting input which, when taken low, will clear the flip-flop by forcing the Q output to logic 0. This action can be carried out at anytime and is totally independent of the presence of a clock pulse. If all of the flip-flops have their CLR pins taken to a common line, then we have created a 'reset line'. This is quite often done as a facility to flush out the counter when required anyway. In this case, it can be used to reset the counter at the required point in the sequence, provided that we can find a way of making the counter *know* when that point has been reached and to act upon it.

Look at the sequences above again. The state *following* the final state for the decade counter is 1010. This is the first of the states to be skipped. If we can detect when it is due and use this information to reset the counter we shall have achieved our aim. To use this state in this way, we examine it to find the simplest way in which it differs from the previous states in the sequence.

Seen it? The answer is found by looking at the 1st and 3rd columns from the left; these both contain 'ones'. No other previous state does so. We now require a logic function that, when two logic 1s are input to it, outputs a logic 0. This latter we then use to take the reset line low, so resetting all stages of the counter. The logic function that does this is a '2-input NAND gate'. The result of this simple modification is shown in Figure 2.

The NAND gate is connected so that its inputs are driven from the Q outputs of flip-flops C and A; its output drives the reset line to all flip-flops. Strictly speaking it isn't really necessary to apply the reset to all stages, only to C and A, since D and B are already reset at this point in the sequence. However, it is quite usual to supply a reset line for clearing the counter initially (hence the reason for the push-button switch and

pull-up resistor). For this reason all flip-flops are connected onto the reset line.

This appears to be a very easy way of making a pure binary counter into a decade counter. It's too good to be true in fact! There is no immediately obvious reason why the circuit shouldn't work. In fact how well it does work is somewhat unpredictable – that's the trouble really. The reason for this can be explained as follows.

Suppose that the counter reaches the last state in the required sequence, namely 1001. We know that the next clock pulse will cause it to go into the state 1010 which, by virtue of the NAND gate, should cause an immediate reset. When this clock pulse is applied, flip-flops C and A both present logic 1s to the NAND gate, which then places a logic 0 on the reset line. As a result, flip-flops C and A start to reset. Assume that either flip-flop, say flip-flop C, (an arbitrary choice) is rather faster than flip-flop A and resets first. Its Q output goes to logic 0 while flip-flop A is still changing state. The fact that flip-flop C has reset means that it is no longer presenting a logic 1 to the NAND gate; this means that the output of the latter will rise to logic 1; since it was only the output of this NAND gate that was holding the reset line low, the entire reset line goes back to logic 1. Flip-flop A, still struggling to change state, is thwarted in doing so and returns to the set state. The counter has not reset but it is now in the state 1000, totally the wrong point in the cycle.

So what looks like a good idea cannot be guaranteed to work because it is

impossible to predict the relative speeds of the flip-flops. We are not, of course, going to abandon the whole scheme. What we must now do is seek a way around the speed problem. We need to hold the reset line low, not merely until the NAND gate output changes (since that is the root of our problem) but long enough to ensure that both flip-flops have ample time to reset. Only then can we allow the reset line to return high.

Figure 3 shows a modification that can be made to counter circuits of this type to overcome this speed problem. A delay latch is now wired between the output of the NAND gate and the reset line. This latch has two inputs, marked S and R. The S input is driven from the output of the NAND gate, while the R input is connected to the clock line via an inverter. The output of the latch drives the counter reset line. The latch works as follows.

On receipt of the clock pulse following the state 1001, the counter goes temporarily into the state 1010, exactly as described above. The output of the NAND gate goes low, also as before. The difference now is that, instead of using it to take the reset line low directly, it is merely used to 'flip over' the latch, the output of which takes the reset line low. As soon as this happens, the flip-flops C and A start to reset. Assume again that C is faster and resets first; its Q output goes low, causing the output of the NAND gate to go to logic 1. However, now this doesn't matter at all because the delay latch does not respond to logic 1s at its inputs, only to logic 0s. The only way to make this latch flip back to its

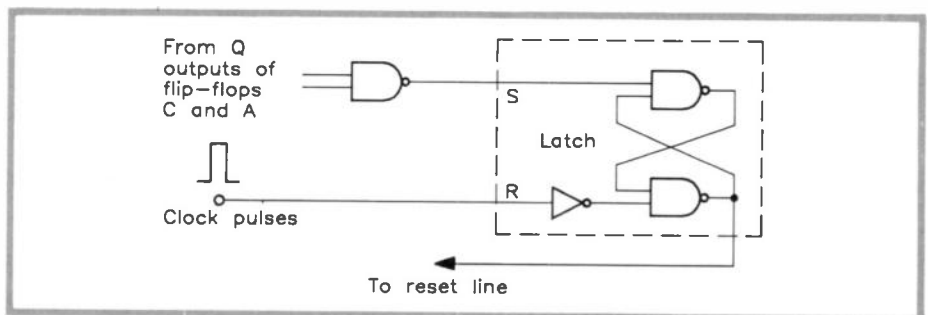

Figure 3. Modification to counter circuits of the Figure 2 type to avoid 'speed' problems.

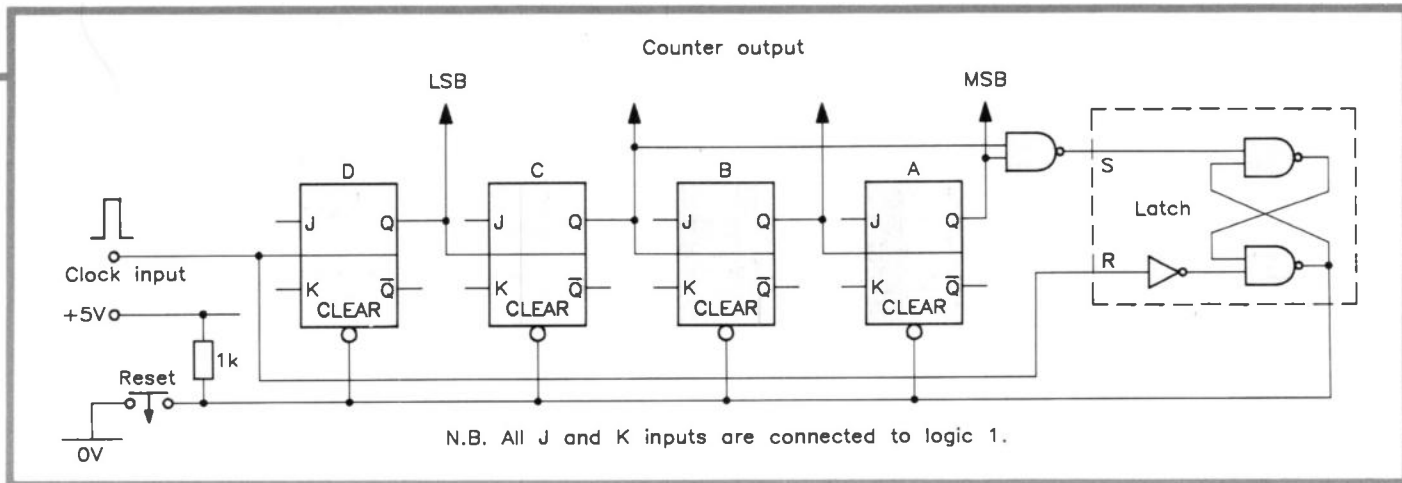

Figure 4. The complete modified design for a decade counter.

original state is to apply a logic 0 to its other input, input R. This happens when the next clock pulse arrives, since the leading edge of this clock pulse will, by the action of the inverter in this line, provide a negative edge to the R input of the delay latch. The latter, therefore, flips back to its original state, lifting the logic 0 from the reset line. At the end of the clock pulse the counter enters its sequence once more. By the time this has happened, flip-flop A will have had ample time to reset.

Figure 4 shows the complete circuit diagram for the decade counter with the delay latch modification included.

General Approach to Asynchronous Counter Design

In the previous example, a modulo-16 binary counter was made to perform the function of a decade counter by forcing a reset at the required point in the sequence. As a general principle this approach can always be used to design a counter of any length. The only stipulation, a fairly obvious one, is that the number of states of the counter to be converted must exceed that of the final design. For example, if a modulo-12 counter is required, then a modulo-16 counter is taken as the basis. Once this has been decided the steps for the design may be summed up as follows:

1. Write down the sequence for the counter to be designed and then write down the first unwanted state following this sequence.

2. Examine this unwanted state and identify the 'least' number of logic 1s that

distinguish this state from previous ones.

3. Connect the inputs of a NAND gate to the Q outputs of those flip-flops corresponding to these logic 1s.

4. Connect the output of the NAND gate to the S input of a latch of the type shown in Figure 3. Use the latch output to drive the reset line.

Depending upon the counter being designed the number of logic 1s to be gated will usually be either one, two or three (assuming counters of four stages or less). Of course, if only a single logic 1 is applicable, the gate required between the Q output and the latch S input is not a NAND gate but just an inverter to develop the logic 0 needed to set the latch.

It should be noted that this method of forcing a reset depends upon permitting the counter to go initially into an unwanted state, for a very brief time interval, during which the logic then acts to force the reset. Naturally, if the counter output is sampled regularly there is a small possibility that this unwanted state could be accepted. This is a weak point of this type of counter, though for many cases the limitation will not be significant.

The Designs of Asynchronous Down Counters

A pure binary up counter, of the type shown in Figure 1, can readily be converted to down counting in two possible ways. One way is to leave the circuit as it is and simply take our outputs from the Q outputs instead of the Q-bar outputs. Since the logic levels at these

outputs are complementary, the sequence at the Q-bar outputs is exactly opposite to the sequence at Q. Thus, an up sequence at the Q outputs coincides with a down sequence at the Q-bar outputs. The other method, where the down sequence is to be available at the Q outputs, involves a simple modification. The clock input of all stages except the first is driven from the Q-bar outputs instead of the Q outputs. A 5-stage down counter is shown in Figure 5 for comparison with the up counter of Figure 1.

The above design procedure is based on the assumption that the counter is an up counter. It would obviously be useful if the method could be extended to the design of down counters as well. An examination of the down counter shows that the method can be adapted to these devices as well. Consider the sequence below, for a three-stage, modulo-8 down counter.

The starting point is, of course, the maximum count value for this example, namely 111. On each clock pulse input the counter value decrements, until the state 000 is reached. The next clock pulse will cause all flip-flops to 'set' to return to the initial state 111. The complete sequence is:

```

111 ← Initial state
110
101
100
011
010
001
000
111 ← Counter sets

```

Suppose now that we wish to design a modulo-5 down counter. There will be three redundant states, as follows: 111, 110

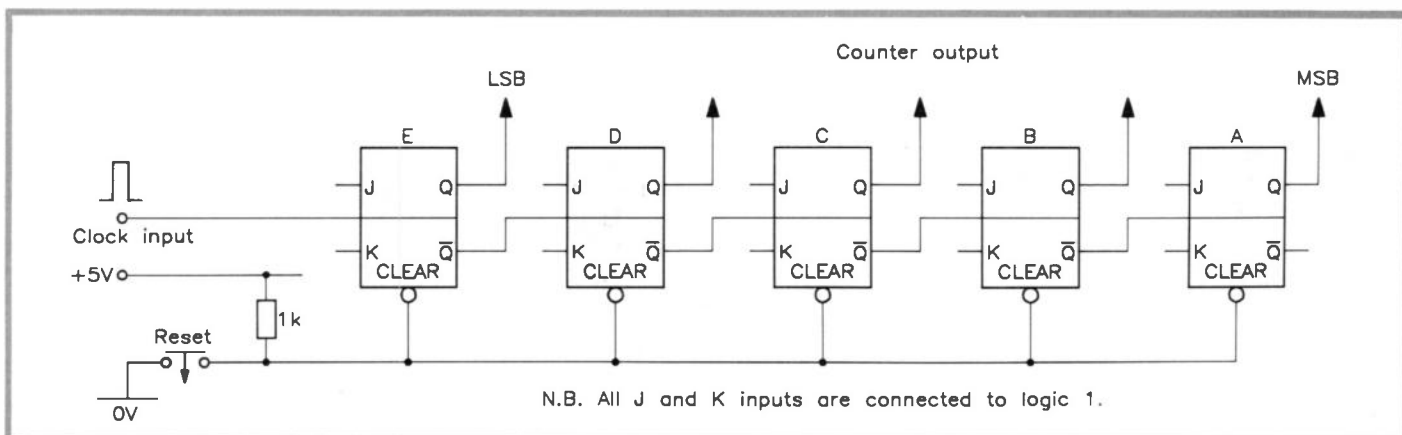

Figure 5. A 5-stage, modulo-32, asynchronous down counter.

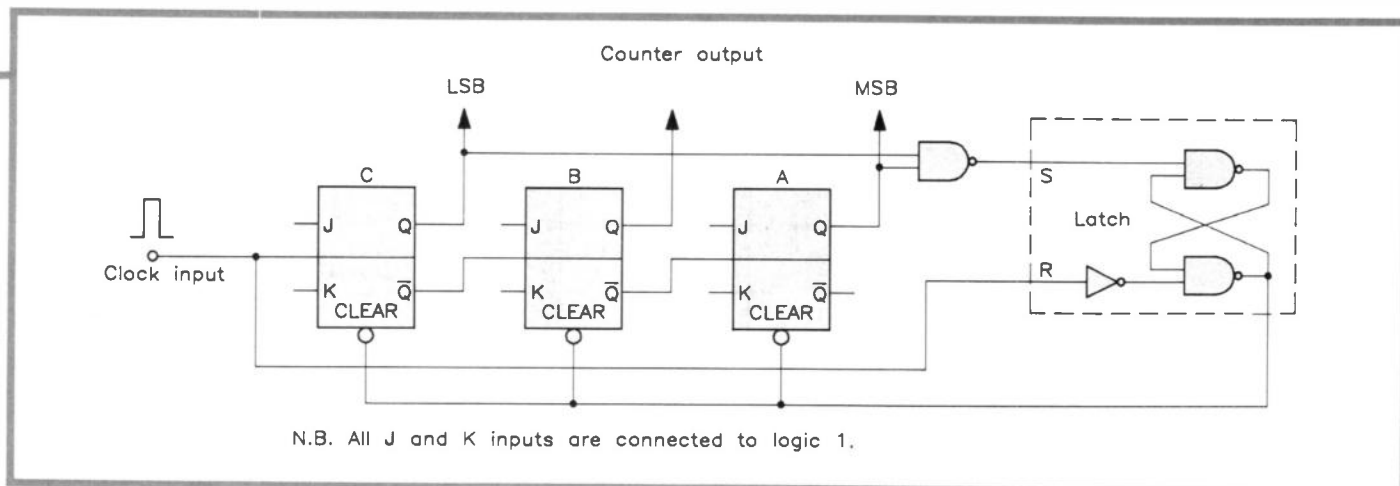

Figure 6. The completed design for the modulo-5 down counter.

and 101. These are the first three states of the modulo-8 counter. Thus, we can see that, whereas in the case of the up counter we have to skip some states at the *end* of the sequence, in the case of the down counter we skip them at the *start* of the sequence. The sequence for the modulo-5 down counter now looks like this:

100 ← Initial state
 011
 010
 001
 000
 100 ← Return to initial state

This sequence highlights an essential difference between the design of up and down counters.

In the case of the up counter, we skip unwanted states by forcing a reset at the appropriate point in the sequence.

In the case of the down counter, we skip unwanted states by forcing the counter to *return to its initial state* after the 'all zeros' state has been reached.

In order to carry out the above action we again allow the counter to go, momentarily, into the first unwanted state. Since this always follows the 'all zeros' state, it will always be the 'all ones' state. This fact is extremely useful. All we have to do is examine the initial state required (e.g. 100 in the case of the modulo-5 counter) and then reset only those flip-flops that correspond to the zeros in this state. Thus, we again identify a unique combination of ones in the 'all ones' state and use those as inputs to a NAND gate to reset the appropriate flip-flops, via a latch as before. Let us make that as clear as possible by completing the design for the modulo-5 down counter.

Here is the sequence once more for this counter, this time including the 'all ones' state so that we can identify the 'ones combination' to be used:

100 ← Initial state
 011
 010
 001
 000
 111 ← Temporary 'all ones' state
 100 ← Forced return to initial state

Look at the 'temporary' state identified above. What combination of 1s (as few as possible) occurs in this state, and does not appear in any other state of the counter? Easy? Yes, the combination '101' does not appear in any previous line.

Therefore, we gate the Q outputs of these flip-flops to drive the reset line, which must only be connected to those flip-flops that require resetting. These are identified from the required state (100) and are obviously the second and third flip-flops. The complete design is shown in Figure 6.

Initialising the Counter

In the case of an up counter, it is usually (though not always) required to start the counter from zero, hence the use of a reset line to all flip-flops in order to clear the entire counter. The situation is obviously different in the case of a down counter, since this has to start from some predetermined state. It is necessary to be able to initialise the counter after switch-on. This would seem to imply that some flip-flops would need to be set and some reset at this time, depending upon the disposition of ones and zeros in the initial state. A moment's notice shows that the required result can be achieved quite simply. All we have to do is apply a 'set' pulse to all flip-flops, causing them to go into the 'all ones' state. This we know will immediately force the counter into the correct initial state since we have designed the counter to do just that in the normal counting sequence. The only limitation imposed by this method is that we cannot use JK chips of the 74107 type since these do not have a SET pin. Instead we shall have to use an alternative, such as the

7476 or 7478 chips. In the case of CMOS ICs, the 4027BE is a suitable device. One could, alternatively, use the 74HC76 so gaining not only economy of supply current but also the higher possible clock frequency of 50MHz. By comparison, the maximum clock frequencies for the 7476 and 4027BE devices are 20MHz and 13MHz, respectively. The clock frequency for the CMOS device 4027BE actually depends upon the supply voltage used, the maximum clock frequency stated above being for a supply voltage of 15V. For a supply voltage of 5V, for example, the clock frequency is limited to a mere 3MHz.

Reversible Counters

It is sometimes required to have a counter that is able to count in either direction, merely at the flick of a switch. As was seen earlier, and illustrated by Figures 1 and 5, the only essential difference between the construction of the two counter types is where the drive to the clock input is taken from. Take it from Q and you have an up counter; take it from \bar{Q} instead and you have a down counter. A change-over switch between Q , \bar{Q} and the following clock input would allow the counter direction to be reversed at will. We obviously don't want to use a mechanical switch so a logic circuit consisting of three NAND gates is used instead. The upper NAND gate of the set, seen in Figure 7, is enabled when UP counting is required and disabled for DOWN counting. Similarly,

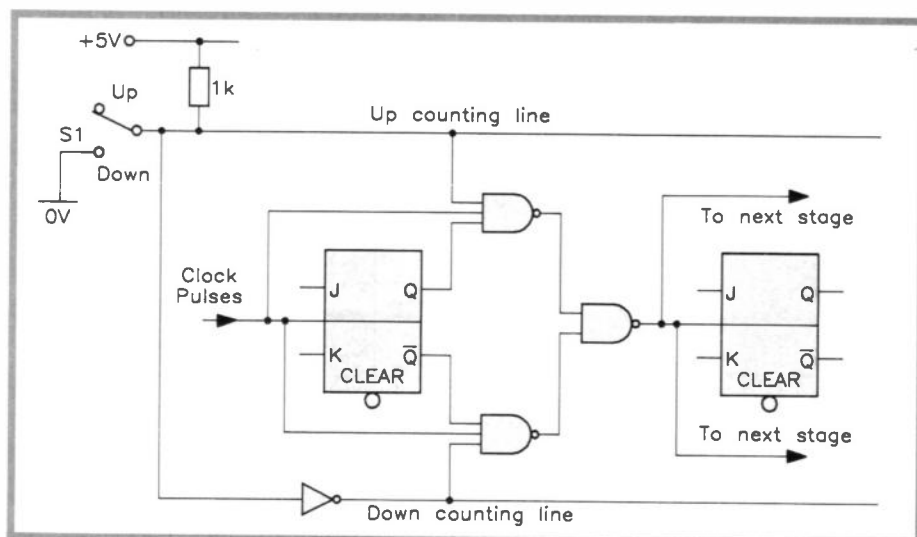

Figure 7. One stage of the extra logic required to form a reversible counter.

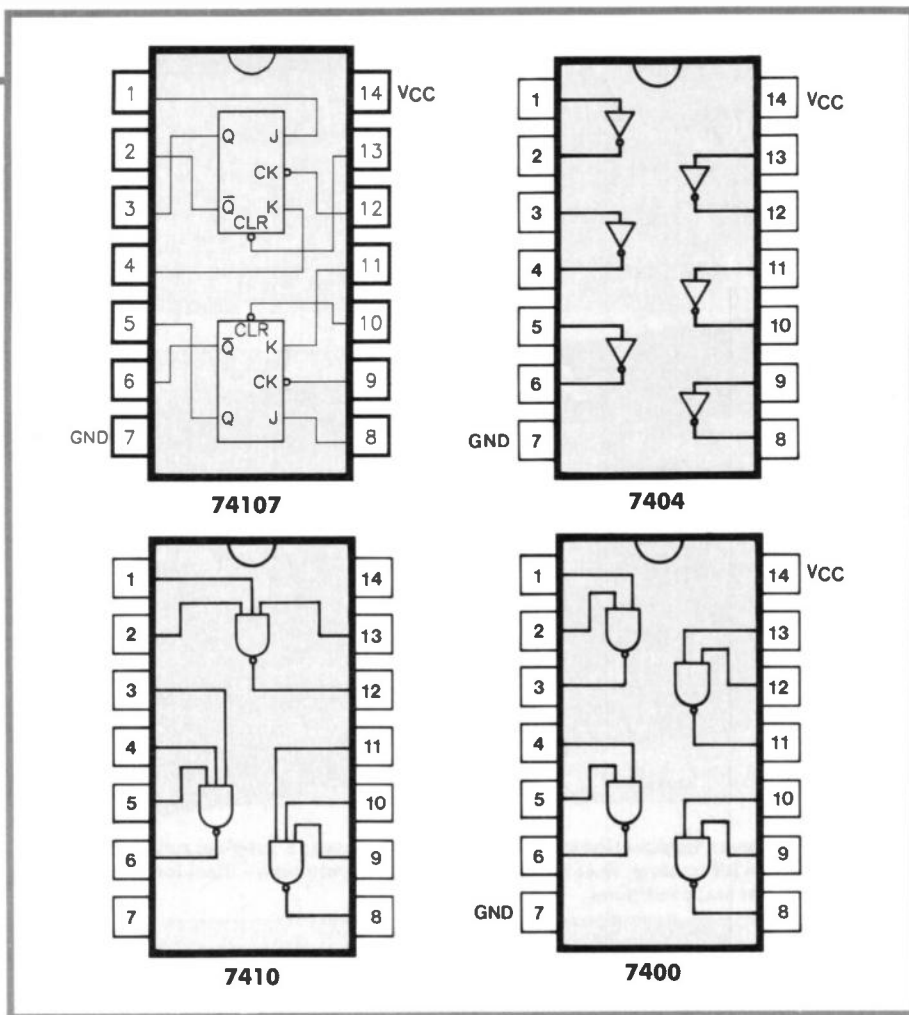

Figure 8. Pin-out diagrams for the ICs used in the circuits shown.

the lower NAND gate is enabled for DOWN counting and disabled for UP counting. This logic, together with the middle NAND gate provides the essential AND/OR logic for the changeover action. The UP line is energised with a logic 1 for UP counting, at which time the DOWN line has a logic 0 level. The use of an inverter ensures that when the reversing switch S1 is operated, the logic levels on the UP and DOWN lines reverse, so reversing the direction of the counter.

It may be wondered why the clock input from the previous stage is included in the gating. It is done so as to avoid the counter state changing inadvertently as a result of the counter direction being reversed. It is left as an intellectual exercise for the reader to figure out just how it does this, indeed how accidental switching could occur if the clock wasn't included in the gating.

This article has shown the procedure that can be adopted in the design of asynchronous counters to any base, whether up counting or down counting is required. The approach has been what might be termed 'semi-discrete' in that the counters have been constructed by using individual flip-flop and gate packages. However, a great variety of counters exist in the form of more complex MSI chips. The next article will explore how we can make the best use of these devices.

VARIOUS

CLEAR-OUT: Thousands of components, ICs, etc. in storage cabinets, bench PSU, freq. gen., tools. The lot £1000. Tel: (0638) 750661 for details after 7pm.

IMPORTED IIT NOKIA 5906 D2-MAC/PAL SATELLITE TV TUNER (no dish) for sale. Superb video and (digital) audio quality. RGB/PAL composite video/UHF outputs. Watch DBS transmissions (Olympus, TV SAT, TDF1, etc.) and Swedish TV (TV3, TV1000) on Astra. In excellent condition, with translated instruction sheet and remote control. Bargain at £200 o.n.o. Phone: Martin (0702) 346003 for details after 7pm.

ETI Smart Talker, built and working, £25 o.n.o. Organ component clearout, SAE for list please. Fred Wright, 23 Merrion Close, Moorside, Sunderland, Tyne & Wear, SR3 2QP. Tel: (091) 5288664.

WIDE RANGE of quality PVC and PTFE equipment wire: PVC-covered 10/0-1mm to 32/0-2mm inclusive, all colours, including bi-colours, 100m reels £1.00 - £2.75 per reel; PTFE insulated 7/0-2mm to 19/0-3mm inclusive, most colours, 12 - 67p per metre. 75 ohm video cable, 1 x 0.58mm copper conductor, 40p per metre. Price lists available for RG213/U, RG214/U, RG179B/U, RG178B/U, RG223/U plus multicore cables, switchgear, primary wire and conduit cable at low prices. Send SAE to: 30 Rookswood, Alton, Hampshire, or telephone (0420) 85450.

MASSIVE CLEAROUT! Large quantity of ICs, Capacitors, Resistors, Transistors, etc. £10 per kg, plus loads of accessories going cheap. Send S.A.E for list to D. Johnson, 11 Kedleston Road, Derby, DE3 1FL.

TIL311 Red Hex displays, integral latch and decoder. Distributor's price over £10 each! Only £6.95 including data. Tel: (0384) 634747.

UNREPEATABLE BARGAIN! Unwanted prize - pair of prestigious Acoustic Research full-range loudspeakers, recent model; 'Red Box Two' (17in. tall), Marvellous on rock, jazz, light music, speech, anything! Worth £140, will accept £70. Write to A. M. Andrews, 56 Tarring High Street, Worthing, BN14 7NR.

CLASSIFIED

If you would like to place an advertisement in this section, here's your chance to tell our 33,837 readers what you want to buy or sell, or tell them about your club's activities - absolutely free of charge. We will publish as many advertisements as we have space for. To give a fair share of the limited space, we will print 30 words free of charge. Thereafter the charge is 10p per word. Please note that only private individuals

will be permitted to advertise. Commercial or trade advertising is strictly prohibited.

Please print all advertisements in bold capital letters. Reference Boxes are available at £1.50 each. Please send replies to address below quoting Reference Box Letters. Please send your advertisement with any payment necessary to: Classifieds, Maplin Mag., P.O. Box 3, Rayleigh, Essex SS6 8LR.

SURPLUS DEVICES FOR SALE - 256k-15 DRAM 50p, 256k-10 DRAM 75p, 256k-60 DRAM £1.00, 27256 EPROM £1.00, 1M-10 DRAM £2.00. Tel: (0443) 202158 evenings

COMPUTER AND ELECTRONICS CLEAR-OUT - Books, Components, Software etc. Send SAE for lists to: D. Hiscock, 164 Mary Rose Avenue, Wootton, Ryde, Isle of Wight. PO33 4PA.

EVEF 'TAY ELECTRONICS volumes 1-11 in binders. Numerous Babani books, some components. G. Snarkes, 50 Edmund Road, Hastings, Sussex, TN35 5LF. Tel: (0424) 434168.

OSCILLOSCOPE, Hameg HM1005, 100MHz, still with 1 year warranty £700. RS UV Exposure Box, £45. Weller solder station £35. Tel: (0993) 705877.

GIANT CLEAR-OUT! Long list of unused components including ICs, capacitors and resistors (some in large quantities). All at bargain prices. Send SAE for list. M. J. Dean, Blenheim, Walton Lane, Bosham, Chichester. West Sussex, PO18 8QF.

OSCILLOSCOPE, Hitachi V-1060, 100 MHz. Dual trace, Auto ranging, £200. Canon series 1 Laser printer, serial interface, £150. Tel: (0705) 664094 (Portsmouth).

MUSICAL

MAPLIN MATINEE ORGAN; operational, but requires final constructional finishing. Complete with cabinet and instructions. Offers around £100. Tel: (081) 845 0534 evenings.

MAPLIN PCBs for musical projects, several of some types. BB44X, CB65V, BB41U, BB65D, BY81C, BB45Y, BB43W, BY90X, BB40T, BY88V, BY87U. Tel: (0782) 516900.

3-OCTAVE KEYBOARD, full-size keys. Complete with double-pole contacts, £10. Leicester (0533) 861199.

COMPUTERS

ARCHIMEDES 310 COLOUR COMPUTER, 20 Mbyte hard disc, books, software, PRIM. Excellent condition £500 o.n.o. New Salter Expert electronics kit £50. Tel: (0638) 750661 after 7pm.

HYBRID MUSIC 5000 for BBC micro. Brand new and complete. Unwanted gift. Cost £164.50. Offers? Tel: Craig (0698) 428907. Free delivery in Strathclyde area.

SHACKLOG AMATEUR RADIO logging and packet software. Real-time QSO logging. QSL

labels. QSO extract, sort, print. Simultaneous logging and packet operation. Alan G3PMR. Tel: (07877) 7913.

FACE 'NIGHTINGALE' V21/23 modem with Beebug 'Command' communication ROM and connecting cable for BBC computer. All in mint condition, with full instruction manuals. £45. Tel: (0294) 52250 evenings.

CASIO FX850P personal computer. Scientific library; 116 functions. BASIC programming language, data bank facility. Dot-matrix display. Excellent condition, supplied with manual. £50 o.n.o. Tel: (0703) 812893 evenings (Southampton).

WANTED

M108 CHIPS for Matinee organ. Full price paid. J. R. Gardiner, 16 Lumford Avenue, Whitehead, Carrickfergus, Co. Antrim BT38 9NR.

ACORN ELECTRON 32-output port data, to use printer. Tel: Paul (081) 466 6492.

AKAI reel-to-reel tape recorder with built-in amplifier and speakers. Must be cheap. Write to: W. M. Snow, 29 Dankworth Road, Brighton Hill, Basingstoke, Hants. RG22 4LJ.

ARCHIMEDES A3000. Any condition as long as it's working. No monitor required. Also interested in software and add-ons. Tel: Craig (0698) 428907 or (041) 883 0898. Will collect.

WANTED DESPERATELY, Powertran delay. Tel: Colin (051) 489 3384.

IBM AT compatible computer system - dead or alive. Will swap new Fluke 8020A handheld DMM with case, and Telegquipment D66 scope (good condition), for a good system. Tel: Mark (0443) 688228.

ROBERTS R600 RADIO. Willing to pay within reason. Tel: (0533) 623139 (Leicester).

M108 SINGLE-CHIP ORGAN IC, please. Replies to: J. D. Jenkins, 3 Orchard Court, Pontlanfraith, Blackwood, Gwent NP2 2NG. Tel: (0495) 225219.

LOAN OR COPY of operating/service manual for Hitachi V-302F 30MHz scope. P Darragh, 48 Goodwood Park Road, Northam, Bideford, Devon Tel: (0237) 474564.

AKAI 4000 DB reel-to-reel tape deck. Write to: William Snow, 29 Dankworth Road, Brighton Hill, Basingstoke, Hants. RG22 4LJ.

If you pick up a copy of the 1992 Maplin Catalogue, you will notice several changes from the previous one. Firstly, the cover has changed; secondly, we have changed over from red to blue ink (thanks to our readers for that one!) but, more importantly, many hundreds of new items have been added. A significant proportion of these new products are a family of superb kits produced by the Belgian company, Velleman Electronics N.V. In fact, there is an entire section of the Catalogue devoted to the range available.

Velleman Electronics N.V. was founded in 1972 and, within a 20-year period, has grown to become one of the largest manufacturers and distributors of active, passive and electro-mechanical components in Belgium. Located in Gavere, the company employs 104 people on its 3,200m² site and has a turnover of 15.5 million US dollars. It consists of three interrelated divisions: Velleman Engineering; Velleman Switch; and Velleman Components.

Velleman Engineering

This arm of the organisation was founded in 1974, and is involved in the development and manufacture of agricultural and industrial systems. From its earliest days, it has been involved with microprocessors (and as such, was probably one of the first European organisations to recognise the potential of such technology). Over the years, it has acquired a large amount of experience with process management systems, PLCs (programmable logic controllers), transducers and similar types of equipment. It aims to offer complete 'custom-made' solutions for process control problems, which can range considerably in complexity. Clients have included Atlas Copco, a Swedish air compressor manufacturer; Mercedes-Benz, who required a purpose-designed board monitoring system (known as UNIMOG); and Daikin, a Japanese air-conditioning manufacturer. Velleman Engineering are involved in many other fields. These include paint-spraying systems (the company currently supplies a large number of European tractor manufacturers), textile plant monitoring equipment, nautical meteorological equipment, laundry machinery controllers, and a host of agricultural projects (including weighing, crop-spraying, livestock feeding and incubation equipment).

Velleman Switch

The primary product of this medium-sized division of Velleman is a superb tactile keyboard, known as 'Clicktouch'. Patented worldwide, this membrane press-button, developed 'in-house', offers an ergonomic 'snap' action, high reliability, easy installation, customer-specified artwork and low cost. Because the contacts are sealed away from the 'outside world', the switch is moisture-proof – just the sort of thing for outside use, and in particular the sort of industrial control equipment manufactured by its sister company! Barco, a manufacturer

INTRODUCING



▲ The Velleman Engineering computer-based 'Sprymatic S' crop-spraying controller, designed for use with tractors. Note the use of 'Clicktouch' switching – ideal for use in adverse outdoor environmental conditions.

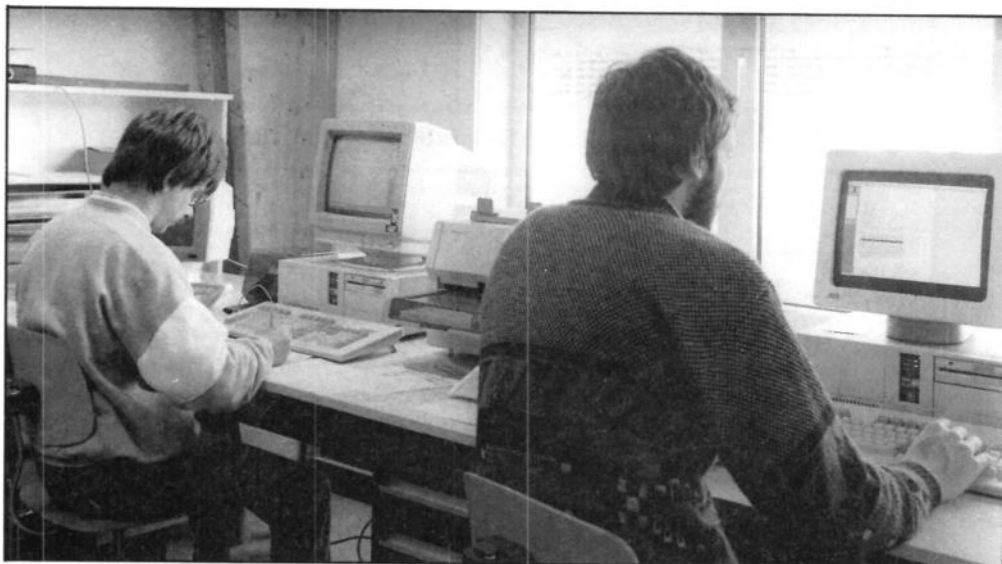

▲ Velleman engineers operating the latest CAD (Computer-Aided Design) equipment. This is used to create PCB artwork, circuit diagrams and other technical drawings.



▲ A view of part of the large storage facility utilised by Velleman Components. Computers are extensively employed to keep track of stock levels – very useful considering the 13,000 different types of component stocked!

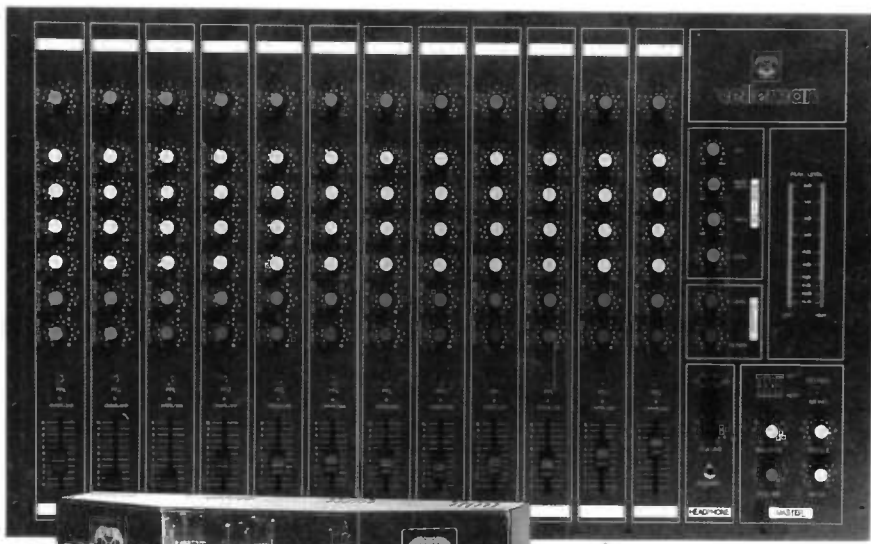

The Velleman Professional Modular Mixing Panel, ideal for small recording studios, theatres and community radio stations, to name a few.

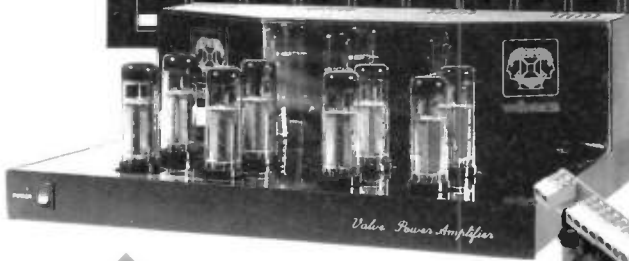

The superb K4000 high-power stereo valve amplifier. This kit offers superb value for money – see next month's 'Electronics' for full details.

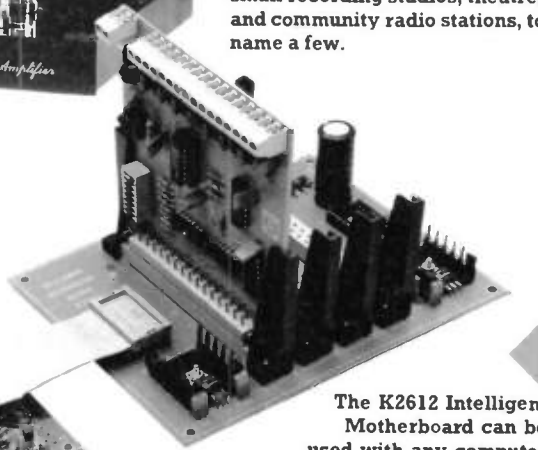

The K2612 Intelligent Motherboard can be used with any computer fitted with an RS232 interface.

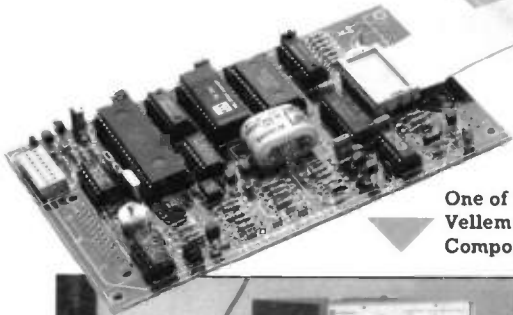

One of the extensive laboratory areas found within the Velleman organisation. Featured below is a Velleman Components service facility.

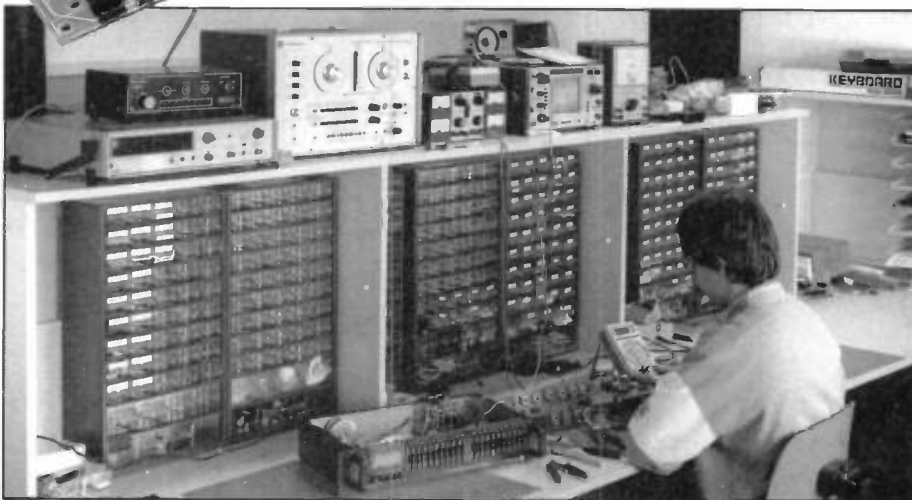

of broadcast-standard video monitors (found in most TV studios in Europe), use 'Clicktouch' controls in their new range of intelligent colour displays. One of the Velleman kits, a digitally-controlled preamplifier, offers an optional remote control unit featuring a 'Clicktouch' keypad. Demand for this product was so great that the company had to move into a new, purpose-designed building. Velleman Switch also manufactures front-panel layers (incorporating 'Clicktouch' controls if required), and specialises in the design and manufacture of products to suit customers' specifications and requirements.

Velleman Components

And now to the side of the company which possibly interests us the most! This division employs only 34 people, yet its turnover is in excess of 8 million US dollars a year. This company deals with 13,000 different product lines, from 34 different brands (including Velleman Switch!). As its name suggests, it is involved in the trade distribution of components. Well-known in the Benelux countries, Velleman Components supply schools, colleges, industry, and over 500 European hobbyist shops (similar to the Maplin stores over here). Some of the 13,000 different components mentioned are used *within* the company – for packaging into the famous KITS (Yes, the same ones that Maplin sells!). Velleman market a range of 131 different kits, of which Maplin stock 112. All kits are supplied with top quality components, glass-fibre PCBs, and comprehensive step-by-step construction guides. There are kits in the Velleman range to suit all interests and levels of proficiency. In Europe, Velleman kits are used by colleges to demonstrate theoretical ('how it works') and practical (construction/soldering) principles of electronics, thus proving their educational value. Kits available from Maplin include power amplifier circuits (including one of the best value-for-money valve power amps on the market – the superb-sounding K4000, to be featured in next month's 'Electronics'); a novel digitally-controlled preamplifier, audio equalisers and spectrum analysers, a superb modular mixing desk, an electronic ignition system, computer (including IBM PC) projects, an innovative vehicle 'parking radar', drill speed controllers, a 0 to 30V 10A (yes, 10 amps!) laboratory PSU, timers, alarm systems and many others.

Every Velleman kit reflects the company's 20-year experience in electronics, and because the company is fairly small, it is responsive to changes – particularly advances in technology (as well as a return to established thermionic valves!). This is shown in the innovative nature of the kits presently available – and no doubt, those of the future. In the meantime, of those currently listed in the Maplin Catalogue, we can safely say that there are Velleman kits available to interest each of us!

By Martin Pipe.



velleman

MICRO-COMPUTER TESTING & FAULT FINDING

by Alan Pickard

Part Three – Floppy and Hard Disc Drives

In Part 2 of the series we looked at microcomputer input and output devices in general, and specifically at keyboard and video monitor operation. Input and output ports of programmable peripheral interface chips were also covered. In this article we look at the two types of disc drive normally used in microcomputers for data storage. These are the floppy disc drive, and to a less (but steadily increasing) extent, the hard disc drive.

Floppy Disc Drives

The physical layout of a 5¼in. disc drive mechanism is shown in Figures 1a and 1b, while a 3½in. disc and drive are shown in Figure 2. A floppy disc consists of a circular piece of mylar plastic, which is only a few thousandths of an inch thick. This is coated with magnetic oxide and encased in a low-friction plastic envelope as shown in Figure 3.

When the disc is inserted into the drive unit, two flanges clamp the disc through its large central hole and spin the disc within its envelope at a constant 300 rpm. The read/write head accesses the disc through the head slot opening of its envelope. Unlike that of a hard disc drive,

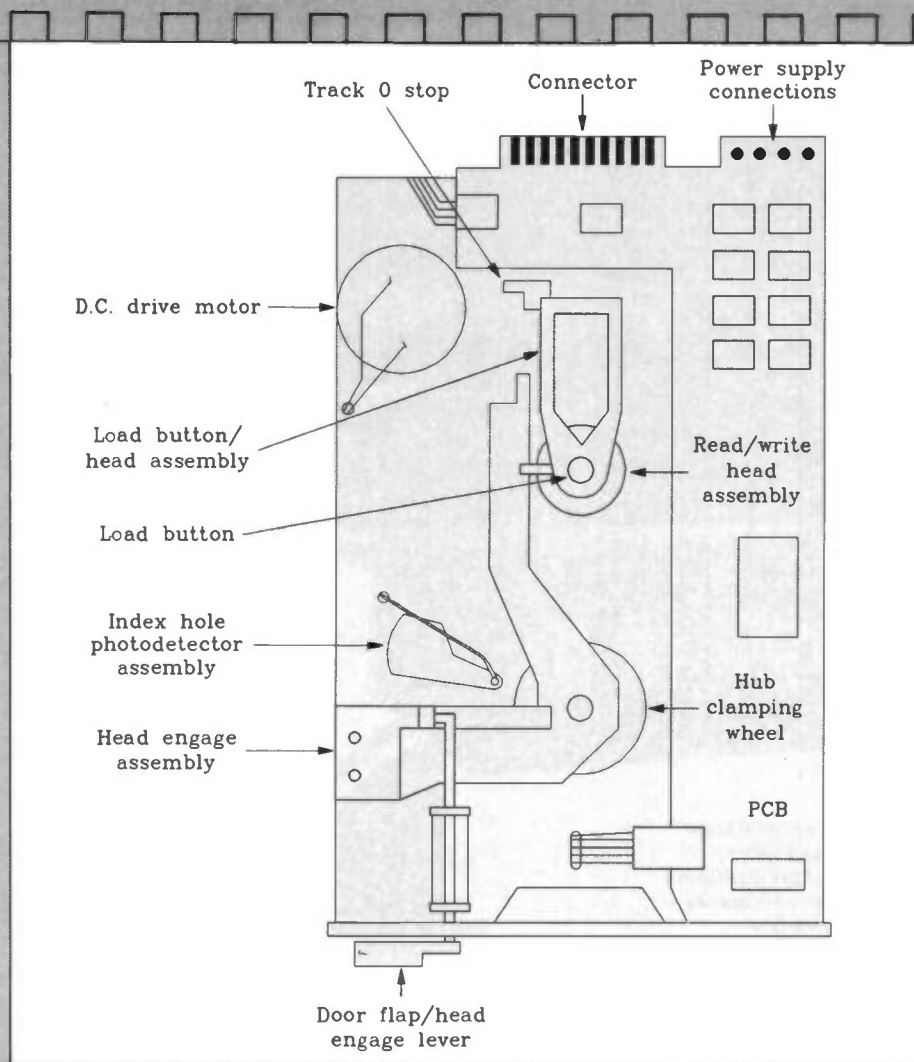

Figure 1a. 5¼in. disc drive mechanism – top view.

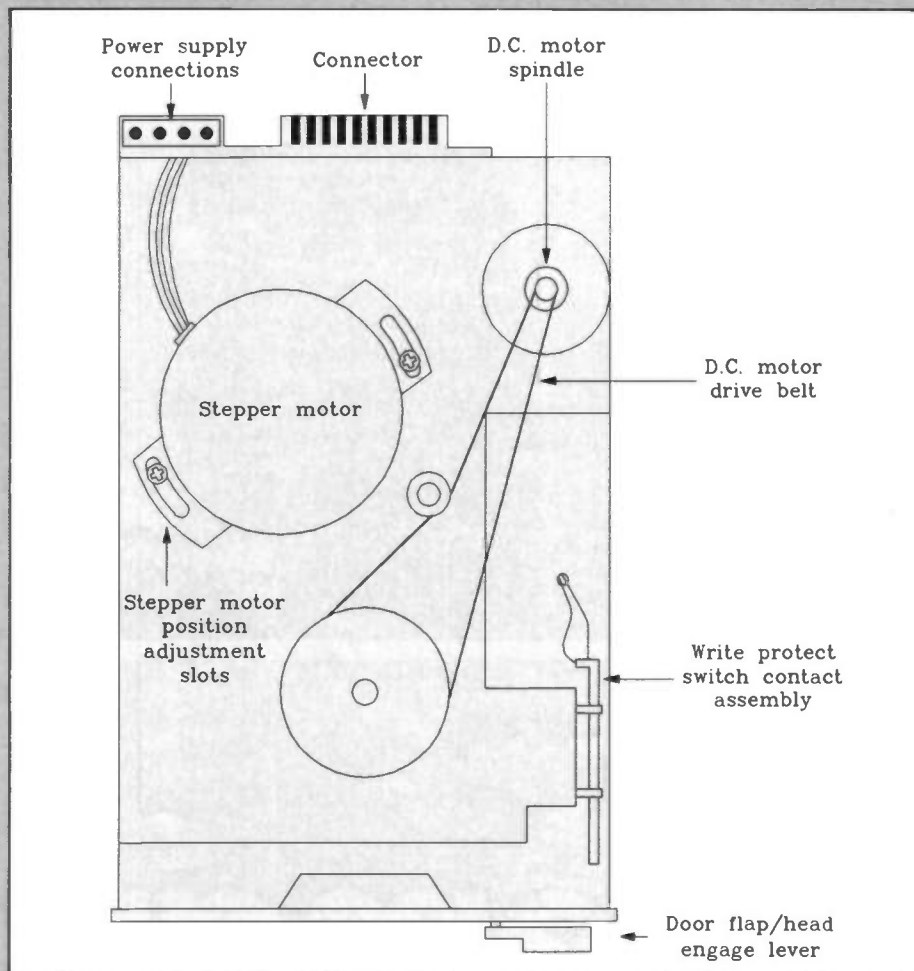

Figure 1b. 5¼in. disc drive mechanism – bottom view.

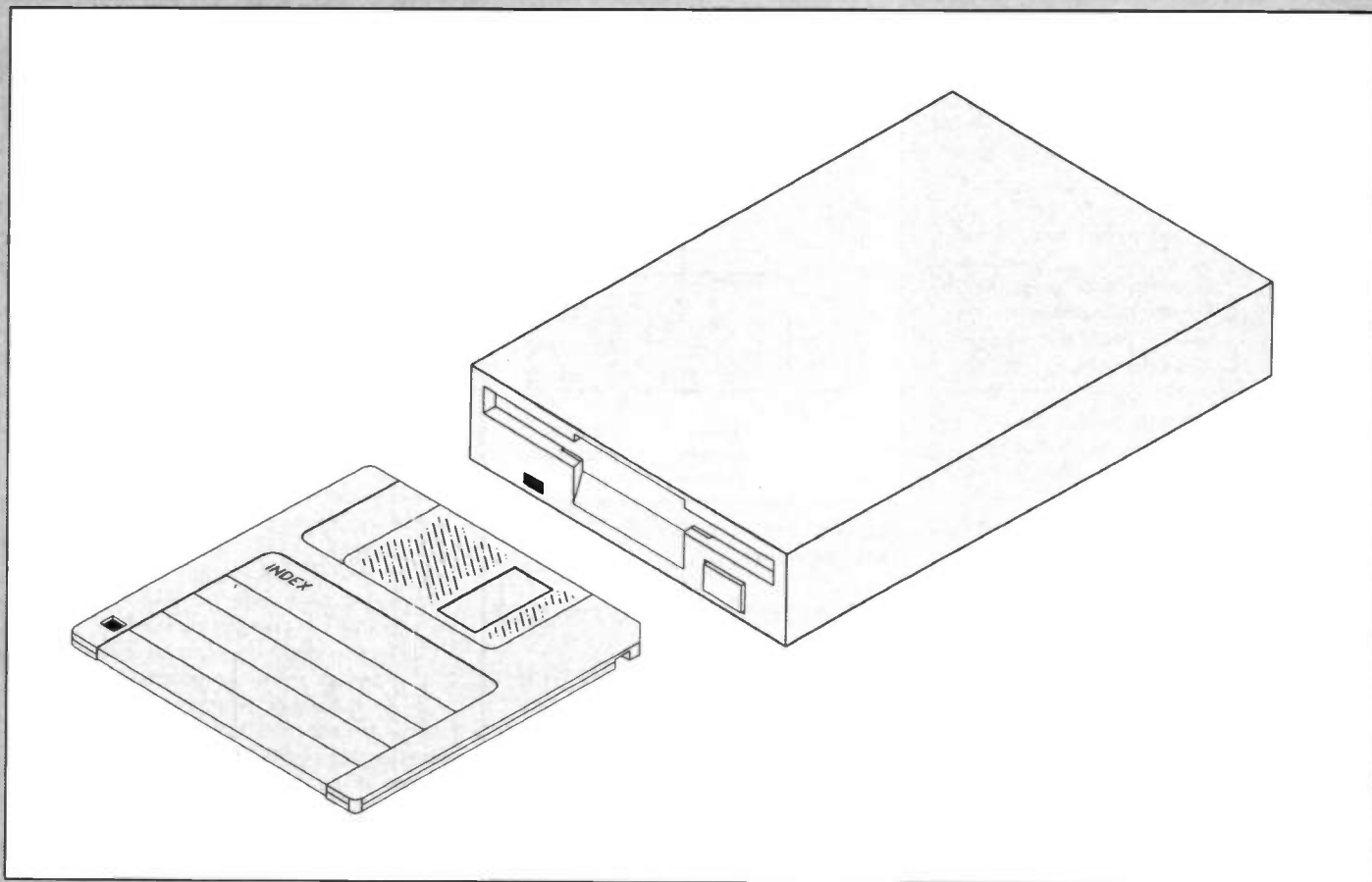

Figure 2. 3 1/2in. disc and drive unit.

the read/write head of the floppy disc drive is permanently 'crashed' (i.e. in contact with the disc) whenever read or write operations take place. In theory this leads to increased disc and head wear, but is necessary due to the relatively slow speed of floppy disc systems. In practice, wear is not a problem by virtue of the generally high standards of disc surfaces and heads. Floppy disc drives can operate effectively for years without any maintenance – and often much abuse!

The write protect notch in the envelope can be used to protect stored data from being overwritten. This is normally achieved with a photodetector which will identify the presence of the notch, and disable the write circuits if it has been covered over. An alternative mechanism makes use of a microswitch. The index hole of the disc indicates the start of the recorded tracks, another photodetector circuit senses when the index hole has passed the detector.

A floppy disc drive unit contains two motors: the rotation of the disc is maintained at a constant 300 rpm by a precision servo-controlled motor while a stepper motor provides accurate positioning of the read/write head over a specific track. A stepper motor is a special type of motor which, when pulsed, will rotate by a fixed increment, such as 5 degrees. A steady series of these pulses will therefore result in rotary motion at a constant speed. The stepper motor can be pulsed to move in a forward or reverse direction, and is used in conjunction with a flexible metal band which converts the rotational movement of the motor into the linear motion

required by the disc head when it is moving from track to track. Other mechanisms use a wheel with a spiral track or a spiral cam to convert the rotary movement into linear action.

To find a particular track the motor may be first stepped to track zero, which is near the outer edge of the disc. On receipt of the appropriate number of pulses (equal to the required track number), the head is moved inward, to the

required track. On most microcomputers, the DOS minimises head travel so that there is no requirement to return to track zero each time that the disc is accessed.

A typical disc drive could be designed for 35 or 40-track operation, with each track divided into 512-byte sectors (refer to Figure 4). These are known as 'soft' sectors and are established by 'formatting' the disc using an appropriate program. The total storage capacity of a

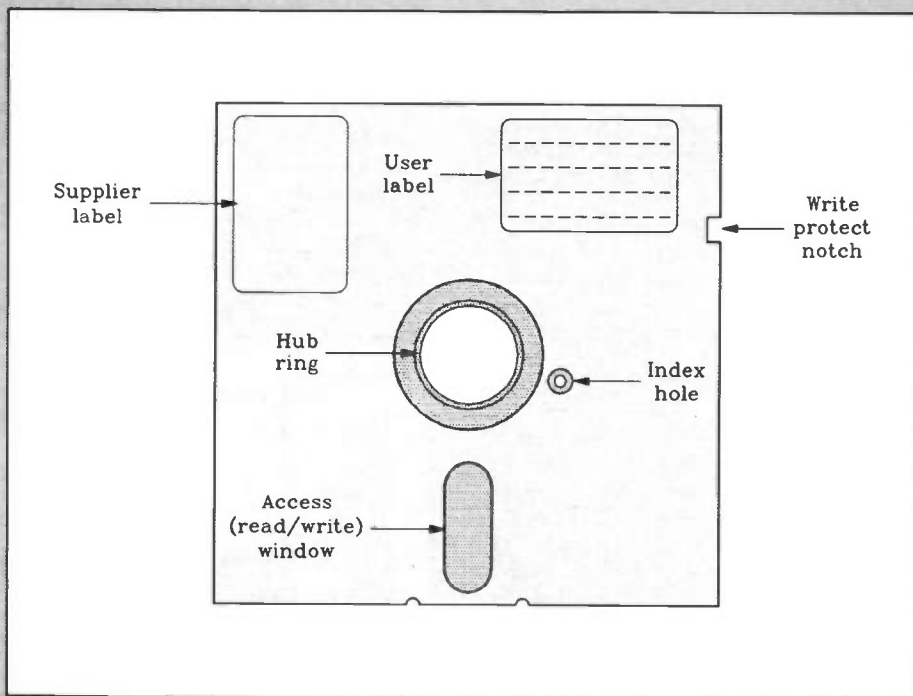

Figure 3. 5 1/4in. disc in protective envelope.

single-sided 40-track disc drive is therefore 40 (tracks) x 10 (sectors) x 512 (bytes per sector) = 204800 bytes, which is equal to 200K bytes. As quite a large number of bytes are used for identification, synchronisation and buffering between sectors, the actual storage capacity for data would be nearer 180K. A double-sided disc drive has two head assemblies enabling both sides of a suitable disc (coated on both sides with magnetic material) to be written to or read from, and thus has twice the storage capacity of a single-side drive, i.e. 360K.

One of the most common varieties of disc drive encountered with microcomputer systems uses 5 1/4in. discs. Between 100K (from relatively early single-sided drives used with machines such as the BBC Micro) and 1.2M (from double-sided high-density drives often fitted to IBM ATs and their clones) can normally be stored on such discs. In addition, 3 1/2in. and 3in. floppies also exist, although the latter has not become popular or 'standard'. In both cases, the actual magnetic disc material is the same as that used in the 5 1/4in. (and

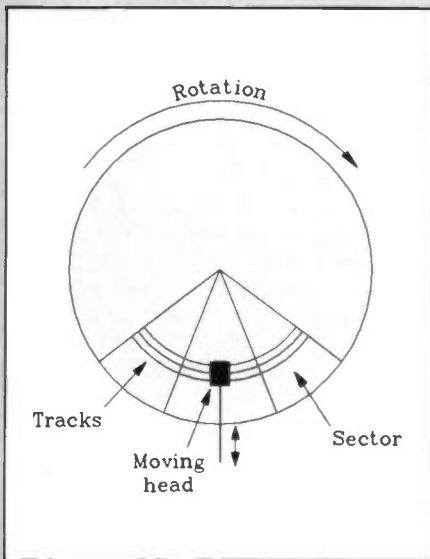

Figure 4. Tracks and sectors.

the now far less common 8in.) discs, the main difference being that a robust plastic cartridge is used to protect the magnetic surfaces, instead of the vulnerable plastic envelope which characterises the 5 1/4in. and 8in. types. These plastic cartridges feature read/write access head protection, and a better write-protect system. With reference to Figure 5, it can be seen that an automatic shutter on the cartridge protects the access window. The 3in. drive is used in the Amstrad PCW machine, as well as the Tatung Einstein mentioned elsewhere in this series. The 3 1/2in. format is very popular and offers similar storage capacities to the 5 1/4in. type (i.e. 720K and 1.44M). The reason that the 3 1/2in. disc has not completely replaced the 5 1/4in. type is probably because many business and private users have built up large collections of 5 1/4in. discs which they are loath to discard or replace. For this reason, many PC users find it extremely useful to have both types of drive fitted to provide flexibility.

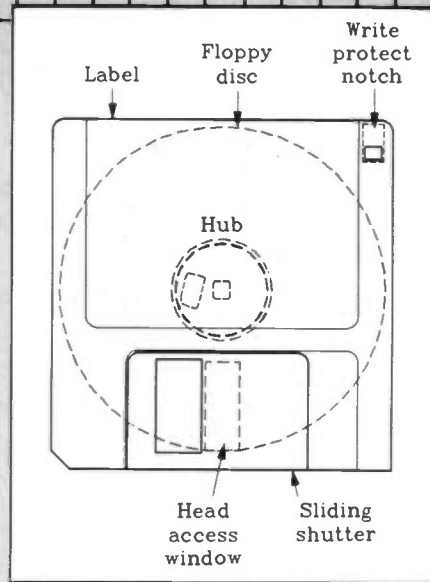

Figure 5. 3 1/2in. floppy disc in rigid cassette housing.

Floppy Disk Formats

The following is some general information on the more widely known disc formats:

5 1/4in. Format

This format can be operated in single-density mode (with frequency modulation - FM) or double-density mode (using modified frequency modulation - MFM). Data transfer for these two modes are 125Kbit/sec and 250Kbit/sec respectively. Track-to-track stepping time is quoted at around 20mS while the average access time is normally around 280mS. Both 40- and 80-track 5 1/4in. disc drives are available, and some are available which provide 40/80 track operation. A 5 1/4in. disc has 48 or 96 tracks per inch (tpi) depending on whether it features 40- or 80-track operation. IBM PC floppy disc formats provide 360K (double-density) and 1.2M (high-density).

3 1/2in. Format

3 1/2in. drives using double-density (MFM) operation can achieve storage capacities of up to 400K per side. Thus, the double-density 3 1/2in. drive used with the IBM PC will give a formatted capacity of 720K, while a high density drive will provide 1.44M. Despite the fact that the magnetic surface area is only half that of a 5 1/4in. disc, the storage capacities of the two are very similar. Stepping times are quoted as 6ms and 3ms for 40- and 80-track respectively, these being much faster than their 5 1/4in. counterparts.

3in. Format

The less popular 3in. format, which is similar in physical appearance to the 3 1/2in. type, retains full software formatting compatibility with the 5 1/4in. format. It is also hardware compatible with the standard 34-way disc bus (i.e. using the same 34-way PCB edge connector), and has the same rotational speed and TPI figure.

The Floppy Disc Drive Controller

A floppy disc drive controller (FDC) is a complex VLSI device which contains the circuitry required for the storage and retrieval of data in the sectors and tracks, which were originally written to the disc during the formatting process. Figure 6 is a block diagram showing how the FDC is interfaced to a microprocessor. Some examples of FDC signal are: load head, direction, seek step, index (active low), trk 0 (active low), select 0, select 1. 'Select' refers to side 0 or 1 of the disc drive or disc surface. These examples are from the 8271 FDC used in some versions of the BBC Micro; Tr00, dirc and step are three examples of signals from the 1770 FDC used in the Einstein computer.

Operation of a 5 1/4in. Disc Drive Mechanism

The following description of the main features of a disc drive makes reference to Figures 1a and 1b. It is useful, if not essential, to be able to recognise and understand how these features operate while investigating a fault condition. Photos 1a and 1b show the top and bottom views of the drive itself.

Figure 1a shows the location of the DC motor which rotates the disc, via a drive belt and the hub clamping wheel. The door flap or head engage lever causes the two flanges of the wheel to grip the hub of the disc, and also the 'load button' to engage onto one of the surfaces of the disc. A piece of felt-like soft material is mounted on the load button which holds the disc surface against the head (from the other side). In principle, this is similar in concept to the operation of a pressure pad in a cassette tape recorder. Please note that such an arrangement is only used in a single-sided drive; in a double-sided drive the load button is replaced by another read/write head for

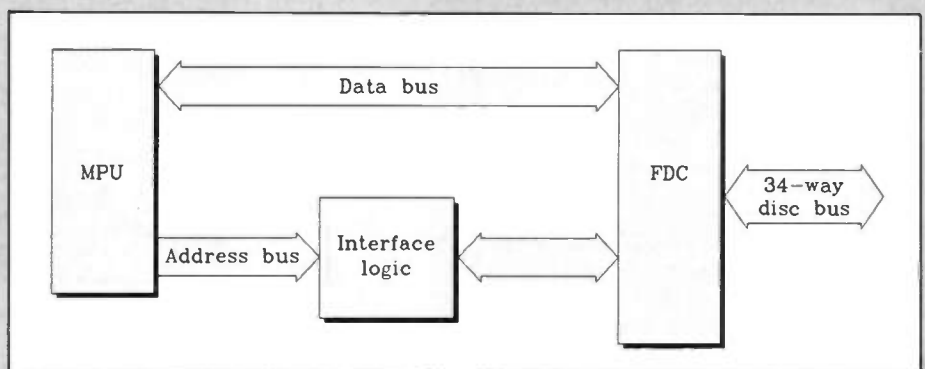

Figure 6. Microprocessor control of floppy disc via FDC.

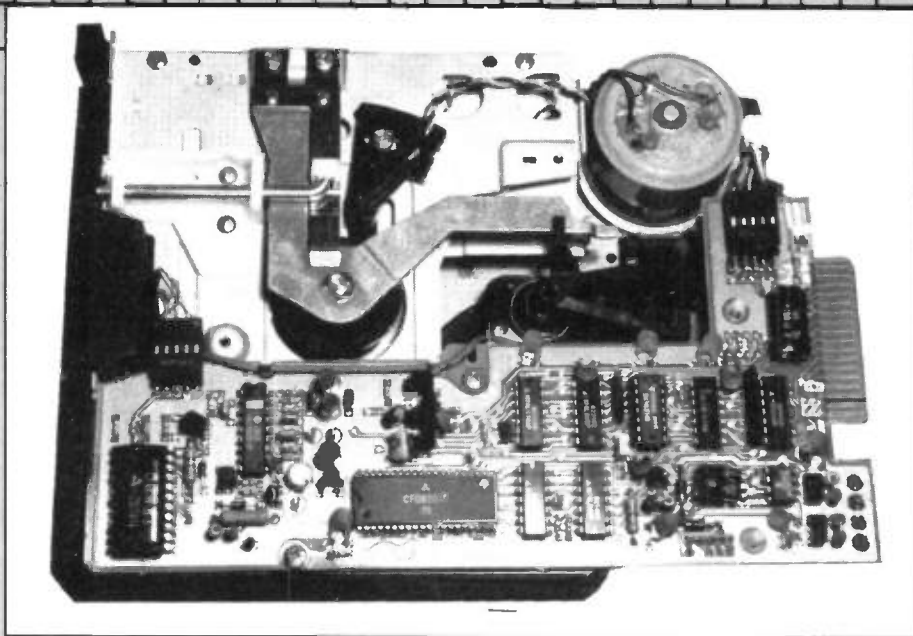

Photo 1a. Top view of 5 1/4 in. disc drive (as per Figure 1a).

the second side of the disc. In this case, the disc surface is 'sandwiched' between the two heads, each of which keeps the other in close physical contact with the magnetic surface. Taking Figure 1a as the top view, if a disc is inserted into the drive so that its labelled side is visible, then the side being accessed will be the underside. This follows since the read/write head is positioned *below* the load button. The index hole sensor consists of a transmitter (LED), and photodetector (photodiode) assembly, whose transmit and receive path is *uninterrupted* only when the index hole passes through it. The track 0 stop is shown at the rear of the load button/head assembly and can be adjusted by means of a screw concealed under the PCB. The PCB itself is shown on the right of the diagram and includes the disc bus edge connector and power supply connections.

Figure 1b shows clearly the stepper motor, which drives the head assembly (via a spiral cam) and enables fast and

accurate location of disc tracks. Adjustments can be made to the positioning of the stepper motor, and are normally done using the appropriate specialist test equipment to be detailed in the next section. The DC drive motor spindle can be seen, along with the belt which transfers energy to a large pulley under the hub clamp assembly. This pulley is clearly visible in the diagram. The write-protect switch contacts are shown on the right of the diagram. These are normally open, and remain open when a disc is inserted unless a write protect tab has been fixed to the disc envelope. This closes the switch via a plunger and as a result the write circuit in the drive is disabled.

All of these features are best understood by inspection of the drive mechanism, preferably removed from the micro-computer and/or its outer casing. Some of the features described can only be seen by peering inside and underneath the PCB, head assembly, etc.

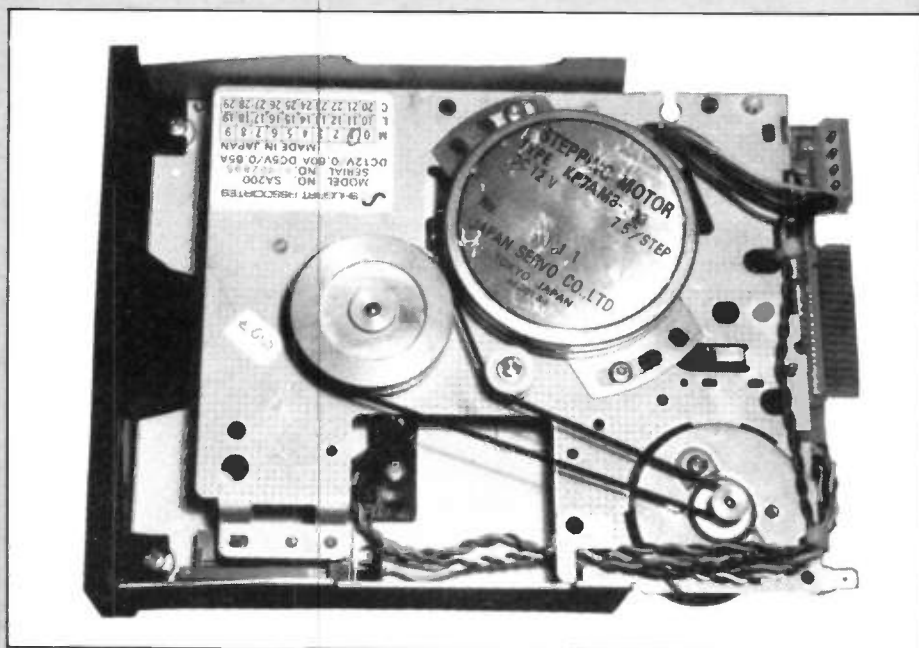

Photo 1b. Bottom view of 5 1/4 in. disc drive (as per Figure 1b).

Adjustments

A floppy disc drive is a surprisingly reliable mechanism combining complex electronic and mechanical systems. These drives, in my experience, require little or no maintenance/repair. It is worth, however, knowing something about their detailed operation even if only to eliminate the drive from a system fault. Many companies are happy to provide servicing aids in the form of cleaning discs. Please note that double-sided cleaning discs should not be used in single-sided drives, otherwise there will be a possibility of dislodging the pressure pad from the load button. Although convenient only when a disc drive has been dismantled, a cotton bud and suitable cleaning fluid (e.g. isopropyl alcohol) can be used to clean the read/write heads. Generally speaking, head cleaning is not required and inspection of heads will usually show them to be clean. Adjustments to mechanical items are rare, unless a drive has been dropped or jarred. It is unusual for a stepper motor to drift out of alignment due to the normal mechanical vibrations caused by frequent operation of the drive. A detailed description of adjustments, however, is given later.

The Floppy Disc 'Exerciser'

The floppy disc exerciser is a specialised (but not particularly expensive) piece of test equipment which is used in conjunction with a dual-trace oscilloscope. Its purpose is to allow a disc drive to operate manually (i.e. independently of the micro-computer's operating system) and can therefore be seen as effectively replacing the FDC, which is under software control.

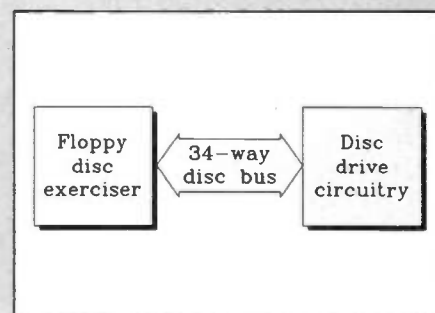

Figure 7. Floppy disc exerciser.

Connected to the disc drive as shown in Figure 7, the floppy disc exerciser is a compact calculator-sized unit with a ribbon cable for drive connection and a number of switches which select the following functions:

- (i) Drive motor operation
- (ii) Single stepping of head
- (iii) Stepping Direction Change
- (iv) Selection of Disc Side (0 or 1)
- (v) Single/Double Sided Operation

An LED provides an indication of the index pulse.

The floppy disc exerciser is best used in conjunction with a special alignment disc. This disc is special in the sense that it

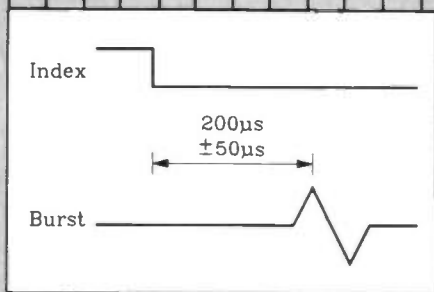

Figure 8. Index-to-burst timing waveform.

contains both analogue and digital information. Track 0 contains data, while Track 1 contains a 'burst signal' which occurs 200µs after the index hole (see Figure 8). This burst can be observed on an oscilloscope via the appropriate test point, and a tolerance of ±50µs is considered to be acceptable. Stepper motor positioning can be checked by setting the exerciser to select track 16. Analogue signals present on tracks 15 and 17 (i.e. on either side of track 16) are shown in Figure 9 as 'waveforms', and for clarity in Figure 10 as patterns on the disc surface. If the head is centrally positioned over track 16, the waveform displayed on the oscilloscope should resemble the so-called 'eye' pattern, shown in Figure 11. For acceptable operation, the amplitude of the smaller lobe must be at least 200mV, while the difference in amplitudes between the two lobes must be less than 5mV. If this is not the case, then the stepper motor may require re-positioning.

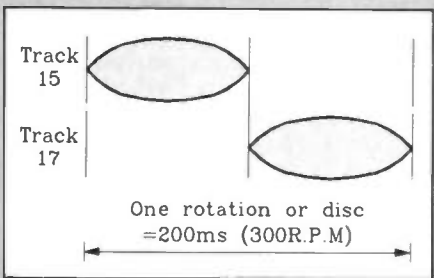

Figure 9. Relationship between track 15 and track 17 signal patterns.

Such an adjustment is very crudely carried out, not unlike the trial-and-error method used to align a car distributor system, where the motor fixing screws are loosened, the motor moved a tiny amount and the screws re-tightened. The effect of the adjustment on the performance is noted and the process is then repeated until the optimum position is found. In the case of the disc drive such adjustments would be made with reference to the pattern displayed on the oscilloscope.

Track zero stop adjustment, if necessary, is achieved through the positioning of the microswitch and involves the loosening and retightening of one or two screws. A similar method is used to re-position the index hole sensor. However, these two adjustments are very rarely required. Other more conventional problems include electronic component or motor failure, drive belt replacement and general mechanical problems.

Hard Disc Drives

A hard disc drive operates using the same principles as its floppy counterpart. The

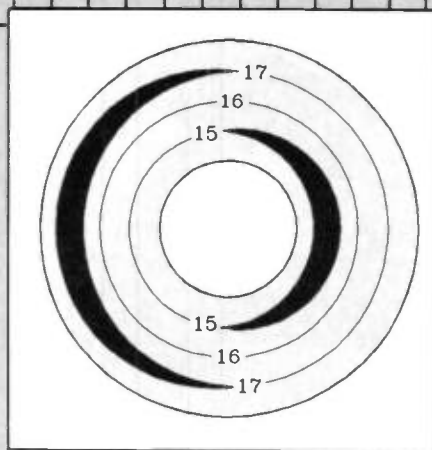

Figure 10. Representation of track 15 and track 17 signal patterns on the surface of the disc.

main differences between the two types is the vastly increased storage capacity on the hard disk (typically 20M or higher) and the fact that the disc is not interchangeable. The storage capacity of a 20M hard disc drive is roughly equivalent to the information contained in 57 books, each containing 250 packed pages (i.e. a total of around 14000 book pages). Although the disc is of a size comparable to those used in floppy disc systems the information density is greatly increased, with figures of between 15000 and 50000 bits per linear inch being commonly quoted. Rotational speeds (typically 3000 rpm ±1%) and data transfer rates (typically 625Kbit/sec) are much higher than those quoted for floppy disc systems, while positioning times are normally between 25 and 50ms. The hard disc, or 'platter', itself is housed in a factory-sealed airtight container which is inaccessible to the user or technician. Figure 12 and Photo 2 show the layout of a typical drive. The example shown is interesting in that it is a 'hard-card', designed to plug directly into the expansion slot of an IBM PC.

The rigid disc of a hard drive (as seen in Figure 12) is one of several which are

stacked with spacers between them. Normally, both sides of each disc are used and individual read/write heads are fitted for each side available. The discs themselves are made from an aluminium alloy coated with the required magnetic material. Each rigid disc is therefore much more dimensionally stable when compared with those used with floppy drives, and as a result can have more tracks (of greater capacity) per inch than a floppy disc surface/surfaces. The high speed of a hard disc system not only makes it possible to read and write data faster, but it also creates a thin cushion of air which floats the read/write head 2 microns or so off the disc surface. To prevent dust and smoke particles (which are usually larger in diameter than the head/disc gap) from 'crashing' the head, the disc assembly is enclosed in a sealed dust-free case. Photo 3 shows a hard disc drive with its dust cover removed (This should NEVER be done under normal circumstances as the risk of contamination and inevitable failure is high!). The two double-sided platters and the head assembly are clearly visible in this photograph.

Technical details of hard disc drive operation are beyond the scope of this article, but one important consideration for technicians and users alike concerns the transportation of hard disc drives or microcomputers containing them. Because the heads of a hard drive are required not to touch the surface, it is essential to ensure that they are 'parked' before being physically lifted, carried or wheeled from one position to another. The head assembly does not actually contain a mechanism for locking or parking itself, but positions the heads on an unused track so that any damage to the disk surface occurs on a part of the disk not used for data storage. This does not occur automatically on power-off (this feature is unnecessary as most hard drives tend to be operated in one place only). Instead,

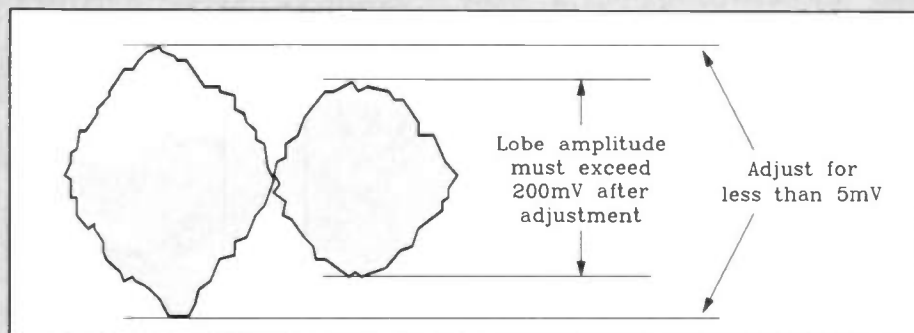

Figure 11. Cat's eyes head alignment waveform.

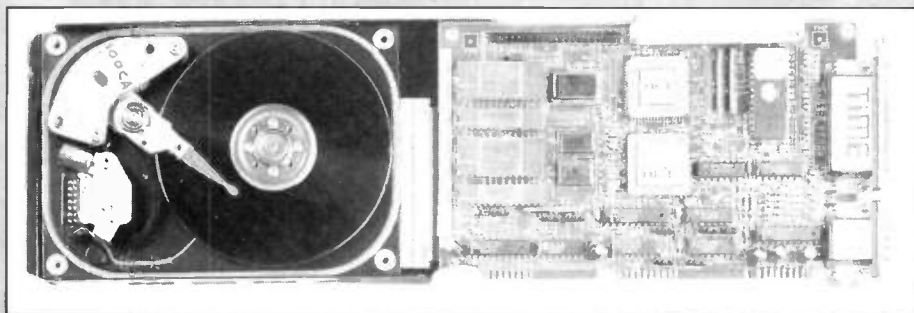

Photo 2. 100M 'Hardcard' for use with the IBM PC (os per Figure 12).

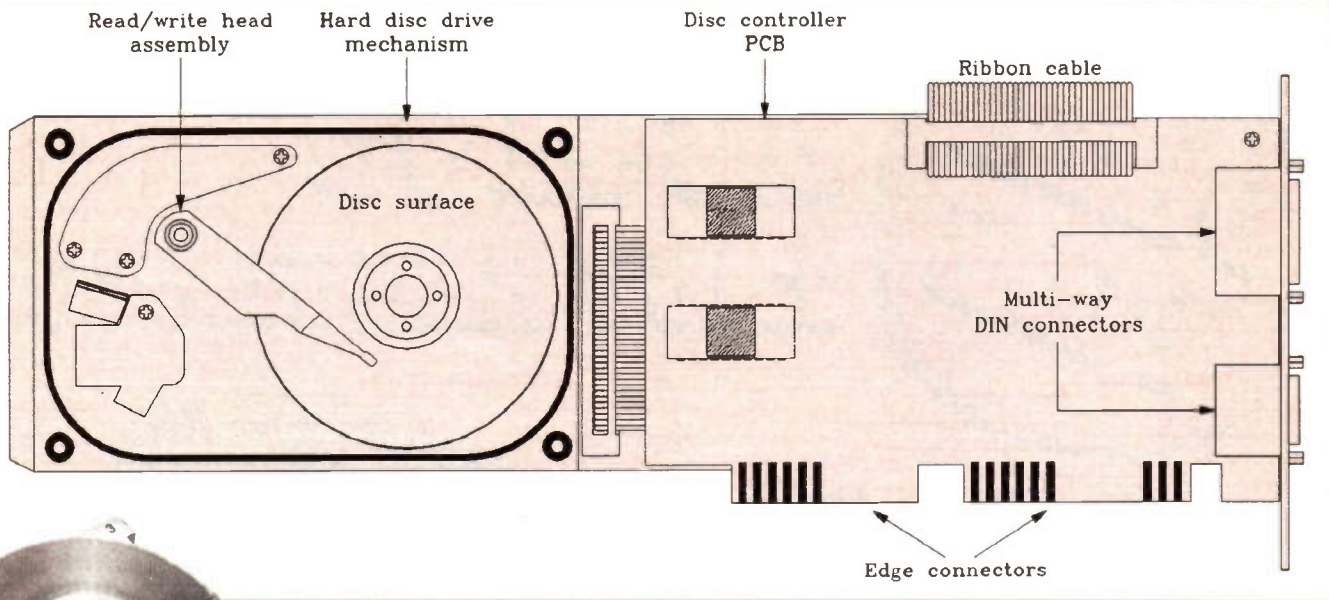

Figure 12. Hard disc drive in the form of a 'Hardcard' (100M capacity).



Photo 3. Hard disc drive showing platters and head assembly.

the parking function is invoked by a software utility command (e.g. under MS-DOS). If this is not done before powering down (e.g. in the case of a power cut or removal of power to the machine) then the machine must be turned back on and re-booted as soon as possible, and the disk parking utility operated before finally powering down the machine again and moving it. In practice, a hard disc mechanism would probably survive being slid across a bench or table, but not being bumped down or pushed along on a trolley.

The Next Stage

Having covered the main hardware areas of the microcomputer, including I/O devices and circuits, it would be useful to look at the types of test equipment used in microcomputer fault-finding and testing. In Part 4 we will look at the oscilloscope, logic probe and logic pulser. More specialised test equipment such as the floppy disc exerciser, logic analyser and signal analyser will also be examined, especially where relevant to the content of Parts 1 to 3.

MAPLIN'S TOP TWENTY KITS

| POSITION | | DESCRIPTION OF KIT | ORDERAS | PRICE | DETAILS IN |
|----------|-----------|---------------------------|---------|--------|------------------------|
| 1. (12) | ◆ | LED Xmas Star | LP54J | £ 6.25 | Magazine 48 (XA48C) |
| 2. (2) | ◆◆ | Vehicle Intruder Alarm | LP65V | £ 9.95 | Magazine 46 (XA46A) |
| 3. (3) | ◆◆ | Live Wire Detector | LK63T | £ 4.25 | Magazine 48 (XA48C) |
| 4. (4) | ◆◆ | MOSFET Amplifier | LP56L | £19.95 | Magazine 41 (XA41U) |
| 5. (7) | ◆ | Car Battery Monitor | LK42V | £ 7.95 | Magazine 37 (XA37S) |
| 6. (9) | ◆ | Courtesy Light Extender | LP66W | £ 2.75 | Magazine 44 (XA44X) |
| 7. (6) | ◆ | L200 Data File | LP69A | £ 3.95 | Magazine 46 (XA46A) |
| 8. (8) | ◆◆ | Mini Metal Detector | LM35Q | £ 4.95 | Magazine 48 (XA48C) |
| 9. (5) | ◆ | TDA7052 Kit | LP16S | £ 4.45 | Magazine 37 (XA37S) |
| 10. (10) | ◆◆ | MSM6322 Data File | LP58N | £11.45 | Magazine 44 (XA44X) |
| 11. (1) | ◆ | 1 300 Timer | LP30H | £ 4.95 | Magazine 38 (XA38R) |
| 12. (14) | ◆ | Digital Watch | FS18U | £ 2.45 | Catalogue '92 (CA09K) |
| 13. (13) | ◆◆ | Partylite | LW93B | £10.25 | Catalogue '92 (CA09K) |
| 14. (11) | ◆ | PWM Motor Driver | LK54J | £ 9.95 | Best of Book 3 (XC03D) |
| 15. (20) | ◆ | IBM Expansion Sys | LP12N | £18.25 | Magazine 43 (XA43C) |
| 16. (-) | RE-ENTRY | Low Cost Alarm | LP72P | £12.95 | Magazine 45 (XA45Y) |
| 17. (-) | NEW ENTRY | Simple Melody Generator 1 | LM43W | £ 2.75 | Magazine 26 (XA26D) |
| 18. (16) | ◆ | Siren Sound Generator | LM42V | £ 4.25 | Magazine 26 (XA26D) |
| 19. (17) | ◆ | TDA2822 Amplifier | LP03D | £ 6.95 | Magazine 34 (XA34M) |
| 20. (-) | NEW ENTRY | I/R Remote Tester | LP53H | £ 6.45 | Magazine 44 (XA44X) |

Over 150 other kits also available. All kits supplied with instructions. The descriptions are necessarily short. Please ensure you know exactly what the kit is and what it comprises before ordering, by checking the appropriate project book, magazine or catalogue mentioned in the list above.

Maplin

Do you Enjoy your work?
Or would you prefer to
Work at what you enjoy?

If you are an electronics enthusiast and looking for an interesting career with a future, Maplin has the answer.

We currently have vacancies for

TECHNICAL SALES STAFF

SOUTH LONDON, LEICESTER AND COVENTRY

These vacancies are being created as a result of the Maplin expansion programme and offer real prospects up to and including Branch Management.

A knowledge of sales, although an asset, is not essential. But, to become part of the team you do need to be self motivated and have a cheerful personality. Applicants should also be smart and have a knowledge of electronic components.

We offer excellent working conditions and job security, plus a good salary with commission and a realistic pension scheme.

Apply in writing enclosing CV to: David Snoad, P.O. Box 3, Rayleigh, Essex. Or for further information, ring 0702 554155.

If you are seeking an interesting career in a High Tech environment then contact us

NOW!

**DATA
FILE**

RC4195

±15V REGULATOR

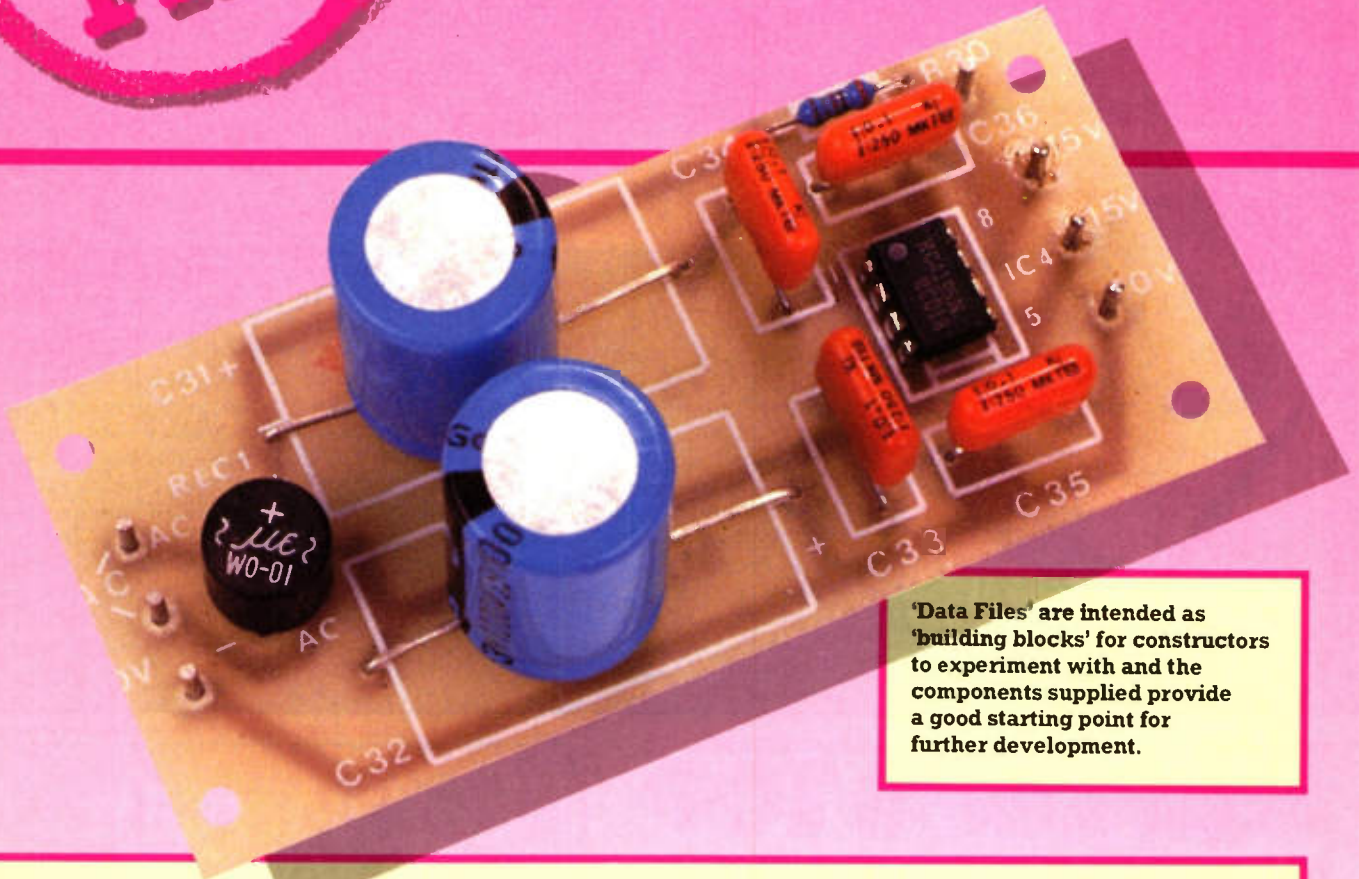

'Data Files' are intended as 'building blocks' for constructors to experiment with and the components supplied provide a good starting point for further development.

FEATURES

- ★ ±15V operational amplifier power supply with low component count
- ★ Thermal shutdown
- ★ Short circuit protection
- ★ ±100mA output current
- ★ Can be used as a high voltage single output regulator

The RC4195 is a dual-polarity 'tracking' regulator designed to provide balanced positive and negative 15V output voltages. This device is designed for local 'on-card' regulation, eliminating distribution problems associated with single-point regulation. Only two external components are required for operation (two 10μF output decoupling capacitors).

Device Description

The IC can supply currents of up to 100mA per supply rail.

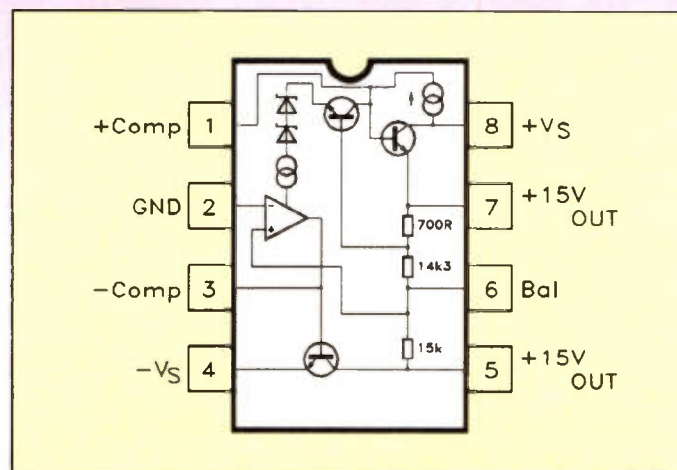

Figure 1. Functional block diagram.

To keep the device within its maximum power dissipation figure of 600mW, the maximum input voltage should be 18V. This is demonstrated by the following equation:

Power dissipation per rail = $(V_i - V_o) \cdot I_L$, where:

V_i = Input voltage
 V_o = Output voltage
 I_L = Load current

This figure is multiplied by 2 (as there are two rails) to give the total IC power dissipation.

Substituting in the correct figures gives:

$$((18 - 15) \times 0.1) \times 2 = 0.6W$$

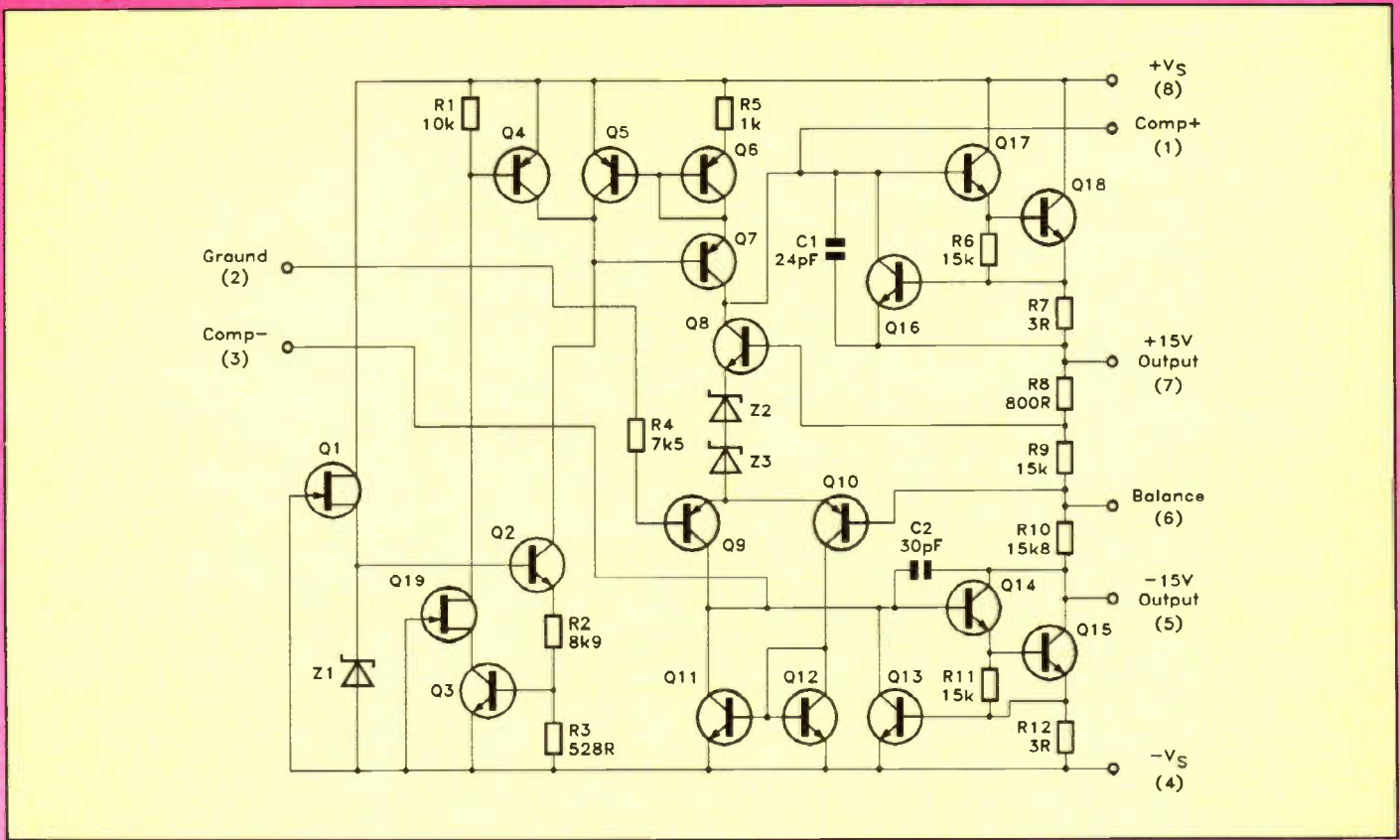

Figure 2. IC circuit diagram.

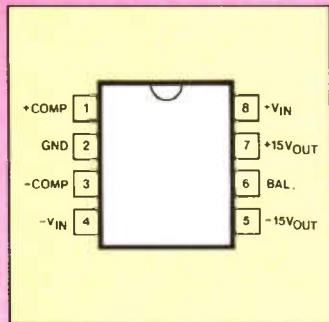

Figure 3. 4195 IC pin-out.

A functional block diagram is given in Figure 1. Figure 2 reveals the internal circuit diagram, while Figure 3 shows the IC pin-out. Tables 1 and 2 give the electrical and thermal characteristics respectively, whilst Table 3 gives the absolute maximum ratings. Graphs 1 to 6 show typical performance characteristics of the device. Figure 4 shows a typical application of the regulator, while Figure 5 shows the regulator configured to give a single high voltage output. Figure 6 shows how to use external pass transistors and current limiting circuitry to increase output current delivery. To balance the output voltages a potentiometer is fitted, with its resistive element connected across the output supply rails and its wiper connected to the 'balance' input, as shown in Figure 7.

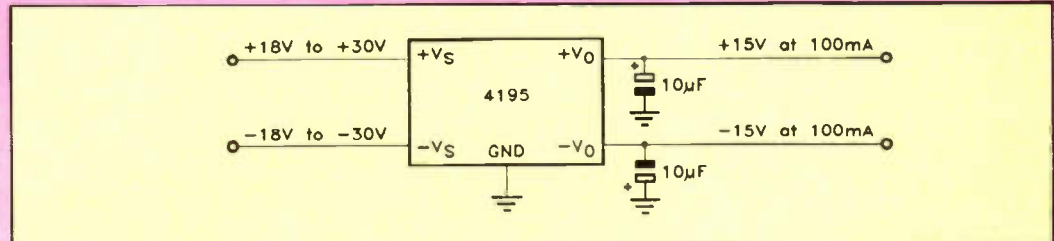

Figure 4. 4195 set up in balanced output configuration.

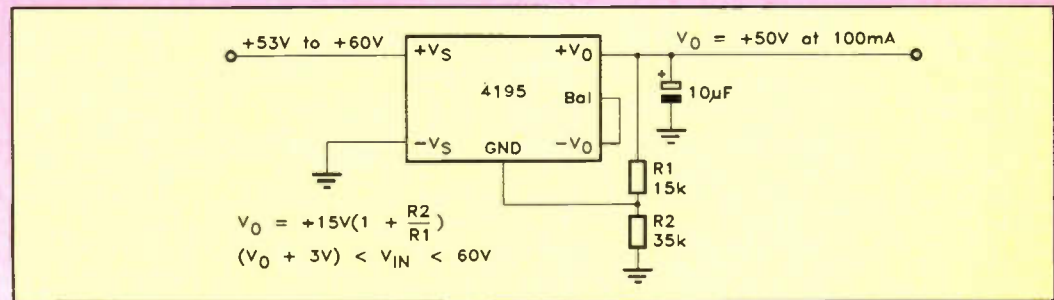

Figure 5. Positive single supply (+15V < V_o < +50V).

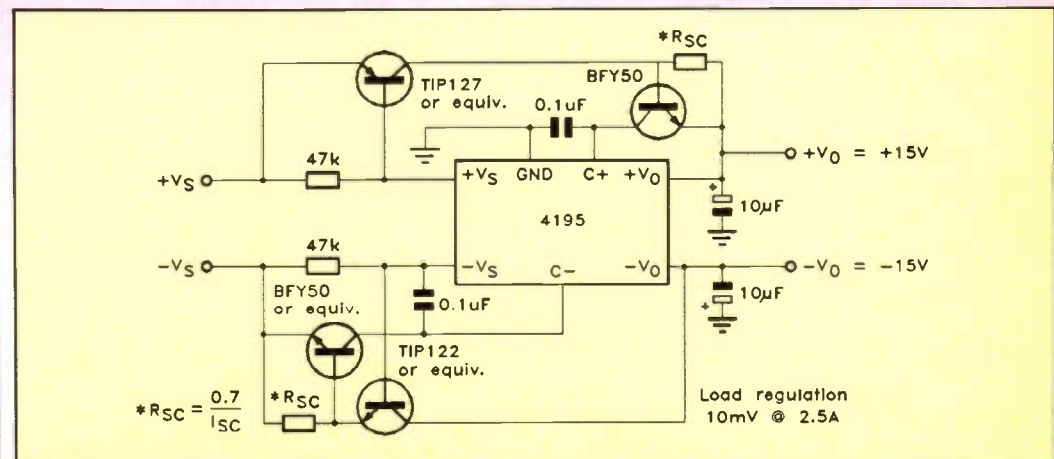

Figure 6. 4195 set up for high-current output.

($I_L = \pm 1\text{mA}$; $V_i = \pm 20\text{V}$; $C_L = 10\mu\text{F}$; $T_A = 0^\circ\text{C}$ to $+70^\circ\text{C}$).

| Parameter | Conditions | Min. | Typ. | Max. |
|--|--|-------|--------------------|--------------------|
| Line regulation: | $V_i = \pm 18\text{V}$ to $\pm 30\text{V}$ | | 2mV | 20mV |
| Load regulation: | $I_L = 1\text{mA}$ to 100mA | | 5mV | 30mV |
| Output voltage drift with temperature: | | | 0.005%/°C | 0.015%/°C |
| Supply current: | $V_i = \pm 30\text{V}$; $I_L = 0\text{mA}$ | | $\pm 1.5\text{mA}$ | $\pm 4.0\text{mA}$ |
| Supply voltage: | | 18V | | 30V |
| Output voltage: | $T_j = +25^\circ\text{C}$ | 14.5V | 15.0V | 15.5V |
| Output voltage tracking: | | | $\pm 50\text{mV}$ | $\pm 300\text{mV}$ |
| Ripple rejection: | $f = 120\text{Hz}$; $T_j = +25^\circ\text{C}$ | | 75dB | |
| Input-Output voltage differential: | $I_L = 50\text{mA}$ | 3V | | |
| Short circuit current: | $T_j = +25^\circ\text{C}$ | | 220mA | |
| Output voltage noise: | $T_j = +25^\circ\text{C}$; $f = 100\text{Hz}$ to 10kHz | | 60μV RMS | |
| Internal thermal shutdown: | | | 175°C | |

NOTE 1. The specifications given above apply for the given junction temperature, since pulse test conditions are used.

Table 1. Electrical characteristics.

| | |
|---|---------------|
| Maximum junction temperature: | 125°C |
| Maximum power dissipation ($T_A < 50^\circ\text{C}$): | 468mW |
| Thermal resistance θ_{JA} : | 160°C/W |
| For $T_A > 50^\circ\text{C}$, derate at: | 6.25mW per °C |

| | |
|---|---|
| Supply voltage ($\pm V_i$) to ground: | $\pm 30\text{V}$ |
| Load current: | 100mA |
| Operating junction temperature range: | 0°C to $+125^\circ\text{C}$ |
| Storage temperature range: | -65°C to $+150^\circ\text{C}$ |
| Lead soldering temperature (10 sec.): | $+300^\circ\text{C}$ |

Table 2. Thermal characteristics.

Table 3. Absolute maximum ratings.

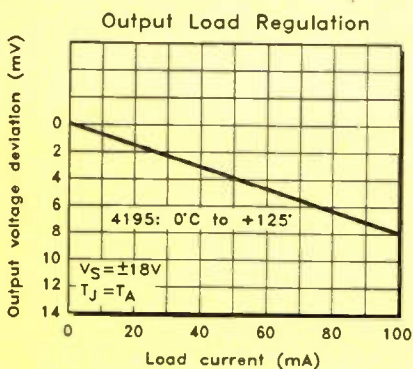

Graph 1. Output load regulation.

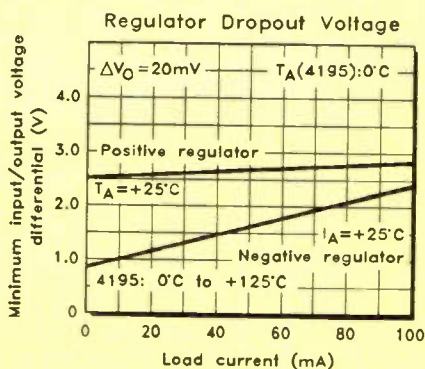

Graph 2. Regulator dropout voltage.

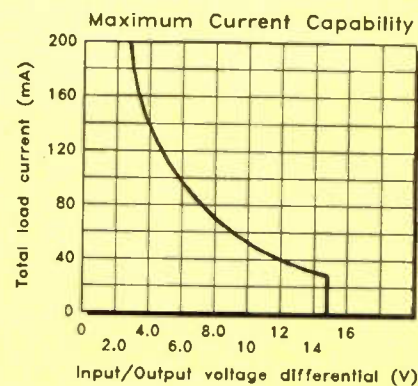

Graph 3. Maximum current capability.

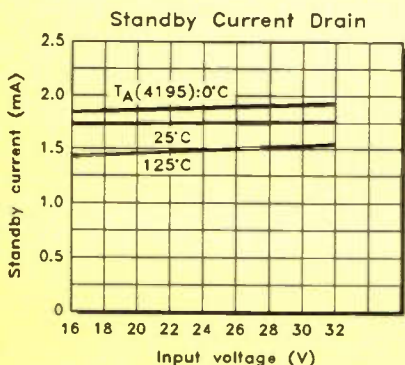

Graph 4. Standby current drain.

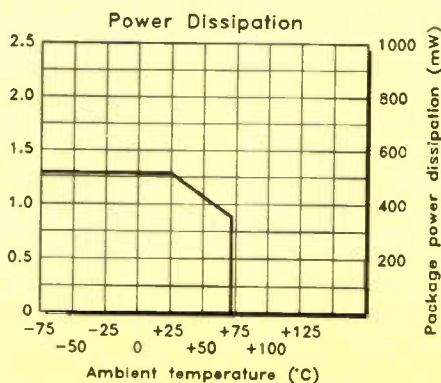

Graph 5. Power dissipation.

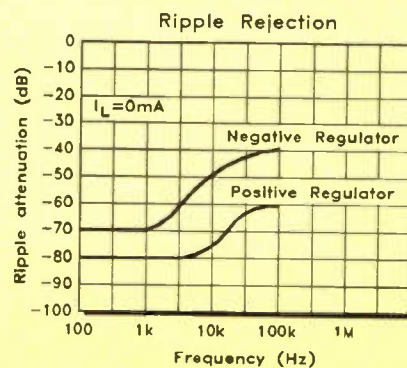

Graph 6. Ripple rejection.

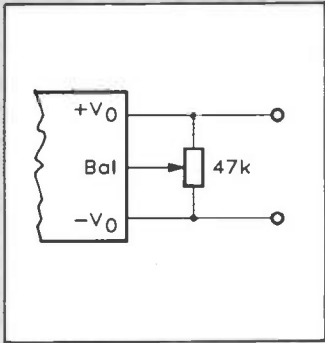

Figure 7. Balancing the output rails.

Kit Available

A complete kit of parts (including a high quality fibreglass PCB with a component legend to aid component positioning) is available, allowing a basic $\pm 15V$ power supply to be constructed using the RC4195 IC. To aid heat dissipation, it is recommended that the regulator device is soldered directly to the PCB, so that the copper track will act as a heatsink. The circuit diagram for the kit is given in Figure 8, and the PCB legend is shown in Figure 9.

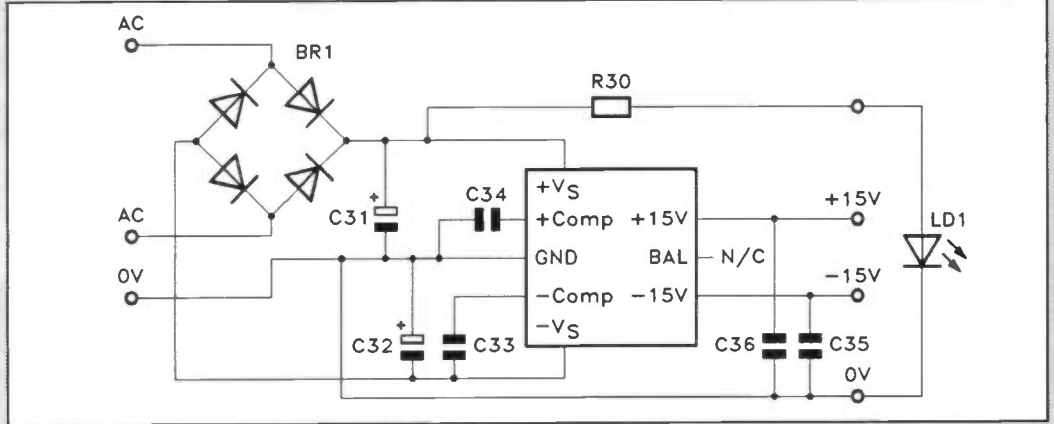
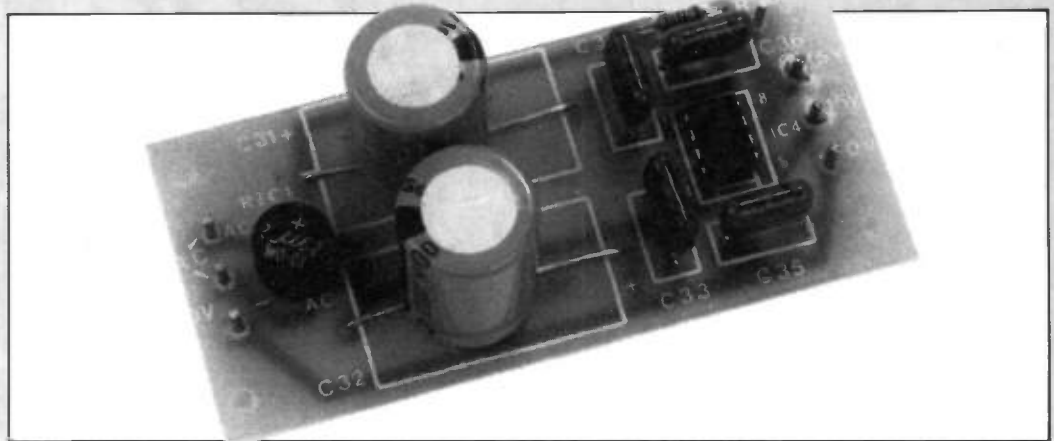

Figure 8. Circuit diagram.



The assembled $\pm 15V$ regulator PCB.

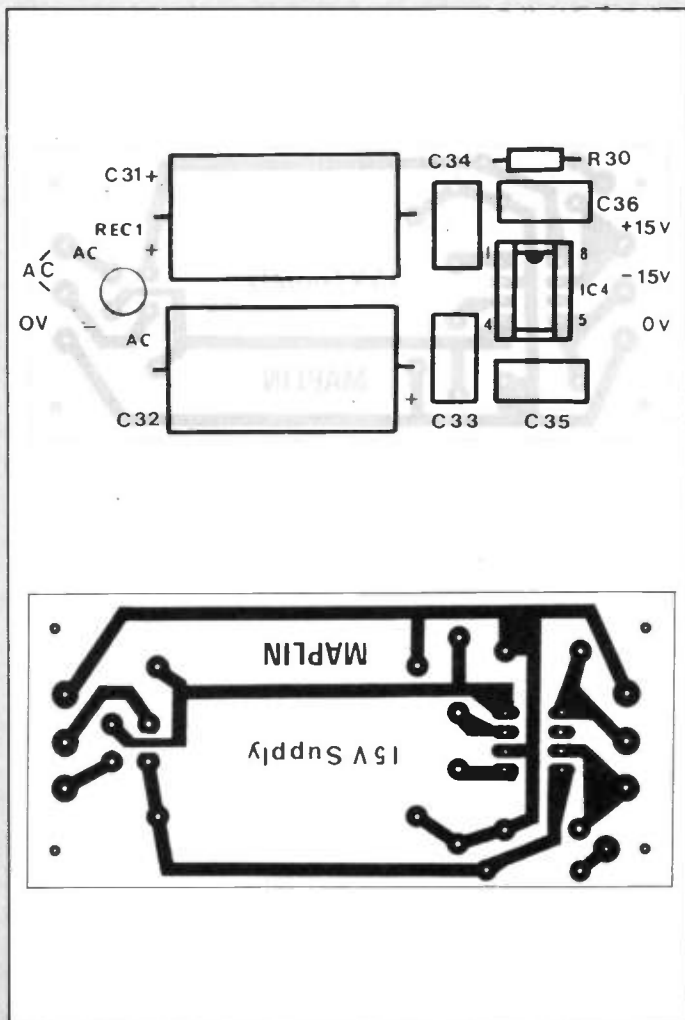

Figure 9. PCB legend and track.

RC4195 $\pm 15V$ REGULATOR PARTS LIST

RESISTOR: 0.6W 1% Metal Film

R30 1k8 1 (M1K8)

CAPACITORS

C31,32 PC Elect 1000 μ F 35V 2 (FF18U)

C33,34,35,36 Polyester 100nF 4 (BX76H)

SEMICONDUCTORS

IC4 4195 1 (XX02C)

BR1 W01 1 (QL38R)

LD1 LED Red 1 (WL27E)

MISCELLANEOUS

Pins 2141 1 Pkt (FL21X)

PCB 1 (XX04E)

Instruction Leaflet 1 (XT33L)

Constructors' Guide 1 (XH79L)

The Maplin 'Get-You-Working' service is not available for this project.

The above items are available as a kit, which offers a saving over buying the parts separately.

Order As LP88V (4195 Data File) Price £4.95.

Please Note: where 'package' quantities are stated in the Parts List (e.g. packet, strip, reel, etc.) the exact quantity required to build the project will be supplied in the kit.

PART SIX
The Inductor-Resistor-Capacitor Series Circuit

by Philip Lawton

PREDICTING WAVESHAPES USING A COMPUTER

Introduction

Carrying on from the Resistor-Inductor-Capacitor circuit predictions of Part 5, this part contains some very important facts about the responses of the Inductor-Resistor-Capacitor series circuit, to a sinusoidally varying voltage. It actually follows on from Part 2 (the Capacitor-Resistor series circuit). Again, 'Things to do' are suggested.

Synopsis

There are two important facts. Firstly, at one particular frequency, the circuit current is *in phase* with the supply voltage. Secondly, at a slightly lower frequency, the maximum capacitor potential may be *greater* than the supply voltage.

Listing 11 (GW-BASIC) and Listing 12 (BBC BASIC) detail the short computer program used to calculate the impedance, current and capacitor potential of the Inductor-Resistor-Capacitor series circuit (the LRC circuit). However, these programs can be adapted for other machines.

The impedance, calculated over four decades of frequency, is shown in Figure 19. The capacitor potential, associated with resistances of 10100Ω and 800Ω , is shown in Figures 20 and 21 respectively.

Figure 22 shows the input to a computer program called 'IC' (not shown here), required for the calculation of impedance, current and capacitor potential. The results are plotted as a Bode diagram in Figure 23, the magnitude terms for which can be found in the Appendix. (Refer to Part 2 for details on Bode diagrams).

The program 'IC', which runs on a PC and performs impedance and complex number calculations, provides tabulated inputs, calculations and results, plus the three classic graphs: sinusoidal waveforms of all the signals; Bode diagrams of the frequency response; and harmonic summation of 0 to 16 harmonics. It can be used to model passive circuits and evaluate transfer functions at any frequency. This program, written by Barry Barker and Philip Lawton, is available for use. (Telephone 0533 413889 (Mondays 2-3pm or 7-8pm) for further details.)

Things to Do

Construct the circuit and measure the voltage drop across the resistor for an input of $1.\sin.(1000.t)V$. Use an oscilloscope to estimate the phase, and then calculate the current and the impedance. Compare the measurements with the

predictions, and consider the accuracy of the theory. Then repeat the above for the capacitor potential at appropriate frequencies.

Amend the short program, so that it will plot the Bode diagrams. Listings 11 and 12 show the program, which uses a FOR...STEP...NEXT loop and the statement 'W = 10 ↑ P' in order to increment the frequency according to a logarithmic law. It calculates the impedance, current and capacitor potential in both magnitude and phase.

The formula for the total reactance (X) associates a negative sign with the capacitive reactance. This is done so that the predicted results agree with the measurements in magnitude and phase. Note that the capacitive reactance itself is not negative.

At one frequency the inductive reactance and the capacitive reactance sum to zero, and thus the predicted

SERIES CIRCUIT L-R-C FREQUENCY AND IMPEDANCE

| r/s | dBs | degs |
|-----------|--------|--------|
| 10.00 | 100.04 | -84.24 |
| 31.62 | 90.41 | -72.28 |
| 100.00 | 83.01 | -44.43 |
| 316.23 | 80.42 | -15.74 |
| 1000.00 | 80.09 | 0.00 |
| 3162.28 | 80.42 | 15.74 |
| 10000.00 | 83.01 | 44.43 |
| 31622.78 | 90.41 | 72.28 |
| 100000.00 | 100.04 | 84.24 |

Figure 19. Calculated impedance, R = 10100Ω (80.09dB).

```

5 REM LRC PC version
10 SCREEN 2 : CLS
20 PRINT " SERIES CIRCUIT L-R-C"
30 PRINT " FREQUENCY AND IMPEDANCE"
40 PRINT "          r/s          dBs          degs"
50 L=1 : R=10100 : C=.000001 : E=1
60 FOR P=1 TO 5 STEP .5 : W=10^P
70 X=W*L-1/(W*C) : REM -OPERATOR
80 ZMAG=SQR(R^2+X^2) : REM MAGNITUDE
90 ZPHA=ATN(X/R)*57.3 : REM PHASE
100 IMAG=E/ZMAG : IPHA=0-ZPHA
110 VMAG=IMAG*1/(W*C) : VPHA=IPHA-90
120 PRINT USING "#####.##";W,20*LOG(ZMAG)/2.3026,ZPHA
130 NEXT P
140 REM Note +20dBs per decade or 0. Correction 3dBs.
150 REM wn=1000 R=2000 zeta=1
160 REM V>1 when R<1414 zeta<0.707
170 REM PSET(LOG(W)/2.3,20*LOG(Z)/2.3) I V
180 REM L-R and C-R circuits R=1000

```

Listing 11. The prediction program in PC GW-BASIC.

```

5 REM LRC BBC Acorn version
10 MODE 4
20 PRINT " SERIES CIRCUIT L-R-C"
30 PRINT " FREQUENCY AND IMPEDANCE"
40 PRINT "          r/s          dBs          degs"
50 L=1 : R=10100 : C=1E-6 : E=1 : @%=&2020A
60 FOR P=1 TO 5 STEP .5 : W=10^P
70 X=W*L-1/(W*C) : REM -OPERATOR
80 ZMAG=SQR(R^2+X^2) : REM MAGNITUDE
90 ZPHA=ATN(X/R)*57.3 : REM PHASE
100 IMAG=E/ZMAG : IPHA=0-ZPHA
110 VMAG=IMAG*1/(W*C) : VPHA=IPHA-90
120 PRINT W,20*LOG(ZMAG),ZPHA
130 NEXT P
140 REM Note +20dBs per decade or 0
150 REM wn=1000 R=2000 zeta=1
160 REM V>1 when R<1414 zeta<0.707
170 REM PLOT69,LOG(W),20*LOG(Z) I V
180 REM L-R and C-R circuits R=1000

```

Listing 12. The prediction program in Acorn BBC BASIC.

impedance is resistive only. This frequency, where $\omega L = 1 / (\omega C)$, is called the *resonant frequency*. It is equal to the natural frequency $\omega_n = 1 / (\sqrt{C \cdot L})$. The program can be altered to model the L-R or the C-R circuit (use $R = 1000\Omega$ to yield $\omega_b = 1000$ rad/s).

Figure 19 shows the results of the impedance calculated over four frequency decades. As the frequency is changed from $1E1$ to $1E5$ rad/s, the impedance changes; from capacitive, through resistive, to inductive. One important result occurs while the circuit is resistive (10100Ω at $1E3$ rad/s); the circuit current is *in phase* with the supply voltage. The resonant frequency is $1E3$ rad/s (159Hz), and it can be predicted mathematically by $\omega_n = 1 / (\sqrt{C \cdot L})$.

When the circuit resistance is high [deduced using the damping factor $Z = (R/2) \cdot (\sqrt{C/L})$], there are two other interesting frequencies. These are the break-up frequencies of $1E2$ and $1E4$ rad/s associated with $R = 10100\Omega$. At these frequencies the *asymptotes* (remember them from Part 2?) meet, the magnitude correction is 3dB, and the associated phase shift is 45° . The slopes of the asymptotes are $-/+20$ dB/decade and 0 dB/decade. A phase shift of 90° occurs over two decades at each break frequency. There is also a constant phase shift of 90° , which can be deduced from the term $1 / (\omega \cdot C \cdot R)$, as well as a slope of -20 dB/decade (see Appendix 1).

At lower values of resistance ($R \approx 2000\Omega$), there are still two break-up fre-

quencies as well as the term $1 / (\omega \cdot C \cdot R)$, but the individual effects overlap (see Appendix 1). For very low values of resistance ($R < 2000\Omega$), the asymptotes meet at the natural frequency, and the corrections are obtained from normalised curves.

Figure 20 shows the predicted capacitor potential over four frequency decades, when the resistance is 10100Ω . At low frequencies, the capacitor voltage is equal to the input voltage. It is attenuated at higher frequencies, initially at 20 dB/decade, and finally at 40 dB/decade. The break-down frequencies are $1E2$ and $1E4$ rad/s. The circuit is overdamped; the damping factor, Z , is greater than unity ($Z > 1$; for $R = 10100\Omega$, $Z = 5.05$).

SERIES CIRCUIT L-R-C

FREQUENCY CAPACITOR VOLTS

| r/s | dBs | degs |
|-----------|--------|---------|
| 10.00 | -0.04 | -5.76 |
| 31.62 | -0.41 | -17.72 |
| 100.00 | -3.01 | -45.57 |
| 316.23 | -10.42 | -74.26 |
| 1000.00 | -20.09 | -90.00 |
| 3162.28 | -30.42 | -105.74 |
| 10000.00 | -43.01 | -134.43 |
| 31622.78 | -60.41 | -162.28 |
| 100000.00 | -80.04 | -174.24 |

Figure 20. Calculated potential, R = 10100Ω (Z = 5.05).

SERIES CIRCUIT L-R-C

FREQUENCY CAPACITOR VOLTS

| r/s | dBs | degs |
|-----------|--------|---------|
| 10.00 | 0.00 | -0.45 |
| 31.62 | 0.01 | -1.44 |
| 100.00 | 0.06 | -4.61 |
| 316.23 | 0.58 | -15.69 |
| 1000.00 | 1.94 | -90.00 |
| 3162.28 | -19.42 | -164.31 |
| 10000.00 | -39.94 | -175.39 |
| 31622.78 | -59.99 | -178.56 |
| 100000.00 | -80.00 | -179.55 |

Figure 21. Calculated potential, R = 800Ω (Z = 0.4).

An interesting result arises where the resistance is 2000Ω; the two break-down frequencies are equal to the natural frequency of 1000 rad/s. The two corrections of 3dB are summed, as are the two phase shifts of -45°. The circuit is critically damped (Z = 1).

Another interesting resistance value is 1414Ω. At the natural frequency, the magnitude is -3dB, whilst the phase is -90°. The circuit is underdamped (Z < 1; for R = 1414Ω, Z = 0.707). The frequency response corresponds to the Butterworth filter (low-pass; two-pole; maximum flat). Two asymptotes (0dB/decade and -40dB/decade) meet at the natural frequency. The correction, which depends on the value of Z, is obtained from normalised curves.

When the resistance is less than 1414Ω, the capacitor voltage is greater than the input voltage over a small range of frequencies.

Figure 21 shows the predicted capacitor potential over four frequency decades. The resistance is 800Ω (Z = 0.4). Note that at frequencies near to the natural frequency, the capacitor potential

is greater than the supply voltage. The attenuation, at frequencies greater than the natural frequency, is 40dB/decade (low pass; two complex poles, or 'peaks').

In Figure 22, the input to the program 'IC' is to undertake the calculations for the frequency response (Bode) diagram. At the natural frequency of 1000 rad/s (159-155Hz), the impedance is a minimum of 800Ω, the current is a maximum of 1.25mA, and the capacitor potential is 1.25V. The frequency can be altered, and all the recalculations displayed. The input is very easy to amend. The program can also be used to evaluate the appropriate transfer functions as well, for harmonic synthesis - but that is another topic!

Figure 23 shows the results plotted as a Bode diagram using the program IC. At the natural frequency of 1000 rad/s (159-155Hz), the impedance has a minimum and the current has a maximum, whilst at nearby frequencies the capacitor potential is greater than the supply voltage. At a frequency of 823 rad/s (131Hz), the capacitor potential has

a maximum of 1.36V. As the resistance is reduced, the impedance is reduced, and the current is increased. The capacitor potential is also increased, and its maximum occurs at frequencies closer to the natural frequency.

Summary

Two important facts have been introduced. Firstly, the current in an L-R-C series circuit can be in phase with the supply voltage (known as 'resonance'). Secondly, the capacitor potential can be greater than the supply voltage if the resistance is low (a condition known as 'underdamped', where Z < 0.707 for sinusoidal voltages).

The circuit is in resonance when $\omega L = 1 / \omega C$. This is equal to the natural frequency, $\omega_n (= 1 / \sqrt{C \cdot L})$. It may have two break frequencies, depending on the value of resistance, and hence the damping factor, $Z (= (R / 2) \cdot \sqrt{C / L})$; $Z \geq 1$. It also has a term $\omega \cdot C \cdot R$.

The tedious and repetitive calculations were undertaken by two different types of computer program, either a few

IMPEDANCE & COMPLEX NUMBER CALCULATIONS.

Frequency = 1.59155E+02 Hz
 $W = 2 * 3.142 * F = 1.00000E+03$ rad/s
 $PT=1/F = 6.283/W = 6.28318E-03$ s

| INPUTS | | RESULTS | | | |
|----------|--------------------------|---|-----------|---------------------|-------|
| ===== | | ===== | | | |
| VARIABLE | | RESISTANCE | REACTANCE | IMPEDANCE | PHASE |
| MNEMONIC | | $A * \sin(W * T) + B * \cos(W * T) = M * \sin(W * T + P)$ | | | |
| VALUE(S) | | | | | |
| EQUATION | | | | | |
| VAR M | VALUE(S) EQUATION | F = 1.59155E+02 Hz | | W = 1.00000E+03 r/s | |
| E1 | P 1.0000E+00, 0.0000E+00 | 1.00E+00 +J 0.00E+00 | | 1.00E+00 +P 0.0 | E1 |
| R3 | R 8.0000E+02 | 8.00E+02 +J 0.00E+00 | | 8.00E+02 +P 0.0 | R3 |
| Z4 | L 0.0000E+00, 1.0000E+00 | 0.00E+00 +J 1.00E+03 | | 1.00E+03 +P 90.0 | Z4 |
| Z2 | = R3 + Z4 | 8.00E+02 +J 1.00E+03 | | 1.28E+03 +P 51.2 | Z2 |
| Z0 | C 0.0000E+00, 1.0000E-06 | 0.00E+00 -J 1.00E+03 | | 1.00E+03 -P 90.0 | Z0 |
| Z1 | = Z2 + Z0 | 8.00E+02 +J 7.32E-04 | | 8.00E+02 +P 0.0 | Z1 |
| I1 | = E1 / Z1 | 1.25E-03 -J 1.14E-09 | | 1.25E-03 -P 0.0 | I1 |
| VO | = Z0 * I1 | -1.14E-06 -J 1.25E+00 | | 1.25E+00 -P 90.0 | VO |

Figure 22. Input to the 'IC' program, producing the results for resonance.

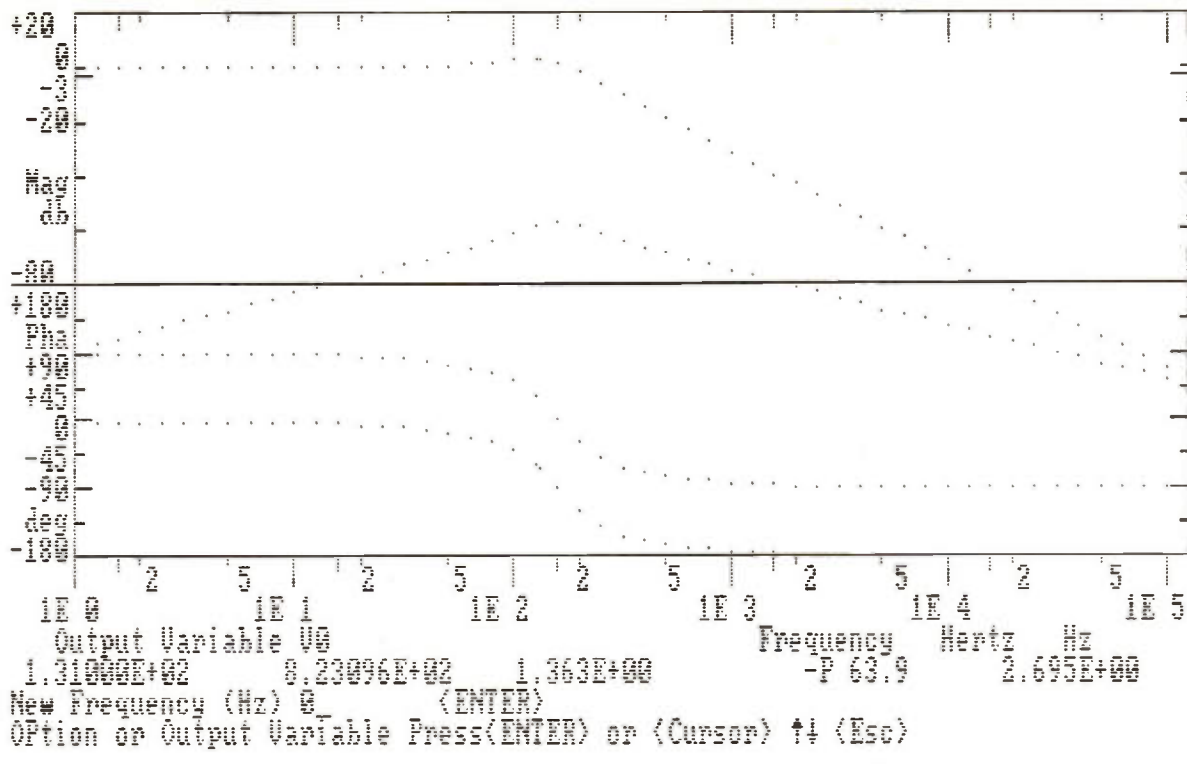

Figure 23. Bode diagram produced by the 'IC' program. R = 800Ω, Z = 0.4. Capacitor potential is at top and circuit current at bottom.

lines of code (Listings 11 or 12), or the program 'IC'. Both are very useful. The L-R-C circuit and its associated theory are of great interest, and are worthy of further study.

Appendix 1

The formulae relating to the Inductor-Resistor-Capacitor series circuit can be rearranged to yield terms, which can be used to plot or sketch the Bode diagram. To achieve this re-arrangement, the algebra has to use operator 'j' (use R + jωL + (1 / jωC)) or operator 's' (use R + sL + (1 / sC)) to label the reactances.

The impedance is:

$$R \cdot \sqrt{1^2 + (\omega\tau_1)^2} \cdot \sqrt{1^2 + (\omega\tau_2)^2}$$

$$\text{phase} = (\arctan [(\omega\tau_1)/1]) + (\arctan (\omega\tau_2)/1) - 1.57$$

The current is:

$$R \cdot \sqrt{1^2 + (\omega\tau_1)^2} \cdot \sqrt{1^2 + (\omega\tau_2)^2}$$

$$\text{phase} = - (\arctan [(\omega\tau_1)/1]) - (\arctan [(\omega\tau_2)/1]) + 1.57$$

The capacitor potential is:

$$\frac{1}{\sqrt{1^2 + (\omega\tau_1)^2} \cdot \sqrt{1^2 + (\omega\tau_2)^2}}$$

$$\text{phase} = - (\arctan [(\omega\tau_1)/1]) - (\arctan [(\omega\tau_2)/1])$$

where τ1 and τ2 are derived from the real roots of the quadratic equation.

$$(L.Css) + (C.Rs) + 1 = 0 \quad (s=j\omega)$$

Also τ = C.R

Notes

1 / (τ1) and 1 / (τ2) are the break frequencies, and are numerically equal to the roots of the quadratic equation. They are called zeros (numerator, break-up) or poles (denominator, break-down).

Consider the roots of 1ss + 2zs + 1, where z has the values 1, 2, 3, 4, 5. The symbol z represents the damping factor, Z. When Z is less than 1, the roots are

complex, and normalised curves are used to sketch the shape of the response about the natural frequency. A program for evaluating the roots of the quadratic is very useful.

$$(L.Css) + (C.Rs) + 1 = ((L/R).(C.R)ss) + ((C.R).s) + 1$$

This is approximately equal to:

$$(((L/R)s) + 1).(((C.R).s) + 1),$$

if (L/R) + (C.R) = (C.R) (large R?),

otherwise the roots of the quadratic are required.

τ1 and τ2 can only be regarded as time constants when they are in the denominator of an appropriate expression.

Bode diagrams are very useful tools, due to the straight lines (asymptotes), and the fact that 'logs of multiplications become additions'. The series concludes with Part 7 in the next issue, which examines rectifier circuits, and plotting the magnitude of ripple on rectified DC supplies, amongst other things.



In next month's super issue of 'Electronics - the Maplin Magazine', there are some really great projects and features for you to get your teeth into! The March issue is on sale 7th February 1992, available from

Maplin's regional stores and newsagents countrywide, and of course by subscription (see page 13 for details). To whet your appetite, here's just a taster of some of the goodies on offer:

VELLEMAN STEREO VALVE POWER AMPLIFIER

A full review on this superb piece of Hi-Fi equipment. How did it sound when matched with suitable speakers and front-end? There is also an informal circuit description, and tips on how to make the most of it in your listening environment.

INFRA-RED VIDEO LINK

For those of you who need a totally legal wireless transmission medium with a bandwidth of 4MHz, look no

further. The March issue gives full construction details for the transmitter.

THE VIDEO BOX

At last, one for the home video enthusiast! By popular demand, we show you how to build a highly versatile video fader and signal processing unit that offers tremendous value for money.

BT MUSEUM

A look behind the scenes of the free-to-enter BT Museum, located in the heart of London. A voucher is included which entitles you to a free booklet when you make your visit. There's also the chance to win an all expenses paid trip to BT's Goonhilly Satellite Earth Station in Cornwall.

ELECTRONICS IN AVIATION

The second part in this fascinating series tackles the subject of aircraft communication. This article also discusses how you can monitor airband transmissions.

PEEP ALARM

A handy and compact alarm with a penetrating siren, which is triggered by changes in light level. Easy to construct, there are numerous uses for this low-cost device.

Plus, of course, there's all the usual features for you to enjoy! 'ELECTRONICS - THE MAPLIN MAGAZINE', BRITAIN'S BEST SELLING ELECTRONICS MAGAZINE.

PERSONAL COMMUNICATIONS NETWORK-

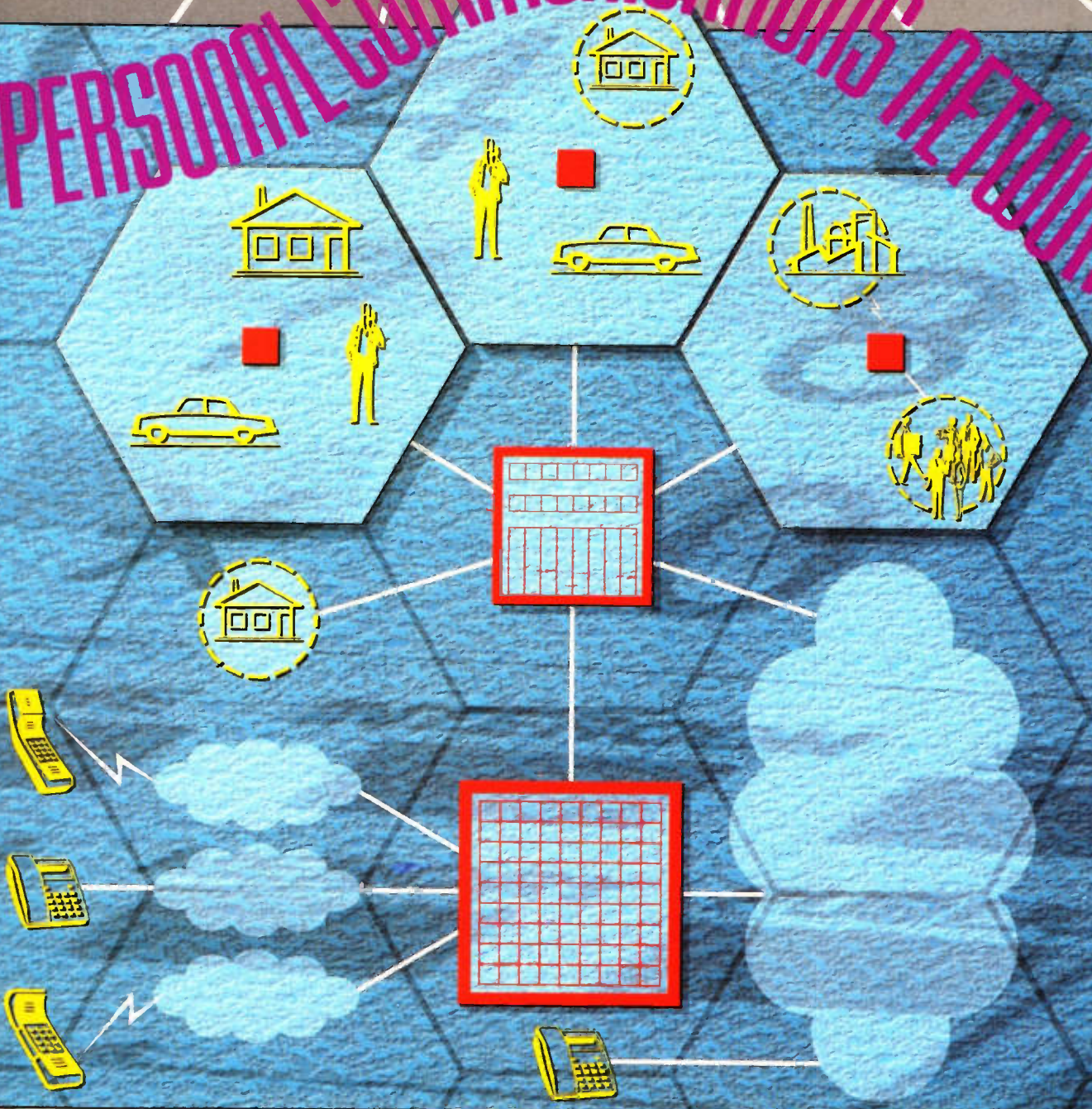

Implementation in the UK

by Peter Ramsdale FIEE

Personal communications networks have been widely tipped as the future course of telecomms. Peter Ramsdale, Technical Director of Unitel, describes how the first networks will be implemented in the UK.

Introduction

What is personal communications? Is it a fixed network or a cellular radio network, an intelligent network, or some combination of cordless telephones and paging? Well, it could be any or none of these. Rather than defining a technology, personal communications is best described by the features that individual users would expect from their 'ideal' telecomms service. Because of this individual nature a

single definition is not possible, but the attributes sought by most people can be encompassed by a common vision.

In January 1989, the UK Department of Trade and Industry published a consultative document entitled 'Phones on the Move', which embodied a vision of a new kind of telephone service available through the use of a single personal handset connected to a network by radio. This would offer a two-way, fully mobile service competing both with existing cellular and public switched fixed network services. In December 1989, licences for personal communications networks (PCNs) were awarded to three consortia: Unitel, Mercury and Microtel.

Since then, almost every participant in the mobile communications arena has tried to link their service to the personal concept. As has been pointed out, what was once known as 'mobile communications' has become 'personal communications'. A number of mobile telecomms services may be described as the precursors rather than the providers of personal communications, ranging from simple paging and early cordless telephony to analogue cellular and the first digital public cordless service, known as telepoint (see Appendices). This list will soon be lengthened by the arrival, this year, of a digital cellular service using the *Groupe Speciale Mobile* (GSM) standard.

COST EFFECTIVE INTERCONNECT

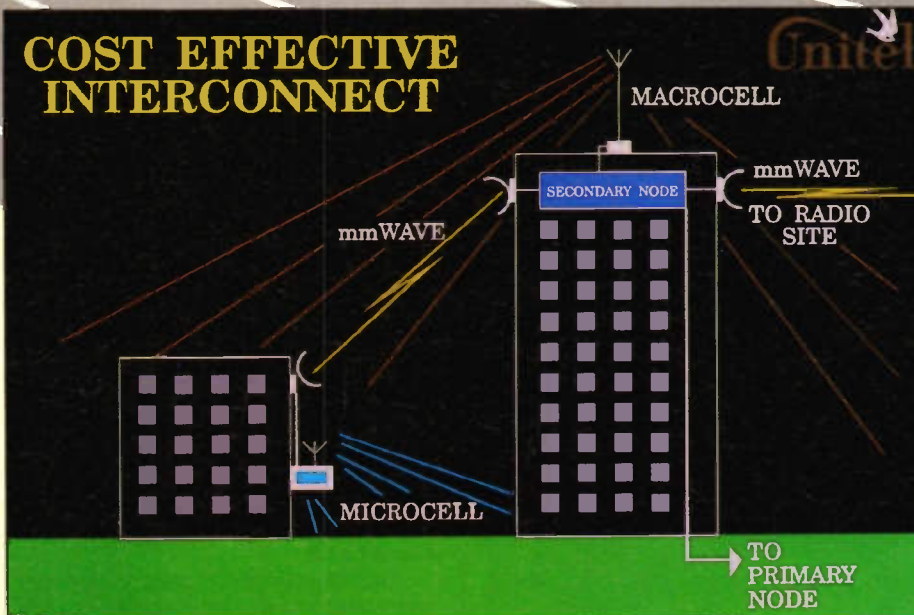

Interconnection between cell sites using millimetre-wave links.

The basic difference between these services and the PCNs due to come into operation in mid-1992 is that PCNs will have been designed and implemented with the specific intention of making the full personal-communications vision a reality. The PCN is the first system attempting to bring both fixed and mobile applications together; a personal service from one handset, not a separate mobile and fixed phone.

In its submission to the DTI during the licence-application process, the Unitel consortium expressed the notion that PCNs would provide 'Phones for people not places'. This is more than just a useful slogan; it is the keystone of a PCN philosophy, to treat people as individuals and align telecomms to suit specific lifestyles. Providing greater choice for the customer was one of the driving forces behind the creation of the licences. PCNs will fulfil this brief not just by providing a more sophisticated telephone service for the person on the move, but by tailoring service packages to meet the demands of a wide variety of users, ranging from the business executive, the doctor or the builder to the teenager, the working parent or the housebound senior citizen. This is the real implication of the personal communications vision.

The Network

To carry the PCN service into everyday use will need a network infrastructure and management system capable of providing a high degree of flexibility and functionality. The PCN operators are investing millions of pounds in the creation of countrywide, state-of-the-art digital telephone networks. These will use advanced network methods to offer a range of features that will be new to most telephone users and will introduce automation in management, maintenance and reconfiguration.

The PCNs will indeed be based on the cellular concept, but there are two clear areas in which they will differ from existing cellular systems. First, the networks will be established from the outset to provide personal communications for the mass market, i.e. they are designed to support low-power portable handsets, unlike the analogue cellular systems, which were originally designed for high-powered carphones. Secondly, to ensure that

they will not suffer the capacity restrictions of existing cellular services, the three UK operators have been allocated a total of 150MHz of spectrum, which is the largest commercial allocation of spectrum ever made (except for TV). This allows PCN to bring the benefits of mobile digital telephony to the mass market for the first time.

These advantages are not the result of any extraordinary technological discovery. They stem more from the trend towards liberalisation and increased competition that has characterised UK government telecomms policy over the past 10 years. The PCN is the latest in a series of initiatives designed to foster improved services for the customer.

Before looking at the technical challenge, it is important to return to the customer perspective to see how the vision will translate

into daily life. The customer will use an inexpensive, lightweight handset. The digital network will ensure a fully mobile service offering good quality. Customers will be able to call, and to receive calls, from anywhere in the world, and service packages will be available providing features to suit the needs of specific user groups. These features will give customers full control over their calls: for example, allowing calls to be diverted to a voice-mail service and taken at a more convenient time.

Although the service described above answers to the demands of the market, extensive market research has shown that the PCN concept is not received as enthusiastically as some might imagine. Cellular services might be said to have blazed the PCN trail, but they have not left a good impression in the public imagination. Poor quality, high cost and social stigma (the 'yuppie image') give PCN a tough act to follow. At the same time, an appreciation of the benefits of constant contact is tempered by a desire to restrict access when required. The network must take all these factors into account to provide a service that ensures accessibility, mobility and control.

Standards

PCN is being developed in the context of international initiatives in mobile telecomms. The Digital European Cordless Telephone (DECT) standard seeks to harmonise cordless telephone standards across Europe, whereas GSM provides for a digital cellular system with



Propagation tests in a typical location (photo courtesy of HMV).



A typical lightweight, low-cost handset.



Different styles of handset will be available to suit the users image and practical requirements.

pan-European roaming capability. Further into the future, the research in advanced communications for Europe (RACE) project proposes merging three types of system: a universal mobile telecomms service (UMTS) with cordless and cellular attributes, a high-bit-rate broadband system probably operating at millimetre-wave frequencies and capable of supporting a mobile office, and a PSTN, the attributes of which can be enhanced by the portable segments.

With PCN scheduled for launch in 1992, choices have been made based on an assessment of evolving technology and an awareness of commercial realities. The main issues concern standards, network design and implementation, and terminal development.

In view of the launch date for commercial service, the DTI ruled that the technical specification for PCN networks must be based on a European standard, the preferred candidates being GSM or DECT. However, a full DECT standard was not available at the time, and the three successful applicants all indicated GSM as the most appropriate basis.

This is consistent with the conclusions reached by the European Telecomms Standards Institute (ETSI) Strategic Review committee on mobile systems, which recommended to the ETSI Technical Assembly in March 1990 that the GSM 900MHz system be further developed for use at 1800MHz.

This choice, together with the pan-European aspect of the standard, will make things easier for operators, manufacturers and users alike. Some changes to the standard had to be made for PCN, however, as it uses considerably higher frequencies (between 1710 and 1880MHz) and to accommodate the specific requirements of personal communications. Work is taking place to establish this standard, which is known as digital cellular system (DCS 1800).

For the first phase, ratified by ETSI in January 1991 it was decided to minimise any changes to the GSM standard. Network architecture and functions, roaming, handover, security features (including the use of subscriber identity modules) and speech transcoding will be similar to GSM. It is mainly

in the RF areas that the standard needed adapting, primarily as a direct consequence of operating in the 1800MHz region and across a much wider frequency band (150MHz, compared with 50MHz).

Operating at twice the GSM frequency, has two important consequences. First, propagation losses increase by 6 - 8dB, which when combined with the requirement to support only hand-portables leads to smaller cell sizes. This is consistent with supporting a mass market.

Secondly, Doppler spread is doubled, and unless taken into account this would cause difficulties when terminals were used in highspeed environments, e.g. intercity trains.

Unitel is carrying out an extensive programme of propagation and interference measurements including both outdoor and indoor tests. Measurements are being made in a wide variety of locations. In fact, radio coverage is being investigated anywhere a subscriber may regularly frequent.

The DTI is allowing the UK PCN operators to share infrastructure to encourage early national coverage of both urban and rural areas, and to reduce the impact of cell site deployment on the environment. Some changes to the GSM standard are necessary to exploit this opportunity.

Technology

In developing the radio specifications, the logical approach to preparing proposals for the DCS 1800 standard was to decide on hand portable power class, establish base station power class, and determine RF performance parameters, particularly intermodulation, spurious emissions and blocking specifications.

Various scenarios were developed regarding the physical separation of mobiles and base stations. These are more rigorous than GSM as regards distance between mobile and base station, which is the key issue in many cases because of the nature of PCN use. In this way the most critical cases were identified, and by a process of iteration it was possible to arrive at parameters that met both service and implementation requirements.

One of the most crucial aspects was the determination of handset power. Two power classes were chosen: 1W and 250mW maximum power, which can be stepped down as operating conditions allow.

Opportunities have been found for relaxing the standard for DCS 1800, which should, in time, reduce the complexity and cost compared with GSM units. In general the relaxations arise from the lower power classes, and many of the parameters that have not changed should also be easier to achieve. Furthermore, since the proposed RF parameters are optimised for hand-portables from the outset, this will give better performance than GSM in the personal communications environment.

Some people suspect that PCN will suffer from a lack of appropriate cheap, low-powered handsets at system start-up. However, the progress made in the standards development



Doctor on call. PCN technology will offer tailored service packages for users.

and definition of RF parameters has given manufacturers ample guidelines to start designing their terminal equipment, and if PCN can reach the mass consumer market the manufacturers will benefit from the economies of scale.

A PCN comprises a grid of macrocells providing contiguous overlay coverage across the country. These cells will vary in size according to the expected traffic density, from less than 1km radius in city centres up to 8km in rural areas. A microcell underlay will be used to maintain service quality and provide capacity at traffic peaks in areas such as stations, shopping centres and sports stadia. To enhance network coverage and quality of service, very small cells, known as picocells, will also be deployed, for example, to cover a single household. Elongated or 'ribbon' cells will be used to provide additional coverage along motorways and other major routes.

Overlay/underlay methods are still in their infancy. They attempt to bring together the attributes of cellular radio, with its regular fixed re-use of frequencies across a grid of cells and small isolated cells, with dynamically allocated channels, such as those used by telepoint bases. These very small cells provide very high capacity, measured in erlangs (see Appendices) per square kilometer, by virtue of their small coverage areas. By matching the available capacity to personal usage patterns, the available radio spectrum is efficiently re-used.

All customers will be fully mobile, and able to move between cells of all types. The 'handover' procedure is not only essential for the provision of a fully mobile service but is also important for quality. Handover reduces the possibility of dropped calls even while stationary, particularly at the edge of cells.

It is worth noting another important stimulus announced by the UK DTI for

differentiating PCN from the existing UK cellular systems. The PCN operators will be allowed, from launch, to use millimeter-wave links to interconnect the base transceiver systems of macro and microcells to the base-station controller.

This will allow a faster and more cost-effective system rollout. The 38GHz band was specified for these links, and the 55GHz band will also be available for short-hop links, for interconnecting picocells and avoiding obstructions in longer hops.

The outcome of the telecomms Duopoly Review could significantly increase the scope for PCN interconnection options. These will provide further opportunities to reduce infrastructure costs.

Agreements

A Memorandum of Understanding (MoU) concluded by the GSM operators and administrations has proved itself to be a very effective forum for co-ordinating common interests (e.g. the design of standard system interfaces to allow multi-vendor sourcing, and a united approach to intellectual property rights), as well as allowing discussions and agreement on the commercial and operational aspects and priorities relating to establishing the GSM system.

On 23rd August 1990, the three UK PCN operators signed a co-operation agreement at the DTI. This is seen as the first stage of a two-stage approach designed to lead to a similar MoU for DCS 1800 operators. Signatories are committed to introduce PCN services in the UK, based on the DCS 1800 standard from 1992, and in other countries at some later date, and to agree on the commercial and operational principles to support roaming from 1993.

The Association of European PCN

Operators has now come into being, and has opened a dialogue with the GSM/MoU to access certain information needed to complement the standard, and to explore and identify areas of common interest where joint activities can be pursued. The association will also provide a focus for other European PCN operators and administrations to join as their plans become clear.

ETSI has agreed a common evolution of the DCS 1800 and GSM standards for phase 2. GSM has determined proposals for the phase 2 work programme and assigned priorities.

The main requirements for phase 2 are:

- ★ Development of the half-rate speech coding specification, including channel coding and associated signalling.
 - ★ Study of dual numbering.
 - ★ Reduced SIM size: 'mini-SIM'.
 - ★ Infrastructure sharing.
 - ★ Operation of mobiles in microcells, including cell selection and re-selection, channel allocation and handover. Solutions will depend on the radio cell structure to be adopted.
 - ★ Flexible introduction of new services.
 - ★ Incorporation of issues specific to frequency, such as extension of the 900MHz band, and incorporation of revised delay profiles at 1.8GHz.
 - ★ Optimisation of phase 1 GSM standard in the light of operational experience.
- All phase 2 work is scheduled for completion by December 1991.

Realisation

With system start-up planned for 1992, PCN operators are keeping to a demanding implementation schedule, developing systems based on emerging technology and effective network design. PCN will turn the vision of 'phones for people, not places', with its promise of more choice and better service, into a practical reality during the 1990s.

Appendices

This article was reproduced by kind permission of Unitel and IEE Review, © IEE Review February 1991. IEE Review and Unitel may be contacted at the addresses given below:

IEE Review,
Michael Farraday House,
Six Hills Way,
Stevenage,
Hertfordshire, SG1 2AY.

Unitel Information Centre,
Elstree Tower,
Elstree Way,
Borehamwood,
Hertfordshire, WD6 1DT.

Telepoint — see 'Electronics' February to March 1989 issue 30 — The Cordless Phone Box Arrives.

Erlang — an erlang is defined as one line busy for one hour. Similarly, two lines busy for half an hour each, or ten lines busy for six minutes each.

INTRODUCTION TO Boolean Algebra

Part 2 by Graham Dixey C.Eng., M.I.E.E.

The Karnaugh Map

The truth table, discussed in Part One, showed the state of the output for each possible input combination. Each line of the truth table corresponded to one of these possibilities. Therefore, to show the complete picture, there had to be as many lines present as there were possible combinations of inputs. We also saw how it was possible to produce the corresponding algebraic expression from the truth table by extracting only those terms for which the output was logic 1. It was then necessary to carry out a minimisation procedure to reduce this algebraic expression to a simpler form. The Karnaugh map is an alternative method of displaying the information contained in the truth table, but with the added advantage of permitting the minimisation to be carried out on the map itself. Once the basic ideas have been grasped, this will be found to be a much easier (and less error-prone) procedure than using algebraic simplification, which often relies upon intuitive methods of finding the right approach or, at the very least, identifying which terms combine for simplification.

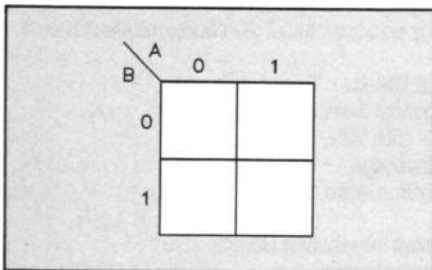

Figure 1. The simplest type of Karnaugh map, for two variables only.

If the Karnaugh map is to represent every condition or state found in the truth table, then it must have a way of storing each of these states. In the truth table they are stored in lines; in the Karnaugh map they are stored in squares, each with its own 'map reference' - hence the reason for calling it a 'map'. But how can we assign map references that relate

logically to the states represented by the map squares? The answer is to use the actual algebraic terms that each of the squares represents. For example, for a three-variable map with variables A, B and C, the first line of the truth table tells us that all three variables have the value logic 0. That is $ABC = 000$. The next combination is $ABC = 001$; the next is $ABC = 010$, and so on. Therefore, we could use a system in which these 3-bit numbers were the actual map references. As we know, a map reference has two parts: the X (horizontal) co-ordinate and the Y (vertical) co-ordinate. Thus, part of the number would have to be the 'X-part', while the other part would become the 'Y-part'. Let us see how this would work out for the simplest type of map, which has two variables only. This map is shown in Figure 1.

Because there is an even number of variables, the map is square. It has just four squares, one for each of the combinations possible. The variables are called A and B, and the values of A form the X co-ordinates, while the values of B form the Y co-ordinates. Each square is identified by the co-ordinates in exactly the same way as for geographical maps, the A co-ordinate being given first. Thus, in this example, the squares are 'mapped' as follows: top left = 00; top right = 10; bottom left = 01 and bottom right = 11.

It is not always convenient to use these numbers to identify the squares. After all, in the algebraic expression that we wish to end up with, all terms will be described alphabetically by combinations of their variable names; A, B, C, etc. Therefore, we need to be able

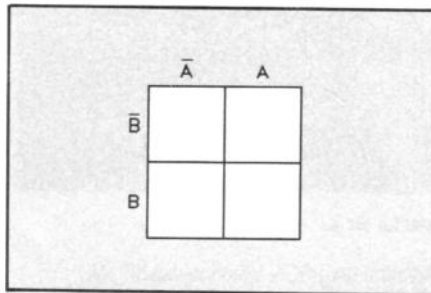

Figure 2. An alternative method of providing the map references.

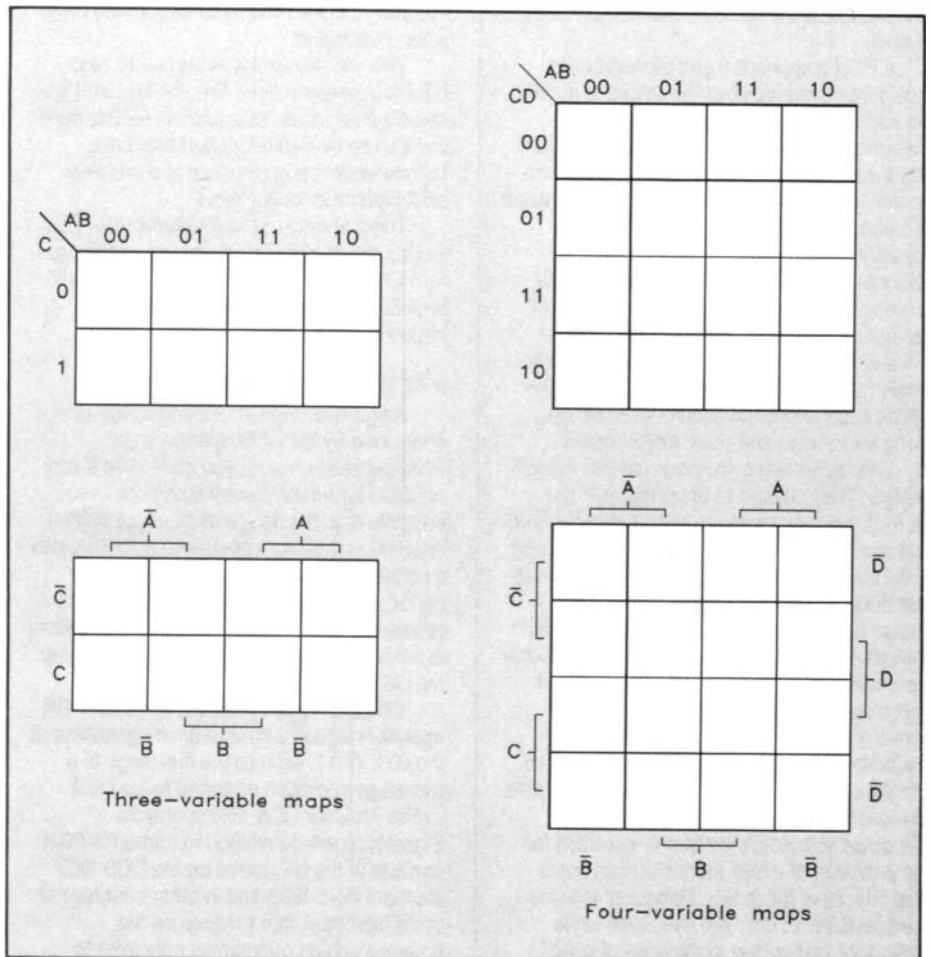

Figure 3. Karnaugh maps for three and four variables. Both types of co-ordinate system (see text) are illustrated.

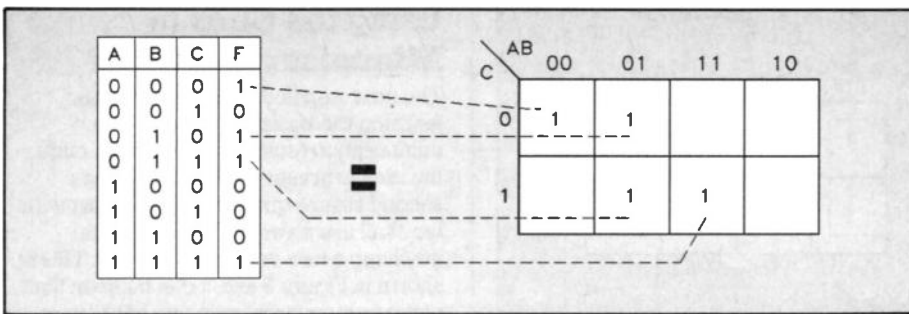

Figure 4. A truth table for three variables, and its corresponding Karnaugh map.

to look at each square and identify it in one of two possible ways – either by the numerical reference described above, or by the corresponding algebraic term. There is nothing new to learn in this, as the following shows:

- The term 00 can be written as $\bar{A}\bar{B}$.
- The term 01 can be written as $\bar{A}B$.
- The term 10 can be written as $A\bar{B}$.
- The term 11 can be written as AB .

For this reason there is an alternative form of map, which some people prefer. It has the advantage of describing the squares in an alphabetic manner, rather than a numeric one. It is probably a matter of what you were taught originally as to which method you prefer using. The map of Figure 1 is redrawn in the alternative fashion in Figure 2. Thus, to identify any square it is only necessary to read off the algebraic references. The top left square now becomes $\bar{A}\bar{B}$ instead of 00. Frankly, it is in one's interest to be able to look at a map and see it in terms of either method of description. It is probably easier to draw the map with numerical references and mentally translate the terms into their algebraic

counterparts, rather than vice-versa. For example, when looking at the top-left square, one sees that $A = 0$ [noting that this gives us not-A (\bar{A})] and that $B = 0$ [noting that this gives us not-B (\bar{B})]. Combining these two snippets of information in the right order tells us that the term for this square is $\bar{A}\bar{B}$.

Karnaugh maps may be drawn for two, three or four variables. For three- and four-variable maps (such as those shown in Figure 3), it is usual to plot A and B horizontally, and C and D vertically. It is important to note how the map references for the squares are arranged; it is not arbitrary. The rule is that, between any two adjacent squares, only one variable changes in value. Thus, across four squares, the sequence of co-ordinates is: 00, 01, 11 and 10 and NOT 00, 01, 10 and 11. The safe way is to memorise this sequence and keep to it.

Mapping a Boolean Function

1. From a truth table

Figure 4 shows a three-variable truth table, and a corresponding three-variable map. It will be noticed that four of the

squares of the map have been filled in with 'ones'. The values of all other squares are zero, but it is usual just to leave them blank. Four lines of the truth table also contain 'ones'. We should not be surprised to discover that they correspond to the same terms in both cases – let us check this. The terms are as follows:

- $ABC = 000$ (i.e. $\bar{A}\bar{B}\bar{C}$)
- $ABC = 010$ (i.e. $\bar{A}B\bar{C}$)
- $ABC = 011$ (i.e. $\bar{A}B.C$)
- $ABC = 111$ (i.e. $A.B.C$)

Both the numeric and alphabetic co-ordinates are given. Whichever is used, it should be quite clear that the four terms of the truth table correspond to the same four terms on the map.

2. From an algebraic statement

It is possible that, instead of having a truth table as a starting point, we have an algebraic statement. The previous example would be described by the statement:

$$F = \bar{A}\bar{B}\bar{C} + \bar{A}B\bar{C} + \bar{A}B.C + A.B.C$$

These four terms have to be transferred onto the map. If we use alphabetic co-ordinates then these terms are the co-ordinates for the squares. However, if we are using numeric co-ordinates on our map we must transpose the above, mentally or otherwise, into this form. Remembering that a variable that has a negation bar over it is represented by a '0' (or a '1' if it does not), the expression now looks like this:

$$F = 000 + 010 + 011 + 111$$

It is most unlikely that we should actually write down the expression in this form. It is given to illustrate the point being made. In practice it is much more likely that we should enter the terms, one at a time, onto the map.

Forming Cells

This is an essential step in the process of using the map to minimise a function. A 'cell' is nothing more than a group of adjacent 'ones' in the form of a square or rectangle in which there could be two, four, eight or sixteen 'ones'. The rectangles may be horizontal or vertical, but NEVER diagonal – and only the groups stated are permitted. Figure 5 shows some common cells, which should be fairly obvious. The only cell of this type not shown is one which contains 16 'ones', occupying the whole of a four-variable map. It can be said now that when ALL squares of ANY map are completely filled with 'ones', then $F = 1$. You can't get any simpler than that!

There are other cells that can be formed (following the same rules for shape and size), originating from a peculiarity of the Karnaugh map. The concept arising from this peculiarity can be stated as follows:

"For the purposes of forming cells, the opposite edges of the map may be considered to be adjacent."

This obviously won't be relevant to two-variable maps (they are adjacent

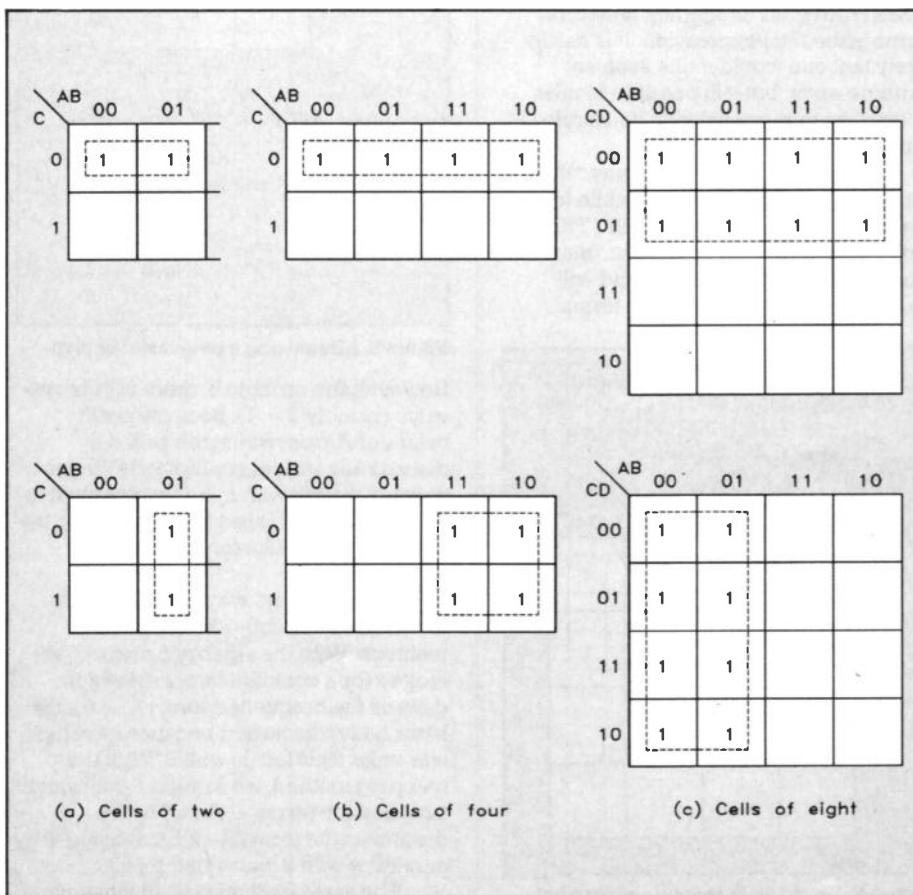

Figure 5. Some common cell groupings.

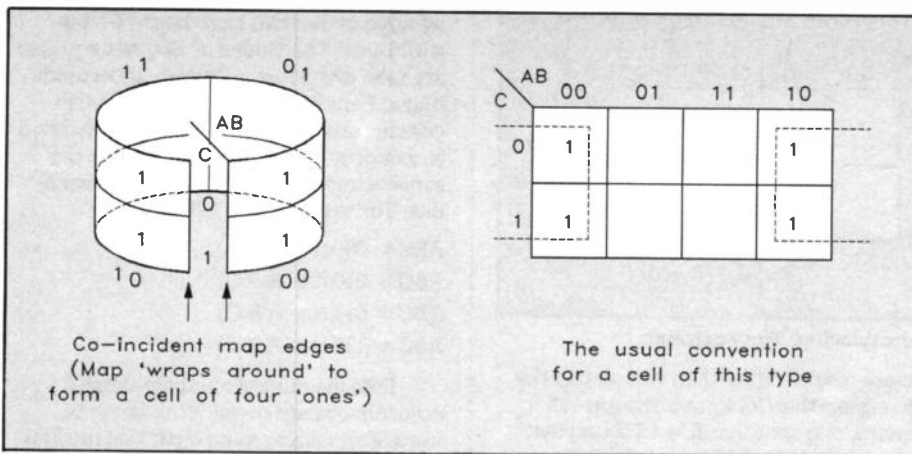

Figure 6. The 'wrap-around' effect of the three-variable map.

anyway); nor will it be relevant to the top and bottom edges of three-variable maps, for the same reason. It does, however, apply to the left and right edges of the three-variable map, and to all edges of four-variable maps. This concept, when applied to the three-variable map, is particularly easy to appreciate, as can be seen from Figure 6. All one has to do is imagine that the map is 'wrapped around', like the label on a can of baked beans, so that the ends are together. The two 'pairs of ones' are clearly adjacent and combine to form a single square group of four ones. A problem arises when we try to visualise a physical analogue of the four-variable map, because we are faced here with the situation of a map that not only wraps around from left to right, but also from top to bottom at the same time! This sort of concept is best accepted without the benefit of a mental image. An example to illustrate this 'dual wrap-around' effect appears in Figure 7.

Based on this concept, the map of Figure 7 can be understood by appreciating that the top-left square is adjacent to the top-right square, and also to the bottom-left square. Similarly, the top-right square is adjacent to the top-left square, and also to the bottom-right square. Thus, all four squares containing ones are adjacent, and form a square cell of four ones.

The Golden Rule of Mapping

This can be stated as follows:

"Always form the *smallest* number of the *largest* size cells possible."

There is a very good reason for doing this. Every cell that is formed on the map represents a term in the final, simplified, expression. Since it is the aim of this exercise that the final expression should be as simple as possible, the fewer the number of terms (and hence cells) the better. In addition, the larger a cell is, the simpler the term that it represents. All of this has to be taken on trust at the moment, but will be quite clear a little later. On the basis that the silliest ideas stick in the memory best, we shall now take a particularly silly example to illustrate this point. This is shown in Figure 8.

The simplest cell formation is just one rectangular cell of eight. However, it is possible to form no less than SIX

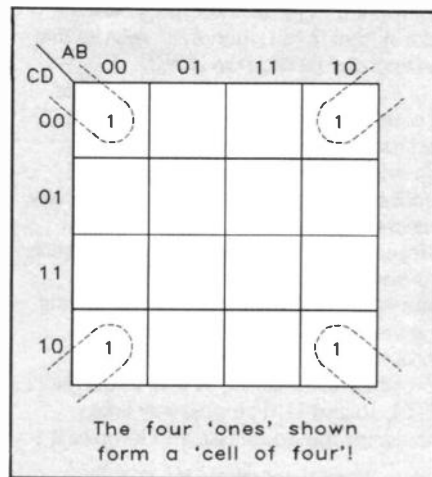

Figure 7. An example of the 'dual wrap-around' effect on the four-variable map.

horizontal cells of two (three per line), FOUR vertical cells of two; TWO square cells of four and TWO rectangular cells of four.

This makes a grand total of FOURTEEN cells altogether, hence 14 terms in the final expression. It is hardly likely that one would make such an extreme error, but it is possible to miss getting the minimal solution if this rule is forgotten.

To state the rule another way: "Try to form as few cells as possible while trying to include all 'ones' within a cell". This won't always be possible; some 'ones' simply won't fit into any cell, and will have to be left as unsimplified terms.

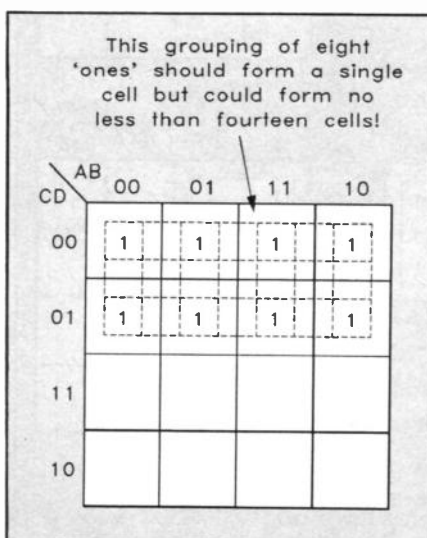

Figure 8. An extreme example of forming too many cells!

Using the Cells to Minimise a Function

The next step is crucial as it involves learning the basic idea behind the minimisation technique. However, once the idea is grasped, its use becomes second nature quite quickly. To start with we shall use a very simple example, involving a two-variable map only. This is shown in Figure 9 and it can be seen that, of the four squares, only two have been filled in, namely the lower two. These form a single cell of two, the two squares representing the terms $AB = 01$ (i.e. $\bar{A}.B$) and $AB = 11$ (i.e. $A.B$). If we were using algebraic methods to minimise this function, we should write: $F = \bar{A}.B + A.B$ and then look for a common factor in the two terms. It is, of course, B . We should then factorise the expression to give:

$$F = B(\bar{A} + A)$$

Since the value of $\bar{A} + A$ is 1, this expression reduces to $F = B$. This shows that the variable A is redundant. Now we are going to achieve the same result with the Karnaugh map, using the following method:

We examine the cell that we have pencilled in, and look at the co-ordinates of the 'ones' within that cell. We notice that, as far as variable A is concerned, both possible values of A appear within the cell (i.e. $A = 0$ and $A = 1$, corresponding to \bar{A} and A respectively).

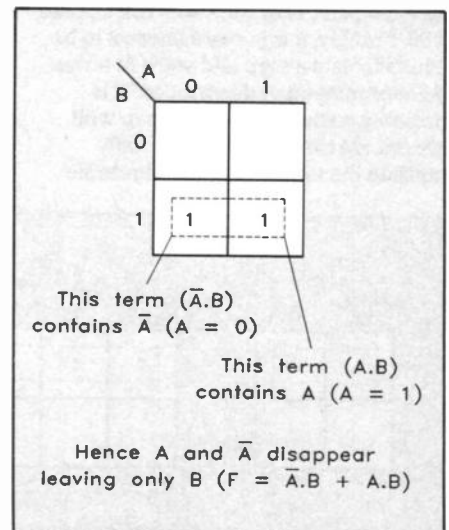

Figure 9. Minimising a two-variable map.

However, for variable B , there is only one value (namely $B = 1$). Because both values of A exist within the cell, we discard this variable completely. We are then left simply with $B = 1$; in other words just B . The result is just the same as for the algebraic simplification carried out previously.

To understand why the result is the same, think carefully about the two methods. With the algebraic method, we looked for a common factor (B) which gave us the bracketted term ($\bar{A} + A$), the latter being discarded because its value was unity. This left us with B . With the mapping method, we formed a cell which included the terms \bar{A} , A and B . We discarded the terms \bar{A} and A , leaving ourselves with B . Same end result!

The same method is used whatever the size of the cell, the complication that

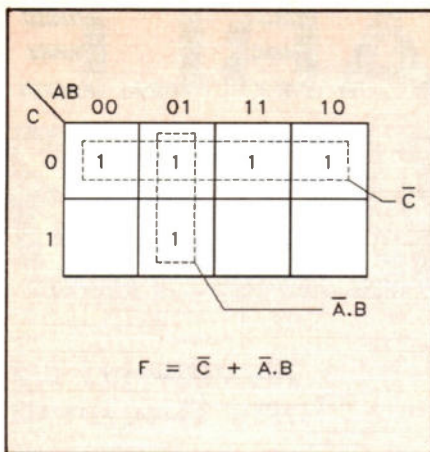

Figure 10. Minimising a three-variable map.

arises being that very large cells eliminate more than one variable. The following statements are always true, irrespective of the size of the map:

- A cell of two eliminates just one variable.
- A cell of four eliminates two variables; on a two-variable map, the function simplifies to '1'.
- A cell of eight eliminates three variables; on a three-variable map, the function simplifies to '1'.
- A cell of sixteen eliminates four variables; on a four-variable map, the function simplifies to '1'.

Let us now take a more complicated example. In Figure 10, a three-variable map has five squares filled in, to give a cell of four and a cell of two. Taking the former first, we note that both of the variables A and B exist in both values within the cell. In other words, within this cell we have $A = 0$; $A = 1$; $B = 0$ and $B = 1$. Thus, both of these variables are discarded within this cell. This leaves only $C = 0$ (\bar{C}); in other words, this cell simplifies to just \bar{C} . In the case of the cell of two, variable C is present in both its 'divisions' and so is discarded, leaving us with $AB = 01$ i.e. $\bar{A}.B$. The simplified function is the OR of the terms left over i.e. $F = \bar{C} + \bar{A}.B$. This result is easily checked, by writing out the full algebraic expression (which is $F = \bar{A}.B.\bar{C} + \bar{A}.B.C + A.B.\bar{C} + A.B.C + \bar{A}.B.C$) and factorising it in the usual way. If done correctly, the result should be the same. Why not try it and see?

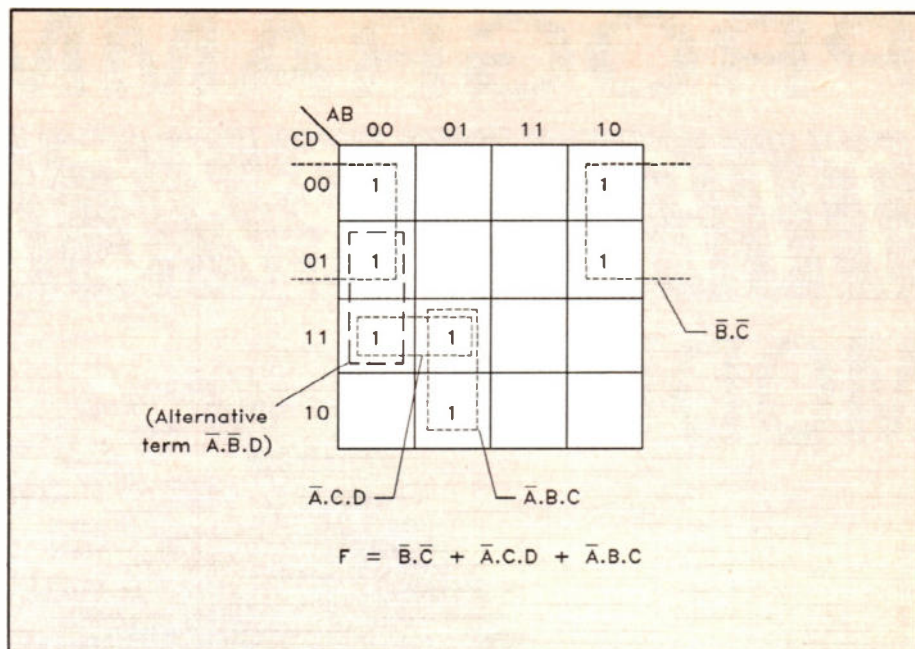

Figure 11. Minimising a four-variable map, with alternative cells.

It may now have been appreciated that the use of the Karnaugh map for minimising or simplifying an algebraic expression is nothing more than an application of the axiom that $X + \bar{X} = 1$, where X is any variable you like: A, B, C, etc. This is clear when it is remembered that the term (or terms) to be eliminated is always that which exists within a cell in both its '0' and '1' forms, as with the algebraic method.

One final example to conclude the matter. Figure 11 shows a four-variable map in which there are three cells; one cell of four and two cells of two. However, it also illustrates what is quite a common situation. The square occupied by the term 0011 can link with either the square immediately to its right (as we have actually done here), or it could link instead with the one immediately above (as marked on the diagram with coarse dashed lines). It doesn't matter which cell we choose to form; the result will be as simple either way, although there will, of course, be a difference in the final algebraic expression. This doesn't matter either but it does show that there isn't always a unique result. Had we minimised by factorising we should have encountered the same situation, namely two alternative factorisations.

Looking at the map, just before examining the cells in detail, let us consider what it tells us in the light of what we already know. There are three cells, hence three terms in the final expression. The cell of four will eliminate two variables (leaving two), while each of the two-variable cells will only eliminate one variable, leaving three in each term.

Starting with the cell of four, the variables to be eliminated using our rules are A and D, since these are the ones for which both values (0 and 1), exist. What is left is the two-variable term $\bar{B}.C$. For the horizontal cell of two, only B will be eliminated, leaving the term $\bar{A}.C.D$. For the vertical cell of two, only D is eliminated, leaving the term $\bar{A}.B.C$. The final expression is, therefore:

$$F = \bar{B}.C + \bar{A}.C.D + \bar{A}.B.C.$$

If the above three examples have been followed, there should be no difficulty in handling any others, since there is just the one rule to apply all the time, once the cells have been identified.

The first two articles on Boolean algebra have laid the foundations, upon which its practical applications in logic circuit design will rest. This will be the subject of the next, and final, article.

COMPETITION WINNERS

Bob's Best Books Competition

The questions and correct answers were as follows:

- How many books has Robert Penfold written? **93.**
- In H.G. Wells' book 'War of The Worlds', which planet did the invaders come from? **Mars.**
- How old is Robert Penfold? **38.**
- Who is the Editor of 'Electronics - The Maplin Magazine'? **Robert Ball.**

The lucky winner is:

Mr. A.J. Goloskof of Tewkesbury, Gloucestershire, who will receive a copy of each of Robert Penfold's top ten best selling books currently stocked by Maplin.

These are: *Getting The Most From Your Multimeter*; *More Advanced Uses of The Multimeter*; *How to Use Oscilloscopes and Other Test Equipment*; *Power Supply Projects*; *More Advanced Power Supply Projects*; *Electronic Music Projects*; *More Advanced MIDI Projects*; *Audio Amplifier Construction*; *Electronic Security Devices*; and *How To Expand, Modernise and Repair PCs and Compatibles*.

The Science Museum Competition

The questions and correct answers were as follows:

- In Britain, a typical family's energy bills (gas, electricity, petrol etc.) add up in one year to: **more than £700.**

- Gear wheels were invented: **about 2,000 years ago.**

- The world's largest telescope mirror is: **about six metres across.**

- If all the TV programmes seen by an average person in Britain in one year were put end to end, how long would they last: **more than one month (closer in fact to two months).**

The following four lucky people will each receive a one year family season ticket, normally costing £15, allowing two adults and up to four children an unlimited number of visits to the Science Museum throughout 1992:

Mr. Alex Edwards, Dunsfold, Surrey; Timothy Pratt, Walton-on-Thames; Mr. Peter Scrivener, Totton, Hampshire; M.L. Peake, Bilston, West Midlands.

PROGRAMMABLE

TIMER/CLOCK

MODULE

Reviewed by
Tony Bricknell

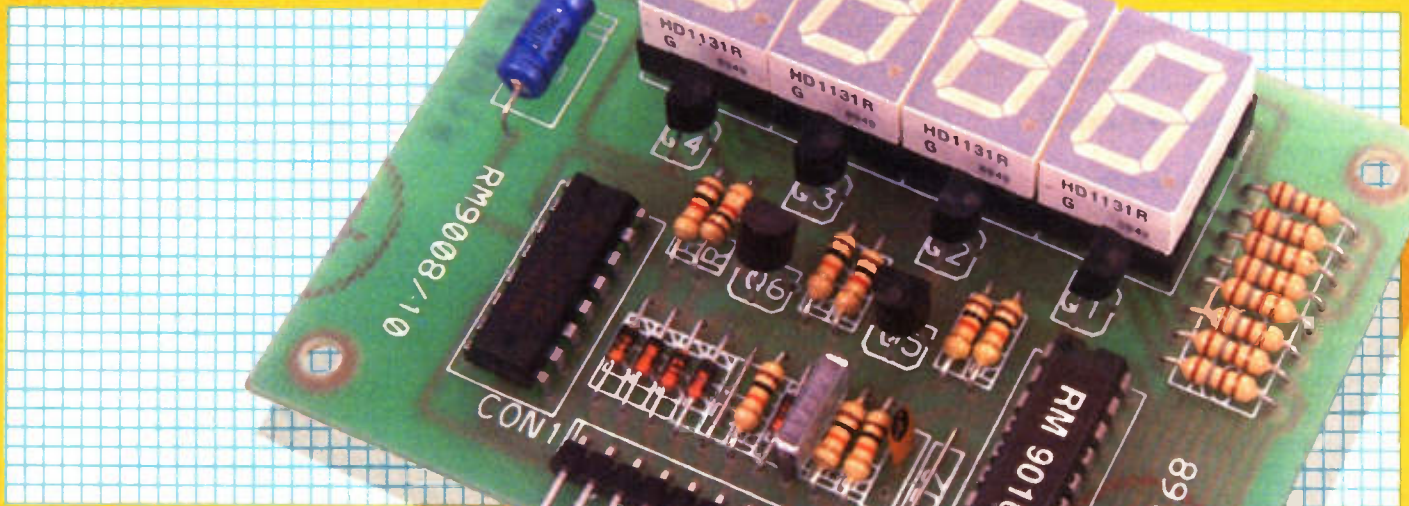

The RM9010 is a ready-built single-board fully programmable timer/clock module, supplied with a comprehensive instruction leaflet.

Figure 1 shows the circuit diagram of the module. All connections to the module are present on a single 9-way connector, CON1. The wiring diagram of the RM9010 is shown in Figure 2. Four non-latching push-to-make switches are required to control the timer (SW1-SW4), and are connected to CON1-1 to CON1-4, with a common connection on CON1-5. An open-collector switched output is available on CON1-7 enabling the module to be used with a variety of different equipment. Note that this can only switch a maximum of 50V/100mA. To facilitate the switching of higher currents, the output may be used to switch a separate, off-board relay. When switching DC resistive or inductive loads up to 16A, it is recommended that the 'Remote Power Switch' kit is used (LP07H).

For switching 240V AC mains, it is recommended that the 'Mains Opto-Switch' kit (LP55K) is used. This employs a zero-crossing fired triac to virtually eliminate all switching noise that would otherwise occur. Note that TR1 should not be inserted, and instead a wire link should be placed between its collector and emitter pads on the PCB, as shown in Figure 2.

FEATURES

- ★ ½ inch 4-digit LED display
- ★ 2 programmable 'on' times
- ★ 2 programmable 'off' times
- ★ Manual on/off override and timer enable/disable function
- ★ Single +5V/100mA supply required
- ★ Clock input for mains frequency
- ★ 50V/100mA Open-collector switched output

APPLICATIONS

- ★ Security lighting control
- ★ Recording radio transmissions at preset times
- ★ Immersion heater control
- ★ Central heating control

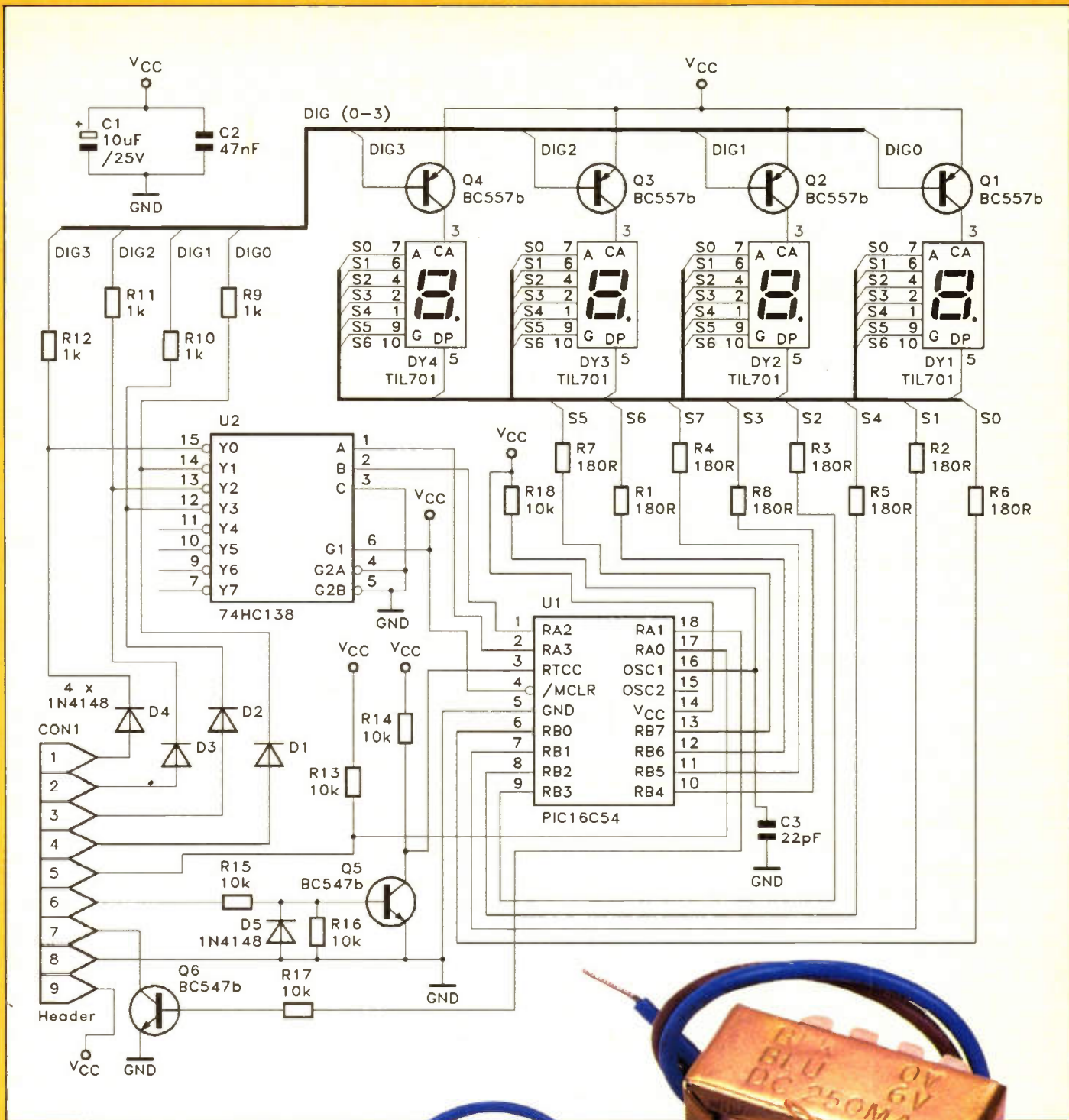

Figure 1. Circuit diagram.

Power Supply

The RM9010 requires a single supply voltage of +5V, and will draw an absolute maximum of 100mA. This is applied to CON1-9 (+5V) and CON1-8 (0V), and a 50Hz timebase applied to CON1-6. Figure 3 shows a suitable power supply which enables the module to be used with 240V 50Hz mains. This circuit can be built on stripboard; a suggested layout is shown in Figure 4. Alternatively, using the circuit shown in Figure 5, the module can operate from a DC voltage of between 7 and 15V. In this circuit, the 50Hz timebase is generated by IC1, with the benefit that the module can remain operative during a mains failure. A suggested stripboard layout for this circuit is shown in Figure 6.

Photos 1 and 2 show the two power supply circuits, each assembled on pieces of stripboard.

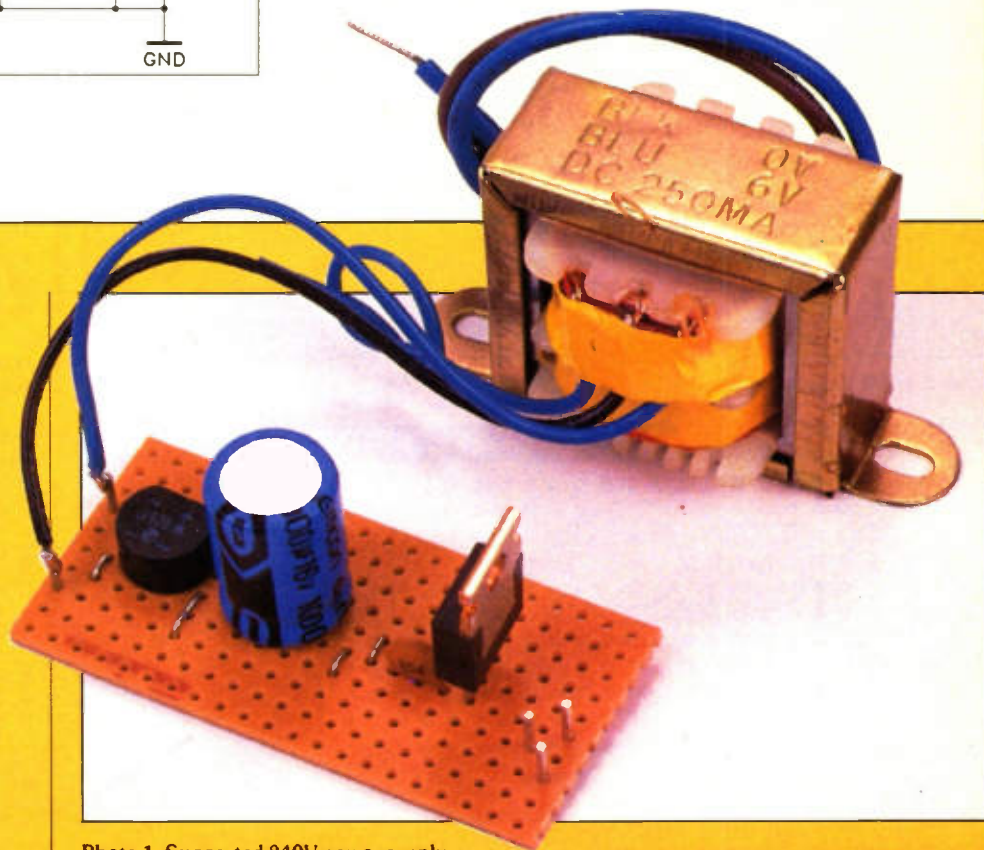

Photo 1. Suggested 240V power supply.

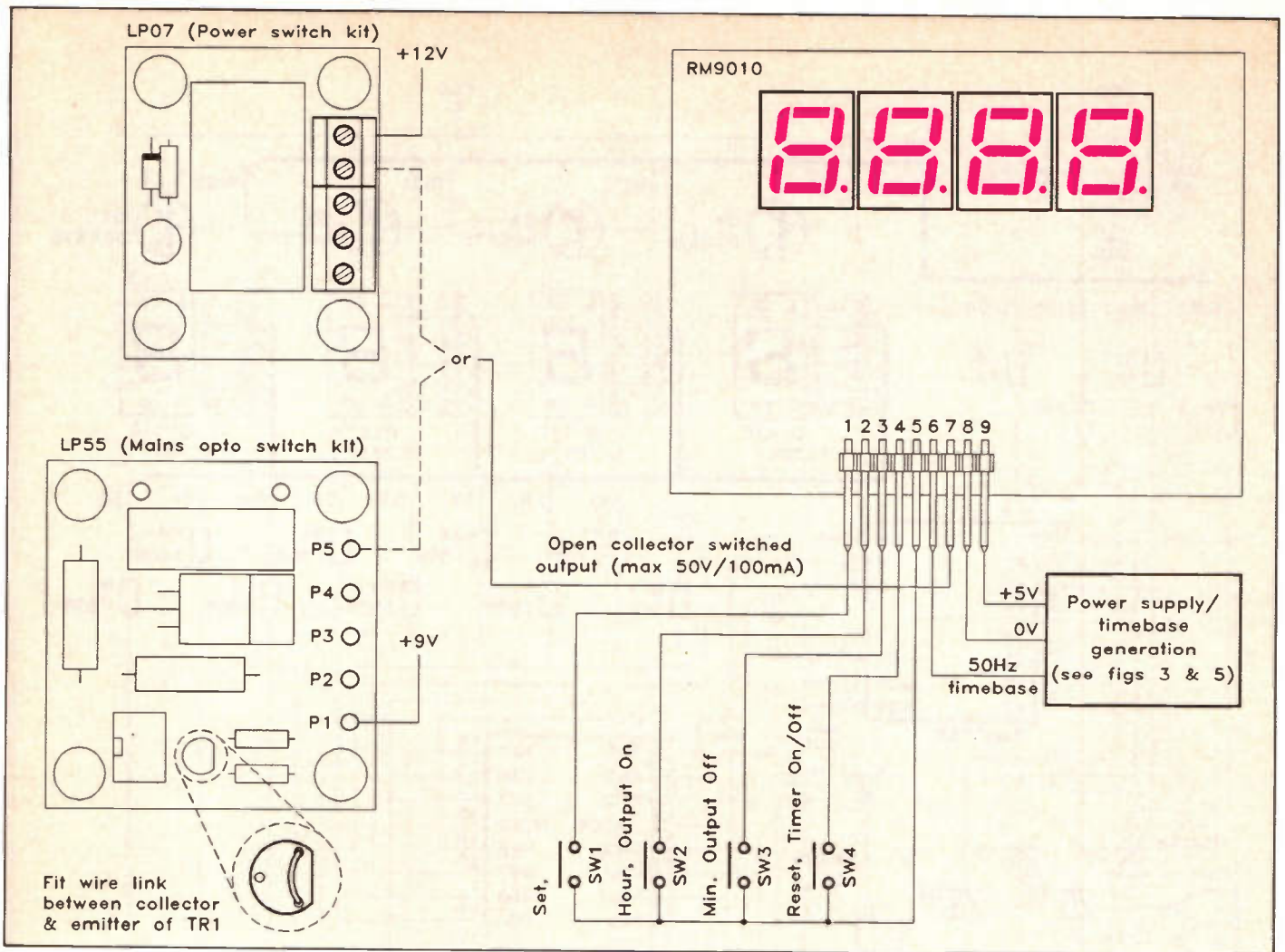

Figure 2. Wiring diagram.

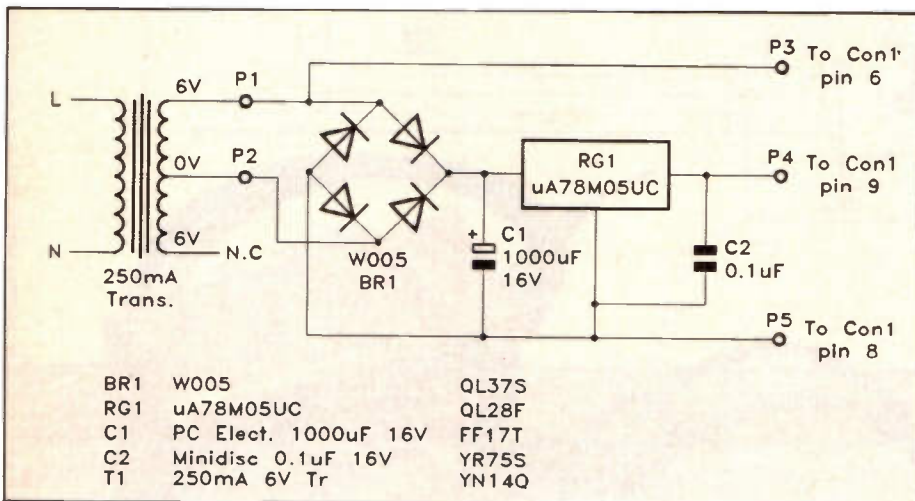

Figure 3. 240V 50Hz power supply.

Operating Instructions

On initial power-up, all internal registers are set to zero and the module is in 'Set' mode.

The flashing word 'hour' now invites the user to set the clock to the correct time, using the HOUR and MIN buttons. If an incorrect value is entered, pressing the RESET button returns the displayed time to 0.00.

Once the correct time has been entered, pressing the SET button several times allows the ON1, OFF1, ON2 and OFF2 times to be displayed. These can be edited in the same way as the clock time, by using the HOUR, MIN and RESET switches.

After displaying the OFF2 time, the module reverts to normal clock mode, indicated by the middle decimal point

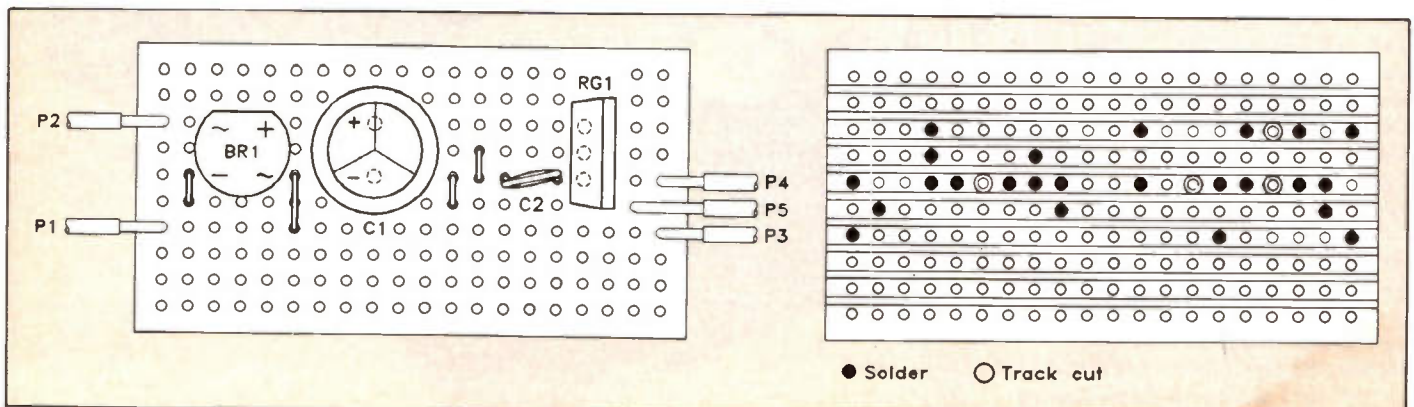

Figure 4. Suggested 240V stripboard layout.

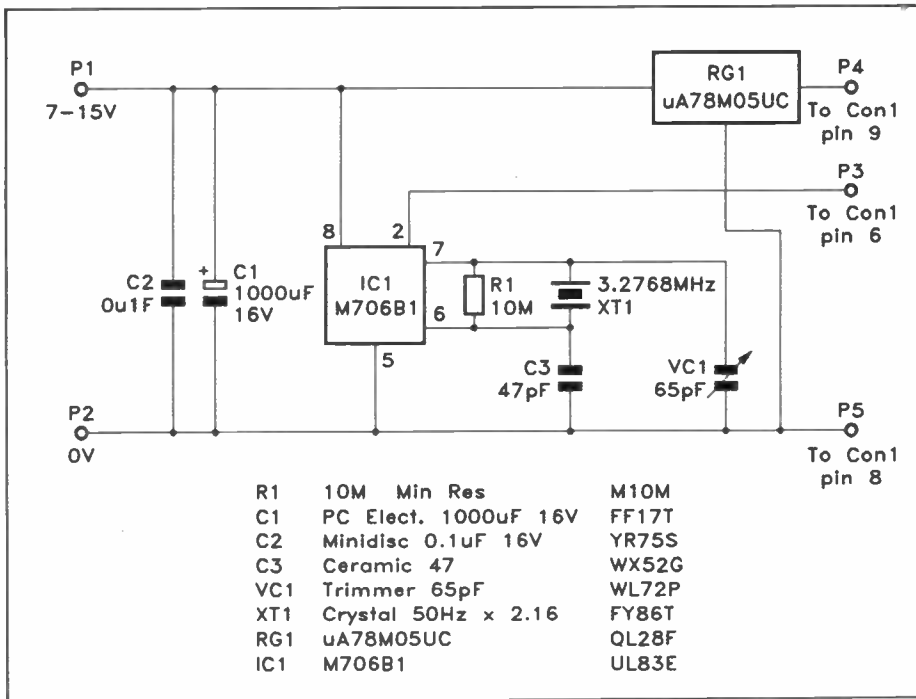

Figure 5. 7 to 15V DC power supply.

flashing. In the clock mode, the functions of the HOUR, MIN and RESET switches change to those shown below:

- HOUR – Manually turn the output on.
- MIN – Manually turn the output off.
- RESET – Controls whether the output is switched according to the programmed values or not, by turning the timer function on and off. When the timer is disabled, the middle decimal point is continuously lit.

The status of the output is always shown by the right-hand decimal point – when illuminated, the output is on.

To re-set the clock, or the programmed ON and OFF times, it is necessary to enter the set mode by pressing the SET button. Successive depressions of the SET button will now take the module through CLOCK, ON1, OFF1, ON2 and OFF2 display/set modes.

Applications

This compact clock/timer module, with its two 24-hour on/off switch times, is ideal for controlling immersion heaters and electric blankets, and for turning lighting on and off when on holiday (to give the impression that the house is occupied, etc).

In shops, the module could be used to switch window display lighting at peak times and, in industrial process control applications, valves and heating elements could be switched at fixed time intervals.

Availability

The Programmable Timer/Clock module is obtainable from Maplin Electronics by mail-order or through their numerous regional stores. The order code is LP87U and the price just £24.95.

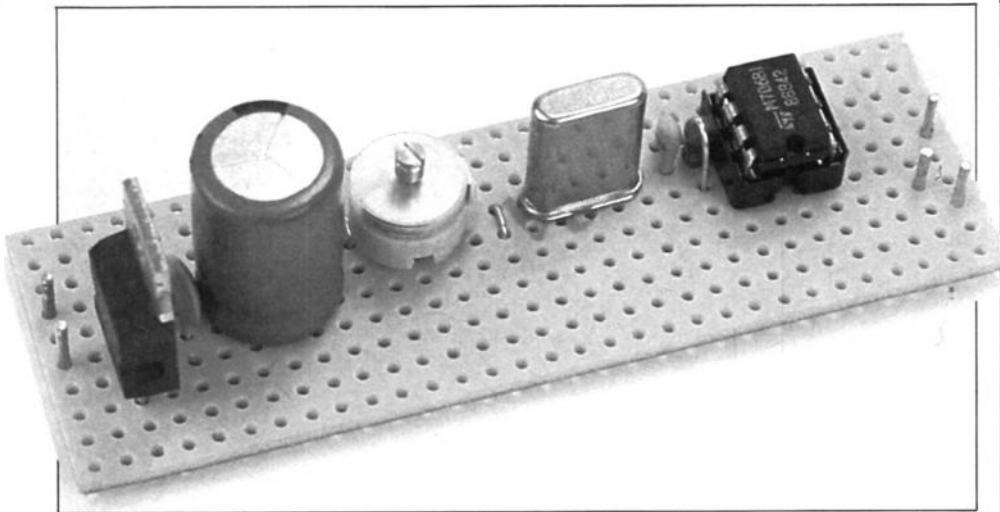

Photo 2. Suggested 7 to 15V power supply.

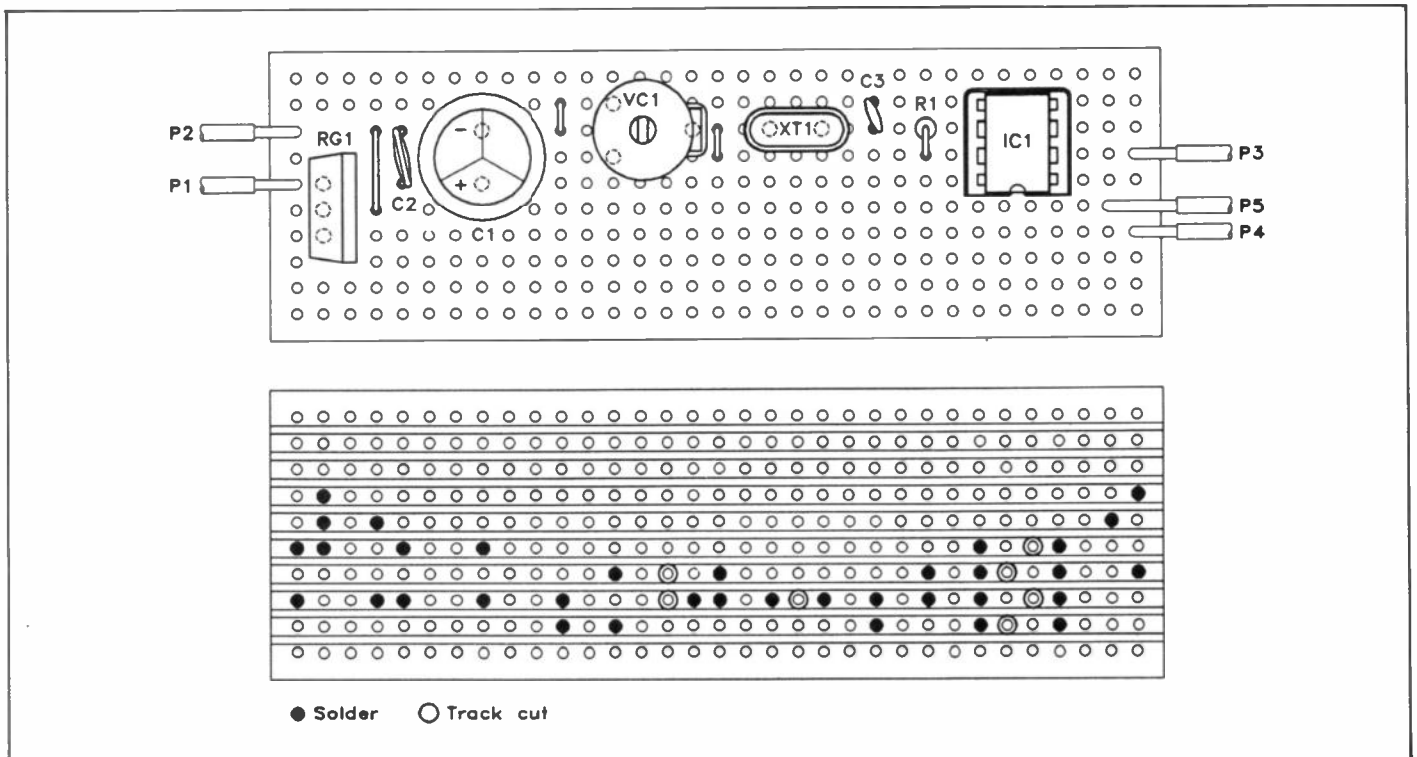

Figure 6. Suggested 7 to 15V stripboard layout.

THE 486/386 DEBATE

by Frank Booty

Intel's new 486 and 386 microprocessors are set to take the PC into a new dimension.

A large number of microcomputer users are now discovering the need for higher power systems, required for the increasingly demanding applications of today – and tomorrow. Such users, who represent the fast changing mid-range desktop computer market, do not necessarily think of themselves as 'powerful computer' users. In fact, most of the applications commonly used by this group can be seen in most offices. Despite the seemingly humble, everyday roles that their computers fill, many of these people will be aware that their existing desktop computer is simply not powerful enough. It's the usual story. As soon as you get used to, and come to rely on, the capabilities of your word processor, database or spreadsheet or whatever, you then want it to work faster.

Before exploring further the question why the mainstream user might now need more power, let us first consider the technology that could satisfy the need.

In essence, it will soon be provided by the latest 486 microprocessor-based systems that will match the necessary price vs performance ratio, making powerful programs available to a broader group of users than was previously the case. The company behind the 486 (and its brother, the 386) is Intel.

MEET THE FAMILY

The 386 SX microprocessor is a 32-bit CPU with a 16-bit external data bus and a 24-bit internal address bus. The SX brings the high performance software of the 486 architecture to mid-range systems. It combines the performance benefits of 32-bit programming architecture with the cost savings associated with 16-bit hardware systems.

The SX is 100% object code, compatible with the 386 DX, 286 and 8086 microprocessors. Systems manufacturers are then able to provide 386 DX based systems optimised for performance, and 386 SX based systems optimised for low cost, and both sharing the same operating systems and application software. Systems based on the 386 SX CPU can access the largest existing microcomputer software base, including the expanding 32-bit software base. However, only Intel's 386 DX architecture can run UNIX, OS/2 and MS-DOS operating systems.

The 486 microprocessor has a full 32-bit architecture with on-chip memory

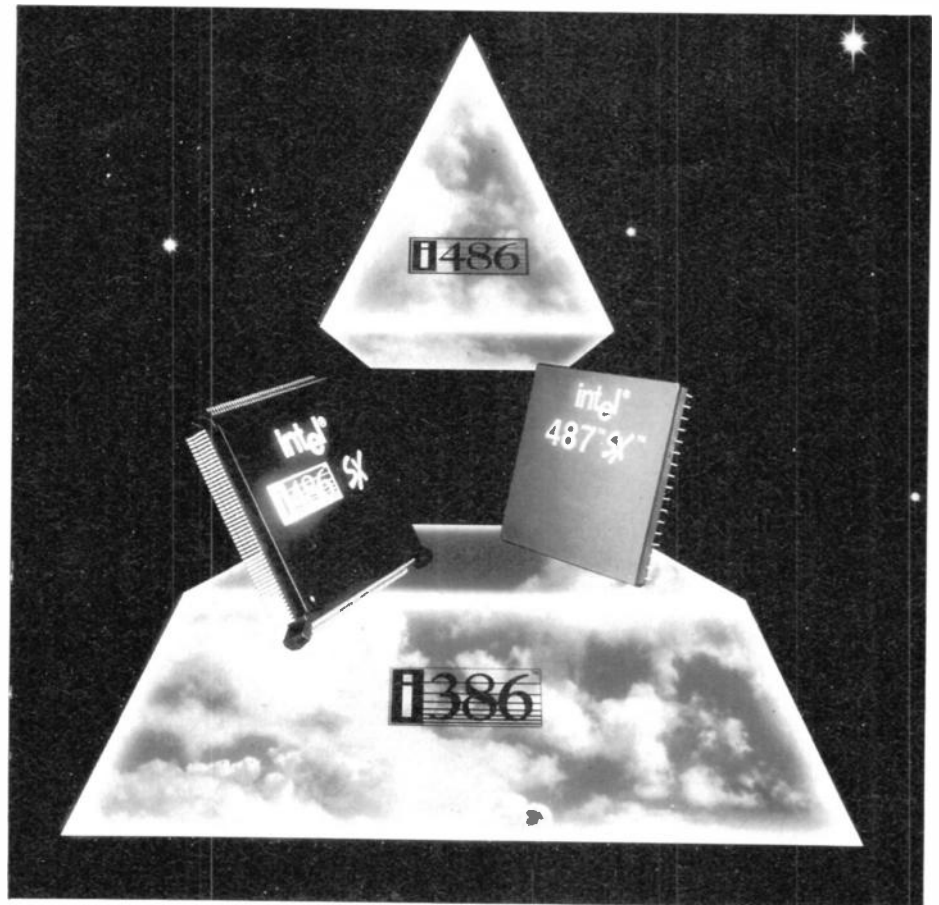

management, floating point storage buffer and cache memory. The 486 contains all the features of the 386, but with enhancements to increase performance. The instruction set includes the complete 386 microprocessor instruction set, along with extensions for serving new applications. The on-chip memory management unit (MMU) is fully compatible with the 386 microprocessor's MMU. The 486 also contains the 387's maths co-processor on the same chip die. A key point here is that all software written for the 386, 387 maths co-processor and previous members of the 86/87 architectural family will run on the 486 without any modifications.

CACHES, SEGMENTS AND MODES

Many enhancements have been added to the 486 microprocessor to increase performance. Built-in 'cache memory' allows frequently used data and code to be stored on-chip, reducing the number of accesses required to the external buses. The principle is rather like using on-chip registers, but developed to produce what is in effect local RAM space (see below).

RISC (Reduced Instruction Set Computing) design techniques have been used to reduce instruction cycle times, while a 'bus burst' feature enables fast cache fills (i.e., one instruction can copy an area of memory into a cache, so that all there is on the bus at any moment is data for the duration of the fill, with no further time wasting, interspersed instructions). Taken altogether, these features lead to a speed greater than twice that of a 386 microprocessor.

In addition there is a Memory Management Unit (MMU) comprising a segmentation unit and a paging unit. Segmentation allows management of the logical address space, allowing both data and code to be easily relocated, and providing the efficient sharing of global resources. The paging mechanism operates 'beneath' segmentation, and is transparent to the former process. Paging is optional and can be disabled by system software. Each particular segment can be divided into one or more further 4K-byte segments. Meanwhile, to implement a virtual memory system, the 486 microprocessor also supports full restart capability for all page and segment faults.

The memory of the 486 is organised

into one or more variable length segments, each of which can be up to 4 Gigabytes(!) in size. A segment can have attributes associated with it which include its location, size, type (stack, code or data), and protection characteristics. Each task on a 486 system can have a maximum of 16,381 segments, each of which can be up to 4 Gigabytes. This means that each task has a maximum of 64 Terabytes (64 trillion bytes) of virtual memory!

The segmentation unit provides four levels of protection for isolating and protecting both applications and the operating system from each other. This hardware enforced protection has the valuable spin-off of enabling systems to be designed with a high degree of integrity.

There are two modes of operation for the 486 unit – Real Address Mode (Real Mode), and Protected Virtual Address Mode (Protected Mode).

In Real Mode, the 486 microprocessor operates as a very fast 8086. Primarily, Real Mode is needed in order to set up the processor for Protected Mode operation, which provides access to the complex memory management paging and privilege capabilities of the processor.

Within Protected Mode, software can switch between tasks designated as Virtual 8086 Mode types, each of which behaves with 8086 semantics allowing 8086 application programs to be used, or an entire operating system software.

NUMBER CRUNCHING

Intel designed the on-chip floating point unit to operate in parallel with the arithmetic and logic unit to provide arithmetic instructions for a variety of numeric data types. The floating point unit executes many built-in, transcendental functions (for example tangent, sine, cosine and log functions), and conforms fully to the ANSI/IEEE standard 754–1985 for floating point arithmetic.

The on-chip cache is 8K-bytes in size, and includes special features which ensure flexibility with external memory system design. Individual pages can be designated as 'cacheable' or 'non-cacheable' by software or hardware. In addition, the cache can be enabled and disabled by software or hardware.

Given the undisputed level of excellence and power that both the 486 and 386 possess, one might sensibly ask why the mainstream user needs such a mighty line-up. The answers are not necessarily difficult to find, indeed, they may be patently obvious.

THE QUEST FOR SPEED

One reason may be illustrated by the behaviour of computers equipped with a Graphical User Interface (GUI). Many users discovered that, when they switched to Windows 3.0, DESQview, X Windows or some other popular GUI, their machine felt 'more cumbersome' and/or slower. Such impressions are exacerbated by the use of pen and voice input – while these 'friendly' interfaces make computers easier to use, they do add processing overhead, and it may be argued that such



The Compaq Deskpro 486/25 delivers 15 million instructions per second and up to three times the performance of 25MHz 386 based systems, bringing workstation power to the desktop PC environment.

complexities (from the computer's point of view) can make it *less* easy to use!

Aside from these developments, the applications themselves are demanding more performance from processors. Spreadsheets now offer multi-page consolidation, more cells, more advanced calculations and more complex charts and graphics. Database programs allow more intuitive queries, professional reports, form design and high level programming. Word processing packages are supplied with special fonts and graphics. And then of course some applications bundle the whole lot together, and add extras.

Then there are applications which will work the processor harder still. Desk top

publishing (DTP), for example, provides complete book-length precision control over typography and graphics, with 'live links' to all input files. Document Image Processing (DIP) applications are producing compound documents on demand from large databases, indeed DIP is set to be a boom market for the '90s.

Multimedia applications are integrating graphics, audio and video, all controlled by computer and used interactively. Then there is that most recent and demanding application, 'Virtual Reality'.

With all these applications, as they mature and become more in the mainstream of things, the computers they

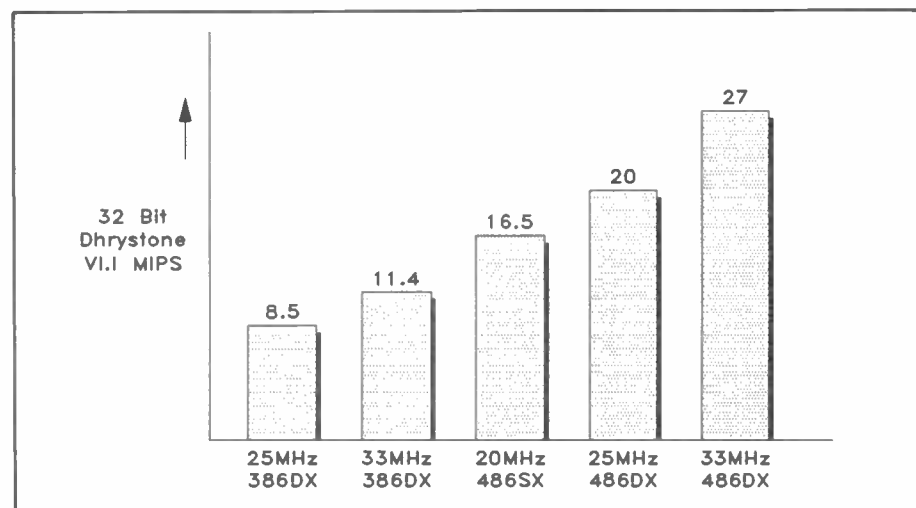

Figure 1. Performance comparison of the members of Intel's 386/486 family, offering 32-bit performance spanning the range of business computing requirements. Using the Dhrystone benchmark, the family delivers up to 27 million instructions per second. (The 50MHz 486 was not yet available for this comparison.)

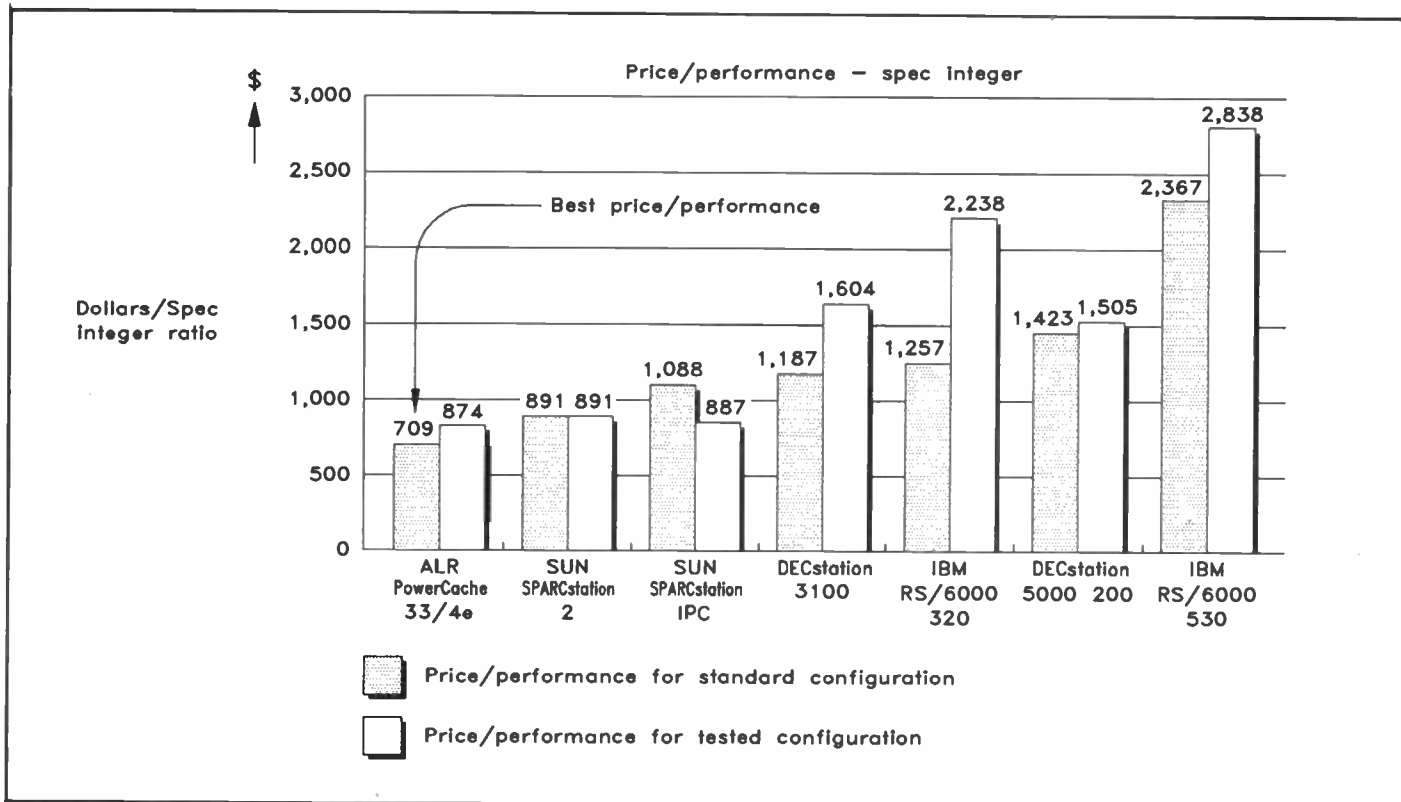

Figure 2. Price vs performance for SPEC integer tests. The SPEC integer programs do not contain any business applications, but they can be used to predict approximate 32-bit business performance.

run on will have to be up to the job. Which means the processors will have to be powerful.

Scientific and Computer Aided Design (CAD) applications are manipulating ever more complex images in true 3D, colour and animation, and using built-in, intelligent algorithms to apply design rules and analysis – all of which demands more computer power. Further, screen graphics is no longer a field exclusively handled by an elite group of specialists. Graphics are integral to most program types these days and updating graphics files takes a lot of computer power too.

Aside from this, the computer programs themselves are bigger with more features (which means more lines of code), and more input/output (which means more things to keep track of). Upgrades of existing programs can normally use more processing speed.

To all the foregoing can be added multi-tasking, networking and data communications. Plus more integration, bigger files, higher resolution and more complex output requirements. The computer will have to handle all this at a speed faster than hitherto experienced – faster boot up, screen updating and program execution. To do this, the equipment needs a powerful processor – something like Intel's 33MHz 80486, Digital Equipment's 25MHz R3000, IBM's 25MHz 2564 or SUN's 40MHz CY7C600.

POWER TO THE PEOPLE

When Intel introduced the 486 DX microprocessor, it delivered twice the performance of the 386 DX at the same clock rate (33MHz) – see Figure 1. There was enough computing power for high-end desktop machines, and enough throughput for servers and mainframe computers. The 486 DX family (see Figures

2 and 3) is competitive with specialised RISC processors, yet offers an architecture 100 per cent binary compatible with the 386 microprocessor family.

In much the same way as the 386 SX CPU introduced more users to the 386 family, the 486 SX microprocessor opens the door to 486 computing performance. The 486 SX CPU is supplied with the same one clock per instruction integer core as the 486 DX microprocessor, complete with on-chip cache, memory management unit and 32-bit burst bus. The difference between the two is that the 486 SX CPU clock rate is 20MHz and the math co-processor is optional, enabling lower microprocessor and total system cost. By this means, 486 technology becomes accessible to the mainstream user, and in

so doing creates a new system category – the 486 SX microprocessor based computer. The block schematic of Figure 4 shows what is contained in a 486.

It is a system that delivers higher performance than a 386 DX based system running at 33MHz with added cache, and at a competitive price. Indeed, a 386 DX microprocessor would have to run at speeds up to 45MHz to approximate this performance with 32-bit software. Depending on configuration and the application software used, these systems can execute programs up to 40 per cent faster.

According to Intel, the performance is achieved by using 486 technology with on-chip cache, improved memory management and optimised design

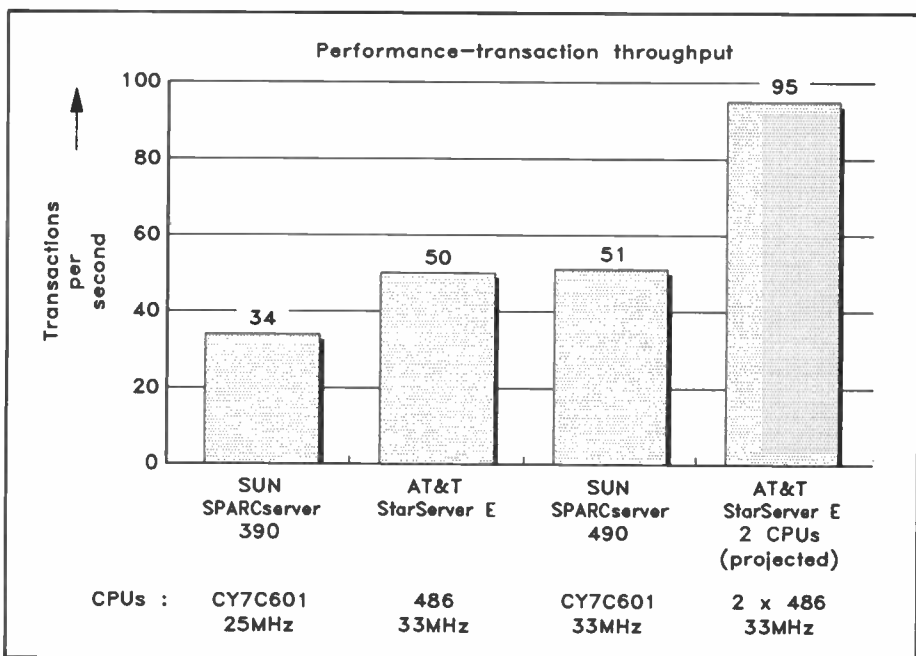

Figure 3. Transaction processing performance. This set of specifications simulate a simple user withdrawal or deposit to an account in a retail banking environment.

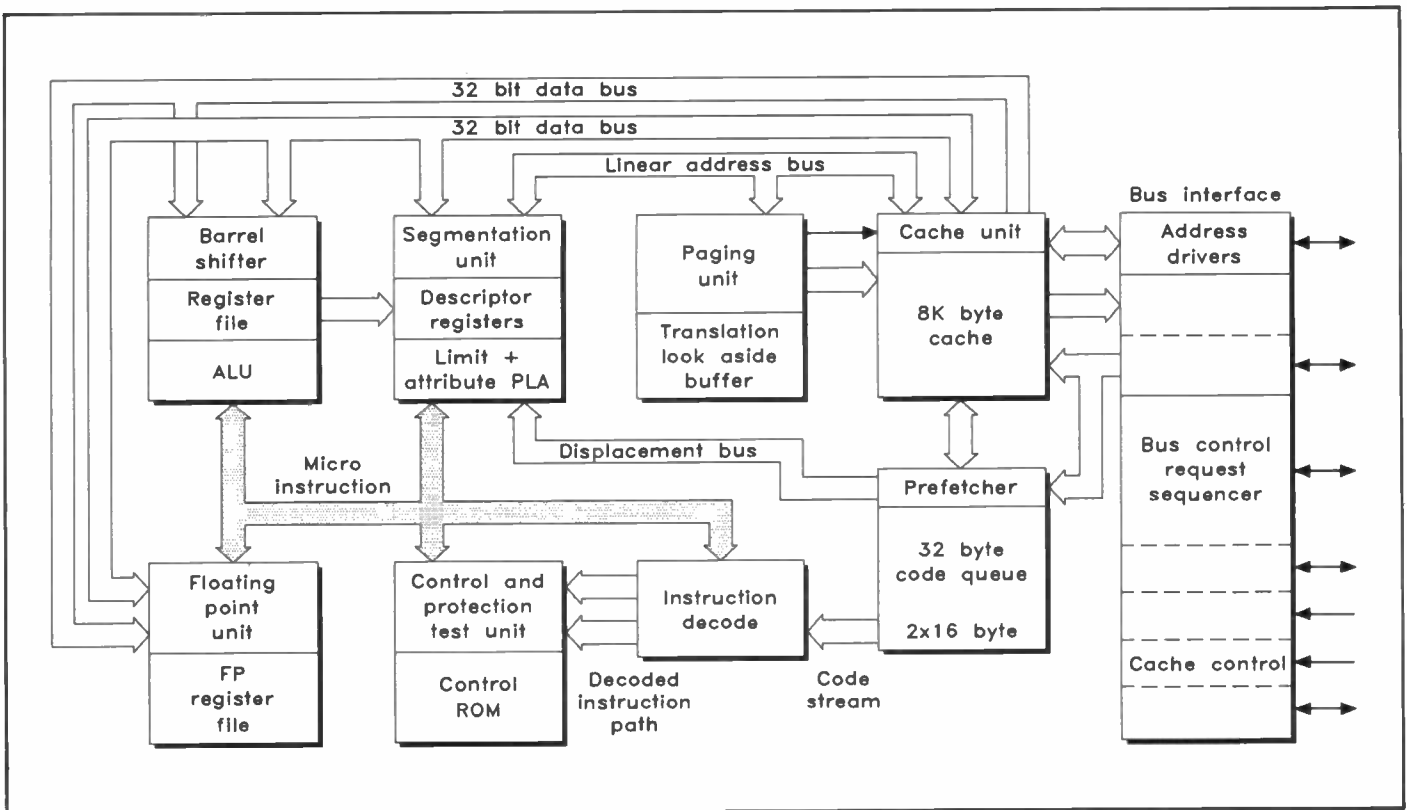

Figure 4. The 486 microprocessor pipelined 32-bit architecture. One million transistors integrate cache memory, floating point hardware and memory management on one chip, while retaining binary compatibility with previous members of the 86 architectural family.

technology to execute frequent instructions in a single cycle. The 486 SX can address up to 4 Gigabytes of physical memory and 64 Terabytes of virtual memory. The unit further supports Windows 386 enhanced mode, thereby offering access to the processor's virtual memory capabilities, as well as enabling multi-tasking of non-Windows applications.

Adding the math co-processor is recommended for those applications with mathematical operations involving very large numbers, floating point numbers, complex calculations and graphics. Examples include spreadsheets, business graphics and CAD work. Most users and computer manufacturers today prefer making the math co-processor optional. By doing this, the user can either purchase the processor with the system, or add it later as financial resources allow and applications dictate. Of course the spin-off is a lower entry cost which can be advantageous to all.

Adding the 487 SX math co-processor increases the speed of maths-intensive software applications by as much as five times over the 486 SX CPU alone. By integrating the floating point unit and CPU functions on-chip, the 487 SX unit delivers up to 70 per cent more performance than a 386 DX 33 CPU with added 387 DX 33 math co-processor based system. Now, there is an industry trend for OEMs to add 'zero insertion force' sockets for 'performance' upgrades. Such an approach enables dealer sales and user installation at a low incremental cost, and also provides system manufacturers and users with easier access to future upgrade options.

The approach by Intel with its 486 technology provides a low-cost entry to the world of EISA (Extended Industry Standard

Architecture) or MCA (Micro Channel Architecture) 32-bit bus computing. Indeed, the company offers integrated chip sets for both of these popular bus architectures. The family of products offered is intended to satisfy a range of market sectors from 'notebook' or 'palmtop' computers to enterprise-wide systems; from entry level to high-end desktops and servers. Figure 5 serves to illustrate how the family might cater for the various business computing market sectors.

DOWN-SIZING

The increasing industry trend towards 'down-sizing' is setting the IBM mid-range market alight, and creating a market opportunity worth an estimated £100 million in the U.K. and £1.3 billion across Europe, as users look for alternatives to the AS/400 minicomputer to replace their ageing System/36 minicomputers.

Today up to 65 per cent of System/36

users are still considering what their next machine should be. With the advent of the 386 and now the 486, down-sizing to multi-user PCs and PC networks has become a real issue in the IBM mid-range replacement market. Down-sizing can also be achieved with such performance and cost benefits that mid-range users not wishing to re-develop applications see PC-based solutions as a natural replacement.

Down-sizing from a mid-range to PC is a practical reality and one that can be achieved without any program or applications re-development – all the hardware and software technology needed to make down-sizing possible is already available. Down-sizing can also be achieved at a minimal cost as well as offering considerable performance benefits.

According to a recent survey of the

Continued on page 59.

| | | | |
|-----------------|--------------|-----------------------|-------------------------|
| ↑ \$ Cost | 12,000+ | Server/Multi-user | 486 - 50 |
| | 8,000-12,000 | High end desktop | 486 - 50 |
| | 5,000-8,000 | Performance mid-range | 486 - 25/33 386 - 40 |
| | 3,000-5,000 | Volume mid-range | 486SX 386DX |
| | <3,000 | Entry level | 386SX 386SL |

Figure 5. The business computing market comprises several sectors characterised by the price and performance of different computer systems. This shows the range of computer usage in 1991.

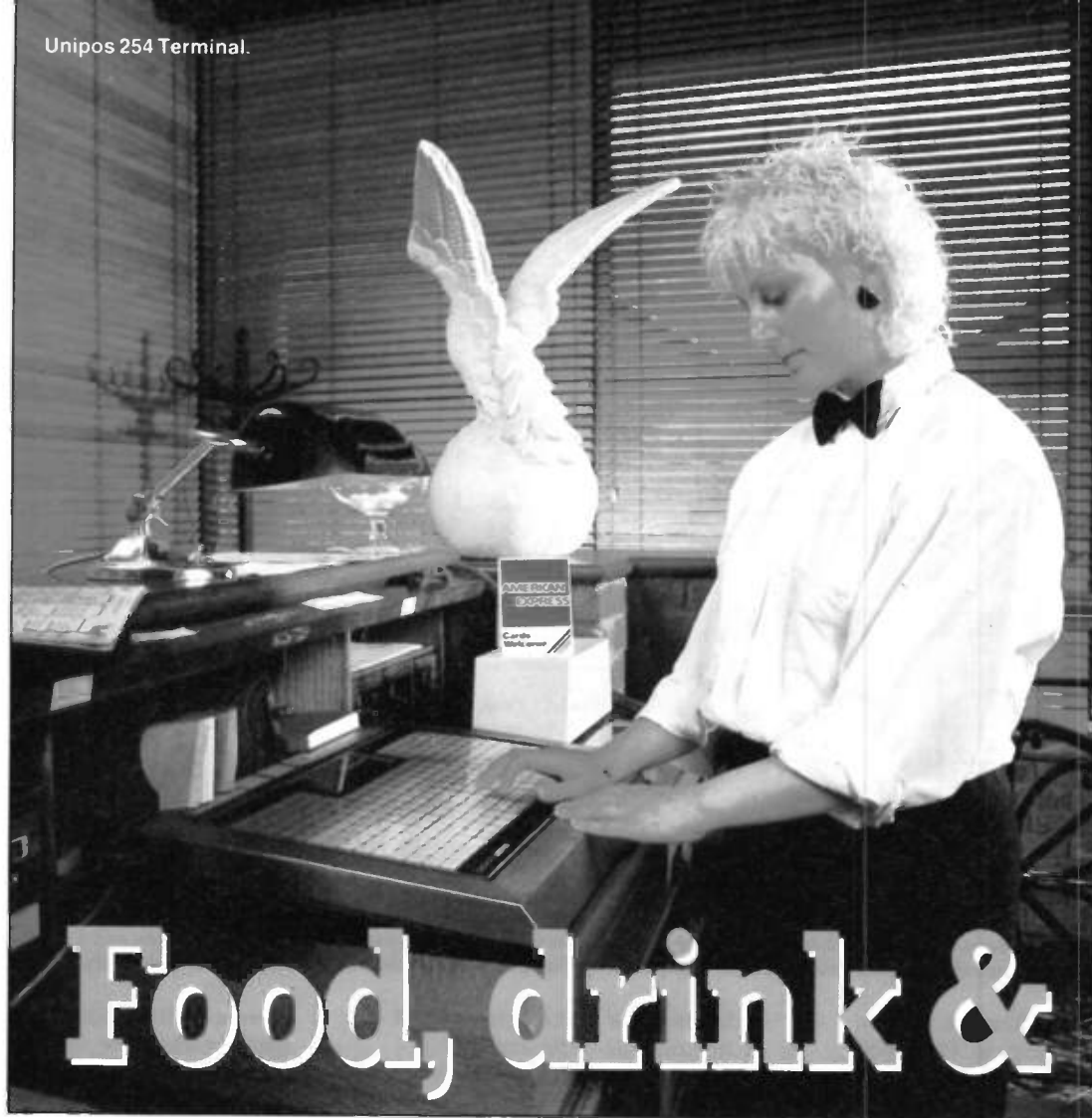

Food, drink &

EPOS

by David Holroyd

The very pleasurable acts of buying(?) a round of drinks or going out for dinner are being subjected to an electronic revolution. The existence of Electronic Point of Sale or EPOS equipment in supermarkets, and shops generally (including the ever-expanding chain of Maplin stores), is now very widespread. There are now very few cans of beans or bags of screws which are not subjected to the dreaded Bar-Code scanner at the Point of Sale till or check-out. A simple swipe of the scanner wand over the bar-code not only ensures that the correct price of an item is charged to the customer's bill, but also updates stock level records, provides re-ordering information and gives statistical data on sales, customer purchasing habits and company turnover.

However, a bar-code printed on a pint of beer or across a steak dinner would be rather more complicated – and certainly not as tasty! This is why a range of new electronic and computer equipment intended specifically for the bar and restaurant industries has been introduced. A major competitor in this recent market is Checkout Computers, who have kindly supplied us with details of their products.

A Byte to Eat

Their story starts over five years ago when Berni Inns, then independently owned, commissioned a range of EPOS hardware and software for their restaurants. These large terminals were similar to the Unipos 254, illustrated in the picture above.

Unipos 254 terminals can cater for (no pun intended!) up to 254 different items, each with their own button on the

splash-proof membrane keypad. Entries can be as simple as pressing the 'Steak' pad, for example, and can be modified by pressing other pre-defined keys which provide other essential information e.g. the mode of cooking (rare, well-done, etc.) and any other special requirements. This simplified multiple entry system is known by Checkout as 'linked menu' selection. The 40 x 8 dot matrix alphanumeric display can also be linked to an additional customer remote display. A Unipos 254 terminal is intended to be used as the terminal in each serving area, or station within a restaurant, although it can recognise up to 256 of the different infra-red security key codings assigned to each waiter.

After taking the order from the customer, the waiter 'logs onto' the system thereby identifying himself. The waiter then uses his terminal to send the order at a rate of 9600 baud via an asynchronous communication channel to



Photo 1a. A waitress sending an order to the kitchen using the Unipos system . . .



Photo 1b. . . . and the chef receiving it the other end.



Photo 2. Printing the bill.

both the kitchen (to inform the chefs on dish preparation) and the office computer (which keeps track of food stock levels, etc.). Photo 1a shows a waitress entering an order, while in Photo 1b a member of kitchen staff receives the information by means of a printer. After the food has been prepared, the waiter/waitress will be paged with the information that the order is complete and ready to be served to the customer. Any terminal can produce the bill; Photo 2 shows bill production at a remote site. Bill and order printers are usually 40-column types with either 10 or 15 lines per second (l.p.s.) feed and 3 l.p.s. print speeds. These are essentially customisable receipt printers which produce standard size tear-off tickets.

Back-office and managerial support for these systems will vary with the size of network. Checkout recommend a central computer system featuring: a microprocessor with 16-bit architecture and a 150 to 600 nanosecond CPU

instruction cycle time; an IBM 3780 Protocol converter; 128Kb to 4Mb of RAM; and a mass storage medium in the form of a hard disc with capacity in the order of 20 to 120Mb, and a standard SCSI disc interface. There should also be between 2 and 80 asynchronous communication channels, each with a data transfer rate of between 75 and 19200 baud, these ensuring support for the terminals used. The central office-based computer system unit shown in Photo 3 is based around a Data General Nova 16-bit computer, and is fitted with optional X25 and Viewdata interfaces.

Take-away Terminal

As can be seen, the Restaurant arrangements are flexible and well-designed. With the addition of the hand-held REPOS (Remote Entry Point of Sale) Order Taker, flexibility is increased further still. Here, orders may

be taken and transmitted directly to the computer systems and kitchen printer via an infra-red sensor. It provides fast ordering and direct communication with other staff as well as the computer. Photo 4 shows such a system in use. This hand-held Order Taker uses a supertwist 40 x 8 LC display fitted with a switchable back-light. It has 45 pre-defined keys and, like the 254 terminal described earlier, transmits at 9600 baud to the host. It will store up to 499 open table orders from 96 different servers. These are all identified by coded plastic keys, as featured on the Unipos 254, but to save space some keys have several functions. Its 1kg weight and 366 x 180 x 110mm size make it highly portable, although a similar system in use on the Continent utilises even smaller Psion Organiser-sized units. Data transmission from portable terminals is received by remote I.R. sensors which are located around the building. It is often this 'pointing of a terminal to the sky' which

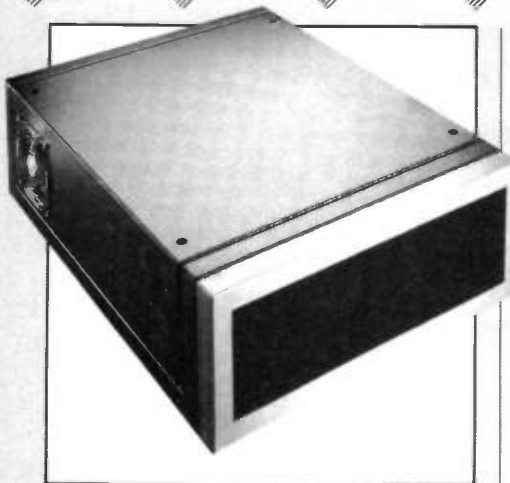

Photo 3. Office Computer Unit.

alerts the diner to the operation of the remote system.

Order entry for all terminals is made simple with the system requiring table and waiter details before commencing. Set and 'linked' menus are offered, the system ensuring that as soon as the starters have been entered/ordered, a main course will be prompted for. If the selection is limited or speciality-based (e.g. in the cases of pizza parlours and burger bars) then the system can be designed to offer options around the specific themes.

Most of the convenience angles seem to have been covered and the business advantages of tighter stock control, faster order-taking and less opportunity for 'shrinkage' (i.e. wastage and theft) are highly evident in an industry plagued by such problems. In many ways it seems odd that it took so long to produce a system for such an area. But it exists now, and in the words of one user: "it really does offer the means to develop a successful and profitable establishment".

Propping up the Bar

It is easy to see how such clever technology (i.e. the hand-held terminal

and its sensors) can be used in the familiar restaurant, hotel and banqueting settings. Possibly more innovative would be the use of such ordering systems in bars and pubs. How many times have we all marvelled at the mental arithmetic skills (as well as the other attributes) of our favourite bar server. Ten different drinks, numerous crisps and peanuts (and one for herself) and back comes an

answer: "seventeen pounds eighty", which seems about right so we pay up. We are unlikely to have either receipts or a price list, and so the running total of the order has been held only in that talented brain. Not any more!

Using terminals such as Unipos 128 or Unipad 78, all the benefits of EPOS in other settings can be introduced into that swiftest and busiest of places – the bar.



Photo 4. A REPOS terminal in use.



Photo 5. Unipos 78 'Selection Pad'.

The basics are the same; the keys represent specific priced items (such as a 'dash' of lime or a 'sly' of vodka). Printers for receipts and audit purposes can be installed, although the usual stock control and audit trails exist. Unipad 78, shown in Photo 5, transmits via a multiplexer (installed if several bar terminals are used) to the main host computer and acts as an extra terminal, enabling bar staff to take orders without having to rush to and from the till. Access to the till can be controlled through plastic keys or identity codes. Electronic systems in the bar seem to provide many advantages. It should enable our drinks to be more quickly served, the manager will know how many staff he needs, and ordering/paper work will be much simplified. Such systems will also give us something really new – a receipt for our drinks (a feature which is handy when you are out with

friends, so that you can PROVE you bought the *last* round...)

A fiendish new device called the Unilink Dispense Monitor, shown in Photo 6, will record all dispensing information from either spirit measures or beer flow meters. It will record each occasion that a bottle is removed or the barrel changed, thus enabling a direct comparison of sales and actual amounts dispensed to take place. In other words, if incorrect measures have been served then the manager will be informed as to when that occurred. More importantly, such a system will deter bar staff from theft.

Waxing Philosophical

The Bar and the Restaurant are congenial places of companionship and entertainment. True, they need good service, pleasant settings and customer care. Now, with the latest of electronic advances, the manager will be able to spend more time creating that ambience so far missing in many of today's watering holes. Such a case would provide a *real* example of electronics improving our environment and benefiting the really important aspects of our everyday lives!

Could it be that electronics is starting to reach the parts other disciplines do not always reach?



Photo 6. Unilink Drink Dispense Monitor.

The 386/486 Debate continued from page 55.

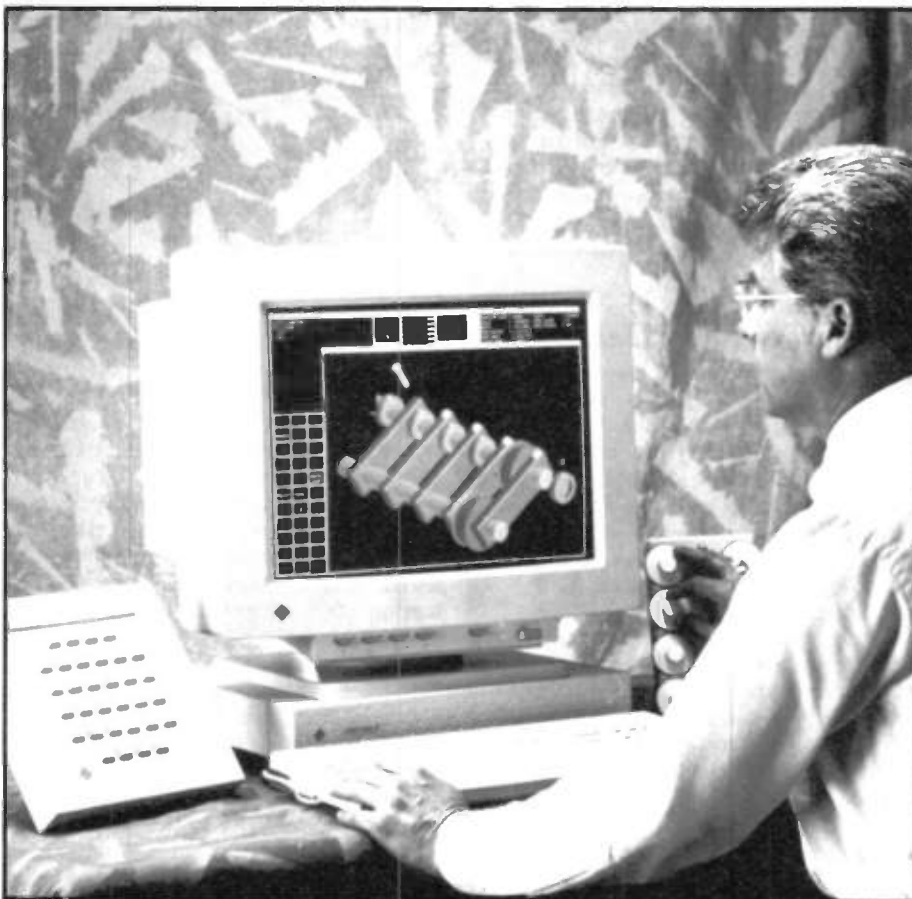

SUN's midrange 3-D graphics workstation for the designer, drafter and engineer, with solid 3-D graphics capability.

IBM mid-range market, over three quarters of users already have PCs attached to their system, and nearly a third of sites are planning to install a network in the next year. In a series of benchtests conducted to compare the multi-user performance of the Compaq SystemPro PC, using California Software's 'Baby' software, with that of an IBM AS/400 Model B30, the SystemPro outperformed the AS/400 by up to 50 per cent in terms of transactional throughput.

CPU BENCHMARKS

The Systems Performance Evaluation Co-operative (SPEC) is a non-profit making organisation formed to develop a standard suite of benchmark programs that effectively measure the performance of computing systems in actual application environments. The performance of a system under test is measured by comparing the execution time of individual programs to that of a Digital Equipment VAX 11/780 system. A SPEC ratio is the ratio of the elapsed time on a specific platform for a specific benchmark. When tests were conducted using a 486 microprocessor based system – the ALR PowerCache 33/4e – the results were either better than or comparable to those from highly priced technical workstations. Also, when considering the ratio of price vs performance, the ALR PowerCache 33/4e outperforms competitive systems from DEC, IBM and SUN.

Mains-Operated Linear DC

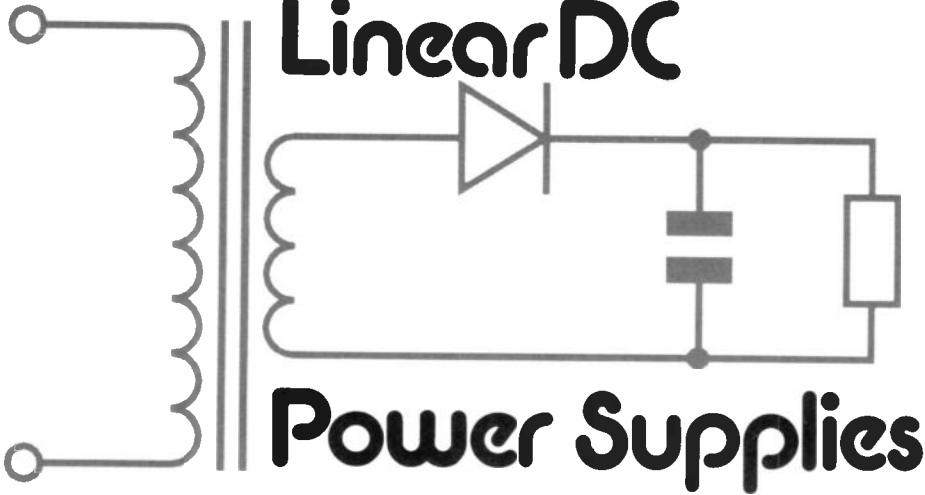

Power Supplies

Part Three – COMPUTER-AIDED DESIGN

by *J.M. Woodgate B.Sc.(Eng.), C.Eng., M.I.E.E.,
M.A.E.S., F.Inst.S.C.E.*

Prologue

This is Part 3 of a series, and you will need the other parts to get the best from this one, so, if you have not already got them, beg, borrow or order the previous two issues of the magazine IMMEDIATELY! We are talking about circuits for obtaining DC supplies from the mains, using various rectifier circuits with reservoir capacitors. Mostly we are talking about low-voltage supplies, and circuits including a mains transformer. In Parts 1 and 2, we have looked at most of the common types of circuit, and how to design them with insight. In this part, we have one more circuit to look at, and then we have a computer-aided design program.

Hangover

Having finished Part 2, I realised that at the end of Part 1, that I had promised a 'voltage one-and-a-half-er' circuit, so we had better clear that up now. This is one of the tricks that enable various different DC voltage supplies to be obtained from one transformer, without wasting power in 'dropping resistors'.

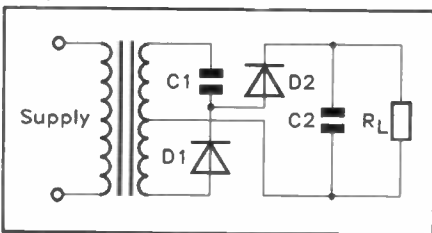

Figure 9. Voltage 'one-and-a-half-er', derived from the diode pump voltage-doubler.

The circuit is shown in Figure 9, and is basically a diode-pump doubler (see Part 2), but the reservoir capacitor and the load resistor are returned to the centre-tap of the transformer secondary winding, instead of to the end. A practical example gave the

following results. Each half-secondary produced 8V rms, and a diode-pump doubler across one half-secondary produced 20V DC on load. The load resistor was 470Ω for all the tests, so that the load current was higher for higher output voltages. A diode-pump doubler across the whole secondary winding produced 40V DC, while the 'one-and-a-half-er' produced 30V, and would thus be a more elegant and efficient way of obtaining 30V than generating 40V and then wasting 10V (and, with the 470Ω load, 850mW as heat: this value could be several watts if the current were larger) in a dropping resistor. Provided it is of adequate current rating, the same centre-tapped secondary winding can also be used with the circuits of Figure 2a or Figure 4a (Part 1), or Figure 5b (Part 2), to provide one, two or even more, other DC supplies.

Computer-Aided Design

Computer-aided design (CAD) programs cover a very wide field, ranging from those so difficult to use that they have been labelled 'computer-hindered design', to others which do all the difficult work for the designer to such an extent that a non-technical computer operator only has to enter some elementary data and then follow simple on-screen instructions. Programs that are difficult to use are simply bad programs, and should be carefully distinguished from those which work well but require the user to have considerable understanding of the design procedures and the subject in general. Programs which do all the work are sometimes criticised for 'de-skilling' design, and there is some substance in this, for a blind reliance on the computer can result in serious errors (usually by people, not the computer) not being detected. For example, a program might faithfully design a power supply to give 100MA (100

million amps) at 12V if the operator mistypes '100mA'! Nevertheless, the program to be described does 'do all the work', and flags up some errors or problems (of those which it can detect) by on-screen messages. You can't make the 'MA' error, because you have to enter everything in plain volts and amps. There is a way to accept inputs which include metric multiplier abbreviations and print outputs with them as well, which I have in an impedance calculating program that may be published one day, but it would make the present program too long if it were included.

Starting-Up

The design calculations presented in Parts 1 and 2 refer to the circuit conditions when the steady-state has been reached, which is normally less than 10 cycles of the mains supply frequency after switch-on, and this, for the 50Hz mains, is 0.2s. As far as the user of the equipment is concerned, this is usually quite adequate, but in terms of electronics, 200ms is a long, long time, and all sorts of things can happen in this 'start-up phase'. In particular, surge currents can cause fuses to blow. We saw an extreme case in Part 2 with the series-capacitor direct-on-line circuit, where we could get a surge of 180A unless we prevented it. Less extreme surge currents occur in transformer-fed circuits, but they often greatly influence the necessary current rating and 'pre-arcing time characteristic' of the fuses in the transformer primary and/or secondary circuits. These surges occur because at switch-on the reservoir capacitor is not charged, and behaves as a very low resistance load on the DC output. The impedance looking into the transformer primary is then due to leakage inductance, which should be negligible, and a resistance R_c :

$$R_c = R_1 + R_s/n^2,$$

where R_1 is the resistance of the primary winding, n is the turns ratio, equal to the ratio of primary voltage to no-load secondary voltage, and:

$$R_s = R_2 + kR_d + R_c,$$

where R_2 is the resistance of the secondary winding, kR_d is the effective resistance of k diodes in series (normally 2 for the full-wave bridge and 1 for all the other circuits) and R_c is the resistance (ESR) of the reservoir capacitor.

The worst case of surge current occurs when the mains switch is closed at the peak of the mains voltage waveform, so, for 240V mains, we get a peak instantaneous surge current I_{ps} :

$$I_{ps} = 240\sqrt{2}/R_c$$

Until the reservoir capacitor is as fully charged as it is ever going to be, i.e. the circuit has entered the 'steady state', progressively smaller surge currents flow during each successive half-cycle of supply voltage. Normally, these do not have to be taken into account, but we shall see later how this could be done. But how can we find out what is happening in the circuit while this charging process is going on?

Step-by-Step

It is possible to calculate in some detail what happens in the start-up phase by 'analogue' mathematical methods (i.e. find functions that represent the states of the circuit through time, and manipulate these to find desired results), but often it isn't very easy. There is another way, which may be called the 'step-by-step' approach, although it has other fancy names (such as 'finite element analysis'). We begin by looking at what happens in an initial very short time interval, immediately after switch-on. If this interval is short enough, compared with one cycle of mains frequency, we can make some approximations which greatly simplify the calculations without significant loss of accuracy. We then use the results of these calculations to find out what happens in the next very short interval, and so on. To do this, however, we need a deep understanding of what actually happens in the circuit, which we can often gain from the complicated 'analogue' analysis under certain special conditions. For example, we might be able to analyse the circuit behaviour with a square-wave input, and then use *that* insight to do a step-by-step analysis for a distorted sine-wave input, which we couldn't easily (if at all) solve directly. If we don't understand how the circuit behaves, we are unlikely to know what to calculate at each step.

Of course, this approach requires several calculations to be done for every small step, which means hundreds or even thousands of calculations before we obtain the final results. In the past, astronomical and mathematical tables, which required the use of methods similar to our 'step-by-step' analysis, were compiled by large groups of mathematicians (often students) sitting at desks, busily crunching numbers for weeks on end. Believe it or not, these people were called 'computers'.

Luckily, we don't need to do this; our computers are particularly good at doing hundreds or thousands of similar calculations, and do them much faster and more accurately than people do. So step-by-step methods, which were often impracticable before computers became available, are now much in favour. Perhaps this fashion, like many others, is tending to go too far. Remember that you need to have a basic understanding of how a circuit works before you can write a step-by-step program. There is a trend now to use the printed results of step-by-step programs AS A SUBSTITUTE for understanding how the circuit behaves in given conditions. This is a very dangerous trend, for who will write the programs when everyone has forgotten how the circuits work?

In the program to be described, the hard bit was done by Mr. J. English, and published in 'Electronic Product Design' in 1985. This is the part which calculates all the values of 'intermediate variables' which have to be passed on to the next step, and, while the individual calculations are rather easy, the reasons for them, and the physical significance of the various intermediate variables, are too complex to go into here. The variable names used in the program are not necessarily the same as the symbols used in the equations in the rest of the series. In 1985, computer

```
10 REM : 19.2MREC07
20 REM : PROGRAM "RECTIFIER" by J.M. Woodgate August 1991 Version B.1
30 REM : based on an original by J. English 1985
40 ONERROR GOTO 2770
50 DIM res(15,5) : DIM lookup(16,1)
60 PROCalphatable
70 PROCintro
80 REPEAT
90 PROCmenu
100 UNTIL done
110 CLS : END
120 :
130 DEF PROCcalc
140 IF TY=0 TY=TX
150 K=1000000/(CA*72*H2)
160 IF TY=1 VF=2*VD : RF=2*RD : ELSE VF=VD : RF=RD
170 PRINT "START-UP PHASE"
180 INPUT "Number of half-cycles to analyse (RETURN for 15, max.51) "stp
190 IF stp=0 stp=15
200 IF stp MOD 2 =0 stp=stp+1
210 IF stp >51 stp=51
220 PRINT "Half"; TAB(6); "O/P"; TAB(13); "O/P"; TAB(20); "TfrSec";
TAB(27); "TfrSec"; TAB(34); "TfrPr"
230 PRINT "cyc."; TAB(6); "Vmax"; TAB(13); "Vmin"; TAB(20); "Irms";
TAB(27); "Ipk"; TAB(33); "IrmsmA"
240 VW=0 : VU=0 : OVL=0 : count=0
250 FOR J=1 TO stp
260 VM=0 : VN=3*VS : IP=0 : VP=0 : VQ=2*VS : WD=0
270 IF J MOD 2=1 OR TY MOD2=1 MS=0
280 FOR I=0 TO 35
290 IF J MOD 2=0 AND TY MOD2=0 VI=0 : VJ=1.414*VS*SIN(.0873*I+.0436)
ELSE VI=1.414*VS*SIN(.0873*I+.0436) : VJ=0
300 IF J<3 ID=IL*VW/VS ELSE ID=IL
310 IC=(VI-VW-VF)/(RS+RF)
320 IF IC<0 IC=0
330 MS=MS+IC^2
340 VW=VW+(IC-ID)*K
350 WD=WD+IC*(VD+RD*IC)
360 IF TY=4 PROCdouble
370 VO=VW+VU
380 IF VO<VN VN=VO
390 IF VO>VM VM=VO
400 IF IC>IP IP=FNround(IC,2)
420 NEXT I
430 IF TY=1 AND J>1 RM=SQR(MS/72) ELSE RM=SQR(MS/36)
435 II=10^-3*FNround(RM*VS/VH,3)
440 RM=FNround(RM,2)
450 WD=WD/72 : WD=FNround(1000*WD,2)
460 IF J=1 IS=RM : IQ=IS*VS/VH : IQ=1000*FNround(IQ,3)
470 IF J<5 OR J MOD 4 =3 PROCstep
480 NEXT J
490 PROChold
500 VL=(VM+VN)/2 : VL=FNround(VL,2)
510 VR=(VM-VN)/2 : VR=FNround(VR,2)
520 IF TY MOD 2 =1 rratio =RS*IL/TL ELSE rratio =RS*IL/(2*VL)
525 PROCalpha
530 IF IA=0 IA=RM
540 IF VA=0 VA=VS-(RM*RS)
550 IF PR=0 PR=FNround((VS-VA)*100/VS,2)
560 VA=FNround(VA,2)
570 prp=FNround(100*VV/VL,2)
580 IF TY=2 CI=0.031*VR/K ELSE IF TY=4 CI=0.031*VC/K ELSE IF TY MOD2=1
CI=0.062*VR/K
590 CI=1000*FNround(CI,3)
600 DCR=100*(SQR(2)*VS-VL)/VL : DCR=FNround(DCR,1)
610 PROCgrab : resflag=TRUE : PROCoutprint : ENDPROC
620 :
630 DEF PROCinprint
640 PRINT "INPUTS"
650 PRINT "Title of this run "; US
660 PRINT "Rectifier circuit type "; TYS
670 PRINT "Primary voltage "; VH; " V"
680 PRINT "Actual mains voltage/Nominal mains voltage "; FS
690 PRINT "Mains supply frequency "; HZ; " Hz"
700 PRINT "Reservoir capacitor value "; CA; " uF"
710 PRINT "Diode forward voltage "; VD; " V"
720 PRINT "Effective diode resistance "; RD; " ohm"
730 PRINT "DC load current "; IL; " A"
740 IF wflag PROCwinprint
750 IF rflag PROCrinprint
760 IF NOT wflag : IF NOT rflag sflag=TRUE
770 ENDPROC
780 :
790 DEF PROCoutprint
800 PRINT "OUTPUTS"
810 PRINT "Actual mains voltage "; FS*VH; " V"
820 PRINT "DC output voltage "; VL; " V"
830 PRINT "P-P ripple volts "; VV; " V"
840 PRINT "P-P ripple "; prp; " %"
850 PRINT "DC output voltage regulation, no load - full load "; DCR; " %"
860 PRINT "Secondary source resistance "; RS; " ohm"
870 PRINT "Full-load rms secondary current "; RM; " A"
880 IF RM>IA PRINT "RMS SECONDARY CURRENT EXCEEDS RATED VALUE"
890 PRINT "Conduction angle "; alpha; " deg"
900 PRINT "Conduction time ratio "; tratio
910 PRINT "1/2-cycle secy. surge current "; IS; " A"
920 PRINT "1/2-cycle pri. surge current "; IQ; " mA"
930 PRINT "Repetitive peak diode current "; IP; " A"
940 PRINT "Res'voir cap.rms ripple current "; FNround(CI,2); " mA"
950 PRINT "Diode power dissipation "; WD; " mW"
960 IF nopflag PROChold
970 ENDPROC
980 :
990 DEF PROCmenu
1000 done=FALSE : CLS
```

Listing 1.

Listing 1 continued.

```

1010 PRINT "Select choice by pressing the key indicated "
1020 PRINT "R - Calculate results"
1030 PRINT "Q - Quit program"
1040 IF resflag nopflag=FALSE : PRINT "P - Print results"
1050 A =GET AND &DF : IF A=82 CLS : nopflag=TRUE : PROCindata : ENDPROC
1060 IF A=81 done=TRUE : ENDPROC
1070 IF resflag : IF A=80 PROCprintres : nopflag=TRUE : ENDPROC
1080 PROCmenu : ENDPROC
1090 :
1100 DEF PROCgrab
1110 TX=TY : VX=VA : IX=IA : PX=PR : HX=HZ : CX=CA : FX=FS : VY=VD :
    RY=RD : IY=IL : VW=VH
1120 VZ=VS : RW=R1 : RV=RP
1130 ENDPROC
1140 :
1150 DEF PROCstep
1160 VL=(VM+VN)/2
1170 IF J=stp-4 OVL=VL
1180 VM=FNround(VL,2)
1190 VN=FNround(VL,2)
1200 VR=VM-VN : REM RIPPLE VOLTS P-P
1210 VC=VP-VQ : REM DOUBLER CAP RIPPLE P-P
1220 IF TY=4 VV=VC ELSE VV=VR
1230 VV=FNround(VV,2)
1240 PRINT " "; STRS(J); TAB(6); VM; TAB(13); VN; TAB(20); RM; TAB(27);
    IP; TAB(34); II
1250 res(count,0)=J : res(count,1)=VM : res(count,2)=VN : res(count,3)=RM
    : res(count,4)=IP : res(count,5)=II
1260 IF J=stp AND OVL<0.95*VL DV =FNround(100*(VL-OVL)/VL,2) : PRINT
    "Steady state not reached. DC output voltage increased by "; DV;
    "% over last 2 cycles. Increase number of half-cycles to analyse."
    : shortflag=TRUE
1270 count =count+1
1280 ENDPROC
1290 :
1300 DEF PROCdouble
1310 IG=(VJ-VU-VF)/(RS+RF)
1320 IF IG<0 IG=0
1330 MS=MS+IG^2
1340 VU=VU+(IG-ID)*K
1350 IF VU>VP VP=VU
1360 IF VU<VQ VQ=VU
1370 ENDPROC
1380 :
1390 DEF PROChold
1400 PRINT "Press any key to continue" : IFGET ENDPROC
1410 :
1420 DEF PROCwdg
1430 INPUT "No-load secondary volts at nominal primary voltage"; VS
1440 INPUT "Secondary winding resistance (average of two half-windings
    for biphaser)"; R1
1450 wflag=TRUE : rflag=FALSE
1460 INPUT "Primary winding resistance"; RP
1470 IF VS=0 VS=VZ
1480 IF R1=0 R1=RW
1490 IFRP=0 RP=RV
1500 RS=R1+RP*(VS/VH)^2 : RS=FNround(RS,2)
1510 IF sflag : PROCwinprint : sflag=FALSE
1520 PROCcheck : IF FNn(GS) CLS : PROCwdg : ENDPROC
1530 PROCcalc : ENDPROC
1540 :
1550 DEF PROCreg
1560 INPUT "Nominal full load secondary volts"; VA
1570 INPUT "Nominal full load secondary current"; IA
1580 wflag=FALSE : rflag=TRUE
1590 IF VA=0 VA=VX
1600 IF IA=0 IA=IX
1610 INPUT "Nominal % regulation (no-load to full-load)"; PR
1620 IF PR=0 PR=PX
1630 VS=FS*VA/(1-PR/100) : VS=FNround(VS,2)
1640 RS=VA*PR/((100-PR)*IA) : RS=FNround(RS,3)
1650 R1=FNround(RS/2,2) : RP=FNround(RS/2*(VH/VS)^2,2)
1660 IF sflag : PROCrinprint : sflag=FALSE
1670 PROCcheck : IF FNn(GS) CLS : PROCreg : ENDPROC
1680 PROCcalc : ENDPROC
1690 :
1700 DEF PROCintro
1710 TX=0 : VX=0 : IX=0 : PX=0 : HX=0 : CX=0 : FX=0 : VY=0 : RY=0 :
    IY=0 : VW=0 : VZ=0 : RW=0 : RV=0
1720 wflag=FALSE : rflag=FALSE : sflag=FALSE : nopflag=TRUE :
    shortflag=FALSE
1730 done = FALSE : pflag=FALSE : resflag=FALSE : CLS : PRINT
    "Program 'Rectifier' by J.M. Woodgate July 1991"
1740 PRINT "Do you want to read the instructions (Y/N) " : GS = GETS
    : IF FNY(GS) PROCinstrs : ENDPROC ELSE ENDPROC
1750 :
1760 DEF PROCinstrs
1770 IF NOT pflag CLS
1780 PRINT "Program 'Rectifier' by J.M. Woodgate July 1991"
1790 PRINT "This program deals with half-wave, biphaser (full-wave),
    full-wave bridge and symmetrical voltage-doubler rectifiers,
    with mains transformer and reservoir capacitor."
1800 PRINT "It calculates the d.c. output voltage and peak-to-peak
    ripple voltage at a specified load current,";
1810 PRINT " the r.m.s. secondary winding current, the half-cycle surge
    current, the r.m.s. ripple current";
1820 PRINT " through the reservoir capacitor and the diode repetitive
    peak current and power dissipation"
1830 PRINT "Follow the on-screen instructions. After the first run, you
    can run again with mostly the same values by pressing 'RETURN' when
    asked for input. You can enter any new values from the keyboard."
1840 IF pflag : pflag=FALSE : ENDPROC
1850 PRINT "Do you want a print-out of the instructions? "; GS=GETS :
    PRINTGS : IF FNY(GS) pflag=TRUE : PROCprinter : PROCinstrs :
    PROCpreset : CLS

```

memory capacity was much less than it is now, so the original program had only 122 lines, and you really had to be able to 'read' the BASIC program to understand what was being printed out or displayed on the screen.

The Program

This greatly extended and modified program has 279 lines, and is written in BBC BASIC. Because it uses no graphics, assembler or the special BBC BASIC operating system calls (*FX and OSXXXX), it should be fairly easy to translate into other dialects of BASIC. The main special feature of BBC BASIC relevant to this program is that it does not use 'LPRINT' to send characters to the printer. Instead, it turns the printer data-channel on by means of 'PRINT CHR\$2' and off by means of 'PRINT CHR\$3' (for example, see line 2320). Also, the code 'VDU2' means 'PRINT CHR\$2', with the advantage that ASCII codes can be strung together with commas, after 'VDU' without the need to repeat it. You can see this in line 1960. To ensure that ASCII codes are passed to the printer, without being trapped by the operating system, a code '1' must precede all ASCII codes in VDU statements, except '2' and '3', intended for the printer alone. For example VDU27 would produce the same effect as pressing 'ESCAPE', but VDU1,27 passes the code 27 to the printer. The printer codes are based on the Epson FX80 set, and most 'Epson-compatible' printers will understand them with no trouble.

How it Works

The program is 'highly structured', which means that most operations which belong together are logically grouped into functions and procedures. It is also 'menu-driven', which means that the main program is reduced to lines 80 to 110 only! Line 40 is for error-trapping which should catch any 'run-time' errors and not leave the computer in an odd condition (such as with a corrupted stack or RAM). Lines 50 to 70 do some setting up, and deal with the initial instructions for using the program, which can also be printed out. This text is not 'formatted', so you may get split words at the ends of lines, but it is still readable. Only 25 lines of instructions are given, but you could add some more by calling PROChold (line 1390) after line 1830 and then adding some more lines of text. PROCAlphatable, called in line 60, fills the array 'lookup' with values of α (alpha), the conduction angle, and the corresponding values of R_s/pR_1 (see Part 1), called 'rratio' in the program. This enables us to find α from R_s/pR_1 , even though we can't solve the equation that way round. In PROCAlpha, the array is scanned until an entry greater than 'rratio' is found, and then a close approximation to α is found by 'linear interpolation' (line 2550).

The first time we see the menu, we can either 'quit' or 'calculate results'. Assuming we are not quitters, we are then asked for information (input data) about the circuit and then about the transformer. Allowance is made for calculating what happens with increased or reduced mains supply voltages. If we have a transformer on the bench, we can measure its winding resistances and no-load output voltage

Listing 1 continued.

```

1860 ENDPROC
1870 :
1880 DEF FNy(AS) =INSTR("Yy",AS)
1890 :
1900 DEF FNn(AS)=(FNy(AS)=0)
1910 :
1920 DEF FNround(X,Y)
1930 IF X<0.1 =INT(10^(Y+1)*X+0.5)/10^(Y+1) ELSE =INT(10^Y*X+0.5)/10^Y
1940 :
1950 DEF PROCprinter
1960 VDU2,1,27,1,64,1,27,1,78,1,12,1,27,1,33,1,8,1,27,1,108,1,7
1970 ENDPROC
1980 :
1990 DEF PROCpreset
2000 VDU1,12,1,27,1,64,3 : ENDPROC
2010 :
2020 DEF PROCindata
2030 VA=0 : IA=0 : PR=0
2040 INPUT "Enter the title of this run "US
2050 INPUT "Enter the rectifier circuit type number, Bridge = 1,
Half-wave = 2, Biphas (full-wave) = 3, Doubler = 4 "TY
2060 IF TY=1 TYS="Bridge" ELSE IF TY=2 TYS="Half-wave" ELSE IF TY=3
TYS="Bi-phase (full-wave)" ELSE TYS="Doubler"
2070 PRINT "Rectifier circuit type : "; TYS
2080 INPUT "Nominal primary voltage "; VH : IF VH=0 VH=VW
2090 INPUT "Actual mains voltage/Nominal mains voltage (Std. values 0.9
and 1.06) "; FS : IF FS=0 FS=FX
2100 INPUT "Mains supply frequency, Hz "; HZ
2110 INPUT "Reservoir capacitor value uF "; CA
2120 INPUT "Diode forward voltage (Std. value 0.5 V) "; VD
2130 INPUT "Effective diode resistance (Std. value 1/(2 x If at Vf = 1 V)
"; RD
2140 INPUT "DC load current, A (not mA!) "; IL
2150 IFCA=0 CA=CX
2160 IF HZ=0 HZ=HX
2170 IF VD=0 VD=VY
2180 IF RD=0 RD=RY
2190 IF IL=0 IL=IY
2200 PROCinprint
2210 PROCcheck : IF FNn(GS) CLS : PROCindata : ENDPROC
2220 PRINT "TRANSFORMER DATA"
2230 PRINT "Press 'W' for design from Winding resistances, or
'R' for design based on percentage regulation"
2240 A=GET AND &DF
2250 IF A=87 PROCwdg : ENDPROC
2260 IF A=82 PROCreg : ENDPROC
2270 PRINT "'W' or 'R' only, please" : GOTO 2230 : ENDPROC
2280 :
2290 DEF PROCprintres
2300 PROCprinter
2310 PRINT "RECTIFIER by J.M. Woodgate August 1991 from an original
by J. English"
2320 PRINTCHR$3
2330 INPUTLINE"Type in a comment line to be printed "CS
2340 PRINT CHR$2 : PRINT "Comment : "; CS
2350 PROCinprint
2360 IF NOT nopflag PRINT "START-UP PHASE"
2370 PRINT "Half"; TAB(6); "O/P"; TAB(13); "O/P"; TAB(20); "TfrSec";
TAB(27); "TfrSec"; TAB(34); "TfrPr"
2380 PRINT "cyc."; TAB(6); "Vmax"; TAB(13); "Vmin"; TAB(20); "Irms";
TAB(27); "Ipk"; TAB(33); "IrmsmA"
2390 FOR J=0 TO count-1
2400 PRINT " "; STR$(res(J,0));
2410 FOR I=1 TO 5 : Z=6+7*(I-1) : PRINTTAB(Z); res(J,I); : NEXT I
2420 PRINT : NEXT J : PRINT
2430 IF shortflag PRINT "Steady state not reached. DC output voltage
increased by "; DV; "% over last 2 cycles. Increase number of
half-cycles to analyse."
2440 PROCoutprint
2450 PROCpreset : ENDPROC
2460 :
2470 DEF PROCalphatable
2480 FOR I = 0 TO 16 : alpha=10*(I+1)
2490 lookup(I,0)=alpha
2500 lookup(I,1)=(TAN(RAD(alpha/2))-RAD(alpha/2))/PI
2510 NEXT : ENDPROC
2520 :
2530 DEF PROCalpha
2540 I=0 : REPEAT : I=I+1 : UNTIL rratio<lookup(I,1)
2550 alpha=lookup(I-1,0)+10*(rratio-lookup(I-1,1))/(lookup(I,1)-
lookup(I-1,1))
2560 tratio=alpha/360 : tratio=FNround(tratio,2)
2570 alpha=FNround(alpha,0)
2580 ENDPROC
2590 :
2600 DEF PROCcheck
2610 PRINT "Are all data items correct (Y/N)?" : GS=GETS : ENDPROC
2620 :
2630 :
2640 DEF PROCwinprint
2650 PRINT "Secondary source volts (emf) "; VS; " V"
2660 PRINT "Secondary winding resistance "; R1; " ohm"
2670 PRINT "Primary winding resistance "; RP; " ohm"
2680 IF rflag PRINT "Assuming equal primary and secondary copper losses"
2690 ENDPROC
2700 :
2710 DEF PROCrinprint
2720 PRINT "Full-load secondary voltage "; VA; " V"
2730 PRINT "Full-load secondary current "; IA; " A"
2740 PRINT "Sec. wdg. voltage regulation no load-full load "; PR; " %"
2750 ENDPROC
2760 :
2770 ONERROROFF : PRINTCHR$3 : REPORT : PRINT " at line "; ERL
2780 PRINT "Try again (Y/N)?" : GS=GETS
2790 IF FNy(GS) RUN ELSE CLS
2800 END

```

(remembering also to measure the input voltage, since it may not be precisely 240V), but if we are looking at a catalogue, we are much more likely to be told the full-load output voltage and the percentage regulation. The program allows us to choose which sort of data to enter. If we have to choose the 'percentage regulation' route, the program has to assume how the copper losses (winding resistance \times current-squared) are divided between the primary and secondary windings, and tells us that it assumes an equal division, because, barring certain second-order effects, this gives the most efficient transformer design. If you know that equal division is not true for your particular transformer, e.g. you are using one secondary winding of one of the types with two identical secondaries, or one of the multi-tapped types, then the best thing is to calculate the primary resistance from the regulation, as indicated in Part 1, assuming that the primary introduces half the losses, and then calculate the secondary resistances by assuming that they divide the remaining half of the losses in proportion to their VA ratings (see Appendix). You can then use the 'winding resistances' approach.

Number-Crunching

The program then starts the 'step-by-step' process, using PROCcalc and its two satellites, PROCdouble and PROCstep. This is Mr. English's code, more or less as the original, except that a few more things are calculated and the computer is dissuaded from printing everything out to nine places of decimals by PROCround, instead of by piecemeal code. This allows results to be printed with appropriate numbers of decimals: two places seems sensible for the output voltage, for example, but not for the conduction angle or the percentage ripple.

You are asked to choose the number of half-cycles over which to carry out the step-by-step process. There is a maximum set at 51 so as to keep the array 'res' (line 50), which stores results for printing, to a reasonable size. You have to choose an odd number, otherwise the program gives silly answers for half-wave and doubler circuits, but having said that, if you do choose an even number, the program automatically adds an extra one. The original program used a fixed number of half-cycles, 15, but since 1985 the availability of very large capacitance reservoir capacitors has greatly improved, and, particularly with values above 10mF (10,000 μ F), 15 half-cycles may not be long enough for the capacitor to charge fully, i.e. the steady-state has not been reached. Therefore, the program checks how much the DC output voltage changes over the last four half-cycles in the step sequence, and if this is more than 5%, you have chosen too few half-cycles, and the program automatically prints a warning in the results.

The step-by-step process involves 540 sets of calculations if 15 steps are chosen, although only 36 results are displayed on screen or printed. On a BBC micro, this process takes about 30s, which is a valid reason not to fix the number of steps at a larger value. Even so, it is enormously

Continued on page 68.



CNN INTERNATIONAL

TELLS IT TO THE WORLD

by Alan Simpson

While the US and the Allies may have won the six-week 'Battle of the Gulf' earlier this year, the undisputed winner of the TV news 'war' was Cable News Network (CNN) International – the all-news network. CNN won such an accolade by providing live, wall-to-wall coverage of the 'Mother of all Wars'. While the BBC struggled to get their Kate Adie onto the front line, CNN were already there. Similarly, while established British broadcasters such as BBC and ITV obediently followed the rules set by the Allied High Command, CNN just got on with reporting the war from behind the enemy lines in a top room of a Baghdad hotel.

For many viewers the 'war' was won hands-down by CNN, with the battle between the news agencies and TV stations being a no-go contest. Avid viewers included the Presidents

of the United States, France, Egypt and very probably, the USSR. London cable companies and dish installers reported being inundated with orders for the reception of CNN services. In the UK, ITV was the first network to relay live CNN broadcasts followed in due course by the BBC. CNN was also the first network to report the missile attack on Israel, and also the first to enter liberated Kuwait. Thanks to its coverage of the Gulf war, the CNN network has been firmly planted on the world media map.

24-Hour Global TV News

CNN International is the world's first 24-hour television news station. The signal is transmitted via satellite from their Atlanta headquarters in the United States and can be accessed in the UK either through a cable network operator or by means of a satellite

dish. Typical subscribers include hotels, broadcasters, businesses and governments. With international news bureaux located around the world and a news staff of over 1600, CNN provides current international news and information; fast, live access to breaking news stories; continuously updated news reports; a convenient 24-hour viewing format and essential business/financial news and features.

CNN currently reaches more than 55 million households in the US, with distribution by satellite to the Far East, Australasia and South America. Receivable in more than 120 countries world-wide, CNN is now viewed in some 7 million homes in Europe. The news network was set up by Ted Turner, often described as a flamboyant buccaneer, over eleven years ago. Several times married, Turner is now 'socialising' with actress and keep-fit personality Jane Fonda.



Above: Off-screen photo of a live CNN report given at an early stage of the Gulf War.

Left: The main CNN newsroom in Atlanta Georgia, USA.

CNN Milestones

CNN first arrived on air back in June 1980. Less than one year later, the network was showing live coverage of the first space shuttle launch, and in 1985 the release of the TWA hostages in Beirut. In between, the network had 'gone global' and by 1985, reached some 50 million US households.

In addition to CNN's 24-hour news operation, the network now has more than 225 local TV affiliates in the US. It is also a subscriber to World-Wide Television News and a participant in the Eurovision, Intervision and Asian Broadcasting Union news pools, which cover Europe, North America, the Middle/Far East and the Eastern European countries. CNN maintains news-exchange agreements with

numerous international broadcasters, which range from CBC in Canada and TV Asahi in Japan, to the Ten Network in Australia.

During the Gulf war, CNN regularly achieved ratings measured in millions world-wide. So ubiquitous was the channel in the corridors of power that US officials replaced the well-known phrase 'no comment' with 'I know no more than I have seen on CNN'. Press comment, meanwhile, was lavish: 'CNN - The Winner of the Gulf War, beat the BBC and ITN in state-of-the-art technology', 'The Network of our Time' and 'Anything said on CNN is influencing world leaders, because George Bush and Saddam Hussein are both in the audience of this international network' being typical quotes.



Brian Nelson and Molly McCoy presenting the news, as it happens, in CNN's Atlanta studio.

No CNN - No Comment

Or, as The Financial Times puts it: 'For news junkies and policy makers, an alternative fix has become available in the form of Cable News Network. All of which possibly explains why its most celebrated addicts, on top of news and financial dealing rooms around the world, number Presidents Bush, Castro and Gorbachev. Other CNN viewers include Mrs Thatcher, who has apparently overcome her initial suspicion that cable television only showed pornography; and Yasser Arafat, whose Palestine Liberation Organisation has its own satellite dish'.

Getting the Picture

Before the outbreak of war, CNN signals were routed from Baghdad in Iraq to Amman in Jordan via the Arabsat satellite. The signals were up-linked from Jordan and sent, via a 'Ku' band transponder on board the Intelsat VF-2 satellite, to New Jersey. From here, it was sent via the American Galaxy domestic satellite to the CNN studio complex in Atlanta. The news reports were distributed, as part of CNN's programming, in Europe via the Stationsar 12 Gorizont ('C' band) and Intelsat V1-F4 ('Ku' band) satellites. The latter allowed cable TV companies, hotels and satellite TV enthusiasts to receive CNN programmes with relatively small dish antennae. Just in case you are wondering, the total time of transmission took no longer than a second. However, in order to stay on the air live, after hostilities had broken out, CNN made use of a special four-wire open telephone linked to a microwave dish on the roof of a hotel. This was routed 'line-of-sight' to a dish in Amman and sent from there to the Atlanta studio complex in a manner similar to that already described. Other key Middle Eastern areas, linked by satellite to Atlanta included Kuwait City, Israel, Dhahran and Riyadh.

Closer to home, SKY's 24-hour news channel might have been the first on the air with the news in the UK, but because the company was sharing satellite capacity with four British networks, it could not compete with the rapidly organised, full-time transponder lease booked by CNN.

But it is not all hard-line news. CNN also transmits regular business and sports reports and for those who want to relax after a heavy day keeping in touch with world-wide news events, regular Showbiz coverage. But you will have to stay up to 10:30pm or 4am to catch these broadcast schedules. You could time-shift such programmes with your video recorder, and who knows, by the time you sit down to watch your recording, the terrestrial networks might have caught on to the major news events of the day - those already covered by CNN!

For more information, tel: CNN London 071-637-6735.

Can I Receive CNN at Home?

by Martin Pipe

To receive CNN broadcasts, there are three main options. The first, as already discussed, is through a cable TV network if your area is served by one. These normally provide Sky TV in addition to CNN, MTV and other less well-known (but nevertheless interesting) channels such as Super Channel (general entertainment and pop videos) and The Discovery Channel (devoted to broadcasting highly interesting documentaries), to name but a few. Some cable TV companies also provide normal terrestrial stations (BBC 1 and 2, ITV, C4 - normally with an additional ITV region or two thrown in for good measure). This has the added bonus of superior picture quality, as the cable TV station's aerial installation will normally be far better than those normally found at home. As a result, ghosting and grainy pictures are eliminated at a stroke! Cable TV services are run by companies such as Rediffusion and Westminster Cable (who report that subscriptions to CNN have risen by about a third since the Gulf War).

Another option is to pick up CNN from the Soviet Statstionar 12 satellite, one of the Gorizont series, located at 11°W. Unfortunately, the CNN programme is transmitted from a 'low' frequency 'C' band transponder (transponder 6, operating at 3825MHz). This signal is spread out over a very wide area, and a large dish of 3 to 4 metres in diameter (as well as a 'C' band LNB) is required to satisfactorily pick up these weak (29dBW downlink power) transmissions. Unless you are a die-hard satellite TV enthusiast who already possesses the required equipment, this is a very expensive way of setting about joining the merry band of CNN-watchers. Such a large dish would not blend too well into a normal domestic environment, and planning permission would be required for it.

The most practical method of receiving the CNN broadcast is from the Intelsat V1-F4 satellite, located at an orbital position of 27.5°W. This 'Ku' band signal is strong enough to be picked up using a back-yard dish of around 1.2m diameter or less, depending on the noise figure of the LNB. In these days of LNBs using low-noise HEMT (high electron-mobility transistor) technology, a 90cm dish can be satisfactorily used (although a slightly larger dish may be required for use in more northerly areas). This size of dish has the advantage of not requiring planning permission. If you are lucky enough to have a system with a motorised dish, then other satellites with 'Ku' band transponders (such as Astra 1A/1B which broadcast the ubiquitous Sky programmes) can be picked up when the dish is tracked along the geostationary arc from hori-

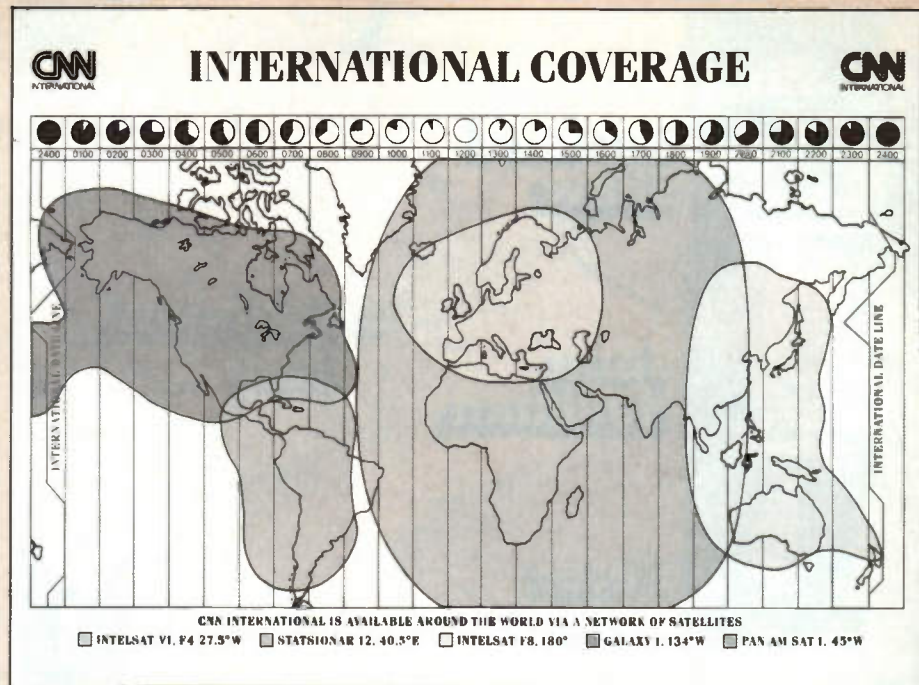

Map showing global coverage of CNN.

zon to horizon. As a result, all satellites with strong enough transmissions will be received. This opens up an exciting new world of television and radio, with news-feeds from live events, films, documentaries, music and general entertainment channels all being available. At least half of these are broadcast with sound-tracks in languages other than English. Such languages include French, Spanish, German and Dutch. A multi-satellite receiving system could therefore prove a real boon to the language student.

The CNN transmission originating from Intelsat V1-F4 is broadcast on a frequency of 11.155GHz, and is vertically polarised. Like the 'C' band transmission from the above Gorizont

satellite, this signal is broadcast using the PAL colour encoding system i.e. that used throughout the UK. In addition to the CNN TV programmes, an additional sub-carrier accommodates an additional sound service, known as CNN Radio. Other English programmes transmitted by this satellite include The Discovery Channel (mentioned earlier), and a channel providing programming specifically for children.

Although CNN has no plans at present to broadcast to Europe via the Astra satellite cluster, there is a possibility of receiving CNN with your existing Sky satellite TV system. This may be achieved by repositioning your dish from Astra (19.2° East) to Intelsat



Peter Arnett reporting live from Baghdad during the Gulf War. The dish aerial, of the microwave link used to send out his reports, can be seen clearly.

(27.5° West), ensuring first that nothing will block the dishes' new view of the sky. If you are in any doubt about your ability to do this, consult a dish installer, who may well recommend a new dish, particularly if your present dish is a small (45 or 60cm) type. Using a 60cm dish may bring in a picture, but is likely to be full of 'sparklies' and other noise. This is because the average 60cm dish system was designed to pick up the relatively strong (downlink power 53dBW) signals from the Astra satellite. The CNN signals from the Intelsat satellite are very weak in comparison (downlink power 33dBW), and so the FM detector inside the receiver unit is likely to be working very close to its threshold level. Rain, attenuating the weak signal still further, will make the picture even worse, and it could disappear altogether. Experimenting with a 60cm (or smaller) dish is therefore not really recommended, although a lower noise LNB might improve matters (and improve Astra reception, particularly during heavy rain). If you have an 80cm dish, you may be able to obtain a much better picture, which will be improved with the substitution of a better LNB. Due to advances in microwave technology, LNBs with noise figures of 0.9dB (half that of the Marconi LNB supplied with popular Amstrad systems and the like) are available for less than £100. In either case, if you are moving your existing dish, please ensure that you mark the

existing positions of the elevation and azimuth bolts on the metalwork with a marker pen, so that you can restore the dish to its original position if required. Another option involves buying a second dish, possibly second-hand. The novelty of Sky TV has worn-off for some people, who now wish to dispose of their equipment – often at very keen prices. Likewise, dishes are normally available from satellite TV dealers, who can sometimes offer competitively-priced used equipment (e.g. 1.2m dishes). However, please note that planning permission is often required for two dishes.

Another point to remember is that some Astra receivers do not offer continuous tuning across the sound subcarrier band (normally 5.5 to 8MHz). As a result, the CNN audio transmission (on 6.65 MHz) may sound distorted (the nearest fixed Astra sound subcarrier is 6.5MHz). To this end designs for sound converters have been published, and indeed some are commercially available for units such as the popular Amstrad range of receivers. Most modern receivers offer sound subcarrier tuning, however, to take full advantage of the many radio services now being broadcast alongside TV channels (such as CNN Radio mentioned earlier, and those proliferating on the Astra satellites e.g. ITN News and Sky Radio).

Finally, for those of you trying to receive CNN with an Astra-type system,

please note that the 'skew' angle of the vertically polarised CNN signal may differ slightly from that of the Astra transponder used to set the system up originally.

If your system incorporates a Marconi-type switched-polarisation LNB (for example, Amstrad, Ferguson and Pace systems), this item should be turned slightly within its dish arm mounting bracket for best results. Before attempting this, make a note of the original position of the LNB in case you want to revert back to optimal Astra reception! If your system uses a mechanical servo-controlled 'polarotor' or a magnetic polariser, follow the equipment manufacturers set-up instructions for 'fine-tuning' the polarisation skew. Some receivers (e.g. the Salora 5902/ITT Nokia SAT1100) offer independently programmable skew for each channel. In this case, CNN could be assigned a dedicated channel number with its own specific polarisation setting.

The purpose of this part of the article has been to generate an interest in the many fascinating radio and TV channels available to an individual equipped with a satellite dish. Those who want to find out more are referred to the superb range of books on the subject available from Maplin. A particularly suitable book for the beginner is 'An Introduction to Satellite Television', written by F.A. Wilson. This is available by ordering WP99H, price £5.95.

CIRCUIT MAKER

Circuit Maker is a forum for readers' circuits, ideas and tips. The circuits and information presented here must be considered as a basis for your own experimentation, no warranty is given for suitability in particular applications, reliability or circuit operation. Maplin cannot support in any way, the information presented here. However, where possible, we will endeavour to check that information presented, is correct, and that circuits will function as stated. If you would like your ideas to be considered for inclusion in Circuit Maker, please mark your submission 'Circuit Maker' and send it to: The Editor, 'Electronics – The Maplin Magazine', P.O. Box 3, Rayleigh, Essex, SS6 8LR.

Simple 1:1 M/S Ratio on a 555 Timer by Alistair Brown

The NE555 timer IC, and its CMOS variants, is a very versatile chip, but unfortunately a method of obtaining a 1:1 mark/space ratio square wave does not seem to be easily implemented (at least as far as the data sheet is concerned). The circuit below achieves this by feeding back the output into the trigger and threshold pins, the discharge pin is unused in this circuit. It is advisable to use a CMOS Schmitt trigger on the output if accuracy is essential.

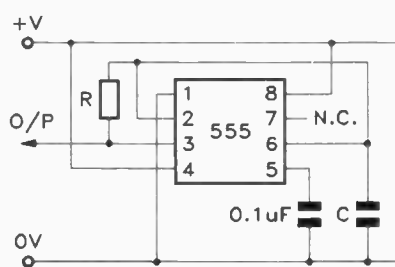

The frequency is given by:

$$f = 1 \div (1.1 \times R \times C)$$

Resistor range: $1k\Omega < R < 10M\Omega$

Capacitor range: $1nF < C < 100\mu F$

Frequency range: $0.001 < f < 400kHz$

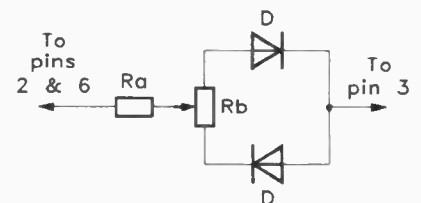

Variable M/S Ratio with Constant Frequency

With the addition of a potentiometer and a pair of diodes, the circuit can be further modified to provide a variable mark/space ratio output, whilst maintaining constant frequency. The modified network replaces 'R' in the basic circuit. Uses include, with the addition of a power output stage, a simple PWM motor speed controller. The diodes should be small signal types, e.g. 1N4148, etc.

The frequency can be calculated with the same formula as before, but insert the value of R calculated from the formula below:

$$R = R_a + (R_b \div 2)$$

The value is approximate due to the steering diodes, using germanium or Schottky diodes in the circuit will improve the accuracy of the calculation.

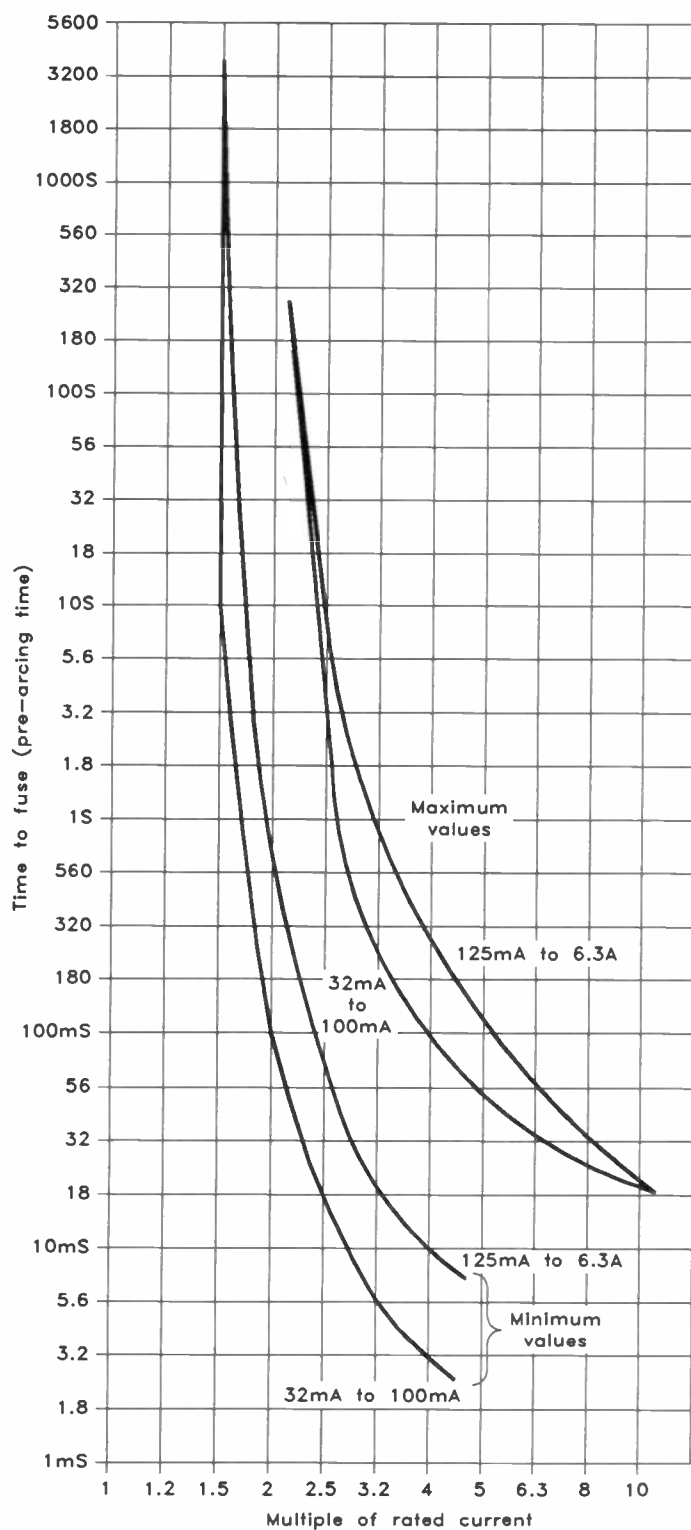

Figure 10. Pre-arcing time/current curves for 5 x 20mm quick-acting (F) fuses.

DC Power Supply Part Three continued from page 63.

faster than one could obtain the same results by other methods!

The tabulated results of the step-by-step process appear on the screen and are followed by the rest of the results, 14 items in all. If the results are calculated from winding resistances, it is possible for the rms secondary current to exceed the manufacturer's rated value, and a warning message appears in this case.

Print-Out

After displaying all the results, the program goes back to the menu, and this time an extra option, to print out the results, is offered. Selecting this prints out the results, with any warning messages, as

they were displayed on the screen. The printer is first initialised (line 1960), a 1 inch skip-over perforation is set, emphasised characters are selected for improved appearance and photo-copying, and a 7 space left-hand margin is set. You can add in a 'comment' to give any information you want to attach to the printed results. You are not limited to one line of text, but the keyboard buffer limits you to 255 characters on the BBC Micro, and other computers behave similarly. After printing, the printer is reset by line 2000.

Working Program

The listing published here, as Listing 1, is unchanged from the actual original work-

ing version, and has been printed from machine-readable text files and not re-typed, so any program problems you may have will be due to errors in copy-typing the listing. For this reason, known 'difficult' characters have been avoided. As 'Electronics' is not primarily a computer magazine, there is no way that magazine staff or the author of the series can solve these problems for you by 'remote control'.

If there is enough demand, a program disk might become available.

Fuses and How to Select Them

The Jolly Red Maplin Catalogue (as was: Ed) lists five types of cartridge fuse, each in several current ratings. How do we choose which type and is it obvious which current rating to use? That's two questions, and the answer to the second is 'No', but before we can see how to choose the current rating, we have to study the first question.

We can forget one type immediately, except for its proper use inside 13A mains plugs. This is the '1in.' (6.3 x 25mm) type, order codes HQ31J to HQ34M, which has a ceramic body. We then have two sizes of fuse, the 20 x 5mm and the '1 1/4 x 1/4in.' or 6.3 x 32mm. Both of these come in two varieties, described as 'quickblow' and 'anti-surge'. Actually, these are the American names, and in Europe, and internationally, things are somewhat different. Until recently, the characteristics of 6.3 x 32mm fuses were not standardised internationally, and in the USA and Canada there are many different standard types, which makes selection difficult, and serious mistakes rather easy. For example, I once found a fuse rated at a circuit voltage of 32V maximum, used as the mains fuse in the 240V mains version of an American amplifier! Generally speaking, it is better to use the 20 x 5mm types in electronic equipment, if only for their smaller size. The characteristics of these are standardised internationally in IEC 127, which has the allegedly equivalent British Standard BS4265, but the BS is lagging a long way behind the IEC standard, which now has five separate parts.

Current and Pre-Arcing Time Ratings

Cartridge fuses basically contain an 'element', a piece of thin wire which melts if the current through it is too great. In some types of fuse, the wire is surrounded by a sandy type material, so you can't see it. In other types, the wire is replaced by a cup containing a tiny pellet of metal of low melting temperature (rather like solder), into which is inserted the 'tail' of a stretched coil spring, which carries the current into the cup. If the metal in the cup gets hot enough to melt, the spring flies back and breaks the circuit. Yet another type has a pellet of metal in the middle of a length of wire or tape.

The current that the element can carry for a long period depends on how hot it gets relative to its melting temperature. How hot it gets depends on how much heat is generated by the current, which is:

$$P = I^2R W, \text{ or joules per second,}$$

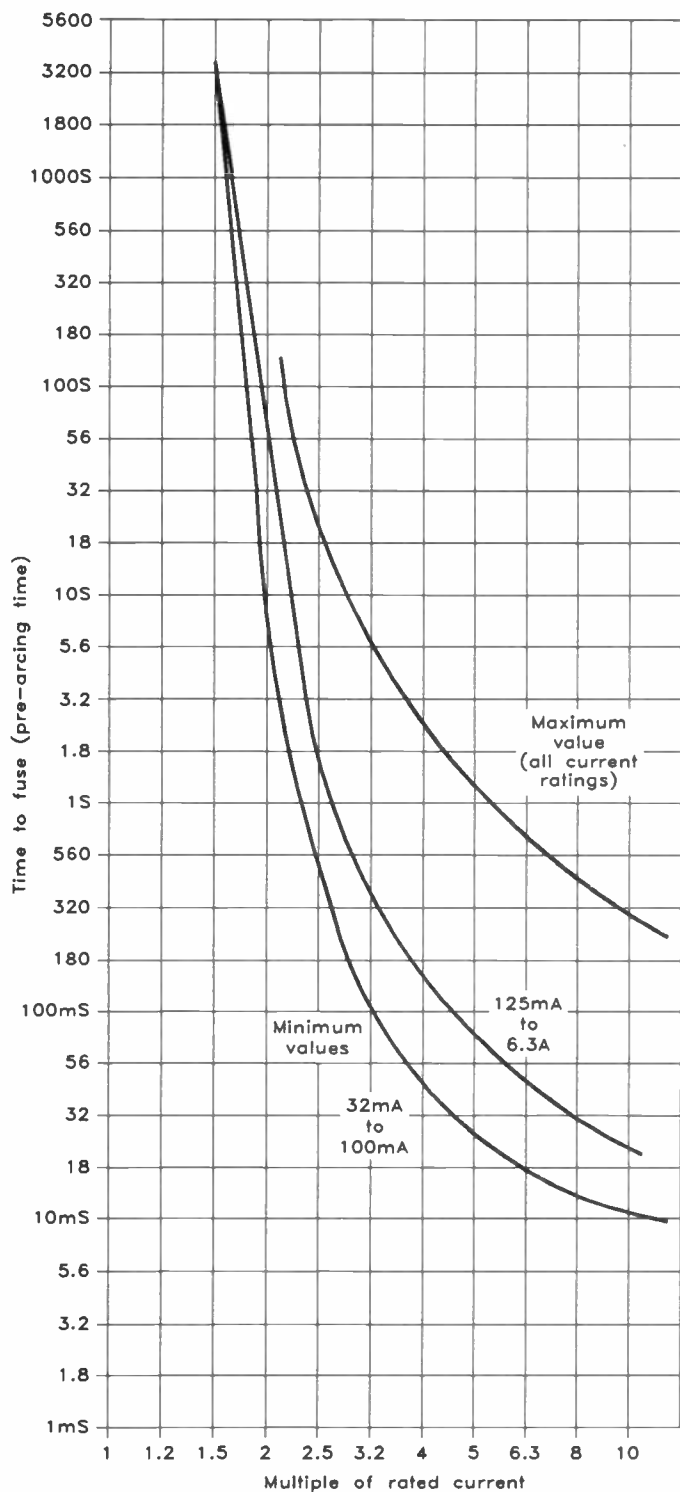

Figure 11. Pre-arcing time/current curves for 5 x 20mm time-lag (T) fuses.

where I is the rms current and R is the resistance. R itself varies with the temperature, which is a definite complication for fuse designers, but need not worry us too much. However, the element also loses heat, by conduction through the end-caps, and through any 'sand' filling. This filling may be a substance which melts at a temperature of a few hundred degrees Celsius, and if so it also absorbs 'latent heat of fusion'.

For the types of fuse we are considering, the 'rated current' is the current the fuse will CARRY indefinitely. (Note that for some other types of fuse, the 'rated current' is the current at which the fuse will BLOW!) Now, if the element is in the form of a thin wire of a metal having a high resistivity and a low melting point,

such as tin or lead, it will heat up very rapidly, and, if the current is only slightly larger than the rated current, the element will quickly melt. Although tin and lead are no longer used – because they are mechanically weak, tend to re-crystallise and fail even at the rated current and, in the case of tin, disintegrate at low ambient temperatures – such fuses are known as 'quick-acting' types, and are coded with the letter 'F' (from the German 'flink', meaning 'quick'). These fuses are mainly for use in circuits where the current is not subject to surges under normal working conditions, and only increases if there is a fault. The time between the application of the current, and it being interrupted by the fuse blowing, is known as the 'pre-arcing time'.

Conversely, if we surround the wire – which has a low resistivity and a high melting point, such as copper – with 'sand', or if we use a bigger piece of metal, such as a tape or a 'pot', which takes longer to heat up, we can make a fuse that absorbs a lot of energy before melting, and can therefore tolerate current surges, hence the name 'anti-surge'. Unfortunately, this name suggests that somehow the fuse PREVENTS current-surges, which is quite wrong. In fact the reverse is true, it ALLOWS them by NOT melting. Hence, internationally, they are known as 'time-lag' fuses, and coded with the letter 'T' (from, rather poetically, the German 'traege', meaning 'lazy'). Clearly, these are the type we should normally use in both the primary AND secondary circuits of our transformer, since both currents are subject to switch-on surges. In addition, if our power supply is for an audio power amplifier for example, there will be surges while the amplifier is working, too.

Current-Time Curves

To choose a fuse, we need to know how long it takes for the fuse to blow at a given current. These 'current/pre-arcing time curves' are published in some fuse manufacturers' catalogues and in the standards, but are not well-known. Approximate curves, good enough for most purposes in the home laboratory, are given in Figures 10 and 11. So that we don't need a separate curve for each current rating, the current axis is scaled in terms of multiples of the rated current, and this makes it convenient to use a logarithmic scale, which you may recognise as the same as the standard 1/3-octave audio frequencies. The time axis also has to be logarithmic, because the time varies from infinite (at rated current), with the longest defined time being 1 hour, down to a few milliseconds.

Using the Current-Time Curves

If we look at the start-up phase results of the example run of the program (Figure 12), we see that the first primary current surge is 403mA. This occurs after one half-cycle, or 10ms using 50Hz mains. If you object to this on the grounds that the current is zero at the end of the half-cycle, you have a point, but we are concerned with heating effects, and, therefore, rms currents, not instantaneous ones. The program line 330 shows how the variable MS, which is the mean-square current, builds up progressively. After 10ms, then, the rms current is 403mA.

Looking at Figure 10, in an attempt to use a quick-acting fuse, the 10ms line cuts the MINIMUM time curves at '2.7 times' (for 32 to 100mA fuses) or '4 times'. 2.7 times 100mA is less than 400mA, so we can't use even a 100mA fuse. The next standard current is 160mA, and for this the '4 times' applies, giving $160 \times 4 = 640$ mA capacity at 10ms. If we choose this value, and look at the surges after 2, 3, 4 etc. half-cycles, i.e. 20, 30 and 40ms, we find that they lie well below the 'minimum' curve and will therefore not give trouble. However, we also see from the program results that the steady-state

RECTIFIER
by J.M. Woodgate August 1991 from an original by J. English

Comment: A typical example

INPUTS

Title of this run WWW
Rectifier circuit type Bridge
Primary voltage 240 V
Actual mains voltage/Nominal mains voltage 0.9
Mains supply frequency 50 Hz
Reservoir capacitor value 2200 uF
Diode forward voltage 0.5 V
Effective diode resistance 0.35 ohm
DC load current 0.25 A

Secondary source volts (emf) 20 V
Secondary winding resistance 0.5 ohm
Primary winding resistance 150 ohm

START-UP PHASE

| Half cyc. | O/P Vmax | O/P Vmin | TfrSec I rms | TfrSec Ipk | TfrPr I rmsmA |
|-----------|----------|----------|--------------|------------|---------------|
| 1 | 17.08 | 1.3E-2 | 4.84 | 7.69 | 403 |
| 2 | 21.47 | 16.65 | 1.84 | 3.6 | 153 |
| 3 | 23.16 | 20.79 | 1.08 | 2.37 | 90.3 |
| 4 | 23.96 | 22.43 | 0.79 | 1.83 | 65.5 |
| 7 | 24.68 | 23.76 | 0.55 | 1.38 | 45.8 |
| 11 | 24.8 | 23.96 | 0.51 | 1.31 | 42.8 |
| 15 | 24.8 | 23.97 | 0.51 | 1.31 | 42.6 |

OUTPUTS

Actual mains voltage 216 V
DC output voltage 24.39 V
P-P ripple volts 0.83 V
P-P ripple 3.4 %
DC output voltage regulation, no load - full load 16 %
Secondary source resistance 1.54 ohm
Full-load rms secondary current 0.51 A
Conduction angle 58 deg
Conduction time ratio 0.16
1/2-cycle secy. surge current 4.84 A
1/2-cycle pri. surge current 403 mA
Repetitive peak diode current 1.31 A
Res'voir cap.rms ripple current 201 mA
Diode power dissipation 108.28 mW

END

Figure 12. A print-out of the program results for a typical example.

primary current is 42.6mA. Our 160mA fuse would carry nearly FOUR TIMES this current indefinitely, and SIX times this for about 10 minutes if a fault occurred, so the primary fuse would probably only blow in time to prevent a burn-up if there were a fault which caused much more than this current to flow. This fuse is not providing much protection!

The situation is better with a time-lag fuse. Looking at Figure 11, we find that a 40mA fuse would accept 400mA for a minimum of 10ms. This is a bit too close for comfort: high mains voltage or component tolerances could tip the balance and the fuse would blow on switch-on. Also, Maplin don't list a 40mA fuse (32mA and 40mA fuses are expensive)! A 50mA time-lag fuse (coded 'T50mA'), would be a good choice, and would blow within two minutes, at most, if the primary current rose to 120mA, less than three times the normal current. At five times the normal current, it would blow within less than about 3s. A check with the later surges shows that none of these will cause the fuse any trouble. Note how low the current rating of this fuse is. I often find, even in commercially-manufactured products, primary fuses of much too high current rating, because the designer does not know, or does not care, how to find the proper value.

A similar exercise shows that a time-lag fuse will work in the secondary circuit as well. By extending the curve in Figure 11, the 'minimum, 125mA to 6.3A' curve meets the '10ms' line at about 15 times the rated current, so a T320mA fuse would accept the surge. But this is lower than the steady rms current of 0.51A, and we would choose a T630mA fuse. This fuse would accept a fault current of 1.32A for up to two minutes, and we must make sure that

this will not cause a burn-up in the equipment. Trying Figure 10, we find that a F1.25A fuse is needed to cope with the surge at 10ms, and this will accept 2.6A for something between about 500ms and two minutes. Such a wide variation is undesirable, and this fault current is higher than that for the T630mA fuse, so that is the better choice.

Breaking Capacity

In the Catalogue, 'rupturing capacity' is stated for the various types of fuse. This is not a comment on the weight of the components, but the American term for 'breaking capacity'. If we connected one of these little fuses straight across the mains supply (DON'T DO IT!), the rate of heat production might be enough to raise the temperature of the wire to BOILING point, so that metal vapour would be produced. This could cause a prolonged arc, and the glass tube might explode. Alternatively, the glass might melt and it then conducts electricity, also causing a destructive arc and explosion. So we find that these fuses are rated at 35A breaking capacity. Up to now, this has been considered adequate for electronic equipment, at least up to about 1kW consumption, but in lighting equipment, high-power bulbs often fail by arcing internally, producing a very large current pulse which can certainly explode ordinary fuses: I speak from experience! So you will find in such equipment, fuses of the same sizes as mentioned above, with T and F time characteristics, but having ceramic tubes instead of glass, and/or having sand fillings. These are 'high breaking capacity' (HBC) or 'high rupturing capacity' (HRC) fuses, which will safely break currents up to 300 to 1500A, depending on the type. These fuses MUST be replaced by HBC

fuses, otherwise fuseholders will be destroyed and glass particles may be blown out into YOUR eyes. In future, HBC fuses may be required to be fitted in electronic equipment as well.

Tailpiece

This completes the series on linear power supplies, at least for the moment. The electricity supply authorities are becoming concerned about the harmonic currents drawn by these circuits, and are proposing to put limits on them, This could make life VERY difficult for power-supply designers, and much discussion in standards committees can be expected in the coming year. The outcome may be formed into a follow-up to this series.

Appendix

Calculating winding resistances from regulation, for transformers with multiple secondaries.

In all this analysis, the hysteresis and magnetising current losses due to the transformer core are neglected. The resulting approximate results are usually not seriously in error, but for large transformers corrections should be applied. This requires the mass of the core to be known or calculated, and the loss characteristics of the material must be known. If the latter are not known, a rough guide for magnetising current loss is 3VA/kg. The current concerned adds vectorially (i.e. as the square-root of the sum of the squares) to the main primary current. Hysteresis loss may be taken as about 1W/kg. The corresponding current adds IN-PHASE to the main primary current.

Suppose we have a transformer designed for a mains input voltage of V_m , with two secondary windings, '1' and '2', rated at full-load voltages and currents of V_1 and I_1 , V_2 and I_2 respectively. The percentage regulation is R, and to simplify the expressions we immediately convert this to the per-unit regulation $r = R/100$. For winding 1, the no-load voltage is $V_1(1+r)$, so the voltage drop caused by current I_1 is $V_1r/2$. The factor 2 is there because we assume that the copper losses are divided equally between the primary winding, and all the secondary windings added together. The resistance of the winding is thus $V_1r/2I_1$. Similarly, the resistance of the other secondary winding is $V_2r/2I_2$.

We can also find the primary winding resistance. The primary full-load current can be found from the 'VA' rating of the transformer. Let this be P, then the primary current $I_p = P/V_m$, and the voltage drop across the primary resistance is $V_m r/2$. So the primary resistance $R_p = V_m^2 r/200P$.

If the mean turn length of the secondary windings is m, the 'turns per no-load volt' is t and the current density in the secondary windings is J at full load, then the winding 1 consists of $V_1(1+r)t$ turns of length m and the cross-sectional area of the wire is I_1/J . If the resistivity of the wire material is ρ , the resistance of the winding is $\rho V_1(1+r)tI_1/J$, and that of winding 2 is $\rho V_2(1+r)tI_2/J$. The winding areas are $V_1(1+r)tI_1/J$, and $V_2(1+r)tI_2/J$, which are thus proportional to V_1I_1 and V_2I_2 , i.e. to the VA ratings of the windings.

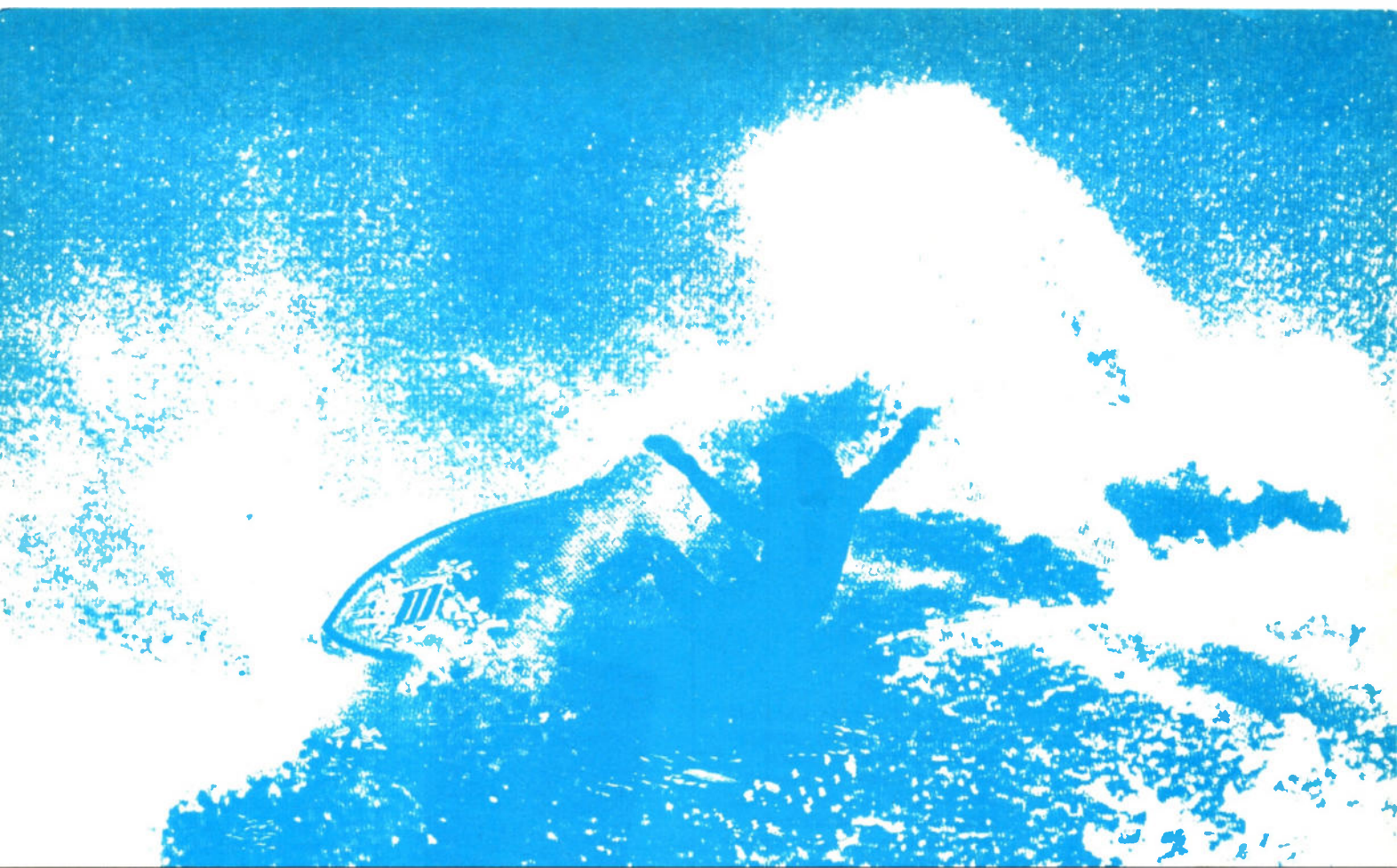

Let's talk waveforms...

...AND THE BEST IN OSCILLOSCOPES.

Our new range of precision laboratory oscilloscopes offer not only the best features, but also prices. From the sophisticated 20MHz 7025 to the delayed sweep 40MHz 7046, advanced design and high quality combine to bring you features such as; 1mV/div sensitivity, advanced 6-inch CRT with percentage markers and internal graticule, eliminating parallax error and ensuring a highly accurate display. X-Y mode allows Lissajous patterns to be produced and phase shifts measured.

The 7025 has all the capabilities required of a general purpose oscilloscope and will accept signals from DC to at least 20MHz with a high degree of accuracy. The 20MHz 7026 incorporates a delayed sweep time base, which can be used to magnify a portion of the waveform, and makes accurate time interval measurements and

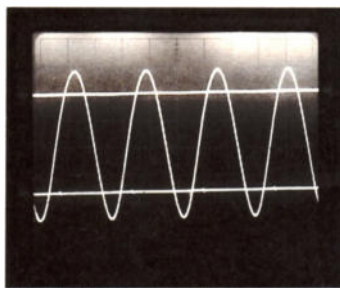

the study of short duration events possible. The sophisticated 40MHz 7045 includes a 40ns delay line to help show very short duration events in their entirety. A delayed sweep oscilloscope of advanced design and high quality is found in the shape of the 40MHz delayed sweep 7046, having an increased magnification along with a 40MHz bandwidth and capable of displaying complex signals with precision and accuracy.

Full details of our oscilloscopes and all other test equipment can be found in the 1992 Maplin catalogue, available from **WHSMITH** or Maplin shops nationwide £2.75 or by post

£2.95. Phone the Credit Card Hotline, 0702 554161 or visit your local store.



Maplin
ELECTRONICS

GL29G 20MHz scope 7025...£299.95. GL30H 20MHz scope 7026 ...£349.95. GL31J 40MHz scope 7045...£449.95. GL33L 40MHz scope 7046...£499.95 (illustrated).

All items subject to availability. Handling charge £1. Indicates carriage charge of £5.30. All prices inclusive of VAT.

NEW BOOKS

Radio Control Helicopter Models

by John Drake

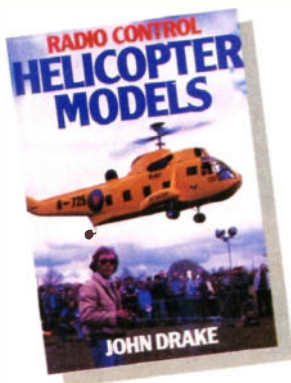

Intended for aero-modellers who wish to have a go at designing their own helicopter, this book seems at first glance highly technical and mathematical, but on reading it you will find it straightforward and simple to follow. The basic examples or analogies make for a clear explanation of the principles and complexities of the different aspects of helicopter dynamics and engineering. There are complete drawings for the construction of a .60-powered model – but which will require the use of a lathe and similar machining work – and valuable chapters on pre-flight checks and how to actually fly completed models. For the enquiring modeller, this book will provide a fascinating insight into what is still generally a little-understood area of model flight.

The author has virtually made it his life's work to understand and overcome the many practical problems that come from making a model helicopter fly, but, as with real aeroplanes, these problems are just as valid with real helicopters, and similarly are solved as they would be for the full sized machine. To quote from the preface, at the event of a lecture given about full sized helicopter development, the speaker's opening words were "A helicopter is a mechanical engineer's dream, but an aero-dynamicist's nightmare."
1980. 149 pages. 210 x 144mm, illustrated.

Order As WT99H (RC Helicopter Models) £5.95 NV

Peter Norton's DOS 5 Guide

Fourth Edition

by Peter Norton

This book is about getting started with DOS – the disk operating system for the family of IBM and compatible personal computers – but it doesn't stop with DOS. It is about much more, because there are two parts to this book, even though you won't find them broken down into separate sections. The first part tells about the things you need to know about getting started with DOS and getting the most out of it. The other part is equally valuable and teaches you how to become an effective user of a small PC.

On the one hand this book tells you about DOS and how to make good use of the commands that are built into it. On the other, it also gives you information on such topics as how to choose intelligently among the hundreds of programs offered for sale. Both parts are based on genuine and valuable practical advice. In these pages, you'll find out how to make your PC work for you. You'll learn what works and what doesn't, what to buy, what to use, and none of this advice is theoretical, but based on 25 years of experience working with computers from PCs to mainframes.

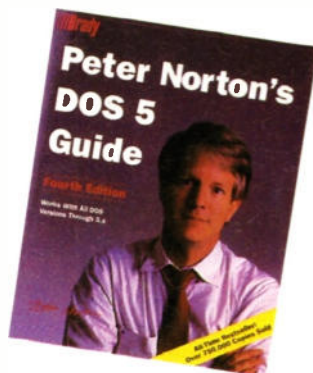

Peter Norton has dedicated the last 10 years to PCs and this book is the result of that experience, and is based on sound common sense. Highly recommended for new users to DOS 5 or DOS in general.
1991. 498 pages. 234 x 187mm, illustrated.

Order As WT96E (DOS 5 Guide) £21.70 NV

Microcomputer Interfacing

A Practical Guide for Technicians, Engineers and Scientists

by Joseph J. Carr



The microprocessor has literally revolutionised the electronic instrument and control system design fields, and has done so in record time. Where instrument designers were once exclusively analogue engineers, today's instrument designer has to be a synergist who can integrate the principals of sensor selection, analogue circuit design, computer hardware selection and/or design, and software design and operation. Today, even small instruments are based on microprocessor chips, and for that reason these devices are considered in some detail.

There are three basic forms of computer mentioned. First there is of course the IBM PC or compatible type that is now the standard of the industry. But also covered are the Apple II computer and the Z80 chip. The reason for the inclusion of these two is that a survey showed that many small laboratories and plant process control computers are still Apple II machines purchased in the early days. The Z80 chip is included because a large number of Z80 single-board computers are 'embedded' into products which don't look like computers from the outside, but are nonetheless dedicated personal computers.

The book provides a practical, workbench basis for both electronics engineers and other technicians whose expertise is in fields other than electronics or computing. American book.
1991. 462 pages. 227 x 150mm, illustrated.

Order As WT98G (Micro Interfacing) £18.95 NV

dBase III Plus

A Short Course – Educational Software Included

by Dennis P. Curtin

From the innovative 'Computer Application Software Series' (COMPASS), this educational book introduces the reader to dBase III Plus® on three levels: concepts, procedures and activities. This short course text is specifically written for instances where time is limited. The text is organised into self-contained topics covering the following subjects:

The concepts section explains the principles of database management, and all discussions apply to dBase III Plus, but many can be applied to other microcomputer programs as well.

The procedures section describes, step-by-step, how to execute dBase commands.

Hints and tips deal with many advanced procedures and are cross-referenced to other topics where related procedures are illustrated.

The tutorials section demonstrates, command-by-command, how to use the procedures explained in the topic.

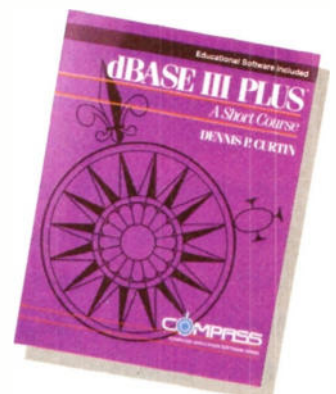

The exercises provide additional opportunities to practice and gain experience with concepts and procedures, and a questions section tests your comprehension. An example database is shown in Part 2 of the book, comprising a project that analyses census data. This requires that the reader understands such database activities as sorting and indexing records, querying a database and printing a report. The book comes with two 5 1/4 in. floppy disks with the example software and data to experiment with. American book.
1991. 145 pages. 275 x 210mm, illustrated.

Order As WZ01B (dBase III Plus Book) £25.70 NV

GETTING INTO THE PICTURE

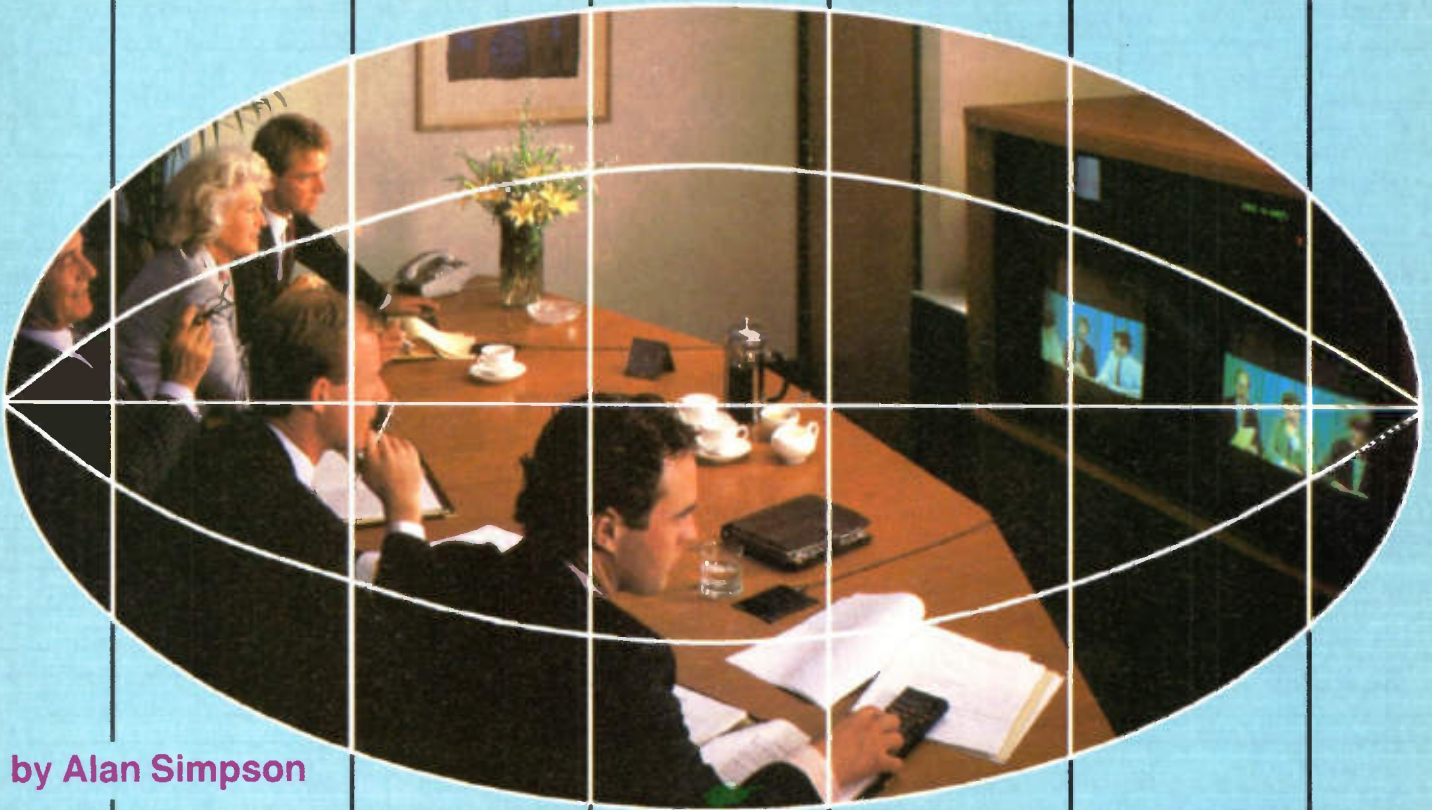

by Alan Simpson

The Mother of all Wars' of early 1991 took its toll, not just of oil-wells, but also international travel. "The business travel industry will never be the same", says Michael Naughton of international communications consultancy Applied Network Research (ANR). "Suddenly company executives have discovered that life in the not-so-fast checkout lane at Terminal Three has lost its edge". But while British Airways may be flying around in ever-decreasing circles (and blaming all and sundry for its misfortunes), British Telecom (or BT as it now likes to be called) has a large smile on its corporate face. Yes, this high and mighty company has found an alternative to boring business travel. It is called teleconferencing, a concept as old as television itself. Cost alone has held back its general use as a business communication tool, mainly because of the considerable expense of transmitting a full-bandwidth broadcast-quality television signal.

ANR believes that advancing technology, international liberalisation policies and the general hassle (not to mention costs) associated with travel are combining to make videoconferencing a highly viable company facility. The technology might have been around for some time but, as Michael points out, facsimile had been around for over one hundred years before the user got the message – or rather the image.

Long Distance Close-up

Videoconferencing is the art of being in two places at the same time. The manager or engineer can be 'present' at

an urgent sales meeting in the US while conducting a major user upgrade in Europe. The company can launch a major product or service, linking its head office with world-wide regional offices for the presentation. One alternative to travelling, says Andersen Consulting, is using the telephone. However, the limitations involved would soon have the executive heading for Heathrow. Visual meetings, even if the parties are only electronically present, have few substitutes.

As Andersen point out, videoconferencing is needed, not necessarily to cut down on travelling, but to reduce the number of contacts required. As a technology, videoconferencing is not exactly new, having been available in the US for almost thirty years. What is new, explained Bristol-based videoconferencing system supplier Internet Technology, is the arrival of digital networks, and methods which reduce the number of telephone circuits needed to successfully transmit video. Similarly, international standards are now emerging and the costs of both equipment and transmission are falling, which is good news for the industry and users alike.

Close-up on Long Distance

A videoconference, says Jim Barron of BT Visual & Broadcast Services, is a meeting between groups of people in separate locations linked live by television. The participants can see, hear and talk to each other simultaneously; they can also show documents, plans or products to

their counterparts at the other locations. In other words, videoconferencing is a private two-way television service. Face-to-face meetings are therefore possible without the need to travel, cutting down on the high costs, inconvenience and time which this often involves. According to BT, 60% of senior executives from small-to-medium sized companies spend at least one day a week out of the office travelling to and attending meetings, with 43% spending over six hours a week travelling alone. Added to this are accommodation and travel costs, particularly air fares. These amounted recently to an estimated £13 billion a year for British firms.

Cracking the Code

The principle behind videoconferencing is very simple indeed – involving nothing more than the simultaneous transmission and reception, of television pictures and sound, between two or more locations. At the heart of every videoconferencing system is the videocodec (or VIDEOCoder and DECoder). This is analogous to the modem in a traditional data communications application and is basically a piece of hardware which converts the audio and video information into a format suitable for transmission over a digital telephony circuit. The videocodec achieves this by making use of a computer-produced algorithm, which compresses the bandwidth of normal video signals and digitises them, along with the related audio signals.

In real terms, this means that the full-motion video signals which would have needed the equivalent of about 1800 telephone lines for transmission,

now only require some 16 telephone lines or less, thanks to the ability of the system to analyse and transmit only movement (i.e. the *changes* between successive frames) Given an average conference, the amount of movement is fairly limited (unless the chief executive happens to thump the table!), and this means that even fewer telephone lines are needed to transmit the signals. The videocodec also handles the processing of high-resolution graphics (from computers and presentation artwork) and automatically converts between 525 and 625-line TV standards which differ from country to country – very important where international communication is involved. Thanks to the fast pace of development, there has been a steady improvement of image quality at lower transmission speeds.

Equally important, as Internet emphasises, is the network. A dial-up network could be acceptable for a one-to-one meeting, but if there are six people at each end of the line then picture quality needs to be better in order to serve the larger TV screens required as a result. The current BT videoconferencing system operates at any data rate from 2Mb/sec, down to 64Kb/sec. At the top rate, BT state that the picture approaches that of broadcast quality while at 64Kb/sec it still offers clear pictures which can be viewed in private videoconferencing rooms or on the latest desktop video phones. The combined forces of BT and Motorola have recently produced an eight piece chip-set which will deliver over 6,000 MIPS (yes, *millions* of instructions per second!). The new Application Specific Integrated Circuits (ASICs) will enhance pre- and post-video processing, motion estimation and compensation, while providing for lower chip and board count in future videocodec products.

In fact, BT believes that it is well-placed to crack the world markets. For a start, BT is taking on the US videoconferencing market and hoping to seize some 30% from the existing duopoly – CLI and PictureTel. One of the key competitive advantages for BT over its rivals is that all BT equipment is manufactured to international standards. Following the ratification of the H261 Standard for the manufacture of videoconferencing equipment by the CCITT, BT is the first (and so far only) vendor to equip its videocodecs to this standard.

Roll on Videoconferencing

In the near future, BT will announce the availability of the world's first H261 compatible multi-control unit, which will allow users to set up eight simultaneous videoconferencing sessions. Future developments from BT will include desktop units allowing personal and individual videoconferencing. These will

work with a video switch, enabling interfacing with each other as well as full-sized videoconferencing rooms. With the roll-out of international switched digital networks, such as ISDN, dial-up videoconferencing will become increasingly available and will in turn lead to applications such as videophones.



But it does not look like BT will have it all their own way. In fact, their effective monopoly in the videoconferencing services market appears under threat from a specialist videoconferencing service provider which is undercutting the BT rates by 50% for business videocalls to the USA and Europe. Internet Technology is offering customers the use of its Marlow studio in the Thames Valley area for £362 an hour (to the USA) compared with BT's own rate of £725. Call charges to Europe for the same service show a similar reduction, at £206 compared with £362 on BT. At the same time, Internet Chairman Michael Davis has caused the world's airlines to sit up and notice, by claiming that an increased take-up of videoconferencing following the tariff reduction will see a

Left: Mike McCourt, introducing Motorola's latest videocodec chipset with BT's Steve Maine.

Below: Students using videoconferencing during an IBM interactive training session.

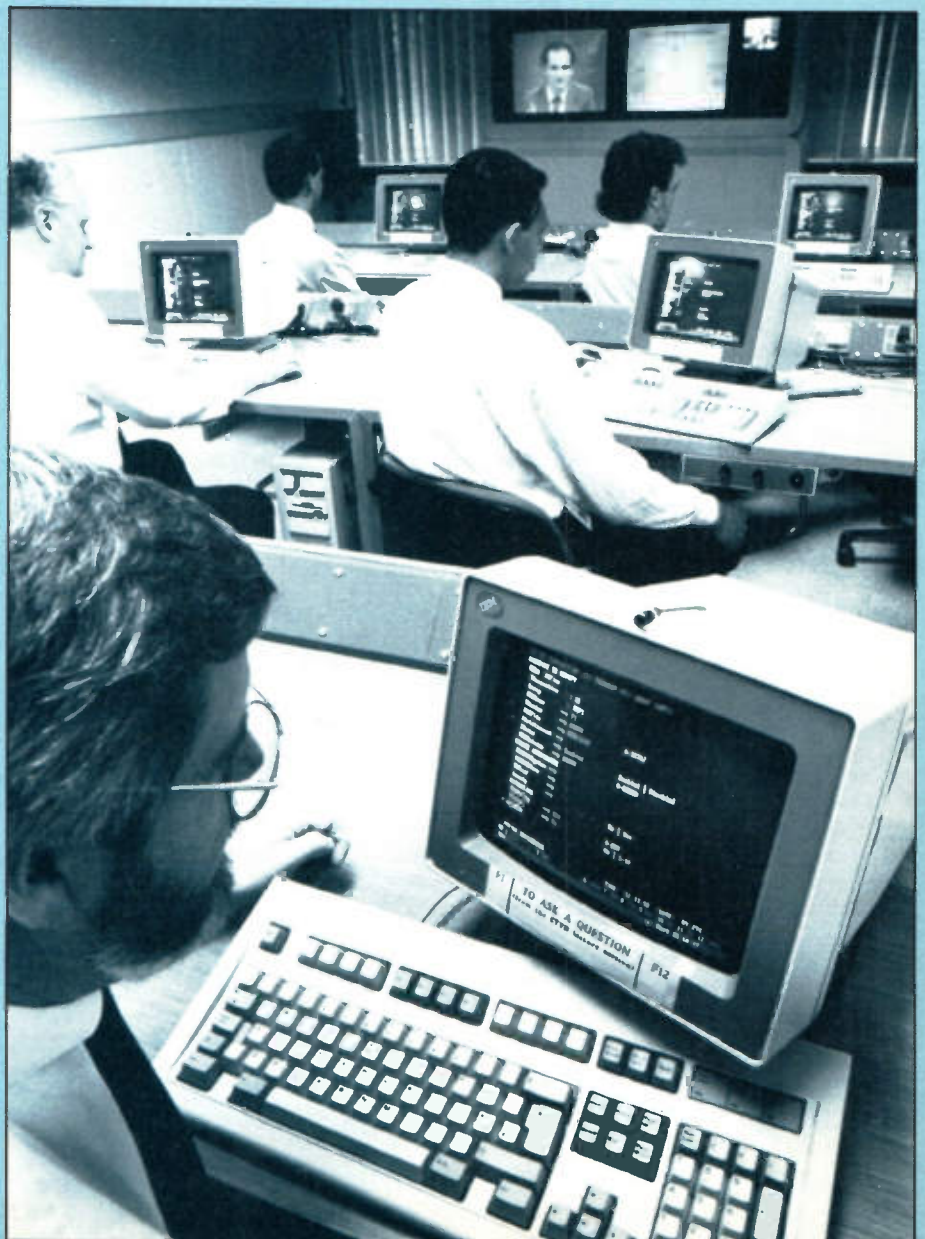

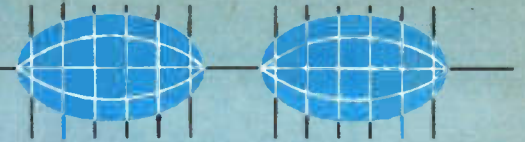
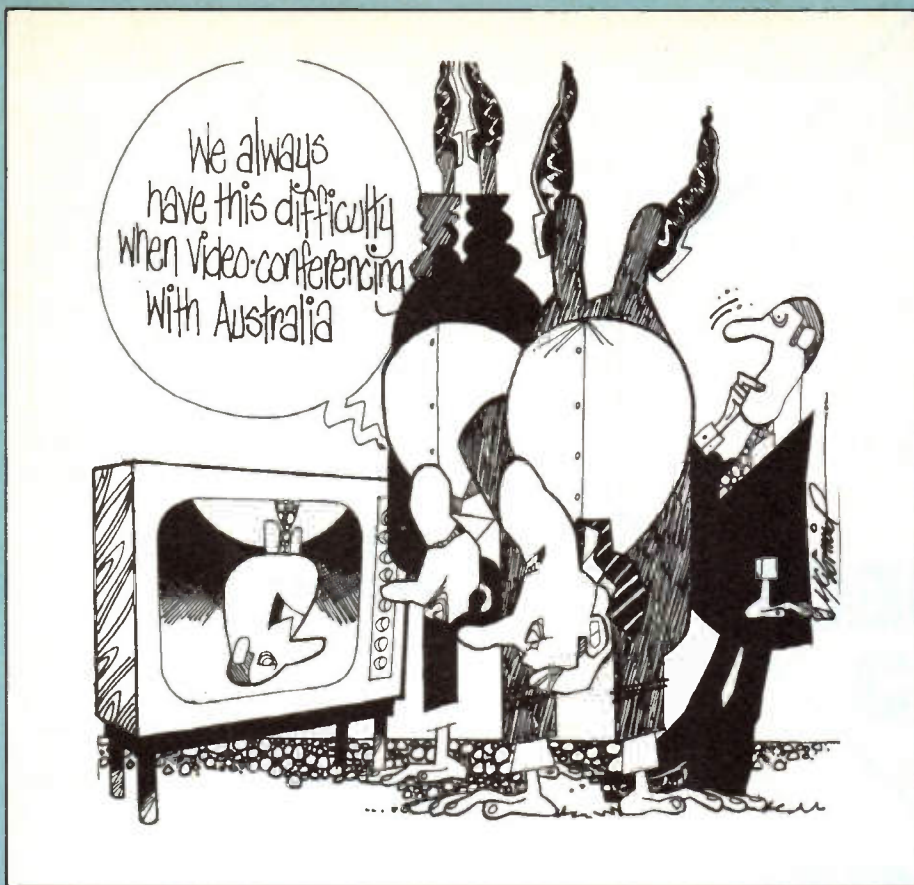

steady fall in international business travel. His contention is that the cost of a videocall to the USA can undercut a business-class air ticket to New York by 80%, with added savings of travelling time, hotel bills and fatigue.

Home or Away

Videoconferencing operations can take place either in-house or at a local conference centre. These centres feature fully fitted and equipped studios with engineers and, if necessary, skilled conference controllers available to help manage the proceedings. ANR says that most heavy users of videoconferencing facilities would take the in-house studio approach. Essential success factors include a pleasant environment, one which is comfortable and relaxing. Lighting and sound reverberation matters do need special attention, although Internet claim that their sharp-image equipment works under normal room lighting conditions.

Safe and Sound

Security, says Michael Bacon of the Hoskyns Group is a major concern for videoconferencing users, fundamentally because the expensive nature of the communication means that it will be used for high-value discussions – policy, strategy, and tactics. As a result, an additional consideration is the transmission medium itself. Fibre-optic end-to-end is reasonably secure, satellite is a broadcast medium (and is thus potentially open to all), microwave can be intercepted quite easily, and copper-wire is also insecure. The cost of intercepting the routing, and then interpreting the signal to extract the videoconference, can be high – but may be cost-justified by the content of the conference. As Michael Bacon points out, if a videoconference uses public networks then PTTs have access to the signal – and the content if it has not been encrypted. Although there are a few manufacturers of units suitable for encryption of high-speed videoconferencing signals, none at present have that essential BT green approval sticker. Similarly, it is not unknown for a studio to be accidentally connected to the wrong location.

But not all are convinced that a multi-million pound teleconferencing market will be created within the UK. After all, unlike the States, anywhere in the UK can be reached in under an hour by plane, or within a couple of hours by InterCity trains. It seems a safe bet that those monthly sales meetings will still rotate between London, Birmingham and Manchester, at least until the next British Rail or Air Domestic fare hike.

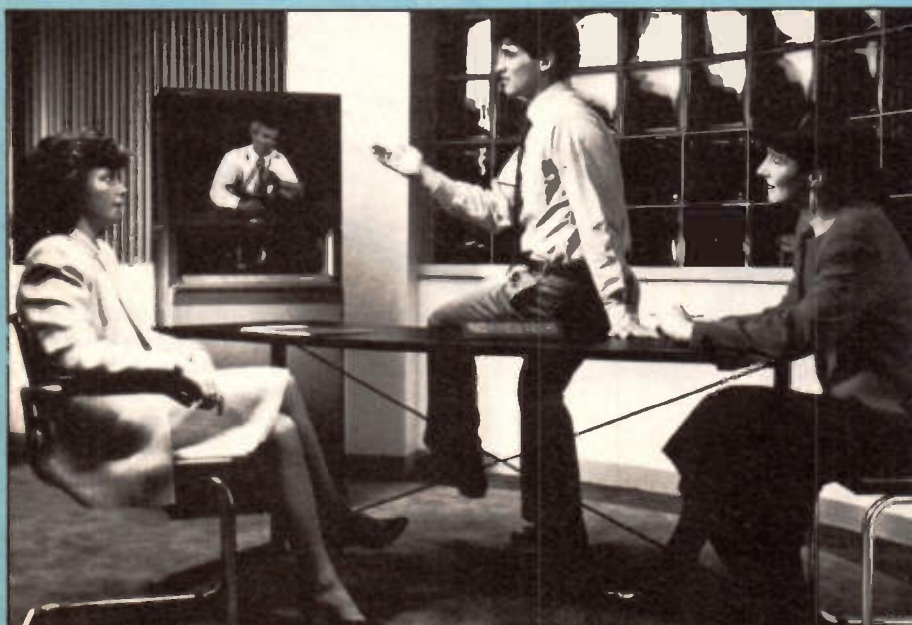

Above left: A current high-performance video codec processor, the C3000 from PictureTel.

Left: A videoconferencing system being used in a business environment.

All
You Need
to Build Your Own

FUN TRONICS

PROJECT No3

WATER INDICATOR

Text by Robert Penfold

This is the third in a series of easy-to-build electronics projects for complete beginners, who require a simple and fun starter to electronic project building. These projects are ideal for the young person as no soldering is needed. All the projects are built on the same type and size of plastic 'peg-board'. The only tools needed to build this project, and the others in the series, are a pair of wire cutters/strippers and a small screwdriver; a pair of pliers would also be useful.

This Month's Project

As no species of plant have yet learned to speak, they can not tell you if they are thirsty. This has resulted in many pot plants becoming dead twigs before their time! You know that they are suffering from a lack of water when they start to go brown and their leaves curl, at which point they are often beyond hope! This water detector project has been designed mainly to show if any water is present in the soil (or not), warning you to act before there is any major damage to any plants. A simple

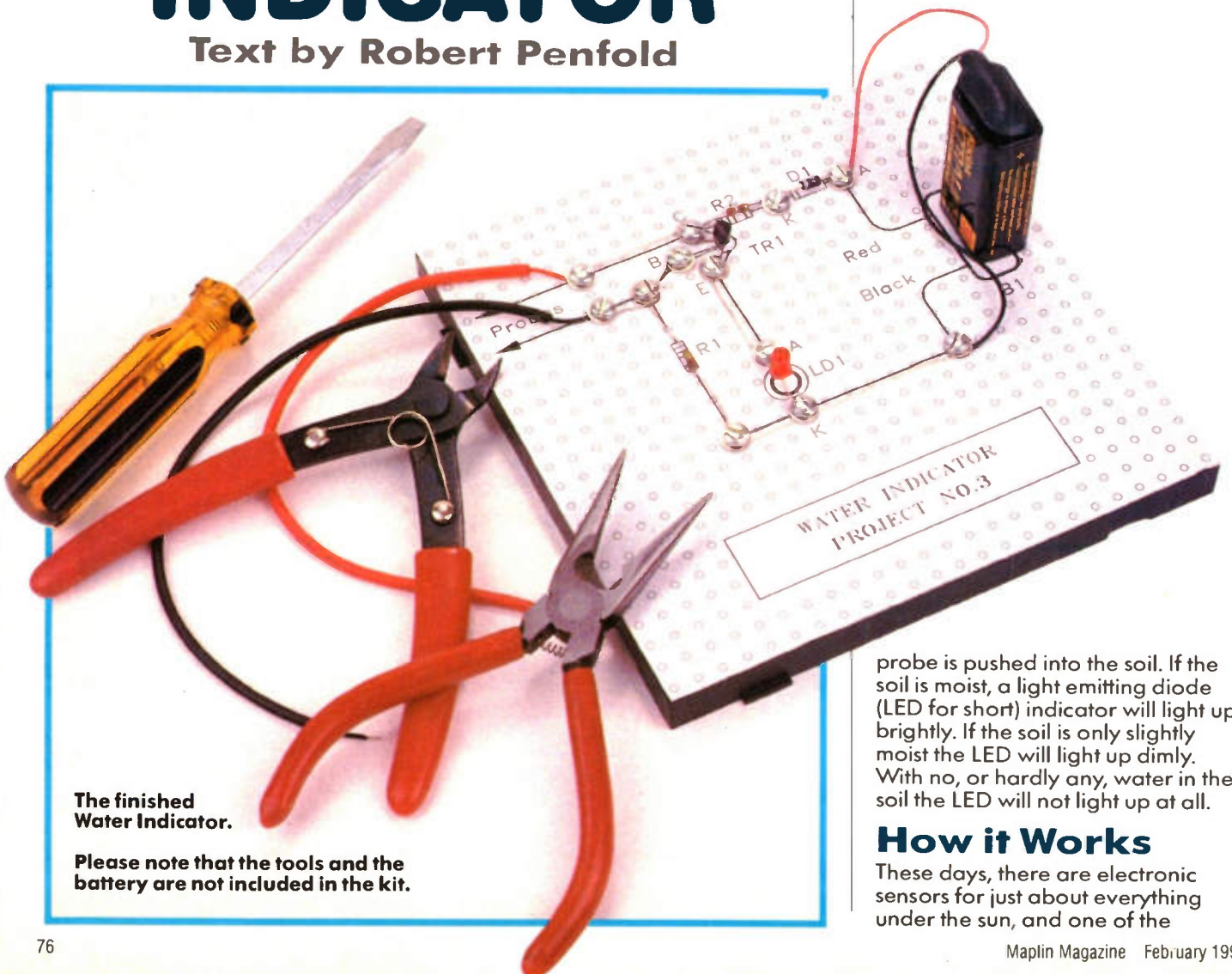

The finished
Water Indicator.

Please note that the tools and the
battery are not included in the kit.

probe is pushed into the soil. If the soil is moist, a light emitting diode (LED for short) indicator will light up brightly. If the soil is only slightly moist the LED will light up dimly. With no, or hardly any, water in the soil the LED will not light up at all.

How it Works

These days, there are electronic sensors for just about everything under the sun, and one of the

easiest things to sense is water. Actually this is not quite true. *Pure* water does not conduct electricity very well, making its presence difficult to detect. However, the water normally found in the everyday world is not completely pure, and even tiny amounts of impurity are enough to make water able to pass electricity. This makes it very easy to detect. Such impurities are present in tap water, and even in rain water. The water found in soil certainly contains enough impurities to make it easy to detect.

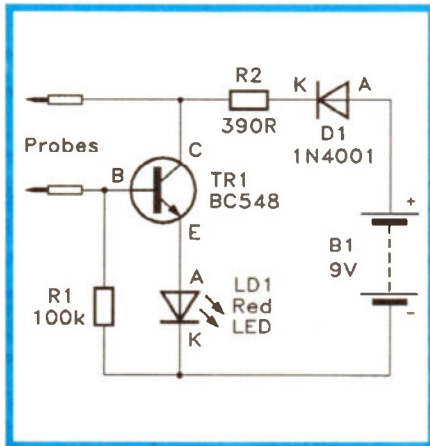

Figure 1. The Water Indicator circuit diagram.

Figure 1 shows the circuit diagram for the Water Indicator project. The probes consist simply of two pieces of insulated wire (with their ends stripped bare), which are pushed into the soil. In electronic terms, the 'resistance' of moist soil, to the flow of an electric current, is quite low. However, using a small probe does not permit a large enough current flow to drive an LED. Instead, a simple transistor amplifier must be used, allowing the tiny amount of electricity flowing through the soil to produce a larger flow through the LED.

TR1 is the transistor amplifier, and LD1 is the indicator LED connected at TR1's output. R2 limits the supply current to a level that is safe for TR1 and LD1. Some of the current from R2 will also flow into the probe. This will pass through the soil (which simply acts as another resistor), and then back through the other probe, where it can be amplified by TR1. R1, another resistor, is present to 'tap off' some of the current from the probe, and return it to the battery. This is done to make the circuit less sensitive, otherwise LD1 would glow brightly even if there was a lot of resistance (in other words, hardly any water) present in the soil. D1 is a protection diode; if you should accidentally try to connect the battery the wrong way round, D1 will block the flow of electricity. This ensures that none of the components will be damaged.

Getting it Together

Firstly, read through this section and then *carefully* follow its instructions, one step at a time. Refer to the photographs of the finished project if this helps.

1. Cut out the component guide-sheet provided with the kit (which is a full-size copy of Figure 2), and glue it to the top of the plastic board. Paper glue or gum should be okay. Do not soak the paper with glue, a few small 'dabs' will do.

2. Fit the link-wires to the board using the self-tapping screws and washers provided. The link-wires are made from bare wire. Loop the wire, in a *clockwise* direction around each screw to which it must connect, taking the wire under the washers. Do not fully tighten a screw until all the leads that are under it are in place, and do not over-tighten the screws, otherwise the plastic board may be damaged.

3. Recognise and fit the components, in the order given below, using the same method as for the link wires. Cut the components' wires so that they are just long enough to loop around the screws; otherwise long leads left flapping around may touch each other (this is known as a 'short-circuit') and may stop your circuit from working.

a) The first components to be fitted are Resistors R1 and R2. These are small sausage-like components having a leadout wire at each end, and several coloured bands around their bodies. For R1 these colours are brown, black, yellow, and gold. The colours for R2 are orange, white, brown, and gold. These first three bands tell us the value of the resistor. R1 has a value of 100,000 ohms, which is often written as 100 kilohms, or 100k Ω for short. R2, however, has a value of 390 ohms (written as 390 Ω or 390R for short.) The fourth band tells us how near to the given value the resistor is likely to be. This fourth band is known as the 'tolerance' band. Unlike diodes or transistors, it does not matter which way round resistors are connected.

b) Next fit the LED, LD1, which is a 'blob' of clear red plastic, with two wires coming out of one end. It is fitted in the position shown on the guide-sheet, and *must* be connected the right way round – or it will not light up. One side of LD1 is flattened (the lead on this side of the LED is known as the cathode (K), while the lead on the other, rounded, side is called the anode (A)), see Figure 3. Make sure that LD1 is fitted so that the 'flattened' side lines up with the drawing of the LED printed on the guide-sheet.

c) TR1 should be fitted next to the board. This has a small black

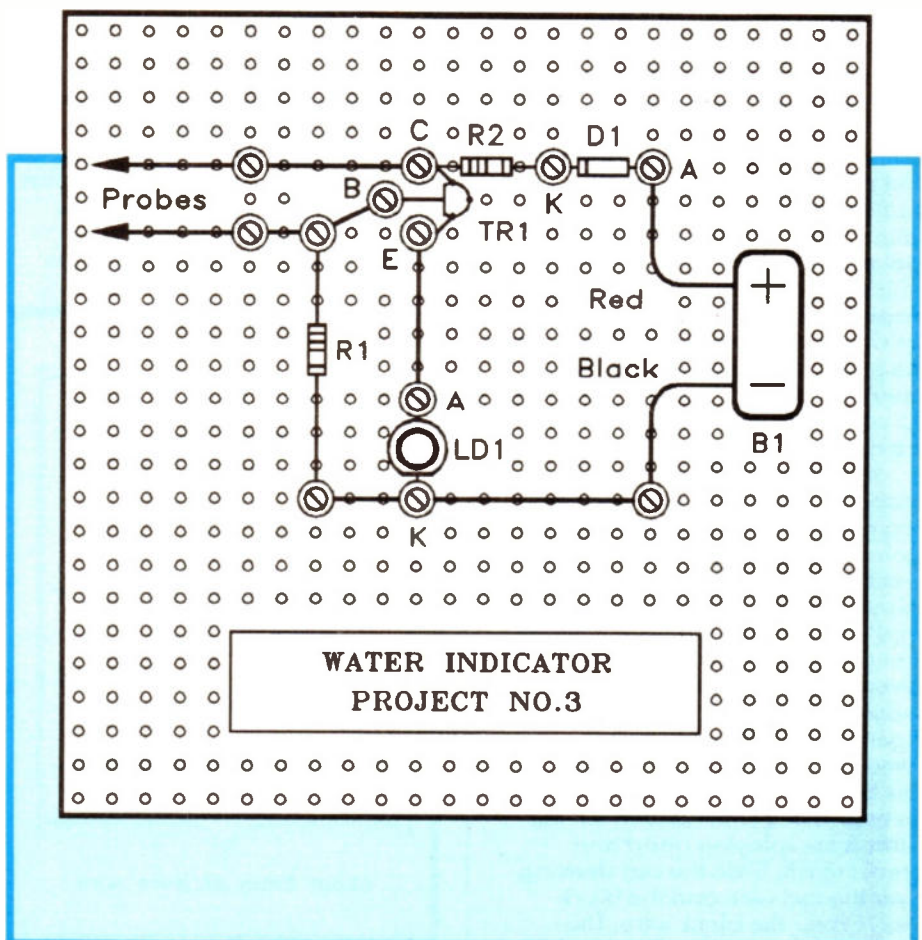

Figure 2. The layout of the components.

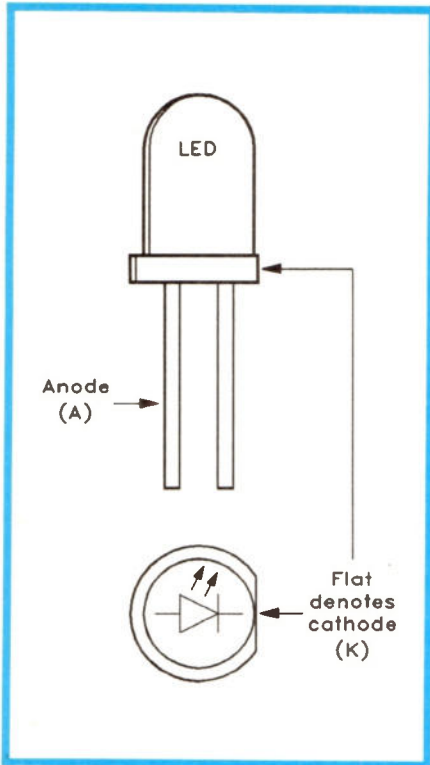

Figure 3. LED symbol and connections.

plastic body with three lead-out wires. It will be marked with the type number, which in this case is 'BC548'. Other markings may also be present; you will have to get used to picking out the important markings on chips and transistors (and ignoring the others!). You must ensure that TR1 is fitted to the board correctly. Figure 4 shows which lead is which, making this task easy.

d) The next component to be fitted is D1, which is a small tube-like component having a lead at each end of its black body. Like LD1, it must be connected the right way round (In other words, D1 is a 'polarised' component). Its 'polarity', which tells us the way in which it must be positioned, is indicated by a white (or silver) band close to one end of the body, see Figure 5. The diode should be fitted so that the band lines up with the band on the drawing of the diode on the guide-sheet.

e) We now need to make the probes. These are made up from two pieces of insulated wire (coloured red and black) and two pieces of hollow insulated sleeving (also coloured red and black). The wire is multi-stranded, which means that the metal core consists of several very fine wires. The probes should be made up as shown in Figure 6, use wire strippers to remove the insulation where shown. The bare ends of the leads should be twisted together to prevent the wires from playing apart and breaking off. Slide the red sleeving over the red wire and the black sleeve over the black wire. This sleeving forms the body of each probe. Connect the two wires to the

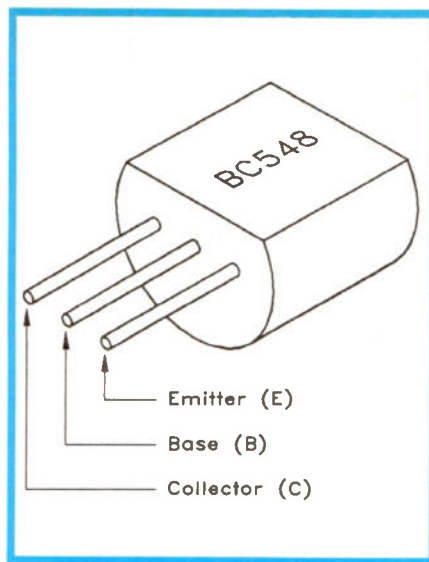

Figure 4. Transistor circuit symbols and lead identification.

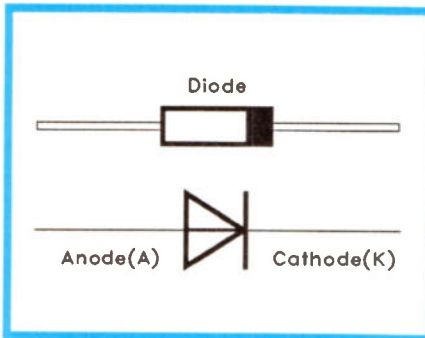

Figure 5. Diode symbol and connections (D1).

screws on the board marked 'Probes' – the red wire should go to the screw nearest to R2 (and the collector ('C') of the transistor). The free ends of the two wires (with the 8mm insulation stripped off) form the probes themselves.

f) Lastly fit the battery connector and battery. B1, the connector must be attached to the board with its coloured leads the correct way round. The battery connector has

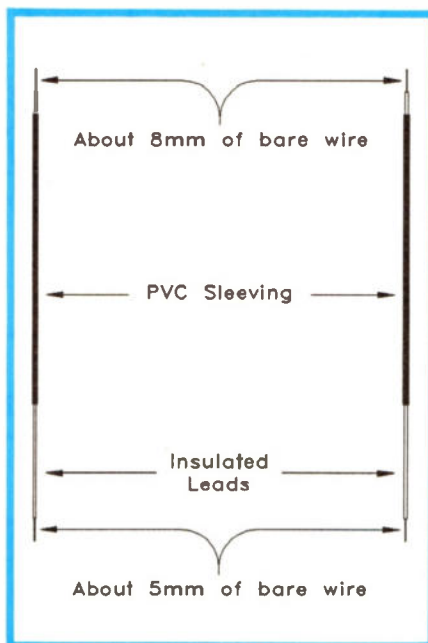

Figure 6. Preparing the probes.

two press-stud clips on a piece of plastic and two wires coming from it, coloured red and black. The red and black leads should be connected as shown on the layout sheet. The 9V PP3 type battery should be connected to the battery connector; it will only fit properly one way round.

Testing and Use

When the battery is connected, the LED should not light, although it will if the bare ends of the two probes are connected together. If the unit does not work in either case, disconnect the battery at once. The most likely cause of problems is TR1, LD1, D1, or the battery being connected the wrong way round. Check the connections to these components carefully. Also make sure that the fine strands of wire of the battery clip leads make good contact with their terminals on the board.

If all is well, the unit is ready for use. In order to obtain dependable results, the two wire probes should *always* be held the same distance (between 10 and 20mm) apart. It is a good idea to mount the probes on a wooden handle that will hold them a suitable distance apart. You might also like to use some fairly stout single-strand wire for the probes. If you wish to make the unit *more* sensitive, make the probes longer by removing more insulation from the wires. To make the unit *less* sensitive, trim the wires back slightly.

Other Uses

Lie Detector

This unit is really just a detector of high resistances. This can be the resistance of your body. If you try holding the bare ends of the two probes, LD1 might light up dimly. You will probably have to hold them quite hard to make anything happen, though. If you have no luck, try removing R1, which will substantially increase the sensitivity of the circuit. Simple lie detectors work by measuring skin resistance. In other words, if the subject (victim?) tells the truth the brightness of the LED will remain unchanged. If they tell a lie they sweat more, and the LED lights more brightly. Perhaps this is something not to be taken too seriously – because this method of lie detection has never proved very reliable in scientific tests!

Availability

The Funtronics Water Indicator is available from Maplin Electronics, through our chain of regional stores, or by mail order, order code LP90X Price £2.95.

Stray Signals

by Point Contact

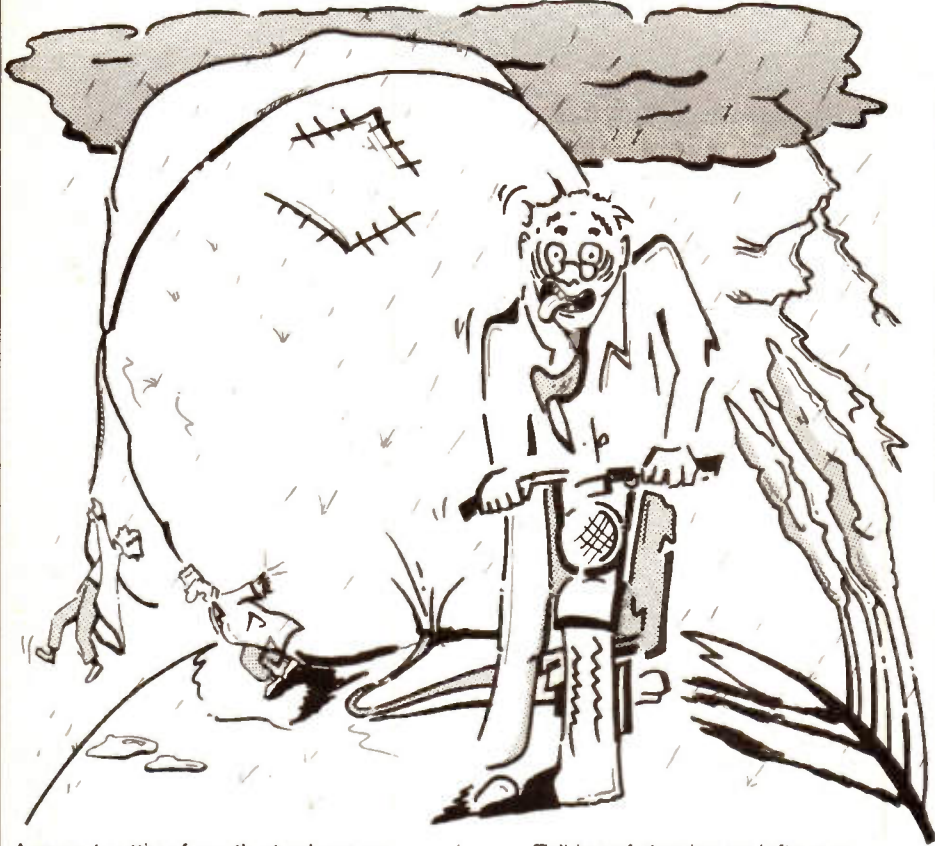

A recent cutting from the trade press announced a DTI approved radio data modem operating in the UHF band and communicating, on the baseband side, via the RS232 interface. Two of these modems can communicate with each other in simplex or semi-duplex mode, with both being either mobile, fixed or one fixed and one mobile. There are two salient points of interest: firstly, the modem requires no licence, and secondly, it has a range of up to 3km. The 'no-licence required' aspect is in line with current thinking on de-regulation and no red tape, but, presumably, if the buyer pays no licence, then no caring administrator is going to keep track of which modems are being used where. In short, there will be no frequency allocation and no frequency planning! Clearly the possibility of interference between users will increase in proportion to the modem's popularity. Apparently the device incorporates a squelch facility designed to ignore reception errors caused by radio interference, but, assuming this is perfectly effective, then interference will not produce errors, but will still reduce the throughput or effective data rate, perhaps to an embarrassing degree. Sometimes a modicum of red tape can be in the interests of the user.

Talking of clearing up leftovers from previous instalments of Stray Signals, in number three I mentioned my dummy transistors. In my early days in Central Research Labs in the mid fifties, transistors (germanium, of course) were like gold dust, but everyone wanted to get hold of one. Those produced by the company were housed in a can rather like a TO18 in style, but approximately three times as tall. Three lead wires, with red, white and green insulating sleeves for emitter, collector and base respectively, poked out of the bottom and the body of the device was covered by a tight fitting red plastic sleeve. PC found that by slitting red 'Lassovic' insulation tape down to $\frac{9}{16}$ ths of an inch wide and rolling it around three suitably sleeved wires, a convincing looking transistor resulted. Of course the finder's joy rapidly turned to disillusionment on applying the AVO test and finding both the 'junctions' open circuit. But my Mark II had one or two people puzzled. I scrounged some miniature diodes and joined the cathodes of two together – this became the green coded 'base' lead, the anodes being coded white and red. Of course this device passed the AVO test with flying colours – it's just that it didn't have any gain!

However, to turn to other matters, and, conscious that he left you all agog at the end of his last ramblings, PC feels he is morally obliged to fill you in on the question of that hot air balloon. Well, it was duly constructed and the great day came when we planned to try it out. It was bundled into PC's Mini van and we all met up, by prior arrangement, one summer evening on top of B----- Hill, a local beauty spot and landmark in the South Downs. But how to inflate the monster? My little butane blow torch would obviously have been totally inadequate, but as ever lateral thinking came to our aid. One of our consortium was KR, with whom PC still has professional dealings; indeed, on a recent visit to a vendor he and I travelled in comfort in his palatial Jaguar. At that time however, his *modus locomovendi* (did PC have the benefit of a classical education?) was a motorbike, so we coupled a tube to the exhaust pipe and fed the hot exhaust gases into the balloon, which was lying on the ground, with the top end held up as high as possible by the tallest member of the consortium. With the motorbike perched on its stand, and set to something more than a fast tick over, the balloon began to inflate promisingly – but then nemesis set in. In true English summer fashion, a large black cloud rolled up, closely followed by more. It grew darker and darker, the wind started to get up and the odd spot of rain heralded more to come. We soon reached stalemate, where the heat input to the balloon was almost matched by the heat losses from its enormous surface, by now wet all over, when KR became alarmed at the frightfully hot smell from his motorbike. Like most bikes then and now, the motor was designed to be air cooled, and so while stationary it was denied any means of cooling. So the event was postponed, to await a more propitious occasion, which somehow didn't seem to materialise that summer.

Yours sincerely,

Point Contact

These are our top twenty best selling books based on mail order and shop sales during November '91.

Our own magazines and publications are not included in the 'chart' below.

20 best selling books

The Maplin order code of each book is shown together with page numbers for our 1992 catalogue. We stock over 250 different titles, covering a wide range of electronics and computing topics.

2



A Concise Introduction to MS-DOS, by N. Kantaris. (WS94C) Cat. P101. Previous Position: 1. Price £2.95.

3



How to Expand, Modify and Repair PC's and Compatibles, by R. A. Penfold. (WS95D) Cat. P104. Previous Position: 3. Price £4.95.

4



IC555 Projects, by E. A. Parr. (LY04E) Cat. P85. Previous Position: 4. Price £2.95.

5



How to Use Oscilloscopes and Other Test Equipment, by R. A. Penfold. (WS65V) Cat. P80. Previous Position: 11. Price £3.50.

6

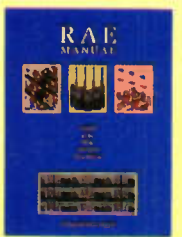

Radio Amateurs Examination Manual, by G. L. Benbow. (WP87U) Cat. P91. Previous Position: 8. Price £6.75.

Number ONE

Getting The Most From Your Multimeter

by R. A. Penfold
A unique, and very useful book, showing you how to best use your multimeter.

(WP94C) Cat. P80.
Previous Position: 2

Price £2.95



16



More Advanced Power Supply Projects, by R. A. Penfold. (WP92A) Cat. P77. Previous Position: 15. Price £2.95.

17



The Complete VHF/UHF Frequency Guide, by B. Laver. (WT70M) Cat. P93. Previous Position: 20. Price £5.95.

7



Power Supply Projects, by R. A. Penfold. (XW52G) Cat. P83. Previous Position: 10. Price £2.50.

10



The Washing Machine Manual, by Graham Dixon. (WS98C) Cat. P96. Previous Position: 9. Price £11.95.

13



Scanners, by Peter Rouse. (WP47B) Cat. P93. Previous Position: 13. Price £8.95.

18



Electronic Music Projects, by R. A. Penfold. (XW40T) Cat. P89. Previous Position: 19. Price £2.50.

8



A Concise Advanced User's Guide to MS-DOS, by N. Kantaris. (WS44X) Cat. P102. Previous Position: 5. Price £2.95.

11



The Maplin Electronic Circuits Handbook, by Michael Tooley. (WT02C) Cat. P82. Previous Position: 6. Price £10.95.

14



Electronic Security Devices, by R. A. Penfold. (RL43W) Cat. P84. Previous Position: 16. Price £2.50.

19



Audio Amplifier Construction, by R. A. Penfold. (WM31J) Cat. P87. Previous Position: 18. Price £2.95.

9



International Transistor Equivalents Guide, by Adrian Michaels. (WG30H) Cat. P76. Previous Position: 14. Price £3.95.

12

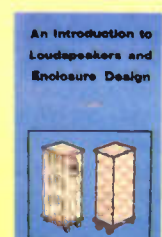

An Introduction to Loudspeakers and Enclosure Design, by V. Capel. (WS31J) Cat. P87. Previous Position: 7. Price £2.95.

15



Remote Control Handbook, by Owen Bishop. (WS23A) Cat. P83. Previous Position: 12. Price £3.95.

20



Loudspeaker Enclosure Design and Construction. (WM82D) Cat. P88. Previous Position: Re-Entry. Price £9.95.

1992 BUYER'S GUIDE TO ELECTRONIC COMPONENTS

Maplin



Order your copy of the New MAPLIN Catalogue on sale NOW!
Pick up a copy from any WHSMITH for just £2.75 or post this coupon now to receive your copy for just £2.75 + 20p p&p. If you live outside the U.K. send £4.85 or £2.95 for 14 International Reply Coupons. I enclose £2.95

Name.....
Address.....
Post Code.....
Send to Maplin Electronics,
P.O. Box 3, Rayleigh,
Essex SS6 8LR.
MM92

Over 600 product packed pages with more than 600 brand new products.
On sale now, only £2.75

Available from all branches of WHSMITH and Maplin shops nationwide. Hundreds of new products at super low prices!